



North America's Largest Metal Forming,  
Fabricating, Welding and Finishing Event

OFFICIAL  
**ON-SITE GUIDE  
& DIRECTORY**

Your complete resource for navigating the show.



**LASERSHOWS.**



**FIREWORKS.**



**ROLLERCOASTERS.**

THE ONE EVENT TO SEE THE MOST SPECTACULAR  
METAL FABRICATION TECHNOLOGY. **FABTECH 2012.**

---

November 12-14, 2012 |  
Las Vegas Convention Center  
[fabtechexpo.com](http://fabtechexpo.com)

Follow us:



Cosponsors:



# SteelTailor™ Portable CNC Cutting Machines



**POWER Series**  
Portable CNC Cutting Machines



*Best seller in SteelTailor family!*

**VALIANT series**  
Portable CNC Cutting Machines



*World leader of portable cutting machines!*

**DRAGON I**  
Portable Gantry CNC Cutting Machines



*Portable gantry with two rails & dual drivers!*

**SMART I**  
Portable Table Plasma CNC Cutting Machines



*Simple and beautiful!*

**SMART I**  
Portable Table Plasma CNC Cutting Machines



*Everything of a table CNC and more!*

[www.SteelTailor.com](http://www.SteelTailor.com)

## Booth No.: N4919

# IDM Laser™ Economical Sheet Metal CNC Cutting Machines

**CLAYA II**  
Sheet Metal Fiber Laser CNC Cutting Machines



*As thin as 0.2mm till 3mm.*

**LEGEND II**  
Sheet Metal Plasma CNC Cutting Machines



*As thin as 0.3mm till 5mm.*

**B5**  
Sheet Metal Plasma CNC Cutting Machines



*As thin as 2mm till 22mm.*

**VERSATILE**  
Sheet Metal Plasma CNC Cutting Machines



*As thin as 0.3mm till 22mm.*

[www.IDMLaser.com](http://www.IDMLaser.com)



# FABTECH 2012

Booth N4102



*Welding & Cutting Solutions*



**VERNON TOOL**



AR12-127 © The Lincoln Electric Co. All Rights Reserved.  
[www.lincolnelectric.com](http://www.lincolnelectric.com)



# EXPERIENCE FABTECH

## TABLE OF CONTENTS

<b>Show Information</b>	<b>6-8</b>
About the Show .....	7
Show Hours .....	7
FABTECH Social Media .....	7
FABTECH Mobile App .....	7
Locating Exhibitors on Show Floor .....	8
<b>Registration</b>	<b>8</b>
<b>Event Services</b>	<b>8-9</b>
ATM's .....	9
Badge Correction .....	9
Badge Pick up .....	9
Business Center .....	9
Coat/Baggage Check .....	9
Disability Services .....	9
First Aid/Emergency .....	9
Internet Service .....	9
Lost and Found .....	9
Lost Badges .....	9
Media Room .....	9
Restaurants at LVCC .....	9
Restaurant Offsite Reservations .....	9
Show Management Office .....	9
Tourism & Concierge Desk .....	9
VIP Lounge .....	9
<b>Hotel &amp; Travel</b>	<b>10-13</b>
Official Event Hotels .....	10
Hotel Shuttle .....	12
Parking at LVCC .....	13
Taxi Cabs .....	13
Monorail .....	13
Airport .....	13
<b>General Information</b>	<b>14-15</b>
<b>Special Events</b>	<b>16-18</b>
State of the Industry: Manufacturers' Executive Outlook .....	16
Post-Election Analysis: How the Results Impact U.S. Manufacturing .....	16
To Offshore or Reshore? How to Objectively Decide .....	17
AWS Skills Competition .....	17
New Product Presentations .....	18
<b>Networking Events</b>	<b>17</b>
Cocktails & Comedy .....	17
Happy Hour .....	17
<b>Education and Professional Events</b>	<b>20-26</b>
Pricing Information .....	21
LVCC Meeting Room Map .....	22
Schedule-at-a-Glance .....	23-25
Cosponsor Events & Meetings .....	26
<b>New Products</b>	<b>28</b>
<b>Exhibitor Contact Information</b>	<b>51</b>
<b>Exhibitor List by Product Category</b>	<b>147</b>
<b>Floor Plan</b>	<b>218-219</b>
<b>International Exhibitors</b>	<b>219</b>
<b>Advertisers Index</b>	<b>224</b>

## HOW TO USE THE ON-SITE GUIDE & DIRECTORY

The show directory is divided into several tabbed sections to make it easy for you to find whatever you need while visiting FABTECH at the **Las Vegas Convention Center**.

### GENERAL INFORMATION

Beginning on page 9, find information on attendee event services such as baggage check, first aid, lost and found, hotel shuttle information and also schedules, descriptions and room locations for special events at this year's show.

### EDUCATIONAL PROGRAMS & PROFESSIONAL EVENTS

Starting on page 20, find information on the educational programs and pricing, a LVCC meeting room map, schedule-at-a-glance and a list of cosponsor events & meetings at FABTECH. Detailed information on individual education sessions can be found within the FABTECH 2012 Education Program brochures available next to the Show Directory stands in the lobby and at the FABTECH education headquarters, Room N115 or AWS education headquarters, Room N236.

### NEW PRODUCTS

The first tabbed section found on page 28, contains details about the new products and technologies introduced at the show. Take the opportunity to review the descriptions provided by the exhibitors prior to visiting their booth to see the products in action.

### EXHIBITOR LIST

The second tabbed section found on page 51, is an alphabetical listing of exhibitors who are showcasing their products and services at FABTECH 2012. This section includes important exhibitor contact information that can be used as a resource when you return to your office. Exhibitor List is current as of 10/05/12.

### PRODUCT CATEGORIES

The third tabbed section found on page 147, provides a list of exhibitors by specific technology or type of equipment or service displayed in their booths. Use this section as a quick index to compare equipment at the show.

### EXHIBIT FLOOR PLAN

The fourth and final tabbed section found between pages 218 and 219, is a visual representation of the exhibitor booth locations in both the North Hall and Central Hall, including an alphabetical list of all exhibitors represented at the show.

#### Thank You to Our Show Sponsors





# the **lasers** specialists

**Steve Campbell**

CEO, S&B Metal Products

Lakeland, Florida



“**OPTIPLEX's automated setup is the cornerstone of S&B's lean strategies.**”



**OPTIPLEX** was designed to deliver performance features that specifically meet the needs of high variation job shops.

- Material thicknesses from thin gage to 1" standard.
- New PreView 2 control with touch screen and integrated tech tables simplifies operation.
- AIO5 with automated setup assures optimized operation with less operator dependency.
- New Type 10 resonator with ECO Mode lowers operating costs.

S&B is a premier fabricator that produces a great range of low volume parts for customers that include major amusement parks in Orlando, Florida. Their new OPTIPLEX helps them automatically change setups for laser-cut parts twelve times a day, while cutting is optimized to significantly improve throughput at lower operating costs.

Go to <http://optiplex.mazakoptonics.com> to view their video or contact Mazak at **847.252.4500** for more information.



**FABTECH  
Booth 3428**



Over 50 different laser-cutting models

**Mazak**  
OPTONICS CORP.



# EXPERIENCE FABTECH

## WELCOME TO FABTECH 2012!

### Dear FABTECH 2012 Attendee,

On behalf of the Fabricators & Manufacturers Association, International, Society of Manufacturing Engineers, American Welding Society, Precision Metalforming Association and the Chemical Coaters Association International, welcome to North America's largest metal forming, fabricating, welding and finishing event.

Here you will discover all the latest equipment, products and services, brought to you by leading companies, offering solutions to work smarter and be more competitive. There's nothing else like it!



Innovation is key at FABTECH and the show has been designed for every market segment in the metal manufacturing industry. From technology pavilions dedicated to Forming & Fabricating, Metal Forming, Tool & Die, Finishing, Tube & Pipe, and Welding to technology specific educational tracks to new product presentations and extraordinary networking opportunities – FABTECH 2012 is personalized just for you.

Throughout the show, whether you are comparing the latest technology, looking for new ideas and solutions or diversifying your current business, FABTECH offers numerous opportunities to learn and grow. Choose from 100+ educational programs with over 50 new sessions, visit live product demonstrations, and attend free presentations to learn from the experts on how you can be more competitive.

While in Las Vegas, make sure you take advantage of the many opportunities to interact with colleagues in an informal setting during Cocktails & Comedy, FABTECH Happy Hour or the many Las Vegas options available and cement those special relationships that hold our industry together.

Thank you for attending FABTECH 2012, and enjoy the show.

Sincerely,



Bill Rice  
President  
American Welding Society



Burke Doar  
Chairman  
Fabricators & Manufacturers  
Association, International®



LeRoux Gillespie  
President  
Society of Manufacturing  
Engineers



P.J. Thompson  
Chairman  
Precision Metalforming  
Association



Sam Woehler  
President  
Chemical Coaters  
Association International



## ABOUT THE SHOW

FABTECH is the largest metal forming, fabricating, welding, and finishing event in North America. The event exists to bring buyers and sellers together in a convenient venue that facilitates business relationships, networking, education, and the buying process. This premier industry trade show and conference is cosponsored by the American Welding Society (AWS), the Fabricators and Manufacturers Association, International (FMA), the Society of Manufacturing Engineers (SME), the Precision Metalforming Association (PMA) and the Chemical Coaters Association International (CCAI).

## CONNECT WITH FABTECH

FABTECH is not just an event, it's a year-round experience. Connect and engage with other industry professionals and show attendees on FABTECH's social media sites—before, during and after the event!



Check out the new FABTECH blog! Find the latest industry news and technology updates, along with updates on the FABTECH exposition and conference at [blog.fabtechexpo.com](http://blog.fabtechexpo.com).

facebook

Like us on Facebook at [facebook.com/fabtechexpo](http://facebook.com/fabtechexpo) and interact with our fans.

twitter

Follow us on Twitter, @fabtechexpo and #fabtechexpo, to receive information and updates on the show and the industry.

LinkedIn

Network with hundreds of industry professionals in our FABTECH LinkedIn group and join the active conversations.

YouTube  
Broadcast Yourself™

Watch FABTECH on YouTube at [youtube.com/fabtechexpo](http://youtube.com/fabtechexpo) and share and discuss.

## 2012 SHOW HOURS

**Monday, November 12** . . . . . 9:00 a.m. – 6:00 p.m.

**Tuesday, November 13** . . . . . 9:00 a.m. – 5:00 p.m.

**Wednesday, November 14** . . . . . 9:00 a.m. – 4:00 p.m.

## FABTECH 2012 IS MOBILE!

Scan a QR code below with your smartphone app reader to download the FABTECH Mobile App. Available for iPhone, iPad and Android devices. There's also a web-based version of the application for all other web browser-enabled smartphones. The application is designed to enhance your show experience and puts important event information in the palm of your hand so you can access it anytime, anywhere.



Available on the App Store



Available for Android



Web browser-enabled



Or, visit [fabtechexpo.com/mobile-app](http://fabtechexpo.com/mobile-app) to download

## SHOW REGISTRATION

Registration is located in the Central Hall & North Hall lobbies. Anyone who will be attending the exposition MUST register to receive a badge to be admitted to the show. Admission to the exposition is FREE for FMA, SME, AWS, PMA, and CCAI members and \$50 for non-members. Student admission is FREE for members and is \$5 for non-members. No one under the age of 16 will be admitted, and proof of age may be required.

### Central Hall Lobby is for:

Exhibitor registration  
On-site registration  
Already registered (badge pickup)

### North Hall Lobby is for:

Already registered (badge pickup)  
NO on-site registration



## REGISTRATION HOURS

	Exhibitor	Attendee
Friday, November 9	10:00 a.m. – 4:00 p.m.	N/A
Saturday, November 10	8:00 a.m. – 4:30 p.m.	N/A
Sunday, November 11	8:00 a.m. – 4:00 p.m.	10:00 a.m. – 4:30 p.m.
Monday, November 12	7:00 a.m. – 5:00 p.m.	7:00 a.m. – 5:00 p.m.
Tuesday, November 13	7:30 a.m. – 4:00 p.m.	7:30 a.m. – 4:00 p.m.
Wednesday, November 14	8:00 a.m. – 3:00 p.m.	8:00 a.m. – 3:00 p.m.

## HOW TO LOCATE EXHIBITORS ON THE SHOW FLOOR

### Exhibitor Booths

FABTECH 2012 encompasses both the North Hall and Central Hall at the Las Vegas Convention Center. The exhibitor booths are arranged in five (5) technology areas. Overhead signs are displayed throughout the show floor to indicate each technology area, making it convenient for you to find and compare the products and services that you are interested in. In addition, the directory includes a floor plan which is color-coded by these five technology areas:

Forming & Fabricating
Metal Forming, Tool/Die
Finishing
Tube & Pipe
Welding

### New Products

Each year hundreds of new products debut at FABTECH. You will find that each exhibitor with a new product on display is noted with a light bulb  at their booth. In addition, you can look for these icons in front of their name in the Exhibitor List section of this directory and on the exhibitor Floor Plan. You can also find new product information in the tabbed New Product section of this directory starting on page 28.

### Exhibitors by Product Listings

You can refer to the Product Categories tabbed section of the directory to find companies listed by the products and services they provide. Here you will find over 450 individual product categories with exhibitor name and booth number listed below each category.





## EVENT SERVICES

### ATMs

An ATM is located in the Central Hall lobby.

### Badge Corrections

Anyone who will need changes to an exposition or conference badge can go to Registration in the Central Hall lobby.

### Badge Pick Up

Pre-registered attendees can pick up their show badge in the North Hall and Central Hall Lobby Registration areas.

### Business Center

FedEx/Kinko's is located outside C3 and also just west of C1. (Refer to the map on page 22).

### Coat/Baggage Check

Coat and baggage check is located outside C3. (Refer to the map on page 22).

### Disability Services

LVCC is a wheelchair-accessible complex and follows all regulations required by the Americans & Disabilities Act (ADA). If you require a motorized wheelchair during FABTECH, call Scootaround at (888) 441-7575.

### First Aid/Emergency

First aid is located next to Room N118 and also in the North Hall Lobby next to entrance N2. (Refer to the map on page 22).

### Internet Service

Free wireless internet service is provided by SmartCity at the LVCC in the lobby areas only, for attendees who wish to perform light web browsing and basic email activities. This service is not designed to support mission critical functions or streaming applications. Technical support is not provided for individual computers/users. Questions? Contact SmartCity at (888) 446-6911.

Free wireless internet is available in lobby areas only.

Accessing the free wireless is easy as selecting and connecting to the Free Wireless network (SSID) from your list of available networks.

Visitor requiring more robust wireless service may opt to purchase an upgrade service:

Lobby Areas: \$12.95 per day/per computer. Exhibit Halls & Meeting rooms: \$99.95 per day/per computer. Select the Instant Internet SSID, purchase service using a credit card.

### Lost and Found

Items turned in to show management can be claimed in the security office, Room N118. (Refer to the map on page 22).

### Lost Badges

Lost exposition and conference badges can be reprinted at anyone of the registration areas.

### Media Room

The Media Room is located in room N251; phone: (702) 943-3506. Official members of the press are required to register in the Media Room for show and conference admission. Proper credentials are required. (Refer to the map on page 22).

### Restaurants at the LVCC

A FABTECH Bistro is located in both the North and Central Halls. Advance reservations required. Tickets available at the FABTECH Bistro Reservation Desk in the Central Hall lobby.

Lucky's Restaurant is located in the Central Hall lobby.

Additional dining locations are located inside the North and Central



halls. Look for the ♿ on the floor plan, located in the back of this directory, for additional dining locations.

### Restaurant Offsite Reservations

Book your reservations before you leave the show floor. Staff will be on hand during show hours to assist exhibitors and attendees with restaurant reservations as well as offer recommendations. The restaurant reservation counter is located in the Central Hall lobby, phone: (702) 943-3512.

### Show Management Office

The Show Office is located in Room N245. phone: (702) 943-3501 fax: (702)943-3503

American Welding Society Show Office, Room N245 phone: (702) 943-3504

### Tourism & Concierge Desk

Located outside Lucky's restaurant/C1. Flight information is also available at this location. (Refer to the map on page 22).

### VIP Lounge

The VIP Lounge is located in Room N249.

## OFFICIAL EVENT HOTELS

Hotel Name	Distance to Convention Center	Phone
Bally's Hotel and Casino	3.0 Miles	(702) 739-4111
Bellagio	2.3 Miles	(702) 693-7111
Caesars Palace - <i>FMA HQ Hotel</i>	2.5 Miles	(702) 731-7110
Cosmopolitan of Las Vegas	2.7 Miles	(702) 698-7000
Courtyard Convention Center	1.0 Blocks	(702) 791-3600
Embassy Suites Convention Center	0.5 Miles	(702) 893-8000
Encore at Wynn Las Vegas	1.2 Miles	(702) 770-7000
Harrahs Las Vegas	2.0 Miles	(702) 369-5000
Hilton Grand Vacations Suites Las Vegas	0.7 Miles	(702) 946-9210
Las Vegas Marriott	1.0 Blocks	(702) 650-2000
LVH (formerly Las Vegas Hilton) – <i>AWS HQ Hotel</i>	Adjacent	(702) 732-5111
Mirage Hotel and Casino– <i>SME HQ Hotel</i>	1.6 Miles	(702) 791-7111
Paris Las Vegas	2.5 Miles	(702) 946-7000
Renaissance Las Vegas	1.0 Blocks	(702) 784-5700
Residence Inn Convention Center Las Vegas	1.0 Blocks	(702) 796-9300
Riviera Hotel and Casino	1.0 Miles	(702) 734-5110
SpringHill Suites Convention Center	1.0 Blocks	(702) 433-5880
Treasure Island – <i>CCAI HQ Hotel</i>	1.2 Miles	(702) 894-7111
Venetian Resort Hotel Casino – <i>PMA HQ Hotel</i>	1.5 Miles	(702) 414-1000







# WELDING. CUTTING. SOLUTIONS.

## Experience ESAB's innovative welding and cutting products and processes in action at FABTECH.



**PowerCut® 400/700** The newest additions to the powerful, durable, and simple PowerCut lines of plasma cutting packages.



**SPOOLARC® Elite** The next big thing in solid wire, SPOOLARC Elite gives welders less downtime and more weld time.



**PUROX® Elite Series** Our new and improved gas apparatus offers top-of-the-line safety, durability, and performance, no matter your welding or cutting application.



**Mechanized Cutting** Our experts will demonstrate how our new technology and processes can be integrated to work together seamlessly for maximum productivity and profitability.



**Welding Automation** Quality, capacity, and of course much higher productivity. Our Automation division will exhibit several key products and processes.



**Warrior** The new arc welding game-changer from ESAB will be unveiled at FABTECH. Don't miss it!

To learn more about our welding and cutting solutions, **stop by booths N-3922 and N-4122**, visit [esabna.com/fabtech-2012](http://esabna.com/fabtech-2012), or scan the QR code with your mobile device.



## TRANSPORTATION & PARKING

### SHUTTLE SCHEDULE\*

ROUTES 1-4		
	Inbound to LVCC North Hall From Hotels Every 15-20 Minutes	Return to Hotels From LVCC North Hall Every 30 Minutes
<b>Monday, 11/12</b>	7:00 a.m. - 10:30 a.m.	3:00 p.m. - 7:00 p.m.
<b>Tuesday, 11/13</b>	7:00 a.m. - 10:30 a.m.	2:30 p.m. - 5:30 p.m.
<b>Wednesday, 11/14</b>	7:00 a.m. - 10:30 a.m.	2:30 p.m. - 5:30 p.m.

### PROPOSED ROUTES & BOARDING SCHEDULE\*

ROUTE 1	BOARDING POINT
Bally's Las Vegas	Flamingo Road Entrance
Bellagio	Tour Bus Area
Cosmopolitan	Tour Bus Area
Paris Las Vegas	At Bally's, Flamingo Road Entrance
ROUTE 2	
Caesars Palace	Colosseum Bus Entrance
Mirage	Tour Bus Area
Treasure Island	Tour Bus Area
ROUTE 3	
Embassy Suites	Convention Center Front Entrance
Harrah's	Tour Bus Area
Venetian Sands	Tour Bus Area
ROUTE 4	
Encore at Wynn	Wynn Boulevard Entrance
Hilton Grand Vacation at Las Vegas	Curbside on Karen
Riviera	
WALKING DISTANCE (No service required)	
Courtyard by Marriott	
LVH (formerly the Las Vegas Hilton)	
Marriott Suites Convention Center	
Renaissance Las Vegas	
Residence Inn Convention Center	
SpringHill Suites	

\*Please be advised that pick up times & locations listed above are subject to change. Please consult the signage in your hotel lobby for up-to-date schedule and boarding point information.



# EXPERIENCE FABTECH

## Taxi Cabs

Sixteen taxicab companies service the Las Vegas valley, and can offer a convenient method of transportation throughout Las Vegas. Initial activation of taximeter is \$3.30. Each additional 1/13th mile (\$2.60 per mile — includes \$.20 per mile fuel surcharge) is \$0.20. There is an additional fee per pick-up at the McCarran Airport of \$1.80. Please note that fares may vary depending on time of day, day of week, route taken, destination, weather, road conditions and traffic.

## Monorail

Running from 7 to 2 a.m. Monday–Thursday and 7 to 3 a.m. Friday–Sunday, the Las Vegas Monorail connects the Las Vegas Convention Center and LVH to a variety of hotels on the Strip, including MGM Grand, Bally's, Flamingo, and Harrah's. Traveling at a top speed of 50 mph, the monorail is often the quickest travel option to and from FABTECH.

### Pricing:

Single Ride Ticket: \$ 5.00      Three-Day Pass: \$24.00  
One-Day Pass: \$12.00

## McCarran Airport

5757 Wayne Newton Boulevard  
Las Vegas, Nevada  
(702) 261-5211

## Airport Shuttle

A number of affordable options are available for quick and convenient travel to and from the airport. Contact the McCarran Airport at (702) 261-5211 for a complete list of options available.

## LVCC Parking

Gold, Silver 1 & 2 lots will be utilized for parking; \$10.00 parking fee per space with in/out privileges. Anyone leaving the convention center & planning to return the same day can get their ticket stamped for re-entry.

# Custom Marketing for Your Job Shop

The Job Shop Company is a full service custom marketing organization with over 35 years of helping job shops and contract manufacturers market their services. *We know what OEM engineers and buyers are searching for and how to communicate to them.* With thousands of satisfied job shops, we have the knowledge and tools to help your organization drive sales.

Visit us in Booth C5035

**Marketing North American  
Job Shops for Over 35 Years**



The Job Shop Company • 16 Waterbury Road, Prospect, CT 06712  
800-225-4535 • [www.TheJobShopCompany.com](http://www.TheJobShopCompany.com)

## GENERAL INFORMATION



### Solicitation Information

Unauthorized solicitation (suitcasing/outboarding) of or marketing to exhibiting companies is strictly prohibited. Selling activities and distribution of literature, samples and marketing materials are permitted only from within the booth space of officially contracted exhibitors.

### Photography/Filming Restrictions

No videotapes, motion picture film, or other type of cameras are allowed in the exposition area except those belonging to news media and technical press, approved in advance by FABTECH Public Relations staff. Check-in is required at the Media Room located in N251. The use of camera phones for the sole purpose of photography at the show is prohibited.

## EXHIBITOR ADVISORY COUNCIL

The FABTECH Exhibitor Advisory Council (EAC) was established to provide show management with industry input and feedback on trade show issues. The group meets annually during the shows and communicates throughout the year. All exhibitors are encouraged to contact Council members or show management with ideas, feedback, and concerns. The Council is comprised of experienced personnel from exhibiting firms representing each of the five show technology areas.

### WELDING

**Sue Bartholomew**  
Director of Marketing  
ESAB Welding & Cutting  
Products

**David Bellamy**  
Manager Tradeshow  
and Events  
Miller Electric Mfg. Co.

**J. R. (Rusty) Franklin**  
VP Sales and Marketing  
Sellstrom Manufacturing Co.

**Ann Pennino, CME**  
Exhibit Manager  
Praxair, Inc

**Scott Skrjanc**  
Event Marketing Manager  
Lincoln Electric

### FABRICATING

**Mike Albrecht**  
National Sales Manager  
Scotchman Industries Inc.

**Sheila Lamothe**  
Marketing Manager  
TRUMPF

### FABRICATING (CONT'D)

**Lyle Menke**  
Vice President Marketing  
Peddinghaus

**Mark Lobit**  
Marketing Manager  
Mazak Optonics

**Nick Ostrowski**  
General Manager, Media/  
Promotions/Tooling Sales  
Amada America

### TUBE & PIPE

**Jeff Arendas**  
Product Manager,  
Laser Tube Systems  
BLM Group USA

**Bernardo Gutierrez**  
VP Sales Latin America  
Thermatool

**John Hodges**  
Sales Engineer  
T-Drill

### STAMPING

**Lance Curtis**  
Vice President of Sales  
Link Electric & Safety Control Co.

**James Ward**  
General Sales Manager  
Coe Press Equipment Corp

**Lee Ellard**  
National Sales Manager  
Stamtec, Inc

### FINISHING

**Peter Dority**  
VP Sales & Mktg  
Coral Chemical

**John Cole**  
President  
Parker Ionics

**Sam Woehler**  
VP Sales  
George Koch Sons, LLC

### SHOW MANAGEMENT

**John Catalano**  
Society of Manufacturing  
Engineers

**Mark Hoper**  
Fabricators & Manufacturers  
Association, International®

**Joe Krall**  
American Welding Society

**Andy Flando**  
Precision Metalforming  
Association

**Andy Goyer**  
Chemical Coaters  
Association, International



## About the Show Sponsors

FABTECH is cosponsored by five leading industry associations; the American Welding Society (AWS), the Fabricators and Manufacturers Association, International® (FMA), the Society of Manufacturing Engineers (SME), the Precision Metalforming Association (PMA) and the Chemical Coaters Association International (CCAI).



The Fabricators & Manufacturers Association, International, headquartered in Rockford, Ill., USA, is a non-profit educational association dedicated exclusively to metal forming and fabricating professionals. Founded in 1970, it is considered the world's largest educational association for its industry, with thousands of members worldwide. FMA provides in-depth technical information and educational opportunities through conferences, award-winning magazines, extensive research services, and co-sponsorship of the FABTECH International series. Visit FMA at [www.fmanet.org](http://www.fmanet.org).



The American Welding Society (AWS) was founded in 1919 as a multifaceted, non-profit organization with a mission to advance the science, technology and application of welding and allied joining and cutting processes, including brazing, soldering, and thermal spraying. Headquartered in Doral, Florida and led by a volunteer organization of officers and directors, AWS serves about 70,000 members worldwide and is composed of 22 Districts with 250 sections and student chapters. For more information, visit [www.aws.org](http://www.aws.org).



The Chemical Coaters Association International is a technical and professional organization that provides information and training on surface coating technologies. CCAI's foundation is its series of active local chapters across the U.S. that conduct technical meetings on all aspects of organic finishing. Chapters serve as an excellent forum to discuss regional concerns while offering outstanding networking opportunities for finishers and suppliers. CCAI works to raise the standards of finishing operations through educational meetings and seminars, training manuals, certification programs, and outreach programs with colleges and universities. Visit CCAI at [www.ccaiweb.com](http://www.ccaiweb.com).



The Society of Manufacturing Engineers is the world's leading professional society supporting manufacturing education. Through its member programs, publications, expositions and professional development resources, SME promotes an increased awareness of manufacturing engineering and helps keep manufacturing professionals up to date on leading trends and technologies. Headquartered in Michigan, SME influences more than half a million manufacturing engineers and executives annually. The Society has members in 70 countries supported by a network of hundreds of chapters worldwide. Visit SME at [www.sme.org](http://www.sme.org).



The Precision Metalforming Association is the full-service trade association representing the \$113-billion metalforming industry of North America—the industry that creates precision metal products using stamping, fabricating, spinning, slide forming and roll forming technologies, and other value-added processes. Its nearly 1,000 member companies also include suppliers of equipment, materials and services to the industry. PMA leads innovative member companies toward superior competitiveness and profitability through advocacy, networking, statistics, the PMA Educational Foundation, FABTECH and METALFORM tradeshow, and MetalForming magazine. Visit PMA at [www.pma.org](http://www.pma.org).



## Association Contact Information

### AWS Booth # N2031

#### American Welding Society

8669 Doral Blvd.  
Doral, FL 33166  
1-800-443-9353  
[www.aws.org](http://www.aws.org)

### FMA Booth # C6538

#### Fabricators & Manufacturers Association, International®

833 Featherstone Road  
Rockford, IL 61107  
888-394-4362  
[www.fmanet.org](http://www.fmanet.org)

### SME Booth # C6542

#### Society of Manufacturing Engineers

One SME Drive  
Dearborn, MI 48121  
1-313-425-3000  
[www.sme.org](http://www.sme.org)

### PMA Booth # C463

#### Precision Metalforming Association

6363 Oak Tree Boulevard  
Independence, OH 44131  
1-216-901-8800  
[www.pma.org](http://www.pma.org)

### CCAI Booth # C1948

#### Chemical Coaters Association International

5040 Old Taylor Mill Rd.  
PMB 13  
Taylor Mill, KY 41015  
1-859-356-1030  
[www.ccaiweb.com](http://www.ccaiweb.com)

## SPECIAL EVENTS free and open to all attendees



**Moderator: Chris Kuehl**  
Economic Analyst for FMA,  
Managing Director, Armada  
Corporate Intelligence

### STATE OF THE INDUSTRY: MANUFACTURERS' EXECUTIVE OUTLOOK

**MONDAY, NOVEMBER 12, 12:30 p.m. – 1:45 p.m.**

**Location: North FABTECH Theater**

How are businesses that attend FABTECH dealing with change in today's manufacturing environment? Hear insights from leaders representing job-shops, contract manufacturers and other service providers who are dealing with the same issues of supply, demand, labor and changing business sectors that affect your survival in today's economy. Join the interactive Q & A lead by Chris Kuehl, FMA Economist to ask questions and offer your perspective on the future of the industry. Return to your company with new insights that will guide your decision-making in 2013.

**Panelists:**



**Rick Taylor**  
President and CEO  
Jay Industries Inc.



**Gregg Simpson**  
President and Owner  
Ohio Laser LLC



**Patrick J. Thompson (PJ)**  
President  
Trans-Matic Manufacturing Co.



**Jerry B. Ward**  
Vice President  
Metcam Inc.



**Shivie Dhillon**  
Owner and President  
SunDial Powder Coatings



**Moderator: Paul Nathanson**  
Founding Partner  
Policy Resolution Group

### POST-ELECTION ANALYSIS: HOW THE RESULTS IMPACT U.S. MANUFACTURING

**TUESDAY, NOVEMBER 13, 12:30 p.m. – 1:30 p.m.**

**Location: North FABTECH Theater**

The November 2012 elections will have a profound impact on businesses and manufacturing in America. Congress and the President will need to address major issues such as tax reform and environmental regulations in 2013, along with the next steps on health care. Our panelists of Washington insiders will share their insights and take questions on the election results and their implications for these issues and policy implications for labor law, trade agreements, defense spending and energy policy — issues that will impact U.S. manufacturing and your business for many years to come.

**Panelists:**



**Omar S. Nashashibi**  
Partner The Franklin  
Partnership, LLP



**David Goch**  
Partner  
Webster, Chamberlain & Bean



## TO OFFSHORE OR RESHORE? HOW TO OBJECTIVELY DECIDE!

**TUESDAY, NOVEMBER 13, 4:00 p.m. – 4:30 p.m.**

Location: Central FABTECH Theater

Reshoring created about 50,000 manufacturing jobs in the last few years, about 10% of the total U.S. manufacturing jobs added since the low in January 2010. The Reshoring Initiative's Harry Moser will share tips to help you and your customers objectively decide when and what to reshore. Learn how the Initiative's Total Cost of Ownership (TCO) Estimator software helps identify and calculate total cost, including "hidden costs" of offshoring.



**Moderator: Harry Moser**  
Founder and President,  
Reshoring Initiative

## AWS SKILLS COMPETITION

**MONDAY, NOVEMBER 12, 9:00 a.m. – 6:00 p.m.**

**TUESDAY, NOVEMBER 13, 9:00 a.m. – 5:00 p.m.**

**WEDNESDAY, NOVEMBER 14, 9:00 a.m. – 4:00 p.m.**

Location: North Hall, Booth N1131

Check out the mad welding skills of the six top qualifying National SkillsUSA student welders. The excitement heats up throughout the show as they compete for the top three TeamUSA spots in the 2012 Invitational Weld Trials taking place right on the show floor.



## NETWORKING EVENTS free and open to all attendees

### COCKTAILS AND COMEDY

**MONDAY, NOVEMBER 12**

Location: Room N109/N110

**Doors open: 5:30 p.m.**

**Show: 6:15 p.m. – 7:00 p.m.**

Bring on the fun! Connect with new friends and old and celebrate the close of opening day "Vegas-style" at the FABTECH Cocktails and Comedy event. Kick back, relax and enjoy a night of laughs with comedian Greg Hahn. Greg has appeared on Late Night with Conan Obrien, Comedy Central, ABC, CBS and FOX. His lively interactive performance will make you laugh until you cry. You won't want to miss it!

Complimentary beverage ticket if pre-registered for Cocktails & Comedy. Cash bar available.



### HAPPY HOUR

**TUESDAY, NOVEMBER 13, 3:00 p.m. – 5:00 p.m.**

Location: North & Central Halls

Mix and mingle with other attendees and exhibitors during FABTECH Happy Hour. Held on the exhibit hall floor, Happy Hour is a great way to network with peers in a relaxed, entertaining environment while perusing the technology in exhibitor booths.



# EXPERIENCE FABTECH

## NEW PRODUCT PRESENTATIONS

Location: FABTECH Theater, North & Central Halls

Sit in on brief exhibitor-led sessions of the best new products and technologies to hit the market at the FABTECH Theater. With dozens of companies making presentations in two theaters located on the exhibit floor, this is a great opportunity to stay on the leading edge. **Free and open to all attendees.**

Monday, November 12				Tuesday, November 13				Wednesday, November 14			
Time:	Company	Technology	Topic	Time:	Company	Technology	Topic	Time:	Company	Technology	Topic
<b>FABTECH THEATER — CENTRAL HALL</b>											
				10:00 a.m.	<b>TRUMPF Inc</b>	Lasers	TruLaser 5030 Fiber	10:00 a.m.	<b>Binks, DeVilbiss, Ransburg, BGK</b>	Finishing	Advancements in Liquid Fluid Handling Equipment
11:00 a.m.	<b>Wagner Industrial Solutions</b>	Finishing	GM 5000: Liquid Electrostatic Gun	10:45 a.m.	<b>Chicago Slitter</b>	Fabricating	Innovative Coil Fed Laser Blanking Systems	10:45 a.m.	<b>Wintriss Controls</b>	Metalforming	You Can't Fix What You Don't Measure
11:45 a.m.	<b>EXEL North America</b>	Finishing	SAMES InoBell Powder Bell Application	11:30 a.m.	<b>Pretreatment Equipment Mfg Inc</b>	Finishing	Economical Lean Modular Pretreatment System	11:30 a.m.	<b>Photomachining Inc.</b>	Lasers	Fundamentals of Laser Micromachining
1:00 p.m.	<b>Jet Edge</b>	Fabricating	Eco-Friendly Waterjet Pump Technology	1:00 p.m.	<b>Daifuku</b>	Finishing	Extend the Life of your Chain Conveyor with LubriPin				
1:45 p.m.	<b>Proto-1 Manufacturing</b>	Tube & Pipe	Tube Sizing Made Simple	1:45 p.m.	<b>Amada America Inc</b>	Fabricating	HD Press Brake with Automated Tool Changer				
2:30 p.m.	<b>Amada America Inc</b>	Lasers	Fiber Laser Cuts Processing Time in Half	2:30 p.m.	<b>Automec Inc</b>	Metalforming	Tonnage vs. Technology				
3:15 p.m.	<b>DuBois Chemicals</b>	Finishing	First Ever Dilutable Gel: DfE Recognized General Purpose Degreaser	3:15 p.m.	<b>Simufact-Americas LLC</b>	Fabricating	Simulation of the Complete Sheet Metal Manufacturing Process				
4:00 p.m.	<b>FabTrol Systems Inc</b>	Fabricating	Increase Capacity, Shorten Schedules and Improve Quality								
<b>FABTECH THEATER — NORTH HALL</b>											
				10:00 a.m.	<b>Flame Technologies Inc</b>	Safety	Cost Effective Cooling Improves Worker Productivity and Safety	10:00 a.m.	<b>Norton Abrasives</b>	Abrasives	Norton BlueFire Metal Fabrication Products
11:00 a.m.	<b>Chart Inc.</b>	Welding	Flexible, Cost-Effective Gas Supply Solutions for Laser & Welding Applications	10:45 a.m.	<b>Fronius USA LLC</b>	Welding	CMT Twin: The Best of Two Technologies	10:45 a.m.	<b>Frommelt Safety Products</b>	Welding	Guardian Defender Automated Barrier Door
				11:30 a.m.	<b>American Welding Society</b>	Welding	Online Welding Training and Certification through American Welding Online	11:30 a.m.	<b>RealWeld Systems, Inc.</b>	Welding	Weld Training with the Arc On or Off
2:30 p.m.	<b>Bernard &amp; Tre-gaskiss</b>	Welding	New QUICK LOAD Liner AutoLength System Reduces Downtime Caused by Short MIG Gun Liners	2:30 p.m.	<b>OTC Daihen Inc</b>	Welding	FD Series: Changing the Future of Manufacturing				
3:15 p.m.	<b>Bug-O Systems</b>	Welding	Increasing Productivity & Quality of Welding Pipe through Automation	3:15 p.m.	<b>Metabo Corp</b>	Welding	WEPBA Angle Grinders Combine with Combinator Grinding Wheels				
4:00 p.m.	<b>Strong Hand Tools</b>	Welding	Affordable, High Precision German Welding Tables	4:00 p.m.	<b>Rethink Robotics</b>	Robotics	Robots with Common Sense				





**WHERE IS THE WORLD'S LARGEST  
MACHINE MARKETPLACE?**

Visit us in Booth C8545



## EDUCATION PROGRAM

The Fabricators & Manufacturers Association, Int'l (FMA), Society of Manufacturing Engineers (SME), Precision Metalforming Association (PMA), and Chemical Coaters Association International (CCAI), co-sponsor the sessions on cutting, finishing, forming & fabricating, lean, management, stamping, and tube & pipe. All sessions are two hours in length, offering practical knowledge you can use right away. Sessions with Tech Tours combine classroom instruction followed by expert-led guided tours on the show floor to see technology operating in designated booths.

The American Welding Society (AWS) presents a comprehensive lineup of welding education. Led by the industry's top professionals, programs focus on best practices and new commercial developments in welding and thermal spray. Events include conferences, seminars, RWMA Resistance Welding School, professional program, society events, & more.



### Continuing Education Credits

Individuals who attend AWS education programs are awarded 1 PDH (Professional Development Hour) for each hour of education program attendance. Individuals seeking FMA Recertification Credits will be awarded 2 credits for each conference session attended (forming & fabricating, cutting, or finishing tracks) plus an additional 2 credits for attending the show. Individuals who attend SME education programs may be eligible to receive one credit per hour attended toward their SME-managed recertification requirements.

### Tax Deduction

An income tax deduction may be allowed for expenses of education (including registration fees, travel, lodging, and meals) undertaken to maintain and improve professional skills. (Treas. Reg. Sec. 1.162-5). Contact your tax consultant for additional details.

### How to Find Sessions

- Use the **Schedule-at-a-Glance** on pages 23-25 to get a quick preview of all the programs offered at the 2012 event. Programs are grouped by eight tracks: Cutting, Finishing, Forming & Fabricating, Lean, Management, Stamping, Tube & Pipe and Welding.
- Review the **Floor Plan Layout** on page 22 for a visual overview of the meeting rooms where all the FABTECH education and professional events take place.
- Details of the educational programs available at FABTECH can be found in the supplemental **FABTECH 2012 Education Program**. The FABTECH 2012 Education Programs are located next to the Show Directory stands in the lobby, the registration areas in the North Hall Lobby and Central Hall Lobby, the FABTECH education headquarters, Room N115, the AWS education headquarters, Room N236 and also available on the FABTECH mobile app (see page 7 to download the mobile app now).

## EXPERIENCE LEVELS

Use this key to find the education that meets your needs.

- B Basic** – Recommended for the attendee who is new to the industry or needs a refresher on the topic.
- I Intermediate** – Designed for the attendee who already has a basic understanding of the subject matter.
- A Advanced** – For the attendee with several years of experience who is seeking more in-depth information.



# EXPERIENCE FABTECH

## ON-SITE PRICING INFORMATION

On-site registration for paid educational events is available in the **Central Hall Lobby**.

<b>Cutting, Finishing, Forming &amp; Fabricating, Lean, Management, Stamping, and Tube &amp; Pipe Education</b>		
	Member	Non-Member*
<b>1 Session</b>	\$175	\$200
<b>2 Sessions</b>	\$305	\$350
<b>3 Sessions</b>	\$400	\$470*
<b>4 Sessions</b>	\$500	\$570*
<b>Full Conference (5 or more sessions)</b> Includes (1) \$20 lunch ticket	\$705	\$805*

\*Non-member rates for 3 or more sessions include a one-year complimentary membership to one of the co-sponsoring associations (FMA, SME, PMA, CCAI).

<b>Welding Education</b>		
	Member	Non-Member <sup>a</sup>
<b>1-Day AWS Educational Sessions<sup>b</sup></b>	\$150	\$225
<b>3-Day AWS Educational Sessions<sup>b</sup></b>	\$225	\$360
<b>1/2-Day Seminar</b>	\$150	\$285
<b>1-Day Conference or Seminar</b>	\$345	\$480
<b>2-Day Seminar</b>	\$550	\$685
<b>2-Day RWMA Resistance Welding School</b>	\$475	\$695
<b>1-Day Professional Program</b>	\$150	\$285
<b>3-Day Professional Program</b>	\$225	\$360
<b>Student Professional Program</b>	\$75	\$90 <sup>c</sup>
<b>AWS Awards Luncheon</b>	\$30	\$30

<sup>a</sup> Non-member price for AWS Sessions only includes a two-year AWS Individual Membership.  
<sup>b</sup> This year, the Education Annual Program and the National Welding Education Conference (Weld-Ed) have teamed together to provide the new program titled AWS Educational Sessions. Non-member AWS Educational Sessions price includes a one-year AWS Membership.  
<sup>c</sup> Non-member Student Professional Program price includes a one-year AWS Student Membership.



# EXPERIENCE FABTECH

## LVCC MEETING ROOMS

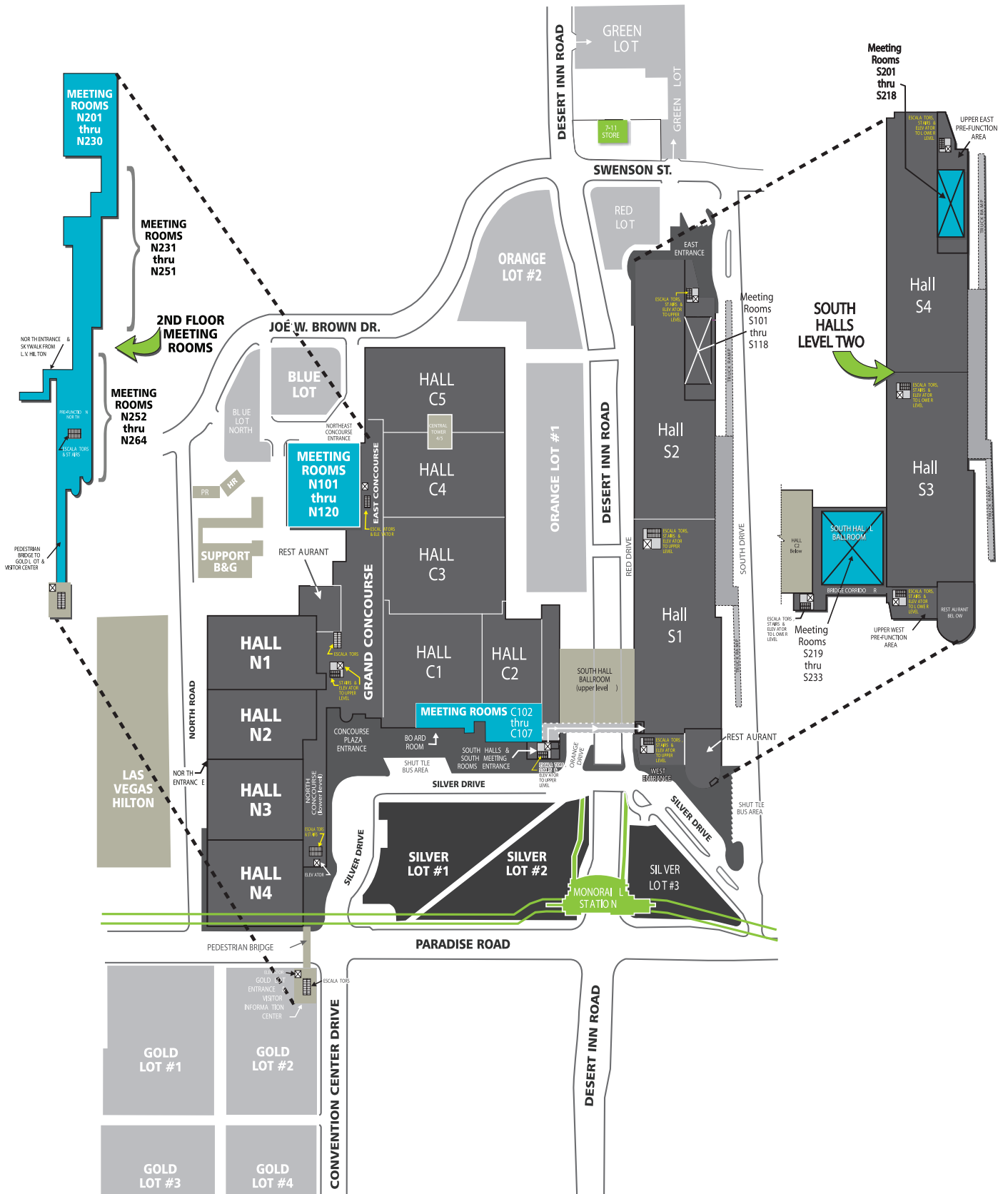

# EXPERIENCE FABTECH

## SCHEDULE-AT-A-GLANCE

### MONDAY, NOVEMBER 12

TECHNOLOGY	8:00 a.m. – 10:00 a.m.	10:30 a.m. – 12:30 p.m.	1:30 p.m. – 3:30 p.m.
<b>CUTTING</b>	F10: <b>NEW!</b> Overview of Laser Technology and Systems <b>I</b> Room N116	F20: <b>NEW!</b> Innovations and Considerations for Fiber or CO <sub>2</sub> Laser Technology <b>A</b> Room N116	F30: Advancements in Fiber Laser <b>I</b> Room N116
<b>FINISHING</b>	C10: <b>NEW!</b> Building Blocks of a Powder Coating System <b>B</b> Room N102	C20: <b>NEW!</b> Autodeposition & Powder Coating Hand-in-Hand <b>I</b> Room N102	C30: Powder Coating Conversion & Case Studies <b>I</b> Room N102
	C11: <b>NEW!</b> Running Efficient Liquid Systems <b>A</b> Room N103	C21: <b>NEW!</b> When to Use a Custom Coater <b>B</b> Room N103	C31: <b>NEW!</b> Finishing Essentials: Conveyors, Racking & Testing <b>B</b> Room N103
<b>FORMING &amp; FABRICATING</b>	F11: Roll Forming Fundamentals <b>B</b> Room N119	F21: General to Advanced Roll Forming Concepts <b>A</b> Room N119	F31: What's New in Press Brakes with Tech Tour <b>I</b> Room N119
	F12: <b>NEW!</b> Designing Parts for Sheet Metal <b>A</b> Room N120		F32: Estimating: Made to Order <b>I</b> Room N120
<b>LEAN</b>	F13: Low-Volume, High-Variety — No Problem for Lean <b>I</b> Room N114	F22: <b>NEW!</b> Profit Destroyers: Finding and Fixing Them <b>A</b> Room N114	F33: Introduction to 5S and the Visual Workplace <b>I</b> Room N114
<b>MANAGEMENT</b>	F14: <b>NEW!</b> Safety and Productivity for a Responsible Partnership <b>I</b> Room N113	F23: Driving High Performance Through Employee Engagement <b>I</b> Room N113	F34: <b>NEW!</b> Survival and Success Through Shared Lean Vision <b>I</b> Room N113
	F15: Social Marketing on Speed — Crash Course <b>I</b> Room N117	F24: <b>NEW!</b> Online Marketing for Manufacturers: Growing Your Business Using the Web <b>B</b> Room N117	F35: <b>NEW!</b> Let's All Play Nicely Together: Managing Boomers, Xers and Yers in Your Business <b>A</b> Room N117
<b>STAMPING</b>	S10: New Tool Steels to Improve Die Life <b>I</b> Room N108	S20: Introduction to Formability Engineering and Analysis <b>B</b> Room N108	S30: Progressive Strip Layout and Stamping Estimating <b>B</b> Room N108
	S11: <b>NEW!</b> Improving Business Results Through Effective Cost Models and Training <b>I</b> Room N107	S21: <b>NEW!</b> Case Studies - In-Die Sensor Applications and Growing Talent Through Internships <b>I</b> Room N107	S31: <b>NEW!</b> Effective C.I., Safety and World Class Idea Cultures <b>I</b> Room N107
<b>TUBE &amp; PIPE</b>	F16: <b>NEW!</b> Advancements in Welded Tube Production <b>I</b> Room N101	F25: <b>NEW!</b> Principles of Tube Fabrication <b>B</b> Room N101	F36: <b>NEW!</b> Lean and Green Tube Bending <b>I</b> Room N101
<b>WELDING</b>			
<b>SEMINARS</b>	W10: Metallurgy Applied to Everyday Welding • Room N259 . . . . .		8:30 a.m. – 4:30 p.m.
	W11: Advanced Visual Inspection Workshop • Room N260 . . . . .		8:30 a.m. – 4:30 p.m.
	W12: API 1104 Code Clinic (Spanish) • Room N253 . . . . .		1:00 p.m. – 5:00 p.m.
	W15: ASME Section IX, B31.1 & B31.3 Code Clinic - Day 1 • Room N261 . . . . .		8:30 a.m. – 4:30 p.m.
<b>CONFERENCES</b>	W26: Underwater Welding and Cutting • Room N254 . . . . .		9:00 a.m. – 3:30 p.m.
	W30: Thermal Spray Basics: Putting Coatings to Work – FREE • Room N256 . . . . .		1:00 p.m. – 4:00 p.m.
<b>PROFESSIONAL PROGRAM</b>	W32: Rooms N238/N240/N242 Session 1: Industry/University Collaborative Research Center on Integrated Materials Joining Science for Energy Applications – Welding Metallurgy . . . . . 1:30 p.m. – 5:30 p.m. Session 2: Arc Welding Studies . . . . . 1:30 p.m. – 5:30 p.m. Session 3: Weld Microstructure and Properties . . . . . 1:30 p.m. – 5:30 p.m.		
<b>EDUCATIONAL SESSIONS</b>	W37: AWS Educational Sessions • Room N264 . . . . . 8:00 a.m. – 5:00 p.m.		
<b>SPECIAL PROGRAMS</b>	AWS Skills Competition - Day 1 • Show Floor, Booth N1131 . . . . .		9:00 a.m. – 6:00 p.m.
	W42: AWS Education Program Q & A – FREE • Room N258 . . . . .		2:00 p.m. – 3:00 p.m.
	W43: Brazing Symposium – FREE • Room N262 . . . . .		2:00 p.m. – 5:00 p.m.

# EXPERIENCE FABTECH

## SCHEDULE-AT-A-GLANCE

### TUESDAY, NOVEMBER 13

TECHNOLOGY	8:00 a.m. – 10:00 a.m.	10:30 a.m. – 12:30 p.m.	1:30 p.m. – 3:30 p.m.
<b>CUTTING</b>	F40: <b>Comparative Cutting with Tech Tour</b> [B] Room N116	F50: <b>Advancements in Waterjet Cutting</b> [I] Room N116	F60: <b>Advancements in Plasma Cutting</b> [I] Room N116
<b>FINISHING</b>	C40: <b>Conceptos Básicos de Pintura en Polvo en Español</b> [B] Room N102	C50: <b>Efficient Parts Curing with Infrared Technology</b> [B] Room N102	C60: <b>NEW! Trends in Powder Coating Application Equipment</b> [A] Room N102
	C41: <b>NEW! Finishing Essentials: The Importance of Cleaning Prior to Pretreatment</b> [I] Room N103	C51: <b>NEW! A World of Their Own: What's Trending in Coatings</b> [A] Room N103	C61: <b>Protecting Your Finishing Operation</b> [B] Room N103
	C42: <b>NEW! Paint Line Efficiencies and Energy Savings</b> [A] Room N107	C52: <b>NEW! How World-Class Coaters Use Kaizen to Optimize Finishing Line Productivity</b> [I] Room N107	C62: <b>NEW! Innovations in Pretreatment</b> [A] Room N107
<b>FORMING &amp; FABRICATING</b>	F41: <b>NEW! Tooling Solutions for Metal Fabrication</b> [B] Room N119	F51: <b>Effectively Slitting and Blanking Coils</b> [I] Room N119	F61: <b>NEW! How Flat is Your Material? Advancements in Leveling Technology</b> [A] Room N119
	F42: <b>Automated Deburring: A Surprising Cost and Time Saving with Tech Tour</b> [B] Room N120	F52: <b>NEW! Plate Fabrication</b> [I] Room N120	F62: <b>NEW! Using Robotics in Metal Forming and Fabrication</b> [I] Room N120
<b>LEAN</b>	F43: <b>NEW! Introduction to Value Stream Mapping</b> [A] Room N114	F53: <b>NEW! Facility Design and Layout for Lean Manufacturing</b> [I] Room N114	F63: <b>NEW! Quick Changeover Techniques to Reduce Set-up Time</b> [A] Room N114
<b>MANAGEMENT</b>	F44: <b>A Practical Approach to Developing a Strategic Plan for the Job Shop</b> [I] Room N113	F54: <b>NEW! Merger, Acquisition and Capital Review - Preparing Your Company for a Liquidity Event</b> [A] Room N113	F64: <b>NEW! Catapult The Cow – Case Studies in Lean Manufacturing</b> [I] Room N113
	F45: <b>NEW! Developing a Winning Sales Force</b> [I] Room N117	F55: <b>NEW! Strategies to Help Custom Manufacturers Increase Sales and Leads</b> [I] Room N117	F65: <b>NEW! Manufacturing Metrics: Training to Drive Sustainable Business Processes</b> [A] Room N117
<b>STAMPING</b>	S40: <b>NEW! Advances in Stamping Technology: Servo Drives and In-Die Fastening</b> [I] Room N108	S50: <b>NEW! Enhancing Quality Through Efficient Hole Punching and Springback Control</b> [I] Room N108	S60: <b>Stamping High Strength Steel in Progressive Dies</b> [I] Room N108
<b>TUBE &amp; PIPE</b>	F46: <b>NEW! Reducing Scrap on Tube and Pipe Mills</b> [I] Room N101	F56: <b>NEW! Tube Mill Coolants and Testing</b> [A] Room N101	F66: <b>NEW! Best Practices in Hydroforming</b> [B] Room N101
<b>WELDING</b>			
<b>SEMINARS</b>	W13: <b>D1.1 – Code Clinic (Spanish)</b> • Room N257 . . . . .		8:30 a.m. – 4:30 p.m.
	W15: <b>ASME Section IX, B31.1 &amp; B31.3 Code Clinic - Day 2</b> • Room N261 . . . . .		8:30 a.m. – 4:30 p.m.
	W16: <b>The Why and How of Welding Procedure Specifications</b> [B] • Room N259 . . . . .		8:30 a.m. – 12:00 p.m.
	W17: <b>The Why and How of Welding Procedure Specifications</b> [A] • Room N259 . . . . .		1:00 p.m. – 5:00 p.m.
	W18: <b>The Why and How of Welding Procedure Specifications (Full Day)</b> [B] [A] • Room N259 . . . . .		8:30 a.m. – 5:00 p.m.
	W19: <b>Understanding Welding Symbols</b> [B] • Room N262 . . . . .		8:30 a.m. – 12:00 p.m.
	W20: <b>Understanding Welding Symbols</b> [A] • Room N262 . . . . .		1:00 p.m. – 5:00 p.m.
	W21: <b>Understanding Welding Symbols (Full Day)</b> [B] [A] • Room N262 . . . . .		8:30 a.m. – 5:00 p.m.
	W22: <b>Welding of Stainless Steel</b> [B] • Room N232 . . . . .		8:30 a.m. – 4:30 p.m.
<b>CONFERENCES</b>	W27: <b>Health and Safety in the Welding Environment</b> • Room N253 . . . . .		9:00 a.m. – 4:00 p.m.
	W29: <b>Thermal Spray Technology: High-Performance Surfaces</b> • Room N255 . . . . .		9:00 a.m. – 5:00 p.m.
<b>RWMA SCHOOL</b>	W31: <b>RWMA Resistance Welding School - Day 1</b> • Rooms N239/N241 . . . . .		7:45 a.m. – 5:30 p.m.
<b>PROFESSIONAL PROGRAM</b>	W33: Rooms N238/N240/N242		
	Session 4: <b>Keynote Address: Dr. Peter Mayr</b> . . . . .		8:00 a.m. – 9:00 a.m.
	Session 5: <b>Industry/University Collaborative Research Center on Integrated Materials Joining Science for Energy Applications – Modeling</b> . . . . .		9:00 a.m. – 12:00 p.m.
	Session 6: <b>Friction Stir Welding &amp; Solid State Processes</b> . . . . .		9:00 a.m. – 12:00 p.m.
	Session 7: <b>Welding Metallurgy</b> . . . . .		9:00 a.m. – 12:00 p.m.
	Session 8: <b>Sensing Applications</b> . . . . .		2:00 p.m. – 5:00 p.m.
Session 9: <b>Industry/University Collaborative Research Center on Integrated Materials Joining Science for Energy Applications – Weldability</b> . . . . .		2:00 p.m. – 5:30 p.m.	
Session 10: <b>Applied Technology</b> . . . . .		2:00 p.m. – 5:30 p.m.	
<b>EDUCATIONAL SESSIONS</b>	W38: <b>AWS Educational Sessions (including Plummer Lecture)</b> • Room N264 . . . . .		8:00 a.m. – 5:00 p.m.
<b>SPECIAL PROGRAMS</b>	AWS Skills Competition - Day 2 • Show Floor, Booth N1131 . . . . .		9:00 a.m. – 5:00 p.m.
	W41: <b>AWS Awards Luncheon</b> • Rooms N258/N260 . . . . .		12:00 p.m. – 2:00 p.m.



# EXPERIENCE FABTECH

## SCHEDULE-AT-A-GLANCE

### WEDNESDAY, NOVEMBER 14

TECHNOLOGY	8:00 a.m. – 10:00 a.m.	10:30 a.m. – 12:30 p.m.
<b>CUTTING</b>	F70: <b>NEW!</b> Industrial Applications in Laser <b>I</b> Room N116	
<b>FINISHING</b>	C70: <b>NEW!</b> Manual Powder Coating: The Basics <b>B</b> Room N102	C80: <b>NEW!</b> Cost Saving Measures for Powder Coating <b>A</b> Room N102
	C71: Advances in Porcelain Enamel <b>B</b> Room N103	C81: Introduction to Electrocoating <b>B</b> Room N103
<b>FORMING &amp; FABRICATING</b>	F71: <b>NEW!</b> Maximizing Your Press Brake <b>A</b> Room N119	
<b>LEAN</b>	F72: <b>NEW!</b> Introduction to Total Productive Maintenance <b>I</b> Room N114	F80: <b>NEW!</b> The Six Sigma Problem Solving Strategy in a "Nutshell" <b>A</b> Room N114
<b>MANAGEMENT</b>	F73: Implementing Lean Manufacturing in a High Mix – Low Volume Shop <b>I</b> Room N113	F81: <b>NEW!</b> Backshoring/Reshoring: A Manufacturing Opportunity <b>B</b> Room N117
	F74: <b>NEW!</b> Leadership: Supporting Growth and Profitability <b>A</b> Room N117	
<b>STAMPING</b>	S70: <b>NEW!</b> Improving Stamping Efficiencies Through Measuring and Right Sizing Equipment <b>I</b> Room N108	S80: <b>NEW!</b> Stamping Press Maintenance – Preventive and Planned Obsolescence <b>I</b> Room N108
<b>WELDING</b>		
<b>SEMINARS</b>	W14: D1.5 - Bridge Code Clinic • Room N257 . . . . . 8:30 a.m. – 12:00 p.m.	
	W23: Welding of Stainless Steel (Avoiding Weld Defects) <b>I</b> • Room N260 . . . . . 8:30 a.m. – 4:30 p.m.	
	W25: Corrosion of Welds: Causes and Cures • Room N262 . . . . . 8:30 a.m. – 3:00 p.m.	
<b>CONFERENCES</b>	W28: Trends in Nondestructive Examination • Room N255 . . . . . 9:00 a.m. – 3:30 p.m.	
<b>RWMA SCHOOL</b>	W31: RWMA Resistance Welding School - Day 2 • Rooms N239/N241 . . . . . 8:00 a.m. – 3:45 p.m.	
<b>PROFESSIONAL PROGRAM</b>	W34: Rooms N240/N242	
	Session 11: Keynote Address: Prof. Philip Withers . . . . . 8:00 a.m. – 9:00 a.m.	
	Session 12: Applications of Weld Modeling . . . . . 9:00 a.m. – 12:30 p.m.	
	Session 13: Weldability . . . . . 9:00 a.m. – 12:30 p.m.	
<b>EDUCATIONAL SESSIONS</b>	W39: AWS Educational Sessions • Room N264 . . . . . 8:00 a.m. – 12:00 p.m.	
<b>SPECIAL PROGRAMS</b>	W44: AWS Prayer Breakfast • Room N253 . . . . . 7:30 a.m. - 9:00 a.m.	
	AWS Skills Competition - Day 3 • Show Floor, Booth N1131 . . . . . 9:00 a.m. – 4:00 p.m.	
	AWS Certification Exam (advance application required) • Rooms N219/N220 . . . . . 7:00 a.m. – 6:00 p.m.	

# EXPERIENCE FABTECH

## ASSOCIATION MEETINGS

MEETING	DATE	START TIME	END TIME	LOCATION*	ASSOCIATION
AWS Education Committee Meeting	11/11/12	8:00 a.m.	2:00 p.m.	N233	AWS
D10P Subcommittee on Local Heat Treating of Pipework	11/11/12	1:00 p.m.	4:00 p.m.	Las Vegas Hotel, Exec Board Rm	AWS
C7B Subcommittee on Electron Beam Welding and Cutting	11/11/12	2:00 p.m.	4:00 p.m.	Las Vegas Hotel, Conf. 5 & 6	AWS
C7C Subcommittee on Laser Beam Welding and Cutting	11/11/12	4:30 p.m.	6:00 p.m.	Las Vegas Hotel, Conf. 5 & 6	AWS
C7 Committee on High Energy Beam Welding and Cutting	11/11/12	6:30 p.m.	8:00 p.m.	Las Vegas Hotel, Conf. 5 & 6	AWS
C5 Committee on Arc Welding and Cutting	11/12/12	8:00 a.m.	12:00 p.m.	N237	AWS
C2 Committee and Subcommittees on Thermal Spraying	11/12/12	8:00 a.m.	5:00 p.m.	N233	AWS
D15C Subcommittee on Track Welding	11/12/12	8:00 a.m.	5:00 p.m.	N239	AWS
C6D Committee on Friction Stir Welding	11/12/12	8:00 a.m.	5:00 p.m.	N235	AWS
D17D Subcommittee on Resistance Welding in the Aircraft and Aerospace Industries	11/12/12	8:00 a.m.	5:00 p.m.	N232	AWS
D17J Subcommittee on Friction Stir Welding in the Aircraft and Aerospace Industries	11/12/12	8:00 a.m.	5:00 p.m.	N231	AWS
AWS Opening Session & Annual Business Meeting	11/12/12	9:00 a.m.	12:00 p.m.	N255/N257	AWS
Comfort A. Adams Lecture	11/12/12	10:30 a.m.	12:00 p.m.	N255/N257	AWS
D14G Subcommittee on Welding of Rotating Equipment	11/12/12	1:00 p.m.	5:00 p.m.	N237	AWS
AWS Officer's/President's/Counterpart's Reception	11/12/12	6:30 p.m.	8:00 p.m.	Las Vegas Hotel, Ballroom A	AWS
SME Forming & Fabricating Community Advisory Meeting	11/13/12	7:00 a.m.	11:00 a.m.	N213	SME
D16 Committee on Robotic and Automatic Welding	11/13/12	7:30 a.m.	9:00 a.m.	Las Vegas Hotel, Conf. 7	AWS
FMAC Economic Forecast Breakfast (w/ Chris Kuehl)	11/13/12	8:00 a.m.	9:00 a.m.	N227 & N228	FMA
D14I Subcommittee on Welding on Hydraulic Cylinders	11/13/12	8:00 a.m.	12:00 p.m.	Las Vegas Hotel, Conf. 1 & 2	AWS
D17K Subcommittee on Fusion Welding in the Aircraft and Aerospace Industries	11/13/12	8:00 a.m.	5:00 p.m.	N231	AWS
C3 Committee and Subcommittees on Brazing and Soldering	11/13/12	8:00 a.m.	5:00 p.m.	Las Vegas Hotel, Pav. 11	AWS
D9 Committee on Welding, Brazing, and Soldering of Sheet Metal	11/13/12	9:00 a.m.	5:00 p.m.	Las Vegas Hotel, Conf. 3	AWS
B1C Task Group on the Welding Inspection Handbook	11/13/12	9:30 a.m.	5:00 p.m.	Las Vegas Hotel, Conf. 7	AWS
Thomas Lecture	11/13/12	10:00 a.m.	10:30 a.m.	N232	AWS
Plummer Lecture	11/13/12	10:45 a.m.	11:45 a.m.	N264	AWS
AWS Awards/Foundation Luncheon	11/13/12	12:00 p.m.	2:00 p.m.	N258/260	AWS
AWS Welding Handbook Committee Meeting	11/13/12	1:00 p.m.	3:30 p.m.	N234	AWS
D14E Subcommittee on Welding of Cranes and Presses	11/13/12	1:00 p.m.	5:00 p.m.	Las Vegas Hotel, Conf. 1 & 2	AWS
AWS National Nominating Committee – Open Meeting	11/13/12	2:00 p.m.	3:00 p.m.	N256	AWS
Women of Gases & Welding Reception	11/13/12	5:00 p.m.	6:00 p.m.	North Hall Theater	AWS
FMAC Meet the Editors	11/13/12	5:00 p.m.	7:00 p.m.	N227 & N228	FMA
SME Member Reception	11/13/12	5:00 p.m.	7:00 p.m.	N109/N110	SME
AWS Technical Papers Committee Meeting	11/13/12	5:15 p.m.	6:15 p.m.	N234	AWS
D14C Subcommittee on Welding of Earthmoving and Construction Equipment	11/14/12	8:00 a.m.	10:00 a.m.	Las Vegas Hotel, Conf. 1 & 2	AWS
B1B Subcommittee on Visual Examination of Welds	11/14/12	8:00 a.m.	10:00 a.m.	Las Vegas Hotel, Conf. 3	AWS
G2D Subcommittee on Reactive Alloys	11/14/12	8:00 a.m.	10:30 a.m.	N238	AWS
D17 Committee on Welding in the Aircraft and Aerospace Industries	11/14/12	8:00 a.m.	12:00 p.m.	N231	AWS
C3 Committee and Subcommittees on Brazing and Soldering	11/14/12	8:00 a.m.	5:00 p.m.	Las Vegas Hotel, Pav. 11	AWS
D14 Committee on Machinery and Equipment	11/14/12	10:00 a.m.	12:00 p.m.	Las Vegas Hotel, Conf. 1 & 2	AWS
B1 Committee on Methods of Inspection	11/14/12	10:00 a.m.	12:00 p.m.	Las Vegas Hotel, Conf. 3	AWS
A5K Subcommittee on Titanium and Zirconium Filler Metals	11/14/12	10:30 a.m.	12:00 p.m.	N238	AWS
ACIIW	11/14/12	10:30 a.m.	12:00 p.m.	N232	AWS

\*Location of events is within the Las Vegas Convention Center unless otherwise noted.

# FIRST AGAIN!

While others were scrambling to reconfigure their CO<sub>2</sub> lasers for fiber optics, Salvagnini was introducing its second generation of cutting edge fiber lasers – the L3 & L5. Once again the legacy laser makers were too late.

## THE SALVAGNINI L3 & L5 FIBER LASER CUTTERS

- Proven fiber optic technology
- 60-100% faster than CO<sub>2</sub> lasers
- 70% less power consumption
- Cost per part reduced by 50%
- No laser gases required
- Virtually maintenance free
- Ecologically responsible
- Economical to buy and own



So if you're considering a new laser cutter, don't you think it's about time to invest in the future instead of the past? Visit Salvagnini at FABTECH Booth No. C3928 to see the L5 with its patented Compass Drive.

[www.salvagnini.com](http://www.salvagnini.com)

(513) 874-8284

salvagnini  
**FIRST**  
The Shape of Things to Come.





Join Amada at  
**Booth C3916**  
and partner with the  
world leader.

**HD-ATC Press  
Brake Eliminates  
Setup and Test  
Bends!**



**FOL-AJ Fiber  
Laser Cuts  
Processing Time in  
Half!**

## Our Engineering. YOUR Success.

At Amada, everything we do is engineered to ensure YOUR success. That's why we're committed to the ongoing development of innovative machine technologies — like the new FOL-AJ fiber laser and HD-ATC Hybrid Drive press brake equipped with an automatic tool changer. Like all Amada solutions, they achieve the highest levels of performance and enable you to cut operating costs while reducing environmental impact.

By partnering with the global leader, you'll profit from leading-edge technologies. You'll also gain direct one-on-one access to Amada's engineers, application experts and dedicated team of manufacturing and software specialists. In fact, our newly-completed Los Angeles Technical Center (LATC) works in tandem with the Amada Solution Center in Schaumburg, IL to ensure access is convenient for customers nationwide.

Visit us at FABTECH and let us prove that now more than ever, one company defines industry leadership and is uniquely positioned to ensure YOUR success — that company is Amada.

Amada is proud to be the FABTECH mobile app sponsor for iPhone, iPad and Android devices



### LIVE FEED DEMONSTRATIONS!

- Amada's booth will showcase state-of-the-art technologies and machine demonstrations via live feed from both the Los Angeles Technical Center (LATC) and the Amada Solution Center in Schaumburg, IL — allowing you to experience a wider range of systems and solutions.



Los Angeles Technical Center



Amada Solution Center





THE MUSCLE BEHIND THE MACHINE.™



VISIT US AT FABTECH  
BOOTH # N2610

REACH NEW LEVELS OF PERFORMANCE WITH BLUEFIRE ABRASIVE PRODUCTS INFUSED WITH A PROPRIETARY ZIRCONIA ALUMINA GRAIN UPGRADE FROM NORTON.



**Norton BlueFire™  
Depressed Center Wheels**



**Norton BlueFire™  
Flap Discs**

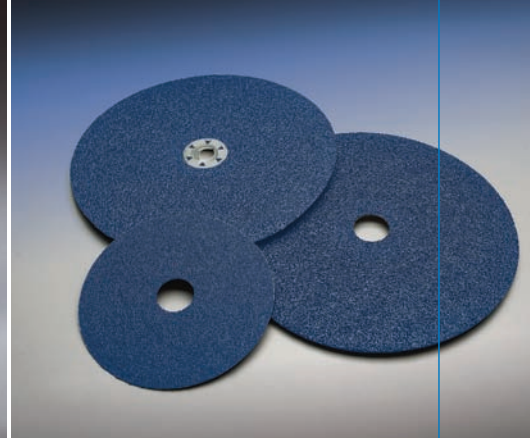

**Norton BlueFire™  
Fiber Discs**

The unique microstructure, optimal chemistry, and superior process control result in an abrasive grain with significantly higher material removal rates and up to 30% longer life over conventional zirconia products on high pressure applications for maximum productivity on stainless, super alloys, steel, cast iron, and welds.

Look to Norton for innovation that saves on your bottom line .



TM



# NEW PRODUCTS

## Arc Welding

### 3M

Booth N5502

#### Speedglas™ Welding Helmet 9100 MP

3M introduces its Speedglas™ welding helmet 9100 featuring multi-protection; HH, APF 25, welding and grinding headgear.

### ABICOR Binzel Corp

Booth N5508

#### DELTA-MIG®

American style MIG torch for heavy-duty applications. Available up to 480 amps.

#### RAB Grip Fume Extraction MIG Welding Torch

ABICOR introduces its fume extraction MIG welding torch with ergonomic handle. Available in a light-weight version the MIG welding torch has a smaller extraction tube diameter for better accessibility.

### D/F Machine Specialties Inc

Booth N2224

#### Hardbanding & Hardfacing Automation Torch

D/F's heavy duty water-cooled torch is ideal and has been used for metal build up, hardbanding, hardfacing and metal spray applications, or even retrofit with a flux delivery system for sub-arc applications, and applications where carbide is added.

### Dinse Inc

Booth N2717

#### MET 3700 Gas Cooled Welding Torch

The MET 3700 has a patented design that utilizes the separately delivered gas to the neck of the welding torch. Dinse welding torches also reduce shielding gas consumption up to 25% by delivering the shielding gas through a separate gas line opposed to traditional deliver through the liner.

### JASIC Technology Co Ltd

Booth N2019

#### 1-PCB Series MMA (IGBT) Inverter

The 1-PCB series offers a tight & compact structure; easy production, stable and reliable; air duct integration for higher efficiency; good shaping and full function; arc force, anti-stick, hot start, lift TIG, V.R.D, and O.H. lamp.

### MAGMAWELD

Booth N1628

#### Monostick 160i Welding Inverter

MAGMAWELD introduces its single phase portable MMA (SMAW) DC welding inverter. Features include excellent arc characteristics with all types of electrodes up to 4mm (5/32"), low energy consumption, works with generator sets and long cables, fan cooled and thermally protected against overloading and a light but rugged design.

### OTC DAIHEN Inc

Booth N3622

#### FD Series Robots

The FD Series advanced arc welding robots are a suitable solution for arc welding automation. Features include a new style and light weight teach pendant, quality control functions, compact eco-friendly design with reduced power consumption, welding condition guide function, jog dial, one-touch access, space conservation and increased reliability.

### Southern Stud Weld Inc

Booth N2616

#### Soyer BMS-9N Stud Welding Machine

The soyer BMS-9N is a small, lightweight and portable capacitive discharge stud welding system. PS-9 Gun displays the status of the welding equipment via a traffic light LED system.

## Assembly

### Attexor Clinch Systems SA

Booth C5622

#### SPOT CLINCH 4006 P 50 MAS

The Spt Clinch 4006 P 50 MAS is a stand-alone machine that can join up to 2 x 0.08" or 2 x gauge 14 or 2 x 2 mm of mild steel at a rate of up to 100 joints per minute. The tool provides high force, more than 50 kN (11Klbs) for strong joints. The deep C frame, 16" or 400 mm, is suitable for large pieces

## Bending/Forming

### Baileigh Industrial Inc

Booth C7513

#### MB-60CNC-R

The MB-60CNC-R is a 9 axis 60mm fully automatic CNC controlled mandrel bender which includes roll banding axis and a Windows® operating system.

### Beckwood Press Co

Booth C1228

#### Custom 10-Post Hydraulic Heated Platen Press

The Beckwood Press features a unique, 10-post hydraulic heated platen press with 5 zones of force control, each consisting of two hydraulic cylinders. The press is used in the compression molding of honeycomb panels for application in a variety of different industries.

### Dake Corporation

Booth C6923

#### PST 100S 100-Ton 2-Post Platen Hydraulic Press

Dake Corporation introduces the PST 100S, a 100-ton, semiautomatic, 2-post platen, hydraulic press. Both the upper travelling platen and the lower fixed platen have t-slots to mount tooling. Stroke and return distance are set by adjustable limit switches.

### Haeusler AG

Booth C5540

#### 4-Roll Plate Roll VRM-hy Special

Haeusler introduces its VRMhy special, a 4-roll machine with an actively controlled top roll support. The top roll support enables rolling of higher wall thicknesses at given bending diameters compared to standard plate rolls.

### MegaFab-Piranha-Whitney-Bertsch

Booth C5113

#### Bertsch NC Control

Bertsch NC control features include: program creation by editing individual blocks or teach as you roll, able to program a blended radius, proportional control of all roll movements, 15" color touch screen display, unlimited job storage via internal memory, usb storage, or network connection and designed, developed and supported by the MegaFab engineering and service group.

### Xinxiang Tianfeng Machinery Manufacture Co Ltd

Booth C7148

#### TF piling sheet roll forming line

TF piling sheet line adopts quick-change cassettes structure, offering users one machine that can produce 8 profiles with the advantages of high speed and automation.





**Brazing & Soldering**

**Elo Automated Stainless Steel Technologies Qingdao Co Ltd**  
Booth C8342

**Metal Parts, Heat Exchanger, Condenser, and Finned Tube**

Elo Automated Stainless Steel Technologies Qingdao Co Ltd offers a wide variety of stainless steel and metal products with the highest quality according to European quality standards utilizing robot welding equipment, high-precision CNC equipment and LVD laser and cutting equipment. Specialists from Denmark assist the company with support and training.

**Lucas-Milhaupt Inc**  
Booth N5027

**Sil-Fos® Rings**

Lucas-Milhaupt Inc Sil-Fos 15 rings are designed for brazing copper tubular components for HVAC/R installation applications. The rings use a calculated alloy volume for standard size copper tube providing repeatable joint quality while controlling alloy usage.

**UltraBraz**  
Booth N6226

**Luvata and Ultra Infiltrant**

UltraBraz is specifically designed for furnace brazing applications and is effective in overcoming the challenges of large gap brazing. UltraBraz's joint strength, wetting and filling characteristics are superior to traditional alloys.

**Western Enterprises**  
Booth N2933

**VN -250 / 500 HVAC Nitrogen Purging Regulator**

Western Enterprises offers the VN-250/500, a nitrogen preset regulator and flowmeter all in one for purging HVAC linesets.

**Business Services**

**American Welding Society**  
Booth N2031

**Online Welding Safety Certificate Course**

Improve safety and health of your welding operations. Three-hour self-paced course from

AWS covers electric shock, vision and skin protection, ventilation, fire protection, handling of gases, and much more. Free demo at [awo.aws.org](http://awo.aws.org)

**Association For Iron & Steel Technology**  
Booth C8530

**AIST Process Benchmark (APB)**

The AIST Process Benchmark is an online benchmarking tool for tracking key performance indicators (KPIs) between users engaged in the direct manufacturing of iron and steel.

**Chemical Coaters Assoc Int'L**  
Booth C1948

**Powder Coating Training Manual**

CCAI offers its sixth edition of Powder Coating for Industrial Finishing Applications, which has been completely revised and updated to provide all the information finishers need to produce quality powder coated parts.

Problem solving is what sets us apart from the competition. Our overhead material handling systems are customized to meet your specific application requirements. SPANCO is the leader in pre-engineered and custom overhead material handling solutions.

**Freestanding & Ceiling Mounted Workstation Bridge Cranes**

[www.spanco.com](http://www.spanco.com)  
East & West Coast Shipping  
Call us: **(800) 869-2080**

**FABTECH BOOTH #C2212**

**CUSTOM SOLUTIONS**  
ALL SPANCO WORKSTATION CRANES ARE MMA CERTIFIED!

**SPANCO** Inc.  
Promise to perform.

## Business Services

### Fabricators & Manufacturers Association

Booth C6538

#### 2012 Financial Ratios Survey Results

FMA's 2012 Financial Ratios Survey is a collection of liquidity, profitability, asset and debt management, operational benchmarking, and value proposition and marketing effectiveness data where results are shown based on company size, sales volume, geographic region, and plant square footage.

### Industrial Machinery Digest

Booth C8506

[IMDauctions.com](http://IMDauctions.com)

### Precision Metalforming Association

Booth C463

#### Fabricating Product News

PMA offers its Fabricating Product News, a dedicated publication featuring new products and the latest technology hitting the market to help metal fabricators increase their competitive edge.

### Society of Manufacturing Engineers

Booth C6542

#### Manufacturing Knowledge Base (MKB)

A peer-reviewed, validated, and encyclopedic WIKI combines the best features, expert content, illustrations and images of the former Tool & Manufacturing Engineer's Handbook, dictionary, thesaurus and other works that span major manufacturing processes.

### Weld.com

Booth N4809

#### Apples-to-Apples

Apples-to-Apples contains unbiased product comparisons evaluating all manufacturers' products in given categories from the consumer level, all the way to industrial grade machines.

## Coil Processing

### ARKU Coil Systems Inc

Booth C7528

#### FlatMaster® Hydraulic Precision Leveler

ARKU introduces its hydraulic precision leveler FlatMaster® which features gap control,

overload protection and a quick change system for its leveling rollers. ARKU achieves excellent leveling results for material from .020 to 2 3/8" thickness.

### Butech Bliss

Booth C5532

#### Synergy Leveling System™

The Synergy Leveling System™ includes Butech Bliss' independent work roll drive system and a proprietary work roll configuration. This technology requires up to 30% less horsepower for a given level of plastification than a conventional leveler.

### Feed Lease Corp

Booth C928

#### Tail Out Pony Servo Feeds

Feed Lease Corp offers its Tail Out Pony Servo Feeds which are designed to tail out the end of a coil. The system is primarily used in blanking application and allows the operator to produce more parts per coil and minimize the amount of scrap that is thrown away.

### Herr Voss Stamco

Booth C7239

#### ELT™ Enhanced Leveling Technology

ELT™ enhanced leveling technology meets the quality demand for stable material during and after post processing by laser, plasma or water jet cutting methods. This technology can be deployed as part of a new cut-to-length line, or as a standalone process with the ability to enhance individual sheets.

### Lapham-Hickey Steel Corp

Booth C840

#### Bradbury eDrive and FlatTrak

The eDrive system offers two gear boxes allowing for greater yield of the material through the levelers. This eliminates stress ensuring the material remains flat. The in line Flat Trak system provides informed decisions prior to the cut ensuring quality.

### Leveltek Intl LLC

Booth C5950

#### LT-1100 Stretcher Leveling System

Leveltek Intl LLC introduces its Stretcher Leveling System, which produces non-marked, memory-free, laser quality metals.

## Red Bud Industries

Booth C4732

#### Automatic CNC Programmable Slitting Head

Red Bud Industries fully automatic CNC programmable slitting head can be used in both multi-blanking and slitting lines. It is fully automated and will set itself up without operator intervention in less than two minutes. The design supports up to ten cuts at .250".

## United Performance Metals

Booth C1157

#### Traverse Winder

United Performance Metals offers the value of Traverse Winding solutions to its slit coil operations. UPM can offer its customers slit edge or edge conditioned coils with many times the linear strip footage as would be possible on conventional or pancake wound coils.

## Cutting

### BTM Bandsaws

Booth C8416

#### Model 125 SA Grating Saw

BTM Bandsaws offer the Model 125, a unique, custom designed semi-automatic bandsaw machine for cutting grating sheet steel, or polyurethane foam panels. This bandsaw features a movable guide arm with specially designed vertical clamping and electronic variable blade speed adjustment.

### Chicago Slitter

Booth C7023

#### Coil Fed Laser Blanking Line

The Coil Fed Laser Blanking Line can eliminate costly dies and die maintenance, cut ultra high strength steel easily and is flexible enough for low, medium to high volume part production.

### Delta Steel Technologies

Booth C5952

#### Rotary Shear

Delta Steel Technologies introduces its latest rotary shear technology. The company has engineered and built a rotary shear able to cut 1" thick by 102" wide high-strength steel.

### HGG Profiling Equipment

Booth C8127

#### MPC 350

The HGG multi-profile cutting machine can be configured to cut a variety of profile shapes,



including pipes, box sections, angle bars and flat sheet metal strips. With ProCAM software and a free DSTV 3D viewer, user capabilities are multiplied.

### **Hougen Manufacturing Inc** Booth C4821

#### **ROTACUT™ Master Kits**

Master Kits include 16 different sizes of RotaCut™ Sheet Metal Hole Cutters in a handy storage case.

### **Komatsu America Industries LLC** Booth C6510

#### **Twister Fine Plasma**

Komatsu introduces its Twister Fine Plasma featuring a 6 x 12 table.

### **MegaFab-Piranha-Whitney-Bertsch** Booth C5113

#### **Whitney Advantage**

The Whitney Advantage high precision plasma cutting system features: 2m x 4m unitized steel tubular fram, precise positioning, high acceleration/deceleration for contour definition at fast cutting speeds, multi-zone downdraft cutting table, Hypertherm Edge Pro CNC control, Hypertherm HPR130XD or HPR260XD plasma cutting system, Hypertherm ArcGlide THC torch height control and True Hole™ capability.

### **Messer Cutting Systems** Booth C5916

#### **EdgeMax**

The EdgeMax is designed as a compact machine with a rugged unitized steel table / frame, full capture bearing assemblies and a low-mass aluminum beam. Driven by dual brushless AC motors, the EdgeMax provides fast acceleration, precise motion and a very stable cutting platform.

#### **Fiber Laser with Plasma Combination**

Fiber laser with plasma combination machines are 2.5 times more productive over traditional Plasma Oxyfuel systems a lower operating cost.

#### **MetalMaster Plus**

The MetalMaster Plus is a unitized gantry cutting machine that utilizes precision plasma to produce excellent cut parts.

#### **MetalMaster Plus Shuttle Table**

The MetalMaster Plus shuttle table is a heavy

performance precision gantry cutting machine and dual pallet shuttle table.

#### **MPC2000**

Messer Cutting Systems offers the redesigned MPC2000 which features linear ways, long-life band drives, and larger end trucks.

#### **PlateMaster**

The PlateMaster is a rugged steel, dual drive box beam gantry with heavy duty floor mounted rail system, provides a platform for Plasma and Oxyfuel cutting.

#### **Titan II**

The Titan II is a robust gantry machine. Designed for use in a wide variety of industries, it uses the latest technology to provide versatile cutting capability.

#### **TMC4500 ST**

The TMC4500 is heavy duty box-beam constructed gantry cutting machine, built to perform in your rigorous production environment.

### **Metabo Corp** Booth N6131

#### **Ultra-M 4.0 Ah Battery**

Lithium-Ion batteries by Metabo Corp feature state-of-the-art cell monitoring system, electronic single cell protection (ESCP), are lightweight, compact with patented air-cooled charging technology and do not have a memory effect. It can be charged at the user's convenience without having to wait for the battery to totally discharge and does not lose any of its charging capability.

### **Pace Technologies Corp** Booth N2916

#### **MEGA-M250 Abrasive Saw**

This bench top model abrasive saw is great for sectioning welds for inspection. With a 10-inch blade capacity, this saw can cut through 2.5-inches of stock material. The cam locking vises allow for easy fixturing and sectioning of parts.

### **Praxair Inc** Booth N5202

#### **ProStar PRO Series CNC Cutting Tables**

The ProStar PRO series of CNC cutting tables includes six models designed for light manufacturing, job shops and serious hobbyists. They feature a welded steel framework, high-precision components, and professional-grade CNC controllers.

### **Rhino Cutting Systems** Booth N6138

#### **Fab Shop Series of Cutting Tables**

The Fab Shop series of cutting tables are for customers with lighter production needs and a smaller budget. Features include: ELICAL rack and pinions, one piece design, pre-tuned and tested, standard 5' x 10' cutting envelope, 6 programmable ventilation zones or auto raise lower water table, 1kW drives and precision planetary gear boxes, thermal dynamics and arc voltage high performance height control with crash detection.

### **Sahajanand Laser Technology LTD** Booth C8230

#### **Fiber Laser Cutting Machine**

Sahajanand Laser Technology Ltd offers a fiber laser cutting machine featuring mid-range high precision sheet-metal cutting Brahmastra Prime using the latest laser technology synchronized with hi-end CNC controller.

### **SteelTailor Ltd** Booth N4919

#### **Valiant Series**

SteelTailor Valiant series is for antilever type portable machines. The cross beam can be removed easily from the central unit, installation and packing of the machine is convenient and the spring follow-up device is removed. Additional features include: wider rail frame, rack and pinion precision; plasma and oxy-fuel, compatible; automatic torch height control; can be extended to maximum: 2000mm x 15000mm.

### **Thermacut Inc** Booth N5508

#### **SilverPro Electrodes**

Thermacut's Silver-Pro electrodes are the combination of a copper electrode body and a solid silver insert for mechanized cutting processes.

### **Victory Plasma Systems Inc** Booth N4833

#### **Pipe Cutter**

In addition to the Victory Plasma Systems regular downdraft or water table cutting systems, additional pipe-cutting capabilities are available.





## Fastening & Joining

### International Technologies Inc

Booth C8111

#### TapONE CNC tapping system

The TapONE taps holes in nested sheets of parts up to .196" thick and up to 50" wide by unlimited length utilizing a 4-station servo driven tapping head.

### LORD Corporation

Booth N2011

#### Maxlok™ Acrylic Adhesives

Maxlok™ acrylic adhesives provide a lower-cost alternative compared to traditional fastening methods and bond a wide variety of substrates. Designed to withstand low and high-temperature environments subject to high peel loads, Maxlok™ adhesives improve aesthetics and durability and reduce stress points, leaks and corrosion.

### Norlok Technology Inc

Booth C4840

#### Surelok III

Norlok Technology Inc introduces its Surelok III clinching machine. Features include: cold drawn process for fastening sheet metal and a clean alternative to spot welding and riveting. Surelok III uses standard shop air, no electrics, heat, fumes or surface damage, no added fasteners and the APU power unit uses less shop air.

## Finishing

### AFC Finishing Systems

Booth C2548

#### Airflex Sweeper Recovery System

The Airflex Sweeper is a full floor media recovery system that automatically recovers abrasive material from the floor. Floor is made of modular corridors, each with a series of flexible rubber blades set at regular intervals.

### Baril Coatings USA

Booth C2158

#### Coat Over Rust Encapsulator

C.O.R.E., coat over rust encapsulator, can be applied directly over rusted metal to restore it to a beautiful, strong, protected surface resistant to moisture, chemicals and abrasion. C.O.R.E. is available in gloss black and silver aluminum.

### Binks DeVilbiss Ransburg BGK

Booth C2532

#### Airless 75

The Binks Airless 75 spray gun is made with forged anodized aluminum body, and features a thick-walled stainless steel fluid tube and is compatible with high solids and abrasive industrial materials.

#### MX35-60 Airless Pump

The MX 35-60 airless pump outfit delivers 7,000 psi of fluid pressure and 3.5 gallons per minute of paint for demanding applications in the corrosion, industrial, bridge & infrastructure, shipbuilding, oil & gas, pipeline, and rail-car industries.

#### Ransburg Aerobell 168

With its flexible, transfer efficient applicator and robust, proven air-bearing turbine design; you can count on the AeroBell 168 to keep your system running at peak performance.

### Chemetall US Inc

Booth C2709

#### Gardobond® AP 9811, a non-phosphorous pretreatment

Gardobond® AP 9811, is a non-phosphorous pretreatment for 3-stage spray washers that is a drop-in replacement for iron phosphate processes. It is compatible with mild steel equipment so expensive stainless steel is not required.

### Chicago Pneumatic Tool Co

Booth C4750

#### CP3850 Heavy Duty Industrial Grinder/Sander

Chicago Pneumatic's heavy duty CP3850 industrial angle grinder/sander reins top in its class in delivering superior torque for maximum productivity in contouring, deburring, cutting, and sanding.

### Comco Inc

Booth C5052

#### Shot Peening Equipment

Comco Inc. offers the latest advances in Shot Peening technology with its precision Shot Peening system for demanding production or job shop environments.

### Daifuku Webb

Booth C2425

#### LubriPin

LubriPin features concave edges and a notch at the top of the pin-enabling the oil to flow quickly down the pin, reaching the areas with the highest wear point fast. LubriPin increases the longevity of chain conveyors by 32% & reduces chain stretch.

### Decoral System USA Corp

Booth C1954

#### IR® and HORIZON® Technologies

IR® technology is a process suitable for the decoration in wood grain and marble finish for 3dimensional and welded metal parts. HORIZON® technology is another process for the decoration of extrusion or rolled formed profiles.

### DuBois Chemicals

Booth C2545

#### Next Generation Zirconization

DuBois Chemicals offers Next Generation Zirconization, an easy-to-use non-phosphate pretreatment that offers complete coverage with no heat required. The Next Generation Zirconization generates virtually no sludge and cuts chemical usage. Paint adhesion and corrosion resistance are superior to alternatives.

### DuPont Industrial CoatingSolutions

Booth C2542

#### Abcite® by Thermoclad

DuPont™ Abcite® thermoplastic powders have been specifically formulated as a tough, chip-resistant finish providing excellent corrosion and UV protection without the need for a primer.

#### Alesta® AR (Architectural)

Alesta® AR powder coatings meets and exceeds the rigorous requirements of AAMA 2603, AAMA 2604 and AAMA 2605.

#### Alesta® RAL HAA

Alesta® RAL HAA powder is designed for decorative and protective applications; formulated to provide excellent weathering performance and transfer efficiency, designed to meet AAMA 2603 specifications and recommended for indoor or outdoor applications.



# CHEMICAL COATERS ASSOCIATION INTERNATIONAL

The Education & Information Network for the Finishing Industry

## Visit us in booth C1948

Training Manuals for Finishing • Custom Coater Showcase • Chapter Information • Membership Information

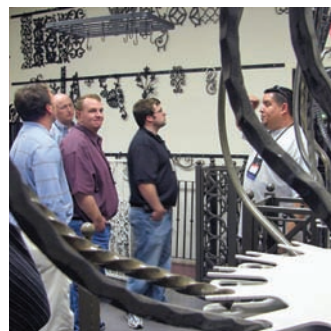
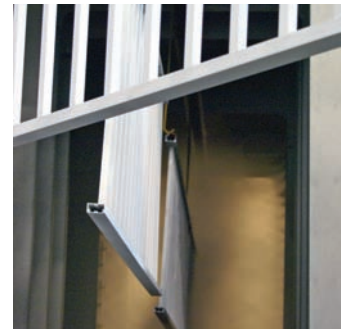

**WE ARE BUILDING A BETTER FINISHING INDUSTRY!**



**JOIN ONE OF OUR CHAPTERS TODAY:**

Atlantic Coast • Central States (Kansas City)  
Iowa/Central Illinois • Greater Cincinnati • Las Vegas  
Northern Illinois • Portland • Southern California  
Texas • Twin Cities • West Michigan • Wisconsin

North America's Largest Metal Forming, Fabricating,  
Welding and Finishing Event

[WWW.CCAIWEB.COM](http://WWW.CCAIWEB.COM)





## Finishing

### EXEL North America

Booth C2264

#### Kremlin Rexson PU3000 Plural Component Electro-Mec

The PU3000 incorporates a unique plug and play concept for mixing two component paints. The pulse free control technology delivers pulsation free performance for improved quality of mixing and application.

### Graco Inc

Booth C2350

#### Pro Xp Electrostatic Guns

Pro Xp expert performance electrostatic guns combine the benefits of material savings and excellent finish quality into a smaller and lighter gun body, making it easier to spray. Other Pro Xp features include an ergonomic handle for operator comfort, built in power supply to reduce operator fatigue and aircaps that use less air to lower your energy bill. Every gun is tested and delivered with a certificate indicating the spray pattern, mechanical performance and electrical performance.

#### ProControl 1KE Fluid and Air Management System

The ProControl 1KE actively manages fluids and air pressure to lock in precise spray parameters. Graco's fluid and air management system monitors fluids, and has added controls to manage fluids and improve spray performance.

#### E-Flo Dual Control Electric Circulating Pumps

The E-Flo DC is an energy efficient electric pump for medium sized circulation systems. The design allows users to get all of the benefits of a pneumatic air motor, with the efficiency of an electric motor. This electric pump can maintain constant pressure like a pneumatic pump by speeding up or slowing down if it detects a change in pressure, resulting in a smooth and even flow. It also features local control, and no VFDs are required for installation.

### Hangzhou Xiangsheng Abrasive Machine Manufacturing Co., Ltd

Booth C7142

#### SB1000 Two-Side-One-Pass

SB1000 can do rounding interior and exterior

contours and preserves the galvanized surface or protection film on parts.

### Hubbard-Hall Inc

Booth C2156

#### Iron Phosphate Alternative

Hubbard-Hall Inc. introduces cost effective, low temperature zirconium based conversion coatings that replaces iron phosphate solutions with several added benefits.

### Inline Sieve

Booth C2552

#### Sieve for Box Feeders

The Inline Sieve is an improved powder delivery system, delivering high density powder at a low velocity, now made to work in both fluidized hopper or box feeder.

### IntelliFinishing

Booth C2528

#### Shuttle

Save floor space when finishing large parts using the IntelliFinishing shuttle. Customers have decreased floor space by approximately 40% with the use of the shuttle for moving long parts.

### KCI America Co Ltd

Booth C2062

#### 301 Manual Coating System

CKI American Co Ltd offers its KCI-300 series which features an innovative design with four pre-programmed control options to coating a variety different project needs.

### Metcast Service Tech Resources

Booth C6946

#### e-Wheel Technology

The e-Wheel™ is the next evolution in blast wheels. Designed for upgrading existing wheel units and provides improved performance, lower maintenance costs, improved motor life and a patented Nucklesaver™ tool that makes it the easiest wheel to maintain.

### Michigan Pneumatic Tool Inc

Booth N6034

#### MP-5667VS-ORANGE

The MP-5667VS-ORANGE (3HP) and the MP-6666VSC-ORANGE (4HP) vertical grinders are tools for metal removal jobs including scale, rust, and weld splatter removal.

### Midwest Finishing Systems Inc

Booth C2526

#### Spray Wand Stations

Midwest Finishing offers the quality and performance found in its larger systems to the line of customizable spray wand stations. The innovative design offers a cost-effective, all-in-one cleaning and pretreatment solution.

### Nordson Corp

Booth C2517

#### Encore LT Hopper and VBF Systems

Nordson Corp introduces its manual powder coating mobile hopper and vibratory box feeder systems.

#### Encore LT Transportable System

Manual powder spray gun demonstration system.

#### Encore PE System

The Encore PE auto gun features a straight-through powder path and electrode air-wash and deflector design. The gun is lighter weight and better balanced for improved operator control. Its higher 100 kV electrostatic voltage output charges powder more effectively for better transfer efficiency.

#### OptiMix Plural Component Systems

Plural component metering systems.

#### Stedi-Flo Liquid Pumps

Liquid pumps.

#### Trilogy Non-Electrostatic Liquid Spray Guns

Non-electrostatic liquid spray guns.

### Norton Abrasives

Booth N2610

#### BlueFire™ Product Line

Norton Abrasives has implemented a performance upgrade across its better tier of metal fabricating abrasives products for portable grinding applications. Sub-branded as Norton BlueFire™, these product feature a performance zirconia alumina grain.

#### RapidPrep™ Non-Woven Line

Norton Abrasives introduces the Norton RapidPrep™ line of non-woven discs, belts and wheels. The RapidPrep line features innovative grain technology, providing significantly improved finishes, cutting rates and wear life.





## Osborn Booth N3309

### TY™ Encapsulated Stringer Bead Brushes

The refined TY™ encapsulated stringer bead brushes were developed by Osborn, in conjunction with leading offshore pipeline companies to quickly and effectively clean J-weld joints.

## Parker Ionics/Parkwood Engineering Booth C2523

### Q-MCB Very Quick Color Change Booth Technology

The Q-MCB color change booth technology features color changes in 5-9 minutes. Advanced air flow design within the booth minimizes powder accumulations making color changes quick and easy. The MBF Powder Kitchen features easy, automatic operation and cleaning. Application efficiencies of up to 97.8% are achievable using Q-MCB booth technology.

## Penn United Technologies Inc Booth C1420

### Metal Finishing Services

Penn United Tehnologies Inc's plating department offers cleaning, coating and plating services to both customer and our in-house metal manufactured products.

## Pretreatment Equipment Mfg Inc Booth C1962

### SprayLean Inline Washer and Pretreatment System

Perfect for today's new non-phosphate products, SprayLean features a small footprint and a modular, interchangeable pod design that's easily expandable for any application or future process changes. SprayLean offers easy access to tanks with our removable shroud design. The modular design provides for fast installation with very low maintenance and low energy consumption.

### P400 Spraywand Pretreatment Application System

PEM is proud to introduce the P400 Spraywand pretreatment system. The P400 offers a sustainable, improved environmental footprint over conventional spraywands.

## Production Systems Inc Booth C1858

### Multi-Cycle Cabinet Washer

Production Systems Inc introduces its single compartment multi stage parts washer. The washer can process parts up to 40" W x 90" H x 96" L PLC controlled for cycle sequence and cycle timing and is offered in an 88" W x 12' L foot print. Stainless steel construction for long life.

## Sherwin Williams Booth C1956

### Powdura - Satin Sheen in RAL Colors

The addition of satin sheen powder coatings in RAL colors to our family of Powdura® powder coatings. Sherwin-Williams now offers 188 RAL colors available in both satin and high gloss finishes, all with super durable TGIC-free polyester technology.

## Timesavers Inc Booth C6340

### Minibelt Machine

The Minibelt Machine from Timesavers is an efficiently sized, power-packed and inexpensive automated deburring solution. Now a company can automate its deburring at a very low price.

## TWN Industries Inc Booth C2446

### Wildfire Camouflage by Moon Shine Attitude Attire

Wildfire Camouflage™ water transfer printing film is the latest pattern created by Moon Shine Attitude Attire™, a designer brand of casual wear for outdoorsmen and women. The pattern depicts a forest condition never before represented as a camouflage with a yellow and orange inferno engulfing the woods. Bold color and strong attitude make this pattern a noticeable lifestyle look.

## Wagner Industrial Solutions Booth C1951

### WAGNER PEM-X1

The PEM-X1 powder gun from WAGNER has a sleek ergonomic design and innovative technology changes.

## Walter Surface Technologies Booth N2628

### ENDURO-FLEX™

A proprietary abrasive grain blend increases ENDURO-FLEX™ flap disc life by more than 50% and is structured to deliver consistent metal removal throughout the life of the flap disc. ENDURO-FLEX™ features a patented backing that can be trimmed to expose fresh abrasive flaps without producing dust. ENDURO-FLEX™ also offers smooth grinding with minimal vibration.

## Wendt USA LLC Booth N2606

### FleXtreme™ Flap Disc

The FleXtreme disc features a backing that wears down evenly with the flaps and eliminates trimming and reduces material costs by using more of the abrasive material.

## Gases & Gas Equipment

## ESAB Welding & Cutting Products Booth N3922

### Oxweld and Purox Elite Series

The line of Oxweld and Purox Elite products feature the top-of-the-line quality, performance, and durability while adding updated safety and design features, all at a competitive price.

## REXARC International Booth N1515

### Portable Gas Distribution Center

Rexarc's portable gas distribution centers have portability for work on the go. Flexibility to be customized to your specific needs.

## Hydroforming

## Interlaken Technology Booth C947

### Multi-Functional Hydroforming Press

An all-in-one Hydroforming and Warm Forming Press System for production manufacturing and metals research.

## Triform Sheet Hydroforming Booth C1226

### 32-10-12SC Deep Draw Sheet Hydroforming Press

Triform announces its latest and largest Deep Draw Sheet Hydroforming press to-date. The 32-10-12SC features a 32" diameter forming area, 10,000 PSI maximum forming pressure and a 12" stroke for deep drawing parts up to 13" in depth.

## Hydroforming

### Triform Sheet Hydroforming Booth C1226

#### Tray-Style Sheet Hydroforming Presses

Triform introduces two sheet hydroforming models in tray formats. The 1648BD features a 16"x48" envelope, and the 2448BD, a 24"x48" envelope. Both presses deliver standard pressure up to 5,000 PSI, with an option for 10,000 PSI.

## Inspection & Testing

### Carestream Booth N2426

#### Industrex Digital Viewing Software v4.1

The Industrex digital viewing software is Diconde compliant. Features include: fast and accurate image acquisition, simple, effective analysis tools, flexible data management system, simple interface, remote access and secure data storage and retrieval.

### Danatronics Inc Booth N1418

#### EHC-09A, Hand-Held Ultrasonic Thickness Gage

Danatronics is pleased to announce the EHC-09A, its entry level ultrasonic thickness gage packed with many features previously available such as: two point calibration, in mm and usec, graphic display with multi-language support, field upgradable option for echo to echo ignore coatings, 100k datlogger with export to excel, A-scan and B-scan, two year warranty, made in the USA.

### InterTest Inc Booth N5824

#### iShot Weld-i Zoom Automated Weld Monitoring System

Zoom in to view real time detailed color video images of your welding process. The zoom capability allows you to place the camera head far enough back so it is protected from the harsh conditions around the torch head.

### KoCos America LLC Booth C2223

#### OMCAT Catalytic Converter Measuring System

The KoCoS OMCAT catalytic converter measuring system provides a fast and efficient means of carrying out complex geometrical measurements and determining the gap bulk

density (GBD) of automotive catalytic converters. The measurement results are automatically passed on to manufacturing machinery for production process control.

### Laboratory Testing Inc Booth C2310

#### Fracture Toughness Testing

LTI offers fracture toughness testing to ASTM E399 & E1820 to measure conditions causing a crack in material to lengthen when subjected to a load. Specimens in a range of sizes can be tested to 55,000 lbs. of force at temperatures from -150° F to +350° F.

### Melttools LLC Booth N1618

#### MeltView DART Camera for Welding

The MeltView DART is a high dynamic range camera for monitoring welding up close. Combining superior image quality with small size and ruggedized features, the DART delivers real-time, recordable video of GMAW, GTAW, PAW and other processes.

### Meta Vision Systems Inc Booth N5015

#### Weld Bead Detection for Pipe Coating Control

Meta Vision Systems innovative smart laser sensor weld bead detection system for pipe coating control saves money by optimizing the amount of coating material applied while guaranteeing the right amount of coating thickness

### Metronor Inc Booth C453

#### MetroArm

The virtual arm is a portable coordinate measuring system. Features include: handheld probe, no arms or pedestals, point & measure in seconds, no moving parts or joints, robust, reliable & accurate, easy & effortless to operate, affordable & complete.

### Servo-Robot Inc Booth N5907

#### SPARK

SPARK is an arc process viewing and monitoring system produced by Servo-Robot.

### Shantou Inst of Ultrasonic Instruments Co Ltd (SIUI) Booth N2715

#### SUPOR Ultrasonic Flaw Detector

SUPOR is a phased array and TOFD flaw de-

tor with modular design. Features include: 8.4" LCD monitor with resolution 800 x 600 pixels, modular design with different combination for selection, touch screen operation and up to 6 hours operation.

### Starrett Bytewise Measurement Systems Booth C3453

#### Profile360 G3

Starrett-Bytewise measurement systems announces the introduction of the Profile360 Generation3 in-line profile measurement System. The sensors inside the Profile360 G3 have been re-engineered around higher-resolution detectors that are produced in its advanced calibration laboratory.

### Xiris Automation Inc Booth C2312

#### XVC-O Welding View Camera

Xiris introduces the XVC-O, which can be mounted right at the welding tip to allow the operator to remotely view and monitor the welding process, including MIG, MAG, TIG, plasma and laser welding applications.

## Job Shop/Contract Manufacturing

### Chelar Tool & Die Inc Booth C349

#### Bridge Mill Technology

Chelar Tool & Die has acquisitioned a large double column bridge mill in order to meet customers' expectations of short lead times and fast turnarounds.

## Lasers

### Amada America Inc Booth C3916

#### FOL3015AJ Fiber Laser

The FOL3015AJ is engineered to produce the highest quality parts at unmatched speed while reducing operating costs and environmental waste. Benefits include: faster cutting of thin material, superior speed and edge quality in material thicknesses up to 7/8" P.R.E., rapid traverse speeds of 13,380"/min. and a 5G acceleration speed for the entire work envelope.



## Bystronic Inc

Booth C4328

### BySprint Fiber 3015

The BySprint Fiber 3015 offers unprecedented parts output in the thin sheet range yet powerful enough to cut steel up to 3/4" thick with high process reliability and precision. Benefits include lower operating, maintenance and energy costs.

## Enutron International

Booth C7750

### Adira LP Laser

The Adira LP Laser is the latest evolution of laser-cutting technology. Featuring high-speed linear drives resulting in unmatched acceleration and dynamics, allowing for a faster and more efficient cutting process.

## Ermak USA

Booth C3447

### FIBERMAK Linear Drive Fiber Laser Cutting Machine

Meeting with the FIBERMAK™, fast, accurate, smooth ERMAK™'s high-tech fiber laser cuts mild steel up to 3/4" thickness with max precision and exceptional quality in a fast paced manufacturing environment.

## Haco-Lasit

Booth C3440

### Haco Cutlite Laser Cutting Systems with Automation

Laser Cutting Systems ( Fiber and CO2 ) 1- 6 KW . High speed linear motor with dual pallet exchanger and optional fully automated tower storage and delivery system for 24/7 production.

### Tower Mark

Hasco-Lasit introduces its Tower Mark, laser marking with pneumatic door , compact footprint fiber or CO2 , XYZ and rotary.

## Hypertherm Inc

Booth N3906

### HyIntensity Fiber Laser HFL030

Hypertherm introduces its most powerful fiber laser yet, a 3.0 kilowatt system. This system joins its Hypertherm siblings as the first fully integrated fiber laser system specifically designed for cutting.

## Laser Mechanisms Inc

Booth C3810

### FiberCut RAc Laser Processing Head

For 3D robotic cutting with a fiber-coupled la-

ser, the FiberCut RAc is a compact, low moving mass processing head. All connections enter at a right angle for tight part access, easy cable routing and stress reduction on the input fiber.

## LaserStar Technologies Corp

Booth C5647

### FiberStar Open Laser Marking System

FiberStar's Class 4, integration laser marking systems offer the benefits of a direct metal marking, non-contact, abrasion-resistant, permanent laser marking onto almost any type of material.

### Industrial Laser Marking Systems

The 3803 series industrial FiberCube® is a compact, turnkey laser marking, laser engraving and laser cutting system that offers the benefits of a non-contact, abrasion-resistant, permanent laser mark, laser engraving, or cut onto almost any type of material.

### Laser Marking, Engraving & Cutting Systems

The FiberCube® laser marking system (3801 Series) is a compact, turnkey laser marking system that offers the benefits of a non-contact, abrasion-resistant, permanent laser mark, engraving, or cut onto almost any type of material.

### Laser Welding System for Mold Repair

LaserStar's 7700 series with universal jig open workspace laser laser welding workstations are ideal for a wide range of unique and custom integration applications to meet the various demands of metal joining, complex assembly, and repair applications.

### Manual Laser Welding Systems

1900 series LaserStar industrial welding workstations are ideal for a wide range of metal joining, complex assembly, automation and repair applications for the industrial marketplace.

### Multi-Purpose Laser Welding Workstations

Integrated turn key laser welding solutions LaserStar Technologies offers a wide range of standard and custom laser welding workstations to meet a variety of precision spot and seam laser welding applications.

## LVD Strippit

Booth C3937

### Touch-L

LVD Strippit introduces Touch-L, a touch screen graphical user interface for select models of its laser cutting systems. Touch-L simplifies laser cutting by using intuitive graphical icons and visual indicators to display and control functions.

## Mazak Optonics Corp

Booth C3428

### OPTIPLEX Fiber Laser-cutting System

The OPTIPLEX 3015 Fiber laser processes reflective materials, such as copper, brass, aluminum and exotic aerospace materials, with greater speeds and thicknesses than its CO2 counterpart.

## MC Machinery Systems Inc/ Mitsubishi

Booth C3040

### NX-F Fiber Laser

Model 3015 NX-F features include: stroke (X x Y x Z): 125.9" (3198 mm) x 62.9" (1598 mm) x 4.7" (119 mm), rapid traverse rate (per min.): single axis, 4724" (120 m); simultaneous 6680" (170 m), positioning accuracy: 0.0019/20" (0.05/500 mm), repeatability: ± (X, axis Y) ±0.00039" (0.01 mm).

## TeraDiode Inc

Booth C8523

### TeraBlade 2kW High Brightness Direct Diode Laser

TeraDiode introduces its first multikilowatt high brightness direct diode laser source, featuring 2kW from a 100 micron fiber and a BPP of 4mm-mrad. This 970nm laser has a wall plug efficiency of 40%, exceeding the efficiency of fiber & disk lasers.

### TeraBlade 500W High Brightness Direct Diode Laser

TeraDiode introduces its high brightness 500W direct diode laser source, featuring a 50 micron fiber and a BPP below 4mm-mrad. This 970nm laser has a power conversion efficiency near 50%, well above comparable fiber lasers.





## Lasers

### TRUMPF Inc

Booth C3016

#### TruLaser 5030 fiber/5040 fiber with TruDisk 5000

The TruLaser 5030 fiber with 5kW TruDisk laser is a high powered solid-state 2D laser cutting machine and can cut mild steel up to 1" thick. When cutting with nitrogen, speeds can increase as much as 149% over the 3kW TruDisk 3001.

### Wayne Trail, a Lincoln Electric Company

Booth N4513

#### FLEX LASE PRO

The FLEX LASE PRO from Wayne Trail, is a high-speed scanner based laser processing solution that is ideal for laser etching, surface treatment, welding, marking, cutting and more.

## Lubrication

### Chemetall US Inc

Booth C2709

#### Tech Cool 35630 Synthetic Coolant

Chemetall's latest coolant is Tech Cool® 35630, a full synthetic product that is the perfect balance of performance, versatility and is effective on all substrates.

### Cimcool Fluid Technology

Booth C1452

#### CIMMILL™

CIMMILL™ fluids, designed to meet the tube and pipe industry challenges are formulated to offer trouble-free performance and increase productivity by up to 20%. CIMMILL™ fluids offer excellent lubricity, rust protection, foam control and extend sump life.

### Fuchs Lubricants Co

Booth C1517

#### Eco Draw HSS 2900

Eco Draw HSS 2900 is a petroleum-free stamping lubricant designed to address the growing complexities of the automotive metalforming industry.

### Industrial Innovations Inc

Booth C836

#### Zero Drip Die Mount Nozzle Assembly

The patented 99.5% drip free, Z series nozzles cut down on die setup time and cost. Addi-

tional features include: easily mounts to die, no moving parts or wasted lubricant, precise application control, light weight construction, universally adjustable and numerous spray patterns.

### Metalloid Corp

Booth C1447

#### ADVANCE 6325

Metalloid Corporation's ADVANCE 6325 is a VOC free green vanishing lubricant for light to medium duty forming operations. ADVANCE 6325 offers multi-metal compatibility, fast vaporization, excellent lubricity and meets the SCAQMD.

#### ENDFORM 5331

ENDFORM 5331 is a synthetic biodegradable lubricant. ENDFORM 5331 offers multi-metal lubrication, ultra low surface tension, easy cleaning and more. This green product is great for stainless steel end forming and meets the SCAQMD requirements.

#### METCOR 52

Metalloid Corporation's METCOR 52 is an oil free, biodegradable, indoor corrosion preventative for all metals. It allows for long term indoor protection, dry transparent film, is easy to clean off and more. METCOR 52 meets the requirements of the SCAQMD.

## Maintenance & Repair

### CoreTemp

Booth N6236

#### Turbo Flap Discs

Turbo High Density flap discs built-in training video right on the label.

### Richardson Electronics Ltd

Booth C3721

#### Bellows & Dust Collection Filters

Richardson Electronics now offers replacement bellows for CO2 lasers and replacement dust collection filters for Handte and Keller systems that are used with CO2 lasers.

### Scotchman Industries Inc

Booth C4923

#### Electric Stroke Control w/Remote Elect. Foot Pedal

The 50-ton electric stroke control with remote electric foot pedal option includes factory installation, two electric limit switches for accurate and consistent repeatability, and a remote foot pedal.

## Material Handling/Marking

### Demag Cranes and Components

Booth C560

#### DCS-Pro Chain Hoists

Demag's innovative DCSPRO chain hoists are 3 phase AC powered and offer optimized safety and efficiency, best-in class features and convenient operation.

### Haco-Lasit

Booth C3440

#### Marking Laser System- Gantry

Haco Lasit USA offer laser marking with more automation, smaller footprint and full gantry which allows for greater production and greater accuracy. Palletized pick and place, can be XY, 1/2 gantry and full gantry.

### Magnetic Products Inc

Booth C5510

#### Eco-Flow Magnetic Coolant Cleaner

MPI's Eco-Flow magnetic coolant cleaner boasts a significant improvement in ferrous swarf capture rate as compared to other magnetic filtration systems.

### MegaFab-Piranha-Whitney-Bertsch

Booth C5113

#### Whitney Automation

Automate your Whitney machine. Eliminate material handling bottlenecks, increase in-process time, simplify loading and part removal. Automation features include: PlatePARTNER and Plate PARTNER gantry, skeleton removal table, PartHANDLER II and conveyor feed loader and unloader. Whitney offers automation solutions for all sizes and combination machines.

### Mighty Hook Inc

Booth C2420

#### Angle Pivot System

The Angle Pivot System is a patented technology that allows significant improvement in line density losses due to conveyor elevation changes. Depending on the degree of slope, line density can improve by up to 50% with ROI in the 6 month to 1 year period.



## Richards-Wilcox Inc

Booth C2252

### E-Chain High Performance Chain

e-Chain is a high performance conveyor chain suitable for new conveyor systems or replacement chain applications and features a unique patent-pending caged bearing design.

## Samuel Strapping Systems

Booth C1524

### Fully Automatic Stencil System

Fully automated Inkjet Stencil System for panels & lumber.

## U-Mark Inc

Booth N2406

### M15 Permanent Marker

U-Mark Inc offers the M15, its all-purpose permanent ink marker. Great for industrial and professional use.

## Versatility Professional Tool Storage, LLC

Booth C1248

### Press Brake Cabinets

Versatility Professional Tool Storage offers its line of press brake cabinets for tool storage for sheet metal fabricators.

## Metal Suppliers

## AMETEK Specialty Metal Products for Fab

Booth C914

### Ti 6/4 ELI (Grade 23) Strip

AMETEK Specialty Metal Products introduces Ti 6/4 ELI (Grade 23) strip as thin as 0.004" with outstanding performance characteristics.

## Benxi Guangzheng Tungsten & Molybdenum Co Ltd

Booth C456

### Molybdenum Products

Molybdenum products are mainly used in vacuum furnace parts, lighting material, heater, semiconductor parts, LED etc.

## Cambridge Lee Industries LLC

Booth C8333

### Copper Shapes and Tellurium Copper Rod and Bar

Cambridge-Lee mill offers copper shapes and tellurium copper CDA 145 rod and bar. Also large copper ETP 110 and OFE 101 bus bar smallest to largest cross sections available, all drawn to size. Edges include: square, radius, full round, silver plated.

## Liaoning Longyuan Industry Co Ltd

Booth C455

### High Carbon Steel Shot

## Other Machinery/Equipment/Parts/Products

## Anomatic Corp

Booth C2452

### Double Anodized Closure

Highly aesthetic dispensing anodized aluminum closure assembly.

## Desch Canada Ltd

Booth C1235

### Servox DS

The Servox DS offers flexibility in terms of output torque, gear ratio range and motor variation. The output torque is transmitted via planetary gearing. Depending on the geometric conditions, between two and four servo motors can produce the drive on the input side. Flexible combination of the gear ratio/number of motors offer a broad range of applications. The gear ratios range from 4 to around 48.

## Diamond Ground Products Inc

Booth N5726

### Piranha Tungsten Electrode Grinder Upgrade Kit

Piranha upgrade kits can be used on older model Piranha tungsten grinders to enable grinding tungsten as short as .75" (19.05mm).

## DuBois Chemicals

Booth C4938

### treo® Jel D Water Reducible Gel Degreaser

Dubois introduces its treo® Jel D, a water reducible gel degreaser that is ideal for tough general purpose industrial cleaning.

## ERIEZ

Booth C7316

### SumpDoc™

The SumpDoc™ is an all-in-one portable fluid recycling system that will completely filter and rejuvenate metalworking fluids in a machine tool sump without interrupting production.

## Formtek Metal Forming & Hill Engineering

Booth C3708

### QVW-150 Forming Mill Integration

Lamnea Bruk, a manufacturer of flux core wire equipment has integrated the Yoder QVW-150 forming mill into its manufacturing system.

## General Automatic Transfer

Booth C2550

### Batch Oven

General Automatic Transfer offers 18 sizes with enhanced and improved air circulation, heater locations, and PLC control. In addition, 6'x6', 8'x8' and 10'x10' clear door openings with 10' deep to 30' deep in 4' increments.

## LPI Inc

Booth C2424

### LPI Vertical Access Lift (VAL-10)

LPI's vertical access lift, the VAL-10, is suitable for commercial/industrial trades, maintenance, and construction applications, and facility and equipment servicing and repair.

## Messer Cutting Systems

Booth C5916

### SmartLifter

Messer Cutting Systems introduces the SmartLifter for use with plasma or oxyfuel torches.

## MJC Engineering & Technology Inc

Booth C1156

### F450.2000-4 Flow Former

The F450.2000-4 flow former is designed utilizing four forming rollers to provide more power and stability providing increased efficiency.

## MTM Meissner Technik Mullenbach GmbH

Booth C2155

### FLEX-CELL

The patented MTM-FLEX-CELL processing cell offers the capabilities of common robot cells for deburring, where a wet robot is needed, while only requiring a non-wet robot placed outside of the wet cell to use its whole benefits and flexibility.

## Other Machinery/ Equipment/Parts/Products

### MTM Meissner Technik Mullenbach Gmbh

Booth C2155

#### Round Cycle Cleaning Systems

MTM Meissner Technik Mullenbach Gmbh introduces its patented MTM round-cycle cleaning system with highly efficient hood technology to the U.S. market. Different process steps can take place simultaneously and therefore short cycle times with high cleanliness requirements can be realized.

#### ROBOTAKT

The patented MTM-ROBOTAKT is an end cleaning system that combines the benefits of round-cycle systems like short auxiliary & cycle times, all times precise item-positioning and concurrent process steps with the flexibility of common robot deburring cells.

### Packsize LLC

Booth C1336

#### iQ FUSION

The iQ FUSION is a multi-patented, corrugated converting machine that gives material handling departments more opportunity by presenting a smaller footprint for On Demand Packaging™.

### Prodim USA

Booth C8521

#### Proliner 10

Proliner 10 is the ultimate measuring tool. It can measure up to 60' from one location.

### Scrape-N-Burr

Booth N1316

#### Scrape-N-Burr

The Scrape-N-Burr is a heavy duty scraper specifically designed for cleaning operations in the harsh world of welding and metal fabrication. This tool is made to stand up to the hard use and rough environments in facilities.

### Unipunch Products Inc

Booth C3732

#### 5202 Quick Die Change and Clamping System

The UniPunch 5202 quick die change template mounting system is designed as a universal press platform for reducing setup time during part change over.

### Vibro Dynamics Corp

Booth C1012

#### Custom Elastomeric Vibration Isolation System

Vibro Dynamics Corp introduces its custom elastomeric vibration isolation pad systems specifically engineered for each machine and application.

### Vicon - Plasma Automation Inc

Booth N5031

#### Fabricator SS High Density Plasma System

Vicon - Plasma Automation Inc offers a heavy duty, high density plasma cutting system available with choice of plasma power supply for cutting up to 1", and or oxy fuel for cutting up to 2". Dual high speed motors enabling traversing speed of up to 2000 ipm.

### Worlee-Chemie GmbH

Booth C1964

#### Thermal Insulating Coating

Krautzberger spraying unit for thermal insulating coating.

### Yestool/Aloris-USA

Booth C8310

#### KRUZ-SLK Drill Body & IDFK Carbide Insert

The RUZ drill body & IDFK carbide insert are designed specifically for the structural drilling market. Inserts have special double angle cutting edges that decrease flexing when under pressure.

### Zerust Corrosion Solutions (Northern Tech Intl Corp)

Booth C1014

#### Zerust ActivPak Corrosion Inhibiting Diffuser

Drop-in flash-corrosion inhibitor.

## Plate & Structural Fabricating

### AGT

Booth N2333

#### BeamMaster

The BeamMaster, an automated steel beam assembler and welder, is for small batch and lot-of-one production. Targeted for structural steel fabricators, this equipment uses industrial robots and 3D vision with self learning technology.

### Centricut

Booth C4935

#### Centricut CoolFlow nozzles for Komatsu Raser

Centricut brings CoolFlow nozzle technology to Komatsu Raser 40 and Raser 90/120 systems. CoolFlow technology applied to Komatsu nozzles results in reduced leaking and extended consumable life.

### Faccin USA Inc

Booth C6323

#### PGS Ultra CNC Control (v2012)

Faccin USA Inc introduces its PGS Ultra CNC control for four roll machines. Complex shapes (including customizable ones), multi-radius parts, cones and more are all included as are tools to correct for plate inconsistencies.

### Ficpe Corporation

Booth C6550

#### Gemini 36 HD

CNC plate processing system for cutting, drilling, tapping, countersinking, milling and weld preparation.

### Hypertherm Inc

Booth N3906

#### Hypertherm Powermax105®

The Powermax105 is a 105 amp air plasma system for hand and automated cutting and gouging designed to comfortably cut 1¼ inch (32 mm) thick metal, and sever metal up to 2 inches (50 mm) thick.

### MegaFab-Piranha-Whitney- Bertsch

Booth C5113

#### High Speed Drilling System

MegaFab-Piranha-Whitney-Bertsch offers high a performance drilling system that can be used in conjunction with punching, plasma-cutting, and/or marking on Whitney combination machines.

### Pacific Aerospace & Electronics

Booth N1607

#### Galvanic Corrosion Resistant Maritime Components

Explosively bonded metals are produced with a solid-state welding process that uses controlled explosive energy to join two or more otherwise incompatible and/or exotic materials at the molecular level.





**Trilogy Machinery Inc**

Booth C5140

**SUNRISE ANC - Fully Automatic Punching System**

The SUNRISE ANC combines a dual-cylinder ironworker or punching machine in tonnages up to 220 US tons, with up to a 20' single-axis fully automatic CNC in-feed system for punching flat bar, angle and channel webs.

**Uni-Hydro Inc**

Booth C8537

**Uni-Hydro Super Turret**

Uni-Hydro Inc introduces its 56 ton super turret that has a single end punch, notching station, structural shearing station, flat bar shear station and a 56 ton six station turret all in one machine.

**Press Brakes**

**Amada America Inc**

Booth C3916

**HD-ATC**

Amada introduces the HD press brake with automated tool changer.

**Bystronic Inc**

Booth C4328

**Xpert Press Brake**

The Bystronic Xpert press brake is equipped with a comprehensive database in material bend allowances and extensive empirical bending knowledge. Xpert options: FastBend + safety system, energy saver, optical bend guiding, LEDs and a laser angle measuring device.

**Punching**

**Lambie Engineering LLC**

Booth C4850

**Right Sized Handle Hole Punch**

This pneumatic machine punches holes in a line of pots and pans for the handle attachment.

**MegaFab-Piranha-Whitney-Bertsch**

Booth C5113

**The Piranha P2 Ironworker**

Piranha 50 ton ironworker model.

**Murata Machinery USA Inc**

Booth C3028

**Automated Machines**

Murata Machinery USA, Inc. offers automated turret punch presses including the Matorum 2048ST, the 3048, the SL-1250 and the FG-1250.

**Squeeze more from existing machines.**

Make **RETROFITS** easy as **1,2,3.**

1. **Connect** efficiently to transducers and fieldbuses. Simulate to speed setup and testing.
2. **Control** electric, hydraulic and pneumatic closed-loop motion smoothly and precisely.
3. **Optimize** swiftly with motion wizards and graphs for more throughput and machine life.



1-2 Axis

Multi-axis

**RMC75 and RMC150 Motion Controllers**

- 1, 2, or up to 8 axes
- User programs control position and pressure/force
- Wizards for quick, easy setup and tuning
- EtherNet/IP, PROFINET and PROFIBUS connectivity

Call 1-360-254-8688 or choose your controller at [deltamotion.com](http://deltamotion.com)

**DELTA**  
COMPUTER SYSTEMS  
Motion Control



SEE US AT FABTECH, BOOTH C1024



**DALE BATES**  
V.P. / GENERAL MANAGER

**YOUR**  
**SWAGE**  
**CRIMP**  
**PIERCE**  
**SPIN**  
**EXTRUDE**  
**BEAD**  
**REDUCE**  
**BEND**  
**FORM**  
**ROLL**  
**CLOSE**

**EXPERTS**



**EARL HAAS**  
ENGINEERING MANAGER

Visit us in Booth C2225

**OVERTON INDUSTRIES**  
TUBE-FORMING SOLUTIONS

*Designers and builders of special machines and tooling for tube and pipe end form applications*

**CALL US TODAY AT**  
**317-736-7700**

2155 McClain Drive  
Franklin, Indiana 46131  
[www.overtonind.com](http://www.overtonind.com)



## Resistance Welding

### Centerline (Windsor) Ltd

Booth N1926

#### FlexGun Welding Guns

Compact, modular spot welding guns.

### Dengensha America Corp

Booth N5722

#### E-Series MFDC Welder

The NDZ E-series MFDC welder features advanced controls for lower weld currents and better heat efficiency, making it suitable for welding thin steel plates. The E-series also reaches maximum current levels faster, creating stronger projection welds.

## Robotics

### ABICOR Binzel Corp

Booth N5508

#### ABIDOT

Robotic welding TCP programming aid.

#### Scansonic AL01 and AL03

Scansonic adaptive laser processing optics for brazing and welding provided by ABICOR Binzel. AL01 (brazing) & AL03 (brazing and welding) products offer a variety of processing options for various laser platforms & materials including aluminum.

#### TH6D Seam Tracking Sensor System by Scansonic

A solution for hard to follow seams in automated processing of laser & arc welded materials. 3DI scanning allows this package to be effective in processing reflective surfaces like aluminum & stainless steel.

### Abtex Corp

Booth C7547

#### Robotic Deburring and Polishing

Abtex custom designs, engineers and integrates each robotic deburring system to customers needs and specifications.

### HAI Advanced Material Spec

Booth N2319

#### AUTOCote

Automated thermal spray cell system.

### Motoman Robotics Division

Booth N5222

#### MC2000 Robot

The Motoman® MC2000 Master Cut robot is designed with high rigidity and precision

drives to provide superior path accuracy for laser cutting small holes and sharp corners. Path accuracy can be within 0.1 mm, depending on the application.

### Nachi Robotic Systems Inc

Booth N3622

#### SRA Robot

The Nachi SRA robot series features payloads of 100kg to 210kg that can be handled at best in class speeds. Reach of the SRA Robot is available from 2.6 to 3.1 meters.

### Rethink Robotics

Booth N1313

#### Baxter

Baxter is a revolutionary category of robot that is redefining the way robots can be used in manufacturing environments. Affordably priced, versatile and safe enough to work alongside people, Baxter is an ideal solution for companies of all sizes.

### Robotiq

Booth N6119

#### 2-Finger Adaptive Gripper

The 2-finger adaptive gripper is an electric gripper which provides unique versatility in handling a wide variety of parts through 3 different gripping modes, high payload to weight ratio coupled with a compact form factor and precise control on fingers' position, speed and force.

### Universal Tool & Engineering

Booth C1839

#### Robot Tube Bending Work Cell

Universal Tool & Engineering introduces its complete turn key tube bending work cell which includes: bulk tube loading, seam detection and placement, robot tube placement, CNC mandrel tube bending and robot unloading.

### Wolf Robotics LLC

Booth N4910

#### LeanArc Options

Wolf Robotics' introduces its line-up of Lean-Arc® welding cells, featuring increased capabilities, new positioner options and more.

#### Robotic 3D Cutting and Welding

Wolf Robotics offers options to switch between arc welding, pre-heat and cutting processes, all using the same robot equipped with precision tool changers.

#### Quick Change Tooling

Wolf Robotics is proud to introduce Smart-

Dock™, a secure and quick method for interchanging tooling on robotic positioners.

### Yaskawa America Inc

Booth N5222

#### Motoman MC2000 Robot

The Motoman® MC2000 Master Cut robot is designed with high rigidity and precision drives to provide superior path accuracy for laser cutting small holes and sharp corners. Path accuracy can be within 0.1 mm, depending on the application.

## Safety & Environmental

### Ace Industrial Products

Booth N5009

#### WeldSense 73-251 Portable Fume Extractor

Ace's latest portable fume extractor is lightweight, has two speeds for all types of welding, and features an onboard filter cleaning system for convenience and cost savings. Made in the USA.

### Antec Electronics Co Ltd

Booth N1609

#### Antec Auto-Darkening Welding Helmet AH6-660

The auto-darkening welding helmet, AH6-660, is suitable for all arc welding processes such as MIG, MAG, TIG, SMAW, plasma arc and carbon arc.

### Avani Environmental Intl Inc.

Booth N4537

#### Avani Environmental Intl., Inc. SDT-1.5 Downdraft

The SDT-1.5 downdraft table with accessories package includes: welder shelf, welder cabinet with fume arm and gas shelf.

### Chemetall US Inc

Booth C2709

#### Tech Cool 35052CF Semi-Synthetic Coolant

Chemetall's Tech Cool 35052CF is the next generation in green coolant technology available. Ultra high lubricity, Aerospace grade performance without chlorine. Dramatically lower operating costs.

### Fastenal Company

Booth N5736

#### Blackstone® Welding Jackets

Fastenal Company introduces its latest line of



flame resistant sateen body/leather sleeve combo welding jackets.

### Flame Technologies Inc

Booth N3219

#### HydroMist Fans by Fan Tech

HydroMist industrial fans use flash evaporation technology, which results in dramatically cooled air, reducing temperatures in the immediate area by up to 30° F.

### Frommelt Safety Products

Booth N4827

#### Guardian Defender Automated Barrier Door

Frommelt Safety introduces the Guardian Defender™ visibly safer than light curtains. PLe, Cat 4 level safety with a movable physical barrier restricts access to dangerous machine movement while at the same time containing process driving hazards.

### Goff's Enterprises Inc

Booth N2625

#### Weld Blankets

Goff's lightweight and flexible weld blankets are designed to be draped over materials, equipment and to provide protection from welding and grinding sparks, molten and hot debris, torch cutting spatter and more.

### H2Pump LLC

Booth C1154

#### HRS™ (Hydrogen Recycling System)

H2Pump offers efficient, reliable, low-cost electrochemical hydrogen recovery and recycling technology which extracts hydrogen from industrial waste streams.

### Industrial Maid

Booth N2428

#### Industrial Maid Model PFC8-DD32

Industrial Maid introduces its model PFC8-DD32 portable downdraft table, 36" W x 32" D. Built in the USA. Designed to capture welding fumes, grinding dust, plasma smoke and other nuisance dusts.

### John Tillman Co

Booth N3606

#### 1472 Black Top Grain Goatskin TrueFit Glove

Made of top grain goatskin with a reverse grain goatskin reinforced palm for longer life. Double stitched leather fingertips & reinforced thumb provide extra protection. Offers great dexterity.

### Klimawent USA LLC

Booth N5634

#### TELERGO

The Klimawent telescopic extraction arm TELERGO is a perfect solution for welding fume extraction. The pollutants are captured directly at the emission source, avoiding their expansion within the working space.

### Lincoln Electric Co

Booth N4102

#### Guardian Fire Safety Systems for Fume Control

Lincoln Electric introduces the Electric Guardian™, a safety solution for weld fume control systems. Offered in three categories: products to prevent, detect, and suppress fire.

### Nordfab Ducting

Booth N1928

#### TDH Extractor Arm

The TDH Arm is the perfect extractor for capturing welding smoke, fumes and dust in workshops.

### Roll Machining Technologies & Solutions

Booth C1526

#### S.I.K.

The RMTS's setup inspection kit features: 50% less scrap on change over's, the right height, rim clearances preset, great for offline setups, weld rolls & last fin pass, no trial or error and inspects the roll completely before installing on the mill.

### Ross Controls

Booth C849

#### Compact Modular L-O-X® Manual Lockout Valves

Ross Control® is pleased to announce the latest additions to its safety product family, the Modular L-O-X® manual lockout valve and Modular L-O-X® with EEZ-ON® operation.

### Tapeswitch Corp

Booth C3813

#### PSSR/2 Safety Interface Controller

The PSSR/2 safety interface controller is for end of the line resistor switches, safety mats, safety edges, and bumpers.

### Saws & Cut-off Machines

### New Centurion Enterprises Ltd

Booth C8347

#### Exact 280E Pipe Cutter

The 280E pipe cut systems expanded power (1750 W) and range of pipe (1.5" - 12") provides an extended range of use compared to it's predecessor the EXACT 200 (1100 W, .5"-8").

### Cosen Saws USA

Booth C7136

#### CNC-800DM Programmable Double Miter Bandsaw

The CNC-800DM is a fully programmable, double mitring bandsaw with a rigid dual column design. It incorporates a hefty 10HP saw motor to power its 51mm wide saw blade. It has a capacity of 20" round, and 16" x 31" rectangle at 90° degrees. At +/- 45° the saw has a capacity of 17.7" round, and 16" x 21" rectangle.

### DoAll Co/DGI Supply

Booth C7713

#### Value Engineered Tilt Frame

DoAll introduces its value engineered tilt frame, designed to meet the stringent requirements of fabricators.

### Haberle / Ken Bergman & Assoc LLC

Booth C7137

#### Brobo TNF125

The Brobo TNF125 aluminum semi-auto up-cutting machine with a 450mm CBT sawblade. Capacity is "11 x 5"

### Scotchman Industries Inc

Booth C4923

#### CPO 315 RFA Cold Saw

The CPO 315 RFA auto cold saw provides uninterrupted cutting on tubing, solids, & extrusions & supplies the highest quality cuts. The improved RFA decreases cycle times, can store speeds & feeds, and is ideal for high volume, long length applications.





## Software & Machine Controls

### Autoform Engineering

Booth C936

#### AutoForm Plus R4

The AutoForm Plus R4 features an enhanced workflow support integrating planning, costing, engineering and virtual tryout of the full stamping process; systematic process improvement through a rapid, easy to use and standards-based variation of key process drivers; semi-automatic result evaluation and issue detection for better, faster and more repeatable decision making; integrated reporting providing a fast, template-based report generation and automated updates through a link to the design file; ProcessDesigner, a CATIA-integrated application significantly speeding up the creation and update of die surfaces for milling.

### Engineering Technology Associates Inc

Booth C1414

#### DYNAFORM Enhanced with Optimization

Optimization of sheet metal forming is possible using the simulation software tool, DYNAFORM™. Go beyond identifying problem areas by incorporating design optimization to improve product performance.

### Henning Industrial Software Inc

Booth C4822

#### Visual EstiTrack Shop Kiosk

The optional Visual EstiTrack Shop Kiosk is an add-on application to Henning Software's flagship ERP product Visual EstiTrack.

### Messer Cutting Systems

Booth C5916

#### Automatic Plate Alignment Video Camera

Messer Cutting Systems offers an automatic plate alignment video camera. The EdgeMax cutting machine, Messer's global control S shows this feature, live.

### Metalix CAD/CAM Ltd

Booth C4911

#### cnckad Version - V11

Metalix presents cnckad, a complete CAD/CAM solution for sheet metal manufacturing. Easy transformation from 2D & 3D design, through auto nesting, processing, to NC code, its graphic simulation onto machine.

### MIE Solutions Inc

Booth C7212

#### MIE Trak PRO

MIE Trak Pro is a software solution for the manufacturing industry that integrates and streamlines operation across all the sales, manufacturing, engineering and accounting functions to provide maximum efficiency and immediate ROI.

### PEP Technology

Booth C8320

#### PEP Technology

### Powder Coating Consultants

Booth C2422

#### Cost Gauge Pro

Finishing system operational cost estimator software available in powder coating, liquid paint, and combination versions.

### Reis Robotics USA Inc

Booth N5910

#### reisPAD

Reis presents the control generation ROBOTstar-VI with the innovative portable teach pendant reisPAD in tablet format.

### Robotmaster-In-House Solutions Inc.

Booth N5933

#### Robotmaster V6

Robotmaster-In-House Solutions Inc expands on existing powerful optimizing tools and introduces the Robotmaster V6 for off-line programming of 6 axis robots.

### Shop Edge Software Inc

Booth C1434

#### Shop Edge Shop Floor Monitor

See the shop floor in real-time with the shop floor monitor by Shop Edge Software Inc. Valuable production information is captured directly from machines, and feeds the highly visual, information rich display. It is easily accessible from a web browser, anywhere.

### Sigmatex Systems LLC

Booth C4932

#### SigmaNEST Version 10

SigmaTEK unveils the industry's most powerful CAD/CAM nesting engine in SigmaNEST® version 10.

### Simufact-Americas LLC

Booth C1352

#### Simufact.welding 3.1

Simufact.welding 3.1 enables the simulation of various welding methods. It provides a realistic prediction of component distortion, also taking into account microstructure transformations.

### SpaceClaim Corp

Booth C8330

#### SpaceClaim Engineer 2012

SpaceClaim Engineer, a 3D direct modeler, has sheet metal capabilities focused on getting parts ready for production. Take any format and turn it into a flat pattern using its powerful sheet metal environment.

### Trendex Information Systems Inc

Booth N3218

#### Gastrend Graphical (GUI)

Gastrend Graphical is software for the welding supply distributor that allows the management of accounts receivable, accounts payable, general ledger, inventory, purchase orders, sales orders and invoices using a graphical user interface (GUI).

### Wintriss Controls

Booth C3711

#### ShopFloorConnect

ShopFloorConnect's factory reporting software and machine-mounted interfaces combine to automatically collect important production data from any machine with little or no operator involvement.

## Stamping

### AIDA-America Corp

Booth C1210

#### DSF Series Servo Presses

The Direct Drive Servo Former (DSF Series) is comprised of AIDA's complete range of servo presses, from 80 - 3,500 tons.

### Beckwood Press Co

Booth C1228

#### Custom Gib-Guided Hydraulic Presses

Beckwood offers custom hydraulic gib-guided presses, in addition to their post & bushing configurations. Like all made-to-order Beckwood presses, Beckwood's gib-guided offerings are engineered to each customer's specific application needs.



## Bettcher Manufacturing LLC

### Booth C1053

#### Compressor Shell

Bettcher Manufacturing LLC's compressor shell, which used to be made of two parts welded together, has been developed out of a single piece of blank using deep draw. The part is made using a 29" diameter blank and 0.133 thickness. The final part reaches 18" high draw.

## Greenerd Press & Machine Company Inc

### Booth C815

#### Custom Hydraulic Press Solutions

With product capabilities to 40,000 tons and bed sizes exceeding 240" (6,100mm), Greenerd presses are available in a variety of styles ranging from gap frame and straight-side to die-spotting and forging presses.

## Ningbo Hi-Tech Moldie Machinery Co Ltd

### Booth C356

#### OEM Stamping Parts

Ningbo Hi-Tech Moldie Machinery Co Inc offers 8 years' experience in OEM /ODM service. It has 12 sets of stamping machines from 5T to 200T and experience in the U.S. and European market.

## Penn United Technologies Inc

### Booth C1420

#### Precision Metal Stamping Dies and Metal Stamping

Penn United Technologies Inc can provide capacity for low-to-medium and high volume applications, matching the right precision metal stamping die features to specific needs and tolerances. Stamping operations use state of the art stamping presses.

## PennEngineering

### Booth C1215

#### PEMSERTER® Series 4® Press with Automatic Feed

The PEMSERTER® Series 4® press with automatic feed provides 6 tons of force and has a 45.7 cm / 18" throat depth. It is designed to install self-clinching nuts, studs, and stand-offs in sizes M2.5 to M6 / #2-56 to 1/4".

## Stamtec Presses

### Booth C1052

#### iLS1 Series Link Motion Servo Press

The iLS1-160 Intelligent Link Motion Servo

Press. The standard drive system is replaced by servos. Proprietary press controls achieve a wide variety of stroke and slide movement profiles, while supplying full working energy capacity even at low speeds.

## Thermal Spraying

## Bay State Surface Technologies

### Booth N2419

#### Plasma Spray Control Console Model CP-160

The Bay State CP-160 plasma spray console features high capacity flowmeters for higher production rates with Argon, Helium, and Hydrogen. An external flowmeter selector switch and stainless steel tubing have also been added for improved safety.

## Polymet Corp

### Booth N2313

#### Vecalloy B Amorphous Alloy

Vecalloy B is an amorphous alloy designed specially for arc spray systems. Vecalloy B can be used in applications such as boiler tubes, exhaust fans, drill collars, hydraulic shafts, and anti-skid. The product is available in 1/16" diameter form.

## Tool & Die

## Anchor Danly

### Booth C931

#### Cage Stopper End Cap

Anchor Danly announces the availability of its Danly Cage Stopper End Cap. The Cage Stopper is an option when cage travel required is more than what is available with the traditional Danly ball bearing cages.

## Associated Spring Raymond

### Booth C1426

#### D Line Die Springs

Associated Spring Raymond Die Springs are manufactured using a wire cross section developed to provide optimum balance between load-carrying characteristics and cycle life. The D Line Die Springs are manufactured to ISO 10243 standards and are designed to be interchangeable with many major manufacturers of the same type, size, and color.

## ATI Industrial Automation

### Booth N5708

#### ATI Utility Coupler

ATI Industrial Automation introduces its series of Utility Couplers for quickly changing utilities in docking and fixturing applications. The master side connection features a unique compliance mechanism that allows for large tooling misalignments.

## Bohler Uddeholm Corp

### Booth C1417

#### K294 and S693 Microclean

Bohler K294 MICROCLEAR is a third generation PM A11 tool steel, and Bohler S693 Microclean is a PM M4 high speed steel. Produced in third generation PM technology, to provide superior performance in cold work tooling and cutting tool applications.

## Carr Lane Manufacturing Co

### Booth N3036

#### Toggle Clamps with Safety Locks

Latch-action toggle clamps are available in five sizes and vertical-handle toggle clamps are available in three sizes. The compact hold-down clamps have a unique finger-grip T handle and an open arm that provides adjustable spindle location. Horizontal-handle toggle clamps are available in two sizes. The lowprofile hold-down clamps also have an open arm that provides adjustable spindle location.

## Diehl Steel Co

### Booth C1410

#### Steel Ready-Block

Ready-Block's are tool steel blocks that are available in the hardened, squared and ground condition. A starter hole is provided to allow the toolmaker to immediately begin the wire EDM process.

## International Mold Steel

### Booth C556

#### Toolox 44

ToolOX 44 is a pre-hardened tool steel, supplied at HRC45. ToolOX 44's exceptional toughness allows it to perform well in both hot and cold work applications. Toolox 44's high draw temperature of 1090 F makes it ideal for PVD coatings for additional wear.



## Tool & Die

### J Tech

Booth C755

#### In Die Stud Assembly

J-Tech has expanded its product line to include in-die assembly of studs. The studs can be pierce & clinch or clinch only. The studs can be installed from the top down, bottom up or cam action. The in-die assembly systems include the feeder and tooling.

### Kong NGAI Precision Metal Mould Shenzhen Co Ltd

Booth C856

#### Stamping Die, Metal Parts, Prototype Products

Kong Ngai produces stamping die, metal part, and prototype product for the automotive, industrial, office and home electric appliances industry. Product types include metal component parts for automotive, copier, printer, water heater, hob, cooker hood, television, network cabinets, token lenders and ATM 's.

### Latrobe Specialty Steel Distribution

Booth C915

#### CPM 4V

CPM 4V is part of Crucible's Killer V's family of cold work steels and its outstanding combination of properties make it an ideal candidate for tools to work advanced high-strength steels (AHSS).

### MegaFab-Piranha-Whitney-Bertsch

Booth C5113

#### Pro Punch

The Process developed by Whitney uses the Pro Punch™ and will produce finished holes with a burnished micro-finish and .0005 roundness. Similar to the popular punch and shave operation, this three step process will reduce or eliminate secondary operations like drilling and reaming.

### Pacesetter Systems

Booth C1412

#### Die Align

This innovative tool makes it easy to accurately locate and center any die on a press. The V-Block mounts on the back of the die shoe and guides it left to right, and front to back around a pin (1" diameter) that's installed in the bolster. The stop block rests on

the other side of the die and helps square it evenly on the press. Die-Align is designed to align a die of any size.

### Penn United Technologies Inc

Booth C1420

#### Machined Components

Penn United Technologies Inc's precision machining group specializes in high precision metal machining for critical-application components.

### Superior Die Set Corp

Booth C658

#### Type D Ball Bearing Die Set Product Line

Interchangeable with competitive ball bearing systems, inch sizes, straight sleeve and shoulder bushings, press fit and demountable pins, available with maxi-cage end caps.

## Tooling

### American Punch Co

Booth C5026

#### Ironworker Tooling with Customer-Specified Keyways

Stock oblong and square tooling with customer-specified keyways are now being shipped same day ordered exclusively from American Punch Company.

## Tube & Pipe Fabricating or Welding

### Advanced Tubular Technologies Inc

Booth C1556

#### VTube-LASER Tube Measuring Software for FARO

Advanced Tubular Technologies Inc introduces its VTube-LASER, designed from the ground up only for tube fabricators, to make qualifying tube and correcting benders easier and more productive than possible before using FARO ScanArms.

### Aquasol Corp

Booth N3613

#### I-Purge Inflatable Purge Bladders

The I-Purge System is equipped with optimum relief valve technology. I-Purge inflates at a precise rate which protects the inner bladder from over inflation while minimizing fill time. The tubing system efficiently inflates the bladders, forming an air tight seal to prevent leakage of the inert gas from the weld zone.

### Pro-Ox 100 Oxygen Monitor

The Aquasol Corp introduces its Pro-OX™ oxygen monitor with accessories kit. The ergonomically designed moninto fits nicely into the hand for a comfortable hold and accurately measures oxygen concentration with .01% (100 ppm) resolution.

### Bug-O Systems

Booth N4813

#### Pipe Welding Solutions

Bug-O Systems provides many solutions for medium to large diameter pipe welding. From high-tech digital control to economical, simple to operate tractors.

### COB Industries Inc

Booth N5919

#### PurgElite™ Pipe Purging Systems

COB Industries Inc introduces its Argweld® PurgElite™ systems, inflatable pipe purging systems with a simpler design with no valves to set or adjust. These systems are cost-effective and are the fast, easy purging method that can be used on 1" pipe and up.

### Fit Rite

Booth N6126

#### Fit Rite Precision Pipe Fitting System

The patented Fit Rite precision pipe fitting system dramatically improves the speed and accuracy of pipe to pipe, pipe to flange, pipe to elbow, or any other pipe spool combination. The fit up and welding time is improved by 50-90% over traditional pipe fitting methods in all sizes ranging from 1/2" to 72" pipe.

### HOT COILS

Booth N5115

#### 230 Volt Pipe Preheat Coils

The coils allow world-wide use for preheating and bake-out applications, require 230 volt, 15 amp power supply and can heat the pipe to 550°F (286°C) in minutes. The adj. thermostat accurately holds temperature within +/- 2.5°F. Will fit 4", 6", 8", 10" and 12" pipe.

### Innerspec Technologies

Booth N2217

#### Longitudinal Weld Inspection for ERW Tubes

The temate Ti-W(ERW) performs ultrasonic non-destructive testing of welds without couplant for inspection of tubes at higher temperatures. Installs immediately after the welder. Meets API standards.





## Lillbacka Powerco USA Inc

Booth C2132

### Heavy Duty Production 2000 UC King Crimper

The King Crimper 2000 has a maximum crimping force of 2,000 metric tons and has a crimping range from 7.87" to 25.6".

### Olympus NDT

Booth N1613

### OmniScan MX2

The OmniScan MX2 phased array flaw detector provides powerful inspection capabilities for manual and automated phased array applications. Features include a case design with a 10.4 inch innovative touch screen interface and high-speed data transfer.

### Proto-1 Manufacturing

Booth C1825

### TSM-3.5D Tube Sizing Machine

The TSM-3.5D tube sizing machine offers a small footprint, quick change tooling and is affordable. Features include: a double head design with left side for expanding from 2" - 3.5" raw tube with 3/8" range per tool and the right side reduces from 2" - 3.5" raw tube with 3/8" range per tool. This machine is portable, has touch screen controls and is designed for cell operation.

### Sumner Manufacturing Co Inc

Booth N1519

### Sumner's HOLD-E pipe clamp

A quick easy, safe clamp for holding pipe on vee-head jack stands. The Qwik™ release button allows clamp arms to open and close in seconds.

### Team Industries Inc

Booth N2929

### Generation V 8,000 lb. Weld Positioner

The Generation V weld positioner features a capacity of 8,200 lbs. 6 inches from the face of the gripper and comes equipped with a full function remote hand pendant as well as a standard corded foot pedal.

### Tubex Technology Machinery Inc

Booth C2334

### SMI SILVER 2 CD Tube Bending Machine

The SMI Silver 2 CD is a direct from coil tube bender design especially for copper, Aluminum and stainless.

## Winton Machine Co

Booth C1725

### Electric Bend Head Option

Winton Machine has added a 3-axis electric servo bend head as an option on its 20mm CNC tube benders.

### Online XYZ-LRA Converter

Winton offers expanded data points with its online XYZ-LRA converter, which converts XYZ data to LRA data.

### Twin-Head Tube Bender

Winton's model TW50 twin head tube bending machine is a hydraulic powered rotary compression tube bender that can bend tubes up to 2 inches in diameter, like those used in farm fencing.

## Tube & Pipe Producing

### Kent Corp

Booth C2128

### HRF-050 Lead Accumulator

Kent Corporation's introduces its lead HRF-050 accumulator for battery lines.

### Welder for Downhole Coiled Products

Kent Corp introduces its 45 degree bias shear and end welder for API downhole coiled products.

### Scotchman Industries Inc

Booth C4923

### HSX 100-02 Heavy Duty High Speed Tube & Pipe

The HSX 100-02 is designed and built for large diameter pipe and stainless steel applications. This machine is quick, sturdy, precise and ideally suited for grinding stainless steel rapidly with a belt speed of 131.25 feet per second.

### Wuxi Dixin Steel Pipe Co Ltd

Booth C1554

### Heavy Wall Tubes of ASTM A511

Heavy wall of grade 300 series seamless tubes per ASTM A511, such as size 6" OD X 1" WA in the picture, are very professional here in DIXIN. Size ranges from 1" OD X 3/8" WA to 7" OD X 1" WA are all covered. Abrasive blasting on OD surface is workable.

## Waterjet

### Jet Edge

Booth C4349

### ECO-JET Waterjet Pump

Jet Edge's 55KSI, 30hp ECO-JET waterjet pump features an efficient direct drive design that consumes up to 50% less electricity than a 50hp pump but produces the same output.

### Mid Rail Gantry with Permalign® EDGE

Featuring Jet Edge's Permalign® EDGE cutting technology, the mid rail gantry waterjet system is capable of cutting precise zero-taper parts and bevels up to 55°.

### KMT Waterjet Systems Inc

Booth C6334

### High Pressure Streamline PRO2® Pump

KMT Streamline PRO2® series pumps feature pressure up to 90,000psi, at 60hp & 125hp and offer the combination of horsepower and pressure with significant advances in uptime.

### OMAX Corp

Booth C3940

### Drill Head

Achieve reliable piercing of composites and laminates with an OMAX engineered pneumatic drill specifically designed for the waterjet environment.

### Semyx LLC

Booth C6347

### Optima Series Waterjet Cutting Systems

The OPTIMA waterjet cutting series provides a vigorous industrial design and rigid construction that combines precision and simplicity. The OPTIMA is made to handle high production for versatile applications. OPTIMA models come in a wide variety of sizes.

### Techni Waterjet

Booth C5128

### Intec-G2 Value Series

TECHNI Waterjet™ introduces the Intec-G2 value series line of waterjet cutting systems which includes a smaller footprint, without taking away from the cutting area and a larger monitor screen for added ease to the customer.



## Welding Consumables

### Changzhou Shine Science & Technology Co Ltd

Booth N2527

#### AS-4001F Pro

Professional welding helmet certified by ANSI, CSA, AS/NZS and CE (plus rating). The helmet is also suitable for a variety of color paint and decals. Leading edge technology assures the helmet to be used under the most severe condition.

### Changzhou Zhengyang Welding Material Co Ltd

Booth N2306

#### Welding Wire

Changzhou Zhengyang Welding Material Co Ltd offers weatherability steel welding wire, stainless steel welding wire, flux cored welding wire, aluminum welding wire, brazing welding wire in addition to its hundred of other varieties and specifications.

### Easy Abrasives LLC

Booth N2618

#### Cutoff Wheel

Easy Abrasives LLC offers type 1 and 27 metal/steel cutting wheels.

### IBEDA /Superflash Compressed Gas Equipment Inc

Booth N3437

#### Gas Adjustable Gas Mixer

SuperFlash gas mixers allow users to mix their own gases at almost any ratio needed to fit their specific process requirements. The SuperFlash compressed gas equipment two-gas mixer allows users to blend their own shielding gases at almost any ratio.

### Nanjing Youtian Metal Technology Co Ltd

Booth N1616

#### Zirconium/Hafnium/Titanium Wire

Wire is available in various grades and sizes with relative standards strictly observed in the manufacturing. Nanjing Youtian Metal Technology specializes in Zr/Hf/Ti products.

### Nevatia Steel & Alloys Pvt LTD

Booth N2824

#### Nevinox® MIG & TIG Filler Wire

Nevatia Steel a leading ISO 9001, 14001 & OHSAS 18001 company producing stainless steel MIG and TIG filler wires in India. Nev-

inox® MIG and TIG filler wires for GMAW now approved by Bureau Veritas marine, TUV for pressure vessels & equipment, CE and Deutsche Bahn.

## Welding Machines/ Equipment

### ABICOR Binzel Corp

Booth N5508

#### Regula® EWR Electronic Welding Regulator

EWR gas regulator, offered by ABICOR Binzel, combines four methods of gas regulation. By combining all four methods, gas consumption during the welding process can be regulated & reduced by an average of 40% and up to 60%.

#### ArcOne

Booth N3231

#### iDF™ Intelligent-Darkening-Filter

The iDF™ Intelligent-Darkening Filter offers standard shade adjustment 3/5-14; auto-variable shade adjustment 3/5-14; special TIG mode with up-slope and down-slope control; 8 unique memory settings customizing each helmet.

#### Bernard

Booth N5516

#### FILTAIR Fume Extraction Gun

The Bernard FILTAIR fume extraction gun allows for balance of suction with shielding gas flow to protect against porosity, ensure efficient source capture and provide reliable welding performance.

#### Bluco Corp

Booth N2819

#### Modular Fixturing for Welding

Bluco Corporation offers the latest technology in modular fixturing for welding. Many components have been added including the Titanium-Aluminum series angles.

### Centerline (Windsor) Ltd

Booth N1926

#### FlexFast Lite™

A modular welding machine for small to medium fasteners.

#### FlexFast™ Modular Welder

A highly configurable fastener welding machine.

### Diversi-Tech Inc

Booth N1922

#### Fume Tracker

The Fume Tracker eliminates welding fumes. This technology offers hands free capture of

welding fumes and complies with OSHA clean air regulations.

### ELCo Enterprises

Booth N2831

#### Torch Wizard™ Nozzle Cleaning Station

The Torch Wizard™ robotic nozzle cleaning stations maintain quality and productivity in your weld cell by quickly removing spatter build-up in the gas nozzle. The station sprays & reams simultaneously, reducing cycle time by 50%.

### Fabrisonic LLC

Booth N6218

#### SonicLayer Additive Manufacturing Product Line

Fabrisonic introduces its line of ultrasonic additive manufacturing (UAM) equipment. UAM is a disruptive solid state welding technology that provides manufacturers an alternative way to create by using sound waves to weld thin layers of dissimilar metals.

### Goldland Industrial Co Ltd

Booth N6300

#### Auto Darkening Welding Helmet

Goldland Industrial Co Ltd introduces its auto darkening welding helmet with features that include a large view area, 97mm x 61mm (3.81" x2.4"), solar cell batteries, 3V lithium batteries (CR2450 2EA, replaceable) and four arc sensors.

### Guild International

Booth C2234

#### Guild International Laser Zapwelder

Guild International offers a 6 KW CO2 Zapwelder™, which employs laser cutting and laser welding machine for joining various grades of aluminum alloys.

### Gullco International

Booth N5002

#### Pipe KAT® for Rigid Track

The Pipe KAT® from Gullco features a re-engineered design. This improved Pipe KAT® is smaller, easier to install and includes some additional control features including remote control of the voltage adjustment.

### Irc Automation Inc

Booth N2431

#### IRCO Products

Irc Automation Inc designs and manufactures positioning equipment and automated welding systems for industrial welding and



fabricating. In business for over 50 year, Irco machines an be found all over the world, operating in the toughest environments.

### **Linemaster Switch Corp** Booth C2324

#### **Hercules Wireless RF Foot Switch**

Linemaster's Hercules wireless foot control utilizes RF technology for optimal signal transmission and reception. This system has 40 foot transmission range and is powered by three AA Alkaline batteries, which can last up to 700 hours.

### **Magnatech LLC** Booth N6133

#### **EZ Orbital 517**

The Model 517 is a tube welding controller that integrates the operation of a standard, commercial GTAW power source with the weld head.

### **Matuschek Welding Products Inc** Booth N1708

#### **SPATZMulti04 Weld Recorder and Analyzer**

The hand held SPATZMuti04 helps to optimize and monitor the resistance welding process, collect data, and troubleshoot.

### **MK Products Inc** Booth N2804

#### **CobraTurn™ Digital Turntable**

From small to large weld assemblies, the CobraTurn rotates welding jobs and is ideal for all applications up to the rated load capacities.

### **Nelson Stud Welding** Booth N5922

#### **NCD Plus Product Line**

NCD+™ is a dependable, generation capacitor discharge (CD) stud welding power source built on the foundation of 30,000 Hz switch-mode power conversion topology controlled by high performance 32-bit RISC processor with integrated DSP.

### **Phoenix International Inc** Booth N2328

#### **Type 4 Flux Cored Wire Oven**

Type 4 flux cored wire ovens feature: capacity of 4 spools (12 inch) or 3 spools (16 inch) of flux cored wire, are ideally suited for preheating parts or general purpose storage, thermostatic control and optional thermometer available for immediate temperature indication.

### **Preston-Eastin Inc** Booth N5731

#### **PE-30-6**

Preston-Eastin introduces its 3,000 lbs. two-axis positioner. The PE-30-6 is designed with a smaller footprint to help maximize effective use of floor space, reduce operator fatigue, increase productivity and improve weld quality.

### **PT-Mat** Booth N3337

#### **Plasma Transfer Arc Torch**

High deposition PTA torch for heavy deposition of coating and hardfacing in the mining and oil and gas industry.

### **Red Rock Automation/ Romar/MEC** Booth N4805

#### **Romy**

Romy is the latest tank fabrication tools in the line of ROMAR/MEC - Fit Up Gear products. These can replace half-clamps with a safe and effective device.

### **Rimco Equipment** Booth N1631

#### **Rotator 1250**

RIMCO Equipment introduces its Rotator 1250, featuring the time saving benefits of turning and positioning steel beams safely and efficiently, without using a saw horse or dangerous turning methods.

### **Robotic Technologies of TN** Booth N6025

#### **RTT-MSW-100 Mobile Suitcase Welder**

Robotic Technologies introduces its sub \$10,000 mobile, robotic, welding platform capable of carrying significant payloads (60+ lbs).

### **SMK Co Ltd** Booth N1524

#### **Incorrect Nut Setting Detection for Nut/Bolt Weld**

SMK Co Ltd offers its incorrect nut setting detection system which prevents defectively welded parts from coming out and with a high degree of accuracy can detect whether or not a nut/bolt is set correctly immediately prior to welding.

### **Staubli Corp Multi Contact USA** Booth N3636

#### **Tool Changers for Robots**

Stäubli and Multi-Contact tool changers for robots cover a wide range of applications, from very small to heavy payload applications requiring large moment capacity.

### **Strong Hand Tools** Booth N3631

#### **High Precision Siegmund Welding Tables**

Strong Hand Tools offers high precision, German made Siegmund welding tables for heavy duty fixturing. Siegmund tables feature a one piece reinforced steel plate design with five faces for an extremely rigid and flat work surface.

### **Tregaskiss** Booth N5513

#### **QUICK LOAD™ Liner AutoLength™ System**

The liner system for semi-automatic and robotic MIG guns minimizes wire feeding, burn-back and contact tip issues caused by liners that are cut up to one inch (2.54 cm) too short, while also reducing MIG gun liner replacement time by half.

### **Weldcraft** Booth N5516

#### **WP-280 Water-Cooled GTAW Torch**

The WP-280 water-cooled TIG torch is designed with the company's exclusive Super Cool™ technology to provide consistent and dependable cooling performance.

### **Welding Alloys USA** Booth N4917

#### **Hardlite Ultra-thin Hardfaced Wear Pate**

Welding Alloys Hardlite features an extremely refined micro-structure with high volume of chromium carbides alloying an ultra high wear resistance. 68 HRC is achieved through the company's unique patented process. Ask WA's team at Booth # N4917.

### **Wuxi Ronniwell Machinery** Booth N1707

#### **Welding Rotator**

Wind tower/tank/cylinder welding rotator, PU roller, self-alignment type.



# **1 MOTORUM** **VAST POSSIBILITIES**

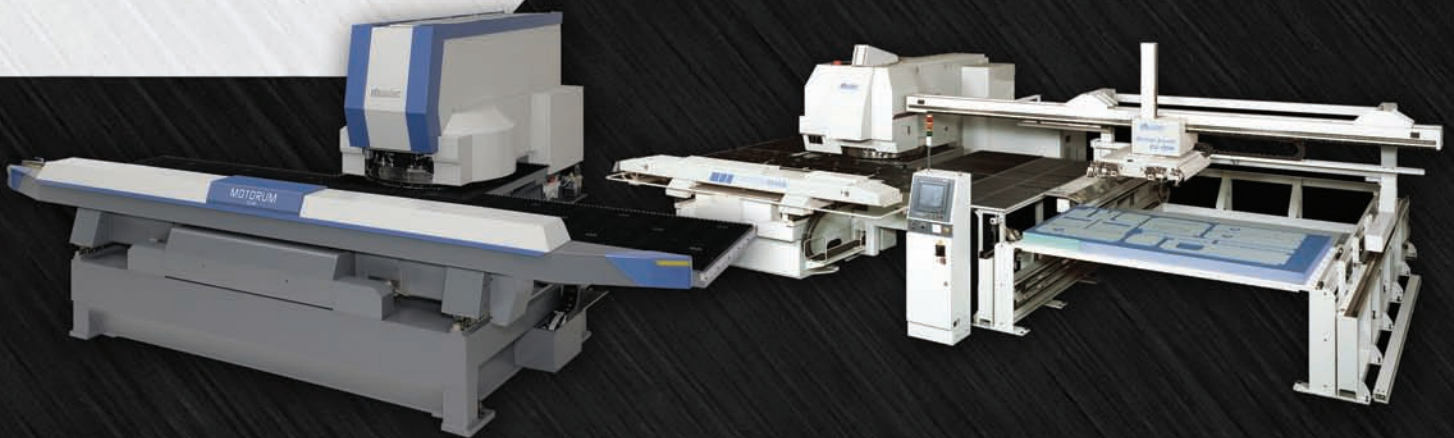

## **Engineered for Reliability.**

Muratec's Motorum Series is engineered for reliable performance. Automated loading and sorting, affordable tooling and efficient power consumption turn Muratec Turret Punch Presses into a profit center for your shop. Visit us to learn how adding our Turret Punch Press to your floor can reduce costs and open up productivity for multiple processes.

**muratec**

MURATA MACHINERY USA, INC.

**FABTECH BOOTH  
#C3028**

[www.turret punch presses.com](http://www.turret punch presses.com)



# Fladder®

Flexible, effective, fast  
Automatic, oscillating deburring system  
for stainless, aluminum and other materials.

## Deburring of punched, laser cut and machined pieces

- No critical heating of the surface
- No destruction of protective foil.
- Rounding edges without damage to the surface
- Deburring of 3 dimensional pieces is possible.

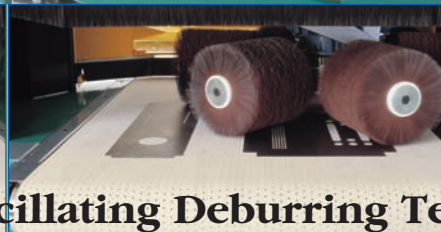
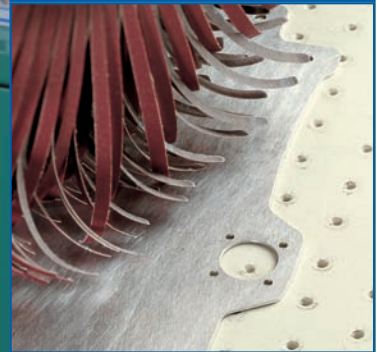
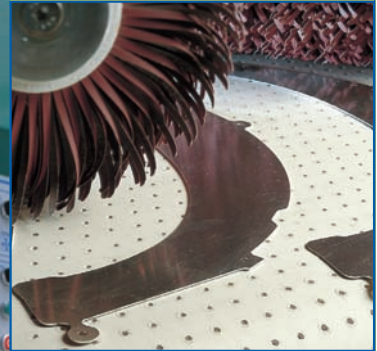
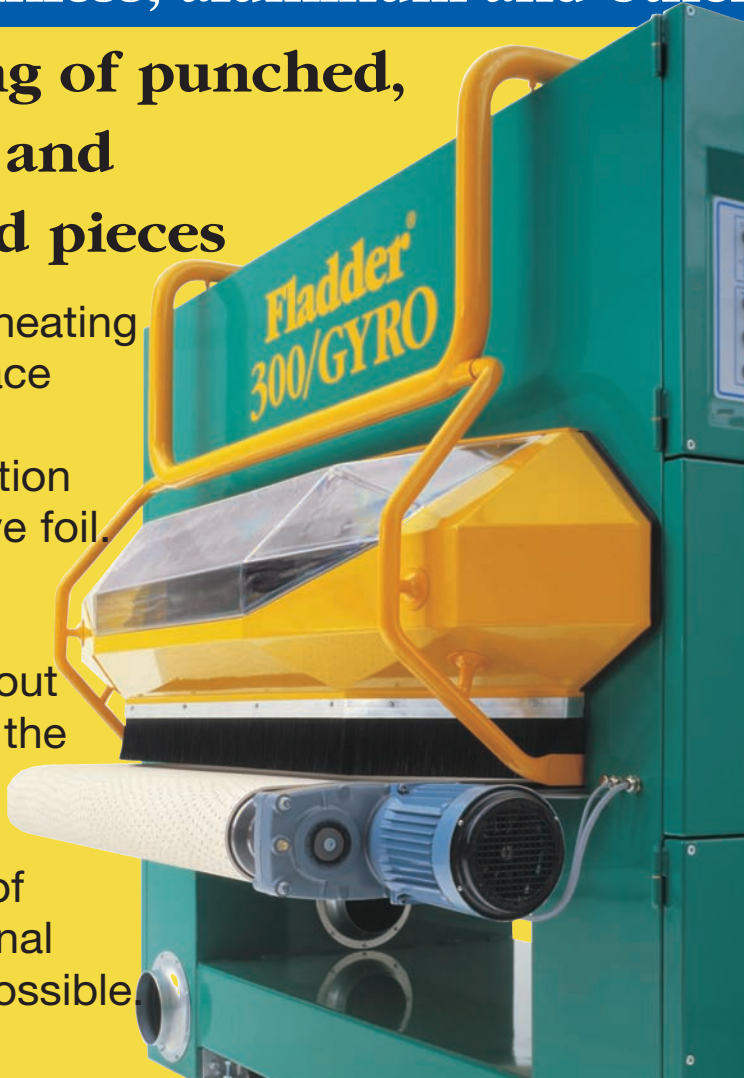

Dry, Oscillating Deburring Technique

## Hansen & Hundebol Inc.

3402 Oakcliff Road  
Suite B-7  
Atlanta GA 30340

Phone: (770) 452-1271  
Fax: (770) 452-7090  
E-mail: [fladder@bellsouth.net](mailto:fladder@bellsouth.net)  
Web: [www.fladder.com](http://www.fladder.com)

# CUT COSTS NOT QUALITY

**Just 3 clicks and we ship!**  
Visit [BandSawParts.com](http://BandSawParts.com) and save up to 40% every day!



Times have been tough lately, but you already knew that. Something you might not know is that you don't have to sacrifice quality to keep your margins. BandSawParts.com offers savings of up to 40% every day on our complete inventory, stocked with the highest-quality replacement parts you'll find anywhere. Our strong value proposition, built on prompt and courteous service, unequalled expertise, and attention to detail are just some of the reasons you'll get even more for your money. Over 50,000 ready-to-ship parts for brand-name machines like Hydmech, Marvel, DoAll, Amada, Jet, and Wellsaw, along with parts for every other major band saw manufacturer ensures if you order it today, it ships today. Call, or visit our web site, and join the growing list of satisfied customers who are cutting costs, keeping the quality, and staying strong.



**BANDSAWPARTS**  
**.COM**

KEEP YOUR SAWS IN MOTION

[www.bandsawparts.com](http://www.bandsawparts.com) · 800.240.2932

Visit us in Booth C7538

  
**NORTH AMERICAN  
STEEL ALLIANCE**  
THE INDEPENDENT ADVANTAGE.



# EXHIBITOR LIST



## 2020 Software Solutions Inc Booth C1724

10885 330th St  
Lindstrom, MN 55045-9104 United States  
ph: 651-257-8715  
www.virtualbender.com  
Software & Machine Controls

## 321 Fixtures Booth C1756

18244 NW Dustin Ln  
Beaverton, OR 97006-3395 United States  
ph: 503-329-0560  
Assembly

## 3M Booth N5502

Bldg 235-2W-70  
Saint Paul, MN 55144-0001 United States  
ph: 800-243-4630  
www.3m.com/occsafety  
Finishing, Welding Machines/Equipment

## 5S Supply Booth C3454

9270 Corsair Road  
Suite #18  
Frankfort, IL 60423-2619 United States  
ph: 815-469-5678  
fax: 815-469-5601  
www.5ssupply.com  
Business Services, Maintenance & Repair,  
Tool & Die

## A&V Waterjet Tech Inc Booth C7533

N116W18395 Morse Dr  
Germantown, WI 53022-2486 United States  
ph: 262-250-8100  
www.avwaterjet.com  
Waterjet

## ABB Inc Booth N6102

1250 Brown Rd  
Auburn Hills, MI 48326-1507 United States  
ph: 248-391-8400  
fax: 248-391-8440  
www.abb.com  
Robotics



## Abbey International Booth C1514

8817 Pleasantwood Ave NW  
North Canton, OH 44720 United States  
ph: 330-244-1960  
fax: 330-244-1961  
www.abbeyintl.com  
Saws & Cut-off Machines, Tube & Pipe  
Fabricating or Welding, Tube & Pipe  
Producing



## Experts in Resistance Welding



Over 75 years of  
reliable service  
to customers  
across the globe.

Visit us at Booth #N5722 and see our  
**NEW E-Series MFDC welder**

Stationary Welders  
Lightweight Weld Guns  
Servo-spot Weld Guns  
Welding Monitors

Welding Controls  
Transformers  
Automatic Nut  
& Bolt Feeders

Visit our website  
www.dengensha.com  
for more info, pictures and videos

440.439.8081  
440.439.8217 fax  
sales@dengensha.com



## Complete Tracking Solution for Fabricators and Galvanizers

To ensure 100% traceability  
of your products, visit our  
Booth #C5609 at FABTECH!

PH: +1-740-642-3600  
www.infosight.com

# "We BARCODE Difficult Stuff"™



**ABICOR Binzel Corp**  
**Booth N5508**

650 Medimmune Ct Ste 110  
Frederick, MD 21703-2602 United States  
ph: 301-846-4196  
fax: 301-846-4497  
www.abicorusa.com  
Arc Welding, Finishing, Material Handling/  
Marking, Robotics, Tube & Pipe Producing,  
Welding Consumables, Welding Machines/  
Equipment

**Abtex Corp**  
**Booth C7547**

89 Main St  
PO Box 188  
Dresden, NY 14441 United States  
ph: 315-536-7403  
fax: 315-536-0280  
www.abtex.com  
Business Services, Finishing, Robotics

**Accra-Wire Controls Inc**  
**Booth C1256**

10891 Northland Dr  
Rockford, MI 49341-8627 United States  
ph: 616-866-3434  
fax: 616-866-9468  
www.accrainc.com  
Coil Processing, Material Handling/Marking

**Accurate Die Design Inc/  
Logopress Corp**  
**Booth C1423**

12835 W Verona Dr  
New Berlin, WI 53151-4620 United States  
ph: 262-938-9316  
fax: 262-938-3933  
www.accuratediedesign.com  
Business Services, Software & Machine  
Controls  
*Distributors:*  
SolidWorks Resellers World Wide

**Accurex Measurement Inc**  
**Booth C2125**

225 S Chester Rd Ste 6  
Swarthmore, PA 19081-1919 United States  
ph: 610-544-1006

fax: 610-544-1033  
www.tubemeasure.com  
Business Services, Inspection & Testing



**Accurpress America Inc**  
**Booth C3047**

450 Concourse Dr  
Rapid City, SD 57703-4766 United States  
ph: 605-718-2550  
fax: 605-718-2551  
www.accurpress.com  
Business Services, Metalforming &  
Fabricating Equipment, Press Brakes,  
Robotics, Software & Machine Controls,  
Tooling

**Accustream Inc**  
**Booth C8109**

309 5th Ave NW  
New Brighton, MN 55112-3239 United  
States  
ph: 651-294-8600  
fax: 651-294-8620  
www.accustream.com  
Waterjet

**Ace Industrial Products**  
**Booth N5009**

5043 Farlin Ave  
Saint Louis, MO 63115-1204 United States  
ph: 314-385-5178  
fax: 314-385-3254  
www.aceindustrialproducts.com  
Safety & Environmental

**AceCad Software**  
**Booth C2825**

825 Springdale Dr  
Exton, PA 19341-2843 United States  
ph: 610-280-9840  
fax: 610-280-9841  
www.acecadsoftware.com  
Management Services, Software & Machine  
Controls

**Acrotech**  
**Booth C8213**

PO Box 466  
Lake City, MN 55041-0466 United States  
ph: 651-345-3362

fax: 651-345-3759  
www.acrotechinc.com  
Bending/Forming, Job Shop/Contract  
Manufacturing, Tooling

**ACT Test Panels LLC**  
**Booth C2434**

273 Industrial Dr  
Hillsdale, MI 49242-1078 United States  
ph: 517-439-1485  
fax: 517-439-1652  
www.acttestpanels.com  
Business Services, Inspection & Testing

**Addison Machine  
Engineering Inc**  
**Booth C2115**

1301 Industrial St  
Reedsburg, WI 53959-2139 United States  
ph: 608-524-6454  
fax: 608-524-6099  
www.ameinc.com

**AddisonMckee Inc**  
**Booth C2339**

1637 Kingsview Dr  
Lebanon, OH 45036-8395 United States  
ph: 513-228-7000  
fax: 513-228-7234  
www.addisonmckee.com  
Bending/Forming, Saws & Cut-off Machines,  
Tooling, Tube & Pipe Fabricating or Welding

**Advanced Laser Services LLC**  
**Booth C5634**

3499 Hearthstone Pl  
Douglasville, GA 30135-7284 United States  
ph: 866-995-2937  
www.advancedlaserservices.com  
Business Services, Job Shop/Contract  
Manufacturing, Lasers, Maintenance &  
Repair, Other Machinery/Equipment/Parts/  
Products

**Advanced Manufacturing  
Solutions LLC**  
**Booth C6351**

PO Box 511143  
Punta Gorda, FL 33951-1143 United States  
ph: 941-637-6660  
fax: 941-637-8036  
www.pressbrakesafety.com  
Safety & Environmental



We've got **nozzles** for every kind of spray, mist, blast or blow-off application you've got – **IN STOCK!**



**NOZZLES FOR EVERY APPLICATION:**

- DUST CONTROL**
- PHOSPHATING**
- CHEMICAL PROCESSING**
- PHARMACEUTICAL PROCESSING**
- PARTS CLEANING**
- AIR ATOMIZING & MISTING**
- FOAM CONTROL**
- COATING & FINISHING**
- VEHICLE WASHING**
- AIR COOLING**
- DRYING & BLOW OFF**

**Competitive pricing • Fast delivery • Huge In-Stock Inventory  
Superior Service**

**Call for our catalog today! (734) 389-0464**



Visit us in Booth C1361

**BEX<sup>®</sup>**  
**SPRAY NOZZLES**



836 Phoenix Drive, Ann Arbor, MI 48108 • Phone: (734) 389-0464 • Fax: (734) 389-0470 • Email: sales@bex.com

**www.bex.com**





 **Advanced Tubular Technologies Inc**  
**Booth C1556**

2548 Campbellgate Dr  
Waterford, MI 48329-3118 United States  
ph: 248-674-2059  
fax: 248-690-2396  
www.advancedtubular.com  
Inspection & Testing, Material Handling/  
Marking, Software & Machine Controls

**Aerospace Manufacturing and Design**  
**Booth C8338**

4020 Kinross Lakes Pkwy # 201  
Richfield, OH 44286-9249 United States  
ph: 330-523-5400  
fax: 330-659-0823  
www.giemediamedia.com  
Business Services

 **AFC Finishing Systems**  
**Booth C2548**

250 Airport Pkwy  
Oroville, CA 95965-9249 United States  
ph: 530-533-8907  
fax: 530-553-0179  
www.afc-ca.com  
Finishing

**A-G Tool & Die**  
**Booth C920**

5927 State Route 128  
Miamitown, OH 45041 United States  
ph: 513-353-3090  
fax: 513-353-3095  
www.agtooldie.com  
Job Shop/Contract Manufacturing,  
Machining/EDM, Tool & Die, Tooling

 **AGT**  
**Booth N2333**

8800 Boul Parent  
Trois-Rivieres, QC G9A 5E1 Canada  
ph: 819-693-9682  
fax: 819-693-9028  
Assembly, Robotics

 **AIDA-America Corp**  
**Booth C1210**

7660 Center Point 70 Blvd  
Dayton, OH 45424-6365 United States  
ph: 937-237-2382  
fax: 937-237-1995

www.aida-global.com  
Business Services, Coil Processing, Material  
Handling/Marking, Stamping

**AIM Inc**  
**Booth C1832**

502 S Vista Ave  
Addison, IL 60101-4423 United States  
ph: 630-458-0008  
fax: 630-458-0730  
www.aimmachines.com  
Bending/Forming, Robotics, Tube & Pipe  
Fabricating or Welding

**Air Products and Chemicals Inc**  
**Booth C3814**

7201 Hamilton Blvd  
Allentown, PA 18195-9642 United States  
ph: 610-481-4080  
fax: 610-706-7305  
www.airproducts.com  
Gases & Gas Equipment

**Airflow Systems Inc**  
**Booth N1110**

11221 Pagemill Rd  
Dallas, TX 75243-8314 United States  
ph: 214-503-8008  
fax: 214-503-9596  
www.airflowsystems.com  
Other Machinery/Equipment/Parts/Products,  
Safety & Environmental

**Airgas Inc**  
**Booth N5231**

259 N Radnor Chester Rd  
Radnor, PA 19087-5283 United States  
ph: 610-230-3045  
fax: 610-687-6932  
www.airgas.com  
Arc Welding, Business Services, Cutting,  
Gases & Gas Equipment, Inspection &  
Testing, Plate & Structural Fabricating,  
Robotics, Safety & Environmental

**Ajan Elektronik Servis San Ve**  
**Booth N5237**

AOSB 10014 Sokak No 1  
Cigli-Izmir, 35620 Turkey  
ph: 90 232 328 1202  
fax: 90 232 328 1501  
www.ajanncnc.com  
Plate & Structural Fabricating

**Ajax Tocco Magnethermic**  
**Booth C2337**

1745 Overland Ave NE  
Warren, OH 44483-2860 United States  
ph: 330-372-8511  
fax: 330-372-8644  
www.ajaxtocco.com



**AKS Cutting Systems Inc**  
**Booth C5135**

4905 Rocky River Dr  
Cleveland, OH 44135-3245 United States  
ph: 216-267-1818  
fax: 216-267-1850  
www.akscutting.com  
Cutting, Lasers, Other Machinery/Equipment/  
Parts/Products, Plate & Structural  
Fabricating, Software & Machine Controls,  
Tube & Pipe Fabricating or Welding

**Akyapak**  
**Booth C5545**

Akcallar Sanayi Bilgesi  
No 08 Akcallar  
Bursa, 16225 Turkey  
ph: 224 2807500  
fax: 224 2807502  
www.akyapak.com  
Plate & Structural Fabricating  
*Distributors:*  
GV Fabricating Machinery Sales

**AkzoNobel Powder Coatings**  
**Booth C2258**

20 Culvert St  
Nashville, TN 37210-4210 United States  
ph: 615-259-2430  
fax: 615-255-7903  
www.akzonobel.com/powder  
Finishing

**Alabama Economic Development**  
**Booth C7145**

PO Box 1668  
Decatur, AL 35602 United States  
ph: 256-353-9450  
www.northalabamausa.com



## Alabama Laser

### Booth N6322

55 Laser Blvd  
Munford, AL 36268-0055 United States

ph: 256-358-9055

fax: 256-358-4515

www.alabamalaser.com

Job Shop/Contract Manufacturing, Lasers,  
Material Handling/Marking, Welding  
Machines/Equipment



## AlcoTec Wire Co

### Booth N4122

2750 Aero Park Dr  
Traverse City, MI 49686-9263 United States

ph: 231-941-4111

fax: 231-941-9154

## Alfra USA LLC

### Booth N6033

120 Prairie Lake Rd Ste B  
East Dundee, IL 60118-9128 United States

ph: 847-844-8900

fax: 847-844-8950

www.alfra.us

## Allcryo

### Booth N2218

PO Box 2772  
Conroe, TX 77305-2772 United States

ph: 936-672-3128

fax: 936-597-5550

www.allcryo.com

## Alliance Express

### Booth C1857

3123 Station Rd  
Erie, PA 16510-6501 United States

ph: 800-847-0486

fax: 866-651-6617

www.alliance-express.com

Finishing

# Alliance

## Machine and Engraving, LLC

## Alliance Machine and Engraving LLC

### Booth C5520

12102 Washington Hwy  
Ashland, VA 23005-7640 United States

ph: 804-798-1199

fax: 804-798-1195

www.alliancemachineandengraving.com

Bending/Forming, Business Services, Coil  
Processing, Material Handling/Marking,  
Other Machinery/Equipment/Parts/Products

## ALM Materials Handling

### Booth N5927

200 Benchmark Dr  
Streator, IL 61364-9400 United States

ph: 815-673-5546

fax: 815-673-2292

www.almmh.com

Assembly, Machining/EDM, Maintenance &  
Repair, Material Handling/Marking

## Alma Cam USA LLC

### Booth C4834

1905 Wright Blvd  
Schaumburg, IL 60193-4567 United States

ph: 847-380-9993

www.almacamusa.com

Robotics, Software & Machine Controls

## Alma Machinery Co

### Booth C1431

841 Mayberry Springs Rd  
Columbia, TN 38401-9346 United States

ph: 615-369-7788

fax: 615-369-7789

www.almamachinery.com

Coil Processing, Hydroforming, Material  
Handling/Marking, Stamping

## Almco Inc

### Booth C1220

507 W Front St  
Albert Lea, MN 56007-2700 United States

ph: 507-377-2102

fax: 507-377-0451

www.almco.com

Finishing

## Almetals Co

### Booth C346

51035 Grand River Ave  
Wixom, MI 48393-3329 United States

ph: 248-348-7722

fax: 248-348-7627

www.almetals.com

## Alpha Professional Tools

### Booth N6331

103 Bauer Dr  
Oakland, NJ 07436-3102 United States

ph: 201-337-3343

fax: 201-337-2216

www.alpha-tools.com

Finishing, Other Machinery/Equipment/Parts/  
Products, Saws & Cut-off Machines, Tooling

## Alpine Bender Machinery

### Booth C1836

12340 Eastend Ave  
Chino, CA 91710-2009 United States

ph: 909-902-5400

fax: 909-902-5410

www.alpinebender.com

Material Handling/Marking, Other  
Machinery/Equipment/Parts/Products, Saws  
& Cut-off Machines, Tooling, Tube & Pipe  
Fabricating or Welding

## Alro Steel Corporation

### Booth C7446

3100 E High St  
Jackson, MI 49203-6413 United States

ph: 517-787-5500

fax: 517-787-6390

www.alro.com

## AltaMAR Inc

### Booth C1522

223 Osborne Rd NE  
Fridley, MN 55432-3168 United States

ph: 763-586-7906

fax: 763-586-7908

www.altamarinc.com

Job Shop/Contract Manufacturing, Lasers,  
Tube & Pipe Fabricating or Welding, Welding  
Machines/Equipment



## Alternative Parts Inc

### Booth C3726

7 Sawgrass Dr  
Bellport, NY 11713-1547 United States  
ph: 631-345-9500  
fax: 631-345-9580  
www.altparts.com  
Business Services, Lasers, Maintenance & Repair, Other Machinery/Equipment/Parts/Products, Press Brakes, Punching, Software & Machine Controls

## AM Machinery Sales

### Booth C5528

114 Camars Dr  
Warminster, PA 18974-3875 United States  
ph: 215-293-0333  
fax: 215-293-0337  
www.ammachinerysales.com  
Finishing, Tube & Pipe Fabricating or Welding



## Amada America Inc

### Booth C3916

7025 Firestone Blvd  
Buena Park, CA 90621-1869 United States  
ph: 714-735-5147  
fax: 714-994-6143  
www.amada.com  
Lasers, Press Brakes, Punching, Software & Machine Controls, Tooling

## Ambrell Precision Induction Heating

### Booth C4950

39 Main St  
Scottsville, NY 14546-1356 United States  
ph: 585-889-9000  
fax: 585-889-4030  
www.ambrell.com  
Brazing & Soldering, Finishing, Other Machinery/Equipment/Parts/Products, Tube & Pipe Producing

## America Fortune Company

### Booth N1908

6600 Sands Point Dr Ste 121  
Houston, TX 77074-3712 United States  
ph: 713-779-8882  
fax: 713-774-1763  
www.americafortune.com  
Gases & Gas Equipment

## American Express Open

### Booth C8233

200 Vesey St  
New York, NY 10285-1000 United States  
ph: 212-640-2000  
fax: 212-640-9171  
www.open.com  
Business Services

## American Finishing Resources

### Booth C1855

476 Clay St  
Chilton, WI 53014-1414 United States  
ph: 920-849-7738  
fax: 920-849-2800  
www.afrnw.com  
Business Services, Finishing, Job Shop/Contract Manufacturing, Material Handling/Marking

## American Institute Of Steel Construction

### Booth C8410

1 E Wacker Dr Ste 700  
Chicago, IL 60601-2007 United States  
ph: 312-670-2400  
fax: 312-670-5403  
www.aisc.org



## American Machine & Rollform Tech

### Booth C5520

1200 E Cole St  
Moundridge, KS 67107-8803 United States  
ph: 620-345-6394  
fax: 620-345-6381  
www.bradburygroup.com  
Bending/Forming, Coil Processing, Cutting, Punching, Saws & Cut-off Machines, Stamping, Tool & Die, Tooling

## American Photonics

### Booth C3825

6621 19th St E  
Sarasota, FL 34243-4024 United States  
ph: 941-752-5811  
fax: 941-752-5861  
www.americanphotonics.com  
Lasers

## American Punch Co

### Booth C5026

1655 Century Corners Pkwy  
Euclid, OH 44132-3321 United States  
ph: 216-731-4501  
fax: 216-731-3790  
www.americanpunchco.com  
Cutting, Punching, Tool & Die, Tooling

## American Roll Form

### Booth C5038

892 Callendar Blvd  
Painesville, OH 44077-1218 United States  
ph: 440-352-0753  
fax: 440-352-1959  
www.arfpcorp.com  
Job Shop/Contract Manufacturing, Metal Suppliers

## American Society For Nondestructive Testing

### Booth N1615

1711 Arlingate Ln  
Columbus, OH 43228-4116 United States  
ph: 614-274-6003  
fax: 614-274-6899  
www.asnt.org  
Business Services, Inspection & Testing

## American Technical Publishers

### Booth N1709

10100 Orland Pkwy Ste 200  
Orland Park, IL 60467-5763 United States  
ph: 708-957-1100  
fax: 708-957-1101  
www.go2atp.com

## American Torch Tip Co Inc

### Booth N2022

6212 29th St E  
Bradenton, FL 34203-5304 United States  
ph: 941-753-7557  
fax: 941-753-6917  
www.americantorchtip.com  
Arc Welding, Cutting, Finishing, Lasers, Plate & Structural Fabricating, Robotics, Thermal Spraying, Welding Machines/Equipment

## American Welding Online

### Booth N2233

8669 Doral Blvd.  
Doral, FL 33166 United States  
ph: 800-443-9353  
fax: 305-443-7559  
www.aws.org  
Business Services





### **American Welding Society**

#### **Booth N2031**

8669 Doral Blvd.  
Doral, FL 33166 United States  
ph: 800-443-9353  
fax: 305-443-7559  
www.aws.org  
Business Services

### **AMET Inc**

#### **Booth N4518**

355 Dividend Dr  
Rexburg, ID 83445 United States  
ph: 208-356-7274  
fax: 208-356-8932  
www.ametinc.com  
Arc Welding, Bending/Forming, Coil Processing, Inspection & Testing, Material Handling/Marking, Robotics, Software & Machine Controls, Tube & Pipe Producing, Welding Machines/Equipment

### **AMETEK Specialty Metal Products for Fab**

#### **Booth C914**

1780 Rohrerstown Rd  
Lancaster, PA 17601-2320 United States  
ph: 717-569-7061  
fax: 717-569-7642  
www.ametekmetals.com  
Business Services, Metal Suppliers, Thermal Spraying, Welding Consumables

### **Amiberica Inc**

#### **Booth C1860**

3701 S Ashland Ave  
Chicago, IL 60609-2130 United States  
ph: 773-247-3600  
fax: 773-247-3069  
www.amiberica.com  
Finishing

### **Ampco Metal Inc**

#### **Booth C2326**

1117 E Algonquin Rd  
Arlington Hts, IL 60005-4791 United States  
ph: 847-437-6000  
fax: 847-437-6008  
www.ampcometal.com

Bending/Forming, Metal Suppliers, Stamping, Thermal Spraying, Tooling, Welding Consumables

### **Anchor Danly**

#### **Booth C931**

38505 Country Club Dr Ste 100  
Farmington Hills, MI 48331-3403 United States  
ph: 800-652-6462  
fax: 800-406-4410  
www.anchoranly.com  
Job Shop/Contract Manufacturing, Material Handling/Marking, Stamping, Tool & Die, Tooling

### **Anest Iwata USA Inc**

#### **Booth C2746**

5325 Muhlhauser Rd  
Hamilton, OH 45011-9349 United States  
ph: 513-755-3100  
fax: 513-755-0888  
www.anestiwata.com  
Finishing, Surface Treatment & Cleaning Equipment



### **Anomatic Corp**

#### **Booth C2452**

1650 Tamarack Rd  
Newark, OH 43055 United States  
ph: 740-522-2203  
fax: 740-522-3339  
www.anomatic.com  
Business Services, Finishing, Job Shop/Contract Manufacturing, Metal Suppliers, Punching, Stamping

### **Antec Electronics Co Ltd**

#### **Booth N1609**

17B Shuangmiao Industry Zone  
Luoshe, Wuxi, Jiangsu 214187 China  
ph: 86 510 8331700  
fax: 86 510 8331891  
www.antec.cn  
Welding Machines/Equipment

### **Anthony Welded Products Inc**

#### **Booth N3127**

PO Box 2107  
Bakersfield, CA 93303-2107 United States

ph: 877-721-7211  
fax: 661-725-0811  
www.anthonycarts.com

### **AP&T North America Inc**

#### **Booth C1231**

4817 Persimmon Ct  
Monroe, NC 28110-9314 United States  
ph: 704-220-3215  
fax: 704-292-2906  
www.apgroup.com  
Hydroforming, Robotics, Safety & Environmental, Software & Machine Controls, Stamping, Tool & Die, Tooling

### **APEL International**

#### **Booth N1526**

11201 Ampere Ct  
Louisville, KY 40299-3884 United States  
ph: 502-240-0443  
fax: 502-240-0717  
www.apelfilters.com  
Finishing, Safety & Environmental



### **Apex Machine Group/SlipCon USA**

#### **Booth C5528**

4700 Olson Memorial Hwy  
Minneapolis, MN 55422-5144 United States  
ph: 952-746-2330  
fax: 952-746-2331  
www.slipcon.com  
Finishing, Material Handling/Marking, Other Machinery/Equipment/Parts/Products, Safety & Environmental



### **APPI Energy**

#### **Booth C463**

224 Phillip Morris Dr Ste 402  
Salisbury, MD 21804-2001 United States  
ph: 800-520-6685  
fax: 410-749-8769  
www.appienergy.com



"Applying Multiple Company Services to Ensure YOUR Manufacturing Success!"

## Applied Manufacturing Services LLC

**Booth C920**

4052 Pelton Rd  
Fostoria, OH 44830 United States  
ph: 419-619-1331



## Aquasol Corp

**Booth N3613**

80 Thompson St  
N Tonawanda, NY 14120-5312 United States  
ph: 716-564-8888  
fax: 716-564-8889

[www.aquasolwelding.com](http://www.aquasolwelding.com)

Finishing, Gases & Gas Equipment, Other Machinery/Equipment/Parts/Products, Thermal Spraying, Welding Consumables, Welding Machines/Equipment

## Arbor Metals

**Booth C855**

811 Regal Row  
Dallas, TX 75247-4406 United States  
ph: 214-357-6161  
fax: 214-357-6590  
[www.arbormetals.com](http://www.arbormetals.com)

## Arc Machines Inc

**Booth N5522**

10500 Orbital Way  
Pacoima, CA 91331-7129 United States  
ph: 818-896-9556  
fax: 818-890-3724  
[www.arcmachines.com](http://www.arcmachines.com)  
Arc Welding, Welding Machines/Equipment

## Arc Products

**Booth N4507**

1245 30th St  
San Diego, CA 92154-3477 United States  
ph: 619-628-1022  
fax: 619-628-1028  
[www.arcproducts.com](http://www.arcproducts.com)  
Arc Welding, Welding Machines/Equipment

## Arc Specialties Inc

**Booth N1610**

1730 Stebbins Dr  
Houston, TX 77043-2807 United States  
ph: 713-631-7575  
fax: 713-356-0844  
[www.arcspecialties.com](http://www.arcspecialties.com)  
Arc Welding, Business Services, Cutting, Fastening & Joining, Finishing, Inspection & Testing, Material Handling/Marking, Robotics, Software & Machine Controls, Thermal Spraying, Tube & Pipe Fabricating or Welding

## ARCON Welding Equipment LLC

**Booth N2215**

2203 Northwood Dr Unit 10  
Salisbury, MD 21801-8829 United States  
ph: 888-512-7266  
fax: 410-572-6027  
[www.arconweld.com](http://www.arconweld.com)



## ArcOne

**Booth N3231**

85 Independence Drive  
Taunton, MA 02780-1076 United States  
ph: 508-884-9600  
fax: 508-884-9666  
[www.arc1weldsafe.com](http://www.arc1weldsafe.com)  
Arc Welding, Safety & Environmental, Welding Machines/Equipment

## Arkema Inc

**Booth C1863**

900 First Ave  
Kng Of Prussa, PA 19406-1308 United States  
ph: 610-878-6500  
fax: 610-878-6400  
[www.arkema.com](http://www.arkema.com)

## ARKU Coil Systems Inc

**Booth C7528**

11405 Grooms Rd  
Cincinnati, OH 45242-1407 United States  
ph: 513-985-0500  
fax: 513-985-0580  
[www.us.arku.com](http://www.us.arku.com)  
Coil Processing, Job Shop/Contract Manufacturing, Plate & Structural Fabricating, Press Brakes, Stamping

## Armstrong/Kover Kwick Inc feat NCCM Mill Rolls

**Booth C7047**

401 Sproul St  
Mc Kees Rocks, PA 15136-2883 United States  
ph: 800-252-3358  
[www.akkinc.com](http://www.akkinc.com)  
Coil Processing, Finishing, Material Handling/Marking, Tooling  
**Distributors:**  
NCCM Mill Rolls

## Arro-Mark Co LLC

**Booth C5836**

158 W Forest Ave  
Englewood, NJ 07631-4526 United States  
ph: 201-567-4112  
fax: 201-567-1373  
[www.arromark.com](http://www.arromark.com)  
Material Handling/Marking

## Arrowhead Manufacturers & Fabricators Assoc

**Booth C8242**

PO Box 150  
Elbow Lake, MN 56531-0150 United States  
ph: 877-330-2632  
fax: 218-685-5397  
[www.amfa-mn-wi.org](http://www.amfa-mn-wi.org)  
Business Services, Cutting, Fastening & Joining, Gases & Gas Equipment, Job Shop/Contract Manufacturing

## ASKO Inc

**Booth C4810**

501 W 7th Ave  
Homestead, PA 15120-1036 United States  
ph: 412-461-4110  
fax: 412-461-5400  
[www.askoinc.com](http://www.askoinc.com)  
Business Services, Coil Processing, Cutting, Finishing, Metalforming & Fabricating Equipment, Saws & Cut-off Machines, Software & Machine Controls

## Associated Spring Raymond

**Booth C1426**

370 W Dussel Dr Ste A  
Maumee, OH 43537-1604 United States  
ph: 419-891-9292  
fax: 419-891-9192  
[www.asraymond.com](http://www.asraymond.com)  
Fastening & Joining, Tool & Die

## Association For Iron & Steel Technology

### Booth C8530

186 Thorn Hill Rd  
Warrendale, PA 15086-7528 United States  
ph: 724-814-3000  
fax: 724-814-3001  
www.aist.org  
Business Services



## Athader

### Booth C5520

Zuatzu Parque Empresarial Edificio Uliá, 12  
San Sebastian Gipuzkoa, 20018 Spain  
ph: 34 943 219199  
fax: 34 943 219181  
www.athader.com  
Coil Processing, Cutting, Finishing, Material  
Handling/Marking, Saws & Cut-off Machines

## ATI Industrial Automation

### Booth N5708

1031 Goodworth Dr  
Apex, NC 27539-3869 United States  
ph: 919-772-0115  
fax: 919-772-8259  
www.ati-ia.com  
Finishing, Robotics, Stamping, Tool & Die

## ATI Stellram

### Booth N1733

1 Teledyne Pl  
La Vergne, TN 37086-3529 United States  
ph: 615-641-4206  
www.stellram.com  
Cutting, Finishing, Welding Consumables

## Atlanta Drive Systems Inc

### Booth C8323

1775 Route 34 Unit D10  
Farmingdale, NJ 07727 United States  
ph: 732-282-0480  
fax: 732-282-0450

www.atlantadrives.com  
Other Machinery/Equipment/Parts/Products,  
Software & Machine Controls

## Atlantic Tool & Die Co

### Booth C1155

19963 Progress Drive  
Strongsville, OH 44149 United States  
ph: 440-238-6931  
fax: 440-238-2210  
www.atlantictool.com  
Assembly, Job Shop/Contract Manufacturing,  
Tool & Die

## Atlatl Inc

### Booth C8519

219 Safety Ave  
Andrews, SC 29510-6971 United States  
ph: 843-264-8096  
fax: 843-264-8584  
www.erectastep.com



Visit us in Booth C2724

*Experience  
the Magic Rack®  
Difference*

### Custom-design racking solutions engineered to maximize your finishing line.

That's the Magic Rack® difference. Our personal approach to providing unique solutions that make optimum use of rack space is what has made us the industry leader in custom finishing solutions for over 30 years.

Whether we visit your facility, or you send us your part for analysis, our goal is to provide the best racking solution to **improve your production efficiencies** and **reduce operating costs**.

**Contact us today to discuss how our exclusive *Magic Rack*® 9-Step Analysis process and unique patented racking technology can solve your most challenging finishing needs.**



RACKING UP SOLUTIONS.

### PRODUCTION PLUS CORP.

Toll-free (U.S.): 866.492.8811  
Phone: 614.492.8811  
E-mail: sales@MagicRack.com  
www.MagicRack.com



Made in the U.S.A.

*Photo courtesy of Neaton Auto Products.*





 **Attexor Clinch Systems SA**  
**Booth C5622**

Chemin des Larges Pieces - Z.I.B  
Ecublens, 1024 Switzerland  
ph: 00 41 216948000  
fax: 00 41 216948001  
www.clinchsystems.com  
Assembly, Fastening & Joining, Finishing,  
Other Machinery/Equipment/Parts/Products,  
Punching, Robotics, Stamping, Tooling,  
Welding Machines/Equipment  
*Distributors:*  
ADVANCED Clinch Systems, Inc.

**Auburn Manufacturing Inc**  
**Booth N4904**

PO Box 220  
Mechanic Falls, ME 04256-0220 United States  
ph: 207-345-8771  
fax: 207-345-3380  
www.auburnmfg.com  
Material Handling/Marking, Safety &  
Environmental, Welding Machines/  
Equipment

 **Autoform Engineering**  
**Booth C936**

3150 Livernois Rd STE 201  
Troy, MI 48083 United States  
ph: 248-269-4000  
fax: 888-528-8636  
www.autoform.com  
Software & Machine Controls

**Automated Tapping Systems**  
**Booth C820**

22 Davos Rd  
Brick, NJ 08724-4306 United States  
ph: 732-899-2282  
fax: 732-899-0277  
www.automatedtappingsystems.com  
Machining/EDM, Tool & Die

**Automec Inc**  
**Booth C4832**

PO Box 519  
Waltham, MA 02453-0519 United States  
ph: 781-893-3403  
fax: 781-899-5708  
www.automec.com  
Cutting, Machining/EDM, Material Handling/  
Marking, Press Brakes, Saws & Cut-off  
Machines

 **Avani Environmental Intl Inc.**  
**Booth N4537**

95 Cypress Dr  
Youngsville, NC 27596-8795 United States  
ph: 919-488-5163  
fax: 919-570-2863  
www.avanienvironmental.com  
Safety & Environmental

**AVS Industries LLC**  
**Booth N6018**

21 Bellecor Drive  
New Castle, DE 19720-1743 United States  
ph: 302-221-1720  
fax: 302-221-1721  
www.avsind.com  
Safety & Environmental, Welding Machines/  
Equipment

**AW&S Co Ltd**  
**Booth N2207**

501 Keumbong Technovalley  
93-5 Dangjeong-Dong  
Gunpo City, Kyounggi-Do 435030 Korea  
(South)  
ph: 82 31 477 8505  
fax: 82 31 477 8503  
www.awands.co.kr

**AWS Foundation**  
**Booth N1336**

550 NW LeJeune Rd  
Miami, FL 33126-5649 United States  
ph: 305-443-9353  
fax: 305-443-7559  
www.aws.org

**AWS Publications/World  
Engineering Xchange**  
**Booth N2028**

13301 NW 47th Ave  
Opa Locka, FL 33054-4316 United States  
ph: 305-826-6192  
fax: 305-826-6195  
www.awspubs.com

**Axelent Inc**  
**Booth N5127**

10499 164th Pl Ste B  
Orland Park, IL 60467-5436 United States  
ph: 708-745-3130  
fax: 708-745-3125  
www.axelentusa.com  
Safety & Environmental

**AZ Metalworker**  
**Booth C8321**

PO Box 93295  
Phoenix, AZ 85070-3295 United States  
ph: 602-412-7696  
www.azmetalworker.com

**AZZ Galvanizing Services**  
**Booth C5835**

One Museum Place  
3100 West 7th St Ste 500  
Fort Worth, TX 76107 United States  
ph: 817-810-0095  
fax: 817-336-5354  
www.azzgalvanizing.com  
Finishing

**B&B Steel Products Inc**  
**Booth N3107**

1205 Indiana  
South Houston, TX 77587-3223 United  
States  
ph: 713-747-8502  
fax: 713-747-8505  
www.b-b-jack.com  
Material Handling/Marking

**Bad Dog Tools**  
**Booth N3106**

PO Box 851  
24 Broadcommon Road  
Bristol, RI 02809 United States  
ph: 401-253-1330  
fax: 401-253-1377  
www.baddogtools.com  
Cutting, Other Machinery/Equipment/  
Parts/Products

 **Baileigh Industrial Inc**  
**Booth C7513**

1625 Dufek Dr  
Manitowoc, WI 54220-8372 United States  
ph: 920-684-4990  
fax: 920-684-3944  
www.baileighindustrial.com  
Bending/Forming, Cutting, Machining/EDM,  
Plate & Structural Fabricating, Press Brakes,  
Saws & Cut-off Machines, Tube & Pipe  
Fabricating or Welding, Waterjet

**Balluff Inc**  
**Booth C1047**

8125 Holton Dr  
Florence, KY 41042-3009 United States



ph: 859-727-2200  
 fax: 859-727-8506  
 www.balluff.com  
 Software & Machine Controls

### **BandSawParts.com** Booth C7538

9502 E Hardy Rd  
 Houston, TX 77093-6637 United States  
 ph: 713-884-1104  
 fax: 713-884-1113  
 www.bandsawparts.com  
 Cutting, Maintenance & Repair, Saws &  
 Cut-off Machines

### **Baril Coatings USA** Booth C2158

401 Growth Parkway  
 Angola, IN 46703-9323 United States  
 ph: 260-665-8431  
 fax: 260-665-8511  
 www.barilcoatings.com  
 Finishing

# BARTON

### **Barton** Booth C4916

6 Warren St  
 Glens Falls, NY 12801-4531 United States  
 ph: 800-741-7756  
 fax: 518-798-5728  
 www.barton.com  
 Cutting, Maintenance & Repair, Waterjet

### **Bascon Inc** Booth C7146

607-500 Redna Terrace  
 Cincinnati, OH 45215-1171 United States  
 ph: 513-772-1674  
 fax: 513-772-1684  
 www.basconinc.com  
 Business Services

### **Basis-Tech Industrial Ltd** Booth N6118

122 Mayland Ct  
 San Jose, CA 95138-1517 United States  
 ph: 800-518-0328  
 www.basis-tech.net

### **Bay State Surface Technologies** Booth N2419

201 Washington St  
 Auburn, MA 01501-3224 United States  
 ph: 508-832-5035  
 fax: 508-832-5043  
 www.baystatesurfacetech.com  
 Brazing & Soldering, Resistance Welding,  
 Robotics, Safety & Environmental, Thermal  
 Spraying, Welding Consumables  
*Distributors:*  
 Technology Management Consultants Poland  
 Industrial Connect Mexico  
 Eutectic Korea, Ltd.

### **Baykal Makina Sanayi ve Ticaret AS** Booth C5940, C5947

Organize Sanayi Bilgesi  
 Lacivert Cad. No:1/A - NilÅfer  
 Bursa, 16140 Turkey  
 ph: 90 224 2431610  
 fax: 90 224 2431286  
 www.baykal.com.tr  
 Bending/Forming, Cutting, Lasers, Other  
 Machinery/Equipment/Parts/Products, Plate  
 & Structural Fabricating, Press Brakes,  
 Punching, Tooling, Tube & Pipe Fabricating or  
 Welding  
*Distributors:*  
 FAB-LINE MACHINERY ILC

### **BECCA Inc** Booth C1854

2010 Cobb International Blvd  
 Suite H  
 Kennesaw, GA 30152-4364 United States  
 ph: 770-419-5913  
 fax: 770-419-9438  
 www.beccainc.com  
 Finishing, Other Machinery/Equipment/Parts/  
 Products, Safety & Environmental



### **Beck Automation** Booth C5520

814 Fee Fee Rd  
 St Louis, MO 63043-3219 United States  
 ph: 314-576-9736  
 fax: 314-227-2104

www.beckautomation.com  
 Bending/Forming, Business Services, Coil  
 Processing, Material Handling/Marking,  
 Saws & Cut-off Machines, Software &  
 Machine Controls, Stamping

### **Beckhoff Automation** Booth C7545

12150 Nicollet Ave  
 Burnsville, MN 55337-1647 United States  
 ph: 952-890-0000  
 fax: 952-890-2888  
 www.beckhoffautomation.com  
 Safety & Environmental, Software &  
 Machine Controls



### **Beckwood Press Co** Booth C1228

889 Horan Dr  
 St. Louis, MO 63026-2405 United States  
 ph: 636-343-4100  
 fax: 800-737-0444  
 www.beckwoodpress.com  
 Hydroforming, Other Machinery/Equipment/  
 Parts/Products, Punching, Stamping

### **Behringer Saws Inc** Booth C5722

721 Hemlock Rd  
 Morgantown, PA 19543 United States  
 ph: 610-286-9777  
 fax: 610-286-9699  
 www.behringersaws.com  
 Machining/EDM, Material Handling/  
 Marking, Plate & Structural Fabricating,  
 Punching, Saws & Cut-off Machines

### **Beijing Essen Welding & Cutting Fair** Booth N6200

2-5-1607 Lianhuaxiaoqu  
 Haidian District  
 Beijing, Beijing 100036 China  
 ph: 86 10 6397240  
 fax: 86 10 6398055  
 www.essen.cmes.org  
 Arc Welding, Welding Consumables



**Beilun Futuo Mechanical Tools Co Ltd**  
**Booth N6026**

No 88 Moju Rd  
Daqi Industrial Zone  
Beilun, Ningbo Zhejiang 315806 China  
ph: 86 574 86107333  
fax: 86 574 86106558  
www.futuo.com  
Cutting, Finishing, Saws & Cut-off  
Machines, Tooling

 **Benxi Guangzheng Tungsten & Molybdenum Co Ltd**  
**Booth C456**

Room 1611 16F No 8-1 Jiefang (N) Road  
Benxi, Liaoning 117000 China  
ph: 86 414 2810123  
fax: 86 414 2864789  
www.chinamowti.com  
Fastening & Joining, Metal Suppliers, Other  
Machinery/Equipment/Parts/Products,  
Welding Consumables, Welding Machines/  
Equipment



 **Bernard**  
**Booth N5516**

449 W Corning Rd  
Box 667  
Beecher, IL 60401 United States  
ph: 708-946-2281  
fax: 708-946-6726  
Arc Welding, Welding Machines/Equipment

**BESSEY Tools North America**  
**Booth N4931**

1555 Bishop St N, Unit 6  
Cambridge, ON N1R 7J4 Canada  
ph: 800-828-1004  
fax: 519-621-3442  
www.besseytools.com  
Cutting, Fastening & Joining, Lubrication,  
Material Handling/Marking, Other  
Machinery/Equipment/Parts/Products

**BesTech Tool Corp**  
**Booth C921**

1605 Corporate Center Dr  
West Bend, WI 53095-9800 United States  
ph: 262-338-6312

fax: 262-338-1158  
www.bestechtool.com  
Job Shop/Contract Manufacturing, Tool &  
Die, Tooling



**Betenbender Manufacturing Inc**  
**Booth C3744**

5806 Quality Ridge Rd.  
PO Box 140  
Coggon, IA 52218-0140 United States  
ph: 319-435-2378  
fax: 319-435-2262  
www.betenbender.com  
Cutting, Material Handling/Marking,  
Other Machinery/Equipment/Parts/Products,  
Press Brakes, Stamping, Tooling

 **Bettcher Manufacturing LLC**  
**Booth C1053**

6801 S 33rd St Bldg M  
McAllen, TX 78503-8968 United States  
ph: 956-618-5805  
fax: 956-618-3633  
www.bettcherllc.com  
Arc Welding, Assembly, Finishing, Other  
Machinery/Equipment/Parts/Products, Press  
Brakes, Punching, Resistance Welding,  
Robotics, Stamping



**BEWO Cutting Systems**  
**Booth C2128**

De Kroonstraat 15  
PO Box 5059  
EB Tilburg, 05004 Netherlands  
ph: 31 013467691  
fax: 31 134680201



**Bex Spray Nozzles**  
**Booth C1361**

836 Phoenix Dr  
Ann Arbor, MI 48108-2221 United States  
ph: 734-389-0464  
fax: 734-389-0470  
www.bex.com

**Big Ass Fans**  
**Booth C7742**

800 Winchester Rd  
Lexington, KY 40505 United States  
ph: 859-233-1271  
fax: 859-233-0139  
www.bigassfans.com  
Maintenance & Repair, Other Machinery/  
Equipment/Parts/Products, Safety &  
Environmental

**Big Steel Rack**  
**Booth C8528**

2427 Research Dr  
Jackson, MI 49203-6409 United States  
ph: 517-789-8988  
fax: 517-789-8495  
www.bigsteellrack.com  
Material Handling/Marking

**BigC: Dino-Lite Scopes**  
**Booth C2055**

20655 S Western Ave Ste 116  
Torrance, CA 90501-1800 United States  
ph: 310-618-9990  
fax: 310-618-9996  
www.bigc.com  
Inspection & Testing

**Bilsing Automation North America**  
**Booth C926**

22287 Starks Dr  
Clinton Twp, MI 48036-1199 United States  
ph: 586-463-0686  
fax: 586-463-1003  
www.bilsing-automation.com  
Robotics, Tooling





**BINKS DeVILBISS Ransburg BGK.**

 **Binks DeVilbiss  
Ransburg BGK  
Booth C2532**

195 Internationale Blvd  
Glendale Hts, IL 60139-4204 United States  
ph: 630-237-5130  
fax: 800-368-8401  
www.itwfea.com  
Finishing

**Blackjack Pipejack Stands LLC  
Booth N3028**

PO Box 93  
Oakhurst, TX 77359 United States  
ph: 936-377-4839  
fax: 936-377-2065  
www.pipejack.com

**Blastec Inc  
Booth C8142**

4965 Atlanta Hwy  
Alpharetta, GA 30004-2922 United States  
ph: 770-475-2700  
fax: 770-475-2336  
www.blastec.com  
Finishing

**Bliss Clearing Niagara  
Booth C933**

1004 E State St  
Hastings, MI 49058-9166 United States  
ph: 269-943-3300  
fax: 269-948-3313  
www.bcntechserv.com  
Bending/Forming, Business Services,  
Maintenance & Repair, Other Machinery/  
Equipment/Parts/Products, Stamping, Tooling

**BLM GROUP USA Corp  
Booth C1717**

29380 Beck Rd  
Wixom, MI 48393-3648 United States  
ph: 248-560-0080  
fax: 248-560-0083  
www.blmgroupp.com  
Finishing, Inspection & Testing, Lasers, Saws  
& Cut-off Machines, Tube & Pipe Fabricating  
or Welding

**Blow Press Co.  
Booth C857**

633 Southgate Dr  
Guelph, ON N1G 3W6 Canada  
ph: 519-763-3321  
fax: 519-763-7021  
www.blowpress.com

 **Bluco Corp  
Booth N2819**

3500 Thayer Ct  
Aurora, IL 60504-3108 United States  
ph: 630-637-1820  
fax: 630-637-1847  
www.bluco.com  
Material Handling/Marking

**BMM Welding Material Co  
Booth N6109**

No 5 Fangzhuang Lu  
Zuanmenwai  
Beijing, 100078 China  
ph: 86 10 676 49947  
fax: 86 10 676 44579  
www.bjmm.com  
Brazing & Soldering, Metal Suppliers,  
Resistance Welding, Thermal Spraying,  
Welding Consumables, Welding Machines/  
Equipment

 **Bohler Uddeholm Corp  
Booth C1417**

2505 Millennium Dr  
Elgin, IL 60124-7815 United States  
ph: 630-638-2520  
fax: 630-883-3101  
www.bucorp.com  
Metal Suppliers, Tooling

**Bohler Welding Group USA Inc  
Booth N2013**

10401 Greenbough Dr  
Stafford, TX 77477-5014 United States  
ph: 281-499-1212  
fax: 281-499-4347  
www.bohlerweldinggroupusa.com.com  
Brazing & Soldering, Finishing, Welding  
Consumables

**Bolttech Mannings  
Booth N2326**

501 Mosside Blvd  
North Versailles, PA 15137-2552 United States  
ph: 724-872-4873  
fax: 866-542-4895  
www.bolttechmannings.com  
Business Services, Cutting, Inspection &  
Testing, Job Shop/Contract Manufacturing,  
Other Machinery/Equipment/Parts/Products

**Bonal Technologies Inc  
Booth N2924**

1300 N Campbell Rd  
Royal Oak, MI 48067-1573 United States  
ph: 248-582-0900  
fax: 248-582-0901  
www.bonal.com  
Inspection & Testing, Machining/EDM, Other  
Machinery/Equipment/Parts/Products

**Bore Repair Systems Inc  
Booth N6319**

PO Box 59  
Alstead, NH 03602 United States  
ph: 603-835-2409  
fax: 603-835-2609  
www.borerepair.com  
Machining/EDM, Maintenance & Repair,  
Welding Machines/Equipment

**Bosch Power Tool Corp  
Booth N5006**

1800 W Central Rd  
Mt Prospect, IL 60056-2230 United States  
ph: 224-232-2000  
fax: 224-232-2611  
www.boschtools.com  
Cutting, Finishing, Hand & Portable Tools,  
Metalforming & Fabricating Equipment,  
Other Machinery/Equipment/Parts/Products,  
Saws & Cut-off Machines, Tooling

**Bosch Rexroth Corp  
Booth C8316**

14001 S Lakes Dr  
Charlotte, NC 28273-6791 United States  
ph: 704-583-4338  
www.boschrexroth-us.com



**Boschert Precision Machinery Inc**  
**Booth C2820**

PO Box 409  
Butler, WI 53007-0409 United States  
ph: 262-783-7816  
fax: 262-373-1165  
www.boschertusa.com  
Bending/Forming, Plate & Structural Fabricating, Press Brakes, Punching, Software & Machine Controls, Tooling, Tube & Pipe Fabricating or Welding

**Bowlin Engineering**  
**Booth C4838**

600 Burlington Rd  
Saginaw, TX 76179-1310 United States  
ph: 817-232-2020  
fax: 817-232-4081  
www.bowlinengineering.com  
Business Services, Job Shop/Contract Manufacturing, Material Handling/Marking, Other Machinery/Equipment/Parts/Products, Plate & Structural Fabricating, Safety & Environmental

**Box On Demand by Plymouth Packaging**  
**Booth C4824**

4075 Columbia Ave W  
Battle Creek, MI 49015-9606 United States  
ph: 269-964-7181  
fax: 269-964-9969  
www.boxondemand.com  
Material Handling/Marking, Other Machinery/Equipment/Parts/Products



**Bradbury Co., Inc., The**  
**Booth C5520**

1200 E Cole St  
Moundridge, KS 67107-8803 United States  
ph: 620-345-6394  
fax: 620-345-6381  
www.bradburygroup.com  
Bending/Forming, Coil Processing, Job Shop/

Contract Manufacturing, Saws & Cut-off Machines, Tool & Die, Tooling



**Bradbury Group Australia**  
**Booth C5520**

25 Eurora St  
Kingston, Qld 04114 Australia  
ph: 61 732 993111  
fax: 61 732 995511  
www.bradburygroup.com  
Bending/Forming, Coil Processing, Material Handling/Marking, Saws & Cut-off Machines, Tooling



**Bradbury Group, The**  
**Booth C5520**

PO Box 667  
Moundridge, KS 67107-0667 United States  
ph: 620-345-6394  
fax: 620-345-6381  
www.bradburygroup.com  
Bending/Forming, Coil Processing, Job Shop/Contract Manufacturing, Saws & Cut-off Machines, Tool & Die, Tooling

**Bradford Derustit Corp**  
**Booth N4804**

21660 Waterford Dr  
Yorba Linda, CA 92887-2650 United States  
ph: 714-695-0899  
fax: 877-285-2080  
www.derustit.com  
Finishing, Maintenance & Repair

**Brandt Engineered Products Ltd**  
**Booth C1755**

PO Box 1876  
302 Mill St  
Regina, SK S4P 3E1 Canada  
ph: 306-791-7557  
fax: 306-791-0098  
www.brandt.ca  
Business Services, Inspection & Testing, Job Shop/Contract Manufacturing, Tube & Pipe Fabricating or Welding, Tube & Pipe Producing

**Broco Inc**  
**Booth N4926**

10868 Bell Ct  
Rch Cucamonga, CA 91730-4835 United States  
ph: 909-483-3222  
fax: 909-483-3233  
www.brocoinc.com  
Brazing & Soldering, Cutting, Finishing, Welding Consumables

**Brown Boggs**  
**Booth C1409**

151 Belfield Rd  
Toronto, ON M9W 1G8 Canada  
ph: 416-241-0320  
fax: 416-736-3622  
www.brownboggs.com  
Stamping

**Bruderer Machinery Inc**  
**Booth C925**

1200 Hendricks Cswy  
Ridgefield, NJ 07657-2106 United States  
ph: 201-941-2121  
fax: 201-886-2010  
www.bruderer.com  
Coil Processing, Lubrication, Stamping

**Bruker Elemental**  
**Booth C7339**

415 N Quay St  
Kennewick, WA 99336-7783 United States  
ph: 509-783-9850  
fax: 509-735-9696  
www.bruker.com/hhxf  
Inspection & Testing

 **BTM Bandsaws**  
**Booth C8416**

113 Winniett St  
Woodstock, ON N4S 5Z8 Canada  
ph: 519-539-0450  
fax: 519-539-2210  
Material Handling/Marking, Saws & Cut-off Machines

**Buffalo Shrink Wrap**  
**Booth N2210**

PO Box 537  
Clarence, NY 14031-0537 United States  
ph: 716-759-0462  
fax: 716-759-0467  
www.buffaloshrinkwrap.com  
Maintenance & Repair, Material Handling/Marking



### **Bug-O Systems** Booth N4813, N5013

161 Hillpointe Dr  
Canonsburg, PA 15317 United States  
ph: 412-331-1776  
fax: 412-331-0383  
www.bugo.com  
Bending/Forming, Cutting, Material  
Handling/Marking, Plate & Structural  
Fabricating, Thermal Spraying, Welding  
Machines/Equipment

### **Bulk Chemicals Inc** Booth C2433

1074 Stinson Dr  
Reading, PA 19605-9440 United States  
ph: 610-926-4128  
fax: 610-926-6125  
www.bulkchemicals.us  
Finishing

## **BULLARD** ABRASIVES

### **Bullard Abrasives Inc** Booth N1831

6 Carol Dr  
Lincoln, RI 02865-4402 United States  
ph: 401-333-3000  
fax: 401-333-3077  
www.bullardabrasives.com

### **Burghardt + Schmidt GmbH** Booth C4934

Raiffeisenstr 24  
Remchingen, 75196 Germany  
ph: 49 7232 366146  
fax: 49 7232 366165  
www.b-s-germany.de  
Coil Processing, Cutting, Maintenance &  
Repair, Material Handling/Marking  
**Distributors:**  
Burghardt+Schmidt Distribution Office USA  
Peter Swenson

### **Burny & Kaliburn** Booth N2422

4130 Carolina Commerce Pkwy  
Ladson, SC 29456-6707 United States  
ph:

### **Burr King Manufacturing Co** Booth C4740

1220 Tamara Ln  
Warsaw, MO 65355-3346 United States  
ph: 660-438-8998  
fax: 660-438-8991  
www.burrrking.com  
Finishing, Safety & Environmental

### **Butech Bliss** Booth C5532

550 S Ellsworth Ave  
Salem, OH 44460-3067 United States  
ph: 330-337-0000  
fax: 330-337-0800  
www.butech.com  
Bending/Forming, Business Services, Coil  
Processing, Job Shop/Contract  
Manufacturing, Material Handling/Marking,  
Metalforming & Fabricating Equipment

### **BUWW Coverings Inc** Booth C7320

4462 Boeing Dr  
Rockford, IL 61109-2931 United States  
ph: 815-962-2899  
fax: 815-962-2897  
www.buww.com  
Business Services, Job Shop/Contract  
Manufacturing, Other Machinery/Equipment/  
Parts/Products, Safety & Environmental



### **Bystronic Inc** Booth C4328

200 Airport Rd  
Elgin, IL 60123-9325 United States  
ph: 847-214-0300  
fax: 847-241-0299  
www.bystronicusa.com  
Lasers, Press Brakes, Software & Machine  
Controls, Tooling, Tube & Pipe Producing,  
Waterjet

### **C H Symington & Co Inc** Booth N2213

6063 Frantz Rd Ste 103  
Dublin, OH 43017-3369 United States  
ph: 614-766-2602

fax: 614-766-2715  
www.chsymington.com  
Cutting, Material Handling/Marking, Welding  
Consumables, Welding Machines/Equipment

### **C Marshall Fabrication Machinery** Booth C7716

2281 Oakdale Cir  
Simi Valley, CA 93063-5042 United States  
ph: 805-527-1340  
fax: 805-527-7619  
www.cmarshallfab.com  
Bending/Forming, Cutting, Plate & Structural  
Fabricating, Press Brakes, Tube & Pipe  
Fabricating or Welding

### **C.A. Technologies Inc** Booth C1763

337 S Arthur Ave  
Louisville, CO 80027-3011 United States  
ph: 303-438-5707  
fax: 303-438-5708  
www.spraycat.com  
Finishing



### **Cabelas Inc** Booth North Hall Lobby

1 Cabelas Drive  
Sidney, NE 69160 United States  
ph: 800-237-4444  
fax: 888-249-4596  
www.cabelas.com  
Business Services

### **California Cold Saw** Booth C7240

1843 East St  
Concord, CA 94520-2123 United States  
ph: 925-687-7710  
fax: 925-687-0689  
www.californiacoldsaw.com  
Cutting, Lubrication, Tooling





## Calvary Industries Inc

### Booth C2734

9233 Seward Rd  
Fairfield, OH 45014-5407 United States  
ph: 513-874-1113  
fax: 513-860-6184  
www.calvaryindustries.com  
Finishing, Lubrication, Welding Consumables

## Cambco Inc

### Booth C7430

1019 Rankin Rd  
Houston, TX 77073-4605 United States  
ph: 281-731-4320  
fax: 281-821-6505  
www.cambcoinc.com  
Other Machinery/Equipment/Parts/Products

## Cambridge Lee Industries LLC

### Booth C8333

1340 Soldiers Field Rd Ste 5  
Boston, MA 02135-1031 United States  
ph: 617-783-3100  
fax: 617-787-7823  
www.camleeindustrialmetals.com  
Metal Suppliers

## Cambridge Vacuum Engineering

### Booth N3038

630 Silver St Ste 7A  
Agawam, MA 01001-2940 United States  
ph: 413-789-4600  
fax: 413-786-0508  
www.camvaceng.com  
Welding Machines/Equipment

#### *Distributors:*

Cambridge Vacuum Engineering, Inc.

## Cantesco

### Booth N3027

1200 N America Dr  
West Seneca, NY 14224-5303 United States  
ph: 716-558-2971  
fax: 716-693-8373  
www.cantesco.com  
Gases & Gas Equipment, Inspection & Testing, Welding Consumables

## Capital Weld Cleaners

### Booth N3007

720 N Golden Key St Ste B6  
Gilbert, AZ 85233-3807 United States  
ph: 480-967-0016  
fax: 480-907-2078  
www.capitalweldcleaners.com  
Finishing, Welding Machines/Equipment

## Cardinal Paint and Powder

### Booth C1761

1329 Potrero Ave  
S El Monte, CA 91733-3012 United States  
ph: 323-283-9335  
fax: 626-444-0382  
www.cardinalpaint.com  
Finishing



## Carell Corp/Eagle Bending Machines

### Booth C5928

PO Box 850  
Stapleton, AL 36578-0850 United States  
ph: 251-937-0947  
fax: 251-937-4742  
www.carellcorp.com  
Bending/Forming, Other Machinery/  
Equipment/Parts/Products, Plate & Structural  
Fabricating, Tooling, Tube & Pipe Fabricating  
or Welding

## Carestream

### Booth N2426

1049 W Ridge Rd  
Rochester, NY 14615 United States  
ph: 800-328-2910  
fax: 800-445-9967  
www.carestreamhealth.com  
Business Services, Inspection & Testing,  
Other Machinery/Equipment/Parts/Products,  
Resistance Welding

## Carhartt Workwear

### Booth N1506

89 Broadway  
Park Ridge, NJ 07656-2135 United States  
ph: 201-379-3102  
fax: 888-643-3159  
www.ruggedoutfitters.net

Safety & Environmental

#### *Distributors:*

Carhartt Under Armour Dickies Bulwark

## Carpenter Chemicals LC

### Booth C2712

206 N Washington St - Ste 330  
Alexandria, VA 22314-2528 United States  
ph: 703-683-1570  
fax: 703-683-4131  
www.cc-lc.com  
Finishing

## Carr Lane Manufacturing Co

### Booth N3036

4200 Carr Lane Ct  
Saint Louis, MO 63119-2196 United States  
ph: 314-647-6200  
fax: 314-647-5736  
www.carrlane.com  
Business Services, Fastening & Joining,  
Material Handling/Marking, Tool & Die

## Catalytic Industrial Systems

### Booth C2421

PO Box 827  
Independence, KS 67301-0827 United States  
ph: 631-331-0750  
www.cat-group.com  
Finishing

## Cedar Valley Region of Iowa

### Booth C7429

10 W 4th St Ste 310  
Waterloo, IA 50701-5428 United States  
ph: 877-773-9959  
fax: 319-267-2620  
www.cedarvalleyregion.com  
Business Services

## CEIA USA

### Booth N2917

9155 Dutton Dr  
Twinsburg, OH 44087-1956 United States  
ph: 330-405-3190  
fax: 330-405-3196  
www.ceia-usa.com  
Brazeing & Soldering



**Centerline (Windsor) Ltd**  
Booth N1926

415 Morton Dr  
Windsor, ON N9J 3T8 Canada  
ph: 519-734-8464  
fax: 519-734-2004  
www.cntrline.com  
Assembly, Finishing, Punching, Resistance  
Welding, Robotics, Thermal Spraying, Tool &  
Die, Welding Consumables

**Centricut**  
Booth C4935

2 Technology Dr  
West Lebanon, NH 03784-1671 United  
States  
ph: 603-298-7849  
fax: 603-298-5938  
www.centricut.com  
Cutting, Lasers, Other Machinery/Equipment/  
Parts/Products, Plate & Structural Fabricating

**Cerbaco Ltd**  
Booth N2706

809 Harrison St  
Frenchtown, NJ 08825-1122 United States  
ph: 908-996-1333  
fax: 908-996-0023  
www.cerbaco.com  
Welding Machines/Equipment

**Certified Safety Mfg**  
Booth C256

1400 Chestnut Ave  
Kansas City, MO 64127-2023 United States  
ph: 800-854-7474  
fax: 816-483-9091  
www.certifiedsafety.com  
Safety & Environmental  
*Distributors:*  
Glove Connection

**CFCM Canadian Finishing &  
Coatings Manufacturing**  
Booth C2747

225 The East Mall, Ste 1103  
Toronto, ON M9B 0A9 Canada  
ph: 416-255-1808  
fax: 416-519-1313  
www.cfc.ca  
Business Services

**CGW-Camel Grinding  
Wheels USA**  
Booth N5526

7525 N Oak Park Ave  
Niles, IL 60714-3819 United States  
ph: 847-647-5994  
fax: 800-447-3731  
www.cgwheels.com  
Cutting, Finishing

**CH Steel Solutions Inc**  
Booth C7348

6440 Promler St NW  
North Canton, OH 44720-7625 United States  
ph: 330-814-6911  
fax: 714-933-4304  
www.chsteelsolutions.com  
Business Services, Material Handling/  
Marking

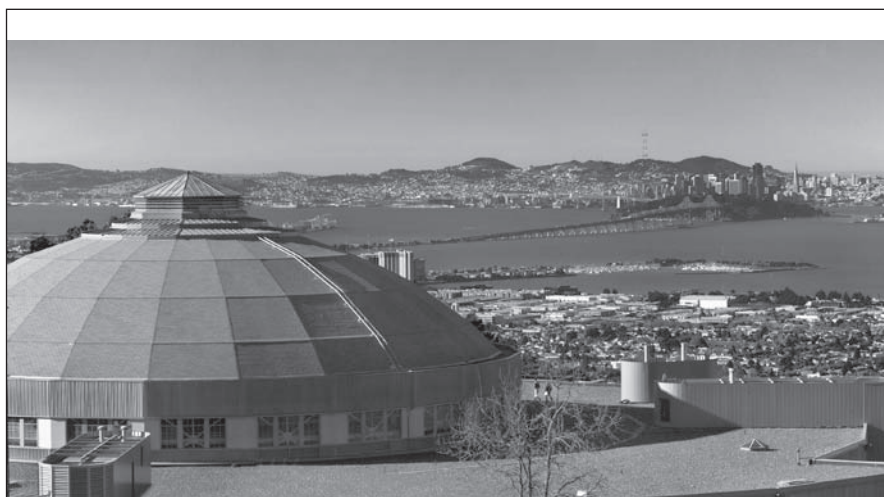

**R&D Machine Shop  
Engineering Division**

- Cutting edge technology
- Career opportunities
- Excellent benefits & retirement plan
- Coworkers as smart as you

We're looking for excellent Machinists for unique R&D work. Our spacious machine shop is well-equipped with engine lathes, Bridgeports, grinders, CNC machining centers (3, 4 & 5-axis), CNC turning centers, a live-tooling turning center, wire/sinker EDMs, waterjet machine, and SLA and ABS plastic rapid prototyping machines.

Apply online:  
[go.lbl.gov/72876\\_machinist](http://go.lbl.gov/72876_machinist)

**Advancing Science by Design**  
[engineering.lbl.gov](http://engineering.lbl.gov)

AA/EEO





## Changzhou Golden Globe Welding & Cutting Equipment Co Ltd

Booth N3236

No 19 Qianjia Industrial Park  
Yaoguan Town, Jiangsu Province  
Changzhou, 213016 China  
ph: 86 519 8515509  
fax: 86 519 8886958  
www.czgg.com

## Changzhou Huarui Welding & Cutting Equip Co Ltd

Booth N5126

Nanzai Panjia Town  
Changzhou, Jiangsu Prov 213171 China  
ph: 86 519 86201365  
fax: 86 519 82916069  
www.huarui-cn.com  
Arc Welding, Welding Consumables,  
Welding Machines/Equipment

## Changzhou Huatong Welding Industry Co Ltd

Booth N6310

7 Industrial Rd  
Yaoguan Town, Changzhou 213102 China  
ph: 86 519 88703378  
fax: 86 519 88701888  
www.htw.cn  
Arc Welding, Cutting, Other Machinery/  
Equipment/Parts/Products, Press Brakes,  
Welding Consumables

## Changzhou Shine Science & Technology Co Ltd

Booth N2527

No.318 Wuyi Rd  
Qi Shuyan Economic Dev Zone  
Changzhou, Jiangsu 213025 China  
ph: 86 519 88388837  
fax: 86 519 88388839  
www.shine-xunan.com  
Welding Machines/Equipment

## Changzhou Wujin Golden Globe Welding & Cutting Machinery Co Ltd

Booth N5900

Sanqin Industrial Zone  
Qingyang Rd Hutang Town  
Changzhou, JIANGSU 213162 China  
ph: 86 519 86708027  
fax: 86 519 86708157

www.cn-goldenglobe.com  
Job Shop/Contract Manufacturing, Material  
Handling/Marking, Robotics, Welding  
Consumables, Welding Machines/Equipment

## Changzhou Zhengyang Welding Material Co Ltd

Booth N2306

Changzhou Airport Industrial Development  
Zone  
Changzhou, Jiangsu 213133 China  
ph: 86 139 12315951  
fax: 86 519 83208998  
www.zywelding.com  
Welding Consumables

## Chart Inc

Booth N3204

407 7th St NW  
New Prague, MN 56071-1010 United States  
ph: 952-758-4484  
fax: 952-758-8244  
www.chart-ind.com  
Gases & Gas Equipment, Job Shop/Contract  
Manufacturing, Lasers, Tube & Pipe  
Fabricating or Welding



## Chelar Tool & Die Inc

Booth C349

11 N Florida Ave  
Belleville, IL 62221-5498 United States  
ph: 618-234-6550  
fax: 618-234-6572  
www.chelar.com  
Job Shop/Contract Manufacturing, Other  
Machinery/Equipment/Parts/Products,  
Stamping, Tool & Die, Tooling



## Chemetall US Inc

Booth C2709

675 Central Ave  
New Providence, NJ 07974-1560 United  
States  
ph: 908-464-6900  
fax: 908-464-2377  
www.chemetallamericas.com

Finishing, Inspection & Testing, Lubrication,  
Safety & Environmental



CHEMICAL COATERS  
ASSOCIATION INTERNATIONAL

## Chemical Coaters Assoc Int'l

Booth C1948

PO Box 110578  
Lakewood Ranch, FL 34211-0008 United  
States  
ph: 941-373-1830  
fax: 941-373-1828  
www.ccaiweb.com  
Business Services, Finishing, Job Shop/  
Contract Manufacturing, Robotics

## Chemtool Inc

Booth C660

801 W Rockton Rd  
Rockton, IL 61072-1647 United States  
ph: 815-957-4140  
fax: 815-624-0381  
www.chemtool.com  
Bending/Forming, Cutting, Finishing,  
Hydroforming, Lubrication, Plate & Structural  
Fabricating, Robotics, Safety &  
Environmental, Tooling

## Chicago Pneumatic Tool Co

Booth C4750

1800 Overview Dr  
Rock Hill, SC 29730-7463 United States  
ph: 803-817-7349  
fax: 866-399-9619  
www.cp.com  
Cutting, Finishing, Other Machinery/  
Equipment/Parts/Products, Tooling



## Chicago Slitter

Booth C7023

1025 W Thorndale Ave  
Itasca, IL 60143-1336 United States  
ph: 630-875-9800  
fax: 630-773-3414  
www.chicagoslitter.com





Bending/Forming, Coil Processing, Lasers,  
Other Machinery/Equipment/Parts/Products,  
Punching

### **China National Aero Technology IE Hangzhou Co** Booth C160

181 Tian Mu Shan Rd  
Skyline Plaza  
Hang Zhou, 310013 China  
ph: 86 571 85172392  
fax: 86 571 85172053  
www.catichz.com  
Job Shop/Contract Manufacturing, Stamping

### **Chiyoda Kogyo-Maruka USA** Booth C2134

1210 NE Douglas St  
Lees Summit, MO 64086-4604 United States  
ph: 800-220-2361  
fax: 816-524-5444  
www.marukausa.com/chiyoda.html  
Inspection & Testing, Tube & Pipe Fabricating  
or Welding

### **Cidan Machinery Inc** Booth C3449

611 Highway 74 S Ste 700  
Peachtree Cty, GA 30269-3083 United States  
ph: 770-692-7230  
fax: 770-692-7274  
www.cidanmachinery.com  
Bending/Forming, Coil Processing,  
Metalforming & Fabricating Equipment,  
Other Machinery/Equipment/Parts/Products

### **CIECO Inc** Booth C1334

2401 Hookstown Grade Rd  
Clinton, PA 15026-1813 United States  
ph: 412-262-5581  
fax: 412-264-9272  
www.ciecocontrols.com  
Job Shop/Contract Manufacturing, Safety &  
Environmental, Software & Machine  
Controls, Tool & Die

### **Cimcool Fluid Technology** Booth C1452

3000 Disney Ave  
Cincinnati, OH 45209-5028 United States  
ph: 513-458-8117  
fax: 513-458-8179  
www.cimcool.com

Finishing, Lubrication, Other Machinery/  
Equipment/Parts/Products

### **CIMID Corp** Booth C8327

PO Box 717  
Pine Brook, NJ 07058-0717 United States  
ph: 973-227-8960  
fax: 973-227-8969  
www.cimid.com  
Bending/Forming, Finishing, Hydroforming,  
Machining/EDM, Plate & Structural  
Fabricating, Robotics, Stamping

### **CK Worldwide** Booth N3615

3501 C St NE  
Auburn, WA 98002-1702 United States  
ph: 253-854-5820  
fax: 253-939-1746  
www.ckworldwide.com  
Arc Welding, Welding Consumables,  
Welding Machines/Equipment

### **Clara Vision** Booth N1706

ZA des Godets  
La Noisette BAT A6 BP441  
Verrieres Le Buisson, 91370 France  
ph: 33 169860130  
fax: 33 169282461  
www.weldingexpert.net  
Inspection & Testing, Software &  
Machine Controls

### **Clark Fixture Technologies** Booth C1520

410 N Dunbridge Rd  
Bowling Green, OH 43402-8963 United  
States  
ph: 419-354-1541-104  
fax: 419-353-5690  
www.clarkfixtures.com  
Business Services, Inspection & Testing,  
Material Handling/Marking, Tooling, Tube &  
Pipe Fabricating or Welding

### **Clean Air Consultants/Filter 1** Booth C2428

2525 National Dr  
Garland, TX 75041-2351 United States  
ph: 972-278-2664  
fax: 972-278-1810  
www.filter-1.com

Material Handling/Marking, Safety &  
Environmental

### **Cleveland Punch & Die Co** Booth C5711

666 Pratt St  
Ravenna, OH 44266-3161 United States  
ph: 800-451-4342  
fax: 800-451-6877  
www.clevelandpunch.com  
Cutting, Lubrication, Plate & Structural  
Fabricating, Punching, Tooling

### **Cleveland Steel Tool Co** Booth C5522

474 E 105th St  
Cleveland, OH 44108-1378 United States  
ph: 216-681-7400  
fax: 216-681-7009  
www.clevelandsteeltool.com  
Cutting, Job Shop/Contract Manufacturing,  
Machining/EDM, Other Machinery/  
Equipment/Parts/Products, Plate & Structural  
Fabricating, Punching, Tool & Die, Tooling  
*Distributors:*  
Bardan Supply  
Boston Valley Tooling

### **Climax Portable Machining & Welding Systems** Booth N1422

2712 East 2nd St  
Newberg, OR 97132 United States  
ph: 503-538-2185  
fax: 503-554-7240  
www.cpmt.com  
Arc Welding, Bending/Forming, Cutting,  
Machining/EDM, Maintenance & Repair,  
Other Machinery/Equipment/Parts/Products,  
Robotics, Welding Machines/Equipment

### **Clips & Clamps Industries** Booth C148

15050 Keel St  
Plymouth, MI 48170-6006 United States  
ph: 734-455-0880  
fax: 734-455-4270  
www.clipsclamps.com  
Assembly, Bending/Forming, Fastening &  
Joining, Job Shop/Contract Manufacturing,  
Resistance Welding, Robotics, Stamping



## Cloos Robotic Welding Inc

Booth N3618

911 Albion Ave  
Schaumburg, IL 60193-4550 United States

ph: 847-923-9988

fax: 847-923-9989

www.cloosrobot.com

Arc Welding, Inspection & Testing, Plate & Structural Fabricating, Robotics, Welding Machines/Equipment

## CM Industries Inc

Booth N2810

505 Oakwood Rd  
Lake Zurich, IL 60047-1534 United States

ph: 847-550-0033

fax: 847-550-0444

www.cmindustries.com

Arc Welding, Robotics, Welding Consumables, Welding Machines/Equipment

## CMF Jammes Rolling and Welding

Booth C5538

4 Rue Renç Panhard ZI Ladoux  
63118

Cebazat, France

ph: 33 473258500

fax: 33 473258565

Arc Welding, Bending/Forming

## CML USA Inc Ercolina

Booth C3739

3100 Research Pkwy  
Davenport, IA 52806-9332 United States

ph: 563-391-7700

fax: 563-391-7710

www.ercolina-usa.com

Bending/Forming, Plate & Structural Fabricating, Tooling, Tube & Pipe Fabricating or Welding



## CNA Insurance

Booth C7247

999 Third Avenue  
Suite 2500  
Seattle, WA 98104 United States

ph: 206-587-7149

fax: 312-894-5217

Business Services

## CNC Automotion

Booth C7450

U3 20 Redcliffe Gardens Drive  
Clontarf, Qld 04019 Australia

ph: 61 732 837572

fax: 61 732 837579

## CNC West

Booth C8437

16835 Angonquin St Ste 158  
Huntington Beach, CA 92649 United States

ph: 714-840-1300

fax: 714-840-5555

www.cnc-west.com

## COB Industries Inc

Booth N5919

PO Box 36-1175  
Melbourne, FL 32936-1175 United States

ph: 321-723-3200

fax: 321-984-8455

www.cob-industries.com

Cutting, Finishing, Gases & Gas Equipment, Inspection & Testing, Machining/EDM, Tube & Pipe Fabricating or Welding, Welding Consumables, Welding Machines/Equipment

## COE Press Equipment

Booth C1323

40549 Brentwood Dr  
Sterling Hts, MI 48310-2299 United States

ph: 586-979-4400

fax: 586-979-2970

www.cpec.com

Coil Processing, Finishing

## Coherent Inc

Booth C7309

5100 Patrick Henry Dr  
Santa Clara, CA 95054-1112 United States

ph: 408-764-4000

fax: 408-764-4825

www.coherent.com

Lasers

## Coil World Magazine

Booth C2064

8 Highpoint  
Cedar Grove, NJ 07009-1972 United States

ph: 973-571-7155

fax: 973-571-7102

www.coilworld.com

## COLE-TUVE Inc

Booth C5740

PO Box 233  
White Marsh, MD 21162-0233 United States

ph: 410-933-0700

fax: 410-933-0600

www.coletuve.com



## Col-Met Spray Booths Inc

Booth C2537

1635 Innovation Dr  
Rockwall, TX 75243 United States

ph: 972-772-1919

fax: 972-772-1833

www.colmetsb.com

Finishing

## Combilift USA

Booth C5726

303 Concord St  
Greensboro, NC 27406-3635 United States

ph: 336-378-8884

fax: 336-378-8842

www.combilift.com

Material Handling/Marking

## Combustion and Systems Inc

Booth C2411

PO Box 3705  
Lawrenceburg, IN 47025-3705 United States

ph: 859-814-8847

fax: 859-814-8848

www.combustionandsystems.com

Business Services, Finishing, Job Shop/ Contract Manufacturing, Robotics

## Comco Inc

Booth C5052

2151 N Lincoln St  
Burbank, CA 91504-3392 United States

ph: 818-841-5500

fax: 818-955-8365

www.comcoinc.com

Cutting, Finishing, Robotics

## COMEQ Inc

Booth C5125

PO Box 207  
White Marsh, MD 21162-0207 United States



ph: 410-933-8500

fax: 410-933-1600

www.comeq.com

Bending/Forming, Cutting, Other Machinery/  
Equipment/Parts/Products, Plate & Structural  
Fabricating, Press Brakes, Punching, Tube &  
Pipe Fabricating or Welding

**COMPRESSED AIR  
BEST PRACTICES®**  
airbestpractices.com

### Compressed Air Booth N3034

217 Deer Meadow Dr  
Pittsburgh, PA 15241-2253 United States

ph: 412-980-9901

www.airbestpractices.com

Business Services, Finishing, Safety &  
Environmental

### Computer Engineering Inc Booth N3327

509 NW 5th St  
Blue Springs, MO 64014-2705 United States

ph: 816-228-2976

fax: 816-228-0680

www.computereng.com

Software & Machine Controls



### Computers Unlimited Booth N3315

2407 Montana Ave  
Billings, MT 59101-2336 United States

ph: 406-255-9500

fax: 406-255-9652

www.cu.net

Business Services, Software & Machine  
Controls

### CONCOA Inc Booth C5733

1501 Harpers Rd  
Virginia Beach, VA 23454-5303 United  
States

ph: 757-422-8330

fax: 757-422-3125

www.concoa.com

### Controlled Automation Inc Booth C7730

PO Box 888  
Bryant, AR 72089-0888 United States

ph: 501-557-5109

fax: 501-557-5618

www.controlledautomation.com

Business Services, Machining/EDM, Material  
Handling/Marking, Metalforming & Fabricating  
Equipment, Other Machinery/Equipment/  
Parts/Products, Plate & Structural Fabricating,  
Punching, Saws & Cut-off Machines, Software  
& Machine Controls, Stamping

### CorActive High Tech Booth C8446

2700 Rue Jean-Perrin Suite 121  
Quebec, QC G2C 1S9 Canada

ph: 418-845-2466

fax: 418-845-2609

### Coral Chemical Co Booth C2417

1915 Industrial Ave  
Zion, IL 60099-1435 United States

ph: 847-246-6666

fax: 847-246-6667

www.coral.com

Finishing, Lubrication, Safety &  
Environmental

### Coral Spa / Industrial Air Solutions Booth N2813

PO Box 90246  
Raleigh, NC 27675 United States

ph: 919-844-3293

fax: 919-518-1667

www.industrialairsolutions.com

Finishing, Material Handling/Marking, Safety  
& Environmental

### Cordstrap USA Inc Booth C7433

2000 S Sylvania Ave Ste 101  
Sturtevant, WI 53177-2161 United States

ph: 262-898-6670

fax: 262-898-6677

www.cordstrap.net

Business Services, Material Handling/  
Marking, Safety & Environmental

### CoreTemp Booth N6236

101 W Dudley Town Rd  
Bloomfield, CT 06002 United States

ph: 860-882-1043

fax: 860-906-1113

www.coretempinc.com

Business Services, Finishing, Safety &  
Environmental, Saws & Cut-off Machines

### Corewire Ltd Booth N2910

Station Road West Ash Vale  
Aldershot Hampshire, GU12 5LZ United  
Kingdom

ph: 44 1252 517766

fax: 44 1252 515833

www.corewire.com

Arc Welding, Maintenance & Repair, Tool &  
Die, Welding Consumables, Welding  
Machines/Equipment

### COR-MET INC Booth N5534

12500 Grand River Rd  
Brighton, MI 48116-8326 United States

ph: 810-227-3257

fax: 810-227-9266

www.cor-met.com

Job Shop/Contract Manufacturing, Tool &  
Die, Welding Consumables

### Corporate Finance Associates - Chicago Booth C4851

770 Beacon St Ste A  
West Dundee, IL 60118-2107 United States

ph: 847-836-7035

fax: 847-836-7254

www.cfachicago.com

### Cosen Saws USA Booth C7136

11626-B Wilmar Blvd  
Charlotte, NC 28273-6417 United States

ph: 704-943-1030

fax: 704-943-1031

www.cosen.com

Saws & Cut-off Machines





### **Costa & Grissom Machinery Co** **Booth C7516**

107 Seminole Dr  
Archdale, NC 27263-3254 United States  
ph: 336-434-6644  
fax: 336-434-6656  
www.costagrissom.com  
Coil Processing, Finishing

### **CR Cuscinetti A Rulli Srl** **Booth C5636**

Via Pertini 6/8 Zona Industriale  
Codogno, LO 26845 Italy  
ph: 39 0377 437021  
fax: 39 0377 437107  
www.crsrl.com  
Machining/EDM, Maintenance & Repair,  
Other Machinery/Equipment/Parts/Products

### **Creaform 3d** **Booth C552**

5825 Rue Saint-Georges  
L'Évis, QC G6V 4L2 Canada  
ph: 418-833-4446  
fax: 418-833-9588  
www.creaform3d.com  
Business Services, Inspection & Testing

### **Crest Steel Corporation** **Booth C7340**

10833 Valley View St Ste 100  
Cypress, CA 90630-5039 United States  
ph: 714-822-5222  
fax: 714-761-4800

### **Crippa SPA** **Booth C1828**

Via M Buonarroti 3  
Arosio, Como 22060 Italy  
ph: 39 031 760 200  
fax: 011 39 031 762 403  
www.crippa.it

### **CS Unitec Inc** **Booth N5531**

22 Harbor Ave  
Norwalk, CT 06850-4210 United States  
ph: 203-853-9522  
fax: 203-853-9921  
www.csunitec.com  
Bending/Forming, Cutting, Finishing,  
Machining/EDM, Other Machinery/  
Equipment/Parts/Products, Saws & Cut-off  
Machines, Tooling, Tube & Pipe Fabricating  
or Welding

### **C-spec** **Booth N4817**

PO Box 5188  
Concord, CA 94524-0188 United States  
ph: 877-977-7999  
fax: 925-930-8223  
www.cspec.com  
Software & Machine Controls

### **CTD Machines Inc** **Booth C8423**

2300 E 11th St  
Los Angeles, CA 90021-2817 United States  
ph: 213-689-4455  
fax: 213-689-1255  
www.ctdsaw.com  
Saws & Cut-off Machines

### **Custom Fabricating & Supplies** **Booth C2510**

6100 Industrial Ct  
Greendale, WI 53129-2430 United States  
ph: 414-421-2600  
fax: 414-421-2700  
www.customfabricate.com  
Finishing, Thermal Spraying

### **Cut Technologies Metal LLC** **Booth C7248**

3254 Bennett Dr  
Bellingham, WA 98225-1114 United States  
ph: 800-435-4370  
fax: 360-733-0618  
www.cuttech.com

### **Cyl-Tec Inc** **Booth N3138**

950 W Industrial Dr  
Aurora, IL 60506-1150 United States  
ph: 630-844-8800  
fax: 630-844-5100  
www.cyl-tec.com  
Brazing & Soldering, Gases & Gas  
Equipment, Job Shop/Contract  
Manufacturing, Lasers

### **D&H Machinery Inc** **Booth C2112**

723 Phillips Ave  
Bldg D2  
Toledo, OH 43612-1362 United States  
ph: 419-841-3586  
fax: 419-841-2986  
www.dnhmachinery.com

Coil Processing, Finishing, Material  
Handling/Marking, Other Machinery/  
Equipment/Parts/Products, Stamping, Tube &  
Pipe Producing

### **D/F Machine Specialties Inc** **Booth N2224**

1750 Howard Dr  
North Mankato, MN 56003-1516 United  
States  
ph: 507-625-6200  
fax: 507-625-6203  
www.dfmachinespecialties.com  
Arc Welding, Resistance Welding, Robotics,  
Tube & Pipe Fabricating or Welding, Tube &  
Pipe Producing, Welding Consumables,  
Welding Machines/Equipment  
**Distributors:**  
Airgas  
Praxair  
Air Liquide

### **Daifuku Webb** **Booth C2425**

34375 W 12 Mile Rd  
Farmington Hills, MI 48331-5624 United  
States  
ph: 248-553-1000  
fax: 248-553-1228  
www.daifukuwebb.com  
Finishing, Material Handling/Marking,  
Robotics

### **Daito USA Inc** **Booth C8133**

1470 Elmhurst Rd  
Elk Grove Vlg, IL 60007-6417 United States  
ph: 847-437-6788  
fax: 847-437-6789  
www.daito-seiki.com

### **Dake Corporation** **Booth C6923**

724 Robbins Rd  
Grand Haven, MI 49417-2690 United States  
ph: 616-847-4872  
fax: 800-846-3253  
www.dakecorp.com  
Assembly, Bending/Forming, Maintenance &  
Repair, Press Brakes, Saws & Cut-off  
Machines, Stamping, Tube & Pipe Fabricating  
or Welding

# International Metal Tube



**The leading independent magazine  
for metal tube and pipe producers and processors**

**Magazine, Digital Version & Full Pdf published 6 times a year  
To subscribe or explore our marketing opportunities**

**Contact Vince Maynard**

**[imtmagazine@virginmedia.com](mailto:imtmagazine@virginmedia.com)**

**Tel: +44(0)1732 505724    Mobile +44 (0)7747 002286**



**Dakota Ultrasonics**  
**Booth N2624**

1500 Green Hills Rd Ste 107  
Scotts Valley, CA 95066-4945 United States  
ph: 831-431-9722  
fax: 831-431-9723  
www.dakotaultrasonics.com  
Inspection & Testing

**Dalian Xingli Industrial Products Co Inc**  
**Booth C354**

Qianguan Villiage  
Ganzingzi District  
Dalian, Dalian Liaoning 116001 China  
ph: 86 411 87110929  
fax: 86 411 87115291  
www.xlindustry.cn

**Dallas Industries Inc**  
**Booth C834**

103 Park Dr  
Troy, MI 48083-2770 United States  
ph: 248-583-9400  
fax: 248-583-9402  
www.dallasindustries.com

 **Danatronics Inc**  
**Booth N1418**

150A Andover St Ste 8C  
Danvers, MA 01923-5308 United States  
ph: 978-777-0081  
fax: 978-777-3798  
www.danatronics.com  
Inspection & Testing

**Darex LLC**  
**Booth C8138**

210 E Hersey St  
Ashland, OR 97520-1239 United States  
ph: 800-547-0222  
fax: 541-552-1377  
www.darex.com  
Cutting, Job Shop/Contract Manufacturing,  
Machining/EDM, Maintenance & Repair,  
Other Machinery/Equipment/Parts/Products,  
Safety & Environmental, Tooling

**Dataweld Inc**  
**Booth N2308**

1909 Citizens Bank Dr  
Bossier City, LA 71111-3429 United States  
ph: 318-746-6111  
fax: 318-746-0323

www.dataweld.com  
Business Services, Gases & Gas Equipment,  
Material Handling/Marking, Software &  
Machine Controls

**DAVI Inc**  
**Booth C3435**

4460 Spring Valley Rd  
Dallas, TX 75244-3703 United States  
ph: 972-661-0288  
fax: 972-661-5676  
www.davi.com  
Plate & Structural Fabricating

**Daymark Technologies**  
**Booth N2222**

12830 S Dixie Hwy  
Bowling Green, OH 43402-9697 United States  
ph: 419-494-5387  
fax: 419-354-0514  
www.daymarkettechnologies.com  
Finishing, Gases & Gas Equipment, Welding  
Consumables, Welding Machines/Equipment  
**Distributors:**  
AIRGAS  
Praxair  
O E Meyer

**Dayton Progress Corp**  
**Booth C813**

500 Progress Rd  
Dayton, OH 45449-2351 United States  
ph: 937-384-3597  
fax: 937-847-5754  
www.daytonprogress.com  
Lubrication, Tooling

**DCM Tech Inc**  
**Booth C8346**

4455 Theurer Blvd  
Winona, MN 55987-1593 United States  
ph: 800-533-5339  
fax: 507-452-7970  
www.dcm-tech.com  
Inspection & Testing, Maintenance &  
Repair, Tooling

 **Decoral System USA Corp**  
**Booth C1954**

12477 NW 44th St  
Coral Springs, FL 33065-7639 United States  
ph: 954-755-6021  
fax: 954-755-6029

www.decoralamerica.com  
Finishing

**DeFelsko Corp**  
**Booth C2442**

802 Proctor Ave  
Ogdensburg, NY 13669-2205 United States  
ph: 315-393-4450  
fax: 315-393-8471  
www.defelsko.com  
Inspection & Testing



**DELTA Computer Systems Inc**  
**Booth C1024**

1818 SE 17th St  
Battle Ground, WA 98604-8579 United States  
ph: 360-254-8688  
fax: 360-254-5435  
www.deltamotion.com  
Software & Machine Controls

**Delta Heat Treating**  
**Booth C8240**

15692 Computer Ln  
Huntington Beach, CA 92649-1608 United States  
ph: 714-890-4893  
fax: 714-890-1217  
www.deltaheattreat.com

 **Delta Steel Technologies**  
**Booth C5952**

2204 Century Center Blvd  
Irving, TX 75062 United States  
ph: 972-438-7150  
fax: 972-579-0100  
www.deltasteeltech.com  
Coil Processing, Cutting, Finishing, Lasers,  
Saws & Cut-off Machines

 **Demag Cranes and Components**  
**Booth C560**

29201 Aurora Rd  
Solon, OH 44139-1846 United States  
ph: 310-951-3748  
fax: 714-453-9029  
www.demag-us.com  
Material Handling/Marking





**Dengensha America Corp**  
**Booth N5722**

7647 First Pl  
Bedford, OH 44146-6701 United States  
ph: 440-439-8081  
fax: 440-439-8217  
www.dengensha.com  
Resistance Welding, Welding Consumables

**Denray Machine Inc**  
**Booth N1408**

10775 Lawrence 1140  
Mount Vernon, MO 65712-7205 United States  
ph: 417-466-4046  
fax: 417-466-2394  
www.denray.com

**Desch Canada Ltd**  
**Booth C1235**

240 Shearson Crescent  
Cambridge, ON N1T 1J6 Canada  
ph: 519-621-4560  
fax: 519-623-1169  
www.desch.on.ca  
Other Machinery/Equipment/Parts/Products

**DE-STA-CO**  
**Booth N6113**

1025 Doris Rd  
Auburn Hills, MI 48326-2614 United States  
ph: 248-836-6779  
fax: 248-836-6740  
www.destaco.com  
Assembly, Fastening & Joining

**Detroit Tool Metal Products**  
**Booth C5953**

949 Bethel Rd  
Lebanon, MO 65536-9020 United States  
ph: 417-532-2142  
fax: 417-532-6097  
www.dtmp.com

**Diagraph MSP an ITW Company**  
**Booth N5718**

5307 Meadowland Pkwy  
Marion, IL 62959-5893 United States

ph: 618-997-1751  
fax: 866-350-0196  
www.diagraphmsp.com  
Material Handling/Marking

**Diamond Ground Products Inc**  
**Booth N5726**

2550 Azurite Circle  
Newbury Park, CA 91320-1201 United States  
ph: 805-498-3837  
fax: 805-498-9347  
www.diamondground.com  
Arc Welding, Tooling, Welding Consumables, Welding Machines/Equipment

**Diamond Saw Works Inc**  
**Booth N1416**

12290 Olean Rd  
Chaffee, NY 14030-9767 United States  
ph: 800-828-1180  
fax: 800-237-8853  
www.diamondsaw.com  
Other Machinery/Equipment/Parts/Products

**Diamond Vantage**  
**Booth N1324**

2025 Alton Pkwy  
Irvine, CA 92606-4904 United States  
ph: 866-322-4078  
fax: 949-428-2120  
www.diamondvantage.com

**Diamond Vogel Paints**  
**Booth C2414**

1020 Albany Place SE  
PO Box 0080  
Orange City, IA 51041-0080 United States  
ph: 712-737-4993  
fax: 712-737-4997  
www.diamondvogel.com  
Finishing



**Diehl Steel Co**  
**Booth C1410**

P O Box 17010  
800 Ross Ave  
Cincinnati, OH 45217-1794 United States  
ph: 513-242-8900  
fax: 513-242-8988

www.diehlsteel.com  
Metal Suppliers

**Dinse Inc**  
**Booth N2717**

121 W Trade St Ste 2850  
Charlotte, NC 28202-2293 United States  
ph: 586-404-7434  
fax: 888-896-4871  
www.dinse-us.com  
Arc Welding, Robotics, Welding Consumables, Welding Machines/Equipment

**Direct Wire & Cable**  
**Booth N2519**

PO Box 57  
Denver, PA 17517-9305 United States  
ph: 717-336-2842  
www.directwire.biz  
Welding Consumables, Welding Machines/Equipment

**Diversi-Tech Inc**  
**Booth N1922**

2025 52nd Ave  
Lachine, QC H8T 3C3 Canada  
ph: 514-631-7300  
fax: 514-631-9480  
www.diversitech.ca  
Maintenance & Repair, Other Machinery/Equipment/Parts/Products, Safety & Environmental

**DMP Corp**  
**Booth C2054**

400 Bryant Blvd  
Rock Hill, SC 29732-8210 United States  
ph: 800-845-3681  
fax: 803-324-5773  
www.dmpcorp.com  
Business Services, Finishing, Safety & Environmental

**DoALL Sawing Products**  
**Booth C7713**

1480 S Wolf Rd  
Wheeling, IL 60090-6514 United States  
ph: 800-923-6255  
fax: 847-495-3541  
www.doall.com  
Cutting, Lubrication, Saws & Cut-off Machines



## Donaldson Torit - Donaldson Company Inc

**Booth N6028, C8121**

PO Box 1299  
Minneapolis, MN 55440 United States  
ph: 800-365-1331  
fax: 952-698-2479  
www.donaldsontorit.com  
Safety & Environmental

## Dongsan Bearing Co

**Booth C833**

71B-10L 640-9 Gojan-dong  
Namdong-gu  
Inchaon, 405817 Korea (South)  
ph: 82 32 8212368  
fax: 82 32 8212369  
www.dongsanbearing.com  
Assembly, Other Machinery/Equipment/  
Parts/Products, Tool & Die

## Doringer Cold Saws

**Booth C4913**

13400 Estrella Ave  
Gardena, CA 90248-1513 United States  
ph: 310-366-7766  
fax: 310-366-7573  
www.doringer.com  
Cutting, Lubrication, Saws & Cut-off  
Machines

## Douglas Steel Supply Co

**Booth C5747**

5764 Alcoa Ave  
Vernon, CA 90058-3727 United States  
ph: 323-587-7676  
fax: 323-587-2982  
www.douglassteelsupply.com  
Job Shop/Contract Manufacturing, Metal  
Suppliers

## Dr Gold & Co

**Booth N5026**

Koenigsallee 72  
Duesseldorf NRW, 40212 Germany  
ph: 49 211 320518  
fax: 49 211 131465  
www.carrymate.com  
Material Handling/Marking, Safety &  
Environmental

## Dr Shrink Inc

**Booth C7314**

315 Washington St  
Manistee, MI 49660-1259 United States

ph: 231-723-2685  
www.dr-shrink.com  
Material Handling/Marking

## DualDraw LLC

**Booth N2506**

5900 E 58th Ave Unit A  
Commerce City, CO 80022-3955 United  
States

ph: 303-853-4083  
fax: 303-853-4086  
www.dualdraw.com  
Business Services, Safety & Environmental

## Dubak Engineering Group LLC

**Booth C1553**

417 Bluff Ave Ste 400  
La Grange, IL 60525-6872 United States  
ph: 708-579-5252  
fax: 708-579-5264  
www.dubakengineering.com

## DuBois Chemicals

**Booth C2545, C4938**

3630 E Kemper Rd  
Sharonville, OH 45241-2046 United States  
ph: 513-326-8892  
fax: 513-554-4330  
www.duboischemicals.com  
Finishing, Lubrication



## DuPont Industrial Coating Solutions

**Booth C2542**

9800 Genard Rd  
Houston, TX 77041-7624 United States  
ph: 713-939-4000  
fax: 713-939-4027  
www.powder.dupont.com  
Finishing

## Durable Superior Casters

**Booth C826**

2801 E Abram St  
Arlington, TX 76010-1402 United States  
ph: 972-206-0951  
fax: 972-206-0950  
www.durablecasters.com

## Durable Supply

**Booth N4939**

240 Great Circle Rd Ste 334  
Nashville, TN 37228-1713 United States  
ph: 866-354-9431  
fax: 866-354-1846  
www.durablesupply.com  
Material Handling/Marking

## Durma USA

**Booth C3949**

8916 Pioneer Ave Ste C  
Charlotte, NC 28273-6470 United States  
ph: 704-583-9180  
fax: 704-583-1318  
www.durmausa.com  
Bending/Forming, Lasers, Metalforming &  
Fabricating Equipment, Plate & Structural  
Fabricating, Press Brakes, Punching, Saws &  
Cut-off Machines

## Duroair Technologies Inc

**Booth C1362**

3295 Mainway  
Burlington, ON L7M 1A6 Canada  
ph: 416-988-7576  
fax: 905-397-1072  
www.duroair.com  
Finishing, Safety & Environmental  
**Distributors:**  
BCI Equipment Specialists  
Florida Filtration @ Spray Booth Services  
Ontario Spray Booth

## Durr Ecoclean Inc

**Booth C2437**

31077 Durr Dr  
Wixom, MI 48393-2435 United States  
ph: 248-560-2100  
fax: 248-560-2120  
www.durr-ecoclean.com  
Assembly, Finishing

## DURUM USA

**Booth N2316**

11133 I-45 South Building I  
Conroe, TX 77302 United States  
ph: 936-539-2630  
fax: 936-539-2470  
www.durumusa.com  
Finishing, Thermal Spraying, Welding  
Consumables



## Dynabrade Inc

### Booth C2409

8989 Sheridan Dr  
Clarence, NY 14031-1490 United States  
ph: 716-631-0100  
fax: 716-631-1167  
www.dynabrade.com  
Cutting, Finishing, Machining/EDM, Other Machinery/Equipment/Parts/Products, Saws & Cut-off Machines, Tooling

# Dynamatic®

DRIVE SOURCE INTERNATIONAL, INC.

## Dynamatic (Drive Surch Intl Inc)

### Booth C1409

7900 Durand Ave  
PO Box 0361  
Sturtevant, WI 53177 United States  
ph: 800-548-2169  
fax: 262-554-7041

## Dynatorch Inc

### Booth N4837

3250 US HWY 72  
Paint Rock, AL 35764 United States  
ph: 256-776-6637  
fax: 256-776-6639  
www.dynatorch.com  
Cutting, Lasers, Plate & Structural Fabricating, Robotics, Software & Machine Controls, Tube & Pipe Fabricating or Welding

## EAS Mold & Die Change Systems, Inc

### Booth C1026

PO 1614  
Milwaukee, WI 53201 United States  
ph: 262-783-7955  
fax: 262-783-9799  
www.easchangesystems.com  
Material Handling/Marking, Tool & Die

## Easy Abrasives LLC

### Booth N2618

23 A Commerce Rd  
Fairfield, NJ 07004-1609 United States  
ph: 973-575-7879  
fax: 973-575-6307  
www.easyburs.com  
Cutting, Finishing, Saws & Cut-off Machines, Tooling, Welding Consumables

## Eaton Leonard

### Booth C1723

1391 Specialty Dr Ste A  
Vista, CA 92081-8521 United States  
ph: 760-599-6300  
fax: 760-599-5230  
www.eatonleonard.com  
Bending/Forming, Inspection & Testing, Other Machinery/Equipment/Parts/Products, Saws & Cut-off Machines, Tooling, Tube & Pipe Fabricating or Welding

## Eberle America Inc

### Booth C8312

6311 Ronald Reagan Dr  
Suite 174  
Lake St Louis, MO 63367-2681 United States  
ph: 314-406-1102  
fax: 636-240-6155  
www.eberle-america.com  
Cutting, Saws & Cut-off Machines

## Echo Engineering

### Booth C2056

5406 W 78th St  
Indianapolis, IN 46112 United States  
ph: 317-876-8848  
fax: 317-875-0035  
www.echosupply.com  
Business Services, Finishing

## Econco/CPI

### Booth C3712

1318 Commerce Ave  
Woodland, CA 95776-5908 United States  
ph: 530-662-7553  
fax: 530-666-7760  
www.econco.com  
Job Shop/Contract Manufacturing, Lasers, Tube & Pipe Producing, Welding Machines/Equipment

## Eddie Kane Steel Products

### Booth N2826

701 New York Blvd  
Sea Girt, NJ 08750-1420 United States  
ph: 732-974-3339  
www.eddiekanesteel.com

## Eddytech Systems Inc

### Booth C1752

17830 Englewood Dr Ste 17  
Middleburg Heights, OH 44130-3485  
United States

ph: 440-234-4809  
fax: 440-234-4810  
www.eddytech.com  
Inspection & Testing

## Edwards Manufacturing Co

### Booth C7116

1107 Sykes St  
Albert Lea, MN 56007-3434 United States  
ph: 507-373-8206  
fax: 507-373-9433  
www.edwardsironworkers.com  
Bending/Forming, Metalforming & Fabricating Equipment, Plate & Structural Fabricating, Press Brakes, Punching, Tooling, Tube & Pipe Fabricating or Welding

## EFD Induction Inc

### Booth C2139

31511 Dequindre Rd  
Madison Heights, MI 48071-1537 United States  
ph: 248-658-0700  
fax: 248-658-0701  
www.efd-induction.com  
Brazing & Soldering, Other Machinery/Equipment/Parts/Products, Tooling, Tube & Pipe Producing, Welding Machines/Equipment

## EH Wachs Co

### Booth N5713

600 Knightsbridge Pkwy  
Lincolnshire, IL 60069-3617 United States  
ph: 847-537-8800  
fax: 847-520-1147  
www.ehwachs.com  
Arc Welding, Bending/Forming, Cutting, Finishing, Machining/EDM, Maintenance & Repair, Other Machinery/Equipment/Parts/Products, Saws & Cut-off Machines, Tube & Pipe Fabricating or Welding, Welding Consumables, Welding Machines/Equipment

## Ehrhardt Tool & Machine

### Booth C656

25 Central Industrial Dr  
Granite City, IL 62040-6802 United States  
ph: 314-436-6900  
fax: 314-436-6905  
www.ehrhardttool.com





**Eisenmann Corp**  
**Booth C2439**

150 E Dartmoor Dr  
Crystal Lake, IL 60014-8606 United States  
ph: 815-455-4100  
fax: 815-455-1018  
www.eisenmann.us.com  
Business Services, Finishing

 **ELCo Enterprises**  
**Booth N2831**

5750 Marathon Drive  
Jackson, MI 49201-7711 United States  
ph: 517-782-8040  
fax: 517-782-8039  
www.wire-wizard.com  
Arc Welding, Maintenance & Repair,  
Material Handling/Marking, Robotics,  
Welding Consumables

**Elcometer Inc**  
**Booth N3126**

1893 Rochester Industrial Dr  
Rochester Hls, MI 48309-3342 United States  
ph: 248-650-0500  
fax: 248-650-0501  
www.elcometer.com  
Inspection & Testing

**Elcometer Inc**  
**Booth C2152**

1893 Rochester Industrial Dr  
Rochester Hls, MI 48309-3342 United States  
ph: 248-650-0500  
fax: 248-650-0501  
www.elcometer.com  
Inspection & Testing

**Eldec Induction USA**  
**Booth C1754**

3355 Bald Mountain Rd Ste 30  
Auburn Hills, MI 48326-4312 United States  
ph: 248-364-4750  
fax: 248-364-4751  
www.eldec-usa.com

**Electrocoat Association, The**  
**Booth C2255**

6915 Valley Ave  
P.O. Box 541083  
Cincinnati, OH 45244-3029 United States  
ph: 800-579-8806  
fax: 513-527-8801  
www.electrocoat.org

Business Services, Finishing, Job Shop/  
Contract Manufacturing

**Electron Beam Engineering Inc**  
**Booth N3306**

1425 S Allec St  
Anaheim, CA 92805-6306 United States  
ph: 714-491-5990  
fax: 714-758-0690  
www.ebeinc.com  
Job Shop/Contract Manufacturing, Welding  
Machines/Equipment

**Electron Beam  
Technologies Inc**  
**Booth N3210**

1275 Harvard Dr  
Kankakee, IL 60901-9471 United States  
ph: 815-935-2211  
fax: 815-935-8605  
www.electronbeam.com  
Arc Welding, Maintenance & Repair,  
Material Handling/Marking, Other  
Machinery/Equipment/Parts/Products,  
Robotics

**Electro-Steam Generator Corp**  
**Booth C2410**

50 Indel Ave  
PO Box 438  
Rancocas, NJ 08073 United States  
ph: 609-288-9071  
fax: 609-288-9078  
www.electrosteam.com  
Finishing

**ElektroPhysik**

advancing with technology

**ElektroPhysik USA Inc**  
**Booth C2053**

788 W Algonquin Rd  
Arlington Heights, IL 60005 United States  
ph: 847-437-6616  
fax: 847-437-0053  
www.elektrophysikusa.com  
Inspection & Testing

**Element Materials Technology**  
**Booth N5936**

51229 Century Ct  
Wixom, MI 48393-2074 United States  
ph: 248-960-4900

fax: 248-960-4970  
www.element.com  
Inspection & Testing

**Elizabeth Carbide Components**  
**Booth C150**

200 Monastery Dr  
Latrobe, PA 15650-2656 United States  
ph: 724-539-3574  
fax: 734-537-4732  
www.ecarbco.com  
Job Shop/Contract Manufacturing, Other  
Machinery/Equipment/Parts/Products, Tool &  
Die, Tooling

 **Elo Automated Stainless  
Steel Technologies Qingdao  
Co Ltd**  
**Booth C8342**

No 51, Shuang Yuan Rd  
Qingdao  
Shandong, 266108 China  
ph: 86 532 87718513  
fax: 86 532 87722037  
www.eloautomated.com  
Arc Welding, Bending/Forming, Cutting,  
Lasers, Machining/EDM, Other Machinery/  
Equipment/Parts/Products, Plate & Structural  
Fabricating, Punching, Robotics, Software &  
Machine Controls, Stamping, Tube & Pipe  
Fabricating or Welding



**ELT Tooling**  
**Booth C1728**

435 Roske Dr  
Elkhart, IN 46516-9086 United States  
ph: 574-295-5041  
fax: 574-522-3992  
www.elttooling.com

**Elumatec North America Inc**  
**Booth C2849**

4320 Ralph Jones Ct  
South Bend, IN 46628-9402 United States  
ph: 574-273-1790  
fax: 574-273-1890  
www.elumatecusa.com  
Machining/EDM, Saws & Cut-off Machines

## Emmegi USA Inc

### Booth C7323

20 Murray Hill Pkwy Ste 120  
E Rutherford, NJ 07073-2183 United States  
ph: 201-935-0200  
fax: 201-935-0400  
www.emmegi.com  
Lubrication, Machining/EDM, Material  
Handling/Marking, Other Machinery/  
Equipment/Parts/Products, Robotics, Saws &  
Cut-off Machines, Software & Machine  
Controls

## Engineering Technology Associates Inc

### Booth C1414

1133 E Maple Rd Ste 200  
Troy, MI 48083-2853 United States  
ph: 248-729-3010  
fax: 248-729-3020  
www.eta.com  
Software & Machine Controls

## Enhancement Technologies / Sublitex-Miroglio

### Booth C1561

PO Box 302  
Liberty Corner, NJ 07938-0302 United States  
ph: 908-903-9080  
fax: 908-903-9060  
www.enhancetech.com  
Coil Processing, Finishing

## Enprotech Industrial Technologies LLC

### Booth C1439

2200 Olds Ave  
Lansing, MI 48915-1099 United States  
ph: 517-372-0950  
fax: 517-372-3334  
www.enpromech.com  
Hydroforming, Maintenance & Repair,  
Stamping

## Enutron International

### Booth C7750

3847 Geryville Pike  
Pennsburg, PA 18073-2616 United States  
ph: 215-541-0696  
fax: 215-541-0994  
www.enutron.com  
Bending/Forming, Cutting, Job Shop/Contract  
Manufacturing, Lasers, Material Handling/  
Marking, Press Brakes, Saws & Cut-off  
Machines, Tube & Pipe Fabricating or Welding

## Environmental Air Solutions

### Booth N6315

2220 Jessica Ln  
Coralville, IA 52241-2890 United States  
ph: 319-358-7794  
fax: 319-248-0345  
www.keeptheheat.com  
Maintenance & Repair, Plate & Structural  
Fabricating, Safety & Environmental,  
Welding Consumables

# BETENBENDER

Manufacturing, Inc. 

MADE IN THE USA WITH PRIDE AND DURABILITY



**HYDRAULIC  
PRESS BRAKES:**  
20-Ton to 1000-Ton

**HYDRAULIC  
SHEARS:**  
1/8" (10 GA), 3/16", 1/4",  
3/8", 1/2", 5/8", 3/4", 1", and 1 1/4".

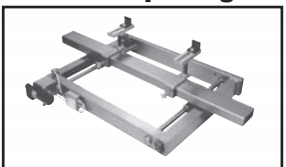
**We Also Provide  
Knife Sharpening!**



**Retrofit Backgauges**  
for Shears and Press Brakes.  
Made to fit most machines  
with minimum modifications.

Visit Us At Fabtech  
Booth# C3744  
Las Vegas, NV  
CUSTOM DESIGNS  
For Custom Applications

BETENBENDER MANUFACTURING, INC.  
5806 Quality Ridge Road • P.O. Box 140  
Coggon, Iowa 52218  
Phone: 319-435-2378 - Fax: 319-435-2262  
E-Mail: sales@betenbender.com

FREE CATALOG! 319-435-2378  
[www.betenbender.com](http://www.betenbender.com)

# KOCH

George Koch Sons, LLC  
*A smarter solution. Worldwide.*

PAINT FINISHING | THERMAL | ACOUSTICAL  
ENVIRONMENTAL | MATERIAL HANDLING

10 S. Eleventh Avenue  
Evansville, IN 47712  
PHONE: 812-465-9672  
EMAIL: sales@kochllc.com

Visit Us in Booth #C2521



## EnvisionTEC Inc

### Booth C3826

15162 S Commerce Dr  
Dearborn, MI 48120-1237 United States  
ph: 313-436-4300  
fax: 313-436-4303  
www.envisiontec.com  
Other Machinery/Equipment/Parts/Products

## Epicor Software Corp

### Booth C7211

4120 Dublin Blvd  
Dublin, CA 94568 United States  
ph: 925-361-9900  
fax: 925-361-9999  
www.epicor.com  
Software & Machine Controls

## Epilog Laser Corp

### Booth C7350

16371 Table Mountain Pkwy  
Golden, CO 80403-1826 United States  
ph: 303-277-1188  
fax: 303-277-9669  
www.epiloglaser.com  
Cutting, Job Shop/Contract Manufacturing,  
Lasers, Material Handling/Marking

## EPSI Masking Co

### Booth C2154

4221 Courtney Rd  
Franksville, WI 53126-9795 United States  
ph: 262-835-0782  
fax: 262-835-0783  
www.epsi.com  
Business Services

## Equipois Inc

### Booth N2324

5440 McConnell Ave.  
Los Angeles, CA 90066-7028 United States  
ph: 310-736-4130  
www.equipoisinc.com  
Assembly, Safety & Environmental

## Erasteel Inc

### Booth C1435

95 Fulton St  
Boonton, NJ 07005-1909 United States  
ph: 973-335-8400  
fax: 973-335-8420  
www.erasteel.com  
Business Services, Metal Suppliers

## Erickson Metals Corp

### Booth C1035

25 Knotter Dr  
Cheshire, CT 06410-1125 United States  
ph: 203-272-2918  
fax: 203-272-2912  
www.ericksonmetals.com  
Job Shop/Contract Manufacturing, Metal  
Suppliers

## ERIEZ

### Booth C7316

2200 Asbury Rd  
Erie, PA 16506 United States  
ph: 814-835-6206  
fax: 814-838-4960  
www.eriez.com  
Coil Processing, Lubrication, Material  
Handling/Marking, Other Machinery/  
Equipment/Parts/Products, Robotics, Safety  
& Environmental

## Ermak USA

### Booth C3447

1260 Landmeier Road  
Elk Grove Village, IL 60007 United States  
ph: 847-640-7765  
fax: 847-640-7808  
www.ermakusa.com  
Bending/Forming, Cutting, Lasers, Plate &  
Structural Fabricating, Press Brakes,  
Punching

## Ervin Industries

### Booth C7448

PO Box 1168  
Ann Arbor, MI 48106-1168 United States  
ph: 734-769-4600  
fax: 734-663-0136  
www.ervinindustries.com  
Finishing



## ESAB Welding & Cutting Products

### Booth N3922, N4122

411 S Ebenezer Rd  
Florence, SC 29501-7916 United States  
ph: 843-669-4411  
fax: 843-664-4258  
www.esabna.com

Arc Welding, Cutting, Plate & Structural  
Fabricating, Robotics, Welding Consumables,  
Welding Machines/Equipment

## ESCO Tool Co

### Booth C5735

75 October Hill Rd  
Holliston, MA 01746-1344 United States  
ph: 508-429-4441  
fax: 508-429-2811  
www.escotool.com  
Bending/Forming, Cutting, Finishing,  
Machining/EDM, Other Machinery/  
Equipment/Parts/Products, Saws & Cut-off  
Machines, Tube & Pipe Fabricating or  
Welding

## Essen Trade Shows

### Booth N2516

1500 Front St Ste 8  
Yorktown Hts, NY 10598-4648 United States  
ph: 914-962-1310  
fax: 914-962-1320  
www.essentradeshows.com  
Business Services

## Etal/INDUX Sa De Cv

### Booth N2433

Felipe Angeles 52  
Tacubaya  
Bellavista, Distrito Federal 01140 Mexico  
ph: 52 52783900  
Brazing & Soldering, Other Machinery/  
Equipment/Parts/Products, Plate & Structural  
Fabricating, Resistance Welding, Robotics

## Etco Industrial Co Ltd

### Booth C953

Room 1204  
Building D Everbright Conv & Exh Center No  
80 Caobao Rd  
Shanghai, Shanghai 200085 China  
ph: 86 24 8855503  
fax: 86 24 8855526  
www.etcchina.com

## Euromac/Metal Finish LLC

### Booth C4716

50 Corporate Ave  
Plainville, CT 06062-1195 United States  
ph: 860-747-6560  
fax: 860-747-6572  
www.metal-finish.com  
Bending/Forming, Finishing, Plate &  
Structural Fabricating, Punching





### **EXEL North America** **Booth C2264**

45001 Five Mile Rd  
Plymouth, MI 48170-2587 United States  
ph: 800-573-5554  
fax: 630-855-8018  
www.exel-na.com  
Finishing, Material Handling/Marking,  
Robotics

### **Expansion Solutions Magazine** **Booth C7346**

PO Box 1385  
Pelham, AL 35124 United States  
ph: 205-403-8780  
fax: 205-403-8790  
www.expansionsolutionsmagazine.com  
Business Services

### **ez-Router Inc** **Booth N1104**

140 County Road 2840  
Mineola, TX 75773-5918 United States  
ph: 903-569-3190  
fax: 903-569-1192  
www.ez-router.com

### **F & G Tool and Die Co** **Booth C1413**

3024 Dryden Rd  
Dayton, OH 45439-1620 United States  
ph: 937-294-1405  
fax: 937-294-3862  
www.fgtool.com  
Bending/Forming, Job Shop/Contract  
Manufacturing, Machining/EDM, Other  
Machinery/Equipment/Parts/Products, Tool &  
Die, Tooling, Welding Consumables



### **Fabricating & Metalworking** **Magazine** **Booth C8508**

262 Yeager Pkwy Ste C  
Pelham, AL 35124-4884 United States  
ph: 866-832-8473  
www.fandmmag.com  
Business Services

### **Fabricator, The** **Booth C8227**

833 Featherstone Rd  
Rockford, IL 61107-6301 United States  
ph: 815-399-8700  
fax: 815-484-7700  
www.thefabricator.com  
Business Services



Fabricators & Manufacturers  
Association, International®

### **Fabricators & Manufacturers** **Association** **Booth C6538**

833 Featherstone Rd  
Rockford, IL 61107-6302 United States  
ph: 815-227-8207  
fax: 815-484-7727  
www.fmanet.org  
Business Services

### **Fabrisonic LLC** **Booth N6218**

1250 Arthur E Adams Dr  
Columbus, OH 43221-3560 United States  
ph: 614-688-5223  
fax: 614-688-5001  
www.fabrisonic.com  
Business Services, Metal Suppliers, Other  
Machinery/Equipment/Parts/Products,  
Welding Machines/Equipment

### **FabSuite** **Booth C5736**

4350 New Town Ave Ste 102  
Williamsburg, VA 23188-2810 United States  
ph: 757-645-0914  
fax: 757-645-0896  
www.fabsuite.com  
Software & Machine Controls

### **FabTrol Systems Inc** **Booth C8131**

1025 Willamette St 3rd Floor  
Eugene, OR 97401-2490 United States  
ph: 541-485-4719  
fax: 541-485-4302  
www.fabtrol.com  
Software & Machine Controls

### **Faccin USA Inc** **Booth C6323**

907 S US Highway 301 S  
Tampa, FL 33619-4338 United States  
ph: 813-664-8884  
fax: 813-664-4544  
www.faccin.com  
Bending/Forming, Coil Processing, Plate &  
Structural Fabricating, Tube & Pipe  
Fabricating or Welding

### **Factory Cat** **Booth N2209**

PO Box 368  
1711 South St  
Racine, WI 53404 United States  
ph: 262-681-3583-112  
fax: 262-681-3753  
www.factorycat.com  
Maintenance & Repair

### **FANUC Robotics America Corp** **Booth N3917**

3900 W Hamlin Rd  
Rochester Hls, MI 48309-3253 United States  
ph: 248-377-7000  
fax: 248-377-7828  
www.fanucrobotics.com  
Robotics

### **FARO Technologies Inc** **Booth C7636**

250 Technology Pk  
Lake Mary, FL 32746-7115 United States  
ph: 800-736-0234  
fax: 407-562-5222  
www.faro.com  
Business Services, Inspection & Testing,  
Material Handling/Marking, Other  
Machinery/Equipment/Parts/Products,  
Software & Machine Controls

### **Fast Rite International** **Booth C854**

1739 Paul Ave  
Glendale Hts, IL 60139-2695 United States  
ph: 630-858-0988  
fax: 630-858-0067  
www.fast-rite.com  
Business Services, Fastening & Joining,  
Finishing, Job Shop/Contract Manufacturing,  
Other Machinery/Equipment/Parts/Products



## **Fastenal Company**

**Booth N5736**

2001 Theurer Blvd  
Winona, MN 55987-1500 United States  
ph: 507-454-5374  
fax: 507-453-8049  
www.fastenal.com  
Business Services, Cutting, Fastening & Joining, Finishing, Lubrication, Safety & Environmental, Tooling, Welding  
Consumables, Welding Machines/Equipment

## **Feed Lease Corp**

**Booth C928**

2600 Crooks Rd  
Rochester Hls, MI 48309-3604 United States  
ph: 248-852-6660  
fax: 248-853-5800  
www.feedlease.com  
Assembly, Coil Processing, Job Shop/  
Contract Manufacturing

## **Fein Power Tools Inc**

**Booth N5902**

1030 Alcon St  
Pittsburgh, PA 15220-3436 United States  
ph: 800-441-9878  
fax: 412-922-8767  
www.feinus.com  
Cutting, Finishing, Machining/EDM, Other Machinery/Equipment/Parts/Products, Saws & Cut-off Machines, Tube & Pipe Fabricating or Welding

## **Felton Inc**

**Booth C7112**

7 Burton Dr  
Londonderry, NH 03053-7435 United States  
ph: 603-425-0200  
fax: 603-425-0242  
www.feltoninc.com  
Finishing, Job Shop/Contract Manufacturing,  
Other Machinery/Equipment/Parts/Products

## **Ferris State Univ**

**Booth N1534**

915 Campus Dr  
Swan Bldg Room 108  
Big Rapids, MI 49307-2277 United States  
ph: 231-591-2000  
fax: 231-591-3944  
www.ferris.edu  
Business Services

# **FFJournal**

The magazine for today's fabricating & forming technology

## **FF Journal Magazine**

**Booth C8236**

625 N Michigan Ave  
Suite 1100  
Chicago, IL 60611-3110 United States  
ph: 312-654-2300  
fax: 312-654-2323  
www.ffjournal.net  
Business Services

## **Fiba Technologies Inc**

**Booth N6324**

1535 Grafton Rd  
Millbury, MA 01527-4332 United States  
ph: 508-887-7100  
fax: 508-754-2254  
www.fibatech.com  
Assembly, Business Services, Finishing,  
Gases & Gas Equipment

## **Fibre-Metal By Honeywell**

**Booth N2006**

900 Douglas Pike  
Smithfield, RI 02917 United States  
ph: 800-343-3411  
fax: 401-233-7641  
www.fibre-metal.com  
Safety & Environmental, Welding Machines/  
Equipment

## **Fibro Inc**

**Booth C249**

139 Harrison Ave  
Rockford, IL 61104-7044 United States  
ph: 800-523-2376  
fax: 815-226-1765  
www.fibroinc.com  
Tool & Die

## **Ficep Corporation**

**Booth C6550**

2301 Industry Ct  
Forest Hill, MD 21050-1683 United States  
ph: 410-588-5800  
fax: 410-588-5900  
www.ficepcorp.com  
Bending/Forming, Business Services, Cutting,  
Machining/EDM, Material Handling/  
Marking, Plate & Structural Fabricating,

Saws & Cut-off Machines, Tube & Pipe  
Fabricating or Welding

## **Fischer Technology Inc**

**Booth C2711**

750 Marshall Phelps Rd  
Windsor, CT 06095-2199 United States  
ph: 860-683-0781  
fax: 860-688-8496  
www.fischer-technology.com  
Inspection & Testing

## **Fit Rite**

**Booth N6126**

1006 N 19th St  
Tampa, FL 33605-6012 United States  
ph: 855-348-7483  
www.fitritefast.com  
Tube & Pipe Fabricating or Welding

## **Fives Bronx Inc**

**Booth C1514**

8817 Pleasantwood Ave NW  
North Canton, OH 44720-4759 United States  
ph: 330-244-1960  
fax: 330-244-1961  
www.fivesgroup.com/fivesbronx  
Bending/Forming, Finishing, Inspection &  
Testing, Saws & Cut-off Machines, Tube & Pipe  
Fabricating or Welding, Tube & Pipe Producing

# **Fladder®**

## **Fladder-Hansen &**

**Hundebol Inc**

**Booth C6328**

3402 Oakcliff Rd Ste B7  
Atlanta, GA 30340-3009 United States  
ph: 770-452-1271  
fax: 770-452-7090  
www.fladder.com  
Finishing

## **Flame Technologies Inc**

**Booth N3219**

703 Cypress Creek Rd  
Cedar Park, TX 78613-4414 United States  
ph: 512-219-8481  
fax: 512-219-8477  
www.flametechnologies.com  
Brazing & Soldering, Cutting, Gases & Gas  
Equipment, Other Machinery/Equipment/



Parts/Products, Plate & Structural Fabricating, Safety & Environmental, Welding Machines/Equipment

### **Flexarm Inc** **Booth C7431**

851 Industrial Dr  
Wapakoneta, OH 45895-9243 United States  
ph: 419-738-8147  
fax: 419-738-8140  
www.flexarminc.com  
Assembly, Machining/EDM, Material Handling/Marking, Other Machinery/Equipment/Parts/Products, Safety & Environmental

### **FloMet LLC** **Booth C858**

810 Flightline Blvd  
Deland, FL 32724-2055 United States  
ph: 386-736-4890  
www.flomet.com

### **Flow International Corp** **Booth C5911**

23500 64th Ave S  
Kent, WA 98032-2305 United States  
ph: 253-850-3500  
fax: 253-813-9377  
www.flowwaterjet.com  
Cutting, Material Handling/Marking, Robotics, Software & Machine Controls, Waterjet

### **Foerster Instruments Inc** **Booth C1523**

140 Industry Dr  
Pittsburgh, PA 15275-1028 United States  
ph: 412-788-8976  
fax: 412-788-8984  
www.foerstergroup.com  
Inspection & Testing, Material Handling/Marking

### **Folding Guard Corp** **Booth N1808**

5858 W 73rd St  
Bedford Park, IL 60638-6216 United States  
ph: 708-325-0400  
fax: 708-325-0450  
www.foldingguard.com  
Safety & Environmental

### **FomUSA** **Booth C6914**

1065 Medina Rd Ste 800  
Medina, OH 44256-5376 United States  
ph: 234-248-4400  
fax: 330-239-3240  
www.fomgroupusa.com  
Assembly, Machining/EDM, Other Machinery/Equipment/Parts/Products, Plate & Structural Fabricating, Saws & Cut-off Machines, Tube & Pipe Fabricating or Welding

### **Fontijne Grotnes Inc** **Booth C2136**

1025 W Thorndale Ave  
Itasca, IL 60143-1336 United States  
ph: 630-875-1111  
fax: 630-875-1201  
www.fontijnegrotnes.com  
Bending/Forming, Tube & Pipe Fabricating or Welding

### **Formdrill USA Inc** **Booth C2222**

4118 N Nashville Ave  
Chicago, IL 60634-1429 United States  
ph: 773-290-1040  
fax: 773-290-1041  
www.formdrill-usa.com  
Fastening & Joining, Machining/EDM, Tooling, Welding Consumables

### **Forming Technologies Inc** **Booth C1421**

3370 South Service Rd  
Burlington, ON L7N 3M6 Canada  
ph: 905-340-3370  
fax: 905-340-0377  
www.forming.com  
Job Shop/Contract Manufacturing, Software & Machine Controls

### **Formtek Metal Forming & Hill Engineering** **Booth C3708**

4899 Commerce Pkwy  
Cleveland, OH 44128-5905 United States  
ph: 216-292-4460  
fax: 216-292-2898  
www.formtekgroup.com  
Bending/Forming, Coil Processing, Saws & Cut-off Machines, Tooling, Tube & Pipe Fabricating or Welding, Tube & Pipe Producing

### **Forster Welding Systems GmbH** **Booth N3325**

Gewerbering 23  
Hohenstein-Ernstthal, D-09337 Germany  
ph: 49 3723 40180  
fax: 49 3723 401818  
www.foerster-gmbh.de

### **Fostoria Process Equipment** **Booth C2148**

PO Box 4973  
Johnson City, TN 37602-4973 United States  
ph: 423-477-4131  
fax: 423-477-5721  
www.fostoriaprosessequipment.com  
Finishing

### **Freeport McMoRan Copper & Gold** **Booth C1254**

48 Bayway Ave  
Elizabeth, NJ 07202 United States  
ph: 908-558-4318  
fax: 908-351-9475  
www.fcx.com/metals/bayway.htm  
Metal Suppliers

### **Friggi N.A. Inc** **Booth C7642**

883 Isabel St  
Woodstock, ON N4S 2A7 Canada  
ph: 519-421-9291  
www.friggics.com  
Lasers, Material Handling/Marking, Other Machinery/Equipment/Parts/Products, Plate & Structural Fabricating, Saws & Cut-off Machines, Tube & Pipe Fabricating or Welding, Waterjet

### **Frommelt Safety Products** **Booth N4827**

8900 N Arbon Dr  
Milwaukee, WI 53223-2451 United States  
ph: 800-553-5560  
fax: 563-589-2776  
www.frommeltsafety.com  
Assembly, Finishing, Lasers, Material Handling/Marking, Robotics, Safety & Environmental, Welding Machines/Equipment





## Fronius USA LLC

### Booth N3425

10421 Citation Dr Ste 1100  
Brighton, MI 48116-6572 United States  
ph: 810-220-4414  
fax: 810-220-4424  
www.fronius-usa.com  
Arc Welding, Resistance Welding, Robotics,  
Welding Machines/Equipment

## Fuchs Lubricants Co

### Booth C1517

17050 Lathrop Ave  
Harvey, IL 60426-6035 United States  
ph: 708-333-8900  
fax: 708-333-4470  
www.fuchs.com  
Lubrication

## Fusion Inc

### Booth N3313

4658 E 355th St  
Willoughby, OH 44094-4630 United States  
ph: 440-602-5510  
fax: 440-602-8761  
www.fusion-inc.com  
Assembly, Brazing & Soldering, Fastening &  
Joining, Job Shop/Contract Manufacturing,  
Robotics, Welding Consumables

## Fuxin Tianyuan Steel Balls Mfg Co Ltd

### Booth C355

Pingxi Industry  
Haizhou District  
Fuxin, Liaoning 123002 China  
ph: 86 418 2590418  
fax: 86 418 2593418  
www.fxtgq.com  
Assembly, Fastening & Joining, Maintenance  
& Repair, Other Machinery/Equipment/Parts/  
Products

## FW Gartner Thermal Spray

### Booth C7111

PO Box 451509  
Houston, TX 77245-1509 United States  
ph: 713-225-0010  
fax: 713-229-9841  
www.fwgts.com

## G&J Hall Tools Inc

### Booth N3025

830 Hanley Industrial Ct

Brentwood, MO 63144-1403 United States

ph: 314-968-5040

fax: 314-968-5543

www.gjhalltools.com  
Cutting, Machining/EDM

## Gaozhou City Longsafety Labor Insurance

### Booth N6201

No 123 Yanjiang Rd  
Gaozhou, Duangdong 525200 China  
ph: 86 668 6666168  
fax: 86 668 6666861  
www.longsafety.com  
Safety & Environmental

## Gasflux Co

### Booth N2833

PO Box 1170  
Elyria, OH 44036 United States  
ph: 440-365-1941  
fax: 440-365-3495  
www.gasflux.com  
Brazing & Soldering, Metal Suppliers,  
Welding Consumables

## gasgrab.com

### Booth N3225

Bow House 3 Brookway  
Newbury  
Berkshire, RG14 5RY United Kingdom  
ph: 163 548500  
fax: 163 548600  
www.gasgrab.com  
Assembly & Joining, Cutting, Gases & Gas  
Equipment, Material Handling/Marking,  
Safety & Environmental

## Gasparini SPA

### Booth C5536

Viale Venezia, 27  
Mirano, Venezia 30035 Italy  
ph: 39 41 5790111  
fax: 39 41 5790147  
www.gasparini-spa.com  
Bending/Forming, Tube & Pipe Producing  
*Distributors:*  
Gasparini S.p.A. - USA

## GAWDA

### Booth N1527

8669 NW 36th St  
Miami, FL 33166 United States  
ph: 877-382-6640

fax: 305-442-7451

www.gawda.org

## GE Measurement & Control

### Booth N3222

50 Industrial Park Rd  
Lewistown, PA 17044-9312 United States  
ph: 717-447-1562  
fax: 717-242-2606  
www.geinspectiontechnologies.com  
Inspection & Testing

## Gem Tool Corporation

### Booth C2320

1125 W Northbranch Drive  
Oak Creek, WI 53154-1432 United States  
ph: 414-762-1545  
fax: 414-762-0615  
www.gemtoolcorp.com  
Cutting, Finishing, Job Shop/Contract  
Manufacturing, Saws & Cut-off Machines,  
Tooling

## Gema

### Booth C2750

4141 W 54th St  
Indianapolis, IN 46254-3728 United States  
ph: 317-298-5000  
fax: 317-298-5010  
www.itwgema.us  
Finishing

## General Automatic Transfer

### Booth C2550

100 Larkin Williams Ind Ct  
Fenton, MO 63026-2409 United States  
ph: 636-343-6370  
fax: 636-343-6972  
www.gatco-systems.cc  
Finishing, Material Handling/Marking,  
Plant Engineering & Maintenance, Surface  
Treatment & Cleaning Equipment

## General Fabrications Corp

### Booth C2648

PO Box 2461  
Sandusky, OH 44871 United States  
ph: 419-625-6055  
fax: 419-625-7843  
www.gfcfinishing.com  
Finishing



## General Tool

### Booth N1622

2025 Alton Pkwy  
Irvine, CA 92606-4904 United States  
ph: 949-261-2322  
fax: 949-261-2614  
www.gtdiamond.com  
Finishing

## Generon IGS

### Booth C5547

16250 Tomball Pkwy  
Houston, TX 77086-1014 United States  
ph: 713-937-5221  
www.igs-global.com  
Gases & Gas Equipment

## Genesis Systems Group

### Booth N3913

8900 N Harrison St  
Davenport, IA 52806-7323 United States  
ph: 563-445-5600  
fax: 563-445-5699  
www.genesis-systems.com  
Arc Welding, Assembly, Material Handling/  
Marking, Robotics

## Genstar Technologies Inc

### Booth N2822

4525 Edison Ave  
Chino, CA 91710-5706 United States  
ph: 909-606-2726  
fax: 909-606-6485  
www.genstartech.com  
Brazing & Soldering, Cutting, Gases & Gas  
Equipment, Lasers, Machining/EDM,  
Material Handling/Marking, Welding  
Machines/Equipment

# KOCH

George Koch Sons, LLC  
A smarter solution. Worldwide.

## George Koch Sons LLC

### Booth C2521

10 S Eleventh Ave  
Evansville, IN 47712-6800 United States  
ph: 812-465-9672  
www.kochllc.com  
Finishing, Safety & Environmental

## Gerb Vibration Control Systems

### Booth C852

1950 Ohio St  
Lisle, IL 60532-2145 United States  
ph: 630-724-1660  
fax: 630-724-1664  
www.gerb.com  
Business Services, Finishing, Machining/  
EDM, Maintenance & Repair, Other  
Machinery/Equipment/Parts/Products,  
Punching, Safety & Environmental, Stamping

## GH Induction Atmospheres LLC

### Booth C2323

35 Industrial Park Cir  
Rochester, NY 14624-2403 United States  
ph: 585-368-2120  
fax: 585-368-2123  
www.inductionatmospheres.com  
Assembly & Joining, Brazing & Soldering,  
Fastening & Joining, Other Machinery/  
Equipment/Parts/Products, Plant Engineering  
& Maintenance, Tube & Pipe Fabricating or  
Welding, Tube & Pipe Producing, Welding  
Machines/Equipment

## GINGRAS/Machinerie G A S

### Booth C3822

762 Chermin Olivier  
Saint-Nicolas, QC G7A 2N2 Canada  
ph: 418-831-1417  
fax: 418-831-4973  
www.gingras-gas.com  
Press Brakes

## Glenn Metalcraft Inc

### Booth C1034

1502 South 14th Street  
P.O. Box 446  
Princeton, MN 55371 United States  
ph: 763-389-6385  
fax: 763-389-5356  
www.glennmetalcraft.com  
Job Shop/Contract Manufacturing

## Global Finishing Solutions

### Booth C2151

12731 Norway Rd  
Osseo, WI 54758-7780 United States  
ph: 715-597-3168  
fax: 715-597-2193  
www.globalfinishing.com  
Finishing, Safety & Environmental

## Global Hardgoods

### Booth N2724

155 Bellflower Cir  
Chagrin Falls, OH 44022-4192 United States  
ph: 216-370-3485  
fax: 216-367-5703  
www.globalhardgoods.com

## Global Metal Spinning Solutions Inc

### Booth C934

9727 Stoneglen Dr  
Colorado Springs, CO 80920 United States  
ph: 719-282-9061  
fax: 719-282-9157  
www.globalmetalspinning.com  
Bending/Forming, Cutting, Finishing, Job  
Shop/Contract Manufacturing, Lubrication,  
Other Machinery/Equipment/Parts/Products,  
Robotics, Tooling, Tube & Pipe Fabricating or  
Welding

## Global Precision Parts Inc

### Booth C2213

7600 US Route 127 North  
PO Box 752  
Van Wert, OH 45891 United States  
ph: 419-233-1399  
fax: 419-238-0223  
www.globalprecisionpartsinc.com  
Job Shop/Contract Manufacturing

## Global Shop Solutions

### Booth C7312

975 Evergreen Cir  
MS 975  
The Woodlands, TX 77380-3637 United  
States  
ph: 281-466-8112  
www.globalshopsolutions.com  
Business Services, Software & Machine  
Controls

## GMA Garnet USA Corp

### Booth C5811

480 N Sam Houston Pky Ste 130  
Houston, TX 77060-3521 United States  
ph: 832-243-9300  
fax: 832-243-9301  
www.garnetsales.com



## GMC Machine Tools Corp

Booth C5033

2001 Elm Ct  
Ontario, CA 91761-7619 United States  
ph: 909-947-7787  
fax: 909-947-7757  
www.gmcmachinetools.com

## GMT North America

Booth C353

6311 Ronald Reagan Dr Ste 157  
Lake St Louis, MO 63367-2681 United States  
ph: 636-410-9090  
fax: 800-403-6173  
www.gmtna.com  
Finishing, Lubrication, Tool & Die, Tooling

## Goff Inc

Booth C2726

12216 NS 3520  
PO Box 1607  
Seminole, OK 74868 United States  
ph: 405-278-6207  
fax: 405-382-7013  
www.goff-inc.com  
Finishing



## Goff's Enterprises Inc

Booth N2625

700 Hickory St  
Pewaukee, WI 53072-3955 United States  
ph: 262-691-4998  
fax: 262-691-3255  
www.goffscurtainwalls.com/fabtech  
Finishing, Material Handling/Marking, Safety & Environmental

## Golden Eagle Minmetals(Beijing) Wldg Materials Co

Booth N5800

No 1 Gaoxinsanjie Huilongguan  
Intl Information Industry Base Changping  
District  
Beijing, 102206 China  
ph: 10 8072 2993  
fax: 10 8072 2991  
www.goldeneaglebj.com  
Metal Suppliers, Welding Consumables,  
Welding Machines/Equipment

## Goldland Industrial Co Ltd

Booth N6300

86F Tianxia Rd  
Shigu Tangxia Town  
Dongguan, GUANGDONG China  
ph: 769 87289366  
fax: 769 87283332  
www.goldlandgd.com  
Welding Machines/Equipment

## GoMeasure3D

Booth C1548

524 Sunset Dr  
Amherst, VA 24521-2527 United States  
ph: 434-946-9125  
fax: 480-393-5876  
www.gomeasure3d.com

## Gorbel Inc

Booth C2336

600 Fishers Run  
Fishers, NY 14453 United States  
ph: 585-924-6262  
fax: 585-924-6273  
www.gorbel.com  
Material Handling/Marking

## Goss Inc

Booth N2722

1511 Route 8  
Glenshaw, PA 15116 United States  
ph: 412-486-6100  
fax: 412-486-6844  
www.gossonline.com  
Brazing & Soldering, Cutting, Welding  
Machines/Equipment

## Gostol TST d.o.o

Booth C7645

Ciginj 63  
Tolmin, 5220 Slovenia  
ph: 386 53801280  
fax: 386 53801290  
www.gostol-tst.eu  
Finishing  
**Distributors:**  
MASSFIN



## Graco Inc

Booth C2350

88 11th Ave NE  
Minneapolis, MN 55413 United States  
ph: 612-623-6101  
fax: 612-378-3510  
www.graco.com/finishing  
Finishing



## Grainger

Booth C463

1305 N Interstate 35E  
Carrollton, TX 75006-8628 United States  
ph: 800-994-7982  
www.grainger.com

## Grand Rapids Machine Repair

Booth C348

4000 Eastern Ave SE  
Grand Rapids, MI 49508-3402 United States  
ph: 616-245-9102  
fax: 616-245-0235  
www.gmr.com

## Greenberry Industrial

Booth C8140

PO Box 759  
Vancouver, OR 98666 United States  
ph: 360-567-0006  
fax: 360-567-0007  
www.greenberry.com  
Business Services

## Greenerd Press & Machine Company Inc

Booth C815

41 Crown Street  
Nashua, NH 03060-6349 United States  
ph: 603-889-4101  
fax: 603-889-7601  
www.greenerd.com  
Fastening & Joining, Other Machinery/  
Equipment/Parts/Products, Punching,  
Stamping





**Guild International**  
Booth C2234

7273 Division St  
Bedford, OH 44146-5490 United States  
ph: 440-232-5887  
fax: 440-232-5878  
www.guildint.com  
Arc Welding, Coil Processing, Resistance  
Welding

**Gulco International**  
Booth N5002

21568 Alexander Rd  
Cleveland, OH 44146-5586 United States  
ph: 440-439-8333  
fax: 440-439-3634  
www.gulco.com  
Arc Welding, Bending/Forming, Cutting,  
Finishing, Machining/EDM, Material  
Handling/Marking, Tube & Pipe Fabricating  
or Welding, Welding Machines/Equipment

**Guspro Inc**  
Booth C1952

PO Box 970  
566 Riverview Dr Unit 4  
Chatham, ON N7M 5L5 Canada  
ph: 519-352-4550  
fax: 519-352-7676  
www.guspro.com  
Finishing, Other Machinery/Equipment/Parts/  
Products, Safety & Environmental

**GW KENT INC**  
Booth N2918

506 S Huron St  
Ypsilanti, MI 48197-5455 United States  
ph: 734-572-1300  
fax: 734-572-0097  
www.gwkent.com  
Metal Suppliers

**H & M Pipe Beveling Machine**  
**Co Inc**  
Booth N3419

311 E 3rd St  
Tulsa, OK 74120-2401 United States  
ph: 918-582-9984  
fax: 918-582-9989  
www.hmpipe.com  
Cutting, Saws & Cut-off Machines

**H & S Tool Inc**  
Booth C1747

PO Box 393  
715 Weber Drive  
Wadsworth, OH 44281 United States  
ph: 330-336-4550  
fax: 330-336-9159  
www.hstool.com

**H2O JET Inc**  
Booth C5713

1145 85th Ave SE  
Tumwater, WA 98501-5708 United States  
ph: 360-866-7161  
fax: 360-539-2440  
www.waterjetparts.com  
Cutting, Finishing, Maintenance & Repair,  
Other Machinery/Equipment/Parts/Products,  
Waterjet

# SCOTCHMAN

## THE NAME YOU CAN COUNT ON.



**50514-CM  
IRONWORKER**



**CPO 350 LT  
COLD SAW**



**FI 8510-20M  
IRONWORKER**



**CPO 350 PKPD with AFS  
COLD SAW**



**AL100U-02  
TUBE & PIPE  
GRINDER/NOTCHER**

MFG. IN NL

**LEASING**  
3.9%-24 Months  
4.9%-36 Months  
on All NEW Scotchman  
Machines

SEE US AT...  
**FABTECH**  
BOOTH C4923

SCOTCHMAN  
**3YR**  
WARRANTY



**The Solution *PREFERRED* by Metal Fabricators!**

Call Toll Free 1-800-843-8844 or Call Direct 605-859-2542 • Fax 1-800-843-5545 or 605-859-2499  
Website [www.scotchman.com](http://www.scotchman.com) • Email [info@scotchman.com](mailto:info@scotchman.com) • Scotchman Industries, Inc., P.O. Box 850, Philip, SD 57567



**EASY**  
Financing!

**EASY**  
Delivery!

**EASY**  
Operation!

**EASY**  
Service!

Call 1-800-843-8844  
to set up a  
**DEMONSTRATION**  
at your work site!



 **H2Pump LLC**  
**Booth C1154**

11 Northway Ln N  
Latham, NY 12110-2204 United States  
ph: 603-601-6810  
fax: 518-783-2241  
www.h2pumpllc.com  
Safety & Environmental

**Haas Saw & Supply**  
**Booth C1535**

2778 Greensburg Rd Ste B  
North Canton, OH 44720-2361 United States  
ph: 843-875-8005  
fax: 843-875-9010  
www.haassaw.com  
Cutting, Saws & Cut-off Machines

 **Haberle / Ken Bergman & Assoc LLC**  
**Booth C7137**

10533 Lorel Ave  
Oak Lawn, IL 60453-5154 United States  
ph: 800-956-1313  
fax: 708-422-3604  
www.haberleusa.com  
Bending/Forming, Cutting, Finishing,  
Lubrication, Material Handling/Marking,  
Saws & Cut-off Machines, Tube & Pipe  
Fabricating or Welding

**Haco Atlantic Inc**  
**Booth C3440**

11629 N Houston Rosslyn Rd  
116  
Houston, TX 77086-3601 United States  
ph: 281-445-3985  
fax: 281-445-3989  
www.hacoatlantic.com  
Plate & Structural Fabricating, Press Brakes,  
Punching, Stamping, Tooling



 **Haco-Lasit**  
**Booth C3440**

11629 N-Houston Rosslyn Road  
Houston, TX 77086 United States  
ph: 508-528-2542  
fax: 281-445-3989  
Lasers, Material Handling/Marking, Plate &  
Structural Fabricating, Punching, Stamping,  
Tooling

**Haeger Inc**  
**Booth C3716**

811 Wakefield Dr Ste B  
Oakdale, CA 95361-7792 United States  
ph: 209-848-4000  
fax: 209-847-6553  
www.haeger.com  
Assembly, Fastening & Joining

 **Haeusler AG**  
**Booth C5540**

Baselstrasse 21  
Duggingen, 4202 Switzerland  
ph: 1141617552222  
fax: 1141617552200  
www.haeusler.com  
Assembly, Bending/Forming, Other  
Machinery/Equipment/Parts/Products, Plate  
& Structural Fabricating, Tube & Pipe  
Fabricating or Welding

 **HAI Advanced Material Spec**  
**Booth N2319**

1688 Sierra Madre Cir  
Placentia, CA 92870-6628 United States  
ph: 714-414-0575  
fax: 714-414-0574  
www.haiams.com  
Arc Welding, Robotics, Thermal Spraying,  
Welding Machines/Equipment

**Halifax Rack & Screw**  
**Booth C7310**

3786 Hopper Hill Rd Unit B  
Cincinnati, OH 45255-5014 United States  
ph: 513-688-0065  
fax: 513-688-1361  
www.halifaxrs.com

Fastening & Joining, Job Shop/Contract  
Manufacturing, Other Machinery/Equipment/  
Parts/Products

 **Hangzhou Xiangsheng Abrasive Machine Manufacturing Co., Ltd**  
**Booth C7142**

No 53 Penggan Rd  
Pingyao Town  
Hangzhou, Zhejiang 311115 China  
ph: 604-726-8476  
www.xs-sander.com  
Finishing  
**Distributors:**  
AME Abrasive Belt Machinery & Equipment Inc.

**Hans Weber Sales and Service Corp**  
**Booth C5716**

PO Box 446  
Paola, KS 66071-0446 United States  
ph: 913-254-1611  
fax: 913-254-1582  
www.weberamerica.com

**Harbert's Products Inc/Allied Flux Reclaiming Ltd**  
**Booth N4824**

PO Box 418  
Greencastle, PA 17225-0418 United States  
ph: 717-597-1748  
fax: 717-597-1717  
www.recycleflux.com  
Arc Welding, Finishing, Tube & Pipe  
Producing, Welding Consumables, Welding  
Machines/Equipment

**Harper Trucks Inc**  
**Booth N1827**

PO Box 12330  
Wichita, KS 67277-2330 United States  
ph: 316-942-1381  
fax: 316-942-8508  
www.harpertrucks.com

**Harris Products Group**  
**Booth N4509**

2345 Murphy Blvd  
Gainesville, GA 30504-6001 United States  
ph: 770-538-6184  
fax: 770-535-8358  
www.harrisproductsgroup.com  
Brazing & Soldering, Cutting, Gases & Gas  
Equipment, Plate & Structural Fabricating



## Hayden Corp

### Booth N2409

333 River St  
West Springfield, MA 01089-3603 United States  
ph: 413-734-4981  
fax: 413-785-5052  
www.haydencorp.com  
Finishing, Job Shop/Contract Manufacturing, Lasers



## Hayes International

### Booth C5520

1200 E Cole St  
Moundridge, KS 67107-8803 United States  
ph: 620-345-6394  
fax: 620-345-6381  
www.hayesint.com

Bending/Forming, Coil Processing, Cutting, Material Handling/Marking, Tooling

## Haynes International

### Booth N1617

1020 W Park Ave  
Kokomo, IN 46904 United States  
ph: 765-456-6012  
fax: 765-456-6905  
www.haynesintl.com  
Metal Suppliers, Thermal Spraying, Welding Consumables

## Haynncorp Industrial Finishing Solutions

### Booth C2360

14866 N Elyria Rd  
West Salem, OH 44287-8958 United States  
ph: 419-853-4747  
fax: 419-853-3737  
www.haynncorp.com  
Business Services, Finishing

#### Distributors:

Anderson Bolds  
Ideal-Line

## HDI

### Booth N6137

PO Box 1617  
Gresham, OR 97030-0519 United States  
ph: 503-977-9325  
fax: 206-274-4855  
www.hdi-inc.com

## HE&M Saw Inc

### Booth C5508

PO Box 1148  
Pryor, OK 74362-1148 United States  
ph: 918-825-4821  
fax: 918-825-4824  
www.hemsaw.com  
Lubrication, Material Handling/Marking, Saws & Cut-off Machines, Welding Consumables

## Hebei Shinning Metals Co Ltd

### Booth C460

Rm1701, No42  
Yuhua West Rd  
Hebei, 50006 China  
ph: 86 311 85296503  
fax: 86 311 85296511  
www.shinningcorp.com

## Heck Industries

### Booth C4828

P.O. Box 425  
Hartland, MI 48353-0425 United States  
ph: 810-632-5400  
fax: 810-632-6640  
www.heckind.net  
Bending/Forming, Finishing, Hand & Portable Tools, Other Machinery/Equipment/Parts/Products, Plate & Structural Fabricating, Tube & Pipe Fabricating or Welding

## Heim Group, The

### Booth C1331

6360 W 73rd St  
Chicago, IL 60638-6127 United States  
ph: 708-496-7450  
fax: 708-496-7428  
www.theheimgroup.com  
Business Services, Other Machinery/Equipment/Parts/Products, Press Brakes, Punching, Stamping, Tool & Die

## Henkel Corp

### Booth C3724

One Henkel Way  
Rocky Hill, CT 06067-3581 United States  
ph: 860-571-5100  
fax: 860-571-5475  
www.henkeln.com

## Henning Industrial Software Inc

### Booth C4822

102 First St, Ste 211  
Hudson, OH 44236-5387 United States  
ph: 330-650-4212  
fax: 330-528-0397  
www.henningssoftware.com  
Software & Machine Controls

## Heritage Packaging

### Booth C7548

625 Fishers Run  
Victor, NY 14564-8905 United States  
ph: 585-742-3310  
fax: 585-742-3311  
www.heritagepackaging.com  
Material Handling/Marking

## Hermes Abrasives Ltd

### Booth N3009

524 Viking Dr  
Virginia Bch, VA 23452-7316 United States  
ph: 757-486-6623  
fax: 800-437-7637  
www.hermesabrasives.com  
Finishing

## Herr Voss Stamco

### Booth C7239

130 Main St  
PO Box AB  
Callery, PA 16024-0178 United States  
ph: 724-538-3180  
fax: 724-538-3056  
www.herr-voss.com  
Coil Processing

## Hess Industries Inc

### Booth C1531

30257 Redfield St  
Niles, MI 49120-5958 United States  
ph: 269-683-4182  
fax: 269-683-1774  
www.hessindustries.com

## Hexagon Metrology Inc

### Booth C8137

250 Circuit Dr  
N Kingstown, RI 02852-7441 United States  
ph: 401-886-2242  
fax: 401-886-2980  
www.hexagonmetrology.us





### Hex-Hut Shelter Systems Ltd Booth N6115

120 2719 7th Ave NE  
Calgary, AB T2A 2L9 Canada  
ph: 403-293-7333  
fax: 403-293-7334  
www.hex-hut.com

Maintenance & Repair, Material Handling/  
Marking, Other Machinery/Equipment/Parts/  
Products, Safety & Environmental

### HGG Profiling Equipment Booth C8127

5519 Indigo Commons Way  
Charleston, SC 29418 United States  
ph: 330-461-6885  
www.hgg.nl

Cutting, Material Handling/Marking, Other  
Machinery/Equipment/Parts/Products, Plate  
& Structural Fabricating, Robotics, Tube &  
Pipe Fabricating or Welding

### HI TecMetal Group Inc Booth C255

1101 E 55th St  
Cleveland, OH 44103-1026 United States  
ph: 216-426-6636  
fax: 216-426-6690

### Hilma Division Carr Lane Roemheld Booth C449

16345 Westwoods Business Park  
Ellisville, MO 63021-4521 United States  
ph: 636-386-8022  
fax: 636-386-8034  
www.clrh.com  
Tool & Die

### HIT Tools USA Booth N1415

4001 Santa Ana St  
Ontario, CA 91761-1559 United States  
ph: 909-974-0369  
fax: 909-390-5293  
www.hittools.com

### Hiwin Corp Booth C1321

1400 Madeline Ln  
Elgin, IL 60124-7829 United States  
ph: 847-827-2270  
fax: 847-827-2291  
www.hiwin.com

Assembly, Lubrication, Other Machinery/  
Equipment/Parts/Products, Software &  
Machine Controls, Tool & Die, Tooling



### Hobart Brothers Booth N5516

101 Trade Square East  
Troy, OH 45373 United States  
ph: 937-332-4000  
fax: 937-332-5224  
www.millerwelds.com  
Welding Consumables

### Hobart Institute of Welding Technology Booth N5819

400 Trade Sq E  
Troy, OH 45373-2463 United States  
ph: 800-332-9448  
fax: 937-332-5200  
www.welding.org  
Business Services

### Hollbrit Inc Booth N6317

105 Industrial Dr Unit 7  
Whitby, ON L1N 5Z9 Canada  
ph: 905-665-8812  
fax: 905-665-8815  
www.hollbrit.com  
Arc Welding, Finishing, Robotics, Welding  
Machines/Equipment



### Honeywell Safety Products Booth N2006

900 Douglas Pke  
Smithfield, RI 02917-1858 United States  
ph: 800-343-3411  
fax: 401-233-7641

### Horn Machine Tools Inc Booth C1734

40455 Brickyard Dr Ste 101  
Madera, CA 93636-9516 United States  
ph: 559-431-4131  
fax: 559-431-4431

www.hornmachinetools.com  
Business Services, Inspection & Testing,  
Saws & Cut-off Machines, Software &  
Machine Controls, Tube & Pipe Fabricating or  
Welding

### HOT COILS Booth N5115

Box 264  
5312 52nd St  
Wabamun, AB T0E 2K0 Canada  
ph: 866-942-6457  
www.hotcoils.com  
Inspection & Testing, Job Shop/Contract  
Manufacturing, Other Machinery/Equipment/  
Parts/Products  
*Distributors:*  
Heat Spec Industries  
Hot Coils East  
Sumac Fabrication Co. Ltd.

### Hotfoil EHS Inc Booth N1319

2960 E State Street Ext  
Hamilton, NJ 08619-4504 United States  
ph: 609-588-0900  
fax: 609-588-8333  
www.hotfoilehs.com  
Arc Welding, Business Services, Job Shop/  
Contract Manufacturing, Other Machinery/  
Equipment/Parts/Products, Welding  
Machines/Equipment  
*Distributors:*  
KASI Technologies Inc.

### Hougén Manufacturing Inc Booth C4821

3001 Hougén Dr  
Swartz Creek, MI 48473-7935 United States  
ph: 810-635-7111  
fax: 810-635-8277  
www.hougen.com  
Cutting, Machining/EDM, Maintenance &  
Repair, Material Handling/Marking, Other  
Machinery/Equipment/Parts/Products

### Houghton International Inc Booth C1437, C1552

PO Box 930  
Valley Forge, PA 19482-0930 United States  
ph: 610-666-4088  
fax: 610-666-0174  
www.houghtonintl.com  
Cutting, Finishing, Lubrication



 **Hubbard-Hall Inc**  
**Booth C2156**

PO Box 790  
Waterbury, CT 06720 United States  
ph: 203-756-5521  
fax: 203-756-9017  
www.hubbardhall.com  
Finishing, Lubrication

**Hyd-Mech Group Ltd**  
**Booth C6523**

1079 Parkinson Rd  
PO Box 1659  
Woodstock, ON N4S 0A9 Canada  
ph: 519-539-2103  
fax: 519-539-5126  
www.hydmech.com  
Material Handling & Packaging, Material  
Handling/Marking, Saws & Cut-off Machines

**Hydro Carbide Inc**  
**Booth C8238**

4439 Route 982  
Latrobe, PA 15650-3700 United States  
ph: 724-539-9701  
fax: 724-539-8140  
www.hydrocarbide.com  
Cutting, Finishing, Metal Suppliers, Other  
Machinery/Equipment/Parts/Products, Tool &  
Die, Tooling, Welding Machines/Equipment

**Hypertherm®**  
**Cut with confidence™**

 **Hypertherm Inc**  
**Booth N3906**

PO Box 5010  
Hanover, NH 03755-5010 United States  
ph: 603-643-0030  
fax: 603-643-5352  
www.hypertherm.com  
Bending/Forming, Cutting, Lasers, Plate &  
Structural Fabricating, Software & Machine  
Controls, Welding Machines/Equipment

**I.S.T. International Surface  
Technologies**  
**Booth C1958**

4160 Industrial Blvd  
Laval, QC H7L 6H1 Canada  
ph: 450-963-2200  
fax: 450-963-5122  
www.ecoind.com  
Finishing, Safety & Environmental

 **IBEDA / Superflash**  
**Compressed Gas Equipment  
Inc**  
**Booth N3437**

28825 Ranney Pkwy  
Westlake, OH 44145-1173 United States  
ph: 888-327-3706  
fax: 440-871-9964  
www.oxyfuelsafety.com  
Gases & Gas Equipment, Safety &  
Environmental, Thermal Spraying, Welding  
Machines/Equipment

**Ideal Welding Systems LP**  
**Booth N5008**

3294 Pyramid Dr  
Rockford, IL 61109-2765 United States  
ph: 815-874-4349  
fax: 815-874-4015  
www.idealweld.com  
Coil Processing, Resistance Welding

**Identification Plates Inc**  
**Booth C8340**

1555 High Point Dr  
Mesquite, TX 75149-9009 United States  
ph: 972-216-1616  
fax: 972-216-1555  
www.idplates.com  
Job Shop/Contract Manufacturing, Metal  
Suppliers

**igm Robotic Systems Inc/  
Astro Arc Polysoude/PTR-  
Precision Technologies Inc**  
**Booth N5226**

W133 N5138 Campbell Dr  
Menomonee Falls, WI 53051-7030 United  
States  
ph: 262-783-2720  
fax: 262-783-2730  
www.igmusa.com

**II-VI Infrared**  
**Booth C4924**

375 Saxonburg Blvd  
Saxonburg, PA 16056-9430 United States  
ph: 724-352-1504  
fax: 724-352-4980  
www.iiviiinfrared.com  
Job Shop/Contract Manufacturing, Lasers,  
Material Handling/Marking, Welding  
Machines/Equipment

**IMPACT Engineering Inc**  
**Booth N5108**

500 E Biddle St  
Jackson, MI 49203-3990 United States  
ph: 517-789-0098  
fax: 517-789-1038  
www.impactwelding.com  
Arc Welding, Assembly, Business Services,  
Inspection & Testing, Job Shop/Contract  
Manufacturing

**Imperial Blades LLC**  
**Booth N1715**

2998 Syene Rd  
Madison, WI 53713-3221 United States  
ph: 608-204-0025  
fax: 608-204-0019  
www.imperialblades.com

**IMS Systems Inc**  
**Booth C8247**

519 Myoma Rd  
Mars, PA 16046-2323 United States  
ph: 724-772-9772  
fax: 724-772-9786  
www.ims-gmbh.de/usa

 **Industrial Innovations Inc**  
**Booth C836**

2650 Thornwood St SW  
Wyoming, MI 49519-2151 United States  
ph: 616-249-1525  
fax: 616-249-0983  
www.industrialinnovations.com  
Safety & Environmental, Tool & Die

**Industrial Laser Solutions**  
**Booth C8520**

98 Spit Brook Rd-LL1  
Nashua, NH 03062-5737 United States  
ph: 480-991-9109  
www.industrial-lasers.com  
Business Services

**Industrial Machine Trader**  
**Booth C8231**

1003 Central Ave  
Fort Dodge, IA 50501-4049 United States  
ph: 800-203-9960  
fax: 515-955-3753  
www.industrialmachinetrader.com  
Other Machinery/Equipment/Parts/Products



# INDUSTRIAL MACHINERY DIGEST

The Industry's Most Extensive Industrial Publication

## Industrial Machinery Digest Booth C8506

262 Yeager Pkwy Ste C  
Pelham, AL 35124-4884 United States  
ph: 205-216-0477  
fax: 205-216-0493  
www.industrialmachinerydigest.com  
Business Services

### Distributors:

IMDauctions.com  
Total Industrial Plant Solutions card deck  
www.TIPScd.com

## Industrial Magnetics Inc Booth C5728

1385 S M 75  
Boyer City, MI 49712-9689 United States  
ph: 231-582-3100  
fax: 231-582-0622  
www.magnetics.com  
Assembly, Fastening & Joining, Material  
Handling/Marking, Robotics

## Industrial Maid Booth N2428

351 S 12th Rd  
Cortland, NE 68331-8144 United States  
ph: 402-798-7116  
fax: 402-798-7117  
www.industrial-maid.com  
Safety & Environmental

## Industrial Market Place Booth C5036

7842 Lincoln Ave  
Skokie, IL 60077-3644 United States  
ph: 847-676-1900  
fax: 847-676-0063  
www.industrialmktpl.com  
Business Services

## Industrial Molded Rubber Products Booth C4723

20015 176th St NW  
Big Lake, MN 55309-8017 United States  
ph: 763-262-3456  
fax: 763-262-3460  
www.imr-inc.com

Job Shop/Contract Manufacturing, Material  
Handling/Marking, Other Machinery/  
Equipment/Parts/Products

## Infor Booth C8438

13560 Morris Rd Ste 4100  
Alpharetta, GA 30004-8995 United States  
ph:  
www.infor.com

## InfoSight Corporation "We Barcode Difficult Stuff"

## InfoSight Corp Booth C5609

20700 US Highway 23  
PO Box 5000  
Chillicothe, OH 45601-7000 United States  
ph: 740-642-3600  
fax: 740-642-5001  
www.infosight.com  
Material Handling/Marking

## Infra Metals Booth C8345

1900 Bessemer Rd  
Petersburg, VA 23805-1112 United States  
ph: 804-957-5900  
fax: 804-957-5800  
www.infra-metals.com

## Inline Sieve Booth C2552

205 Centennial Dr  
Buffalo, MN 55313-9036 United States  
ph: 763-233-6888  
fax: 763-682-4942  
www.inlinesieve.com  
Finishing

## Innerspec Technologies Booth N2217

4004 Murray Pl  
Lynchburg, VA 24502 United States  
ph: 434-847-2023  
fax: 434-948-1313  
www.innerspec.com  
Coil Processing, Finishing, Inspection &  
Testing, Tooling, Tube & Pipe Producing

## INNOVO Corp Booth C1758

2385 United Ln  
Elk Grove Vlg, IL 60007-6816 United States  
ph: 847-616-0063  
fax: 847-616-0059  
www.innovo.us  
Bending/Forming, Saws & Cut-off Machines,  
Tube & Pipe Fabricating or Welding

## Intech Services Inc Booth C2163

211 Lake Dr # J  
Newark, DE 19702-3320 United States  
ph: 302-366-8530  
fax: 302-366-8602  
www.intechservices.com  
Finishing



IntelliFinishing

## IntelliFinishing Booth C2528

418 E Avenue B  
Salina, KS 67401-8960 United States  
ph: 785-309-0356  
fax: 785-825-0590  
www.intellifinishing.com  
Business Services, Finishing, Inspection &  
Testing, Material Handling/Marking,  
Software & Machine Controls

## Interactive Safety Product Inc Booth N3206

9825-A Northcross Center Ct  
Huntersville, NC 28078-7339 United States  
ph: 704-659-7262  
fax: 704-664-7316  
www.helmetsystems.com  
Safety & Environmental, Welding Machines/  
Equipment

## Intercon Enterprises Inc Booth N3227

1125 Fir Ave  
Blaine, WA 98230-9702 United States  
ph: 800-665-6655  
fax: 604-946-5340  
www.intercononline.com  
Gases & Gas Equipment, Inspection &  
Testing, Lubrication, Material Handling/  
Marking, Welding Consumables





## Interlaken Technology Booth C947

8175 Century Blvd  
Chaska, MN 55318-3057 United States  
ph: 952-856-4210  
fax: 952-856-4221  
www.interlaken.com

Business Services, Hydroforming, Inspection & Testing, Job Shop/Contract Manufacturing, Stamping, Tooling

## International Chemical Co Booth C1232

2628 N Mascher St # 48  
Philadelphia, PA 19133-3898 United States  
ph: 215-739-2313  
www.e-icc.com  
Finishing, Lubrication

## International Knife & Saw Inc Booth C4710

1435 N Cashua Rd  
Florence, SC 29501 United States  
ph: 843-662-6345  
fax: 843-664-1103  
www.iksinc.com

## International Mold Steel Booth C556

6796 Powerline Dr  
Florence, KY 41042 United States  
ph: 859-342-6000  
fax: 859-342-6006  
www.imsteel.com  
Machining/EDM, Metal Suppliers, Other Machinery/Equipment/Parts/Products, Saws & Cut-off Machines

## International Sheet Metal Review Booth C8510

Fiddlebridge Lane  
1 Forum Place Winchester Court  
Hatfield, Hertfordshire AL10 0RN United Kingdom  
ph: 44 1707 273999  
www.trmg.co.uk

## International Technologies Inc Booth C8111

634 Pratt Avenue North  
Schaumburg, IL 60193-4557 United States  
ph: 847-301-9005

fax: 847-301-9509  
www.international-technologies.com  
Bending/Forming, Machining/EDM, Maintenance & Repair, Other Machinery/Equipment/Parts/Products, Press Brakes, Punching, Resistance Welding, Safety & Environmental, Tooling

## International Thermal Spray Assoc (ITSA) Booth N2509

PO Box 1638  
Painesville, OH 44077-7432 United States  
ph: 440-357-5400  
fax: 440-357-5430  
www.thermalspray.org  
Thermal Spraying

## International Waterjet Parts Booth C5847

3882 N Schreiber Way #204  
Coeur D Alene, ID 83815 United States  
ph: 866-302-3284  
fax: 866-883-3292  
www.iwpwaterjet.com  
Waterjet

## International Welding Technologies Inc Booth N1724

2650 Egg Harbor Rd  
Lindenwold, NJ 08021-1455 United States  
ph: 856-435-8004  
fax: 856-435-4004  
www.internationalwelding.com  
Arc Welding, Business Services, Fastening & Joining, Inspection & Testing, Job Shop/Contract Manufacturing, Machining/EDM, Maintenance & Repair, Other Machinery/Equipment/Parts/Products, Robotics, Welding Machines/Equipment

## Interpower Induction USA Booth C1355

3578 Van Dyke Rd  
Almont, MI 48003-8045 United States  
ph: 810-798-9201  
fax: 810-798-9301  
www.interpowerinduction.com

## InterTest Inc Booth N5824

303 State Route 94  
Columbia, NJ 07832-2841 United States

ph: 908-496-8008  
fax: 908-496-8004  
www.intertest.com  
Business Services, Inspection & Testing, Tube & Pipe Fabricating or Welding

## IonBond Booth C1010

1823 E Whitcomb Ave  
Madison Hts, MI 48071-1413 United States  
ph: 248-398-9100  
fax: 248-398-2110  
www.ionbond.com  
Cutting, Finishing, Job Shop/Contract Manufacturing, Other Machinery/Equipment/Parts/Products, Tool & Die, Tooling

## IPG Photonics Booth N3931

50 Old Webster Rd  
Oxford, MA 01540-2706 United States  
ph: 508-373-1100  
fax: 508-373-1101  
www.ipgphotonics.com  
Finishing, Lasers, Material Handling/Marking, Other Machinery/Equipment/Parts/Products, Welding Consumables, Welding Machines/Equipment



## Irco Automation Inc Booth N2431

1080 Clay Ave Unit 3  
Burlington, ON L7L 0A1 Canada  
ph: 800-742-1175  
fax: 905-336-7969  
www.ircoautomation.com  
Arc Welding, Material Handling/Marking, Robotics, Tube & Pipe Fabricating or Welding

## Ironworkers Management Progressive Action Cooperative Trust (IMPACT) Booth N3004

1750 New York Ave NW 4th Floor  
Washington, DC 20006-5315 United States  
ph: 202-393-1147  
fax: 202-393-1148  
www.impact-net.org  
Business Services, Inspection & Testing



### **ISB Group** **Booth C4728**

2300 Rue Victoria  
Lachine, QC H8S 1Z3 Canada  
ph: 514-634-7000  
fax: 514-634-9868  
www.isblite.com  
Safety & Environmental, Software &  
Machine Controls, Tool & Die

### **ITW DYMON** **Booth N5818**

805 E Old 56 Hwy  
Olathe, KS 66061-4914 United States  
ph: 913-397-9889  
fax: 800-323-9536  
www.dymon.com

### **ITW Sexton** **Booth C1061**

162 Royal Crest Dr  
Martinsburg, WV 25401-5183 United States  
ph: 304-267-8923  
fax: 304-263-3439  
www.sextoncan.com  
Job Shop/Contract Manufacturing

### **J & S Machine Inc** **Booth C2317**

W6009 490th Ave  
Ellsworth, WI 54011-5235 United States  
ph: 715-273-3376  
fax: 715-273-5241  
www.jsmachine.com  
Bending/Forming, Plate & Structural  
Fabricating, Saws & Cut-off Machines, Tube  
& Pipe Fabricating or Welding

### **J Tech** **Booth C755**

35 Samnah Crescent  
Ingersoll, ON N5C 3J7 Canada  
ph: 519-425-4435  
fax: 519-425-0091  
www.j-techdesign.ca  
Tool & Die

### **Janda Co Inc** **Booth N1924**

1275 Railroad St  
Corona, CA 92882-1838 United States  
ph: 951-734-1935  
fax: 951-734-0649  
www.jandawelders.com

Business Services, Inspection & Testing, Job  
Shop/Contract Manufacturing, Other  
Machinery/Equipment/Parts/Products,  
Resistance Welding, Robotics, Welding  
Consumables, Welding Machines/Equipment  
**Distributors:**  
G.E. Schmidt, Inc.  
Spotwelding Consultants

### **JASIC Technology Co Ltd** **Booth N2019**

No. 3, Qinglan 1st Road, Pingshan District  
Shenzhen, Guangdong 518126 China  
ph: 755-2747-4398  
www.jasic.com.cn  
Arc Welding

### **JAZ USA Inc** **Booth N1831**

6 Carol Dr  
Lincoln, RI 02865-4402 United States  
ph: 877-529-8721  
fax: 877-529-3291  
www.jazusa.com  
Finishing, Saws & Cut-off Machines



### **Jet Edge** **Booth C4349**

12070 43rd St NE  
Saint Michael, MN 55376-8427 United  
States  
ph: 763-497-8700  
fax: 763-497-8701  
www.jetedge.com  
Cutting, Waterjet

### **JETCAM-NestONE Solutions** **Booth C4722**

3796 Thornbrooke Ct Ste A  
Duluth, GA 30097-2280 United States  
ph: 716-215-8014  
fax: 509-693-5131  
www.nestonesolutions.com  
Cutting, Lasers, Plate & Structural  
Fabricating, Punching, Software & Machine  
Controls, Waterjet

### **Jetline Engineering** **Booth N5813**

15 Goodyear St  
Irvine, CA 92618-1812 United States  
ph: 949-951-1515  
fax: 949-951-9237  
www.jetline.com  
Arc Welding, Material Handling/Marking,  
Software & Machine Controls, Tube & Pipe  
Fabricating or Welding

### **Jet** **Booth C5923**

427 New Sanford Rd  
La Vergne, TN 37086-4184 United States  
ph: 615-793-8900  
fax: 615-793-8905  
www.jettools.com  
Bending/Forming, Cutting, Finishing, Material  
Handling/Marking, Press Brakes, Saws &  
Cut-off Machines

### **Jing County Anhui Haori** **Import & Export Trading Co Ltd** **Booth C7410**

Economic Zone  
Jing County  
Anhui, 242500 China  
ph: 86 563 5256017  
fax: 86 563 5256677

### **Jingyu Welding &** **Cutting Co Ltd** **Booth N1608**

Mayao Rd Dondsheng Vlg  
Mahang Hutang Wujin  
Changzhou, JIANGSU 213162 China  
ph: 519 86706120  
fax: 519 86701045  
www.jingyuwelding.com  
Cutting, Material Handling/Marking, Welding  
Consumables, Welding Machines/Equipment

# Higher Productivity at Total Lower Cost



## Complete Finishing Solutions – Booth #2517

When it comes to efficient finishing solutions, let Nordson help put you at the top of the class. Visit us at **Booth #2517** – we'll show you the latest in powder, liquid and UV technologies, providing a complete range of solutions for most any application need!

- **The new Trilogy™ non-electrostatic liquid spray guns, Stedi-Flo™ liquid pumps and OptiMix™ plural component systems** – our largest liquid product expansion to date!
- **Break-Away powder cyclone** – with a revolutionary design that allows operators to physically touch the cleaning surface for maximum effectiveness.
- **Encore® LT manual powder spray guns with Econo-Coat® 1001 batch spray booth** – we'll show you how robust and easy-to-use our newest Encore gun is...as we coat and cure special giveaways.
- **Equipment for dispensing cold adhesives and sealants** – Rhino® bulk unloaders can process even the most viscous materials with precision and reliability.

Stop by and see us at **Booth #2517**. We'll show you how to improve your finishing operations...and your bottom line! [www.nordson.com/ics](http://www.nordson.com/ics)







**Jinhua Bieduo Import & Export Co Ltd**  
**Booth N6309**

Rm 2005-2206 22/F Huijin Intl Business Center  
118 Bayi North St  
Jinhua, Jinhua Zhejiang 321000 China  
ph: 86 579 83533866  
fax: 86 579 83183290  
www.cnbeiduo.net

**JIT Automation Inc**  
**Booth C756**

1-1744 Midland Ave  
Toronto, ON M1P 3C2 Canada  
ph: 905-948-8525  
fax: 905-948-0555  
www.jitautomation.com  
Business Services, Material Handling/  
Marking, Tool & Die  
**Distributors:**  
JIT Automation Inc.

**JLC Electromet Pvt LLC**  
**Booth N5138**

205 Hallene Rd Unit 317C  
Warwick, RI 02886-2453 United States  
ph: 401-737-8380  
fax: 401-384-6757  
www.jlcelectromet.com  
Metal Suppliers, Welding Consumables

**JMR Industrial**  
**Booth C3752**

224 Nazareth Pike STE 23  
Bethlehem, PA 18020 United States  
ph: 610-759-8500  
fax: 610-759-8600  
www.jmrindustrialequipment.com  
Material Handling/Marking, Safety & Environmental

**JMT USA**  
**Booth C5047**

2895 S 300 W  
Salt Lake Cty, UT 84115-3435 United States  
ph: 801-214-7388  
fax: 801-493-0157  
www.jmtusa.com  
Bending/Forming, Plate & Structural  
Fabricating, Press Brakes, Punching, Saws &  
Cut-off Machines

**Job Shop Company, The**

**Booth C5035**

16 Waterbury Rd  
Prospect, CT 06712-1255 United States  
ph: 800-317-0474  
fax: 203-758-3427  
www.thejobshopcompany.com  
Business Services

**Jobscope Corp ERP**  
**Booth C4825**

355 Woodruff Rd Ste 210  
Greenville, SC 29607-3494 United States  
ph: 864-458-3100  
fax: 864-458-3160  
www.jobscope.com  
Software & Machine Controls

 **John Tillman Co**  
**Booth N3606**

1300 W Artesia Blvd  
PO Box 6257  
Compton, CA 90224-6257 United States  
ph: 310-764-0110  
fax: 310-764-2700  
www.jtillman.com  
Safety & Environmental

**Joysun Abrasives Co Ltd**  
**Booth N3208**

No 129 5th Ave., East Hanghai Road  
Economy & Technology Develop Zone  
Zhengzhou, Henan 450016 China  
ph: 86 371 67622388  
fax: 86 371 67622389  
www.joysunabrasives.com  
Assembly, Bending/Forming, Cutting,  
Finishing, Other Machinery/Equipment/Parts/  
Products, Saws & Cut-off Machines, Tool &  
Die, Tooling

**JP Nissen Co**  
**Booth N4922**

2544 Fairhill Ave  
Box 339  
Glenside, PA 19038-3102 United States  
ph: 215-886-2025  
fax: 215-886-0707  
www.nissenmarkers.com  
Material Handling/Marking



**Julia Utensili Spa**  
**Booth C1356**

S S 13 - Km 147 5  
Tarcento, Ud 33017 Italy  
ph: 39 432 784723  
fax: 39 432 784725  
www.julia.it

**Kaeser Compressors Inc**  
**Booth C2534**

PO Box 946  
Fredericksbrg, VA 22404-0946 United States  
ph: 865-288-3272  
fax: 540-898-5520  
www.kaeser.com

**Kaitech**  
**Booth C7639**

33683 Walker Rd  
Avon Lake, OH 44012-1044 United States  
ph: 440-653-9300  
fax: 440-653-9303  
www.empiresystemsinc.com

**Kalas: Industrial**  
**Booth N2026**

167 Greenfield Rd  
Lancaster, PA 17601 United States  
ph: 717-336-5575  
fax: 717-945-1002  
www.kalaszwire.com  
Arc Welding, Welding Machines/Equipment



**KALIBURN**  
**Booth N2422**

4130 Carolina Commerce Pkwy  
Ladson, SC 29456-6707 United States  
ph: 800-321-8072  
www.kaliburn.net

**Kasto Inc**  
**Booth C5934**

3002 Venture Ct  
Export, PA 15632-8949 United States  
ph: 724-325-5600



fax: 724-325-5611  
www.kastoinc.com  
Material Handling/Marking, Saws & Cut-off  
Machines

 **KCI America Co Ltd**  
**Booth C2062**

1570 Barclay Blvd  
Buffalo Grove, IL 60089-4530 United States  
ph: 847-537-8490  
fax: 847-537-8491  
www.kcispray.com/english  
Finishing

**Kemper America Inc**  
**Booth N2631**

5910 Shiloh Rd E Ste 114  
Alpharetta, GA 30005-1717 United States  
ph: 770-416-7070  
fax: 770-828-0643  
www.kemperamerica.com  
Material Handling/Marking, Safety &  
Environmental

**Kennametal Stellite**  
**Booth N2528**

1201 Eisenhower Dr N  
Goshen, IN 46526 United States  
ph: 574-534-2585  
fax: 574-534-3417  
www.stellite.com  
Arc Welding, Metal Suppliers, Metalforming  
& Fabricating Services, Thermal Spraying,  
Welding Consumables, Welding Machines/  
Equipment

 **Kent Corp**  
**Booth C2128, C954**

9601 York Alpha Drive  
North Royalton, OH 44133-3503 United  
States  
ph: 440-582-3400  
fax: 440-237-5368  
www.kenttesgo.com  
Coil Processing, Finishing, Material  
Handling/Marking, Other Machinery/  
Equipment/Parts/Products, Saws & Cut-off  
Machines, Tube & Pipe Fabricating or  
Welding, Tube & Pipe Producing

**Kern Electronics & Lasers**  
**Booth C6513**

1501 Industrial Dr  
Wadena, MN 56482-2500 United States

ph: 218-631-2755  
fax: 218-631-3476  
www.kernlasers.com  
Lasers, Material Handling/Marking

**Ketec Precision Tooling Co LTD**  
**Booth C3834**

No 7 Lifeng Mingzhu Industrial  
PO Box 510931  
Conghua, Guangzhou 510931 China  
ph: 86 20 37965500  
fax: 86 20 37965133  
www.ketecool.com  
Inspection & Testing, Job Shop/Contract  
Manufacturing, Press Brakes, Punching,  
Tooling

**Keyland Polymer Ltd**  
**Booth C2063**

4621 Hinckley Ind Pkwy Unit 8  
Cleveland, OH 44109-6012 United States  
ph: 216-741-5511  
fax: 216-741-7916  
www.keylandpolymer.com  
Finishing, Job Shop/Contract Manufacturing

**Kimberly-Clark Professional**  
**Booth N3407**

1400 Holcomb Bridge Rd  
Roswell, GA 30076-2190 United States  
ph: 800-241-3146  
fax: 800-634-8270  
www.kcc.com  
Safety & Environmental, Welding  
Consumables, Welding Machines/Equipment

**Kinetic Cutting Systems Inc**  
**Booth C6311**

304 West Prospect Rd, Ste F  
Fort Collins, CO 80526 United States  
ph: 970-498-8441  
fax: 970-498-8451  
www.kineticusa.com  
Bending/Forming, Cutting, Machining/EDM,  
Material Handling/Marking, Plate &  
Structural Fabricating, Safety &  
Environmental, Software & Machine  
Controls, Waterjet

 **Klimawent USA LLC**  
**Booth N5634**

1120 Mitchell Ct Ste B  
Crystal Lake, IL 60014-1722 United States  
ph: 847-658-3945

fax: 847-658-5195  
Safety & Environmental

**KLINGSPOR Abrasives Inc**  
**Booth N3135**

PO Box 2367  
2555 Tate Blvd SE  
Hickory, NC 28603-2367 United States  
ph: 800-645-5555  
fax: 800-524-6758  
www.klingspor.com  
Coil Processing, Finishing, Job Shop/Contract  
Manufacturing, Safety & Environmental,  
Saws & Cut-off Machines, Tooling

**KME Germany GmbH & Co KG**  
**Booth N1525**

1000 Jorie Blvd Ste 111  
Oak Brook, IL 60523-4484 United States  
ph: 630-990-2025-117  
fax: 630-990-0258  
www.kmeamerica.com  
Business Services, Metal Suppliers, Other  
Machinery/Equipment/Parts/Products,  
Resistance Welding, Welding Consumables



**KMI Systems Inc**  
**Booth C2722**

4704 Three Oaks Rd  
Crystal Lake, IL 60014-8180 United States  
ph: 815-459-5255  
fax: 815-459-6051  
www.kmisystemsinc.com  
Finishing, Material Handling/Marking

 **KMT Waterjet Systems Inc**  
**Booth C6334**

635 W 12th St  
PO Box 231  
Baxter Springs, KS 66713-1940 United  
States  
ph: 620-856-2151  
fax: 620-856-5050  
www.kmtwaterjet.com  
Cutting, Job Shop/Contract Manufacturing,  
Other Machinery/Equipment/Parts/Products,  
Robotics, Waterjet



## KNUTH Machine Tools USA Inc Booth C4910

590 Bond St  
Lincolnshire, IL 60069-4207 United States  
ph: 847-415-3333  
fax: 847-415-2402  
www.knuth-usa.com

Bending/Forming, Machining/EDM, Other Machinery/Equipment/Parts/Products, Plate & Structural Fabricating, Press Brakes, Punching, Saws & Cut-off Machines, Stamping, Tooling, Tube & Pipe Fabricating or Welding, Waterjet

## Kobelco Welding of America Inc Booth N3938

4755 Alpine Rd Ste 250  
Stafford, TX 77477-4129 United States  
ph: 281-240-5600  
fax: 281-240-5625  
www.kobelcowelding.com  
Welding Consumables

## KoCos America LLC Booth C2223

136 Oak Street, Ste A  
Westerly, RI 02891 United States  
ph: 401-213-6518  
fax: 401-633-7268  
www.kocos.com  
Business Services, Plate & Structural Fabricating  
*Distributors:*  
KoCoS Technologies, LLC



**Koike Aronson, Inc./Ransome**  
We make metal more profitable

## Koike Aronson Inc Booth N4131

635 W Main Street  
PO Box 307  
Arcade, NY 14009 United States  
ph: 585-492-2400  
fax: 585-457-3517  
www.koike.com  
Brazing & Soldering, Cutting, Lasers, Material Handling/Marking, Plate & Structural Fabricating, Robotics, Tube & Pipe Fabricating or Welding, Waterjet, Welding Machines/Equipment



## Kolene Corp Booth C2509

12890 Westwood St  
Detroit, MI 48223-3436 United States  
ph: 313-273-9220  
fax: 313-273-5207  
www.kolene.com  
Finishing, Other Machinery/Equipment/Parts/Products, Welding Consumables

## Komatsu America Industries LLC Booth C1239, C6510

1701 Golf Rd Ste 300  
One Continental Towers  
Rolling Meadows, IL 60008-4227 United States  
ph: 847-437-3750  
fax: 847-437-1811  
www.komatsuplasma.com  
Cutting, Plate & Structural Fabricating, Stamping

## Kong NGAI Precision Metal Mould Shenzhen Co Ltd Booth C856

Fuchengao New Industrial District  
A68 Building  
Shenzhen, Shenzhen Guangdong 518111 China  
ph: 86 138 24382112  
fax: 86 075 584671491  
www.kongnai-hk.com  
Lasers, Machining/EDM, Stamping, Tool & Die, Tooling

## Kosmek USA Booth C1054

1441 Branding Ave Ste 110  
Downers Grove, IL 60515-5624 United States  
ph: 630-241-3465  
fax: 630-241-3834  
www.kosmek.com  
Tool & Die

## Koyo Giken Inc Booth N3109

4020-4 Tana Chuo-ku  
Sagamihara  
Kanagawa, 252-0244 Japan  
ph: 81 42 760 4306  
fax: 81 42 760 4309  
www.koyogiken.co.jp  
Resistance Welding  
*Distributors:*  
International Technologies, Inc.  
LORS Machinery Inc.  
Kennedy Machinery Sales

## Krautzberger LLC Booth C1964

Stockbornstr 13  
Eltville, 65343 Germany  
ph: 49 61236980  
fax: 49 6123698200  
Finishing, Robotics  
*Distributors:*  
Krautzberger NA LLC

## KUKA Robotics Corporation Booth N5702

51870 Shelby Pkwy  
Shelby Twp, MI 48315 United States  
ph: 866-873-5852  
fax: 586-465-8817  
www.kukarobotics.com  
Arc Welding, Business Services, Finishing, Material Handling/Marking, Robotics, Tube & Pipe Fabricating or Welding

## KULLEN - KOTI GmbH Booth N3137

Am Heilbrunnen 83  
Baden-Wuerttemberg  
Reutlingen, D-72766 Germany  
ph: 49 71211420  
fax: 49 7121142260  
www.kullen.com  
Bending/Forming, Finishing, Other Machinery/Equipment/Parts/Products, Tooling

## Kutlug Inc Booth C451, C8536

2709 Orange Ave Ste B  
Santa Ana, CA 92707-3747 United States  
ph: 714-540-5595  
fax: 714-540-5597





 **Laboratory Testing Inc**  
**Booth C2310**

2331 Topaz Dr  
Hatfield, PA 19440-1936 United States  
ph: 215-716-7157  
fax: 800-219-9096  
www.labtesting.com  
Business Services, Inspection & Testing

**LA-CO Industries/Markal**  
**Booth N4802**

1201 Pratt Blvd  
Elk Grove Vlg, IL 60007-5708 United States  
ph: 847-856-7600  
fax: 847-956-9885  
www.markal.com  
Finishing, Inspection & Testing, Lubrication,  
Material Handling/Marking, Other  
Machinery/Equipment/Parts/Products,  
Welding Consumables

**Lambda Research Optics Inc**  
**Booth C5633**

1695 MacArthur Blvd  
Costa Mesa, CA 92626-1440 United States  
ph: 714-327-0600  
fax: 714-327-0610  
www.lambda.cc  
Business Services, Finishing, Lasers, Other  
Machinery/Equipment/Parts/Products

 **Lambie Engineering LLC**  
**Booth C4850**

15404 E Springfield Ave  
Ste L201-B  
Spokane Valley, WA 99037 United States  
ph: 509-868-3100  
fax: 909-928-5435

**Lantek Systems Inc**  
**Booth C4940**

5412 Courseview Dr Ste 140  
Mason, OH 45040-2355 United States  
ph: 903-258-9422  
fax: 513-492-8298  
www.lanteksms.com  
Lasers, Press Brakes, Punching, Software &  
Machine Controls

**Lapco Mfg Inc**  
**Booth N1404**

98 Glenwood St  
Morgan City, LA 70380-2317 United States  
ph: 985-385-5380

fax: 985-384-5081  
www.lapco.com  
Safety & Environmental



 **Lapham-Hickey Steel Corp**  
**Booth C840**

5500 W. 73rd Street  
Chicago, IL 60638 United States  
ph: 800-236-8855  
fax: 920-233-6472  
www.lapham-hickey.com  
Job Shop/Contract Manufacturing, Metal  
Suppliers

**Laser Experts Inc**  
**Booth C5742**

890 Lively Blvd  
Elk Grove Village, IL 60007-2205 United  
States  
ph: 312-638-0957  
fax: 847-952-0970  
www.laserexpertsusa.com  
Business Services, Lasers, Lubrication,  
Maintenance & Repair, Other Machinery/  
Equipment/Parts/Products, Software &  
Machine Controls

 **Laser Mechanisms Inc**  
**Booth C3810**

25325 Regency Dr  
Novi, MI 48375-2159 United States  
ph: 248-474-9480  
fax: 248-474-9277  
www.lasermech.com  
Lasers, Machining/EDM, Robotics, Tube &  
Pipe Producing, Welding Machines/  
Equipment

**Laser Research Optics**  
**Booth C3847**

120 Corliss St  
Providence, RI 02904-2602 United States  
ph: 401-331-3717  
fax: 401-331-4004  
www.laserresearch.net  
Lasers

**Laserage Technology Corp**  
**Booth N3209**

3021 N Delany Rd  
Waukegan, IL 60087-1826 United States  
ph: 847-249-5900  
fax: 847-856-3220  
www.laserage.com  
Job Shop/Contract Manufacturing

**LaserRite (American BiltRite)**  
**Booth C3451**

105 Whittendale Dr  
Moorestown, NJ 08057-1313 United States  
ph: 856-778-0700  
fax: 888-224-6325  
www.abitape.com  
Lasers



 **LaserStar Technologies Corp**  
**Booth C5647**

1 Industrial Court  
Riverside, RI 02915-5218 United States  
ph: 401-438-1500  
fax: 866-516-3043  
www.laserstar.net  
Assembly, Fastening & Joining, Lasers,  
Material Handling/Marking, Welding  
Consumables, Welding Machines/Equipment  
*Distributors:*  
FL LaserStar Center  
CA LaserStar Center

 **Latrobe Specialty Steel**  
**Distribution**  
**Booth C915**

1551 Vienna Pkwy  
Vienna, OH 44473-8703 United States  
ph: 330-609-5137  
fax: 330-609-2054  
www.latrobesteel.com  
Metal Suppliers

**Lazer Safe Pty Ltd**  
**Booth C3824**

27 Action Road  
Malaga, WA 06090 Australia  
ph: 61 892 494388  
fax: 61 892 496011  
www.lazersafe.com.au  
Press Brakes, Safety & Environmental  
*Distributors:*  
THCO LLC



### **LDPI Inc** **Booth C2752**

4404 Anderson Dr  
Eau Claire, WI 54703-0495 United States  
ph: 800-854-0021  
fax: 715-839-8145  
www.ldpi-inc.com  
Finishing, Other Machinery/Equipment/  
Parts/Products

### **Lean Enterprise Training** **Booth C8210**

3530 N Coast Hwy  
Newport, OR 97365-1560 United States  
ph: 503-580-1156  
fax: 503-580-1156  
www.lean1mfg.com

### **Leifeld Metal Spinning AG** **Booth C8112**

Feldstr 2-20  
Ahlen, 59229 Germany  
ph: 49 238296607 330  
fax: 49 238296607 244  
www.leifeldms.de  
Bending/Forming, Other Machinery/  
Equipment/Parts/Products

### **LENOX** **Booth C4808**

301 Chestnut St  
E Longmeadow, MA 01028-2742 United States  
ph: 413-526-5572  
fax: 413-525-8867  
www.lenoxtools.com  
Lubrication, Other Machinery/Equipment/  
Parts/Products, Saws & Cut-off Machines

### **Letourneau University** **Booth N1434**

2100 S Moberly Ave  
Longview, TX 75602-3564 United States  
ph: 903-233-3000  
fax: 903-233-3901  
www.letu.edu



### **Leveltek Intl LLC** **Booth C5950**

PO Box 10  
748 McMechen Street

100 = New Product

Benwood, WV 26031-0010 United States  
ph: 304-232-8530  
fax: 304-232-8536  
www.leveltek.com  
Assembly, Business Services, Coil Processing

### **Liaoning Longyuan Industry Co Ltd** **Booth C455**

Xingyuan Street  
Liaoning  
Lingyuan, Lingyuan Liaoning 122500 China  
ph: 86 411 86662012  
fax: 86 421 6829936  
www.lnlongyuan.com  
Finishing, Metal Suppliers, Other Machinery/  
Equipment/Parts/Products, Welding  
Consumables

### **Liburdi Automation Inc** **Booth N3609**

400 Highway 6 N  
Dundas, ON L9H 7K4 Canada  
ph: 905-689-0734  
fax: 905-689-0739  
www.liburdi.com  
Arc Welding, Robotics, Tube & Pipe  
Producing, Welding Machines/Equipment

### **Lillbacka Powerco USA Inc** **Booth C2132**

619 Estes Ave  
Schaumburg, IL 60193-4402 United States  
ph: 847-301-1300  
fax: 847-301-2562  
www.lillbackausa.com  
Bending/Forming, Fastening & Joining, Tool  
& Die, Tooling, Tube & Pipe Fabricating or  
Welding



### **Lincoln Electric Co** **Booth N4102, N4113, N4515**

22801 Saint Clair Ave  
Cleveland, OH 44117-1199 United States  
ph: 216-481-8100  
fax: 216-486-1750  
www.lincolnelectric.com  
Arc Welding, Robotics, Safety &  
Environmental, Welding Consumables,  
Welding Machines/Equipment

### **Linear Transfer Automation Inc** **Booth C1223**

4 Patterson Rd  
Barrie, ON L4N 5P4 Canada  
ph: 519-572-2369  
fax: 705-735-4688  
www.lineartransfer.com  
Stamping

### **Linemaster Switch Corp** **Booth C2324**

PO Box 238  
29 Plaine Hill Rd  
Woodstock, CT 06281 United States  
ph: 860-974-1000  
fax: 800-974-3668  
www.linemaster.com  
Arc Welding, Material Handling/Marking,  
Press Brakes, Resistance Welding

### **Link Systems** **Booth C909**

444 McNally Dr  
Nashville, TN 37211-3352 United States  
ph: 615-833-4168  
fax: 615-834-1984  
www.linkelectric.com  
Safety & Environmental, Software &  
Machine Controls

### **Linsinger Maschinenbau GmbH** **Booth C1558**

Dr Linsinger-Str24  
Steyrermuehl, O 4662 Austria  
ph: 4376138840  
fax: 4376138840951  
www.linsinger.com

### **Lissmac Corp** **Booth C4340**

356 Hudson River Rd  
Waterford, NY 12188-1914 United States  
ph: 518-326-9094  
fax: 518-326-9098  
www.lissmac.com  
Finishing, Machining/EDM, Material  
Handling/Marking, Other Machinery/  
Equipment/Parts/Products, Robotics

# LOGOPRESS

## Logopress Corp Booth C1423

ZA Les Salines  
Pouilley, Les Vignes F-25115 France  
ph: 33 381602360  
fax: 33 381602369  
www.logopress3.com  
Business Services, Software & Machine Controls  
**Distributors:**  
Accurate Die Design, Inc.  
SolidWorks Resellers World Wide



## Long Haul Trucking Booth C4349

6600 Jansen Ave NE  
Albertville, MN 55301-9686 United States  
ph: 800-255-5153  
fax: 763-497-3253  
www.longhaultrucking.com  
Business Services, Material Handling/  
Marking, Other Machinery/Equipment/Parts/  
Products

## LONGEVITY Welding & Cutting Products Booth N5109

23591 Foley St  
Hayward, CA 94545-1676 United States  
ph: 510-887-7090  
fax: 510-887-7091  
www.lweld.com  
Arc Welding, Cutting, Welding Consumables,  
Welding Machines/Equipment

## LORD Corporation Booth N2011

111 Lord Drive  
Cary, NC 27511-7923 United States  
ph: 877-275-5673  
www.lord.com  
Business Services, Fastening & Joining,  
Finishing

## LPI Inc Booth C2424

4404 Anderson Dr  
Eau Claire, WI 54703-0495 United States  
ph: 715-839-8280  
fax: 715-839-8697  
www.lpi-inc.com  
Finishing, Maintenance & Repair, Material  
Handling/Marking

## LS Industries Inc Booth C8123

710 E 17th St N  
Wichita, KS 67214-1312 United States  
ph: 316-265-7997-328  
fax: 316-265-0013  
www.lsindustries.com  
Finishing, Material Handling/Marking, Other  
Machinery/Equipment/Parts/Products,  
Robotics, Safety & Environmental, Tube &  
Pipe Fabricating or Welding

## LS Starrett Co, The Booth C8114

121 Crescent St  
Athol, MA 01331-1915 United States  
ph: 978-249-3551  
fax: 978-249-3908  
www.starrett.com

## LSP Industries Inc Booth C1212

2511 20th St  
Rockford, IL 61104 United States  
ph: 815-226-8090  
fax: 815-226-9250  
www.lspind.com  
Lubrication

## LT Ultra Precision Optics Booth C8223

10500 Citation Dr  
Brighton, MI 48116 United States  
ph: 248-926-1717  
fax: 248-926-1712  
www.ltultra.com  
Lasers, Robotics, Welding Machines/  
Equipment



## Lucas-Milhaupt Inc Booth N5027

5656 S Pennsylvania Ave  
Cudahy, WI 53110-2453 United States  
ph: 414-769-6000  
fax: 414-769-1093  
www.lucasmilhaupt.com  
Brazing & Soldering, Fastening & Joining,  
Job Shop/Contract Manufacturing, Metal  
Suppliers, Welding Consumables  
**Distributors:**  
Lucas-Milhaupt Toronto  
Lucas-Milhaupt Ribera  
Lucas-Milhaupt Brazing Materials (Suzhou  
Co. Limited)

## Lucky Harvest Co Ltd Booth C958

Bldg D, Huaqiang Rd Shangsha Community  
ChangAn Town  
Dongguan City, 523850 China  
ph: 86 769 8999399  
fax: 86 769 8541310  
www.luckyxiangxin.com  
Job Shop/Contract Manufacturing, Tool &  
Die, Tooling



## LVD Strippit Booth C3937

12975 Clarence Center Rd  
Akron, NY 14001-1371 United States  
ph: 716-542-4511  
fax: 716-542-5957  
www.lvdgroup.com  
Lasers, Press Brakes, Punching, Software &  
Machine Controls, Stamping, Tooling

## M K Morse Co, The Booth C7109

PO Box 8677  
Canton, OH 44711 United States  
ph: 330-453-8187  
fax: 330-453-9379  
www.mkmorse.com  
Cutting, Other Machinery/Equipment/Parts/  
Products, Saws & Cut-off Machines





## Machine Concepts Inc

**Booth C4726**

2167 State Route 66  
Minster, OH 45865-9401 United States  
ph: 419-628-3498  
fax: 419-628-2794  
www.machineconcepts.com  
Business Services, Coil Processing, Material Handling/Marking, Metalforming & Fabricating Equipment

## Machinery Marketing Intl

**Booth C8337**

1101 W Monroe St  
1A  
Chicago, IL 60607-2506 United States  
ph: 312-226-4150  
fax: 312-226-4155  
www.mmi-direct.com  
Bending/Forming, Business Services, Lasers, Machining/EDM, Other Machinery/ Equipment/Parts/Products, Press Brakes, Punching, Robotics, Tube & Pipe Fabricating or Welding, Waterjet

## MachineSales.com

**Booth C8439**

8721 Sunset Blvd #P3  
West Hollywood, CA 90069 United States  
ph: 424-214-009  
fax: 888-238-9805  
www.machinesales.com

## Macrodyne Technologies Inc

**Booth C252**

311 Connie Crescent  
Concord, ON L4K 5R2 Canada  
ph: 905-669-2253  
fax: 905-669-0936  
www.macrodynepress.com  
Hydroforming, Material Handling & Packaging, Material Handling/Marking, Punching, Stamping, Tube & Pipe Producing

## Magestic Systems Inc

**Booth C3710**

205 Fairview Ave  
Westwood, NJ 07675-2224 United States  
ph: 201-263-0090  
fax: 201-263-0091  
www.magestic.com  
Assembly, Software & Machine Controls



## Magic Rack/Production Plus Corp

**Booth C2724**

2490 McGaw Rd  
Obetz, OH 43207-4513 United States  
ph: 614-492-8811  
fax: 614-492-8812  
www.magicrack.com  
Finishing, Material Handling/Marking

## MAGMAWELD

**Booth N1628**

Organize Sanayi Bolgesi  
2 Kisim  
Manisa, 45030 Turkey  
ph: 236 226 2684  
fax: 236 226 2689  
www.magmaweld.com  
Arc Welding, Welding Consumables, Welding Machines/Equipment

## Magnatech LLC

**Booth N6133**

6 Kripes Rd  
East Granby, CT 06026-9645 United States  
ph: 860-653-2573  
fax: 860-653-0486  
www.magnatech-international.com  
Arc Welding, Tube & Pipe Fabricating or Welding, Welding Machines/Equipment

## Magnetic Products Inc

**Booth C5510**

683 Town Center Dr  
PO Box 529  
Highland, MI 48356-2965 United States  
ph: 248-887-5600  
fax: 248-887-6100  
www.mpimagnet.com  
Assembly, Job Shop/Contract Manufacturing, Machining/EDM, Material Handling/Marking, Press Brakes

## Manchester Tool & Die Inc

**Booth C2113**

601 S Wabash Rd  
N Manchester, IN 46962-8148 United States  
ph: 260-982-8524

fax: 260-982-4575  
www.manchestertoolanddie.com

## Mandina's Inspection Services Inc

**Booth N1311**

3861 Peters Rd  
Harvey, LA 70058-2001 United States  
ph: 504-366-1667  
fax: 504-366-1688  
www.mandinasndt.com

## Manufacturing News

**Booth C4936**

1133 Airline Dr Ste 2100  
Grapevine, TX 76051-7501 United States  
ph: 817-488-8488  
fax: 817-488-7813  
www.ipnews.com  
Business Services

## Manufacturing Solutions

**Booth C8429**

1571 MacArthur Blvd  
Costa Mesa, CA 92626-1407 United States  
ph: 714-545-0940  
fax: 310-943-3550  
www.manufacturingsolutions.com  
Lasers, Machining/EDM, Other Machinery/ Equipment/Parts/Products, Plate & Structural Fabricating, Press Brakes, Punching, Waterjet

## Manufacturing Solutions Inc

**Booth N1509**

9485 College St  
Beaumont, TX 77707 United States  
ph: 409-842-4404  
fax: 409-842-9445  
www.msi-tx.com  
Bending/Forming, Finishing, Machining/EDM, Material Handling/Marking, Tube & Pipe Fabricating or Welding



## Marion Die & Fixture Inc

**Booth C5520**

421 W Main St  
Marion, KS 66861-1730 United States  
ph: 620-382-3775  
fax: 620-382-3568  
www.bradburygroup.com



Bending/Forming, Punching, Saws & Cut-off  
Machines, Tool & Die, Tooling

**Marvel Manufacturing Co**  
**Booth C6316**

3501 Marvel Dr  
Oshkosh, WI 54902-7115 United States  
ph: 920-236-7200  
fax: 920-236-7209  
www.sawing.com  
Business Services, Material Handling/  
Marking, Plate & Structural Fabricating,  
Saws & Cut-off Machines, Software &  
Machine Controls

**Maryland Brush Co**  
**Booth N1317**

3221 Frederick Ave  
Baltimore, MD 21229-3807 United States  
ph: 410-945-3300  
fax: 410-945-2682  
www.marylandbrush.com  
Finishing

**Maryland Metals Processing, Inc.**  
Maryland Metals Processing, Inc.

**Maryland Metals Processing**  
**Booth C7239**

4425A N Point Blvd  
Baltimore, MD 21219-1003 United States  
ph: 410-388-9000  
fax: 410-388-9012  
www.marylandmetals.com

**Massaging Insoles By the  
Master's Plan**  
**Booth N3308**

4848 E Cactus Rd, #505-130  
Scottsdale, AZ 85028 United States  
ph: 602-993-0461  
www.massaginginsoles.com  
Safety & Environmental

**Masteel America Corp**  
**Booth C3749**

120-7490 Macdonald Rd  
Delta, BC V4G 1N2 Canada  
ph: 604-952-4434  
fax: 604-952-4432  
www.masteels.com  
Bending/Forming, Machining/EDM, Other  
Machinery/Equipment/Parts/Products, Plate  
& Structural Fabricating, Press Brakes,  
Tooling

**Master Magnetics**  
**Booth C4733**

747 S Gilbert St  
Castle Rock, CO 80104-2262 United States  
ph: 303-688-3966  
fax: 303-688-5303  
www.magnetsource.com  
Fastening & Joining, Material Handling/  
Marking, Other Machinery/Equipment/Parts/  
Products

Whatever your manufacturing needs... we have a solution

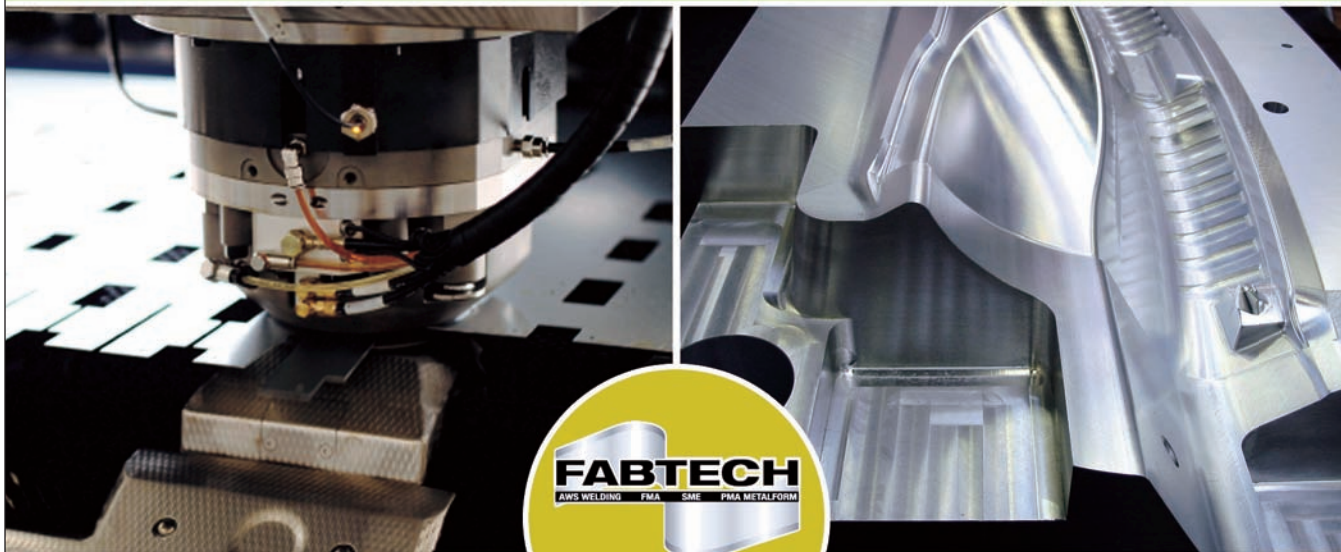

Booth C3747

**radan**

Sheet Metal CAM Solutions  
www.radan.com

**visi**

CAD/CAM For Mold & Die  
www.visicadcam.com

800.875.7232



## Mate Precision Tooling

### Booth C3720

1295 Lund Blvd  
Anoka, MN 55303 United States  
ph: 763-421-0230  
fax: 763-421-0285  
www.mate.com  
Lasers, Tooling

## Matheson

### Booth N6122

166 Keystone Dr  
Montgomeryville, PA 18936-9637 United States  
ph: 215-648-4026  
fax: 215-619-0458  
www.mathesongas.com  
Arc Welding, Gases & Gas Equipment, Material Handling/Marking, Plate & Structural Fabricating, Safety & Environmental, Tooling, Welding Consumables, Welding Machines/Equipment

## Mathey Dearman

### Booth N5710

4344 S Maybelle Ave  
Tulsa, OK 74107 United States  
ph: 918-447-1288  
fax: 918-447-0188  
www.mathey.com  
Bending/Forming, Cutting, Fastening & Joining, Machining/EDM, Maintenance & Repair, Material Handling/Marking, Plate & Structural Fabricating, Saws & Cut-off Machines, Tooling, Tube & Pipe Fabricating or Welding

## Matuschek Welding Products Inc

### Booth N1708

42378 Yearego Dr  
Sterling Hts, MI 48314-3267 United States  
ph: 586-991-2434  
fax: 586-991-2438  
www.matuschekwelding.com  
Assembly, Fastening & Joining, Inspection & Testing, Resistance Welding, Robotics, Software & Machine Controls, Welding Machines/Equipment

## Mayfran International Inc

### Booth C939

6650 Beta Dr  
Cleveland, OH 44143-2352 United States

ph: 440-461-4100

fax: 440-461-5565

www.mayfran.com

Finishing, Material Handling/Marking, Other Machinery/Equipment/Parts/Products

# Mazak

OPTONICS CORP.

## Mazak Optonics Corp

### Booth C3428

2725 Galvin Ct  
Elgin, IL 60124 United States  
ph: 847-252-4500  
fax: 847-252-4599  
www.mazakoptonics.com  
Lasers, Material Handling/Marking, Other Machinery/Equipment/Parts/Products, Saws & Cut-off Machines, Software & Machine Controls, Tube & Pipe Producing

## MB Metal Technologies

### Booth C5013

403 S Hawley Rd  
Milwaukee, WI 53214-1906 United States  
ph: 414-771-9270  
fax: 414-771-9043  
www.mbmataltech.com  
Material Handling/Marking



## MC Machinery Systems Inc/ Mitsubishi

### Booth C3040

1500 N Michael Dr  
Wood Dale, IL 60191-1067 United States  
ph: 630-616-5920  
fax: 630-616-4068  
www.mitsubishi-world.com  
Lasers, Machining/EDM, Press Brakes, Waterjet

## Measurement Systems Intl

### Booth C7138

14240 Interurban Ave S STE 200  
Seattle, WA 98168 United States  
ph: 206-433-0199  
fax: 206-244-8470  
www.msiscales.com  
Coil Processing, Inspection & Testing, Job Shop/Contract Manufacturing

## Mecco Marking & Traceability

### Booth C7342

PO Box 5004  
Cranberry Twp, PA 16066-6436 United States  
ph: 724-779-9555  
fax: 724-779-9556  
www.mecco.com  
Material Handling/Marking

## Medi Mail Inc

### Booth N2608

6 Celtic Dr Ste A3  
Arden, NC 28704-9139 United States  
ph: 877-501-6334  
fax: 508-819-3002  
www.medimassager.com  
Safety & Environmental



## MegaFab-Piranha-Whitney-Bertsch

### Booth C5113

650 Race St  
Rockford, IL 61101-1434 United States  
ph: 800-338-5471  
fax: 877-349-6902  
www.megafab.com  
Plate & Structural Fabricating, Tooling

## Meltric Corp

### Booth N4826

4640 Ironwood Dr  
Franklin, WI 53132-8871 United States  
ph: 800-433-7642  
fax: 414-817-6161  
www.meltric.com  
Arc Welding, Business Services, Job Shop/Contract Manufacturing, Maintenance & Repair, Other Machinery/Equipment/Parts/Products, Robotics, Safety & Environmental

## Melttools LLC

### Booth N1618

1125 E. Milham Ave.  
Portage, MI 49002 United States  
ph: 269-978-0968  
fax: 269-342-5448  
www.melttools.com  
Arc Welding, Inspection & Testing, Robotics, Software & Machine Controls, Welding





Machines/Equipment

*Distributors:*

Melius Ltd.

**Mercer Abrasives**

**Booth N6016**

300 Suburban Ave

Deer Park, NY 11729-6807 United States

ph: 631-243-3900

fax: 631-243-3209

www.mercerabrasives.com

Finishing, Other Machinery/Equipment/Parts/  
Products, Saws & Cut-off Machines



**Messer Cutting Systems**

**Booth C5916**

W141 N9427 Fountain Blvd

Menomonee Falls, WI 53051-1624 United States

ph: 262-255-5520

fax: 262-255-5170

www.messercutting.com

Cutting, Lasers, Material Handling/Marking,  
Plate & Structural Fabricating, Software &  
Machine Controls

**Messer MG Welding Products**

**Booth N2408**

N94W14355 Garwin Mace Dr

Menomonee Falls, WI 53051-1628 United States

ph: 262-532-4677

fax: 262-532-4675

www.messerwelding.com

Brazing & Soldering, Maintenance & Repair,  
Welding Consumables

**Meta Vision Systems Inc**

**Booth N5015**

8084 Trans Canada Hwy

St Laurent, QC H4S 1M5 Canada

ph: 514-333-0140

fax: 514-333-8636

www.meta-mvs.com

Arc Welding, Inspection & Testing, Robotics,  
Tube & Pipe Fabricating or Welding, Welding  
Machines/Equipment

**Metabo Corp**

**Booth N6131**

1231 Wilson Dr

West Chester, PA 19380-4243 United States

ph: 610-436-5900

fax: 610-436-9072

www.metabousa.com

Cutting, Finishing, Maintenance & Repair,  
Other Machinery/Equipment/Parts/Products,  
Saws & Cut-off Machines, Tooling

**Metal Man Work Gear Co**

**Booth N6031**

1750 Prospect Ct Ste 106

Appleton, WI 54914-9028 United States

ph: 888-762-4045

fax: 920-243-1633

www.metalmangear.com

**Metalix CAD/CAM Ltd**

**Booth C4911**

12131 Lakeshore Dr

LaSalle, MI 48145 United States

ph: 734-299-0004

www.metalix.net

Software & Machine Controls

*Distributors:*

A&M Consulting

**Metallizing Equipment  
Co PVT LTD**

**Booth N2417**

E-101 Mia Basni Phase 2

Jodhpur, Rajasthan 342005 India

ph: 91 291 2747601

fax: 91 291 2746359

www.mecpl.com

Finishing, Job Shop/Contract Manufacturing,  
Thermal Spraying

*Distributors:*

Plasma Powders & Systems Incorporated



**Metalloid Corp**

**Booth C1447**

1160 White St

Sturgis, MI 49091 United States

ph: 269-503-7300

fax: 269-503-7795

www.metalloidcorp.com

Finishing, Lubrication

**Metallurgical & Materials  
Technologies Inc**

**Booth C1535**

11701 Sun Belt Ct

Baton Rouge, LA 70809-4211 United States

ph: 225-751-6876

fax: 225-751-6894

www.mmtinc.com

Inspection & Testing

**MetaMation Inc**

**Booth C3737**

1698 Meadow Wood Ln Ste 202

Reno, NV 89502-6589 United States

ph: 775-826-1717

fax: 775-826-1723

www.metamation-us.com

Business Services, Metalforming &  
Fabricating Equipment, Plate & Structural  
Fabricating, Punching, Software & Machine  
Controls



**Metcast Service Tech  
Resources**

**Booth C6946**

16211 W Lincoln Ave

New Berlin, WI 53151-2834 United States

ph: 877-355-7577

fax: 262-785-1066

www.metcastservice.com

Finishing, Safety & Environmental

**Metform International Ltd**

**Booth C5534**

270 Courtneypark Dr E

Mississauga, ON L5T 2S5 Canada

ph: 905-670-2057

fax: 905-670-2059

www.metformintl.com

Bending/Forming, Business Services, Coil  
Processing, Finishing, Material Handling/  
Marking, Metalforming & Fabricating  
Equipment, Saws & Cut-off Machines,  
Tooling



## Metlsaw Systems Inc

### Booth C8229

2950 Bay Vista Ct  
Benicia, CA 94510-1123 United States  
ph: 707-746-6200  
fax: 707-746-5085  
www.metlsaw.com  
Saws & Cut-off Machines



## Metronor Inc

### Booth C453

973 Featherstone Rd Ste 105  
Rockford, IL 61107-5908 United States  
ph: 815-381-0920  
fax: 815-381-0921  
www.metronor.com  
Inspection & Testing

## Mexico Industry Newspaper

### Booth N1318

Rio Alamo #1245-B  
Col Longoria Cd  
Reynosa, 76100 Mexico  
ph: 528999248679  
fax: 528999248679  
www.mexicoindustry.com.mx



## MG S.r.L

### Booth C7716

Vis Ceresolia 20  
Fossano, CN 12045 Italy  
ph: 39 017 2691327  
fax: 39 017 2691675  
www.mgsrl.com  
Bending/Forming

#### *Distributors:*

C Marshall Fabrication Machinery, Inc.

## Michigan Pneumatic Tool Inc

### Booth N6034

10650 Cloverdale St  
Detroit, MI 48204-1103 United States  
ph: 313-933-5890  
fax: 313-933-0440  
www.michiganpneumatic.com

Business Services, Finishing, Maintenance & Repair, Other Machinery/Equipment/Parts/Products, Saws & Cut-off Machines

## Micro Air

### Booth N1806

3025 May St  
Wichita, KS 67213-1536 United States  
ph: 316-771-4217  
fax: 316-219-2995  
www.microaironline.com  
Business Services, Maintenance & Repair, Safety & Environmental

## Micro Arc Welding Inc

### Booth N1413

33 Pullman St  
Worcester, MA 01606-3310 United States  
ph: 508-852-6125  
fax: 508-853-0843

## Midalloy

### Booth N1910

630 Axminster Dr  
St Louis, MO 63011 United States  
ph: 636-349-6000  
fax: 636-349-2240  
www.midalloy.com

## Midwest Bender Services Corp

### Booth C1728

2804 Jeanwood Dr Unit B17-2A  
Elkhart, IN 46514-7672 United States  
ph: 574-266-5230  
fax: 574-266-5276  
www.midwestbenderservices.com  
Bending/Forming, Business Services, Finishing, Job Shop/Contract Manufacturing, Other Machinery/Equipment/Parts/Products, Saws & Cut-off Machines, Tooling, Tube & Pipe Fabricating or Welding

## Midwest Finishing Systems Inc

### Booth C2526

1906 Clover Rd  
Mishawaka, IN 46545-7245 United States  
ph: 574-257-0099  
fax: 574-256-1098  
www.midwestfinishing.com  
Finishing

## Midwest Tool Inc

### Booth C4826

4055 W Peterson Ave Ste 205  
Chicago, IL 60646-6183 United States  
ph: 773-588-1313  
fax: 773-588-3750  
www.sellusedmachinery.com  
Metalforming & Fabricating Equipment, Press Brakes



## MIE Solutions Inc

### Booth C7212

13252 Grden Grove Blvd Ste 215  
Garden Grove, CA 92843-2278 United States  
ph: 714-786-6230  
fax: 562-679-1248  
www.mie-solutions.com  
Business Services, Software & Machine Controls

## MIGHTYHOOK

## Mighty Hook Inc

### Booth C2420

1017 N Cicero Ave  
Chicago, IL 60651-3202 United States  
ph: 773-378-1909  
fax: 773-378-2083  
www.mightyhook.com  
Finishing, Inspection & Testing, Job Shop/Contract Manufacturing, Material Handling/Marking

## Mill Masters

### Booth C1533

39 Mill Masters Dr  
Jackson, TN 38305-4384 United States  
ph: 731-668-5558  
fax: 731-668-2477  
www.millmasters.com  
Coil Processing, Cutting, Inspection & Testing, Saws & Cut-off Machines, Thermal Spraying, Tooling, Tube & Pipe Fabricating or Welding, Tube & Pipe Producing



## Miller Electric Mfg Co

### Booth N5213, N5816

1635 W Spencer St  
Appleton, WI 54912 United States  
ph: 920-831-4646  
fax: 920-735-4013  
www.millerwelds.com  
Arc Welding, Cutting, Robotics, Safety & Environmental, Welding Consumables, Welding Machines/Equipment

## Miller Welding Automation

### Booth N5513

1635 W Spencer St  
Appleton, WI 54912 United States  
ph: 920-831-4646  
fax: 820-735-4013  
www.millerwelds.com  
Arc Welding, Robotics, Welding Machines/Equipment

## Minster Machine Co, The

### Booth C649

240 W Fifth St  
Minster, OH 45865-1065 United States  
ph: 419-628-2331  
fax: 419-628-4224  
www.minster.com  
Coil Processing, Maintenance & Repair, Material Handling/Marking, Stamping, Tool & Die

## MJC Engineering & Technology Inc

### Booth C1156

15701 Container Ln  
Huntingtn Beach, CA 92649-1532 United States  
ph: 714-890-0618  
fax: 714-895-3561  
www.mjceengineering.com  
Bending/Forming, Business Services, Robotics, Software & Machine Controls, Tooling, Tube & Pipe Fabricating or Welding

## MK Products Inc

### Booth N2804

16882 Armstrong Ave  
Irvine, CA 92606-4975 United States  
ph: 949-863-1234  
fax: 949-474-1428  
www.mkproducts.com  
Arc Welding, Welding Consumables, Welding Machines/Equipment

## MMC Superalloy Corp

### Booth N1826

1230 Kamihideya  
Saitama  
Okegawa-Shi, Saitama 363-8510 Japan  
ph: 81 48 7863072  
fax: 81 48 7701013  
Metal Suppliers, Welding Consumables

## Modern Manufacturing Technologies

### Booth C4738

3772 Arapaho Rd  
Addison, TX 75001-4311 United States  
ph: 972-241-0790  
fax: 972-241-0799  
www.mmtinternational.net  
Business Services, Inspection & Testing, Software & Machine Controls

## Module-Air LLC

### Booth N5705

4269M 40th St Ste 200  
Holland, MI 49423 United States  
ph: 616-796-2712  
fax: 616-796-1213  
www.tanistechnologies.com  
Safety & Environmental

## Moeller Precision Tool

### Booth C1020

43938 Plymouth Oaks Blvd  
Plymouth, MI 48170-2584 United States  
ph: 800-521-7613  
fax: 734-416-2200  
www.moellerpunch.com  
Job Shop/Contract Manufacturing, Other Machinery/Equipment/Parts/Products, Tool & Die, Tooling

## Mohawk Machinery Inc

### Booth C654

10601 Glendale Rd  
Cincinnati, OH 45215-1192 United States  
ph: 513-242-7179  
fax: 513-482-4542  
www.mohawkmachinery.com

**MOTOMAN**  
a YASKAWA company

## Motoman Robotics Division

### Booth N5222

100 Automation Way  
Miamisburg, OH 45342-4962 United States  
ph: 937-847-9200  
fax: 937-847-6277  
Robotics, Software & Machine Controls

## MTA-USA LLC

### Booth N2510

25 John Glenn Dr Ste 104  
Amherst, NY 14228-2134 United States  
ph: 716-693-8651  
fax: 716-693-8654  
www.mta-usa.com

## MTI Instruments Inc

### Booth N1417

325 Washington Avenue Ext  
Albany, NY 12205-5582 United States  
ph: 518-218-2550  
fax: 518-218-2506  
www.mtiinstruments.com

**MTM** GmbH  
Meißner Technik Mullenbach

## MTM Meissner Technik Mullenbach GmbH

### Booth C2155

Graf-Albert-Str. 13  
Marienheide, 51709 Germany  
ph: 49 226445600  
fax: 49 2264456038  
www.mtm-gmbh.com  
Finishing  
*Distributors:*  
INP Sales, LLC Susanne Lauda





### MTM Tube Mills

**Booth C2128**

Via Palladio 36  
Spinea, Venezia 130038 Italy  
ph: 39 041 5089611  
fax: 39 041 999611  
www.mtmtubemills.com

### MultiCam Inc

**Booth C5516**

1025 W Royal Lane  
PO Box 612048  
DFW Airport, TX 75261-2048 United States  
ph: 972-929-4070  
fax: 972-929-4071  
www.multicam.com

Lasers, Plate & Structural Fabricating,  
Robotics, Software & Machine Controls,  
Tooling, Waterjet

### Multiplaz

**Booth N4909**

1625 17th Street Suite 5  
Santa Monica, CA 90404-3819 United States  
ph: 310-314-5551  
fax: 310-314-5554  
www.multiplaz.com  
Arc Welding, Brazing & Soldering, Cutting

### Multipress Inc

**Booth C1022**

2222 S 3rd St  
Columbus, OH 43207-2402 United States  
ph: 614-228-0185  
fax: 614-228-2358  
www.multipress.com  
Assembly, Bending/Forming, Fastening &  
Joining, Hydroforming, Punching, Stamping,  
Tube & Pipe Fabricating or Welding

### Multiquip Inc

**Booth N6215**

18910 Wilmington Ave  
Carson, CA 90746-2820 United States  
ph: 310-537-3700  
fax: 310-537-3927  
www.multiquip.com  
Arc Welding



### Murata Machinery USA Inc

**Booth C3028**

2120 Queen City Dr  
Charlotte, NC 28208-2709 United States  
ph: 704-875-9280  
fax: 704-392-6541  
www.muratec-usa.com  
Lasers, Machining/EDM, Plate & Structural  
Fabricating, Punching

### NACE International

**Booth N6325**

1440 S Creek Dr  
Houston, TX 77084-4906 United States  
ph: 281-492-0535  
fax: 281-492-8254

### Nachi America Inc

**Booth C956**

715 Pushville Rd  
Greenwood, IN 46143-9782 United States  
ph: 317-530-1001  
fax: 317-530-1011  
www.nachi-america.com



### Nachi Robotic Systems Inc

**Booth N3622**

22285 Roethel Dr  
Novi, MI 48375-4700 United States  
ph: 248-305-6545  
fax: 248-305-6542  
www.nachirobotics.com  
Assembly, Robotics

### Nadella

**Booth C7150**

761 W Michigan Ave Ste N  
Jackson, MI 49201-1913 United States  
ph: 517-774-4466  
fax: 517-764-0806  
www.nadella.us  
Other Machinery/Equipment/Parts/Products,  
Software & Machine Controls

### Nanjing Youtian Metal Technology Co Ltd

**Booth N1616**

Industrial Zone, Guli Street  
Jiangning District, Nanjing  
Nanjing, 211100 China  
ph: 86 255 8095168  
fax: 86 255 8095169  
www.youtianmetal.com  
Metal Suppliers, Welding Consumables

### Nation Coating Systems Inc

**Booth N2416**

501 Shotwell Dr  
Franklin, OH 45005-4663 United States  
ph: 937-746-7632  
fax: 937-746-7658  
www.nationcoatingsystems.com  
Business Services, Finishing, Thermal  
Spraying  
*Distributors:*  
Diamant Coating Systems, Ltd.

### Nation Wide Products

**Booth N5036**

PO Box 5081  
Abilene, TX 79608-5081 United States  
ph: 800-797-3709  
fax: 325-675-5053  
www.nationwide-products.com

### National Bronze & Metals Inc

**Booth C1512**

2929 W 12th St  
Houston, TX 77008-6113 United States  
ph: 713-869-9600  
fax: 713-869-0883  
www.nbmmetals.com  
Metal Suppliers, Tool & Die

### National Standard LLC

**Booth N1813**

1631 Lake St  
Niles, MI 49120-1270 United States  
ph: 269-687-2024  
fax: 269-683-9276  
www.nationalstandard.com

### Nebraska Public Power District

**Booth C7347**

1414 15th St  
Columbus, NE 68601-5226 United States  
ph: 402-563-5534  
fax: 402-563-5090  
www.nppd.com  
Assembly, Business Services, Tool & Die



**Nederman Inc**  
Booth N1604

150 Transit Ave  
Thomasville, NC 27360-8927 United States  
ph: 336-821-0865  
fax: 336-821-0890  
www.nedermanusa.com  
Safety & Environmental

**Nelson Stud Welding**  
Booth N5922

Nelson Stud Welding  
7900 West Ridge Rd  
Elyria, OH 44036 United States  
ph: 800-635-9353  
fax: 440-329-0597  
www.nelsonstud.com  
Arc Welding, Fastening & Joining, Robotics,  
Welding Machines/Equipment

**NetBraz LLC**  
Booth N4139

351 Apple St  
Mount Orab, OH 45154 United States  
ph: 937-444-1444  
fax: 513-672-0892  
www.netbraze.com  
Brazing & Soldering



**Nevatia Steel & Alloys Pvt LTD**  
Booth N2824

85 Worli Sea Face  
1st Floor  
Mumbai, Maharashtra 400030 India  
ph: 91 222 4944133  
fax: 91 222 4931336  
www.nevatiasteel.com  
Metal Suppliers, Welding Consumables



**Neville Manufacturing Service & Distribution Inc**  
Booth C7548

2320 Clinton St  
Cheektowaga, NY 14227-1735 United States  
ph: 716-834-3038  
fax: 716-834-3043  
www.nevillelumber.com

**New Centurion Enterprises Ltd**  
Booth C8347

8442 Lisa Lane  
Lantzville, BC V0R 2H0 Canada  
ph: 250-390-4868  
fax: 250-390-4837  
Bending/Forming, Cutting, Saws & Cut-off  
Machines  
*Distributors:*  
Dalcart & Associates Inc.

Keim Lumber  
Multiple Canadian Distributors' and  
Locations represented from East coast to  
West coast - Please inquire about them to  
find the nearest retailer

Visit us in  
Booth #C1528



# Your Source

**For Quality Used And Reconditioned  
Tube, Pipe & Rollform Machinery.**





**Extensive Inventory  
of used Tube, Pipe  
and Rollform  
machinery available.**



**Working Together  
with Universal  
Controls Group  
to offer you more!**

- Tube Mills
- Rollformers
- Uncoilers
- Coil Cars
- Cut-Offs
- Straighteners
- Slitting Lines
- Cut-To-Length
- Swagers
- NEW Components

- NEW Controls
- NEW Drives
- NEW Accessories
- Re-Power Kits
- Installation & Start-Up
- Engineering and much more!



**UNIVERSAL TUBE & ROLLFORM  
EQUIPMENT CORPORATION**

*International Metalworking Machinery Dealer*

Scan to view  
our entire  
In-Stock  
Inventory!



26202 Glenwood Rd.  
Perrysburg, OH 43551  
t: +1 (419) 872-2364  
f: +1 (419) 874-2825  
w: [www.utubeonline.com](http://www.utubeonline.com)  
e: [sales@utubeonline.com](mailto:sales@utubeonline.com)









### **New Fire Co Ltd** **Booth N3017**

Room 101 No 88 Branch Lane 2  
XiuYan Rd Pudong  
Shanghai, 200315 China  
ph: 021 68197031  
fax: 021 681973211  
www.newfire.biz  
Safety & Environmental, Welding  
Consumables

### **New Form Tools Ltd** **Booth C2235**

232 Lorne Ave East  
Stratford, ON N5A 7V8 Canada  
ph: 519-272-0921  
fax: 519-272-1996  
www.newformtools.com

### **Newland (Tianjin) Welding Wire and Metal Products Co Ltd** **Booth N6008**

No 7 Zifu Rd  
Tianjin Ziya Environment Prote  
Tianjin, 301605 China  
ph: 22 6871 1221  
fax: 22 6871 1220  
www.groco.cn

### **NGK Metals Corp** **Booth C922**

917 Highway 11 S  
Sweetwater, TN 37874-5730 United States  
ph: 423-351-5500  
fax: 877-645-2328  
www.ngkmetals.com  
Business Services, Metal Suppliers, Welding  
Consumables

### **NIC Industries Inc** **Booth C2426**

7050 Sixth St  
White City, OR 97503-1037 United States  
ph: 541-826-1922  
fax: 541-826-6372  
www.nicindustries.com  
Business Services, Finishing, Surface  
Treatment & Cleaning Equipment

### **Nikon Metrology Inc** **Booth C952**

12701 Grand River Rd  
Brighton, MI 48116-8506 United States

ph: 810-220-4360  
fax: 810-220-4300  
www.nikonmetrology.com  
Inspection & Testing

### **Ningbo Hi-Tech Moldie Machinery Co Ltd** **Booth C356**

Room14-5, 2nd Building, Ningbo High-Tech  
Development Plaza  
No.1528 Jiangnan Rd  
Ningbo, Zhejiang 315040 China  
ph: 86 574 27906068  
fax: 86 574 27906069  
www.moldie.net  
Job Shop/Contract Manufacturing, Other  
Machinery/Equipment/Parts/Products,  
Stamping, Tool & Die

### **Ningbo Jinfeng Welding & Cutting Machinery Manufacture Co Ltd** **Booth N6007**

Xinglu Village  
Hangozhou Bay New Area Cixi  
Ningbo, Zhejiang 315336 China  
ph: 86 574 63487719  
fax: 86 574 63487678  
www.jinfeng-weldcut.com  
Arc Welding, Assembly, Cutting, Gases &  
Gas Equipment, Lasers, Robotics, Saws &  
Cut-off Machines, Tube & Pipe Fabricating or  
Welding, Welding Machines/Equipment

### **Ningbo Jinhui Precision Casting Co Ltd** **Booth C254**

No 1-10 Chuangxin 128  
Qiming Rd Yinzhou  
Ningbo, Ningbo Zhejiang 315000 China  
ph: 86 574 55123069  
fax: 86 574 55123061  
www.nbjinhui.com  
Metal Suppliers

### **Ningbo Powerway Alloy Material Co Ltd** **Booth N5038**

Yunlong Town  
Yinzhou, 315135 China  
ph: 574 83004660  
fax: 574 88349958  
www.pwalloy.com  
Arc Welding, Brazing & Soldering, Metal

Suppliers, Resistance Welding,  
Welding Consumables

### **NIST** **Booth C8421**

100 Bureau Dr  
Gaithersburg, MD 20899 United States  
ph: 301-975-6478  
www.nist.gov  
Business Services, Inspection & Testing

### **Nitto Denko America Inc** **Booth C8409**

300 Frank W Burr Blvd  
5th Floor Ste 66  
Teaneck, NJ 07666-6704 United States  
ph: 201-645-4950  
fax: 201-645-4951  
www.nittousa.com  
Coil Processing, Other Machinery/  
Equipment/Parts/Products

### **Nitto Kohki USA Inc** **Booth C1510**

46 Chancellor Dr  
Roselle, IL 60172 United States  
ph: 630-924-9393  
fax: 630-924-0303  
www.nittokohki.com  
Bending/Forming, Cutting, Finishing, Job  
Shop/Contract Manufacturing, Lubrication,  
Machining/EDM, Maintenance & Repair,  
Punching, Tooling

### **NKS** **Booth C1549**

560 Santa Rosa Dr  
Des Plaines, IL 60441 United States  
ph: 847-257-6570  
fax: 847-824-7250  
www.nks.com  
Metal Suppliers

### **Nordfab Ducting** **Booth N1928**

102 Transit Ave  
Thomasville, NC 27360-8927 United States  
ph: 336-289-2871  
fax: 336-821-0890  
www.nordfab.com  
Material Handling/Marking, Metal Suppliers,  
Safety & Environmental, Tube & Pipe  
Fabricating or Welding





**Nordson Corp**  
**Booth C2517**

300 Nordson Dr  
Amherst, OH 44001-2496 United States  
ph: 440-985-4000  
fax: 440-414-5612  
www.eti.nordson.com  
Finishing, Robotics

**Norlok Technology Inc**  
**Booth C4840**

26 Adams Blvd  
Brantford, ON N3S 7V2 Canada  
ph: 519-759-5896  
fax: 519-759-2948  
www.norlok.com  
Fastening & Joining, Other Machinery/  
Equipment/Parts/Products

**North (Nanjing) Instrument  
Technology Industries Group**  
**Booth N3226**

Rm 4028 Liangshi Mansion  
No 371 South Taiping Rd  
Nanjing, 210002 China  
ph: 2584500313  
fax: 2586648277  
www.northgroup.cn  
Arc Welding, Cutting, Gases & Gas  
Equipment, Plate & Structural Fabricating,  
Safety & Environmental, Welding  
Consumables, Welding Machines/Equipment

**North America Consulting**  
**Booth N6333**

175 Ly Thai To P9 Q10  
Ho Chi Minh, Ho Chi Minh 70000 Vietnam  
ph: 84839270336  
www.naccvietnam.com  
Business Services

**North Carolinas Southeast**  
**Booth C8228**

707 W Broad St  
Elizabethtown, NC 28337 United States  
ph: 910-862-8511  
fax: 910-862-1482  
www.ncse.org  
Business Services

**Northrop Grumman**  
**Booth C8211**

333 Technology Dr Ste 250  
Canonsburg, PA 15317-9513 United States  
ph: 724-873-5500  
fax: 724-873-5652  
www.opentrac.com  
Software & Machine Controls



**Norton Abrasives**  
**Booth N2610**

1 New Bond St  
Worcester, MA 01606-2614 United States  
ph: 508-795-5000  
fax: 508-795-4130  
www.nortonindustrial.com  
Finishing, Maintenance & Repair, Saws &  
Cut-off Machines

**Norwalk Innovation**  
**Booth C1055**

807-A N Prince Ln  
Springfield, MO 65802-6329 United States  
ph: 417-864-3636  
fax: 417-864-3667  
www.norwalkinnovation.com  
Coil Processing, Material Handling/Marking

**Nova Verta USA**  
**Booth C1762**

8207 E Trent Ave  
Spokane Valley, WA 99212-2241 United States  
ph: 800-668-2921  
fax: 509-444-3699  
www.novavertausa.com  
Finishing

**Novacel Inc**  
**Booth C8433**

21 3rd St  
Palmer, MA 01069-1542 United States  
ph: 413-668-2220  
fax: 413-283-3964  
www.novacelinc.com  
Material Handling/Marking

**NSRW**  
**Booth N2533**

PO Box 1147  
Pelham, AL 35124-1926 United States  
ph: 205-663-1500  
fax: 205-663-3221  
www.nsrw.com



**Nucor Building Systems**  
**Booth C1255**

121 Saint Anthony St  
Danville, KY 40422-1458 United States  
ph: 859-516-2322  
www.nucor.com  
Maintenance & Repair, Material Handling/  
Marking, Stamping, Tube & Pipe Fabricating  
or Welding, Tube & Pipe Producing

**Nuferm**  
**Booth C8339**

7 Airport Park Rd  
East Granby, CT 06026-9523 United States  
ph: 860-408-5000  
fax: 860-844-0210  
www.nuferm.com  
Lasers, Material Handling/Marking

**Numalliance Inc**  
**Booth C1547**

1361 Howard St  
Advanced Technology Center  
Elk Grove Vlg, IL 60007-2213 United States  
ph: 847-439-4500  
fax: 847-439-4515  
www.numalliance.com

**Nutek Green**  
**Booth C1753**

7005 Cochran Rd  
Glenwillow, OH 44139 United States  
ph: 440-996-2000  
fax: 440-996-2026  
www.nutekgreen.com



### **Nylok LLC** **Booth N1624**

15260 Hallmark Ct  
Macomb, MI 48042-4007 United States  
ph: 513-520-7552  
fax: 586-786-0598

www.nylok.com

Fastening & Joining, Finishing, Inspection & Testing, Job Shop/Contract Manufacturing, Resistance Welding

### **Oak Press Solutions Inc** **Booth C911**

504 Wade Rd  
Sturgis, MI 49091-9765 United States  
ph: 269-651-8513  
fax: 269-659-4625

www.oakpresses.com

### **Obraze** **Booth N4839**

2121 S 116th St  
West Allis, WI 53227-1005 United States  
ph: 414-431-9456  
fax: 888-626-1294

www.obraze.com

Brazing & Soldering

### **Ocean Machinery Inc** **Booth C7523**

6720 NW 15th Way  
Ft Lauderdale, FL 33309-1528 United States  
ph: 954-956-3131  
fax: 954-956-3199

www.oceanmachinery.com

Machining/EDM, Material Handling/Marking, Plate & Structural Fabricating, Saws & Cut-off Machines, Software & Machine Controls

### **OES Inc** **Booth C248**

4056 Blakie Rd  
London, ON N6L 1P7 Canada  
ph: 519-652-5833  
fax: 519-652-3795

www.oestechnologies.com

Business Services, Inspection & Testing, Software & Machine Controls

### **Ogden Welding Systems** **Booth N3035**

372 Division St  
Schererville, IN 46375-1223 United States

ph: 219-322-5252  
fax: 219-865-1825

www.odgenwelding.com

Arc Welding, Material Handling/Marking, Other Machinery/Equipment/Parts/Products, Welding Machines/Equipment

### **Ohio Laser LLC** **Booth C1511**

8260 Estates Pkwy  
Plain City, OH 43064-8409 United States  
ph: 614-873-7030  
fax: 614-873-7040

www.ohiolaser.com

Job Shop/Contract Manufacturing

### **Ohio State University** **Booth N1433**

155 MEILING HALL # D  
Columbus, OH 43210-0000 United States  
ph: 614-292-1537  
fax: 614-292-1544

www.iwse.eng.ohio-state.edu/we/

### **OKI Bering** **Booth N4531**

9901 Princeton Glendale Rd  
Cincinnati, OH 45245 United States  
ph: 513-341-4002  
fax: 513-341-4903

www.oki-bering.com

Cutting, Finishing, Gases & Gas Equipment, Material Handling/Marking, Other Machinery/Equipment/Parts/Products, Tooling, Welding Consumables, Welding Machines/Equipment

### **Olympus NDT** **Booth N1613**

48 Woerd Ave Ste 105  
Waltham, MA 02453-3824 United States  
ph: 781-419-3900  
fax: 781-419-3980

www.olympus-ims.com

Inspection & Testing

### **OMAX Corp** **Booth C3940**

21409 72nd Ave S  
Kent, WA 98032-1944 United States  
ph: 253-872-2300  
fax: 253-872-6190

www.omax.com

Material Handling/Marking, Tube & Pipe Fabricating or Welding, Waterjet

### **OMNI-X Inc** **Booth C1537**

2751 W Mansfield Ave  
Englewood, CO 80110-8639 United States  
ph: 303-789-3575  
fax: 303-789-4755

www.omnibend.com

Tooling

### **Oncor** **Booth C4837**

1616 Woodall Rodgers Fwy, Suite 5E-004  
Dallas, TX 75202 United States  
ph: 214-486-7030  
fax: 214-486-5012

www.thinkbigthinktexas.com

Business Services

### **O'Neal Flat Rolled Metals** **Booth C8331**

1229 South Fulton Ave  
Brighton, CO 80601 United States  
ph: 303-654-0300  
fax: 303-654-0404

www.ofrmetals.com

Business Services, Job Shop/Contract Manufacturing, Metal Suppliers

### **Ophir Optics Inc** **Booth C3846**

1600 Osgood St Ste 1-150  
North Andover, MA 01845-1055 United States  
ph: 978-657-6410  
fax: 978-657-6056

www.ophiropticsinc.com

Job Shop/Contract Manufacturing, Lasers

### **OPTREL AG** **Booth N1410**

Industriestrasse 2  
Wattwil Ch, 9630 Switzerland  
ph: 719 874200  
fax: 719 874299

www.optrel.com

### **OR Lasertechnology Inc** **Booth C7345**

1420 Howard St  
Elk Grove Vlg, IL 60007-2221 United States  
ph: 847-593-5711  
fax: 847-593-5752

www.or-laser.com

Job Shop/Contract Manufacturing, Lasers,



Material Handling/Marking, Robotics,  
Welding Consumables, Welding Machines/  
Equipment



**Orbitalum Orbital Cutting +  
Welding**  
Booth N5713

600 Knightsbridge Pkwy  
Lincolnshire, IL 60069-3617 United States  
ph: 847-537-8800  
fax: 847-520-1147  
www.ehwachs.com

Arc Welding, Bending/Forming, Cutting,  
Finishing, Machining/EDM, Maintenance &  
Repair, Other Machinery/Equipment/Parts/  
Products, Saws & Cut-off Machines, Tube &  
Pipe Fabricating or Welding, Welding  
Consumables, Welding Machines/Equipment

**Distributors:**

E. H. Wachs



**Oregon Carbide Saw Corp**  
Booth C1356

1713 SE 7th Ave  
Portland, OR 97214-3528 United States  
ph: 503-235-8559  
fax: 503-235-8550  
www.oregoncarbidesaw.com

**Orttech Inc**  
Booth C860

32425 Aurora Rd  
Solon, OH 44139-2858 United States  
ph: 440-498-7458  
fax: 440-498-8268  
www.orttech.com  
Other Machinery/Equipment/Parts/Products

**Osborn**  
Booth C2737, N3309

1100 Resource Drive  
Suite 1  
Cleveland, OH 44131 United States  
ph: 216-361-1900  
fax: 216-361-1913  
www.osborn.com  
Cutting, Finishing, Maintenance & Repair,

Material Handling/Marking, Saws & Cut-off  
Machines, Tooling, Welding Consumables



**OTC DAIHEN Inc**  
Booth N3622

1400 Blauser Dr  
Tipp City, OH 45371-2471 United States  
ph: 937-667-0800  
fax: 937-667-0885  
www.daihen-usa.com  
Arc Welding, Robotics, Welding Machines/  
Equipment



**Overton Industries**  
Booth C2225

2155 McClain Dr  
Franklin, IN 46131 United States  
ph: 317-831-4542  
fax: 317-831-7388  
www.overtonind.com  
Bending/Forming, Job Shop/Contract  
Manufacturing, Saws & Cut-off Machines,  
Tooling, Tube & Pipe Fabricating or Welding

**Oxylance Inc**  
Booth N2228

2501 27th St N  
Birmingham, AL 35234-1225 United States  
ph: 205-322-9906  
fax: 205-250-8560  
www.oxylance.com  
Cutting, Plate & Structural Fabricating,  
Safety & Environmental

**P&G Fluid Power Inc**  
Booth C1320

950 E 10 Mile Rd  
Hazel Park, MI 48030-1220 United States  
ph: 248-545-4441  
fax: 248-399-2889  
www.pgfluidpower.com  
Assembly, Job Shop/Contract Manufacturing,  
Lubrication, Other Machinery/Equipment/  
Parts/Products, Stamping

**Pace Technologies Corp**  
Booth N2916

3601 E 34th St  
Tucson, AZ 85713-5310 United States  
ph: 520-882-6598  
fax: 520-882-6599  
www.metallographic.com  
Cutting, Inspection & Testing

**Pacesetter Systems**  
Booth C1412

25315 Avenue Stanford  
Valencia, CA 91386 United States  
ph: 661-295-8941  
fax: 661-295-8943  
www.pacesettersystems.com  
Material Handling/Marking, Other  
Machinery/Equipment/Parts/Products, Tool &  
Die, Tooling

**Pacific Aerospace &  
Electronics**  
Booth N1607

2249 Diamond Point Rd  
Sequim, WA 98382-8663 United States  
ph: 360-683-4167  
fax: 360-683-4168  
www.pacaero.com  
Bending/Forming, Job Shop/Contract  
Manufacturing, Metal Suppliers

**Pacific Gas and Electric  
Company**  
Booth N1407

245 Market St  
San Francisco, CA 94105 United States  
ph: 925-421-5565  
www.pge.com  
Business Services

**Packsize LLC**  
Booth C1336

6440 Wasatch Blvd Ste 305  
Salt Lake Cty, UT 84121-6310 United States  
ph: 801-518-1101  
fax: 801-944-4815  
www.packsize.com  
Business Services, Material Handling/  
Marking





## Pador Marketing Group

**Booth N2927**

655 32 Ave Ste 201

Lachine, QC H8T 3G6 Canada

ph: 514-634-0861

fax: 514-634-9736

www.pador.com

Arc Welding, Bending/Forming, Material Handling/Marking, Robotics, Saws & Cut-off Machines

## Pan Taiwan Enterprise

**Booth N1718**

16F-1 No 16 Jian Ba Road

Chung Ho District

New Taipei City, 00235 Taiwan

ph: 886 2 82265199

fax: 886 2 82265196

www.pantaiwan.com.tw

Safety & Environmental, Welding Machines/Equipment

## Panasonic Electric Works Corp of America

**Booth C7411**

629 Central Ave

New Providence, NJ 07974-1507 United States

ph: 908-464-3550

fax: 908-771-5655

www.pewa.panasonic.com

Lasers, Material Handling/Marking, Safety & Environmental, Software & Machine Controls

## Pandjiris Inc

**Booth N4810**

5151 Northrup Ave

Saint Louis, MO 63110-2031 United States

ph: 314-776-6893

fax: 314-776-8763

www.pandjiris.com

Arc Welding, Bending/Forming, Fastening & Joining, Finishing, Material Handling/Marking, Other Machinery/Equipment/Parts/Products, Plate & Structural Fabricating, Robotics, Software & Machine Controls, Tooling

## Pangborn Corp

**Booth C6516**

4630 Coates Drive

Fairburn, GA 30213-2975 United States

ph: 404-665-5700

fax: 404-665-5701

www.pangborn.com

Business Services, Finishing, Machining/EDM, Material Handling/Marking, Safety & Environmental

*Distributors:*

Klein-Farris Co. Inc

## Pannier Corp

**Booth C5824**

207 Sandusky St

Pittsburgh, PA 15212-5854 United States

ph: 412-323-4900

fax: 412-323-4962

www.pannier.com

Material Handling/Marking

## Paramount Innovative Mfg

**Booth C2137**

6450 E Bandini Blvd

Commerce, CA 90040-3118 United States

ph: 323-721-2121

fax: 323-721-0122

www.pim-laser.com

Job Shop/Contract Manufacturing

## Parke Filtration and Separation

**Booth C7114**

242 Neck Rd

Haverhill, MA 01835-0732 United States

ph: 978-556-2760

www.balstonfilters.com

Lasers, Other Machinery/Equipment/Parts/Products

## Parker domnick hunter

**Booth N1513**

4087 Walden Ave

Lancaster, NY 14086-1512 United States

ph: 716-686-6400

fax: 704-921-1960

www.domnickhunter.com

Cutting, Finishing, Other Machinery/Equipment/Parts/Products, Resistance Welding, Software & Machine Controls, Thermal Spraying, Welding Consumables, Welding Machines/Equipment



## Parker Ionics/Parkwood Engineering

**Booth C2523**

38147 Abruzzi Dr

Westland, MI 48185-3279 United States

ph: 734-326-7630

fax: 734-326-7638

www.parkerionics.com

Finishing

## Passline Performance

**Booth C2325**

PO Box 373

25416 S Dixie Hwy

Crete, IL 60417 United States

ph: 708-672-5505

fax: 708-672-3838

www.passlineperformance.com

Job Shop/Contract Manufacturing, Metalforming & Fabricating Equipment, Saws & Cut-off Machines, Tool & Die, Tooling, Tube & Pipe Producing

## Pat Mooney Inc

**Booth C6913**

502 S Westgate St

Addison, IL 60101-4525 United States

ph: 630-543-6222

fax: 630-543-5584

www.patmooneysaws.com

Saws & Cut-off Machines

## Pax Products Inc

**Booth C1428**

5097 Monroe Rd

Celina, OH 45822-9033 United States

ph: 419-586-6948

fax: 419-586-6932

www.paxproducts.com

Lubrication, Material Handling/Marking, Safety & Environmental

## PDM Steel Service Centers, Inc.

**Booth C8445**

PO Box 310

Stockton, CA 95201 United States

ph: 209-943-0555

fax: 209-943-1606

www.info@pdmsteel.com

Business Services



## **PDS Bartech Inc** **Booth N5917**

2519 E. Southmore Ave  
Pasadena, TX 77502-1451 United States  
ph: 713-472-8122  
fax: 713-472-6804  
www.pdsbartech.com

Business Services, Job Shop/Contract Manufacturing, Maintenance & Repair, Other Machinery/Equipment/Parts/Products, Software & Machine Controls, Welding Machines/Equipment

## **Pearl Abrasive Co** **Booth N1528**

6832 E Slauson Ave  
Commerce, CA 90040-3617 United States  
ph: 562-776-2492  
fax: 562-927-7561  
www.pearlabrasive.com

## **Peddinghaus Corp** **Booth C7723**

300 N Washington Ave  
Bradley, IL 60915-1600 United States  
ph: 815-937-3800  
fax: 815-937-4003  
www.peddinghaus.com  
Cutting, Machining/EDM, Material Handling/Marking, Plate & Structural Fabricating, Saws & Cut-off Machines, Tooling



## **Penn United Technologies Inc** **Booth C1420**

799 N Pike Rd  
Cabot, PA 16023-2223 United States  
ph: 724-352-1507  
fax: 724-352-4970  
www.pennunited.com

Business Services, Job Shop/Contract Manufacturing, Other Machinery/Equipment/Parts/Products, Tool & Die, Tooling

## **PennEngineering** **Booth C1215**

5190 Old Easton Rd  
Danboro, PA 18916 United States  
ph: 215-766-8853  
fax: 215-766-0143

www.pemnet.com  
Fastening & Joining  
**Distributors:**  
FAB-TECH Machinery

## **PEP Technology** **Booth C8320**

1 Technology Dr Ste D401  
Irvine, CA 92618-2342 United States  
ph: 949-753-7878  
fax: 949-753-8585  
www.peptechnology.com  
Software & Machine Controls

**Distributors:**  
Idronic Pty Ltd

## **Perfection Global LLC** **Booth C3832**

2550 Arthur Ave  
Elk Grove Vlg, IL 60007-6018 United States  
ph: 847-427-3333  
fax: 847-427-8884

www.perfectionmachinery.com  
Bending/Forming, Coil Processing, Lasers, Metalforming & Fabricating Equipment, Other Machinery/Equipment/Parts/Products, Plate & Structural Fabricating, Press Brakes, Punching, Stamping, Tube & Pipe Fabricating or Welding

## **Permabond Engineering Adhesives**

### **Booth C6349**

223 Churchill Ave  
Somerset, NJ 08873-3487 United States  
ph: 732-868-1372  
fax: 732-868-0267

www.permabond.com  
Fastening & Joining, Other Machinery/Equipment/Parts/Products

## **Permadrur Industries Inc** **Booth N3006**

186 Route 206  
Hillsborough, NJ 08844-4123 United States  
ph: 908-359-9767  
fax: 908-359-9773

www.permadrur.com  
Material Handling/Marking, Plate & Structural Fabricating

## **Peter Prinzing GmbH** **Booth C5638**

Siechenlach 2  
Lonsee - Urspring, D-89173 Germany  
ph: 49 7336 96100  
fax: 49 7336 961050

www.prinzing.eu  
Bending/Forming, Metalforming & Fabricating Equipment, Tube & Pipe Fabricating or Welding

## **Peterson Spring** **Booth C549**

21200 Telegraph Rd  
Southfield, MI 48033-4276 United States  
ph: 248-799-5400  
fax: 248-357-5874  
www.pspring.com  
Other Machinery/Equipment/Parts/Products

## **PFERD INC** **Booth N5018**

30 Jytek Dr  
Leominster, MA 01453-5932 United States  
ph: 978-571-0620  
fax: 978-840-6421  
www.pferdusa.com  
Cutting, Finishing, Hand & Portable Tools, Material Handling/Marking, Other Machinery/Equipment/Parts/Products, Saws & Cut-off Machines, Tooling

## **PHI** **Booth C2122**

14955 Salt Lake Ave  
City of Industry, CA 91746-3133 United States  
ph: 626-968-9680  
fax: 626-333-3610  
www.phi-tulip.com  
Bending/Forming, Finishing, Hydroforming, Other Machinery/Equipment/Parts/Products, Stamping, Tooling, Tube & Pipe Fabricating or Welding

## **Philpott Rubber/Lankhorst Mouldings** **Booth C823**

1010 Industrial Pkwy N  
Brunswick, OH 44212-4318 United States  
ph: 330-225-3344  
fax: 330-225-1999  
www.philpottrubber.com  
Coil Processing, Material Handling/Marking



# Phinney

Established 1943

## Phinney Tool & Die Co Inc

### Booth C4720

11023 W Center Street Ext  
Medina, NY 14103-9557 United States  
ph: 585-798-3000  
fax: 585-798-5612  
www.phinneytool.com

## Phoenix International Inc

### Booth N2328

8711 W. Port Ave.  
Milwaukee, WI 53224-3429 United States  
ph: 414-973-3400  
fax: 414-973-3275  
www.phx-international.com  
Inspection & Testing, Maintenance & Repair,  
Welding Machines/Equipment

## Pillar Induction

### Booth C1849

21905 Gateway Rd  
Brookfield, WI 53045-5137 United States  
ph: 800-558-7733  
www.pillar.com

## Pines Technology

### Booth C1749

30505 Clemens Rd  
Westlake, OH 44145-1000 United States  
ph: 440-835-5553  
fax: 440-835-5556  
www.pinestech.com

## PKG Equipment Inc

### Booth C1953

367 Paul Rd  
Rochester, NY 14624-4925 United States  
ph: 585-436-4650  
fax: 585-436-3751  
www.pkgequipment.com  
Finishing

## Plex Systems

### Booth C913

1731 Harmon Rd  
Auburn Hills, MI 48326-1549 United States  
ph: 248-391-8001  
fax: 248-393-1799  
www.plex.com  
Software & Machine Controls

## Pneu-Mech Systems Manufacturing Inc

### Booth C2539

201 Pneu Mech Dr  
Statesville, NC 28625-1609 United States  
ph: 704-495-3140  
fax: 704-871-2780  
www.pneu-mech.com  
Finishing, Job Shop/Contract Manufacturing

## Pollution Control Products

### Booth C2415

2677 Freewood Dr  
Dallas, TX 75220-2510 United States  
ph: 214-358-1539  
fax: 214-358-3379  
www.pcpconline.com  
Business Services, Other Machinery/  
Equipment/Parts/Products, Safety &  
Environmental

## Polymet Corp

### Booth N2313

10073 Commerce Park Dr  
Cincinnati, OH 45246-1333 United States  
ph: 513-842-1119  
fax: 513-842-4959  
www.polymet.us  
Thermal Spraying, Welding Consumables

## Polyurethane Products Corp

### Booth C3811

100 W Interstate Rd  
Addison, IL 60101-4512 United States  
ph: 630-543-6700  
fax: 630-543-0451  
www.polyprod.com  
Bending/Forming, Coil Processing,  
Hydroforming, Material Handling/Marking,  
Tooling

## Porcelain Enamel Institute Inc

### Booth C2436

PO Box 920220  
Norcross, GA 30010-0220 United States  
ph: 770-676-9366  
fax: 770-409-7280  
www.porcelainenamel.com  
Finishing, Metal Suppliers

## Pottiez America LP

### Booth C1025

1170 Howell Mill Rd NW Ste 300  
Atlanta, GA 30318-8638 United States

ph: 404-214-0434

fax: 404-586-6824

www.pottiez.com

Tool & Die, Tooling

## Powder Coating

### Booth C2356

1155 Northland Dr  
Saint Paul, MN 55120-1288 United States  
ph: 651-287-5600  
fax: 651-287-5650  
www.pcoating.com  
Business Services, Finishing, Inspection &  
Testing, Material Handling/Marking

## Powder Coating Consultants

### Booth C2422

1529 Laurel Ave  
Bridgeport, CT 06604-1514 United States  
ph: 203-366-7244  
fax: 203-367-5245  
www.powdercc.com  
Business Services, Inspection & Testing,  
Safety & Environmental, Software &  
Machine Controls

## Powder Parts Inc

### Booth C1861

1750 Todd Farm Dr Ste A  
Elgin, IL 60123-1137 United States  
ph: 847-289-1434  
fax: 847-289-1764  
www.powderequipment.com

## Powder-X Coating Systems

### Booth C1262

1118 Stones River Ct  
La Vergne, TN 37086-2838 United States  
ph: 888-326-4840  
fax: 615-793-5521  
www.powderx.com  
Finishing

## PPG Industries

### Booth C2739

19699 Progress Dr  
Strongsville, OH 44149-3205 United States  
ph: 440-572-2800  
fax: 440-572-6825  
www.ppgcommercialcoatings.com  
Finishing



# Experience the Power of Membership



**PRECISION  
METALFORMING  
ASSOCIATION**

[www.pma.org](http://www.pma.org)



## Network • Learn • Lead

Visit us at Booth C463

**MetalForming**  
Magazine

**PMA**  
PRECISION METALFORMING ASSOCIATION  
EDUCATIONAL  
FOUNDATION

**Fabricating**  
PRODUCT NEWS



 **Praxair Inc**  
**Booth N5202**

39 Old Ridgebury Rd  
Danbury CT 06810-5113 United States  
ph: 800-772-9247  
fax: 716-879-4077  
www.praxairdirect.com  
Arc Welding, Cutting, Gases & Gas  
Equipment, Lasers, Plate & Structural  
Fabricating, Robotics, Tube & Pipe  
Fabricating or Welding, Welding  
Consumables, Welding Machines/Equipment

**Prazi USA**  
**Booth N6136**

PO Box 1165  
Plymouth, MA 02362 United States  
ph: 508-747-1490  
fax: 508-746-8655  
www.praziusa.com

**Precious Plate Inc**  
**Booth C2353**

2124 Liberty Dr  
Niagara Falls, NY 14304-3799 United States  
ph: 716-283-0690  
fax: 716-283-9185  
www.preciousplate.com  
Finishing, Job Shop/Contract Manufacturing



 **Precision Metalforming  
Association**  
**Booth C463**

6363 Oak Tree Blvd  
Independence, OH 44131-2500 United  
States  
ph: 216-901-8800  
fax: 216-901-9669  
www.pma.org  
Business Services

**Precision Punch Corp**  
**Booth C1432**

304 Christian Ln  
Berlin, CT 06037-1420 United States  
ph: 860-229-9902  
fax: 860-224-4238  
www.ppunpunch.com  
Business Services, Job Shop/Contract  
Manufacturing, Other Machinery/Equipment/  
Parts/Products, Tool & Die, Tooling

**Precision Stamping Products**  
**Booth C1158**

4848 River Rd  
Schiller Park, IL 60176-1119 United States  
ph: 847-678-0800  
fax: 847-678-8155  
www.precisionstamp.com  
Job Shop/Contract Manufacturing, Press  
Brakes, Tooling

**Precision Steel Warehouse Inc**  
**Booth C1021**

3500 N Wolf Rd  
Franklin Park, IL 60131-1395 United States  
ph: 847-455-7000  
fax: 847-455-1341  
www.precisionsteel.com  
Metal Suppliers

**Precitec Inc**  
**Booth N3335**

28043 Center Oaks Ct  
Wixom, MI 48393-3344 United States  
ph: 248-446-8100  
fax: 248-446-9409  
www.precitec.us

**Premier Tooling & Mfg Inc**  
**Booth C1032**

8853 Kapp Dr  
Peosta, IA 52068-9447 United States  
ph: 563-557-7006  
fax: 563-557-1998  
www.premiertools.com  
Job Shop/Contract Manufacturing, Stamping,  
Tooling

**Prestige Equipment  
Corporation**  
**Booth C7214**

35 Pinelawn Rd Ste 203W  
Melville, NY 11747-3111 United States  
ph: 631-249-5566  
fax: 631-249-9494  
www.prestigeequipment.com  
Bending/Forming, Cutting, Hydroforming,  
Lasers, Other Machinery/Equipment/Parts/  
Products, Plate & Structural Fabricating,  
Press Brakes, Punching, Saws & Cut-off  
Machines, Tube & Pipe Fabricating or  
Welding, Waterjet

 **Preston-Eastin Inc**  
**Booth N5731**

PO Box 582288  
Tulsa, OK 74115 United States  
ph: 918-834-5591  
fax: 918-834-5595  
www.prestoneastin.com  
Arc Welding, Fastening & Joining, Finishing,  
Machining/EDM, Material Handling/  
Marking, Robotics, Thermal Spraying, Tube &  
Pipe Fabricating or Welding

 **Pretreatment  
Equipment Mfg Inc**  
**Booth C1962, C2413**

320 Mallard Ln  
Mankato, MN 56001-1817 United States  
ph: 507-345-1512  
fax: 507-345-5828  
www.spraywand.com  
Finishing

**Prima Power  
North America Inc**  
**Booth C4336**

555 W Algonquin Rd  
Arlington Hts, IL 60005-4411 United States  
ph: 847-952-6500  
fax: 847-952-6590  
www.primapower.com  
Bending/Forming, Lasers, Material Handling  
& Packaging, Material Handling/Marking,  
Metalforming & Fabricating Equipment, Press  
Brakes, Punching, Software & Machine  
Controls

**Principal Manufacturing Corp**  
**Booth N6017**

2800 S 19th Ave  
Broadview, IL 60155-4754 United States  
ph: 708-865-7500  
fax: 708-865-7632  
www.principalmfg.com

**Process Technologies  
Group Inc**  
**Booth C454**

30W106 Butterfield Rd  
Warrenville, IL 60555-1563 United States  
ph: 630-393-4777  
fax: 630-393-4680  
www.impaxptg.com



### Prodevco Industries Inc Booth C8129

9550 10th Ave Suite 105  
Saint-Georges, QC G5Y 8J8 Canada  
ph: 418-226-4480  
fax: 418-226-4481  
www.prodevcoind.com  
Plate & Structural Fabricating, Robotics

### Prodim USA Booth C8521

7454 Commercial Circle  
Fort Pierce, FL 34951 United States  
ph: 772-465-4000  
fax: 772-465-8700  
www.prodim.nl  
Inspection & Testing, Material Handling/  
Marking, Software & Machine Controls, Tube  
& Pipe Fabricating or Welding

### Production Systems Inc Booth C1858

1500 Trinity Ave  
High Point, NC 27260-8362 United States  
ph: 336-886-7161  
fax: 336-886-6009  
Business Services, Finishing, Robotics,  
Safety & Environmental

### Production Tube Cutting Inc Booth C2215

1100 S Smithville Rd  
Dayton, OH 45403 United States  
ph: 937-254-6138  
fax: 937-254-7545  
www.productiontubecutting.com  
Business Services, Job Shop/Contract  
Manufacturing, Metal Suppliers

### Productivity Tools Inc Booth C8546

17451 Mount Herrmann St Ste F  
Fountain Vly, CA 92708-4115 United States  
ph: 714-964-6115  
fax: 714-964-3227

### Products Finishing Magazine Booth C2254

6915 Valley Ln  
Cincinnati, OH 45244-3029 United States  
ph: 513-527-8800  
fax: 513-527-8801  
www.pfonline.com  
Business Services

### PROFAX / LENCO Booth N3013

1603 N Main  
Pearland, TX 77581 United States  
ph: 281-485-6258  
fax: 281-485-8030  
www.profax-lenco.com  
Arc Welding, Resistance Welding, Welding  
Consumables, Welding Machines/Equipment

### Professional Finishing Systems Booth C8239

12341 Gladstone Ave  
Sylmar, CA 91342-5319 United States  
ph: 818-365-8888  
fax: 818-365-8803  
www.profinishing.com  
Finishing



### Profilbiegetechnik AG

### Profilbiegetechnik Ag Booth C2820

Industriestrasse  
8575 BÖRGLLEN, Switzerland  
ph: 41 716 332151  
fax: 41 716 332143  
www.pbt.ch

### Profiler Inc Booth N2627

PO Box 12858  
Mill Creek, WA 98083 United States  
ph: 360-668-3291  
fax: 360-668-9533  
www.pipemastertools.com

### Pro-Fusion Technologies Booth N3235

222 N Maplewood Ave  
Chicago, IL 60612-2110 United States  
ph: 312-829-6770  
fax: 312-829-6733  
www.kooltools.com

### Project Tool & Die Inc Booth C7313

6955 Danyeur Rd  
Redding, CA 96001-5390 United States  
ph: 530-243-8903

fax: 530-243-8914  
www.projecttoolanddie.com  
Saws & Cut-off Machines, Tooling, Tube &  
Pipe Fabricating or Welding

### Pronic Inc Booth C828

2152 Washtenaw Rd  
Ypsilanti, MI 48197-1708 United States  
ph: 734-480-9200  
fax: 734-480-9300  
www.pronic.com  
Business Services, Tool & Die, Tooling

### Protech Powder Coatings Booth C2162

7600 Henri-Bourassa West  
Saint-Laurent, QC H4S 1W3 Canada  
ph: 514-745-0200  
fax: 514-745-5774  
www.protechpowder.com

### Proto-1 Manufacturing Booth C1825

10 Tower Dr  
Winneconne, WI 54986-8530 United States  
ph: 920-582-4491  
fax: 920-582-4492  
www.proto1mfg.com  
Bending/Forming, Finishing, Metal Suppliers,  
Saws & Cut-off Machines, Stamping, Tooling,  
Tube & Pipe Fabricating or Welding

### PT-Mat Booth N3337

PO Box 660  
Conroe, TX 77305-0660 United States  
ph: 281-419-3232  
fax: 281-419-3237  
Arc Welding, Robotics, Thermal Spraying,  
Welding Consumables





**PTR-Precision  
Technologies Inc**  
**Booth N5226**

120 Post Rd  
Enfield, CT 06082 United States  
ph: 860-741-2281  
fax: 860-745-7932  
www.ptreb.com  
Business Services, Finishing, Job Shop/  
Contract Manufacturing, Machining/EDM,  
Material Handling/Marking, Other  
Machinery/Equipment/Parts/Products,  
Welding Machines/Equipment

**Punch Press**  
**Booth C8430**

210 Park Ave  
STE 1300  
Oklahoma City, OK 73142 United States  
ph: 800-255-7215  
fax: 405-604-5220  
www.punchpressonline.com

**Pushcorp Inc**  
**Booth N5934**

3001 West Kingsley  
Garland, TX 75041 United States  
ph: 972-840-0208  
fax: 972-840-1046  
www.pushcorp.com  
Finishing, Machining/EDM, Robotics, Tooling,  
Tube & Pipe Fabricating or Welding

**Pyro Shield Inc**  
**Booth N6313**

1171 Erie Ct  
Crown Point, IN 46307-2750 United States  
ph: 219-661-8600  
fax: 219-661-8612  
www.pyroshield.com  
Brazing & Soldering, Maintenance & Repair,  
Resistance Welding, Safety & Environmental,  
Tube & Pipe Producing, Welding Machines/  
Equipment

**PythonX-Burlington  
Automation**  
**Booth C8116**

63 Innovation Dr  
Hamilton, ON L9H 7L8 Canada

ph: 289-259-8470  
fax: 905-689-7773  
www.phythonx.com  
Arc Welding, Cutting, Job Shop/Contract  
Manufacturing, Machining/EDM, Material  
Handling/Marking, Other Machinery/  
Equipment/Parts/Products, Plate & Structural  
Fabricating, Robotics, Tooling

**Quaker Chemical Corp**  
**Booth C1852**

901 E Hector St  
Conshohocken, PA 19428-2380 United  
States  
ph: 610-832-4000  
www.quakerchem.com

**R&B Machining Inc**  
**Booth C2124**

2695 Progress Way  
Wilmington, OH 45177-7702 United States  
ph: 937-382-6710  
fax: 937-382-6727  
www.rbmachining.net  
Assembly, Job Shop/Contract Manufacturing,  
Maintenance & Repair, Tool & Die, Tooling,  
Tube & Pipe Fabricating or Welding, Tube &  
Pipe Producing

**RVJ/Unique4U**  
**Booth C1036**

6130 W Flamingo Rd  
PMB #460  
Las Vegas, NV 89103-2280 United States  
ph: 702-871-6377  
fax: 702-222-1212  
Maintenance & Repair, Other Machinery/  
Equipment/Parts/Products



**Radan**  
**Booth C3747**

25 North Lake Street  
Ste 220  
Forest Lake, MN 55025-2539 United States  
ph: 651-982-0100  
www.planit.com  
Software & Machine Controls

**Radyne Corp**  
**Booth N5024**

211 W Boden St  
Milwaukee, WI 53207-6277 United States  
ph: 414-481-8360  
fax: 414-481-8303  
www.radyne.com  
Fastening & Joining, Other Machinery/  
Equipment/Parts/Products, Tube & Pipe  
Fabricating or Welding, Tube & Pipe  
Producing, Welding Machines/Equipment

**Rapid Engineering**  
**Booth C2610**

1100 7 Mile Rd NW  
Comstock Park, MI 49321-9782 United  
States  
ph: 616-784-0500  
fax: 616-784-1910  
www.rapidengineering.com  
Finishing

**RAS Systems LLC**  
**Booth C6921**

1135 Dividend Ct  
Peachtree Cty, GA 30269-1926 United States  
ph: 770-487-7300  
fax: 770-487-1007  
www.ras-systems.com  
Bending/Forming

**Ratermann Mfg Inc**  
**Booth N1531**

601 Pinnacle Pl  
Livermore, CA 94550-9705 United States  
ph: 905-606-2949  
fax: 800-264-7797  
www.rmimfg.com

**REA Elektronik Inc**  
**Booth C1834**

7307 Young Dr  
Walton Hills, OH 44146-5385 United States  
ph: 440-232-0555  
fax: 440-232-5335  
www.rea-jet.com  
Lasers, Material Handling/Marking

**Ready Technology Inc**  
**Booth C832**

333 Progress Rd Unit A  
Dayton, OH 45449-2490 United States  
ph: 937-866-7200  
fax: 937-866-7226



www.readytechnology.com  
Bending/Forming, Other Machinery/  
Equipment/Parts/Products, Tool & Die

### **RealWeld Systems Inc** **Booth N6217**

1250 Arthur E Adams Dr, Ste 204  
Columbus, OH 43221-3585 United States  
ph: 614-688-5083  
www.realweldsystems.com  
Business Services, Inspection & Testing,  
Software & Machine Controls

### **Red Bud Industries** **Booth C4732**

200 B & E Industrial Dr  
Red Bud, IL 62278-2198 United States  
ph: 618-282-3801  
fax: 618-282-6718  
www.redbudindustries.com  
Coil Processing, Material Handling/Marking

### **Red Rock Automation/ Romar/MEC** **Booth N4805**

218 West Richey Road  
Houston, TX 77090-5804 United States  
ph: 281-440-1725  
fax: 281-440-1724  
www.red-rockusa.com  
Arc Welding, Cutting, Material Handling/  
Marking, Robotics, Software & Machine  
Controls, Tube & Pipe Fabricating or Welding,  
Tube & Pipe Producing, Welding Machines/  
Equipment

### **Redifoils LLC** **Booth C1154**

193 Pickering St  
Portland, CT 06480 United States  
ph: 860-342-1500  
fax: 860-342-0588  
www.redifoilsllc.com

### **Red-Ray Manufacturing Co Inc** **Booth C2052**

10-22 County Line Rd  
Branchburg, NJ 08876 United States  
ph: 908-722-0040  
fax: 908-722-2535  
www.red-ray.com  
Finishing, Gases & Gas Equipment

### **Reis Robotics USA Inc** **Booth N5910**

1320 Holmes Road  
Elgin, IL 60123 United States  
ph: 847-741-9500  
fax: 847-888-2762  
www.reisroboticsusa.com  
Assembly, Robotics, Stamping, Tool & Die

### **Reliant Finishing Systems** **Booth C1862**

2541 Highway 67 S  
Somerville, AL 35670-4630 United States  
ph: 256-355-9000  
fax: 256-355-9021  
www.reliantfinishingsystems.com

### **Rethink Robotics** **Booth N1313**

27-43 Wormwood St  
Boston, MA 02210 United States  
ph: 617-500-2487  
www.rethinkrobotics.com  
Robotics

### **Revco Industries Inc** **Booth N3031**

10747 Norwalk Blvd  
Santa Fe Spgs, CA 90670-3823 United  
States  
ph: 800-527-3826  
fax: 800-738-2690  
www.blackstallion.com  
Safety & Environmental

### **REXARC International** **Booth N1515**

35 E 3rd St  
W Alexandria, OH 45381-1231 United States  
ph: 937-839-4604  
fax: 937-839-5897  
www.rexarc.com  
Brazing & Soldering, Gases & Gas  
Equipment, Job Shop/Contract  
Manufacturing, Welding Machines/  
Equipment

### **Rex-Cut Abrasives** **Booth N2708**

960 Airport Road  
Fall River, MA 02720 United States  
ph: 508-678-1985  
fax: 508-677-4850  
www.rexcut.com  
Cutting, Finishing, Robotics, Saws & Cut-off  
Machines

### **Rhino Cutting Systems** **Booth N6138**

596 Arvin Ave  
Stoney Creek, ON L8E 5P1 Canada  
ph: 905-664-0355  
fax: 905-664-0366  
Bending/Forming, Cutting, Plate & Structural  
Fabricating, Tube & Pipe Fabricating or  
Welding, Waterjet

### **Richard Wolf Industrial** **Booth N2309**

353 Corporate Woods Pkwy  
Vernon Hills, IL 60061-3110 United States  
ph: 847-913-1113  
fax: 847-913-6959  
www.richardwolfusa.com  
Finishing, Inspection & Testing, Tooling

### **Richardson Electronics Ltd** **Booth C3721**

40W267 Keslinger Road  
PO Box 393  
Lafox, IL 60147-0393 United States  
ph: 630-208-2200  
fax: 630-208-2553  
www.rell.com  
Lasers, Maintenance & Repair, Plate &  
Structural Fabricating, Software & Machine  
Controls, Tube & Pipe Fabricating or Welding,  
Welding Machines/Equipment

### **Richards-Wilcox Inc** **Booth C2252**

600 S Lake St  
Aurora, IL 60506-5582 United States  
ph: 800-852-1020  
fax: 630-897-6994  
www.rwconveyor.com  
Finishing, Material Handling/Marking

### **RIDGID** **Booth C8412**

400 Clark St  
Elyria, OH 44035-6100 United States  
ph: 440-743-4333  
fax: 440-329-4862  
www.ridgid.com  
Material Handling/Marking, Tube & Pipe  
Fabricating or Welding



## Right Corner of Texas

### Booth C7337

1001 Synergy Blvd Ste 100  
Kilgore, TX 75662-7772 United States  
ph: 903-983-3522  
fax: 903-984-3746  
www.kilgore-edc.com  
Business Services

## Rigo Tools Co Ltd

### Booth N6117

Rm 1810-1811 No 1438  
North Shanxi Rd  
Shanghai, Shanghai 200085 China  
ph: 86 213 3150038  
fax: 86 216 3321951  
www.flap-disc.com.cn

## Rimco Equipment

### Booth N1631

3 Supply Crt  
Arundel, QLD 04214 Australia  
ph: 61 755 947322  
fax: 61 755 947325  
www.rimcorotator.com  
Business Services, Material Handling/  
Marking, Plate & Structural Fabricating,  
Robotics, Safety & Environmental, Tube &  
Pipe Fabricating or Welding, Welding  
Machines/Equipment  
*Distributors:*  
SMS Columbus

## RMI Laser LLC

### Booth C8314

106 Laser St Bldg 2  
Lafayette, CO 80026-2930 United States  
ph: 303-664-9000  
fax: 303-664-9090  
www.rmico.com  
Material Handling/Marking

## Robotic Technologies of TN

### Booth N6025

2560 Nova Cir  
Cookeville, TN 38501-5600 United States  
ph: 310-766-4316  
fax: 931-854-0774  
www.robotictechtn.com  
Arc Welding, Cutting, Inspection & Testing,  
Robotics, Welding Machines/Equipment

## Robotiq

### Booth N6119

966, Chemin Olivier  
Saint-Nicolas, QC G7A 2N1 Canada  
ph: 888-762-6847  
fax: 418-800-0046  
www.robotiq.com  
Robotics

## Robotmaster-In-House Solutions Inc.

### Booth N5933

240A Holiday Inn Dr  
Cambridge, ON N3C 3X4 Canada  
ph: 519-658-1471  
fax: 519-658-1335  
www.inhousesolutions.com  
Arc Welding, Business Services, Job Shop/  
Contract Manufacturing, Robotics, Software  
& Machine Controls

## Rock Valley Oil & Chemical Co Inc

### Booth C1049

1911 Windsor Rd  
Loves Park, IL 61111-4293 United States  
ph: 815-654-2400-620  
fax: 815-654-2428  
www.rockvalleyoil.com  
Finishing, Lubrication

## Rocklin Manufacturing Co

### Booth C1433

PO Box 1259  
Sioux City, IA 51102 United States  
ph: 712-255-7957  
fax: 712-252-5619  
www.rocklinmanufacturingco.com  
Finishing, Maintenance & Repair, Resistance  
Welding, Tool & Die, Tooling, Welding  
Consumables, Welding Machines/Equipment

## Rocky Mountain Instruments Co (RMI)

### Booth C8313

106 Laser St  
Lafayette, CO 80026-2930 United States  
ph: 303-604-4847  
fax: 303-664-9090  
www.rmico.com  
Lasers

## Roentgen USA

### Booth C5610

2541 E Devon Ave  
Elk Grove Vlg, IL 60007-6313 United States  
ph: 847-787-0135  
fax: 847-787-0138  
www.roentgen-usa.com



## Rohner

### Booth C2550

PO Box 822049  
Vancouver, WA 98682 United States  
ph: 360-885-7641  
fax: 360-896-5748  
www.rohner-usa.com  
Job Shop/Contract Manufacturing

## Roll Former Corp

### Booth C1037

140 Independence Ln  
Chalfont, PA 18914-1842 United States  
ph: 215-997-2511  
fax: 215-997-5544  
www.rollformercorp.com  
Bending/Forming, Coil Processing, Material  
Handling/Marking

## Roll Machining Technologies & Solutions

### Booth C1526

641 Forestwood Dr  
Romeoville, IL 60446-1392 United States  
ph: 815-372-9100  
fax: 815-372-9105  
www.rollolutions.com  
Cutting, Machining/EDM, Tooling

## Rolled Alloys

### Booth N3024

125 W Sterns Rd  
Temperance, MI 48182-9567 United States  
ph: 734-847-9447  
fax: 734-847-6917  
www.rolledalloys.com  
Metal Suppliers





## Roller Die + Forming Co

### Booth C8309

1172 Industrial Blvd  
Louisville, KY 40219-1889 United States  
ph: 502-969-1327  
fax: 502-969-2561  
www.rollerdie.com

## Rolleri USA

### Booth C3750

33270 Lear Industrial Parkway  
Avon, OH 44011 United States  
ph: 440-835-2580  
www.rolleritools.com  
Tooling



## RoMan Engineering Services

### Booth N2431

32711 Glendale St  
Livonia, MI 48150-1611 United States  
ph: 248-585-5540  
fax: 248-585-5577  
www.romaneng.com

## RoMan Mfg Inc

### Booth N2431

861 47th St SW  
Grand Rapids, MI 49509-5103 United States  
ph: 616-530-8641  
fax: 616-530-8953  
www.romanmfg.com

## rose plastic USA LP

### Booth N3213

PO Box 698  
California, PA 15419 United States  
ph: 724-938-8530  
fax: 724-938-8532  
www.rose-plastic.us  
Material Handling/Marking

## Rosler Metal Finishing USA LLC

### Booth C7733

1551 Denso Rd  
Battle Creek, MI 49037-7390 United States  
ph: 269-441-3000  
fax: 269-441-3001  
www.rosler.us  
Finishing

## Ross Controls

### Booth C849

1250 Stephenson Hwy  
Troy, MI 48083-1115 United States  
ph: 248-764-1800  
fax: 248-764-1850  
www.rosscontrols.com  
Assembly, Maintenance & Repair, Other  
Machinery/Equipment/Parts/Products, Press  
Brakes, Safety & Environmental, Stamping

## RPMC Lasers

### Booth C8411

203 Joseph St  
O Fallon, MO 63366-2614 United States  
ph: 636-272-7227  
fax: 636-272-3909  
www.rpmclasers.com  
Job Shop/Contract Manufacturing, Lasers,  
Other Machinery/Equipment/Parts/Products

## RPS Robot Protection Systems Inc

### Booth N6316

1001 N West St, Ste 1200  
Wilmington, DE 19801 United States  
ph: 302-295-4942  
www.robotcover.net  
Business Services, Robotics, Safety &  
Environmental

## RUF Briquetting Systems

### Booth C7250

31336 Industrial Pkwy Ste 5  
North Olmsted, OH 44070-6335 United  
States  
ph: 440-779-2747  
fax: 440-779-1404  
www.ruf-briquetter.com

## Ruko Tool Inc

### Booth C8428

3939 Royal Dr NW Ste 210  
Kennesaw, GA 30144-6486 United States  
ph: 678-331-8001  
fax: 678-331-8009  
www.rukotool.com

## RWMA

### Booth N1626

8669 NW 36th St  
Miami, FL 33166 United States  
ph: 305-443-9353  
fax: 305-442-7459  
www.rwma.org  
Resistance Welding

## Saar Hartmetall USA LLC

### Booth N5925

1009 Mary Laidley Dr  
Covington, KY 41017-9528 United States  
ph: 859-331-8770  
fax: 859-331-8771  
www.shmusa.com  
Bending/Forming, Cutting, Finishing, Tooling,  
Welding Consumables

## Saf-T-Cart Inc

### Booth N2619

PO Box 1869  
Clarksdale, MS 38614-7869 United States  
ph: 662-624-6492  
fax: 662-627-1640  
www.saftcart.com  
Material Handling/Marking

## Sahajanand Laser Technology LTD

### Booth C8230

E-30 Electronics Estate Gidc  
Sector No 26  
Gandhinagar, Gujarat 382028 India  
ph: 91 792 3287461  
fax: 91 792 3287470  
www.sahajanandlaser.com  
Lasers  
*Distributors:*  
AETHER ASIA PACIFIC CO. LTD

## Sakura of America

### Booth N2504

30780 San Clemente St  
Hayward, CA 94544-7131 United States  
ph: 800-776-6257  
fax: 510-475-0973  
www.sakuraofamerica.com  
Maintenance & Repair, Material Handling/  
Marking



# salvagnini

THE SHAPE OF THINGS TO COME

## Salvagnini America Inc

**Booth C3928**

27 Bicentennial Ct  
Hamilton, OH 45015-1382 United States  
ph: 513-874-8284  
fax: 513-874-2229  
www.salvagnini.com  
Bending/Forming, Lasers, Material Handling/  
Marking, Other Machinery/Equipment/Parts/  
Products, Press Brakes, Punching, Robotics,  
Software & Machine Controls, Tooling

## Samco Machinery Ltd

**Booth C1217**

315 Nantucket Blvd  
Toronto, ON M1P 2P2 Canada  
ph: 416-285-0619  
fax: 416-285-1353  
www.samco-machinery.com  
Bending/Forming, Coil Processing, Metal  
Suppliers, Stamping, Tooling

## Samson Roll Formed Products Co

**Booth C6350**

6101 W Oakton St  
Skokie, IL 60077 United States  
ph: 847-965-6700  
fax: 847-965-8950  
www.samsonrollform.com  
Job Shop/Contract Manufacturing, Metal  
Suppliers, Tooling

## Samuel Strapping Systems

**Booth C1524**

1365 Derwent Way  
New Westminster, BC V3M 5V9 Canada  
ph: 800-667-1264  
fax: 604-521-3028  
www.samuelssystem.com  
Coil Processing, Material Handling/Marking

## Sandvik Materials Technology

**Booth N3019**

982 Griffin Pond Rd  
Clarks Summit, PA 18411 United States  
ph: 570-587-7500  
fax: 570-585-7686  
www.smt.sandvik.com/nafta

Metal Suppliers, Thermal Spraying, Welding  
Consumables

## Sanpo Publications Inc

**Booth N1507**

1-11 Kanda Sakuma-cho  
Chiyoda-ku  
Tokyo, 101-0025 Japan  
ph: 81 33258641  
fax: 81 33258643  
www.sanpo-pub-co.jp  
Business Services

## Saru Silver Alloy Private Limited

**Booth N2410**

3 Saru Nagar  
Sardhana Road  
Meerut, Uttar Pradesh 250001 India  
ph: 91 1212555433  
fax: 91 1212555515  
www.sarusilver.com  
Brazing & Soldering

## Save Phace Inc

**Booth N1419**

2909 Fallon Dr  
Sherman, TX 75090-2067 United States  
ph: 866-783-3223  
fax: 888-828-8873  
www.savephace.com

## Sawblade.Com

**Booth C7338**

PO Box 7929  
Houston, TX 77270-7929 United States  
ph: 713-697-1605  
fax: 713-884-1113  
www.bandsawblade.com

## SB Machine Tools

**Booth C2322**

920 B East State Pkwy  
Schaumburg, IL 60173-4527 United States  
ph: 847-882-9600  
fax: 847-882-9800  
www.sbmachinetools.com  
Tube & Pipe Fabricating or Welding

## SB Specialty Metals

**Booth C825**

7449 Morgan Rd, Ste 2  
Liverpool, NY 13090 United States  
ph: 817-649-2800

fax: 817-633-8142  
www.sbsm.com

## Scantool USA By CML USA

**Booth C7147**

3100 Research Pkwy  
Davenport, IA 52806-9332 United States  
ph: 563-391-7700  
fax: 563-391-7710  
www.scantool.com  
Bending/Forming, Finishing, Tube & Pipe  
Fabricating or Welding

## Schaefer Ventilation

**Booth N2609**

1 Industrial Blvd Ste 101  
PO Box 460  
Sauk Rapids, MN 56379 United States  
ph: 320-251-8696  
fax: 320-251-2922  
www.americ.com

## Schmolz + Bickenbach USA Inc

**Booth C5011**

365 Village Dr  
Carol Stream, IL 60188-1828 United States  
ph: 630-682-3900  
fax: 630-682-4259  
www.schmolz-bickenbach.us

## Schreiber Chillers

**Booth N2327**

2625 Emerald Dr  
Kalamazoo, MI 49001-4542 United States  
ph: 800-968-5665  
fax: 269-349-8951  
www.schreiberchillers.com  
Finishing, Other Machinery/Equipment/Parts/  
Products, Thermal Spraying, Welding  
Machines/Equipment

## Schuler Incorporated

**Booth C917**

7145 Commerce Blvd  
Canton, MI 48187-4288 United States  
ph: 734-207-7200  
fax: 734-207-7222  
www.schulerinc.com  
Business Services, Coil Processing,  
Hydroforming, Job Shop/Contract  
Manufacturing, Maintenance & Repair,  
Stamping



**Scotchman Industries Inc**  
Booth C4923

PO Box 850, 180 E. Hwy 14  
Philip, SD 57567-0850 United States  
ph: 605-859-2542  
fax: 605-859-2499  
www.scotchman.com  
Business Services, Maintenance & Repair,  
Other Machinery/Equipment/Parts/Products,  
Plate & Structural Fabricating, Saws &  
Cut-off Machines, Tooling, Tube & Pipe  
Fabricating or Welding

## Scrape-N-Burr

**Scrape-N-Burr**  
Booth N1316

1500 Meadowbreeze Cir  
Neenah, WI 54956-4476 United States  
ph: 920-486-5351  
fax: 920-486-5352  
www.scrapenburr.com  
Other Machinery/Equipment/Parts/Products

**Seco Technology**  
Booth N1719

466 Bear Creek Rd  
Dalton, GA 30721-4874 United States  
ph: 706-272-0133  
fax: 706-272-0135  
www.secoatech.com  
Arc Welding, Resistance Welding, Robotics,  
Welding Consumables, Welding Machines/  
Equipment

**SelfLube**  
Booth C558

526 O'Malley Dr  
Coopersville, MI 49404-1372 United States  
ph: 616-837-9721  
fax: 800-383-9277  
www.selflube.com  
Tool & Die

**Sellstrom Manufacturing Co**  
Booth N3413

2050 Hammond Drive  
Schaumburg, IL 60173 United States  
ph: 847-358-2000  
fax: 847-358-8564  
www.sellstrom.com  
Lasers, Safety & Environmental, Welding  
Machines/Equipment

# PERFORMANCE COUNTS™





### Weiler Abrasive Flap Discs

Made in the U.S.A. and trusted by industry professionals worldwide. Weiler offers the most complete line of flap discs in the market place. Choose from:

- Original Tiger Discs - the benchmark of the industry, designed for a high cut rate and long life.
- Vortec Pro® Flap Discs - high cut rate at a value price.
- Big Cat® High Density Flap Discs - increased conformability and long life.
- Saber Tooth™ Flap Discs - for stainless, aluminum and other hard-to-grind metals.
- Trimmable Tiger™ Flap Discs - trimmable backing for extended life and increased flexibility.
- BobCat™ Mini Discs - for confined areas

Performance-engineered for application specific situations, all provide a high cut rate and long life.

Coming Soon!



When Performance Counts...  
Count on Weiler!



800-835-9999 • www.weilercorp.com

©2012 Weiler Corporation. All Rights Reserved.





 **Semyx LLC**  
**Booth C6347**

1010 Abutment Rd  
Dalton, GA 30721 United States  
ph: 706-529-0123  
fax: 706-529-0124  
www.semyx.com  
Cutting, Job Shop/Contract Manufacturing,  
Maintenance & Repair, Other Machinery/  
Equipment/Parts/Products, Plate & Structural  
Fabricating, Software & Machine Controls,  
Waterjet

**Sentry Insurance**  
**Booth C4926**

1800 North Point Dr  
Stevens Point, WI 54481-1283 United States  
ph: 800-841-2417  
fax: 714-937-1605  
www.sentry.com  
Business Services

**Sertom Group North America LLC**  
**Booth C6911**

PO Box 980  
7537 Grace Dr  
Roscoe, IL 61073-0980 United States  
ph: 815-904-1666  
fax: 952-431-3626  
www.tsgnorthamerica.com  
Bending/Forming, Business Services,  
Management Services, Material Handling/  
Marking, Other Machinery/Equipment/Parts/  
Products, Plate & Structural Fabricating, Tube  
& Pipe Fabricating or Welding

**Service Lamp Corp**  
**Booth C8246**

112 Route 73  
Voorhees, NJ 08043-9575 United States  
ph: 856-768-0404  
fax: 856-768-8270  
www.servicelamp.com  
Other Machinery/Equipment/Parts/Products

 **Servo-Robot Inc**  
**Booth N5907**

1370 Hocquart  
Saint-Bruno, QC J3V 6E1 Canada  
ph: 450-653-7868  
fax: 450-653-7869  
www.servorobot.com  
Arc Welding, Inspection & Testing, Robotics,

Software & Machine Controls, Welding  
Machines/Equipment

**SEYI America Inc**  
**Booth C653**

843 Joint Park Blvd  
Tullahoma, TN 37388-6836 United States  
ph: 931-455-7700  
www.seyiamerica.com  
Business Services, Material Handling/  
Marking, Punching, Software & Machine  
Controls, Stamping

**Shanghai Top Bridge Industry Co Ltd**  
**Booth N6211**

No 100 Hengfeng North Dr  
Zhabei District  
Shanghai, Shanghai 200085 China  
ph: 86 215 1616451  
fax: 86 215 1616450  
www.top-bridge.net

 **Shantou Inst of Ultrasonic Instruments Co Ltd (SIUI)**  
**Booth N2715**

Number 77 Jinsha Rd  
Shantou  
Guangdong, 515041 China  
ph: 754 88250150  
fax: 754 88251499  
www.siui.com  
Inspection & Testing

**Shenyang Machinery Imp and Export Corp LTD**  
**Booth C158**

11/F International Trade Building No 35  
Qingnian St  
Shenyang District  
Shenyang, 110014 China  
ph: 86 242 2744418  
fax: 86 242 2733994  
www.smcastings.com

**Shenzhen Haiyi Tool & Die Ltd**  
**Booth C358**

A4 Block The 2nd Industrial Zone  
Linpokeng Haosan Shajing  
Shenzhen, Guangdong 518104 China  
ph: 86 755 27536901  
fax: 86 755 27536901 802  
www.szhaiyi.com.cn

**Shenzhen Huayuanda Technology Co Ltd**  
**Booth C949**

No 508, DongHuan Rd Huangpu Village  
Shajing Town, Bao'an District  
Shenzhen, Guangdong 518125 China  
ph: 86 755 27220010  
fax: 86 755 27221586  
www.yuanlinhk.com  
Job Shop/Contract Manufacturing

**Shenzhen SYH Tooling Co Ltd**  
**Booth C821**

6th Block 2nd Industrial Zone Ma'anshan  
Shajing  
Shenzhen  
Shenzhen, Guangdong Province 518104  
China  
ph: 86 755 2150867  
fax: 86 755 2150887  
www.syh mold.com  
Tooling

**Shercon Inc**  
**Booth C2735**

6262 Katella Ave  
Cypress, CA 90630-5204 United States  
ph: 714-548-3999  
fax: 714-548-3991  
www.shercon.com  
Business Services, Other Machinery/  
Equipment/Parts/Products, Surface  
Treatment & Cleaning Equipment

**Sherwin Inc**  
**Booth N5918**

1615 Distribution Drive  
Burlington, KY 41005 United States  
ph: 859-525-6881  
fax: 859-525-6887  
www.sherwininc.com  
Inspection & Testing

 **Sherwin Williams**  
**Booth C1956**

101 W Prospect Ave  
Cleveland, OH 44115-1093 United States  
ph: 800-254-5979  
fax: 216-566-1593  
www.oem.sherwin.com

### Shijiazhuang Fitex Trading Co Ltd

**Booth C159**

Room 1305 - 1307, No. 77 Guangan Street,  
Shijiazhuang, Hebei 50011 China

ph: 86 311 89615268

fax: 86 311 89615269

www.fitexcasting.com

Inspection & Testing, Job Shop/Contract  
Manufacturing, Machining/EDM, Other  
Machinery/Equipment/Parts/Products

### Shop Data Systems Inc

**Booth C7413**

712 E Walnut St

Garland, TX 75040-6608 United States

ph: 561-494-2719

fax: 972-272-7062

www.shopdata.com

### Shop Edge Software Inc

**Booth C1434**

30 Duke St W Suite 1101

Kitchener, ON N2H 3W5 Canada

ph: 877-417-1212

www.shopedgesoftware.com

Software & Machine Controls

### Shoptech Software

**Booth C7013**

180 Glastonbury Blvd Ste 303

Glastonbury, CT 06033-4439 United States

ph: 860-633-0740

fax: 860-633-0741

www.shoptech.com

Software & Machine Controls

### Shred-Tech Compass Systems

**Booth C7550**

295 Pinebush Rd

Cambridge, ON N1T 1B2 Canada

ph: 519-621-3560

fax: 519-621-4288

www.shred-tech.com

Business Services, Material Handling/  
Marking, Other Machinery/Equipment/Parts/  
Products

### sia Abrasives Inc

**Booth N1726**

1327-J Wood Branch Dr.

Charlotte, NC 28273-6477 United States

ph: 704-587-7355

fax: 704-587-7350

www.sia-usa.com

Finishing



### SIC Marking USA Inc

**Booth C8509**

3812 William Flynn Hwy

Allison Park, PA 15101-3660 United States

ph: 412-487-1165

fax: 412-487-1995

www.sic-marking.com

Material Handling/Marking



### SigmaTEK Systems LLC

**Booth C4932**

1445 Kemper Meadow Dr.

Cincinnati, OH 45240-1637 United States

ph: 513-674-0005

fax: 513-674-0009

www.sigmanest.com

Punching, Software & Machine Controls

### Simufact-Americas LLC

**Booth C1352**

11685 Spicer Dr

Plymouth, MI 48170-4347 United States

ph: 734-238-2173

fax: 888-899-8386

www.simufact-americas.com

Software & Machine Controls, Tool & Die

### Site Location Partnership (SLP)

**Booth N1406**

6021 Morriss Road, Ste. 107

Flower Mound, TX 75028 United States

ph: 972-874-7483

fax: 972-692-0384

www.sitelocationpartnership.com

Business Services

### SKF USA Inc

**Booth C1233**

890 Forty Food Road

Box 352

Lansdale, PA 19446-0352 United States

ph: 267-436-6506

fax: 267-436-6001

www.skfusa.com/machinetoolservices

### SKM Industries Inc

**Booth N1717**

PO Box 278

Olyphant, PA 18447-0278 United States

ph: 570-383-3062

fax: 570-383-9482

www.skmproducts.com

Finishing, Maintenance & Repair, Material  
Handling/Marking, Other Machinery/  
Equipment/Parts/Products, Tooling, Welding  
Machines/Equipment

### SMe Software Inc

**Booth C7245**

PO Box 445

Athol, ID 83801-0445 United States

ph: 877-762-7766

fax: 800-428-0492

www.smartermanager.com

Business Services, Software & Machine  
Controls



### Smith Equipment

**Booth N5516**

2601 Lockheed Ave

Watertown, SD 57201-5636 United States

ph: 605-882-3200

fax: 605-882-2100

www.smithequipment.com

### SMK Co Ltd

**Booth N1524**

723 Ohshima

Midori-ku

Sagamihara, Kanagawa 252-0135 Japan

ph: 81 4276 30130

fax: 81 4276 33484

www.e-smk.com

Resistance Welding, Robotics, Welding  
Consumables

### SNIPS Magazine

**Booth C7447**

2401 W Big Beaver Rd Ste 700

Troy, MI 48084-3333 United States

ph: 248-244-6249

fax: 248-786-1396

www.snipsmag.com



**Society of  
Manufacturing  
Engineers**

 **Society of Manufacturing  
Engineers**  
**Booth C6542**

PO Box 930  
Dearborn, MI 48121-0930 United States  
ph: 313-425-3000  
fax: 313-425-3401  
www.sme.org  
Business Services

**Solar Atmospheres of  
California**  
**Booth C923**

1969 Clearview Rd  
Souderton, PA 18964-1021 United States  
ph: 215-721-1502  
fax: 215-723-6460  
www.solaratm.com  
Job Shop/Contract Manufacturing

**Southern Copper & Supply**  
**Booth N1926**

PO Box 570  
Pelham, AL 35124 United States  
ph: 205-664-9440  
fax: 205-664-1365  
www.southerncopper.com  
Metal Suppliers, Resistance Welding,  
Welding Consumables, Welding Machines/  
Equipment

 **Southern Stud Weld Inc**  
**Booth N2616**

PO Box 10745  
Houston, TX 75061 United States  
ph: 972-790-3339  
fax: 972-313-0864  
Arc Welding, Fastening & Joining, Inspection  
& Testing, Robotics, Welding Machines/  
Equipment  
*Distributors:*  
Heinz Soyer Bolzenschwei-technik GmbH

**Southern Systems Inc**  
**Booth C2256**

4101 Viscount Ave  
Memphis, TN 38118-6192 United States  
ph: 901-362-7340  
fax: 901-360-8002

www.ssiconveyors.com  
Assembly, Material Handling & Packaging,  
Material Handling/Marking

**Southern Welding  
Systems Intl**  
**Booth N3117**

3908 1st St  
Pearland, TX 77581-4745 United States  
ph: 281-485-9772  
fax: 281-485-4386  
www.swsintl.com

 **SpaceClaim Corp**  
**Booth C8330**

150 Baker Avenue Ext  
Concord, MA 01742-2126 United States  
ph: 978-482-2100  
fax: 978-369-5864  
www.spaceclaim.com  
Software & Machine Controls

**Spacecontrol GmbH**  
**Booth C8440**

Am Technologiepark 10  
Seefeld, 82229 Germany  
ph: 49 81529096820  
fax: 49 81529096859  
www.spacecontrol.de

**SPANCO Inc**  
**Booth C2212**

604 Hemlock Rd Ste 2  
Morgantown, PA 19543-9711 United States  
ph: 610-286-7200  
fax: 610-286-0085  
www.spanco.com  
Material Handling/Marking

**Special Metals Welding  
Products Co**  
**Booth N3118**

1401 Burriss Rd  
Newton, NC 28658-1754 United States  
ph: 828-695-2703  
fax: 828-464-8993  
www.specialmetalswelding.com  
Metal Suppliers, Thermal Spraying, Welding  
Consumables

**Special Springs LLC North  
America**  
**Booth C1335**

48602 Downing St  
Wixom, MI 48393 United States  
ph: 248-924-3888  
fax: 248-924-2888  
www.specialsprings.com

**Specialty Strip & Oscillating  
Inc**  
**Booth C957**

1262 Standard Ave  
Masury, OH 44438-1484 United States  
ph: 330-448-2228  
fax: 330-448-6455  
www.specialtystrip.com

**Spray Systems Inc**  
**Booth C1260**

1363 E Grand Ave  
Pomona, CA 91766-3855 United States  
ph: 909-623-6944  
fax: 909-622-6267  
www.spraysystems.com  
Finishing

**Spray-Tech/Junair**  
**Booth C2164**

1427 N Linden Ave  
Rialto, CA 92376-8601 United States  
ph: 909-419-7011  
fax: 909-419-7020  
www.spraytech.com  
Finishing

**St Louis Metallizing Co**  
**Booth N2315**

4123 Sarpy Ave  
St Louis, MO 63110 United States  
ph: 314-531-5253  
fax: 314-531-4706  
www.stlmetallizing.com  
Finishing, Job Shop/Contract Manufacturing,  
Lasers, Thermal Spraying

**StampingSimulation.Com  
Pty Ltd**  
**Booth C851**

501 Silverside Drive, Suite 105  
Wilmington, DE 19809 United States  
ph: 866-617-8267  
fax: 302-319-5141  
www.stampingsimulation.com





Business Services, Software & Machine Controls

 **Stamtec Presses**  
**Booth C1052**

4160 Hillsboro Hwy  
Manchester, TN 37355-6451 United States  
ph: 931-393-5050  
fax: 931-393-5060  
www.stamtec.com  
Coil Processing, Punching, Stamping

 **Starrett Bytewise**  
**Measurement Systems**  
**Booth C3453**

1150 Brookstone Centre Pkwy  
Columbus, GA 31904-4577 United States  
ph: 706-323-5142  
fax: 706-323-0178  
www.bytwise.com  
Bending/Forming, Business Services,  
Inspection & Testing, Job Shop/Contract  
Manufacturing, Software & Machine  
Controls

**State of Wyoming**  
**Booth N3133**

214 W 15th St  
Cheyenne, WY 82002 United States  
ph: 307-777-2800  
www.wyomingbusiness.org  
Business Services

 **Staubli Corp Multi Contact**  
**USA**  
**Booth N3636**

201 Parkway West  
Duncan, SC 29334-9279 United States  
ph: 864-433-1980  
fax: 864-486-5495  
www.staubli.com  
Metal Suppliers, Robotics, Welding  
Machines/Equipment



**Steel King Industries Inc**  
**Booth C1057**

2700 Chamber St  
Stevens Point, WI 54481-4856 United States  
ph: 715-341-3120  
fax: 715-341-8792

www.steelking.com  
Material Handling/Marking

**Steel Storage Systems Inc**  
**Booth C6916**

6301 Dexter St  
Commerce City, CO 80022-3128 United States  
ph: 303-287-0291  
fax: 303-287-0159  
www.steelstorage.com  
Material Handling/Marking

**Steelman Industries Inc**  
**Booth C2058**

2800 State Highway 135 N  
Kilgore, TX 75662-8948 United States  
ph: 903-984-3061  
fax: 903-984-1384  
www.steelman.com  
Finishing

**Steelmax Tools**  
**Booth N4737**

112 Inverness Circle East  
Suite F  
Englewood, CO 80112 United States  
ph: 303-690-9146  
fax: 303-690-9172  
www.steelmax.com  
Cutting, Machining/EDM, Material Handling/  
Marking, Other Machinery/Equipment/Parts/  
Products, Robotics, Saws & Cut-off  
Machines, Tube & Pipe Fabricating or  
Welding, Welding Machines/Equipment

**SteelOrbis**  
**Booth C3751**

832 Camino Del Mar Ste 2  
Del Mar, CA 92014-2808 United States  
ph: 713-589-6049  
fax: 713-589-6049  
www.steelorbis.com  
Business Services

 **SteelTailor Ltd**  
**Booth N4919**

Cannes Industrial Park No 18  
Shuang Qiao Dong Lu Chaoyang D  
Beijing, 10012 China  
ph: 86 10 51265475  
fax: 86 10 51290845  
www.steeltailor.com  
Cutting, Lasers, Other Machinery/Equipment/

Parts/Products, Plate & Structural  
Fabricating, Robotics

**Steinbichler Vision Systems**  
**Inc**  
**Booth C8328**

46995 Five Mile Rd  
Plymouth, MI 48170-2486 United States  
ph: 734-927-1540  
fax: 734-927-1549  
www.steinbichler-vision.com

**Steiner Industries**  
**Booth N3022**

5801 N. Tripp Ave  
Chicago, IL 60646-6013 United States  
ph: 773-588-3444  
fax: 773-588-3450  
www.steinerindustries.com  
Material Handling/Marking, Safety &  
Environmental, Welding Machines/  
Equipment

# Stierli-Bieger

**Stierli Bieger AG**  
**Booth C2820**

Schellenrain 1  
CH-6210 Sursee, Switzerland  
ph: 41 41 9202055  
fax: 41 41 9202455

**Stor-Loc Corp**  
**Booth C8531**

880 N Washington Ave  
Kankakee, IL 60901-2004 United States  
ph: 800-786-7562  
fax: 800-315-8769  
www.storloc.com

**Strathmore Products Inc**  
**Booth C1955**

1970 W Fayette St  
Syracuse, NY 13204-1703 United States  
ph: 315-488-5401  
fax: 315-488-2715  
www.strathmoreproducts.com  
Finishing



## Striker Systems

Booth C3728

104 S.C.T. Dr  
PO Box 41  
White House, TN 37188-0041 United States  
ph: 615-672-5132  
fax: 615-672-5139  
www.strikersystems.com  
Software & Machine Controls

## Stripmatic Products Inc

Booth C1415

5301 Grant Ave Ste 200  
Cleveland, OH 44125 United States  
ph: 216-241-7143  
fax: 216-241-6303  
www.stripmatic.com  
Job Shop/Contract Manufacturing, Lasers,  
Metal Suppliers, Stamping



## Strong Hand Tools

Booth N3631

7141 Paramount Blvd  
Pico Rivera, CA 90660-3769 United States  
ph: 800-989-5244  
fax: 562-949-4875  
www.stronghandtools.com  
Fastening & Joining, Material Handling/  
Marking, Other Machinery/Equipment/Parts/  
Products

## Strong Hold Products

Booth N1619

6333 Strawberry Ln  
Louisville, KY 40214-2930 United States  
ph: 502-363-4175  
fax: 502-363-3827  
www.strong-hold.com

## Stud Welding Associates Inc

Booth N6327

12200 Alameda Drive  
Strongsville, OH 44149-3021 United States  
ph: 800-874-7860  
fax: 440-783-3178  
www.studwelding.com  
Arc Welding, Business Services, Fastening &  
Joining, Welding Machines/Equipment

## Studio Eleven/Vivid Mfg Group

Booth C754

PO Box 315  
301 S. Main St.  
Fort Loramie, OH 45845-0315 United States  
ph: 937-295-2225  
fax: 937-295-3334  
www.studioeleven.net  
Business Services

## Suhner Industrial Products Inc

Booth N3010

PO Box 1234  
Rome, GA 30162 United States  
ph: 706-235-8047  
fax: 706-235-8045  
www.suhnerusa.com  
Cutting, Finishing, Saws & Cut-off Machines,  
Tooling



## Sulzer Metco US Inc

Booth N2413

1101 Prospect Ave  
Westbury, NY 11590-2724 United States  
ph: 516-338-2422  
fax: 516-338-2414  
www.sulzermetco.com  
Brazing & Soldering, Finishing, Lasers,  
Thermal Spraying, Welding Consumables

## Sumner Manufacturing Co Inc

Booth N1519

7514 Alabonson Rd  
Houston, TX 77088-4036 United States  
ph: 281-999-6900  
fax: 281-999-6966  
www.sumner.com  
Material Handling/Marking, Tube & Pipe  
Fabricating or Welding, Welding  
Consumables

## Sundisc Abrasives USA

Booth N1322

11805 Westline Industrial Dr  
Saint Louis, MO 63146-3312 United States  
ph: 314-432-2870  
fax: 314-567-0124  
www.sundiscabrasives.com

## Sunstone Engineering

Booth N5916

1693 American Way Ste 5  
Payson, UT 84651-5586 United States  
ph: 801-658-0015  
fax: 866-701-1209  
www.sunstonespotwelders.com  
Arc Welding, Lasers, Metal Suppliers,  
Resistance Welding, Welding Consumables,  
Welding Machines/Equipment

## Suntex Composite Industrial Co Ltd

Booth N6311

1212 Fortune International Bldg  
717 Wuluo Rd  
Wuhan, Wuhan Hubei China  
ph: 86 278 7869042  
fax: 86 278 7164892

## Superfici America Inc

Booth C1160

4715 Corporate Dr NW Ste 100  
Concord, NC 28027-9104 United States  
ph: 704-875-8751  
fax: 704-875-8752  
www.superficiamerica.com

## Superform USA

Booth C1060

6825 Jurupa Ave  
Riverside, CA 92504-1039 United States  
ph: 951-351-4100  
fax: 951-351-1189  
www.superformusa.com  
Job Shop/Contract Manufacturing

## Superior Abrasives Inc

Booth N3215

4800 Wadsworth Rd  
Dayton, OH 45414-4224 United States  
ph: 937-278-9123  
fax: 937-278-7581  
www.superiorabrasives.com  
Finishing

## Superior Die Set Corp

Booth C658

900 W Drexel Ave  
Oak Creek, WI 53154-1935 United States  
ph: 414-764-4900  
fax: 800-657-0855  
www.superiordieset.com  
Job Shop/Contract Manufacturing, Metal

Suppliers, Plate & Structural Fabricating,  
Tool & Die, Tooling

### Superior Products Booth N2517

3786 Ridge Rd  
Cleveland, OH 44144-1127 United States  
ph: 800-651-9490  
fax: 216-651-4071  
www.superiorprod.com  
Gases & Gas Equipment, Job Shop/Contract  
Manufacturing, Metal Suppliers, Welding  
Machines/Equipment

### SuperMax Tools Booth C1461

1275 Corporate Center Dr  
Saint Paul, MN 55121-1371 United States  
ph: 651-454-3401  
fax: 651-454-3465  
www.supermaxtools.com

### Sutherland Presses Booth C152

22561 Carbon Mesa Rd  
Malibu, CA 90265-5018 United States  
ph: 310-453-6981  
fax: 310-453-6982  
www.sutherland.presses.industry.net  
Business Services, Coil Processing, Material  
Handling/Marking, Stamping

### Swagelok Marketing Services Co Booth N3431

31500 Aurora Road  
Solon, OH 44139-3304 United States  
ph: 440-349-5934  
fax: 440-349-5806  
www.swagelok.com  
Arc Welding, Fastening & Joining, Finishing,  
Gases & Gas Equipment, Material Handling/  
Marking, Metal Suppliers, Other Machinery/  
Equipment/Parts/Products, Tube & Pipe  
Fabricating or Welding, Welding Machines/  
Equipment

### T&H Lemont Booth C2117

5118 Dansher Rd  
Countryside, IL 60525-6906 United States  
ph: 708-482-1800  
fax: 708-482-1802  
www.thlemont.com

Assembly, Bending/Forming, Business  
Services, Coil Processing, Cutting, Finishing,  
Saws & Cut-off Machines, Tooling, Tube &  
Pipe Fabricating or Welding, Tube & Pipe  
Producing

### TAFa Inc Booth N2318

146 Pembroke Rd  
Concord, NH 03301-5735 United States  
ph: 603-224-9585  
fax: 603-225-4342  
www.praxairsurfacetechologies.com  
Finishing, Thermal Spraying

### Tapeswitch Corp Booth C3813

100 Schmitt Blvd  
Farmingdale, NY 11735-1424 United States  
ph: 631-630-0442  
fax: 631-630-0454  
www.tapeswitch.com  
Business Services, Machining/EDM, Material  
Handling/Marking, Other Machinery/  
Equipment/Parts/Products, Press Brakes,  
Robotics, Safety & Environmental, Software  
& Machine Controls

### TaurinGroup USA Booth C1739

10270 Birtcher Dr  
Mira Loma, CA 91752-1827 United States  
ph: 909-476-8007  
fax: 909-476-8023  
www.tauringroupusa.com  
Bending/Forming, Job Shop/Contract  
Manufacturing, Metal Suppliers, Other  
Machinery/Equipment/Parts/Products, Plate  
& Structural Fabricating, Tooling, Tube & Pipe  
Fabricating or Welding

### Taylor Enterprises Inc Booth C347

2586 Southport Rd  
Spartanburg, SC 29302-2982 United States  
ph: 864-573-9518  
fax: 864-583-4150  
www.teifms.com  
Business Services, Lubrication

Visit us at Booth C2215

## PRODUCTION TUBE CUTTING

COMPETITIVE SOURCE...

COMPETENT SOLUTIONS.

- tube cutting, bending & forming
- tube machining & pre-assembly
- engineered tubes & tailored blanks
- custom tube fabrication

Satisfying customers since 1959.



ISO 9001:2008  
Zero Defects is the standard

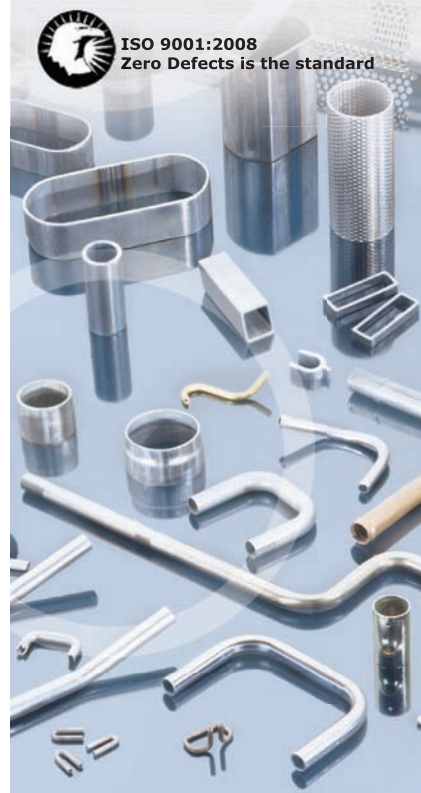

## PRODUCTION TUBE CUTTING

1100 S. Smithville Rd.

Dayton, OH 45403

1-800-334-7327 • 937-254-6138

Fax 937-254-7545

www.productiontubecutting.com

sales@productiontubecutting.com

For tube specifications and

design information visit

TUBEWEB™  
.com





## TCT Stainless Steel Inc

### Booth C1058

6300 19 Mile Rd  
Sterling Heights, MI 48314-2108 United States  
ph: 586-254-5333  
fax: 586-731-0729  
www.tctstainless.com  
Bending/Forming, Coil Processing, Inspection & Testing, Metal Suppliers

## TDC Filter Inc

### Booth N2622

2 Territorial Ct  
Bolingbrook, IL 60440-3558 United States  
ph: 630-410-6200  
fax: 630-410-6201  
www.tdcfilter.com  
Finishing, Safety & Environmental

## T-DRILL Industries Inc

### Booth C2121

1740 Corporate Dr Ste 820  
Norcross, GA 30093-2910 United States  
ph: 770-925-0520  
fax: 770-925-3912  
www.t-drill.com  
Bending/Forming, Coil Processing, Cutting, Finishing, Other Machinery/Equipment/Parts/Products, Saws & Cut-off Machines, Tube & Pipe Fabricating or Welding

## Team Industries Inc

### Booth N2929

1200 Maloney Rd  
PO Box 350  
Kaukauna, WI 54130 United States  
ph: 920-766-7977  
fax: 920-766-0486  
www.teamind.com  
Arc Welding, Job Shop/Contract Manufacturing, Material Handling/Marking

## TEC Torch Co Inc

### Booth N4822

PO Box 1870  
San Marcos, CA 92079-1870 United States  
ph: 760-747-3700  
www.tectorch.com  
Arc Welding, Welding Machines/Equipment

## Techflex Inc

### Booth N3018

29 Brookfield Dr  
Sparta, NJ 07871-3212 United States  
ph: 973-300-9242  
fax: 973-300-9409  
www.techflex.com

## Techni Waterjet

### Booth C5128

15301 W 109th St  
Lenexa, KS 66219-1201 United States  
ph: 913-492-3700  
fax: 913-492-3702  
www.techniwaterjet.com  
Cutting, Material Handling/Marking, Waterjet  
**Distributors:**  
Icon Machine Tool, Inc.  
Hart Machine Tool  
S&S Machinery LLC

## Technical Translation Services

### Booth N2604

37841 Euclid Ave  
Cleveland, OH 44094-5981 United States  
ph: 440-942-3130  
fax: 440-951-6197  
www.techtranslation.com  
Business Services

## Techniks Inc

### Booth C7140

9930 E 56th St  
Indianapolis, IN 46236-2810 United States  
ph: 317-803-8000  
fax: 317-803-8001  
www.techniksusa.com  
Material Handling/Marking

## Technogenia Inc

### Booth N4924

708 Metcalf St  
Conroe, TX 77301-2740 United States  
ph: 936-441-4770  
fax: 936-539-4760  
www.technogeniausa.com  
Brazing & Soldering, Finishing, Job Shop/Contract Manufacturing, Maintenance & Repair, Metal Suppliers, Surface Treatment & Cleaning Equipment, Welding Consumables, Welding Machines/Equipment

## TECMEN Electronics Co Ltd

### Booth N2427

Bldg D-B No 21 N Liuzhou Rd  
XiaoLiu Industry Park  
Nanjing, Jiangsu 210031 China  
ph: 86 25 85551955  
fax: 86 25 85551933  
www.tecmen.cn  
Welding Machines/Equipment

## Tempil an ITW Company

### Booth N5815

2901 Hamilton Blvd  
S Plainfield, NJ 07080-2517 United States  
ph: 908-757-8300  
fax: 908-757-9273  
www.tempil.com  
Inspection & Testing

## Temple Economic Development Corp

### Booth C7439

1 South First Street  
Temple, TX 76501 United States  
ph: 254-773-8332  
fax: 254-773-8856  
www.choosetemple.com  
Business Services

## Tennessee Galvanizing Inc

### Booth C7113

PO Box 609  
Jasper, TN 37347-0609 United States  
ph: 423-942-1020  
fax: 423-942-1040  
www.tennesseegalvanizing.com  
Fastening & Joining, Finishing, Job Shop/Contract Manufacturing, Metal Suppliers



## TeraDiode Inc

### Booth C8523

30 Upton Rd  
Wilmington, MA 01887 United States  
ph: 978-952-2501  
fax: 978-952-2507  
www.teradiode.com  
Lasers  
**Distributors:**  
FEIRA Co.,Ltd.



## Termmei Torch & Tip Company

### Booth N2526

#1017 Eco Intl Digital Plaza, #66 Guanhe East Road  
Changzhou, Jiangsu 213000 China  
ph: 86 519 86801833  
fax: 86 519 86801366  
www.termmei.com  
Arc Welding, Cutting, Plate & Structural Fabricating, Safety & Environmental, Welding Consumables, Welding Machines/Equipment

Advanced Consumables

## Thermacut Inc

### Booth N5508

153 Charlestown Rd  
Claremont, NH 03743-5616 United States  
ph: 603-543-0585  
fax: 603-542-5745  
www.thermacut.com  
Arc Welding, Cutting, Plate & Structural Fabricating. Welding Machines/Equipment

## Thermadyne Industries

### Booth N4522

16052 Swingley Rd Rd Ste 300  
Chesterfield, MO 63017-2079 United States  
ph: 636-728-3000  
fax: 636-728-3021  
www.victortechnologies.com

## Thermatool Corp

### Booth C2110

31 Commerce St  
East Haven, CT 06512-4172 United States  
ph: 203-468-4100  
fax: 203-468-4281  
www.thermatool.com  
Business Services, Other Machinery/ Equipment/Parts/Products, Resistance Welding, Saws & Cut-off Machines, Welding Machines/Equipment

## Thermo Scientific Portable XRF Analyzers

### Booth C2328

2 Radcliff Road  
Tewksbury, MA 01876 United States  
ph: 978-670-7460  
fax: 978-215-6121  
www.thermoscientific.com/niton  
Business Services, Inspection & Testing

## Thermo-Calc Software

### Booth N1625

4160 Washington Rd Ste 230  
McMurray, PA 15317-2533 United States  
ph: 724-731-0074  
fax: 724-731-0078  
www.thermocalc.com

## Thomas Industrial Network

### Booth N1517

5 Penn Plaza  
New York, NY 10001-1810 United States  
ph: 888-585-1191  
fax: 212-629-1146  
www.managingautomation.com

## ThyssenKrupp VDM USA, LLC

### Booth N5931

306 Columbia Tpk  
Florham Park, NJ 07932-1217 United States  
ph: 973-236-1664  
fax: 973-236-1960  
www.thyssenkruppvdm.com  
Metal Suppliers, Welding Consumables

## Tianjin Jinlong Welding Material Co Ltd

### Booth N6100

Yuantian Rd Changsheng St  
Gegu Town Jinnan District  
Tianjin, 300352 China  
ph: 22 286 95656  
fax: 22 286 86879  
www.jinlongweld.com  
Brazing & Soldering, Welding Consumables

## Tianjin Metallurgy Group Flourish Steel Industrial Corp Ltd

### Booth N1432

1 No. 1 Rd  
Development Zone North  
Tianjin, 301616 China  
ph: 86 225 9528668  
fax: 86 225 9528628  
www.tjxsd.com.cn

## Tianjin Minmetals NC Co Ltd

### Booth N6000

No 18-112 Second Section Beifangcheng  
Miyunzihilu, Nankai District  
Tianjin, 300112 China  
ph: 86 222 8249488  
fax: 86 222 8248636

## Tianjin Xinsen Welding Materials Co Ltd

### Booth N6001

Huyuan Industrial Area  
Shuangjie Town Beichen Dist  
Tianjin, 300400 China  
ph: 22 26972630  
fax: 22 26972720  
www.xinsenwelding.com

## Tianjin Xuzhi Machinery & Electrical Equipment Co Ltd

### Booth N1431

No 10 Fengning Rd  
Shuang Yuan Science and Technology Area  
Tianjin, Tianjin 300400 China  
ph: 86 22 26989618  
fax: 86 22 26989619  
www.xuzhi.com  
Bending/Forming, Welding Consumables

## TigerStop LLC

### Booth C7442, C7542

12909 NE 95th St  
Vancouver, WA 98682-2426 United States  
ph: 360-254-0661  
fax: 360-260-0755  
www.tigerstop.com  
Material Handling/Marking

## Timesavers Inc

### Booth C6340

11123 89th Ave N  
Maple Grove, MN 55369-4019 United States  
ph: 763-488-6600  
fax: 763-488-6601  
www.timesaversinc.com  
Cutting, Finishing, Other Machinery/ Equipment/Parts/Products, Safety & Environmental



### **Titan Strapping Systems LP** **Booth C1252**

124 Commercial Dr  
 Mooresville, NC 28115-7863 United States  
 ph: 704-663-2490  
 fax: 704-663-2489  
 www.titanstrapping.com

### **Titus Flux Inc/American Welding & Flux** **Booth N4239**

1575 Highway 411 NE Ste 401  
 Cartersville, GA 30121-6100 United States  
 ph: 770-386-3079  
 fax: 770-386-1412  
 www.titusflux.com  
 Welding Consumables

### **TJ Snow Co** **Booth N2613**

120 Nowlin Lane  
 Chattanooga, TN 37421 United States  
 ph: 423-894-6234  
 fax: 423-892-3889  
 www.tjsnow.com  
 Bending/Forming, Business Services,  
 Inspection & Testing, Metal Suppliers, Other  
 Machinery/Equipment/Parts/Products,  
 Resistance Welding, Welding Consumables,  
 Welding Machines/Equipment

### **Today's Indus Prds & Solutions** **Booth C8413**

2070 Valleydale Rd Ste 6  
 Hoover, AL 35244-2035 United States  
 ph: 205-981-4511  
 fax: 205-981-1344  
 www.tipsmag.net

### **Toledo Blank** **Booth C1149**

135 N Fearing Blvd  
 Toledo, OH 43607-3604 United States  
 ph: 419-385-0636  
 fax: 419-385-2305  
 www.toledoblank.com  
 Business Services, Coil Processing,  
 Inspection & Testing, Job Shop/Contract  
 Manufacturing, Metal Suppliers, Software &  
 Machine Controls, Stamping, Tool & Die,  
 Tooling

### **Toledo Integrated Systems** **Booth C1317**

6834 Spring Valley Dr  
 Holland, OH 43528-0010 United States  
 ph: 419-867-4170  
 fax: 419-867-4180  
 www.ttoledo.com  
 Safety & Environmental, Software &  
 Machine Controls

### **Toolmen Corp** **Booth C1253**

878 Westinghouse Rd  
 Georgetown, TX 78626-7532 United States  
 ph: 512-863-9685  
 fax: 888-866-4910  
 www.toolmen1.com  
 Bending/Forming, Cutting, Lasers,  
 Machining/EDM, Other Machinery/  
 Equipment/Parts/Products, Resistance  
 Welding, Saws & Cut-off Machines, Tube &  
 Pipe Fabricating or Welding

### **Tools for Bending** **Booth C2309**

194 W Dakota Ave  
 Denver, CO 80223-2117 United States  
 ph: 303-777-7170  
 fax: 303-777-4749  
 www.toolsforbending.com  
 Job Shop/Contract Manufacturing, Tooling

### **Top Cat Air Tools** **Booth C2361**

38285 Pelton Rd  
 Willoughby, OH 44094-7740 United States  
 ph: 440-954-7500  
 fax: 440-954-7118  
 www.tcservice.com  
 Cutting, Finishing, Other Machinery/  
 Equipment/Parts/Products, Saws & Cut-off  
 Machines, Tooling

### **TOP YES Precision Metal Products Co LTD** **Booth C1028**

Section B Fuhai Industry Park  
 Fuhai Road Fuyong Bao An  
 Shenzhen, Shenzhen Guangdong 518000  
 China  
 ph: 440-537-4224  
 www.topyes.cn  
 Tool & Die

### **Tower Oil & Technology Co** **Booth C1319**

4300 South Tripp Ave  
 Chicago, IL 60632-4319 United States  
 ph: 773-927-6161  
 fax: 773-927-3105  
 www.toweroil.com  
 Business Services, Finishing, Lubrication

### **TOX Pressotechnik LLC** **Booth C5024**

4250 Weaver Pkwy  
 Warrenville, IL 60555-3924 United States  
 ph: 630-447-4600  
 fax: 630-393-6800  
 www.tox-us.com  
 Assembly, Bending/Forming, Fastening &  
 Joining, Software & Machine Controls,  
 Stamping, Tube & Pipe Fabricating or  
 Welding

### **TQC-USA Inc** **Booth C1562**

1521 Imlay City Rd  
 Lapeer, MI 48446-3175 United States  
 ph: 810-664-7600  
 fax: 810-664-7610  
 www.TQC-USA.com

### **Trafimet USA** **Booth N2725**

2237 W 77th St  
 Hialeah, FL 33016-1867 United States  
 ph: 800-585-1185  
 fax: 305-698-2228  
 www.trafimetusa.com  
 Arc Welding, Welding Machines/Equipment

### **Trans-Matic Mfg Co Inc** **Booth C1011**

300 E 48th St  
 Holland, MI 49423-5301 United States  
 ph: 616-820-2528  
 fax: 616-820-2702  
 www.transmatic.com  
 Job Shop/Contract Manufacturing

### **Travelers Companies Inc** **Booth C3734**

1 Tower Sq  
 Hartford, CT 06183-0002 United States  
 ph: 860-277-4755  
 www.travelers.com  
 Business Services





**SME Membership is...**  
Everyone you need to **MEET**.  
Everything you need to **KNOW**.  
Everything you need to **GROW**.



SME is the best resource to deliver the manufacturing knowledge, education, connections and information you need to take control of your future. As a member, you'll gain access to: virtual and local member and technical networks, world-class events and conferences, industry-leading publications, a vast resource of technical knowledge, endless opportunities for professional development and so much more.

Select your **FREE** Manufacturing Engineering White Paper

[sme.org](http://sme.org) – 800.733.4763

**It's all right here for you. Find out more—visit Booth C6542!**



**MEET | KNOW | GROW**



**Tregaskiss**  
Booth N5513

2570 North Talbot Rd  
Windsor, ON NOR 1L0 Canada  
ph: 519-737-3000  
fax: 519-737-1530  
Arc Welding, Robotics, Welding Machines/  
Equipment

**Trendex Information  
Systems Inc**  
Booth N3218

2367 Rue Guçnette  
Saint-Laurent, QC H4R 2E9 Canada  
ph: 514-333-6373  
fax: 514-333-5705  
www.trendexsys.com  
Software & Machine Controls

**Tri Tool Inc**  
Booth N5913

3041 Sunrise Blvd  
Rancho Cordova, CA 95742-6502 United  
States  
ph: 916-288-6100  
fax: 916-288-6150  
www.tritool.com  
Arc Welding, Bending/Forming, Cutting,  
Machining/EDM, Other Machinery/  
Equipment/Parts/Products, Robotics, Saws &  
Cut-off Machines, Tube & Pipe Fabricating or  
Welding, Welding Machines/Equipment



**Triform Sheet Hydroforming**  
Booth C1226

2230 N Sheridan Rd  
Tulsa, OK 74115-3634 United States  
ph: 855-864-4670  
fax: 636-343-4424  
www.triformpress.com  
Bending/Forming, Hydroforming, Other  
Machinery/Equipment/Parts/Products,  
Stamping

**Trilogy Machinery Inc**  
Booth C5140

PO Box 70  
Belcamp, MD 21017-1227 United States  
ph: 410-272-3600  
fax: 410-272-3601  
www.trilogymachinery.com  
Bending/Forming, Coil Processing, Cutting,  
Plate & Structural Fabricating, Punching,  
Tooling, Tube & Pipe Fabricating or Welding

**Trimac Industrial Systems**  
Booth C2359

12601 Kaw Dr Ste C  
Bonner Sprngs, KS 66012-7104 United  
States  
ph: 913-441-0043  
fax: 913-422-2004  
www.infra-red.com  
Finishing, Inspection & Testing

**Tri-Mer Corp**  
Booth N2615

1400 E Monroe St  
Owosso, MI 48867-3868 United States  
ph: 623-694-1637  
fax: 989-723-7844  
www.tri-mer.com  
Finishing, Safety & Environmental

**Triple Crown Products**  
Booth N3318

814 Ela Ave  
Waterford, WI 53185-4237 United States  
ph: 800-619-1110  
fax: 262-534-7879  
www.crownquality.com  
Other Machinery/Equipment/Parts/Products,  
Safety & Environmental



**TRUMPF Inc**  
Booth C3016

111 Hyde Road  
Farmington, CT 06032 United States  
ph: 860-255-6000  
fax: 860-255-6424  
www.us.trumpf.com  
Lasers, Material Handling/Marking, Press  
Brakes, Punching, Software & Machine  
Controls, Tooling, Tube & Pipe Producing,  
Welding Machines/Equipment

**Tru-Weld/Stud Welding  
Products**  
Booth N5724

460 Lake Rd  
Medina, OH 44256-2457 United States  
ph: 330-725-7741-223  
fax: 330-725-0181  
www.truweldstudwelding.com

**Trystar**  
Booth N1818

2917 Industrial Dr  
Faribault, MN 55021-1702 United States  
ph: 507-333-3990  
fax: 507-334-1683  
www.trystar.com  
Arc Welding, Assembly, Welding  
Consumables, Welding Machines/Equipment

**Tsune America**  
Booth C3450

4480 Ray Boll Blvd  
Columbus, IN 47203-1760 United States  
ph: 812-378-9875  
fax: 812-378-9893  
www.tsuneamerica.com  
Cutting, Material Handling/Marking, Saws &  
Cut-off Machines



**TTEngineering**  
Booth C3050

Vicolo Cirimido 7  
Lomazzo, CO 22074 Italy  
ph: 39 296 778262  
fax: 39 296 778290  
www.ttengineering.it

**Tube & Pipe Technology**  
Booth C1555

46 Holly Walk  
Leamington SPA  
Warwickshire, CV32 4HY United Kingdom  
ph: 44 1926 334137  
fax: 44 1926 314755  
www.intras.co.uk

**Tube Bending Concepts Inc**  
Booth C1525

6140 Champlin Dr  
Fountain, CO 80817-4003 United States



ph: 719-382-8606  
 fax: 719-382-3687  
 www.tubebendingconcepts.com

### **Tube Works Inc** **Booth C1449**

4840 Doris Bair Circle STE B  
 Lincoln, NE 68504 United States  
 ph: 402-858-5178  
 www.tubeworksinc.com  
 Business Services, Software & Machine  
 Controls, Tube & Pipe Fabricating or Welding

### **Tubex Technology Machinery Inc** **Booth C2334**

3385 Mainway Dr.  
 Burlington, ON L7M1A6 Canada  
 ph: 800-681-8864  
 www.tubextechnology.com  
 Finishing, Saws & Cut-off Machines, Tube &  
 Pipe Fabricating or Welding

### **Tulsa Welding School** **Booth N2219**

2545 E 11th St  
 Tulsa, OK 74104-3909 United States  
 ph: 918-587-6789  
 fax: 918-587-8827  
 www.weldingschool.com

### **Turck Inc** **Booth C1312**

3000 Campus Dr  
 Plymouth, MN 55441-2656 United States  
 ph: 763-553-7300  
 fax: 763-553-0708  
 www.turck.com  
 Inspection & Testing, Robotics, Software &  
 Machine Controls

### **TWI North America LLC** **Booth N3217**

1505 Highway 6 S Ste 380  
 Houston, TX 77077-1305 United States  
 ph: 281-680-2000  
 fax: 281-680-2004  
 www.twinorthamerica.com  
 Arc Welding

### **TWN Industries Inc** **Booth C2446**

25490 SW 141 Ave  
 Princeton, FL 33032 United States

ph: 305-258-9622  
 fax: 305-258-4847  
 www.watertransferprinting.com  
 Business Services, Finishing, Robotics

### **U.S. Invitational Weld Trials** **Booth N1131**

550 NW Lejeune Rd  
 Miami, FL 33126-5649 United States  
 ph: 305-443-9353  
 fax: 305-443-7559  
 www.aws.org  
 Business Services

### **Uelner Precision Tools & Dies** **Booth C937**

4545 Futuro Ct  
 Dubuque, IA 52002-2615 United States  
 ph: 563-583-5125  
 fax: 563-583-4301  
 www.uelnertool.com  
 Job Shop/Contract Manufacturing, Stamping,  
 Tool & Die, Tooling

### **Ulbrich Stainless Steels & Special Metals Inc** **Booth C1015**

153 Washington Avenue  
 North Haven, CT 06473-1119 United States  
 ph: 203-239-3469  
 fax: 203-239-7479  
 www.ulbrich.com  
 Bending/Forming, Coil Processing, Material  
 Handling/Marking, Metal Suppliers, Tooling

### **UltraBraz** **Booth N6226**

553 Carter Ct  
 Kimberly, WI 54136-2201 United States  
 ph: 920-749-3820  
 fax: 920-749-3850  
 www.luvata.com  
 Brazing & Soldering

### **UltraLube** **Booth C7539**

1550 Franklin Grove Rd  
 Dixon, IL 61021-9110 United States  
 ph: 815-677-1148  
 fax: 815-288-3388  
 www.ultralube.com  
 Lubrication

### **Ultratech Tool & Design Inc** **Booth C1332**

PO Box 548  
 1210 W Scott St  
 Fond Du Lac, WI 54936-0548 United States  
 ph: 920-922-0257  
 fax: 920-922-3715  
 www.ultratechtooldesign.com  
 Job Shop/Contract Manufacturing, Tool &  
 Die, Tooling

### **U-Mark Inc** **Booth N2406**

102 Iowa Ave  
 Belleville, IL 62220-3940 United States  
 ph: 618-235-7500  
 fax: 425-962-9840  
 www.umarkers.com  
 Material Handling/Marking, Other  
 Machinery/Equipment/Parts/Products

### **Uni-Hydro Inc** **Booth C8537**

310 Gemini Ave E  
 Cosmos, MN 56228-6706 United States  
 ph: 320-877-7284  
 fax: 320-877-7204  
 www.unihydro.com  
 Bending/Forming, Cutting, Job Shop/Contract  
 Manufacturing, Maintenance & Repair, Plate  
 & Structural Fabricating, Tooling  
**Distributors:**  
 ISMG MACHINERY & TOOLING

### **Unipunch Products Inc** **Booth C3732**

311 5th St. NW  
 Clear Lake, WI 54005-0017 United States  
 ph: 800-828-7061  
 fax: 800-453-3994  
 www.unipunch.com  
 Bending/Forming, Other Machinery/  
 Equipment/Parts/Products, Tool & Die,  
 Tooling, Tube & Pipe Fabricating or Welding

### **Unisorb Installation Technologies** **Booth C1411**

PO Box 1000  
 Jackson, MI 49201 United States  
 ph: 517-764-6060  
 fax: 517-764-7002  
 www.unisorb.com  
 Business Services, Coil Processing, Other  
 Machinery/Equipment/Parts/Products





## Uni-Spray Systems Inc

Booth C2412

44 Durward Pl  
Waterloo, ON N2L 4E4 Canada  
ph: 519-885-4270  
fax: 519-885-4325  
www.uni-spray.com  
Finishing

## Unist Inc

Booth C847

4134 36th St SE  
Grand Rapids, MI 49512-2903 United States  
ph: 616-949-0853  
fax: 616-949-9503  
www.unist.com  
Coolants & Lubricants, Lubrication

## United Abrasives Inc /SAIT

Booth N3104

185 Boston Post Rd  
North Windham, CT 06256 United States  
ph: 860-456-7131  
fax: 860-456-8341  
www.unitedabrasives.com  
Cutting, Finishing, Saws & Cut-off Machines,  
Tooling

## United Aluminum Corp

Booth C809

100 United Dr  
North Haven, CT 06473-3295 United States  
ph: 203-239-5881  
fax: 203-239-4441  
www.unitedaluminum.com  
Brazing & Soldering, Job Shop/Contract  
Manufacturing, Metal Suppliers

## United Global Sourcing Inc

Booth C8336

5607 New King Dr Ste 100  
Troy, MI 48098-2660 United States  
ph: 248-952-5700  
fax: 248-952-5706  
www.unitedgs.com  
Fastening & Joining, Job Shop/Contract  
Manufacturing, Other Machinery/Equipment/  
Parts/Products



## United Performance Metals

Booth C1157

3475 Symmes Rd  
Hamilton, OH 45015-1363 United States  
ph: 513-860-6500  
fax: 513-874-6857  
www.upmet.com  
Business Services, Job Shop/Contract  
Manufacturing, Metal Suppliers

## Unitool Punch & Die

Booth C4708

20 Norris St  
Buffalo, NY 14207-2207 United States  
ph: 716-873-8453  
fax: 716-873-8694  
www.unitool.com  
Bending/Forming, Plate & Structural  
Fabricating, Press Brakes, Tooling, Tube &  
Pipe Fabricating or Welding



## Universal Controls Group

Booth C1528

26202 Glenwood Rd  
Perrysburg, OH 43551 United States  
ph: 419-872-2364  
fax: 419-874-2825  
www.universalcontrolsgroup.com  
Software & Machine Controls

## Universal Drilling & Cutting Equipment

Booth C3714

974 N Du Page Ave  
Lombard, IL 60148-1244 United States  
ph: 630-495-9940  
fax: 630-495-9941  
www.unibor.com  
Cutting, Machining/EDM, Material Handling/  
Marking

## Universal Tool & Engineering

Booth C1839

3204 Hanover Rd  
Johnson City, TN 37604-1462 United States  
ph: 423-282-0304  
fax: 423-282-8236  
www.universaltool.com  
Material Handling/Marking, Robotics,  
Tooling, Tube & Pipe Fabricating or Welding



## Universal Tube & Rollform Equipment Corp

Booth C1528

26202 Glenwood Rd Ste E  
Perrysburg, OH 43551-4878 United States  
ph: 419-872-2364  
fax: 419-874-2825  
www.utubeonline.com  
Bending/Forming, Coil Processing, Finishing,  
Saws & Cut-off Machines, Tube & Pipe  
Fabricating or Welding, Tube & Pipe  
Producing

## Uniweld Products Inc

Booth N5113

2850 Ravenswood Rd  
Ft Lauderdale, FL 33312-4920 United States  
ph: 954-584-2000  
fax: 954-587-0109  
www.uniweld.com  
Brazing & Soldering, Cutting, Gases & Gas  
Equipment, Welding Consumables, Welding  
Machines/Equipment



**WE LOGISTICS™**  
thenewlogistics.com

## UPS

Booth C463

1000 Semmes Ave  
Richmond, VA 23224-2246 United States  
ph: 866-443-9303  
fax: 804-231-8964  
www.upsfreight.com  
Business Services



## US Industrial Machinery Co Booth C3049

PO Box 2098  
Memphis, TN 38101 United States  
ph: 800-860-1850  
fax: 901-526-2339  
www.usindustrial.com  
Cutting, Plate & Structural Fabricating, Press  
Brakes

## V&S Galvanizing LLC Booth C7427

1000 Buckeye Park Rd  
Columbus, OH 43207-2509 United States  
ph: 313-535-2600  
fax: 313-535-0862  
www.hotdipgalvanizing.com  
Finishing, Job Shop/Contract Manufacturing

## Vacco Industries Booth C8431

10350 Vacco St  
S El Monte, CA 91733-3399 United States  
ph: 626-443-7121  
fax: 626-350-0533  
www.vacco.com  
Business Services, Job Shop/Contract  
Manufacturing, Material Handling/Marking,  
Resistance Welding

## Valmont Coatings Booth C5724

9520 E Broadway Ave  
Tampa, FL 33619-7721 United States  
ph: 813-621-8990  
fax: 813-622-8950  
www.valmont.com  
Metal Suppliers, Other Machinery/  
Equipment/Parts/Products

## Vaughn Manufacturing Co Booth C149

757 Douglas Ave  
Nashville, TN 37207-5508 United States  
ph: 615-262-5775  
fax: 615-228-3760  
www.vaughnmfg.com

## Verisurf Software Inc Booth C7438

4907 E Landon Dr  
Anaheim, CA 92807 United States  
ph: 714-970-1683  
fax: 714-701-0280

www.verisurf.com  
Inspection & Testing, Software & Machine  
Controls

## Vernon Tool / Torchmate Booth N4502

280 S Rock Blvd Ste 150  
Reno, NV 89502-4160 United States  
ph: 775-673-2200  
fax: 775-673-2206

## Versatility Professional Tool Storage, LLC Booth C1248

11532 S Mayfield Ave  
Alsip, IL 60803-6009 United States  
ph: 708-389-8909  
fax: 708-389-8955  
www.versatilitytool.com  
Material Handling/Marking

## Vibro Dynamics Corp Booth C1012

2443 Braga Dr  
Broadview, IL 60155-3941 United States  
ph: 708-345-2050  
fax: 708-345-2225  
www.vibrodynamics.com  
Other Machinery/Equipment/Parts/Products

## Vicon - Plasma Automation Inc Booth N5031

1801 Arctic Avenue  
Bohemia, NY 11716-2413 United States  
ph: 631-563-7234  
www.plasma-automation.com  
Bending/Forming, Coil Processing, Plate &  
Structural Fabricating, Software & Machine  
Controls

## Victor Technologies Intl Inc Booth N4522

16052 Swingley Rdge Rd Ste 300  
Chesterfield, MO 63017-2079 United States  
ph: 636-728-3000  
fax: 636-728-3021  
www.thermadyne.com  
Arc Welding, Brazing & Soldering, Cutting,  
Plate & Structural Fabricating, Robotics,  
Welding Consumables, Welding Machines/  
Equipment

## Victory Plasma Systems Inc Booth N4833

6834 US 431  
Owensboro, KY 42301 United States  
ph: 270-993-7041  
fax: 877-517-2380  
www.victoryplasma.com  
Cutting, Other Machinery/Equipment/Parts/  
Products, Plate & Structural Fabricating,  
Software & Machine Controls, Tube & Pipe  
Fabricating or Welding  
*Distributors:*  
SJ Smith  
Dunn Welding  
TWSCO

## Victory Tool Booth C246

1151 McKinley St  
Anoka, MN 55303-1094 United States  
ph: 763-323-8877  
fax: 763-323-8810  
Job Shop/Contract Manufacturing,  
Tool & Die

## Viking Blast & Wash Systems Booth C8329

731 S Industrial Ct  
Rose Hill, KS 67133 United States  
ph: 316-634-6699  
fax: 316-634-6658  
www.vikingcorporation.com

## Virtek Vision International Booth C4928

785 Bridge St W  
Waterloo, ON N2V 2K1 Canada  
ph: 519-746-7190  
fax: 519-746-3383  
www.gerberttechnology.com

## Visi Booth C3747

28345 Beck Rd  
Wixom, MI 48393 United States  
ph: 248-869-4040  
www.visicadcam.com  
Software & Machine Controls  
*Distributors:*  
TST Tooling Software Technology, LLC



## Vitracoat America Inc

### Booth C1462

2807 Marina Dr  
Elkhart, IN 46514-7669 United States  
ph: 574-264-6090  
fax: 574-264-2776  
www.vitracoat.com

## VJ Technologies

### Booth C2237

89 Carlough Rd  
Bohemia, NY 11716-2903 United States  
ph: 631-589-8800  
fax: 631-589-8992  
www.vjt.com

## voestalpine ? Roll Forming Corp & Rotec Inc.

### Booth C4725

1070 Brooks Industrial Rd  
PO Box 369  
Shelbyville, KY 40066-0369 United States  
ph: 502-633-4435  
fax: 502-633-5824  
www.voestalpine.com/rfc/  
Bending/Forming, Cutting, Metal Suppliers,  
Saws & Cut-off Machines

## Voortman Corporation

### Booth C7739

450 S Spruce St Unit F  
Manteno, IL 60950-9415 United States  
ph: 815-468-6300  
fax: 815-468-6333  
www.voortmancorp.com  
Material Handling & Packaging, Material  
Handling/Marking, Other Machinery/  
Equipment/Parts/Products, Plate & Structural  
Fabricating, Robotics, Saws & Cut-off  
Machines

## VSM Abrasives

### Booth N2828

1012 E Wabash St  
O Fallon, MO 63366-2774 United States  
ph: 800-825-0176  
fax: 636-272-7434  
www.vsmabrasives.com  
Finishing

## Vulcan Catalytic Infrared Oven Systems

### Booth C2512

300 Highpoint Ave  
PO Box 855

Portsmouth, RI 02871-1394 United States  
ph: 401-683-2070  
fax: 401-683-6450  
www.vulcan-mdf.com  
Finishing, Material Handling/Marking,  
Surface Treatment & Cleaning Equipment

## Vulcan Tool Corp

### Booth C812

730 Lorain Ave  
Dayton, OH 45410-2400 United States  
ph: 937-253-6194  
fax: 937-253-1062  
www.vulcancut.com

## VULKAN Blast Shot Technology

### Booth C2362

10 Plant Farm Blvd Unit 2  
Brantford, ON N3S 7W3 Canada  
ph: 519-753-2226  
fax: 519-759-8472  
www.vulkanshot.com  
Finishing

## VyTek Inc

### Booth C8145

195 Industrial Rd  
Fitchburg, MA 01420-4654 United States  
ph: 978-342-9800  
fax: 978-342-0606  
www.vy-tek.com  
Lasers

## WAFIOS Machinery Corp

### Booth C1736

27 NE Industrial Rd  
Branford, CT 06405-2844 United States  
ph: 203-481-5555  
fax: 203-481-9854  
www.wafios.us  
Bending/Forming, Coil Processing, Fastening  
& Joining, Resistance Welding, Tooling, Tube  
& Pipe Fabricating or Welding, Welding  
Machines/Equipment

## Wagner Industrial Solutions

### Booth C1951

300 Airport Rd Unit 1  
Elgin, IL 60123-1600 United States  
ph: 630-503-2400  
fax: 630-503-2377  
www.wagnersystemsinc.com  
Finishing

## Walker Magnetics

### Booth C7536

20 Rockdale St  
Worcester, MA 01606-1922 United States  
ph: 508-853-3232  
fax: 508-852-8649  
www.walkermagnet.com  
Material Handling/Marking, Plate &  
Structural Fabricating, Robotics

## Walter Surface Technologies

### Booth N2628

810 Day Hill Rd  
Windsor, CT 06095-1790 United States  
ph: 860-298-1100  
fax: 860-298-1113  
www.walter.com  
Cutting, Finishing, Lubrication, Maintenance  
& Repair, Safety & Environmental, Saws &  
Cut-off Machines, Tooling



## Walther Pilot North America

### Booth C2609

46890 Continental Dr  
Chesterfield, MI 48047-5269 United States  
ph: 586-598-0347  
fax: 586-598-1457  
www.waltherpilotna.com  
Finishing

## Washington Alloy Co

### Booth N2231

7010 Reames Rd Ste G  
Charlotte, NC 28216-2230 United States  
ph: 704-598-1325  
fax: 704-598-6672  
www.weldingwire.com  
Assembly & Joining, Brazing & Soldering,  
Welding Consumables, Welding Machines/  
Equipment

## Watts Specialties Inc

### Booth N5938, N6037

2323 E Pioneer Ste A  
Puyallup, WA 98372-3502 United States  
ph: 253-848-9288  
fax: 253-848-9295





**Wauseon Machine & Manufacturing Inc**  
Booth C1539

995 Enterprise Ave  
Wauseon, OH 43567-9333 United States  
ph: 419-337-0940  
fax: 419-335-1640  
www.wauseonmachine.com  
Assembly, Bending/Forming, Robotics,  
Tooling, Tube & Pipe Fabricating or Welding

 **Wayne Trail, a Lincoln Electric Company**  
Booth N4513

203 E Park St  
PO Box 257  
Fort Loramie, OH 45845 United States  
ph: 937-295-2120  
fax: 937-295-2642  
www.waynetrail.com

Hydroforming, Lasers, Material Handling/  
Marking, Resistance Welding, Robotics,  
Stamping, Tube & Pipe Fabricating or  
Welding, Welding Machines/Equipment

**Webb-Stiles Co**  
Booth C2435

675 Liverpool Dr  
Valley City, OH 44280-9717 United States  
ph: 330-225-7761  
fax: 330-225-5532  
www.webb-stiles.com  
Material Handling/Marking

**WEH Technologies Inc**  
Booth N2816

24903 Laguna Edge Dr  
Katy, TX 77494-3923 United States  
ph:

**Weil Engineering North America**  
Booth C8209

25909 Meadowbrook Rd  
Novi, MI 48375 United States

ph: 248-344-2211  
fax: 248-344-2220  
www.weilengineering.com  
Bending/Forming, Job Shop/Contract  
Manufacturing, Lasers, Other Machinery/  
Equipment/Parts/Products, Robotics, Safety  
& Environmental, Tube & Pipe Fabricating or  
Welding, Tube & Pipe Producing, Welding  
Machines/Equipment



**Weiler Corp**  
Booth N4831

One Weiler Dr  
Cresco, PA 18326-7846 United States  
ph: 570-595-7495  
fax: 570-595-5980  
www.weilercorp.com  
Finishing, Maintenance & Repair, Saws &  
Cut-off Machines

**Booth #N5106**



**TOUGH.  
HARDWORKING.  
FEARLESS.**

**Stick Gloves • MIG Gloves • TIG Gloves  
FR Cotton Apparel • Leather Apparel**

Designed to meet the protection demands  
of the roughest welding environments.



©2012 West Chester Holdings, Inc. 1-800-647-1900

Visit us online @ [www.west-chester.net](http://www.west-chester.net)



## Weld Engineering Co

### Booth N4818

34 Fruit St  
Shrewsbury, MA 01545-3200 United States  
ph: 508-842-2224  
fax: 508-842-3893  
www.weldengineering.com  
Arc Welding, Welding Consumables,  
Welding Machines/Equipment

## Weld.com

### Booth N4809

161 Hillpointe Dr  
Canonsburg, PA 15317-9502 United States  
ph: 724-820-1880  
fax: 724-820-1897  
www.weld.com  
Arc Welding, Material Handling/Marking,  
Resistance Welding, Welding Consumables,  
Welding Machines/Equipment

## Weld-Aid Products

### Booth N4928

14650 Dequindre St  
Detroit, MI 48212-1504 United States  
ph: 313-883-6977  
fax: 313-883-4930  
www.weldaid.com  
Finishing, Lubrication, Maintenance & Repair,  
Welding Consumables

## Weldas Co

### Booth N5136

128 Seaboard Ln  
Franklin, TN 37067-8219 United States  
ph: 800-524-0162  
fax: 615-377-3635  
www.weldas.com  
Finishing, Safety & Environmental

## Weldcoa

### Booth N3238

335 E Sullivan Rd  
Aurora, IL 60505-9762 United States  
ph: 630-806-2000  
fax: 630-806-2001  
www.weldcoa.com  
Arc Welding, Business Services, Gases &  
Gas Equipment, Material Handling/Marking



## Weldcraft

### Booth N5516

2741 N Roemer Rd  
Appleton, WI 54911-8629 United States  
ph: 920-882-6800  
fax: 920-882-6840  
Arc Welding, Welding Consumables,  
Welding Machines/Equipment

## Weld-Ed Natl Ctr for Welding Education & Training

### Booth N1633

PC 209 1005 N Abbe Rd  
Elyria, OH 44035 United States  
ph: 440-366-4930  
fax: 440-366-4624  
www.weld-ed.org

## Welder Training & Testing Institute

### Booth N1533

729 E. Highland St  
Allentown, PA 18109-3253 United States  
ph: 610-820-9551  
fax: 610-820-0271  
www.wtti.com  
Business Services, Inspection & Testing,  
Other Machinery/Equipment/Parts/Products

## Welding Alloys USA

### Booth N4917

8535 Dixie Hwy  
Florence, KY 41042-3298 United States  
ph: 859-525-0165  
fax: 859-525-9094  
www.welding-alloys.com  
Arc Welding, Finishing, Job Shop/Contract  
Manufacturing, Maintenance & Repair, Plate  
& Structural Fabricating, Welding  
Consumables

## Weldlogic Inc

### Booth N5826

2550 Azurite Cir  
Newbury Park, CA 91320-1201 United States  
ph: 805-498-4004  
fax: 805-498-1761  
www.weldlogic.com  
Arc Welding, Bending/Forming, Job Shop/

Contract Manufacturing, Plate & Structural  
Fabricating, Tube & Pipe Fabricating or  
Welding, Welding Machines/Equipment

## Weldsale LLC

### Booth N5124

2151 Dreer St  
Philadelphia, PA 19125-1918 United States  
ph: 215-739-7474  
fax: 215-426-6650  
www.weldsale.com  
Material Handling/Marking, Plate &  
Structural Fabricating, Safety &  
Environmental, Welding Consumables

## Weldship Corp

### Booth N3033

225 W 2nd St  
Bethlehem, PA 18015-1274 United States  
ph: 610-861-7330  
fax: 610-861-5175  
www.weldship.com  
Gases & Gas Equipment

## WEMCO

### Booth N1627

8669 NW 36th St  
Miami, FL 33166 United States  
ph: 800-443-9353  
fax: 305-442-7451  
www.aws.org/wemco  
Welding Machines/Equipment

## Wendt LLP

### Booth C1424

1322 Garfield St  
Wabash, IN 46992-0666 United States  
ph:  
fax: 260-563-7533  
www.wendtrigging.com

## Wendt USA LLC

### Booth N2606

259 Chicago St  
Buffalo, NY 14204-2216 United States  
ph: 866-335-3527  
fax: 866-336-3527  
www.wendtusa.com  
Finishing, Other Machinery/Equipment/Parts/  
Products

**Wenzhou Xidin Electronics  
Technology Co Ltd**  
Booth N6209

No.12, Kaituo Rd, Houjie Industrial Zone  
Liushi  
Yueqing, Zhejiang 325604 China  
ph: 86 577 89857621  
fax: 86 577 89857623  
www.xidin.com  
Welding Machines/Equipment

**West Chester Holding Inc**  
Booth N5106

100 Corridor Park Drive  
Monroe, OH 45050 United States  
ph: 800-647-1900  
www.west-chester.net  
Safety & Environmental

**West Virginia Development  
Office**  
Booth C7123

1900 Kanawha Blvd E, Bldg 5, Rm 504  
Charleston, WV 25305-0009 United States  
ph: 304-558-2234  
fax: 304-558-0449  
www.wvdo.org  
Job Shop/Contract Manufacturing

 **Western Enterprises**  
Booth N2933

875 Bassett Rd  
Westlake, OH 44145-1142 United States  
ph: 440-871-2160  
fax: 440-835-8283  
www.westernenterprises.com  
Arc Welding, Gases & Gas Equipment, Job  
Shop/Contract Manufacturing, Material  
Handling/Marking, Welding Machines/  
Equipment

**Westingcut Industrial  
Technology Anhui Inc**  
Booth N1424

46 Galley Rd  
Ancaster, ON L9G 4T1 Canada  
ph: 289-239-8161  
fax: 289-239-8161  
www.westingcut.com  
Cutting, Lasers, Other Machinery/Equipment/  
Parts/Products, Plate & Structural  
Fabricating, Robotics, Tube & Pipe  
Fabricating or Welding



**WGI Heavy Minerals Inc**  
Booth C5847

810 E Sherman Ave  
Coeur D Alene, ID 83814-4149 United States  
ph: 208-770-2200  
fax: 208-770-2199  
www.wgiheavyminerals.com

**Wheelabrator Group**  
Booth C7121

1606 Executive Dr  
LaGrange, GA 30240 United States  
ph: 706-884-6884  
fax: 706-884-9940  
www.wheelabratorgroup.com  
Business Services, Finishing, Robotics

**Whistler & Sons Inc, SB**  
Booth C4720

11023 W Center Street Ext  
Medina, NY 14103-9557 United States  
ph: 585-318-4630  
fax: 585-798-5612  
www.sbwhistler.com  
Job Shop/Contract Manufacturing, Punching,  
Tool & Die, Tooling  
*Distributors:*  
PME, LLC.

**White Engineering  
Surface Corp**  
Booth N2508

1 Pheasant Run  
Newtown, PA 18940-1818 United States  
ph: 215-968-5021  
fax: 215-968-2860  
www.whiteengineering.com

**Wila USA**  
Booth C5709

7380 Coca Cola Dr  
Hanover, MD 21076-1789 United States  
ph: 443-459-5496  
fax: 443-459-5515  
www.wilausa.com  
Business Services, Material Handling/  
Marking, Press Brakes, Robotics, Tooling

**Wilco Inc**  
Booth C1422

3502 W Harry St  
Wichita, KS 67213-1494 United States  
ph: 316-943-9379  
fax: 316-943-9664  
www.wilcosteel.com  
Metal Suppliers

**Wilson Tool International**  
Booth C1013, C5116

12912 Farnham Ave N  
White Bear Lake, MN 55110-5929 United  
States  
ph: 651-286-6150  
fax: 800-523-3970  
www.wilsontool.com  
Material Handling/Marking, Tool & Die,  
Tooling

**Wilton**  
Booth N5537

427 New Sanford Rd  
La Vergne, TN 37086-4184 United States  
ph: 800-274-6848  
fax: 615-793-8905  
www.wilontools.com  
Other Machinery/Equipment/Parts/Products

**Winox Industries Ltd**  
Booth N6111

Unit 6, 22/F Far East Consortium Bldg  
121 Des Voeux Rd Central  
Hong Kong, Hong Kong  
ph: 86 755 26697910  
fax: 86 755 26697910  
Brazing & Soldering, Cutting, Finishing,  
Metal Suppliers, Safety & Environmental,  
Saws & Cut-off Machines, Welding  
Consumables, Welding Machines/Equipment



 **Winton Machine Co**  
Booth C1725

470 Satellite Blvd NE Ste F  
Suwanee, GA 30024-7134 United States  
ph: 770-831-1917  
fax: 770-831-6459  
www.wintonmachine.com  
Tube & Pipe Fabricating or Welding





 **Wintriss Controls**  
**Booth C3711**

100 Discovery Way Unit 110  
Acton, MA 01720-4481 United States  
ph: 978-268-2700  
fax: 978-263-2048  
www.wintriss.com  
Business Services, Inspection & Testing,  
Software & Machine Controls, Tool & Die

**Wirecrafters**  
**Booth N1824**

6208 Strawberry Ln  
Louisville, KY 40214-2929 United States  
ph: 502-363-6691  
fax: 502-361-3857  
www.wirecrafters.com  
Business Services, Finishing, Job Shop/  
Contract Manufacturing, Material Handling/  
Marking, Safety & Environmental

**Wireway Husky Corp**  
**Booth N2225**

6146 Denver Industrial Park Rd  
Denver, NC 28037-7805 United States  
ph: 704-483-1900  
fax: 704-483-1911  
www.wirewayhusky.com  
Material Handling/Marking, Safety &  
Environmental

**Witt Gas Controls**  
**Booth N3124**

380 Winkler Dr Ste 200  
Alpharetta, GA 30004-5740 United States  
ph: 770-664-4447  
fax: 770-664-4448  
www.witgas.com  
Gases & Gas Equipment, Plate & Structural  
Fabricating, Welding Machines/Equipment



 **Wolf Robotics LLC**  
**Booth N4910**

4600 Innovation Dr  
Fort Collins, CO 80525-3437 United States  
ph: 970-225-7600  
fax: 970-225-7700  
www.wolfrobotics.com  
Arc Welding, Bending/Forming, Lasers,  
Material Handling/Marking, Plate &

Structural Fabricating, Robotics, Software &  
Machine Controls

**Wolverine Joining Technologies**  
**Booth N2818**

235 Kilvert St  
Warwick, RI 02886-1344 United States  
ph: 401-739-9550  
fax: 401-739-9555  
www.silvaloy.com  
Brazing & Soldering



 **Worlee-Chemie GmbH**  
**Booth C1964**

Grusonstr 22  
Hamburg, 22113 Germany  
ph: 49 40733332400  
fax: 49 40733332450  
www.worlee.de  
Other Machinery/Equipment/Parts/Products

**Wuhan Welhel Photoelectric Co Ltd**  
**Booth N2307**

No 6 Jiangxing Rd  
Jiangnan Dvlp Zone, Wuhan 430023 China  
ph: 86 27 83564006  
fax: 86 27 83564008  
www.welhel.com

 **Wuxi Dixin Steel Pipe Co Ltd**  
**Booth C1554**

Xingye Rd Number 5  
Zhuxi Industrial Zone  
WUXI, 214261 China  
ph: 86 510 87508032  
fax: 86 510 87509385  
www.wxduxin.com  
Metal Suppliers, Tube & Pipe Producing

 **Wuxi Ronniewell Machinery**  
**Booth N1707**

Yangshan Town  
Wuxi, Jiangsu 214156 China  
ph: 86 510 83050580  
fax: 86 510 83050580  
www.ronniewell.com

**Wuxi Volcano Welding & Cutting**  
**Booth N1606**

Outang Dongfeng Industry Pk  
Huishan District  
Wuxi, Jiangsu 214153 China  
ph: 86 510 83291711  
fax: 86 510 83291211  
www.volcanocn.com

**Wysong Parts and Service**  
**Booth C1023**

PO Box 21168  
Greensboro, NC 27405 United States  
ph: 336-621-3960  
fax: 336-621-8360  
www.wysongpartsandservice.com  
Cutting, Job Shop/Contract Manufacturing,  
Press Brakes

 **Xinxiang Tianfeng Machinery Manufacture Co Ltd**  
**Booth C7148**

17# Xin Yi Street , Development  
Area,Xinxiang ,Henan ,China  
Xinxiang City, Henan 45-3000 China  
ph: 86 373 3526693  
fax: 86 373 3526676  
www.tfmm.cc  
Bending/Forming

 **Xiris Automation Inc**  
**Booth C2312**

1016 Sutton Dr, Unit C5  
Burlington, ON L7L 6B8 Canada  
ph: 905-331-6660  
fax: 905-331-6661  
www.xiris.com  
Inspection & Testing  
**Distributors:**  
Magnetic Analysis Corporation  
Potter & Associates Inc.

 **Yaskawa America Inc**  
**Booth N5222**

100 Automation Way  
Miamisburg, OH 45342 United States  
ph: 937-847-6200  
fax: 937-847-6277  
www.motoman.com  
Plate & Structural Fabricating, Robotics,  
Software & Machine Controls, Tube & Pipe  
Fabricating or Welding



**Yestool/Aloris-USA**  
**Booth C8310**

407 Getty Ave  
Clifton, NJ 07011-2121 United States  
ph: 973-772-1201  
fax: 973-772-8606  
www.aloris.com  
Other Machinery/Equipment/Parts/Products,  
Tooling  
*Distributors:*  
Aloris Tool Technology



**YLM - Ying Lin Machine Industrial Co**  
**Booth C2317**

No 46 Hwan-Gong Rd  
Yung-Kang Industrial District  
Tainan, Tainan (city) 71041 Taiwan  
ph: 886 88 66233634  
fax: 886 88 66323534  
www.yim.cm.tw  
Saws & Cut-off Machines, Tube & Pipe  
Fabricating or Welding  
*Distributors:*  
J&S Machine, Inc.

**York Portable Machine Tools**  
**Booth N2925**

1641 17th Ave  
Campbell River, BC V9W 4L5 Canada  
ph: 250-287-7716  
fax: 250-287-8362  
www.yorkmachine.com  
Arc Welding, Cutting, Job Shop/Contract  
Manufacturing, Maintenance & Repair, Other  
Machinery/Equipment/Parts/Products,  
Robotics, Welding Machines/Equipment



**YRC Freight**  
**Booth C463**

10990 Roe Ave  
Leawood, KS 66211-1213 United States  
ph: 800-647-3061  
www.yrcfreight.com

**Yunnan Hengyu Optical Electronics Co (Optech Co)**  
**Booth N4918**

Jinding Scien-Tech  
Garden Xuefu Rd Kunming  
Yunnan, 650033 China  
ph: 86 871 5380185  
fax: 86 871 5389404  
www.artotic.com.cn  
Welding Machines/Equipment

**Zapp Precision Strip**  
**Booth C811**

266 Barnet Blvd  
Dartmouth, MA 02745-1219 United States  
ph: 508-998-6300  
fax: 508-998-6310  
www.zapp.com  
Metal Suppliers

**Zarbeco LLC**  
**Booth C1454**

1240 Sussex Tpke Ste 5  
Randolph, NJ 07869-2944 United States  
ph: 973-989-2043  
fax: 973-933-2336  
www.zarbeco.com  
Inspection & Testing, Software &  
Machine Controls

**Global Leaders in Industrial Finishing Equipment**

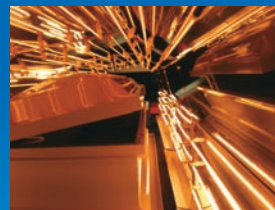

SEE US AT  
**FABTECH**  
FINISHING PAVILION  
November 12-14, 2012  
fabtechexpo.com  
BOOTH #C2532



- Manual and Automatic Spray Guns
- Fluid Supply, Transfer and Circulating Pumps
- Pressure Tanks
- Electrostatic Systems
- IR Ovens
- Chain on Edge/Conveyors and Reciprocators

**DEVILBISS**   **Ransburg**   **BGK**   **BINKS**  
www.devilbiss.com   www.ransburg.com   www.bgk.com   www.binks.com



### **Zerust Corrosion Solutions (Northern Tech Intl Corp)**

**Booth C1014**

4201 Woodland Rd  
Circle Pines, MN 55014-0069 United States  
ph: 763-225-6600  
fax: 763-225-6645  
www.zerust.com  
Finishing, Lubrication, Other Machinery/  
Equipment/Parts/Products

### **Zhejiang Changzheng Project Carbon Electrodes Co Ltd**

**Booth N6210**

No 1 Jindou Rd Nanxun Town  
Huzhou City, Zhejiang 313009 China  
ph: 86 572 3070288  
fax: 86 572 3011768  
www.czcarbon.com  
Cutting, Finishing, Tooling, Welding  
Machines/Equipment

### **Zhejiang Yuguang Aluminium Material Co Ltd**

**Booth N5901**

Baihuashan Industrial Area  
Economic Development Zone  
Wuxi, Zhejiang 321200 China  
ph: 86 579 87921169  
fax: 86 579 87921166  
www.zjyuguang.com

### **Zhengzhou Anxin Abrasives**

**Booth N2817**

No 68 Kexuedadao  
Zhengzhou, 450002 China  
ph: 86 371 63751616  
fax: 86 371 67826977  
Finishing

### **ZJ Industries Inc**

**Booth N2704**

125 W Factory Rd  
Addison, IL 60101-5103 United States  
ph: 630-543-6655  
fax: 630-543-6644  
www.zjindustriesinc.com  
Arc Welding, Metal Suppliers, Resistance  
Welding, Robotics, Welding Consumables,  
Welding Machines/Equipment

### **ZMac Transportation Solutions**

**Booth C1237**

510 College Ave  
Racine, WI 53403-1058 United States  
ph: 877-397-5059  
fax: 262-664-4164

**METALFORM MEXICO** **AWS WELDMEX** **FABTECH MEXICO**

**AWS WELDMEX**  
**FABTECH MEXICO**  
**METALFORM MEXICO**

**2013**

*Largest Manufacturing Show in Mexico!*

**MAY 7 - 9, 2013**  
**CINTERMEX**  
**MONTERREY, MX**

» **9,000 Attendance**  
» **75,000 sq ft.**  
» **400 Exhibitors**

**Co-sponsors**

**AWS** **FMA** **SME** **PMA** **CAI**

American Welding Society | Fabricators & Manufacturers Association, Intl | Society of Manufacturing Engineers | Precision Metalforming Association | Chemical Coaters Association, Intl



# eXCEEDS EXPECTATIONS



## The new eX series.

The manufacturing industry is evolving—and so are we. From the proven success of our best-selling LVP<sup>PLUS</sup> comes the next generation in superior laser-cutting technology: **the eX series.**

This powerful new machine offers a 30 percent reduction in assist gas consumption, faster speeds in a wide range of material, and Eco Mode for lower energy consumption. Add to that our **superior resonators**—which deliver the highest cutting power per watt and never require a rebuild—and you have the best price-to-performance ratio in the industry.

Visit us at Booth C3040



[www.Mitsubishi-World.com/eX](http://www.Mitsubishi-World.com/eX)  
630-616-5920





# Faster to the Finish

PRODUCT INDEX

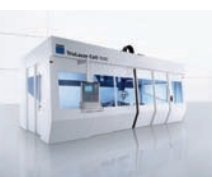

## TRUMPF Powering You Past the Competition

Anybody can put you in the race, but if you want to win, it takes a combination of high performance and quick pit stops. TRUMPF industrial lasers and fabricating machines have long been recognized as the performance leader. Our laser cutting machines, punching machines and press brakes have unique design features that allow quick changeover to keep you running because you are only heading towards the finish if you are producing parts. So get out of the back of the pack and see what being first to the finish can do for your business.

FABTECH Booth C3016 / [www.us.trumpf.com](http://www.us.trumpf.com)

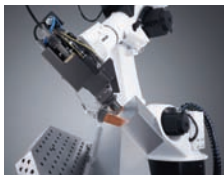

For more information  
scan the QR code with  
your smartphone.





# PRODUCT INDEX

## Abrasive Cutting Compounds

Barton .....	C4916
Beilun Futuo Mechanical Tools Co Ltd.....	N6026
Chemtool Inc.....	C660
Comco Inc.....	C5052
CS Unitec Inc.....	N5531
H2O JET Inc.....	C5713
Houghton International Inc..	C1437, C1552
Joysun Abrasives Co Ltd.....	N3208
Osborn.....	C2737, N3309
Suhner Industrial Products Inc .....	N3010
United Abrasives Inc /SAIT.....	N3104
Walter Surface Technologies .....	N2628
Winox Industries Ltd.....	N6111

## Abrasive Cutting Machines

Baileigh Industrial Inc.....	C7513
Comco Inc.....	C5052
ESCO Tool Co.....	C5735
Flow International Corp.....	C5911
H2O JET Inc.....	C5713

Jet Edge .....	C4349
Jet.....	C5923
Joysun Abrasives Co Ltd.....	N3208
KMT Waterjet Systems Inc.....	C6334
Metabo Corp.....	N6131
Pace Technologies Corp.....	N2916
PFERD INC.....	N5018
Semyx LLC.....	C6347
Suhner Industrial Products Inc .....	N3010
Techni Waterjet.....	C5128
Timesavers Inc.....	C6340
Top Cat Air Tools.....	C2361

## Abrasive Disks/Belts/ Pads/Wheels

3M.....	N5502
Alpha Professional Tools.....	N6331
Apex Machine Group/ SlipCon USA .....	C5528
Armstrong/Kover Kwick Inc feat NCCM Mill Rolls .....	C7047
ATI Stellram.....	N1733

Beilun Futuo Mechanical Tools Co Ltd.....	N6026
Bosch Power Tool Corp.....	N5006
CGW-Camel Grinding Wheels USA ..	N5526
CoreTemp .....	N6236
CS Unitec Inc.....	N5531
Dynabrade Inc.....	C2409
Easy Abrasives LLC.....	N2618
Fast Rite International.....	C854
Felton Inc.....	C7112
Gem Tool Corporation.....	C2320
General Tool .....	N1622
Hangzhou Xiangsheng Abrasive Machine Manufacturing Co., Ltd.....	C7142
Hermes Abrasives Ltd.....	N3009
JAZ USA Inc.....	N1831
Joysun Abrasives Co Ltd.....	N3208
KLINGSPOR Abrasives Inc.....	N3135
Mercer Abrasives .....	N6016
Metabo Corp.....	N6131
Norton Abrasives .....	N2610
OKI Bering.....	N4531

# METAL FABRICATING MACHINES

## SECTION / PROFILE BENDERS

**FABTECH 2012  
BOOTH C5928**  
FREE Tickets on our Website!

**CP40H**  
2" Angle, 2" Pipe  
SOLID ALLOY  
STEEL HEADS  
No Castings!  
Programmable  
Digital Controls  
Works in Horizontal  
and Vertical Position!

**CP30**  
5 MODELS!  
1-1/2" Pipe,  
Angle and  
Sq. Tube!  
Works in  
Horizontal & Vertical  
Positions! LED Readouts



**EAGLE** Professional Machines  
for Serious Fabricators.  
BENDING MACHINES 251-937-0947  
www.eaglebendingmachines.com  
sales@eaglebendingmachines.com - Dealers Welcome



## Plate Rolls / Angle Rolls Tube & Pipe Benders

Plus... Fully Automated Production  
Cells, Vertical Systems, Rebar &  
Ornamental Benders. In-house  
Custom Tooling Shop and More!

**TRUE QUALITY  
AND REAL VALUE  
ARE ALWAYS FOUND  
IN THE DETAILS**

VISIT OUR BOOTH AND SEE FOR YOURSELF!  
**FABTECH 2012 - BOOTH C5928**  
FREE Printable Tickets on our Website!

Many popular machines on display!  
or visit our website and see why  
Carell is the number one choice for  
professionals who compare.

carellcorp.com

P.O. Box 850, Stapleton, AL 36578 - Phone: 251-937-0948 - Fax: 251-937-4742  
sales@carellcorp.com - DEALERS WELCOME



# FABTECH 2012 - BOOTH C5928





## Abrasive Disks/Belts/ Pads/Wheels

Osborn	C2737, N3309
PFERD INC	N5018
Rex-Cut Abrasives	N2708
sia Abrasives Inc	N1726
Suhner Industrial Products Inc	N3010
Superior Abrasives Inc	N3215
United Abrasives Inc /SAIT	N3104
VSM Abrasives	N2828
Walter Surface Technologies	N2628
Weiler Corp	N4831
Wendt USA LLC	N2606
Winnox Industries Ltd	N6111
Zhengzhou Anxin Abrasives	N2817

## Absorbents for Chemical Spills

Armstrong/Kover Kwick Inc feat NCCM Mill Rolls	C7047
---------------------------------------------------	-------

## Air Blow Off-Devices - Finishing

Anest Iwata USA Inc	C2746
Compressed Air	N3034
Dynabrade Inc	C2409
General Automatic Transfer	C2550
General Fabrications Corp	C2648
GMT North America	C353
Midwest Finishing Systems Inc	C2526
Pneu-Mech Systems Manufacturing Inc	C2539

## Air Cleaning/Filtration Systems/ Fume Extraction/Dust Collection Systems

Ace Industrial Products	N5009
Airflow Systems Inc	N1110
APEL International	N1526
Apex Machine Group/ SlipCon USA	C5528
ArcOne	N3231
Avani Environmental Intl Inc	N4537
Bay State Surface Technologies	N2419
Bowlin Engineering	C4838
Burr King Manufacturing Co	C4740
Clean Air Consultants/Filter 1	C2428
Coral Spa / Industrial Air Solutions	N2813
Darex LLC	C8138
Diversi-Tech Inc	N1922
Donaldson Torit - Donaldson Company Inc	C8121, N6028
DualDraw LLC	N2506
Duroair Technologies Inc	C1362
Environmental Air Solutions	N6315
Frommelt Safety Products	N4827
Global Finishing Solutions	C2151
Goff's Enterprises Inc	N2625

Industrial Maid	N2428
Interactive Safety Product Inc	N3206
Kemper America Inc	N2631
Klimawent USA LLC	N5634
Lincoln Electric Co	N4102, N4113, N4515
LS Industries Inc	C8123
Metcast Service Tech Resources	C6946
Micro Air	N1806
Miller Electric Mfg Co	N5213, N5816
Module-Air LLC	N5705
Nederman Inc	N1604
Nordfab Ducting	N1928
North (Nanjing) Instrument Technology Industries Group	N3226
Pangborn Corp	C6516
TDC Filter Inc	N2622
Timesavers Inc	C6340
Tri-Mer Corp	N2615
Weldsale LLC	N5124

## Air Ejection Equipment

Ross Controls	C849
Shred-Tech Compass Systems	C7550

## Air Hammers/ Planishing Machines

Chicago Pneumatic Tool Co	C4750
Michigan Pneumatic Tool Inc	N6034
Nitto Kohki USA Inc	C1510

## Air Make-Up Systems

AFC Finishing Systems	C2548
Col-Met Spray Booths Inc	C2537
General Fabrications Corp	C2648
Nova Verta USA	C1762
Pneu-Mech Systems Manufacturing Inc	C2539
Production Systems Inc	C1858
Rapid Engineering	C2610
Spray-Tech/Junair	C2164

## Air Systems/Fans/ Blowers

Ace Industrial Products	N5009
Airflow Systems Inc	N1110
ArcOne	N3231
Avani Environmental Intl Inc	N4537
Big Ass Fans	C7742
Clean Air Consultants/Filter 1	C2428
Compressed Air	N3034
Coral Spa / Industrial Air Solutions	N2813
Diversi-Tech Inc	N1922
DualDraw LLC	N2506
Duroair Technologies Inc	C1362
Environmental Air Solutions	N6315

Flame Technologies Inc	N3219
Hex-Hut Shelter Systems Ltd	N6115
Industrial Maid	N2428
Kemper America Inc	N2631
Klimawent USA LLC	N5634
Micro Air	N1806
Module-Air LLC	N5705
Nederman Inc	N1604
Weil Engineering North America	C8209

## Aluminum Etchants & Deoxidizers

Calvary Industries Inc	C2734
DuBois Chemicals	C2545, C4938
Hubbard-Hall Inc	C2156

## Angle Bending Rolls

Akyapak	C5545
Baileigh Industrial Inc	C7513
C Marshall Fabrication Machinery	C7716
Carell Corp/Eagle Bending Machines	C5928
CML USA Inc Ercolina	C3739
COMEQ Inc	C5125
DAVI Inc	C3435
Euromac/Metal Finish LLC	C4716
Faccin USA Inc	C6323
Haco Atlantic Inc	C3440
Haeusler AG	C5540
J & S Machine Inc	C2317
JMT USA	C5047
Masteel America Corp	C3749
Perfection Global LLC	C3832
Prestige Equipment Corporation	C7214
Sertom Group North America LLC	C6911
TaurinGroup USA	C1739
Trilogy Machinery Inc	C5140

## Annular Cutters/Drill Bits

American Punch Co	C5026
Bad Dog Tools	N3106
Bolttech Mannings	N2326
Bosch Power Tool Corp	N5006
Cleveland Steel Tool Co	C5522
COB Industries Inc	N5919
CS Unitec Inc	N5531
Fastenal Company	N5736
Fein Power Tools Inc	N5902
G&J Hall Tools Inc	N3025
Hougen Manufacturing Inc	C4821
Hydro Carbide Inc	C8238
Nitto Kohki USA Inc	C1510
OKI Bering	N4531
Steelmax Tools	N4737
Universal Drilling & Cutting Equipment	C3714
Walter Surface Technologies	N2628



# FFJournal<sup>®</sup>

The magazine for today's metal fabricating & forming technologies

**CUTTING-EDGE  
REPORTING ON  
METAL FABRICATING  
AND FORMING**

EXTREME  
FABRICATING:

DISCOVERY  
CHANNEL'S  
"STORM CHASERS"  
VEHICLE

VISIT US AT BOOTH C8236

TREND PUBLISHING METALS GROUP

**FFJournal<sup>®</sup>**  
FFJournal.net

**ModernMetals<sup>®</sup>**  
ModernMetals.com

**THE METALS  
DIRECTORY<sup>®</sup>**  
TheMetalsDirectory.com





## Anodizing Equipment

PKG Equipment Inc . . . . . C1953

## Anti-Spatter Compounds

**ABICOR Binzel Corp.** . . . . . N5508  
 Beijing Essen Welding & Cutting Fair . . . . . N6200  
**Calvary Industries Inc.** . . . . . C2734  
 Cantesco . . . . . N3027  
 CM Industries Inc . . . . . N2810  
 ELCo Enterprises . . . . . N2831  
 HE&M Saw Inc . . . . . C5508  
 Intercon Enterprises Inc . . . . . N3227  
 New Fire Co Ltd. . . . . N3017  
 OKI Bering . . . . . N4531  
 Osborn . . . . . C2737, N3309  
 Secoa Technology . . . . . N1719  
 SMK Co Ltd . . . . . N1524  
 Weld-Aid Products . . . . . N4928  
 Weldsale LLC . . . . . N5124  
 ZJ Industries Inc . . . . . N2704

## Architecture/Engineering Design Firms

Accurate Die Design Inc/Logopress Corp . . . . . C1423  
 Bascon Inc . . . . . C7146  
 Powder Coating Consultants . . . . . C2422

## Assembly Equipment/Systems

321 Fixtures . . . . . C1756  
 AGT . . . . . N2333  
 ALM Materials Handling . . . . . N5927  
 Atlantic Tool & Die Co. . . . . C1155  
 Attexor Clinch Systems SA . . . . . C5622  
 Bettcher Manufacturing LLC . . . . . C1053  
**Centerline (Windsor) Ltd.** . . . . . N1926  
 Clips & Clamps Industries . . . . . C148  
 Dake Corporation . . . . . C6923  
 DE-STA-CO . . . . . N6113  
 Dongsan Bearing Co . . . . . C833  
 Durr Ecoclean Inc . . . . . C2437  
 Equipois Inc . . . . . N2324  
 Feed Lease Corp . . . . . C928  
 Fiba Technologies Inc . . . . . N6324  
 Flexarm Inc . . . . . C7431  
 FomUSA . . . . . C6914  
 Frommelt Safety Products . . . . . N4827  
 Fusion Inc . . . . . N3313  
 Fuxin Tianyuan Steel Balls Mfg Co Ltd . . . . . C355  
 Genesis Systems Group . . . . . N3913  
 Haeger Inc . . . . . C3716  
 Haeusler AG . . . . . C5540  
 Hiwin Corp. . . . . C1321  
 IMPACT Engineering Inc . . . . . N5108

Industrial Magnetics Inc . . . . . C5728  
 Joysun Abrasives Co Ltd. . . . . N3208  
**LaserStar Technologies Corp.** . . . . . C5647  
**Leveltek Intl LLC** . . . . . C5950  
 Magestic Systems Inc . . . . . C3710  
 Magnetic Products Inc . . . . . C5510  
 Matuschek Welding Products Inc . . . . . N1708  
 Multipress Inc . . . . . C1022  
**Nachi Robotic Systems Inc.** . . . . . N3622  
 Nebraska Public Power District . . . . . C7347  
 Ningbo Jinfeng Welding & Cutting Machinery Manufacture Co Ltd . . . . . N6007  
 P&G Fluid Power Inc . . . . . C1320  
 R&B Machining Inc . . . . . C2124  
 Reis Robotics USA Inc . . . . . N5910  
 Ross Controls . . . . . C849  
 Southern Systems Inc . . . . . C2256  
 T&H Lemont . . . . . C2117  
 TOX Pressotechnik LLC . . . . . C5024  
 Trystar . . . . . N1818  
**Wauseon Machine & Manufacturing Inc.** . . . . . C1539

## Associations

American Society For Nondestructive Testing . . . . . N1615  
 American Welding Online . . . . . N2233  
**American Welding Society** . . . . . N2031  
 Arrowhead Manufacturers & Fabricators Assoc . . . . . C8242  
 Association For Iron & Steel Technology . . . . . C8530  
 Electrocoat Association, The . . . . . C2255  
**Fabricators & Manufacturers Association** . . . . . C6538  
 Ironworkers Management Progressive Action Cooperative Trust (IMPACT) . . . . . N3004  
**Society of Manufacturing Engineers** . . . . . C6542

## Automated Storage & Retrieval Systems

CH Steel Solutions Inc . . . . . C7348  
 Demag Cranes and Components . . . . . C560  
 Hyd-Mech Group Ltd. . . . . C6523  
 Kasto Inc . . . . . C5934  
 Macrodyne Technologies Inc . . . . . C252  
 Prima Power North America Inc . . . . . C4336  
**Salvagnini America Inc.** . . . . . C3928  
 Southern Systems Inc . . . . . C2256  
**Steel King Industries Inc.** . . . . . C1057  
**TRUMPF Inc.** . . . . . C3016  
 Voortman Corporation . . . . . C7739  
 Webb-Stiles Co. . . . . C2435

## Automatic Guided Vehicles

CH Steel Solutions Inc . . . . . C7348  
 Daifuku Webb . . . . . C2425

## Bar Fabricating Machines

**Boschert Precision Machinery Inc.** . . . . . C2820  
 C Marshall Fabrication Machinery . . . . . C7716  
**Carell Corp/Eagle Bending Machines** . . . . . C5928  
 Chemtool Inc . . . . . C660  
 Euromac/Metal Finish LLC . . . . . C4716  
 FomUSA . . . . . C6914  
 Haeusler AG . . . . . C5540  
 JMT USA . . . . . C5047  
 Masteel America Corp . . . . . C3749  
 PythonX-Burlington Automation . . . . . C8116  
 Voortman Corporation . . . . . C7739

## Bellows, Metal

Advanced Laser Services LLC . . . . . C5634  
 BUWW Coverings Inc . . . . . C7320  
 Laser Experts Inc . . . . . C5742

## Beveling Machines

Ampco Metal Inc . . . . . C2326  
 Bug-O Systems . . . . . N4813, N5013  
 Climax Portable Machining & Welding Systems . . . . . N1422  
 CS Unitec Inc . . . . . N5531  
 EH Wachs Co. . . . . N5713  
 ESCO Tool Co. . . . . C5735  
 Euromac/Metal Finish LLC . . . . . C4716  
 Gullco International . . . . . N5002  
 Heck Industries . . . . . C4828  
**Hypertherm Inc.** . . . . . N3906  
 J & S Machine Inc . . . . . C2317  
 Kinetic Cutting Systems Inc . . . . . C6311  
 Manufacturing Solutions Inc . . . . . N1509  
 Mathey Dearman . . . . . N5710  
 New Centurion Enterprises Ltd. . . . . C8347  
 Nitto Kohki USA Inc . . . . . C1510  
**Orbitalum Orbital Cutting + Welding.** . . . . . N5713  
 Pador Marketing Group . . . . . N2927  
 Rhino Cutting Systems . . . . . N6138  
 Saar Hartmetall USA LLC . . . . . N5925  
 Sertom Group North America LLC . . . . . C6911  
 Tri Tool Inc . . . . . N5913





## Blanking

AIDA-America Corp. ....	C1210
ARKU Coil Systems Inc. ....	C7528
Beckwood Press Co. ....	C1228
Chelar Tool & Die Inc. ....	C349
China National Aero Technology IE Hangzhou Co. ....	C160
Gerb Vibration Control Systems ....	C852
Kong NGAI Precision Metal Mould Shenzhen Co Ltd. ....	C856
Nucor Building Systems ....	C1255
Stamtec Presses ....	C1052
Sutherland Presses ....	C152
Toledo Blank ....	C1149

## Blasting Equipment & Media

AFC Finishing Systems ....	C2548
Blastec Inc. ....	C8142
Ervin Industries ....	C7448
Euromac/Metal Finish LLC ....	C4716
I.S.T. International Surface Technologies ....	C1958
Liaoning Longyuan Industry Co Ltd. . .	C455
LS Industries Inc. ....	C8123
Metallizing Equipment Co PVT LTD. .	N2417
Metcast Service Tech Resources ....	C6946
Pangborn Corp. ....	C6516
Production Systems Inc. ....	C1858
Rosler Metal Finishing USA LLC. ....	C7733
VULKAN Blast Shot Technology ....	C2362
Wheelabrator Group ....	C7121

## Bore Welding Machines & Components

Bore Repair Systems Inc. ....	N6319
Climax Portable Machining & Welding Systems ....	N1422
D/F Machine Specialties Inc. ....	N2224
PROFAX / LENCO. ....	N3013
York Portable Machine Tools ....	N2925

## Brazing & Soldering Equipment

Ambrell Precision Induction Heating ....	C4950
CEIA USA. ....	N2917
Cyl-Tec Inc. ....	N3138
EFD Induction Inc. ....	C2139
Etal/INDUX Sa De Cv ....	N2433
Flame Technologies Inc. ....	N3219
Fusion Inc. ....	N3313
Gasflux Co. ....	N2833
gasgrab.com ....	N3225
Genstar Technologies Inc. ....	N2822
GH Induction Atmospheres LLC ....	C2323
Goss Inc. ....	N2722
Harris Products Group. ....	N4509

Koike Aronson Inc. ....	N4131
Multiplaz ....	N4909
Obraze ....	N4839
Pyro Shield Inc. ....	N6313
REXARC International. ....	N1515
Washington Alloy Co. ....	N2231

## Brazing Alloys

Bay State Surface Technologies. ....	N2419
BMM Welding Material Co. ....	N6109
Bohler Welding Group USA Inc. ....	N2013
Broco Inc. ....	N4926
Etal/INDUX Sa De Cv ....	N2433
Fusion Inc. ....	N3313
Gasflux Co. ....	N2833
GH Induction Atmospheres LLC ....	C2323
Harris Products Group. ....	N4509
Lucas-Milhaupt Inc. ....	N5027
Messer MG Welding Products ....	N2408
NetBrazo LLC. ....	N4139
Ningbo Powerway Alloy Material Co Ltd. ....	N5038
Obraze ....	N4839
Saru Silver Alloy Private Limited ....	N2410
Sulzer Metco US Inc. ....	N2413
Technogenia Inc. ....	N4924
Tianjin Jinlong Welding Material Co Ltd. ....	N6100
UltraBrazo ....	N6226
United Aluminum Corp. ....	C809
Uniweld Products Inc. ....	N5113
Victor Technologies Intl Inc. ....	N4522
Washington Alloy Co. ....	N2231
Winnox Industries Ltd. ....	N6111
Wolverine Joining Technologies. ....	N2818

## Brushes - Deburring & Polishing

Abtex Corp. ....	C7547
Apex Machine Group/ SlipCon USA ....	C5528
Armstrong/Kover Kwick Inc feat NCCM Mill Rolls ....	C7047
Beilun Futuo Mechanical Tools Co Ltd. ....	N6026
Bosch Power Tool Corp. ....	N5006
Costa & Grissom Machinery Co. ....	C7516
Easy Abrasives LLC. ....	N2618
Fladder-Hansen & Hundebol Inc. ....	C6328
Hangzhou Xiangsheng Abrasive Machine Manufacturing Co., Ltd. .	C7142
JAZ USA Inc. ....	N1831
Kent Corp. ....	C954, C2128
KLINGSPOR Abrasives Inc. ....	N3135
KULLEN - KOTI GmbH. ....	N3137
Lissmac Corp. ....	C4340
Maryland Brush Co. ....	N1317

Metabo Corp. ....	N6131
MTM Meissner Technik Mullenbach GmbH ....	C2155
Nitto Kohki USA Inc. ....	C1510
Norton Abrasives ....	N2610
OKI Bering. ....	N4531
Osborn. ....	C2737, N3309
PFERD INC. ....	N5018
Suhner Industrial Products Inc. ....	N3010
Superior Abrasives Inc. ....	N3215
Timesavers Inc. ....	C6340
United Abrasives Inc /SAIT. ....	N3104
Walter Surface Technologies ....	N2628
Weiler Corp. ....	N4831
Wendt USA LLC. ....	N2606

## Bulgeforming

Interlaken Technology. ....	C947
Triform Sheet Hydroforming. ....	C1226

## Bushings

Anchor Danly. ....	C931
Carr Lane Manufacturing Co. ....	N3036
Elizabeth Carbide Components. ....	C150
Fibro Inc. ....	C249
GMT North America. ....	C353
Hiwin Corp. ....	C1321
Joysun Abrasives Co Ltd. ....	N3208
Moeller Precision Tool ....	C1020
National Bronze & Metals Inc. ....	C1512
SelfLube ....	C558
Superior Die Set Corp. ....	C658

## CAD/Drafting Services

Echo Engineering. ....	C2056
EPSI Masking Co. ....	C2154
Hotfoil EHS Inc. ....	N1319
Unisorb Installation Technologies. . .	C1411

## Carriers/Reels - Cable Hose/ Welding Wire

Changzhou Wujin Golden Globe Welding & Cutting Machinery Co Ltd. ....	N5900
--------------------------------------------------------------------------	-------

## Carts

American Finishing Resources ....	C1855
CH Steel Solutions Inc. ....	C7348
EAS Mold & Die Change Systems, Inc	C1026
Emmegi USA Inc. ....	C7323
Jet. ....	C5923
JIT Automation Inc. ....	C756
JMR Industrial. ....	C3752
Mighty Hook Inc. ....	C2420
Ogden Welding Systems. ....	N3035
Southern Systems Inc. ....	C2256
Webb-Stiles Co. ....	C2435
Weldcoa. ....	N3238



## Casters, Wheels and Glides

Fast Rite International . . . . .	C854
Halifax Rack & Screw . . . . .	C7310
KME Germany GmbH & Co KG . . . . .	N1525
Nadella . . . . .	C7150

## Castings

Benxi Guangzheng Tungsten & Molybdenum Co Ltd . . . . .	C456
Carestream . . . . .	N2426
Kennametal Stellite . . . . .	N2528
Liaoning Longyuan Industry Co Ltd . . . . .	C455
Ningbo Hi-Tech Moldie Machinery Co Ltd . . . . .	C356
Shijiazhuang Fitex Trading Co Ltd . . . . .	C159
United Global Sourcing Inc . . . . .	C8336

## Centrifuges

Euromac/Metal Finish LLC . . . . .	C4716
Gerb Vibration Control Systems . . . . .	C852
Rosler Metal Finishing USA LLC . . . . .	C7733

## Chemical Feeders

Calvary Industries Inc . . . . .	C2734
Chemetall US Inc . . . . .	C2709
Coral Chemical Co . . . . .	C2417
DMP Corp . . . . .	C2054
DuBois Chemicals . . . . .	C2545
DuBois Chemicals . . . . .	C4938
PKG Equipment Inc . . . . .	C1953

## Chillers - Cutting

AKS Cutting Systems Inc . . . . .	C5135
Parker domnick hunter . . . . .	N1513
Semyx LLC . . . . .	C6347

## Chillers - Finishing

Parker domnick hunter . . . . .	N1513
Schreiber Chillers . . . . .	N2327

## Chillers - Other

Advanced Laser Services LLC . . . . .	C5634
Bolttech Mannings . . . . .	N2326
Parker domnick hunter . . . . .	N1513
RPAC Lasers . . . . .	C8411
Schreiber Chillers . . . . .	N2327

## Chillers - Thermal Spray

Bay State Surface Technologies . . . . .	N2419
HAI Advanced Material Spec . . . . .	N2319
International Thermal Spray Assoc (ITSA) . . . . .	N2509
Parker domnick hunter . . . . .	N1513
Schreiber Chillers . . . . .	N2327
Sulzer Metco US Inc . . . . .	N2413

## Chillers - Welding

CM Industries Inc . . . . .	N2810
Janda Co Inc . . . . .	N1924
Parker domnick hunter . . . . .	N1513
Schreiber Chillers . . . . .	N2327
Southern Copper & Supply . . . . .	N1926
TEC Torch Co Inc . . . . .	N4822
TJ Snow Co . . . . .	N2613
ZJ Industries Inc . . . . .	N2704

## Clamps/holders/Jigs/Vises

ABICOR Binzel Corp . . . . .	N5508
B&B Steel Products Inc . . . . .	N3107
BESSEY Tools North America . . . . .	N4931
C H Symington & Co Inc . . . . .	N2213
Carr Lane Manufacturing Co . . . . .	N3036
Clark Fixture Technologies . . . . .	C1520
Dr Gold & Co . . . . .	N5026
EAS Mold & Die Change Systems, Inc . . . . .	C1026
Flexarm Inc . . . . .	C7431
gasgrab.com . . . . .	N3225
Industrial Magnetics Inc . . . . .	C5728
Jingyu Welding & Cutting Co Ltd . . . . .	N1608
JIT Automation Inc . . . . .	C756
Mathey Dearman . . . . .	N5710
OKI Bering . . . . .	N4531
Pacesetter Systems . . . . .	C1412
Rimco Equipment . . . . .	N1631
Strong Hand Tools . . . . .	N3631
Sumner Manufacturing Co Inc . . . . .	N1519
Weldsale LLC . . . . .	N5124
Wilson Tool International . . . . .	C1013, C5116

## Cleaners/Wipes

Advanced Laser Services LLC . . . . .	C5634
Airflow Systems Inc . . . . .	N1110
Aquasol Corp . . . . .	N3613
Cimcool Fluid Technology . . . . .	C1452
Liaoning Longyuan Industry Co Ltd . . . . .	C455
Zerust Corrosion Solutions (Northern Tech Intl Corp) . . . . .	C1014

## Cleaning & Degreasing Compounds

ABICOR Binzel Corp . . . . .	N5508
Almco Inc . . . . .	C1220
Bohler Welding Group USA Inc . . . . .	N2013
Bradford Derustit Corp . . . . .	N4804
Bulk Chemicals Inc . . . . .	C2433
Calvary Industries Inc . . . . .	C2734
Cardinal Paint and Powder . . . . .	C1761
Carpenter Chemicals LC . . . . .	C2712
Chemetall US Inc . . . . .	C2709
Cimcool Fluid Technology . . . . .	C1452
Coral Chemical Co . . . . .	C2417

DuBois Chemicals . . . . .	C2545, C4938
Houghton International Inc . . . . .	C1437, C1552
Hubbard-Hall Inc . . . . .	C2156
International Chemical Co . . . . .	C1232
Kolene Corp . . . . .	C2509
LA-CO Industries/Markal . . . . .	N4802
Metalloid Corp . . . . .	C1447
MTM Meissner Technik Mullenbach GmbH . . . . .	C2155
OKI Bering . . . . .	N4531
Professional Finishing Systems . . . . .	C8239
Rock Valley Oil & Chemical Co Inc . . . . .	C1049
Rosler Metal Finishing USA LLC . . . . .	C7733
Tower Oil & Technology Co . . . . .	C1319
Walter Surface Technologies . . . . .	N2628

## Cleaning & Degreasing Equipment

Almco Inc . . . . .	C1220
BECCA Inc . . . . .	C1854
Bettcher Manufacturing LLC . . . . .	C1053
Capital Weld Cleaners . . . . .	N3007
Carpenter Chemicals LC . . . . .	C2712
Col-Met Spray Booths Inc . . . . .	C2537
Costa & Grissom Machinery Co . . . . .	C7516
DMP Corp . . . . .	C2054
Durr Ecoclean Inc . . . . .	C2437
Eisenmann Corp . . . . .	C2439
Electro-Steam Generator Corp . . . . .	C2410
General Fabrications Corp . . . . .	C2648
Goff Inc . . . . .	C2726
Guspro Inc . . . . .	C1952
H2O JET Inc . . . . .	C5713
I.S.T. International Surface Technologies . . . . .	C1958
KMI Systems Inc . . . . .	C2722
Kolene Corp . . . . .	C2509
KULLEN - KOTI GmbH . . . . .	N3137
LS Industries Inc . . . . .	C8123
Mayfran International Inc . . . . .	C939
Midwest Finishing Systems Inc . . . . .	C2526
MTM Meissner Technik Mullenbach GmbH . . . . .	C2155
Pangborn Corp . . . . .	C6516
PKG Equipment Inc . . . . .	C1953
Pneu-Mech Systems Manufacturing Inc . . . . .	C2539
Pretreatment Equipment Mfg Inc . . . . .	C1962, C2413
Production Systems Inc . . . . .	C1858
Professional Finishing Systems . . . . .	C8239
Rosler Metal Finishing USA LLC . . . . .	C7733
Spray-Tech/Junair . . . . .	C2164
Steelman Industries Inc . . . . .	C2058
Trimac Industrial Systems . . . . .	C2359



Uni-Spray Systems Inc . . . . .	C2412
Wheelabrator Group . . . . .	C7121
Zerust Corrosion Solutions (Northern Tech Intl Corp) . . . . .	C1014

**Cleaning & Phosphatizing  
Equipment**

Bulk Chemicals Inc . . . . .	C2433
Carpenter Chemicals LC . . . . .	C2712
COE Press Equipment . . . . .	C1323
DMP Corp . . . . .	C2054
DuBois Chemicals . . . . .	C2545, C4938
Eisenmann Corp . . . . .	C2439
Electro-Steam Generator Corp . . . . .	C2410
General Automatic Transfer . . . . .	C2550
<b>George Koch Sons LLC . . . . .</b>	<b>C2521</b>
<b>KMI Systems Inc . . . . .</b>	<b>C2722</b>
Midwest Finishing Systems Inc . . . . .	C2526
<b>MTM Meissner Technik</b>	
<b>Mullenbach GmbH . . . . .</b>	<b>C2155</b>
PKG Equipment Inc . . . . .	C1953
Pneu-Mech Systems Manufacturing Inc. . . . .	C2539
Powder Coating . . . . .	C2356
Powder-X Coating Systems . . . . .	C1262
Pretreatment Equipment Mfg Inc . . . . .	C1962, C2413
Rapid Engineering . . . . .	C2610
Trimac Industrial Systems . . . . .	C2359
Uni-Spray Systems Inc . . . . .	C2412

**Clinching/Stitchfolding  
Equipment**

Attexor Clinch Systems SA . . . . .	C5622
-------------------------------------	-------

**Clutches/Brakes & Friction  
Material**

Desch Canada Ltd . . . . .	C1235
Halifax Rack & Screw . . . . .	C7310
Orttech Inc. . . . .	C860

**CNC Machining**

Advanced Laser Services LLC . . . . .	C5634
Alpine Bender Machinery . . . . .	C1836
Baykal Makina Sanayi ve Ticaret AS . . . . .	C5940, C5947
Bettcher Manufacturing LLC . . . . .	C1053
Bliss Clearing Niagara . . . . .	C933
Bolttech Mannings . . . . .	N2326
Changzhou Huatong Welding Industry Co Ltd . . . . .	N6310
<b>Chelar Tool &amp; Die Inc . . . . .</b>	<b>C349</b>
Climax Portable Machining & Welding Systems . . . . .	N1422
Elizabeth Carbide Components . . . . .	C150

Elo Automated Stainless Steel Technologies Qingdao Co Ltd . . . . .	C8342
Emmegi USA Inc . . . . .	C7323
Etal/INDUX Sa De Cv . . . . .	N2433
F & G Tool and Die Co. . . . .	C1413
Fabrisonic LLC . . . . .	N6218
Felton Inc. . . . .	C7112
FomUSA . . . . .	C6914
HGG Profiling Equipment . . . . .	C8127
International Mold Steel . . . . .	C556
Machinery Marketing Intl . . . . .	C8337
Manufacturing Solutions . . . . .	C8429
Masteel America Corp . . . . .	C3749
Moeller Precision Tool . . . . .	C1020
Ningbo Hi-Tech Moldie Machinery Co Ltd . . . . .	C356
P&G Fluid Power Inc . . . . .	C1320
<b>Penn United Technologies Inc. . . . .</b>	<b>C1420</b>
Perfection Global LLC . . . . .	C3832
Precision Punch Corp. . . . .	C1432
Shijiazhuang Fitex Trading Co Ltd . . . . .	C159
SteelTailor Ltd . . . . .	N4919
Tri Tool Inc . . . . .	N5913
United Global Sourcing Inc . . . . .	C8336
Yestool/Aloris-USA . . . . .	C8310

**Coating Equipment**

American Finishing Resources . . . . .	C1855
Anest Iwata USA Inc. . . . .	C2746
<b>Binks DeVilbiss Ransburg BGK . . . . .</b>	<b>C2532</b>
C.A. Technologies Inc . . . . .	C1763
<b>Centerline (Windsor) Ltd . . . . .</b>	<b>N1926</b>
<b>Chemical Coaters Assoc Int'l . . . . .</b>	<b>C1948</b>
Decoral System USA Corp . . . . .	C1954
Delta Steel Technologies . . . . .	C5952
Eisenmann Corp . . . . .	C2439
General Automatic Transfer . . . . .	C2550
<b>George Koch Sons LLC . . . . .</b>	<b>C2521</b>
Global Finishing Solutions . . . . .	C2151
Inline Sieve . . . . .	C2552
Intech Services Inc . . . . .	C2163
IonBond . . . . .	C1010
KCI America Co Ltd . . . . .	C2062
Keyland Polymer Ltd . . . . .	C2063
Krautzberger LLC . . . . .	C1964
NIC Industries Inc . . . . .	C2426
<b>Nordson Corp . . . . .</b>	<b>C2517</b>
Porcelain Enamel Institute Inc . . . . .	C2436
Powder Coating . . . . .	C2356
Powder-X Coating Systems . . . . .	C1262
Production Systems Inc . . . . .	C1858
Richards-Wilcox Inc . . . . .	C2252
Shercon Inc . . . . .	C2735
Spray-Tech/Junair . . . . .	C2164
Technogenia Inc . . . . .	N4924

Trimac Industrial Systems . . . . .	C2359
TWN Industries Inc . . . . .	C2446
Vulcan Catalytic Infrared Oven Systems	C2512
Wagner Industrial Solutions . . . . .	C1951

**Coatings (Consumable)**

AkzoNobel Powder Coatings . . . . .	C2258
Baril Coatings USA . . . . .	C2158
Bulk Chemicals Inc . . . . .	C2433
<b>Calvary Industries Inc . . . . .</b>	<b>C2734</b>
Cardinal Paint and Powder . . . . .	C1761
<b>Chemical Coaters Assoc Int'l . . . . .</b>	<b>C1948</b>
Daymark Technologies . . . . .	N2222
Diamond Vogel Paints . . . . .	C2414
Enhancement Technologies / Sublitex-Miroglio . . . . .	C1561
Gem Tool Corporation . . . . .	C2320
Houghton International Inc . . . . .	C1437, C1552
Intech Services Inc . . . . .	C2163
International Chemical Co. . . . .	C1232
IonBond . . . . .	C1010
Lambda Research Optics Inc. . . . .	C5633
LORD Corporation . . . . .	N2011
PPG Industries . . . . .	C2739
St Louis Metallizing Co . . . . .	N2315
Strathmore Products Inc . . . . .	C1955
<b>Sulzer Metco US Inc . . . . .</b>	<b>N2413</b>
TAFI Inc . . . . .	N2318
Technogenia Inc . . . . .	N4924
Weld-Aid Products . . . . .	N4928

**Coil Cars & Cradles**

<b>American Machine &amp; Rollform Tech. . . . .</b>	<b>C5520</b>
ARKU Coil Systems Inc . . . . .	C7528
<b>Athader . . . . .</b>	<b>C5520</b>
<b>Bradbury Co., Inc., The . . . . .</b>	<b>C5520</b>
<b>Bradbury Group, The . . . . .</b>	<b>C5520</b>
Butech Bliss . . . . .	C5532
<b>Chicago Slitter . . . . .</b>	<b>C7023</b>
Cidan Machinery Inc. . . . .	C3449
COE Press Equipment . . . . .	C1323
D&H Machinery Inc. . . . .	C2112
Delta Steel Technologies . . . . .	C5952
Feed Lease Corp . . . . .	C928
<b>Hayes International . . . . .</b>	<b>C5520</b>
Herr Voss Stamco . . . . .	C7239
Machine Concepts Inc. . . . .	C4726
Metform International Ltd. . . . .	C5534
Minster Machine Co, The . . . . .	C649
Philpott Rubber/Lankhorst Mouldings	C823
Red Bud Industries . . . . .	C4732
Samco Machinery Ltd . . . . .	C1217
<b>Universal Tube &amp; Rollform     Equipment Corp. . . . .</b>	<b>C1528</b>





## Coil Cut-to-Length

American Machine & Rollform Tech.	C5520
ARKU Coil Systems Inc.	C7528
Athader	C5520
Beck Automation	C5520
Bradbury Co., Inc., The	C5520
Bradbury Group, The	C5520
Burghardt + Schmidt GmbH	C4934
Butech Bliss	C5532
Chicago Slitter	C7023
Cidan Machinery Inc.	C3449
COE Press Equipment	C1323
Costa & Grissom Machinery Co.	C7516
D&H Machinery Inc.	C2112
Delta Steel Technologies	C5952
Feed Lease Corp.	C928
Formtek Metal Forming & Hill Engineering	C3708
Herr Voss Stamco	C7239
Leveltek Intl LLC	C5950
Metform International Ltd.	C5534
Norwalk Innovation	C1055
Red Bud Industries	C4732
Samco Machinery Ltd.	C1217
TCT Stainless Steel Inc.	C1058
T-DRILL Industries Inc.	C2121
Ulbrich Stainless Steels & Special Metals Inc.	C1015
Universal Tube & Rollform Equipment Corp.	C1528
Vicon - Plasma Automation Inc.	N5031

## Coil End Joining Equipment

AMET Inc.	N4518
ARKU Coil Systems Inc.	C7528
Guild International	C2234
Ideal Welding Systems LP	N5008
Innerspec Technologies	N2217
Kent Corp.	C954, C2128
Metform International Ltd.	C5534
WAFIOS Machinery Corp.	C1736

## Coil Feed Line

AIDA-America Corp.	C1210
ARKU Coil Systems Inc.	C7528
COE Press Equipment	C1323
Feed Lease Corp.	C928
Herr Voss Stamco	C7239
Minster Machine Co, The	C649
Schuler Incorporated	C917
Stamtec Presses	C1052
Sutherland Presses	C152
Toledo Blank	C1149

## Coil Leveling Equipment

ARKU Coil Systems Inc.	C7528
------------------------	-------

Bradbury Co., Inc., The	C5520
Bradbury Group, The	C5520
Burghardt + Schmidt GmbH	C4934
Butech Bliss	C5532
Chicago Slitter	C7023
Costa & Grissom Machinery Co.	C7516
D&H Machinery Inc.	C2112
Delta Steel Technologies	C5952
Formtek Metal Forming & Hill Engineering	C3708
Herr Voss Stamco	C7239
Leveltek Intl LLC	C5950
Machine Concepts Inc.	C4726
Metform International Ltd.	C5534
Red Bud Industries	C4732
Samco Machinery Ltd.	C1217
TCT Stainless Steel Inc.	C1058

## Coil Lifters/Positioners

D&H Machinery Inc.	C2112
Industrial Magnetics Inc.	C5728
JMR Industrial	C3752
Linemaster Switch Corp.	C2324
Pador Marketing Group	N2927
Permatur Industries Inc.	N3006
Roll Former Corp.	C1037
Walker Magnetics	C7536

## Coil Packaging Systems

Athader	C5520
Burghardt + Schmidt GmbH	C4934
Chicago Slitter	C7023
D&H Machinery Inc.	C2112
Delta Steel Technologies	C5952
Herr Voss Stamco	C7239
Samuel Strapping Systems	C1524

## Coil Processing - Protectors & Covers

Armstrong/Kover Kwick Inc feat NCCM Mill Rolls	C7047
Cidan Machinery Inc.	C3449
Costa & Grissom Machinery Co.	C7516
Nitto Denko America Inc.	C8409
Philpott Rubber/Lankhorst Mouldings	C823
Polyurethane Products Corp.	C3811

## Coil Processing - Tension Boards

Armstrong/Kover Kwick Inc feat NCCM Mill Rolls	C7047
Burghardt + Schmidt GmbH	C4934
Chicago Slitter	C7023
Costa & Grissom Machinery Co.	C7516
Herr Voss Stamco	C7239
Machine Concepts Inc.	C4726

## Coil Processing Accessories

Alliance Machine and Engraving LLC	C5520
Armstrong/Kover Kwick Inc feat NCCM Mill Rolls	C7047
ASKO Inc.	C4810
Athader	C5520
Chicago Slitter	C7023
Cidan Machinery Inc.	C3449
Enhancement Technologies / Sublitez-Miroglio	C1561
ERIEZ	C7316
Herr Voss Stamco	C7239
KLINGSPOR Abrasives Inc.	N3135
Machine Concepts Inc.	C4726
Measurement Systems Intl.	C7138
Nitto Denko America Inc.	C8409
Philpott Rubber/Lankhorst Mouldings	C823
Polyurethane Products Corp.	C3811
Red Bud Industries	C4732

## Coil Processing Rolls - Fabric, Urethane, Felt

Alliance Machine and Engraving LLC	C5520
Armstrong/Kover Kwick Inc feat NCCM Mill Rolls	C7047
Burghardt + Schmidt GmbH	C4934
Chicago Slitter	C7023
Costa & Grissom Machinery Co.	C7516
Herr Voss Stamco	C7239
Machine Concepts Inc.	C4726
Philpott Rubber/Lankhorst Mouldings	C823

## Coil Slitters

ARKU Coil Systems Inc.	C7528
Armstrong/Kover Kwick Inc feat NCCM Mill Rolls	C7047
ASKO Inc.	C4810
Athader	C5520
Bradbury Co., Inc., The	C5520
Bradbury Group, The	C5520
Burghardt + Schmidt GmbH	C4934
Butech Bliss	C5532
Chicago Slitter	C7023
Cidan Machinery Inc.	C3449
COE Press Equipment	C1323
Costa & Grissom Machinery Co.	C7516
D&H Machinery Inc.	C2112
Delta Steel Technologies	C5952
Herr Voss Stamco	C7239
Machine Concepts Inc.	C4726
Metform International Ltd.	C5534
Philpott Rubber/Lankhorst Mouldings	C823
Polyurethane Products Corp.	C3811
Red Bud Industries	C4732



Samco Machinery Ltd . . . . . C1217  
 TCT Stainless Steel Inc . . . . . C1058  
 Ulbrich Stainless Steels &  
 Special Metals Inc . . . . . C1015

**Coil Strip Accumulator/Loop Control Systems**

Burghardt + Schmidt GmbH . . . . . C4934  
 Guild International . . . . . C2234  
 Herr Voss Stamco . . . . . C7239  
 Kent Corp. . . . . C954, C2128  
 Machine Concepts Inc. . . . . C4726  
 Metform International Ltd. . . . . C5534  
 Mill Masters . . . . . C1533  
 T&H Lemont . . . . . C2117

**Coil Uncoilers/Recoilers**

Accra-Wire Controls Inc . . . . . C1256  
 Alma Machinery Co. . . . . C1431  
 Athader . . . . . C5520  
 Bradbury Co., Inc., The . . . . . C5520  
 Bradbury Group Australia . . . . . C5520  
 Bradbury Group, The . . . . . C5520  
 Bruderer Machinery Inc. . . . . C925  
 Burghardt + Schmidt GmbH . . . . . C4934  
 Chicago Slitter . . . . . C7023

Cidan Machinery Inc . . . . . C3449  
 Costa & Grissom Machinery Co . . . . . C7516  
 D&H Machinery Inc. . . . . C2112  
 Delta Steel Technologies . . . . . C5952  
 Feed Lease Corp . . . . . C928  
 Formtek Metal Forming &  
 Hill Engineering . . . . . C3708

Hayes International . . . . . C5520  
 Herr Voss Stamco . . . . . C7239  
 Kent Corp. . . . . C954, C2128  
 Machine Concepts Inc. . . . . C4726  
 Metform International Ltd. . . . . C5534  
 Minster Machine Co, The . . . . . C649  
 Norwalk Innovation . . . . . C1055  
 Red Bud Industries . . . . . C4732  
 Roll Former Corp . . . . . C1037  
 Samco Machinery Ltd . . . . . C1217  
 T-DRILL Industries Inc . . . . . C2121  
 Universal Tube & Rollform  
 Equipment Corp. . . . . C1528  
 WAFIOS Machinery Corp . . . . . C1736

**Combustion Systems for Ovens, Washers**

Fostoria Process Equipment . . . . . C2148  
 General Automatic Transfer . . . . . C2550

General Fabrications Corp. . . . . C2648  
 Midwest Finishing Systems Inc . . . . . C2526  
 Production Systems Inc. . . . . C1858  
 Rapid Engineering . . . . . C2610  
 Red-Ray Manufacturing Co Inc. . . . . C2052  
 Trimac Industrial Systems. . . . . C2359

**Compressed Air Dryers & Filters - Finishing**

C.A. Technologies Inc . . . . . C1763  
 Compressed Air . . . . . N3034  
 Krautberger LLC . . . . . C1964  
 Parker domnick hunter . . . . . N1513  
 TDC Filter Inc. . . . . N2622

**Computer Hardware Systems & Components**

AceCad Software . . . . . C2825  
 AMET Inc. . . . . N4518  
 Beckhoff Automation . . . . . C7545  
 Computers Unlimited . . . . . N3315  
 DELTA Computer Systems Inc. . . . . C1024  
 Global Shop Solutions. . . . . C7312  
 Link Systems . . . . . C909

**EXTREME CLEANING TECHNOLOGIES®**

**Kontinuuous™  
 In-Line Paint  
 Stripping  
 System**

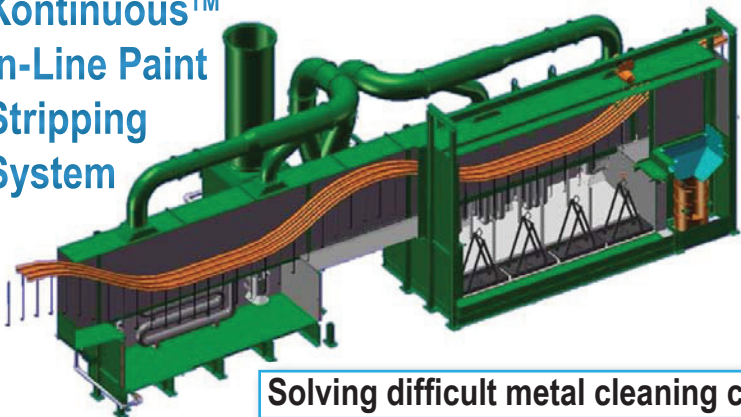

**Solving difficult metal cleaning challenges for over 70 years.**

See Kolene at



**FINISHING PAVILION**  
 November 12-14, 2012  
[fabtechexpo.com](http://fabtechexpo.com)

**Booth # C2509**

- Improve quality and throughput of your paint line with Kontinuuous™ in-line rack and hook stripping.
- Remove organic coatings completely in seconds.



(800) 521-4182

[kolene.com](http://kolene.com)



## Computer Hardware Systems & Components

Prodim USA	C8521
Shop Edge Software Inc	C1434
Toledo Integrated Systems	C1317
Trendex Information Systems Inc	N3218
Victory Plasma Systems Inc	N4833

## Consulting - Finishing Technology

<b>Alliance Machine and Engraving LLC</b>	<b>C5520</b>
American Finishing Resources	C1855
<b>Anomatic Corp.</b>	<b>C2452</b>
Haynncorp Industrial Finishing Solutions	C2360
<b>IntelliFinishing</b>	<b>C2528</b>
Nation Coating Systems Inc	N2416
Powder Coating Consultants	C2422
Production Systems Inc	C1858

## Consulting - Management

5S Supply	C3454
Meltric Corp	N4826
North America Consulting	N6333
Powder Coating Consultants	C2422
<b>Precision Metalforming Association</b>	<b>C463</b>
Site Location Partnership (SLP)	N1406
State of Wyoming	N3133

## Consulting - Manufacturing Technology

Abtex Corp.	C7547
Accurate Die Design Inc/ Logopress Corp	C1423
<b>Anomatic Corp.</b>	<b>C2452</b>
Arc Specialties Inc	N1610
ASKO Inc	C4810
FARO Technologies Inc	C7636
Global Shop Solutions	C7312
KME Germany GmbH & Co KG	N1525
KoCos America LLC	C2223
<b>Logopress Corp</b>	<b>C1423</b>
Meltric Corp	N4826
MetaMation Inc	C3737
<b>MIE Solutions Inc</b>	<b>C7212</b>
Packsize LLC	C1336
<b>Precision Metalforming Association</b>	<b>C463</b>
Pronic Inc	C828
Robotmaster-In-House Solutions Inc	N5933
Shercon Inc	C2735
State of Wyoming	N3133
Tower Oil & Technology Co	C1319
TWN Industries Inc	C2446
Weldcoa	N3238

## Consulting - Marketing

Expansion Solutions Magazine	C7346
<b>Long Haul Trucking</b>	<b>C4349</b>
Nebraska Public Power District	C7347
Site Location Partnership (SLP)	N1406
State of Wyoming	N3133
Studio Eleven/Vivid Mfg Group	C754

## Consulting - Quality/ISO

5S Supply	C3454
FARO Technologies Inc	C7636
Global Shop Solutions	C7312
Powder Coating Consultants	C2422
State of Wyoming	N3133
Welder Training & Testing Institute	N1533

## Consulting - Safety

CH Steel Solutions Inc	C7348
<b>CNA Insurance</b>	<b>C7247</b>
CoreTemp	N6236
DualDraw LLC	N2506
Fastenal Company	N5736
Meltric Corp	N4826
Powder Coating Consultants	C2422
Rimco Equipment	N1631
State of Wyoming	N3133

## Conversion Coatings

Bulk Chemicals Inc	C2433
<b>Calvary Industries Inc</b>	<b>C2734</b>
DuBois Chemicals	C2545
DuBois Chemicals	C4938
Hubbard-Hall Inc	C2156
International Chemical Co	C1232
Powder Coating	C2356
Strathmore Products Inc	C1955

## Conveyor Systems

Accra-Wire Controls Inc	C1256
<b>Apex Machine Group/ SlipCon USA</b>	<b>C5528</b>
Behringer Saws Inc	C5722
BTM Bandsaws	C8416
CH Steel Solutions Inc	C7348
Controlled Automation Inc	C7730
Daifuku Webb	C2425
Emmegi USA Inc	C7323
ERIEZ	C7316
Ficep Corporation	C6550
General Automatic Transfer	C2550
Haberle / Ken Bergman & Assoc LLC	C7137
<b>Hayes International</b>	<b>C5520</b>
Hyd-Mech Group Ltd	C6523
Industrial Magnetics Inc	C5728
<b>IntelliFinishing</b>	<b>C2528</b>
Kasto Inc	C5934

<b>KMI Systems Inc</b>	<b>C2722</b>
Lissmac Corp	C4340
LS Industries Inc	C8123
Magnetic Products Inc	C5510
Marvel Manufacturing Co	C6316
Mayfran International Inc	C939
<b>Mighty Hook Inc</b>	<b>C2420</b>
Ocean Machinery Inc	C7523
Ogden Welding Systems	N3035
Osborn	C2737, N3309
Pangborn Corp	C6516
Pax Products Inc	C1428
Peddinghaus Corp	C7723
Philpott Rubber/Lankhorst Mouldings	C823
Polyurethane Products Corp	C3811
Powder Coating	C2356
PythonX-Burlington Automation	C8116
Richards-Wilcox Inc	C2252
Southern Systems Inc	C2256
Steel Storage Systems Inc	C6916
Voortman Corporation	C7739
Vulcan Catalytic Infrared Oven Systems	C2512
Webb-Stiles Co	C2435

## Coolants

California Cold Saw	C7240
<b>Chemetall US Inc</b>	<b>C2709</b>
Chemtool Inc	C660
Cimcool Fluid Technology	C1452
Coral Chemical Co	C2417
DoALL Sawing Products	C7713
Doringer Cold Saws	C4913
DuBois Chemicals	C2545
DuBois Chemicals	C4938
Emmegi USA Inc	C7323
ERIEZ	C7316
Fuchs Lubricants Co	C1517
Global Metal Spinning Solutions Inc	C934
Haberle / Ken Bergman & Assoc LLC	C7137
HE&M Saw Inc	C5508
Houghton International Inc	C1437, C1552
Intercon Enterprises Inc	N3227
International Chemical Co	C1232
Laser Experts Inc	C5742
LENOX	C4808
<b>Metalloid Corp</b>	<b>C1447</b>
Nitto Kohki USA Inc	C1510
Rock Valley Oil & Chemical Co Inc	C1049
Taylor Enterprises Inc	C347
Tower Oil & Technology Co	C1319
UltraLube	C7539
Unist Inc	C847
Walter Surface Technologies	N2628





## Corner Forming Machines

Euromac/Metal Finish LLC	C4716
Global Metal Spinning Solutions Inc.	C934
International Technologies Inc.	C8111
<b>Triform Sheet Hydroforming</b>	<b>C1226</b>

## Cranes

Demag Cranes and Components	C560
Gorbel Inc.	C2336
JMR Industrial	C3752
Linemaster Switch Corp.	C2324
Permadr Industries Inc.	N3006
SPANCO Inc.	C2212
Vulcan Catalytic Infrared Oven Systems	C2512

## Cryogenic Equipment/Pumps/Trailers

Chart Inc.	N3204
Cyl-Tec Inc.	N3138
Fiba Technologies Inc.	N6324
Weldcoa	N3238
Western Enterprises	N2933

## Custom Machinery - Sheet Metal & Plate

<b>AKS Cutting Systems Inc.</b>	<b>C5135</b>
<b>Apex Machine Group/SlipCon USA</b>	<b>C5528</b>
<b>Beckwood Press Co.</b>	<b>C1228</b>
<b>Betenbender Manufacturing Inc.</b>	<b>C3744</b>
Bliss Clearing Niagara	C933
Bowlin Engineering	C4838
<b>Carell Corp/Eagle Bending Machines</b>	<b>C5928</b>
<b>Chicago Slitter</b>	<b>C7023</b>
COMAQ Inc.	C5125
Controlled Automation Inc.	C7730
Elo Automated Stainless Steel Technologies Qingdao Co Ltd.	C8342
Friggi N.A. Inc.	C7642
Greenerd Press & Machine Company Inc.	C815
KMT Waterjet Systems Inc.	C6334
Lissmac Corp.	C4340
LS Industries Inc.	C8123
Mayfran International Inc.	C939
Ningbo Hi-Tech Moldie Machinery Co Ltd.	C356
Norlok Technology Inc.	C4840
P&G Fluid Power Inc.	C1320
Pandjiris Inc.	N4810
PythonX-Burlington Automation	C8116
<b>Salvagnini America Inc.</b>	<b>C3928</b>
Semx LLC	C6347
Sertom Group North America LLC	C6911

Shred-Tech Compass Systems	C7550
Steelmax Tools	N4737
Timesavers Inc.	C6340
TJ Snow Co.	N2613
Toolmen Corp.	C1253
Tri Tool Inc.	N5913
<b>Triform Sheet Hydroforming</b>	<b>C1226</b>
Unipunch Products Inc.	C3732
Victory Plasma Systems Inc.	N4833
Weil Engineering North America	C8209
Westingcut Industrial Technology Anhui Inc.	N1424

## Cutoff Grinding Wheels

Alpha Professional Tools	N6331
Automec Inc.	C4832
Beilun Futuo Mechanical Tools Co Ltd.	N6026
CoreTemp	N6236
CTD Machines Inc.	C8423
Doringer Cold Saws	C4913
Easy Abrasives LLC	N2618
Gem Tool Corporation	C2320
JAZ USA Inc.	N1831
Joysun Abrasives Co Ltd.	N3208
KLINGSPOR Abrasives Inc.	N3135
Mercer Abrasives	N6016
Metabo Corp.	N6131
<b>Norton Abrasives</b>	<b>N2610</b>
Osborn	C2737, N3309
PFERD INC.	N5018
Rex-Cut Abrasives	N2708
Suhner Industrial Products Inc.	N3010
United Abrasives Inc./SAIT.	N3104
Walter Surface Technologies	N2628
<b>Weiler Corp.</b>	<b>N4831</b>
Winnox Industries Ltd.	N6111

## Cutting Tips

American Torch Tip Co Inc.	N2022
C H Symington & Co Inc.	N2213
Centricut	C4935
Changzhou Huatong Welding Industry Co Ltd.	N6310
Flame Technologies Inc.	N3219
Genstar Technologies Inc.	N2822
Goss Inc.	N2722
Haberle / Ken Bergman & Assoc LLC	C7137
Harris Products Group	N4509
<b>Hypertherm Inc.</b>	<b>N3906</b>
Joysun Abrasives Co Ltd.	N3208
Komatsu America Industries LLC	C1239, C6510
LONGEVITY Welding & Cutting Products	N5109

Mathey Dearman	N5710
<b>Messer Cutting Systems</b>	<b>C5916</b>
Ningbo Jinfeng Welding & Cutting Machinery Manufacture Co Ltd.	N6007
North (Nanjing) Instrument Technology Industries Group.	N3226
Termmei Torch & Tip Company	N2526
<b>Thermacut Inc.</b>	<b>N5508</b>
Uniweld Products Inc.	N5113

## Cutting Tools

Arrowhead Manufacturers & Fabricators Assoc.	C8242
ATI Stellram	N1733
Bad Dog Tools	N3106
BESSEY Tools North America	N4931
C Marshall Fabrication Machinery	C7716
California Cold Saw	C7240
CGW-Camel Grinding Wheels USA	N5526
Chemtool Inc.	C660
Chicago Pneumatic Tool Co.	C4750
Climax Portable Machining & Welding Systems	N1422
Darex LLC	C8138
Dynabrade Inc.	C2409
Easy Abrasives LLC	N2618
Eberle America Inc.	C8312
EH Wachs Co.	N5713
Epilog Laser Corp.	C7350
Ermak USA	C3447
ESCO Tool Co.	C5735
Fastenal Company	N5736
G&J Hall Tools Inc.	N3025
Haberle / Ken Bergman & Assoc LLC	C7137
Harris Products Group	N4509
Hydro Carbide Inc.	C8238
<b>Hypertherm Inc.</b>	<b>N3906</b>
IonBond	C1010
<b>Jet Edge</b>	<b>C4349</b>
Joysun Abrasives Co Ltd.	N3208
M K Morse Co, The	C7109
Miller Electric Mfg Co.	N5213, N5816
Multiplaz	N4909
New Centurion Enterprises Ltd.	C8347
<b>Orbitalum Orbital Cutting + Welding</b>	<b>N5713</b>
Rex-Cut Abrasives	N2708
Suhner Industrial Products Inc.	N3010
T-DRILL Industries Inc.	C2121
Top Cat Air Tools	C2361
Tri Tool Inc.	N5913
Tsune America	C3450
York Portable Machine Tools	N2925



## Cylinders - Hydraulic, Pneumatic

Centerline (Windsor) Ltd. ....	N1926
GMT North America .....	C353
Hilma Division Carr Lane Roemheld ..	C449

## Deburring Equipment

Abtex Corp. ....	C7547
Almco Inc. ....	C1220
AM Machinery Sales .....	C5528
<b>Apex Machine Group/</b>	
<b>SlipCon USA</b> .....	<b>C5528</b>
ATI Industrial Automation .....	N5708
Burr King Manufacturing Co. ....	C4740
CIMID Corp. ....	C8327
Comco Inc. ....	C5052
Costa & Grissom Machinery Co. ....	C7516
CS Unitec Inc. ....	N5531
Dynabrade Inc. ....	C2409
Easy Abrasives LLC .....	N2618
Euromac/Metal Finish LLC .....	C4716
Fastenal Company. ....	N5736
Fein Power Tools Inc. ....	N5902
<b>Fladder-Hansen &amp; Hundebol Inc.</b> ....	<b>C6328</b>
Goff Inc. ....	C2726
Haberle / Ken Bergman & Assoc LLC .....	C7137
Hangzhou Xiangsheng Abrasive Machine Manufacturing Co., Ltd. .	C7142
Heck Industries .....	C4828
Hollbrit Inc. ....	N6317
Jet .....	C5923
Joysun Abrasives Co Ltd. ....	N3208
Kent Corp. ....	C954, C2128
KULLEN - KOTI GmbH .....	N3137
Lissmac Corp. ....	C4340
Metabo Corp. ....	N6131
<b>Metcast Service Tech Resources</b> ...	<b>C6946</b>
Michigan Pneumatic Tool Inc. ....	N6034
<b>MTM Meissner Technik</b>	
<b>Mullenbach GmbH</b> .....	<b>C2155</b>
Nitto Kohki USA Inc. ....	C1510
Osborn. ....	C2737, N3309
Pangborn Corp. ....	C6516
PFERD INC. ....	N5018
PHI. ....	C2122
Preston-Eastin Inc. ....	N5731
Professional Finishing Systems ....	C8239
Pushcorp Inc. ....	N5934
Rex-Cut Abrasives. ....	N2708
Rosler Metal Finishing USA LLC. ....	C7733
Saar Hartmetall USA LLC .....	N5925
Scantool USA By CML USA .....	C7147
Suhner Industrial Products Inc. ....	N3010
T&H Lemont .....	C2117
Timesavers Inc. ....	C6340

United Abrasives Inc /SAIT. ....	N3104
Walter Surface Technologies .....	N2628
<b>Weiler Corp.</b> .....	<b>N4831</b>
Wendt USA LLC. ....	N2606
Wheelabrator Group. ....	C7121

## Die Coatings & Finishes

Corewire Ltd. ....	N2910
IonBond .....	C1010
Moeller Precision Tool .....	C1020
Rocklin Manufacturing Co. ....	C1433
Wilson Tool International. . .	C1013, C5116

## Die Components/Die Cushions/ Die Punches/Buttons/Die Springs

American Punch Co. ....	C5026
Anchor Danly. ....	C931
Associated Spring Raymond. ....	C1426
Carr Lane Manufacturing Co. ....	N3036
<b>Chelar Tool &amp; Die Inc</b> .....	<b>C349</b>
Cleveland Steel Tool Co .....	C5522
Fibro Inc. ....	C249
GMT North America .....	C353
Hydro Carbide Inc. ....	C8238
Moeller Precision Tool .....	C1020
SelfLube .....	C558
Superior Die Set Corp. ....	C658
Toledo Blank .....	C1149
Wilson Tool International. . .	C1013, C5116

## Die Components/Die Cushions/ Die Punches/Die Springs

Passline Performance .....	C2325
Ready Technology Inc .....	C832

## Die Handling Equipment

EAS Mold & Die Change Systems, Inc. ....	C1026
GMT North America .....	C353
JIT Automation Inc .....	C756
<b>Marion Die &amp; Fixture Inc.</b> .....	<b>C5520</b>
Minster Machine Co, The. ....	C649
Pacesetter Systems. ....	C1412
Reis Robotics USA Inc. ....	N5910

## Die Protection Equipment

CIECO Inc. ....	C1334
Industrial Innovations Inc .....	C836
ISB Group .....	C4728
JIT Automation Inc .....	C756
Pacesetter Systems. ....	C1412
Rocklin Manufacturing Co. ....	C1433
Toledo Blank .....	C1149
TOP YES Precision Metal Products Co LTD. ....	C1028
Wintriss Controls .....	C3711

## Die Sets

A-G Tool & Die .....	C920
<b>American Machine &amp; Rollform Tech.</b>	<b>C5520</b>
American Punch Co. ....	C5026
Anchor Danly. ....	C931
<b>Chelar Tool &amp; Die Inc</b> .....	<b>C349</b>
Cleveland Steel Tool Co .....	C5522
Dongsan Bearing Co .....	C833
Elizabeth Carbide Components. ....	C150
Fibro Inc. ....	C249
GMT North America .....	C353
Hydro Carbide Inc. ....	C8238
Lillbacka Powerco USA Inc. ....	C2132
Moeller Precision Tool .....	C1020
Pacesetter Systems. ....	C1412
Pottiez America LP .....	C1025
Ready Technology Inc .....	C832
Superior Die Set Corp. ....	C658
Unipunch Products Inc. ....	C3732
Whistler & Sons Inc, SB .....	C4720

## Die Storage/Handling Systems

Anchor Danly. ....	C931
CH Steel Solutions Inc .....	C7348
EAS Mold & Die Change Systems, Inc .....	C1026
Industrial Magnetics Inc. ....	C5728
Kasto Inc. ....	C5934
Macrodyne Technologies Inc .....	C252
Minster Machine Co, The .....	C649
Pacesetter Systems. ....	C1412
Polyurethane Products Corp .....	C3811
<b>Steel King Industries Inc.</b> .....	<b>C1057</b>
Steel Storage Systems Inc .....	C6916
Versatility Professional Tool Storage, LLC .....	C1248
Webb-Stiles Co. ....	C2435

## Directory/Contact Database

Pacific Gas and Electric Company. . .	N1407
Site Location Partnership (SLP). ....	N1406

## Downdraft Tables/Booths/ Benches

Ace Industrial Products .....	N5009
Airflow Systems Inc .....	N1110
Airgas Inc .....	N5231
Avani Environmental Intl Inc. ....	N4537
Clean Air Consultants/Filter 1. ....	C2428
Coral Spa / Industrial Air Solutions .	N2813
Diversi-Tech Inc. ....	N1922
Donaldson Torit - Donaldson Company Inc. . .	C8121, N6028

DualDraw LLC	N2506
Industrial Maid	N2428
Kemper America Inc	N2631
Kinetic Cutting Systems Inc	C6311
KLINGSPOR Abrasives Inc.	N3135
Micro Air	N1806
Nederman Inc	N1604
Production Systems Inc.	C1858
Weldsale LLC	N5124

### Drilling Machines

Automec Inc	C4832
Baileigh Industrial Inc	C7513
Behringer Saws Inc	C5722
Cleveland Steel Tool Co	C5522
Climax Portable Machining & Welding Systems	N1422
COB Industries Inc.	N5919
Controlled Automation Inc	C7730
CS Unitec Inc.	N5531
Darex LLC	C8138
Dynabrade Inc	C2409
Elumatec North America Inc.	C2849
Emmegi USA Inc	C7323
Fein Power Tools Inc	N5902
Ficep Corporation	C6550
FomUSA	C6914
G&J Hall Tools Inc.	N3025
Hougen Manufacturing Inc	C4821
International Technologies Inc	C8111
Kinetic Cutting Systems Inc	C6311
KNUTH Machine Tools USA Inc	C4910
Kong NGAI Precision Metal Mould Shenzhen Co Ltd	C856
Machinery Marketing Intl	C8337
Manufacturing Solutions	C8429
Manufacturing Solutions Inc.	N1509
Masteel America Corp	C3749
Nitto Kohki USA Inc	C1510
Ocean Machinery Inc	C7523
Peddinghaus Corp.	C7723
<b>PTR-Precision Technologies Inc</b>	<b>N5226</b>
Pushcorp Inc	N5934
PythonX-Burlington Automation	C8116
Shijiazhuang Fitex Trading Co Ltd.	C159
Steelmax Tools	N4737
Toolmen Corp	C1253
Tri Tool Inc	N5913
Universal Drilling & Cutting Equipment	C3714

### Drilling Machines - Thermal Drilling

Baileigh Industrial Inc	C7513
Formdrill USA Inc	C2222
International Technologies Inc	C8111

Kinetic Cutting Systems Inc	C6311
Kong NGAI Precision Metal Mould Shenzhen Co Ltd	C856
Laser Mechanisms Inc	C3810
Peddinghaus Corp	C7723
PythonX-Burlington Automation	C8116

### Drives

Beckhoff Automation	C7545
Emmegi USA Inc	C7323
Hiwin Corp.	C1321
Panasonic Electric Works Corp of America	C7411
<b>Universal Controls Group</b>	<b>C1528</b>
Victory Plasma Systems Inc	N4833

### Drum-Handling Equipment

ELCo Enterprises	N2831
Electron Beam Technologies Inc.	N3210
Jet	C5923
JMR Industrial	C3752
Webb-Stiles Co.	C2435

### Dyes

Enhancement Technologies / Sublitex- Miroglgio	C1561
Strathmore Products Inc	C1955

### E-Commerce/C-Commerce/Web Development

<b>Computers Unlimited</b>	<b>N3315</b>
Dataweld Inc	N2308

### Fabricators & Manufacturers

<b>Association</b>	<b>C6538</b>
State of Wyoming	N3133
SteelOrbis	C3751
Technical Translation Services	N2604

### Economic/Industrial Development Services

Arrowhead Manufacturers & Fabricators Assoc	C8242
Expansion Solutions Magazine	C7346
North America Consulting	N6333
North Carolinas Southeast	C8228
Oncor	C4837
Right Corner of Texas	C7337
Site Location Partnership (SLP)	N1406
State of Wyoming	N3133
Temple Economic Development Corp	C7439

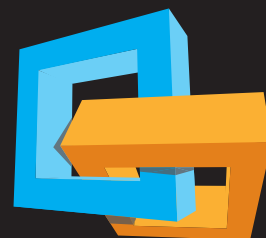

## IntelliFinishing

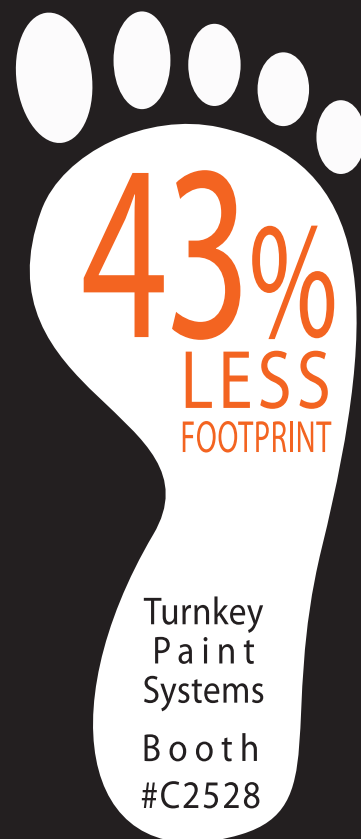

IntelliFinishing Paint Systems:

- Decrease floor space by 43%
- Recipe-based. No batching
- Move parts forward & backward
- Vary speed of conveyance
- 49% cost reduction

See a working demonstration  
of a paint system that is lean,  
energy efficient and different at  
Booth C2528.

888-886-6363  
[www.intellifinishing.com](http://www.intellifinishing.com)

*The Smarter Way to Finish*





## Edge Finishing Equipment

Almco Inc. ....	C1220
AM Machinery Sales .....	C5528
<b>Apex Machine Group/ SlipCon USA .....</b>	<b>C5528</b>
ASKO Inc. ....	C4810
<b>Athader .....</b>	<b>C5520</b>
CIMID Corp. ....	C8327
Costa & Grissom Machinery Co. ....	C7516
D&H Machinery Inc. ....	C2112
Euromac/Metal Finish LLC .....	C4716
EXEL North America .....	C2264
<b>Fladder-Hansen &amp; Hundebol Inc. ....</b>	<b>C6328</b>
Gem Tool Corporation .....	C2320
Gulco International. ....	N5002
Hangzhou Xiangsheng Abrasive Machine Manufacturing Co., Ltd. ....	C7142
Heck Industries .....	C4828
Hollbrit Inc. ....	N6317
Kent Corp. ....	C954, C2128
KULLEN - KOTI GmbH .....	N3137
Lissmac Corp. ....	C4340
Metform International Ltd. ....	C5534
Michigan Pneumatic Tool Inc. ....	N6034
Nitto Kohki USA Inc. ....	C1510
PFERD INC. ....	N5018
Pushcorp Inc. ....	N5934
Rex-Cut Abrasives. ....	N2708
Saar Hartmetall USA LLC .....	N5925
Walter Surface Technologies .....	N2628
<b>Walther Pilot North America .....</b>	<b>C2609</b>
Wendt USA LLC. ....	N2606

## EDM Consumables

Kong NGAI Precision Metal Mould Shenzhen Co Ltd .....	C856
<b>MC Machinery Systems Inc/ Mitsubishi .....</b>	<b>C3040</b>

## EDM Machines

A-G Tool & Die .....	C920
F & G Tool and Die Co. ....	C1413
Kong NGAI Precision Metal Mould Shenzhen Co Ltd .....	C856
Machinery Marketing Intl .....	C8337
<b>MC Machinery Systems Inc/ Mitsubishi .....</b>	<b>C3040</b>

## Electrical & Electronic Components

Alternative Parts Inc. ....	C3726
<b>Beck Automation. ....</b>	<b>C5520</b>
Beckhoff Automation .....	C7545
<b>DELTA Computer Systems Inc. ....</b>	<b>C1024</b>
Laser Experts Inc. ....	C5742
Link Systems .....	C909

Panasonic Electric Works Corp of America .....	C7411
Richardson Electronics Ltd .....	C3721
Tapeswitch Corp. ....	C3813
Toledo Integrated Systems .....	C1317
Turck Inc. ....	C1312
<b>Universal Controls Group .....</b>	<b>C1528</b>

## Electrocoating Equipment

Anest Iwata USA Inc. ....	C2746
Eisenmann Corp. ....	C2439
Electrocoat Association, The .....	C2255
<b>George Koch Sons LLC .....</b>	<b>C2521</b>
KCI America Co Ltd .....	C2062
<b>KMI Systems Inc. ....</b>	<b>C2722</b>
<b>Magic Rack/Production Plus Corp. ...</b>	<b>C2724</b>
PKG Equipment Inc. ....	C1953

## Electrocoating Materials (Consumables)

Armstrong/Kover Kwick Inc feat NCCM Mill Rolls .....	C7047
Electrocoat Association, The .....	C2255
Nylok LLC. ....	N1624
Zhejiang Changzheng Project Carbon Electrodes Co Ltd .....	N6210

## Electrode Holders

<b>ABICOR Binzel Corp. ....</b>	<b>N5508</b>
<b>ArcOne. ....</b>	<b>N3231</b>
<b>Bernard .....</b>	<b>N5516</b>
C H Symington & Co Inc .....	N2213
Direct Wire & Cable .....	N2519
Genstar Technologies Inc. ....	N2822
Gulco International. ....	N5002
Janda Co Inc. ....	N1924
Jingyu Welding & Cutting Co Ltd. ...	N1608
North (Nanjing) Instrument Technology Industries Group. ....	N3226
Phoenix International Inc. ....	N2328
Southern Copper & Supply .....	N1926
Termmei Torch & Tip Company. ....	N2526
TJ Snow Co. ....	N2613
Washington Alloy Co. ....	N2231
Zhejiang Changzheng Project Carbon Electrodes Co Ltd .....	N6210
ZJ Industries Inc. ....	N2704

## Electrodes (Aluminum)

Bohler Welding Group USA Inc. ....	N2013
COB Industries Inc. ....	N5919
<b>Lincoln Electric Co. ....</b>	<b>N4102, N4113, N4515</b>
LONGEVITY Welding & Cutting Products .....	N5109
MAGMAWELD .....	N1628

Messer MG Welding Products .....	N2408
Uniweld Products Inc. ....	N5113
Washington Alloy Co. ....	N2231

## Electrodes (Cast Iron)

Bohler Welding Group USA Inc. ....	N2013
Broco Inc. ....	N4926
MAGMAWELD .....	N1628
Messer MG Welding Products .....	N2408
Special Metals Welding Products Co. ....	N3118
Uniweld Products Inc. ....	N5113
Washington Alloy Co. ....	N2231

## Electrodes (Copper)

Ampco Metal Inc. ....	C2326
BMM Welding Material Co. ....	N6109
C H Symington & Co Inc. ....	N2213
<b>Centerline (Windsor) Ltd. ....</b>	<b>N1926</b>
<b>Dengensha America Corp. ....</b>	<b>N5722</b>
Dinse Inc. ....	N2717
F & G Tool and Die Co. ....	C1413
Golden Eagle Minmetals(Beijing) Wldg Materials Co. ....	N5800
Janda Co Inc. ....	N1924
Kimberly-Clark Professional .....	N3407
KME Germany GmbH & Co KG .....	N1525
MAGMAWELD .....	N1628
Messer MG Welding Products .....	N2408
NGK Metals Corp. ....	C922
Ningbo Powerway Alloy Material Co Ltd. ....	N5038
SMK Co Ltd. ....	N1524
Southern Copper & Supply .....	N1926
Sunstone Engineering. ....	N5916
Termmei Torch & Tip Company. ....	N2526
Tianjin Jinlong Welding Material Co Ltd. ....	N6100
TJ Snow Co. ....	N2613
Uniweld Products Inc. ....	N5113
Washington Alloy Co. ....	N2231
ZJ Industries Inc. ....	N2704

## Electrodes (Nickel)

BMM Welding Material Co. ....	N6109
Bohler Welding Group USA Inc. ....	N2013
Broco Inc. ....	N4926
COB Industries Inc. ....	N5919
COR-MET INC. ....	N5534
Haynes International. ....	N1617
JLC Electromet Pvt LLC. ....	N5138
Kennametal Stellite .....	N2528
MAGMAWELD .....	N1628
Messer MG Welding Products .....	N2408
MMC Superalloy Corp. ....	N1826
Ningbo Powerway Alloy	



Material Co Ltd .....	N5038
Sandvik Materials Technology .....	N3019
Special Metals Welding Products Co .....	N3118
Uniweld Products Inc .....	N5113
Washington Alloy Co .....	N2231

### Electrodes (Stainless Steel)

Benxi Guangzheng Tungsten & Molybdenum Co Ltd .....	C456
BMM Welding Material Co .....	N6109
Bohler Welding Group USA Inc. ....	N2013
Changzhou Huatong Welding Industry Co Ltd .....	N6310
COB Industries Inc. ....	N5919
Lincoln Electric Co. . . . .	N4102, N4113, N4515
LONGEVITY Welding & Cutting Products .....	N5109
MAGMAWELD .....	N1628
Messer MG Welding Products .....	N2408
Nevatia Steel & Alloys Pvt LTD. ....	N2824
Sandvik Materials Technology .....	N3019
Uniweld Products Inc .....	N5113
Washington Alloy Co .....	N2231

### Electrodes (Steel)

BMM Welding Material Co .....	N6109
Bohler Welding Group USA Inc. ....	N2013
Broco Inc .....	N4926
Changzhou Huatong Welding Industry Co Ltd .....	N6310
ESAB Welding & Cutting Products .....	N3922, N4122
Hobart Brothers. ....	N5516
Lincoln Electric Co. . . . .	N4102, N4113, N4515
MAGMAWELD .....	N1628
Messer MG Welding Products .....	N2408
Uniweld Products Inc .....	N5113
Washington Alloy Co .....	N2231

### Electrodes (Tungsten)

ABICOR Binzel Corp. ....	N5508
Benxi Guangzheng Tungsten & Molybdenum Co Ltd .....	C456
BMM Welding Material Co .....	N6109
Changzhou Huatong Welding Industry Co Ltd .....	N6310
CK Worldwide .....	N3615
CM Industries Inc .....	N2810
COB Industries Inc. ....	N5919
Diamond Ground Products Inc. ....	N5726
Easy Abrasives LLC .....	N2618
EH Wachs Co. ....	N5713
Intercon Enterprises Inc .....	N3227
Jingyu Welding & Cutting Co Ltd. . .	N1608
MK Products Inc .....	N2804
OKI Bering .....	N4531

Orbitalum Orbital Cutting + Welding .....	N5713
Southern Copper & Supply .....	N1926
Sunstone Engineering .....	N5916
Termmei Torch & Tip Company .....	N2526
Uniweld Products Inc .....	N5113
Weldcraft .....	N5516

### Electrodes (Underwater)

Broco Inc .....	N4926
Environmental Air Solutions .....	N6315
Sandvik Materials Technology .....	N3019

### Electron Beam Machines & Components

PTR-Precision Technologies Inc .....	N5226
--------------------------------------	-------

### Electroplating Processes & Equipment - Finishing

Anomatic Corp. ....	C2452
DMP Corp .....	C2054
General Fabrications Corp. ....	C2648
Nylok LLC. ....	N1624
PKG Equipment Inc .....	C1953
Precious Plate Inc .....	C2353

### Embossing Machines & Rolls

Alliance Machine and Engraving LLC .....	C5520
Bradbury Co., Inc., The .....	C5520
Bradbury Group, The .....	C5520
Carell Corp/Eagle Bending Machines .....	C5928
Machinery Marketing Intl .....	C8337
Metform International Ltd. ....	C5534
Multipress Inc .....	C1022
Polyurethane Products Corp .....	C3811

### Engineering Services

Abtex Corp. ....	C7547
Accurate Die Design Inc/Logopress Corp .....	C1423
AceCad Software .....	C2825
American Finishing Resources .....	C1855
Anomatic Corp. ....	C2452
Bascon Inc .....	C7146
Brandt Engineered Products Ltd. ....	C1755
CH Steel Solutions Inc .....	C7348
Creaform 3d. ....	C552
DMP Corp .....	C2054
Echo Engineering. ....	C2056
EPSI Masking Co. ....	C2154
Fabrisonic LLC .....	N6218
Gerb Vibration Control Systems .....	C852
InterTest Inc. ....	N5824
JIT Automation Inc .....	C756
KoCos America LLC .....	C2223

Lambda Research Optics Inc. ....	C5633
LORD Corporation .....	N2011
MJC Engineering & Technology Inc. .	C1156
Nation Coating Systems Inc .....	N2416
North America Consulting. ....	N6333
Powder Coating Consultants. ....	C2422
Precision Punch Corp. ....	C1432
Production Tube Cutting Inc .....	C2215
Sertom Group North America LLC ..	C6911
Shred-Tech Compass Systems .....	C7550
StampingSimulation.Com Pty Ltd. ....	C851
Unisorb Installation Technologies. . .	C1411
Wila USA. ....	C5709

### Engineering Services - Rapid Prototyping

Accurex Measurement Inc .....	C2125
American Finishing Resources .....	C1855
Anomatic Corp. ....	C2452
Fabrisonic LLC .....	N6218
Interlaken Technology .....	C947
International Welding Technologies Inc .....	N1724
Lambda Research Optics Inc. ....	C5633
Penn United Technologies Inc. ....	C1420
Shercon Inc .....	C2735

### Environmental/Clean Rooms - Finishing

AFC Finishing Systems .....	C2548
APEL International. ....	N1526
DMP Corp .....	C2054
Eisenmann Corp .....	C2439
EXEL North America .....	C2264
General Automatic Transfer .....	C2550
General Fabrications Corp. ....	C2648
George Koch Sons LLC .....	C2521
Global Finishing Solutions .....	C2151
IntelliFinishing. ....	C2528
KMI Systems Inc. ....	C2722
Liaoning Longyuan Industry Co Ltd. . .	C455
Midwest Finishing Systems Inc .....	C2526
Pneu-Mech Systems Manufacturing Inc. ....	C2539
Rapid Engineering. ....	C2610
Spray-Tech/Junair. ....	C2164
Tri-Mer Corp .....	N2615

### Environmental/Waste Management/Recycling Services

Combustion and Systems Inc .....	C2411
Cordstrap USA Inc. ....	C7433
DMP Corp .....	C2054
Micro Air .....	N1806
Pollution Control Products. ....	C2415



## Ergonomic Equipment/Products

Equipois Inc . . . . .	N2324
Fastenal Company . . . . .	N5736
Flexarm Inc . . . . .	C7431
JMR Industrial . . . . .	C3752
Medi Mall Inc . . . . .	N2608
Miller Electric Mfg Co. . . . .	N5213, N5816
Nederman Inc . . . . .	N1604
Rimco Equipment . . . . .	N1631

## Exothermic Cutting Machines

Airgas Inc . . . . .	N5231
Broco Inc . . . . .	N4926
C H Symington & Co Inc . . . . .	N2213
Dynatorch Inc . . . . .	N4837
Enutron International . . . . .	C7750
Genstar Technologies Inc . . . . .	N2822
<b>Koike Aronson Inc . . . . .</b>	<b>N4131</b>
Oxylance Inc . . . . .	N2228
Red Rock Automation/Romar/MEC . . . . .	N4805
Westingcut Industrial Technology Anhui Inc . . . . .	N1424

## Extruding Machines

Ampco Metal Inc . . . . .	C2326
Butech Bliss . . . . .	C5532
Starrett Bitewise Measurement Systems . . . . .	C3453
T-DRILL Industries Inc . . . . .	C2121

## Fasteners

Arrowhead Manufacturers & Fabricators Assoc. . . . .	C8242
Associated Spring Raymond . . . . .	C1426
Attexor Clinch Systems SA . . . . .	C5622
Benxi Guangzheng Tungsten & Molybdenum Co Ltd . . . . .	C456
BESSEY Tools North America . . . . .	N4931
Carr Lane Manufacturing Co. . . . .	N3036
Clips & Clamps Industries . . . . .	C148
Fast Rite International . . . . .	C854
Fastenal Company . . . . .	N5736
Fuxin Tianyuan Steel Balls Mfg Co Ltd . . . . .	C355
GH Induction Atmospheres LLC . . . . .	C2323
Haeger Inc . . . . .	C3716
Industrial Magnetics Inc . . . . .	C5728
International Welding Technologies Inc . . . . .	N1724
Master Magnetics . . . . .	C4733
Nelson Stud Welding . . . . .	N5922
Norlok Technology Inc . . . . .	C4840
Nylok LLC . . . . .	N1624
PennEngineering . . . . .	C1215
Southern Stud Weld Inc . . . . .	N2616
<b>Strong Hand Tools . . . . .</b>	<b>N3631</b>

Stud Welding Associates Inc . . . . .	N6327
Swagelok Marketing Services Co. . . . .	N3431
Tennessee Galvanizing Inc . . . . .	C7113
United Global Sourcing Inc . . . . .	C8336
WAFIOS Machinery Corp . . . . .	C1736

## Fastening/Joining Equipment

Arc Specialties Inc . . . . .	N1610
Attexor Clinch Systems SA . . . . .	C5622
DE-STA-CO . . . . .	N6113
Fastenal Company . . . . .	N5736
Formdrill USA Inc . . . . .	C2222
Fusion Inc . . . . .	N3313
Fuxin Tianyuan Steel Balls Mfg Co Ltd . . . . .	C355
Greenerd Press & Machine Company Inc . . . . .	C815
Haeger Inc . . . . .	C3716
Halifax Rack & Screw . . . . .	C7310
International Welding Technologies Inc . . . . .	N1724
<b>LaserStar Technologies Corp . . . . .</b>	<b>C5647</b>
Lillbacka Powerco USA Inc . . . . .	C2132
LORD Corporation . . . . .	N2011
<b>Lucas-Milhaupt Inc . . . . .</b>	<b>N5027</b>
Mathey Dearman . . . . .	N5710
Matuschek Welding Products Inc. . . . .	N1708
Multipress Inc . . . . .	C1022
Nelson Stud Welding . . . . .	N5922
Norlok Technology Inc . . . . .	C4840
Nylok LLC . . . . .	N1624
Pandjiris Inc . . . . .	N4810
PennEngineering . . . . .	C1215
Permabond Engineering Adhesives . . . . .	C6349
Preston-Eastin Inc . . . . .	N5731
Radyne Corp . . . . .	N5024
Southern Stud Weld Inc . . . . .	N2616
Stud Welding Associates Inc . . . . .	N6327
TOX Pressotechnik LLC . . . . .	C5024
WAFIOS Machinery Corp . . . . .	C1736

## Filters for Spray Booths

AFC Finishing Systems . . . . .	C2548
APEL International . . . . .	N1526
<b>Binks DeVilbiss Ransburg BGK . . . . .</b>	<b>C2532</b>
C.A. Technologies Inc . . . . .	C1763
<b>Col-Met Spray Booths Inc. . . . .</b>	<b>C2537</b>
Gema . . . . .	C2750
General Fabrications Corp. . . . .	C2648
Global Finishing Solutions . . . . .	C2151
Intech Services Inc . . . . .	C2163
Nova Verta USA . . . . .	C1762
Parker domnick hunter . . . . .	N1513
<b>Parker Ionics/Parkwood Engineering . . . . .</b>	<b>C2523</b>
Spray-Tech/Junair . . . . .	C2164
TDC Filter Inc. . . . .	N2622
Wagner Industrial Solutions . . . . .	C1951

## Financing

American Express Open . . . . .	C8233
State of Wyoming . . . . .	N3133

## Finishing Systems Engineering & Installation Services (Systems Houses)

AFC Finishing Systems . . . . .	C2548
Amiberica Inc . . . . .	C1860
<b>Chemical Coaters Assoc Int'l . . . . .</b>	<b>C1948</b>
Daifuku Webb . . . . .	C2425
Decoral System USA Corp . . . . .	C1954
DMP Corp . . . . .	C2054
Eisenmann Corp . . . . .	C2439
EXEL North America . . . . .	C2264
Fostoria Process Equipment . . . . .	C2148
Gema . . . . .	C2750
General Automatic Transfer . . . . .	C2550
General Fabrications Corp. . . . .	C2648
<b>George Koch Sons LLC . . . . .</b>	<b>C2521</b>
Global Finishing Solutions . . . . .	C2151
Haynncorp Industrial Finishing Solutions . . . . .	C2360
<b>IntelliFinishing . . . . .</b>	<b>C2528</b>
KCI America Co Ltd . . . . .	C2062
<b>KMI Systems Inc . . . . .</b>	<b>C2722</b>
Krautzberger LLC . . . . .	C1964
<b>Metcast Service Tech Resources . . . . .</b>	<b>C6946</b>
Midwest Finishing Systems Inc . . . . .	C2526
<b>Nordson Corp . . . . .</b>	<b>C2517</b>
Pangborn Corp. . . . .	C6516
PKG Equipment Inc . . . . .	C1953
Porcelain Enamel Institute Inc . . . . .	C2436
Production Systems Inc. . . . .	C1858
Professional Finishing Systems . . . . .	C8239
Rapid Engineering . . . . .	C2610
Red-Ray Manufacturing Co Inc . . . . .	C2052
Spray-Tech/Junair . . . . .	C2164
Trimac Industrial Systems . . . . .	C2359
Vulcan Catalytic Infrared Oven Systems . . . . .	C2512
Wagner Industrial Solutions . . . . .	C1951

## Flame Cutting Machines

<b>AKS Cutting Systems Inc . . . . .</b>	<b>C5135</b>
Bug-O Systems . . . . .	N4813, N5013
Changzhou Huatong Welding Industry Co Ltd . . . . .	N6310
Dynatorch Inc . . . . .	N4837
<b>ESAB Welding &amp; Cutting Products . . . . .</b>	<b>N3922, N4122</b>
Ficpe Corporation . . . . .	C6550
Flame Technologies Inc. . . . .	N3219
gasgrab.com . . . . .	N3225



# THE **ULTIMATE** IN PLASMA PRODUCTIVITY

Introducing the **NEW** accu-kut plasma, plate  
and tube processing system from AKS

## SAMPLE CUTS:



4" x 7" - 3/16" wall tube  
with various cut-outs



4" x 4" - 3/8" wall tube  
with bevel cut



1-3/8" mild steel with 3/4"  
bolt holes and bevel cut



## **NEW!** AKS ACCU-KUT TUBE CUTTING OPTION!

- Processes plate and tubing **ON THE SAME MACHINE!**
- Five axis motion can process round, square or rectangular tubing
- Precision servo-driven chuck

### FEATURES:

- Heavy-duty, unitized, rigid, fully-welded design
- Multi-zone air-downdraft
- Advanced torch height-control
- High precision motion control
- AKS touch-screen control

ON DISPLAY AT FABTECH BOOTH C5135



4905 Rocky River Drive  
Cleveland, Ohio 44135

Phone: 216 267-1818  
Phone: 800 962-7803  
Fax: 216 267-1850

**Hypertherm**



## Flame Cutting Machines

Genstar Technologies Inc . . . . .	N2822
Gullco International . . . . .	N5002
H & M Pipe Beveling Machine Co Inc . . . . .	N3419
Harris Products Group . . . . .	N4509
HGG Profiling Equipment . . . . .	C8127
JETCAM-NestONE Solutions . . . . .	C4722
Kinetic Cutting Systems Inc . . . . .	C6311
<b>Koike Aronson Inc . . . . .</b>	<b>N4131</b>
LONGEVITY Welding & Cutting Products . . . . .	N5109
Mathey Dearman . . . . .	N5710
<b>Messer Cutting Systems . . . . .</b>	<b>C5916</b>
Ningbo Jinfeng Welding & Cutting Machinery Manufacture Co Ltd . . . . .	N6007
Peddinghaus Corp . . . . .	C7723
Praxair Inc . . . . .	N5202
Prestige Equipment Corporation . . . . .	C7214
PythonX-Burlington Automation . . . . .	C8116
Red Rock Automation/Romar/MEC . . . . .	N4805
Rhino Cutting Systems . . . . .	N6138
SteelTailor Ltd . . . . .	N4919
Victory Plasma Systems Inc . . . . .	N4833
Westingcut Industrial Technology Anhui Inc . . . . .	N1424

## Flanging Machines

AddisonMckee Inc . . . . .	C2339
CIMID Corp . . . . .	C8327
ESCO Tool Co . . . . .	C5735
Faccin USA Inc . . . . .	C6323
Global Metal Spinning Solutions Inc . . . . .	C934
Haeusler AG . . . . .	C5540
Mathey Dearman . . . . .	N5710
<b>Overton Industries . . . . .</b>	<b>C2225</b>
Peter Prinzing GmbH . . . . .	C5638
PHI . . . . .	C2122
RAS Systems LLC . . . . .	C6921
Sertom Group North America LLC . . . . .	C6911
T-DRILL Industries Inc . . . . .	C2121
<b>Triform Sheet Hydroforming . . . . .</b>	<b>C1226</b>
Trilogy Machinery Inc . . . . .	C5140

## Fluid Processing Components & Systems

Chemtool Inc . . . . .	C660
DMP Corp . . . . .	C2054
ERIEZ . . . . .	C7316
Industrial Innovations Inc . . . . .	C836
Ross Controls . . . . .	C849

## Flux (Gas Welding/Brazing)

<b>ABICOR Binzel Corp . . . . .</b>	<b>N5508</b>
Bay State Surface Technologies . . . . .	N2419
Fusion Inc . . . . .	N3313

Gasflux Co . . . . .	N2833
Golden Eagle Minmetals(Beijing) Wldg Materials Co . . . . .	N5800
LA-CO Industries/Markal . . . . .	N4802
LONGEVITY Welding & Cutting Products . . . . .	N5109
<b>Lucas-Milhaupt Inc . . . . .</b>	<b>N5027</b>
Messer MG Welding Products . . . . .	N2408
Ningbo Powerway Alloy Material Co Ltd . . . . .	N5038
Tianjin Jinlong Welding Material Co Ltd . . . . .	N6100
Washington Alloy Co . . . . .	N2231

## Flux (Soldering)

BMM Welding Material Co . . . . .	N6109
Bohler Welding Group USA Inc . . . . .	N2013
Fusion Inc . . . . .	N3313
Golden Eagle Minmetals(Beijing) Wldg Materials Co . . . . .	N5800
LA-CO Industries/Markal . . . . .	N4802
<b>Lucas-Milhaupt Inc . . . . .</b>	<b>N5027</b>
Messer MG Welding Products . . . . .	N2408
Ningbo Powerway Alloy Material Co Ltd . . . . .	N5038
Uniweld Products Inc . . . . .	N5113
Washington Alloy Co . . . . .	N2231

## Flux (Submerged Arc)

Bohler Welding Group USA Inc . . . . .	N2013
Changzhou Huatong Welding Industry Co Ltd . . . . .	N6310
Corewire Ltd . . . . .	N2910
<b>ESAB Welding &amp; Cutting Products . . . . .</b>	<b>N3922, N4122</b>
Harbert's Products Inc/Allied Flux Reclaiming Ltd . . . . .	N4824
<b>Hobart Brothers . . . . .</b>	<b>N5516</b>
<b>Lincoln Electric Co. . . . .</b>	<b>N4102, N4113, N4515</b>
MAGMAWELD . . . . .	N1628
Sandvik Materials Technology . . . . .	N3019
Special Metals Welding Products Co . . . . .	N3118
Titus Flux Inc/American Welding & Flux . . . . .	N4239
Weld Engineering Co . . . . .	N4818

## Flux Cored Wire

<b>ABICOR Binzel Corp . . . . .</b>	<b>N5508</b>
BMM Welding Material Co . . . . .	N6109
Bohler Welding Group USA Inc . . . . .	N2013
Broco Inc . . . . .	N4926
Changzhou Huatong Welding Industry Co Ltd . . . . .	N6310
Changzhou Zhengyang Welding Material Co Ltd . . . . .	N2306

Corewire Ltd . . . . .	N2910
COR-MET INC . . . . .	N5534
DURUM USA . . . . .	N2316
<b>ESAB Welding &amp; Cutting Products . . . . .</b>	<b>N3922, N4122</b>
<b>Hobart Brothers . . . . .</b>	<b>N5516</b>
Kobelco Welding of America Inc . . . . .	N3938
<b>Lincoln Electric Co. . . . .</b>	<b>N4102, N4113, N4515</b>
<b>Lucas-Milhaupt Inc . . . . .</b>	<b>N5027</b>
MAGMAWELD . . . . .	N1628
Messer MG Welding Products . . . . .	N2408
Ningbo Powerway Alloy Material Co Ltd . . . . .	N5038
Polymet Corp . . . . .	N2313
PT-Mat . . . . .	N3337
Sandvik Materials Technology . . . . .	N3019
Termmei Torch & Tip Company . . . . .	N2526
Tianjin Jinlong Welding Material Co Ltd . . . . .	N6100
Tianjin Xuzhi Machinery & Electrical Equipment Co Ltd . . . . .	N1431
Uniweld Products Inc . . . . .	N5113
Washington Alloy Co . . . . .	N2231
Welding Alloys USA . . . . .	N4917
Winox Industries Ltd . . . . .	N6111

## Flying Cutoff Machines

<b>American Machine &amp; Rollform Tech. . . . .</b>	<b>C5520</b>
<b>Athader . . . . .</b>	<b>C5520</b>
<b>Beck Automation . . . . .</b>	<b>C5520</b>
<b>Bradbury Co., Inc., The . . . . .</b>	<b>C5520</b>
<b>Bradbury Group Australia . . . . .</b>	<b>C5520</b>
<b>Bradbury Group, The . . . . .</b>	<b>C5520</b>
CTD Machines Inc . . . . .	C8423
Formtek Metal Forming & Hill Engineering . . . . .	C3708
Jet . . . . .	C5923
Kent Corp . . . . .	C954, C2128
<b>Marion Die &amp; Fixture Inc. . . . .</b>	<b>C5520</b>
Metform International Ltd . . . . .	C5534
Mill Masters . . . . .	C1533
Passline Performance . . . . .	C2325
<b>Thermatool Corp . . . . .</b>	<b>C2110</b>
<b>Universal Tube &amp; Rollform Equipment Corp . . . . .</b>	<b>C1528</b>

## Folding Machines

Baileigh Industrial Inc . . . . .	C7513
Baykal Makina Sanayi ve Ticaret AS . . . . .	C5940, C5947
<b>Beck Automation . . . . .</b>	<b>C5520</b>
<b>Bradbury Co., Inc., The . . . . .</b>	<b>C5520</b>
<b>Bradbury Group, The . . . . .</b>	<b>C5520</b>
C Marshall Fabrication Machinery . . . . .	C7716
Cidan Machinery Inc . . . . .	C3449
Enutron International . . . . .	C7750



Gasparini SPA .....	C5536
International Technologies Inc .....	C8111
Prestige Equipment Corporation .....	C7214
Prima Power North America Inc .....	C4336
RAS Systems LLC .....	C6921
<b>Triform Sheet Hydroforming .....</b>	<b>C1226</b>

### Foot Switches/Controls/Pedals

ISB Group .....	C4728
Link Systems .....	C909
Tapeswitch Corp .....	C3813

### Free Form Fabrication/Rapid Manufacturing

Fabrisonic LLC .....	N6218
Rimco Equipment .....	N1631
Steelmax Tools .....	N4737

### Frit, Porcelain Enamel

Gema .....	C2750
Midwest Finishing Systems Inc .....	C2526
Porcelain Enamel Institute Inc .....	C2436

### Furnaces

Ambrell Precision Induction Heating .....	C4950
Bolttech Mannings .....	N2326
GH Induction Atmospheres LLC .....	C2323
PDS Bartech Inc. ....	N5917
Pollution Control Products .....	C2415

### Furnaces, Porcelain Enameling

<b>Binks DeVilbiss Ransburg BGK .....</b>	<b>C2532</b>
<b>KMI Systems Inc .....</b>	<b>C2722</b>
Porcelain Enamel Institute Inc .....	C2436

### Furniture Parts & Components

Benxi Guangzheng Tungsten & Molybdenum Co Ltd .....	C456
Fast Rite International .....	C854
Nadella .....	C7150
PDS Bartech Inc. ....	N5917
Peterson Spring .....	C549
United Global Sourcing Inc .....	C8336

### Galvanizing Equipment & Supplies

Armstrong/Kover Kwick Inc feat NCCM Mill Rolls .....	C7047
AZZ Galvanizing Services .....	C5835
Delta Steel Technologies .....	C5952
PKG Equipment Inc .....	C1953
SKM Industries Inc .....	N1717
Tennessee Galvanizing Inc .....	C7113
V&S Galvanizing LLC .....	C7427
Weld-Aid Products .....	N4928

### Garnet Removal Equipment

<b>Barton .....</b>	<b>C4916</b>
Semymx LLC .....	C6347
Techni Waterjet .....	C5128

### Gas Blenders

Airgas Inc .....	N5231
Harris Products Group .....	N4509
IBEDA /Superflash Compressed Gas Equipment Inc .....	N3437
Weldcoa .....	N3238

### Gas Cylinders/Storage Tanks

Airgas Inc .....	N5231
America Fortune Company .....	N1908
Chart Inc .....	N3204
Cyl-Tec Inc .....	N3138
Dataweld Inc .....	N2308
Generon IGS .....	C5547
Matheson .....	N6122
Praxair Inc .....	N5202
Uniweld Products Inc .....	N5113
Weldcoa .....	N3238
Weldship Corp .....	N3033
Western Enterprises .....	N2933

### Gas Distribution & Handling Equipment

Airgas Inc .....	N5231
Chart Inc .....	N3204
gasgrab.com .....	N3225
Generon IGS .....	C5547
Genstar Technologies Inc .....	N2822
Harris Products Group .....	N4509
IBEDA /Superflash Compressed Gas Equipment Inc .....	N3437
Praxair Inc .....	N5202
Red-Ray Manufacturing Co Inc .....	C2052
REXARC International .....	N1515
Superior Products .....	N2517
Weldcoa .....	N3238
Weldship Corp .....	N3033
Western Enterprises .....	N2933
Witt Gas Controls .....	N3124

### Gas Leak De.tection Chemicals

Cantesco .....	N3027
Superior Products .....	N2517
Western Enterprises .....	N2933

### Gases - Cutting

Air Products and Chemicals Inc .....	C3814
Airgas Inc .....	N5231
Chart Inc .....	N3204
Cyl-Tec Inc .....	N3138
Flame Technologies Inc .....	N3219
Generon IGS .....	C5547

Genstar Technologies Inc .....	N2822
Harris Products Group .....	N4509
Matheson .....	N6122
Ningbo Jinfeng Welding & Cutting Machinery Manufacture Co Ltd ..	N6007

### Gases - Welding (Fuel)

Air Products and Chemicals Inc .....	C3814
Airgas Inc .....	N5231
Arrowhead Manufacturers & Fabricators Assoc .....	C8242
Chart Inc .....	N3204
Flame Technologies Inc .....	N3219
Genstar Technologies Inc .....	N2822
Harris Products Group .....	N4509
Witt Gas Controls .....	N3124

### Gases - Welding (Shielding/Purging)

Air Products and Chemicals Inc .....	C3814
Airgas Inc .....	N5231
Chart Inc .....	N3204
COB Industries Inc .....	N5919
Generon IGS .....	C5547
Harris Products Group .....	N4509
Matheson .....	N6122
Ningbo Jinfeng Welding & Cutting Machinery Manufacture Co Ltd ..	N6007
Praxair Inc .....	N5202
Witt Gas Controls .....	N3124

### Gauging/Back Gauging Systems

Automec Inc .....	C4832
<b>Betenbender Manufacturing Inc .....</b>	<b>C3744</b>
Clark Fixture Technologies .....	C1520
Enutron International .....	C7750
FARO Technologies Inc .....	C7636
Foerster Instruments Inc .....	C1523
TigerStop LLC .....	C7442, C7542

### General Contracting/Construction Services

Bascon Inc .....	C7146
Greenberry Industrial .....	C8140
North America Consulting .....	N6333
Pacific Gas and Electric Company ..	N1407

### Generators - Nitrogen Gas

Parker domnick hunter .....	N1513
-----------------------------	-------

### Generators - Steam/Electrical/Electrochemical

LONGEVITY Welding & Cutting Products .....	N5109
Miller Electric Mfg Co .....	N5213, N5816
Trystar .....	N1818





## Gouging Equipment

Arc Specialties Inc . . . . .	N1610
Broco Inc . . . . .	N4926
Bug-O Systems . . . . .	N4813, N5013
C H Symington & Co Inc . . . . .	N2213
<b>ESAB Welding &amp; Cutting Products . . . . .</b>	<b>N4122</b>
Flame Technologies Inc. . . . .	N3219
Gullco International. . . . .	N5002
Harris Products Group. . . . .	N4509
Jingyu Welding & Cutting Co Ltd . . . . .	N1608
Oxylance Inc . . . . .	N2228
Robotic Technologies of TN . . . . .	N6025
Termmei Torch & Tip Company . . . . .	N2526
Victor Technologies Intl Inc. . . . .	N4522
Zhejiang Changzheng Project Carbon Electrodes Co Ltd . . . . .	N6210

## Government Agencies

Expansion Solutions Magazine. . . . .	C7346
NIST. . . . .	C8421
State of Wyoming. . . . .	N3133

## Grinders - Tool

Alpha Professional Tools. . . . .	N6331
Armstrong/Kover Kwick Inc feat NCCM Mill Rolls . . . . .	C7047
Bosch Power Tool Corp . . . . .	N5006
<b>Boschert Precision Machinery Inc. . . . .</b>	<b>C2820</b>
Chemtool Inc . . . . .	C660
Chicago Pneumatic Tool Co. . . . .	C4750
CS Unitec Inc. . . . .	N5531
Darex LLC . . . . .	C8138
DCM Tech Inc . . . . .	C8346
Diamond Ground Products Inc. . . . .	N5726
Dynabrade Inc . . . . .	C2409
Fastenal Company. . . . .	N5736
Gem Tool Corporation . . . . .	C2320
Joysun Abrasives Co Ltd. . . . .	N3208
KLINGSPOR Abrasives Inc. . . . .	N3135
KNUTH Machine Tools USA Inc . . . . .	C4910
Mate Precision Tooling . . . . .	C3720
Matheson . . . . .	N6122
Metabo Corp . . . . .	N6131
OKI Bering . . . . .	N4531
PFERD INC. . . . .	N5018
Pushcorp Inc . . . . .	N5934
Richard Wolf Industrial . . . . .	N2309
Saar Hartmetall USA LLC . . . . .	N5925
Suhner Industrial Products Inc . . . . .	N3010
Top Cat Air Tools . . . . .	C2361
Unipunch Products Inc. . . . .	C3732
United Abrasives Inc /SAIT. . . . .	N3104
Unitool Punch & Die. . . . .	C4708
Walter Surface Technologies . . . . .	N2628
Wilson Tool International . . . . .	C1013, C5116

## Guide Posts

Anchor Danly. . . . .	C931
Elizabeth Carbide Components. . . . .	C150
Fibro Inc. . . . .	C249
GMT North America . . . . .	C353
SelfLube . . . . .	C558
Superior Die Set Corp . . . . .	C658
Whistler & Sons Inc, SB . . . . .	C4720

## Hand Benders

Eaton Leonard . . . . .	C1723
PHI. . . . .	C2122
Swagelok Marketing Services Co. . . . .	N3431
TaurinGroup USA. . . . .	C1739

## Hand Brakes

Cidan Machinery Inc. . . . .	C3449
KNUTH Machine Tools USA Inc . . . . .	C4910

## Hand Tools

Attexor Clinch Systems SA. . . . .	C5622
Bad Dog Tools . . . . .	N3106
BESSEY Tools North America . . . . .	N4931
Cleveland Steel Tool Co . . . . .	C5522
CS Unitec Inc. . . . .	N5531
Dynabrade Inc . . . . .	C2409
FARO Technologies Inc . . . . .	C7636
Flexarm Inc . . . . .	C7431
Heck Industries . . . . .	C4828
Hougen Manufacturing Inc . . . . .	C4821
International Welding Technologies Inc . . . . .	N1724
Joysun Abrasives Co Ltd. . . . .	N3208
KULLEN - KOTI GmbH . . . . .	N3137
LA-CO Industries/Markal . . . . .	N4802
LENOX . . . . .	C4808
M K Morse Co, The . . . . .	C7109
Master Magnetics. . . . .	C4733
Mercer Abrasives . . . . .	N6016
Michigan Pneumatic Tool Inc . . . . .	N6034
OKI Bering . . . . .	N4531
PFERD INC. . . . .	N5018
<b>Scrape-N-Burr . . . . .</b>	<b>N1316</b>
SKM Industries Inc . . . . .	N1717
<b>Strong Hand Tools. . . . .</b>	<b>N3631</b>
Swagelok Marketing Services Co. . . . .	N3431
Top Cat Air Tools . . . . .	C2361
U-Mark Inc. . . . .	N2406
United Global Sourcing Inc . . . . .	C8336
Wilton . . . . .	N5537

## Hand Tools - Nibbling

Bad Dog Tools . . . . .	N3106
BESSEY Tools North America . . . . .	N4931
Bosch Power Tool Corp . . . . .	N5006
Fein Power Tools Inc . . . . .	N5902
Hydro Carbide Inc . . . . .	C8238

## Hardfacing/Surfacing (Powder Alloys)

AMETEK Specialty Metal Products for Fab . . . . .	C914
Bay State Surface Technologies. . . . .	N2419
Bohler Welding Group USA Inc. . . . .	N2013
Broco Inc . . . . .	N4926
DURUM USA. . . . .	N2316
Harbert's Products Inc/ Allied Flux Reclaiming Ltd . . . . .	N4824
IPG Photonics . . . . .	N3931
Kennametal Stellite . . . . .	N2528
Messer MG Welding Products . . . . .	N2408
MMC Superalloy Corp. . . . .	N1826
PT-Mat. . . . .	N3337
<b>Sulzer Metco US Inc . . . . .</b>	<b>N2413</b>
Technogenia Inc . . . . .	N4924
Victor Technologies Intl Inc. . . . .	N4522

## Hardfacing/Surfacing (Strip Cladding)

Bohler Welding Group USA Inc. . . . .	N2013
Harbert's Products Inc/ Allied Flux Reclaiming Ltd . . . . .	N4824
<b>Kolene Corp. . . . .</b>	<b>C2509</b>
Liaoning Longyuan Industry Co Ltd. . . . .	C455
Sandvik Materials Technology . . . . .	N3019
Victor Technologies Intl Inc. . . . .	N4522

## Hardfacing/Surfacing (Wire)

AMETEK Specialty Metal Products for Fab . . . . .	C914
Bay State Surface Technologies. . . . .	N2419
BMM Welding Material Co . . . . .	N6109
Bohler Welding Group USA Inc. . . . .	N2013
Broco Inc . . . . .	N4926
Changzhou Zhengyang Welding Material Co Ltd. . . . .	N2306
Corewire Ltd . . . . .	N2910
COR-MET INC . . . . .	N5534
DURUM USA . . . . .	N2316
Harbert's Products Inc/ Allied Flux Reclaiming Ltd . . . . .	N4824
<b>Hobart Brothers. . . . .</b>	<b>N5516</b>
Kennametal Stellite . . . . .	N2528
Messer MG Welding Products . . . . .	N2408
MMC Superalloy Corp. . . . .	N1826
Polymet Corp. . . . .	N2313
PT-Mat. . . . .	N3337
Sandvik Materials Technology . . . . .	N3019
<b>Sulzer Metco US Inc . . . . .</b>	<b>N2413</b>
Uniweld Products Inc . . . . .	N5113
Washington Alloy Co . . . . .	N2231
Welding Alloys USA . . . . .	N4917



## Hardfacing/Surfacing Equipment - Finishing

Arc Specialties Inc	N1610
Broco Inc	N4926
DURUM USA	N2316
General Tool	N1622
Gullco International	N5002
Harbert's Products Inc/ Allied Flux Reclaiming Ltd	N4824
IPG Photonics	N3931
LS Industries Inc	C8123
Pandjiris Inc	N4810
Rex-Cut Abrasives	N2708
Rocklin Manufacturing Co	C1433
<b>Sulzer Metco US Inc</b>	<b>N2413</b>
Technogenia Inc	N4924
Welding Alloys USA	N4917

## Heat Exchangers

General Automatic Transfer	C2550
Haynncorp Industrial Finishing Solutions	C2360

## Heat Treating Equipment/ Stress Relieving Equipment

Ambrell Precision Induction Heating	C4950
Bolttech Mannings	N2326
Bonal Technologies Inc	N2924
EFD Induction Inc	C2139
ERIEZ	C7316
Flame Technologies Inc	N3219
GH Induction Atmospheres LLC	C2323
Guspro Inc	C1952
HOT COILS	N5115
Hotfoil EHS Inc	N1319
IonBond	C1010
IPG Photonics	N3931
LS Industries Inc	C8123
Parke Filtration and Separation	C7114
PDS Bartech Inc	N5917
Radyne Corp	N5024
Shijiazhuang Fitex Trading Co Ltd	C159
<b>Thermatool Corp</b>	<b>C2110</b>

## In-Die Assembly

Dongsan Bearing Co	C833
J Tech	C755
Uelner Precision Tools & Dies	C937

## In-Die Tapping

A-G Tool & Die	C920
Anchor Danly	C931
Automated Tapping Systems	C820
Fibro Inc	C249
GMT North America	C353
Pronic Inc	C828

TOP YES Precision Metal Products Co LTD	C1028
Uelner Precision Tools & Dies	C937

## Industrial Partitions & Enclosures

Clean Air Consultants/Filter 1	C2428
Frommelt Safety Products	N4827
<b>Goff's Enterprises Inc</b>	<b>N2625</b>
Hex-Hut Shelter Systems Ltd	N6115
JMR Industrial	C3752
Steiner Industries	N3022
Weldcoa	N3238
Wirecrafters	N1824

## Inhibitors

Cardinal Paint and Powder	C1761
DuBois Chemicals	C2545, C4938
Hubbard-Hall Inc	C2156

## Inspection & Testing - Load Monitoring & Weighing

American Society For Nondestructive Testing	N1615
Bolttech Mannings	N2326
HOT COILS	N5115
Measurement Systems Intl	C7138
OES Inc	C248
Wintriss Controls	C3711

## Inspection & Testing - Quality/ Process Control

Airgas Inc	N5231
American Society For Nondestructive Testing	N1615
BigC: Dino-Lite Scopes	C2055
Bruker Elemental	C7339
Carestream	N2426
Clara Vision	N1706
Creaform 3d	C552
Dakota Ultrasonics	N2624
DCM Tech Inc	C8346
DeFelsko Corp	C2442
Eddytech Systems Inc	C1752
Element Materials Technology	N5936
Fischer Technology Inc	C2711
InterTest Inc	N5824
Ironworkers Management Progressive Action Cooperative Trust (IMPACT)	N3004
Laboratory Testing Inc	C2310
Measurement Systems Intl	C7138
Melttools LLC	N1618
Metallurgical & Materials Technologies Inc	C1535

**Metronor Inc** ..... **C453**

Modern Manufacturing Technologies	C4738
Nikon Metrology Inc	C952
NIST	C8421
Nylok LLC	N1624
OES Inc	C248
Pace Technologies Corp	N2916
Phoenix International Inc	N2328
Powder Coating Consultants	C2422
Richard Wolf Industrial	N2309
Servo-Robot Inc	N5907
Shantou Inst of Ultrasonic Instruments Co Ltd (SIUI)	N2715
Sherwin Inc	N5918
Shijiazhuang Fitex Trading Co Ltd	C159
Southern Stud Weld Inc	N2616
Starrett Bytewise Measurement Systems	C3453
Thermo Scientific Portable XRF Analyzers	C2328
Toledo Blank	C1149
Turck Inc	C1312
Verisurf Software Inc	C7438
Welder Training & Testing Institute	N1533
Xiris Automation Inc	C2312
Zarbeco LLC	C1454

## Inspection/Testing Equipment - Dimensional & Shape/ Measuring

Accurex Measurement Inc	C2125
American Society For Nondestructive Testing	N1615
Clara Vision	N1706
Clark Fixture Technologies	C1520
Dakota Ultrasonics	N2624
FARO Technologies Inc	C7636
GE Measurement & Control	N3222
Horn Machine Tools Inc	C1734
Meta Vision Systems Inc	N5015
Metallurgical & Materials Technologies Inc	C1535
<b>Metronor Inc</b>	<b>C453</b>
Mill Masters	C1533
Modern Manufacturing Technologies	C4738
Prodim USA	C8521
Servo-Robot Inc	N5907
Shijiazhuang Fitex Trading Co Ltd	C159
Starrett Bytewise Measurement Systems	C3453



### Inspection/Testing Equipment - Finishing

ACT Test Panels LLC	C2434
American Society For Nondestructive Testing	N1615
Brandt Engineered Products Ltd	C1755
DeFelsko Corp	C2442
Elcometer Inc	N3126
<b>ElektroPhysik USA Inc</b>	<b>C2053</b>
Fischer Technology Inc	C2711
<b>Mighty Hook Inc</b>	<b>C2420</b>
Powder Coating	C2356
Richard Wolf Industrial	N2309
Zarbeco LLC	C1454

### Inspection/Testing Equipment - Hardness

American Society For Nondestructive Testing	N1615
Bolttech Mannings	N2326
Clara Vision	N1706
Elcometer Inc	C2152
Elcometer Inc	N3126
<b>ElektroPhysik USA Inc</b>	<b>C2053</b>
Fischer Technology Inc	C2711
Foerster Instruments Inc	C1523
Innerspec Technologies	N2217
Metallurgical & Materials Technologies Inc	C1535
Pace Technologies Corp	N2916
Shijiazhuang Fitex Trading Co Ltd	C159
TCT Stainless Steel Inc	C1058

### Inspection/Testing Equipment - Leak/Hydrostatic

American Society For Nondestructive Testing	N1615
Brandt Engineered Products Ltd	C1755
Fives Bronx Inc	C1514
Interlaken Technology	C947
Metallurgical & Materials Technologies Inc	C1535
Mill Masters	C1533
Shijiazhuang Fitex Trading Co Ltd	C159

### Inspection/Testing Equipment - Pressure/Force

Carestream	N2426
Interlaken Technology	C947
Measurement Systems Intl	C7138
Metallurgical & Materials Technologies Inc	C1535
OES Inc	C248

### Inspection/Testing Equipment - Sheet Metal

American Society For Nondestructive Testing	N1615
Clark Fixture Technologies	C1520
Dakota Ultrasonics	N2624
Elcometer Inc	C2152
Innerspec Technologies	N2217
Interlaken Technology	C947
Metallurgical & Materials Technologies Inc	C1535
<b>Metronor Inc</b>	<b>C453</b>
Modern Manufacturing Technologies	C4738
Starrett Bytewise Measurement Systems	C3453

### Inspection/Testing Equipment - Surface Finish

American Society For Nondestructive Testing	N1615
DeFelsko Corp	C2442
Elcometer Inc	N3126
Foerster Instruments Inc	C1523
Ketec Precision Tooling Co LTD	C3834
Pace Technologies Corp	N2916
Richard Wolf Industrial	N2309
Robotic Technologies of TN	N6025
Shijiazhuang Fitex Trading Co Ltd	C159
TCT Stainless Steel Inc	C1058
Zarbeco LLC	C1454

### Inspection/Testing Equipment - Temperature

DeFelsko Corp	C2442
IMPACT Engineering Inc	N5108
LA-CO Industries/Markal	N4802
Tempil an ITW Company	N5815

### Inspection/Testing Equipment - Tube/Pipe

Accurex Measurement Inc	C2125
Advanced Tubular Technologies Inc	C1556
BLM GROUP USA Corp	C1717
Brandt Engineered Products Ltd	C1755
Carestream	N2426
Chiyoda Kogyo-Maruka USA	C2134
Clark Fixture Technologies	C1520
Dakota Ultrasonics	N2624
Eaton Leonard	C1723
Eddytech Systems Inc	C1752
Elcometer Inc	C2152
Fives Bronx Inc	C1514
Foerster Instruments Inc	C1523
IMPACT Engineering Inc	N5108
Innerspec Technologies	N2217
Intercon Enterprises Inc	N3227

Interlaken Technology	C947
InterTest Inc	N5824
Meta Vision Systems Inc	N5015
Metallurgical & Materials Technologies Inc	C1535
<b>Metronor Inc</b>	<b>C453</b>
OES Inc	C248
Olympus NDT	N1613
Richard Wolf Industrial	N2309
Servo-Robot Inc	N5907
Starrett Bytewise Measurement Systems	C3453
Xiris Automation Inc	C2312

### Inspection/Testing Services

Accurex Measurement Inc	C2125
ACT Test Panels LLC	C2434
American Society For Nondestructive Testing	N1615
Brandt Engineered Products Ltd	C1755
Carestream	N2426
Clark Fixture Technologies	C1520
FARO Technologies Inc	C7636
Laboratory Testing Inc	C2310
Modern Manufacturing Technologies	C4738
North America Consulting	N6333
OES Inc	C248
PDS Bartech Inc	N5917
Powder Coating Consultants	C2422
Starrett Bytewise Measurement Systems	C3453
Thermo Scientific Portable XRF Analyzers	C2328
Welder Training & Testing Institute	N1533
Wheelabrator Group	C7121

### Insurance/Workers Compensation Services

<b>CNA Insurance</b>	<b>C7247</b>
Sentry Insurance	C4926
Travelers Companies Inc	C3734

### Inventory Management

<b>Beck Automation</b>	<b>C5520</b>
Fast Rite International	C854
Fastenal Company	N5736
Ficep Corporation	C6550
Machinery Marketing Intl	C8337
North America Consulting	N6333
Packsize LLC	C1336
Taylor Enterprises Inc	C347

### Ironworkers

C Marshall Fabrication Machinery	C7716
Cleveland Punch & Die Co	C5711





Cleveland Steel Tool Co	C5522
COMEQ Inc	C5125
Durma USA	C3949
Edwards Manufacturing Co	C7116
Ermak USA	C3447
Haco Atlantic Inc.	C3440
JMT USA	C5047
Manufacturing Solutions	C8429
Marvel Manufacturing Co.	C6316
Masteel America Corp	C3749
MegaFab-Piranha-Whitney-Bertsch	C5113
Peddinghaus Corp	C7723
Scotchman Industries Inc	C4923
Trilogy Machinery Inc	C5140
Uni-Hydro Inc.	C8537
US Industrial Machinery Co	C3049

**Job Shop Finishing Services - Paint/Powder**

BUWW Coverings Inc	C7320
Combustion and Systems Inc	C2411
Electrocoat Association, The	C2255
Glenn Metalcraft Inc.	C1034
Keyland Polymer Ltd	C2063
Lucky Harvest Co Ltd.	C958
Nylok LLC	N1624
Pneu-Mech Systems Manufacturing Inc.	C2539
Rohner	C2550
West Virginia Development Office	C7123

**Job Shop Finishing Services - Platers/Anodizers**

Anomatic Corp.	C2452
Ningbo Hi-Tech Moldie Machinery Co Ltd	C356

**Job Shop/ Contract Manufacturing Services - Stamping - Multi Slide**

Fast Rite International.	C854
--------------------------	------

**Job Shop/Contract Manufacturing Services - Assembling**

American Roll Form	C5038
Anchor Danly	C931
Anomatic Corp.	C2452
Arrowhead Manufacturers & Fabricators Assoc	C8242
Atlantic Tool & Die Co.	C1155
Bowlin Engineering	C4838
Brandt Engineered Products Ltd	C1755
Fast Rite International.	C854
Feed Lease Corp	C928
Felton Inc.	C7112

Global Precision Parts Inc	C2213
IMPACT Engineering Inc	N5108
Lucky Harvest Co Ltd.	C958
Magnetic Products Inc	C5510
Ningbo Hi-Tech Moldie Machinery Co Ltd	C356
Ohio Laser LLC	C1511
Penn United Technologies Inc.	C1420
Production Tube Cutting Inc	C2215

Samson Roll Formed Products Co	C6350
Superior Die Set Corp	C658
Tennessee Galvanizing Inc	C7113
Trans-Matic Mfg Co Inc	C1011
United Global Sourcing Inc	C8336
Vacco Industries	C8431
West Virginia Development Office	C7123
Wysong Parts and Service	C1023
York Portable Machine Tools	N2925

**Fed up with the inconsistencies of 4140?**

The main bearing end caps are a critical component for high horsepower NASCAR engines. We have to certify through hardness of HRC 30 minimum. After machining the part, we test the hardness at the point that was the center of the original plate.

"With 4140 pre heat treated we had inconsistencies. It was common to have a surface hardness of HRC 30 or more, and an internal hardness of HRC of 28 or less - and therefore, a high scrap rate. Since switching to Toolox 33, our scrap has been eliminated. And, uniform through hardness of HRC 30+ is consistent. The improved stability and machinability are just added bonus."

**INTERNATIONAL MOLD STEEL, INC.**

International Mold Steel, Inc.  
6796 Powerline Drive  
Florence, KY 41042  
USA Tel: (859) 342-6000  
Toll Free: 1-800-625-6653  
Fax: (859) 342-6006  
Email: info@imsteel.com  
Web: www.imsteel.com

**FABTECH**  
AISC WELDING CCAT FMA SME PMA METALFORM

Booth # C556

**TOOLOX®**  
ENGINEERING & TOOL STEEL



### Job Shop/Contract Manufacturing Services - Bending & Forming

Acrotech	C8213
A-G Tool & Die	C920
Alabama Laser	N6322
American Finishing Resources	C1855
American Roll Form	C5038
ARKU Coil Systems Inc	C7528
Arrowhead Manufacturers & Fabricators Assoc	C8242
Atlantic Tool & Die Co	C1155
BUWW Coverings Inc	C7320
CIECO Inc	C1334
Enutron International	C7750
Felton Inc	C7112
Interlaken Technology	C947
Lapham-Hickey Steel Corp	C840
Lucky Harvest Co Ltd	C958
Magnetic Products Inc	C5510
Ohio Laser LLC	C1511
Paramount Innovative Mfg	C2137
Premier Tooling & Mfg Inc	C1032
Production Tube Cutting Inc	C2215
R&B Machining Inc	C2124
Samson Roll Formed Products Co	C6350
Superform USA	C1060
TaurinGroup USA	C1739
Team Industries Inc	N2929
Tools for Bending	C2309
Ultratech Tool & Design Inc	C1332
Vacco Industries	C8431
West Virginia Development Office	C7123
Wysong Parts and Service	C1023

### Job Shop/Contract Manufacturing Services - Coating/Painting/Plating

BUWW Coverings Inc	C7320
Electrocoat Association,The	C2255
Felton Inc	C7112
Hayden Corp	N2409
Identification Plates Inc	C8340
IonBond	C1010
Metallizing Equipment Co PVT LTD	N2417
Ningbo Hi-Tech Moldie Machinery Co Ltd	C356
Penn United Technologies Inc	C1420
Precious Plate Inc	C2353
St Louis Metallizing Co	N2315
Team Industries Inc	N2929
Technogenia Inc	N4924
Vacco Industries	C8431
West Virginia Development Office	C7123

### Job Shop/Contract Manufacturing Services - Coil/ Toll Processing

Douglas Steel Supply Co	C5747
Erickson Metals Corp	C1035
Lapham-Hickey Steel Corp	C840
Measurement Systems Intl	C7138
O'Neal Flat Rolled Metals	C8331
Toledo Blank	C1149
United Aluminum Corp	C809
United Performance Metals	C1157

### Job Shop/Contract Manufacturing Services - Cutting

Anchor Danly	C931
Arrowhead Manufacturers & Fabricators Assoc	C8242
Darex LLC	C8138
Douglas Steel Supply Co	C5747
Felton Inc	C7112
Halifax Rack & Screw	C7310
II-VI Infrared	C4924
KMT Waterjet Systems Inc	C6334
Lapham-Hickey Steel Corp	C840
Ohio Laser LLC	C1511
Ophir Optics Inc	C3846
Passline Performance	C2325
Production Tube Cutting Inc	C2215
Robotmaster-In-House Solutions Inc	N5933
Semyx LLC	C6347
Superior Die Set Corp	C658
Team Industries Inc	N2929
United Performance Metals	C1157
West Virginia Development Office	C7123
Wysong Parts and Service	C1023

### Job Shop/Contract Manufacturing Services - EDM Die Manufacturing

Chelar Tool & Die Inc	C349
Elizabeth Carbide Components	C150
Moeller Precision Tool	C1020
Passline Performance	C2325
Penn United Technologies Inc	C1420
Ultratech Tool & Design Inc	C1332
Victory Tool	C246
Whistler & Sons Inc, SB	C4720

### Job Shop/Contract Manufacturing Services - Heat Treating

Alabama Laser	N6322
HOT COILS	N5115
PDS Bartech Inc	N5917

Solar Atmospheres of California	C923
Superior Die Set Corp	C658
Team Industries Inc	N2929
West Virginia Development Office	C7123

### Job Shop/Contract Manufacturing Services - Hot Dip Galvanizing

Shijiazhuang Fitex Trading Co Ltd	C159
Tennessee Galvanizing Inc	C7113
V&S Galvanizing LLC	C7427

### Job Shop/Contract Manufacturing Services - Hydroforming

Interlaken Technology	C947
Trans-Matic Mfg Co Inc	C1011

### Job Shop/Contract Manufacturing Services - Injection Molding

Felton Inc	C7112
Industrial Molded Rubber Products	C4723
Ningbo Hi-Tech Moldie Machinery Co Ltd	C356

### Job Shop/Contract Manufacturing Services - Laser Cutting

Advanced Laser Services LLC	C5634
Alabama Laser	N6322
Arrowhead Manufacturers & Fabricators Assoc	C8242
Bowlin Engineering	C4838
BUWW Coverings Inc	C7320
Chart Inc	N3204
Econco/CPI	C3712
Enutron International	C7750
Epilog Laser Corp	C7350
II-VI Infrared	C4924
Lapham-Hickey Steel Corp	C840
Laserage Technology Corp	N3209
Magnetic Products Inc	C5510
Ohio Laser LLC	C1511
OR Lasertechnology Inc	C7345
Paramount Innovative Mfg	C2137
Robotmaster-In-House Solutions Inc	N5933
United Performance Metals	C1157
Vacco Industries	C8431
West Virginia Development Office	C7123
Wirecrafters	N1824



### Job Shop/Contract Manufacturing Services - Laser Drilling

II-VI Infrared .....	C4924
Laserage Technology Corp .....	N3209
Vacco Industries .....	C8431

### Job Shop/Contract Manufacturing Services - Laser Marking

Alabama Laser .....	N6322
Epilog Laser Corp .....	C7350
Identification Plates Inc. ....	C8340
II-VI Infrared .....	C4924
Moeller Precision Tool .....	C1020
OR Lasertechnology Inc. ....	C7345
Vacco Industries .....	C8431
Weldlogic Inc .....	N5826

### Job Shop/Contract Manufacturing Services - Laser Processing

AltaMAR Inc .....	C1522
II-VI Infrared .....	C4924
Ohio Laser LLC .....	C1511

### Job Shop/Contract Manufacturing Services - Laser Tube Cutting

AltaMAR Inc .....	C1522
Laserage Technology Corp .....	N3209
Ohio Laser LLC .....	C1511
Paramount Innovative Mfg .....	C2137

### Job Shop/Contract Manufacturing Services - Laser Welding

Alabama Laser .....	N6322
AltaMAR Inc .....	C1522
Electron Beam Engineering Inc. ....	N3306
Hayden Corp .....	N2409
II-VI Infrared .....	C4924
Laserage Technology Corp .....	N3209
RPMC Lasers .....	C8411
St Louis Metallizing Co. ....	N2315
Stripmatic Products Inc. ....	C1415
Trans-Matic Mfg Co Inc .....	C1011
Vacco Industries .....	C8431

### Job Shop/Contract Manufacturing Services - Machining

Acrotech .....	C8213
A-G Tool & Die .....	C920
Anchor Danly .....	C931

Arrowhead Manufacturers & Fabricators Assoc .....	C8242
BesTech Tool Corp .....	C921
Bolttech Mannings .....	N2326
Bowlin Engineering .....	C4838
Brandt Engineered Products Ltd ....	C1755
Butech Bliss .....	C5532
<b>Chelar Tool &amp; Die Inc .....</b>	<b>C349</b>
China National Aero Technology IE Hangzhou Co .....	C160
Cleveland Steel Tool Co .....	C5522
Elizabeth Carbide Components .....	C150
F & G Tool and Die Co .....	C1413
Felton Inc. ....	C7112
Gem Tool Corporation .....	C2320
Glenn Metalcraft Inc. ....	C1034
Global Precision Parts Inc. ....	C2213
Halifax Rack & Screw .....	C7310
Hayden Corp .....	N2409
Magnetic Products Inc .....	C5510
Ningbo Hi-Tech Moldie Machinery Co Ltd .....	C356
Ohio Laser LLC .....	C1511
P&G Fluid Power Inc .....	C1320
Pacific Aerospace & Electronics ....	N1607
Paramount Innovative Mfg .....	C2137
Passline Performance .....	C2325
<b>Penn United Technologies Inc. ....</b>	<b>C1420</b>
Precision Punch Corp. ....	C1432
Premier Tooling & Mfg Inc .....	C1032
Robotmaster-In-House Solutions Inc. ....	N5933
Superior Die Set Corp. ....	C658
Superior Products .....	N2517
United Global Sourcing Inc. ....	C8336
Vacco Industries .....	C8431
West Virginia Development Office ..	C7123
Western Enterprises .....	N2933
Whistler & Sons Inc, SB .....	C4720
Wysong Parts and Service .....	C1023
York Portable Machine Tools .....	N2925

### Job Shop/Contract Manufacturing Services - Metal Finishing

<b>Chemical Coaters Assoc Int'l .....</b>	<b>C1948</b>
KLINGSPOR Abrasives Inc. ....	N3135
Shenzhen Huayuanda Technology Co Ltd .....	C949
Tennessee Galvanizing Inc .....	C7113

### Job Shop/Contract Manufacturing Services - Metal Spinning

Glenn Metalcraft Inc. ....	C1034
----------------------------	-------

Global Metal Spinning Solutions Inc .....	C934
----------------------------------------------	------

### Job Shop/Contract Manufacturing Services - Plasma Cutting

Arrowhead Manufacturers & Fabricators Assoc .....	C8242
Glenn Metalcraft Inc. ....	C1034
<b>Lapham-Hickey Steel Corp .....</b>	<b>C840</b>
PythonX-Burlington Automation ....	C8116
Semyx LLC .....	C6347
West Virginia Development Office ..	C7123
Wysong Parts and Service .....	C1023

### Job Shop/Contract Manufacturing Services - Punching

Alabama Laser .....	N6322
American Roll Form .....	C5038
ARKU Coil Systems Inc .....	C7528
Arrowhead Manufacturers & Fabricators Assoc .....	C8242
China National Aero Technology IE Hangzhou Co .....	C160
Felton Inc. ....	C7112
Identification Plates Inc. ....	C8340
Ketec Precision Tooling Co LTD. ....	C3834
Magnetic Products Inc .....	C5510
Ningbo Hi-Tech Moldie Machinery Co Ltd .....	C356
Nitto Kohki USA Inc .....	C1510
Production Tube Cutting Inc .....	C2215
Samson Roll Formed Products Co ...	C6350
Trans-Matic Mfg Co Inc .....	C1011
Ultratech Tool & Design Inc .....	C1332
Uni-Hydro Inc. ....	C8537
West Virginia Development Office ..	C7123
Whistler & Sons Inc, SB .....	C4720

### Job Shop/Contract Manufacturing Services - Roll Forming

American Roll Form .....	C5038
<b>Bradbury Co., Inc., The .....</b>	<b>C5520</b>
<b>Bradbury Group, The .....</b>	<b>C5520</b>
China National Aero Technology IE Hangzhou Co .....	C160
Douglas Steel Supply Co. ....	C5747
Felton Inc. ....	C7112
Ketec Precision Tooling Co LTD. ....	C3834
<b>Lucas-Milhaupt Inc .....</b>	<b>N5027</b>
Passline Performance .....	C2325
Premier Tooling & Mfg Inc .....	C1032
Samson Roll Formed Products Co ...	C6350





**Job Shop/Contract  
Manufacturing Services -  
Roll Forming**

- Starrett Bytewise
- Measurement Systems . . . . . C3453
- West Virginia Development Office . . . C7123

**Job Shop/Contract  
Manufacturing Services -  
Stamping - Deep Drawing**

- Anomatic Corp. . . . . C2452
- BesTech Tool Corp. . . . . C921
- F & G Tool and Die Co. . . . . C1413
- Fast Rite International. . . . . C854
- Forming Technologies Inc . . . . . C1421
- ITW Sexton . . . . . C1061
- Lucky Harvest Co Ltd. . . . . C958
- Ningbo Hi-Tech Moldie  
Machinery Co Ltd . . . . . C356
- Precision Stamping Products . . . . . C1158
- Superform USA . . . . . C1060
- Trans-Matic Mfg Co Inc . . . . . C1011
- Uelner Precision Tools & Dies. . . . . C937
- Ultratech Tool & Design Inc . . . . . C1332
- United Global Sourcing Inc. . . . . C8336

**Job Shop/Contract  
Manufacturing Services -  
Stamping - Fine Blanking**

- American Roll Form. . . . . C5038
- China National Aero  
Technology IE Hangzhou Co . . . . . C160
- Fast Rite International. . . . . C854
- Felton Inc. . . . . C7112
- Magnetic Products Inc . . . . . C5510
- Samson Roll Formed Products Co. . . . C6350
- TaurinGroup USA. . . . . C1739
- United Global Sourcing Inc. . . . . C8336
- Weil Engineering North America . . . C8209

**Job Shop/Contract  
Manufacturing Services -  
Stamping - Four Slide**

- Clips & Clamps Industries. . . . . C148
- F & G Tool and Die Co. . . . . C1413
- Fast Rite International. . . . . C854

**Job Shop/Contract  
Manufacturing Services -  
Stamping - High Speed**

- Fast Rite International. . . . . C854
- Felton Inc. . . . . C7112
- Lucky Harvest Co Ltd. . . . . C958
- Penn United Technologies Inc. . . . . C1420
- Precision Stamping Products . . . . . C1158
- Trans-Matic Mfg Co Inc . . . . . C1011
- Whistler & Sons Inc, SB . . . . . C4720

**Job Shop/Contract  
Manufacturing Services -  
Stamping - Multi Slide**

- Clips & Clamps Industries. . . . . C148
- F & G Tool and Die Co. . . . . C1413

**Job Shop/Contract  
Manufacturing Services -  
Stamping - Progressive**

- A-G Tool & Die . . . . . C920
- Atlantic Tool & Die Co. . . . . C1155
- BesTech Tool Corp. . . . . C921
- Chelar Tool & Die Inc . . . . . C349
- Clips & Clamps Industries. . . . . C148
- F & G Tool and Die Co. . . . . C1413
- Fast Rite International. . . . . C854
- Forming Technologies Inc . . . . . C1421
- Lucky Harvest Co Ltd. . . . . C958
- Penn United Technologies Inc. . . . . C1420
- Precision Stamping Products . . . . . C1158
- Stripmatic Products Inc. . . . . C1415
- Toledo Blank . . . . . C1149
- Trans-Matic Mfg Co Inc . . . . . C1011
- Uelner Precision Tools & Dies. . . . . C937
- Ultratech Tool & Design Inc . . . . . C1332
- Whistler & Sons Inc, SB . . . . . C4720

**Job Shop/Contract  
Manufacturing Services -  
Stamping - Single Stroke**

- A-G Tool & Die . . . . . C920
- Atlantic Tool & Die Co. . . . . C1155
- Chelar Tool & Die Inc . . . . . C349
- Fast Rite International. . . . . C854
- Felton Inc. . . . . C7112
- Forming Technologies Inc . . . . . C1421
- Lucky Harvest Co Ltd. . . . . C958
- Penn United Technologies Inc. . . . . C1420
- Precision Stamping Products . . . . . C1158
- Ultratech Tool & Design Inc . . . . . C1332

**Job Shop/Contract  
Manufacturing Services -  
Stamping - Transfer**

- A-G Tool & Die . . . . . C920
- Atlantic Tool & Die Co. . . . . C1155
- BesTech Tool Corp. . . . . C921
- Fast Rite International. . . . . C854
- Forming Technologies Inc . . . . . C1421
- Lucky Harvest Co Ltd. . . . . C958
- Stripmatic Products Inc. . . . . C1415
- Trans-Matic Mfg Co Inc . . . . . C1011
- Uelner Precision Tools & Dies. . . . . C937

**Job Shop/Contract  
Manufacturing Services - T/P  
Bending & Forming**

- A-G Tool & Die . . . . . C920
- American Roll Form. . . . . C5038
- Atlantic Tool & Die Co. . . . . C1155
- Midwest Bender Services Corp . . . . C1728
- Paramount Innovative Mfg . . . . . C2137
- Production Tube Cutting Inc . . . . . C2215
- R&B Machining Inc. . . . . C2124
- Samson Roll Formed Products Co. . . . C6350
- Schuler Incorporated. . . . . C917
- TaurinGroup USA. . . . . C1739
- Trans-Matic Mfg Co Inc . . . . . C1011
- Weil Engineering North America . . . C8209

**Job Shop/Contract  
Manufacturing Services - T/P  
End Forming/Sizing**

- A-G Tool & Die . . . . . C920
- Atlantic Tool & Die Co. . . . . C1155
- Overton Industries. . . . . C2225
- Production Tube Cutting Inc . . . . . C2215
- R&B Machining Inc. . . . . C2124
- Stripmatic Products Inc. . . . . C1415
- Team Industries Inc. . . . . N2929
- Trans-Matic Mfg Co Inc . . . . . C1011

**Job Shop/Contract  
Manufacturing Services - Tool  
Surface Treatment**

- Alabama Laser . . . . . N6322
- COR-MET INC . . . . . N5534
- Darex LLC . . . . . C8138

**Job Shop/Contract  
Manufacturing Services -  
Waterjet Cutting**

- Arrowhead Manufacturers &  
Fabricators Assoc . . . . . C8242
- BesTech Tool Corp. . . . . C921
- Glenn Metalcraft Inc. . . . . C1034
- Penn United Technologies Inc. . . . . C1420
- Robotmaster-In-House  
Solutions Inc. . . . . N5933
- Semyx LLC. . . . . C6347
- West Virginia Development Office . . C7123

**Job Shop/Contract  
Manufacturing Services -  
Welding - Laser Welding**

- Alabama Laser . . . . . N6322
- AltaMAR Inc . . . . . C1522
- Changzhou Wujin Golden Globe Welding  
& Cutting Machinery Co Ltd . . . . . N5900
- Cyl-Tec Inc . . . . . N3138



Electron Beam Engineering Inc . . . . .	N3306
Pacific Aerospace & Electronics . . . . .	N1607
St Louis Metallizing Co. . . . .	N2315
Stripmatic Products Inc. . . . .	C1415
Trans-Matic Mfg Co Inc . . . . .	C1011
Vacco Industries . . . . .	C8431

**Job Shop/Contract  
Manufacturing Services -  
Welding - Mig Welding**

Arrowhead Manufacturers & Fabricators Assoc . . . . .	C8242
Atlantic Tool & Die Co. . . . .	C1155
Changzhou Wujin Golden Globe Welding & Cutting Machinery Co Ltd . . . . .	N5900
Cyl-Tec Inc . . . . .	N3138
Glenn Metalcraft Inc. . . . .	C1034
Hotfoil EHS Inc . . . . .	N1319
<b>Lapham-Hickey Steel Corp . . . . .</b>	<b>C840</b>
Meltric Corp . . . . .	N4826
Ningbo Hi-Tech Moldie Machinery Co Ltd . . . . .	C356
Nylok LLC. . . . .	N1624
Ohio Laser LLC. . . . .	C1511
Paramount Innovative Mfg . . . . .	C2137
REXARC International . . . . .	N1515
Welding Alloys USA . . . . .	N4917
West Virginia Development Office . .	C7123

**Job Shop/Contract  
Manufacturing Services -  
Welding - Resistance Welding**

Atlantic Tool & Die Co. . . . .	C1155
Electron Beam Engineering Inc. . . . .	N3306
Glenn Metalcraft Inc. . . . .	C1034
ITW Sexton . . . . .	C1061
Janda Co Inc . . . . .	N1924
Trans-Matic Mfg Co Inc . . . . .	C1011
Vacco Industries . . . . .	C8431

**Job Shop/Contract  
Manufacturing Services -  
Welding - Robotic Welding**

Alabama Laser . . . . .	N6322
Anchor Danly. . . . .	C931
Atlantic Tool & Die Co. . . . .	C1155
Glenn Metalcraft Inc. . . . .	C1034
Hayden Corp . . . . .	N2409
<b>Lapham-Hickey Steel Corp . . . . .</b>	<b>C840</b>
Lucky Harvest Co Ltd. . . . .	C958
Ohio Laser LLC. . . . .	C1511
Robotmaster-In-House Solutions Inc. . . . .	N5933
Stripmatic Products Inc. . . . .	C1415

**Job Shop/Contract  
Manufacturing Services -  
Welding - Seam/Spot Welding**

Glenn Metalcraft Inc. . . . .	C1034
Lucky Harvest Co Ltd. . . . .	C958
Meltric Corp . . . . .	N4826
Stripmatic Products Inc. . . . .	C1415
West Virginia Development Office . .	C7123

**Job Shop/Contract  
Manufacturing Services -  
Welding/Brazing**

Alabama Laser . . . . .	N6322
American Roll Form. . . . .	C5038
Anchor Danly. . . . .	C931
Atlantic Tool & Die Co. . . . .	C1155
Bowlin Engineering. . . . .	C4838
Cyl-Tec Inc. . . . .	N3138
Electron Beam Engineering Inc. . . . .	N3306
Fusion Inc . . . . .	N3313
International Welding Technologies Inc . . . . .	N1724
<b>Lucas-Milhaupt Inc . . . . .</b>	<b>N5027</b>
Magnetic Products Inc . . . . .	C5510
Ohio Laser LLC. . . . .	C1511
OR Lasertechnology Inc. . . . .	C7345
Premier Tooling & Mfg Inc . . . . .	C1032
<b>PTR-Precision Technologies Inc . . . . .</b>	<b>N5226</b>
REXARC International . . . . .	N1515
Solar Atmospheres of California. . . . .	C923
Superior Die Set Corp. . . . .	C658
Team Industries Inc. . . . .	N2929
Technogenia Inc . . . . .	N4924
Weil Engineering North America . . .	C8209
Weldlogic Inc . . . . .	N5826
West Virginia Development Office . .	C7123
Western Enterprises . . . . .	N2933
York Portable Machine Tools . . . . .	N2925

**Job Shop/Contract  
Manufacturing Services -  
Wire Forming**

American Finishing Resources . . . . .	C1855
Clips & Clamps Industries. . . . .	C148
Felton Inc. . . . .	C7112
<b>Lucas-Milhaupt Inc . . . . .</b>	<b>N5027</b>
<b>Mighty Hook Inc . . . . .</b>	<b>C2420</b>
United Global Sourcing Inc. . . . .	C8336

**Knives & Blades**

<b>American Machine &amp; Rollform Tech. .</b>	<b>C5520</b>
American Punch Co. . . . .	C5026
ASKO Inc . . . . .	C4810
BandSawParts.com. . . . .	C7538
BESSEY Tools North America . . . . .	N4931
<b>Betenbender Manufacturing Inc. . . . .</b>	<b>C3744</b>

California Cold Saw . . . . .	C7240
Cleveland Punch & Die Co . . . . .	C5711
DoALL Sawing Products . . . . .	C7713
Doringer Cold Saws . . . . .	C4913
Eberle America Inc . . . . .	C8312
Enutron International . . . . .	C7750
Gem Tool Corporation . . . . .	C2320
Haas Saw & Supply . . . . .	C1535
Haberle / Ken Bergman & Assoc LLC .	C7137
Hydro Carbide Inc . . . . .	C8238
M K Morse Co, The. . . . .	C7109
Mill Masters . . . . .	C1533
Roll Machining Technologies & Solutions . . . . .	C1526
Saar Hartmetall USA LLC . . . . .	N5925
T&H Lemont . . . . .	C2117
Trilogy Machinery Inc . . . . .	C5140

**Lacquers**

Cardinal Paint and Powder . . . . .	C1761
Strathmore Products Inc . . . . .	C1955

**Laser Cladding**

Alabama Laser . . . . .	N6322
Coherent Inc . . . . .	C7309
Frommelt Safety Products. . . . .	N4827
Hayden Corp . . . . .	N2409
<b>LaserStar Technologies Corp . . . . .</b>	<b>C5647</b>
RPMC Lasers . . . . .	C8411
St Louis Metallizing Co. . . . .	N2315
<b>Sulzer Metco US Inc. . . . .</b>	<b>N2413</b>
<b>TeraDiode Inc . . . . .</b>	<b>C8523</b>
Wayne Trail, a Lincoln Electric Company . . . . .	N4513

**Laser Cutting Machines**

Advanced Laser Services LLC . . . . .	C5634
<b>AKS Cutting Systems Inc . . . . .</b>	<b>C5135</b>
Alabama Laser . . . . .	N6322
AltaMAR Inc . . . . .	C1522
Alternative Parts Inc. . . . .	C3726
<b>Amada America Inc. . . . .</b>	<b>C3916</b>
Baykal Makina Sanayi ve Ticaret AS. . . . .	C5940, C5947
BLM GROUP USA Corp . . . . .	C1717
<b>Bystronic Inc . . . . .</b>	<b>C4328</b>
Chart Inc . . . . .	N3204
<b>Chicago Slitter. . . . .</b>	<b>C7023</b>
Cyl-Tec Inc. . . . .	N3138
Delta Steel Technologies . . . . .	C5952
Durma USA . . . . .	C3949
Dynatorch Inc . . . . .	N4837
Econco/CPI . . . . .	C3712
Elo Automated Stainless Steel Technologies Qingdao Co Ltd. . . . .	C8342
Enutron International . . . . .	C7750



## Laser Cutting Machines

Epilog Laser Corp	C7350
Ermak USA	C3447
Friggi N.A. Inc	C7642
Genstar Technologies Inc	N2822
Haco-Lasit	C3440
Hypertherm Inc	N3906
IPG Photonics	N3931
JETCAM-NestONE Solutions	C4722
Kern Electronics & Lasers	C6513
Koike Aronson Inc	N4131
Kong NGAI Precision Metal Mould Shenzhen Co Ltd	C856
Lantek Systems Inc	C4940
Laser Experts Inc	C5742
Laser Mechanisms Inc	C3810
LT Ultra Precision Optics	C8223
LVD Stripit	C3937
Manufacturing Solutions	C8429
Mazak Optonics Corp	C3428
MC Machinery Systems Inc/ Mitsubishi	C3040
Messer Cutting Systems	C5916
MultiCam Inc	C5516
Murata Machinery USA Inc	C3028
Ningbo Jinfeng Welding & Cutting Machinery Manufacture Co Ltd	N6007
Ophir Optics Inc	C3846
OR Lasertechnology Inc	C7345
Panasonic Electric Works Corp of America	C7411
Perfection Global LLC	C3832
Prestige Equipment Corporation	C7214
Prima Power North America Inc	C4336
Richardson Electronics Ltd	C3721
RPMC Lasers	C8411
Sahajanand Laser Technology LTD	C8230
Salvagnini America Inc	C3928
SteelTailor Ltd	N4919
Toolmen Corp	C1253
TRUMPF Inc	C3016
VyTek Inc	C8145
Wayne Trail, a Lincoln Electric Company	N4513
Weil Engineering North America	C8209
Westingcut Industrial Technology Anhui Inc	N1424
Wolf Robotics LLC	N4910

## Laser Cutting Optics & Accessories

Advanced Laser Services LLC	C5634
Alternative Parts Inc	C3726
American Photonics	C3825
American Torch Tip Co Inc	N2022
Centricut	C4935

Hypertherm Inc	N3906
II-VI Infrared	C4924
Kern Electronics & Lasers	C6513
Lambda Research Optics Inc	C5633
Laser Experts Inc	C5742
Laser Mechanisms Inc	C3810
Laser Research Optics	C3847
LaserRite (American BiltRite)	C3451
LT Ultra Precision Optics	C8223
Machinery Marketing Intl	C8337
Mate Precision Tooling	C3720
Mazak Optonics Corp	C3428
MC Machinery Systems Inc/ Mitsubishi	C3040
MultiCam Inc	C5516
Ophir Optics Inc	C3846
Parke Filtration and Separation	C7114
Praxair Inc	N5202
Richardson Electronics Ltd	C3721
Rocky Mountain Instruments Co (RMI)	C8313
RPMC Lasers	C8411
Sellstrom Manufacturing Co	N3413

## Lasers - Fiber Laser Cutting Machines

Amada America Inc	C3916
Baykal Makina Sanayi ve Ticaret AS	C5940, C5947
Chicago Slitter	C7023
Enutron International	C7750
Epilog Laser Corp	C7350
Ermak USA	C3447
Haco-Lasit	C3440
Hypertherm Inc	N3906
Koike Aronson Inc	N4131
Lambda Research Optics Inc	C5633
Laser Mechanisms Inc	C3810
LaserStar Technologies Corp	C5647
MC Machinery Systems Inc/ Mitsubishi	C3040
Nufern	C8339
Panasonic Electric Works Corp of America	C7411
RPMC Lasers	C8411
Salvagnini America Inc	C3928
Toolmen Corp	C1253
TRUMPF Inc	C3016
VyTek Inc	C8145
Westingcut Industrial Technology Anhui Inc	N1424

## Lasers - Laser Surface Ablation/Coating Removal

Coherent Inc	C7309
Epilog Laser Corp	C7350

Kern Electronics & Lasers	C6513
LaserStar Technologies Corp	C5647
Panasonic Electric Works Corp of America	C7411
REA Elektronik Inc	C1834
RPMC Lasers	C8411
Wayne Trail, a Lincoln Electric Company	N4513

## Lasers - Polymer Welding

Coherent Inc	C7309
RPMC Lasers	C8411

## Lasers - Remote Welding, CO2

Coherent Inc	C7309
II-VI Infrared	C4924
RPMC Lasers	C8411
TRUMPF Inc	C3016

## Lasers - Remote Welding, Diode

Coherent Inc	C7309
RPMC Lasers	C8411
Sunstone Engineering	N5916
TeraDiode Inc	C8523

## Lasers - Remote Welding, Fiber

AKS Cutting Systems Inc	C5135
Coherent Inc	C7309
LaserStar Technologies Corp	C5647
RPMC Lasers	C8411
Stripmatic Products Inc	C1415
Sunstone Engineering	N5916
TeraDiode Inc	C8523
Wayne Trail, a Lincoln Electric Company	N4513

## Lasers - Remote Welding, Solid State

Coherent Inc	C7309
RPMC Lasers	C8411
TeraDiode Inc	C8523
TRUMPF Inc	C3016

## Lasers - Tube & Profile Welding

Coherent Inc	C7309
LaserStar Technologies Corp	C5647
RPMC Lasers	C8411
Stripmatic Products Inc	C1415
TeraDiode Inc	C8523

## Lean Manufacturing

5S Supply	C3454
Carr Lane Manufacturing Co	N3036
CNA Insurance	C7247
Meltric Corp	N4826
Packsizes LLC	C1336





Pollution Control Products . . . . . C2415  
 Precision Punch Corp. . . . . C1432  
 Rimco Equipment . . . . . N1631  
 Toledo Blank . . . . . C1149  
 Vacco Industries . . . . . C8431  
 Wila USA. . . . . C5709  
 Wintriss Controls . . . . . C3711

**Leasing Services**

Marvel Manufacturing Co. . . . . C6316  
 PDS Bartech Inc. . . . . N5917  
 Scotchman Industries Inc . . . . . C4923  
 Sertom Group North America LLC . . . . . C6911

**Leveling Equipment - Machinery Installation**

ARKU Coil Systems Inc. . . . . C7528  
 Burghardt + Schmidt GmbH . . . . . C4934  
 Butech Bliss. . . . . C5532  
 Herr Voss Stamco . . . . . C7239  
 Leveltek Intl LLC . . . . . C5950  
 Unisorb Installation Technologies. . . . . C1411

**Leveling Equipment - Plate Leveler**

ARKU Coil Systems Inc. . . . . C7528  
 Athader . . . . . C5520  
 Bradbury Co., Inc., The . . . . . C5520  
 Bradbury Group, The . . . . . C5520  
 D&H Machinery Inc. . . . . C2112  
 Delta Steel Technologies . . . . . C5952  
 Faccin USA Inc . . . . . C6323  
 Herr Voss Stamco . . . . . C7239  
 Leveltek Intl LLC . . . . . C5950  
 Trilogy Machinery Inc . . . . . C5140

**Leveling Equipment - Sheet Metal**

ARKU Coil Systems Inc. . . . . C7528  
 Athader . . . . . C5520  
 Bradbury Co., Inc., The . . . . . C5520  
 Bradbury Group, The . . . . . C5520  
 Burghardt + Schmidt GmbH . . . . . C4934  
 Butech Bliss. . . . . C5532  
 D&H Machinery Inc. . . . . C2112  
 Formtek Metal Forming & Hill Engineering. . . . . C3708  
 Herr Voss Stamco . . . . . C7239  
 Leveltek Intl LLC . . . . . C5950  
 Machine Concepts Inc. . . . . C4726  
 Metform International Ltd. . . . . C5534  
 Perfection Global LLC . . . . . C3832  
 Red Bud Industries . . . . . C4732  
 Trilogy Machinery Inc . . . . . C514

**Lift Trucks**

Combilift USA . . . . . C5726  
 Linemaster Switch Corp . . . . . C2324  
 Sumner Manufacturing Co Inc . . . . . N1519

**Light Curtains**

AP&T North America Inc. . . . . C1231  
 AVS Industries LLC . . . . . N6018  
 CIECO Inc. . . . . C1334  
 Frommelt Safety Products. . . . . N4827  
 Gaozhou City Longsafety Labor Insurance. . . . . N6201  
 International Technologies Inc . . . . . C8111  
 ISB Group . . . . . C4728  
 Kimberly-Clark Professional . . . . . N3407  
 Panasonic Electric Works Corp of America . . . . . C7411  
 Tapeswitch Corp . . . . . C3813  
 Toledo Integrated Systems. . . . . C1317

**Loop Controls**

DELTA Computer Systems Inc. . . . . C1024  
 Starrett Bytewise Measurement Systems. . . . . C3453

**Lubricants**

BESSEY Tools North America . . . . . N4931  
 California Cold Saw . . . . . C7240  
 Calvary Industries Inc . . . . . C2734  
 Chemetall US Inc. . . . . C2709  
 Chemtool Inc . . . . . C660  
 Cimcool Fluid Technology . . . . . C1452  
 Cleveland Punch & Die Co . . . . . C5711  
 Coral Chemical Co. . . . . C2417  
 Dayton Progress Corp. . . . . C813  
 DoALL Sawing Products . . . . . C7713  
 DuBois Chemicals . . . . . C2545  
 DuBois Chemicals . . . . . C4938  
 Emmegi USA Inc. . . . . C7323  
 Fastenal Company. . . . . N5736  
 Fuchs Lubricants Co . . . . . C1517  
 Global Metal Spinning Solutions Inc . . . . . C934  
 GMT North America . . . . . C353  
 Hiwin Corp. . . . . C1321  
 Houghton International Inc. . . . . C1437, C1552  
 Hubbard-Hall Inc. . . . . C2156  
 International Chemical Co. . . . . C1232  
 LA-CO Industries/Markal . . . . . N4802  
 Laser Experts Inc. . . . . C5742  
 LENOX. . . . . C4808  
 LSP Industries Inc . . . . . C1212  
 Metalloid Corp . . . . . C1447  
 Rock Valley Oil & Chemical Co Inc . . . . . C1049  
 Taylor Enterprises Inc . . . . . C347  
 Tower Oil & Technology Co. . . . . C1319

UltraLube. . . . . C7539  
 Unist Inc . . . . . C847  
 Walter Surface Technologies . . . . . N2628  
 Weld-Aid Products . . . . . N4928  
 Zerust Corrosion Solutions (Northern Tech Intl Corp). . . . . C1014

**Lubrication Equipment**

Bruderer Machinery Inc. . . . . C925  
 LSP Industries Inc . . . . . C1212  
 P&G Fluid Power Inc . . . . . C1320  
 Pax Products Inc . . . . . C1428  
 Tower Oil & Technology Co . . . . . C1319  
 UltraLube. . . . . C7539  
 Unist Inc . . . . . C847

**Machine Control Hardware & Components**

Alternative Parts Inc . . . . . C3726  
 Beck Automation. . . . . C5520  
 Beckhoff Automation . . . . . C7545  
 CIECO Inc. . . . . C1334  
 DELTA Computer Systems Inc. . . . . C1024  
 Hiwin Corp. . . . . C1321  
 Horn Machine Tools Inc . . . . . C1734  
 Hypertherm Inc . . . . . N3906  
 ISB Group . . . . . C4728  
 Laser Experts Inc. . . . . C5742  
 Link Systems . . . . . C909  
 Panasonic Electric Works Corp of America . . . . . C7411  
 Parker domnick hunter . . . . . N1513  
 PDS Bartech Inc. . . . . N5917  
 Servo-Robot Inc. . . . . N5907  
 SEYI America Inc. . . . . C653  
 Tapeswitch Corp . . . . . C3813  
 Toledo Integrated Systems . . . . . C1317  
 Tube Works Inc . . . . . C1449  
 Universal Controls Group . . . . . C1528  
 Victory Plasma Systems Inc . . . . . N4833  
 Wintriss Controls . . . . . C3711

**Machine Control Software**

Accurpress America Inc . . . . . C3047  
 Advanced Tubular Technologies Inc . . . . . C1556  
 Arc Specialties Inc . . . . . N1610  
 Beck Automation. . . . . C5520  
 Beckhoff Automation . . . . . C7545  
 Controlled Automation Inc . . . . . C7730  
 DELTA Computer Systems Inc. . . . . C1024  
 Dynatorch Inc . . . . . N4837  
 Emmegi USA Inc . . . . . C7323  
 Horn Machine Tools Inc . . . . . C1734  
 Hypertherm Inc . . . . . N3906  
 Jetline Engineering. . . . . N5813  
 Kinetic Cutting Systems Inc . . . . . C6311



## Machine Control Software

Link Systems	C909
Metalix CAD/CAM Ltd	C4911
Ocean Machinery Inc	C7523
Parker domnick hunter	N1513
PDS Bartech Inc.	N5917
PEP Technology	C8320
Servo-Robot Inc.	N5907
Shop Edge Software Inc	C1434
<b>SigmaTEK Systems LLC</b>	<b>C4932</b>
Striker Systems	C3728
Toledo Integrated Systems	C1317
Victory Plasma Systems Inc	N4833

## Machine Monitors

Alternative Parts Inc	C3726
Beckhoff Automation	C7545
CIECO Inc.	C1334
<b>DELTA Computer Systems Inc</b>	<b>C1024</b>
Meltools LLC	N1618
OES Inc	C248
Parker domnick hunter	N1513
Wintriss Controls	C3711

## Machine Rebuilding/ Reconditioning Services

Advanced Laser Services LLC	C5634
AIDA-America Corp.	C1210
<b>Alliance Machine and Engraving LLC</b>	<b>C5250</b>
Bliss Clearing Niagara	C933
Butech Bliss	C5532
BUWW Coverings Inc	C7320
Controlled Automation Inc	C7730
Fiba Technologies Inc	N6324
Ficep Corporation	C6550
Greenberry Industrial	C8140
Heim Group, The	C1331
Horn Machine Tools Inc	C1734
Janda Co Inc	N1924
Laser Experts Inc	C5742
Machine Concepts Inc.	C4726
Metform International Ltd.	C5534
Pangborn Corp.	C6516
Schuler Incorporated.	C917
SEYI America Inc.	C653
Sutherland Presses	C152
T&H Lemont	C2117
TJ Snow Co.	N2613
Tube Works Inc	C1449
Wheelabrator Group	C7121

## Machinery Installation/ Alignment Services

<b>Accurpress America Inc</b>	<b>C3047</b>
AIDA-America Corp.	C1210
Bliss Clearing Niagara	C933

Bowlin Engineering	C4838
Greenberry Industrial	C8140
Laser Experts Inc	C5742
<b>Leveltek Intl LLC</b>	<b>C5950</b>
Schuler Incorporated.	C917
T&H Lemont	C2117
Unisorb Installation Technologies	C1411

## Magnets & Magnetic Equipment

BESSEY Tools North America	N4931
Bug-O Systems	N4813, N5013
EAS Mold & Die Change Systems, Inc	C1026
ERIEZ	C7316
<b>Hayes International</b>	<b>C5520</b>
Hougen Manufacturing Inc	C4821
Industrial Magnetics Inc	C5728
JMR Industrial	C3752
Magnetic Products Inc	C5510
Master Magnetics	C4733
Mathey Dearman	N5710
Permador Industries Inc	N3006
Shred-Tech Compass Systems	C7550
Steelmax Tools	N4737
<b>Strong Hand Tools</b>	<b>N3631</b>
Sumner Manufacturing Co Inc	N1519
Tapeswitch Corp	C3813
Techniks Inc	C7140
Universal Drilling & Cutting Equipment	C3714
Walker Magnetics	C7536
Weldsale LLC	N5124
Western Enterprises	N2933

## Maintenance Equipment/ Products

5S Supply	C3454
Advanced Laser Services LLC	C5634
ALM Materials Handling	N5927
Alternative Parts Inc	C3726
BandSawParts.com	C7538
<b>Barton</b>	<b>C4916</b>
Big Ass Fans	C7742
Bliss Clearing Niagara	C933
Bore Repair Systems Inc	N6319
Bradford Derustit Corp	N4804
Buffalo Shrink Wrap	N2210
Burghardt + Schmidt GmbH	C4934
Climax Portable Machining & Welding Systems	N1422
Corewire Ltd	N2910
CR Cuscinetti A Rulli Srl	C5636
Dake Corporation	C6923
Darex LLC	C8138
DCM Tech Inc	C8346
Diversi-Tech Inc	N1922

EH Wachs Co.	N5713
ELCo Enterprises	N2831
Electron Beam Technologies Inc	N3210
Enprotech Industrial Technologies LLC	C1439
Environmental Air Solutions	N6315
Factory Cat	N2209
Fuxin Tianyuan Steel Balls Mfg Co Ltd	C355
Gerb Vibration Control Systems	C852
H2O JET Inc.	C5713
Hex-Hut Shelter Systems Ltd	N6115
Hougen Manufacturing Inc	C4821
International Technologies Inc	C8111
International Welding Technologies Inc	N1724
Laser Experts Inc	C5742
LPI Inc	C2424
Mathey Dearman	N5710
Meltric Corp	N4826
Messer MG Welding Products	N2408
Metabo Corp	N6131
Michigan Pneumatic Tool Inc	N6034
Micro Air	N1806
Minster Machine Co, The	C649
Nitto Kohki USA Inc	C1510
<b>Norton Abrasives</b>	<b>N2610</b>
<b>Nucor Building Systems</b>	<b>C1255</b>
<b>Orbitalum Orbital Cutting + Welding</b>	<b>N5713</b>
Osborn	C2737, N3309
PDS Bartech Inc.	N5917
Phoenix International Inc	N2328
Pyro Shield Inc.	N6313
R&B Machining Inc.	C2124
RVJ/Unique4U	C1036
Richardson Electronics Ltd	C3721
Rocklin Manufacturing Co.	C1433
Ross Controls	C849
Sakura of America	N2504
Schuler Incorporated	C917
<b>Scotchman Industries Inc</b>	<b>C4923</b>
Semyx LLC	C6347
SKM Industries Inc	N1717
Technogenia Inc	N4924
Uni-Hydro Inc.	C8537
Walter Surface Technologies	N2628
<b>Weiler Corp</b>	<b>N4831</b>
Weld-Aid Products	N4928
Welding Alloys USA	N4917
York Portable Machine Tools	N2925

Visit us in Booth C8508

# FABRICATING METALWORKING®



## SIGN UP FOR YOUR FREE SUBSCRIPTION!



F&M provides technical information, new products and technology, new literature and industry news. Technical features cover diverse processes within the metal forming, welding and metal cutting industries. Business and editorial reports analyze the critical issues shared across each industry.

*Complimentary subscriptions are available in U.S.A. only. The publisher reserves the right to serve only those individuals who meet the qualification guidelines.*



# FABRICATINGANDMETALWORKING.COM INDUSTRIALMACHINERYDIGEST.COM

Sign up today for your



# FREE subscription

## INDUSTRIAL MACHINERY DIGEST®

The Industry's Most Extensive Industrial Publication

Providing competitive solutions for today's metal manufacturer.







## Marking Equipment - Bar Coding Systems & Supplies

Dataweld Inc.	N2308
Haco-Lasit	C3440
InfoSight Corp	C5609
MB Metal Technologies	C5013
Pannier Corp	C5824
REA Elektronik Inc.	C1834
Samuel Strapping Systems	C1524
SIC Marking USA Inc.	C8509

## Marking Equipment - Indenting/Embossing/Etching

Alliance Machine and Engraving LLC	C5520
Controlled Automation Inc	C7730
InfoSight Corp	C5609
Manufacturing Solutions Inc.	N1509
MB Metal Technologies	C5013
Mecco Marking & Traceability	C7342
Pannier Corp	C5824
Peddinghaus Corp	C7723
PFERD INC.	N5018
SIC Marking USA Inc.	C8509
SKM Industries Inc	N1717

## Marking Equipment - Inkjet/Paintjet/Markers

Arro-Mark Co LLC	C5836
Beck Automation	C5520
Diagraph MSP an ITW Company	N5718
Durable Supply	N4939
Foerster Instruments Inc	C1523
InfoSight Corp	C5609
JP Nissen Co.	N4922
LA-CO Industries/Markal	N4802
MB Metal Technologies	C5013
Pannier Corp	C5824
REA Elektronik Inc.	C1834
Sakura of America	N2504
Samuel Strapping Systems	C1524
SKM Industries Inc	N1717
U-Mark Inc.	N2406

## Marking Equipment - Laser Systems

Alabama Laser	N6322
Epilog Laser Corp	C7350
Haco-Lasit	C3440
II-VI Infrared	C4924
InfoSight Corp	C5609
IPG Photonics	N3931
Kern Electronics & Lasers	C6513
LaserStar Technologies Corp	C5647
MB Metal Technologies	C5013
Mecco Marking & Traceability	C7342

Nuferr	C8339
OR Lasertechnology Inc.	C7345
Panasonic Electric Works Corp of America	C7411
Pannier Corp	C5824
REA Elektronik Inc.	C1834
RMI Laser LLC	C8314
SIC Marking USA Inc.	C8509
TRUMPF Inc.	C3016
Vacco Industries	C8431

## Marking Equipment - Signs/Nameplates/Labels

Diagraph MSP an ITW Company	N5718
Haco-Lasit	C3440
InfoSight Corp	C5609
JP Nissen Co.	N4922
MB Metal Technologies	C5013
Pannier Corp	C5824
Samuel Strapping Systems	C1524
SKM Industries Inc	N1717

## Marking Equipment - Thermal/Thermal Transfer

InfoSight Corp	C5609
SKM Industries Inc	N1717

## Masking/Shielding Supplies

Alliance Express	C1857
Aquasol Corp.	N3613
Cardinal Paint and Powder	C1761
COB Industries Inc.	N5919
Custom Fabricating & Supplies	C2510
Echo Engineering	C2056
Goff's Enterprises Inc	N2625
Intech Services Inc	C2163
Magic Rack/Production Plus Corp.	C2724
Mighty Hook Inc	C2420
Powder Coating	C2356
Weldas Co.	N5136
Wirecrafters	N1824

## Mass Finishing Equipment & Media

Almco Inc.	C1220
Burr King Manufacturing Co.	C4740
Ervin Industries	C7448
Euromac/Metal Finish LLC	C4716
Kolene Corp.	C2509
Lissmac Corp.	C4340
LS Industries Inc	C8123
Professional Finishing Systems	C8239
Rosler Metal Finishing USA LLC	C7733
VULKAN Blast Shot Technology	C2362
Walther Pilot North America	C2609

## Material Feeding Equipment

Accra-Wire Controls Inc	C1256
ERIEZ	C7316
Friggi N.A. Inc	C7642
HE&M Saw Inc	C5508
Industrial Magnetics Inc.	C5728
Lissmac Corp.	C4340
Magnetic Products Inc	C5510
Mazak Optonics Corp	C3428
Metform International Ltd.	C5534
Minster Machine Co, The	C649
Pacesetter Systems	C1412
Pangborn Corp.	C6516
Permador Industries Inc	N3006
Prima Power North America Inc	C4336
Red Bud Industries	C4732
Shred-Tech Compass Systems	C7550
Steel Storage Systems Inc	C6916
TigerStop LLC	C7442, C7542
Webb-Stiles Co.	C2435

## Metal Cored Wires

Bay State Surface Technologies	N2419
BMM Welding Material Co	N6109
Broco Inc	N4926
Changzhou Zhengyang Welding Material Co Ltd.	N2306
Corewire Ltd	N2910
COR-MET INC	N5534
DURUM USA	N2316
ESAB Welding & Cutting Products	N3922, N4122
Hobart Brothers	N5516
Kobelco Welding of America Inc	N3938
Lincoln Electric Co.	N4102, N4113, N4515
MAGMAWELD	N1628
Polymet Corp.	N2313
PT-Mat.	N3337
Sulzer Metco US Inc	N2413
Tianjin Jinlong Welding Material Co Ltd	N6100
Washington Alloy Co	N2231
Welding Alloys USA	N4917

## Metal Service Centers

Erasteel Inc	C1435
O'Neal Flat Rolled Metals	C8331
United Performance Metals	C1157

## Metal Shapes Supplied - Angles

Cambridge Lee Industries LLC	C8333
KME Germany GmbH & Co KG	N1525
Lapham-Hickey Steel Corp	C840
Samson Roll Formed Products Co.	C6350
Valmont Coatings	C5724



## Metal Shapes Supplied - Bars & Rods

Ampco Metal Inc. ....	C2326
Benxi Guangzheng Tungsten & Molybdenum Co Ltd .....	C456
Cambridge Lee Industries LLC. ....	C8333
Erasteel Inc. ....	C1435
Hydro Carbide Inc. ....	C8238
KME Germany GmbH & Co KG. ....	N1525
<b>Lapham-Hickey Steel Corp. ....</b>	<b>C840</b>
MMC Superalloy Corp. ....	N1826
National Bronze & Metals Inc. ....	C1512
NGK Metals Corp. ....	C922
Ulbrich Stainless Steels & Special Metals Inc. ....	C1015
Valmont Coatings. ....	C5724

## Metal Shapes Supplied - Beams & Channels

Cambridge Lee Industries LLC. ....	C8333
<b>Lapham-Hickey Steel Corp. ....</b>	<b>C840</b>
Valmont Coatings. ....	C5724

## Metals Supplied - Aluminum/Aluminum Alloys

AMETEK Specialty Metal Products for Fab .....	C914
<b>Anomatic Corp. ....</b>	<b>C2452</b>
BMM Welding Material Co. ....	N6109
Cambridge Lee Industries LLC. ....	C8333
Erickson Metals Corp. ....	C1035
Identification Plates Inc. ....	C8340
<b>Lucas-Milhaupt Inc. ....</b>	<b>N5027</b>
Ningbo Jinhui Precision Casting Co Ltd. ....	C254
NKS. ....	C1549
O'Neal Flat Rolled Metals. ....	C8331
Pacific Aerospace & Electronics. ....	N1607
Superior Die Set Corp. ....	C658
Ulbrich Stainless Steels & Special Metals Inc. ....	C1015
United Aluminum Corp. ....	C809
Winnox Industries Ltd. ....	N6111

## Metals Supplied - Brass/Brass Alloys

AMETEK Specialty Metal Products for Fab .....	C914
Bohler Uddeholm Corp. ....	C1417
Cambridge Lee Industries LLC. ....	C8333
Gasflux Co. ....	N2833
Identification Plates Inc. ....	C8340
KME Germany GmbH & Co KG. ....	N1525
National Bronze & Metals Inc. ....	C1512
Ningbo Jinhui Precision Casting Co Ltd. ....	C254

NKS. ....	C1549
Winnox Industries Ltd. ....	N6111

## Metals Supplied - Bronze/Bronze Alloys

AMETEK Specialty Metal Products for Fab .....	C914
Cambridge Lee Industries LLC. ....	C8333
Gasflux Co. ....	N2833
KME Germany GmbH & Co KG. ....	N1525
National Bronze & Metals Inc. ....	C1512
Ningbo Jinhui Precision Casting Co Ltd. ....	C254
Pacific Aerospace & Electronics. ....	N1607
Winnox Industries Ltd. ....	N6111

## Metals Supplied - Cobalt Alloys

Haynes International. ....	N1617
MMC Superalloy Corp. ....	N1826
Pacific Aerospace & Electronics. ....	N1607
<b>United Performance Metals. ....</b>	<b>C1157</b>

## Metals Supplied - Copper/Copper Alloys

AMETEK Specialty Metal Products for Fab .....	C914
Ampco Metal Inc. ....	C2326
BMM Welding Material Co. ....	N6109
Bohler Uddeholm Corp. ....	C1417
Cambridge Lee Industries LLC. ....	C8333
Freeport McMoRan Copper & Gold. ....	C1254
Gasflux Co. ....	N2833
Golden Eagle Minmetals(Beijing) Wldg Materials Co. ....	N5800
KME Germany GmbH & Co KG. ....	N1525
<b>Lucas-Milhaupt Inc. ....</b>	<b>N5027</b>
MMC Superalloy Corp. ....	N1826
National Bronze & Metals Inc. ....	C1512
NGK Metals Corp. ....	C922
Ningbo Jinhui Precision Casting Co Ltd. ....	C254
Ningbo Powerway Alloy Material Co Ltd. ....	N5038
NKS. ....	C1549
Pacific Aerospace & Electronics. ....	N1607
Precision Steel Warehouse Inc. ....	C1021
Southern Copper & Supply. ....	N1926
TJ Snow Co. ....	N2613
Ulbrich Stainless Steels & Special Metals Inc. ....	C1015
Winnox Industries Ltd. ....	N6111
ZJ Industries Inc. ....	N2704

## Metals Supplied - Hi-Temp Alloys

Benxi Guangzheng Tungsten & Molybdenum Co Ltd. ....	C456
-----------------------------------------------------	------

Cambridge Lee Industries LLC. ....	C8333
Haynes International. ....	N1617
KME Germany GmbH & Co KG. ....	N1525
MMC Superalloy Corp. ....	N1826
NKS. ....	C1549
Pacific Aerospace & Electronics. ....	N1607
<b>United Performance Metals. ....</b>	<b>C1157</b>
Zapp Precision Strip. ....	C811

## Metals Supplied - Nickel/Nickel Alloys

AMETEK Specialty Metal Products for Fab .....	C914
BMM Welding Material Co. ....	N6109
Bohler Uddeholm Corp. ....	C1417
Cambridge Lee Industries LLC. ....	C8333
Haynes International. ....	N1617
Identification Plates Inc. ....	C8340
JLC Electromet Pvt LLC. ....	N5138
Kennametal Stellite. ....	N2528
Latrobe Specialty Steel Distribution. .	C915
<b>Lucas-Milhaupt Inc. ....</b>	<b>N5027</b>
MMC Superalloy Corp. ....	N1826
Ningbo Powerway Alloy Material Co Ltd. ....	N5038
NKS. ....	C1549
Pacific Aerospace & Electronics. ....	N1607
Rolled Alloys. ....	N3024
Special Metals Welding Products Co. ....	N3118
Sunstone Engineering. ....	N5916
Technogenia Inc. ....	N4924
ThyssenKrupp VDM USA, LLC. ....	N5931
Ulbrich Stainless Steels & Special Metals Inc. ....	C1015
<b>United Performance Metals. ....</b>	<b>C1157</b>
Zapp Precision Strip. ....	C811

## Metals Supplied - Powder Metals

AMETEK Specialty Metal Products for Fab .....	C914
Bohler Uddeholm Corp. ....	C1417
<b>Diehl Steel Co. ....</b>	<b>C1410</b>
Erasteel Inc. ....	C1435
Kennametal Stellite. ....	N2528
Latrobe Specialty Steel Distribution. .	C915
Southern Copper & Supply. ....	N1926

## Metals Supplied - Precious/Exotic Metals

AMETEK Specialty Metal Products for Fab .....	C914
Fabrisonic LLC. ....	N6218
Hydro Carbide Inc. ....	C8238
KME Germany GmbH & Co KG. ....	N1525



### Metals Supplied - Precious/ Exotic Metals

Lucas-Milhaupt Inc . . . . .	N5027
Nanjing Youtian Metal Technology Co Ltd . . . . .	N1616
NKS . . . . .	C1549

### Metals Supplied - Precoated

O'Neal Flat Rolled Metals . . . . .	C8331
Precision Steel Warehouse Inc. . . . .	C1021
Sandvik Materials Technology . . . . .	N3019
Toledo Blank . . . . .	C1149
United Aluminum Corp . . . . .	C809

### Metals Supplied - Steel (Carbon)

Bohler Uddeholm Corp . . . . .	C1417
Diehl Steel Co . . . . .	C1410
Douglas Steel Supply Co. . . . .	C5747
Lapham-Hickey Steel Corp . . . . .	C840
Liaoning Longyuan Industry Co Ltd . . . . .	C455
Ningbo Jinhui Precision Casting Co Ltd . . . . .	C254
NKS . . . . .	C1549
O'Neal Flat Rolled Metals . . . . .	C8331
Pacific Aerospace & Electronics . . . . .	N1607
Porcelain Enamel Institute Inc . . . . .	C2436
Precision Steel Warehouse Inc. . . . .	C1021
Superior Die Set Corp . . . . .	C658
Tennessee Galvanizing Inc . . . . .	C7113
Toledo Blank . . . . .	C1149
Valmont Coatings . . . . .	C5724

### Metals Supplied - Steel (High Alloy)

Bohler Uddeholm Corp . . . . .	C1417
Diehl Steel Co . . . . .	C1410
Douglas Steel Supply Co. . . . .	C5747
Erasteel Inc . . . . .	C1435
Haynes International . . . . .	N1617
Lapham-Hickey Steel Corp . . . . .	C840
Latrobe Specialty Steel Distribution . . . . .	C915
Liaoning Longyuan Industry Co Ltd . . . . .	C455
MMC Superalloy Corp . . . . .	N1826
Ningbo Jinhui Precision Casting Co Ltd . . . . .	C254
Pacific Aerospace & Electronics . . . . .	N1607
Precision Steel Warehouse Inc. . . . .	C1021
United Performance Metals . . . . .	C1157

### Metals Supplied - Steel (Low Alloy)

Bohler Uddeholm Corp . . . . .	C1417
Diehl Steel Co . . . . .	C1410
Douglas Steel Supply Co. . . . .	C5747
Lapham-Hickey Steel Corp . . . . .	C840
Latrobe Specialty Steel Distribution . . . . .	C915

Liaoning Longyuan Industry Co Ltd . . . . .	C455
Ningbo Jinhui Precision Casting Co Ltd . . . . .	C254
Pacific Aerospace & Electronics . . . . .	N1607
Precision Steel Warehouse Inc. . . . .	C1021
Toledo Blank . . . . .	C1149
Wilco Inc . . . . .	C1422

### Metals Supplied - Steel (Stainless)

AMETEK Specialty Metal Products for Fab . . . . .	C914
Benxi Guangzheng Tungsten & Molybdenum Co Ltd . . . . .	C456
Bohler Uddeholm Corp . . . . .	C1417
Diehl Steel Co . . . . .	C1410
Identification Plates Inc. . . . .	C8340
Latrobe Specialty Steel Distribution . . . . .	C915
Liaoning Longyuan Industry Co Ltd . . . . .	C455
Nevatia Steel & Alloys Pvt LTD . . . . .	N2824
Ningbo Jinhui Precision Casting Co Ltd . . . . .	C254
NKS . . . . .	C1549
O'Neal Flat Rolled Metals . . . . .	C8331
Pacific Aerospace & Electronics . . . . .	N1607
Precision Steel Warehouse Inc. . . . .	C1021
Rolled Alloys . . . . .	N3024
Sandvik Materials Technology . . . . .	N3019
TCT Stainless Steel Inc. . . . .	C1058
Toledo Blank . . . . .	C1149
Ulbrich Stainless Steels & Special Metals Inc . . . . .	C1015
United Performance Metals . . . . .	C1157
Zapp Precision Strip . . . . .	C811

### Metals Supplied - Steel (Tool)

Benxi Guangzheng Tungsten & Molybdenum Co Ltd . . . . .	C456
Bohler Uddeholm Corp . . . . .	C1417
Diehl Steel Co . . . . .	C1410
Erasteel Inc . . . . .	C1435
International Mold Steel . . . . .	C556
Latrobe Specialty Steel Distribution . . . . .	C915
Ningbo Jinhui Precision Casting Co Ltd . . . . .	C254
Valmont Coatings . . . . .	C5724
Zapp Precision Strip . . . . .	C811

### Metals Supplied - Titanium/ Titanium Alloys

AMETEK Specialty Metal Products for Fab . . . . .	C914
Benxi Guangzheng Tungsten & Molybdenum Co Ltd . . . . .	C456
Haynes International . . . . .	N1617
Latrobe Specialty Steel Distribution . . . . .	C915

Nanjing Youtian Metal Technology Co Ltd . . . . .	N1616
Pacific Aerospace & Electronics . . . . .	N1607
Ulbrich Stainless Steels & Special Metals Inc . . . . .	C1015
United Performance Metals . . . . .	C1157
Zapp Precision Strip . . . . .	C811

### Metals Toll Processing Services

AMETEK Specialty Metal Products for Fab . . . . .	C914
Leveltek Intl LLC . . . . .	C5950
Precision Punch Corp . . . . .	C1432
Production Tube Cutting Inc . . . . .	C2215

### Millwright Services

CH Steel Solutions Inc . . . . .	C7348
Greenberry Industrial . . . . .	C8140

### Motion Control Products

Accurate Die Design Inc/ Logopress Corp . . . . .	C1423
Alternative Parts Inc . . . . .	C3726
Beckhoff Automation . . . . .	C7545
DELTA Computer Systems Inc . . . . .	C1024
Dynatorch Inc . . . . .	N4837
Hiwin Corp . . . . .	C1321
Hypertherm Inc . . . . .	N3906
Jetline Engineering . . . . .	N5813
Kinetic Cutting Systems Inc . . . . .	C6311
Link Systems . . . . .	C909
MJC Engineering & Technology Inc . . . . .	C1156
Nadella . . . . .	C7150
Panasonic Electric Works Corp of America . . . . .	C7411
Pandjiris Inc. . . . .	N4810
Parker domnick hunter . . . . .	N1513
Red Rock Automation/Romar/MEC . . . . .	N4805
Servo-Robot Inc. . . . .	N5907
SigmaTEK Systems LLC . . . . .	C4932
Tapeswitch Corp . . . . .	C3813
Universal Controls Group . . . . .	C1528

### Motors

Alternative Parts Inc . . . . .	C3726
Beckhoff Automation . . . . .	C7545
Hiwin Corp . . . . .	C1321

### Nitrogen Die Cylinders

Anchor Danly . . . . .	C931
Fibro Inc. . . . .	C249
GMT North America . . . . .	C353
Moeller Precision Tool . . . . .	C1020
Ready Technology Inc . . . . .	C832
Superior Die Set Corp . . . . .	C658
Wilson Tool International . . . . .	C1013, C5116





## Noise Control Equipment

Bay State Surface Technologies	N2419
Frommelt Safety Products	N4827
George Koch Sons LLC	C2521
Gerb Vibration Control Systems	C852
Goff's Enterprises Inc	N2625
Micro Air	N1806
Pan Taiwan Enterprise	N1718
Pax Products Inc	C1428

## Nondestructive Testing Equipment

American Society For Nondestructive Testing	N1615
BigC: Dino-Lite Scopes	C2055
Bonal Technologies Inc	N2924
Brandt Engineered Products Ltd	C1755
Bruker Elemental	C7339
Cantesco	N3027
Carestream	N2426
Chemetall US Inc	C2709
COB Industries Inc	N5919
Dakota Ultrasonics	N2624
Danatronics Inc	N1418
DCM Tech Inc	C8346
DeFelsko Corp	C2442
Eddytech Systems Inc	C1752
Elcometer Inc	C2152
Elcometer Inc	N3126
ElektroPhysik USA Inc	C2053
FARO Technologies Inc	C7636
Fischer Technology Inc	C2711
Foerster Instruments Inc	C1523
GE Measurement & Control	N3222
IMPACT Engineering Inc	N5108
Innerspec Technologies	N2217
InterTest Inc	N5824
Metallurgical & Materials Technologies Inc	C1535
Mill Masters	C1533
Nikon Metrology Inc	C952
Olympus NDT	N1613
Richard Wolf Industrial	N2309
Servo-Robot Inc	N5907
Shantou Inst of Ultrasonic Instruments Co Ltd (SIUI)	N2715
Sherwin Inc	N5918
Thermo Scientific Portable XRF Analyzers	C2328
Xiris Automation Inc	C2312

## Notching Machines

AddisonMckee Inc	C2339
AIM Inc	C1832
Baileigh Industrial Inc	C7513

Baykal Makina Sanayi ve Ticaret AS	C5940, C5947
Boschert Precision Machinery Inc	C2820
C Marshall Fabrication Machinery	C7716
Carell Corp/Eagle Bending Machines	C5928
CML USA Inc Ercolina	C3739
COMEQ Inc	C5125
Dake Corporation	C6923
Durma USA	C3949
Edwards Manufacturing Co	C7116
Ermak USA	C3447
Euromac/Metal Finish LLC	C4716
Ficep Corporation	C6550
Haberle / Ken Bergman & Assoc LLC	C7137
Heck Industries	C4828
INNOVO Corp	C1758
Marion Die & Fixture Inc	C5520
Masteel America Corp	C3749
Midwest Bender Services Corp	C1728
Overton Industries	C2225
Proto-1 Manufacturing	C1825
Scantool USA By CML USA	C7147
Uni-Hydro Inc	C8537
Unipunch Products Inc	C3732
Unittool Punch & Die	C4708

## Nozzles for Finishing Spray Washers

General Automatic Transfer	C2550
Hydro Carbide Inc	C8238
Krautzberger LLC	C1964
Midwest Finishing Systems Inc	C2526
Trimac Industrial Systems	C2359
Uni-Spray Systems Inc	C2412

## Online Services

CFCM Canadian Finishing & Coatings Manufacturing	C2747
-----------------------------------------------------	-------

Fabricating & Metalworking Magazine	C8508
Fabricators & Manufacturers Association	C6538

Precision Metalforming Association	C463
Site Location Partnership (SLP)	N1406
SteelOrbis	C3751
Unisorb Installation Technologies	C1411

## Ornamental/Scroll Benders

AIM Inc	C1832
Carell Corp/Eagle Bending Machines	C5928
CML USA Inc Ercolina	C3739
J & S Machine Inc	C2317
TaurinGroup USA	C1739

## Other

Advanced Laser Services LLC	C5634
Aquasol Corp	N3613
Atlanta Drive Systems Inc	C8323
Attexor Clinch Systems SA	C5622
BECCA Inc	C1854
Big Ass Fans	C7742
Box On Demand by Plymouth Packaging	C4824
Cambco Inc	C7430
Centricut	C4935
Chicago Pneumatic Tool Co	C4750
CR Cuscinetti A Rulli Srl	C5636
Desch Canada Ltd	C1235
Diamond Saw Works Inc	N1416
Diversi-Tech Inc	N1922
Dongsan Bearing Co	C833
Electron Beam Technologies Inc	N3210
EnvisionTEC Inc	C3826
Fuxin Tianyuan Steel Balls Mfg Co Ltd	C355
Halifax Rack & Screw	C7310
Hex-Hut Shelter Systems Ltd	N6115
Hiwin Corp	C1321
Industrial Machine Trader	C8231
Industrial Molded Rubber Products	C4723
Kolene Corp	C2509
Long Haul Trucking	C4349
Mayfran International Inc	C939
Meltric Corp	N4826
Nadella	C7150
Nitto Denko America Inc	C8409
Norlok Technology Inc	C4840
Permabond Engineering Adhesives	C6349
RVJ/Unique4U	C1036
Ready Technology Inc	C832
Shercon Inc	C2735
Triple Crown Products	N3318
Valmont Coatings	C5724
Welder Training & Testing Institute	N1533
Worlee-Chemie GmbH	C1964

## Other Machining Equipment

ALM Materials Handling	N5927
Bonal Technologies Inc	N2924
Bore Repair Systems Inc	N6319
CIMID Corp	C8327
Climax Portable Machining & Welding Systems	N1422
CR Cuscinetti A Rulli Srl	C5636
EH Wachs Co	N5713
Elumatec North America Inc	C2849
Emmegi USA Inc	C7323
ESCO Tool Co	C5735
FomUSA	C6914



## Other Machining Equipment

International Welding Technologies Inc . . . . .	N1724
Kong NGAI Precision Metal Mould Shenzhen Co Ltd . . . . .	C856
Lissmac Corp. . . . .	C4340
Machinery Marketing Intl . . . . .	C8337
Magnetic Products Inc . . . . .	C5510
Manufacturing Solutions Inc. . . . .	N1509
Masteel America Corp . . . . .	C3749
Mathey Dearman . . . . .	N5710
<b>MC Machinery Systems Inc/ Mitsubishi . . . . .</b>	<b>C3040</b>
<b>Orbitalum Orbital Cutting + Welding . . . . .</b>	<b>N5713</b>
Pangborn Corp. . . . .	C6516
Pushcorp Inc . . . . .	N5934
Shijiazhuang Fitex Trading Co Ltd. . . . .	C159
Tapeswitch Corp . . . . .	C3813
Tri Tool Inc. . . . .	N5913

## Ovens for Curing Paint & Coatings

AFC Finishing Systems . . . . .	C2548
Ambrell Precision Induction Heating . . . . .	C4950
<b>Binks DeVilbiss Ransburg BGK . . . . .</b>	<b>C2532</b>
Catalytic Industrial Systems . . . . .	C2421
<b>Chemical Coaters Assoc Int'l . . . . .</b>	<b>C1948</b>
<b>Col-Met Spray Booths Inc. . . . .</b>	<b>C2537</b>
Combustion and Systems Inc . . . . .	C2411
Eisenmann Corp . . . . .	C2439
Fostoria Process Equipment . . . . .	C2148
General Automatic Transfer . . . . .	C2550
General Fabrications Corp. . . . .	C2648
<b>George Koch Sons LLC . . . . .</b>	<b>C2521</b>
Global Finishing Solutions . . . . .	C2151
Guspro Inc . . . . .	C1952
Haynncorp Industrial Finishing Solutions . . . . .	C2360
Intech Services Inc . . . . .	C2163
<b>IntelliFinishing. . . . .</b>	<b>C2528</b>
<b>KMI Systems Inc. . . . .</b>	<b>C2722</b>
LS Industries Inc . . . . .	C8123
Midwest Finishing Systems Inc . . . . .	C2526
<b>Nordson Corp . . . . .</b>	<b>C2517</b>
Pneu-Mech Systems Manufacturing Inc. . . . .	C2539
Powder Coating. . . . .	C2356
Production Systems Inc. . . . .	C1858
Rapid Engineering. . . . .	C2610
Red-Ray Manufacturing Co Inc. . . . .	C2052
Spray-Tech/Junair. . . . .	C2164
Steelman Industries Inc . . . . .	C2058
Trimac Industrial Systems. . . . .	C2359

Vulcan Catalytic Infrared Oven Systems . . . . .	C2512
--------------------------------------------------	-------

## Ovens for Drying Parts

AFC Finishing Systems . . . . .	C2548
<b>Binks DeVilbiss Ransburg BGK . . . . .</b>	<b>C2532</b>
Eisenmann Corp . . . . .	C2439
Fostoria Process Equipment . . . . .	C2148
General Automatic Transfer . . . . .	C2550
General Fabrications Corp. . . . .	C2648
<b>George Koch Sons LLC . . . . .</b>	<b>C2521</b>
Global Finishing Solutions . . . . .	C2151
Haynncorp Industrial Finishing Solutions . . . . .	C2360
Intech Services Inc . . . . .	C2163
<b>IntelliFinishing. . . . .</b>	<b>C2528</b>
<b>KMI Systems Inc. . . . .</b>	<b>C2722</b>
LS Industries Inc . . . . .	C8123
Midwest Finishing Systems Inc . . . . .	C2526
Pneu-Mech Systems Manufacturing Inc. . . . .	C2539
Red-Ray Manufacturing Co Inc. . . . .	C2052
Spray-Tech/Junair. . . . .	C2164
Steelman Industries Inc . . . . .	C2058
Trimac Industrial Systems. . . . .	C2359
Vulcan Catalytic Infrared Oven Systems . . . . .	C2512

## Oven-Temperature Monitors/ Curing Analyzers - Finishing

Elcometer Inc. . . . .	N3126
<b>IntelliFinishing. . . . .</b>	<b>C2528</b>
LA-CO Industries/Markal . . . . .	N4802
Trimac Industrial Systems. . . . .	C2359

## Oxyfuel/Gas Cutting Machines

Ajan Elektronik Servis San Ve. . . . .	N5237
<b>AKS Cutting Systems Inc . . . . .</b>	<b>C5135</b>
Bug-O Systems . . . . .	N4813, N5013
Controlled Automation Inc . . . . .	C7730
Dynatorch Inc . . . . .	N4837
Etal/INDUX Sa De Cv . . . . .	N2433
Flame Technologies Inc. . . . .	N3219
Haco Atlantic Inc. . . . .	C3440
<b>Haco-Lasit. . . . .</b>	<b>C3440</b>
Harris Products Group. . . . .	N4509
HGG Profiling Equipment. . . . .	C8127
Kinetic Cutting Systems Inc . . . . .	C6311
<b>Koike Aronson Inc. . . . .</b>	<b>N4131</b>
Komatsu America Industries LLC . . . . .	C1239, C6510
Mathey Dearman . . . . .	N5710
<b>Messer Cutting Systems. . . . .</b>	<b>C5916</b>
MultiCam Inc. . . . .	C5516
Oxylance Inc . . . . .	N2228
Permadrur Industries Inc . . . . .	N3006

PythonX-Burlington Automation . . . . .	C8116
Vicon - Plasma Automation Inc. . . . .	N5031
Victor Technologies Intl Inc. . . . .	N4522
Victory Plasma Systems Inc . . . . .	N4833
Voortman Corporation. . . . .	C7739
Westingcut Industrial Technology Anhui Inc . . . . .	N1424
Witt Gas Controls . . . . .	N3124

## Packaging Machinery & Components

<b>Athader . . . . .</b>	<b>C5520</b>
Box On Demand by Plymouth Packaging . . . . .	C4824
<b>Bradbury Group Australia . . . . .</b>	<b>C5520</b>
Dr Shrink Inc . . . . .	C7314
Industrial Molded Rubber Products . . . . .	C4723
Machine Concepts Inc. . . . .	C4726
Minster Machine Co, The . . . . .	C649
Packsize LLC . . . . .	C1336
Samuel Strapping Systems. . . . .	C1524

## Packaging Materials

Cordstrap USA Inc. . . . .	C7433
Dr Shrink Inc . . . . .	C7314
Emmegi USA Inc . . . . .	C7323
Heritage Packaging. . . . .	C7548
<b>InfoSight Corp. . . . .</b>	<b>C5609</b>
<b>Long Haul Trucking . . . . .</b>	<b>C4349</b>
Packsize LLC . . . . .	C1336
rose plastic USA LP. . . . .	N3213
Ulbrich Stainless Steels & Special Metals Inc . . . . .	C1015

## Paint Application Equipment - Liquid

Anest Iwata USA Inc. . . . .	C2746
<b>Binks DeVilbiss Ransburg BGK . . . . .</b>	<b>C2532</b>
C.A. Technologies Inc . . . . .	C1763
<b>Chemical Coaters Assoc Int'l . . . . .</b>	<b>C1948</b>
EXEL North America . . . . .	C2264
<b>George Koch Sons LLC . . . . .</b>	<b>C2521</b>
<b>Graco Inc. . . . .</b>	<b>C2350</b>
<b>IntelliFinishing. . . . .</b>	<b>C2528</b>
Krautzberger LLC. . . . .	C1964
Midwest Finishing Systems Inc . . . . .	C2526
<b>Nordson Corp . . . . .</b>	<b>C2517</b>
Nylok LLC. . . . .	N1624
Pneu-Mech Systems Manufacturing Inc. . . . .	C2539
SKM Industries Inc . . . . .	N1717
Vulcan Catalytic Infrared Oven Systems . . . . .	C2512
Wagner Industrial Solutions. . . . .	C1951



## Paint Circulating Systems

Binks DeVilbiss Ransburg BGK . . . . .	C2532
Combustion and Systems Inc . . . . .	C2411
EXEL North America . . . . .	C2264
Global Finishing Solutions . . . . .	C2151
Graco Inc . . . . .	C2350
Krautzberger LLC . . . . .	C1964
Production Systems Inc. . . . .	C1858
Spray-Tech/Junair . . . . .	C2164

## Paint Drum Rotators, Mixers, Shakers

Binks DeVilbiss Ransburg BGK . . . . .	C2532
C.A. Technologies Inc . . . . .	C1763
Combustion and Systems Inc . . . . .	C2411
EXEL North America . . . . .	C2264
Graco Inc . . . . .	C2350

## Paint Manufacturers - Liquid

Cardinal Paint and Powder . . . . .	C1761
Chemical Coaters Assoc Int'l . . . . .	C1948
NIC Industries Inc . . . . .	C2426
PPG Industries . . . . .	C2739
SKM Industries Inc . . . . .	N1717
Strathmore Products Inc . . . . .	C1955

## Paint Overspray Recycling/Recovery Systems & Services

Eisenmann Corp . . . . .	C2439
EXEL North America . . . . .	C2264
KCI America Co Ltd . . . . .	C2062
Krautzberger LLC . . . . .	C1964
Wagner Industrial Solutions . . . . .	C1951

## Painting Equipment

American Finishing Resources . . . . .	C1855
Anest Iwata USA Inc. . . . .	C2746
Binks DeVilbiss Ransburg BGK . . . . .	C2532
C.A. Technologies Inc . . . . .	C1763
Chemical Coaters Assoc Int'l . . . . .	C1948
Col-Met Spray Booths Inc. . . . .	C2537
Decoral System USA Corp . . . . .	C1954
Delta Steel Technologies . . . . .	C5952
Duroair Technologies Inc. . . . .	C1362
Eisenmann Corp . . . . .	C2439
EXEL North America . . . . .	C2264
Gema . . . . .	C2750
George Koch Sons LLC . . . . .	C2521
Graco Inc . . . . .	C2350
IntelliFinishing . . . . .	C2528
Keyland Polymer Ltd . . . . .	C2063
Krautzberger LLC . . . . .	C1964
Mighty Hook Inc . . . . .	C2420
Parker Ionics/Parkwood Engineering . . . . .	C2523

## Pneu-Mech Systems

Manufacturing Inc. . . . .	C2539
SKM Industries Inc . . . . .	N1717
Spray-Tech/Junair . . . . .	C2164
Trimac Industrial Systems . . . . .	C2359
Vulcan Catalytic Infrared Oven Systems . . . . .	C2512
Wagner Industrial Solutions . . . . .	C1951

## Palitizers/Depalitizers, Stackers

Wayne Trail, a Lincoln Electric Company . . . . .	N4513
Webb-Stiles Co. . . . .	C2435
Weldcoa . . . . .	N3238

## Panel Benders

Baykal Makina Sanayi ve Ticaret AS . . . . .	C5940, C5947
Chicago Slitter . . . . .	C7023
Cidan Machinery Inc . . . . .	C3449
Elo Automated Stainless Steel Technologies Qingdao Co Ltd . . . . .	C8342
Haeusler AG . . . . .	C5540
International Technologies Inc . . . . .	C8111
Midwest Bender Services Corp . . . . .	C1728
Prima Power North America Inc . . . . .	C4336
RAS Systems LLC . . . . .	C6921
Ready Technology Inc . . . . .	C832
Salvagnini America Inc . . . . .	C3928

## Parts Straighteners

Machine Concepts Inc. . . . .	C4726
Minster Machine Co, The . . . . .	C649

## Pickling Equipment

ASKO Inc . . . . .	C4810
Bohler Welding Group USA Inc. . . . .	N2013
Bradford Derustit Corp . . . . .	N4804
Capital Weld Cleaners . . . . .	N3007
Delta Steel Technologies . . . . .	C5952
Innerspec Technologies . . . . .	N2217
Kolene Corp. . . . .	C2509
PKG Equipment Inc . . . . .	C1953

## Piercing Machines

AIM Inc . . . . .	C1832
INNOVO Corp . . . . .	C1758
Multipress Inc . . . . .	C1022
Proto-1 Manufacturing . . . . .	C1825
TOX Pressotechnik LLC . . . . .	C5024
Unipunch Products Inc. . . . .	C3732
Unittool Punch & Die. . . . .	C4708

## Plasma Cutting Machines & Components

Airgas Inc . . . . .	N5231
Ajan Elektronik Servis San Ve. . . . .	N5237

AKS Cutting Systems Inc . . . . .	C5135
American Torch Tip Co Inc. . . . .	N2022
Baykal Makina Sanayi ve Ticaret AS . . . . .	C5940, C5947
Boschert Precision Machinery Inc. . . . .	C2820
Bowlin Engineering . . . . .	C4838
Bug-O Systems . . . . .	N4813, N5013
Centricut . . . . .	C4935
CIMID Corp . . . . .	C8327
Cloos Robotic Welding Inc . . . . .	N3618
Controlled Automation Inc . . . . .	C7730
Durma USA . . . . .	C3949
Dynatorch Inc . . . . .	N4837
Environmental Air Solutions . . . . .	N6315
Ermak USA . . . . .	C3447
ESAB Welding & Cutting Products . . . . .	N3922
Friggi N.A. Inc . . . . .	C7642
Haco Atlantic Inc. . . . .	C3440
Haco-Lasit . . . . .	C3440
Heck Industries . . . . .	C4828
Hypertherm Inc . . . . .	N3906
JETCAM-NestONE Solutions . . . . .	C4722
JMT USA . . . . .	C5047
Kinetic Cutting Systems Inc . . . . .	C6311
KNUTH Machine Tools USA Inc . . . . .	C4910
Koike Aronson Inc . . . . .	N4131
Komatsu America Industries LLC . . . . .	C1239, C6510
Matheson . . . . .	N6122
MegaFab-Piranha-Whitney-Bertsch . . . . .	C5113
Messer Cutting Systems . . . . .	C5916
MetaMation Inc . . . . .	C3737
MultiCam Inc. . . . .	C5516
Murata Machinery USA Inc . . . . .	C3028
North (Nanjing) Instrument Technology Industries Group . . . . .	N3226
Ocean Machinery Inc . . . . .	C7523
Peddinghaus Corp . . . . .	C7723
Perfection Global LLC . . . . .	C3832
Permatur Industries Inc . . . . .	N3006
Praxair Inc . . . . .	N5202
Prodevco Industries Inc. . . . .	C8129
PythonX-Burlington Automation . . . . .	C8116
Rhino Cutting Systems . . . . .	N6138
Semyx LLC . . . . .	C6347
SteelTailor Ltd . . . . .	N4919
Termmei Torch & Tip Company . . . . .	N2526
Thermacut Inc . . . . .	N5508
Vicon - Plasma Automation Inc. . . . .	N5031
Victor Technologies Intl Inc . . . . .	N4522
Victory Plasma Systems Inc . . . . .	N4833
Voortman Corporation . . . . .	C7739
Walker Magnetics . . . . .	C7536





## Plasma Cutting Machines & Components

Westingcut Industrial Technology Anhui Inc . . . . .	N1424
<b>Wolf Robotics LLC</b> . . . . .	<b>N4910</b>

## Plate & Structural Fabricating Machines

<b>AKS Cutting Systems Inc</b> . . . . .	<b>C5135</b>
Akyapak . . . . .	C5545
ARKU Coil Systems Inc . . . . .	C7528
Behringer Saws Inc . . . . .	C5722
<b>Boschert Precision Machinery Inc.</b> . . . . .	<b>C2820</b>
Bug-O Systems . . . . .	N4813, N5013
<b>Carell Corp/Eagle</b>	
<b>Bending Machines</b> . . . . .	<b>C5928</b>
COMEQ Inc . . . . .	C5125
Controlled Automation Inc . . . . .	C7730
Durma USA . . . . .	C3949
Ermak USA . . . . .	C3447
Faccin USA Inc . . . . .	C6323
Ficep Corporation . . . . .	C6550
Friggi N.A. Inc . . . . .	C7642
Haco Atlantic Inc . . . . .	C3440
Heck Industries . . . . .	C4828
HGG Profiling Equipment . . . . .	C8127
<b>Hypertherm Inc</b> . . . . .	<b>N3906</b>
JMT USA . . . . .	C5047
Kinetic Cutting Systems Inc . . . . .	C6311
KoCos America LLC . . . . .	C2223
Masteel America Corp . . . . .	C3749
Ocean Machinery Inc . . . . .	C7523
Pandjiris Inc . . . . .	N4810
Peddinghaus Corp . . . . .	C7723
Perfection Global LLC . . . . .	C3832
PythonX-Burlington Automation . . . . .	C8116
Richardson Electronics Ltd . . . . .	C3721
Rimco Equipment . . . . .	N1631
<b>Scotchman Industries Inc</b> . . . . .	<b>C4923</b>
Superior Die Set Corp . . . . .	C658
TaurinGroup USA . . . . .	C1739
Unittool Punch & Die . . . . .	C4708
Victory Plasma Systems Inc . . . . .	N4833
Voortman Corporation . . . . .	C7739
Welding Alloys USA . . . . .	N4917
Weldsale LLC . . . . .	N5124
Yaskawa America Inc . . . . .	N5222

## Plate Bending Rolls

Akyapak . . . . .	C5545
Baileigh Industrial Inc . . . . .	C7513
C Marshall Fabrication Machinery . . . . .	C7716
<b>Carell Corp/Eagle</b>	
<b>Bending Machines</b> . . . . .	<b>C5928</b>
CIMID Corp . . . . .	C8327
COMEQ Inc . . . . .	C5125

DAVI Inc . . . . .	C3435
Durma USA . . . . .	C3949
Elo Automated Stainless Steel Technologies Qingdao Co Ltd . . . . .	C8342
Euromac/Metal Finish LLC . . . . .	C4716
Faccin USA Inc . . . . .	C6323
Haeusler AG . . . . .	C5540
JMT USA . . . . .	C5047
KNUTH Machine Tools USA Inc . . . . .	C4910
Masteel America Corp . . . . .	C3749
<b>MegaFab-Piranha-Whitney-Bertsch</b> . . . . .	<b>C5113</b>
Perfection Global LLC . . . . .	C3832
Sertom Group North America LLC . . . . .	C6911
TaurinGroup USA . . . . .	C1739
Trilogy Machinery Inc . . . . .	C5140
US Industrial Machinery Co . . . . .	C3049
Weldlogic Inc . . . . .	N5826

## Pneumatic Lifts, Aerial Work Platforms/Positioners

Flexarm Inc . . . . .	C7431
JMR Industrial . . . . .	C3752
LPI Inc . . . . .	C2424
Pacesetter Systems . . . . .	C1412
Rimco Equipment . . . . .	N1631

## Polishing Media

Almco Inc . . . . .	C1220
Alpha Professional Tools . . . . .	N6331
Armstrong/Kover Kwick Inc feat NCCM Mill Rolls . . . . .	C7047
Burr King Manufacturing Co . . . . .	C4740
Gem Tool Corporation . . . . .	C2320
Joysun Abrasives Co Ltd . . . . .	N3208
LS Industries Inc . . . . .	C8123
Rex-Cut Abrasives . . . . .	N2708
Rosler Metal Finishing USA LLC . . . . .	C7733
Wendt USA LLC . . . . .	N2606

## Polishing/Sanding/Buffering Equipment

Almco Inc . . . . .	C1220
Alpha Professional Tools . . . . .	N6331
AM Machinery Sales . . . . .	C5528
<b>Apex Machine Group/SlipCon USA</b> . . . . .	<b>C5528</b>
Armstrong/Kover Kwick Inc feat NCCM Mill Rolls . . . . .	C7047
Beilun Futuo Mechanical Tools Co Ltd . . . . .	N6026
Burr King Manufacturing Co . . . . .	C4740
Capital Weld Cleaners . . . . .	N3007
CIMID Corp . . . . .	C8327
Costa & Grissom Machinery Co . . . . .	C7516
CS Unitec Inc . . . . .	N5531
Dynabrade Inc . . . . .	C2409
Euromac/Metal Finish LLC . . . . .	C4716

Fein Power Tools Inc . . . . .	N5902
<b>Fladder-Hansen &amp; Hundebol Inc.</b> . . . . .	<b>C6328</b>
Global Metal Spinning Solutions Inc . . . . .	C934
Intech Services Inc . . . . .	C2163
Joysun Abrasives Co Ltd . . . . .	N3208
KLINGSPOR Abrasives Inc . . . . .	N3135
KULLEN - KOTI GmbH . . . . .	N3137
Lissmac Corp . . . . .	C4340
Metabo Corp . . . . .	N6131
<b>Norton Abrasives</b> . . . . .	<b>N2610</b>
Osborn . . . . .	C2737, N3309
PFERD INC . . . . .	N5018
Preston-Eastin Inc . . . . .	N5731
Pushcorp Inc . . . . .	N5934
Rex-Cut Abrasives . . . . .	N2708
Rosler Metal Finishing USA LLC . . . . .	C7733
Scantool USA By CML USA . . . . .	C7147
Suhner Industrial Products Inc . . . . .	N3010
Timesavers Inc . . . . .	C6340
Top Cat Air Tools . . . . .	C2361
United Abrasives Inc /SAIT . . . . .	N3104
Walter Surface Technologies . . . . .	N2628
Wendt USA LLC . . . . .	N2606
Wheelabrator Group . . . . .	C7121

## Pollution Control Chemicals - Finishing

Nederman Inc . . . . .	N1604
------------------------	-------

## Pollution Control Equipment

Ace Industrial Products . . . . .	N5009
Airflow Systems Inc . . . . .	N1110
Avani Environmental Intl Inc . . . . .	N4537
Bowlin Engineering . . . . .	C4838
Clean Air Consultants/Filter 1 . . . . .	C2428
Coral Spa / Industrial Air Solutions . . . . .	N2813
Diversi-Tech Inc . . . . .	N1922
Donaldson Torit - Donaldson Company Inc . . . . .	C8121, N6028
DualDraw LLC . . . . .	N2506
Environmental Air Solutions . . . . .	N6315
<b>Goff's Enterprises Inc</b> . . . . .	<b>N2625</b>
Industrial Maid . . . . .	N2428
Kemper America Inc . . . . .	N2631
Micro Air . . . . .	N1806
Nederman Inc . . . . .	N1604
Pollution Control Products . . . . .	C2415
Tri-Mer Corp . . . . .	N2615
Walter Surface Technologies . . . . .	N2628
Weldsale LLC . . . . .	N5124

## Pollution Control Equipment - Finishing

Guspro Inc . . . . .	C1952
I.S.T. International Surface Technologies . . . . .	C1958

Industrial Maid .....	N2428
<b>Metcast Service Tech Resources</b> .....	<b>C6946</b>
Micro Air .....	N1806
Nederman Inc .....	N1604
Tri-Mer Corp .....	N2615

### Pollution Control Systems (Engineering & Design) - Finishing

Avani Environmental Intl Inc. ....	N4537
DualDraw LLC .....	N2506
Micro Air .....	N1806
Nederman Inc .....	N1604
Powder Coating Consultants. ....	C2422
Tri-Mer Corp .....	N2615

### Portable Power Tools

Alpha Professional Tools. ....	N6331
Bosch Power Tool Corp. ....	N5006
Chicago Pneumatic Tool Co. ....	C4750
Cleveland Steel Tool Co .....	C5522
Dynabrade Inc .....	C2409
EH Wachs Co. ....	N5713
ESCO Tool Co. ....	C5735
Heck Industries .....	C4828
Metabo Corp. ....	N6131
Michigan Pneumatic Tool Inc .....	N6034

### Orbitalum Orbital Cutting

<b>+ Welding</b> .....	<b>N5713</b>
PDS Bartech Inc. ....	N5917
PFERD INC. ....	N5018
Steelmax Tools .....	N4737
T-DRILL Industries Inc .....	C2121
Top Cat Air Tools .....	C2361
Tri Tool Inc .....	N5913
Wendt USA LLC. ....	N2606
York Portable Machine Tools .....	N2925

### Powder Coating Application & Recovery Equipment

AFC Finishing Systems .....	C2548
<b>Chemical Coaters Assoc Int'l</b> .....	<b>C1948</b>
<b>Col-Met Spray Booths Inc.</b> .....	<b>C2537</b>
Combustion and Systems Inc .....	C2411
Enhancement Technologies / Sublitex-Miroglio .....	C1561
EXEL North America .....	C2264
Fostoria Process Equipment .....	C2148
Gema .....	C2750
General Fabrications Corp. ....	C2648
<b>George Koch Sons LLC</b> .....	<b>C2521</b>
Global Finishing Solutions .....	C2151
<b>IntelliFinishing</b> .....	<b>C2528</b>
KCI America Co Ltd .....	C2062
Midwest Finishing Systems Inc .....	C2526
<b>Nordson Corp</b> .....	<b>C2517</b>

**Parker Ionics/Parkwood  
Engineering** .....

<b>Engineering</b> .....	<b>C2523</b>
Pneu-Mech Systems Manufacturing Inc. ....	C2539
Powder Coating .....	C2356
Powder-X Coating Systems. ....	C1262
Production Systems Inc. ....	C1858
Spray-Tech/Junair .....	C2164
Trimac Industrial Systems. ....	C2359
Vulcan Catalytic Infrared Oven Systems .....	C2512
Wagner Industrial Solutions .....	C1951

### Powder Coating Sieves, Screening Devices, Sifters

Combustion and Systems Inc .....	C2411
Gema .....	C2750
Inline Sieve .....	C2552
KCI America Co Ltd .....	C2062
<b>Nordson Corp</b> .....	<b>C2517</b>
<b>Parker Ionics/Parkwood Engineering</b> .....	<b>C2523</b>
Powder Coating .....	C2356
Wagner Industrial Solutions .....	C1951

### Powder Coatings Manufacturers

AkzoNobel Powder Coatings. ....	C2258
Cardinal Paint and Powder .....	C1761
<b>Chemical Coaters Assoc Int'l</b> .....	<b>C1948</b>
Combustion and Systems Inc .....	C2411
Decoral System USA Corp .....	C1954
Diamond Vogel Paints. ....	C2414
<b>DuPont Industrial CoatingSolutions</b> .....	<b>C2542</b>
General Automatic Transfer .....	C2550
Global Finishing Solutions .....	C2151
Intech Services Inc .....	C2163
KCI America Co Ltd .....	C2062
Keyland Polymer Ltd .....	C2063
NIC Industries Inc .....	C2426
Powder Coating .....	C2356
PPG Industries .....	C2739
Spray-Tech/Junair .....	C2164

### Power Supplies for Electrostatic Processes

Gema .....	C2750
Intech Services Inc .....	C2163

### Power Transmission Products

Atlanta Drive Systems Inc. ....	C8323
Nadella .....	C7150



**MESSER**   
Cutting Systems

**BOOTH C5916  
INTRODUCES THE**

**NEW  
TITAN III**

Messer Cutting Systems introduces the **New Titan III** with linear ways in the Y-Axis, along with a rack and pinion design for greater cut part accuracies. Wider end trucks allow for the electrical cabinets to mount within the truck, giving the machine a cleaner look.

**COME SEE THE NEW**

- **New Lifter Technology**
- **Automatic Plate Alignment Video Camera**
- **Fiber Laser and Plasma**



Messer Cutting Systems  
Menomonee Falls, WI  
[www.messer-cs.com](http://www.messer-cs.com)



## Press Automation Transfer Equipment

AIDA-America Corp.	C1210
ATI Industrial Automation	N5708
<b>Beckwood Press Co.</b>	<b>C1228</b>
Bettcher Manufacturing LLC	C1053
Kong NGAI Precision Metal Mould Shenzhen Co Ltd	C856
P&G Fluid Power Inc	C1320
Reis Robotics USA Inc.	N5910
Schuler Incorporated	C917
Wayne Trail, a Lincoln Electric Company	N4513

## Press Brakes (All-Electric)

ARKU Coil Systems Inc	C7528
Automec Inc	C4832
Baykal Makina Sanayi ve Ticaret AS	C5940, C5947
Bettcher Manufacturing LLC	C1053
COMEQ Inc	C5125
Enutron International	C7750
Ermak USA	C3447
International Technologies Inc	C8111
Jet	C5923
Lantek Systems Inc	C4940
Lazer Safe Pty Ltd	C3824
Linemaster Switch Corp	C2324
Manufacturing Solutions	C8429
<b>MC Machinery Systems Inc/ Mitsubishi</b>	<b>C3040</b>
Prima Power North America Inc	C4336
<b>Salvagnini America Inc</b>	<b>C3928</b>
Tapeswitch Corp	C3813
<b>TRUMPF Inc.</b>	<b>C3016</b>
Wila USA	C5709

## Press Brakes (Hydraulic)

<b>Accurpress America Inc</b>	<b>C3047</b>
Alternative Parts Inc	C3726
<b>Amada America Inc.</b>	<b>C3916</b>
Automec Inc	C4832
Baileigh Industrial Inc	C7513
Baykal Makina Sanayi ve Ticaret AS	C5940, C5947
<b>Betenbender Manufacturing Inc.</b>	<b>C3744</b>
Bettcher Manufacturing LLC	C1053
<b>Boschert Precision Machinery Inc.</b>	<b>C2820</b>
<b>Bystronic Inc</b>	<b>C4328</b>
C Marshall Fabrication Machinery	C7716
Changzhou Huatong Welding Industry Co Ltd	N6310
COMEQ Inc	C5125
Dake Corporation	C6923
Durma USA	C3949
Edwards Manufacturing Co	C7116

Enutron International	C7750
Ermak USA	C3447
GINGRAS/Machinerie G A S	C3822
Haco Atlantic Inc	C3440
Jet	C5923
JMT USA	C5047
Ketec Precision Tooling Co LTD	C3834
KNUTH Machine Tools USA Inc	C4910
Lazer Safe Pty Ltd	C3824
Linemaster Switch Corp	C2324
<b>LVD Stripit</b>	<b>C3937</b>
Machinery Marketing Intl	C8337
Masteel America Corp	C3749
<b>MC Machinery Systems Inc/ Mitsubishi</b>	<b>C3040</b>
Midwest Tool Inc	C4826
Perfection Global LLC	C3832
Prestige Equipment Corporation	C7214
Prima Power North America Inc	C4336
<b>Salvagnini America Inc</b>	<b>C3928</b>
<b>TRUMPF Inc.</b>	<b>C3016</b>
Unittool Punch & Die	C4708
US Industrial Machinery Co	C3049
Wila USA	C5709
Wysong Parts and Service	C1023

## Press Brakes (Hydromechanical)

<b>Accurpress America Inc</b>	<b>C3047</b>
Automec Inc	C4832
Ermak USA	C3447
Prestige Equipment Corporation	C7214
Wila USA	C5709
Wysong Parts and Service	C1023

## Press Brakes (Mechanical)

Automec Inc	C4832
Ermak USA	C3447
Heim Group, The	C1331
Jet	C5923
Ketec Precision Tooling Co LTD	C3834
Magnetic Products Inc	C5510
Midwest Tool Inc	C4826
Precision Stamping Products	C1158
Prestige Equipment Corporation	C7214
Wysong Parts and Service	C1023

## Press Brakes (Pneumatic)

C Marshall Fabrication Machinery	C7716
Jet	C5923
Ketec Precision Tooling Co LTD	C3834
Linemaster Switch Corp	C2324
Ross Controls	C849
Unittool Punch & Die	C4708

## Press Controls

Alternative Parts Inc	C3726
AP&T North America Inc	C1231
CIECO Inc	C1334
<b>Radan</b>	<b>C3747</b>
Tapeswitch Corp	C3813
Toledo Blank	C1149
TOX Pressotechnik LLC	C5024
Wintriss Controls	C3711

## Press Counter Balance

CIECO Inc	C1334
Wintriss Controls	C3711

## Press Feeds

AIDA-America Corp.	C1210
Alma Machinery Co.	C1431
Industrial Magnetics Inc	C5728
Minster Machine Co, The	C649
Norwalk Innovation	C1055
Red Bud Industries	C4732
SEYI America Inc.	C653
Sutherland Presses	C152

## Presses - Deep Drawing

AIDA-America Corp.	C1210
Alma Machinery Co.	C1431
Ampco Metal Inc.	C2326
AP&T North America Inc.	C1231
<b>Beckwood Press Co.</b>	<b>C1228</b>
Bettcher Manufacturing LLC	C1053
Enprotech Industrial Technologies LLC	C1439
Greenerd Press & Machine Company Inc	C815
Kong NGAI Precision Metal Mould Shenzhen Co Ltd	C856
Macrodyne Technologies Inc	C252
Minster Machine Co, The	C649
Multipress Inc	C1022
Ningbo Hi-Tech Moldie Machinery Co Ltd	C356
Ross Controls	C849
Schuler Incorporated	C917
SEYI America Inc.	C653
Stamtec Presses	C1052
Sutherland Presses	C152
<b>Triform Sheet Hydroforming</b>	<b>C1226</b>
Uelner Precision Tools & Dies	C937

## Presses - Dishing

<b>Beckwood Press Co.</b>	<b>C1228</b>
CIMID Corp	C8327
Enprotech Industrial Technologies LLC	C1439





Greenerd Press & Machine Company Inc ..... C815  
 Macrodyne Technologies Inc ..... C252  
 Multipress Inc ..... C1022  
**Triform Sheet Hydroforming ..... C1226**

**Presses - Fineblanking**

AIDA-America Corp ..... C1210  
 Enprotech Industrial Technologies LLC ..... C1439  
 Macrodyne Technologies Inc ..... C252  
 Minster Machine Co, The ..... C649  
 Multipress Inc ..... C1022  
 Ross Controls ..... C849  
 SEYI America Inc ..... C653  
 Stamtec Presses ..... C1052

**Presses - Forging**

**Beckwood Press Co ..... C1228**  
 Gerb Vibration Control Systems ..... C852  
 Interlaken Technology ..... C947  
 Ningbo Hi-Tech Moldie Machinery Co Ltd ..... C356  
 Schuler Incorporated ..... C917  
 Stamtec Presses ..... C1052  
 Sutherland Presses ..... C152

**Presses - Hot Stamping**

AP&T North America Inc ..... C1231  
**Beckwood Press Co ..... C1228**  
 Enprotech Industrial Technologies LLC ..... C1439  
 Greenerd Press & Machine Company Inc ..... C815  
 Interlaken Technology ..... C947  
 Macrodyne Technologies Inc ..... C252  
 Schuler Incorporated ..... C917  
 Sutherland Presses ..... C152

**Presses - Hydraulic (Column Style/Post)**

Alma Machinery Co ..... C1431  
**American Machine & Rollform Tech. C5520**  
 AP&T North America Inc ..... C1231  
**Beckwood Press Co ..... C1228**  
 Bettcher Manufacturing LLC ..... C1053  
 Elo Automated Stainless Steel Technologies Qingdao Co Ltd .... C8342  
 Enprotech Industrial Technologies LLC ..... C1439  
 Gerb Vibration Control Systems ..... C852

Greenerd Press & Machine Company Inc ..... C815  
 Interlaken Technology ..... C947  
 Macrodyne Technologies Inc ..... C252  
 Multipress Inc ..... C1022  
 Perfection Global LLC ..... C3832  
 PHI ..... C2122  
 Schuler Incorporated ..... C917  
 SEYI America Inc ..... C653  
 Stamtec Presses ..... C1052  
 Sutherland Presses ..... C152  
 TOX Pressotechnik LLC ..... C5024  
**Triform Sheet Hydroforming ..... C1226**

**Presses - Hydraulic (Gap/C Frame)**

Alma Machinery Co ..... C1431  
**Beckwood Press Co ..... C1228**  
**Betenbender Manufacturing Inc. .... C3744**  
 Brown Boggis ..... C1409  
 Controlled Automation Inc ..... C7730  
 Dake Corporation ..... C6923  
 Enprotech Industrial Technologies LLC ..... C1439

**VISION™**

**SO MUCH POWER  
 SO EASY TO CONTROL.  
 PULL YOUR SHOP OUT OF THE RUT.**

Check out the Accurpress booth #C3047.

**ACCURPRESS**



## Presses - Hydraulic (Gap/C Frame)

Greenerd Press & Machine Company Inc	C815
Haco Atlantic Inc	C3440
Haco-Lasit	C3440
KNUTH Machine Tools USA Inc	C4910
Macrodyne Technologies Inc	C252
Multipress Inc	C1022
Proto-1 Manufacturing	C1825
Samco Machinery Ltd	C1217
SEYI America Inc	C653
Stamtec Presses	C1052
Sutherland Presses	C152
TOX Pressotechnik LLC	C5024
Triform Sheet Hydroforming	C1226

## Presses - Hydraulic (Servo-Drive)

American Machine & Rollform Tech	C5520
AP&T North America Inc	C1231
Brown Boggs	C1409
Clips & Clamps Industries	C148
Interlaken Technology	C947
LVD Strippit	C3937
Samco Machinery Ltd	C1217
Stamtec Presses	C1052

## Presses - Hydraulic (Straight Side)

Alma Machinery Co	C1431
AP&T North America Inc	C1231
Beckwood Press Co	C1228
Brown Boggs	C1409
D&H Machinery Inc	C2112
Greenerd Press & Machine Company Inc	C815
Macrodyne Technologies Inc	C252
Multipress Inc	C1022
Proto-1 Manufacturing	C1825
Schuler Incorporated	C917
SEYI America Inc	C653
Stamtec Presses	C1052
Sutherland Presses	C152
Triform Sheet Hydroforming	C1226

## Presses - Hydroforming (Sheet)/Elastoforming/ Rubber Pad

Alma Machinery Co	C1431
AP&T North America Inc	C1231
Beckwood Press Co	C1228
CIMID Corp	C8327
Enprotech Industrial Technologies LLC	C1439

Interlaken Technology	C947
Macrodyne Technologies Inc	C252
Multipress Inc	C1022
PHI	C2122
Polyurethane Products Corp	C3811
Prestige Equipment Corporation	C7214
Triform Sheet Hydroforming	C1226

## Presses - Mechanical (Gap/C Frame)

AIDA-America Corp	C1210
Alma Machinery Co	C1431
Bettcher Manufacturing LLC	C1053
Bliss Clearing Niagara	C933
Brown Boggs	C1409
Heim Group, The	C1331
Minster Machine Co, The	C649
Perfection Global LLC	C3832
Premier Tooling & Mfg Inc	C1032
Ross Controls	C849
Samco Machinery Ltd	C1217
SEYI America Inc	C653
Stamtec Presses	C1052
Stripmatic Products Inc	C1415
Sutherland Presses	C152

## Presses - Mechanical (Servo-Drive)

AIDA-America Corp	C1210
American Machine & Rollform Tech	C5520
Beck Automation	C5520
Brown Boggs	C1409
Clips & Clamps Industries	C148
Komatsu America Industries LLC	C1239, C6510
Premier Tooling & Mfg Inc	C1032
Ross Controls	C849
Samco Machinery Ltd	C1217
Schuler Incorporated	C917
SEYI America Inc	C653
Stamtec Presses	C1052
Stripmatic Products Inc	C1415
Uelner Precision Tools & Dies	C937

## Presses - Mechanical (Straight Side)

AIDA-America Corp	C1210
Alma Machinery Co	C1431
Bliss Clearing Niagara	C933
Brown Boggs	C1409
Bruderer Machinery Inc	C925
Enprotech Industrial Technologies LLC	C1439
Gerb Vibration Control Systems	C852
Heim Group, The	C1331
Minster Machine Co, The	C649

Perfection Global LLC	C3832
Premier Tooling & Mfg Inc	C1032
Ross Controls	C849
Schuler Incorporated	C917
SEYI America Inc	C653
Stamtec Presses	C1052
Stripmatic Products Inc	C1415
Sutherland Presses	C152
Toledo Blank	C1149
Uelner Precision Tools & Dies	C937

## Presses - Pneumatic

Anchor Danly	C931
Attexor Clinch Systems SA	C5622
Brown Boggs	C1409
Clips & Clamps Industries	C148
Dake Corporation	C6923
Nucor Building Systems	C1255
PHI	C2122
Ross Controls	C849
TOX Pressotechnik LLC	C5024

## Presses - Punch (Single Station)

American Machine & Rollform Tech	C5520
American Punch Co	C5026
Anomatic Corp	C2452
Attexor Clinch Systems SA	C5622
Baykal Makina Sanayi ve Ticaret AS	C5940, C5947
Beckwood Press Co	C1228
Behringer Saws Inc	C5722
Bettcher Manufacturing LLC	C1053
Boschert Precision Machinery Inc	C2820
Centerline (Windsor) Ltd	N1926
Cleveland Punch & Die Co	C5711
Cleveland Steel Tool Co	C5522
COMEQ Inc	C5125
Controlled Automation Inc	C7730
Durma USA	C3949
Edwards Manufacturing Co	C7116
Ermak USA	C3447
Euromac/Metal Finish LLC	C4716
Gerb Vibration Control Systems	C852
Greenerd Press & Machine Company Inc	C815
Haco Atlantic Inc	C3440
Heim Group, The	C1331
Macrodyne Technologies Inc	C252
Manufacturing Solutions	C8429
Marion Die & Fixture Inc	C5520
Multipress Inc	C1022
Nitto Kohki USA Inc	C1510
SEYI America Inc	C653
SigmaTEK Systems LLC	C4932
Stamtec Presses	C1052





- Trilogy Machinery Inc ..... C5140  
**TRUMPF Inc.** ..... **C3016**  
 Whistler & Sons Inc, SB ..... C4720
- Presses - Punch (Turret)**
- Alternative Parts Inc ..... C3726  
**Amada America Inc.** ..... **C3916**  
 Baykal Makina Sanayi  
   ve Ticaret AS ..... C5940, C5947  
 Behringer Saws Inc ..... C5722  
**Boschert Precision Machinery Inc.** ..... **C2820**  
 Cleveland Punch & Die Co ..... C5711  
 Durma USA ..... C3949  
 Elo Automated Stainless Steel  
   Technologies Qingdao Co Ltd ..... C8342  
 Ermak USA ..... C3447  
 Euromac/Metal Finish LLC ..... C4716  
 Haco Atlantic Inc ..... C3440  
**Haco-Lasit** ..... **C3440**  
 International Technologies Inc ..... C8111  
 JETCAM-NestONE Solutions ..... C4722  
 JMT USA ..... C5047  
 Ketec Precision Tooling Co LTD ..... C3834  
 KNUTH Machine Tools USA Inc ..... C4910  
 Lantek Systems Inc ..... C4940  
**LVD Strippit** ..... **C3937**  
 Manufacturing Solutions ..... C8429  
 MetaMation Inc ..... C3737  
**Murata Machinery USA Inc** ..... **C3028**  
 Perfection Global LLC ..... C3832  
 Prestige Equipment Corporation ..... C7214  
 Prima Power North America Inc ..... C4336  
**Salvagnini America Inc.** ..... **C3928**  
**SigmaTEK Systems LLC.** ..... **C4932**  
**TRUMPF Inc.** ..... **C3016**
- Presses - Superplastic Forming**
- Beckwood Press Co.** ..... **C1228**  
 Macrodyne Technologies Inc ..... C252  
**Triform Sheet Hydroforming** ..... **C1226**
- Presses - Transfer**
- AIDA-America Corp ..... C1210  
**Anomatic Corp.** ..... **C2452**  
 AP&T North America Inc ..... C1231  
**Beckwood Press Co.** ..... **C1228**  
 Enprotech Industrial  
   Technologies LLC ..... C1439  
 Gerb Vibration Control Systems ..... C852  
 Greenerd Press &  
   Machine Company Inc ..... C815  
 Linear Transfer Automation Inc ..... C1223  
 Macrodyne Technologies Inc ..... C252  
 Minster Machine Co, The ..... C649  
 Premier Tooling & Mfg Inc ..... C1032  
 Ross Controls ..... C849
- Schuler Incorporated ..... C917  
 SEYI America Inc ..... C653  
 Stamtec Presses ..... C1052  
 Sutherland Presses ..... C152  
 Uelner Precision Tools & Dies ..... C937
- Pressure Regulators/Valves/  
 Flow Meters (Fluid)**
- EXEL North America ..... C2264  
 Pacesetter Systems ..... C1412  
 Swagelok Marketing Services Co. ... N3431
- Pressure Regulators/Valves/  
 Flow Meters (Gas)**
- Airgas Inc ..... N5231  
 Chart Inc ..... N3204  
 Flame Technologies Inc ..... N3219  
 Genstar Technologies Inc ..... N2822  
 Harris Products Group ..... N4509  
 North (Nanjing) Instrument  
   Technology Industries Group. .... N3226  
 Red-Ray Manufacturing Co Inc ..... C2052  
 REXARC International ..... N1515  
 Swagelok Marketing Services Co. ... N3431  
 Uniweld Products Inc ..... N5113  
 Western Enterprises ..... N2933
- Pretreatment Chemicals -  
 Finishing**
- Bulk Chemicals Inc ..... C2433  
**Calvary Industries Inc** ..... **C2734**  
 Carpenter Chemicals LC ..... C2712  
**Chemetall US Inc.** ..... **C2709**  
**Chemical Coaters Assoc Int'l** ..... **C1948**  
 Chemtool Inc ..... C660  
 Coral Chemical Co ..... C2417  
 DMP Corp ..... C2054  
 DuBois Chemicals ..... C2545  
 DuBois Chemicals ..... C4938  
 Electro-Steam Generator Corp ..... C2410  
 Hubbard-Hall Inc ..... C2156  
 Intech Services Inc ..... C2163  
 International Chemical Co ..... C1232  
 Midwest Finishing Systems Inc ..... C2526  
 Powder Coating ..... C2356
- Profile Cutting Machinery**
- AKS Cutting Systems Inc** ..... **C5135**  
 Elo Automated Stainless Steel  
   Technologies Qingdao Co Ltd ..... C8342  
 ESCO Tool Co ..... C5735  
 Haberle / Ken Bergman  
   & Assoc LLC ..... C7137  
 HGG Profiling Equipment ..... C8127  
**Hypertherm Inc** ..... **N3906**  
**Koike Aronson Inc** ..... **N4131**
- Ningbo Jinfeng Welding & Cutting  
 Machinery Manufacture Co Ltd ... N6007  
 Red Rock Automation/  
   Romar/MEC ..... N4805  
 Rhino Cutting Systems ..... N6138  
 Steelmax Tools ..... N4737  
 Toolmen Corp ..... C1253  
 Victory Plasma Systems Inc ..... N4833  
 voestalpine – Roll Forming  
   Corp & Rotec Inc ..... C4725  
 Westingcut Industrial  
   Technology Anhui Inc ..... N1424
- Protectors - Covers/Caps/  
 Film/Tape**
- Armstrong/Kover Kwick  
 Inc feat NCCM Mill Rolls ..... C7047  
 Buffalo Shrink Wrap ..... N2210  
 Dr Shrink Inc ..... C7314  
 Heritage Packaging ..... C7548  
**Mighty Hook Inc** ..... **C2420**  
 Novacel Inc ..... C8433  
 Polyurethane Products Corp ..... C3811  
**Steel King Industries Inc** ..... **C1057**
- Proximity Switches**
- Alternative Parts Inc ..... C3726
- Publishing**
- Aerospace Manufacturing  
 and Design ..... C8338  
 CFCM Canadian Finishing  
   & Coatings Manufacturing ..... C2747  
**Chemical Coaters Assoc Int'l** ..... **C1948**  
**Compressed Air** ..... **N3034**  
 Expansion Solutions Magazine ..... C7346  
**Fabricating & Metalworking  
 Magazine** ..... **C8508**  
 Fabricator, The ..... C8227  
**Fabricators & Manufacturers  
 Association** ..... **C6538**  
**FF Journal Magazine** ..... **C8236**  
 Industrial Laser Solutions ..... C8520  
**Industrial Machinery Digest** ..... **C8506**  
 Industrial Market Place ..... C5036  
 Job Shop Company, The ..... C5035  
 Manufacturing News ..... C4936  
 Powder Coating ..... C2356  
**Precision Metalforming  
 Association** ..... **C463**  
 Products Finishing Magazine ..... C2254  
 Sanpo Publications Inc ..... N1507  
**Society of Manufacturing  
 Engineers** ..... **C6542**  
 SteelOrbis ..... C3751  
 Technical Translation Services ..... N2604





## Pumps - Finishing

Anest Iwata USA Inc. ....	C2746
<b>Binks DeVilbiss Ransburg BGK</b> .....	<b>C2532</b>
DMP Corp .....	C2054
EXEL North America .....	C2264
Gema .....	C2750
General Automatic Transfer .....	C2550
General Fabrications Corp. ....	C2648
<b>Graco Inc</b> .....	<b>C2350</b>
Inline Sieve .....	C2552
Intech Services Inc .....	C2163
Krautzberger LLC .....	C1964
Midwest Finishing Systems Inc ....	C2526
Nation Coating Systems Inc .....	N2416
<b>Nordson Corp</b> .....	<b>C2517</b>
Pangborn Corp. ....	C6516
<b>Walther Pilot North America</b> .....	<b>C2609</b>

## Punching - CNC Bus Par

COMEQ Inc .....	C5125
Machinery Marketing Intl .....	C8337

## Punching - Coil fed CNC

<b>Beckwood Press Co.</b> .....	<b>C1228</b>
Bettcher Manufacturing LLC .....	C1053
<b>Chicago Slitter.</b> .....	<b>C7023</b>

## Purge Paper, Tapes

<b>Aquasol Corp.</b> .....	<b>N3613</b>
Daymark Technologies .....	N2222
Intercon Enterprises Inc .....	N3227
PROFAX / LENCO .....	N3013
Sumner Manufacturing Co Inc .....	N1519

## Purging Equipment - Gases

<b>Aquasol Corp.</b> .....	<b>N3613</b>
Chart Inc .....	N3204
COB Industries Inc. ....	N5919
Daymark Technologies .....	N2222
Generon IGS .....	C5547
Harris Products Group .....	N4509
Intercon Enterprises Inc .....	N3227
OKI Bering .....	N4531
Weldcoa .....	N3238

## Purging Equipment - Welding

<b>Aquasol Corp.</b> .....	<b>N3613</b>
Daymark Technologies .....	N2222
Western Enterprises .....	N2933

## Quick Die Change Systems or Engineering

5S Supply .....	C3454
AP&T North America Inc. ....	C1231
ATI Industrial Automation .....	N5708

EAS Mold & Die Change Systems, Inc .....	C1026
Hilma Division Carr Lane Roemheld .....	C449
JIT Automation Inc .....	C756
Kosmek USA .....	C1054
<b>Marion Die &amp; Fixture Inc.</b> .....	<b>C5520</b>
Pacesetter Systems .....	C1412
<b>Penn United Technologies Inc.</b> .....	<b>C1420</b>

## Racks, Fixtures, Hooks & Hangers for Painting Processes

American Finishing Resources .....	C1855
JMR Industrial .....	C3752
<b>Magic Rack/Production Plus Corp.</b> ..	<b>C2724</b>
<b>Mighty Hook Inc</b> .....	<b>C2420</b>
Southern Systems Inc .....	C2256
<b>Steel King Industries Inc.</b> .....	<b>C1057</b>

## Replacement Parts - Machinery/Equipment

Advanced Laser Services LLC .....	C5634
<b>Alliance Machine and Engraving LLC</b> .....	<b>C5520</b>
Alternative Parts Inc .....	C3726
<b>Apex Machine Group/ SlipCon USA</b> .....	<b>C5528</b>
Bliss Clearing Niagara .....	C933
Dongsan Bearing Co .....	C833
Emmegi USA Inc .....	C7323
FomUSA .....	C6914
H2O JET Inc .....	C5713
Industrial Molded Rubber Products ..	C4723
International Technologies Inc .....	C8111
International Welding Technologies Inc ..	N1724
Lambda Research Optics Inc. ....	C5633
Meltric Corp .....	N4826
Nadella .....	C7150
Ningbo Hi-Tech Moldie Machinery Co Ltd ..	C356
Ogden Welding Systems .....	N3035
Pacesetter Systems .....	C1412
PDS Bartech Inc. ....	N5917
<b>PTR-Precision Technologies Inc</b> .....	<b>N5226</b>
Ready Technology Inc .....	C832
Semyx LLC .....	C6347
Tapeswitch Corp .....	C3813
York Portable Machine Tools .....	N2925

## Research & Development Services

<b>Anomatic Corp.</b> .....	<b>C2452</b>
Nation Coating Systems Inc .....	N2416
NIST .....	C8421
North America Consulting .....	N6333

OES Inc .....	C248
Vacco Industries .....	C8431

## Robotic Equipment - Assembly

ABB Inc .....	N6102
AGT .....	N2333
ATI Industrial Automation .....	N5708
Attexor Clinch Systems SA .....	C5622
Daifuku Webb .....	C2425
FANUC Robotics America Corp. ....	N3917
Fusion Inc .....	N3313
Genesis Systems Group .....	N3913
KUKA Robotics Corporation .....	N5702
<b>Motoman Robotics Division</b> .....	<b>N5222</b>
<b>Nachi Robotic Systems Inc</b> .....	<b>N3622</b>
Reis Robotics USA Inc. ....	N5910
Rethink Robotics .....	N1313
Robotiq .....	N6119
RPS Robot Protection Systems Inc ..	N6316
Staubli Corp Multi Contact USA .....	N3636
Turck Inc .....	C1312
<b>Wauseon Machine &amp; Manufacturing Inc.</b> .....	<b>C1539</b>
Yaskawa America Inc .....	N5222

## Robotic Equipment - Cutting

ABB Inc .....	N6102
AGT .....	N2333
Alma Cam USA LLC .....	C4834
American Torch Tip Co Inc. ....	N2022
Arc Specialties Inc .....	N1610
Cloos Robotic Welding Inc .....	N3618
Dynatorch Inc .....	N4837
FANUC Robotics America Corp. ....	N3917
Flow International Corp. ....	C5911
Genesis Systems Group .....	N3913
HGG Profiling Equipment .....	C8127
KMT Waterjet Systems Inc .....	C6334
KUKA Robotics Corporation .....	N5702
Laser Mechanisms Inc .....	C3810
LT Ultra Precision Optics .....	C8223
Machinery Marketing Intl .....	C8337
<b>Motoman Robotics Division</b> .....	<b>N5222</b>
MultiCam Inc .....	C5516
<b>Nachi Robotic Systems Inc</b> .....	<b>N3622</b>
Prodevco Industries Inc .....	C8129
Pushcorp Inc .....	N5934
PythonX-Burlington Automation ....	C8116
Reis Robotics USA Inc. ....	N5910
Robotic Technologies of TN .....	N6025
Robotmaster-In-House Solutions Inc. ....	N5933
RPS Robot Protection Systems Inc ..	N6316
Staubli Corp Multi Contact USA .....	N3636
Steelmax Tools .....	N4737
SteelTailor Ltd .....	N4919



Voortman Corporation .....	C7739
Wayne Trail, a Lincoln Electric Company .....	N4513
Westingcut Industrial Technology Anhui Inc .....	N1424
<b>Wolf Robotics LLC .....</b>	<b>N4910</b>
Yaskawa America Inc .....	N5222

**Robotic Equipment - Deburring/Grinding/Polishing**

ABB Inc .....	N6102
Abtex Corp. ....	C7547
AGT .....	N2333
ATI Industrial Automation .....	N5708
CIMID Corp .....	C8327
Comco Inc .....	C5052
FANUC Robotics America Corp. ....	N3917
Frommelt Safety Products .....	N4827
Genesis Systems Group .....	N3913
Hollbirt Inc. ....	N6317
KUKA Robotics Corporation .....	N5702
Lissmac Corp. ....	C4340
<b>Motoman Robotics Division .....</b>	<b>N5222</b>
<b>Nachi Robotic Systems Inc .....</b>	<b>N3622</b>
Pushcorp Inc .....	N5934
Reis Robotics USA Inc. ....	N5910
Rex-Cut Abrasives .....	N2708
Robotic Technologies of TN .....	N6025
Robotmaster-In-House Solutions Inc. ....	N5933
RPS Robot Protection Systems Inc ..	N6316
Staubli Corp Multi Contact USA. ....	N3636
<b>Wolf Robotics LLC .....</b>	<b>N4910</b>
Yaskawa America Inc .....	N5222

**Robotic Equipment - Finishing**

ABB Inc .....	N6102
AGT .....	N2333
ATI Industrial Automation .....	N5708
Comco Inc .....	C5052
EXEL North America .....	C2264
FANUC Robotics America Corp. ....	N3917
Krautzberger LLC .....	C1964
<b>Motoman Robotics Division .....</b>	<b>N5222</b>
<b>Nachi Robotic Systems Inc .....</b>	<b>N3622</b>
<b>Nordson Corp .....</b>	<b>C2517</b>
Production Systems Inc. ....	C1858
Pushcorp Inc .....	N5934
Rethink Robotics .....	N1313
RPS Robot Protection Systems Inc ..	N6316
Staubli Corp Multi Contact USA. ....	N3636
TWN Industries Inc .....	C2446
Wheelabrator Group .....	C7121
Yaskawa America Inc .....	N5222

**Robotic Equipment - Laser Vision**

ABB Inc .....	N6102
AGT .....	N2333
FANUC Robotics America Corp. ....	N3917
Meltools LLC .....	N1618
Meta Vision Systems Inc .....	N5015
<b>Motoman Robotics Division .....</b>	<b>N5222</b>
<b>Nachi Robotic Systems Inc .....</b>	<b>N3622</b>
RPS Robot Protection Systems Inc ..	N6316
Staubli Corp Multi Contact USA. ....	N3636
SteelTailor Ltd .....	N4919
Yaskawa America Inc .....	N5222

**Robotic Equipment - Machining**

ABB Inc .....	N6102
AGT .....	N2333
Bettcher Manufacturing LLC .....	C1053
Chemtool Inc .....	C660
CM Industries Inc .....	N2810
Emmegi USA Inc .....	C7323
FANUC Robotics America Corp. ....	N3917
Genesis Systems Group .....	N3913
KUKA Robotics Corporation .....	N5702
<b>Motoman Robotics Division .....</b>	<b>N5222</b>
<b>Nachi Robotic Systems Inc .....</b>	<b>N3622</b>
Pushcorp Inc .....	N5934
Reis Robotics USA Inc. ....	N5910
Robotmaster-In-House Solutions Inc. ....	N5933
RPS Robot Protection Systems Inc ..	N6316
Staubli Corp Multi Contact USA. ....	N3636
Tapeswitch Corp .....	C3813
Yaskawa America Inc .....	N5222
York Portable Machine Tools .....	N2925

**Robotic Equipment - Material Handling/Tending**

ABB Inc .....	N6102
<b>Accurpress America Inc .....</b>	<b>C3047</b>
AIM Inc .....	C1832
Alma Cam USA LLC .....	C4834
AP&T North America Inc. ....	C1231
ATI Industrial Automation .....	N5708
Electron Beam Technologies Inc. ....	N3210
FANUC Robotics America Corp. ....	N3917
Frommelt Safety Products .....	N4827
Genesis Systems Group .....	N3913
Global Metal Spinning Solutions Inc .	C934
<b>Koike Aronson Inc .....</b>	<b>N4131</b>
KUKA Robotics Corporation .....	N5702
MJC Engineering & Technology Inc .	C1156
<b>Motoman Robotics Division .....</b>	<b>N5222</b>
<b>Nachi Robotic Systems Inc .....</b>	<b>N3622</b>
Preston-Eastin Inc .....	N5731
Reis Robotics USA Inc. ....	N5910

Rethink Robotics .....	N1313
Rimco Equipment .....	N1631
Robotiq .....	N6119
RPS Robot Protection Systems Inc ..	N6316
<b>Salvagnini America Inc .....</b>	<b>C3928</b>
Staubli Corp Multi Contact USA. ....	N3636
Universal Tool & Engineering .....	C1839
Walker Magnetics .....	C7536
<b>Wauseon Machine &amp; Manufacturing Inc. ....</b>	<b>C1539</b>
Wayne Trail, a Lincoln Electric Company .....	N4513
<b>Wolf Robotics LLC .....</b>	<b>N4910</b>
Yaskawa America Inc .....	N5222

**Robotic Equipment - Painting/Finishing**

ABB Inc .....	N6102
AGT .....	N2333
Bay State Surface Technologies .....	N2419
<b>Chemical Coaters Assoc Int'l .....</b>	<b>C1948</b>
Combustion and Systems Inc .....	C2411
EXEL North America .....	C2264
FANUC Robotics America Corp. ....	N3917
Krautzberger LLC .....	C1964
LS Industries Inc .....	C8123
<b>Motoman Robotics Division .....</b>	<b>N5222</b>
<b>Nordson Corp .....</b>	<b>C2517</b>
Preston-Eastin Inc .....	N5731
Reis Robotics USA Inc. ....	N5910
Robotic Technologies of TN .....	N6025
Robotmaster-In-House Solutions Inc. ....	N5933
RPS Robot Protection Systems Inc ..	N6316
Staubli Corp Multi Contact USA. ....	N3636
Yaskawa America Inc .....	N5222

**Robotic Equipment - Robot Tooling/Grippers**

ABB Inc .....	N6102
Alma Cam USA LLC .....	C4834
AP&T North America Inc. ....	C1231
ATI Industrial Automation .....	N5708
Bilsing Automation North America. ....	C926
ERIEZ .....	C7316
FANUC Robotics America Corp. ....	N3917
Genesis Systems Group .....	N3913
Industrial Magnetics Inc .....	C5728
<b>Motoman Robotics Division .....</b>	<b>N5222</b>
<b>Nachi Robotic Systems Inc .....</b>	<b>N3622</b>
Reis Robotics USA Inc. ....	N5910
Robotiq .....	N6119
RPS Robot Protection Systems Inc ..	N6316
Staubli Corp Multi Contact USA. ....	N3636
Walker Magnetics .....	C7536
Wila USA .....	C5709
Yaskawa America Inc .....	N5222



## Robotic Equipment - Welding (Arc)

ABB Inc	N6102
<b>ABICOR Binzel Corp.</b>	<b>N5508</b>
AGT	N2333
Airgas Inc	N5231
Alma Cam USA LLC	C4834
American Torch Tip Co Inc.	N2022
AMET Inc.	N4518
Arc Specialties Inc	N1610
ATI Industrial Automation	N5708
Bettcher Manufacturing LLC	C1053
Changzhou Wujin Golden Globe Welding & Cutting Machinery Co Ltd	N5900
Climax Portable Machining & Welding Systems	N1422
Clips & Clamps Industries	C148
Cloos Robotic Welding Inc	N3618
CM Industries Inc	N2810
D/F Machine Specialties Inc.	N2224
Dinse Inc	N2717
ELCo Enterprises	N2831
Elo Automated Stainless Steel Technologies Qingdao Co Ltd	C8342
<b>ESAB Welding &amp; Cutting Products</b>	<b>N3922, N4122</b>
FANUC Robotics America Corp.	N3917
Frommelt Safety Products	N4827
Fronius USA LLC	N3425
Genesis Systems Group	N3913
HAI Advanced Material Spec	N2319
Hollbrit Inc.	N6317
International Welding Technologies Inc	N1724
<b>Iroco Automation Inc.</b>	<b>N2431</b>
KUKA Robotics Corporation	N5702
Liburdi Automation Inc	N3609
<b>Lincoln Electric Co.</b>	<b>N4102, N4113, N4515</b>
Meltric Corp	N4826
Miller Electric Mfg Co.	N5213, N5816
Miller Welding Automation	N5513
<b>Motoman Robotics Division</b>	<b>N5222</b>
Nelson Stud Welding	N5922
<b>OTC DAIHEN Inc</b>	<b>N3622</b>
Pador Marketing Group	N2927
Pandjiris Inc.	N4810
Praxair Inc	N5202
Preston-Eastin Inc	N5731
PT-Mat.	N3337
Red Rock Automation/Romar/MEC	N4805
Reis Robotics USA Inc.	N5910
Robotic Technologies of TN	N6025
Robotiq	N6119
Robotmaster-In-House	

Solutions Inc.	N5933
RPS Robot Protection Systems Inc	N6316
Secoa Technology	N1719
Servo-Robot Inc.	N5907
Southern Stud Weld Inc	N2616
Steelmax Tools	N4737
<b>Tregaskiss</b>	<b>N5513</b>
Tri Tool Inc.	N5913
Victor Technologies Intl Inc.	N4522
Wayne Trail, a Lincoln Electric Company	N4513
<b>Wolf Robotics LLC.</b>	<b>N4910</b>
Yaskawa America Inc	N5222
York Portable Machine Tools	N2925
ZJ Industries Inc	N2704

## Robotic Equipment - Welding (Laser)

ABB Inc	N6102
AGT	N2333
Alma Cam USA LLC	C4834
American Torch Tip Co Inc.	N2022
Changzhou Wujin Golden Globe Welding & Cutting Machinery Co Ltd	N5900
Cloos Robotic Welding Inc	N3618
Dinse Inc	N2717
ELCo Enterprises	N2831
FANUC Robotics America Corp.	N3917
Frommelt Safety Products	N4827
Fronius USA LLC	N3425
Genesis Systems Group	N3913
KUKA Robotics Corporation	N5702
Laser Mechanisms Inc	C3810
Liburdi Automation Inc	N3609
LT Ultra Precision Optics	C8223
<b>Motoman Robotics Division</b>	<b>N5222</b>
OR Lasertechnology Inc.	C7345
Reis Robotics USA Inc.	N5910
Robotic Technologies of TN	N6025
Robotmaster-In-House Solutions Inc.	N5933
RPS Robot Protection Systems Inc	N6316
Servo-Robot Inc.	N5907
Wayne Trail, a Lincoln Electric Company	N4513
Weil Engineering North America	C8209
<b>Wolf Robotics LLC.</b>	<b>N4910</b>
Yaskawa America Inc	N5222

## Robotic Equipment - Welding (Resistance)

ABB Inc	N6102
<b>ABICOR Binzel Corp.</b>	<b>N5508</b>
<b>Centerline (Windsor) Ltd.</b>	<b>N1926</b>
Elo Automated Stainless Steel Technologies Qingdao Co Ltd	C8342

Etal/INDUX Sa De Cv	N2433
FANUC Robotics America Corp.	N3917
Fronius USA LLC	N3425
Genesis Systems Group	N3913
Janda Co Inc	N1924
KUKA Robotics Corporation	N5702
Matuschek Welding Products Inc.	N1708
<b>Motoman Robotics Division</b>	<b>N5222</b>
<b>Nachi Robotic Systems Inc</b>	<b>N3622</b>
Ningbo Jinfeng Welding & Cutting Machinery Manufacture Co Ltd	N6007
Reis Robotics USA Inc.	N5910
Robotiq	N6119
RPS Robot Protection Systems Inc	N6316
SMK Co Ltd	N1524
Wayne Trail, a Lincoln Electric Company	N4513
<b>Wolf Robotics LLC.</b>	<b>N4910</b>
Yaskawa America Inc	N5222
ZJ Industries Inc	N2704

## Roll Benders

Acrotech	C8213
Ampco Metal Inc.	C2326
Baileigh Industrial Inc	C7513
<b>Boschert Precision Machinery Inc.</b>	<b>C2820</b>
C Marshall Fabrication Machinery	C7716
<b>Carell Corp/Eagle Bending Machines</b>	<b>C5928</b>
CIMID Corp	C8327
CMF Jammes Rolling and Welding	C5538
CML USA Inc Ercolina	C3739
COMEQ Inc	C5125
Eaton Leonard	C1723
Euromac/Metal Finish LLC	C4716
Faccin USA Inc	C6323
Global Metal Spinning Solutions Inc	C934
Haeusler AG	C5540
J & S Machine Inc.	C2317
Jet	C5923
JMT USA	C5047
KNUTH Machine Tools USA Inc	C4910
<b>MG S.r.L.</b>	<b>C7716</b>
Midwest Bender Services Corp	C1728
Peter Prinzing GmbH	C5638
Prestige Equipment Corporation	C7214
Ready Technology Inc	C832
Sertom Group North America LLC	C6911
TaurinGroup USA	C1739
Trilogy Machinery Inc	C5140

## Roll Formed Metal Shapes

American Roll Form	C5038
Douglas Steel Supply Co.	C5747
Hydro Carbide Inc	C8238
MMC Superalloy Corp.	N1826





National Bronze & Metals Inc. ....	C1512
Samco Machinery Ltd. ....	C1217
Samson Roll Formed Products Co. ...	C6350
Southern Copper & Supply. ....	N1926
TaurinGroup USA. ....	C1739
Ulbrich Stainless Steels & Special Metals Inc. ....	C1015
voestalpine – Roll Forming Corp & Rotec Inc. ....	C4725

### Roll Forming Machines

Acrotech. ....	C8213
American Machine & Rollform Tech. ....	C5520
Beck Automation. ....	C5520
Bradbury Co., Inc., The. ....	C5520
Bradbury Group Australia. ....	C5520
Bradbury Group, The. ....	C5520
C Marshall Fabrication Machinery. ....	C7716
Chemtool Inc. ....	C660
CMF Jammes Rolling and Welding. ....	C5538
Eaton Leonard. ....	C1723
Fontijne Grotnes Inc. ....	C2136
Formtek Metal Forming & Hill Engineering. ....	C3708
Gasparini SPA. ....	C5536
Haeusler AG. ....	C5540
Hayes International. ....	C5520
Masteel America Corp. ....	C3749
Metform International Ltd. ....	C5534
MG S.r.L. ....	C7716
Perfection Global LLC. ....	C3832
RAS Systems LLC. ....	C6921
Roll Former Corp. ....	C1037
Samco Machinery Ltd. ....	C1217
Sertom Group North America LLC. ...	C6911
Starrett Byewise Measurement Systems. ....	C3453
T&H Lemont. ....	C2117
TaurinGroup USA. ....	C1739
Universal Tube & Rollform Equipment Corp. ....	C1528
Vicon - Plasma Automation Inc. ....	N5031
voestalpine – Roll Forming Corp & Rotec Inc. ....	C4725
Weil Engineering North America. ...	C8209
Weldlogic Inc. ....	N5826
Xinxiang Tianfeng Machinery Manufacture Co Ltd. ....	C7148

### Rolling Mills

Ampco Metal Inc. ....	C2326
Beck Automation. ....	C5520
Fives Bronx Inc. ....	C1514
Formtek Metal Forming & Hill Engineering. ....	C3708
Hayes International. ....	C5520

KULLEN - KOTI GmbH. ....	N3137
Samco Machinery Ltd. ....	C1217
Sertom Group North America LLC. ...	C6911
T&H Lemont. ....	C2117
TCT Stainless Steel Inc. ....	C1058
Tianjin Xuzhi Machinery & Electrical Equipment Co Ltd. ....	N1431
Ulbrich Stainless Steels & Special Metals Inc. ....	C1015

### Rolls - Fabric, Urethane, Felt

Armstrong/Kover Kwick Inc feat NCCM Mill Rolls. ....	C7047
Auburn Manufacturing Inc. ....	N4904
Buffalo Shrink Wrap. ....	N2210
Webb-Stiles Co. ....	C2435

### Rust Inhibitors - Finishing

Almco Inc. ....	C1220
Bradford Derustit Corp. ....	N4804
Bulk Chemicals Inc. ....	C2433
Calvary Industries Inc. ....	C2734
Cardinal Paint and Powder. ....	C1761
Chemetall US Inc. ....	C2709
Chemtool Inc. ....	C660
Cimcool Fluid Technology. ....	C1452
DuBois Chemicals. ....	C2545
DuBois Chemicals. ....	C4938
Houghton International Inc. ...	C1437, C1552
Hubbard-Hall Inc. ....	C2156
International Chemical Co. ....	C1232
Metalloid Corp. ....	C1447
Osborn. ....	C2737, N3309
Professional Finishing Systems. ...	C8239
Rock Valley Oil & Chemical Co Inc. .	C1049
Tower Oil & Technology Co. ....	C1319
Weld-Aid Products. ....	N4928
Zerust Corrosion Solutions (Northern Tech Intl Corp). ....	C1014

### Rust Removers - Finishing

Almco Inc. ....	C1220
Alpha Professional Tools. ....	N6331
Beilun Futuo Mechanical Tools Co Ltd. ....	N6026
Calvary Industries Inc. ....	C2734
Chemetall US Inc. ....	C2709
Chemtool Inc. ....	C660
Cimcool Fluid Technology. ....	C1452
DuBois Chemicals. ....	C2545, C4938
Easy Abrasives LLC. ....	N2618
Hubbard-Hall Inc. ....	C2156
International Chemical Co. ....	C1232
Metalloid Corp. ....	C1447
Osborn. ....	C2737, N3309
Professional Finishing Systems. ...	C8239

Rex-Cut Abrasives. ....	N2708
Weiler Corp. ....	N4831
Wheelabrator Group. ....	C7121
Zerust Corrosion Solutions (Northern Tech Intl Corp). ....	C1014

### Safety Floor Matting

Gaozhou City Longsafety Labor Insurance. ....	N6201
ISB Group. ....	C4728
Tapeswitch Corp. ....	C3813

### Safety/Guarding Apparel

ArcOne. ....	N3231
BUWW Coverings Inc. ....	C7320
Carhartt Workwear. ....	N1506
Certified Safety Mfg. ....	C256
Cordstrap USA Inc. ....	C7433
Fastenal Company. ....	N5736
Fibre-Metal By Honeywell. ....	N2006
Gaozhou City Longsafety Labor Insurance. ....	N6201
Interactive Safety Product Inc. ....	N3206
John Tillman Co. ....	N3606
Kemper America Inc. ....	N2631
KLINGSPOR Abrasives Inc. ....	N3135
Lapco Mfg Inc. ....	N1404
Massaging Insoles By the Master's Plan. ....	N3308
Matheson. ....	N6122
Miller Electric Mfg Co. ....	N5213, N5816
New Fire Co Ltd. ....	N3017
North (Nanjing) Instrument Technology Industries Group. ....	N3226
Oxylance Inc. ....	N2228
Pan Taiwan Enterprise. ....	N1718
Revco Industries Inc. ....	N3031
RPS Robot Protection Systems Inc. .	N6316
Sellstrom Manufacturing Co. ....	N3413
Steiner Industries. ....	N3022
Triple Crown Products. ....	N3318
Weldas Co. ....	N5136
West Chester Holding Inc. ....	N5106
Winnox Industries Ltd. ....	N6111

### Safety/Guarding Equipment/ Lockouts

Advanced Manufacturing Solutions LLC. ....	C6351
AP&T North America Inc. ....	C1231
ArcOne. ....	N3231
Axellent Inc. ....	N5127
Beckhoff Automation. ....	C7545
CIECO Inc. ....	C1334
Cordstrap USA Inc. ....	C7433
Dr Gold & Co. ....	N5026



## Safety/Guarding Equipment/ Lockouts

Fibre-Metal By Honeywell	N2006
Folding Guard Corp	N1808
Frommelt Safety Products	N4827
Gaozhou City Longsafety Labor Insurance	N6201
gasgrab.com	N3225
<b>Goff's Enterprises Inc</b>	<b>N2625</b>
Hex-Hut Shelter Systems Ltd	N6115
IBEDA /Superflash Compressed Gas Equipment Inc	N3437
Interactive Safety Product Inc	N3206
ISB Group	C4728
John Tillman Co.	N3606
Lazer Safe Pty Ltd	C3824
Link Systems	C909
Medi Mall Inc	N2608
Meltric Corp	N4826
Pan Taiwan Enterprise	N1718
Pax Products Inc	C1428
Rimco Equipment	N1631
Ross Controls	C849
Sellstrom Manufacturing Co.	N3413
Steiner Industries	N3022
Tapeswitch Corp	C3813
Termmei Torch & Tip Company	N2526
Weldas Co.	N5136
Wirecrafters	N1824
Wireway Husky Corp.	N2225

## Saws

Alpine Bender Machinery	C1836
ASKO Inc	C4810
Automec Inc	C4832
Baileigh Industrial Inc	C7513
BandSawParts.com	C7538
Behringer Saws Inc.	C5722
BLM GROUP USA Corp	C1717
Bosch Power Tool Corp	N5006
BTM Bandsaws	C8416
Controlled Automation Inc	C7730
Cosen Saws USA	C7136
CS Unitec Inc	N5531
CTD Machines Inc	C8423
Dake Corporation	C6923
Delta Steel Technologies	C5952
DoALL Sawing Products	C7713
Doringer Cold Saws	C4913
Durma USA	C3949
Eberle America Inc	C8312
EH Wachs Co.	N5713
Elumatec North America Inc	C2849
Emmegi USA Inc	C7323
Enutron International	C7750

ESCO Tool Co.	C5735
Fein Power Tools Inc	N5902
Ficep Corporation	C6550
FomUSA	C6914
Friggi N.A. Inc	C7642
Haas Saw & Supply	C1535
Haberle / Ken Bergman & Assoc LLC	C7137
HE&M Saw Inc	C5508
Hyd-Mech Group Ltd	C6523
International Mold Steel	C556
J & S Machine Inc.	C2317
Jet	C5923
JMT USA	C5047
Kasto Inc	C5934
Kent Corp.	C954, C2128
KNUTH Machine Tools USA Inc	C4910
LENOX	C4808
M K Morse Co, The	C7109
Marvel Manufacturing Co.	C6316
Metlsaw Systems Inc	C8229
Michigan Pneumatic Tool Inc	N6034
New Centurion Enterprises Ltd.	C8347
Ocean Machinery Inc	C7523
<b>Orbitalum Orbital Cutting + Welding</b>	<b>N5713</b>
Pat Mooney Inc.	C6913
Peddinghaus Corp	C7723
Prestige Equipment Corporation	C7214
<b>Scotchman Industries Inc</b>	<b>C4923</b>
Steelmax Tools	N4737
T-DRILL Industries Inc	C2121
<b>Thermatool Corp</b>	<b>C2110</b>
Top Cat Air Tools	C2361
Tsune America	C3450
Tubex Technology Machinery Inc	C2334
United Abrasives Inc /SAIT	N3104
voestalpine – Roll Forming Corp & Rotec Inc.	C4725
Voortman Corporation	C7739

## Schools - College & University (2 & 4 year)

Ferris State Univ	N1534
U.S. Invitational Weld Trials	N1131

## Schools - Vocational & Technical

Arrowhead Manufacturers & Fabricators Assoc	C8242
Hobart Institute of Welding Technology	N5819
Ironworkers Management Progressive Action Cooperative Trust (IMPACT)	N3004
North America Consulting	N6333
Welder Training & Testing Institute	N1533

## Scrap Buying Specialist

NGK Metals Corp	C922
-----------------	------

## Scrap Chopping & Handling Equipment

Burghardt + Schmidt GmbH	C4934
Butech Bliss	C5532
D&H Machinery Inc.	C2112
ERIEZ	C7316
gasgrab.com	N3225
Kent Corp.	C954, C2128
Machine Concepts Inc.	C4726
Magnetic Products Inc	C5510
Metform International Ltd.	C5534
Red Bud Industries	C4732
Shred-Tech Compass Systems	C7550
Walker Magnetics	C7536

## Seaming Machines

AMET Inc.	N4518
CMF Jammes Rolling and Welding	C5538
Gullco International	N5002
Multipress Inc	C1022
Pandjiris Inc.	N4810
Peter Prinzing GmbH	C5638
RAS Systems LLC	C6921
Roll Former Corp	C1037
Weil Engineering North America	C8209

## Security Systems/Services

RPS Robot Protection Systems Inc	N6316
Wirecrafters	N1824

## Sensors & Transducers

Balluff Inc	C1047
CIECO Inc.	C1334
ISB Group	C4728
Toledo Integrated Systems	C1317

## Sensors / Transducers

OES Inc	C248
Panasonic Electric Works Corp of America	C7411
Tapeswitch Corp	C3813

## Service/Repair & Parts

Alternative Parts Inc	C3726
Bliss Clearing Niagara	C933
Bolttech Mannings	N2326
Eisenmann Corp	C2439
Fiba Technologies Inc	N6324
Janda Co Inc	N1924
Michigan Pneumatic Tool Inc	N6034
Midwest Bender Services Corp	C1728
Nation Coating Systems Inc	N2416
Stud Welding Associates Inc	N6327
Tapeswitch Corp	C3813



TJ Snow Co. . . . . N2613  
 Wheelabrator Group . . . . . C7121

**Shears**

Accurpress America Inc . . . . . C3047  
 American Machine & Rollform Tech. C5520  
 American Punch Co. . . . . C5026  
 ASKO Inc . . . . . C4810  
 Athader . . . . . C5520  
 Automec Inc . . . . . C4832  
 Baileigh Industrial Inc. . . . . C7513  
 Baykal Makina Sanayi  
     ve Ticaret AS. . . . . C5940, C5947  
 BESSEY Tools North America . . . . . N4931  
 Betenbender Manufacturing Inc. . . . . C3744  
 Bosch Power Tool Corp. . . . . N5006  
 Burghardt + Schmidt GmbH . . . . . C4934  
 Butech Bliss. . . . . C5532  
 Cidan Machinery Inc . . . . . C3449  
 COMEQ Inc . . . . . C5125  
 Controlled Automation Inc . . . . . C7730  
 Delta Steel Technologies . . . . . C5952  
 Durma USA . . . . . C3949  
 Edwards Manufacturing Co . . . . . C7116  
 Enutron International . . . . . C7750  
 Ermak USA . . . . . C3447

Global Metal Spinning Solutions Inc . C934  
 Hayes International. . . . . C5520  
 Machine Concepts Inc. . . . . C4726  
 MetaMation Inc . . . . . C3737  
 Metform International Ltd. . . . . C5534  
 Midwest Tool Inc. . . . . C4826  
 Passline Performance . . . . . C2325  
 Perfection Global LLC . . . . . C3832  
 Peter Prinzing GmbH. . . . . C5638  
 Prima Power North America Inc. . . . . C4336  
 Uni-Hydro Inc. . . . . C8537  
 US Industrial Machinery Co . . . . . C3049  
 voestalpine – Roll Forming  
     Corp & Rotec Inc. . . . . C4725  
 Wysong Parts and Service . . . . . C1023

**Shipping Containers & Accessories**

Buffalo Shrink Wrap . . . . . N2210  
 Dr Shrink Inc . . . . . C7314  
 InfoSight Corp . . . . . C5609  
 JMR Industrial. . . . . C3752  
 Long Haul Trucking . . . . . C4349  
 rose plastic USA LP. . . . . N3213  
 Saf-T-Cart Inc . . . . . N2619  
 Steel King Industries Inc. . . . . C1057

**Shipping/Transportation Services**

Cordstrap USA Inc. . . . . C7433  
 Precision Metalforming Association. . C463  
 UPS . . . . . C463

**Shop Lighting**

LDPI Inc . . . . . C2752  
 Service Lamp Corp . . . . . C8246

**Shotblasting Machines**

Blastec Inc. . . . . C8142  
 Comco Inc . . . . . C5052  
 Goff Inc . . . . . C2726  
 Gostol TST d.o.o . . . . . C7645  
 I.S.T. International Surface  
     Technologies. . . . . C1958  
 LS Industries Inc . . . . . C8123  
 Metallizing Equipment Co PVT LTD. . N2417  
 Metcast Service Tech Resources . . . C6946  
 Pangborn Corp. . . . . C6516  
 Rosler Metal Finishing USA LLC. . . . C7733  
 Wheelabrator Group. . . . . C7121

**We've got flex appeal™**

Visit us in Booth C7538

**M42 Band Saw Blade Prices**

Discounts for ordering 2, 5 or 10 bands.

WIDTH	3/4"	1"	1-1/4"	1-1/2"
10'-0'	26.44	29.44	33.44	44.12
10'-6'	27.44	30.59	34.79	45.60
11'-0'	28.44	31.74	36.14	47.09
11'-6'	29.44	32.89	37.49	48.57
12'-0'	30.44	34.04	38.84	50.05
12'-6'	31.44	35.19	40.19	51.53
13'-0'	32.44	36.34	41.54	53.02
13'-6'	33.44	37.49	42.89	54.60
14'-0'	34.44	38.64	44.24	55.98
14'-6'	35.44	39.79	45.59	57.46
15'-0'	36.44	40.94	46.94	58.95
15'-6'	37.44	42.09	48.29	60.43
16'-0'	38.44	43.24	49.64	61.91
16'-6'	39.44	44.39	50.99	63.39

**877.501.7297**

**SAWBLADE • COM™**  
RUN LEAN

**UNITED**  
 PERFORMANCE METALS  
O'NEAL HIGH-PERFORMANCE METALS GROUP

3475 Symmes Rd | Hamilton, OH 45015

**SHEET • COIL • STRIP • PLATE • NEAR NET SHAPES**

**Exhibiting at Fabtech  
 Booth C1157**

Stainless Steel		High Temp Alloy	Cobalt Alloy
• 17-4PH	• 302 ANN	• A-286	• 188
• 17-7PH	• 304/304L	• Alloy 263	• L605
• 301 ANN	• 316/316L	• Alloy 800H/HT	
• 301-1/4 Hard	• 321 ANN	• Alloy-X	
• 301-1/2 Hard	• 347 ANN	• Inconel 625	
• 301 Full Hard	• 410 ANN	• Inconel 718	
		• Inconel X750	

**GET A QUOTE!**

**1.888.282.3292**

**www.upmet.com sales@upmet.com**

**CAPABILITIES**  
 Slitting • Edging • Leveling • Shearing  
 Laser/Water Jet Cutting





## Site Selection Services

Cedar Valley Region of Iowa	C7429
Expansion Solutions Magazine	C7346
Site Location Partnership (SLP)	N1406
State of Wyoming	N3133

## Slide Forming & Spring Machines

Clips & Clamps Industries	C148
F & G Tool and Die Co	C1413
WAFIOS Machinery Corp	C1736

## Sludge Handling Equipment - Finishing

Eisenmann Corp	C2439
General Automatic Transfer	C2550
KMI Systems Inc	C2722
PKG Equipment Inc	C1953
Pneu-Mech Systems Manufacturing Inc	C2539

## Smut Removers

Calvary Industries Inc	C2734
Chemetall US Inc	C2709
DuBois Chemicals	C2545, C4938
Hubbard-Hall Inc	C2156
International Chemical Co	C1232

## Software - Accounting/Job Costing

AceCad Software	C2825
Computers Unlimited	N3315
Dataweld Inc	N2308
Epicor Software Corp	C7211
FabSuite	C5736
Global Shop Solutions	C7312
Henning Industrial Software Inc	C4822
JETCAM-NestONE Solutions	C4722
Jobscope Corp ERP	C4825
Lantek Systems Inc	C4940
Metalix CAD/CAM Ltd	C4911
MIE Solutions Inc	C7212
PEP Technology	C8320
Plex Systems	C913
Radan	C3747
Shop Edge Software Inc	C1434
Shoptech Software	C7013
SigmaTEK Systems LLC	C4932
SMe Software Inc	C7245
Trendex Information Systems Inc	N3218

## Software - CAD/CAM

2020 Software Solutions Inc	C1724
Accurate Die Design Inc/ Logopress Corp	C1423
AceCad Software	C2825

AKS Cutting Systems Inc	C5135
Alma Cam USA LLC	C4834
Amada America Inc	C3916
Boschert Precision Machinery Inc	C2820
Bystronic Inc	C4328
Dynatorch Inc	N4837
Elo Automated Stainless Steel Technologies Qingdao Co Ltd	C8342
FARO Technologies Inc	C7636
Forming Technologies Inc	C1421
Hypertherm Inc	N3906
JETCAM-NestONE Solutions	C4722
Kinetic Cutting Systems Inc	C6311
Lantek Systems Inc	C4940
Logopress Corp	C1423
LVD Strippit	C3937
Magestic Systems Inc	C3710
Mazak Optonics Corp	C3428
Messer Cutting Systems	C5916
Metalix CAD/CAM Ltd	C4911
MetaMation Inc	C3737
MIE Solutions Inc	C7212
MultiCam Inc	C5516
PEP Technology	C8320
Radan	C3747
Robotmaster-In-House Solutions Inc	N5933
Semyx LLC	C6347
SigmaTEK Systems LLC	C4932
SpaceClaim Corp	C8330
Starrett Bytewise Measurement Systems	C3453
Striker Systems	C3728
TRUMPF Inc	C3016
Verisurf Software Inc	C7438
Vicon - Plasma Automation Inc	N5031
Victory Plasma Systems Inc	N4833
Visi	C3747

## Software - Cost Estimating

Accurate Die Design Inc/ Logopress Corp	C1423
AceCad Software	C2825
Alma Cam USA LLC	C4834
Autoform Engineering	C936
Computer Engineering Inc	N3327
Epicor Software Corp	C7211
FabSuite	C5736
FabTrol Systems Inc	C8131
Flow International Corp	C5911
Forming Technologies Inc	C1421
Global Shop Solutions	C7312
Henning Industrial Software Inc	C4822
JETCAM-NestONE Solutions	C4722
Jobscope Corp ERP	C4825

Kinetic Cutting Systems Inc	C6311
Lantek Systems Inc	C4940
Logopress Corp	C1423
Magestic Systems Inc	C3710
Metalix CAD/CAM Ltd	C4911
MIE Solutions Inc	C7212
PEP Technology	C8320
Plex Systems	C913
Powder Coating Consultants	C2422
Radan	C3747
Semyx LLC	C6347
Shoptech Software	C7013
SigmaTEK Systems LLC	C4932
SMe Software Inc	C7245
Striker Systems	C3728

## Software - CRM (Customer Relationship Management)

AceCad Software	C2825
Computers Unlimited	N3315
Epicor Software Corp	C7211
FabTrol Systems Inc	C8131
Global Shop Solutions	C7312
Henning Industrial Software Inc	C4822
Lantek Systems Inc	C4940
Metalix CAD/CAM Ltd	C4911
MIE Solutions Inc	C7212
Northrop Grumman	C8211
Plex Systems	C913

## Software - Document Control

AceCad Software	C2825
Computer Engineering Inc	N3327
Computers Unlimited	N3315
C-spec	N4817
FabSuite	C5736
FabTrol Systems Inc	C8131
Henning Industrial Software Inc	C4822
MetaMation Inc	C3737
MIE Solutions Inc	C7212
Northrop Grumman	C8211
PEP Technology	C8320
Plex Systems	C913
Shoptech Software	C7013
SigmaTEK Systems LLC	C4932
SMe Software Inc	C7245

## Software - ERP (Enterprise Resource Planning)

AceCad Software	C2825
Computers Unlimited	N3315
Elo Automated Stainless Steel Technologies Qingdao Co Ltd	C8342
Epicor Software Corp	C7211
Global Shop Solutions	C7312
Henning Industrial Software Inc	C4822



JETCAM-NestONE Solutions	C4722
Jobscope Corp ERP	C4825
Lantek Systems Inc	C4940
Magestic Systems Inc	C3710
Metalix CAD/CAM Ltd	C4911
MetaMation Inc	C3737
<b>MIE Solutions Inc</b>	<b>C7212</b>
Northrop Grumman	C8211
PEP Technology	C8320
Plex Systems	C913
Shop Edge Software Inc	C1434
Shoptech Software	C7013
SMe Software Inc	C7245

**Software - Finishing**

Alma Cam USA LLC	C4834
FabTrol Systems Inc	C8131
<b>IntelliFinishing</b>	<b>C2528</b>
Powder Coating Consultants	C2422

**Software - FMS  
(Flexible Mfg. Systems)**

AceCad Software	C2825
Global Shop Solutions	C7312
JETCAM-NestONE Solutions	C4722
Lantek Systems Inc	C4940
Laser Experts Inc	C5742
<b>Mazak Optonics Corp</b>	<b>C3428</b>
MetaMation Inc	C3737
<b>MIE Solutions Inc</b>	<b>C7212</b>
<b>Radan</b>	<b>C3747</b>
Striker Systems	C3728

**Software - Folding/Unfolding**

2020 Software Solutions Inc	C1724
Accurate Die Design Inc/ Logopress Corp	C1423
<b>Accurpress America Inc</b>	<b>C3047</b>
Alma Cam USA LLC	C4834
Autoform Engineering	C936
Forming Technologies Inc	C1421
JETCAM-NestONE Solutions	C4722
Lantek Systems Inc	C4940
<b>Logopress Corp</b>	<b>C1423</b>
<b>LVD Strippit</b>	<b>C3937</b>
Metalix CAD/CAM Ltd	C4911
MetaMation Inc	C3737
<b>Radan</b>	<b>C3747</b>
<b>Salvagnini America Inc</b>	<b>C3928</b>
Striker Systems	C3728

**Software - Inventory/  
Purchasing**

AceCad Software	C2825
<b>Computers Unlimited</b>	<b>N3315</b>
Dataweld Inc	N2308

Epicor Software Corp	C7211
FabSuite	C5736
FabTrol Systems Inc	C8131
Global Shop Solutions	C7312
Henning Industrial Software Inc	C4822
Jobscope Corp ERP	C4825
Lantek Systems Inc	C4940
Magestic Systems Inc	C3710
Metalix CAD/CAM Ltd	C4911
<b>MIE Solutions Inc</b>	<b>C7212</b>
Northrop Grumman	C8211
PEP Technology	C8320
Plex Systems	C913
Shop Edge Software Inc	C1434
Shoptech Software	C7013
<b>SigmaTEK Systems LLC</b>	<b>C4932</b>
SMe Software Inc	C7245
Trendex Information Systems Inc	N3218

**Software - Labor/Order Tracking**

AceCad Software	C2825
<b>Computers Unlimited</b>	<b>N3315</b>
Dataweld Inc	N2308
Epicor Software Corp	C7211
FabSuite	C5736
FabTrol Systems Inc	C8131
Global Shop Solutions	C7312
Henning Industrial Software Inc	C4822
JETCAM-NestONE Solutions	C4722
Jobscope Corp ERP	C4825
Lantek Systems Inc	C4940
Magestic Systems Inc	C3710
<b>MIE Solutions Inc</b>	<b>C7212</b>
PEP Technology	C8320
Plex Systems	C913
Shop Edge Software Inc	C1434
Shoptech Software	C7013
<b>SigmaTEK Systems LLC</b>	<b>C4932</b>
SMe Software Inc	C7245
Trendex Information Systems Inc	N3218

**Software - Load Monitors**

CIECO Inc	C1334
FabTrol Systems Inc	C8131
Lantek Systems Inc	C4940
OES Inc	C248
SEYI America Inc	C653
Toledo Integrated Systems	C1317
Wintriss Controls	C3711

**Software - Nesting/  
Optimization**

Accurate Die Design Inc/ Logopress Corp	C1423
AceCad Software	C2825
Alma Cam USA LLC	C4834

Autoform Engineering	C936
<b>Beck Automation</b>	<b>C5520</b>
<b>Bystronic Inc</b>	<b>C4328</b>
FabSuite	C5736
FabTrol Systems Inc	C8131
Flow International Corp	C5911
Forming Technologies Inc	C1421
Global Shop Solutions	C7312
<b>Hypertherm Inc</b>	<b>N3906</b>
JETCAM-NestONE Solutions	C4722
Kinetic Cutting Systems Inc	C6311
Lantek Systems Inc	C4940
Laser Experts Inc	C5742
<b>Logopress Corp</b>	<b>C1423</b>
<b>LVD Strippit</b>	<b>C3937</b>
Magestic Systems Inc	C3710
Marvel Manufacturing Co	C6316
<b>Mazak Optonics Corp</b>	<b>C3428</b>
<b>Messer Cutting Systems</b>	<b>C5916</b>
Metalix CAD/CAM Ltd	C4911
MetaMation Inc	C3737
<b>MIE Solutions Inc</b>	<b>C7212</b>
MultiCam Inc	C5516
PEP Technology	C8320
Plex Systems	C913
Prima Power North America Inc	C4336
<b>Radan</b>	<b>C3747</b>
<b>Salvagnini America Inc</b>	<b>C3928</b>
Semx LLC	C6347
<b>SigmaTEK Systems LLC</b>	<b>C4932</b>
Striker Systems	C3728
Vicon - Plasma Automation Inc	N5031
Victory Plasma Systems Inc	N4833

**Software - OEE**

Beckhoff Automation	C7545
Shop Edge Software Inc	C1434
Wintriss Controls	C3711

**Software - Plant Maintenance**

OES Inc	C248
Shop Edge Software Inc	C1434

**Software - Project Management**

AceCad Software	C2825
Computer Engineering Inc	N3327
C-spec	N4817
Epicor Software Corp	C7211
FabSuite	C5736
FabTrol Systems Inc	C8131
Global Shop Solutions	C7312
Henning Industrial Software Inc	C4822
Jobscope Corp ERP	C4825
<b>Mazak Optonics Corp</b>	<b>C3428</b>
Metalix CAD/CAM Ltd	C4911
<b>MIE Solutions Inc</b>	<b>C7212</b>



## Software - Project Management

OES Inc	C248
Plex Systems	C913
Radan	C3747
Shoptech Software	C7013
SigmaTEK Systems LLC	C4932
SMe Software Inc	C7245

## Software - Quality Control

Advanced Tubular Technologies Inc	C1556
AMET Inc	N4518
ASKO Inc	C4810
Clara Vision	N1706
Computer Engineering Inc	N3327
C-spec	N4817
Epicor Software Corp	C7211
FabSuite	C5736
FabTrol Systems Inc	C8131
FARO Technologies Inc	C7636
Global Shop Solutions	C7312
Henning Industrial Software Inc	C4822
Jobscope Corp ERP	C4825
Link Systems	C909
Magestic Systems Inc	C3710
Matuschek Welding Products Inc	N1708
MIE Solutions Inc	C7212
Modern Manufacturing Technologies	C4738
Northrop Grumman	C8211
OES Inc	C248
Plex Systems	C913
Shop Edge Software Inc	C1434
Shoptech Software	C7013
SMe Software Inc	C7245
Starrett Bytewise Measurement Systems	C3453
Zarbeco LLC	C1454

## Software - Rapid Prototype

Advanced Tubular Technologies Inc	C1556
Salvagnini America Inc	C3928

## Software - Scheduling

AceCad Software	C2825
Beck Automation	C5520
Epicor Software Corp	C7211
FabSuite	C5736
FabTrol Systems Inc	C8131
Global Shop Solutions	C7312
Henning Industrial Software Inc	C4822
JETCAM-NestONE Solutions	C4722
Jobscope Corp ERP	C4825
Lantek Systems Inc	C4940
Laser Experts Inc	C5742
Link Systems	C909

Magestic Systems Inc	C3710
MIE Solutions Inc	C7212
Northrop Grumman	C8211
PEP Technology	C8320
Plex Systems	C913
Radan	C3747
Shop Edge Software Inc	C1434
Shoptech Software	C7013
SigmaTEK Systems LLC	C4932
SMe Software Inc	C7245
Striker Systems	C3728
Toledo Integrated Systems	C1317
Wintriss Controls	C3711

## Software - Simulation

2020 Software Solutions Inc	C1724
Accurate Die Design Inc/Logopress Corp	C1423
Accurpress America Inc	C3047
Alma Cam USA LLC	C4834
Autoform Engineering	C936
DELTA Computer Systems Inc	C1024
Engineering Technology Associates Inc	C1414
Forming Technologies Inc	C1421
Laser Experts Inc	C5742
Logopress Corp	C1423
Metalix CAD/CAM Ltd	C4911
MetaMation Inc	C3737
MIE Solutions Inc	C7212
Motoman Robotics Division	N5222
Radan	C3747
RealWeld Systems Inc	N6217
Robotmaster-In-House Solutions Inc	N5933
Salvagnini America Inc	C3928
Simufact-Americas LLC	C1352
StampingSimulation.Com Pty Ltd	C851
Striker Systems	C3728
Wolf Robotics LLC	N4910
Yaskawa America Inc	N5222

## Soldering Alloys

BMM Welding Material Co	N6109
Etal/INDUX Sa De Cv	N2433
Fusion Inc	N3313
GH Induction Atmospheres LLC	C2323
Harris Products Group	N4509
Lucas-Milhaupt Inc	N5027
Messer MG Welding Products	N2408
NetBrazo LLC	N4139
Ningbo Powerway Alloy Material Co Ltd	N5038
Obraze	N4839
Uniweld Products Inc	N5113
Washington Alloy Co	N2231

Winox Industries Ltd	N6111
Wolverine Joining Technologies	N2818

## Solvents/Thinners for Paint

Calvary Industries Inc	C2734
Cardinal Paint and Powder	C1761
I.S.T. International Surface Technologies	C1958
Intech Services Inc	C2163
International Chemical Co	C1232
Strathmore Products Inc	C1955

## Special Forming Machines (Explosive, Peen, Ultrasonic, etc.)

AIM Inc	C1832
Fontijne Grotnes Inc	C2136
Pacific Aerospace & Electronics	N1607
Ready Technology Inc	C832
Sertom Group North America LLC	C6911
Triform Sheet Hydroforming	C1226
Wolf Robotics LLC	N4910

## Spinning Machines/Flow Forming Machines

Fontijne Grotnes Inc	C2136
Global Metal Spinning Solutions Inc	C934
International Technologies Inc	C8111
Leifeld Metal Spinning AG	C8112
MJC Engineering & Technology Inc	C1156
Overton Industries	C2225
T-DRILL Industries Inc	C2121
Triform Sheet Hydroforming	C1226

## Spray Booth Cleaning Materials (Consumables)

Calvary Industries Inc	C2734
Cardinal Paint and Powder	C1761
Chemetall US Inc	C2709
DuBois Chemicals	C2545
DuBois Chemicals	C4938
Global Finishing Solutions	C2151
International Chemical Co	C1232

## Spray Booth Coatings

Binks DeVilbiss Ransburg BGK	C2532
Bulk Chemicals Inc	C2433
C.A. Technologies Inc	C1763
Calvary Industries Inc	C2734
Cardinal Paint and Powder	C1761
Chemetall US Inc	C2709
Diamond Vogel Paints	C2414
DuBois Chemicals	C2545, C4938
Global Finishing Solutions	C2151
Hayden Corp	N2409
KCI America Co Ltd	C2062
Keyland Polymer Ltd	C2063



# The **ONE** Association that Serves Industry Professionals in All These Areas



Stop by **FMA Booth C6538** at **FABTECH**. Get the resources that will help you **be the best YOU can be** in your field and...

- **Save 33%** on an FMA membership (personal membership \$99, show special\*)
- Check out the **FMA store** and get one item FREE with your new membership\*\*
- Enter a drawing to **win an iPad** — one winner every day\*\*\*
- Get a **unique gift** available nowhere else on the show floor
- **Test your putting skills.** Enter a drawing to win free registration to Leadership Summit 2013 with golf at Innisbrook Golf Resort, Palm Harbor, Fla. \$1,100 value!\*\*\*

\*first-time new members only, \*\*Select list of products, coupon expires 12/31/12, \*\*\*Winner need not be present at time of drawing



**FMA Booth C6538**

Fabricators & Manufacturers  
Association, International®



Las Vegas Convention Center, November 12-14, 2012



## Spray Booth Coatings

Krautzberger LLC	C1964
St Louis Metallizing Co	N2315
Strathmore Products Inc	C1955

## Spray Booth Contaminant Control Devices

Duroair Technologies Inc	C1362
Frommelt Safety Products	N4827
Gema	C2750
Global Finishing Solutions	C2151
Goff's Enterprises Inc	N2625
Nordson Corp	C2517
Spray-Tech/Junair	C2164

## Spray Booth Equipment

AFC Finishing Systems	C2548
Anest Iwata USA Inc	C2746
Col-Met Spray Booths Inc	C2537
Decoral System USA Corp	C1954
Duroair Technologies Inc	C1362
Eisenmann Corp	C2439
EXEL North America	C2264
Fostoria Process Equipment	C2148
Gema	C2750
General Fabrications Corp	C2648
Global Finishing Solutions	C2151
Inline Sieve	C2552
Intech Services Inc	C2163
KCI America Co Ltd	C2062
Krautzberger LLC	C1964
LDPI Inc	C2752
LPI Inc	C2424
Nordson Corp	C2517
Nova Verta USA	C1762
Parker Ionics/Parkwood Engineering	C2523
Pneu-Mech Systems	
Manufacturing Inc	C2539
Spray-Tech/Junair	C2164
Trimac Industrial Systems	C2359
Vulcan Catalytic Infrared	
Oven Systems	C2512
Wagner Industrial Solutions	C1951
Walther Pilot North America	C2609
Wheelabrator Group	C7121

## Spray Booths for Painting/Powder Coating

AFC Finishing Systems	C2548
Chemical Coaters Assoc Int'l	C1948
Col-Met Spray Booths Inc	C2537
Combustion and Systems Inc	C2411
Duroair Technologies Inc	C1362
Eisenmann Corp	C2439
Fostoria Process Equipment	C2148
Gema	C2750

General Fabrications Corp	C2648
Global Finishing Solutions	C2151
Goff's Enterprises Inc	N2625
Haynncorp Industrial	
Finishing Solutions	C2360
Intech Services Inc	C2163
IntelliFinishing	C2528
KCI America Co Ltd	C2062
KMI Systems Inc	C2722
Nordson Corp	C2517
Nova Verta USA	C1762
Parker Ionics/Parkwood	
Engineering	C2523
Pneu-Mech Systems	
Manufacturing Inc	C2539
Porcelain Enamel Institute Inc	C2436
Production Systems Inc	C1858
Spray Systems Inc	C1260
Spray-Tech/Junair	C2164
Trimac Industrial Systems	C2359
Vulcan Catalytic Infrared	
Oven Systems	C2512
Wagner Industrial Solutions	C1951
Walther Pilot North America	C2609
Wheelabrator Group	C7121

## Spray Gun Controls, Movers, Washers

Binks DeVilbiss Ransburg BGK	C2532
EXEL North America	C2264
Gema	C2750
Nordson Corp	C2517
Parker Ionics/Parkwood Engineering	C2523
Wagner Industrial Solutions	C1951
Walther Pilot North America	C2609

## Storage Shelves/Racks, Palletized Beds, Cages & Accessories

Big Steel Rack	C8528
Bowlin Engineering	C4838
Buffalo Shrink Wrap	N2210
CH Steel Solutions Inc	C7348
JMR Industrial	C3752
Kemper America Inc	N2631
Richards-Wilcox Inc	C2252
Saf-T-Cart Inc	N2619
Steel King Industries Inc	C1057
Sumner Manufacturing Co Inc	N1519
Versatility Professional	
Tool Storage, LLC	C1248
Weldcoa	N3238
Wirecrafters	N1824
Wireway Husky Corp	N2225

## Straightening Equipment

AIDA-America Corp	C1210
Alma Machinery Co	C1431
ARKU Coil Systems Inc	C7528
Athader	C5520
Burghardt + Schmidt GmbH	C4934
Chicago Slitter	C7023
COE Press Equipment	C1323
Costa & Grissom Machinery Co	C7516
D&H Machinery Inc	C2112
Delta Steel Technologies	C5952
Feed Lease Corp	C928
Herr Voss Stamco	C7239
Machine Concepts Inc	C4726
Metform International Ltd	C5534
Norwalk Innovation	C1055
Red Bud Industries	C4732
Samco Machinery Ltd	C1217
T&H Lemont	C2117
T-DRILL Industries Inc	C2121
Trilogy Machinery Inc	C5140
Universal Tube & Rollform	
Equipment Corp	C1528
WAFIOS Machinery Corp	C1736

## Stretch Formers

Triform Sheet Hydroforming	C1226
----------------------------	-------

## Stripping Solutions, Equipment & Services

Alpha Professional Tools	N6331
American Finishing Resources	C1855
Bulk Chemicals Inc	C2433
Chemetail US Inc	C2709
Guspro Inc	C1952
Hubbard-Hall Inc	C2156
International Chemical Co	C1232
Kolene Corp	C2509
Powder Coating	C2356
Steelman Industries Inc	C2058

## Supply Chain Management

Airgas Inc	N5231
CNA Insurance	C7247
Fast Rite International	C854
Fastenal Company	N5736
SME Software Inc	C7245
Taylor Enterprises Inc	C347

## Systems Integration

AIDA-America Corp	C1210
Dataweld Inc	N2308
DMP Corp	C2054
IntelliFinishing	C2528
Production Systems Inc	C1858
Sutherland Presses	C152



## Tables - Cutting/Water Tables

Bowlin Engineering	C4838
Controlled Automation Inc	C7730
Flow International Corp.	C5911
Friggi N.A. Inc	C7642
Kinetic Cutting Systems Inc	C6311
Koike Aronson Inc	N4131
Messer Cutting Systems	C5916
OMAX Corp	C3940
Permatur Industries Inc	N3006
Rimco Equipment	N1631
Techni Waterjet	C5128
Weldsale LLC	N5124

## Tables - Indexing & Positioning

Accra-Wire Controls Inc	C1256
Arc Specialties Inc	N1610
Bluco Corp	N2819
Enutron International	C7750
Gullco International	N5002
JMR Industrial	C3752
Linemaster Switch Corp	C2324
Pandjiris Inc	N4810
Preston-Eastin Inc	N5731
Red Rock Automation/Romar/MEC	N4805
TigerStop LLC	C7442, C7542

## Tanks & Tank Supplies - Finishing

Binks DeVilbiss Ransburg BGK	C2532
DMP Corp	C2054
General Automatic Transfer	C2550
Krautzberger LLC	C1964
Pangborn Corp	C6516
PKG Equipment Inc	C1953
Pneu-Mech Systems Manufacturing Inc	C2539
Rex-Cut Abrasives	N2708
Tennessee Galvanizing Inc	C7113
Trimac Industrial Systems	C2359
Tri-Mer Corp	N2615
TWN Industries Inc	C2446
Walther Pilot North America	C2609

## Tapping Machines

Automated Tapping Systems	C820
Climax Portable Machining & Welding Systems	N1422
Fein Power Tools Inc	N5902
Ficep Corporation	C6550
Flexarm Inc	C7431
FomUSA	C6914
Formdrill USA Inc	C2222
International Technologies Inc	C8111
Kong NGAI Precision Metal Mould Shenzhen Co Ltd	C856

Machinery Marketing Intl	C8337
Shijiazhuang Fitex Trading Co Ltd	C159

## Thermal Spray Masking Tape/ Consumables

Aquasol Corp	N3613
Bay State Surface Technologies	N2419
Custom Fabricating & Supplies	C2510
HAI Advanced Material Spec	N2319
International Thermal Spray Assoc (ITSA)	N2509
Metallizing Equipment Co PVT LTD	N2417
Sulzer Metco US Inc	N2413

## Thermal Spray Wires & Powders

AMETEK Specialty Metal Products for Fab	C914
Ampco Metal Inc	C2326
Bay State Surface Technologies	N2419
BMM Welding Material Co	N6109
DURUM USA	N2316
HAI Advanced Material Spec	N2319
Haynes International	N1617
International Thermal Spray Assoc (ITSA)	N2509
Kennametal Stellite	N2528
Metallizing Equipment Co PVT LTD	N2417
Nation Coating Systems Inc	N2416
Polymet Corp	N2313
PT-Mat	N3337
Sandvik Materials Technology	N3019
Special Metals Welding Products Co	N3118
St Louis Metallizing Co	N2315
Sulzer Metco US Inc	N2413
TAFI Inc	N2318

## Thermal Spraying Machines & Components

American Torch Tip Co Inc	N2022
Arc Specialties Inc	N1610
Bay State Surface Technologies	N2419
Bug-O Systems	N4813, N5013
Centerline (Windsor) Ltd	N1926
HAI Advanced Material Spec	N2319
IBEDA /Superflash Compressed Gas Equipment Inc	N3437
International Thermal Spray Assoc (ITSA)	N2509
Metallizing Equipment Co PVT LTD	N2417
Mill Masters	C1533
Preston-Eastin Inc	N5731
St Louis Metallizing Co	N2315
Sulzer Metco US Inc	N2413
TAFI Inc	N2318

## Tool & Die Design

A-G Tool & Die	C920
American Machine & Rollform Tech	C5520
Atlantic Tool & Die Co	C1155
BesTech Tool Corp	C921
Bradbury Co., Inc., The	C5520
Bradbury Group, The	C5520
Chelar Tool & Die Inc	C349
Cleveland Steel Tool Co	C5522
COR-MET INC	N5534
F & G Tool and Die Co	C1413
Heim Group, The	C1331
Kong NGAI Precision Metal Mould Shenzhen Co Ltd	C856
Lucky Harvest Co Ltd	C958
Marion Die & Fixture Inc	C5520
Nebraska Public Power District	C7347
Ningbo Hi-Tech Moldie Machinery Co Ltd	C356
Penn United Technologies Inc	C1420
Pottiez America LP	C1025
R&B Machining Inc	C2124
Simufact-Americas LLC	C1352
Superior Die Set Corp	C658
TOP YES Precision Metal Products Co LTD	C1028
Uelner Precision Tools & Dies	C937
Ultratech Tool & Design Inc	C1332
Unipunch Products Inc	C3732
Victory Tool	C246

## Tool Storage/Cabinets

Wila USA	C5709
Wirecrafters	N1824

## Tool Surface Treatment Equipment

Beilun Futuo Mechanical Tools Co Ltd	N6026
Bohler Uddeholm Corp	C1417
EFD Induction Inc	C2139
IonBond	C1010
Joysun Abrasives Co Ltd	N3208
KULLEN - KOTI GmbH	N3137
Metabo Corp	N6131
Osborn	C2737, N3309
Rocklin Manufacturing Co	C1433
SKM Industries Inc	N1717
Wilson Tool International	C1013, C5116

## Tooling - Carbide

California Cold Saw	C7240
Chemtool Inc	C660
Darex LLC	C8138
Easy Abrasives LLC	N2618
Elizabeth Carbide Components	C150





**Tool Surface Treatment Equipment**

F & G Tool and Die Co	C1413
Formdrill USA Inc	C2222
Hydro Carbide Inc	C8238
<b>Overton Industries</b>	<b>C2225</b>
<b>Penn United Technologies Inc</b>	<b>C1420</b>
Precision Punch Corp.	C1432
Suhner Industrial Products Inc	N3010
WAFIOS Machinery Corp	C1736
Yestool/Aloris-USA	C8310

**Tooling - Ceramic**

California Cold Saw	C7240
Elizabeth Carbide Components	C150
<b>Overton Industries</b>	<b>C2225</b>
WAFIOS Machinery Corp	C1736

**Tooling - Components**

American Punch Co	C5026
Anchor Danly	C931
BesTech Tool Corp	C921
Bilsing Automation North America	C926
<b>Chelar Tool &amp; Die Inc</b>	<b>C349</b>
Dayton Progress Corp	C813
Elizabeth Carbide Components	C150
Formdrill USA Inc	C2222
Gem Tool Corporation	C2320
Global Metal Spinning Solutions Inc	C934
GMT North America	C353
Hiwin Corp	C1321
Hydro Carbide Inc	C8238
<b>MegaFab-Piranha-Whitney-Bertsch</b>	<b>C5113</b>
MJC Engineering & Technology Inc	C1156
Moeller Precision Tool	C1020
MultiCam Inc	C5516
Pacesetter Systems	C1412
<b>Penn United Technologies Inc</b>	<b>C1420</b>
Polyurethane Products Corp	C3811
Pottiez America LP	C1025
Precision Punch Corp.	C1432
Precision Stamping Products	C1158
Pronic Inc	C828
R&B Machining Inc	C2124
Rolleri USA	C3750
Saar Hartmetall USA LLC	N5925
Ulbrich Stainless Steels & Special Metals Inc	C1015
Whistler & Sons Inc, SB	C4720
Zhejiang Changzheng Project Carbon Electrodes Co Ltd	N6210

**Tooling - Hydraulic Presses**

AddisonMckee Inc	C2339
<b>American Machine &amp; Rollform Tech</b>	<b>C5520</b>
American Punch Co	C5026

AP&T North America Inc	C1231
Attexor Clinch Systems SA	C5622
<b>Betenbender Manufacturing Inc</b>	<b>C3744</b>
Bilsing Automation North America	C926
Cleveland Punch & Die Co	C5711
Cleveland Steel Tool Co	C5522
Edwards Manufacturing Co	C7116
Formtek Metal Forming & Hill Engineering	C3708
Interlaken Technology	C947
<b>Marion Die &amp; Fixture Inc</b>	<b>C5520</b>
Pacesetter Systems	C1412
Peddinghaus Corp	C7723
Polyurethane Products Corp	C3811
Proto-1 Manufacturing	C1825
Uelner Precision Tools & Dies	C937
Unipunch Products Inc	C3732
Unitool Punch & Die	C4708
Whistler & Sons Inc, SB	C4720
Wila USA	C5709
Wilson Tool International	C1013, C5116

**Tooling - Ironworkers**

American Punch Co	C5026
Cleveland Punch & Die Co	C5711
Cleveland Steel Tool Co	C5522
Edwards Manufacturing Co	C7116
Haco Atlantic Inc	C3440
<b>Haco-Lasit</b>	<b>C3440</b>
<b>MegaFab-Piranha-Whitney-Bertsch</b>	<b>C5113</b>
Peddinghaus Corp	C7723
<b>Scotchman Industries Inc</b>	<b>C4923</b>
Suhner Industrial Products Inc	N3010
Trilogy Machinery Inc	C5140
Uni-Hydro Inc	C8537
Wilson Tool International	C1013, C5116

**Tooling - Plate Fabricating**

<b>Accurpress America Inc</b>	<b>C3047</b>
American Punch Co	C5026
<b>Betenbender Manufacturing Inc</b>	<b>C3744</b>
<b>Carrell Corp/Eagle Bending Machines</b>	<b>C5928</b>
<b>Chelar Tool &amp; Die Inc</b>	<b>C349</b>
Cleveland Punch & Die Co	C5711
Cleveland Steel Tool Co	C5522
<b>MegaFab-Piranha-Whitney-Bertsch</b>	<b>C5113</b>
Pandjiris Inc	N4810
Pushcorp Inc	N5934
PythonX-Burlington Automation	C8116
Shenzhen SYH Tooling Co Ltd	C821
Suhner Industrial Products Inc	N3010
Superior Die Set Corp	C658
Trilogy Machinery Inc	C5140
Unipunch Products Inc	C3732

Unitool Punch & Die	C4708
Wila USA	C5709

**Tooling - Press Brakes**

<b>Accurpress America Inc</b>	<b>C3047</b>
<b>Amada America Inc</b>	<b>C3916</b>
Baykal Makina Sanayi ve Ticaret AS	C5940, C5947
<b>Betenbender Manufacturing Inc</b>	<b>C3744</b>
Bohler Uddeholm Corp	C1417
<b>Bystronic Inc</b>	<b>C4328</b>
Cleveland Punch & Die Co	C5711
Edwards Manufacturing Co	C7116
Haco Atlantic Inc	C3440
<b>Haco-Lasit</b>	<b>C3440</b>
International Technologies Inc	C8111
<b>LVD Strippit</b>	<b>C3937</b>
Masteel America Corp	C3749
Polyurethane Products Corp	C3811
Premier Tooling & Mfg Inc	C1032
Rolleri USA	C3750
<b>TRUMPF Inc</b>	<b>C3016</b>
Unipunch Products Inc	C3732
Unitool Punch & Die	C4708
Whistler & Sons Inc, SB	C4720
Wila USA	C5709
Wilson Tool International	C1013, C5116

**Tooling - Progressive Die**

A-G Tool & Die	C920
American Punch Co	C5026
BesTech Tool Corp	C921
Bohler Uddeholm Corp	C1417
<b>Chelar Tool &amp; Die Inc</b>	<b>C349</b>
F & G Tool and Die Co	C1413
Kong NGAI Precision Metal Mould Shenzhen Co Ltd	C856
Lucky Harvest Co Ltd	C958
<b>Marion Die &amp; Fixture Inc</b>	<b>C5520</b>
Moeller Precision Tool	C1020
<b>Penn United Technologies Inc</b>	<b>C1420</b>
Precision Punch Corp.	C1432
Toledo Blank	C1149
Uelner Precision Tools & Dies	C937
Ultratech Tool & Design Inc	C1332
Whistler & Sons Inc, SB	C4720

**Tooling - Punch Presses**

<b>Amada America Inc</b>	<b>C3916</b>
<b>American Machine &amp; Rollform Tech</b>	<b>C5520</b>
American Punch Co	C5026
Attexor Clinch Systems SA	C5622
BesTech Tool Corp	C921
<b>Boschert Precision Machinery Inc</b>	<b>C2820</b>
<b>Bradbury Co., Inc., The</b>	<b>C5520</b>
<b>Bradbury Group, The</b>	<b>C5520</b>



<b>Chelar Tool &amp; Die Inc</b> .....	<b>C349</b>
Cleveland Punch & Die Co .....	C5711
Cleveland Steel Tool Co .....	C5522
Dayton Progress Corp .....	C813
Gem Tool Corporation .....	C2320
GMT North America .....	C353
Ketec Precision Tooling Co LTD. ....	C3834
<b>Marion Die &amp; Fixture Inc.</b> .....	<b>C5520</b>
Mate Precision Tooling .....	C3720
<b>MegaFab-Piranha-Whitney-Bertsch</b> .	<b>C5113</b>
Moeller Precision Tool .....	C1020
Nitto Kohki USA Inc .....	C1510
Pacesetter Systems .....	C1412
Polyurethane Products Corp .....	C3811
Precision Punch Corp. ....	C1432
Premier Tooling & Mfg Inc .....	C1032
<b>Salvagnini America Inc.</b> .....	<b>C3928</b>
Samco Machinery Ltd .....	C1217
<b>TRUMPF Inc.</b> .....	<b>C3016</b>
Ultratech Tool & Design Inc .....	C1332
Unipunch Products Inc. ....	C3732
Unittool Punch & Die. ....	C4708
Whistler & Sons Inc, SB .....	C4720
Wilson Tool International ...	C1013, C5116

### Tooling - Roll Forming

Acrotech .....	C8213
<b>American Machine &amp; Rollform Tech.</b>	<b>C5520</b>
American Punch Co .....	C5026
Bohler Uddeholm Corp .....	C1417
<b>Bradbury Co., Inc., The</b> .....	<b>C5520</b>
<b>Bradbury Group Australia</b> .....	<b>C5520</b>
<b>Bradbury Group, The</b> .....	<b>C5520</b>
Elizabeth Carbide Components .....	C150
Formdrill USA Inc .....	C2222
Formtek Metal Forming & Hill Engineering .....	C3708
Gem Tool Corporation .....	C2320
<b>Hayes International</b> .....	<b>C5520</b>
Metform International Ltd. ....	C5534
Mill Masters .....	C1533
Passline Performance .....	C2325
Polyurethane Products Corp .....	C3811
Precision Punch Corp. ....	C1432
Pronic Inc. ....	C828
Roll Machining Technologies & Solutions .....	C1526
Samco Machinery Ltd .....	C1217
Samson Roll Formed Products Co. ...	C6350
T&H Lemont .....	C2117
TaurinGroup USA .....	C1739
Wilson Tool International ...	C1013, C5116

### Tooling - Transfer Dies

A-G Tool & Die .....	C920
American Punch Co. ....	C5026
BesTech Tool Corp. ....	C921

Bliss Clearing Niagara .....	C933
<b>Chelar Tool &amp; Die Inc</b> .....	<b>C349</b>
F & G Tool and Die Co. ....	C1413
Kong NGAI Precision Metal Mould Shenzhen Co Ltd .....	C856
Lucky Harvest Co Ltd. ....	C958
Moeller Precision Tool .....	C1020
Pacesetter Systems .....	C1412
Uelner Precision Tools & Dies. ....	C937

### Tooling - Tube/Pipe Benders/ End Formers

AddisonMckee Inc. ....	C2339
A-G Tool & Die .....	C920
Alpine Bender Machinery .....	C1836
Ampco Metal Inc. ....	C2326
<b>Carell Corp/Eagle Bending Machines</b> .....	<b>C5928</b>
Clark Fixture Technologies .....	C1520
CML USA Inc Ercolina .....	C3739
Eaton Leonard .....	C1723
Edwards Manufacturing Co .....	C7116
Gem Tool Corporation .....	C2320
Lillbacka Powerco USA Inc. ....	C2132
Mathey Dearman .....	N5710
Midwest Bender Services Corp .....	C1728
OMNI-X Inc .....	C1537
<b>Overton Industries</b> .....	<b>C2225</b>
PHI .....	C2122
R&B Machining Inc .....	C2124
Suhner Industrial Products Inc .....	N3010
T&H Lemont .....	C2117
TaurinGroup USA .....	C1739
Tools for Bending .....	C2309
Universal Tool & Engineering .....	C1839
WAFIOS Machinery Corp .....	C1736
<b>Wauseon Machine &amp; Manufacturing Inc.</b> .....	<b>C1539</b>

### Tooling - Tube/Pipe Mills

California Cold Saw .....	C7240
Formtek Metal Forming & Hill Engineering .....	C3708
Gem Tool Corporation .....	C2320
Innerspec Technologies .....	N2217
Mill Masters .....	C1533
Moeller Precision Tool .....	C1020
PHI .....	C2122
Pushcorp Inc .....	N5934
Roll Machining Technologies & Solutions .....	C1526
Saar Hartmetall USA LLC .....	N5925
T&H Lemont .....	C2117

### Tooling - Unitized Punching/ Notching

Elizabeth Carbide Components .....	C150
------------------------------------	------

Gem Tool Corporation .....	C2320
Nitto Kohki USA Inc .....	C1510
Project Tool & Die Inc .....	C7313
SKM Industries Inc .....	N1717
Unipunch Products Inc. ....	C3732
Unittool Punch & Die. ....	C4708
Whistler & Sons Inc, SB .....	C4720

### Tooling - Urethane

Acrotech .....	C8213
Anchor Danly .....	C931
Dayton Progress Corp .....	C813
GMT North America .....	C353
Moeller Precision Tool .....	C1020
Wila USA .....	C5709
Wilson Tool International ...	C1013, C5116

### Touch-Up Paint

Anest Iwata USA Inc. ....	C2746
Cardinal Paint and Powder .....	C1761
Diamond Vogel Paints .....	C2414
Powder Coating .....	C2356
SKM Industries Inc .....	N1717
Strathmore Products Inc .....	C1955
Weld-Aid Products .....	N4928

### Trade Show Organizer

Association For Iron & Steel Technology .....	C8530
Essen Trade Shows .....	N2516

### Fabricators & Manufacturers

<b>Association</b> .....	<b>C6538</b>
Sanpo Publications Inc .....	N1507
<b>Society of Manufacturing Engineers</b> .....	<b>C6542</b>

### Trailers

<b>Long Haul Trucking</b> .....	<b>C4349</b>
---------------------------------	--------------

### Training Services - Management

American Society For Nondestructive Testing .....	N1615
American Welding Online .....	N2233
<b>American Welding Society</b> .....	<b>N2031</b>
<b>Fabricators &amp; Manufacturers Association</b> .....	<b>C6538</b>
North America Consulting .....	N6333
<b>Precision Metalforming Association</b> .....	<b>C463</b>
<b>Society of Manufacturing Engineers</b> .....	<b>C6542</b>
State of Wyoming .....	N3133
Technical Translation Services .....	N2604



## Training Services - Technical

Accurate Die Design Inc/ Logopress Corp .....	C1423
AIDA-America Corp .....	C1210
Airgas Inc .....	N5231
American Society For Nondestructive Testing .....	N1615
American Welding Online .....	N2233
<b>American Welding Society</b> .....	<b>N2031</b>
ASKO Inc .....	C4810
Association For Iron & Steel Technology .....	C8530
<b>Chemical Coaters Assoc Int'l</b> .....	<b>C1948</b>
Electrocoat Association, The .....	C2255
<b>Fabricators &amp; Manufacturers Association</b> .....	<b>C6538</b>
IMPACT Engineering Inc .....	N5108
Ironworkers Management Progressive Action Cooperative Trust (IMPACT) .....	N3004
KUKA Robotics Corporation .....	N5702
Laser Experts Inc .....	C5742
LORD Corporation .....	N2011
NIC Industries Inc .....	C2426
North America Consulting .....	N6333
Powder Coating Consultants .....	C2422
<b>Precision Metalforming Association</b> .....	<b>C463</b>
<b>PTR-Precision Technologies Inc</b> .....	<b>N5226</b>
RealWeld Systems Inc .....	N6217
<b>Society of Manufacturing Engineers</b> .....	<b>C6542</b>
State of Wyoming .....	N3133
Sutherland Presses .....	C152
T&H Lemont .....	C2117
Technical Translation Services .....	N2604
<b>Thermatool Corp</b> .....	<b>C2110</b>
Tower Oil & Technology Co. ....	C1319
Welder Training & Testing Institute .....	N1533
Wheelabrator Group .....	C7121

## Tube/Pipe Assembly Equipment/Systems

<b>Abbey International</b> .....	<b>C1514</b>
Alpine Bender Machinery .....	C1836
Chart Inc .....	N3204
COB Industries Inc .....	N5919
D/F Machine Specialties Inc .....	N2224
Fit Rite .....	N6126
Fives Bronx Inc .....	C1514
Gullco International .....	N5002
Haeusler AG .....	C5540
<b>Irc Automation Inc</b> .....	<b>N2431</b>
KUKA Robotics Corporation .....	N5702
Magnatech LLC .....	N6133
Mathey Dearman .....	N5710

Meta Vision Systems Inc .....	N5015
<b>Nucor Building Systems</b> .....	<b>C1255</b>
Praxair Inc .....	N5202
Preston-Eastin Inc .....	N5731
Prodim USA .....	C8521
Richardson Electronics Ltd .....	C3721
Sumner Manufacturing Co Inc .....	N1519
T&H Lemont .....	C2117
TaurinGroup USA .....	C1739
Weil Engineering North America ...	C8209
Yaskawa America Inc .....	N5222

## Tube/Pipe Bends & Fittings

GW KENT INC .....	N2918
Haynes International .....	N1617
National Bronze & Metals Inc. ....	C1512
Nordfab Ducting .....	N1928
Production Tube Cutting Inc .....	C2215
Proto-1 Manufacturing .....	C1825
Swagelok Marketing Services Co. ...	N3431
TaurinGroup USA .....	C1739
Valmont Coatings .....	C5724

## Tube/Pipe Bundling Equipment

Prodim USA .....	C8521
Sertom Group North America LLC ...	C6911
Tsune America .....	C3450

## Tube/Pipe Cleaning/ Degreasing Equipment

Almco Inc .....	C1220
BLM GROUP USA Corp .....	C1717
Chemtool Inc .....	C660
Durr Ecoclean Inc .....	C2437
Goff Inc .....	C2726
LS Industries Inc .....	C8123
Pangborn Corp .....	C6516
Quaker Chemical Corp .....	C1852
Steelman Industries Inc .....	C2058

## Tube/Pipe CNC Pipe Cutting

<b>AKS Cutting Systems Inc</b> .....	<b>C5135</b>
Alpine Bender Machinery .....	C1836
AltaMAR Inc .....	C1522
Baykal Makina Sanayi ve Ticaret AS .....	C5940, C5947
BLM GROUP USA Corp .....	C1717
Enutron International .....	C7750
Ficep Corporation .....	C6550
Friggi N.A. Inc .....	C7642
HGG Profiling Equipment .....	C8127
INNOVO Corp .....	C1758
J & S Machine Inc .....	C2317
<b>Koike Aronson Inc</b> .....	<b>N4131</b>
Machinery Marketing Intl. ....	C8337
Ningbo Jinfeng Welding & Cutting	

Machinery Manufacture Co Ltd ..	N6007
Pushcorp Inc .....	N5934
Red Rock Automation/Romar/MEC ..	N4805
Rhino Cutting Systems .....	N6138
SB Machine Tools .....	C2322
Toolmen Corp .....	C1253
Tri Tool Inc .....	N5913
Tubex Technology Machinery Inc ...	C2334
Victory Plasma Systems Inc .....	N4833
Westingcut Industrial Technology Anhui Inc .....	N1424
<b>Winton Machine Co</b> .....	<b>C1725</b>
<b>YLM - Ying Lin Machine Industrial Co</b> .....	<b>C2317</b>

## Tube/Pipe Compression Benders

Alpine Bender Machinery .....	C1836
BLM GROUP USA Corp .....	C1717
<b>Carell Corp/Eagle Bending Machines</b> .....	<b>C5928</b>
Eaton Leonard .....	C1723
J & S Machine Inc .....	C2317
PHI .....	C2122
TaurinGroup USA .....	C1739
Tubex Technology Machinery Inc ...	C2334
Universal Tool & Engineering .....	C1839
<b>Wauseon Machine &amp; Manufacturing Inc</b> .....	<b>C1539</b>
<b>Winton Machine Co</b> .....	<b>C1725</b>
<b>YLM - Ying Lin Machine Industrial Co</b> .....	<b>C2317</b>

## Tube/Pipe Connectors

Benxi Guangzheng Tungsten & Molybdenum Co Ltd .....	C456
GW KENT INC .....	N2918
Haynes International .....	N1617
National Bronze & Metals Inc. ....	C1512
Nordfab Ducting .....	N1928
Pacific Aerospace & Electronics ...	N1607
Production Tube Cutting Inc .....	C2215
Staubli Corp Multi Contact USA ...	N3636
Superior Products .....	N2517
Swagelok Marketing Services Co. ...	N3431

## Tube/Pipe Custom Machinery

<b>Abbey International</b> .....	<b>C1514</b>
<b>AKS Cutting Systems Inc</b> .....	<b>C5135</b>
Alpine Bender Machinery .....	C1836
AltaMAR Inc .....	C1522
Arc Specialties Inc .....	N1610
Brandt Engineered Products Ltd ...	C1755
<b>Carell Corp/Eagle Bending Machines</b> .....	<b>C5928</b>
Clark Fixture Technologies .....	C1520





CML USA Inc Ercolina	C3739
Eaton Leonard	C1723
EH Wachs Co.	N5713
Fit Rite	N6126
Fives Bronx Inc	C1514
Fontijne Grotnes Inc	C2136
Formtek Metal Forming & Hill Engineering	C3708
Friggi N.A. Inc	C7642
Global Metal Spinning Solutions Inc	C934
Haberle / Ken Bergman & Assoc LLC	C7137
HGG Profiling Equipment	C8127
INNOVO Corp	C1758
Jetline Engineering	N5813
Kent Corp.	C954, C2128
LS Industries Inc	C8123
Manufacturing Solutions Inc.	N1509
Mathey Dearman	N5710
Midwest Bender Services Corp	C1728
Mill Masters	C1533
OMAX Corp	C3940
<b>Orbitalum Orbital Cutting + Welding</b>	<b>N5713</b>
Project Tool & Die Inc	C7313
Proto-1 Manufacturing	C1825
Pushcorp Inc	N5934
Richardson Electronics Ltd	C3721
Rimco Equipment	N1631
Steelmax Tools	N4737
TaurinGroup USA.	C1739
T-DRILL Industries Inc	C2121
Toolmen Corp	C1253
Tri Tool Inc	N5913
Tube Works Inc	C1449
Tubex Technology Machinery Inc	C2334
Universal Tool & Engineering	C1839
WAFIOS Machinery Corp	C1736
<b>Wauseon Machine &amp; Manufacturing Inc.</b>	<b>C1539</b>
Weil Engineering North America	C8209
<b>Winton Machine Co</b>	<b>C1725</b>

**Tube/Pipe Cut-off Machines**

<b>Abbey International</b>	<b>C1514</b>
AddisonMckee Inc.	C2339
Alpine Bender Machinery	C1836
Automec Inc	C4832
BTM Bandsaws	C8416
Cosen Saws USA	C7136
CTD Machines Inc.	C8423
Dake Corporation	C6923
Doringer Cold Saws	C4913
Dynabrade Inc	C2409
Eaton Leonard	C1723

Eberle America Inc	C8312
EH Wachs Co.	N5713
Enutron International	C7750
ESCO Tool Co.	C5735
Fives Bronx Inc	C1514
FomUSA	C6914
Formtek Metal Forming & Hill Engineering	C3708
Friggi N.A. Inc	C7642
H & M Pipe Beveling Machine Co Inc	N3419
Haas Saw & Supply	C1535

Haberle / Ken Bergman & Assoc LLC	C7137
Horn Machine Tools Inc	C1734
Hyd-Mech Group Ltd.	C6523
INNOVO Corp	C1758
J & S Machine Inc.	C2317
Kent Corp.	C954, C2128
<b>Marion Die &amp; Fixture Inc.</b>	<b>C5520</b>
Mathey Dearman	N5710
<b>Mazak Optonics Corp</b>	<b>C3428</b>

# ALL SET TO CHANNEL SUCCESS.

**INNOVATIVE TUBE AND PIPE  
FLUID SOLUTIONS FROM QUAKER**

Making tubes and pipes means more than a simple production line. There are lubricants, process fluids and coatings to consider, and that's just the beginning. You've got to constantly monitor and maintain your machinery, processes and workforce. So you need a partner with the products and expertise to get things running and keep them running at their best – front to back, with you at each step. That's why you need Quaker. No challenge is too big for relentless innovation, hard work and a sincere desire to help you maximize your productivity and improve your bottom line. It's our obsession and inside everything we do. Because at the heart of the tube and pipe industry, you'll find us.

**It's what's inside that counts.**



Visit us at booth **C1852**

[quakerchem.com/fabtech2012](http://quakerchem.com/fabtech2012)  
**EU +31.297.544644**  
**US 1.800.523.7010**





## Tube/Pipe Cut-off Machines

Metlsaw Systems Inc . . . . .	C8229
Midwest Bender Services Corp . . . . .	C1728
Mill Masters . . . . .	C1533
New Centurion Enterprises Ltd. . . . .	C8347
Ningbo Jinfeng Welding & Cutting Machinery Manufacture Co Ltd . . . . .	N6007

### Orbitalum Orbital Cutting

+ Welding . . . . . N5713

Overton Industries . . . . . C2225

Pador Marketing Group . . . . . N2927

Passline Performance . . . . . C2325

Pat Mooney Inc . . . . . C6913

Project Tool & Die Inc . . . . . C7313

Proto-1 Manufacturing . . . . . C1825

Scotchman Industries Inc . . . . . C4923

T&H Lemont . . . . . C2117

T-DRILL Industries Inc . . . . . C2121

Thermatool Corp . . . . . C2110

Toolmen Corp . . . . . C1253

Top Cat Air Tools . . . . . C2361

Tri Tool Inc . . . . . N5913

Tsune America . . . . . C3450

Tubex Technology Machinery Inc . . . . . C2334

voestalpine – Roll Forming Corp

& Rotec Inc. . . . . C4725

### YLM - Ying Lin Machine

Industrial Co . . . . . C2317

## Tube/Pipe Deburring Equipment

Abtex Corp. . . . . C7547

Almco Inc. . . . . C1220

### Apex Machine Group/

SlipCon USA . . . . . C5528

Beilun Futuo Mechanical

Tools Co Ltd. . . . . N6026

BLM GROUP USA Corp . . . . . C1717

Comco Inc . . . . . C5052

CS Unitec Inc. . . . . N5531

EH Wachs Co. . . . . N5713

Fein Power Tools Inc . . . . . N5902

Fives Bronx Inc . . . . . C1514

Haberle / Ken Bergman

& Assoc LLC . . . . . C7137

Kent Corp. . . . . C954, C2128

KLINGSPOR Abrasives Inc. . . . . N3135

KUKA Robotics Corporation . . . . . N5702

KULLEN - KOTI GmbH . . . . . N3137

Manufacturing Solutions Inc. . . . . N1509

Metcast Service Tech Resources . . . . . C6946

Midwest Bender Services Corp . . . . . C1728

Nitto Kohki USA Inc . . . . . C1510

### Orbitalum Orbital Cutting

+ Welding . . . . . N5713

Osborn . . . . . C2737, N3309

Pangborn Corp. . . . . C6516

PFERD INC. . . . . N5018

PHI . . . . . C2122

Proto-1 Manufacturing . . . . . C1825

Rex-Cut Abrasives . . . . . N2708

Rosler Metal Finishing USA LLC . . . . . C7733

Saar Hartmetall USA LLC . . . . . N5925

Scantool USA By CML USA . . . . . C7147

Suhner Industrial Products Inc . . . . . N3010

Swagelok Marketing Services Co. . . . . N3431

T-DRILL Industries Inc . . . . . C2121

Tubex Technology Machinery Inc . . . . . C2334

### Universal Tube & Rollform

Equipment Corp. . . . . C1528

Weiler Corp . . . . . N4831

Wendt USA LLC. . . . . N2606

Wheelabrator Group . . . . . C7121

## Tube/Pipe Draw Benches

Abbey International. . . . . C1514

Fives Bronx Inc . . . . . C1514

Nucor Building Systems . . . . . C1255

R&B Machining Inc . . . . . C2124

### Universal Tube & Rollform

Equipment Corp. . . . . C1528

Wuxi Dixin Steel Pipe Co Ltd . . . . . C1554

## Tube/Pipe End Forming Equipment

AddisonMckee Inc. . . . . C2339

AIM Inc . . . . . C1832

Alpine Bender Machinery . . . . . C1836

Brandt Engineered Products Ltd . . . . . C1755

Chiyoda Kogyo-Maruka USA. . . . . C2134

Eaton Leonard . . . . . C1723

Fontijne Grotnes Inc . . . . . C2136

GH Induction Atmospheres LLC . . . . . C2323

Global Metal Spinning Solutions Inc . . . . . C934

Haeusler AG . . . . . C5540

Heck Industries . . . . . C4828

INNOVO Corp . . . . . C1758

J & S Machine Inc. . . . . C2317

Manufacturing Solutions Inc. . . . . N1509

Midwest Bender Services Corp . . . . . C1728

MJC Engineering & Technology Inc . . . . . C1156

Multipress Inc . . . . . C1022

Overton Industries. . . . . C2225

Perfection Global LLC . . . . . C3832

Peter Prinzing GmbH . . . . . C5638

PHI . . . . . C2122

Proto-1 Manufacturing . . . . . C1825

R&B Machining Inc . . . . . C2124

SB Machine Tools . . . . . C2322

Scotchman Industries Inc . . . . . C4923

Tubex Technology Machinery Inc . . . . . C2334

Universal Tool & Engineering . . . . . C1839

### Wauseon Machine &

Manufacturing Inc. . . . . C1539

Winton Machine Co . . . . . C1725

### YLM - Ying Lin Machine

Industrial Co . . . . . C2317

## Tube/Pipe Expanders

AddisonMckee Inc. . . . . C2339

BLM GROUP USA Corp . . . . . C1717

CS Unitec Inc. . . . . N5531

Eaton Leonard . . . . . C1723

ESCO Tool Co. . . . . C5735

Fontijne Grotnes Inc . . . . . C2136

Haeusler AG . . . . . C5540

INNOVO Corp . . . . . C1758

Nordfab Ducting . . . . . N1928

Peter Prinzing GmbH . . . . . C5638

R&B Machining Inc. . . . . C2124

T-DRILL Industries Inc . . . . . C2121

### Universal Tube & Rollform

Equipment Corp. . . . . C1528

### Wauseon Machine &

Manufacturing Inc. . . . . C1539

Winton Machine Co . . . . . C1725

## Tube/Pipe Extrusion Presses

Macrodyne Technologies Inc . . . . . C252

Nucor Building Systems . . . . . C1255

## Tube/Pipe Finning Machines

AM Machinery Sales . . . . . C5528

Elo Automated Stainless Steel

Technologies Qingdao Co Ltd . . . . . C8342

ESCO Tool Co. . . . . C5735

Peter Prinzing GmbH . . . . . C5638

## Tube/Pipe Flanging Machines

AddisonMckee Inc. . . . . C2339

BLM GROUP USA Corp . . . . . C1717

Eaton Leonard . . . . . C1723

EH Wachs Co. . . . . N5713

ESCO Tool Co. . . . . C5735

Haeusler AG . . . . . C5540

INNOVO Corp . . . . . C1758

MJC Engineering & Technology Inc . . . . . C1156

### Orbitalum Orbital Cutting

+ Welding . . . . . N5713

Overton Industries. . . . . C2225

Peter Prinzing GmbH . . . . . C5638

PHI . . . . . C2122

Proto-1 Manufacturing . . . . . C1825

T-DRILL Industries Inc . . . . . C2121

Trilogy Machinery Inc . . . . . C5140

Universal Tool & Engineering . . . . . C1839

### Wauseon Machine &

Manufacturing Inc. . . . . C1539



### Tube/Pipe Flaring Machines

AddisonMckee Inc. ....	C2339
BLM GROUP USA Corp. ....	C1717
Eaton Leonard. ....	C1723
INNOVO Corp. ....	C1758
J & S Machine Inc. ....	C2317
<b>Overton Industries. ....</b>	<b>C2225</b>
PHI. ....	C2122
Proto-1 Manufacturing. ....	C1825
Sertom Group North America LLC. ....	C6911
T-DRILL Industries Inc. ....	C2121
Universal Tool & Engineering. ....	C1839
<b>Universal Tube &amp; Rollform Equipment Corp. ....</b>	<b>C1528</b>
<b>Wauseon Machine &amp; Manufacturing Inc. ....</b>	<b>C1539</b>

### Tube/Pipe Grinding & Polishing Equipment

AM Machinery Sales. ....	C5528
<b>Apex Machine Group/ SlipCon USA. ....</b>	<b>C5528</b>
CIMID Corp. ....	C8327
Costa & Grissom Machinery Co. ....	C7516
CS Unitec Inc. ....	N5531
Dynabrade Inc. ....	C2409
Fein Power Tools Inc. ....	N5902
Fiba Technologies Inc. ....	N6324
KLINGSPOR Abrasives Inc. ....	N3135
KUKA Robotics Corporation. ....	N5702
Metabo Corp. ....	N6131
Michigan Pneumatic Tool Inc. ....	N6034
Osborn. ....	C2737, N3309
PFERD INC. ....	N5018
Rex-Cut Abrasives. ....	N2708
Scantool USA By CML USA. ....	C7147
Suhner Industrial Products Inc. ....	N3010
Top Cat Air Tools. ....	C2361
Wendt USA LLC. ....	N2606

### Tube/Pipe Grooving Machines

MJC Engineering & Technology Inc. ....	C1156
<b>Overton Industries. ....</b>	<b>C2225</b>
Proto-1 Manufacturing. ....	C1825
Pushcorp Inc. ....	N5934
RIDGID. ....	C8412
Toolmen Corp. ....	C1253
<b>Wauseon Machine &amp; Manufacturing Inc. ....</b>	<b>C1539</b>

### Tube/Pipe Hand Benders

Baileigh Industrial Inc. ....	C7513
Dake Corporation. ....	C6923
Eaton Leonard. ....	C1723
Heck Industries. ....	C4828
Peter Prinzing GmbH. ....	C5638

PHI. ....	C2122
Swagelok Marketing Services Co. ....	N3431
TaurinGroup USA. ....	C1739
Trilogy Machinery Inc. ....	C5140
<b>Wauseon Machine &amp; Manufacturing Inc. ....</b>	<b>C1539</b>
<b>Winton Machine Co. ....</b>	<b>C1725</b>

### Tube/Pipe Handling Systems

Alpine Bender Machinery. ....	C1836
CH Steel Solutions Inc. ....	C7348
Demag Cranes and Components. ....	C560
ERIEZ. ....	C7316
Foerster Instruments Inc. ....	C1523
Friggi N.A. Inc. ....	C7642
HGG Profiling Equipment. ....	C8127
<b>Irco Automation Inc. ....</b>	<b>N2431</b>
Manufacturing Solutions Inc. ....	N1509
Nordfab Ducting. ....	N1928
<b>Nucor Building Systems. ....</b>	<b>C1255</b>
Prodim USA. ....	C8521
Red Rock Automation/Romar/MEC. ....	N4805
Rimco Equipment. ....	N1631
Steel Storage Systems Inc. ....	C6916
Sumner Manufacturing Co Inc. ....	N1519
Universal Tool & Engineering. ....	C1839
Walker Magnetics. ....	C7536

### Tube/Pipe Hydroforming Machines

AP&T North America Inc. ....	C1231
Chemtool Inc. ....	C660
Enprotech Industrial Technologies LLC. ....	C1439
Interlaken Technology. ....	C947
Macrodyne Technologies Inc. ....	C252
Schuler Incorporated. ....	C917
Wayne Trail, a Lincoln Electric Company. ....	N4513

### Tube/Pipe Incremental Benders

Alpine Bender Machinery. ....	C1836
BLM GROUP USA Corp. ....	C1717
<b>Boschert Precision Machinery Inc. ....</b>	<b>C2820</b>
Dake Corporation. ....	C6923
Eaton Leonard. ....	C1723
Sertom Group North America LLC. ....	C6911
WAFIOS Machinery Corp. ....	C1736

### Tube/Pipe Induction Benders

GH Induction Atmospheres LLC. ....	C2323
Radyne Corp. ....	N5024

### Tube/Pipe Mills - ERW

<b>Abbey International. ....</b>	<b>C1514</b>
Brandt Engineered Products Ltd. ....	C1755

Econco/CPI. ....	C3712
Fives Bronx Inc. ....	C1514
Gasparini SPA. ....	C5536
Innerspec Technologies. ....	N2217
Mill Masters. ....	C1533
<b>Nucor Building Systems. ....</b>	<b>C1255</b>
Passline Performance. ....	C2325
T&H Lemont. ....	C2117
<b>Universal Tube &amp; Rollform Equipment Corp. ....</b>	<b>C1528</b>

### Tube/Pipe Mills - GTAW (TIG)

<b>ABICOR Binzel Corp. ....</b>	<b>N5508</b>
AMET Inc. ....	N4518
Brandt Engineered Products Ltd. ....	C1755
D/F Machine Specialties Inc. ....	N2224
Gasparini SPA. ....	C5536
Innerspec Technologies. ....	N2217
Liburdi Automation Inc. ....	N3609
Mill Masters. ....	C1533
<b>Nucor Building Systems. ....</b>	<b>C1255</b>
Passline Performance. ....	C2325
Red Rock Automation/Romar/MEC. ....	N4805
<b>Universal Tube &amp; Rollform Equipment Corp. ....</b>	<b>C1528</b>

### Tube/Pipe Mills - High Frequency

Brandt Engineered Products Ltd. ....	C1755
D&H Machinery Inc. ....	C2112
Econco/CPI. ....	C3712
Formtek Metal Forming & Hill Engineering. ....	C3708
Gasparini SPA. ....	C5536
Innerspec Technologies. ....	N2217
Kent Corp. ....	C954, C2128
Mill Masters. ....	C1533
<b>Nucor Building Systems. ....</b>	<b>C1255</b>
Passline Performance. ....	C2325
T&H Lemont. ....	C2117
<b>Universal Tube &amp; Rollform Equipment Corp. ....</b>	<b>C1528</b>

### Tube/Pipe Mills - Induction

Ambrell Precision Induction Heating. ....	C4950
Econco/CPI. ....	C3712
Formtek Metal Forming & Hill Engineering. ....	C3708
Gasparini SPA. ....	C5536
GH Induction Atmospheres LLC. ....	C2323
<b>Nucor Building Systems. ....</b>	<b>C1255</b>
Passline Performance. ....	C2325
Radyne Corp. ....	N5024





### Tube/Pipe Mills - Laser

<b>Bystronic Inc</b> .....	<b>C4328</b>
Econco/CPI .....	C3712
Formtek Metal Forming & Hill Engineering .....	C3708
Gasparini SPA .....	C5536
Innerspec Technologies .....	N2217
Laser Mechanisms Inc .....	C3810
<b>Mazak Optonics Corp</b> .....	<b>C3428</b>
Mill Masters .....	C1533
<b>Nucor Building Systems</b> .....	<b>C1255</b>
<b>TRUMPF Inc</b> .....	<b>C3016</b>
Weil Engineering North America ...	C8209

### Tube/Pipe Mills - Pilger

<b>Nucor Building Systems</b> .....	<b>C1255</b>
Wuxi Dixin Steel Pipe Co Ltd .....	C1554

### Tube/Pipe Mills - Spiral

Brandt Engineered Products Ltd .....	C1755
Gasparini SPA .....	C5536
Harbert's Products Inc/ Allied Flux Reclaiming Ltd .....	N4824
Innerspec Technologies .....	N2217
<b>Nucor Building Systems</b> .....	<b>C1255</b>

### Tube/Pipe Mills - Welding Power Supplies

EFD Induction Inc. ....	C2139
Harbert's Products Inc/ Allied Flux Reclaiming Ltd .....	N4824
Liburdi Automation Inc .....	N3609
Pyro Shield Inc. ....	N6313

### Tube/Pipe Notching Machines

AddisonMckee Inc. ....	C2339
Baileigh Industrial Inc .....	C7513
CML USA Inc Ercolina .....	C3739
Dake Corporation .....	C6923
Dynatorch Inc .....	N4837
Edwards Manufacturing Co .....	C7116
Fein Power Tools Inc .....	N5902
FomUSA .....	C6914
Haberle / Ken Bergman & Assoc LLC .....	C7137
Heck Industries .....	C4828
HGG Profiling Equipment .....	C8127
INNOVO Corp .....	C1758
InterTest Inc. ....	N5824
Midwest Bender Services Corp ...	C1728
<b>Overton Industries</b> .....	<b>C2225</b>
Project Tool & Die Inc .....	C7313
Proto-1 Manufacturing .....	C1825
R&B Machining Inc .....	C2124
Scantool USA By CML USA .....	C7147
<b>Scotchman Industries Inc</b> .....	<b>C4923</b>

Toolmen Corp .....	C1253
TOX Pressotechnik LLC .....	C5024
Unipunch Products Inc .....	C3732
Unittool Punch & Die .....	C4708
Weil Engineering North America ...	C8209

### Tube/Pipe Ovalforming Machines

Peter Prinzing GmbH .....	C5638
Proto-1 Manufacturing .....	C1825
Toolmen Corp .....	C1253
Weldlogic Inc .....	N5826

### Tube/Pipe Piercing Machines

AddisonMckee Inc. ....	C2339
AM Machinery Sales .....	C5528
Dynatorch Inc .....	N4837
INNOVO Corp .....	C1758
Proto-1 Manufacturing .....	C1825
TOX Pressotechnik LLC .....	C5024
Unipunch Products Inc .....	C3732
Unittool Punch & Die .....	C4708
Universal Tool & Engineering .....	C1839

### Tube/Pipe Ram Benders

AddisonMckee Inc. ....	C2339
Alpine Bender Machinery .....	C1836
<b>Boschert Precision Machinery Inc.</b> ...	<b>C2820</b>
Fein Power Tools Inc .....	N5902
INNOVO Corp .....	C1758
J & S Machine Inc. ....	C2317
Proto-1 Manufacturing .....	C1825
Universal Tool & Engineering .....	C1839

### Tube/Pipe Reducers

AddisonMckee Inc. ....	C2339
INNOVO Corp .....	C1758
J & S Machine Inc. ....	C2317
Lillbacka Powerco USA Inc .....	C2132
Nordfab Ducting .....	N1928
<b>Overton Industries</b> .....	<b>C2225</b>
Proto-1 Manufacturing .....	C1825
R&B Machining Inc .....	C2124
<b>Wauseon Machine &amp; Manufacturing Inc.</b> .....	<b>C1539</b>

### Tube/Pipe Roll Benders

<b>Boschert Precision Machinery Inc.</b> ...	<b>C2820</b>
C Marshall Fabrication Machinery ..	C7716
<b>Carell Corp/Eagle Bending Machines</b> .....	<b>C5928</b>
CML USA Inc Ercolina .....	C3739
COMEQ Inc .....	C5125
Dake Corporation .....	C6923
Faccin USA Inc .....	C6323
Haeusler AG .....	C5540

J & S Machine Inc. ....	C2317
KNUTH Machine Tools USA Inc ....	C4910
Peter Prinzing GmbH .....	C5638
Prestige Equipment Corporation ....	C7214
TaurinGroup USA .....	C1739
Trilogy Machinery Inc .....	C5140
Weldlogic Inc .....	N5826
<b>Winton Machine Co</b> .....	<b>C1725</b>

### Tube/Pipe Rotary Draw Benders

AddisonMckee Inc. ....	C2339
Alpine Bender Machinery .....	C1836
Baileigh Industrial Inc .....	C7513
BLM GROUP USA Corp .....	C1717

#### Carell Corp/Eagle

<b>Bending Machines</b> .....	<b>C5928</b>
Chiyoda Kogyo-Maruka USA .....	C2134
CML USA Inc Ercolina .....	C3739
Eaton Leonard .....	C1723
Edwards Manufacturing Co .....	C7116
Horn Machine Tools Inc .....	C1734
INNOVO Corp .....	C1758
J & S Machine Inc. ....	C2317
TaurinGroup USA .....	C1739
Tube Works Inc .....	C1449
Tubex Technology Machinery Inc ...	C2334
Universal Tool & Engineering .....	C1839

#### Universal Tube & Rollform

<b>Equipment Corp.</b> .....	<b>C1528</b>
WAFIOS Machinery Corp .....	C1736
Wayne Trail, a Lincoln Electric Company .....	N4513
<b>Winton Machine Co</b> .....	<b>C1725</b>
<b>YLM - Ying Lin Machine Industrial Co</b> .....	<b>C2317</b>

### Tube/Pipe Scarfing Equipment

American Torch Tip Co Inc. ....	N2022
ESCO Tool Co. ....	C5735
Gem Tool Corporation .....	C2320
Kent Corp. ....	C954, C2128
Saar Hartmetall USA LLC .....	N5925
T&H Lemont .....	C2117

### Tube/Pipe Serpentine Benders

AIM Inc .....	C1832
Alpine Bender Machinery .....	C1836
J & S Machine Inc. ....	C2317
Tubex Technology Machinery Inc ...	C2334
Universal Tool & Engineering .....	C1839
<b>Winton Machine Co</b> .....	<b>C1725</b>



### Tube/Pipe Stands/Jacks/ Positioners

Advanced Tubular Technologies Inc .	C1556
Intercon Enterprises Inc . . . . .	N3227
<b>Irco Automation Inc. . . . .</b>	<b>N2431</b>
RIDGID. . . . .	C8412

### Tube/Pipe Stretch Benders

Alpine Bender Machinery . . . . .	C1836
-----------------------------------	-------

### Tube/Pipe Supplied - Copper/ Copper Alloys

Ampco Metal Inc. . . . .	C2326
Cambridge Lee Industries LLC. . . . .	C8333
Haynes International. . . . .	N1617
KME Germany GmbH & Co KG . . . . .	N1525
Liaoning Longyuan Industry Co Ltd . . . . .	C455
National Bronze & Metals Inc. . . . .	C1512
Ningbo Powerway Alloy Material Co Ltd. . . . .	N5038
Production Tube Cutting Inc . . . . .	C2215
ZJ Industries Inc . . . . .	N2704

### Tube/Pipe Supplied - Other Ferrous Metals

American Roll Form. . . . .	C5038
Haynes International. . . . .	N1617
Liaoning Longyuan Industry Co Ltd . . . . .	C455
Production Tube Cutting Inc . . . . .	C2215
Stripmatic Products Inc. . . . .	C1415

### Tube/Pipe Supplied - Other Nonferrous Metals

Cambridge Lee Industries LLC. . . . .	C8333
Liaoning Longyuan Industry Co Ltd . . . . .	C455
MMC Superalloy Corp. . . . .	N1826
Nanjing Youtian Metal Technology Co Ltd. . . . .	N1616
National Bronze & Metals Inc. . . . .	C1512
Ningbo Powerway Alloy Material Co Ltd. . . . .	N5038
Production Tube Cutting Inc . . . . .	C2215

### Tube/Pipe Supplied - Steel (Carbon)

American Roll Form. . . . .	C5038
<b>Lapham-Hickey Steel Corp . . . . .</b>	<b>C840</b>
Liaoning Longyuan Industry Co Ltd . . . . .	C455
Production Tube Cutting Inc . . . . .	C2215
Stripmatic Products Inc. . . . .	C1415
Valmont Coatings . . . . .	C5724

### Tube/Pipe Supplied - Steel (Stainless)

Benxi Guangzheng Tungsten & Molybdenum Co Ltd . . . . .	C456
------------------------------------------------------------	------

Liaoning Longyuan Industry Co Ltd . . . . .	C455
Production Tube Cutting Inc . . . . .	C2215
Stripmatic Products Inc. . . . .	C1415
Swagelok Marketing Services Co. . . . .	N3431
Wuxi Dixin Steel Pipe Co Ltd . . . . .	C1554

### Tube/Pipe Swaging Machines

AddisonMckee Inc. . . . .	C2339
BLM GROUP USA Corp . . . . .	C1717
CML USA Inc Ercolina. . . . .	C3739
INNOVO Corp . . . . .	C1758
Lillbacka Powerco USA Inc. . . . .	C2132
<b>Overton Industries. . . . .</b>	<b>C2225</b>
PHI . . . . .	C2122
Project Tool & Die Inc. . . . .	C7313
Proto-1 Manufacturing . . . . .	C1825
Swagelok Marketing Services Co. . . . .	N3431
<b>Universal Tube &amp; Rollform Equipment Corp. . . . .</b>	<b>C1528</b>
<b>Wauseon Machine &amp; Manufacturing Inc. . . . .</b>	<b>C1539</b>

### Tube/Pipe Threading/ Knurling Machines

<b>Nucor Building Systems . . . . .</b>	<b>C1255</b>
Proto-1 Manufacturing . . . . .	C1825
RIDGID. . . . .	C8412

### Turning Machines

Climax Portable Machining & Welding Systems . . . . .	N1422
Elo Automated Stainless Steel Technologies Qingdao Co Ltd . . . . .	C8342
F & G Tool and Die Co. . . . .	C1413
Genstar Technologies Inc . . . . .	N2822
Gerb Vibration Control Systems . . . . .	C852
Gulco International. . . . .	N5002
International Mold Steel. . . . .	C556
KNUTH Machine Tools USA Inc . . . . .	C4910
Kong NGAI Precision Metal Mould Shenzhen Co Ltd . . . . .	C856
Machinery Marketing Intl . . . . .	C8337
Manufacturing Solutions . . . . .	C8429
Manufacturing Solutions Inc. . . . .	N1509
<b>Murata Machinery USA Inc . . . . .</b>	<b>C3028</b>
Preston-Eastin Inc . . . . .	N5731
Roll Machining Technologies & Solutions. . . . .	C1526
Shijiazhuang Fitex Trading Co Ltd. . . . .	C159

### Ultrafiltration Equipment for Electrocoating

DMP Corp . . . . .	C2054
Eisenmann Corp . . . . .	C2439

### Ultrasonic Cleaning Equipment

Almco Inc. . . . .	C1220
Durr Ecoclean Inc . . . . .	C2437
I.S.T. International Surface Technologies . . . . .	C1958
<b>MTM Meissner Technik Mullenbach GmbH . . . . .</b>	<b>C2155</b>
PKG Equipment Inc . . . . .	C1953

### Used Machinery

Advanced Laser Services LLC . . . . .	C5634
Alternative Parts Inc . . . . .	C3726
<b>Betenbender Manufacturing Inc. . . . .</b>	<b>C3744</b>
Bliss Clearing Niagara . . . . .	C933
Climax Portable Machining & Welding Systems . . . . .	N1422
COMEQ Inc . . . . .	C5125
Controlled Automation Inc . . . . .	C7730
D&H Machinery Inc. . . . .	C2112
Darex LLC . . . . .	C8138
Global Metal Spinning Solutions Inc . . . . .	C934
Haeusler AG . . . . .	C5540
Heim Group, The . . . . .	C1331
International Technologies Inc . . . . .	C8111
Janda Co Inc . . . . .	N1924
Kent Corp. . . . .	C954, C2128
Leifeld Metal Spinning AG . . . . .	C8112
Machinery Marketing Intl . . . . .	C8337
<b>Mazak Optonics Corp . . . . .</b>	<b>C3428</b>
Midwest Bender Services Corp . . . . .	C1728
Ogden Welding Systems. . . . .	N3035
Prestige Equipment Corporation. . . . .	C7214
<b>PTR-Precision Technologies Inc . . . . .</b>	<b>N5226</b>
<b>Salvagnini America Inc . . . . .</b>	<b>C3928</b>
<b>Scotchman Industries Inc . . . . .</b>	<b>C4923</b>
Semyx LLC. . . . .	C6347
TJ Snow Co. . . . .	N2613
Voortman Corporation. . . . .	C7739

### UV Curable Coatings

Cardinal Paint and Powder . . . . .	C1761
Keyland Polymer Ltd . . . . .	C2063
PPG Industries. . . . .	C2739
Strathmore Products Inc . . . . .	C1955

### UV Curing Equipment & Lamps

<b>Nordson Corp . . . . .</b>	<b>C2517</b>
Production Systems Inc. . . . .	C1858
Richard Wolf Industrial. . . . .	N2309



## Vacuum Lifting & Positioning Equipment

Burghardt + Schmidt GmbH	C4934
Coral Spa / Industrial	
Air Solutions	N2813
Demag Cranes and Components	C560
Industrial Magnetics Inc	C5728
JMR Industrial	C3752
Lissmac Corp	C4340
Permadur Industries Inc	N3006
Red Rock Automation/Romar/MEC	N4805

## Vacuum Systems for Powder Coating

Combustion and Systems Inc	C2411
Coral Spa / Industrial	
Air Solutions	N2813
KCI America Co Ltd	C2062
Powder Coating	C2356

## Vacuum/Oscillator Tubes

Benxi Guangzheng Tungsten & Molybdenum Co Ltd	C456
Econco/CPI	C3712
Richardson Electronics Ltd	C3721
<b>Thermatool Corp</b>	<b>C2110</b>

## Varnish

Cardinal Paint and Powder	C1761
Strathmore Products Inc	C1955

## Vibration Control/ Machine Mounting Equipment

Gerb Vibration Control Systems	C852
Mayfran International Inc	C939
<b>Strong Hand Tools</b>	<b>N3631</b>
Unisorb Installation Technologies	C1411
Vibro Dynamics Corp	C1012

## Waste Treatment & Recovery Processes & Equipment

BECCA Inc	C1854
<b>Chemetall US Inc</b>	<b>C2709</b>
Coral Chemical Co	C2417
DMP Corp	C2054
Gaozhou City Longsafety	
Labor Insurance	N6201
<b>George Koch Sons LLC</b>	<b>C2521</b>
<b>H2Pump LLC</b>	<b>C1154</b>
I.S.T. International	
Surface Technologies	C1958
Industrial Innovations Inc	C836
Meltric Corp	N4826
Nederman Inc	N1604

## Water Circulators - Welding

CM Industries Inc	N2810
-------------------	-------

## Waterjet Cutting Machines & Components

A&V Waterjet Tech Inc	C7533
Accustream Inc	C8109
Baileigh Industrial Inc	C7513
<b>Barton</b>	<b>C4916</b>
<b>Bystronic Inc</b>	<b>C4328</b>
Flow International Corp	C5911
Friggi N.A. Inc	C7642
H2O JET Inc	C5713
International Waterjet Parts	C5847
<b>Jet Edge</b>	<b>C4349</b>
JETCAM-NestONE Solutions	C4722
Kinetic Cutting Systems Inc	C6311
KMT Waterjet Systems Inc	C6334
KNUTH Machine Tools USA Inc	C4910
<b>Koike Aronson Inc</b>	<b>N4131</b>
Machinery Marketing Intl	C8337
Manufacturing Solutions	C8429
<b>MC Machinery Systems Inc/ Mitsubishi</b>	<b>C3040</b>
MultiCam Inc	C5516
OMAX Corp	C3940
Prestige Equipment Corporation	C7214
Rhino Cutting Systems	N6138
Semyx LLC	C6347
Techni Waterjet	C5128

## Weld Backings

<b>Aquasol Corp</b>	<b>N3613</b>
Bug-O Systems	N4813, N5013
Cerbaco Ltd	N2706
COB Industries Inc	N5919
Gullico International	N5002
PROFAX / Lenco	N3013
Southern Copper & Supply	N1926

## Weld Curtains

Auburn Manufacturing Inc	N4904
CoreTemp	N6236
Frommelt Safety Products	N4827
Gaozhou City Longsafety	
Labor Insurance	N6201
<b>Goff's Enterprises Inc</b>	<b>N2625</b>
Hex-Hut Shelter Systems Ltd	N6115
Pan Taiwan Enterprise	N1718
Pyro Shield Inc	N6313
Sellstrom Manufacturing Co	N3413
Steiner Industries	N3022
Winnox Industries Ltd	N6111

## Weld Quality Monitors/ Checkers/Sensors/ Measurement

American Society For Nondestructive Testing	N1615
AMET Inc	N4518
Arc Specialties Inc	N1610
Brandt Engineered Products Ltd	C1755
Clara Vision	N1706
Cloos Robotic Welding Inc	N3618
COB Industries Inc	N5919
Eddytech Systems Inc	C1752
Elcometer Inc	N3126
Fischer Technology Inc	C2711
GE Measurement & Control	N3222
HOT COILS	N5115
IMPACT Engineering Inc	N5108
Innerspec Technologies	N2217
Intercon Enterprises Inc	N3227
International Welding Technologies Inc	N1724
InterTest Inc	N5824
Janda Co Inc	N1924
Matuschek Welding Products Inc	N1708
Melttools LLC	N1618
Meta Vision Systems Inc	N5015
Metallurgical & Materials Technologies Inc	C1535
OES Inc	C248
RealWeld Systems Inc	N6217
Robotic Technologies of TN	N6025
Servo-Robot Inc	N5907
Starrett Byte-wise	
Measurement Systems	C3453
TJ Snow Co	N2613
Xiris Automation Inc	C2312

## Welding - Arc (GMAW) Machines & Components

<b>ABICOR Binzel Corp</b>	<b>N5508</b>
Airgas Inc	N5231
American Torch Tip Co Inc	N2022
<b>ArcOne</b>	<b>N3231</b>
Beijing Essen Welding & Cutting Fair	N6200
<b>Bernard</b>	<b>N5516</b>
Bettcher Manufacturing LLC	C1053
Changzhou Huatong	
Welding Industry Co Ltd	N6310
CK Worldwide	N3615
Climax Portable Machining & Welding Systems	N1422
Cloos Robotic Welding Inc	N3618
CM Industries Inc	N2810





# American Welding Society

## Visit us at Booth # N2031



### MEMBERSHIP

Your membership in AWS opens numerous doors for your personal career or business. Local Section meetings in your community provide an opportunity to network with your fellow welding industry professionals. Your membership also includes a subscription to the



monthly *Welding Journal*, the world's premier welding publication. Plus, you will enjoy significant member discounts on

AWS books, certifications, and educational programs.

If you join today at FABTECH, you can purchase a *Welding Handbook* volume for just \$35 — a \$115 value.

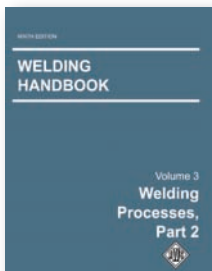

### CERTIFICATION

The quality of welding and the advancement opportunities for welding personnel worldwide have been greatly advanced by AWS certification programs. Led by the



internationally recognized AWS Certified Welding Inspector

program, AWS certifications also include programs for educators, sales representatives, engineers, supervisors, welders, and robotic welding personnel.

The foundation of AWS certifications is its collection of several hundred technical standards and codes which are proven and widely respected on every continent.

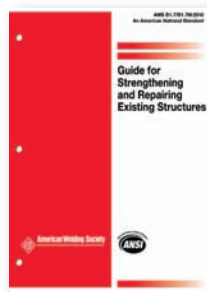

### EDUCATION

Adding to one's knowledge of welding science and applications is a lifelong endeavor for AWS members and volunteers. From preparation for certification exams to conferences on emerging technologies, a wealth of educational opportunities from AWS await you.

Right here at FABTECH you can attend sessions on topics like underwater welding, brush up on your knowledge of welding stainless steels or sheet metal, survey the latest in welding research, or prepare for certification.

Year-round conferences on a wide variety of industry topics are held in various locations or can be viewed online. And American Welding Online (AWO) offers online professional development that fits your schedule and budget.



# www.aws.org

*The mission of the American Welding Society is to advance the science, technology, and application of welding and allied joining and cutting processes worldwide, including brazing, soldering, and thermal spraying.*



## Welding - Arc (GMAW) Machines & Components

CMF Jammes Rolling and Welding	C5538
D/F Machine Specialties Inc.	N2224
Dinse Inc	N2717
ELCo Enterprises	N2831
Electron Beam Technologies Inc.	N3210
<b>ESAB Welding &amp; Cutting Products</b>	<b>N3922, N4122</b>
Fronius USA LLC	N3425
Genesis Systems Group	N3913
Guild International	C2234
Gullco International	N5002
Hollbrit Inc.	N6317
Hotfoil EHS Inc	N1319
IMPACT Engineering Inc	N5108
<b>Irco Automation Inc.</b>	<b>N2431</b>
JASIC Technology Co Ltd	N2019
Jetline Engineering	N5813
Kalas: Industrial	N2026
Liburdi Automation Inc	N3609
<b>Lincoln Electric Co.</b>	<b>N4102, N4113, N4515</b>
Linemaster Switch Corp	C2324
LONGEVITY Welding & Cutting Products	N5109
MAGMAWELD	N1628
Magnatech LLC	N6133
Matheson	N6122
Meltools LLC	N1618
Meta Vision Systems Inc	N5015
Miller Electric Mfg Co.	N5213, N5816
Miller Welding Automation	N5513
MK Products Inc	N2804
Ningbo Powerway Alloy Material Co Ltd	N5038
North (Nanjing) Instrument Technology Industries Group	N3226
Ogden Welding Systems	N3035
<b>OTC DAIHEN Inc</b>	<b>N3622</b>
Pador Marketing Group	N2927
Pandjiris Inc.	N4810
Preston-Eastin Inc	N5731
PROFAX / LENCO	N3013
Red Rock Automation/Romar/MEC	N4805
Robotic Technologies of TN	N6025
Secoa Technology	N1719
Servo-Robot Inc.	N5907
Team Industries Inc	N2929
Termmei Torch & Tip Company	N2526
Trafimet USA	N2725
<b>Tregaskiss</b>	<b>N5513</b>
Tri Tool Inc	N5913
Trystar	N1818

TWI North America LLC	N3217
Victor Technologies Intl Inc	N4522
Weld.com	N4809
Weldcoa	N3238
Welding Alloys USA	N4917
Weldlogic Inc	N5826
Western Enterprises	N2933
<b>Wolf Robotics LLC</b>	<b>N4910</b>
York Portable Machine Tools	N2925
ZJ Industries Inc	N2704

## Welding - Arc (GTAW) Machines & Components

<b>ABICOR Binzel Corp.</b>	<b>N5508</b>
American Torch Tip Co Inc.	N2022
AMET Inc.	N4518
Arc Machines Inc	N5522
Arc Products	N4507
Arc Specialties Inc	N1610
<b>ArcOne</b>	<b>N3231</b>
Changzhou Huatong Welding Industry Co Ltd	N6310
CK Worldwide	N3615
Climax Portable Machining & Welding Systems	N1422
CM Industries Inc	N2810
CMF Jammes Rolling and Welding	C5538
D/F Machine Specialties Inc.	N2224
Diamond Ground Products Inc.	N5726
Dinse Inc	N2717
EH Wachs Co.	N5713
Electron Beam Technologies Inc.	N3210
Elo Automated Stainless Steel Technologies Qingdao Co Ltd	C8342
<b>ESAB Welding &amp; Cutting Products</b>	<b>N3922, N4122</b>
Fronius USA LLC	N3425
Genesis Systems Group	N3913
Guild International	C2234
<b>Irco Automation Inc.</b>	<b>N2431</b>
JASIC Technology Co Ltd	N2019
Jetline Engineering	N5813
Kalas: Industrial	N2026
Liburdi Automation Inc	N3609
<b>Lincoln Electric Co.</b>	<b>N4102, N4113, N4515</b>
Linemaster Switch Corp	C2324
LONGEVITY Welding & Cutting Products	N5109
MAGMAWELD	N1628
Magnatech LLC	N6133
Matheson	N6122
Meltools LLC	N1618
Meta Vision Systems Inc	N5015

Miller Electric Mfg Co.	N5213, N5816
Miller Welding Automation	N5513
Multiquip Inc.	N6215
Ningbo Powerway Alloy Material Co Ltd	N5038
North (Nanjing) Instrument Technology Industries Group	N3226
<b>Orbitalum Orbital Cutting + Welding</b>	<b>N5713</b>
<b>OTC DAIHEN Inc</b>	<b>N3622</b>
Pandjiris Inc.	N4810
PROFAX / LENCO	N3013
Red Rock Automation/Romar/MEC	N4805
Servo-Robot Inc.	N5907
Sunstone Engineering	N5916
Swagelok Marketing Services Co.	N3431
Team Industries Inc.	N2929
TEC Torch Co Inc	N4822
Termmei Torch & Tip Company	N2526
Trafimet USA	N2725
Tri Tool Inc	N5913
Victor Technologies Intl Inc.	N4522
Weld.com	N4809
Weldcoa	N3238
<b>Weldcraft</b>	<b>N5516</b>
Weldlogic Inc	N5826
ZJ Industries Inc	N2704

## Welding - Arc (Plasma) Machines & Components

American Torch Tip Co Inc.	N2022
AMET Inc.	N4518
Arc Specialties Inc	N1610
Changzhou Huatong Welding Industry Co Ltd	N6310
Cloos Robotic Welding Inc	N3618
CMF Jammes Rolling and Welding	C5538
Diamond Ground Products Inc.	N5726
Electron Beam Technologies Inc.	N3210
<b>ESAB Welding &amp; Cutting Products</b>	<b>N3922, N4122</b>
Fronius USA LLC	N3425
Genesis Systems Group	N3913
Guild International	C2234
HAI Advanced Material Spec	N2319
Hollbrit Inc.	N6317
<b>Irco Automation Inc.</b>	<b>N2431</b>
JASIC Technology Co Ltd	N2019
Jetline Engineering	N5813
Kalas: Industrial	N2026
Kennametal Stellite	N2528
KUKA Robotics Corporation	N5702
Liburdi Automation Inc	N3609
Linemaster Switch Corp	C2324



LONGEVITY Welding & Cutting Products	N5109
Matheson	N6122
Melttools LLC	N1618
Meta Vision Systems Inc	N5015
Multiplaz	N4909
North (Nanjing) Instrument Technology Industries Group	N3226
<b>OTC DAIHEN Inc</b>	<b>N3622</b>
Pandjiris Inc.	N4810
PROFAX / LENCO	N3013
PT-Mat	N3337
PythonX-Burlington Automation	C8116
Robotmaster-In-House Solutions Inc.	N5933
Servo-Robot Inc.	N5907
Sunstone Engineering	N5916
<b>Thermacut Inc</b>	<b>N5508</b>
Trafimet USA	N2725
Victor Technologies Intl Inc	N4522
Weldcoa	N3238
Weldlogic Inc	N5826
<b>Wolf Robotics LLC</b>	<b>N4910</b>

### Welding - Arc (Stud) Machines & Components

Changzhou Huatong Welding Industry Co Ltd	N6310
Cloos Robotic Welding Inc	N3618
D/F Machine Specialties Inc.	N2224
Genesis Systems Group	N3913
International Welding Technologies Inc	N1724
Kalas: Industrial	N2026
KUKA Robotics Corporation	N5702
Linemaster Switch Corp	C2324
Nelson Stud Welding	N5922
Ningbo Powerway Alloy Material Co Ltd	N5038
Southern Stud Weld Inc	N2616
Stud Welding Associates Inc	N6327
<b>Wolf Robotics LLC</b>	<b>N4910</b>
ZJ Industries Inc	N2704

### Welding - Arc (Submerged) Machines & Components

American Torch Tip Co Inc.	N2022
Arc Products	N4507
Arc Specialties Inc	N1610
Changzhou Huatong Welding Industry Co Ltd	N6310
CMF Jammes Rolling and Welding	C5538
Corewire Ltd	N2910
D/F Machine Specialties Inc.	N2224
ELCo Enterprises	N2831

<b>ESAB Welding &amp; Cutting Products</b>	<b>N3922, N4122</b>
Gullco International	N5002
Harbert's Products Inc/ Allied Flux Reclaiming Ltd	N4824
IMPACT Engineering Inc	N5108
<b>Irco Automation Inc.</b>	<b>N2431</b>
JASIC Technology Co Ltd	N2019
Jetline Engineering	N5813
Kalas: Industrial	N2026
<b>Lincoln Electric Co.</b>	<b>N4102, N4113, N4515</b>

Linemaster Switch Corp	C2324
Melttools LLC	N1618
Meta Vision Systems Inc	N5015
Miller Electric Mfg Co.	N5213, N5816
Ningbo Jinfeng Welding & Cutting Machinery Manufacture Co Ltd	N6007
North (Nanjing) Instrument Technology Industries Group	N3226
Ogden Welding Systems	N3035
Pador Marketing Group	N2927
Pandjiris Inc.	N4810
Praxair Inc	N5202
PROFAX / LENCO	N3013
Red Rock Automation/Romar/MEC	N4805
Servo-Robot Inc.	N5907
Team Industries Inc	N2929
TWI North America LLC	N3217
Weld Engineering Co	N4818
Weld.com	N4809
Welding Alloys USA	N4917
<b>Wolf Robotics LLC</b>	<b>N4910</b>

### Welding - Capacitor Discharge

Matuschek Welding Products Inc.	N1708
Southern Copper & Supply	N1926
Southern Stud Weld Inc	N2616
Stud Welding Associates Inc	N6327
Sunstone Engineering	N5916

### Welding - Electron Beam Machines & Components

Cambridge Vacuum Engineering	N3038
D/F Machine Specialties Inc.	N2224
Electron Beam Engineering Inc.	N3306

### Welding - Electronic

International Welding Technologies Inc	N1724
Sunstone Engineering	N5916

### Welding - Fixed Weld Automation Systems

Arc Machines Inc	N5522
Bug-O Systems	N4813, N5013

D/F Machine Specialties Inc.	N2224
Hollbrit Inc.	N6317
Janda Co Inc	N1924
Melttools LLC	N1618
Meta Vision Systems Inc	N5015
Nelson Stud Welding	N5922
Ogden Welding Systems	N3035
Southern Stud Weld Inc	N2616
Stud Welding Associates Inc	N6327

### Welding - Induction Machines & Components

EFD Induction Inc.	C2139
GH Induction Atmospheres LLC	C2323
Miller Electric Mfg Co.	N5213, N5816
Ogden Welding Systems	N3035
Radyne Corp	N5024
Richardson Electronics Ltd	C3721
<b>Thermatool Corp</b>	<b>C2110</b>
WAFIOS Machinery Corp	C1736

### Welding - Laser Beam Machines & Components

Alabama Laser	N6322
AltaMAR Inc	C1522
Dinse Inc	N2717
II-VI Infrared	C4924
IPG Photonics	N3931
Laser Mechanisms Inc	C3810
<b>LaserStar Technologies Corp</b>	<b>C5647</b>
LT Ultra Precision Optics	C8223
Melttools LLC	N1618
OR Lasertechnology Inc.	C7345
Richardson Electronics Ltd	C3721
Servo-Robot Inc.	N5907
Sunstone Engineering	N5916
Technogenia Inc	N4924
<b>TRUMPF Inc.</b>	<b>C3016</b>
Wayne Trail, a Lincoln Electric Company	N4513
Weil Engineering North America	C8209
Weld.com	N4809
Witt Gas Controls	N3124

### Welding - Micro Welding

Matuschek Welding Products Inc.	N1708
Melttools LLC	N1618
Ogden Welding Systems	N3035
Rocklin Manufacturing Co.	C1433
Sunstone Engineering	N5916
WEMCO	N1627





## Welding - Orbital Machines & Components

AMET Inc. ....	N4518
Arc Machines Inc. ....	N5522
Arc Products. ....	N4507
Bug-O Systems. ....	N4813, N5013
Diamond Ground Products Inc. ....	N5726
EH Wachs Co. ....	N5713
Liburdi Automation Inc. ....	N3609
Magnatech LLC. ....	N6133
Matheson. ....	N6122
Meltools LLC. ....	N1618
MK Products Inc. ....	N2804
<b>Orbitalum Orbital Cutting</b>	
+ <b>Welding</b> .....	<b>N5713</b>
Robotic Technologies of TN. ....	N6025
Swagelok Marketing Services Co. ....	N3431
Tri Tool Inc. ....	N5913
Weldlogic Inc. ....	N5826
York Portable Machine Tools. ....	N2925

## Welding - Oxyfuel Machines & Components

American Torch Tip Co Inc. ....	N2022
Bug-O Systems. ....	N4813, N5013
Flame Technologies Inc. ....	N3219
IBEDA /Superflash Compressed Gas Equipment Inc. ....	N3437
<b>Koike Aronson Inc.</b> .....	<b>N4131</b>
<b>Thermacut Inc.</b> .....	<b>N5508</b>
Uniweld Products Inc. ....	N5113
Weld.com. ....	N4809
Western Enterprises. ....	N2933
Witt Gas Controls. ....	N3124

## Welding - Plastic Welding Machines & Components

IPG Photonics. ....	N3931
Richardson Electronics Ltd. ....	C3721

## Welding - Portable MIG Welder

Bore Repair Systems Inc. ....	N6319
Bug-O Systems. ....	N4813, N5013
MAGMAWELD. ....	N1628
Miller Electric Mfg Co. ....	N5213, N5816
North (Nanjing) Instrument Technology Industries Group. ....	N3226
Robotic Technologies of TN. ....	N6025
Weld.com. ....	N4809

## Welding - Resistance (Flash & Upset) Machines & Comp.

Etal/INDUX Sa De Cv. ....	N2433
Ideal Welding Systems LP. ....	N5008
Janda Co Inc. ....	N1924
Nylok LLC. ....	N1624

RWMA. ....	N1626
Southern Copper & Supply. ....	N1926
TJ Snow Co. ....	N2613
WAFIOS Machinery Corp. ....	C1736
ZJ Industries Inc. ....	N2704

## Welding - Resistance (Seam) Machines & Components

Carestream. ....	N2426
<b>Centerline (Windsor) Ltd.</b> .....	<b>N1926</b>
<b>Dengensha America Corp.</b> .....	<b>N5722</b>
Etal/INDUX Sa De Cv. ....	N2433
Guild International. ....	C2234
Janda Co Inc. ....	N1924
Linemaster Switch Corp. ....	C2324
Matuschek Welding Products Inc. ....	N1708
Ningbo Powerway Alloy Material Co Ltd. ....	N5038
Southern Copper & Supply. ....	N1926
Sunstone Engineering. ....	N5916
<b>Thermatool Corp.</b> .....	<b>C2110</b>
TJ Snow Co. ....	N2613
Toolmen Corp. ....	C1253
Weld.com. ....	N4809
ZJ Industries Inc. ....	N2704

## Welding - Resistance (Spot) Machines & Components

Bay State Surface Technologies. ....	N2419
Bettcher Manufacturing LLC. ....	C1053
BMM Welding Material Co. ....	N6109
<b>Centerline (Windsor) Ltd.</b> .....	<b>N1926</b>
Clips & Clamps Industries. ....	C148
D/F Machine Specialties Inc. ....	N2224
<b>Dengensha America Corp.</b> .....	<b>N5722</b>
Etal/INDUX Sa De Cv. ....	N2433
Fronius USA LLC. ....	N3425
Ideal Welding Systems LP. ....	N5008
International Technologies Inc. ....	C8111
Janda Co Inc. ....	N1924
KME Germany GmbH & Co KG. ....	N1525
Koyo Giken Inc. ....	N3109
Linemaster Switch Corp. ....	C2324
Matuschek Welding Products Inc. ....	N1708
Ningbo Powerway Alloy Material Co Ltd. ....	N5038
Parker domnick hunter. ....	N1513
PROFAX / LENCO. ....	N3013
Rocklin Manufacturing Co. ....	C1433
Secoa Technology. ....	N1719
SMK Co Ltd. ....	N1524
Southern Copper & Supply. ....	N1926
Sunstone Engineering. ....	N5916
TJ Snow Co. ....	N2613
Toolmen Corp. ....	C1253
Vacco Industries. ....	C8431

Wayne Trail, a Lincoln Electric Company. ....	N4513
ZJ Industries Inc. ....	N2704

## Welding - Resistance Welding Controls

<b>Dengensha America Corp.</b> .....	<b>N5722</b>
Etal/INDUX Sa De Cv. ....	N2433
Janda Co Inc. ....	N1924
Matuschek Welding Products Inc. ....	N1708
Parker domnick hunter. ....	N1513
SMK Co Ltd. ....	N1524
Southern Copper & Supply. ....	N1926
TJ Snow Co. ....	N2613
Toolmen Corp. ....	C1253

## Welding - Solid State (Friction, Ultrasonic, Explosive) Mach. & Comp.

Attexor Clinch Systems SA. ....	C5622
Fabrisonic LLC. ....	N6218
Superior Products. ....	N2517

## Welding - Thermic/Exothermic Machines & Components

C H Symington & Co Inc. ....	N2213
------------------------------	-------

## Welding Blankets

Auburn Manufacturing Inc. ....	N4904
AVS Industries LLC. ....	N6018
Changzhou Wujin Golden Globe Welding & Cutting Machinery Co Ltd. ....	N5900
Frommelt Safety Products. ....	N4827
Kimberly-Clark Professional. ....	N3407
Pan Taiwan Enterprise. ....	N1718
PDS Bartech Inc. ....	N5917
Pyro Shield Inc. ....	N6313
Sellstrom Manufacturing Co. ....	N3413
Steiner Industries. ....	N3022
Winnox Industries Ltd. ....	N6111

## Welding Flux Recovery Systems

Bug-O Systems. ....	N4813, N5013
Corewire Ltd. ....	N2910
Harbert's Products Inc/Allied Flux Reclaiming Ltd. ....	N4824
Red Rock Automation/ Romar/MEC. ....	N4805
Weld Engineering Co. ....	N4818
Weld.com. ....	N4809

## Welding Guns/Torches

<b>ABICOR Binzel Corp.</b> .....	<b>N5508</b>
American Torch Tip Co Inc. ....	N2022
<b>ArcOne.</b> .....	<b>N3231</b>
<b>Bernard.</b> .....	<b>N5516</b>



- Bore Repair Systems Inc. . . . . N6319  
 Bug-O Systems . . . . . N4813, N5013  
 C H Symington & Co Inc . . . . . N2213  
 Changzhou Huarui Welding  
 & Cutting Equip Co Ltd . . . . . N5126  
 Changzhou Wujin Golden Globe Welding  
 & Cutting Machinery Co Ltd . . . . . N5900  
 CK Worldwide . . . . . N3615  
 Climax Portable Machining &  
 Welding Systems . . . . . N1422  
 CM Industries Inc . . . . . N2810  
 D/F Machine Specialties Inc. . . . . N2224  
 Dinse Inc . . . . . N2717  
 Direct Wire & Cable . . . . . N2519  
 Fronius USA LLC . . . . . N3425  
 HAI Advanced Material Spec . . . . . N2319  
 Jingyu Welding & Cutting Co Ltd . . . . . N1608  
 Kennametal Stellite . . . . . N2528  
 Liburdi Automation Inc . . . . . N3609  
 Lincoln Electric Co. . . . . N4102,  
 N4113, N4515  
 LONGEVITY Welding &  
 Cutting Products . . . . . N5109  
 Matheson . . . . . N6122  
 MK Products Inc . . . . . N2804  
 North (Nanjing) Instrument  
 Technology Industries Group. . . . . N3226  
 OKI Bering . . . . . N4531  
 Praxair Inc . . . . . N5202  
 PROFAX / Lenco . . . . . N3013  
 REXARC International . . . . . N1515  
 TEC Torch Co Inc . . . . . N4822  
 Technogenia Inc . . . . . N4924  
 Thermacut Inc . . . . . N5508  
 Trafimet USA . . . . . N2725  
 Tregaskiss . . . . . N5513  
 Uniweld Products Inc . . . . . N5113  
 Victor Technologies Intl Inc. . . . . N4522  
 Weldcraft . . . . . N5516  
 York Portable Machine Tools . . . . . N2925  
 ZJ Industries Inc . . . . . N2704
- Welding Helmets, Respirators & Accessories**  
 3M . . . . . N5502  
 Antec Electronics Co Ltd . . . . . N1609  
 ArcOne . . . . . N3231  
 Changzhou Huarui Welding  
 & Cutting Equip Co Ltd . . . . . N5126  
 Changzhou Shine Science &  
 Technology Co Ltd . . . . . N2527  
 Fastenal Company . . . . . N5736  
 Fibre-Metal By Honeywell . . . . . N2006  
 Fronius USA LLC . . . . . N3425  
 Goldland Industrial Co Ltd. . . . . N6300
- Interactive Safety Product Inc. . . . . N3206  
 Jingyu Welding & Cutting Co Ltd . . . . . N1608  
 Kimberly-Clark Professional . . . . . N3407  
 Lincoln Electric Co. . . . . N4102,  
 N4113, N4515  
 Matheson . . . . . N6122  
 Miller Electric Mfg Co. . . . . N5213, N5816  
 North (Nanjing) Instrument  
 Technology Industries Group. . . . . N3226  
 Pan Taiwan Enterprise . . . . . N1718  
 Praxair Inc . . . . . N5202  
 Sellstrom Manufacturing Co. . . . . N3413  
 SKM Industries Inc . . . . . N1717  
 TECMEN Electronics Co Ltd . . . . . N2427  
 Weld.com . . . . . N4809  
 Wenzhou Xidin Electronics  
 Technology Co Ltd . . . . . N6209  
 Yunnan Hengyu Optical Electronics  
 Co (Optech Co) . . . . . N4918
- Welding Inserts (Consumable)**  
 Changzhou Huarui Welding &  
 Cutting Equip Co Ltd . . . . . N5126  
 D/F Machine Specialties Inc. . . . . N2224  
 Dinse Inc . . . . . N2717  
 Direct Wire & Cable . . . . . N2519  
 Formdrill USA Inc . . . . . C2222  
 KME Germany GmbH & Co KG . . . . . N1525  
 Matheson . . . . . N6122  
 Ningbo Powerway Alloy  
 Material Co Ltd . . . . . N5038  
 Osborn . . . . . C2737, N3309  
 Praxair Inc . . . . . N5202  
 Saar Hartmetall USA LLC . . . . . N5925  
 Secoa Technology . . . . . N1719  
 Southern Copper & Supply . . . . . N1926  
 Trystar . . . . . N1818  
 Victor Technologies Intl Inc. . . . . N4522
- Welding Power Cables & Connectors/Lugs**  
 ABICOR Binzel Corp. . . . . N5508  
 Bernard . . . . . N5516  
 C H Symington & Co Inc . . . . . N2213  
 Changzhou Huarui Welding  
 & Cutting Equip Co Ltd . . . . . N5126  
 CK Worldwide . . . . . N3615  
 CM Industries Inc . . . . . N2810  
 D/F Machine Specialties Inc. . . . . N2224  
 Dinse Inc . . . . . N2717  
 Direct Wire & Cable . . . . . N2519  
 Fronius USA LLC . . . . . N3425  
 Jingyu Welding & Cutting Co Ltd . . . . . N1608  
 Kalas: Industrial . . . . . N2026  
 PDS Bartech Inc. . . . . N5917  
 PROFAX / Lenco . . . . . N3013
- Staubli Corp Multi Contact USA . . . . . N3636  
 Stud Welding Associates Inc . . . . . N6327  
 Trafimet USA . . . . . N2725  
 Trystar . . . . . N1818  
 Weldcraft . . . . . N5516
- Welding Power Supplies - Electron Beam**  
 BMM Welding Material Co . . . . . N6109  
 Electron Beam Engineering Inc. . . . . N3306  
 PTR-Precision Technologies Inc . . . . . N5226
- Welding Power Supplies - GMAW/GTAW**  
 Arc Machines Inc . . . . . N5522  
 Capital Weld Cleaners . . . . . N3007  
 Cloos Robotic Welding Inc . . . . . N3618  
 EH Wachs Co. . . . . N5713  
 ESAB Welding &  
 Cutting Products . . . . . N3922, N4122  
 Fronius USA LLC . . . . . N3425  
 Hotfoil EHS Inc . . . . . N1319  
 Liburdi Automation Inc . . . . . N3609  
 Lincoln Electric Co. . . . . N4102,  
 N4113, N4515  
 LONGEVITY Welding &  
 Cutting Products . . . . . N5109  
 MAGMAWELD . . . . . N1628  
 Magnatech LLC . . . . . N6133  
 Miller Electric Mfg Co. . . . . N5213, N5816  
 Miller Welding Automation . . . . . N5513  
 MK Products Inc . . . . . N2804  
 Orbitalum Orbital Cutting  
 + Welding . . . . . N5713  
 OTC DAIHEN Inc . . . . . N3622  
 Praxair Inc . . . . . N5202  
 Swagelok Marketing Services Co. . . . . N3431  
 Victor Technologies Intl Inc. . . . . N4522  
 Weld.com . . . . . N4809  
 Weldlogic Inc . . . . . N5826
- Welding Power Supplies - Induction**  
 EFD Induction Inc. . . . . C2139  
 GH Induction Atmospheres LLC . . . . . C2323  
 Miller Electric Mfg Co. . . . . N5213, N5816  
 Richardson Electronics Ltd . . . . . C3721  
 Thermatool Corp . . . . . C2110
- Welding Power Supplies - Laser**  
 IPG Photonics . . . . . N3931  
 Liburdi Automation Inc . . . . . N3609  
 OR Lasertechnology Inc. . . . . C7345  
 Richardson Electronics Ltd . . . . . C3721  
 Sunstone Engineering . . . . . N5916  
 Weld.com . . . . . N4809



### Welding Power Supplies - Orbital

Arc Machines Inc	N5522
EH Wachs Co	N5713
Liburdi Automation Inc	N3609
Magnatech LLC	N6133
MK Products Inc	N2804
<b>Orbitalum Orbital Cutting</b>	
+ Welding	N5713
Swagelok Marketing Services Co	N3431
Weldlogic Inc	N5826

### Welding Power Supplies - Plasma Arc

AMET Inc	N4518
Changzhou Huarui Welding & Cutting Equip Co Ltd	N5126
Diamond Ground Products Inc	N5726
<b>ESAB Welding &amp; Cutting Products</b>	N3922, N4122
JASIC Technology Co Ltd	N2019
Kalas: Industrial	N2026
Liburdi Automation Inc	N3609
LONGEVITY Welding & Cutting Products	N5109
Meltric Corp	N4826
Multiplaz	N4909
<b>OTC DAIHEN Inc</b>	N3622
PythonX-Burlington Automation	C8116
Victor Technologies Intl Inc	N4522
Weld.com	N4809
Weldlogic Inc	N5826

### Welding Power Supplies - Resistance

Etal/INDUX Sa De Cv	N2433
Fronius USA LLC	N3425
Janda Co Inc	N1924
Matuschek Welding Products Inc	N1708
Pyro Shield Inc	N6313
Southern Copper & Supply	N1926
Sunstone Engineering	N5916
<b>Thermatool Corp</b>	C2110
TJ Snow Co	N2613

### Welding Power Supplies - SMAW/SAW

<b>ESAB Welding &amp; Cutting Products</b>	N3922, N4122
Harbert's Products Inc/ Allied Flux Reclaiming Ltd	N4824
<b>Lincoln Electric Co</b>	N4102, N4113, N4515
LONGEVITY Welding & Cutting Products	N5109
MAGMAWELD	N1628

Miller Electric Mfg Co	N5213, N5816
Weld.com	N4809

### Welding Power Supplies - Solid State

EFD Induction Inc	C2139
International Welding Technologies Inc	N1724
IPG Photonics	N3931
Nelson Stud Welding	N5922
Southern Stud Weld Inc	N2616
Stud Welding Associates Inc	N6327
<b>Thermatool Corp</b>	C2110

### Welding Rod & Flux Drying Ovens

Golden Eagle Minmetals(Beijing) Wldg Materials Co	N5800
Gullico International	N5002
Harbert's Products Inc/ Allied Flux Reclaiming Ltd	N4824
Phoenix International Inc	N2328
PROFAX / Lenco	N3013
Weld Engineering Co	N4818

### Welding Stands/Platens/ Positioners/Manipulators

ALM Materials Handling	N5927
AMET Inc	N4518
Arc Specialties Inc	N1610
B&B Steel Products Inc	N3107
Bluco Corp	N2819
Genesis Systems Group	N3913
Genstar Technologies Inc	N2822
Gullico International	N5002
Industrial Magnetics Inc	C5728
<b>Irc Automation Inc</b>	N2431
Jetline Engineering	N5813
<b>Koike Aronson Inc</b>	N4131
KUKA Robotics Corporation	N5702
Linemaster Switch Corp	C2324
Master Magnetics	C4733
Matheson	N6122
Preston-Eastin Inc	N5731
<b>Ptr-Precision Technologies Inc</b>	N5226
Red Rock Automation/Romar/MEC	N4805
<b>Strong Hand Tools</b>	N3631
Team Industries Inc	N2929
Weld.com	N4809
Weldcoa	N3238
Weldsale LLC	N5124
<b>Wolf Robotics LLC</b>	N4910

### Welding Tips/Nozzles

<b>ABICOR Binzel Corp</b>	N5508
American Torch Tip Co Inc	N2022

<b>Bernard</b>	N5516
BMM Welding Material Co	N6109
C H Symington & Co Inc	N2213
Changzhou Huarui Welding & Cutting Equip Co Ltd	N5126
Changzhou Wujin Golden Globe Welding & Cutting Machinery Co Ltd	N5900
CK Worldwide	N3615
Climax Portable Machining & Welding Systems	N1422
CM Industries Inc	N2810
D/F Machine Specialties Inc	N2224
Diamond Ground Products Inc	N5726
Dinse Inc	N2717
Fastenal Company	N5736
Flame Technologies Inc	N3219
Fronius USA LLC	N3425
Goss Inc	N2722
Hydro Carbide Inc	C8238
<b>Hypertherm Inc</b>	N3906
II-VI Infrared	C4924
Kennametal Stellite	N2528
LONGEVITY Welding & Cutting Products	N5109
MK Products Inc	N2804
Ningbo Jinfeng Welding & Cutting Machinery Manufacture Co Ltd	N6007
North (Nanjing) Instrument Technology Industries Group	N3226
OKI Bering	N4531
Praxair Inc	N5202
PROFAX / Lenco	N3013
Secoa Technology	N1719
TEC Torch Co Inc	N4822
Termmei Torch & Tip Company	N2526
<b>Thermacut Inc</b>	N5508
Trafimet USA	N2725
<b>Tregaskiss</b>	N5513
Uniweld Products Inc	N5113
Victor Technologies Intl Inc	N4522
<b>Weldcraft</b>	N5516
ZJ Industries Inc	N2704

### Welding Wire

AMETEK Specialty Metal Products for Fab	C914
Ampco Metal Inc	C2326
ATI Stellram	N1733
Bay State Surface Technologies	N2419
Benxi Guangzheng Tungsten & Molybdenum Co Ltd	C456
BMM Welding Material Co	N6109
Bohler Welding Group USA Inc	N2013
Broco Inc	N4926



Changzhou Huarui Welding & Cutting Equip Co Ltd . . . . .	N5126	Welding Alloys USA . . . . .	N4917
Changzhou Huatong Welding Industry Co Ltd . . . . .	N6310	Winnox Industries Ltd. . . . .	N6111
Changzhou Wujin Golden Globe Welding & Cutting Machinery Co Ltd . . . . .	N5900	<b>Wire - Raw Materials</b>	
Changzhou Zhengyang Welding Material Co Ltd. . . . .	N2306	AMETEK Specialty Metal	
Corewire Ltd . . . . .	N2910	Products for Fab . . . . .	C914
COR-MET INC . . . . .	N5534	Bay State Surface Technologies. . . . .	N2419
<b>ESAB Welding &amp; Cutting Products. . . . .</b>	<b>N3922, N4122</b>	Benxi Guangzheng Tungsten & Molybdenum Co Ltd . . . . .	C456
Fastenal Company. . . . .	N5736	Changzhou Zhengyang Welding Material Co Ltd. . . . .	N2306
Golden Eagle Minmetals(Beijing)		Haynes International. . . . .	N1617
Wldg Materials Co. . . . .	N5800	JLC Electromet Pvt LLC . . . . .	N5138
Harbert's Products Inc/ Allied Flux Reclaiming Ltd . . . . .	N4824	Nanjing Youtian Metal Technology Co Ltd. . . . .	N1616
Haynes International. . . . .	N1617	<b>Nevatia Steel &amp; Alloys Pvt LTD. . . . .</b>	<b>N2824</b>
<b>Hobart Brothers. . . . .</b>	<b>N5516</b>	Termmei Torch & Tip Company . . . . .	N2526
Intercon Enterprises Inc . . . . .	N3227	<b>Wire EDM</b>	
JLC Electromet Pvt LLC . . . . .	N5138	A-G Tool & Die . . . . .	C920
Kennametal Stellite . . . . .	N2528	<b>Chelar Tool &amp; Die Inc . . . . .</b>	<b>C349</b>
Kobelco Welding of America Inc . . . . .	N3938	Elizabeth Carbide Components. . . . .	C150
<b>LaserStar Technologies Corp . . . . .</b>	<b>C5647</b>	F & G Tool and Die Co. . . . .	C1413
LONGEVITY Welding & Cutting Products . . . . .	N5109	<b>Marion Die &amp; Fixture Inc. . . . .</b>	<b>C5520</b>
MAGMAWELD . . . . .	N1628	Moeller Precision Tool . . . . .	C1020
Matheson . . . . .	N6122	Passline Performance . . . . .	C2325
Messer MG Welding Products . . . . .	N2408	Precision Punch Corp. . . . .	C1432
MK Products Inc . . . . .	N2804	TOP YES Precision Metal Products Co LTD . . . . .	C1028
MMC Superalloy Corp. . . . .	N1826	Uelner Precision Tools & Dies. . . . .	C937
Nanjing Youtian Metal Technology Co Ltd. . . . .	N1616	Ultratech Tool & Design Inc . . . . .	C1332
<b>Nevatia Steel &amp; Alloys Pvt LTD. . . . .</b>	<b>N2824</b>	Victory Tool . . . . .	C246
Ningbo Powerway Alloy Material Co Ltd. . . . .	N5038	<b>Wire Forming Machines</b>	
North (Nanjing) Instrument Technology Industries Group. . . . .	N3226	AIM Inc . . . . .	C1832
OKI Bering . . . . .	N4531	Bliss Clearing Niagara . . . . .	C933
OR Lasertechnology Inc. . . . .	C7345	Clips & Clamps Industries. . . . .	C148
Polymet Corp. . . . .	N2313	Joysun Abrasives Co Ltd. . . . .	N3208
Praxair Inc . . . . .	N5202	Lillbacka Powerco USA Inc. . . . .	C2132
Rocklin Manufacturing Co. . . . .	C1433	Midwest Bender Services Corp . . . . .	C1728
Sandvik Materials Technology . . . . .	N3019	Starrett Bytewise Measurement Systems. . . . .	C3453
Special Metals Welding Products Co . . . . .	N3118	Tianjin Xuzhi Machinery & Electrical Equipment Co Ltd . . . . .	N1431
Technogenia Inc . . . . .	N4924	TJ Snow Co. . . . .	N2613
ThyssenKrupp VDM USA, LLC. . . . .	N5931	Toolmen Corp . . . . .	C1253
Tianjin Jinlong Welding Material Co Ltd. . . . .	N6100	Ulbrich Stainless Steels & Special Metals Inc . . . . .	C1015
Tianjin Xuzhi Machinery & Electrical Equipment Co Ltd . . . . .	N1431	WAFIOS Machinery Corp . . . . .	C1736
Uniweld Products Inc . . . . .	N5113	<b>Wauseon Machine &amp; Manufacturing Inc. . . . .</b>	<b>C1539</b>
Weld.com . . . . .	N4809		

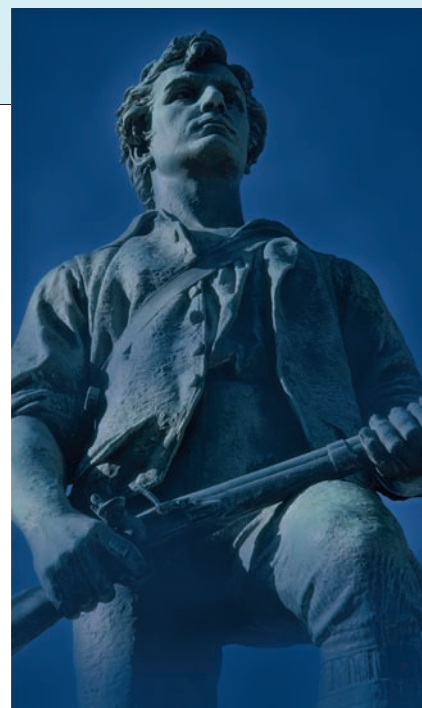

**Metalworking is  
Your Business.**

**Insuring Metalworkers  
is Sentry's Business.**

Find out how Sentry's  
expertise can help keep  
your metalworking facility  
safe, reduce your losses and  
hold the line on insurance  
premiums. For your  
insurance and safety needs,  
**CALL TODAY!**

**1-877-373-6879**  
**sentry.com**



**SENTRY®**  
**INSURANCE**

**Visit us in Booth C4926**

Property and casualty coverages and safety services are underwritten, issued and/or administered by a member of the Sentry Insurance Group, Stevens Point, WI. For a complete listing of companies, visit [sentry.com](http://sentry.com). Policies, coverages, benefits and discounts are not available in all states. See policy for complete coverage details.

© Captain John Parker image. 40-3072 729898 1/18/11

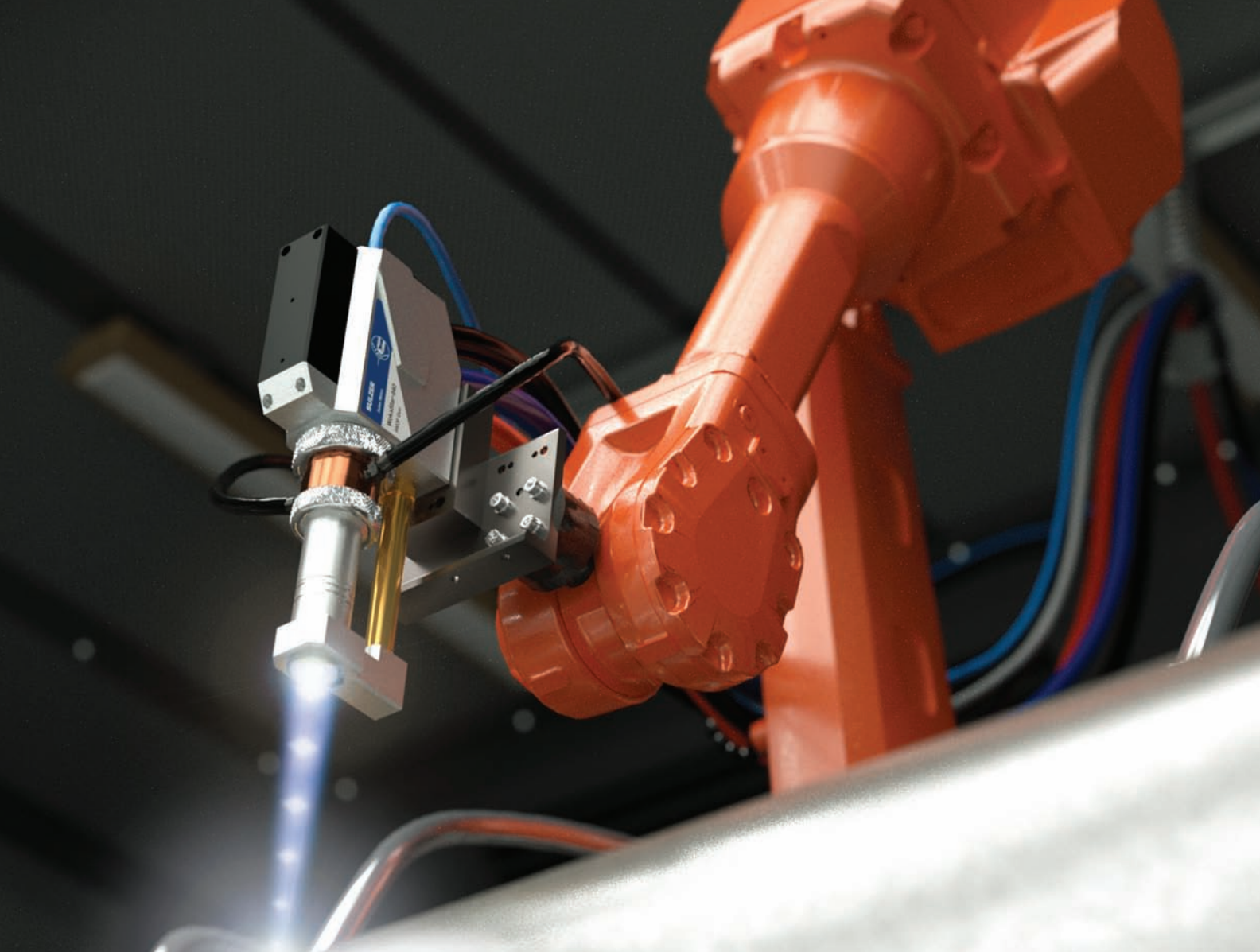

# Maximize Product Potential Minimize Production Costs With Hard-Working, Efficient Surfaces

## We have your surface solutions for:

Abrasion • Erosion • Fretting • Sliding Wear • Impact  
• Corrosion • Oxidation • Thermal Effects • Electrical  
Conductivity or Resistance • Shielding • Restoration  
• And More

Talk to us. Let us show you how to benefit from our expertise as a leading global supplier of solutions, products and services for thermal spray, brazing, PTA, laser-cladding, welding, and other functional surface technologies.

© 2012 Sulzer Metco

Meet us at:

**FABTECH International & AWS Welding Show**  
November 12 – 14, 2012, Las Vegas Convention Center,  
NV, U.S.A.,  
Booth# 2413

[info@sulzermetco.com](mailto:info@sulzermetco.com)  
[www.sulzer.com](http://www.sulzer.com)

## SULZER





Proven by People. Powered by Plex Online.



**Cloud ERP**  
**The evolution**  
**of information**  
**for manufacturers.**

*Learn how high-performing manufacturers have evolved. [www.plex.com/evolution](http://www.plex.com/evolution)*

**Run a better business from the ground up.** Cloud ERP from Plex Online integrates operational data from the shop floor and communicates it in real time to management on the top floor. From small manufacturing facilities to global operations, high-performing manufacturers are using Cloud ERP to drive business growth. Make better decisions with anywhere, anytime access to information about your manufacturing processes. **Evolve your business with Cloud ERP, the evolution of IT.**



**Provider of Plex Online**

**Cloud ERP for Manufacturers**

**Plex Systems, Inc.**

[www.plex.com](http://www.plex.com) • [info@plex.com](mailto:info@plex.com)

**855.534.8012**



[www.twitter.com/PlexSystems](https://twitter.com/PlexSystems)

**Visit us in Booth C913**

**FLOOR PLAN**



# ALL-IN-ONE Innovation Demonstration

*Experience it in booth C653*



## So you want to win more jobs? Do more with less?

Then you must innovate. Whether it's through technology, process, production, or costs, the choice is yours; *why not choose them all?*

## SEYI will show you how. Come to booth C653.

Experience a hands-on demonstration of SEYI's Direct Drive Servo press technology. Take away practical examples and insight on how to decrease forming stages, increase throughput, and save money... all in one SEYI press system.

### The Main Attraction

*"Increasing throughput with Pendulum Motion"*



Using a multi-stage progressive stamping operation, we'll show you how to nearly double your throughput.

### Hands-On How-To

- ▶ Getting your feed line in-sync.
- ▶ Controller Programming 101.
- ▶ Calculating your investment ROI.

**Free drink tickets** for the SEYI-sponsored bar when you come to booth C653 on Monday, November 12.



**SEYI**  
PRESSING AHEAD

# INTERNATIONAL EXHIBITORS



## Australia

### **Bradbury Group Australia** . . Booth C5520

Bending/Forming, Coil Processing, Material Handling/Marking, Saws & Cut-off Machines, Tooling

### **CNC Automotion** . . . . . Booth C7450

### **Lazer Safe Pty Ltd** . . . . . Booth C3824

Press Brakes, Safety & Environmental

### **Rimco Equipment** . . . . . Booth N1631

Business Services, Material Handling/Marking, Plate & Structural Fabricating, Robotics, Safety & Environmental, Tube & Pipe Fabricating or Welding, Welding Machines/Equipment

## Austria

### **Linsinger**

### **Maschinenbau GmbH** . . . . . Booth C1558

## Canada

### **AGT** . . . . . Booth N2333

Assembly, Robotics

### **BESSEY Tools**

### **North America** . . . . . Booth N4931

Cutting, Fastening & Joining, Lubrication, Material Handling/Marking, Other Machinery/Equipment/Parts/Products

### **Blow Press Co.** . . . . . Booth C857

### **Brandt Engineered**

### **Products Ltd** . . . . . Booth C1755

Business Services, Inspection & Testing, Job Shop/Contract Manufacturing, Tube & Pipe Fabricating or Welding, Tube & Pipe Producing

### **Brown Boggs** . . . . . Booth C1409

Stamping

### **BTM Bandsaws** . . . . . Booth C8416

Material Handling/Marking, Saws & Cut-off Machines

### **Centerline (Windsor) Ltd** . . Booth N1926

Assembly, Finishing, Punching, Resistance Welding, Robotics, Thermal Spraying, Tool & Die, Welding Consumables

### **CFCM Canadian Finishing & Coatings Manufacturing** . . Booth C2747

Business Services

### **CorActive High Tech** . . . . . Booth C8446

### **Creaform 3d** . . . . . Booth C552

Business Services, Inspection & Testing

### **Desch Canada Ltd** . . . . . Booth C1235

Other Machinery/Equipment/Parts/Products

## OFFLINE ROBOTIC PROGRAMMING FOR WELDING APPLICATIONS

- Optimization & checking for singularity, joint limits, collisions...
- Support for custom cycles i.e. touch sensing & seam tracking
- Full simulation including collision detection

NEW VERSION!  
ROBOTMASTER  
V6

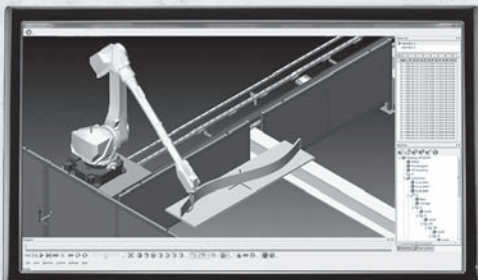

BOOTH #N5933



**Robotmaster**<sup>®</sup>  
CAD/CAM FOR ROBOTS  
www.robotmaster.com | 800.529.5517





## Canada

### **Diversi-Tech Inc. . . . . Booth N1922**

Maintenance & Repair, Other Machinery/  
Equipment/Parts/Products, Safety &  
Environmental

### **Duroair Technologies Inc. . . Booth C1362**

Finishing, Safety & Environmental

### **Forming Technologies Inc. . Booth C1421**

Job Shop/Contract Manufacturing, Software  
& Machine Controls

### **Friggi N.A. Inc. . . . . Booth C7642**

Lasers, Material Handling/Marking, Other  
Machinery/Equipment/Parts/Products, Plate  
& Structural Fabricating, Saws & Cut-off  
Machines, Tube & Pipe Fabricating or  
Welding, Waterjet

### **GINGRAS/**

### **Machinerie G A S . . . . . Booth C3822**

Press Brakes

### **Guspro Inc. . . . . Booth C1952**

Finishing, Other Machinery/Equipment/Parts/  
Products, Safety & Environmental

### **Hex-Hut Shelter**

### **Systems Ltd. . . . . Booth N6115**

Maintenance & Repair, Material Handling/  
Marking, Other Machinery/Equipment/Parts/  
Products, Safety & Environmental

### **Hollbrit Inc . . . . . Booth N6317**

Arc Welding, Finishing, Robotics, Welding  
Machines/Equipment

### **HOT COILS. . . . . Booth N5115**

Inspection & Testing, Job Shop/Contract  
Manufacturing, Other Machinery/Equipment/  
Parts/Products

### **Hyd-Mech Group Ltd. . . . . Booth C6523**

Material Handling & Packaging, Material  
Handling/Marking, Saws & Cut-off Machines

### **I.S.T. International Surface**

### **Technologies . . . . . Booth C1958**

Finishing, Safety & Environmental

### **IrcO Automation Inc. . . . . Booth N2431**

Arc Welding, Material Handling/Marking,  
Robotics, Tube & Pipe Fabricating or Welding

### **ISB Group . . . . . Booth C4728**

Safety & Environmental, Software &  
Machine Controls, Tool & Die

### **J Tech. . . . . Booth C755**

Tool & Die

### **JIT Automation Inc . . . . . Booth C756**

Business Services, Material Handling/  
Marking, Tool & Die

### **Liburdi Automation Inc. . . . Booth N3609**

Arc Welding, Robotics, Tube & Pipe  
Producing, Welding Machines/Equipment

### **Linear Transfer**

### **Automation Inc. . . . . Booth C1223**

Stamping

### **Macrodyne**

### **Technologies Inc . . . . . Booth C252**

Hydroforming, Material Handling &  
Packaging, Material Handling/Marking,  
Punching, Stamping, Tube & Pipe Producing

### **Masteel America Corp . . . . Booth C3749**

Bending/Forming, Machining/EDM, Other  
Machinery/Equipment/Parts/Products, Plate  
& Structural Fabricating, Press Brakes,  
Tooling

### **Meta Vision Systems Inc . . Booth N5015**

Arc Welding, Inspection & Testing, Robotics,  
Tube & Pipe Fabricating or Welding, Welding  
Machines/Equipment

### **Metform International Ltd . . Booth C5534**

Bending/Forming, Business Services, Coil  
Processing, Finishing, Material Handling/  
Marking, Metalforming & Fabricating  
Equipment, Saws & Cut-off Machines,  
Tooling

### **New Centurion**

### **Enterprises Ltd . . . . . Booth C8347**

Bending/Forming, Cutting, Saws & Cut-off  
Machines

### **New Form Tools Ltd. . . . . Booth C2235**

### **Norlok Technology Inc . . . . Booth C4840**

Fastening & Joining, Other Machinery/  
Equipment/Parts/Products

### **OES Inc . . . . . Booth C248**

Business Services, Inspection & Testing,  
Software & Machine Controls

### **Pador Marketing Group . . . Booth N2927**

Arc Welding, Bending/Forming, Material  
Handling/Marking, Robotics, Saws & Cut-off  
Machines

### **Prodevco Industries Inc . . . Booth C8129**

Plate & Structural Fabricating, Robotics

### **Protech Powder Coatings . . Booth C2162**

### **PythonX-Burlington**

### **Automation . . . . . Booth C8116**

Arc Welding, Cutting, Job Shop/Contract  
Manufacturing, Machining/EDM, Material  
Handling/Marking, Other Machinery/  
Equipment/Parts/Products, Plate & Structural  
Fabricating, Robotics, Tooling

### **Rhino Cutting Systems . . . . Booth N6138**

Bending/Forming, Cutting, Plate & Structural  
Fabricating, Tube & Pipe Fabricating or  
Welding, Waterjet

### **Robotiq. . . . . Booth N6119**

Robotics

### **Robotmaster-In-House**

### **Solutions Inc. . . . . Booth N5933**

Arc Welding, Business Services, Job Shop/  
Contract Manufacturing, Robotics, Software  
& Machine Controls

### **Samco Machinery Ltd. . . . . Booth C1217**

Bending/Forming, Coil Processing, Metal  
Suppliers, Stamping, Tooling

### **Samuel Strapping Systems . Booth C1524**

Coil Processing, Material Handling/Marking

### **Servo-Robot Inc . . . . . Booth N5907**

Arc Welding, Inspection & Testing, Robotics,  
Software & Machine Controls, Welding  
Machines/Equipment

### **Shop Edge Software Inc. . . . Booth C1434**

Software & Machine Controls

### **Shred-Tech**

### **Compass Systems . . . . . Booth C7550**

Business Services, Material Handling/  
Marking, Other Machinery/Equipment/Parts/  
Products

### **Tregaskiss. . . . . Booth N5513**

Arc Welding, Robotics, Welding Machines/  
Equipment

### **Trendex Information**

### **Systems Inc. . . . . Booth N3218**

Software & Machine Controls

### **Tubex Technology**

### **Machinery Inc . . . . . Booth C2334**

Finishing, Saws & Cut-off Machines, Tube &  
Pipe Fabricating or Welding

### **Uni-Spray Systems Inc . . . . Booth C2412**

Finishing

### **Virtek Vision International. . Booth C4928**





**VULKAN Blast Shot Technology** ..... Booth C2362  
Finishing

**Westingcut Industrial Technology Anhui Inc** ..... Booth N1424  
Cutting, Lasers, Other Machinery/Equipment/Parts/Products, Plate & Structural Fabricating, Robotics, Tube & Pipe Fabricating or Welding

**Xiris Automation Inc** ..... Booth C2312  
Inspection & Testing

**York Portable Machine Tools** ..... Booth N2925  
Arc Welding, Cutting, Job Shop/Contract Manufacturing, Maintenance & Repair, Other Machinery/Equipment/Parts/Products, Robotics, Welding Machines/Equipment

## China

**Antec Electronics Co Ltd** .. Booth N1609  
Welding Machines/Equipment

**Beijing Essen Welding & Cutting Fair** ..... Booth N6200  
Arc Welding, Welding Consumables

**Beilun Futuo Mechanical Tools Co Ltd** ..... Booth N6026  
Cutting, Finishing, Saws & Cut-off Machines, Tooling

**Benxi Guangzheng Tungsten & Molybdenum Co Ltd** ..... Booth C456  
Fastening & Joining, Metal Suppliers, Other Machinery/Equipment/Parts/Products, Welding Consumables, Welding Machines/Equipment

**BMM Welding Material Co** . Booth N6109  
Brazing & Soldering, Metal Suppliers, Resistance Welding, Thermal Spraying, Welding Consumables, Welding Machines/Equipment

**Changzhou Golden Globe Welding & Cutting Equipment Co Ltd** .. Booth N3236

**Changzhou Huarui Welding & Cutting Equip Co Ltd** ..... Booth N5126  
Arc Welding, Welding Consumables, Welding Machines/Equipment

**Changzhou Huatong Welding Industry Co Ltd** ..... Booth N6310  
Arc Welding, Cutting, Other Machinery/Equipment/Parts/Products, Press Brakes, Welding Consumables

**Changzhou Shine Science & Technology Co Ltd** ..... Booth N2527  
Welding Machines/Equipment

**Changzhou Wujin Golden Globe Welding & Cutting Machinery Co Ltd** ..... Booth N5900  
Job Shop/Contract Manufacturing, Material Handling/Marking, Robotics, Welding Consumables, Welding Machines/Equipment

**Changzhou Zhengyang Welding Material Co Ltd** ..... Booth N2306  
Welding Consumables

**China National Aero Technology IE Hangzhou Co** ..... Booth C160  
Job Shop/Contract Manufacturing, Stamping

**Dalian Xingli Industrial Products Co Inc** ..... Booth C354

**Elo Automated Stainless Steel Technologies Qingdao Co Ltd** ..... Booth C8342  
Arc Welding, Bending/Forming, Cutting, Lasers, Machining/EDM, Other Machinery/Equipment/Parts/Products, Plate & Structural Fabricating, Punching, Robotics, Software & Machine Controls, Stamping, Tube & Pipe Fabricating or Welding

**Etco Industrial Co Ltd** ..... Booth C953

**Fuxin Tianyuan Steel Balls Mfg Co Ltd** ..... Booth C355  
Assembly, Fastening & Joining, Maintenance & Repair, Other Machinery/Equipment/Parts/Products

**Gaozhou City Longsafety Labor Insurance** ..... Booth N6201  
Safety & Environmental

**Golden Eagle Minmetals(Beijing) Wldg Materials Co** ..... Booth N5800  
Metal Suppliers, Welding Consumables, Welding Machines/Equipment

**Goldland Industrial Co Ltd** . Booth N6300  
Welding Machines/Equipment

**Hangzhou Xiangsheng Abrasive Machine Manufacturing Co., Ltd** ..... Booth C7142  
Finishing

**Hebei Shinning Metals Co Ltd** ..... Booth C460

**JASIC Technology Co Ltd** . Booth N2019  
Arc Welding

**Jing County Anhui Haori Import & Export Trading Co Ltd** ..... Booth C7410

**Jingyu Welding & Cutting Co Ltd** ..... Booth N1608  
Cutting, Material Handling/Marking, Welding Consumables, Welding Machines/Equipment

**Jinhua Bieduo Import & Export Co Ltd** ..... Booth N6309

**Joysun Abrasives Co Ltd** .. Booth N3208  
Assembly, Bending/Forming, Cutting, Finishing, Other Machinery/Equipment/Parts/Products, Saws & Cut-off Machines, Tool & Die, Tooling

**Ketec Precision Tooling Co LTD** ..... Booth C3834  
Inspection & Testing, Job Shop/Contract Manufacturing, Press Brakes, Punching, Tooling

**Kong NGAI Precision Metal Mould Shenzhen Co Ltd** .... Booth C856  
Lasers, Machining/EDM, Stamping, Tool & Die, Tooling

**Liaoning Longyuan Industry Co Ltd** ..... Booth C455  
Finishing, Metal Suppliers, Other Machinery/Equipment/Parts/Products, Welding Consumables

**Lucky Harvest Co Ltd** ..... Booth C958  
Job Shop/Contract Manufacturing, Tool & Die, Tooling

**Nanjing Youtian Metal Technology Co Ltd** ..... Booth N1616  
Metal Suppliers, Welding Consumables

**New Fire Co Ltd** ..... Booth N3017  
Safety & Environmental, Welding Consumables

**Newland (Tianjin) Welding Wire and Metal Products Co Ltd** .... Booth N6008

**Ningbo Hi-Tech Moldie Machinery Co Ltd** ..... Booth C356  
Job Shop/Contract Manufacturing, Other Machinery/Equipment/Parts/Products, Stamping, Tool & Die



## China

### **Ningbo Jinfeng Welding & Cutting Machinery Manufacture Co Ltd** ..... Booth N6007

Arc Welding, Assembly, Cutting, Gases & Gas Equipment, Lasers, Robotics, Saws & Cut-off Machines, Tube & Pipe Fabricating or Welding, Welding Machines/Equipment

### **Ningbo Jinhui Precision Casting Co Ltd** ..... Booth C254

Metal Suppliers

### **Ningbo Powerway Alloy Material Co Ltd** ..... Booth N5038

Arc Welding, Brazing & Soldering, Metal Suppliers, Resistance Welding, Welding Consumables

### **North (Nanjing) Instrument Technology Industries Group** ..... Booth N3226

Arc Welding, Cutting, Gases & Gas Equipment, Plate & Structural Fabricating, Safety & Environmental, Welding Consumables, Welding Machines/Equipment

### **Rigo Tools Co Ltd** ..... Booth N6117

### **Shanghai Top Bridge Industry Co Ltd** ..... Booth N6211

### **Shantou Inst of Ultrasonic Instruments Co Ltd (SIUI)** .. Booth N2715

Inspection & Testing

### **Shenyang Machinery Imp and Export Corp LTD** ..... Booth C158

### **Shenzhen Haiyi Tool & Die Ltd** ..... Booth C358

### **Shenzhen Huayuanda Technology Co Ltd** ..... Booth C949

Job Shop/Contract Manufacturing

### **Shenzhen SYH Tooling Co Ltd** ..... Booth C821

Tooling

### **Shijiazhuang Fitex Trading Co Ltd** ..... Booth C159

Inspection & Testing, Job Shop/Contract Manufacturing, Machining/EDM, Other Machinery/Equipment/Parts/Products

### **SteelTailor Ltd** ..... Booth N4919

Cutting, Lasers, Other Machinery/Equipment/Parts/Products, Plate & Structural Fabricating, Robotics

### **Suntex Composite Industrial Co Ltd** ..... Booth N6311

### **TECMEN Electronics Co Ltd** ..... Booth N2427

Welding Machines/Equipment

### **Termmei Torch & Tip Company** ..... Booth N2526

Arc Welding, Cutting, Plate & Structural Fabricating, Safety & Environmental, Welding Consumables, Welding Machines/Equipment

### **Tianjin Jinlong Welding Material Co Ltd** ..... Booth N6100

Brazing & Soldering, Welding Consumables

### **Tianjin Metallurgy Group Flourish Steel Industrial Corp Ltd** .. Booth N1432

### **Tianjin Minmetals NC Co Ltd** ..... Booth N6000

### **Tianjin Xinsen Welding Materials Co Ltd** ..... Booth N6001

### **Tianjin Xuzhi Machinery & Electrical Equipment Co Ltd** ..... Booth N1431

Bending/Forming, Welding Consumables

### **TOP YES Precision Metal Products Co LTD** ..... Booth C1028

Tool & Die

### **Wenzhou Xidin Electronics Technology Co Ltd** ..... Booth N6209

Welding Machines/Equipment

### **Wuhan Welhel Photoelectric Co Ltd** ..... Booth N2307

### **Wuxi Dixin Steel Pipe Co Ltd** ..... Booth C1554

Metal Suppliers, Tube & Pipe Producing

### **Wuxi Ronniewell Machinery** ..... Booth N1707

### **Wuxi Volcano Welding & Cutting** ..... Booth N1606

### **Xinxiang Tianfeng Machinery Manufacture Co Ltd** ..... Booth C7148

Bending/Forming

### **Yunnan Hengyu Optical Electronics Co (Optech Co)** ..... Booth N4918

Welding Machines/Equipment

### **Zhejiang Changzheng Project Carbon Electrodes Co Ltd** ..... Booth N6210

Cutting, Finishing, Tooling, Welding Machines/Equipment

### **Zhejiang Yuguang Aluminium Material Co Ltd** ..... Booth N5901

### **Zhengzhou Anxin Abrasives** ..... Booth N2817

Finishing

## France

### **Clara Vision** ..... Booth N1706

Inspection & Testing, Software & Machine Controls

### **CMF Jammes Rolling and Welding** ..... Booth C5538

Arc Welding, Bending/Forming

### **Logopress Corp** ..... Booth C1423

Business Services, Software & Machine Controls

## Germany

### **Burghardt + Schmidt GmbH** ..... Booth C4934

Coil Processing, Cutting, Maintenance & Repair, Material Handling/Marking

### **Dr Gold & Co** ..... Booth N5026

Material Handling/Marking, Safety & Environmental

### **Forster Welding Systems GmbH** ..... Booth N3325

### **Krautzberger LLC** ..... Booth C1964

Finishing, Robotics

### **KULLEN - KOTI GmbH** ..... Booth N3137

Bending/Forming, Finishing, Other Machinery/Equipment/Parts/Products, Tooling

### **Leifeld Metal Spinning AG** . Booth C8112

Bending/Forming, Other Machinery/Equipment/Parts/Products

### **MTM Meissner Technik Mullenbach GmbH** ..... Booth C2155

Finishing

### **Peter Prinzing GmbH** ..... Booth C5638

Bending/Forming, Metalforming & Fabricating Equipment, Tube & Pipe Fabricating or Welding

### **Spacecontrol GmbH** ..... Booth C8440

### **Worlee-Chemie GmbH** .... Booth C1964

Other Machinery/Equipment/Parts/Products



## Hong Kong

**Winox Industries Ltd. . . . Booth N6111**  
 Brazing & Soldering, Cutting, Finishing,  
 Metal Suppliers, Safety & Environmental,  
 Saws & Cut-off Machines, Welding  
 Consumables, Welding Machines/Equipment

## India

**Metallizing Equipment  
 Co PVT LTD . . . . . Booth N2417**  
 Finishing, Job Shop/Contract Manufacturing,  
 Thermal Spraying

**Nevatia Steel & Alloys  
 Pvt LTD. . . . . Booth N2824**  
 Metal Suppliers, Welding Consumables

**Sahajanand Laser  
 Technology LTD . . . . . Booth C8230**  
 Lasers

**Saru Silver Alloy  
 Private Limited. . . . . Booth N2410**  
 Brazing & Soldering

## Italy

**CR Cuscinetti A Rulli Srl . . . Booth C5636**  
 Machining/EDM, Maintenance & Repair,  
 Other Machinery/Equipment/Parts/Products

**Crippa SPA . . . . . Booth C1828**

**Gasparini SPA . . . . . Booth C5536**  
 Bending/Forming, Tube & Pipe Producing

**Julia Utensili Spa . . . . . Booth C1356**

**MG S.r.L. . . . . Booth C7716**  
 Bending/Forming

**MTM Tube Mills. . . . . Booth C2128**

**TTEngineering . . . . . Booth C3050**

## Japan

**Koyo Giken Inc. . . . . Booth N3109**  
 Resistance Welding

**MMC Superalloy Corp . . . Booth N1826**  
 Metal Suppliers, Welding Consumables

**Sanpo Publications Inc . . . Booth N1507**  
 Business Services

**SMK Co Ltd . . . . . Booth N1524**  
 Resistance Welding, Robotics, Welding  
 Consumables

## Korea (South)

**AW&S Co Ltd . . . . . Booth N2207**

**Dongsan Bearing Co . . . . . Booth C833**  
 Assembly, Other Machinery/Equipment/  
 Parts/Products, Tool & Die

## Mexico

**Etal/INDUX Sa De Cv. . . . . Booth N2433**  
 Brazing & Soldering, Other Machinery/  
 Equipment/Parts/Products, Plate & Structural  
 Fabricating, Resistance Welding, Robotics

**Mexico Industry  
 Newspaper . . . . . Booth N1318**

## Netherlands

**BEWO Cutting Systems. . . . Booth C2128**

## Slovenia

**Gostol TST d.o.o. . . . . Booth C7645**  
 Finishing

## Spain

**Athader . . . . . Booth C5520**  
 Coil Processing, Cutting, Finishing, Material  
 Handling/Marking, Saws & Cut-off Machines

## Switzerland

**Attexor Clinch Systems SA . Booth C5622**  
 Assembly, Fastening & Joining, Finishing,  
 Other Machinery/Equipment/Parts/Products,  
 Punching, Robotics, Stamping, Tooling,  
 Welding Machines/Equipment

**Haeusler AG . . . . . Booth C5540**  
 Assembly, Bending/Forming, Other  
 Machinery/Equipment/Parts/Products, Plate  
 & Structural Fabricating, Tube & Pipe  
 Fabricating or Welding

**OPTREL AG . . . . . Booth N1410**

**Profilbiegetechnik Ag. . . . Booth C2820**

**Stierli Bieger AG . . . . . Booth C2820**

## Taiwan

**Pan Taiwan Enterprise . . . Booth N1718**  
 Safety & Environmental, Welding Machines/  
 Equipment

**YLM - Ying Lin Machine  
 Industrial Co . . . . . Booth C2317**  
 Saws & Cut-off Machines, Tube & Pipe  
 Fabricating or Welding

## Turkey

**Ajan Elektronik  
 Servis San Ve . . . . . Booth N5237**  
 Plate & Structural Fabricating

**Akyapak. . . . . Booth C5545**  
 Plate & Structural Fabricating

**Baykal Makina  
 Sanayi ve Ticaret  
 AS . . . . . Booth C5940, C5947**  
 Bending/Forming, Cutting, Lasers, Other  
 Machinery/Equipment/Parts/Products, Plate  
 & Structural Fabricating, Press Brakes,  
 Punching, Tooling, Tube & Pipe Fabricating or  
 Welding

**MAGMAWELD . . . . . Booth N1628**  
 Arc Welding, Welding Consumables,  
 Welding Machines/Equipment

## United Kingdom

**Corewire Ltd . . . . . Booth N2910**  
 Arc Welding, Maintenance & Repair, Tool &  
 Die, Welding Consumables, Welding  
 Machines/Equipment

**gasgrab.com . . . . . Booth N3225**  
 Assembly & Joining, Cutting, Gases & Gas  
 Equipment, Material Handling/Marking,  
 Safety & Environmental

**International Sheet  
 Metal Review. . . . . Booth C8510**

**Tube & Pipe Technology. . . Booth C1555**

## Vietnam

**North America  
 Consulting . . . . . Booth N6333**  
 Business Services





# Ad Index

<b>Accurpress America</b> .....	187	<b>Fladder - Hansen &amp; Hundebol Inc.</b> ...	Exhibitor List TAB	<b>Plex Systems</b> .....	Floor Plan TAB
<b>AKS Cutting Systems Inc.</b> .....	163	<b>George Koch Sons LLC</b> .....	79	<b>Precision Metalforming Association</b> .....	117
<b>Amada America Inc</b> ...	New Products TAB	<b>InfoSight Corp</b> .....	51	<b>Production Tube Cutting Inc.</b> .....	131
<b>American Welding Society</b> .....	211	<b>IntelliFinishing</b> .....	159	<b>Quaker Chemical Corp.</b> .....	205
<b>BandSawPart.com</b> ..	Exhibitor List TAB, 195	<b>International Metal Tube</b> .....	73	<b>Radan</b> .....	103
<b>Betenbender Manufacturing Inc.</b> .....	79	<b>International Mold Steel</b> .....	169	<b>Robotmaster-In-House Solutions</b> ...	219
<b>Bex Spray Nozzles</b> .....	53	<b>Job Shop Company, The</b> .....	13	<b>Salvagnini America Inc</b> .....	New Products TAB
<b>Binks DeVilbiss Ransburg BGK</b> .....	145	<b>Kolene Corp</b> .....	155	<b>Scotchman Industries Inc</b> .....	87
<b>Bystronic Inc</b> .....	Back Cover	<b>Lawrence Berkeley Lab</b> .....	67	<b>Sentry Insurance</b> .....	217
<b>Carell Corp/ Eagle Bending Machines</b> .....	147	<b>Lincoln Electric Co</b> .....	3	<b>SEYI America Inc.</b> .....	Floor Plan TAB
<b>Chemical Coaters Assoc Int'l.</b> .....	33	<b>LVD Strippit</b> .....	Inside Back Cover	<b>Society of Manufacturing Engineers</b> .....	135
<b>DELTA Computer Systems</b> .....	41	<b>MachineTools.com</b> .....	19	<b>SPANCO Inc</b> .....	29
<b>Dengensha America Corp</b> .....	51	<b>Magic Rack /Production Plus Corp</b> ...	59	<b>SteelTailor Ltd</b> .....	Inside Front Cover
<b>ESAB Welding &amp; Cutting</b> .....	Outsert, 11	<b>Mazak Optonics Corp</b> .....	5	<b>Sulzer Metco US Inc.</b> .....	218
<b>Fabricating &amp; Metalworking Magazine</b> .....	177	<b>MC Machinery Systems/ Mitsubishi</b> .....	Floor Plan Insert, Product Index TAB	<b>TRUMPF Inc.</b> .....	Product Index TAB
<b>Fabricators &amp; Manufacturers Association</b> .....	199	<b>Messer Cutting Systems Inc.</b> .....	185	<b>Tube &amp; Pipe Technology</b> .....	221
<b>FABTECH® 2013</b> .....	226	<b>Murata Machinery USA Inc</b> .....	50	<b>United Performance Metals</b> .....	195
<b>FABTECH® Mexico, AWS Weldmex, METALFORM Mexico</b> .....	146	<b>Nordson Corp</b> .....	95	<b>Universal Tube &amp; Rollform</b> .....	109
<b>FF Journal Magazine</b> .....	149	<b>Norton Abrasives</b> .....	27	<b>Weiler Corp</b> .....	125
		<b>Overton Industries</b> .....	41	<b>West Chester Holdings</b> .....	141



# The world's leading tube and pipe trade magazines



**Pick up your free copy & CD  
at booth #C1555**

Tel: +44 1926 334137  
Fax: +44 1926 314755

**[www.read-tpt.com](http://www.read-tpt.com)  
[www.read-tpi.com](http://www.read-tpi.com)**

SAVE THE DATE

# CHICAGO

2013



North America's Largest Metal Forming, Fabricating,  
Welding and Finishing Event

**NOVEMBER 18-21, 2013**

MCCORMICK PLACE  
CHICAGO, ILLINOIS USA

**[fabtechexpo.com](http://fabtechexpo.com)**

Follow us:   

Co-sponsors:



PMA







OF INNOVATION AND SOLUTIONS

See us at **FABTECH** booth no. **C3937**

# Make it with LVD LASER TECHNOLOGY

Make it **FAST** with the Axel Series



Make it **HEAVY-DUTY** with the Impuls Series



Make it **AUTOMATED** with the Sirius Series



Make it **FOR LESS** with the Orion Series

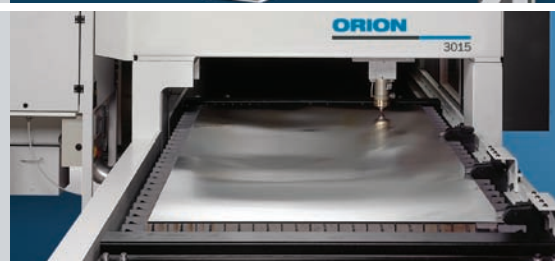

LVD offers a wide range of reliable laser cutting systems to meet any application need. Choose from affordable entry level machines to highly automated systems. Make your choice LVD.

Learn more at [www.makeitwithlvdlasers.com](http://www.makeitwithlvdlasers.com) or call **800-828-1527**.



[www.lvdgroup.com](http://www.lvdgroup.com)

Sheet Metalworking, Our Passion, Your Solution

**Bystronic**

**Best choice.**

**Pure energy.**

**Xcite:** The most innovative electric press brake on the market.

Laser | Bending | Waterjet  
bystronicusa.com

**Introducing  
Xcite  
Booth C4328**



Download the Tag scanner  
app from <http://gettag.mobi>  
and scan this tag.