

2021 **F-650/F-750** Owner's Manual



owner.ford.com



ford.ca



April 2020
Second Printing
Litho in U.S.A.



MC4J19A321 BA



The information contained in this publication was correct at the time of going to print. In the interest of continuous development, we reserve the right to change specifications, design or equipment at any time without notice or obligation. No part of this publication may be reproduced, transmitted, stored in a retrieval system or translated into any language in any form by any means without our written permission. Errors and omissions excepted.

© Ford Motor Company 2020

All rights reserved.

Part Number: 202010 20200318203854

California Proposition 65



WARNING: Operating, servicing and maintaining a passenger vehicle or off-highway motor vehicle can expose you to chemicals including engine exhaust, carbon monoxide, phthalates, and lead, which are known to the State of California to cause cancer and birth defects or other reproductive harm. To minimize exposure, avoid breathing exhaust, do not idle the engine except as necessary, service your vehicle in a well-ventilated area and wear gloves or wash your hands frequently when servicing your vehicle. For more information go to www.P65Warnings.ca.gov/passenger-vehicle.



WARNING: Battery posts, terminals and related accessories contain lead and lead compounds, chemicals known to the State of California to cause cancer and reproductive harm.
Wash your hands after handling.

Table of Contents

Introduction

About This Manual	7
Symbols Glossary	10
Data Recording	13
Perchlorate	17
Ford Credit	17
Replacement Parts Recommendation	17
Special Notices	18
Mobile Communications Equipment	19
Export Unique Options	19
Federal Highway Administration Regulation	20
Entering, Exiting or Climbing on This Vehicle	20

Environment

Protecting the Environment	21
Noise Pollution Control	21

At a Glance

Instrument Panel	22
------------------------	----

Child Safety

General Information	24
Installing Child Restraints	26
Booster Seats	32
Child Restraint Positioning	34
Child Safety Locks	36

Seatbelts

Principle of Operation	37
Fastening the Seatbelts	38
Seatbelt Height Adjustment	41
Seatbelt Warning Lamp and Indicator Chime	42
Seatbelt Reminder	42
Child Restraint and Seatbelt Maintenance	44
Seatbelt Extensions	44

Keys and Remote Controls

General Information on Radio Frequencies	45
Remote Control	46
Replacing a Lost Key or Remote Control	48

Doors and Locks

Locking and Unlocking	49
-----------------------------	----

Security

Passive Anti-Theft System	51
---------------------------------	----

Steering Wheel

Adjusting the Steering Wheel	52
Cruise Control - Vehicles With: Adaptive Cruise Control	52
Cruise Control - Vehicles With: Cruise Control	53
Information Display Control	53
Horn	53

Wipers and Washers

Windshield Wipers	54
Windshield Washers	54

Lighting

General Information	55
Lighting Control	55
Autolamps	56
Instrument Lighting Dimmer	56
Headlamp Exit Delay	56
Daytime Running Lamps	57
Automatic High Beam Control	57
Direction Indicators	58
Interior Lamps	58

Windows and Mirrors

Power Windows	59
Exterior Mirrors	60

Table of Contents

Interior Mirror	62
Sun Visors	62

Instrument Cluster

Gauges	63
Warning Lamps and Indicators	66
Audible Warnings and Indicators	69

Information Displays

General Information	70
Information Messages	73

Climate Control

Manual Climate Control	79
Hints on Controlling the Interior Climate	80
Heated Exterior Mirrors	81

Seats

Sitting in the Correct Position	82
Head Restraints	82
Manual Seats	84
Power Seats	85
Rear Seats	86
Front Seat Armrest	87
Rear Seat Armrest	88

Auxiliary Power Points

Auxiliary Power Points	89
------------------------------	----

USB Ports

Locating the USB Ports	91
Charging a Device	91

Storage Compartments

Overhead Console	92
------------------------	----

Starting and Stopping the Engine

General Information	93
---------------------------	----

Ignition Switch	93
Starting a Gasoline Engine	94
Starting a Diesel Engine	95
Switching Off the Engine	96
Engine Idle Shutdown	96
Engine Block Heater	97

Fuel and Refueling

Safety Precautions	99
Fuel Quality - Diesel	100
Fuel Quality - Gasoline	103
Running Out of Fuel - Diesel	103
Running Out of Fuel - Gasoline	104
Refueling - Diesel	104
Refueling - Gasoline	105
Fuel Consumption	106
Fuel Tank Selector Switch	108

Engine Emission Control

Emission Law	109
Catalytic Converter	110
Selective Catalytic Reductant System - Diesel	112
Diesel Particulate Filter	116

Transmission

Automatic Transmission	122
Power Take-Off	126

Rear Axle

General Information	128
Electronic Locking Differential	128
2-Speed Rear Axle	129

Brakes

General Information	130
Hints on Driving With Anti-Lock Brakes	131
Parking Brake	131
Hill Start Assist	134

Table of Contents

Air Brakes	135
Exhaust Brake	136
Trailer Brakes	138

Traction Control

Principle of Operation	142
Using Traction Control - Vehicles With: Air Brakes	142
Using Traction Control - Vehicles With: Hydraulic Brakes	142

Stability Control

Principle of Operation - Vehicles With: Hydraulic Brakes	144
Principle of Operation - Vehicles With: Air Brakes	145
Using Stability Control	146

Cruise Control - Vehicles With: Adaptive Cruise Control

Using Adaptive Cruise Control	148
-------------------------------------	-----

Cruise Control - Vehicles With: Cruise Control

What Is Cruise Control	154
Switching Cruise Control On and Off	154
Setting the Cruise Control Speed	154
Canceling the Set Speed	155
Resuming the Set Speed	155
Cruise Control Indicators	155

Driving Aids

Driver Alert	156
Lane Keeping System	157
Steering	160
Pre-Collision Assist - Vehicles With: Air Brakes	161
Pre-Collision Assist - Vehicles With: Hydraulic Brakes	163

Load Carrying

Load Limit	168
Air Suspension	169

Towing

Towing a Trailer	171
Recommended Towing Weights	172
Essential Towing Checks	173
Fifth Wheel Operation	174

Driving Hints

General Driving Points	176
Economical Driving	177
Cold Weather Precautions	177
Breaking-In	179
Driving Through Water	180

Roadside Emergencies

Roadside Assistance	181
Hazard Flashers	182
Fuel Shutoff	182
Jump Starting the Vehicle	183
Transporting the Vehicle	185
Towing Points	186

Customer Assistance

Getting the Services You Need	187
In California (U.S. Only)	188
The Better Business Bureau (BBB) Auto Line Program (U.S. Only)	189
Getting Assistance Outside the U.S. and Canada	190
Ordering Additional Owner's Literature	191
Reporting Safety Defects (U.S. Only)	191
Reporting Safety Defects (Canada Only)	192

Table of Contents

Fuses

Fuse Specification Chart	193
Changing a Fuse	201

Vehicle Inspection Guide

Vehicle Inspection Information	203
--------------------------------------	-----

Maintenance

General Information	212
Opening and Closing the Hood	213
Under Hood Overview - 6.7L Diesel	215
Under Hood Overview - 7.3L	216
Engine Oil Dipstick - 7.3L	217
Engine Oil Dipstick - 6.7L Diesel	217
Engine Oil Check - 7.3L	217
Engine Oil Check - 6.7L Diesel	218
Changing the Engine Oil and Oil Filter	219
Oil Change Indicator Reset	220
Changing the Engine Air Filter - 6.7L Diesel	221
Changing the Engine Air Filter - 7.3L	223
Draining the Fuel Filter Water Trap - 6.7L Diesel	225
Engine Coolant Check - 7.3L	226
Engine Coolant Check - 6.7L Diesel	231
Automatic Transmission Fluid Check	236
Brake Fluid Check	237
Power Steering Fluid Check	238
Changing the 12V Battery	239
Adjusting the Headlamps	240
Washer Fluid Check	242
Fuel Filter - 7.3L	242
Checking the Wiper Blades	242
Changing the Wiper Blades	242
Removing a Headlamp	243
Changing a Bulb	243

Changing the Engine-Mounted and Diesel Fuel Conditioner Module Fuel Filters - 6.7L Diesel	244
Electrical System Inspection	247
Air Induction System Inspection	247
Exhaust System Inspection	248
Brake System Inspection	248
Axle Inspection	251
Steering System Inspection	252
Suspension System Inspection	252
Frame and Tow Hook Inspection	253
Rear Axle Fluid Check	253
Spring U-Bolt Check	253

Vehicle Care

General Information	255
Cleaning Products	255
Cleaning the Exterior	256
Waxing	257
Cleaning the Engine	257
Cleaning the Windows and Wiper Blades	257
Cleaning the Interior	258
Cleaning the Instrument Panel and Instrument Cluster Lens	258
Repairing Minor Paint Damage	259
Cleaning the Wheels	259
Vehicle Storage	260

Wheels and Tires

Tire Care	262
Using Snow Chains	277
Changing a Road Wheel	277
Technical Specifications	279

Capacities and Specifications

Engine Specifications - 6.7L Diesel	281
Engine Specifications - 7.3L	282
Motorcraft Parts - 6.7L Diesel	283

Table of Contents

Motorcraft Parts - 7.3L	285	End User License Agreement	351
Vehicle Identification Number	286	Declaration of Conformity	376
Transmission Code Designation	287		
Capacities and Specifications - 6.7L Diesel	288		
Capacities and Specifications - 7.3L	297		
Bulb Specification Chart	305		

Connected Vehicle

Connected Vehicle Requirements	306
Connected Vehicle Limitations	306
Connecting the Vehicle to a Mobile Network	306
Connected Vehicle – Troubleshooting	306

Audio System

General Information	307
Audio Unit	307
Digital Radio	310
Connecting a Bluetooth® Device	312
Streaming Bluetooth Audio	313
Playing Media From a USB Device	313
Using Voice Recognition	313

Accessories

Auxiliary Switches	315
--------------------------	-----

Ford Protect

Ford Protect	317
--------------------	-----

Scheduled Maintenance

General Maintenance Information	319
Normal Scheduled Maintenance	323
Special Operating Conditions Scheduled Maintenance	329
Scheduled Maintenance Record	337

Appendices

Electromagnetic Compatibility	348
-------------------------------------	-----

Introduction

ABOUT THIS MANUAL

Thank you for choosing Ford. We recommend that you take some time to get to know your vehicle by reading this manual. The more that you know about your vehicle, the greater the safety and pleasure you will get from driving it.



WARNING: Driving while distracted can result in loss of vehicle control, crash and injury. We strongly recommend that you use extreme caution when using any device that may take your focus off the road. Your primary responsibility is the safe operation of your vehicle. We recommend against the use of any hand-held device while driving and encourage the use of voice-operated systems when possible. Make sure you are aware of all applicable local laws that may affect the use of electronic devices while driving.

Note: Always use and operate your vehicle in line with all applicable laws and regulations.

Note: Pass on this manual when selling your vehicle. It is an integral part of your vehicle.

Note: Your vehicle's powertrain control systems can detect and store information about vehicle modifications that increase horsepower and torque output such as whether or not performance-enhancing powertrain components commonly referred to as performance chips have been used. This information will stay in the system's memory and cannot be erased even if the modification is removed. Ford Motor Company, Ford of Canada, Ford of Mexico and service or repair facilities can retrieve this information when servicing your vehicle. Ford Motor Company may use this information to determine if your warranty covers any needed repairs.

Note: Some aftermarket products may cause severe engine/transmission and/or exhaust system damage; refer to your warranty information for more information.

Your new diesel engine will feel, drive and function somewhat differently than a gasoline engine. Therefore it is very important that you read and thoroughly familiarize yourself and others operating the vehicle with this guide. There is a special procedure for turning off the diesel engine. See **Starting a Diesel Engine** (page 95). It is important to read and understand this material in order to maintain the best service life for your engine.

Ford may discontinue models or change specifications without any notice and without incurring obligations.

Note: Either Ford Motor Company or an authorized Ford dealer may have originally sold this incomplete vehicle to a vehicle modifier who upfitted it. As a result, some of the options and features on this vehicle may differ from what we describe in this manual.

This manual may qualify the location of a component as left-hand side or right-hand side. The side is determined when facing forward in the seat.

Introduction



E154903

- A Right-hand side.
- B Left-hand side.

Warnings



WARNING: Throughout this guide, you will find warnings identified by the warning symbol. Warnings remind you to be especially careful to reduce the risk of personal injury.

Diesel Engine Information

The diesel engine fuel system is a pressurized two-stage filtration system and consists of:

- A frame-mounted Fuel and Water Separator primary filter with an electric fuel pump and water drain
- An engine-mounted secondary fuel filter
- A fuel injector for each cylinder (8 total)
- A high-pressure fuel pump
- A high-pressure fuel rail for each cylinder bank (2 total)
- Numerous high-pressure pipes from the high-pressure pump to the rails, and rails to the injectors

The fuel and water separator removes both water and impurities from the fuel. The engine-mounted filter filters finer impurities from the diesel fuel. The engine-mounted fuel filter and the frame-mounted fuel filter should be changed at the recommended service interval or when indicated by the information display **LOW FUEL PRESSURE** message. See **Scheduled Maintenance** (page 319).

The fuel and water separator should be drained at regular intervals (recommended at every oil change) or when indicated by the information display and water in fuel indicator light. See **Fuel Quality** (page 100).

Proper fuel filter maintenance and prompt water draining when the water in fuel light illuminates is essential to prevent injection equipment damage. Ignoring the water in fuel light or the information display message **WATER IN FUEL DRAIN FILTER** can cause your vehicle to go into a reduced power mode.

A frame-mounted electric fuel pump located inside the fuel and water separator draws fuel from the fuel tank to provide pressurized fuel to the engine. The fuel pump contains a pressure relief valve for overpressure protection in the event of restricted flow.

The fuel injection system is controlled through the powertrain control module.

Engine Protection Mode

Ford diesel engines are equipped with engine protection and emission control systems. These systems monitor critical temperatures and pressures, and modify engine operation accordingly. These modified engine performance characteristics are normal.

Introduction

If these modified engine performance characteristics persist for an extended period and either the service engine soon or powertrain malfunction, reduced power, electronic throttle control light is illuminated, have the system checked by an authorized dealer.



Service engine soon



Powertrain malfunction, reduced power, electronic throttle control

Diesel Lubrication System

It is important to change the engine oil at the recommended service intervals or when indicated by the information display to maintain oil viscosity. Extending the oil and filter change interval beyond the recommended interval can negatively affect engine performance, fuel economy and engine life. See **Engine Oil Check** (page 218).

Engine and secondary cooling system

The cooling system contains a primary cooling loop to cool the engine and a secondary cooling loop to cool the transmission, charge air, and fuel. The coolant serves three primary purposes: to provide heat transfer, freeze point protection, and corrosion protection using additives.

Vehicles with diesel engines typically are used to carry heavy loads and accumulate mileage rapidly. These two factors may cause the additives in the coolant to wear out in a shorter time. You can find more information about coolant additives and coolant change intervals in the coolant chapter. See **General Maintenance Information** (page 319). Operating the engine with insufficient coolant or coolant additive can cause severe engine damage.

Selective catalytic reduction system

Your vehicle is equipped with a selective catalytic reduction system designed to reduce emission levels of nitrogen oxides from the exhaust of your diesel engine. This system relies on the use of Diesel Exhaust Fluid (DEF) that you must replenish at certain intervals. Failure to maintain proper DEF levels or if the DEF becomes contaminated will result in vehicle speed limitations or result in your vehicle entering an idle-only mode. See **Selective Catalytic Reductant System** (page 112).

Minor Troubleshooting Guide

If the engine won't crank



WARNING: Battery posts, terminals and related accessories contain lead and lead compounds. Wash hands after handling.

Turn on the headlights. If the lights are dim, do not go on at all or when the ignition is turned to the start position, the lights become dim or go out, the battery connections may be loose or corroded, or the battery may be discharged. If there is a clicking or stuttering sound coming from the engine compartment when you turn the key to the start position, this may also indicate a loose or corroded battery connection.

Check the battery connections at the battery posts, cable connection to the engine grounding point and at the starter connection.

If you suspect a discharged battery, have it checked and corrected.

Introduction

- The gearshift lever must be in **P** (Park) or **N** (Neutral) in order for the starter to operate.
- Try operating the starter switch several times. This operation may clean potentially corroded contacts or make the switch temporarily operable until you can reach the dealer.
- If all electrical connections are tight and you need assistance to start, See **Jump Starting the Vehicle** (page 183).

If engine cranks but won't start

Prolonged starter cranking (in excess of 10 seconds) could cause damage to the starter motor or the high-pressure fuel pump.

- Check the fuel gauge. You may be out of fuel. If the gauge shows that there is fuel in the tank, the trouble may be in the electrical system or the fuel system. If equipped with an auxiliary tank, be sure that the tank control switch is set for the tank with fuel and not on an empty tank.
- Leaving your ignition key turned to on for over two minutes without starting may make starting difficult because the glow plugs will cease activation. Reset the system by turning the ignition key to off and then back to on again.

Note: *If the system is out of fuel and the engine will not start, do not continue cranking the engine. Continued cranking can damage the high-pressure fuel pump.*

If the engine runs hot

The following could cause the engine to overheat:

- Lack of coolant
- Dirty cooling system.
- Plugged radiator fins, A/C condenser and/or oil cooler
- Malfunctioning fan drive

- Driving with frozen coolant
- Sticking thermostat
- Overloading or pulling heavy trailers during hot weather
- Grill or radiator air blockage
- Slipping or missing drive belt
- Plugged or very dirty air filter

If fuses burn out



WARNING: Replacement fuses and circuit breakers must always be the same rating as the original equipment shown. Never replace a fuse or circuit breaker with one of a higher rating. Higher rated fuses or circuit breakers could allow circuit overloading in the event of a circuit malfunction, resulting in severe vehicle damage or personal injury due to fire.

Burned-out or blown fuses usually indicate an electrical short-circuit, although a fuse may occasionally burn out from vibration. Insert a second fuse. If this fuse immediately burns out and you cannot locate the cause, return your vehicle to your dealer for a circuit check. See **Changing a Fuse** (page 201).

Selective catalytic reduction system speed limit and Idle-only modes

If the vehicle's speed is limited or in an idle-only mode, the selective catalytic reduction system may be limiting the vehicle's functions due to low or contaminated DEF. Check the DEF. See **Selective Catalytic Reductant System** (page 112).

SYMBOLS GLOSSARY

These are some of the symbols you may see on your vehicle.

Introduction



Air conditioning system



Air conditioning system lubricant type



Anti-lock braking system



Avoid smoking, flames or sparks



Battery



Battery acid



Brake fluid - non petroleum based



Brake system



Brake system



Cabin air filter



Check fuel cap



Child safety door lock or unlock



Child seat lower anchor



Child seat tether anchor



Cruise control



Do not open when hot



Engine air filter



Engine coolant



Engine coolant temperature



Engine oil



Explosive gas



Fan warning



Fasten seatbelt



Flammable



Front airbag



Front fog lamps



Fuel pump reset



Fuse compartment



Hazard flashers



Heated rear window

Introduction



Windshield defrosting system



Interior luggage compartment release



Jack



Keep out of reach of children



Lighting control



Low tire pressure warning



Maintain correct fluid level



Note operating instructions



Horn control



Panic alarm



Parking aid



Parking brake



Power steering fluid



Power windows front/rear



Power window lockout



Requires registered technician



Safety alert



See Owner's Manual



See Service Manual



Service engine soon



Passenger airbag activated



Passenger airbag deactivated



Side airbag



Shield the eyes



Stability control



Hill descent control



Trail control



Windshield wiping system



Windshield wash and wipe

Introduction

DATA RECORDING



WARNING: Do not connect wireless plug-in devices to the data link connector. Unauthorized third parties could gain access to vehicle data and impair the performance of safety related systems. Only allow repair facilities that follow our service and repair instructions to connect their equipment to the data link connector.

We respect your privacy and are committed to protecting it. The information contained in this publication was correct at the time of going to print, but as technology rapidly changes, we recommend that you visit the regional Ford website for the latest information.

Your vehicle has electronic control units that have data recording functionality and the ability to permanently or temporarily store data. This data could include information on the condition and status of your vehicle, vehicle maintenance requirements, events and malfunctions. The types of data that can be recorded are described in this section. Some of the data recorded is stored in event logs or error logs.

Note: *Error logs are reset following a service or repair.*

Note: *We may provide information in response to requests from law enforcement, other government authorities and third parties acting with lawful authority or through a legal process. Such information could be used by them in legal proceedings.*

Data recorded includes, for example:

- Operating states of system components, for example, fuel level, tire pressure and battery charge level.
- Vehicle and component status, for example, wheel speed, deceleration, lateral acceleration and seatbelt status.
- Events or errors in essential systems, for example, headlamps and brakes.
- System responses to driving situations, for example, airbag deployment and stability control.
- Environmental conditions, for example, temperature.

Some of this data, when used in combination with other information, for example, an accident report, damage to a vehicle or eyewitness statements, could be associated with a specific person.

Service Data

Service data recorders in your vehicle are capable of collecting and storing diagnostic information about your vehicle. This potentially includes information about the performance or status of various systems and modules in the vehicle, such as engine, throttle, steering or brake systems. In order to properly diagnose and service your vehicle, Ford Motor Company (Ford of Canada in Canada), and service and repair facilities may access or share among them vehicle diagnostic information received through a direct connection to your vehicle when diagnosing or servicing your vehicle. Additionally, Ford Motor Company (Ford of Canada, in Canada) may, where permitted by law, use vehicle diagnostic information for vehicle improvement or with other information we may have about you, for example, your contact information, to offer you products or services that may interest you. Data may be provided to our

Introduction

service providers such as part suppliers that may help diagnose malfunctions, and who are similarly obligated to protect data. We retain this data only as long as necessary to perform these functions or to comply with law. We may provide information where required in response to official requests to law enforcement or other government authorities or third parties acting with lawful authority or court order, and such information may be used in legal proceedings. For U.S. only (if equipped), if you choose to use connected apps and services, you consent that certain diagnostic information may also be accessed electronically by Ford Motor Company and Ford authorized service facilities, and that the diagnostic information may be used to provide services to you, personalizing your experience, troubleshoot, and to improve products and services and offer you products and services that may interest you, where permitted by law. For Canada only, for more information, please review the Ford of Canada privacy policy at www.ford.ca, including our U.S. data storage and use of service providers in other jurisdictions who may be subject to legal requirements in Canada, the United States and other countries applicable to them, for example, lawful requirements to disclose personal information to governmental authorities in those countries.

Event Data

This vehicle is equipped with an event data recorder. The main purpose of an event data recorder is to record, in certain crash or near crash-like situations, such as an airbag deployment or hitting a road obstacle; this data assist in understanding how a vehicle's systems performed. The event data recorder is designed to record data related to vehicle dynamics and safety systems for a short period of time, typically 30 seconds or less.

The event data recorder in this vehicle is designed to record such data as:

- How various systems in your vehicle were operating;
- Whether or not the driver and passenger seatbelts were buckled/fastened;
- How far (if at all) the driver was depressing the accelerator and/or the brake pedal; and
- How fast the vehicle was traveling; and
- Where the driver was positioning the steering wheel.

This data can help provide a better understanding of the circumstances in which crashes and injuries occur.

Note: *Event data recorder data is recorded by your vehicle only if a non-trivial crash situation occurs; no data is recorded by the event data recorder under normal driving conditions and no personal data or information (e.g., name, gender, age, and crash location) is recorded. However, other parties, such as law enforcement, could combine the event data recorder data with the type of personally identifying data routinely acquired during a crash investigation.*

Introduction

To read data recorded by an event data recorder, special equipment is required, and access to the vehicle or the event data recorder is needed. In addition to the vehicle manufacturer, other parties, such as law enforcement, that have such special equipment, can read the information if they have access to the vehicle or the event data recorder.

Comfort, Convenience and Entertainment Data

Your vehicle has electronic control units that have the ability to store data based on your personalized settings. The data is stored locally in the vehicle or on devices that you connect to it, for example, a USB drive or digital music player. You can delete some of this data and also choose whether to share it through the services to which you subscribe.

Comfort and Convenience Data

Data recorded includes, for example:

- Seat and steering wheel position.
- Climate control settings.
- Radio presets.

Entertainment Data

Data recorded includes, for example:

- Music, videos or album art.
- Contacts and corresponding address book entries.
- Navigation destinations.

Services That We Provide

If you use our services, we collect and use data, for example, account information, vehicle location and driving characteristics, that could identify you. We transmit this data through a dedicated, protected connection. We only collect and use data

to enable your use of our services to which you have subscribed, with your consent or where permitted by law. For additional information, see the terms and conditions of the services to which you have subscribed.

Services That Third Parties Provide

We recommend that you review the terms and conditions and data privacy information for any services to which you subscribe. We take no responsibility for services that third parties provide.

Vehicles With a Connectivity Device (If Equipped)



The connectivity device has a SIM. The connectivity device was enabled when your vehicle was built and periodically sends messages to stay connected to the cell phone network. These messages could include information that identifies your vehicle, the SIM and the electronic serial number of the connectivity device. Cell phone network service providers could have access to additional information, for example, cell phone network tower identification.

Note: *The connectivity device continues to send this information unless you disable the connectivity device. To find out more about having the connectivity device disabled, contact the Ford Customer Relationship Center. Disabling this connectivity device is permanent. See **Connected Vehicle** (page 306).*

If FordPass is connected to your vehicle, Ford also receives additional information, for example, location and vehicle data. See FordPass Terms and Privacy Policy. For additional information about our privacy policy, visit www.FordConnected.com or refer to your local Ford website.

Introduction

Note: To stop the connectivity device from sharing this information, for example, location and vehicle data, see your Connectivity Settings through the FordPass app. You may also remove the vehicle from your FordPass account.

Note: The service can be unavailable or interrupted for a number of reasons, for example, environmental or topographical conditions and data plan coverage.

Note: To find out if your vehicle has a connectivity technology, visit www.FordConnected.com.

Note: If you plan to no longer use your vehicle, for example, by selling or donating it, remember to remove the vehicle from your FordPass account. If you recently purchased the vehicle and want to disable connectivity, please contact the Ford Customer Relationship Center through the FordPass app or by using the e-mail address on the local Ford website.

Vehicles With SYNC

Mobile Device Data

If you connect a mobile device to your vehicle, you can display data from your device on the touchscreen for example, music and album art. You can share your vehicle data with mobile apps on your device through the system.

The mobile apps function operates by your connected device sending data to us in the United States. The data is encrypted and includes the vehicle identification number of your vehicle, the SYNC module serial number, odometer, enabled apps, usage statistics and debugging information. We retain it only as long as necessary to provide the service, to troubleshoot, for continuous improvement and to offer you products and services that may be of interest to you according to your preferences and where allowed by law.

If you connect a cell phone to the system, the system creates a profile that links to that cell phone. The cell phone profile enables more mobile features and efficient operation. The profile contains, for example, data from your phonebook, read and unread text messages and call history, including history of calls when your cell phone was not connected to the system.

If you connect a media device, the system creates and retains a media device index of supported media content. The system also records a short diagnostic log of approximately 10 minutes of all recent system activity.

The cell phone profile, media device index and diagnostic log remain in your vehicle unless you delete them and are generally accessible only in your vehicle when you connect your cell phone or media device. If you no longer plan to use the system or your vehicle, we recommend you use the master reset function to erase the stored information.

System data cannot be accessed without special equipment and access to your vehicle's module.

For additional information about our privacy policy, refer to your local Ford website.

Note: To find out if your vehicle has a connectivity technology, visit www.FordConnected.com.

Vehicles With an Emergency Call System

When the emergency call system is active, it may disclose to emergency services that your vehicle has been in a crash involving the deployment of an airbag or activation of the fuel pump shut-off. Certain versions or updates to the emergency call system may also be capable of electronically or verbally disclosing to emergency services operators your vehicle location or other

Introduction

details about your vehicle or crash to assist emergency services operators to provide the most appropriate emergency services. If you do not want to disclose this information, do not activate the emergency call system.

Note: *You cannot deactivate emergency call systems that are required by law.*

PERCHLORATE

Certain components in your vehicle such as airbag modules, seatbelt pretensioners and remote control batteries may contain perchlorate material. Special handling may apply for service or vehicle end of life disposal.

For more information visit:

Web Address
www.dtsc.ca.gov/hazardouswaste/perchlorate

FORD CREDIT

US Only

Ford Credit offers a full range of financing and lease plans to help you acquire your vehicle. If you have financed or leased your vehicle through Ford Credit, thank you for your business.

For assistance call 1-800-727-7000, or for more information about Ford Credit and access to the online Account Manager tool, visit www.ford.com/finance.

REPLACEMENT PARTS RECOMMENDATION

We have built your vehicle to the highest standards using quality parts. We recommend that you demand the use of genuine Ford and Motorcraft parts whenever your vehicle requires scheduled maintenance or repair. You can clearly identify genuine Ford and Motorcraft parts by looking for the Ford, FoMoCo or Motorcraft branding on the parts or their packaging.

Scheduled Maintenance and Mechanical Repairs

One of the best ways for you to make sure that your vehicle provides years of service is to have it maintained in line with our recommendations using parts that conform to the specifications detailed in this Owner's Manual.

Genuine Ford and Motorcraft parts meet or exceed these specifications.

Collision Repairs

We hope that you never experience a collision, but accidents happen sometimes.

Genuine Ford replacement collision parts meet our stringent requirements for fit, finish, structural integrity, corrosion protection and dent resistance. During vehicle development we validate that these parts deliver the intended level of protection as a whole system. A great way to know for sure you are getting this level of protection is to use genuine Ford replacement collision parts.

Warranty on Replacement Parts

Genuine Ford and Motorcraft replacement parts are the only replacement parts that benefit from a Ford Warranty.

Introduction

The Ford Warranty may not cover damage caused to your vehicle as a result of failed non-Ford parts.

For additional information, refer to the terms and conditions of the Ford Warranty.

SPECIAL NOTICES

New Vehicle Limited Warranty

Vehicles sold in the United States and Canada

For a detailed description of what is covered by your New Vehicle Limited Warranty, see your warranty guide that is available online. For more information, refer to our website and download your copy of the warranty guide.

Vehicles sold outside the United States and Canada

For a detailed description of what is covered by your New Vehicle Limited Warranty, see the warranty guide that is provided to you along with your Owner's Manual.

Special Instructions

For your added safety, your vehicle is fitted with sophisticated electronic controls.



WARNING: You risk death or serious injury to yourself and others if you do not follow the instruction highlighted by the warning symbol. Failure to follow the specific warnings and instructions could result in personal injury.



WARNING: NEVER use a rearward facing child restraint on a seat protected by an ACTIVE AIRBAG in front of it, DEATH or SERIOUS INJURY to the CHILD can occur.

On Board Diagnostics Data Link Connector



WARNING: Do not connect wireless plug-in devices to the data link connector. Unauthorized third parties could gain access to vehicle data and impair the performance of safety related systems. Only allow repair facilities that follow our service and repair instructions to connect their equipment to the data link connector.

Your vehicle has an OBD Data Link Connector (DLC) that is used in conjunction with a diagnostic scan tool for vehicle diagnostics, repairs and reprogramming services. Installing an aftermarket device that uses the DLC during normal driving for purposes such as remote insurance company monitoring, transmission of vehicle data to other devices or entities, or altering the performance of the vehicle, may cause interference with or even damage to vehicle systems. We do not recommend or endorse the use of unapproved aftermarket plug-in devices. The vehicle Warranty will not cover damage caused by an aftermarket plug-in device.

Notice to Owners of Pickup Trucks and Utility Type Vehicles



WARNING: Utility vehicles have a significantly higher rollover rate than other types of vehicles.

Before you drive your vehicle, please read this Owner's Guide carefully. Your vehicle is not a passenger car. As with other vehicles of this type, failure to operate this vehicle correctly may result in loss of vehicle control, vehicle rollover, personal injury or death.

Introduction

Using Your Vehicle With a Snowplow

Do not use this vehicle for snowplowing.

Your vehicle does not have a snowplowing package.

Using your Vehicle as an Ambulance

If your light truck has the Ford Ambulance Preparation Package, it may be utilized as an ambulance. Ford urges ambulance manufacturers to follow the recommendations of the Ford Incomplete Vehicle Manual, Ford Truck Body Builder's Layout Book and the Qualified Vehicle Modifiers (QVM) Guidelines as well as pertinent supplements. For additional information, please contact the Truck Body Builders Advisory Service at <http://www.fleet.ford.com/truckbbas/> and then by selecting Contact Us or by phone at 1-877-840-4338.

Use of your Ford light truck as an ambulance, without the Ford Ambulance Preparation Package voids the Ford New Vehicle Limited Warranty and may void the emissions warranties. In addition, ambulance usage without the preparation package could cause high underbody temperatures, over-pressurized fuel and a risk of spraying fuel, which could lead to fires.

If your vehicle has the Ford Ambulance Preparation Package, it will be indicated on the Safety Compliance Certification Label. The label is on the driver side door pillar or on the rear edge of the driver door. You can determine whether the ambulance manufacturer followed Ford's recommendations by directly contacting that manufacturer.

MOBILE COMMUNICATIONS EQUIPMENT



WARNING: Driving while distracted can result in loss of vehicle control, crash and injury. We strongly recommend that you use extreme caution when using any device that may take your focus off the road. Your primary responsibility is the safe operation of your vehicle. We recommend against the use of any hand-held device while driving and encourage the use of voice-operated systems when possible. Make sure you are aware of all applicable local laws that may affect the use of electronic devices while driving.

Using mobile communications equipment is becoming increasingly important in the conduct of business and personal affairs. However, you must not compromise your own or others' safety when using such equipment. Mobile communications can enhance personal safety and security when appropriately used, particularly in emergency situations. Safety must be paramount when using mobile communications equipment to avoid negating these benefits. Mobile communication equipment includes, but is not limited to, cellular phones, pagers, portable email devices, text messaging devices and portable two-way radios.

EXPORT UNIQUE OPTIONS

For your particular global region, your vehicle may be equipped with features and options that are different from the features and options that are described in this Owner's Manual. A market unique supplement may be supplied that complements this book. By referring to the

Introduction

market unique supplement, if provided, you can properly identify those features, recommendations and specifications that are unique to your vehicle. This Owner's Manual is written primarily for the U.S. and Canadian Markets. Features or equipment listed as standard may be different on units built for export. **Refer to this Owner's Manual for all other required information and warnings.**

FEDERAL HIGHWAY ADMINISTRATION REGULATION

Regulations such as those issued by the Federal Highway Administration or issued pursuant to the Occupational Safety and Health Act (OSHA), and state and local laws and regulations may require additional equipment for the way you intend to use your vehicle. It is the responsibility of the registered owner to determine the applicability of such laws and regulations to your intended use for the vehicle, and to arrange for the installation of required equipment. The dealer has information about the availability of equipment which can be ordered for your vehicle.

ENTERING, EXITING OR CLIMBING ON THIS VEHICLE



WARNING: Do not carry items while entering, exiting or climbing. Make sure you keep a firm grip. Always face the vehicle step and handle system while climbing up and down. Do not climb behind the cab unless you have three point contact with a step and handle system at all times.

You must be careful and deliberate to minimize the possibility of personal injury from a slip and fall when entering, exiting or climbing on your vehicle. Always use the steps and assist handles before climbing. Do not skip any steps or assist handles. Use three point contact at all times with at least two feet and one hand or two hands and one foot firmly placed during all phases of entering, exiting or climbing. Always keep your shoe soles and hands clean. Keep the steps and assist handles free of snow, ice, oil, grease, substances or debris. Be sure to take extra care in bad weather. Avoid wearing thick gloves. Always perform trailer hook-up while standing on the ground.

Environment

PROTECTING THE ENVIRONMENT

You should play your part in protecting the environment. Correct vehicle usage and the authorized disposal of waste, cleaning and lubrication materials are significant steps toward this aim.

For additional information about our sustainability progress and initiatives, visit www.sustainability.ford.com.

NOISE POLLUTION CONTROL

In order to keep to the federal exterior noise regulations, your vehicle may be equipped with noise emission items. Depending on your vehicle configuration, it may have all or some of the following items:

Air Intake System

Inspect the air cleaner. Do not alter its location. Do not alter inlet and outlet piping.

Body

Inspect wheel well splash shields, cab shields and under hood insulation for deterioration, dislocation and orientation.

Cooling System

- Inspect the fan for blade damage. If you find any damage, replace with the recommended parts. Inspect for fan-to-shroud interference and any damage to shroud, such as cracks and holes.
- Do not change fan ratio or alter fan spacer dimensions and positions.

- Inspect fan clutch for proper operation. Make sure the fan is disengaged when cooling of the engine is not required.
- Inspect radiator shutters (if equipped) for proper operation. The shutters should be open during normal operating temperatures.

Engine

Valve covers and block covers damp-out engine mechanical noise. If they need replacing, make sure to replace them with the recommended parts. Check for mechanical isolations.

Transmission Enclosure

Inspect for cracks, holes and tears. Clean any deposits, such as oil, dirt and stones.

Exhaust System

- Inspect for leaks at various joint connections and loose clamps.
- Perform a visual inspection for cracks or holes in the muffler and tail pipe.
- Always use the recommended replacement parts.
- Do not change the tail pipe elbow or offset tail pipe orientation from the standard position as originally received.
- To avoid abnormal changes in vehicle sound levels, it is necessary for the owner to perform inspections and necessary maintenance at specified intervals. See **Scheduled Maintenance** (page 319).

At a Glance

INSTRUMENT PANEL

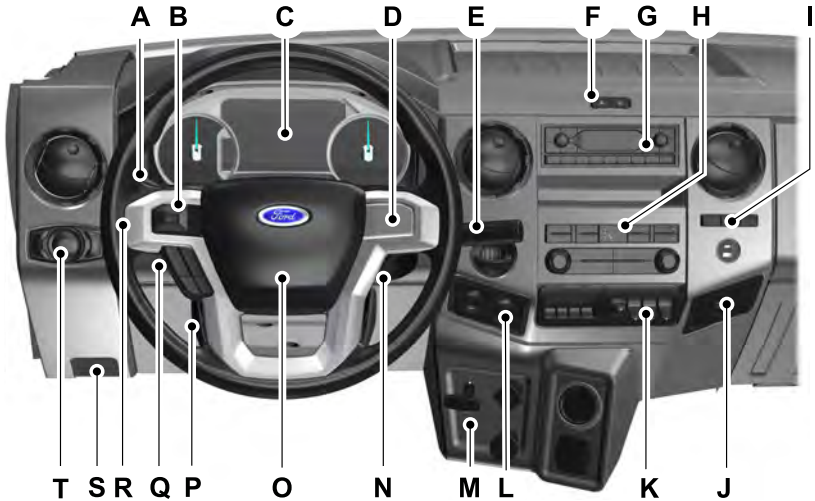

- A Direction indicators. See **Direction Indicators** (page 58). Wiper lever. See **Windshield Wipers** (page 54).
- B Information display control. See **Information Display Control** (page 53).
- C Instrument cluster. See **General Information** (page 70).
- D Audio control.
- E Gearshift lever. See **Automatic Transmission** (page 122).
- F Hazard flasher switch. See **Hazard Flashers** (page 182).
- G Audio unit. See **Audio System** (page 307).
- H Climate controls. See **Climate Control** (page 79).
- I Traction control switch. See **Traction Control** (page 142).
- J USB port. See **USB Ports** (page 91).
- K Auxiliary switches. See **Auxiliary Switches** (page 315).
- L Exhaust brake. See **Exhaust Brake** (page 136). Power point. See **Auxiliary Power Points** (page 89).
- M Brake controls. See **Brakes** (page 130).
- N Ignition. See **Ignition Switch** (page 93).

At a Glance

- O Horn. See **Horn** (page 53).
- P Steering wheel adjustment. See **Adjusting the Steering Wheel** (page 52).
- Q Cruise control. See **Cruise Control** (page 154).
- R Horn. See **Horn** (page 53).
- S Data link connector.
- T Lighting control. See **Lighting Control** (page 55).

Child Safety

GENERAL INFORMATION

See the following sections for directions on how to properly use safety restraints for children.



WARNING: Always make sure your child is secured properly in a device that is appropriate for their height, age and weight. Child safety restraints must be bought separately from your vehicle. Failure to follow these instructions and guidelines may result in an increased risk of serious injury or death to your child.



WARNING: All children are shaped differently. The National Highway Traffic Safety Administration and other safety organizations, base their recommendations for child restraints on probable child height, age and weight thresholds, or on the minimum requirements of the law. We recommend that you check with a NHTSA Certified Child Passenger Safety Technician

(CPST) to make sure that you properly install the child restraint in your vehicle and that you consult your pediatrician to make sure you have a child restraint appropriate for your child. To locate a child restraint fitting station and CPST, contact NHTSA toll free at 1-888-327-4236 or go to www.nhtsa.dot.gov. In Canada, contact Transport Canada toll free at 1-800-333-0371 or go to www.tc.gc.ca to find a Child Car Seat Clinic in your area. Failure to properly restrain children in child restraints made especially for their height, age and weight, may result in an increased risk of serious injury or death to your child.



WARNING: On hot days, the temperature inside the vehicle can rise very quickly. Exposure of people or animals to these high temperatures for even a short time can cause death or serious heat related injuries, including brain damage. Small children are particularly at risk.

Child Safety

Recommendations for Safety Restraints for Children

Child	Child Size, Height, Weight, or Age	Recommended Restraint Type
Infants or toddlers	Children weighing 40 lb (18 kg) or less (generally age four or younger).	Use a child restraint (sometimes called an infant carrier, convertible seat, or toddler seat).
Small children	Children who have outgrown or no longer properly fit in a child restraint (generally children who are less than 57 in (1.45 m) tall, are greater than age four and less than age 12, and between 40 lb (18 kg) and 80 lb (36 kg) and upward to 100 lb (45 kg) if recommended by your child restraint manufacturer).	Use a belt-positioning booster seat.
Larger children	Children who have outgrown or no longer properly fit in a belt-positioning booster seat (generally children who are at least 57 in (1.45 m) tall or greater than 80 lb (36 kg) or 100 lb (45 kg) if recommended by child restraint manufacturer).	Use a vehicle seatbelt having the lap belt snug and low across the hips, shoulder belt centered across the shoulder and chest, and seat backrest upright.

- You are required by law to properly use child restraints for infants and toddlers in the United States and Canada.
- Many states and provinces require that small children use approved booster seats until they reach age eight, a height of 57 in (1.45 m) tall, or 80 lb (36 kg). Check your local and state or provincial laws for specific requirements about the safety of children in your vehicle.
- When possible, always properly restrain children 12 years of age and under in a rear seating position of your vehicle. Accident statistics suggest that children are safer when properly restrained in the rear seating positions than in a front seating position.
- When installing a rear facing child restraint, adjust the vehicle seats to avoid interference between the child restraint and the vehicle seat in front of the child restraint.

Child Safety

INSTALLING CHILD RESTRAINTS

Child Restraints



E142594

Use a child restraint (sometimes called an infant carrier, convertible seat, or toddler seat) for infants, toddlers, or children weighing 40 lb (18 kg) or less (generally age four or younger).

Using Lap and Shoulder Belts



WARNING: Do not place a rearward facing child restraint in front of an active airbag. Failure to follow this instruction could result in personal injury or death.



WARNING: Properly secure children 12 years old and under in a rear seating position whenever possible. If you are unable to properly secure all children in a rear seating position, properly secure the largest child on the front seat. If you must use a forward facing child restraint on the front seat, move the seat as far back as possible. Failure to follow these instructions could result in personal injury or death.



WARNING: Depending on where you secure a child restraint, and depending on the child restraint design, you may block access to certain seatbelt buckle assemblies and LATCH lower anchors, rendering those features potentially unusable. To avoid risk of injury, make sure occupants only use seating positions where they are able to be properly restrained.

When installing a child restraint with combination lap and shoulder belts:

- Use the correct seatbelt buckle for that seating position.
- Insert the belt tongue into the proper buckle until you hear a snap and feel it latch. Make sure the tongue is securely fastened in the buckle.
- Keep the buckle release button pointing up and away from the child restraint, with the tongue between the child restraint and the release button, to prevent accidental unbuckling.
- Place the vehicle seat upon which the child restraint will be installed in the upright position.
- This vehicle does not require the use of a locking clip.

Perform the following steps when installing the child restraint with combination lap and shoulder belts:

Note: *Although the child restraint illustrated is a forward facing child restraint, the steps are the same for installing a rear facing child restraint.*

Child Safety



1. Position the child restraint in a seat with a combination lap and shoulder belt.



2. Pull down on the shoulder belt and then grasp the shoulder belt and lap belt together.



3. While holding the shoulder and lap belt portions together, route the tongue through the child restraint according to the child restraint manufacturer's instructions. Be sure the belt webbing is not twisted.

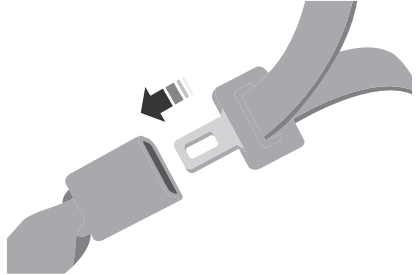

4. Insert the belt tongue into the proper buckle (the buckle closest to the direction the tongue is coming from) for that seating position until you hear a snap and feel the latch engage. Make sure the tongue is latched securely by pulling on it.



5. To put the retractor in the automatic locking mode, grasp the shoulder portion of the belt and pull downward until you pull all of the belt out.

Child Safety

6. Allow the belt to retract to remove slack. The belt clicks as it retracts to indicate it is in the automatic locking mode.
7. Try to pull the belt out of the retractor to make sure the retractor is in the automatic locking mode (you should not be able to pull more belt out). If the retractor is not locked, unbuckle the belt and repeat Steps 5 and 6.



8. Remove remaining slack from the belt. Force the seat down with extra weight, for example, by pressing down or kneeling on the child restraint while pulling up on the shoulder belt in order to force slack from the belt. This is necessary to remove the remaining slack that exists once you add the extra weight of the child to the child restraint. It also helps to achieve the proper snugness of the child restraint to your vehicle. Sometimes, a slight lean toward the buckle helps to remove remaining slack from the belt.
9. Attach the tether strap (if the child restraint is equipped).

10. Before placing the child in the seat, forcibly move the seat forward and back to make sure the seat is securely held in place.

To check this, grab the seat at the belt path and attempt to move it side to side and forward and back. There should be no more than 1 in (2.5 cm) of movement for proper installation.

We recommend checking with a NHTSA Certified Child Passenger Safety Technician to make certain the child restraint is properly installed. In Canada, check with Transport Canada for referral to a Child Car Seat Clinic.

Using Cinch Tongue Lap and Shoulder Belts (All Front Center, Super Cab and Crew Cab Rear Center Positions)



WARNING: Do not place a rearward facing child restraint in front of an active airbag. Failure to follow this instruction could result in personal injury or death.

Child Safety



WARNING: Properly secure children 12 years old and under in a rear seating position whenever possible. If you are unable to properly secure all children in a rear seating position, properly secure the largest child on the front seat. If you must use a forward facing child restraint on the front seat, move the seat as far back as possible. Failure to follow these instructions could result in personal injury or death.



WARNING: Always use both the lap and shoulder portion of the seatbelt in the center seating position.

The belt webbing below the tongue is the lap portion of the combination lap and shoulder belt. The belt webbing above the tongue is the shoulder belt portion of the combination lap and shoulder belt.



1. Position the child restraint in the front center seat.



2. Slide the tongue up the webbing.



3. While holding both shoulder and lap portions next to the tongue, route the tongue and webbing through the child restraint according to the child restraint manufacturer's instructions. Be sure that the belt webbing is not twisted.

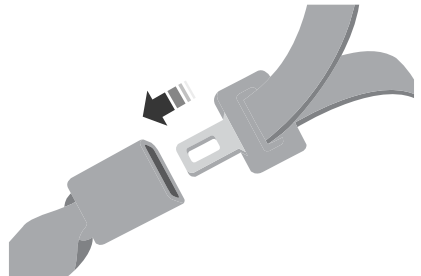

Child Safety

4. Insert the belt tongue into the proper buckle (the buckle closest to the direction the tongue is coming from) for that seating position until you hear a snap and feel the latch engage. Make sure the tongue is latched securely by pulling on it.



5. While pushing down with your knee on the child restraint, pull up on the shoulder belt portion to tighten the lap belt portion of the combination lap and shoulder belt.
6. Allow the seatbelt to retract and remove any slack in the belt to securely tighten the child restraint in the vehicle.
7. Attach the tether strap (if the child restraint is equipped).

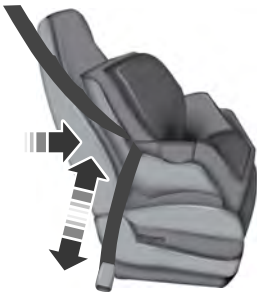

8. Before placing the child in the seat, forcibly move the seat forward and back to make sure the seat is securely held in place. To check this, grab the seat at the belt path and attempt to move it side to side and forward and back. There should be no more than 1 in (2.5 cm) of movement for proper installation.
9. Check from time to time to be sure that there is no slack in the lap and shoulder belt. The shoulder belt must be snug to keep the lap belt tight during a crash.

We recommend checking with a NHTSA Certified Child Passenger Safety Technician to make certain the child restraint is properly installed. In Canada, check with Transport Canada for referral to a Child Car Seat Clinic.

Using Lower Anchors and Tethers for Children (LATCH)

The LATCH system is composed of three vehicle anchor points: two lower anchors where the vehicle seat backrest and seat cushion meet (called the seat bight) and one top tether anchor behind that seating position. Your vehicle does not have the lower anchor points in the seat bight. For this vehicle, use the vehicle seatbelt and upper tether to secure a child restraint.

Using Tether Straps

Many forward-facing child restraints include a tether strap which extends from the back of the child restraint and hooks to an anchoring point called the top tether anchor. Tether straps are available as an accessory for many older child restraints. Contact the manufacturer of your child restraint for information about ordering a tether strap, or to obtain a longer tether strap if the tether strap on your child restraint does not reach the appropriate top tether anchor in the vehicle.

Child Safety

The passenger seats of your vehicle may have built-in tether strap anchors behind the seats as described below.

The tether strap anchors in your vehicle are in the following positions (shown from top view):

F-Series Regular Cab

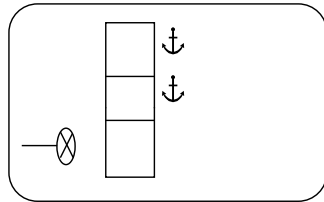
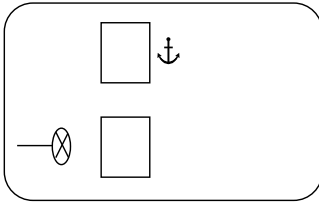

E162709

F-Series Crew Cab

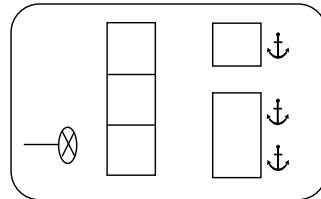
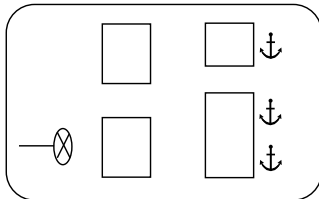

Attach the tether strap only to the appropriate tether anchor as shown. The tether strap may not work properly if attached somewhere other than the correct tether anchor.

Once you install the child restraint using the seatbelt, you can attach the top tether strap.

Tether Strap Attachment

1. Route the child restraint tether strap over the back of the seat.

Note: For vehicles with adjustable head restraints, route the tether strap under the head restraint and between the head restraint posts, otherwise route the tether strap over the top of the seat backrest. If the top of the child restraint hits the head restraint, raise the head restraint to let the child restraint fit further rearward.

2. Locate the correct anchor for the selected seating position.

Child Safety

3. You may need to pull the seat backrest forward to access the tether anchors. Make sure the seat is locked in the upright position before installing the child restraint.

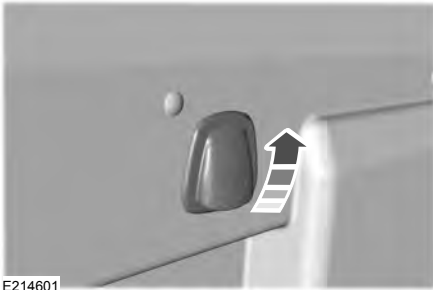

4. Remove the tether cover.

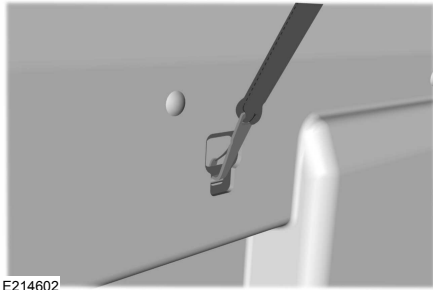

5. Clip the tether strap to the anchor as shown.

If the tether strap is clipped incorrectly, the child restraint may not be retained properly in the event of a crash.

6. Tighten the child restraint tether strap according to the manufacturer's instructions.

If you do not anchor the child restraint properly, the risk of a child being injured in a crash greatly increases.

If your child restraint system has a tether strap and the child restraint manufacturer recommends its use, we also recommend its use.

BOOSTER SEATS

⚠ WARNING: Do not put the shoulder section of the seatbelt or allow the child to put the shoulder section of the seatbelt under their arm or behind their back. Failure to follow this instruction could reduce the effectiveness of the seatbelt and increase the risk of injury or death in a crash.

Use a belt-positioning booster seat for children who have outgrown or no longer properly fit in a child safety restraint (generally children who are less than 57 in (1.45 m) tall, are greater than age 4 and less than age 12, and between 40 lb (18 kg) and 80 lb (36 kg) and upward to 100 lb (45 kg) if recommended by your child restraint manufacturer). Many state and provincial laws require that children use approved booster seats until they reach age eight, a height of 57 in (1.45 m) tall, or 80 lb (36 kg).

Booster seats should be used until you can answer YES to ALL of these questions when seated without a booster seat:

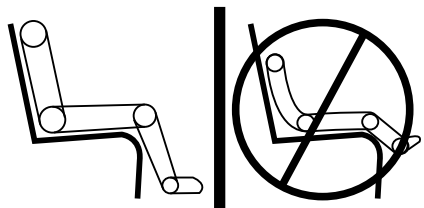

Child Safety

- Can the child sit all the way back against their vehicle seat backrest with knees bent comfortably at the edge of the seat cushion?
- Can the child sit without slouching?
- Does the lap belt rest low across the hips?
- Is the shoulder belt centered on the shoulder and chest?
- Can the child stay seated like this for the whole trip?

Always use booster seats in conjunction with your vehicle lap and shoulder belt.

Types of Booster Seats



- Backless booster seats

If your backless booster seat has a removable shield, remove the shield. If a vehicle seating position has a low seat backrest or no head restraint, a backless booster seat may place your child's head (as measured at the tops of the ears)

above the top of the seat. In this case, move the backless booster to another seating position with a higher seat backrest or head restraint and lap and shoulder belts, or consider using a high back booster seat.



- High back booster seats

If, with a backless booster seat, you cannot find a seating position that adequately supports your child's head, a high back booster seat would be a better choice.

Children and booster seats vary in size and shape. Choose a booster that keeps the lap belt low and snug across the hips, never up across the stomach, and lets you adjust the shoulder belt to cross the chest and rest snugly near the center of the shoulder. The following drawings compare the ideal fit (center) to a shoulder belt uncomfortably close to the neck and a shoulder belt that could slip off the shoulder. The drawings also show how the lap belt should be low and snug across the child's hips.

Child Safety



If the booster seat slides on the vehicle seat upon which it is being used, placing a rubberized mesh sold as shelf or carpet liner under the booster seat may improve this condition. Do not introduce any item thicker than this under the booster seat. Check with the booster seat manufacturer's instructions.

CHILD RESTRAINT POSITIONING

⚠️ WARNING: Airbags can kill or injure a child in a child seat. Never place a rear-facing child seat in front of an active airbag. If you must use a forward-facing child seat in the front seat, move the vehicle seat upon which the child seat is installed all the way back. When possible, all children age 12 and under should be properly restrained in a rear seating position. If all children cannot be seated and restrained properly in a rear seating position, properly restrain the largest child in the front seat.

Child Safety



WARNING: Always carefully follow the instructions and warnings provided by the manufacturer of any child restraint to determine if the restraint device is appropriate for your child's size, height, weight, or age. Follow the child restraint manufacturer's instructions and warnings provided for installation and use in conjunction with the instructions and warnings provided by your vehicle manufacturer. A safety seat that is improperly installed or utilized, is inappropriate for your child's height, age, or weight or does not properly fit the child may increase the risk of serious injury or death.



WARNING: Never let a passenger hold a child on his or her lap while your vehicle is moving. The passenger cannot protect the child from injury in a crash, which may result in serious injury or death.



WARNING: Never use pillows, books, or towels to boost a child. They can slide around and increase the likelihood of injury or death in a crash.



WARNING: Always restrain an unoccupied child seat or booster seat. These objects may become projectiles in a crash or sudden stop, which may increase the risk of serious injury.



WARNING: Never place, or allow a child to place, the shoulder belt under a child's arm or behind the back because it reduces the protection for the upper part of the body and may increase the risk of injury or death in a crash.



WARNING: To avoid risk of injury, do not leave children or pets unattended in your vehicle.

Child Safety

Recommendations for attaching child safety restraints for children

Restraint Type	Combined child and seat weight	Use any attachment method as indicated below by X				
		LATCH (lower anchors and top tether anchor)	LATCH (lower anchors only)	Safety belt and top tether anchor	Safety belt and LATCH (lower anchors and top tether anchor)	Safety belt only
Rear facing child seat	Up to 65 lb (29.5 kg)					X
Rear facing child seat	Over 65 lb (29.5 kg)					X
Forward facing child seat	Up to 65 lb (29.5 kg)			X		
Forward facing child seat	Over 65 lb (29.5 kg)			X		

Note: The child seat must rest tightly against the vehicle seat upon which it is installed. It may be necessary to lift or remove the head restraint. See **Head Restraints** (page 82).

CHILD SAFETY LOCKS (IF EQUIPPED)

When these locks are set, the rear doors cannot be opened from the inside.



E162719

The childproof locks are located on the rear edge of each rear door. You must set the lock separately for each door.

Move the lock control up or down to engage or disengage the childproof lock.

Seatbelts

PRINCIPLE OF OPERATION



WARNING: Always drive and ride with the seat backrest upright and the lap belt snug and low across the hips.



WARNING: To reduce the risk of injury, make sure children sit where they can be properly restrained.



WARNING: Never let a passenger hold a child on his or her lap while your vehicle is moving. The passenger cannot protect the child from injury in a crash which may result in serious injury or death.



WARNING: All occupants of the vehicle, including the driver, should always properly wear their safety belts, even when an airbag supplemental restraint system is provided. Failure to properly wear your safety belt could seriously increase the risk of injury or death.



WARNING: It is extremely dangerous to ride in a cargo area, inside or outside of a vehicle. In a crash, people riding in these areas are more likely to be seriously injured or killed. Do not allow people to ride in any area of your vehicle that is not equipped with seats and safety belts. Be sure everyone in your vehicle is in a seat and using a safety belt properly.



WARNING: In a rollover crash, an unbelted person is significantly more likely to die than a person wearing a safety belt.



WARNING: Each seating position in your vehicle has a specific safety belt assembly which is made up of one buckle and one tongue that are designed to be used as a pair. 1) Use the shoulder belt on the outside shoulder only. Never wear the shoulder belt under the arm. 2) Never swing the safety belt around your neck over the inside shoulder. 3) Never use a single belt for more than one person.



WARNING: When possible, all children 12 years old and under should be properly restrained in a rear seating position. Failure to follow this could seriously increase the risk of injury or death.



WARNING: Safety belts and seats can become hot in a vehicle that has been closed up in sunny weather; they could burn a small child. Check seat covers and buckles before you place a child anywhere near them.



WARNING: Front and rear seat occupants, including pregnant women, should wear safety belts for optimum protection in an accident.

All seating positions in this vehicle have lap and shoulder safety belts. All occupants of the vehicle should always properly wear their safety belts, even when an airbag supplemental restraint system is provided.

The safety belt system consists of:

- Lap and shoulder safety belts.
- Shoulder safety belt with automatic locking mode, (except driver safety belt).

Seatbelts

- Height adjuster at the front outboard seating positions.
- Safety belt pretensioner at the front outboard seating positions.



- Safety belt warning light and chime.

FASTENING THE SEATBELTS

The front outboard and rear safety restraints in the vehicle are combination lap and shoulder belts.

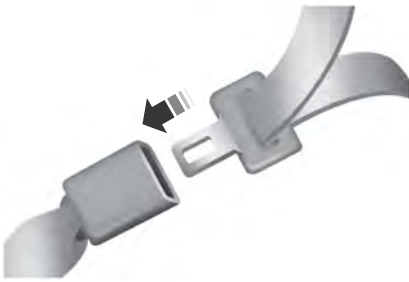

1. Insert the belt tongue into the proper buckle (the buckle closest to the direction the tongue is coming from) until you hear a snap and feel it latch. Make sure you securely fasten the tongue in the buckle.

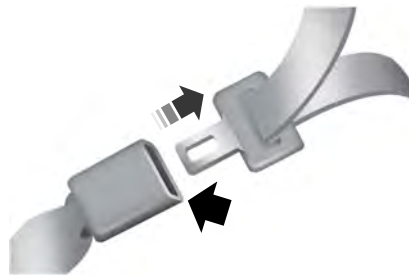

2. To unfasten, press the release button and remove the tongue from the buckle.

Using the Seatbelt with Cinch Tongue (Front Center and Rear Center Seats Only)

The cinch tongue slides up and down the belt webbing when the belt is stowed or while putting seatbelts on. When the lap and shoulder seatbelt is buckled, the cinch tongue allows the lap portion to be shortened, but pinches the webbing to keep the lap portion from getting longer. The cinch tongue is designed to slip during a crash, so always wear the shoulder belt properly and do not allow any slack in either the lap or shoulder portions.

Before you can reach and latch a lap and shoulder belt having a cinch tongue into the buckle, you may have to lengthen the lap belt portion of it.



1. To lengthen the lap belt, pull some webbing out of the shoulder belt retractor.
2. While holding the webbing below the tongue, grasp the tip (metal portion) of the tongue so that it is parallel to the webbing and slide the tongue upward.
3. Provide enough lap belt length so that the tongue can reach the buckle.

Seatbelts

Fastening the Cinch Tongue



WARNING: Always drive and ride with your seatback upright and the lap belt snug and low across the hips.

1. Pull the lap and shoulder belt from the retractor so that the shoulder belt portion of the seatbelt crosses your shoulder and chest.
2. Be sure the belt is not twisted. If the belt is twisted, remove the twist.
3. Insert the belt tongue into the proper buckle for your seating position until you hear a snap and feel it latch.
4. Make sure the tongue is securely fastened to the buckle by pulling on the tongue.

While you are fastened in the seatbelt, the lap and shoulder belt with a cinch tongue adjusts to your movement. However, if you brake hard, turn hard, or if your vehicle receives an impact of 5 mph (8 km/h) or more, the seatbelt will become locked and help reduce your forward movement.

Lap Belts



WARNING: Always drive and ride with your seatback upright and the lap belt snug and low across the hips.

The front center lap belt does not adjust automatically.



E208768

Insert the tongue into the correct buckle (the buckle closest to the direction the tongue is coming from). To lengthen the belt, turn the tongue at a right angle to the belt and pull across your lap until it reaches the buckle. To tighten the belt, pull the loose end of the belt through the tongue until it fits snugly across the hips.

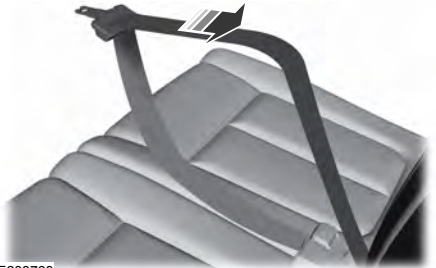

E208769

Shorten and fasten the belt when not in use.

Seatbelts

Using Seatbelts During Pregnancy



WARNING: Always ride and drive with your seatback upright and properly fasten your seatbelt. Fit the lap portion of the seatbelt snugly and low across the hips. Position the shoulder portion of the seatbelt across your chest. Pregnant women must follow this practice. See the following figure.

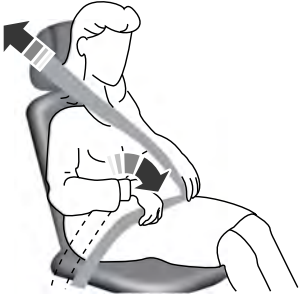

Pregnant women should always wear their seatbelt. Position the lap belt portion of a combination lap and shoulder belt low across the hips below the belly and worn as tight as comfort allows. Position the shoulder belt to cross the middle of the shoulder and the center of the chest.

Seatbelt Locking Modes



WARNING: If your vehicle is involved in a crash, have the seatbelts and associated components inspected as soon as possible. Failure to follow this instruction could result in personal injury or death.

The safety restraints in the vehicle are combination lap and shoulder belts. The driver seatbelt has the first type of locking mode. The front outboard passenger and rear outboard seat seatbelts have both types of locking modes described as follows:

Vehicle Sensitive Mode

This is the normal retractor mode, which allows free shoulder belt length adjustment to your movements and locking in response to vehicle movement. For example, if the driver brakes suddenly or turns a corner sharply, or the vehicle receives an impact of about 5 mph (8 km/h) or more, the combination seatbelts will lock to help reduce forward movement of the driver and passengers.

In addition, the retractor is designed to lock if you pull the webbing out too quickly. If the seatbelt retractor locks, slowly lower the height adjuster to allow the seatbelt to retract. If the retractor does not unlock, pull the seatbelt out slowly then feed a small length of webbing back toward the stowed position. For rear seatbelts, recline the rear seat backrest or push the seat backrest cushion away from the seatbelt. Feed a small length of webbing back toward the stowed position.

Automatic Locking Mode

In this mode, the shoulder belt automatically prelocks. The belt still retracts to remove any slack in the shoulder belt. The automatic locking mode is not available on the driver seatbelt or optional front center or rear center seatbelt.

Seatbelts

When to Use the Automatic Locking Mode

Use this mode any time a child safety seat, except a booster, is installed in passenger front or rear seating positions. Properly restrain children 12 years old and under in a rear seating position whenever possible. See **Child Safety** (page 24).

How to Use the Automatic Locking Mode



1. Buckle the combination lap and shoulder belt.
2. Grasp the shoulder portion and pull downward until you pull the entire belt out.
3. Allow the belt to retract. As the belt retracts, you will hear a clicking sound. This indicates the seatbelt is now in the automatic locking mode.

How to Disengage the Automatic Locking Mode

Unbuckle the combination lap and shoulder belt and allow it to retract completely to disengage the automatic locking mode and activate the vehicle sensitive (emergency) locking mode.

Energy Management Feature

- This vehicle has a seatbelt system with an energy management feature at the front outboard seating positions to help further reduce the risk of injury in the event of a head-on crash.
- The front outboard seatbelt systems have a retractor assembly that is designed to pay out webbing in a controlled manner. This feature is designed to help reduce the belt force acting on the occupant's chest.

SEATBELT HEIGHT ADJUSTMENT

⚠ WARNING: Position the safety belt height adjuster so that the belt rests across the middle of your shoulder. Failure to adjust the safety belt properly could reduce the effectiveness of the safety belt and increase the risk of injury in a crash.

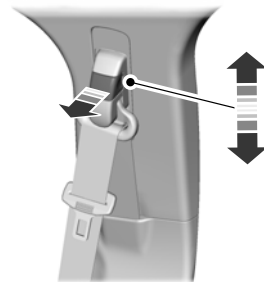

Adjust the height of the shoulder belt so the belt rests across the middle of your shoulder.

To adjust the shoulder belt height:

1. Pull the button and slide the height adjuster up or down.

Seatbelts

2. Release the button and pull down on the height adjuster to make sure it is locked in place.

SEATBELT WARNING LAMP AND INDICATOR CHIME



This lamp illuminates and an indicator chime will sound if the driver seatbelt has not been fastened when the vehicle's ignition is turned on.

Conditions of operation

If	Then
The driver seatbelt is not buckled before the ignition switch is turned to the on position...	The seatbelt warning lamp illuminates and the indicator chime sounds for a few seconds.
The driver seatbelt is buckled while the warning lamp is illuminated and the indicator chime is sounding...	The seatbelt warning lamp and indicator chime turn off.
The driver seatbelt is buckled before the ignition switch is turned to the on position...	The seatbelt warning lamp and indicator chime remain off.

SEATBELT REMINDER

Belt-Minder™

This feature supplements the safety belt warning function by providing additional reminders that intermittently sound a tone and illuminate the safety belt warning light when you are in the driver seat or you have a front seat passenger and a safety belt is unbuckled.

The system uses information from the front passenger sensing system to determine if a front seat passenger is present and therefore potentially in need of a warning. To avoid activating the Belt-Minder feature for objects you place in the front passenger seat, only the front seat passengers receive warnings as determined by the front passenger sensing system.

If the Belt-Minder warnings expire (warnings for about five minutes) for one passenger (driver or front passenger), the other passenger can still cause the Belt-Minder feature to turn on.

Seatbelts

If...	Then...
You and the front seat passenger buckle your safety belts before you switch the ignition on or less than 1-2 minutes elapse after you switch the ignition on...	The Belt-Minder feature will not activate.
You or the front seat passenger do not buckle your safety belts before your vehicle reaches at least 6 mph (9.7 km/h) and 1-2 minutes elapse after you switch the ignition on...	The Belt-Minder feature activates, the safety belt warning light illuminates and a warning tone sounds for 6 seconds every 25 seconds, repeating for about 5 minutes or until you and the front seat passenger buckle your safety belts.
The safety belt for the driver or front passenger is unbuckled for about 1 minute while the vehicle is traveling at least 6 mph (9.7 km/h) and more than 1-2 minutes elapse after you switch the ignition on...	The Belt-Minder feature activates, the safety belt warning light illuminates and a warning tone sounds for 6 seconds every 25 seconds, repeating for about 5 minutes or until you and the front seat passenger buckle your safety belts.

Deactivating and Activating the Belt-Minder Feature



WARNING: While the system allows you to deactivate it, this system is designed to improve your chances of being safely belted and surviving an accident. We recommend you leave the system activated for yourself and others who may use the vehicle.

Note: *The driver and front passenger warnings switch on and off independently. When you perform this procedure for one seating position, do not buckle the other position as this will terminate the process.*

Read Steps 1 - 4 thoroughly before proceeding with the programming procedure.

Before following the procedure, make sure that:

- The parking brake is set.
 - The transmission is in park (P) or neutral (N).
 - The ignition is off.
 - The driver and front passenger safety belts are unbuckled.
1. Switch the ignition on. Do not start the vehicle.
 2. Wait until the safety belt warning light turns off (about one minute). After Step 2, wait an additional 5 seconds before proceeding with Step 3. Once you start Step 3, you must complete the procedure within 30 seconds.
 3. For the seating position you are switching off, buckle then unbuckle the safety belt three times at a moderate speed, ending in the unbuckled state. After Step 3, the safety belt warning light turns on.

Seatbelts

4. While the safety belt warning light is on, buckle and then unbuckle the safety belt. After Step 4, the safety belt warning light flashes for confirmation.
 - This will switch the feature off for that seating position if it is currently on.
 - This will switch the feature on for that seating position if it is currently off.

CHILD RESTRAINT AND SEATBELT MAINTENANCE

Inspect the vehicle seatbelts and child safety seat systems periodically to make sure they work properly and are not damaged. Inspect the vehicle and child restraint seatbelts to make sure there are no nicks, tears or cuts. Replace if necessary. All vehicle seatbelt assemblies, including retractors, buckles, front seatbelt buckle assemblies, buckle support assemblies (slide bar-if equipped), shoulder belt height adjusters (if equipped), shoulder belt guide on seat backrest (if equipped), child safety seat LATCH and tether anchors, and attaching hardware, should be inspected after a crash. Read the child restraint manufacturer's instructions for additional inspection and maintenance information specific to the child restraint.

We recommend that all seatbelt assemblies in use in vehicles involved in a crash be replaced. However, if the crash was minor and an authorized dealer finds that the belts do not show damage and continue to operate properly, they do not need to be replaced. Seatbelt assemblies not in use during a crash should also be inspected and replaced if either damage or improper operation is noted.

Properly care for seatbelts. See **Vehicle Care** (page 255).

SEATBELT EXTENSIONS



WARNING: Persons who fit into the vehicle's seatbelt should not use an extension. Unnecessary use could result in serious personal injury in the event of a crash.



WARNING: Only use extensions provided free of charge by our dealers. The dealer will provide an extension designed specifically for this vehicle, model year and seating position. The use of an extension intended for another vehicle, model year or seating position may not offer you the full protection of your vehicle's seatbelt restraint system.



WARNING: Never use seatbelt extensions to install child restraints.



WARNING: Do not use a seatbelt extension with an inflatable seatbelt.



WARNING: Do not use extensions to change the way the seatbelt fits across the torso, over the lap or to make the seatbelt buckle easier to reach.

If, because of body size or driving position, it is not possible to properly fasten the seatbelt over your lap and shoulder, an extension that is compatible with the seatbelts is available free of charge from our dealers. Only use our seatbelt extensions made by the original equipment seatbelt manufacturer with our seatbelts. Ask your authorized dealer if your extension is compatible with your vehicle restraint system.

Keys and Remote Controls

GENERAL INFORMATION ON RADIO FREQUENCIES

This device complies with Part 15 of the FCC Rules and with Industry Canada license-exempt RSS standard(s). Operation is subject to the following two conditions: (1) This device may not cause harmful interference, and (2) This device must accept any interference received, including interference that may cause undesired operation.



WARNING: Changes or modifications not expressly approved by the party responsible for compliance could void the user's authority to operate the equipment. The term "IC:" before the radio certification number only signifies that Industry Canada technical specifications were met.

The typical operating range for your transmitter is approximately 33 ft (10 m). Vehicles with the remote start feature will have a greater range.

One of the following could cause a decrease in operating range:

- Weather conditions.
- Nearby radio towers.
- Structures around the vehicle.
- Other vehicles parked next to your vehicle.

The radio frequency used by your remote control can also be used by other radio transmitters, for example amateur radios, medical equipment, wireless headphones, wireless remote controls, cell phones, battery chargers and alarm systems. If the frequencies are jammed, you will not be able to use your remote control. You can lock and unlock the doors with the key.

Note: Make sure to lock your vehicle before leaving it unattended.

Note: If you are in range, the remote control will operate if you press any button unintentionally.

Note: The remote control contains sensitive electrical components. Exposure to moisture or impact may cause permanent damage.

Intelligent Access (If Equipped)

The system uses a radio frequency signal to communicate with your vehicle and authorize your vehicle to unlock when one of the following conditions are met:

- You activate the front exterior door handle switch.
- You press the luggage compartment button.
- You press a button on the transmitter.

If excessive radio frequency interference is present in the area or if the transmitter battery is low, you may need to mechanically unlock your door. You can use the mechanical key blade in your intelligent access key to open the driver door in this situation. See **Remote Control** (page 46).

Keys and Remote Controls

REMOTE CONTROL (IF EQUIPPED)



E195660

Note: If there are problems with the remote entry system, make sure to take all remote entry transmitters with you to an authorized dealer in order to aid in troubleshooting the problem.

Note: If your vehicle is fitted with the E-Guard Cargo Protection System™, the remote transmitter unlock command only unlocks the front doors. The side or rear cargo doors can only be unlocked from outside your vehicle using the key.

Reprogramming the Remote Control

You must have all remote controls readily accessible before beginning this procedure. Any remote control that is not present during the programming procedure will no longer operate your vehicle.

Note: You can program a maximum of four coded keys to your vehicle.

Note: Do not apply the brake pedal during this procedure.

1. Switch the ignition from off to on 8 times within 10 seconds, finishing in the on position. The doors lock then unlock to confirm that programming has started.
2. Press any button on the remote control that you want to program within 20 seconds. The doors lock then unlock to confirm that programming was successful.
3. Repeat step 2 to program each additional remote control.
4. After you have programmed all remote controls, switch the ignition off.
5. The doors lock then unlock to confirm that programming is complete.

Changing the Remote Control Battery

The remote control uses one coin-type three-volt lithium battery CR2032 or equivalent.



Make sure that you dispose of old batteries in an environmentally friendly way. Seek advice from your local authority about recycling old batteries.

Keys and Remote Controls



E195662

1. Twist a thin coin in the slot of the transmitter near the key ring to remove the battery cover.

Note: Do not remove the rubber cover and circuit board from the front housing of the remote entry transmitter.

Note: Do not wipe off any grease on the battery terminals or on the back surface of the circuit board.

2. Remove the old battery.



E195661

3. Insert the new battery. Refer to the symbols inside the transmitter for the correct orientation of the battery. Press the battery down to make sure it is fully in the housing.
4. Reinstall the battery housing cover onto the transmitter.

Note: Replacing the battery does not erase the programmed key from your vehicle. The transmitter should operate normally.

Car Finder



Press the button twice within three seconds. The horn sounds and the direction indicators flash. We recommend you use this method to locate your vehicle, rather than using the panic alarm.

Sounding the Panic Alarm



Press the button to sound the panic alarm. Press the button again or switch the ignition on to turn it off.

Keys and Remote Controls

Note: *The panic alarm operates regardless of the ignition position.*

REPLACING A LOST KEY OR REMOTE CONTROL

Replacement keys or remote controls can be purchased from an authorized dealer. Authorized dealers can program remote controls for your vehicle.

Doors and Locks

LOCKING AND UNLOCKING

You can use the power door lock control or the remote control to lock and unlock your vehicle.

Power Door Locks (If Equipped)

The power door lock control is on the driver and front passenger door panels.



E163049

- A Unlock.
- B Lock.

Remote Control (If Equipped)

Unlocking the Doors (Two-Stage Unlock)



Press the button to unlock the driver door.

Press the button again within three seconds to unlock all doors. The direction indicators flash.

Press and hold both the lock and unlock buttons on the remote control for four seconds to disable or enable two-stage unlocking. Disabling two-stage unlocking allows all vehicle doors to unlock with one press of the button. The direction indicators flash twice to indicate a change to the unlocking mode. The unlocking mode applies to the remote control.

Locking the Doors



Press the button to lock all the doors. The direction indicators flash.

Press the button again within three seconds to confirm that all the doors lock. The doors lock again, the horn sounds and the direction indicators flash if all the doors lock.

Mislock

If any door is open or if the hood is open on vehicles with an anti-theft alarm or remote start, the horn sounds twice and the lamps do not flash.

Smart Unlocks (If Equipped)

This feature helps prevent you from locking yourself out of your vehicle if your key is still in the ignition.

When you open the driver door and lock your vehicle with the power door lock control, all the doors lock, then unlock if your key is still in the ignition.

You can still lock your vehicle with the key in the ignition by:

- Using the manual lock on the door.
- Locking the driver door with a key.
- Using the lock button on the remote control.

Autolock (If Equipped)

Autolock locks all the doors when:

- All doors closed.
- The ignition is on.
- You shift into any gear putting your vehicle in motion.
- Your vehicle reaches a speed greater than 12 mph (20 km/h).

Doors and Locks

Autolock repeats when:

- You open, then close any door while the ignition is on and your vehicle speed is 9 mph (15 km/h) or lower.
- Your vehicle reaches a speed greater than 12 mph (20 km/h).

Autounlock

Autounlock unlocks all the doors when:

- The ignition is on, all the doors closed, and your vehicle has been moving at a speed greater than 12 mph (20 km/h).
- Your vehicle comes to a stop and you switch the ignition off or to the accessory position.
- You open the driver door within 10 minutes of switching the ignition off or to accessory.

Note: *The doors do not autounlock if you electronically lock your vehicle after you switch the ignition off and before you open the driver door.*

Enabling or Disabling Autounlock

You can enable or disable the autounlock feature in the information display or an authorized dealer can do it for you. See **General Information** (page 70).

Illuminated Entry

The interior lamps and select exterior lamps illuminate when you unlock the doors with the remote entry system.

The illuminated entry system turns off the lights if:

- The ignition is on.
- You press the remote control lock button.
- 25 seconds have passed.

The dome lamp does not turn on if the control is in the off position.

The lights do not turn off if:

- You turn them on with the dimmer control.
- Any door is open.

Battery Saver

The battery saver turns off the interior lamps 10 minutes after you switch the ignition off if a door is open and the dome lamp switch is on. It turns off the interior lamps after 10 minutes if the dome lamp switch is off.

PASSIVE ANTI-THEFT SYSTEM (IF EQUIPPED)

Note: *The system is not compatible with non-Ford aftermarket remote start systems. Use of these systems could result in engine starting problems and a loss of security protection.*

Note: *Prevent these objects from touching the coded key when starting your vehicle. Metallic objects, electronic devices or a second coded key on the same key chain could result in vehicle starting problems, especially if they are too close to the key when starting your vehicle. Switch the ignition off, move all objects on the key chain away from the coded key and restart your vehicle if a problem occurs.*

Note: *Do not leave a duplicate coded key in your vehicle. Always take your keys and lock all doors when leaving your vehicle.*

SecuriLock®

The system helps prevent the engine from starting unless you use a coded key programmed to your vehicle. Using the wrong key may prevent your vehicle from starting. A message may appear in the information display.

If you are unable to start your vehicle with a coded key, it is not operating correctly. A message may appear in the information display.

Automatic Arming

The system arms when you switch the ignition off.

Automatic Disarming

The system disarms when you switch the ignition on with a coded key.

Replacement Keys

Your vehicle may have two integrated keyhead transmitters.

The integrated keyhead transmitter functions as a programmed ignition key that starts your vehicle.

If your programmed transmitters or standard SecuriLock coded keys become lost or stolen and you do not have an extra coded key, you need to have your vehicle towed to an authorized dealer. You need to erase the key codes from your vehicle and program new coded keys.

Store an extra programmed key away from your vehicle in a safe place. To purchase additional spare or replacement keys, contact an authorized dealer.

If you have a spare key, you need to program it. See **Replacing a Lost Key or Remote Control** (page 48).

Steering Wheel

ADJUSTING THE STEERING WHEEL



WARNING: Do not adjust the steering wheel when your vehicle is moving.

Note: Make sure that you are sitting in the correct position. See **Sitting in the Correct Position** (page 82).

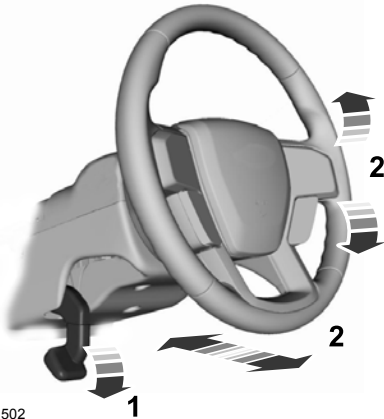

E261502

1. Unlock the steering column.
2. Adjust the steering wheel to the desired position.

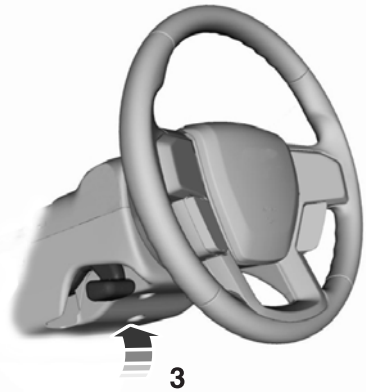

E261503

3. Lock the steering column.

CRUISE CONTROL - VEHICLES WITH: ADAPTIVE CRUISE CONTROL



E191337

See **Using Adaptive Cruise Control** (page 148).

Steering Wheel

CRUISE CONTROL - VEHICLES WITH: CRUISE CONTROL



E191329

See **Using Adaptive Cruise Control** (page 148).

INFORMATION DISPLAY CONTROL



E191336

See **Information Displays** (page 70).

HORN



You can activate the horn by pressing on the steering wheel near the horn icon. Some vehicles may also have a horn button on the instrument panel near the lighting control.

Wipers and Washers

WINDSHIELD WIPERS

Note: Fully defrost the windshield before you switch the windshield wipers on.

Note: Make sure you switch the windshield wipers off before entering a car wash.

Note: If streaks or smears appear on the windshield, clean the windshield and the wiper blades. If that does not resolve the issue, install new wiper blades.

Note: Do not operate the wipers on a dry windshield. This may scratch the glass, damage the wiper blades or cause the wiper motor to burn out. Always use the windshield washers before wiping a dry windshield.

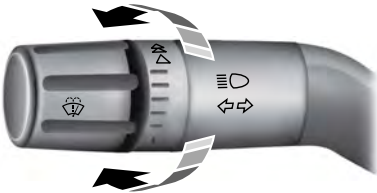

E172816

- Rotate away from you for a long wipe interval.
- Rotate toward you for a short wipe interval.

Speed Dependent Wipers

When your vehicle speed increases, the interval between wipes decreases.

WINDSHIELD WASHERS



E172818

- A brief press causes a single wipe without washer fluid.
- A brief press and hold causes the wipers to swipe three times with washer fluid.
- A long press and hold turns on the wipers and washer fluid for up to 10 seconds.

A wipe occurs a few seconds after washing to clear any remaining washer fluid. You can switch this feature on or off in the information display. See **Information Displays** (page 70).

Note: Do not operate the washers when the washer reservoir is empty. This could cause the washer pump to overheat.

Lighting

GENERAL INFORMATION

Condensation in the Exterior Front Lamps and Rear Lamps

Exterior front lamps and rear lamps have vents to accommodate normal changes in air pressure.

Condensation can be a natural by-product of this design. When moist air enters the lamp assembly through the vents, there is a possibility that condensation can occur when the temperature is cold. When normal condensation occurs, a fine mist can form on the interior of the lens. The fine mist eventually clears and exits through the vents during normal operation.

Clearing time may take as long as 48 hours under dry weather conditions.

Examples of acceptable condensation are:

- The presence of a fine mist (no streaks, drip marks or large droplets).
- A fine mist covers less than 50% of the lens.

Examples of unacceptable condensation are:

- A water puddle inside the lamp.
- Streaks, drip marks or large droplets present on the interior of the lens.

If you see any unacceptable condensation, have your vehicle checked by an authorized dealer.

LIGHTING CONTROL

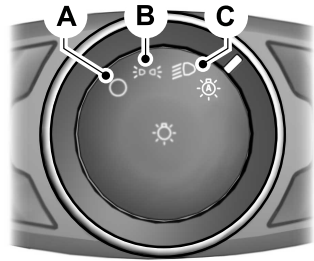

- A Lamps off.
- B Parking lamps, instrument panel lamps, license plate lamps and rear lamps.
- C Headlamps.

Headlamp High Beam

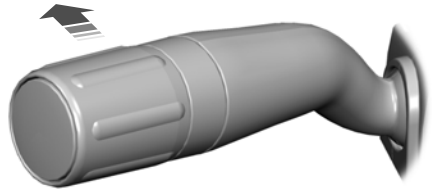

Push the lever away from you to switch the high beam on.

Push the lever forward again or pull the lever toward you to switch the high beams off.

Lighting

Flashing the Headlamp High Beam

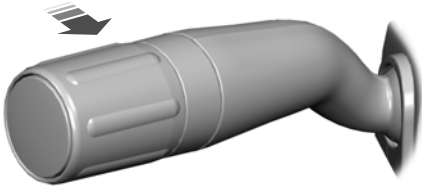

Slightly pull the lever toward you and release it to flash the headlamps.

AUTOLAMPS (IF EQUIPPED)



WARNING: The system does not relieve you of your responsibility to drive with due care and attention. You may need to override the system if it does not turn the headlamps on in low visibility conditions, for example daytime fog.

Autolamps turn the headlamps on in low light situations or when the wipers operate.



Switch the lighting control to the autolamps position.

The headlamps remain on for a period of time after you switch the ignition off. Use the information display controls to adjust the period of time that the headlamps remain on.

Note: *If you switch the autolamps on, you cannot switch the high beams on until the system turns the low beams on.*

Windshield Wiper Activated Headlamps

When you switch the autolamps on, the headlamps turn on within 10 seconds of switching the wipers on. They turn off approximately 60 seconds after you switch the windshield wipers off.

The headlamps do not turn on with the wipers:

- During a single wipe.
- When using the windshield washers.
- If the wipers are in intermittent mode.

Note: *If you switch the autolamps and the autowipers on, the headlamps turn on when the windshield wipers continuously operate.*

INSTRUMENT LIGHTING DIMMER

The instrument lighting dimmer buttons are on the lighting control.



Repeatedly press one of the buttons to adjust the brightness.



HEADLAMP EXIT DELAY

After you switch the ignition off, you can switch the headlamps on by pulling the direction indicator lever toward you. You will hear a short tone. The headlamps will switch off automatically after three minutes with any door open or 30 seconds after the last door has been closed. You can cancel this feature by pulling the direction indicator toward you again or switching the ignition on.

Lighting

DAYTIME RUNNING LAMPS (IF EQUIPPED)



WARNING: The daytime running lamps system does not activate the rear lamps and may not provide adequate lighting during low visibility driving conditions. Make sure you switch the headlamps on, as appropriate, during all low visibility conditions. Failure to do so may result in a crash.

The system turns the lamps on in daylight conditions.

To switch the system on, switch the lighting control to any position except headlamps.

AUTOMATIC HIGH BEAM CONTROL (IF EQUIPPED)



WARNING: The system does not relieve you of your responsibility to drive with due care and attention. You may need to override the system if it does not turn the high beams on or off.

The system turns on high beams if it is dark enough and no other traffic is present. If it detects an approaching vehicle's headlamps or tail lamps, or street lighting ahead, the system turns off high beams before they can distract other road users. Low beams remain on.

Note: *The system may not operate properly if the sensor is blocked. Keep the windshield free from obstruction or damage.*

Note: *The system may not operate properly in cold or inclement conditions. You can switch on the high beams by overriding the system.*

Note: *If the system detects a blockage, for example bird droppings, bug splatter, snow or ice, the system goes into low beam mode until you clear the blockage. A message may appear in the information display if the camera is blocked.*

Note: *Using much larger tires or equipping vehicle accessories such as snowplows can modify your vehicle's ride height and degrade automatic high beam control performance.*

A camera sensor, centrally mounted behind the windshield of your vehicle, continuously monitors conditions to turn the high beams on and off.

Once the system is active, the high beams turn on if:

- The ambient light level is low enough.
- There is no traffic in front of your vehicle.
- The vehicle speed is greater than approximately 32 mph (51 km/h).

The system turns the high beams off if:

- The ambient light level is high enough that high beams are not required.
- The system detects an approaching vehicle's headlamps or tail lamps.
- The vehicle speed falls below approximately 27 mph (44 km/h).
- The system detects severe rain, snow or fog.
- The camera is blocked.

Switching the System On and Off

Switch the system on using the information display. See **Information Displays** (page 70).

Lighting

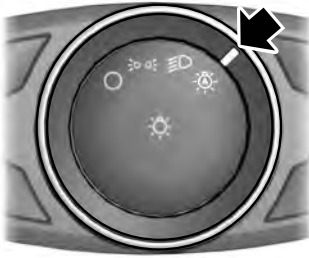

E142451

Switch the lighting control to the autolamps position. See **Autolamps** (page 56).

Overriding the System

Push the lever away from you to switch between high beam and low beam.

Automatic High Beam Indicator



The indicator illuminates to confirm when the system is ready to assist.

DIRECTION INDICATORS

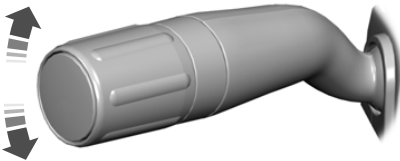

Push the lever up or down to use the direction indicators.

Note: Tap the lever up or down to make the direction indicators flash three times.

INTERIOR LAMPS

The lamps turn on under the following conditions:

- You open any door.
- You press a remote control button.

Map Lamps



E163273

Dome and Map Lamps





E163274

Press the button to switch the lamps on or off.

Windows and Mirrors

POWER WINDOWS (IF EQUIPPED)

 **WARNING:** Do not leave children unattended in your vehicle and do not let them play with the power windows. Failure to follow this instruction could result in personal injury.

 **WARNING:** When closing the power windows, verify they are free of obstruction and make sure that children and pets are not in the proximity of the window openings.

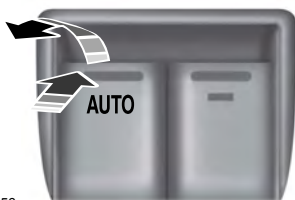

E163056

Note: You may hear a pulsing noise when just one of the windows is open. Lower the opposite window slightly to reduce this noise.

Press the switch to open the window. Lift the switch to close the window.

One-Touch Up or Down (If Equipped)

Press or lift the switch fully and release it. Press or lift it again to stop the window.

Note: The window may disable for up to five minutes if you cycle it up and down repeatedly. This helps prevent damage to the motor. Normal operation resumes once the motor cools.

Restoring the One-Touch Up Function

You may lose the one-touch function if the vehicle battery is low.

Note: Perform one-touch up re-calibration with the door closed. Calibrating with the door open causes the window to bounce back continuously.

To reset the function after the battery recharges:

1. Pull the switch all the way up.
2. Hold the switch until the glass stops and continue to hold for two seconds.
3. Press the switch down and operate the window to the full down position. One-touch up is now functional.

Bounce-Back

The window stops automatically while closing. It reverses some distance if there is an obstacle in the way.

Overriding the Bounce-Back Feature

 **WARNING:** If you override bounce-back, the window does not reverse if it detects an obstacle. Take care when closing the windows to avoid personal injury or damage to your vehicle.

Pull up the window switch and hold within two seconds of the window reaching the bounce-back position. The window travels up with no bounce-back protection. The window stops if you release the switch before the window closes fully.

Window Lock (If Equipped)

Press the control to lock or unlock the rear window controls.

Windows and Mirrors

EXTERIOR MIRRORS

Auxiliary Convex Mirrors



E208233

Convex mirrors are a ball-stud design for precise adjustment to maximize viewing area.

Power Exterior Mirrors (If Equipped)



WARNING: Do not adjust the mirrors when your vehicle is moving.

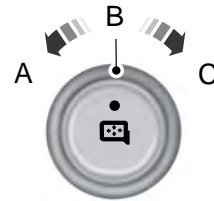

E163059

- A Left-hand mirror.
- B Off.
- C Right-hand mirror.

To adjust a mirror:

1. Rotate the control to select the mirror you want to adjust.
2. Adjust the position of the mirror.
3. Return the control to the center position to lock mirrors in place.

Foldaway Exterior Mirrors

For tight parking conditions, you can push the mirror toward the door window glass. Before driving, make sure that you fully engage the mirror in its support when returning it to its original position.

Power-Folding Mirrors (If Equipped)



E163060

1. Rotate the control so the dots line up.
2. Pull the control back to fold the mirrors in or out.

Windows and Mirrors

Note: If you repeatedly fold and unfold the mirrors several times within one minute, the system may disable to protect the motors from overheating. It resets to normal function automatically within three to five minutes.

You can also fold a mirror manually by pushing it toward the door window glass. After you manually adjust the mirror, you need to reset it.

To reset the power–folding mirror system and return it to its normal function:

- Fold the mirror manually by pushing it toward the door window glass.
- Use the power–fold control to fold and unfold the mirror two or three times. The mirror makes a sound as it resets.

Heated Exterior Mirrors (If Equipped)

See **Heated Exterior Mirrors** (page 81).

Signal Indicator Mirrors (If Equipped)

The outer portion of the appropriate mirror housing blinks when you use the direction indicator.

Clearance Lamps (If Equipped)

The lower, outer part of the mirror housings light when you switch on the headlamps or parking lamps.

Telescoping Mirrors (If Equipped)

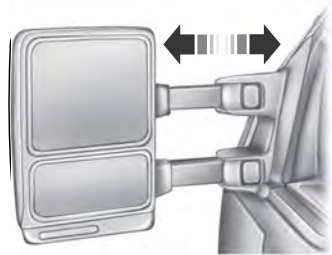

E163061

This feature lets you extend the mirror about 3 in (76 mm). It is useful when towing a trailer. You can manually pull out or push in the mirrors to the desired position.

PowerScope™ Power Telescoping Mirrors (If Equipped)

This feature lets you position both mirrors in or out at the same time. The control is on the door trim panel.

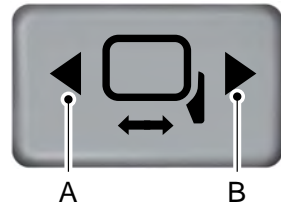

E163062

- A Telescope out.
- B Telescope in.

Windows and Mirrors

To adjust the mirrors:

- Press and hold the control.
- When you position the mirrors in or out, the motors run as long as you hold the control. The running motors allow you to make adjustments as needed.
- After positioning the mirrors, return the control to the center position to help protect the motors from overheating.

INTERIOR MIRROR (IF EQUIPPED)



WARNING: Do not adjust the mirror when your vehicle is moving.

Note: Do not clean the housing or glass of any mirror with harsh abrasives, fuel or other petroleum or ammonia-based cleaning products

You can adjust the interior mirror to your preference. Some mirrors also have a second pivot point. This lets you move the mirror head up or down and from side to side.

Pull the tab below the mirror toward you to reduce glare at night.

SUN VISORS

Slide-on-rod (If Equipped)

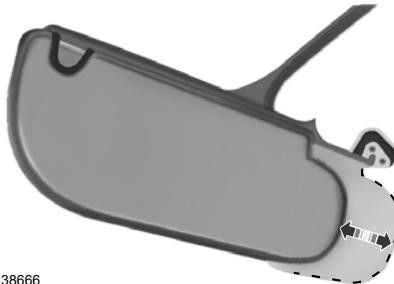

E138666

Rotate the sun visor toward the side window and extend it rearward for extra shade.

Instrument Cluster

GAUGES

2.3 Inch Display

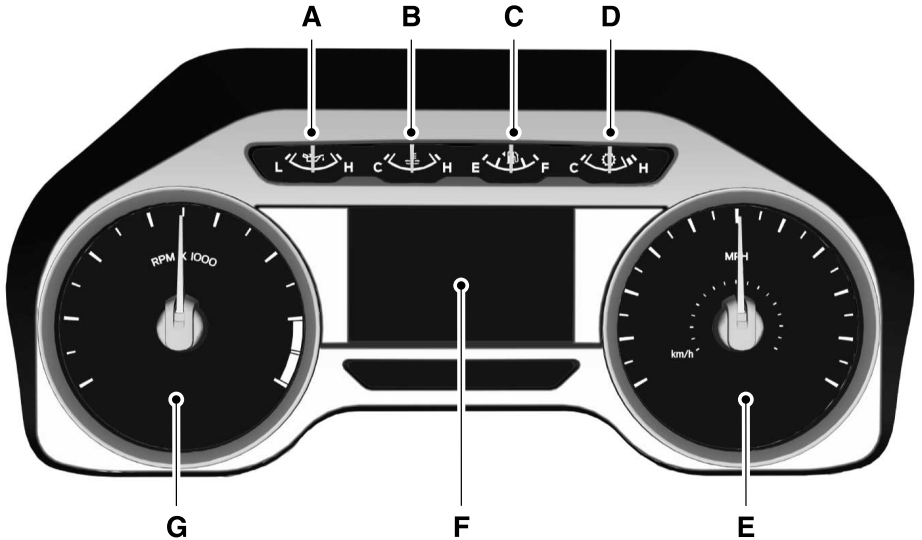

E219638

- A Engine oil pressure gauge.
- B Engine coolant temperature gauge.
- C Fuel gauge.
- D Transmission fluid temperature or Diesel Exhaust Fluid (DEF) gauge.
- E Speedometer.
- F Information display. See **General Information** (page 70).
- G Tachometer.

Instrument Cluster

8 Inch Display

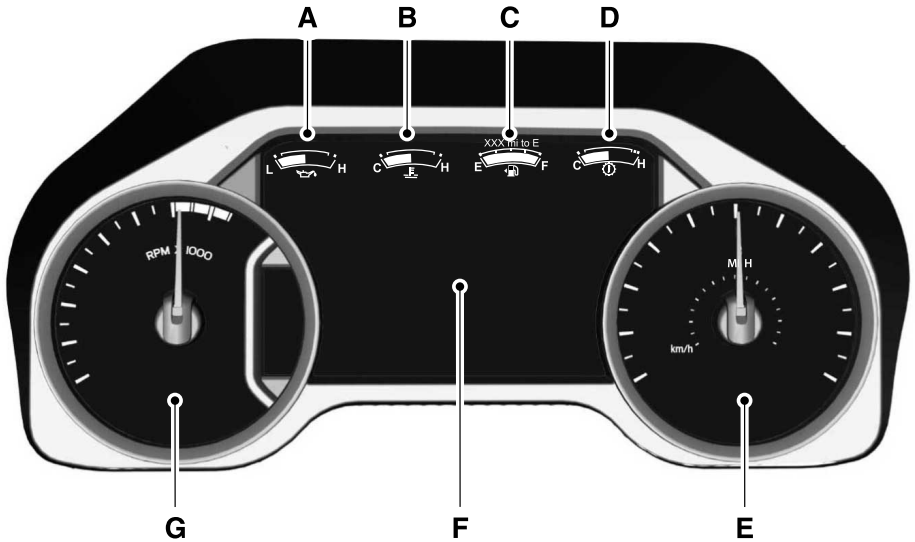

- A Engine oil pressure gauge.
- B Engine coolant temperature gauge.
- C Fuel gauge.
- D Configurable gauge.
- E Speedometer.
- F Information display. See **General Information** (page 70).
- G Tachometer.

Instrument Cluster

Engine Oil Pressure Gauge

Indicates engine oil pressure. At normal operating temperature, the level indicator is in the normal range. If the pressure gauge falls below the normal range, stop your vehicle, switch off the engine and check the engine oil level. Add oil if needed. If the oil level is correct, have your vehicle checked by an authorized dealer.

Engine Coolant Temperature Gauge



WARNING: Do not remove the coolant reservoir cap when the engine is on or the cooling system is hot. Wait 10 minutes for the cooling system to cool down. Cover the coolant reservoir cap with a thick cloth to prevent the possibility of scalding and slowly remove the cap. Failure to follow this instruction could result in personal injury.

Indicates engine coolant temperature. At normal operating temperature, the level indicator is in the normal range. If the engine coolant temperature exceeds the normal range, stop your vehicle as soon as possible, switch off the engine and let the engine cool.

Fuel Gauge

The fuel gauge indicates about how much fuel is in the fuel tank.

The arrow adjacent to the fuel pump symbol indicates on which side of your vehicle the fuel filler door is located.

Note: *The fuel gauge may vary slightly when your vehicle is moving or on a slope.*

Low Fuel Reminder

A low fuel level reminder displays and sounds when the distance to empty reaches 75 mi (120 km) to empty for MyKey, and at 50 mi (80 km), 25 mi (40 km), 10 mi (20 km) and 0 mi (0 km) for all vehicle keys.

Note: *The low fuel reminder can appear at different fuel gauge positions depending on fuel economy conditions. This variation is normal.*

Distance to Empty

Indicates the approximate distance your vehicle can travel on the fuel remaining in the tank. Changes in driving pattern can cause the value to not only decrease but also increase or stay constant for periods of time.

Configurable Gauge

Transmission Fluid Temperature Gauge

Indicates transmission fluid temperature. At normal operating temperature, the level indicator is in the normal range. If the transmission fluid temperature exceeds the normal range, stop your vehicle as soon as possible and verify the airflow is not restricted by snow or debris blocking airflow through the grille.

Special operating conditions such as snowplowing, towing, or off-road use may cause higher than normal operating temperatures. See **Special Operating Conditions Scheduled Maintenance** (page 329).

To lower the transmission temperature into the normal range, alter the severity of your driving conditions. Operating the transmission for extended periods with the gauge in the higher than normal area may cause internal transmission damage. If the gauge continues to show high temperatures, see an authorized dealer.

Instrument Cluster

Diesel Exhaust Fluid Gauge

Indicates the fluid level in the DEF tank.

Voltmeter

Displays electrical system voltage.

WARNING LAMPS AND INDICATORS

The following warning lamps and indicators alert you to a vehicle condition that may become serious. Some lamps illuminate when you start your vehicle to make sure they work. If any lamps remain on after starting your vehicle, refer to the respective system warning lamp for further information.

Note: *Some warning indicators appear in the information display and operate the same as a warning lamp but do not illuminate when you start your vehicle.*

Anti-Lock Braking System



If it illuminates when you are driving, this indicates a malfunction. Your vehicle continues to have normal braking without the anti-lock brake system function. Have your vehicle checked as soon as possible.

Automatic Regeneration Control (If Equipped)



Illuminates when you switch it off.

Battery



If it illuminates while driving, it indicates a malfunction. Switch off all unnecessary electrical equipment and have the system checked by an authorized dealer immediately.

Brake System



WARNING: Driving your vehicle with the warning lamp on is dangerous. A significant decrease in braking performance may occur. It may take you longer to stop your vehicle. Have your vehicle checked as soon as possible. Driving extended distances with the parking brake engaged can cause brake failure and the risk of personal injury.



Indicates low brake fluid level or a brake system malfunction. Have the system checked immediately by an authorized dealer.

Check Suspension (If Equipped)



Illuminates when you press the air suspension dump switch.

Cruise Control



Illuminates when you switch on this feature. See **What Is Cruise Control** (page 154).

Diesel Exhaust Fluid (If Equipped)



Illuminates with the key in the ON position, when the fluid is contaminated or the level falls below 1.0 gal (3.8 L). Refill the tank or, at a minimum, add at least 1.0 gal (3.8 L) in the tank.

Direction Indicator



Illuminates when you switch on the left or right direction indicator or when you switch on the hazard warning flashers. If the indicators stay on or flash faster, check for a burned out bulb.

Instrument Cluster

Door Ajar



Displays when the ignition is on and any door is not completely closed.

Electronic Locking Differential (If Equipped)



Illuminates when using the electronic locking differential.

Engine Coolant Temperature



If it illuminates when your vehicle is moving, this indicates that the engine is overheating. Stop your vehicle as soon as it is safe to do so and switch the engine off. Have your vehicle checked as soon as possible. See **Engine Coolant Check** (page 226). idk

Engine Oil Pressure



If it illuminates with the engine running, or when you are driving, this indicates a malfunction. Stop your vehicle as soon as it is safe to do so and switch off the engine. Check the engine oil level.

Note: Do not resume your journey if it illuminates despite the level being correct. Have the system checked as soon as possible.

Exhaust Brake On (If Equipped)



The exhaust brake indicator light illuminates when you switch the exhaust brake on.

Fasten Seatbelt



Illuminates and a tone sounds to remind you to fasten your seatbelt.

High Beam



Illuminates when you switch on the high beam headlamps. It flashes when you use the headlamp flasher.

Hydromax



Illuminates to indicate normal hydromax booster reserve system activation when the engine is off and the service brake pedal is applied. This light may also illuminate momentarily if the engine is running and the driver turns the steering wheel fully in one direction while braking. If the light remains on while the engine is running, this indicates inadequate hydraulic booster pressure or reserve pump system failure. Stop the vehicle as soon as possible and seek service immediately by your authorized dealer.

Parking Lamps



Illuminates when you switch the parking lamps on.

Low Fuel Level (If Equipped)



Illuminates when the fuel level is low or the fuel tank is nearly empty. Refuel as soon as possible.

Parking Brake Warning



Illuminates briefly when you switch the ignition to the on position, with the engine off. It also illuminates when you apply the parking brake. If the park brake lamp does not illuminate at these times, seek service immediately. Vehicles with the power parking brake option: If the park brake warning lamp begins to blink after setting

Instrument Cluster

the parking brake, this may indicate a failure in the parking brake system. Have the system checked as soon as possible. Driving extended distances with the parking brake engaged can cause brake failure and the risk of personal injury.

Parking Lamps



Illuminates when you switch the low beam headlamps or the parking lamps on.

Powertrain Malfunction/Reduced Power/Electronic Throttle Control

(If Equipped)



Illuminates in the event of a powertrain fault. Contact an authorized dealer as soon as possible.

Service Engine Soon



If it illuminates when the engine is running, the on board diagnostics system notifies you that the emission control system requires service.

If it flashes, engine misfire may be occurring. Increased exhaust gas temperatures could damage the catalytic converter or other vehicle components. Avoid heavy acceleration and deceleration and have your vehicle serviced immediately.

It illuminates when you switch the ignition on prior to engine start to check the bulb and to indicate whether your vehicle is ready for Inspection and Maintenance (I/M) testing.

Normally, it illuminates until the engine is cranked and automatically turns off if no malfunctions are present. However, if after 15 seconds it flashes eight times, this indicates that your vehicle is not ready for Inspection and Maintenance (I/M) testing.

See **Catalytic Converter** (page 110).

Stability Control Indicator (If Equipped)



Flashes during operation.

If it does not illuminate when you switch the ignition on, or remains on when the engine is running, this indicates a malfunction. Have your vehicle checked as soon as possible.

Traction Control Indicator



It flashes during a traction control event.

If it does not illuminate when you switch the ignition on, or remains on when the engine is running, this indicates a malfunction. Have your vehicle checked as soon as possible.

Traction Control System Off



Illuminates when you switch the system off.

Trailer Anti-Lock Brake System (ABS)



Illuminates briefly when you switch on the ignition, and only when a PLC trailer or a PLC diagnostic tool is connected. If the light fails to illuminate, remains on after you start the vehicle or continues to flash, have the system serviced immediately.

Instrument Cluster

Transmission Tow/Haul



Illuminates when you switch on the tow/haul feature. If the light flashes steadily, have the system serviced immediately, damage to the transmission could occur.

Two Speed Axle (If Equipped)



The Two Speed Axle indicator comes on when you switch the low axle range on.

Wait to Start (If Equipped)



Illuminates when you switch the ignition on as part of the pre-start system. Wait until the wait to start indicator turns off before attempting to start vehicle.



WARNING: Do not use starting fluid, for example ether, in the air intake system. Such fluid could cause immediate explosive damage to the engine and possible personal injury.

Water in Fuel (If Equipped)



Illuminates when the fuel filter/water separator has a significant quantity of water in it.

If the light illuminates when the engine is running, stop the vehicle as soon as safely possible, shut off the engine, then drain the fuel filter/water separator.

Allowing water to stay in the system could result in extensive damage to, or failure of, the fuel injection system.



WARNING: Do not drain the water-in-fuel separator while the engine is running. Failure to follow this warning may result in fire, serious injury, death or property damage.

AUDIBLE WARNINGS AND INDICATORS

Headlamps On Warning Chime

Sounds when you remove the key from the ignition and open the driver's door and you have left the headlamps or parking lamps on.

Key in Ignition Warning Chime

Sounds when you open the driver's door and you have left the key in the ignition.

Parking Brake On Warning Chime

Sounds when you have left the parking brake on and drive your vehicle. If the warning chime remains on after you have released the parking brake, have the system checked by your authorized dealer immediately.

Information Displays

GENERAL INFORMATION



WARNING: Driving while distracted can result in loss of vehicle control, crash and injury. We strongly recommend that you use extreme caution when using any device that may take your focus off the road. Your primary responsibility is the safe operation of your vehicle. We recommend against the use of any hand-held device while driving and encourage the use of voice-operated systems when possible. Make sure you are aware of all applicable local laws that may affect the use of electronic devices while driving.

Note: Trailer options are not available if your vehicle speed is greater than 3 mph (5 km/h).

Information Display Controls



E184451

- Press the up and down arrow buttons to scroll through and highlight the options within a menu.
- Press the right arrow button to enter a sub-menu.
- Press the left arrow button to exit a menu.
- Press the **OK** button to choose and confirm settings or messages.



This icon shows the features on or off status. A check in the box indicates the feature is on, and unchecked indicates the feature is off.

2.3 Inch Display Menu

Note: Some options may appear slightly different or not at all if the items are optional.

Main Menu
Trip 1
Trip 2
Fuel Economy
Driver Assist
Settings

Information Displays

Trip 1 or 2

Displays the following of an individual journey.

- Digital speed.
- Distance.
- Time.
- Distance to empty.
- Average fuel economy.

Note: Hold **OK** to reset fuel history and average fuel economy.

Fuel Economy

Displays the following:

- Instant fuel economy.
- Average fuel economy.
- Average speed.
- Distance to empty.

Note: Hold **OK** to reset fuel history and average fuel economy.

Driver Assist

Displays the following:

- Progressive range select.
- Engine hours.
- Voltmeter.
- Maintenance monitor.
- Oil Temp.

Settings

Settings		
Vehicle	Auto Regen	Select Your Setting
	Lighting	
	Locks	
	Windows	
	Wiper Controls	
Displ. Settings	Units	Select Your Setting
	Temperature	
	Language	

8 Inch Display Menu

Note: Some options may appear slightly different or not at all if the items are optional.

Information Displays

Main Menu
MyView
Trip/Fuel
Truck Info
Settings

MyView

MyView	
Trip 1	
Fuel Economy	
Configure MyView	For more options, press the OK button.

Trip/Fuel

Trip/Fuel
Trip 1
Trip 2
Fuel Economy
Fuel History

Trip 1 or 2

Displays the following of an individual journey.

- Trip timer.
- Distance to empty.
- Trip odometer.
- Average fuel economy.

Note: Hold **OK** to reset fuel history and average fuel economy.

Fuel Economy

Displays your instantaneous fuel usage as a bar graph and average mpg.

Fuel History

Displays your fuel usage based on time. The graph is updated each minute with the fuel economy that you achieved during 30 minutes of driving.

Information Displays

Truck Info

Truck Info
Gauge View
Digital Speedometer
Engine Information
Maintenance Monitor
Transmission Temperature

- Engine Information - Shows engine hours, engine idle hours and engine oil temp and oil life.

Settings

Settings			
Advanced Settings	Vehicle	Lighting	Select Your Setting
		Easy Entry/Exit	
		Locks	
		Windows	
		Wiper Controls	
Displ. Settings	Displ. Settings	Measurement Units	Select Your Setting
		Temperature Units	
		Tire Pressure	
		Language	

INFORMATION MESSAGES

Note: Depending on your vehicle options and instrument cluster type, not all of the messages display or are available. Additionally, the information display may abbreviate or shorten certain messages.

Press the RESET button to acknowledge and remove some messages from the information display. The information display automatically removes other messages after a short time.

You need to confirm certain messages before you can access the menus.

Information Displays

Diesel Messages



WARNING: When the CLEANING EXHAUST FILTER message appears in

the information display, do not park near flammable materials, vapors or structures until filter cleaning is complete.

Message	Action
CHECK COOLANT ADDITIVE	The coolant additive needs checking.
CLEANING EXHAUST FILTER	Your vehicle has entered the cleaning mode. Various engine actions raise the exhaust temperature in the diesel particulate filter system to burn off the particles (exhaust soot). After the vehicle burns off the particles, the exhaust temperature returns to normal levels. This message is normal.
EXHAUST OVER-LOADED DRIVE TO CLEAN EXHAUST AT LIMIT DRIVE TO CLEAN NOW	The diesel particulate filter is full of particles (exhaust soot) and you are not operating the vehicle in a manner that allows normal cleaning. One of these messages stays on until the exhaust filter cleaning has begun, at which time the CLEANING EXHAUST FILTER message displays. We recommend you drive the vehicle above 30 mph (48 km/h) until the CLEANING EXHAUST FILTER message turns off. The diesel particulate filter continues to fill with particles (exhaust soot) if you ignore this message. The service engine soon light illuminates and engine power may be limited, if cleaning is not permitted. Your vehicle requires dealer service to restore it to full-power operation.
STOP SAFELY NOW	Your vehicle exhaust system temperature exceeds intended operating range. If this warning occurs, a chime sounds, followed by reduced engine power. The engine shuts down when your vehicle speed is below 3 mph (5 km/h). Stop the vehicle as soon as safely possible. Have the system checked by an authorized dealer.
ENGINE OIL DILUTED	The diluted engine oil needs to be changed.
ENGINE WARMING REDUCED POWER	Your vehicle will have reduced engine torque until the engine is warmed sufficiently.
ENGINE TURNS OFF IN XX SECONDS	The powertrain control module intentionally turns the engine off due to your vehicle being in the final 30 seconds of a countdown. The diesel engine shutdown for extended idling is an optional feature.
ENGINE TURNED OFF	Appears after the 30-second countdown.

Information Displays

Message	Action
ENGINE WARMING PLEASE WAIT	In extremely cold weather, typically below -15°F (-26°C) and if the engine block heater is not utilized, your engine does not respond to accelerator pedal movement for 30 seconds. This restriction allows your engine to circulate the oil properly in order to avoid engine damage.
EXHAUST FILTER DRIVE COMPLETE	Your diesel particulate filter is clean.
EXHAUST FILTER CLEANED	Your diesel particulate filter is clean.
EXHAUST CLEAN STOPPED	The manual operator commanded regeneration process has stopped.
DPF LOADING OF 50% OR GREATER	Your message center may report a DPF loading of 50% or greater on initial delivery or following service DPF re-set, this is normal.
EXHAUST FLUID RANGE XXX MI	The distance you can travel before depleting the remaining diesel exhaust fluid.
IN XX MILES, SPEED LIMITED TO XX MPH EXHAUST FLUID EMPTY	Your diesel exhaust fluid is nearing empty. Your vehicle's top speed becomes limited in the displayed distance. You must replenish the diesel exhaust fluid to resume normal operation of your vehicle.
SPEED LIMITED TO XX MPH UPON RESTART EXHAUST FLUID EMPTY	Your remaining diesel exhaust fluid has depleted. Your speed is limited upon restart. You must replenish the diesel exhaust fluid to resume normal operation of your vehicle.
SPEED LIMITED TO XX MPH EXHAUST FLUID EMPTY	The diesel exhaust fluid is empty. You must replenish the diesel exhaust fluid to resume normal operation of your vehicle.
ENGINE IDLED SOON EXHAUST FLUID EMPTY	The selective catalytic reduction system detects low exhaust fluid. The engine eventually enters into an idle-only mode. You must replenish the diesel exhaust fluid to resume normal operation of your vehicle.
ENGINE IDLED - SEE OWNER'S MANUAL EXHAUST FLUID EMPTY	A problem exists with the selective catalytic reduction system. The vehicle enters into an idle-only mode. If the exhaust fluid is empty, you must replenish the diesel exhaust fluid to resume normal operation of your vehicle.
IN XX MILES, SPEED LIMITED TO 50 MPH EXHAUST FLUID SYSTEM FAULT	The selective catalytic reduction system detects a fault. The vehicle's top speed becomes limited in the displayed distance starting at 50 mi (80 km) and count down from this point. Have the system checked by an authorized dealer.

Information Displays

Message	Action
SPEED LIMITED TO 50 MPH UPON RESTART EXHAUST FLUID SYSTEM FAULT	The selective catalytic reduction system detects a fault. The vehicle's top speed becomes limited upon restarting. Have the system checked by an authorized dealer.
SPEED LIMITED TO 50 MPH EXHAUST FLUID SYSTEM FAULT	The selective catalytic reduction system detects a fault. The vehicle's top speed is limited. Have the system checked by an authorized dealer.
ENGINE IDLED SOON EXHAUST FLUID SYSTEM FAULT SEE MANUAL	The selective catalytic reduction system detects a fault. The engine enters into an idle-only mode. Have the system checked by an authorized dealer.
ENGINE IDLED - SEE OWNER'S MANUAL EXHAUST FLUID SYSTEM FAULT	The selective catalytic reduction system detects a fault. The engine eventually enters into an idle-only mode. Press OK to override the idle mode. Have the system checked by an authorized dealer.
FUEL FILTER CHANGE REQUIRED	A fuel filter change is required.
EXHAUST OVER LIMIT SERVICE NOW	You must have your vehicle serviced by an authorized dealer if approximately two hours after the EXHAUST OVERLOADED DRIVE TO CLEAN message has displayed and you have not driven your vehicle above 30 mph (48 km/h) for at least 20 minutes to clean the diesel particulate filter. You are responsible for assuring that you operate your vehicle in a manner that allows diesel particulate filter cleaning to occur. Ignoring the EXHAUST OVER LIMIT SERVICE NOW warning message could lead to reduced drivability and customer expense, including damage to the diesel particulate filter. Your new vehicle warranty may not cover this damage.
WATER IN FUEL DRAIN FILTER SEE MANUAL	The water separator has reached a predetermined capacity and needs draining.
LOW FUEL PRESSURE	A low fuel pressure condition has occurred due to cold, low fuel level or fuel filters need to be changed.

Information Displays

Engine

Message	Action
TRANSPORT MODE CONTACT DEALER	Your vehicle is set to transport mode. The transport mode disables certain vehicle functions to prevent battery discharge.
POWER REDUCED TO LOWER ENGINE TEMP	The vehicle has reduced engine speed because fluid temperatures are at or near their max operating limits.

Fuel

Message	Action
FUEL LEVEL LOW	An early reminder of a low fuel condition.
CHECK FUEL CAP	The fuel cap may not be properly closed.

Key

Message	Action
TO DRIVE: TURN KEY TO ON	The factory equipped remote start is active. Turn your key to on to drive.

Maintenance

Message	Action
ENGINE OIL CHANGE SOON	The engine oil life is nearing its end.
OIL CHANGE REQUIRED	The oil life left reaches 0%.
BRAKE FLUID LEVEL LOW	The brake fluid level is low and the brake system needs inspection immediately.
CHECK BRAKE SYSTEM	The brake system needs servicing. If the warning stays on or continues to come on, have the system checked by an authorized dealer as soon as possible.

Information Displays

Park Brake

Message	Action
PARK BRAKE ENGAGED	The parking brake is set and your vehicle is in motion.

Climate Control

MANUAL CLIMATE CONTROL

(IF EQUIPPED)



Note: Depending on your vehicle option package, the controls may look different from what you see here.

Directing the Air



Press and release the button to direct air between the instrument panel air vents, footwell air vents and windshield air vents and de-mister.

Setting the Blower Motor Speed

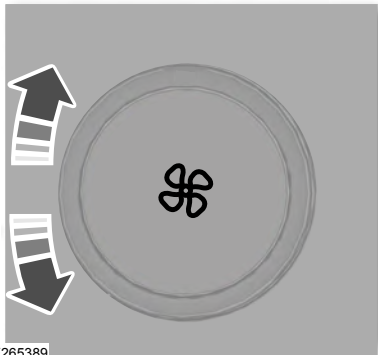

E265389

Turn the control to adjust the volume of air circulated in the vehicle.

Setting the Temperature

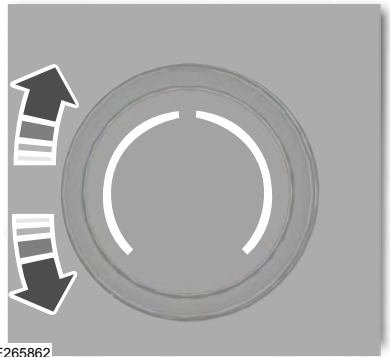

E265862

Turn the control to set the temperature.

Switching the Air Conditioning On and Off



Press and release the button to switch the air conditioning on or off.

Use air conditioning with recirculated air to improve cooling performance and efficiency.

Note: In certain conditions (for example, maximum defrost), the air conditioning compressor may continue to operate even though you switch off the air conditioning.

Switching the Climate Control On and Off



Press and release the button.

Switching Defrost On and Off



Press and release the button to distribute air through the windshield air vents and de-mister.

Climate Control

Air directed to the instrument panel and footwell air vents turns off. You can also use this setting to defog and clear the windshield of a thin covering of ice.

Switching Maximum Air Conditioning On and Off



Press and release the button for maximum cooling.

The left-hand and right-hand settings set to LO, recirculated air flows through the instrument panel air vents, air conditioning turns on and the blower motor adjusts to the highest speed.

Switching Recirculated Air On and Off



Press and release the button to switch between outside air and recirculated air.

The air currently in the passenger compartment recirculates. This may reduce the time needed to cool the interior (when used with A/C) and reduce unwanted odors from entering your vehicle.

Note: *Recirculated air may turn off (or prevent you from switching on) in all air flow modes except MAX A/C to reduce the risk of fogging. Recirculation may also turn on and off in various air distribution control combinations during hot weather in order to improve cooling efficiency.*

HINTS ON CONTROLLING THE INTERIOR CLIMATE

General Hints

Note: *Prolonged use of recirculated air may cause the windows to fog up.*

Note: *You may feel a small amount of air from the footwell air vents regardless of the air distribution setting.*

Note: *To reduce humidity build-up inside your vehicle, do not drive with the system switched off or with recirculated air always switched on.*

Note: *Do not place objects under the front seats as this may interfere with the airflow to the rear seats.*

Note: *Remove any snow, ice or leaves from the air intake area at the base of the windshield.*

Note: *To improve the time to reach a comfortable temperature in hot weather, drive with the windows open until you feel cold air through the air vents.*

Quickly Heating the Interior

1. Adjust the blower motor speed to the highest speed setting.
2. Adjust the temperature control to the highest setting.
3. Direct air to the footwell air vents.

Recommended Settings for Heating

1. Adjust the blower motor speed to the center setting.
2. Adjust the temperature control to the midway point of the hot settings.
3. Direct air to the footwell air vents.

Quickly Cooling the Interior

1. Select **MAX A/C**.
2. Drive with the windows open for a short period of time.

Recommended Settings for Cooling

1. Adjust the blower motor speed to the center setting.
2. Adjust the temperature control to the midway point of the cold settings.

Climate Control

3. Direct air to the instrument panel air vents.

Vehicle Stationary for Extended Periods During Extreme High Ambient Temperatures

1. Apply the parking brake.
2. Place your vehicle in park (P) or neutral.
3. Select **MAX A/C**.
4. Adjust the blower motor speed to the lowest speed setting.

Defogging the Side Windows in Cold Weather

1. Direct air to the instrument panel and windshield air vents.
2. Press and release **A/C**.
3. Adjust the temperature control to the setting you prefer.
4. Adjust the blower motor speed to the highest setting.
5. Direct air toward the side windows.
6. Close the instrument panel air vents.

HEATED EXTERIOR MIRRORS

(IF EQUIPPED)



Press the button to clear the exterior mirrors of thin ice and fog. Press the button again to switch them off. They switch off after a short period of time.

Note: Do not remove ice from the mirrors with a scraper or adjust the mirror glass when it is frozen in place. These actions could cause damage to the glass and mirrors.

Note: Do not clean the mirror housing or glass with harsh abrasives, fuel or other petroleum-based cleaning products.

Seats

SITTING IN THE CORRECT POSITION



WARNING: Do not recline the seatback as this can cause the occupant to slide under the safety belt, resulting in serious injury in the event of a crash.



WARNING: Do not place objects higher than the seatback to reduce the risk of serious injury in the event of a crash or during heavy braking.

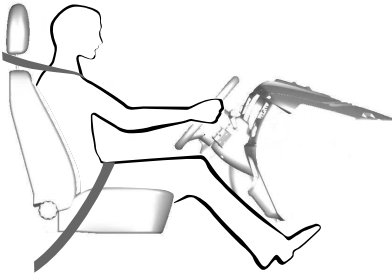

When you use them properly, the seat, head restraint, safety belt and airbags will provide optimum protection in the event of a crash.

We recommend that you follow these guidelines:

- Sit in an upright position with the base of your spine as far back as possible.
- Do not recline the seatback more than 30 degrees.
- Adjust the head restraint so that the top of it is level with the top of your head and as far forward as possible. Make sure that you remain comfortable.

- Keep sufficient distance between yourself and the steering wheel. We recommend a minimum of 10 in (25 cm) between your breastbone and the airbag cover.
- Hold the steering wheel with your arms slightly bent.
- Bend your legs slightly so that you can press the pedals fully.
- Position the shoulder strap of the safety belt over the center of your shoulder and position the lap strap tightly across your hips.

Make sure that your driving position is comfortable and that you can maintain full control of your vehicle.

HEAD RESTRAINTS



WARNING: Fully adjust the head restraint before you sit in or operate your vehicle. This will help minimize the risk of neck injury in the event of a crash. Do not adjust the head restraint when your vehicle is moving.



WARNING: The head restraint is a safety device. Whenever possible it should be installed and properly adjusted when the seat is occupied. Failure to adjust the head restraint properly could reduce its effectiveness during certain impacts.

Note: *Adjust the seat backrest to an upright driving position before adjusting the head restraint. Adjust the head restraint so that the top of it is level with the top of your head and as far forward as possible. Make sure that you remain comfortable. If you are extremely tall, adjust the head restraint to its highest position.*

Seats

Front Seat Adjustable Head Restraint (If Equipped)

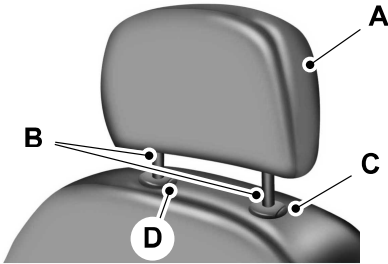

E138642

The head restraints consist of:

- A An energy absorbing head restraint.
- B Two steel stems.
- C Guide sleeve adjust and release button.
- D Guide sleeve unlock and remove button.

Adjusting the Head Restraint

Raising the Head Restraint

Pull the head restraint up.

Lowering the Head Restraint

1. Press and hold button C.
2. Push the head restraint down.

Removing the Head Restraint

1. Press and hold buttons C and D.
2. Pull the head restraint up.

Installing the Head Restraint

Align the steel stems into the guide sleeves and push the head restraint down until it locks.

Front Row Center, Outboard (Crew Cab), and Rear Seat Center (Crew Cab) Head Restraints

Note: *The SuperCab has rear outermost head restraints that you cannot remove and are bolted to the back wall.*

Your vehicle may have head restraints that are non-adjustable. The non-adjustable head restraints consist of:

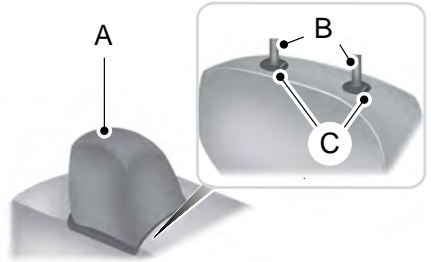

E162872

- A An energy absorbing head restraint.
- B Two steel stems.
- C Guide sleeve unlock and remove button.

Removing the Head Restraint

1. Press and hold the C buttons.
2. Pull up the head restraint.

Installing the Head Restraint

Align the steel stems into the guide sleeves and push the head restraint down until it locks.

Tilting Head Restraints (If Equipped)

The front head restraints tilt for extra comfort. To tilt the head restraint, do the following:

Seats



1. Adjust the seat backrest to an upright driving or riding position.
2. Pivot the head restraint forward toward your head to the preferred position.

After the head restraint reaches the forward-most tilt position, pivot it forward again to release it to the rearward, un-tilted position.

Note: Do not attempt to force the head restraint backward after it is tilted. Instead, continue tilting it forward until the head restraint releases to the upright position.

MANUAL SEATS



WARNING: Do not adjust the driver seat or seatback when your vehicle is moving.

Moving the Seat Backward and Forward

Type 1



E162727

Type 2



E226571

Recline Adjustment

Type 1



E162728

Seats

Type 2



E208773

Tilting the Seatback Forward (Two-Passenger Bench Seat)



E208777

Lift the handle to unlock and release the seatback forward.

Manual Lumbar (If Equipped)

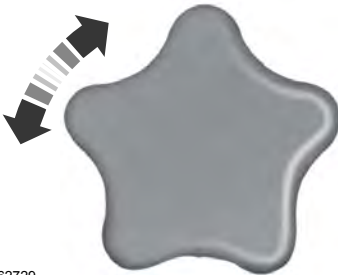

E162729

The lumbar control is on the outboard side of the seat. Turn the control to adjust your support.

POWER SEATS (IF EQUIPPED)

WARNING: Do not adjust the driver seat or seat backrest when your vehicle is moving. This may result in sudden seat movement, causing the loss of control of your vehicle.

WARNING: Do not place cargo or any objects behind the seatback before returning it to the original position.

Air-Ride Seat

Type 1

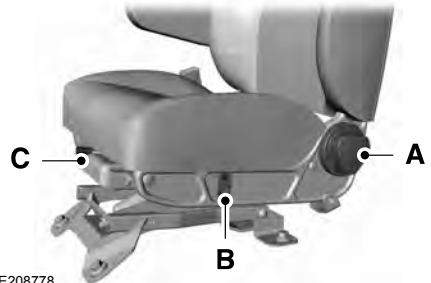

E208778

- A. Rotate the handle to adjust the angle of the seat backrest.
- B. Pull the control up to raise the seat. Push the control down to lower the seat.
- C. Move the lever to the left to move the seat forward or backward. Release the lever to lock the seat in position.

Seats

Type 2

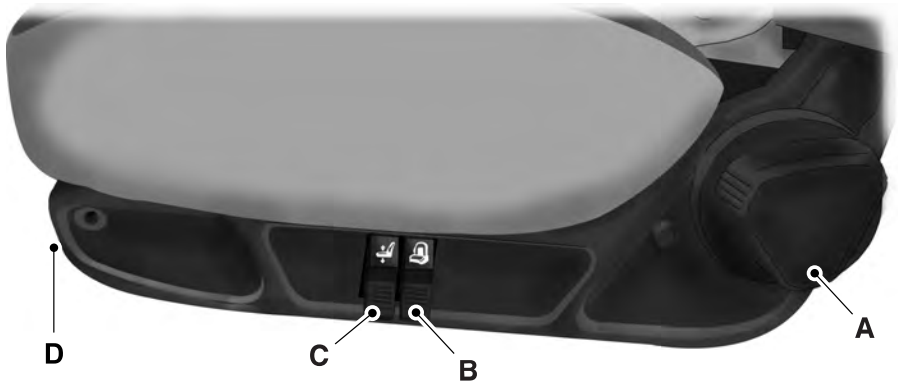

- A. Rotate the handle to adjust the angle of the seat backrest.
- B. Pull the lever up to inflate the lumbar. Push the lever down to deflate the lumbar.
- C. Pull the lever up to raise the seat height. Push the lever down to lower the seat height.
- D. Move the lever to the left to move the seat forward or backward. Release the lever to lock the seat in position.

REAR SEATS (IF EQUIPPED)

Folding Up the Rear Seats (SuperCab)



E162737

1. Pull the control to release the seat cushion.

Seats

2. Rotate the seat cushion up until it locks into the vertical storage position.

Returning the Seat to the Seating Position



WARNING: Make sure that cargo or any objects are not trapped underneath the seat cushion before returning the seat cushion to its original position, and that the seat cushion locks into place. Failure to do so may prevent the seat from operating properly in the event of a crash, which could increase the risk of serious injury.

1. Pull the control on the side of the seat to release the seat cushion from the storage position.
2. Push the seat cushion down until it locks into the horizontal position.

Folding the Rear Seat Back (Crew Cab)

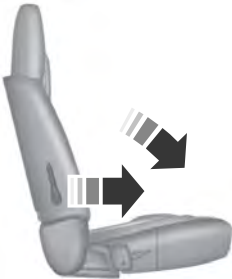

E162738

1. Pull forward on the control to fold down the seatback.
2. Pull down on the handle and lift up on the seatback to return it to the original position.

Folding up the Rear Seat Cushion

1. Pull the control to release the seat cushion.
2. Rotate the seat cushion up until it locks into the vertical storage position.

Returning the Seat to the Seating Position



WARNING: Make sure that cargo or any objects are not trapped underneath the seat cushion before returning the seat cushion to its original position, and that the seat cushion locks into place. Failure to do so may prevent the seat from operating properly in the event of a crash, which could increase the risk of serious injury.

1. Pull the control on the side of the seat to release the seat cushion from the storage position.
2. Push the seat cushion down until it locks into the horizontal position.

FRONT SEAT ARMREST



E162745

Seats

Press the button on the right-hand side of the seat, then pull the seat backrest down to release the armrest. You can gain access to the cupholders and optional seat backrest storage bin.



E162746

REAR SEAT ARMREST (IF EQUIPPED)



E162744

Fold the armrest down to use it.

Pull up on the tab to open the storage bin.

Lift up on the seat backrest to return it to the upright position.

20% Seat Cushion Storage (If Equipped)



E265303

Lift the latch to open the lid and gain access to the storage compartment under the center seat cushion.

Auxiliary Power Points

12 Volt DC Power Point



WARNING: Do not plug optional electrical accessories into the cigar lighter socket. Incorrect use of the cigar lighter can cause damage not covered by the vehicle warranty, and can result in fire or serious injury.

Note: When you switch the ignition on, you can use the socket to power 12 volt appliances with a maximum current rating of 15 amps.

If the power supply does not work after you switch the ignition off, switch the ignition on.

Note: Do not hang any accessory from the accessory plug.

Note: Do not use the power point over the vehicle capacity of 12 volt DC 180 watts or a fuse may blow.

Note: Always keep the power point caps closed when not in use.

Do not insert objects other than an accessory plug into the power point. This damages the power point and may blow the fuse.

Run the vehicle for full capacity use of the power point.

To prevent the battery from running out of charge:

- Do not use the power point longer than necessary when the vehicle is not running.
- Do not leave devices plugged in overnight or when you park your vehicle for extended periods.

Locations

Power points may be in the following locations:

- On the instrument panel (two locations).
- Inside the front under-seat storage compartment.
- Inside the rear under-seat storage compartment.

110 Volt AC Power Point (if Equipped)



WARNING: Do not keep electrical devices plugged in the power point whenever the device is not in use. Do not use any extension cord with the 110 volt AC power point, since it will defeat the safety protection design. Doing so may cause the power point to overload due to powering multiple devices that can reach beyond the 150 watt load limit and could result in fire or serious injury.

Note: The power point turns off when you switch the ignition off, or when the battery voltage drops below 11 volts.

You can use the power point for electric devices that require up to 150 watts. It is in the center of the instrument panel.



Note: Depending on your vehicle, the power point cover may open to the right or upward.

Auxiliary Power Points

When the indicator light on the power point is:

- On: The power point is working, the ignition is on and a device is plugged in.
- Off: The power point is off, the ignition is off or no device is plugged in.
- Flashing: The power point is in fault mode.

The power outlet temporarily turns off power when in fault mode if the device exceeds the 150 watt limit. Unplug your device and switch the ignition off. Switch the ignition back on, but do not plug your device back in. Let the system cool off and switch the ignition off to reset the fault mode. Switch the ignition back on and make sure the indicator light remains on.

Do not use the power point for certain electric devices, including:

- Cathode-ray, tube-type televisions.
- Motor loads, such as vacuum cleaners, electric saws and other electric power tools or compressor-driven refrigerators.
- Measuring devices, which process precise data, such as medical equipment or measuring equipment.
- Other appliances requiring an extremely stable power supply such as microcomputer-controlled electric blankets or touch-sensor lamps.

USB Ports

LOCATING THE USB PORTS

Data Transfer USB Ports



The USB Ports could be in the following locations:

- On the lower instrument panel.
- Inside the media bin.
- Inside the center console.

Note: *These USB ports can also charge devices.*

Note: *Not all USB ports in your vehicle have data transfer capabilities.*

Note: *We recommend using only USB-IF certified cables and adapters. Non-certified cables and adapters may not work.*

Charge Only USB Ports



The USB ports could be in the following locations:

- On the lower instrument panel.
- Inside the media bin.
- Inside the center console.
- On the rear of the center console.
- In the cargo area.

CHARGING A DEVICE

Connect your device to the USB port.

You can use the charger when the vehicle is in accessory mode, when the vehicle is running, or when SYNC is on.

Storage Compartments

OVERHEAD CONSOLE (IF EQUIPPED)



E266392

Press near the rear edge of the door to open it.

Starting and Stopping the Engine

GENERAL INFORMATION



WARNING: Extended idling at high engine speeds can produce very high temperatures in the engine and exhaust system, creating the risk of fire or other damage.



WARNING: Do not park, idle or drive your vehicle on dry grass or other dry ground cover. The emission system heats up the engine compartment and exhaust system, creating the risk of fire.



WARNING: Do not start the engine in a closed garage or in other enclosed areas. Exhaust fumes are toxic. Always open the garage door before you start the engine. Failure to follow this instruction could result in personal injury or death.



WARNING: Exhaust leaks may result in entry of harmful and potentially lethal fumes into the passenger compartment. If you smell exhaust fumes inside your vehicle, have your vehicle inspected immediately. Do not drive if you smell exhaust fumes.

If you disconnect the battery, your vehicle could exhibit some unusual driving characteristics for approximately 5 mi (8 km) after you reconnect it. This is because the engine management system must realign itself with the engine. You can disregard any unusual driving characteristics during this period.

The powertrain control system meets all Canadian interference-causing equipment standard requirements regulating the impulse electrical field or radio noise.

When you start the engine, avoid pressing the accelerator pedal before and during operation.

If you operate your vehicle in a heavy snow storm or blowing snow conditions, the engine air induction could become partially clogged with snow and ice. If this occurs, the engine could experience a significant reduction in power output. At the earliest opportunity, clear all the snow and ice away from the air induction inlet.

IGNITION SWITCH

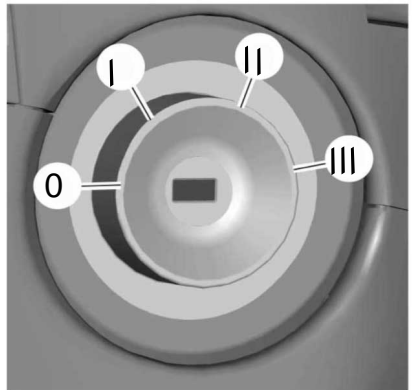

0 (off) - The ignition is off.

Note: When you switch the ignition off and leave your vehicle, do not leave your key in the ignition. This could cause your vehicle battery to lose charge.

I (accessory) - Allows the electrical accessories, such as the radio, to operate while the engine is not running.

Note: Do not leave the ignition key in this position for too long. This could cause your vehicle battery to lose charge.

II (on) - All electrical circuits are operational and the warning lamps and indicators illuminate.

Starting and Stopping the Engine

/// (start) - Cranks the engine.

STARTING A GASOLINE ENGINE (IF EQUIPPED)

When you start the engine, the idle speed increases, this helps to warm up the engine. If the engine idle speed does not slow down automatically, have your vehicle checked by an authorized dealer.

Before starting the engine check the following:

- Make sure all occupants have fastened their safety belts.
- Make sure the headlamps and electrical accessories are off.
- Make sure the parking brake is on.
- Make sure the transmission is in park (P) or neutral (N).
- Turn the ignition key to the on position.

Note: *Do not touch the accelerator pedal.*

1. Fully press the brake pedal.
2. Turn the key to the start position to start the engine. Release the key when the engine starts.

Note: *The engine may continue cranking for up to 15 seconds or until it starts.*

Note: *If you cannot start the engine on the first try, wait for a short period and try again.*

Failure to Start

If you cannot start the engine after three attempts, wait 10 seconds and follow this procedure:

1. Fully press the brake pedal.
2. Fully press the accelerator pedal and hold it there.
3. Start the engine.

Stopping the Engine When Your Vehicle is Stationary

1. Shift into park (P) or neutral (N).
2. Turn the key to the off position.
3. Apply the parking brake.

Stopping the Engine When Your Vehicle is Moving



WARNING: Switching off the engine when the vehicle is still moving will result in a loss of brake and steering assistance. The steering will not lock, but higher effort will be required. When the ignition is switched off, some electrical circuits, including air bags, warning lamps and indicators may also be off. If the ignition was turned off accidentally, you can shift into neutral (N) and re-start the engine.

1. Put the transmission into neutral (N) and use the brakes to bring your vehicle to a safe stop.
2. When your vehicle has stopped, shift into park (P) or neutral (N) and switch the ignition off.
3. Apply the parking brake.

Guarding Against Exhaust Fumes



WARNING: If you smell exhaust fumes inside your vehicle, have your vehicle checked by your authorized dealer immediately. Do not drive your vehicle if you smell exhaust fumes. Carbon monoxide is present in exhaust fumes. Take precautions to avoid its dangerous effects.

Starting and Stopping the Engine

Important Ventilating Information

If you stop your vehicle and then leave the engine idling for long periods of time, we recommend that you do one of the following:

- Open the windows at least 1 in (3 cm).
- Set your climate control to outside air.

STARTING A DIESEL ENGINE (IF EQUIPPED)

Read all starting instructions carefully before you start your vehicle.

Diesel Engine Fast Start Glow Plug System

The diesel engine glow system consists of:

- Eight glow plugs (one per cylinder)
- Glow Plug Control Module
- Engine Coolant Temperature sensor
- Barometric pressure sensor
- Environmental temperature sensor

The powertrain and glow plug control modules electronically control the glow plug system. After you switch the ignition on the glow plug control module immediately energizes the glow plugs. The glow plug control module using the engine coolant temperature, barometric pressure sensor and environmental temperature sensor will determine how long the glow plugs stay energized. The required time for the glow plugs to be energized decreases as the coolant temperature, barometric pressure and environmental temperature increase.

Before starting the engine, check the following:

- Make sure all occupants fasten their seatbelt.
- Make sure the headlamps and electrical accessories are off.
- Make sure the parking brake is on.
- Make sure the transmission is in park (P) or neutral (N).
- Turn the ignition key to the on position.

Note: Do not press the accelerator during starting.

Cold Weather Starting



WARNING: Do not use starting fluid, for example ether, in the air intake system. Such fluid could cause immediate explosive damage to the engine and possible personal injury.



WARNING: Do not mix diesel with gasoline, gasohol or alcohol. This could cause an explosion.

We recommend using the engine block heater for starting when the ambient temperature is at or below -9°F (-23°C) See **Engine Block Heater** (page 97).

When operating in cold weather, you can use Motorcraft® cetane improvers or non-alcohol-based cetane improvers from a reputable manufacturer as needed.

Do not crank the engine for more than 10 seconds as starter damage may occur. If the engine fails to start, turn the key to the off position and wait 30 seconds before trying again.

Starting and Stopping the Engine

Your vehicle may be equipped with a cold weather starting strategy that prevents severe engine damage by assisting in engine lubrication warm-up. In extremely cold ambient temperatures, this strategy activates and prevents the accelerator pedal use for 30 seconds after starting your vehicle. A message appears in the information display as your vehicle warms up. By not allowing the accelerator pedal use, the engine oil can properly lubricate the bearings preventing engine damage due to lack of proper lubrication. After the 30-second warm-up period, the accelerator pedal is operational again and a message appears informing you that your vehicle is ok to drive.

When starting the engine in extremely cold temperatures, for example -15°F (-26°C), we recommend you allow the engine to idle for several minutes before driving your vehicle.



Illuminates when you switch the ignition on as part of the pre-starting system.

1. Turn the key to the on position without turning the key to the start position. Do not start the engine until the wait to start indicator turns off.
2. When the wait to start indicator turns off, turn the key to the start position and release the key as soon as the engine starts. After starting the engine, the glow plugs may remain on for a period. If you do not start the engine before the glow plug activation time ends, you need to reset the glow plugs by turning the key to the off position.
3. After the engine starts, allow it to idle for about 15 seconds. This is to protect the engine. Do not increase engine speed until the oil pressure gauge indicates normal pressure.

SWITCHING OFF THE ENGINE

Allow the engine to idle for three to five minutes before shutting it down. The larger the engine, the greater the need is for this idling period.

Note: *Try to limit engine idle to 10 minutes. Excessive idling reduces fuel economy.*

ENGINE IDLE SHUTDOWN (IF EQUIPPED)



WARNING: In the event of engine shutdown, make sure your vehicle is safely off the road and the problem is resolved before returning to the road. Failure to do so may result in a crash, serious injury or death.

This feature automatically shuts down the engine when it has been idling in park (P) or neutral (N) for an extended period, depending on the setting.

When the engine idle shutdown process has started:

- A chime sounds and a message appears in the information display showing a timer counting down from 30 seconds.
- You can reset the timer by pressing the brake pedal, accelerator pedal, or by shifting into another gear.
- If you do not intervene within 30 seconds, the engine shuts down and a message appears in the information display alerting you that the engine has shut down.

Starting and Stopping the Engine

- Shortly after the engine has shut down, the electrical system simulates a key off and even though the ignition is still on, the electrical system simulates a normal accessory delay period before shutting down.
- You must switch the ignition off to reset the system before restarting your vehicle.

The engine idle shutdown timer does not start if:

- The engine is operating in battery charge protect or power take-off mode.
- The exhaust emission control device is regenerating.

ENGINE BLOCK HEATER (IF EQUIPPED)



WARNING: Failure to follow engine block heater instructions could result in property damage or serious personal injury.



WARNING: Do not use your heater with ungrounded electrical systems or two-pronged adapters. There is a risk of electrical shock.

Note: *The heater is most effective when outdoor temperatures are below 0°F (-18°C).*

The heater acts as a starting aid by warming the engine coolant. This allows the climate control system to respond quickly. The equipment includes a heater element (installed in the engine block) and a wire harness. You can connect the system to a grounded 120-volt AC electrical source.

We recommend that you do the following for a safe and correct operation:

- Use a 16-gauge outdoor extension cord that is product certified by Underwriter's Laboratory (UL) or Canadian Standards Association (CSA). This extension cord must be suitable for use outdoors, in cold temperatures, and be clearly marked Suitable for Use with Outdoor Appliances. Do not use an indoor extension cord outdoors. This could result in an electric shock or become a fire hazard.
- Use as short an extension cord as possible.
- Do not use multiple extension cords.
- Make sure that when in operation, the extension cord plug and heater cord plug connections are free and clear of water. This could cause an electric shock or fire.
- Make sure your vehicle is parked in a clean area, clear of combustibles.
- Make sure the heater, heater cord and extension cord are firmly connected.
- Check for heat anywhere in the electrical hookup once the system has been operating for approximately 30 minutes.
- Make sure the system is unplugged and properly stowed before starting and driving your vehicle. Make sure the protective cover seals the prongs of the block heater cord plug when not in use.
- Make sure the heater system is checked for proper operation before winter.

Using the Engine Block Heater

Make sure the receptacle terminals are clean and dry prior to use. Clean them with a dry cloth if necessary.

Starting and Stopping the Engine

The heater uses 0.4 to 1.0 kilowatt-hours of energy per hour of use. The system does not have a thermostat. It achieves maximum temperature after approximately three hours of operation. Using the heater longer than three hours does not improve system performance and unnecessarily uses electricity.

Fuel and Refueling

SAFETY PRECAUTIONS



WARNING: Do not overfill the fuel tank. The pressure in an overfilled tank may cause leakage and lead to fuel spray and fire.



WARNING: The fuel system may be under pressure. If you hear a hissing sound near the fuel filler inlet, do not refuel until the sound stops. Otherwise, fuel may spray out, which could cause serious personal injury.



WARNING: Fuels can cause serious injury or death if misused or mishandled.



WARNING: Gasoline may contain benzene, which is a cancer-causing agent.



WARNING: When refueling always shut the engine off and never allow sparks or open flames near the fuel tank filler valve. Never smoke or use a cell phone while refueling. Fuel vapor is extremely hazardous under certain conditions. Avoid inhaling excess fumes.



WARNING: Flow of fuel through a fuel pump nozzle can produce static electricity. This can cause a fire if you are filling an ungrounded fuel container.



WARNING: Stop refueling after the fuel pump nozzle automatically shuts off for the second time. Failure to follow this will fill the expansion space in the fuel tank and could lead to fuel overflowing.

Observe the following guidelines when handling automotive fuel:

- Extinguish all smoking materials and any open flames before refueling your vehicle.
- Automotive fuels can be harmful or fatal if swallowed. Fuel such as gasoline is highly toxic and if swallowed can cause death or permanent injury. If swallowed, call a physician immediately, even if no symptoms are immediately apparent. The toxic effects of fuel may not be visible for hours.
- Avoid inhaling fuel vapors. Inhaling too much fuel vapor of any kind can lead to eye and respiratory tract irritation. In severe cases, excessive or prolonged breathing of fuel vapor can cause serious illness and permanent injury.
- Avoid getting fuel liquid in your eyes. If you splash fuel in your eyes, remove contact lenses (if worn), flush with water for 15 minutes and seek medical attention. Failure to seek proper medical attention could lead to permanent injury.
- Fuels can also be harmful if absorbed through the skin. If you splash fuel on your skin, clothing or both, promptly remove contaminated clothing and wash your skin thoroughly with soap and water. Repeated or prolonged skin contact with fuel liquid or vapor causes skin irritation.
- Be particularly careful if you are taking "Antabuse" or other forms of disulfiram for the treatment of alcoholism. Breathing gasoline vapors, or skin contact could cause an adverse reaction. In sensitive individuals, serious

Fuel and Refueling

personal injury or sickness may result. If you splash fuel on your skin, promptly wash your skin thoroughly with soap and water. Consult a physician immediately if you experience an adverse reaction.

Low Fuel Pressure (If Equipped)

Diesel engine vehicles have a low fuel pressure detection system.

The following are possible causes for a low fuel pressure warning message to appear in the information display:

- Cold start or during cold operation below 32°F (0°C). If the low fuel pressure message appears during a cold start or up to 10 minutes after the initial cold start, monitor the information display. If the low fuel pressure message disappears and does not re-appear after the engine has fully warmed up, waxed or gelled fuel is what most likely caused the message. Do not use alcohol based additives to correct fuel gelling. This may result in damage to the fuel injectors and systems. Use an anti-gel additive. See **Capacities and Specifications** (page 288).

Note: *The vehicle Warranty may be void if you use additives that do not meet or exceed Ford specifications. If the low fuel pressure message persistently appears after re-fueling and then disappears when the engine has fully warmed up, consider using different fuel sources.*

- Low fuel operation: If the low fuel pressure message appears when your vehicle is warm and during low fuel tank level operation (near empty), refuel your vehicle. If the message reappears after fueling, see below. If the message does not come back, the low fuel pressure condition was due to low fuel levels in the fuel tank.
- Normal operation: If the low fuel pressure message appears during normal operation when the engine is fully warm, and fuel level is not low, you must change the fuel filters regardless of the maintenance schedule interval.
- If replacement of the fuel filter does not remedy the low fuel pressure message during normal operation as defined above, take the vehicle to an authorized dealer.

FUEL QUALITY - DIESEL

Fuel Requirements - Choosing The Right Fuel: Vehicles Operated Where Ultra Low Sulfur Diesel Fuel Is Required (United States/Canada/Puerto Rico/U.S. Virgin Islands And Other Locales)

Use Ultra-Low Sulfur Diesel fuel, also known as ULSD, designated as number 1-D or 2-D with a maximum of 15 ppm sulfur in your diesel vehicle. You can operate your vehicle on diesel fuels containing up to 20% biodiesel, also known as B20. These fuels should meet the ASTM D975 diesel or the ASTM D7467 B6-B20 biodiesel industry specifications. Outside of North America, use fuels meeting EN590 or equivalent local market standard.

Fuel and Refueling

We recommend the use of Top Tier Diesel fuel where available to help minimize engine deposits and maintain optimal vehicle and engine performance. Look for the Top Tier logo at the station. For additional information, visit www.toptiergas.com.

Note: *The vehicle Warranty does not cover damage caused by using an improper type of fuel or fuel additive.*

Note: *Do not blend used engine oil with diesel fuel under any circumstances. Blending used oil with the fuel significantly increases exhaust emissions and reduces engine life due to increased internal wear.*



Using low sulfur diesel fuel with 16-500 ppm or high sulfur diesel fuel with greater than 500 ppm in your diesel engine will cause certain emission components to malfunction, which could also cause the service engine soon light to illuminate, indicating an emissions-related concern.

Diesel fuel is adjusted seasonally for cold temperature. For best results at temperatures below 19°F (-7°C), it is recommended to use a diesel fuel which has been seasonally adjusted for the ambient conditions.

Fuel Requirements - Choosing The Right Fuel: Vehicles Operated Where Ultra Low Sulfur Diesel Fuel Is Not Required

For the engine to operate reliably on low-sulfur or high-sulfur diesel fuel, the engine must be a factory built high-sulfur engine, available as a dealer order option for select markets, or an ultra low sulfur diesel fuel configured engine that has been retrofitted for high-sulfur diesel fuel using authorized dealer service parts. Failure to

use retrofit components other than those available through your authorized dealer will result in coolant system damage, engine overheating, selective catalyst reduction system or diesel particulate filter damage and possible base engine damage.

Use only a diesel engine configured for use with high sulfur diesel fuel in markets with diesel fuel that has sulfur content greater than 15 ppm. Using low sulfur diesel fuel with 16–500 ppm or high sulfur diesel fuel with greater than 500 ppm in a diesel engine requiring only Ultra Low Sulfur Diesel fuel could result in damage to engine emission control devices and the aftertreatment system, potentially rendering the vehicle inoperable.

Vehicles with engines configured for use with high sulfur diesel fuel are only available for sale in countries where ultra low sulfur diesel fuel is generally not available or mandated by the government. Vehicles originally sold in a ultra low sulfur diesel fuel market that are subsequently exported to non- ultra low sulfur diesel fuel markets will need to be retrofitted at the customer's expense using authorized dealer service parts in order to be reliably operated on non- ultra low sulfur diesel fuel.

Biodiesel

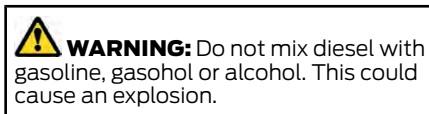

Biodiesel fuel is a chemically converted product from renewable fuel sources, such as vegetable oils, animal fats and waste cooking greases.

Fuel and Refueling

To help achieve acceptable engine performance and durability when using biodiesel in your vehicle:

- Confirm the biodiesel content of the fuel to be 20% biodiesel or less, also known as B20.
- Only use biodiesel fuel of good quality that complies with industry standards.
- Follow the recommended service maintenance intervals. See **Scheduled Maintenance** (page 319).
- Do not store biodiesel fuel in the fuel tank for more than 1 month.
- Consider changing brands or reducing biodiesel content if you have cold temperature fuel gelling issues or a frequent LOW FUEL PRESSURE message appearing.

Note: *Do not use home heating oil, agricultural fuel, raw fats and oils, waste cooking greases, biodiesel fuels greater than 20% or any diesel fuel not intended for highway use. Red dye is used to identify fuels intended for agricultural and non-highway use. Damage to the fuel injection system, engine and exhaust catalyst can occur if an improper fuel is used.*

Use of biodiesel in concentrations greater than 20% could cause damage to your vehicle, including engine and/or exhaust catalyst and particulate filter failures. Concentrations greater than 20% can also cause fuel filter restrictions that could result in a lack of power or damage to fuel system components, including fuel pump and fuel injector failures.

SAE 5W-40 or SAE 15W-40 oil is recommended for fuels with greater than 5% biodiesel, also known as B5. Follow the recommended oil change intervals and other maintenance when operating on biodiesel. See **Special Operating Conditions Scheduled Maintenance** (page 329).

Look for a label on the fuel pump to confirm the amount of biodiesel contained in a diesel fuel. Biodiesel content is often indicated with the letter B followed by the percent of biodiesel in the fuel. For example, B20 indicates a fuel containing 20% biodiesel. Ask the service station attendant to confirm the biodiesel content of a diesel fuel if you do not see a label on the fuel pump.

Note: *Biodiesel fuels degrade more easily than diesel fuels not containing biodiesel. Degraded or oxidized biodiesel can damage fuel system seals and plastics and corrode steel parts. If you plan to park or store your vehicle for more than 1 month, empty your vehicle fuel tank of biodiesel fuel. Fill the tank with a pure petroleum-based diesel fuel and run your vehicle for a minimum of 30 minutes.*

During cold weather, if you have problems operating on biodiesel, you may need to use a diesel fuel with lower biodiesel content, try another brand, or discontinue the use of biodiesel.

Diesel Fuel Additives

It should not be necessary to add any aftermarket additives to your fuel if you use a high quality diesel fuel that conforms to ASTM industry specifications. Aftermarket additives can damage the fuel injector system or engine.

Use Motorcraft® cetane booster or an equivalent cetane booster additive if you suspect fuel has low cetane. Use Motorcraft® anti-gel & performance improver or an equivalent additive if there is fuel gelling.

Do not use alcohol-based additives to improve cetane quality, to prevent fuel gelling or any other use. The use of alcohol additives may result in damage to the fuel injectors and system. See **Capacities and Specifications** (page 288).

Fuel and Refueling

The Vehicle Warranty may not cover repairs needed to correct the effects of using an aftermarket product that does not meet our specifications in your fuel.

FUEL QUALITY - GASOLINE

Choosing the Right Fuel

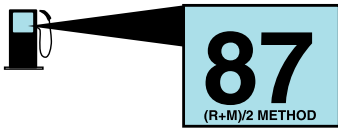

Your vehicle is designed to operate on regular unleaded gasoline with a minimum pump (R+M)/2 octane rating of 87.

Some fuel stations, particularly those in high altitude areas, offer fuels posted as regular unleaded gasoline with an octane rating below 87. The use of these fuels could result in engine damage that will not be covered by the vehicle warranty.

We do not recommend these fuels. For best overall vehicle and engine performance, premium fuel with an octane rating of 91 or higher is recommended. The performance gained by using premium fuel is most noticeable in hot weather as well as other conditions, for example when towing a trailer. See **Towing a Trailer** (page 171).

Do not be concerned if the engine sometimes knocks lightly. However, if the engine knocks heavily while using fuel with the recommended octane rating, contact an authorized dealer to prevent any engine damage.

We recommend Top Tier detergent gasolines, where available to help minimize engine deposits and maintain optimal vehicle and engine performance. For additional information, refer to www.toptiergas.com.

Note: *Use of any fuel for which the vehicle was not designed can impair the emission control system, cause loss of vehicle performance, and cause damage to the engine which may not be covered by the vehicle Warranty.*

Do not use:

- Diesel fuel.
- Fuels containing kerosene or paraffin.
- Fuel containing more than 10% ethanol or E85 fuel.
- Fuels containing methanol.
- Fuels containing metallic-based additives, including manganese-based compounds.
- Fuels containing the octane booster additive, methylcyclopentadienyl manganese tricarbonyl (MMT).
- Leaded fuel, using leaded fuel is prohibited by law.

The use of fuels with metallic compounds such as methylcyclopentadienyl manganese tricarbonyl (commonly known as MMT), which is a manganese-based fuel additive, will impair engine performance and affect the emission control system.

RUNNING OUT OF FUEL - DIESEL

Avoid running out of fuel. This allows air to enter the fuel system and may make it difficult to restart your vehicle.

Fuel and Refueling

If your vehicle runs out of fuel:

- Normally adding 4–5 gal (15–19 L) of fuel is enough to restart the engine. If your vehicle is out of fuel and on a steep grade, more than 5 gal (19 L) may be required.
- You must purge trapped air from the system before restarting the engine.

Purging Air From the System

Switch the ignition on for 30 seconds and then switch the ignition off. Repeat this operation six times in a row to purge any trapped air from the fuel system.

Any remaining air in the system self-purges when the engine starts. The engine may run rough or produce white smoke when air remains in the fuel system. This is normal and stops after a short period. If the engine continues to run rough, have your vehicle checked as soon as possible.

Starting the Engine

Do not crank the engine for more than 10 seconds as starter damage may occur. If the engine fails to start, switch the ignition off and wait 30 seconds before cranking the engine again. See **Starting a Diesel Engine** (page 95).

RUNNING OUT OF FUEL - GASOLINE

Avoid running out of fuel because this situation may have an adverse effect on powertrain components.

If you run out of fuel:

- You may need to switch the ignition from off to on several times after refueling to allow the fuel system to pump the fuel from the tank to the engine. When restarting, cranking time takes a few seconds longer than normal. With keyless ignition, just start the engine. Crank time will be longer than usual.
- Normally, adding 1 gal (3.8 L) of fuel is enough to restart the engine. If the vehicle is out of fuel and on a steep grade, more than 1 gal (3.8 L) may be required.
- The service engine soon indicator may come on. See **Warning Lamps and Indicators** (page 66).

REFUELING - DIESEL

An engine that suddenly becomes noisy or operates poorly after a fuel fill could be using substandard fuel. We recommend that you purchase diesel fuel from a reputable fuel station.

Use only clean, approved containers that will prevent the entry of dirt or water whenever you store diesel fuel.

Do not store diesel fuel in a galvanized container. The fuel dissolves the zinc in the galvanized container. The zinc will then remain in the fuel. If you run the contaminated fuel through the engine, the zinc damages the fuel injectors. Engine damage caused may not be covered by the vehicle Warranty.

Fuel and Refueling

Fuel Filler Cap



WARNING: The fuel system may be under pressure. If you hear a hissing sound near the fuel filler inlet, do not refuel until the sound stops. Otherwise, fuel may spray out, which could cause serious personal injury.

Note: If you do not use the correct fuel filler cap, excessive pressure or vacuum in the fuel tank may damage the fuel system or cause the fuel cap to disengage in a crash.

The fuel tank has a threaded fuel filler cap.

Note: If you must replace the fuel filler cap, replace it with a fuel filler cap that is designed for your vehicle. The vehicle Warranty may be void for any damage to the fuel tank or fuel system if the correct genuine Ford, Motorcraft or other certified fuel filler cap is not used.

When refueling the vehicle fuel tank do the following.

1. When your vehicle has stopped, shift into neutral (N) or park (P).
2. Apply the parking brake and switch the ignition off.
3. Turn the fuel filler cap counterclockwise and remove it.
4. Refuel your vehicle as required.
5. Replace the fuel filler cap, turn it clockwise until you feel a strong resistance.

Fuel Fill Rate

Your vehicle has a fuel fill pipe that is able to accept fuel up to 20 gal (75 L) per minute from a fuel-dispensing nozzle. Pumping fuel at greater flow rates may result in premature nozzle shut-off or spit back.

Truck stops have fuel pumps and nozzles designed for larger, heavy-duty trucks. If you are refueling your vehicle at a truck stop and the nozzle shuts off repeatedly, wait 5-10 seconds, then use a slower fill rate.

REFUELING - GASOLINE



WARNING: Fuel vapor burns violently and a fuel fire can cause severe injuries.



WARNING: Read and follow all the instructions on the pump island.



WARNING: When refueling always shut the engine off and never allow sparks or open flames near the fuel tank filler valve. Never smoke or use a cell phone while refueling. Fuel vapor is extremely hazardous under certain conditions. Avoid inhaling excess fumes.



WARNING: Stay outside your vehicle and do not leave the fuel pump unattended when refueling your vehicle.



WARNING: Keep children away from the fuel pump; never let children pump fuel.



WARNING: Wait at least 10 seconds before removing the fuel pump nozzle to allow any residual fuel to drain into the fuel tank.



WARNING: Stop refueling after the fuel pump nozzle automatically shuts off for the second time. Failure to follow this will fill the expansion space in the fuel tank and could lead to fuel overflowing.

Fuel and Refueling



WARNING: Do not remove the fuel pump nozzle from its fully inserted position when refueling.

Use the following guidelines to avoid electrostatic charge build-up when filling an ungrounded fuel container:

- Place approved fuel container on the ground.
- Do not fill a fuel container while it is in the vehicle (including the cargo area).
- Keep the fuel pump nozzle in contact with the fuel container while filling.
- Do not use a device that would hold the fuel pump handle in the fill position.

Fuel Filler Cap



WARNING: The fuel system may be under pressure. If you hear a hissing sound near the fuel filler inlet, do not refuel until the sound stops. Otherwise, fuel may spray out, which could cause serious personal injury.



WARNING: If you do not use the correct fuel filler cap, excessive pressure or vacuum in the fuel tank may damage the fuel system or cause the fuel cap to disengage in a crash. Failure to follow this warning could result in serious personal injury.

The fuel tank has a threaded fuel filler cap.

Note: *If you must replace the fuel filler cap, replace it with a fuel filler cap that is designed for your vehicle. The vehicle Warranty may be void for any damage to the fuel tank or fuel system if the correct genuine Ford, Motorcraft or other certified fuel filler cap is not used.*

When refueling the vehicle fuel tank do the following.

1. When your vehicle has stopped, shift into neutral (N) or park (P).
2. Apply the parking brake and switch the ignition off.
3. Turn the fuel filler cap counterclockwise and remove it.
4. Refuel your vehicle as required.
5. Replace the fuel filler cap, turn it clockwise until you feel a strong resistance.

If the fuel cap warning lamp or a warning message appears in the instrument cluster, you may not have installed the fuel filler cap correctly.

If the fuel cap warning lamp remains on, at the next opportunity, safely pull off of the road, remove the fuel filler cap, align the cap properly and reinstall it. The check fuel cap warning lamp or warning message may not reset immediately. It may take several driving cycles for the indicators to turn off. A driving cycle consists of an engine start-up (after four or more hours with the engine off) followed by normal city and highway driving.

FUEL CONSUMPTION

The advertised capacity is the maximum amount of fuel that you can add to the fuel tank after running out of fuel. Included in the advertised capacity is an empty reserve. The empty reserve is an unspecified amount of fuel that remains in the fuel tank when the fuel gauge indicates empty.

Note: *The amount of fuel in the empty reserve varies and should not be relied upon to increase driving range.*

Fuel and Refueling

Filling the Fuel Tank

For consistent results when refueling:

- Turn the ignition off before fueling; an inaccurate reading results if the engine is left running.
- Use the same fill rate (low-medium-high) each time the tank is filled.
- Allow no more than one automatic shut-off when refueling.

Results are most accurate when the filling method is consistent.

Calculating Fuel Economy

Do not measure fuel economy during the first 1,000 mi (1,600 km) of driving (this is your engine's break-in period). A more accurate measurement is obtained after 2,000 mi (3,200 km) to 3,000 mi (4,800 km). Also, fuel expense, frequency of fill ups or fuel gauge readings are not accurate ways to measure fuel economy.

1. Fill the fuel tank completely and record the initial odometer reading.
2. Each time you fill the fuel tank, record the amount of fuel added.
3. After at least three fill ups, fill the fuel tank and record the current odometer reading.
4. Subtract your initial odometer reading from the current odometer reading.

To calculate L/100 km (liters per 100 kilometers) fuel consumption, multiply the liters used by 100, then divide by kilometers traveled. To calculate MPG (miles per gallon) fuel consumption, divide miles traveled by gallons used.

Keep a record for at least one month and record the type of driving (city or highway). This provides an accurate estimate of your vehicle's fuel economy under current driving conditions. Keeping records during summer and winter will show how temperature impacts fuel economy.

Conditions

- Heavily loading your vehicle reduces fuel economy.
- Carrying unnecessary weight in your vehicle may reduce fuel economy.
- Adding certain accessories to your vehicle such as bug deflectors, rollbars or light bars, running boards and ski racks may reduce fuel economy.
- Using fuel blended with alcohol may lower fuel economy.
- Fuel economy may decrease with lower temperatures.
- Fuel economy may decrease when driving short distances.
- You will get better fuel economy when driving on flat terrain than when driving on hilly terrain.

Fuel and Refueling

FUEL TANK SELECTOR SWITCH (IF EQUIPPED)



E205996

Your vehicle may have two fuel tanks. The fuel in each fuel tank is independently used. Use the switch on the instrument panel to select the left-hand or right-hand fuel tank. The fuel gauge indicates the remaining fuel in the selected fuel tank. See **Gauges** (page 63).

Engine Emission Control

EMISSION LAW



WARNING: Do not remove or alter the original equipment floor covering or insulation between it and the metal floor of the vehicle. The floor covering and insulation protect occupants of the vehicle from the engine and exhaust system heat and noise. On vehicles with no original equipment floor covering insulation, do not carry passengers in a manner that permits prolonged skin contact with the metal floor. Failure to follow these instructions may result in fire or personal injury.

U.S. federal laws and certain state laws prohibit removing or rendering inoperative emission control system components. Similar federal or provincial laws may apply in Canada. We do not approve of any vehicle modification without first determining applicable laws.



Tampering with emissions control systems including related sensors or the Diesel Exhaust Fluid system can result in reduced engine power and the illumination of the service engine soon light.

Tampering With a Noise Control System

Federal laws prohibit the following acts:

- Removal or rendering inoperative by any person other than for purposes of maintenance.
- Repair or replacement of any device or element of the design incorporated into a new vehicle for the purpose of noise control prior to its sale or delivery to the ultimate purchaser or while it is in use.
- The use of the vehicle after any person removes or renders inoperative any device or element of the design.

The U.S. Environmental Protection Agency may presume to constitute tampering as follows:

- Removal of hood blanket, fender apron absorbers, fender apron barriers, underbody noise shields or acoustically absorptive material.
- Tampering or rendering inoperative the engine speed governor, to allow engine speed to exceed manufacturer specifications.

If the engine does not start, runs rough, experiences a decrease in engine performance, experiences excess fuel consumption or produces excessive exhaust smoke, check for the following:

- A plugged or disconnected air inlet system hose.
- A plugged engine air filter element.
- Water in the fuel filter and water separator.
- A clogged fuel filter.
- Contaminated fuel.
- Air in the fuel system, due to loose connections.
- An open or pinched sensor hose.
- Incorrect engine oil level.

Engine Emission Control

- Incorrect fuel for climatic conditions.
- Incorrect engine oil viscosity for climactic conditions.

Note: *Some vehicles have a lifetime fuel filter that is integrated with the fuel tank. Regular maintenance or replacement is not needed.*

Note: *If these checks do not help you correct the concern, have your vehicle checked as soon as possible.*

Noise Emissions Warranty, Prohibited Tampering Acts and Maintenance

On January 1, 1978, Federal regulation became effective governing the noise emission on trucks over 10,000 lb (4,536 kg) Gross Vehicle Weight Rating (GVWR). The preceding statements concerning prohibited tampering acts and maintenance, and the noise warranty found in the Warranty Guide, are applicable to complete chassis cabs over 10,000 lb (4,536 kg) GVWR.

CATALYTIC CONVERTER



WARNING: Do not park, idle or drive your vehicle on dry grass or other dry ground cover. The emission system heats up the engine compartment and exhaust system, creating the risk of fire.



WARNING: The normal operating temperature of the exhaust system is very high. Never work around or attempt to repair any part of the exhaust system until it has cooled. Use special care when working around the catalytic converter. The catalytic converter heats up to a very high temperature after only a short period of engine operation and stays hot after the engine is switched off.



WARNING: Exhaust leaks may result in entry of harmful and potentially lethal fumes into the passenger compartment. If you smell exhaust fumes inside your vehicle, have your vehicle inspected immediately. Do not drive if you smell exhaust fumes.

Your vehicle has various emission control components and a catalytic converter that enables it to comply with applicable exhaust emission standards.

To make sure that the catalytic converter and other emission control components continue to work properly:

- Do not crank the engine for more than 10 seconds at a time.
- Do not run the engine with a spark plug lead disconnected.
- Do not push-start or tow-start your vehicle. Use booster cables. See **Jump Starting the Vehicle** (page 183).
- Use only the specified fuel listed.
- Do not switch the ignition off when your vehicle is moving.
- Avoid running out of fuel.
- Have the items listed in scheduled maintenance information performed according to the specified schedule.

Note: *Resulting component damage may not be covered by the vehicle Warranty.*

The scheduled maintenance items listed in scheduled maintenance information are essential to the life and performance of your vehicle and to its emissions system.

If you use anything other than Ford, Motorcraft or Ford-authorized parts for maintenance replacements or for service of components affecting emission control, such non-Ford parts should be equivalent to genuine Ford Motor Company parts in performance and durability.

Engine Emission Control

Illumination of the service engine soon indicator, charging system warning light or the temperature warning light, fluid leaks, strange odors, smoke or loss of engine power could indicate that the emission control system is not working properly.

An improperly operating or damaged exhaust system may allow exhaust to enter the vehicle. Have a damaged or improperly operating exhaust system inspected and repaired immediately.

Do not make any unauthorized changes to your vehicle or engine. By law, vehicle owners and anyone who manufactures, repairs, services, sells, leases, trades vehicles, or supervises a fleet of vehicles are not permitted to intentionally remove an emission control device or prevent it from working. Information about your vehicle's emission system is on the Vehicle Emission Control Information Decal located on or near the engine. This decal also lists engine displacement.

Please consult your warranty information for complete details.

On-Board Diagnostics (OBD-II)

Your vehicle has a computer known as the on-board diagnostics system (OBD-II) that monitors the engine's emission control system. The system protects the environment by making sure that your vehicle continues to meet government emission standards. The OBD-II system also assists a service technician in properly servicing your vehicle.



When the service engine soon indicator illuminates, the OBD-II system has detected a malfunction. Temporary malfunctions may cause the service engine soon indicator to illuminate. Examples are:

1. Your vehicle has run out of fuel—the engine may misfire or run poorly.
2. Poor fuel quality or water in the fuel—the engine may misfire or run poorly.
3. The fuel fill inlet may not have closed properly. See **Refueling** (page 104).
4. Driving through deep water—the electrical system may be wet.

You can correct these temporary malfunctions by filling the fuel tank with good quality fuel, properly closing the fuel fill inlet or letting the electrical system dry out. After three driving cycles without these or any other temporary malfunctions present, the service engine soon indicator should stay off the next time you start the engine. A driving cycle consists of a cold engine startup followed by mixed city and highway driving. No additional vehicle service is required.

If the service engine soon indicator remains on, have your vehicle serviced at the first available opportunity. Although some malfunctions detected by the OBD-II may not have symptoms that are apparent, continued driving with the service engine soon indicator on can result in increased emissions, lower fuel economy, reduced engine and transmission smoothness and lead to more costly repairs.

Readiness for Inspection and Maintenance (I/M) Testing

Some state and provincial and local governments may have Inspection/Maintenance (I/M) programs to inspect the emission control equipment on your vehicle. Failure to pass this inspection could prevent you from getting a vehicle registration.



If the service engine soon indicator is on or the bulb does not work, your vehicle may need service. See On-Board Diagnostics.

Engine Emission Control

Your vehicle may not pass the I/M test if the service engine soon indicator is on or not working properly (bulb is burned out), or if the OBD-II system has determined that some of the emission control systems have not been properly checked. In this case, the vehicle is not ready for I/M testing.

If the vehicle's engine or transmission has just been serviced, or the battery has recently run down or been replaced, the OBD-II system may indicate that the vehicle is not ready for I/M testing. To determine if the vehicle is ready for I/M testing, turn the ignition key to the on position for 15 seconds without cranking the engine. If the service engine soon indicator blinks eight times, it means that the vehicle is not ready for I/M testing; if the service engine soon indicator stays on solid, it means that your vehicle is ready for I/M testing.

The OBD-II system checks the emission control system during normal driving. A complete check may take several days.

If the vehicle is not ready for I/M testing, you can perform the following driving cycle consisting of mixed city and highway driving:

1. 15 minutes of steady driving on an expressway or highway followed by 20 minutes of stop-and-go driving with at least four 30-second idle periods.
2. Allow your vehicle to sit for at least eight hours with the ignition off. Then, start the vehicle and complete the above driving cycle. The vehicle must warm up to its normal operating temperature. Once started, do not turn off the vehicle until the above driving cycle is complete.

If the vehicle is still not ready for I/M testing, you need to repeat the above driving cycle.

SELECTIVE CATALYTIC REDUCTANT SYSTEM-DIESEL

Your vehicle may have a selective catalytic reduction system. The system helps reduce emission levels of oxides of nitrogen from the exhaust system. The system automatically injects diesel exhaust fluid into the exhaust system to enable correct selective catalytic reduction system function.

Note: *Selective catalytic reduction systems are not fitted to vehicles in markets where only high-sulfur diesel fuel is available.*

Diesel Exhaust Fluid Level

In order for the system to operate correctly you must maintain the diesel exhaust fluid level.

The system has a sensor to monitor fluid level and quality/concentration. A warning message appears in the information display when the diesel exhaust fluid level is low. If a warning message appears, refill the diesel exhaust fluid tank as soon as possible. See **Information Messages** (page 73).

Filling the Diesel Exhaust Fluid Tank



WARNING: Keep diesel exhaust fluid out of reach of children. Avoid contact with skin, eyes or clothing. In case of contact with your eyes, flush immediately with water and get prompt medical attention. In case of contact with your skin, clean immediately with soap and water. If you swallow any diesel exhaust fluid, drink plenty of water, call a physician immediately.

Engine Emission Control



WARNING: Only refill the diesel exhaust fluid tank in a well ventilated area. When you remove the diesel exhaust fluid tank filler cap or a diesel exhaust fluid container cap, ammonia vapors may escape. Ammonia vapors can be irritating to skin, eyes and mucous membranes. Inhaling ammonia vapors can cause burning to the eyes, throat and nose and cause coughing and watery eyes.

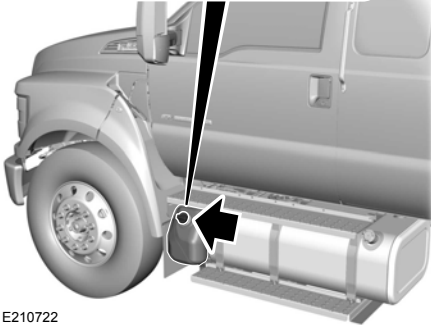
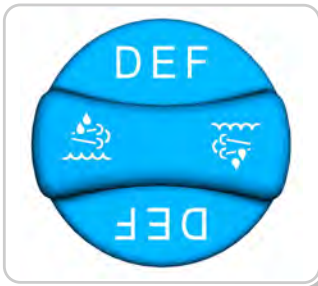

E210722

The diesel exhaust fluid tank has a blue filler cap. The tank is behind the left-hand front wheel. Fill the tank using a fluid pump at a diesel exhaust fluid filling station or a diesel exhaust fluid container. We recommend Motorcraft® diesel exhaust fluid. See **Capacities and Specifications** (page 288).



Only use diesel exhaust fluid that is certified by the American Petroleum Institute (API). Non-certified diesel exhaust fluid use can cause damage not covered by the vehicle Warranty.

Note: Do not put diesel exhaust fluid in the fuel tank or put diesel fuel in the diesel exhaust fluid tank. This can cause damage not covered by the vehicle Warranty.

You can purchase diesel exhaust fluid at an authorized dealer, most highway truck stops or you can contact roadside assistance for help in finding a retailer that sells diesel exhaust fluid. In addition, there is a government website to help you find the nearest location to purchase diesel exhaust fluid:

<http://www.discoverdef.com>.

Filling the Diesel Exhaust Fluid Tank Using a Fuel Station Pump

Filling the diesel exhaust fluid tank using a nozzle is similar to fuel fill. The nozzle shuts off automatically when the tank is full. Do not continue to fill the tank as this may cause spilling and overfill and can cause damage to the tank in freezing conditions.

Filling the Diesel Exhaust Fluid Tank Using a Container

The following procedure applies to Motorcraft diesel exhaust fluid or similar fluid containers. Always follow the manufacturer's instructions.

Engine Emission Control

1. Remove the diesel exhaust fluid container cap. Place the spout on to the container and tighten it until you feel a strong resistance.
2. Remove the diesel exhaust fluid tank filler cap.
3. Insert the spout into the filler neck until the seal on the spout seats on to the filler neck. Pour the fluid into the tank. When the tank is full the fluid stops. In case of direct fill tank, the spout does not seal against the fill tank interface and does not stop the flowing automatically.
4. Return the container to the vertical position slightly below the diesel exhaust fluid filler neck. Allow any fluid remaining in the spout to drain back in to the container.
5. Remove the spout from the diesel exhaust fluid filler neck. Replace the diesel exhaust fluid tank cap.
6. Remove the spout from the diesel exhaust fluid container and replace the cap.

Note: *If there is diesel exhaust fluid left in the container retain it for later use. The spout is re-useable. Wash the spout with clean water prior to storage. Do not use the diesel exhaust fluid spout with any other fluid.*

Filling the Diesel Exhaust Fluid Tank in Cold Climates

Diesel exhaust fluid freezes if the ambient temperature is below 12°F (-11°C). Your vehicle has a preheating system which allows diesel exhaust fluid to operate below 12°F (-11°C). If you do not use your vehicle for an extended period when the ambient temperature is below 12°F (-11°C), the fluid in the tank freezes. If the tank is overfilled and the fluid freezes it may damage the tank. This is not covered by the vehicle warranty.

Diesel Exhaust Fluid Warning Messages and Vehicle Operations



WARNING: Diesel exhaust fluid must be refilled when low or replaced when contaminated or your vehicle speed becomes limited to 50 mph (80 km/h). In these conditions, drive with caution and refill diesel exhaust fluid immediately. If the diesel exhaust fluid becomes empty or contaminated and fluid is not replaced, your vehicle becomes limited to engine idle only once stopped. In these conditions, be cautious where you stop your vehicle because you may not be able to drive long distances or maintain highway speeds until you refill or replace the diesel exhaust fluid.

Note: *Diluted diesel exhaust fluid must be drained and replaced.*



WARNING: Tampering with or disabling the selective catalytic reduction system results in severe vehicle performance limitation including eventual speed limiting to 5 mph (8 km/h).

The information display shows a series of messages about the amount of diesel exhaust fluid available. A systems check displays messages indicating the amount of diesel exhaust fluid available or displays a warning message indicating the approximate distance remaining as the fluid in the diesel exhaust fluid tank nears empty. See **Information Messages** (page 73).

Engine Emission Control



As the diesel exhaust fluid level nears empty, the warning symbol displays and a series of tones and messages starting at 500 mi (800 km) remaining before diesel exhaust fluid is depleted. The warning symbol and messages continue until you refill the diesel exhaust fluid tank.

Continued driving without refilling results in the following actions as required by the California Air Resources Board (CARB) and the U.S. Environmental Protection Agency (EPA):

- Within a preset distance to empty, speed is limited upon vehicle restart. Prior to this occurring a message appears in the information display.
- Further vehicle operation without refilling the diesel exhaust fluid tank causes the engine to enter an idle-only condition. This only occurs upon vehicle refueling or at an extended idle. A message indicates the required actions to resume normal operation. It is required to add a minimum of 1.0 gal (3.8 L) of diesel exhaust fluid to the tank to exit the idle-only condition, but your vehicle is still in the speed-limiting mode until you refill the tank completely.

Note: For either vehicle speed limiting or idle-only condition, normal vehicle operation resumes when you refill the diesel exhaust fluid tank.

Note: When filling the diesel exhaust fluid tank from empty, there may be a short delay before detecting the increased level of fluid. The increased level detection must occur before your vehicle returns to full power.

Diesel Exhaust Fluid Guidelines and Information

- Use only diesel exhaust fluid that carries the American Petroleum Institute (API) certified diesel exhaust fluid trademark or ISO 22241.
- Do not put diesel exhaust fluid in the diesel fuel tank. If this happens, do not switch the ignition on. Drain the fuel tank as soon as possible.
- Do not overfill the diesel exhaust fluid tank.
- Diesel exhaust fluid is corrosive.
- Do not re-use the diesel exhaust fluid container once it is emptied.
- Avoid spilling diesel exhaust fluid on painted surfaces, carpeting or plastic components. Immediately wipe away any diesel exhaust fluid that has spilled with a damp cloth and water. If it has already crystallized, use warm water and a sponge.
- Store diesel exhaust fluid out of direct sunlight and in temperatures between 23°F (-5°C) and 68°F (20°C).
- Diesel exhaust fluid freezes below 12°F (-11°C).
- Do not store the diesel exhaust fluid bottle in your vehicle. If it leaks it could cause damage to interior components or release an ammonia odor inside your vehicle.
- Diesel exhaust fluid is non-flammable, non-toxic, colorless and water-soluble liquid.
- The system has a diesel exhaust fluid quality sensor. Dilution of diesel exhaust fluid or use of any other liquid in the SCR system leads to a diesel exhaust fluid system fault, eventually leading to the vehicle only operating in idle-only mode.

Engine Emission Control

- Do not dilute diesel exhaust fluid with water or any other liquid.
- An ammonia odor may be smelled when the cap is removed or during refill. Refill diesel exhaust fluid in a well ventilated area.

Typical Diesel Exhaust Fluid Usage When Using the Power Take Off (PTO)

Continuous PTO use—Minimal PTO use

0–7,800 mi (0–12,550 km)

Contaminated Diesel Exhaust Fluid or Inoperative Selective Catalytic Reduction System

Selective catalytic reduction systems are sensitive to contamination of the diesel exhaust fluid. Maintaining the purity of the fluid is important to avoid system malfunctions. Do not add fuel or any additive to the diesel exhaust fluid tank. If you remove or drain the diesel exhaust fluid tank, do not use the same fluid to refill the tank. The system has a sensor to monitor fluid quality.



A warning lamp illuminates and a message appears in the information display if the system becomes contaminated or inoperative.

Continued driving without replacing diesel exhaust fluid or having the selective catalytic reduction system repaired results in the following actions as required by the California Air Resources Board (CARB) and U.S. Environmental Protection Agency (EPA):

- Within a preset distance to empty, speed is limited upon vehicle restart. Prior to this occurring a message appears in the information display.
- Further vehicle operation without replacing contaminated diesel exhaust fluid causes the engine to enter an idle-only condition. This only occurs upon vehicle refueling, vehicle idling in park for 1 hour, or engine shutdown for 10 minutes or more and is indicated by a message in the information display indicating required actions to resume normal operation.

Note: For vehicle speed limiting or idle-only condition, normal vehicle operation resumes when you repair the contaminated system. To service a contaminated or inoperative system, see an authorized dealer.

DIESEL PARTICULATE FILTER

(IF EQUIPPED)

Your vehicle has a diesel particulate filter. The diesel particulate filter is an inline filter in the exhaust system that reduces carbon emissions by trapping exhaust particles before they reach the tailpipe. The diesel particulate filter looks similar to a traditional exhaust catalyst, except larger, and is part of the exhaust system under your vehicle. The filter couples to a diesel oxidation catalyst that reduces the amount of harmful exhaust emitted from the tailpipe. As soot gathers in the system, it begins to restrict the filter. Periodically, you need to clean the soot that gathers inside the filter. You can clean the soot in two different ways, passive regeneration and

Engine Emission Control

active regeneration. Both methods occur automatically and require no actions from the driver. During either one of these regeneration methods, you may notice a change in exhaust tone. At certain times, various messages related to the diesel particulate filter appear in the information displays.

Oxidation Catalytic Converter and Diesel Particulate Filter System (if

Equipped)



WARNING: The normal operating temperature of the exhaust system is very high. Never work around or attempt to repair any part of the exhaust system until it has cooled. Use special care when working around the diesel oxidation catalytic converter or the diesel particulate filter. The diesel oxidation catalytic converter and the diesel particulate filter heat up to very high temperatures after only a short period of engine operation and remain hot after you switch the engine off.

Diesel Particulate Filter Maintenance

You must properly maintain your vehicle's diesel particulate filter in order for it to function properly.

Do not disregard maintenance messages that appear in the information display. Failure to follow the instructions of an information message may degrade vehicle performance and could lead to engine damage that may not be covered by the vehicle Warranty.

Failure to perform active or operator commanded regeneration when instructed could result in a clogged diesel particulate filter. If the diesel particulate filter fills beyond the regeneration threshold, your vehicle disables the ability for active and operator commanded regeneration. This could result in irreversible damage to the diesel particulate filter requiring replacement that may not be covered by the vehicle Warranty.

Passive Regeneration

In passive regeneration, the exhaust system temperature and constituents automatically clean the filter by oxidizing the soot. Cleaning automatically occurs during normal vehicle operating conditions due to driving patterns.

Active Regeneration

Once the diesel particulate filter is full of exhaust particles, the engine control module commands the exhaust system to clean the filter through active regeneration. Active regeneration requires the engine computer to raise the exhaust temperature to eliminate the particles. During cleaning, the particles convert to harmless gasses. Once cleaned the diesel particulate filter continues trapping exhaust particles.

The regeneration process operates more efficiently when you drive your vehicle at a constant speed above 30 mph (48 km/h) and at a steady engine speed for approximately 20 minutes. The frequency and duration of regeneration fluctuates by how you drive your vehicle, outside air temperature and altitude. For most driving, regeneration frequency varies from 100–500 mi (160–805 km) between occurrences and each occurrence lasts 9–35 minutes. You can usually reduce the duration of regeneration if you maintain a constant speed above 30 mph (48 km/h).

Engine Emission Control

When the engine control module detects that the diesel particulate filter is nearly full of particulates and you are not operating your vehicle in a manner to allow effective automatic regeneration, messages appear in the information display as a reminder for you to drive your vehicle in order to clean the diesel particulate filter. If you drive your vehicle in a manner to allow effective automatic regeneration, the information display shows a cleaning exhaust filter message, which is the normal regeneration process. You can also choose operator commanded regeneration to clean the exhaust system at this point. See **Information Messages** (page 73).

If you are not able to drive in a manner that allows effective automatic active regeneration or you choose to perform regeneration of the diesel particulate filter while at idle, then operator commanded regeneration would need to be performed.

Operator Commanded Regeneration (If Equipped)

If your vehicle is operated with significant stationary operation, low speed drive cycles less than 25 mph (40 km/h), short drive cycles, a drive time is less than 10 - 15 minutes or the vehicle does not fully warm up, passive and active regeneration may not sufficiently clean the diesel particulate filter system. Operator commanded regeneration allows you to manually start regeneration of the diesel particulate filter at idle to clean the filter only when the diesel particulate filter is full (100%). If you are not sure whether your vehicle has this feature, contact an authorized dealer.

When to Carry Out Operator Commanded Regeneration

You can use the operator commanded regeneration feature when a message appears in the information display only. When viewing the Exhaust Filter Status message - Exhaust Filter XX% and the diesel particulate filter message indicates FULL, and you are not able to drive in a manner that allows effective automatic active regeneration, or if you choose to manually start the regeneration of the diesel particulate filter manually while the vehicle is idle. See **Information Messages** (page 73).

Operator Commanded Regeneration Precautions and Safe Exhaust Position



WARNING: Do not park or idle your vehicle over dry leaves, dry grass or other combustible materials. The regeneration process creates very high exhaust gas temperatures and the exhaust will radiate a considerable amount of heat during and after regeneration and after you have switched the engine off. This is a potential fire hazard.



WARNING: Stay clear of the exhaust tailpipe during regeneration. Hot exhaust gases can burn you badly.

Make sure that the louvers located at the tip of the exhaust are clear of any obstructions as they are used to introduce fresh air into the tailpipe to cool the exhaust gases as they leave the exhaust system.

Engine Emission Control

Before you start operator commanded regeneration, do the following:

- Shift into park (P) or if you have an RNDM selector shift into neutral (N) and apply the parking and or air brake, on stable, level ground.
- Park your vehicle outside of any structure.
- Park your vehicle 10–15 ft (3–5 m) away from any obstructions and away from materials that can easily combust or melt, for example paper, leaves, petroleum products, fuels, plastics and other dry organic material.
- Make sure there is a minimum of 1/8 tank of fuel.
- Make sure all fluids are at proper levels.

How to Start Operator Commanded Regeneration



WARNING: Stay clear of the exhaust tailpipe during regeneration. Hot exhaust gases can burn you badly.

Note: You cannot use the operator commanded regeneration until the diesel particulate filter load percentage has reached 100%. The diesel particulate filter load percentage fluctuates up and down when driving your vehicle due to active and passive regenerations.

Note: During the use of operator commanded regeneration, you may observe a light amount of white smoke. This is normal.



You may not be able to use operator commanded regeneration if the service engine soon warning lamp appears in the information display

Information Display Procedure

Start your vehicle engine and when it has reached the normal operating temperature, arrow through the display to get to the Diesel Particulate Filter Status on the Truck Info tab. Exhaust Filter XX%/FULL displays. Operator commanded regeneration can only be initiated when FULL. See **Information Display Control** (page 53). If a message advising that the exhaust filter is full appears in the information display, press and hold the OK button to initiate Exhaust Cleaning. If successful, a second prompt appears regarding exhaust position required to initiate operator commanded regeneration. Be sure to understand each prompt. If you are not sure what is being asked by each prompt, contact an authorized dealer. If the exhaust system meets the position requirements then press and hold the OK button to fully activate the Operator Commanded Regeneration. The display confirms the operation has started and when it has finished.

You can also drive to clean the filter.



When the system is at the point of oversaturation, the service engine warning lamp illuminates and a message appears in the information display. You cannot initiate filter cleaning. You must have your vehicle checked as soon as possible.

Once operator commanded regeneration starts, engine speed increases to approximately 1600 rpm and the cooling fan speed increases. You will hear a change in audible sound due to engine speed and cooling fan speed increases.

It is not necessary to open the hood on the engine compartment. Once operator commanded regeneration completes, the engine speed returns to normal idling. The exhaust system remains very hot for several minutes even after regeneration is

Engine Emission Control

complete. Do not reposition the vehicle over materials that could burn until the exhaust system has had sufficient time to cool. Depending on the amount of soot collected by the diesel particulate filter, ambient temperature and altitude, operator commanded regeneration lasts approximately 30 minutes.

Operator Commanded Regeneration with Automatic Regeneration Control (If Equipped)

If your vehicle is operated with significant stationary operation, low speed drive cycles less than 25 mph (40 km/h), short drive cycles, drive time less than 15 minutes or the vehicle does not fully warm up, passive and active regeneration may not sufficiently clean the diesel particulate filter system. You can switch off automatic regeneration until better driving conditions are available, for example steady high speed driving. You can then switch automatic regeneration back on to clean the diesel particulate filter.

Switching Automatic Regeneration Control On and Off

To switch operator commanded regeneration on and off, use the information display control on the steering wheel. See **Information Display Control** (page 53). Scroll through the Settings tab to ensure there is a check in the box next to Auto Regeneration, this means it is active. To deactivate Auto Regeneration, uncheck the box. A message appears "Auto Exhaust Cleaning Off" along with an icon indicating that Auto Exhaust Cleaning is disabled. The icon stays illuminated until you switch Auto Exhaust Cleaning back on by checking the box.

How to Interrupt or Cancel Operator Commanded Regeneration

If you need to cancel the operator commanded regeneration, pressing the brake, accelerator or switching the engine off stops the procedure. Depending on the amount of time you allowed the operator commanded regeneration to operate, soot may not have had sufficient time to be fully eliminated, but the exhaust system and exhaust gas may still be hot. If you shut your vehicle off during operator commanded regeneration, you may notice turbo flutter. This is a normal consequence caused by shutting off a diesel engine during boosted operation and is considered normal.

Filter Service and Maintenance

Over time, a slight amount of ash builds up in the diesel particulate filter, which is not removed during the regeneration process. The filter may need to be replaced with a new or remanufactured part at approximately 250,000 mi (400,000 km). Actual mileage varies depending on engine and vehicle operating conditions.



If filter service is required, the engine control system warning lamp illuminates in the information display.



If there are any issues with the diesel particulate filter system, the engine control system warning lamp and a service engine soon warning lamp illuminate to inform you that your vehicle requires service. Have your vehicle checked as soon as possible.



Engine Emission Control

Resonator and Tailpipe Assembly Maintenance

Aftermarket devices or modifications to the exhaust system may reduce the effectiveness of the exhaust system as well as cause damage to the exhaust system or engine. This may also degrade vehicle performance and could lead to engine damage that may not be covered by the vehicle Warranty.

Transmission

AUTOMATIC TRANSMISSION



WARNING: Apply the parking brake, shift into park (P), switch the ignition off and remove the key before you leave your vehicle. Failure to follow this instruction could result in personal injury or death.

Understanding the Shift Positions of a 6-Speed Automatic Transmission

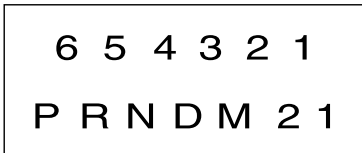

E163183

P R N D M 2 1

Putting your vehicle in or out of gear:

1. Fully press down the brake pedal.
2. Move the gearshift lever into the preferred gear.
3. When you finish driving, come to a complete stop.
4. Move the gearshift lever and securely latch it in park (P) or neutral (N).

The instrument cluster displays the current gear.

Park (P)

This position locks the transmission and prevents the rear wheels from turning.

Reverse (R)

With the gearshift lever in reverse (R), your vehicle moves backward. Always come to a complete stop before shifting into and out of reverse (R).

Neutral (N)

With the gearshift lever in neutral (N), you can start your vehicle and it is free to roll. Hold the brake pedal down when in this position.

Drive (D)

Drive (D) is the normal driving position for the best fuel economy. The overdrive function allows automatic upshifts and downshifts through gears one through six.

Manual (M)

With the gearshift lever in manual (M), the driver can change gears up or down as preferred. By moving the gearshift lever from drive (D) to manual (M), you now have control of selecting the gear you prefer using buttons on the shift lever.

To return to the normal drive (D) position, move the shift lever back from manual (M) to drive (D).

The transmission operates in gears one through six.

Second (2)

The transmission operates in second (2) gear only. Use second (2) gear to start-up on slippery roads.

Transmission

First (1)

- The transmission operates in first (1) gear only.
- Provides maximum engine braking.
- Allows upshifts by moving the gearshift lever.
- Does not downshift into first (1) gear at high speeds but allows for first (1) gear when vehicle reaches slower speeds.

Forced downshifts

- Allowed in drive (D) with the tow/haul feature on or off.
- Press the accelerator to the floor.
- Allows the transmission to select an appropriate gear.

Tow/Haul Mode



WARNING: Do not use tow/haul when the road surface is slippery. Failure to follow this instruction could result in the loss of control of your vehicle.



WARNING: Do not use diesel engine exhaust braking when the road surface is slippery. Failure to follow this instruction could result in the loss of control of your vehicle.



To activate tow/haul, press the button on the gearshift lever once. An indicator light illuminates in the instrument cluster.

The tow/haul feature:

- Delays upshifts to reduce the frequency of transmission shifting.
- Provides engine braking in all forward gears, which slows your vehicle and assists you in controlling your vehicle when descending a slope.
- Depending on driving conditions and load conditions, could downshift the transmission to slow your vehicle and help to control the vehicle speed when descending a hill without pressing the accelerator pedal. Tapping the brake pedal downshifts the transmission to provide additional braking, but only if the downshift does not cause an engine overspeed condition.

The tow/haul feature improves transmission operation when towing a trailer or a heavy load. All transmission gear ranges are available when using tow/haul.

To deactivate the tow/haul feature and return to normal driving mode, press the button on the gearshift lever twice. The indicator light deactivates. Tow/haul also deactivates when you power down your vehicle.

Note: *Under certain conditions, the automatic tow/haul feature engages, and the indicator comes on without pressing the tow/haul button.*

Understanding Your SelectShift™ Automatic Transmission

Your vehicle has a SelectShift automatic transmission gearshift lever. SelectShift automatic transmission gives you the ability to change gears up or down, without a clutch, as you prefer.

Transmission



Use the buttons on the shifter to lock or unlock gears and manually select gears. Press the + button to upshift or the – button to downshift.

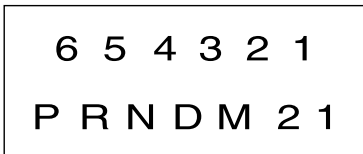

E163183

With the gearshift lever in drive (D), press the – button to activate SelectShift. The instrument cluster indicates the available and selected gears.

All available gears display with the current gear indicated. Press the – button again to lock out gears beginning with the highest gear. For example, press the – button twice to lock out sixth (6) and fifth (5) gears. Only the available gears display, and the transmission shifts between the available gears. Press the + button to unlock gears.

By moving the gearshift lever from the drive (D) position to the manual (M) position, you could now manually select the gear you prefer. Only the current gear displays. Press the + button or the – button to upshift or downshift. If you press the – button at a vehicle speed that would cause an engine overspeed, the requested gear flashes, then disappears, and the transmission remains in the current gear.

Recommended Shift Speeds

Upshift according to the following chart:

Upshifts when Accelerating (Recommended for Best Fuel Economy)		
Shift from:	Gasoline Engines	Diesel Engines
1 – 2	15 mph (24 km/h)	12 mph (20 km/h)
2 – 3	25 mph (40 km/h)	19 mph (31 km/h)
3 – 4	40 mph (64 km/h)	26 mph (42 km/h)
4 – 5	45 mph (72 km/h)	34 mph (55 km/h)
5 – 6	50 mph (80 km/h)	46 mph (74 km/h)

Transmission

To prevent the engine from running at too low an RPM, which could cause it to stall, SelectShift still makes some downshifts if it has determined that you have not downshifted in time. Although SelectShift makes some downshifts for you, it still allows you to downshift at any time if the SelectShift determines there is no damage to the engine from over-revving.

SelectShift does not automatically upshift, even if the engine is approaching the RPM limit. Shift manually by pressing the + button.

Note: *Engine damage could occur if you rev the engine excessively and hold it without shifting.*

Progressive Range Selection - PRS (If Equipped)

Progressive Range Selection gives you the ability to lockout gears from the automatic shifting range. This could provide you with an improved driving experience, for example, in slippery conditions or when experiencing a steep slope.

With the gearshift lever in drive (D), press the – button to activate progressive range selection. The instrument cluster indicates the available and selected gears.

All available gears display with the current gear indicated. Press the – button again to lock out gears beginning with the highest gear. For example, press the – button twice to lock out sixth (6) and fifth (5) gears. Only the available gears display, and the transmission shifts between the available gears. Press the + button to unlock gears to allow the transmission to shift to higher gears. The transmission shifts within the gear range you select.

Automatic Transmission Adaptive Learning

This feature could increase durability and provide consistent shift feel over the life of your vehicle. A new vehicle or transmission may have firm shifts, soft shifts, or both. This is normal and does not affect the function or durability of the transmission. Over time, the adaptive learning process fully updates transmission operation.

Brake-Shift Interlock



WARNING: Do not drive your vehicle until you verify that the stoplamps are working.



WARNING: When doing this procedure, you need to take the transmission out of park (P) which means your vehicle can roll freely. To avoid unwanted vehicle movement, always fully apply the parking brake prior to doing this procedure. Use wheels chocks if appropriate.



WARNING: If the parking brake is fully released, but the brake warning lamp remains illuminated, the brakes may not be working properly. Have your vehicle checked as soon as possible.

Your vehicle has a feature that prevents the gearshift lever from moving from park (P) when you switch the ignition on but you are not pressing on the brake pedal.

If you cannot move the gearshift lever out of the park (P) position with the ignition in the on position and the brake pedal pressed, a malfunction could have occurred. It is possible that a fuse has blown, or your vehicle's brake lamps are not operating properly. See **Fuse Specification Chart** (page 193).

Transmission

If you do not have a blown fuse and the brake lamps are properly working, the following procedure allows you to move the gearshift lever from park (P):

1. Apply the parking brake. Switch the ignition key to off, then remove the key.
2. Move the steering column to the full down and full rearward position, toward the driver seat.
3. Remove the gearshift lever boot.
4. Place your fingers into the hole where you removed the gearshift lever boot and pull the top half of the shroud up and forward to separate it from the lower half of the shroud. There is a hinge at the forward edge of the top of the shroud. Roll the top half of the shroud upward on the hinge point, then pull straight rearward toward the driver seat to remove.
5. Remove the top half of the shroud.
6. Remove the three fasteners under the column that secure the lower shroud half to the column.



E163185

7. Pull the lock lever into the full unlocked position and remove the lower shroud cover by pulling the lever handle through the slot in the cover.
8. Apply the brake. Gently lift the override disk and move the gearshift lever into neutral (N).

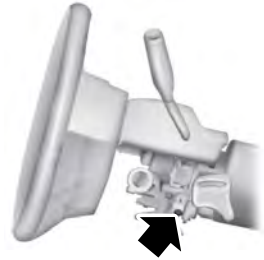

E163186

9. Start your vehicle.

Perform Steps 4 through 8 in reverse order, making sure to engage the hinge pivots between the upper and lower halves of the shroud. Keep slight pressure in the forward direction as you rotate the halves together.

If Your Vehicle Gets Stuck in Mud or Snow

If your vehicle is stuck in mud or snow, you could rock it out by shifting between forward and reverse gears, stopping between shifts in a steady pattern. Press lightly on the accelerator in each gear.

Note: Do not rock your vehicle if the engine is not at normal operating temperature or damage to the transmission could occur.

Note: Do not rock your vehicle for more than a minute or damage to the transmission and tires could occur, or the engine could overheat.

POWER TAKE-OFF (IF EQUIPPED)

Auxiliary equipment called power take-off, or PTO, is often added to the engine or transmission to operate utility equipment. Examples include a wheel-lift for tow trucks, cranes, tools for construction or tire service and pumping fluids. PTO applications draw auxiliary horsepower from the powertrain, often while the

Transmission

vehicle is stationary or mobile. In the stationary condition, there is limited cooling air flow through the radiator and around the vehicle that normally occurs when a vehicle is moving. The aftermarket PTO system installer, having the most knowledge of the final application, is responsible for determining whether additional chassis heat protection or powertrain cooling is required and alerting the user to the safe and proper operation.

Your vehicle is approved for use as a Stationary Mode, SplitShaft Mode or Mobile Mode power source within the limits and operating guidelines detailed in the Ford Truck Body Builders Layout Book, found at <https://fordbbas.com/home> and through the Ford Truck Body Builders Advisory Service. The transmission power source modes are engine specific.

Rear Axle

GENERAL INFORMATION



WARNING: Exceeding these ratings by overloading can cause component failure resulting in property damage, personal injury or death.

Fluid Temperature

If the operating temperature exceeds 250°F (121°C), the rate of axle lubrication oxidation increases and shortens the life of the lubricant and seals, requiring axle lubrication changes to become more frequent to preserve the axle. Do not consistently run extreme pressure (EP) lubricants above 250°F (121°C).

Axle Conversions



WARNING: When operating a loaded vehicle, the driver must keep all adjustable axles on the ground at all times, supporting their share of the vehicle's load. Failure to do so can overload other axles, tires, wheels, springs, steering components, brakes and frames, resulting in early component failure, loss of vehicle control, possible property damage and personal injury.

We do not recommend, or approve, performing axle conversions. However, we understand that, on occasion, others install aftermarket add-on axles on the truck chassis that allow operator control for weight transfer from other axles (such as air lift axles).

ELECTRONIC LOCKING DIFFERENTIAL (IF EQUIPPED)

Driver-Controlled Electronic Locking Differential

Note: *Never use the differential lock at vehicle speeds above 25 mph (40 km/h).*

Some drive axles have a driver-controlled differential lock. The differential lock can lock or unlock the differential when your vehicle is moving or stopped. When you require extra traction, the differential lock provides full power to both wheels.

When you lock the differential, your vehicle's turning radius increases (under-steer).

Take care to avoid sudden accelerations when both drive wheels are on a slippery surface.



WARNING: Sudden acceleration on slippery surfaces could cause the wheels to spin, the vehicle to turn sideways on a crowned road surface or in a turn, possibly resulting in loss of vehicle control and personal injury.

Activating the Electronic Locking Differential

You can lock and unlock the differential when your vehicle is moving at a constant speed of less than 25 mph (40 km/h) and while the wheels are not slipping. Do not lock the differential when your vehicle is traveling down steep grades and when traction is minimal.

The differential lock and differential lock light automatically disengage at speeds above 25 mph (40 km/h). The differential lock remains off until either you restart your vehicle, or you turn the differential lock switch off then back on.

Rear Axle

Servicing a Vehicle with an Electronic Locking Differential

Turn the engine off and raise all drive wheels of the locker differential axle to prevent your vehicle from moving when servicing the wheels, tires or brakes. Axles equipped with a driver-controlled differential deliver power to both wheels even when only one wheel is on the ground.



WARNING: Failure to raise all drive wheels with this type of differential could cause the vehicle to move unexpectedly, resulting in property damage, personal injury or death.

2-SPEED REAR AXLE (IF EQUIPPED)



WARNING: Never shift a two-speed axle when descending a steep grade as this may cause loss of vehicle control and result in personal injury.

Note: Do not shift between ranges when the speed control is on.

A two-speed rear axle allows the driver to select a low range for greater pulling power and a high range for greater road speed and fuel economy. You can also use these ranges to provide extra steps between transmission shifts when driving on steep grades or fuel economy may be factors.

Axle Shifting

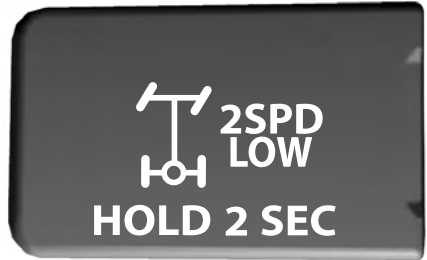

E208228

Note: Do not shift the axle to LOW when your vehicle is moving. Use LOW when you drive a fully loaded vehicle on a severe grade or in congested traffic. Use HIGH for all normal driving conditions with a lightly loaded or partially loaded vehicle.

Note: The axle is set to HIGH by default.

To shift the axle between HIGH and LOW with the vehicle stopped, place the transmission in position N, then press and hold the button for two seconds.

Brakes

GENERAL INFORMATION



WARNING: Do not apply the brake pedal and accelerator pedal simultaneously. Applying both pedals simultaneously for more than a few seconds will limit engine performance, which may result in difficulty maintaining speed in traffic and could lead to serious injury.

Note: *Occasional brake noise is normal. If a metal-to-metal, continuous grinding or continuous squeal sound is present, the brake linings may be worn-out. Have the system checked as soon as possible. If your vehicle has continuous vibration or shudder in the steering wheel while braking, have it checked by an authorized dealer.*

All standard equipment brakes are self-adjusting. Automatic adjustment, when required, occurs whenever you apply and release the brakes during forward or reverse operation.

Know the required stopping distances for all driving conditions you may encounter. For longer brake lining life, take full advantage of engine braking power when coming to a stop.

Wet brakes result in reduced braking efficiency. Gently press the brake pedal a few times when driving from a car wash or standing water to dry the brakes.

If the brakes do not grip well:

- Check brake adjustment.
- Check the brake linings for excessive wear.
- Check the system air pressure on vehicles with air brakes.

- Let the brakes cool if you have been using them excessively, as in mountain driving or after several fast, high-speed stops.
- If you have been driving through deep water, gently apply the brakes several times while your vehicle is moving slowly.

Brake Over Accelerator

In the event the accelerator pedal becomes stuck or entrapped, apply steady and firm pressure to the brake pedal to slow the vehicle and reduce engine power. If you experience this condition, apply the brakes and bring your vehicle to a safe stop. Move the transmission to park (P), switch the engine off and apply the parking brake. Inspect the accelerator pedal for any interference. If none are found and the condition persists, have your vehicle towed to the nearest authorized dealer

Anti-lock Brake System

This system helps you maintain steering control during emergency stops by keeping the brakes from locking.



This lamp momentarily illuminates when you switch the ignition on. If the light does not illuminate during start up, remains on or flashes, the system may be disabled. Have the system checked by an authorized dealer.



If you connect a PLC trailer with the ignition on, the trailer ABS light also illuminates. If the light fails to illuminate, if it remains on after you start the vehicle or continues to flash, have the system serviced immediately.

See **Warning Lamps and Indicators** (page 66).

Brakes



If the system is disabled, normal braking is still effective. If the brake warning lamp illuminates when you release the parking brake, have the system checked by an authorized dealer. It also illuminates momentarily when you switch the ignition on to confirm the lamp is functional. If it does not illuminate when you switch the ignition on, or begins to flash at any time, have the system checked by an authorized dealer.

HINTS ON DRIVING WITH ANTI-LOCK BRAKES

The anti-lock braking system does not eliminate the risks when:

- You drive too closely to the vehicle in front of you.
- Your vehicle is hydroplaning.
- You take corners too fast.
- The road surface is poor.

Note: *If the system activates, the brake pedal may pulse and may travel further. Maintain pressure on the brake pedal. You may also hear a noise from the system. This is normal.*

PARKING BRAKE

Hydraulic Brakes (If Equipped)



WARNING: Always set the parking brake and leave your vehicle with the transmission in park (P).



WARNING: This control is for parking only. Do not leave the vehicle unattended after setting the parking brake without placing the transmission in park (P). We recommend using wheel chocks for hilly or off-road circumstances.



WARNING: Unexpected and possibly sudden vehicle movement may occur if you do not take these precautions.



WARNING: If the parking brake is fully released, but the brake warning lamp remains illuminated, the brakes may not be working properly. Have your vehicle checked as soon as possible.

Apply the parking brake whenever the vehicle is parked. To set the parking brake, pull the handle up until it snaps into the locked position.

When the parking brake is out of adjustment, seek service immediately.



The parking brake warning lamp in the instrument cluster illuminates, and remains illuminated (when you switch on the ignition), until you release the parking brake.



E210347

Brakes

Push the palm release lever (A) on the parking brake handle (B) and push down as far as possible to release the brake. Driving with the parking brake on causes the brakes to wear out quickly and reduces fuel economy.

We recommend you not use the parking brake to stop a moving vehicle. However, if the normal brakes fail, you can use the parking brake to stop your vehicle in an emergency. Since the parking brake only applies retardation to the rear wheels, the vehicle's stopping distance increases greatly and the handling of your vehicle is adversely affected.

Releasing Spring Manually



WARNING: Do not attempt to disassemble the parking brake air chamber under any circumstances as this may cause serious injury.



WARNING: Block the wheels to help prevent the vehicle from moving.



WARNING: Unexpected and possibly sudden vehicle movement may occur if you do not take these precautions.

If you release hydraulic pressure from the spring brake chamber, the power spring applies the brake. If the hydraulic pressure can be re-established, you must release the spring brake in order to move your vehicle.

Air Brakes (If Equipped)



WARNING: This control is for parking only. Do not leave the vehicle unattended after setting the parking brake without placing the transmission in park (P). We recommend using wheel chocks for hilly or off-road circumstances.

If the service brakes fail to operate while your vehicle is moving, you can make an emergency stop with the parking brake. Since the parking brake only applies stopping power to the rear wheels, your vehicle's stopping distance greatly increases and the handling of your vehicle is adversely affected. Make repairs immediately to an inoperative air brake system circuit.



E210341

Pull the yellow, dash-mounted parking brake knob to apply the parking brake.



The parking brake light illuminates and remains illuminated (when you switch the ignition to the on position) until you release the parking brake.

Brakes

Releasing the Parking Brake



WARNING: When your vehicle is stationary, keep the brake pedal fully pressed when shifting gears. Failure to follow this instruction could result in personal injury, death or property damage.

Note: Read and understand the following steps and perform them whenever you prepare to drive the vehicle.

Note: The parking brake does not disengage unless sufficient system air pressure is available.

1. Press and hold the service brake pedal while the engine is running.
2. Select the appropriate drive gear.
3. Push and hold the yellow dash-mounted parking brake knob until the parking brake light turns off, then release.

Parking Brake Light Illumination Due to Low Air Pressure

If the air pressure becomes too low at any time during vehicle operation, the parking brake may apply and the parking brake light turns on.

If the parking brake applies due to low air pressure, immediate service is required to the parking brake system.

Releasing Spring Brake with Air Pressure

The air system in all vehicles with spring-actuated rear wheel parking brakes has a valve on the governor for connection to an outside air supply. The valve lets you recharge the system with air from an outside source, releasing the spring-actuated parking brakes. Your vehicle is now ready to tow in an emergency.

You can only use an outside air source if the protected system is in operating condition. If you cannot restore air pressure in the protected air system, you must release the spring-actuated brakes manually.

Releasing Spring Manually

Do not use impact wrenches as they may damage the piston and prevent proper caging of the spring. Do not apply more than 50 lb.ft (68 Nm) to the release bolt nut.

1. Remove the stud tool and nut from the carrying pocket on the brake chamber assembly.

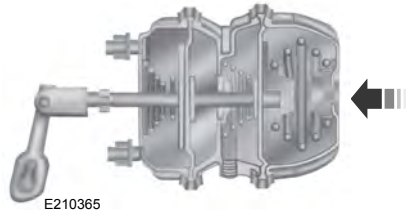

2. Remove the access plug from the end of the spring chamber.
3. Insert the release stud through the opening in the chamber and into the spring pressure plate.

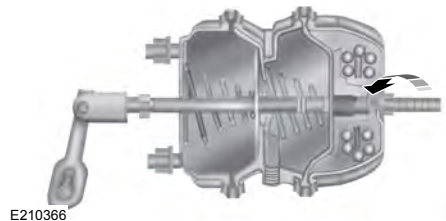

4. Turn the release stud ¼ turn to engage the stud tangs with the slot in the pressure plate. Keep the stud engaged and install the nut on the release stud.

Brakes

5. Tighten the nut until the spring is fully caged and brakes released. Do not loosen or remove the release stud and nut unless you completely assemble and securely clamp the brake chamber.
6. After restoring the air pressure, unscrew and remove the release stud and install in the carrying pocket. Install the access plug.

HILL START ASSIST



WARNING: The system does not replace the parking brake. When you leave your vehicle, always apply the parking brake.



WARNING: You must remain in your vehicle when the system turns on. At all times, you are responsible for controlling your vehicle, supervising the system and intervening, if required. Failure to take care may result in the loss of control of your vehicle, serious personal injury or death.



WARNING: The system will turn off if a malfunction is apparent or if you rev the engine excessively. Failure to take care may result in the loss of control of your vehicle, serious personal injury or death.

The system makes it easier to pull away when your vehicle is on a slope without the need to use the parking brake.

When the system is active, your vehicle remains stationary on the slope for two to three seconds after you release the brake pedal. This allows time to move your foot from the brake to the accelerator pedal. The system releases the brakes automatically once the engine has

developed sufficient torque to prevent your vehicle from rolling down the slope. This is an advantage when pulling away on a slope, for example from a car park ramp, traffic lights or when reversing uphill into a parking space.

The system activates on any slope that causes your vehicle to roll.

Note: *There is no warning light to indicate the system is either on or off.*

Using Hill Start Assist

1. Press the brake pedal to bring your vehicle to a complete standstill. Keep the brake pedal pressed and shift into first gear when facing uphill or reverse (R) when facing downhill.
2. If the sensors detect that your vehicle is on a slope, the system activates automatically.
3. When you remove your foot from the brake pedal, your vehicle remains on the slope without rolling away for about two to three seconds. This hold time automatically extends if you are in the process of driving off.
4. Drive off in the normal manner. The system releases the brakes automatically.

Note: *When you remove your foot from the brake pedal and press the pedal again when the system is active, you will experience significantly reduced brake pedal travel. This is normal.*

Switching the System On and Off

Vehicles with Manual Transmission

You can switch this feature on or off in the information display. The system remembers the last setting when you start your vehicle.

Brakes

Vehicles with Automatic Transmission

You cannot turn the system on or off. When you switch the ignition on, the system automatically turns on.

AIR BRAKES (IF EQUIPPED)



WARNING: Do not drive or continue to drive if the low air pressure buzzer is sounding or the brake warning light is lit. These warnings indicate that air pressure is not to normal operating level. Continued use of the vehicle could result in loss of braking ability.



WARNING: Avoid repeated light application of the brake pedal. This depletes air pressure faster and could result in loss of braking capability.



WARNING: Do not move the vehicle when the air pressure is insufficient because the brake system may be inoperative.

After starting the engine, give the air compressor time to build up the air pressure to 60 psi (414 kPa) before moving your vehicle.



E210336

Periodically check the air pressure gauge while driving. Pressure should range between approximately 100 psi (690 kPa) to 130 psi (896 kPa). The air compressor governor cut-in and cutout pressure settings are set at the factory and are not adjustable.



When air pressure is insufficient (below 60 psi (414 kPa)), a warning light illuminates and a buzzer sounds when the ignition is in the on position. This may happen because excessive brake applications are depleting the system air pressure. If this condition occurs, stop driving your vehicle until the compressor has fully recharged the air system.

Select a gear ratio to help slow your vehicle before descending grades. Supplementing with brakes, as required, help to safely slow the vehicle and avoids overspeeding the engine.

Air Chamber Stroke Indication

Air chamber push rods have orange stroke indicator markers that warn when the braking system requires adjustment or repair. The painted orange indicator is on the air chamber push rod at the slack adjuster stroke dimension that requires service when visible during brake application.

A qualified service technician should perform air brake inspection and adjustment or repairs keeping to the instructions in the service manual.

Brakes

Cam Brakes - Automatic Slack Adjusters

WARNING: Do not manually adjust the automatic slack adjusters to correct excessive push rod stroke as it may result in reduced brake effectiveness and a vehicle crash. Excessive push rod stroke indicates that a problem exists with the automatic adjuster, with the installation of the adjuster, or with foundation brake components that manual adjustment does not remedy. Seek service from a qualified facility for excessive push rod stroke.



E210337

Standard air brakes (cam) are equipped with automatic brake adjusters. Automatic adjustment occurs during brake applications. Inspect brakes for proper adjustment at the specified intervals. See **Scheduled Maintenance** (page 319).

Emergency Air Brake

WARNING: Do not continue to operate the vehicle with a failure of one of the brake systems. Take the vehicle to your dealer for service immediately.

All vehicles are equipped with a dual brake system. In the unlikely event of a failure of one system, the second system functions for emergency stopping. The brake pedal controls all these systems in the same manner as for normal stops.

EXHAUST BRAKE (IF EQUIPPED)

WARNING: Do not use tow/haul when the road surface is slippery. Failure to follow this instruction could result in the loss of control of your vehicle.

WARNING: Do not use diesel engine exhaust braking when the road surface is slippery. Failure to follow this instruction could result in the loss of control of your vehicle.

Note: Installing an exhaust or auxiliary brake does not necessarily protect the engine from exceeding the maximum governed speed. Use the primary brakes to make sure the engine never exceeds the maximum governed speed under any circumstance.

Note: Before starting the engine, make sure that the exhaust brake is off. Do not switch the exhaust brake on until the engine has reached normal operating temperature.

Note: Engine speed has a major influence on limiting performance. When engine speed stays at the maximum allowable level, the exhaust brake operates at peak performance.

Note: Exhaust brakes operate effectively with automatic transmissions. However, performance varies with engine speed and the gear selected by the transmission.

Brakes

An exhaust brake is an auxiliary braking system that assists, but does not replace, the primary brake system. It helps control vehicle speed. It is not a vehicle-stopping device.

Use the button on the instrument panel, in combination with the accelerator pedal, to maximize the use of the exhaust brake in the following conditions:

- Off-highway driving.
- Mountain driving.
- Heavy traffic.
- High-speed highway driving.



E215226

To switch the exhaust brake on, press the button. A light on the instrument cluster indicates the system is on. Press the button again to switch it off.

While approaching a steep grade, make sure that the exhaust brake switch is on. The exhaust brake begins working as soon as you remove your foot from the accelerator pedal.

Before descending a hill or steep grade, always select the proper gear. If you take the transmission out of gear while descending, you may not be able to select another gear because of maximum governed RPM.

Make sure the engine speed does not exceed the maximum allowable engine RPM. Exceeding the maximum allowable engine RPM can result in damage to the engine. Apply the service brakes to reduce the engine RPM or make a slower descent by using a lower gear.

While driving down a grade, use a low enough gear to descend safely with a minimum application of the service brakes. As a general guideline, use the same gear as you use to ascend the hill.

Exhaust Brake Operating Characteristics

The exhaust brake switches on when you remove your feet from the accelerator pedal and the exhaust brake is on.

If the brake is working properly, you may notice:

- A slight change in engine sound when the exhaust brake turns on.
- A smooth braking effect. Do not expect a retarding effect similar to sudden, hard application of the service brakes.
- A retarding force possibly felt acting against your body during brake application, depending on the grade and vehicle load. This force helps your vehicle resist increasing speeds down grades.
- Engine temperatures remaining in the normal operating range.

Brakes

- A drop in engine RPM, depending on grade and vehicle load, during a descent.
- A decrease in road speed when applying the exhaust brake during a descent, except when your vehicle is carrying a heavy load or the grade is extremely steep. In these instances, you may need to apply the service brakes occasionally.

TRAILER BRAKES

Trailer Brake Hand Control (If Equipped)



WARNING: The hand control should never be used to apply the brakes when the tractor and trailer are parked unattended. Air may leak from the system and the vehicle could possibly move, resulting in possible property damage, personal injury or death.



E210339

The hand control is located on the right-hand side of the instrument panel. It applies the trailer service brakes, which are independent of the truck or tractor service brakes.

It operates a valve that provides gradual control of air pressure applied. When the valve is only partially applied, you can override the trailer brakes by pressing fully on the brake pedal.

To apply the trailer brakes using the hand control, move the lever downward. The further you push the lever down, the greater the air pressure is applied to the brakes. The lever remains in place until manually moved.

To release the trailer brakes, move the lever up completely.

Trailer Air Supply and Parking Brake Modular Controls (If Equipped)



E210340

The trailer air supply valve delivers air to the trailer supply and automatically pops out, shutting off the trailer supply, if pressure decreases to approximately 35 psi (249 kPa).



E210341

The parking brake controls the spring brakes on the tractor. When you pull the knob out, it causes the trailer supply valve to pop out, applying both the tractor and trailer parking brakes. You can independently release the trailer brakes by pushing only the trailer air supply valve in.

Brakes

Initial Charge

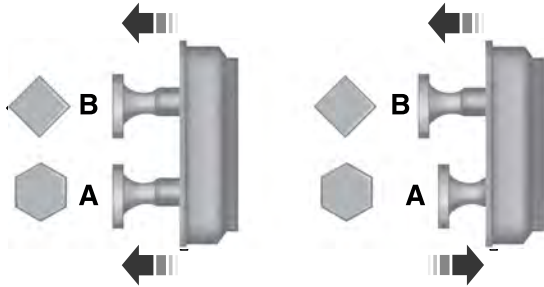

E210342

With the air system completely discharged, both knobs (A and B) are out. When the air pressure reaches 70 psi (481 kPa), the trailer air supply (A - red knob) may be pushed in and should stay in, charging the trailer air system and releasing the trailer brakes.

You can push in the parking brake (B - yellow knob) and supply air to the tractor spring brakes, releasing them.

Normal Driving Position

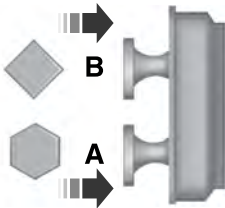

E210343

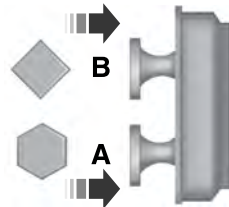

E210343

Push in both knobs (A and B) to supply air to both trailer and tractor spring brakes, releasing all brakes.

Brakes

System Park

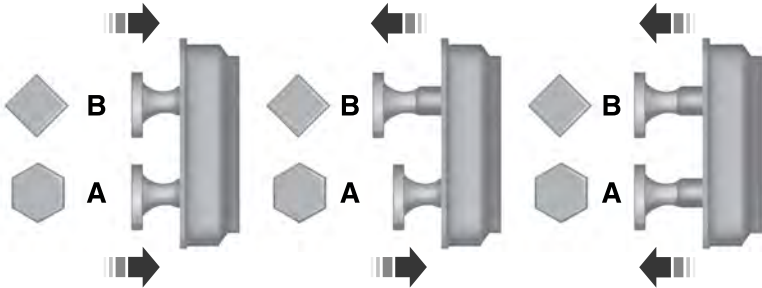

E210344

With both knobs (A and B) pushed in (normal driving position), the parking brakes for both the tractor and trailer can be applied by pulling the parking brake knob (B) out, exhausting air from the tractor spring brakes, simultaneously causing the trailer air supply valve to pop out, applying the trailer brakes.

Trailer Charge

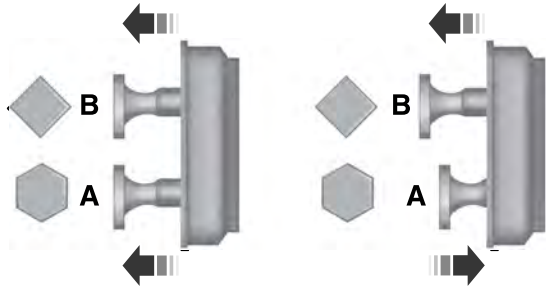

E210342

If both knobs (A and B) are out, and you want to recharge the trailer while leaving the tractor spring brakes applied, the trailer air supply (A) can be pushed in to recharge the trailer air supply line. You can also use this mode to park a combination vehicle with tractor spring brakes.

Brakes

Automatic Application

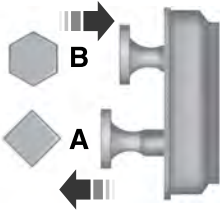

E210345

If both knobs (A and B) are pushed in and the brake system air pressure is reduced to approximately 35 psi (249 kPa), the trailer air supply (A) knob automatically pops out applying the emergency or parking brakes on the trailer. If the trailer air supply (A) knob is manually held in and the air pressure is reduced to approximately 30 psi (207 kPa), a tripper piston within the valve moves, exhausting the trailer air supply, applying the trailer brakes. Further reduction of air pressure, while holding the trailer air supply knob in, causes the parking brake knob to pop out at 25 psi (172 kPa).

Actuation of Trailer Park (Emergency) or Tractor Bobtail Position

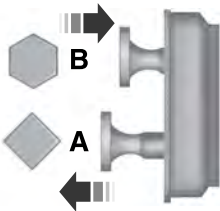

E210345

To actuate the trailer brakes only, pull out the trailer air supply (A) knob. This applies the trailer brakes whether the trailer uses emergency or spring brakes.

You can also use this mode when the tractor or truck with trailer is used during bobtail operation.

Traction Control

PRINCIPLE OF OPERATION

The traction control system helps avoid drive wheel spin and loss of traction.

If your vehicle begins to slide, the system applies the brakes to individual wheels and, when needed, reduces engine power at the same time. If the wheels spin when accelerating on slippery or loose surfaces, the system reduces engine power in order to increase traction.

Note: *The system does not apply the brakes when vehicle speed is above 25 mph (40 km/h).*

USING TRACTION CONTROL - VEHICLES WITH: AIR BRAKES



WARNING: The stability and traction control light illuminates steadily if the system detects a failure. Make sure you did not manually disable the traction control system using the information display controls or the switch. If the stability control and traction control light is still illuminating steadily, have the system serviced by an authorized dealer immediately. Operating your vehicle with the traction control disabled could lead to an increased risk of loss of vehicle control, vehicle rollover, personal injury and death.

TCS OFF

Press the TCS Off button on the instrument panel to enable the mud/snow mode.

This is beneficial when your vehicle is stuck in snow or on a slippery road surface. This mode allows wheel spin to dig your vehicle out and allows you to rock your vehicle.

Press the switch again to select standard traction control. The system automatically selects standard traction control at the next ignition cycle.

System Indicator Light

Note: *If the traction control light does not flash during a traction control event or stays illuminated, the system is not functioning properly. Take your vehicle to an authorized dealer for service.*

During traction control operation, the traction control light flashes rapidly and the engine does not rev-up when you press further on the accelerator. This is normal and is no reason for concern.

In Mud/Snow mode, the TCS OFF light illuminates on the instrument cluster. If a traction event occurs in either mode, the Stability Control and Traction Control light flashes rapidly.

USING TRACTION CONTROL - VEHICLES WITH: HYDRAULIC BRAKES



WARNING: Aggressive driving in any road conditions can cause you to lose control of your vehicle increasing the risk of severe personal injury or property damage. The traction control activating is an indication that at least some of the tires have exceeded their ability to grip the road; this may lead to an increased risk of loss of vehicle control, vehicle rollover, personal injury and death. If you experience a severe road event, **slow down**.

The system turns on each time you switch the ignition on.

Traction Control

A black rectangular button with the text "TCS OFF" in white, sans-serif capital letters.

Use the traction control button on the instrument panel to switch the system off or on.

If your vehicle is stuck in mud or snow, switching traction control off is beneficial as this allows the wheels to spin.

Press the button again to switch the traction control system on.

System Indicator Light

Note: *If the traction control light does not flash during a traction control event or stays on, the system is not operating. Have the system checked as soon as possible.*

During a traction control event, the traction control light rapidly flashes. Pressing further on the accelerator does not cause the engine to rev higher. This is normal and is no reason for concern.

When the system turns the traction control off, the OFF light illuminates on the instrument cluster. If a traction event occurs in either mode, the stability control and traction control light rapidly flashes.

Stability Control (If Equipped)

PRINCIPLE OF OPERATION - VEHICLES WITH: HYDRAULIC BRAKES



WARNING: Vehicle modifications involving braking system, aftermarket roof racks, suspension, steering system, tire construction and wheel and tire size may change the handling characteristics of your vehicle and may adversely affect the performance of the electronic stability control system. In addition, installing any stereo loudspeakers may interfere with and adversely affect the electronic stability control system. Install any aftermarket stereo loudspeaker as far as possible from the front center console, the tunnel, and the front seats in order to minimize the risk of interfering with the electronic stability control sensors. Reducing the effectiveness of the electronic stability control system could lead to an increased risk of loss of vehicle control, vehicle rollover, personal injury and death.



WARNING: Remember that even advanced technology cannot defy the laws of physics. It's always possible to lose control of a vehicle due to inappropriate driver input for the conditions. Aggressive driving on any road condition can cause you to lose control of your vehicle increasing the risk of personal injury or property damage. Activation of the electronic stability control system is an indication that at least some of the tires have exceeded their ability to grip the road; this could

reduce the operator's ability to control the vehicle potentially resulting in a loss of vehicle control, vehicle rollover, personal injury and death. If your electronic stability control system activates, SLOW DOWN.

The system turns on each time you switch the ignition on.

If a fault occurs in either the stability control or the traction control system, the following conditions are possible:

- The stability and traction control light illuminate.
- The stability control and traction control systems are not maintaining traction of the wheels.

If a driving condition activates either the stability control or the traction control system, the following conditions are possible:

- The stability and traction control light flash.
- Your vehicle slows down.
- The system reduces engine power.
- A vibration in the brake pedal.
- The brake pedal is stiffer than usual.
- If the driving condition is severe and your foot is not on the brake, the brake pedal could move as the system applies higher brake force.

The stability control system has several features built into it to help you maintain control of your vehicle:

Electronic Stability Control

The system assists in preventing skids or lateral slides by applying the brakes to one or more of the wheels individually and, if necessary, decreases engine power.

Stability Control (If Equipped)

Traction Control

The system helps maintain traction of the wheels by detecting and controlling wheel spin. See **Using Traction Control** (page 142).

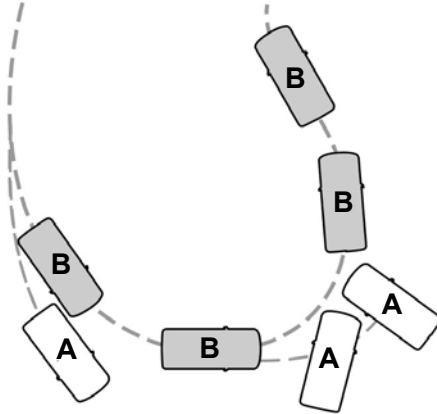

E72903

- A Vehicle without stability control skidding off its intended route.
- B Vehicle with stability control maintaining control on a slippery surface.

PRINCIPLE OF OPERATION - VEHICLES WITH: AIR BRAKES



WARNING: Vehicle modifications involving braking system, aftermarket roof racks, suspension, steering system, tire construction and wheel and tire size may change the handling characteristics of your vehicle and may adversely affect the performance of the electronic stability control system. In addition,

installing any stereo loudspeakers may interfere with and adversely affect the electronic stability control system. Install any aftermarket stereo loudspeaker as far as possible from the front center console, the tunnel, and the front seats in order to minimize the risk of interfering with the electronic stability control sensors. Reducing the effectiveness of the electronic stability control system could lead to an increased risk of loss of vehicle control, vehicle rollover, personal injury and death.



WARNING: Remember that even advanced technology cannot defy the laws of physics. It's always possible to lose control of a vehicle due to inappropriate driver input for the conditions. Aggressive driving on any road condition can cause you to lose control of your vehicle increasing the risk of personal injury or property damage. Activation of the electronic stability control system is an indication that at least some of the tires have exceeded their ability to grip the road; this could reduce the operator's ability to control the vehicle potentially resulting in a loss of vehicle control, vehicle rollover, personal injury and death. If your electronic stability control system activates, SLOW DOWN.

The system automatically turns on each time you switch the ignition on.

If a fault occurs in either the stability control or the traction control system, you may experience the following conditions:

- The stability and traction control light illuminates steadily.

Stability Control (If Equipped)

- The stability control and traction control systems do not enhance your vehicle's ability to maintain traction of the wheels.

If a driving condition activates either the stability control or the traction control system you may experience the following conditions:

- The stability and traction control light flashes rapidly.
- Your vehicle slows down.
- Reduced engine power.

The stability control system has several features built into it to help you maintain control of your vehicle:

Electronic Stability Control

The system enhances your vehicle's ability to prevent skids or lateral slides by applying brakes to one or more of the wheels individually and, if necessary, reducing engine power.

Roll Stability Control

The system enhances your vehicle's ability to prevent rollovers by detecting your vehicle's motion and the rate at which it changes by applying the brakes to one or more wheels individually.

Traction Control

The system enhances your vehicle's ability to maintain traction of the wheels by detecting and controlling wheel spin. See **Using Traction Control** (page 142).

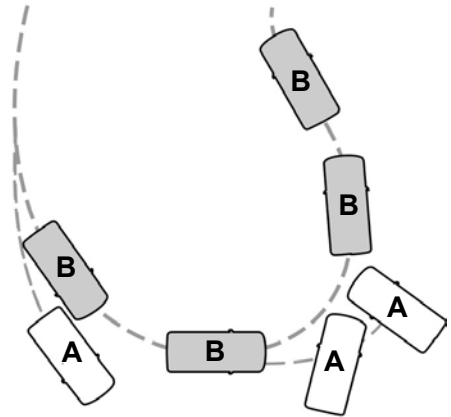

E72903

- A Vehicle without stability control skidding off its intended route.
- B Vehicle with stability control maintaining control on a slippery surface.

USING STABILITY CONTROL (IF EQUIPPED)

The system automatically turns on each time you switch the ignition on.

You cannot switch the stability control and roll stability control systems off, but when you shift into reverse (R), the systems deactivate.

You can switch the traction control system off or on. See **Traction Control** (page 142).

Limitations of the Stability System

Stability Control effectiveness may be greatly reduced if:

Stability Control (If Equipped)

- Your load shifts due to improper retention, accident damage or the inherently mobile nature of some loads, for example, hanging meat, live animals or partially laden tankers.
- Your vehicle or load has an unusually high or off-set center of gravity (CG).
- Your brakes are not properly adjusted or maintained.
- One side of your vehicle drops off the pavement at an angle that is too great to be counteracted by a reduction in speed.

To Maximize the Effectiveness Of Stability Control

- Make sure that the weight of your load is evenly distributed, from front to back, side to side and you secure it properly at all times.
- Exercise extreme caution at all times while driving and avoid sharp turns, sudden steering inputs or abrupt lane changes at high speeds, particularly if:
 - Hauling loads that can shift.
 - Your vehicle or load has a high or off-set center of gravity when loaded.
 - You are towing doubles or triples.

ESC Usage with Tractor/Trailer

The ESC system is designed to work with trailer air brake systems. We do not recommend its use with any other trailer brake system.

ESC and Towing with Non-tractor Trucks (Straight or Kick-up Frame)

Non-tractor Trucks (Straight or Kick-up Frame) with air brake ESC, should not be used for towing any type of trailer.

Chassis Modifications

Stability Control is specifically calibrated and validated only for your vehicle's original configuration. If you alter your vehicle's chassis components, for example, a wheel base extension or reduction, tag axle addition or removal, a major body change such as conversion of a tractor into a truck. Ford Motor Company is not responsible for the performance of the stability control system if you modify any major components such as axle, suspension or steering system.

Cruise Control - Vehicles With: Adaptive Cruise Control

USING ADAPTIVE CRUISE CONTROL

WARNING: You are responsible for controlling your vehicle at all times. The system is designed to be an aid and does not relieve you of your responsibility to drive with due care and attention. Failure to follow this instruction could result in the loss of control of your vehicle, personal injury or death.

WARNING: Pay close attention to changing road conditions such as entering or leaving a highway, on roads with intersections or roundabouts, roads without visible lanes of travel, roads that are winding, slippery, unpaved, or steep slopes.

WARNING: Do not use the system in poor visibility, for example fog, heavy rain, spray or snow.

WARNING: Do not use the system when towing a trailer that has aftermarket electronic trailer brake controls. Failure to follow this instruction could result in the loss of control of your vehicle, personal injury or death.

WARNING: Do not use tire sizes other than those recommended because this can affect the normal operation of the system. Failure to do so may result in a loss of vehicle control, which could result in serious injury.

WARNING: The system may not detect stationary or slow moving vehicles below 6 mph (10 km/h).

WARNING: The system does not detect pedestrians or objects in the road.

WARNING: The system does not detect oncoming vehicles in the same lane.

WARNING: The system is not a crash warning or avoidance system.

WARNING: Do not use the system with a snow plow blade installed.

The system adjusts your vehicle speed to maintain the set gap between you and the vehicle in front of you in the same lane. You can select four gap settings.

The system uses a radar sensor that projects a beam directly in front of your vehicle.



E262918

The adaptive cruise controls are on the steering wheel.

Switching Adaptive Cruise Control On

ON Press and release the button.

 The indicator, current gap setting and set speed appear in the information display.

Cruise Control - Vehicles With: Adaptive Cruise Control



E233874

Setting the Adaptive Cruise Speed

Drive to your preferred speed.

SET+

SET-

Press and release either button.

Take your foot off the accelerator pedal.

The indicator, current gap setting and set speed appear in the information display.



E233874

A vehicle graphic illuminates if there is a vehicle detected in front of you.

Note: When adaptive cruise control is active, the speedometer may vary slightly from the set speed displayed in the information display.

Following a Vehicle



WARNING: When following a vehicle that is braking, your vehicle does not always decelerate quickly enough to avoid a crash without driver intervention. Apply the brakes when necessary. Failure to follow this instruction could result in personal injury or death.



WARNING: The system only warns of vehicles detected by the radar sensor. In some cases there may be no warning or a delayed warning. Apply the brakes when necessary. Failure to follow this instruction could result in personal injury or death.

Note: When you are following a vehicle and you switch on a direction indicator, adaptive cruise control may provide a small temporary acceleration to help you pass.

Note: The brakes may emit noise when applied by the system.

When a vehicle ahead of you enters the same lane or a slower vehicle is ahead in the same lane, the vehicle speed adjusts to maintain a preset gap distance. A vehicle graphic illuminates in the instrument cluster.

Your vehicle maintains a consistent gap from the vehicle ahead until:

- The vehicle in front of you accelerates to a speed above the set speed.
- The vehicle in front of you moves out of the lane you are in.
- Your vehicle speed falls below 12 mph (20 km/h).
- You set a new gap distance.

The system applies the brakes to slow your vehicle to maintain a safe gap distance from the vehicle in front. The system only applies limited braking. You can override the system by applying the brakes.

Cruise Control - Vehicles With: Adaptive Cruise Control

If the system determines that its maximum braking level is not sufficient, an audible warning sounds, a message appears in the information display and an indicator flashes when the system continues to brake. Take immediate action.

Setting the Gap Distance

You can decrease or increase the distance between your vehicle and the vehicle in front by pressing the gap control.

There are four gap settings from shortest to longest.



Press and release to decrease the gap distance.



Press and release to increase the gap distance.



E233874

The selected gap appears in the information display as shown by the bars in the image.

Each time you switch the system on, it selects the last chosen gap setting.

Note: *The gap setting is time dependent and therefore the distance adjusts with your vehicle speed.*

Note: *It is your responsibility to select a gap appropriate to the driving conditions.*

Overriding the Set Speed



WARNING: If you override the system by pressing the accelerator pedal, it does not automatically apply the brakes to maintain a gap from any vehicle ahead.

When you press the accelerator pedal, you override the set speed and gap distance.



Use the accelerator pedal normally to intentionally exceed the set speed limit.

When you override the system, the green indicator light illuminates and the vehicle image does not appear in the information display.

The system resumes operation when you release the accelerator pedal. The vehicle speed decreases to the set speed, or a lower speed if following a slower vehicle.

Changing the Set Speed



Press and release to increase the set speed in small increments.



Press and release to decrease the set speed in small increments.

Press and hold either button to change the set speed in large increments. Release the button when you reach your preferred speed.

The system may apply the brakes to slow the vehicle to the new set speed. The set speed displays continuously in the information display when the system is active.

Canceling the Set Speed



Press and release the button or tap the brake pedal.

Cruise Control - Vehicles With: Adaptive Cruise Control

The set speed does not erase.

Resuming the Set Speed

 Press and release the button.

Your vehicle speed returns to the previously set speed and gap setting. The set speed displays continuously in the information display when the system is active.

Note: Only use resume if you are aware of the set speed and intend to return to it.

Automatic Cancellation

The system is not functional at vehicle speeds below 12 mph (20 km/h). The information display indicates low engine speed, an audible alarm sounds and the automatic braking releases if the vehicle drops below this speed.

Automatic cancellation can also occur when:

- The tires lose traction.
- You apply the parking brake.

Note: If the engine speed drops too low, an audible warning sounds and a message appears in the information display. Automatic braking releases.

Hilly Condition and Trailer Tow Usage

You should select a lower gear when the system is active in situations such as prolonged downhill driving on steep grades, for example in mountainous areas. The system needs additional engine braking in these situations to reduce the load on the vehicle's regular brake system to prevent it from overheating.

Note: An audible alarm sounds and the system shuts down if it applies brakes for an extended period of time. This allows the brakes to cool. The system functions normally again after the brakes cool.

Note: When towing with adaptive cruise control, switch on Tow/Haul Mode and Diesel Engine Brake.

Switching Adaptive Cruise Control Off

 Press and release the button when the system is in standby mode, or switch the ignition off.

Note: You erase the set speed and gap setting when you switch the system off.

Detection Issues



WARNING: On rare occasions, detection issues can occur due to the road infrastructures, for example bridges, tunnels and safety barriers. In these cases, the system may brake late or unexpectedly. At all times, you are responsible for controlling your vehicle, supervising the system and intervening, if required.



WARNING: If the system malfunctions, have your vehicle checked as soon as possible.

The radar sensor has a limited field of view. It may not detect vehicles at all or detect a vehicle later than expected in some situations. The lead vehicle graphic does not illuminate if the system does not detect a vehicle in front of you.

Cruise Control - Vehicles With: Adaptive Cruise Control

A

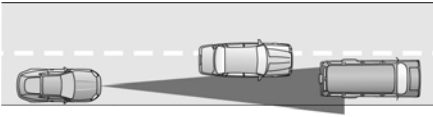

B



C

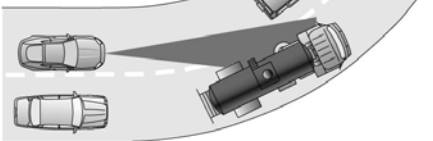

E71621

Detection issues can occur:

- A When driving on a different line than the vehicle in front.
- B With vehicles that edge into your lane. The system can only detect these vehicles once they move fully into your lane.
- C There may be issues with the detection of vehicles in front when driving into and coming out of a bend or curve in the road.

In these cases, the system may brake late or unexpectedly. You should stay alert and take action when necessary.

If something hits the front end of your vehicle or damage occurs, the radar-sensing zone may change. This could cause missed or false vehicle detection.

System Not Available

Conditions that can cause the system to deactivate or prevent the system from activating when requested include:

- A blocked sensor.
- High brake temperature.
- A failure in the system or a related system.

Blocked Sensor

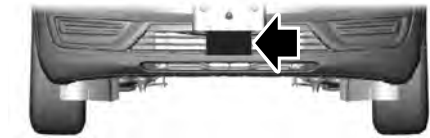

A message displays if something obstructs the radar signals from the sensor. The sensor is in the lower grille. The system cannot detect a vehicle ahead and does not function when something blocks the sensor.

Note: *You cannot see the sensor. It is behind a fascia panel.*

Keep the front of your vehicle free of dirt, metal badges or objects. Vehicle front protectors and aftermarket lights may also block the sensor.

Cruise Control - Vehicles With: Adaptive Cruise Control

Possible causes and actions for a message displaying:

Cause	Action
The surface of the radar is dirty or obstructed.	Clean the grille surface in front of the radar or remove the object causing the obstruction.
The surface of the radar is clean but the message remains in the display.	Wait a short time. It may take several minutes for the radar to detect that it is free from obstruction.
Heavy rain or snow is interfering with the radar signals.	Do not use the system in these conditions because it may not detect any vehicles ahead.
Water, snow or ice on the surface of the road may interfere with the radar signals.	Do not use the system in these conditions because it may not detect any vehicles ahead.
You are in a desert or remote area with no other vehicles and no roadside objects.	Wait a short time or switch to normal cruise control.

Due to the nature of radar technology, it is possible to get a blockage warning with no actual block. A false blocked condition either self clears, or clears after you restart your vehicle.

Cruise Control - Vehicles With: Cruise Control

WHAT IS CRUISE CONTROL

Cruise control lets you maintain a set speed without keeping your foot on the accelerator pedal.

Requirements

Use cruise control when the vehicle speed is greater than 20 mph (30 km/h).

SWITCHING CRUISE CONTROL ON AND OFF



WARNING: Do not use cruise control on winding roads, in heavy traffic or when the road surface is slippery. This could result in loss of vehicle control, serious injury or death.

The cruise controls are on the steering wheel. See **Cruise Control** (page 53).

Switching Cruise Control On

ON

Press the button.

Switching Cruise Control Off

OFF

Press the button when the system is in standby mode.

The system also turns off when you switch the ignition off.

Note: *The set speed erases when you switch the system off.*

SETTING THE CRUISE CONTROL SPEED



WARNING: When you are going downhill, your vehicle speed could increase above the set speed. The system does not apply the brakes.

Drive to the speed you prefer.

SET+

Press either button to set the current speed.

SET-

Take your foot off the accelerator pedal.

Note: *The indicator changes color in the information display.*

Changing the Set Speed

SET+

Press and release the button to increase the set speed in small increments.

Press and hold the button to accelerate. Release the button when you reach your preferred speed.

SET-

Press and release the button to decrease the set speed in small increments.

Press and hold the button to decelerate. Release the button when you reach your preferred speed.

Note: *If you accelerate by pressing the accelerator pedal, the set speed does not change. When you release the accelerator pedal, your vehicle returns to the speed that you previously set.*

Cruise Control - Vehicles With: Cruise Control

CANCELING THE SET SPEED

CNCL Press the button, or tap the brake pedal to cancel the set speed.

Note: *The system remembers the set speed.*

Note: *The system cancels if the vehicle speed drops below 10 mph (16 km/h) under the set speed when driving uphill.*

RESUMING THE SET SPEED

RES Press the button.

CRUISE CONTROL INDICATORS

 Illuminates when you switch the system on.

Driving Aids

DRIVER ALERT (IF EQUIPPED)



WARNING: You are responsible for controlling your vehicle at all times. The system is designed to be an aid and does not relieve you of your responsibility to drive with due care and attention. Failure to follow this instruction could result in the loss of control of your vehicle, personal injury or death.



WARNING: The system may not function if the sensor is blocked.



WARNING: Take regular rest breaks if you feel tired. Do not wait for the system to warn you.



WARNING: Certain driving styles may result in the system warning you even if you are not feeling tired.



WARNING: In cold and severe weather conditions the system may not function. Rain, snow and spray can all limit sensor performance.



WARNING: The system will not operate if the sensor cannot track the road lane markings.



WARNING: If damage occurs in the immediate area surrounding the sensor, have your vehicle checked as soon as possible.



WARNING: The system may not correctly operate if your vehicle is fitted with a suspension kit not approved by us.

Note: Keep the windshield free from obstructions. For example, bird droppings, insects and snow or ice.

Note: If you have a blocked camera or damaged windshield, the system may not function.

Note: The system remembers the last setting when you start your vehicle, unless it detects a MyKey™.

Note: If enabled in the menu, the system activates at speeds above 40 mph (64 km/h).

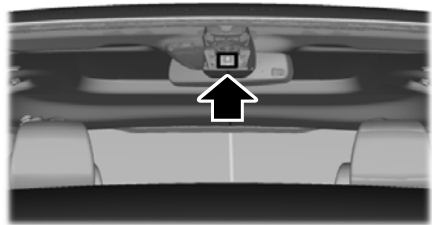

E249505

The system monitors your driving behavior using various inputs including the front camera sensor.

If the system detects reduced driving alertness below a certain threshold, the system alerts you using a tone and a message in the information display.

Using Driver Alert

Switching the system on and off

You may switch the system on or off through the information display by selecting Settings, Driver Assist and then Driver Alert in the menu. When activated, the system monitors your alertness level based upon your driving behavior in relation to the lane markings, and other factors.

System Warnings

Note: The system does not issue warnings below approximately 40 mph (64 km/h).

Driving Aids

The warning system is in two stages. At first the system issues a temporary warning that you need to take a rest. This message only appears for a short time. If the system detects further reduction in driving alertness, another warning could be issued which remains in the information display for a longer time. Press OK on the steering wheel control to clear the warning. When active the system runs in the background and only issues a warning if required.

Resetting the System

You can reset the system by either:

- Switching the ignition off and on.
- Stopping the vehicle and then opening and closing the driver door.

LANE KEEPING SYSTEM (IF EQUIPPED)

WARNING: You are responsible for controlling your vehicle at all times. The system is designed to be an aid and does not relieve you of your responsibility to drive with due care and attention. Failure to follow this instruction could result in the loss of control of your vehicle, personal injury or death.

WARNING: Always drive with due care and attention when using and operating the controls and features on your vehicle.

WARNING: In cold and severe weather conditions the system may not function. Rain, snow and spray can all limit sensor performance.

WARNING: The system will not operate if the sensor cannot track the road lane markings.

WARNING: The sensor may incorrectly track lane markings as other structures or objects. This can result in a false or missed warning.

WARNING: Large contrasts in outside lighting can limit sensor performance.

WARNING: The system may not operate properly if the sensor is blocked. Keep the windshield free from obstruction.

WARNING: If damage occurs in the immediate area surrounding the sensor, have your vehicle checked as soon as possible.

WARNING: The system may not correctly operate if your vehicle is fitted with a suspension kit not approved by us.

Note: The system works as long as the camera can detect one lane marking at a speed above 40 mph (64 km/h).

Note: The system may not function with a blocked camera, or if the windshield is damaged or dirty.



E243054

Driving Aids

When you switch the system on and it detects an unintentional drift out of your lane is likely to occur, the system notifies or assists you to stay in your lane through the steering system and information display. The system provides a warning by an audible tone.

Switching the System On and Off

Note: The system on or off setting is stored until it is manually changed, unless a MyKey is detected. If the system detects a MyKey, it defaults to on and the mode is set to alert.

Note: If a MyKey is detected, pressing the button does not affect the on or off status of the system. You can only change the mode and sensitivity settings.



Press the button to switch the system on or off. The button is above the audio unit or on the center console.

System Settings

The system sensitivity and intensity can be adjusted through the display screen. The system remembers the last selection. You do not need to readjust the setting each time you turn on your vehicle.

Sensitivity: This setting allows you to select where in the lane a warning is provided. Increasing the sensitivity setting moves the warning zones in closer to your vehicle.

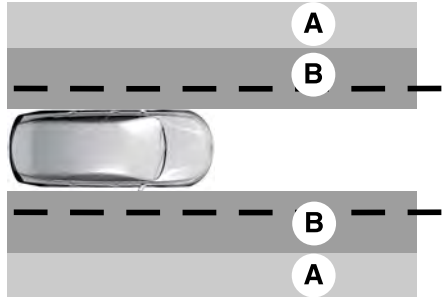

- A Normal
- B Increased

Note: The alert diagram illustrates general zone coverage. It does not provide exact zone parameters.

System Display



E233874

When you switch on the system, a graphic with lane markings appears in the display screen.

Note: The overhead vehicle graphic may still display if adaptive cruise control is enabled.

While the system is on, the color of the lane markings change to indicate the system status.

Driving Aids

Gray: Indicates that the system is temporarily unable to provide a warning on the indicated side(s). This may be because:

- Your vehicle is below the activation speed.
- The direction indicator is active.
- Your vehicle is in a dynamic maneuver.
- The road has no or poor lane markings in the camera field-of-view.
- The camera is obscured or unable to detect the lane markings due to environmental, traffic or vehicle conditions. For example, significant sun angles, shadows, snow, heavy rain or fog, following a large vehicle that is blocking or shadowing the lane or poor headlamp illumination.

See **Troubleshooting** for additional information.

Green: Indicates that the system is available or ready to provide a warning on the indicated side(s).

Red: Indicates that the system is providing or has just provided a lane keeping alert warning.

You can temporarily disable the system at any time by doing the following:

- Quick braking.
- Fast acceleration.
- Using your direction indicator.
- Evasive steering maneuver.
- Driving too close to the lane markings.

Troubleshooting

Why is the feature not available (line markings are gray) when I can see the lane markings on the road?
Your vehicle speed is outside the operational range of the feature.
The sun is shining directly into the camera lens.
A quick intentional lane change has occurred.
Your vehicle stays too close to the lane markings.
Driving at high speeds in curves.
The last feature activation occurred a short time ago.
Ambiguous lane markings, for example in construction zones.
Rapid transition from light to dark, or from dark to light.
Sudden offset in lane markings.
ABS or AdvanceTrac™ is active.
There is a camera blockage due to dirt, grime, fog, frost or water on the windshield.
You are driving too close to the vehicle in front of you.
Transitioning between no lane markings to lane markings or vice versa.

Driving Aids

Why is the feature not available (line markings are gray) when I can see the lane markings on the road?
--

There is standing water on the road.

Faint lane markings, for example partial yellow lane markings on concrete roads.
--

Lane width is too narrow or too wide.

The camera has not been calibrated after a windshield replacement.
--

Driving on tight roads or on uneven roads.
--

Vehicle accessories are blocking the camera, for example a snow plow.

STEERING

Hydraulic Power Steering

To help prevent damage to the power steering system:

- Do not hold the steering wheel at its furthest turning points for more than three to five seconds when the engine is running.
- Avoid continuously steering back and forth with elevated engine RPM as this may overheat the system. If trying to free a stuck vehicle, pause between attempts to allow the power steering system to cool or seek assistance. Typical steering and driving maneuvers allow the system to cool.
- Do not operate the vehicle if the power steering pump fluid level is below the MIN mark on the reservoir.
- Some noise is normal during operation. If excessive, check for low power steering pump fluid level before seeking service by your dealer.

- Heavy or uneven efforts may be caused by low power steering fluid. Check for low power steering pump fluid level before seeking service by your dealer.
- Do not fill the power steering pump reservoir above the MAX mark on the reservoir, as this may result in leaks from the reservoir.

If the power steering system breaks down or if you switch the engine off, you can steer the vehicle manually, but it takes more effort.

If you have any steering components serviced or replaced, install new fasteners. Many fasteners have coatings with thread adhesive, or have prevailing torque features you cannot reuse. Do not reuse a bolt or nut. Torque fasteners to specifications.

Steering Tips

If the steering wanders or pulls, check for:

- An improperly inflated tire.
- Uneven tire wear.
- Loose or worn suspension components.
- Loose or worn steering components.
- Improper vehicle alignment.

Driving Aids

Note: A high crown in the road or high crosswinds may also make the steering seem to wander or pull.

PRE-COLLISION ASSIST - VEHICLES WITH: AIR BRAKES

 **WARNING:** You are responsible for controlling your vehicle at all times. The system is designed to be an aid and does not relieve you of your responsibility to drive with due care and attention. Failure to follow this instruction could result in the loss of control of your vehicle, personal injury or death.

 **WARNING:** The system does not detect vehicles that are driving in a different direction, pedestrians, cyclists or animals. Apply the brakes when necessary. Failure to follow this instruction could result in the loss of control of your vehicle, personal injury or death.

 **WARNING:** The system is not designed to detect non-metallic objects and does not reliably detect some objects with limited metallic surfaces. For example, recreational vehicles, motorcycles and guard rails. Apply the brakes when necessary. Failure to follow this instruction could result in the loss of control of your vehicle, personal injury or death.

 **WARNING:** The system does not operate during hard acceleration or steering. Failure to take care may lead to a crash or personal injury.

 **WARNING:** Some situations and objects prevent hazard detection. For example low or direct sunlight, inclement weather, unconventional vehicle types, and pedestrians. Apply the brakes when necessary. Failure to follow this instruction could result in the loss of control of your vehicle, personal injury or death.

 **WARNING:** The system may fail or operate with reduced function during cold and severe weather conditions. Snow, ice, rain, spray and fog can adversely affect the system. Keep the front camera and radar free of snow and ice. Failure to take care may result in the loss of control of your vehicle, serious personal injury or death.

 **WARNING:** The system cannot help prevent all crashes. Do not rely on this system to replace driver judgment and the need to maintain a safe distance and speed.

 **WARNING:** Take additional care if your vehicle is heavily loaded or you are towing a trailer. These conditions could result in reduced performance of this system. Failure to follow this instruction could result in the loss of control of your vehicle, personal injury or death.

Using the Pre-Collision Assist System

If your vehicle is approaching a stationary vehicle in your lane of travel, the system provides an Alert. Stationary vehicle detection is active at speeds above approximately 10 mph (16 km/h).



E156130

Driving Aids

If your vehicle is rapidly approaching another vehicle traveling in the same direction as yours, the system provides two levels of functionality:

1. Alert.
2. Active Braking.

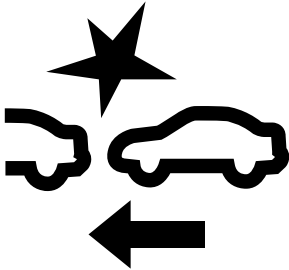

E255268

Alert: When active, a flashing visual warning appears and an audible warning tone sounds.

Active Braking: Active Braking is active at speeds above approximately 14.9 mph (24 km/h). Active braking may activate if the system determines that a collision is imminent. The system may help the driver reduce impact damage or avoid the crash completely.

Pre-Collision Assist Settings

Active braking turns on every time you switch the ignition on. You cannot adjust the Pre-Collision Assist settings.

Note: We recommend that you switch the system off if you install a snow plow or similar object in such a way that it may block the radar sensor. Your vehicle remembers the system status across key cycles.

Blocked Sensors

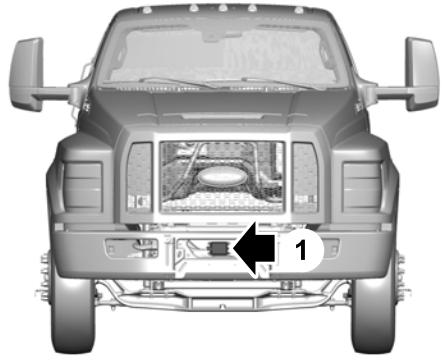

- 1 Radar sensor.

The information display shows a blocked sensor message to indicate a sensor obstruction. The radar sensor is located behind the bumper and mounted to the frame below the center of the grille. If you install a snow plow or similar object, you may block the radar sensor. With a blocked sensor, the Pre-Collision Assist system may not function, or performance may reduce. The following table lists possible causes and actions for when this message displays.

Driving Aids

Radar Troubleshooting

Cause	Action
The surface of the radar in the grille is dirty or obstructed in some way.	Clean the grille surface in front of the radar or remove the object causing the obstruction.
The surface of the radar in the grille is clean but the message remains in the display screen.	Wait a short time. It may take several minutes for the radar to detect that there is no obstruction.
Heavy rain, spray, snow or fog is interfering with the radar signals.	The Pre-Collision Assist system is temporarily disabled. Pre-Collision Assist automatically reactivates a short time after the weather conditions improve.
Swirling water or snow or ice on the surface of the road may interfere with the radar signals.	The Pre-Collision Assist system is temporarily disabled. Pre-Collision Assist automatically reactivates a short time after the weather conditions improve.
Radar is out of alignment due to a front end impact.	Contact an authorized dealer to have the radar checked for proper coverage and operation.

Note: *If something hits the front end of your vehicle or damage occurs and your vehicle has a radar sensor, the radar sensing zone may change. This could cause missed or false vehicle detections. Contact an authorized dealer to have the radar checked for proper coverage and operation.*

PRE-COLLISION ASSIST - VEHICLES WITH: HYDRAULIC BRAKES



WARNING: You are responsible for controlling your vehicle at all times. The system is designed to be an aid and does not relieve you of your responsibility to drive with due care and attention. Failure to follow this instruction could result in the loss of control of your vehicle, personal injury or death.

Driving Aids

WARNING: The system does not detect vehicles that are driving in a different direction, pedestrians, cyclists or animals. Apply the brakes when necessary. Failure to follow this instruction could result in the loss of control of your vehicle, personal injury or death.

WARNING: The system does not operate during hard acceleration or steering. Failure to take care may lead to a crash or personal injury.

WARNING: The system may fail or operate with reduced function during cold and severe weather conditions. Snow, ice, rain, spray and fog can adversely affect the system. Keep the front camera and radar free of snow and ice. Failure to take care may result in the loss of control of your vehicle, serious personal injury or death.

WARNING: Some situations and objects prevent hazard detection. For example low or direct sunlight, inclement weather, unconventional vehicle types, and pedestrians. Apply the brakes when necessary. Failure to follow this instruction could result in the loss of control of your vehicle, personal injury or death.

WARNING: The system cannot help prevent all crashes. Do not rely on this system to replace driver judgment and the need to maintain a safe distance and speed.

WARNING: Take additional care if your vehicle is heavily loaded or you are towing a trailer. These conditions could result in reduced performance of this system. Failure to follow this instruction could result in the loss of control of your vehicle, personal injury or death.

Using the Pre-Collision Assist System

The Pre-Collision Assist system is active at speeds above approximately 3 mph (5 km/h).



E156130

If your vehicle is rapidly approaching another stationary vehicle or a vehicle traveling in the same direction the system provides three levels of functionality:

1. Alert
2. Brake Support
3. Active Braking

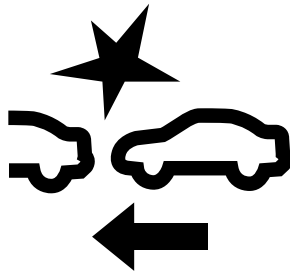

E255268

Alert: When active, a flashing visual warning appears and an audible warning tone sounds.

Driving Aids

Brake Support: The system is designed to help reduce the impact speed by preparing the brakes for rapid braking. The system does not automatically apply the brakes. If you press the brake pedal, the system could apply additional braking up to maximum braking force, even if you lightly press the brake pedal.

Active Braking: Active braking may activate if the system determines that a collision is imminent. The system may help the driver reduce impact damage or avoid the crash completely.

Note: *If you perceive Pre-Collision Assist alerts as being too frequent or disturbing, then you can reduce the alert sensitivity, though the manufacturer recommends using the highest sensitivity setting where possible. Setting lower sensitivity would lead to fewer and later system warnings.*

Distance Indication and Alert

Distance Indication and Alert is a function that provides the driver with a graphical indication of the time gap to other preceding vehicles traveling in the same direction. The Distance Indication and Alert screen in the display screen shows one of the graphics that follow.



E254791

If the time gap to a preceding vehicle is small, a red visual indication displays.

Note: *Distance Indication and Alert deactivates and the graphics do not display when Adaptive Cruise Control is active.*

Adjusting the Pre-Collision Assist Settings

You can adjust the following settings by using the information display controls. See **General Information** (page 70).

- You can change Alert and Distance Alert sensitivity to one of three possible settings.
- You can switch Distance Indication and Alert on or off.
- If required, you can switch Active Braking on or off.
- If required, you can switch the entire Pre-Collision Assist feature on or off.

Note: *Active braking automatically turns on every time you switch the ignition on.*

Driving Aids

Note: We recommend that you switch the system off if you install a snow plow or similar object in such a way that it may block the radar sensor. Your vehicle remembers the selected setting across key cycles.

Blocked Sensors

If a message regarding a blocked sensor or camera appears in the information display, the radar signals or camera images are obstructed. With a blocked sensor or camera, the Pre-Collision Assist system may not function, or performance may reduce. The following table lists possible causes and actions for when this message displays.

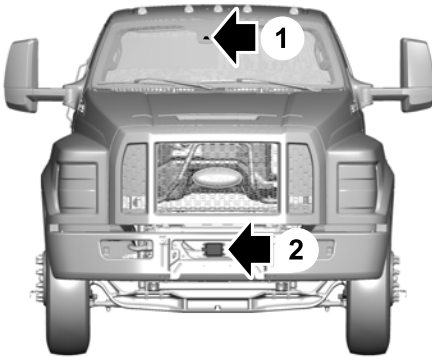

- 1 Camera
- 2 Radar sensor

Camera Troubleshooting

Cause	Action
The windshield in front of the camera is dirty or obstructed in some way.	Clean the outside of the windshield in front of the camera.
The windshield in front of the camera is clean but the message remains in the display screen.	Wait a short time. It may take several minutes for the camera to detect that there is no obstruction.

Driving Aids

Radar Troubleshooting

Cause	Action
The surface of the radar in the grille is dirty or obstructed in some way.	Clean the grille surface in front of the radar or remove the object causing the obstruction.
The surface of the radar in the grille is clean but the message remains in the display screen.	Wait a short time. It may take several minutes for the radar to detect that there is no obstruction.
Heavy rain, spray, snow or fog is interfering with the radar signals.	The Pre-Collision Assist system is temporarily disabled. Pre-Collision Assist automatically reactivates a short time after the weather conditions improve.
Swirling water or snow or ice on the surface of the road may interfere with the radar signals.	The Pre-Collision Assist system is temporarily disabled. Pre-Collision Assist automatically reactivates a short time after the weather conditions improve.
Radar is out of alignment due to a front end impact.	Contact an authorized dealer to have the radar checked for proper coverage and operation.

Note: *Proper system operation requires a clear view of the road by the camera. Have any windshield damage in the area of the camera's field of view repaired.*

Note: *If something hits the front end of your vehicle or damage occurs and your vehicle has a radar sensor, the radar sensing zone may change. This could cause missed or false vehicle detections. Contact an authorized dealer to have the radar checked for proper coverage and operation.*

Note: *If your vehicle detects excessive heat at the camera or a potential misalignment condition, a message may display in the information display indicating temporary sensor unavailability. When operational conditions are correct, the message deactivates. For example, when the ambient temperature around the sensor decreases or the sensor automatically recalibrates successfully.*

Load Carrying

LOAD LIMIT



WARNING: Do not exceed the GVWR or the GAWR specified on the Safety Compliance Certification Label.



WARNING: Do not use replacement tires with lower load carrying capacities than the original tires because they may lower the vehicle's GVWR and GAWR limitations. Replacement tires with a higher limit than the originals do not increase the GVWR and GAWR limitations.



WARNING: Exceeding any vehicle weight rating limitation could result in serious damage to the vehicle and/or personal injury.

Every vehicle manufactured by Ford Motor Company is supplied with information on the Safety Compliance Certification Label, located on either the B-pillar or the driver's door edge, listing the maximum loading for the vehicle (GVWR), and its axle systems (GAWR) at the tire to ground interface.

Example only:

INCOMPLETE VEHICLE MANUFACTURED BY
FORD MOTOR COMPANY

DATE: XX/XX GVWR: XXXX KG (XXXX LB)
FRONT GAWR: REAR GAWR:

A SUITABLE TIRE-RIM CHOICE

XXXX KG (XXXX LB)	WITH	XXXX KG (XXXX LB)	WITH
XXXXXXXXXXXXXXXXXX	TIRES	XXXXXXXXXXXXXXXXXX	TIRES
XXXXXXXX	RIMS	XXXXXXXX	RIMS
AT XXXX kPa/ XXX PSI COLD	AT	XXXX kPa/ XXX PSI COLD	
VIN: XXXXXXXXXXXXXXXXXXXX			



EXT PNT: XX	XXXXXX	RC: XX	DSO: XXXX
WB	INT/TP	TR	SPR
XXX	XX	XX	XXXX
	XXXXXXXXXXXX	XXX	XXXX-XXXXXXXX-XX

E210937

Under no circumstances should your vehicle be loaded in excess of the GVWR or GAWR. It is the operator's responsibility to ensure that neither the axle capacities, spring capacities, tire capacities nor the vehicle rated GVWR is exceeded.

Unloaded or Lightly Loaded Vehicles



WARNING: When operating empty or lightly loaded, sudden or hard braking may induce wheel lockup with loss of vehicle control and the possibility of accident and serious injury, especially on wet or slippery road surfaces.

The braking system has been designed to safely stop your vehicle when fully loaded to its GVWR.

Load Carrying

AIR SUSPENSION (IF EQUIPPED)

Note: Do not operate your vehicle without air in the suspension springs. Operating your vehicle without air in the suspension springs damages the suspension, degrades ride performance and may cause property damage.

The air suspension system automatically adjusts to different loads to maintain a constant frame height, allows for ease of vehicle loading, provides improved vehicle ride, and increased driver comfort.

Air Suspension Dump Button

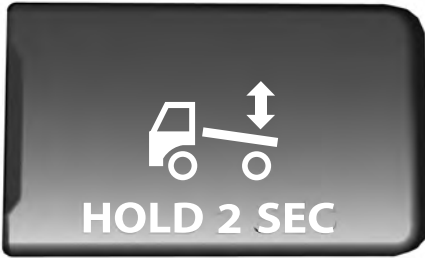

E213409

Note: The suspension dumps air when the ignition is in the accessory or on position, but fills only when the ignition is in the on position.

A button located on the instrument panel controls the system. It operates only when the ignition is in the accessory or on position and the air tanks have sufficient pressure to fill the air springs. When you turn off the ignition, the suspension remains in whatever state it was last set.

Pressing and holding the button for two seconds exhausts air from the air springs, lowering the frame for loading. Pressing and holding the button for two seconds fills the air springs so your vehicle remains at normal ride height.

System Indicator Light

The air suspension indicator light illuminates when using the button to release air pressure in the rear air springs. Never drive your vehicle when the warning lamp is illuminated and there is low (or no) air pressure in the springs.

Connecting and Disconnecting a Trailer with Air Suspension and Air Suspension Dump Button

When connecting to a trailer:

- Press and hold the button for two seconds to exhaust air from the air suspension system.
- Press and hold the button for two seconds, and then raise the landing gear after making the connection to the trailer.

When disconnecting the trailer:

- Lower the landing gear, and then press and hold the button for two seconds.
- Disconnect the brake hoses, trailer-side and rear light connectors, then pull the release lever on the fifth wheel.

You must fill the air springs before operating with a trailer or operating in the bobtail mode.

Suspension Conversions

 **WARNING:** When operating a loaded vehicle, the driver must keep all adjustable axles on the ground at all times, supporting their share of the vehicle's load. Failure to do so can overload other axles, tires, wheels, springs, steering components, brakes and frames, resulting in early component failure, loss of vehicle control, possible property damage and personal injury.

Load Carrying

We do not recommend performing, or approve of, suspension conversions. However, we understand that, on occasion, others install aftermarket add-on suspensions on the truck chassis that allow operator control for weight transfer from other axles (such as air lift axles).

Towing

TOWING A TRAILER



WARNING: Do not exceed the GVWR or the GAWR specified on the certification label.



WARNING: Towing trailers beyond the maximum recommended gross trailer weight exceeds the limit of the vehicle and could result in engine damage, transmission damage, structural damage, loss of vehicle control, vehicle rollover and personal injury.

Your vehicle may have electrical items, such as fuses or relays, related to towing. See **Fuses** (page 193).

Your vehicle's load capacity designation is by weight, not by volume, so you cannot necessarily use all available space when loading a vehicle.

Towing a trailer places an extra load on your vehicle's engine, transmission, axle, brakes, tires and suspension. Inspect these components periodically during, and after, any towing operation.

Load Placement

To help minimize how trailer movement affects your vehicle when driving:

- Load the heaviest items closest to the trailer floor.
- Load the heaviest items centered between the left and right side trailer tires.
- Load the heaviest items above the trailer axles or just slightly forward toward the trailer tongue. Do not allow the final trailer tongue weight to go above or below 10-15% of the loaded trailer weight.

When driving with a trailer or payload, a slight takeoff vibration or shudder may be present due to the increased payload weight. Additional information regarding proper trailer loading and setting your vehicle up for towing is located in another chapter of this manual. See **Load Limit** (page 168).

You can also find information in the **RV & Trailer Towing Guide** available at your authorized dealer, or online.

RV & Trailer Towing Guide Online

Website	http://www.fleet.ford.com/towing-guides/
---------	---

Towing

RECOMMENDED TOWING WEIGHTS

Vehicles with Gasoline Engine		
Model	Maximum GVWR	Maximum GCWR
F-650 Pro-Loader (Kick-Up Frame)	20,500–26,000 lb (9,299–11,793 kg)	1
F-650 Pro-Loader (Straight Frame)/F-650 Straight Frame	25,600–29,000 lb (11,612–13,154 kg)	1
F-750	26,000–33,000 lb (11,793–14,970 kg)	1

¹ Specific GCWR and maximum trailer weight applicable to your vehicle is dependent on many variables including transmission capability. Check with your sales consultant for the exact rating on your vehicle.

Vehicles with Diesel Engine		
Model	Maximum GVWR	Maximum GCWR
F-650 Pro-Loader (Kick-Up Frame)	20,500–26,000 lb (9,299–11,793 kg)	1
F-650 Pro-Loader (Straight Frame)/F-650 Straight Frame	25,600–29,000 lb (11,612–13,154 kg)	1
F-750	26,000–37,000 lb (11,793–16,783 kg)	1

¹ Specific GCWR and maximum trailer weight applicable to your vehicle is dependent on many variables including transmission capability. Check with your sales consultant for the exact rating on your vehicle.

Towing

ESSENTIAL TOWING CHECKS

See **Load limits** in the Load Carrying chapter for load specification terms found on the tire label and Safety Compliance label and instructions on calculating your vehicle's load.

Remember to account for the trailer tongue weight as part of your vehicle load when calculating the total vehicle weight.

Hitches

Do not use a hitch that either clamps onto the bumper or attaches to the axle. You must distribute the load in your trailer so that 10-15% of the total weight of the trailer is on the tongue.

Safety Chains

Note: Do not attach safety chains to the bumper.

Always connect the safety chains to the frame or hook retainers of your vehicle hitch.

To connect the safety chains, cross the chains under the trailer tongue and allow enough slack for turning tight corners. Do not allow the chains to drag on the ground.

Trailer Brakes



WARNING: Do not connect a trailer's hydraulic brake system directly to your vehicle's brake system. Your vehicle may not have enough braking power and your chances of having a collision greatly increase.

Electric brakes and manual, automatic or surge-type trailer brakes are safe if you install them properly and adjust them to the manufacturer's specifications. The trailer brakes must meet local and federal regulations.

The rating for the tow vehicle's braking system operation is at the gross vehicle weight rating, not the gross combined weight rating.

Trailer Lamps



WARNING: Never connect any trailer lamp wiring to the vehicle's tail lamp wiring; this may damage the electrical system resulting in fire. Contact your authorized dealer as soon as possible for assistance in proper trailer tow wiring installation. Additional electrical equipment may be required.

Trailer lamps are required on most towed vehicles. Make sure all running lights, brake lights, turn signals and hazard lights are working.

Before Towing a Trailer

Practice turning, stopping and backing up to get the feel of your vehicle-trailer combination before starting on a trip. When turning, make wider turns so the trailer wheels clear curbs and other obstacles.

When Towing a Trailer

- Check your hitch, electrical connections and trailer wheel lug nuts thoroughly after you have traveled 50 mph (80 km/h).
- When stopped in congested or heavy traffic during hot weather, place the transmission in park (P) or neutral (N) to aid engine and transmission cooling and to help air conditioning performance.
- Turn off the speed control with heavy loads or in hilly terrain. The speed control may turn off automatically when you are towing on long, steep grades.

Towing

- Shift to a lower gear when driving down a long or steep hill. Do not apply the brakes continuously, as they may overheat and become less effective.
- If your transmission is equipped with the Tow/Haul feature, use this feature when towing. This provides engine braking and helps eliminate excessive transmission shifting for optimum fuel economy and transmission cooling.
- Allow more distance for stopping with a trailer attached. Anticipate stops and brake gradually.

FIFTH WHEEL OPERATION



WARNING: Failure to follow the fifth wheel manufacturer's instructions for hooking and unhooking as well as sliding the fifth wheel could result in an accident, personal injury or death.



WARNING: When the tractor and trailer are parked unattended, the trailer brake hand control should never be used to apply the brake, since air may leak from the system, allowing vehicle movement, resulting in possible property damage, personal injury or death.

Before hook-up, make sure:

- The fifth wheel jaws are fully open.
- The fifth wheel is fully tilted back to prevent body damage when the tractor is backed under a trailer.
- You block the trailer wheels and adjust and apply the trailer spring brakes. Never chase a trailer.
- The brake hoses and light cords are clear of the fifth wheel.

Hook-up

1. Back the tractor squarely under the trailer, engaging the fifth-wheel jaws on the kingpin. Always back up slowly; make sure the trailer is neither too high nor too low. Avoid backing under the trailer from an angle.
2. Connect the service and emergency brake hoses and trailer light connector.
3. Inspect the jaws of the fifth wheel to be sure they have fully closed on the trailer kingpin and the trailer plate is resting securely on the fifth wheel.
4. Make sure the coupler release lever is in the locked position.
5. Charge the trailer brake system. Set the trailer brakes, with either the hand valve or tractor protection valve. Pull against the trailer for an extra check of proper hook-up. Do not pull hard enough to damage or strain the equipment.
6. Set the tractor parking brakes and fully raise the trailer landing gear.
7. Check the operation of all trailer lights and correct any lights that may be faulty.

Un-hook

1. Try to keep the tractor and trailer in a straight line.
2. Apply the parking brakes.
3. Lower the trailer landing gear, making sure it is on solid, level ground. The weight of the trailer is to be on the landing gear.
4. Block the trailer wheels.
5. Disconnect the brake hoses and light cords. Be sure hoses and cords are clear.
6. Pull coupler release lever to disengage the fifth wheel jaws.

Towing

7. Release the tractor parking brakes.
8. Pull out from the trailer slowly, allowing the landing gear to take the load gradually.

Driving Hints

GENERAL DRIVING POINTS

General Information

- Accelerate smoothly and evenly. Rapid acceleration increases fuel consumption without increasing engine performance.
- When approaching a hill, press the accelerator smoothly to start the incline at full power, and then shift down as needed to maintain vehicle speed.
- When going down a hill, or long steep grades, prevent overspeeding of the engine. Normally, choose the same gear to descend the hill that you use to ascend the hill. The engine governor has no control over engine speed when it is being pushed by a loaded vehicle.
- Do not operate in a gear that permits an engine speed more than the maximum governed speed or high-idle RPM (no load).
- Always shift to a lower gear at high altitudes to prevent engine smoking.

Backing Up



WARNING: All vehicles have blind spots. To reduce the risk of severe injury or property damage, never move your vehicle to the side or rear or change lanes without being sure your way is clear on both sides and to your rear.



WARNING: To reduce the risk of the possibility of personal injury while backing up the vehicle, always be sure your vehicle's path is clear.

Before backing up your vehicle, be sure you can do so safely. If anything behind the cab limits your view, do not rely on mirrors alone to make sure that your intended path is clear. If other people are in the vicinity, have someone standing well behind your vehicle and outside of your intended path (visible through an exterior mirror) guide you as you back up.

Although OSHA or some governmental regulations may require the use of an electrical or mechanical back up alarm to warn bystanders, such an alarm does not guarantee that the intended path is clear. When in doubt, get out of your vehicle and visually check the intended path is clear. Back up slowly as to allow others time to move, if necessary.

If you install an electrical back up alarm, connect it to the backup lamp circuit.

Parking



WARNING: When parking your vehicle, do not leave the transmission in gear; if the key is in the on position and the vehicle rolls, the engine could start. Failure to follow these instructions could result in an unattended vehicle moving, possibly causing personal injury or property damage.

Always use the parking brake. When parking on a grade, block the wheels and turn the front wheels to one side so that if your vehicle rolls, the front tires act against the curb to stop your vehicle. The front wheels are more effective at stopping a rolling vehicle than the rear wheels.

Driving Hints

ECONOMICAL DRIVING

Your fuel economy is affected by several things, such as how you drive, the conditions you drive under, and how you maintain your vehicle.

You may improve your fuel economy by keeping these things in mind:

- Accelerate and slow down in a smooth, moderate fashion.
- Drive at steady speeds without stopping.
- Anticipate stops; slowing down may eliminate the need to stop.
- Close the windows for high-speed driving.
- Drive at reasonable speeds. Traveling at 55 mph (90 km/h) uses 15% less fuel than traveling at 65 mph (105 km/h).
- Keep the tires properly inflated and use only the recommended size.
- Use the recommended engine oil.
- Perform all regularly scheduled maintenance.

Avoid these actions; they reduce your fuel economy:

- Sudden accelerations or hard accelerations.
- Warm up your vehicle on cold mornings.
- Use the air conditioner.
- Use the speed control in hilly terrain.
- Rest your foot on the brake pedal while driving.
- Carry unnecessary weight. Approximately 1 mpg [0.4 km/L] is lost for every 400 lb (180 kg) of weight carried.
- Driving with the wheels out of alignment.

Conditions

- Adding certain accessories to your vehicle may reduce fuel economy. For example bug deflectors, rollbars, light bars, running boards, ski racks or luggage racks.
- Using fuel blended with alcohol may lower fuel economy.
- Fuel economy may decrease with lower temperatures during the first 5–10 mi (12–16 km) of driving.
- Driving on flat terrain offers improved fuel economy as compared to driving on hilly terrain.
- Transmissions give their best fuel economy when operated in the top cruise gear and with steady pressure on the gas pedal.

COLD WEATHER PRECAUTIONS

Note: *Idling in cold weather does not heat the engine to its normal operating temperature. Long periods of idling, especially in cold weather, can cause a buildup of deposits which can cause engine damage.*

Changing to a lighter grade engine oil also makes starting easier under these conditions. Refer to Engine oil specifications. See **Capacities and Specifications** (page 288).

Diesel fuel is adjusted seasonally for cold temperatures. Diesel fuel which has not been properly formulated for the ambient conditions may gel which can clog the fuel filters. One indication that the fuel filter(s) may be clogged is if the engine starts, stalls after a short time, and then does not restart. If you have been using biodiesel, you may need to use a fuel with lower biodiesel content, try another brand, or discontinue using biodiesel. Do not use

Driving Hints

alcohol based additives to correct fuel gelling. This may result in damage to the fuel injectors and system. Use the proper anti-gel and performance improvement product. See **Capacities and Specifications** (page 288).

Your vehicle is equipped with a fuel and water separator that recirculates fuel from the engine to help prevent fuel filter clogging. To avoid engine fuel starvation during cold weather operation of 32°F (0°C) or below, we recommended that the fuel level in your tank should not drop below 1/4 full. This helps prevent air from entering the fuel system and stalling the engine.

Your vehicle is equipped with a selective catalyst reduction system that uses Diesel Exhaust Fluid (DEF) to operate properly. You need to replenish your vehicle's DEF at certain intervals. When filling your vehicle's DEF tank in cold weather, you must take special care to prevent damage to the tank. See **Selective Catalytic Reductant System** (page 112).

In cold weather below 32°F (0°C), the engine may slowly increase to a higher idle speed if left idling in park (P) or neutral (N).

If you operate your vehicle in a heavy snowstorm or blowing snow conditions, snow and ice can clog the engine air induction. If this occurs, the engine may experience a significant reduction in power output. At the earliest opportunity, clear all the snow or ice away from inside the air filter assembly. Remove the air cleaner cover and the pleated paper filter, leaving the foam filter in and remove any snow or ice. Make sure you install the foam filter correctly in place. Remove any debris, snow or ice on the foam filter by brushing the surface with soft brush. Once you have cleared all of the debris, reinstall the air filter and assembly.

Do not use water, solvents, or a hard brush for cleaning the foam filter.



WARNING: To reduce the risk of vehicle damage and/or personal burn injuries do not start your engine with the air filter removed and do not remove it while the engine is running.

In order to operate the engine in temperatures of 32°F (0°C) or lower, read the following instructions:

- Make sure that the batteries are of sufficient size and are fully charged. Check other electrical components to make sure they are in optimum condition
- Use the proper coolant solution at the concentration recommended protecting the engine against damage from freezing
- Try to keep the fuel tank full as much as possible at the end of operation to prevent condensation in the fuel system
- Make sure you use proper cold weather engine oil and that it is at its proper level. Also, if necessary, make sure to follow the engine oil and filter change schedule found under the Special operating conditions section listed in the scheduled maintenance information
- At temperatures of -9°F (-23°C) or below, it is recommended that you use an engine block heater to improve cold engine starting
- If operating in arctic temperatures of -20°F (-29°C) or lower, consult your truck dealer for information about special cold weather equipment and precautions

Driving Hints

The following cold weather idling guidelines are recommended:

- You can use Motorcraft® cetane improvers or non-alcohol-based cetane improvers from a reputable manufacturer as needed.
- Maintain the engine cooling system properly.
- Avoid shutting the engine down after an extensive idling period. Drive your vehicle for several miles with the engine at normal operating temperatures under a moderate load.
- Consider using an engine block heater.
- For extended idle times use an approved idle speed increase device.

Winter Operating Tips for Arctic Operation -20°F (-29°C) and Below

The following information is a guideline only and is not to be the only source of possible solutions in resolving extreme cold temperature issues.

Starting Aids



WARNING: Do not use starting fluid, such as ether, in the air intake system (see air filter decal). Such fluid could cause immediate explosive damage to the engine and possible personal injury.

The use of the factory engine block heater assists in engine starting in extreme cold ambient temperatures. See **Engine Block Heater** (page 97).

Idle Control

Your vehicle may have a factory option for a stationary elevated idle control through dash-mounted upfitter switches that allows the operator to elevate the idle rpm for extended idle periods, as well as aftermarket equipment such as PTO operation. You must configure this feature even if ordered from the factory. See your authorized dealer for required upfitting.

Operation in Snow and Rain

Vehicle operation in heavy snowfall or extreme rain conditions may feed excessive amounts of snow or water into the air intake system. This could plug the air filter with snow and may cause the engine to lose power and possibly shut down.

We recommend the following actions after operating your vehicle up to 199 mi (320 km) in snowfall or extreme rain:

- Snow: At the earliest opportunity, open the hood and clear all the snow and ice from the air filter housing inlet (do not remove the foam filter) and reset the air filter restriction gauge.

Note: *Removal of the foam filter degrades your vehicle performance during snow and hot weather conditions.*

- Extreme rain: The air filter dries after about 15–30 minutes at highway speeds. At the earliest opportunity, open the hood and reset the air filter restriction gauge.

BREAKING-IN

You need to break in new tires for approximately 300 mi (480 km). During this time, your vehicle may exhibit some unusual driving characteristics.

Driving Hints

Drive your new vehicle at least 1,000 mi (1,600 km) before towing a trailer. Make sure you use the specified engine oil. See **Capacities and Specifications** (page 288).

Do not add friction modifier compounds or special break-in oils during the first few thousand miles (kilometers) of operation. These additives may prevent piston ring seating.

DRIVING THROUGH WATER



WARNING: Do not drive through flowing or deep water as you may lose control of your vehicle.

Note: *Driving through standing water can cause vehicle damage.*

Note: *Engine damage can occur if water enters the air filter.*

Before driving through standing water, check the depth. Never drive through water that is higher than the bottom of the wheel hubs.

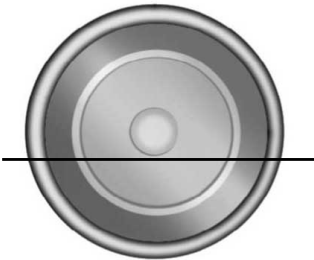

E176913

When driving through standing water, drive very slowly and do not stop your vehicle. Your brake performance and traction may be limited. After driving through water and as soon as it is safe to do so:

- Lightly press the brake pedal to dry the brakes and to check that they work.
- Check that the horn works.
- Check that the exterior lights work.
- Turn the steering wheel to check that the steering power assist works.

Operation in Standing Water

Ingestion of water into the diesel engine can result in immediate and severe damage to the engine. If driving through water, slow down to avoid splashing water into the intake. If the engine stalls, and you suspect ingestion of water into the engine, do not try to restart the engine. Consult your dealer for service immediately.

Your fuel tank vents to the atmosphere by valves on top of the tank and through the fuel cap. If water reaches the top of the tank, the valves may pull water into the fuel tank. Water in the fuel can cause performance issues and damage the fuel injection system.

Roadside Emergencies

ROADSIDE ASSISTANCE

Vehicles Sold in the United States: Getting Roadside Assistance

To fully assist you should you have a vehicle concern, Ford Motor Company offers a complimentary roadside assistance program. This program is separate from the New Vehicle Limited Warranty.

The service is available:

- 24 hours a day, seven days a week.
- For the coverage period supplied with your vehicle.

Roadside Assistance covers:

- A flat tire change with a good spare (except vehicles supplied with a tire inflation kit).
- Battery jump start.
- Lock-out assistance (key replacement cost is the customer's responsibility).
- Fuel delivery — independent service contractors, if not prohibited by state, local or municipal law, shall deliver up to 2 gal (8 L) of gasoline or 5 gal (20 L) of diesel fuel to a disabled vehicle. Roadside Assistance limits fuel delivery service to two no-charge occurrences within a 12-month period.
- Winch out — available within 100 ft (30 m) of a paved or county maintained road, no recoveries.

- Towing — independent service contractors, if not prohibited by state, local or municipal law, shall tow Ford eligible vehicles to an authorized dealer within 35 mi (56 km) of the disablement location or to the nearest authorized dealer. If a member requests a tow to an authorized dealer that is more than 35 mi (56 km) from the disablement location, the member shall be responsible for any mileage costs in excess of 35 mi (56 km).
- Roadside Assistance includes up to \$200 for a towed trailer if the disabled eligible vehicle requires service at the nearest authorized dealer. If the towing vehicle is operational but the trailer is not, then the trailer does not qualify for any roadside services.

Vehicles Sold in the United States: Using Roadside Assistance

Complete the roadside assistance identification card and place it in your wallet for quick reference. This card is in the Owner's Manual kit.

United States vehicle customers who require Roadside Assistance, call 1-800-241-3673.

If you need to arrange roadside assistance for yourself, Ford Motor Company reimburses a reasonable amount for towing to the nearest dealership within 35 mi (56 km). To obtain reimbursement information, United States vehicle customers call 1-800-241-3673. Customers need to submit their original receipts.

Roadside Emergencies

Vehicles Sold in Canada: Getting Roadside Assistance

To fully assist you should you have a vehicle concern, Ford Motor Company of Canada, Limited offers a complimentary roadside assistance program. This program is eligible within Canada or the continental United States.

The service is available 24 hours a day, seven days a week.

This program is separate from the New Vehicle Limited Warranty, but the coverage is concurrent with the powertrain coverage period of your vehicle. Canadian roadside coverage and benefits may differ from the U.S. coverage.

If you require more information, please call us in Canada at 1-800-665-2006, or visit our website at www.ford.ca.

HAZARD FLASHERS

Note: *If used when the vehicle is not running, the battery loses charge. As a result, there may be insufficient power to restart your vehicle.*

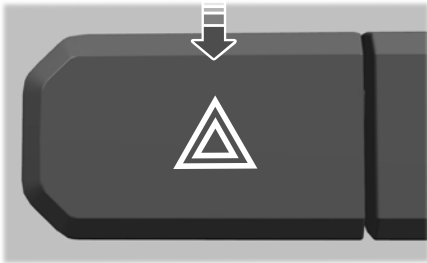

The hazard flasher control is located on the instrument panel. Use it when your vehicle is creating a safety hazard for other motorists.

- Press the flasher control and all front and rear direction indicators flash.
- Press the flasher control again to switch them off.

FUEL SHUTOFF

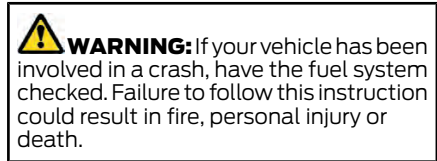

Note: *When you try to restart your vehicle after a fuel shutoff, your vehicle makes sure that various systems are safe to restart. Once your vehicle determines that the systems are safe, your vehicle allows you to restart.*

Note: *In the event that your vehicle does not restart after your third attempt, contact a qualified technician.*

The fuel pump shutoff stops the flow of fuel to the engine in the event of a moderate to severe crash. Not every impact causes a shutoff.

Should your vehicle shut off after a crash, you may restart your vehicle.

If your vehicle has a key system:

1. Turn key to the off position.
2. Turn key to the start position.
3. Turn key to the off position.
4. Turn key to the on position.
5. The fuel pump is now re-enabled.

Roadside Emergencies

JUMP STARTING THE VEHICLE



WARNING: Batteries normally produce explosive gases which can cause personal injury. Therefore, do not allow flames, sparks or lighted substances to come near the battery. When working near the battery, always shield your face and protect your eyes. Always provide correct ventilation.



WARNING: Keep batteries out of reach of children. Batteries contain sulfuric acid. Avoid contact with skin, eyes or clothing. Shield your eyes when working near the battery to protect against possible splashing of acid solution. In case of acid contact with skin or eyes, flush immediately with water for a minimum of 15 minutes and get prompt medical attention. If acid is swallowed, call a physician immediately.



WARNING: Use only adequately sized cables with insulated clamps.

Preparing Your Vehicle

Do not attempt to push-start your automatic transmission vehicle.

Note: Attempting to push-start a vehicle with an automatic transmission may cause transmission damage.

Note: Use only a 12-volt supply to start your vehicle.

Note: Do not disconnect the battery of the disabled vehicle as this could damage the vehicle electrical system.

Park the booster vehicle close to the hood of the disabled vehicle, making sure the two vehicles do not touch.

Connecting the Jumper Cables



WARNING: Do not attach the cables to fuel lines, engine rocker covers, the intake manifold or electrical components as grounding points. Stay clear of moving parts. To avoid reverse polarity connections, make sure that you correctly identify the positive (+) and negative (-) terminals on both the disabled and booster vehicles before connecting the cables.



WARNING: Do not attach the end of the positive cable to the studs or L-shaped eyelet located above the positive (+) terminal of your vehicle's battery. High current may flow through and cause damage to the fuses.



WARNING: Do not connect the end of the second cable to the negative (-) terminal of the battery to be jumped. A spark may cause an explosion of the gases that surround the battery.

Note: In the illustration, the bottom vehicle represents the booster vehicle.

Roadside Emergencies

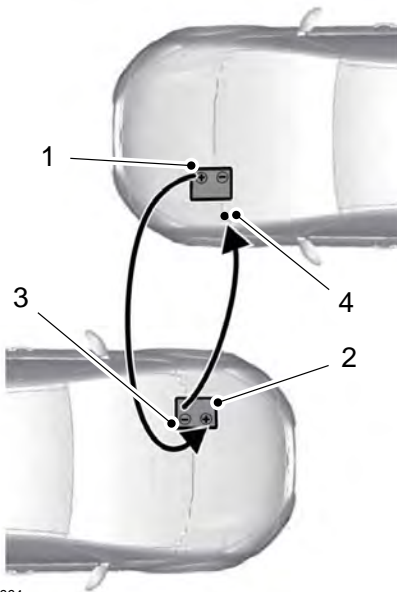

E142664

1. Connect the positive (+) jumper cable to the positive (+) terminal of the discharged battery.
2. Connect the other end of the positive (+) cable to the positive (+) terminal of the booster vehicle battery.
3. Connect the negative (-) cable to the negative (-) terminal of the booster vehicle battery.
4. Make the final connection of the negative (-) cable to an exposed metal part of the stalled vehicle's engine, away from the battery and the fuel injection system, or connect the negative (-) cable to a ground connection point if available.

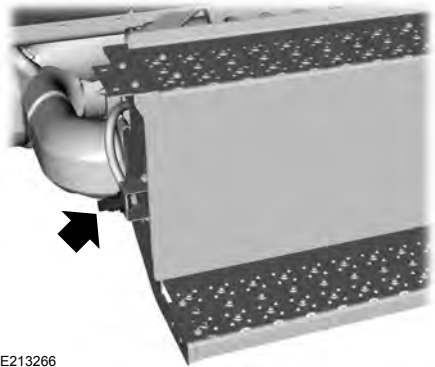

E213266

Note: *There is an optional jump start terminal underneath the passenger side entry steps.*

Jump Starting

1. Start the engine of the booster vehicle and rev the engine moderately, or press the accelerator gently to keep your engine speed between 2000 and 3000 RPM, as shown in your tachometer.
2. Start the engine of the disabled vehicle.
3. Once the disabled vehicle has been started, run both vehicle engines for an additional three minutes before disconnecting the jumper cables.

Removing the Jumper Cables

Remove the jumper cables in the reverse order that they were connected.

Roadside Emergencies

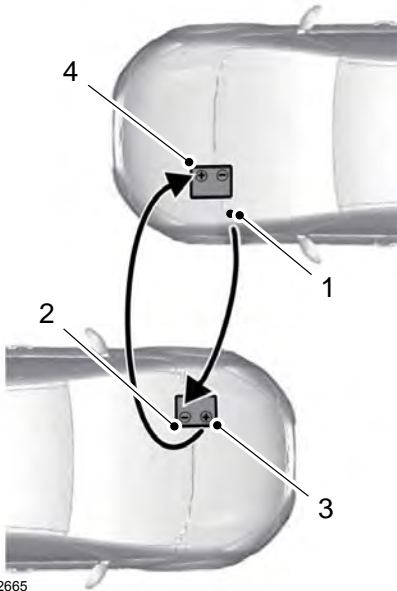

E142665

1. Remove the negative (-) jumper cable from the disabled vehicle.
2. Remove the jumper cable on the negative (-) terminal of the booster vehicle battery.
3. Remove the jumper cable from the positive (+) terminal of the booster vehicle battery.
4. Remove the jumper cable from the positive (+) terminal of the disabled vehicle battery.
5. Allow the engine to idle for at least one minute.

TRANSPORTING THE VEHICLE



WARNING: Block the wheels to help prevent the vehicle from moving.



WARNING: Unexpected and possibly sudden vehicle movement may occur if you do not take these precautions.

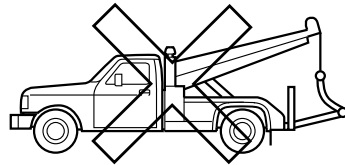
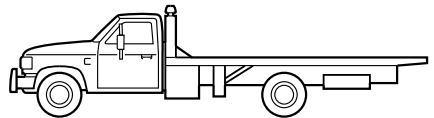
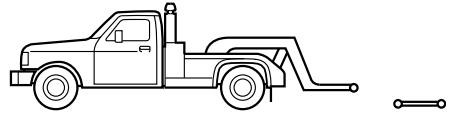

If you need to have your vehicle towed, contact a professional towing service or, if you are a member of a roadside assistance program, your roadside assistance service provider.

We recommend the use of a wheel lift and dollies or flatbed equipment to tow your vehicle. Do not tow with a slingbelt. Ford Motor Company has not approved a slingbelt towing procedure. Vehicle damage may occur if towed incorrectly, or by any other means.

Roadside Emergencies

Ford Motor Company produces a towing manual for all authorized tow truck operators. Have your tow truck operator refer to this manual for proper hook-up and towing procedures for your vehicle.

It is acceptable to have your two-wheel drive vehicle towed with the front wheels on the ground (without dollies) and the rear wheels off the ground.

TOWING POINTS



WARNING: Using recovery hooks is dangerous and should only be done by a person familiar with proper vehicle recovery safety practices. Improper use of recovery hooks may cause hook failure or separation from the vehicle and could result in serious injury or death.



WARNING: Always slowly remove the slack from the recovery strap prior to pulling. Failure to do so can introduce significantly higher loads which can cause the recovery hooks to break off, or the recovery strap to fail which can cause serious injury or death.



WARNING: Never link two straps together with a clevis pin. These heavy metal objects could become projectiles if the strap breaks and can cause serious injury or death.

Your vehicle comes equipped with frame-mounted front recovery hooks. These hooks should never have a load applied to them greater than the gross vehicle weight rating of your vehicle.

Before using recovery hooks:

- Make sure all attaching points are secure and capable of withstanding the applied load.
- Never use chains, cables or tow straps with metal hook ends.
- Only use recovery straps that have a minimum breaking strength two to three times the gross vehicle weight of the stuck vehicle.
- Make sure the recovery strap is in good condition and free of visible cuts, tears or damage.
- Use a damper device such as a tarp, heavy blanket or piece of carpet draped over the recovery strap to help absorb the energy in the event the strap breaks.
- Make sure the stuck vehicle is not loaded heavier than its gross vehicle weight rating specified on the certification label.
- Always align the tow vehicle and stuck vehicle in a straight line (within 10 degrees).
- Keep bystanders to the **sides** of the vehicle, at a distance of at least twice the length of the recovery strap. This helps avoid injury from the hazard of a recovery hook or strap breaking, or a vehicle lurching into their path.

Customer Assistance

GETTING THE SERVICES YOU NEED

Warranty repairs to your vehicle must be performed by an authorized dealer. While any authorized dealer handling your vehicle line will provide warranty service, we recommend you return to your selling authorized dealer who wants to ensure your continued satisfaction.

Please note that certain warranty repairs require special training and equipment, so not all authorized dealers are authorized to perform all warranty repairs. This means that, depending on the warranty repair needed, you may have to take your vehicle to another authorized dealer.

A reasonable time must be allowed to perform a repair after taking your vehicle to the authorized dealer. Repairs will be made using Ford or Motorcraft® parts, or remanufactured or other parts that are authorized by Ford.

Away From Home

If you are away from home when your vehicle needs service, contact the Ford Customer Relationship Center or use the online resources listed below to find the nearest authorized dealer.

In the United States:

Mailing address

Ford Motor Company
Customer Relationship Center
P.O. Box 6248
Dearborn, MI 48126

Telephone

1-800-392-3673 (FORD)
(TDD for the hearing impaired:
1-800-232-5952)

If your vehicle is configured as a motorhome please call 1-800-444-3311 for support.

Additional information and resources are available online:

Website
www.owner.ford.com

These are some of the items that can be found online:

- U.S. dealer locator by Dealer Name, City/State or Zip Code.
- Owner Manuals.
- Maintenance Schedules.
- Recalls.
- Ford Extended Service Plans.
- Ford Genuine Accessories.
- Service specials and promotions.

In Canada:

Mailing address

Customer Relationship Centre
Ford Motor Company of Canada, Limited
P.O. Box 2000
Oakville, Ontario L6K 0C8

Telephone

1-800-565-3673 (FORD)
(TDD for the hearing impaired:
1-888-658-6805)

Website
www.ford.ca

Facebook

FordServiceCA (English)
FordServiceQC (Français)

Twitter

@FordServiceCA

Customer Assistance

Additional Assistance

If you have questions or concerns, or are unsatisfied with the service you are receiving, follow these steps:

1. Contact your Sales Representative or Service Advisor at your selling or servicing authorized dealer.
2. If your inquiry or concern remains unresolved, contact the Sales Manager, Service Manager or Customer Relations Manager.
3. If you require assistance or clarification on Ford Motor Company policies, please contact the Ford Customer Relationship Center.

In order to help us serve you better, please have the following information available when contacting a Customer Relationship Center:

- Vehicle Identification Number.
- Your telephone number (home and business).
- The name of the authorized dealer and city where located.
- The vehicle's current odometer reading.

In some states within the United States, you must directly notify Ford in writing before pursuing remedies under your state's warranty laws, and Ford is also allowed a final repair attempt.

Additionally, in some states within the United States, a consumer has the option of submitting a warranty dispute to the BBB Auto Line before taking action under the Magnuson-Moss Warranty Act, or to the extent allowed by state law, before pursuing replacement or repurchase remedies provided by certain state laws. This dispute handling procedure is not required prior to enforcing state created rights or other rights which are independent of the Magnuson-Moss Warranty Act or state replacement or repurchase laws.

IN CALIFORNIA (U.S. ONLY)

California Civil Code Section 1793.2(d) requires that, if a manufacturer or its representative is unable to repair a motor vehicle to conform to the vehicle's applicable express warranty after a reasonable number of attempts, the manufacturer shall be required to either replace the vehicle with one substantially identical or repurchase the vehicle and reimburse the buyer in an amount equal to the actual price paid or payable by the consumer (less a reasonable allowance for consumer use). The consumer has the right to choose whether to receive a refund or replacement vehicle.

California Civil Code Section 1793.22(b) presumes that the manufacturer has had a reasonable number of attempts to conform the vehicle to its applicable express warranties if, within the first 18 months of ownership of a new vehicle or the first 18,000 mi (29,000 km), whichever occurs first:

1. Two or more repair attempts are made on the same non-conformity likely to cause death or serious bodily injury OR
2. Four or more repair attempts are made on the same nonconformity (a defect or condition that substantially impairs the use, value or safety of the vehicle) OR
3. The vehicle is out of service for repair of nonconformities for a total of more than 30 calendar days (not necessarily all at one time).

In the case of 1 or 2 above, the consumer must also notify the manufacturer of the need for the repair of the nonconformity at the following address:

Ford Motor Company
16800 Executive Plaza Drive
Mail Drop 3NE-B
Dearborn, MI 48126

Customer Assistance

You are required to submit your warranty dispute to BBB AUTO LINE before asserting in court any rights or remedies conferred by California Civil Code Section 1793.22(b). You are also required to use BBB AUTO LINE before exercising rights or seeking remedies created by the Federal Magnuson-Moss Warranty Act, 15 U.S.C. sec. 2301 et seq. If you choose to seek redress by pursuing rights and remedies not created by California Civil Code Section 1793.22(b) or the Magnuson-Moss Warranty Act, resort to BBB AUTO LINE is not required by those statutes.

THE BETTER BUSINESS BUREAU (BBB) AUTO LINE PROGRAM (U.S. ONLY)

Your satisfaction is important to Ford Motor Company and to your dealer. If a warranty concern has not been resolved using the three-step procedure outlined earlier in this chapter in the Getting the Services you need section, you may be eligible to participate in the BBB AUTO LINE program.

The BBB AUTO LINE program consists of two parts – mediation and arbitration. During mediation, a representative of the BBB will contact both you and Ford Motor Company to explore options for settlement of the claim. If an agreement is not reached during mediation or you do not want to participate in mediation, and if your claim is eligible, you may participate in the arbitration process. An arbitration hearing will be scheduled so that you can present your case in an informal setting before an impartial person. The arbitrator will consider the testimony provided and make a decision after the hearing.

Disputes submitted to the BBB AUTO LINE program are usually decided within forty days after you file your claim with the BBB. You are not bound by the decision, and may reject the decision and proceed to court where all findings of the BBB Auto Line dispute, and decision, are admissible in the court action. Should you choose to accept the BBB AUTO LINE decision, Ford is then bound by the decision, and must comply with the decision within 30 days of receipt of your acceptance letter.

BBB AUTO LINE Application: Using the information provided below, please call or write to request a program application. You will be asked for your name and address, general information about your new vehicle, information about your warranty concerns, and any steps you have already taken to try to resolve them. A Customer Claim Form will be mailed that will need to be completed, signed and returned to the BBB along with proof of ownership. Upon receipt, the BBB will review the claim for eligibility under the Program Summary Guidelines.

You can get more information by calling BBB AUTO LINE at 1-800-955-5100, or writing to:

**BBB AUTO LINE
3033 Wilson Boulevard, Suite 600
Arlington, Virginia 22201**

BBB AUTO LINE applications can also be requested by calling the Ford Motor Company Customer Relationship Center at 1-800-392-3673.

For additional information refer to the Better Business Bureau website.

Note: *Ford Motor Company reserves the right to change eligibility limitations, modify procedures, or to discontinue this process at any time without notice and without obligation.*

Customer Assistance

GETTING ASSISTANCE OUTSIDE THE U.S. AND CANADA

Before exporting your vehicle to a foreign country, contact the appropriate foreign embassy or consulate. These officials can inform you of local vehicle registration regulations and where to find diesel fuel.

If you cannot find diesel fuel or can only get fuel with an anti-knock index lower than is recommended for your vehicle, contact a regional office or owner relations/customer relationship office.

The use of low quality diesel fuel may affect your emissions control system and may cause engine damage. Ford Motor Company/Ford of Canada is not responsible for any damage caused by use of improper fuel. In the United States, using leaded fuel may also result in difficulty importing your vehicle back into the U.S.

Ford dealerships outside of the U.S. and Canada may be unable to support the F-650/750 due to the specialized training and servicing requirements of these vehicles. If your vehicle must be serviced while you are traveling or living in Central or South America, the Caribbean, or the Middle East, contact the nearest Ford dealership. If the dealership cannot help you, write or call:

FORD MOTOR COMPANY
Customer Relationship Center
1555 Fairlane Drive
Fairlane Business Park #3
Allen Park, Michigan 48101
U.S.A.
Telephone: (313) 594-4857
Fax: (313) 390-0804
Email: expcac@ford.com

For customers in Guam, the Commonwealth of the Northern Mariana Islands (CNMI), America Samoa, and the U.S. Virgin Islands, please feel free to call our Toll-Free Number: (800) 841-FORD (3673).

If your vehicle must be serviced while you are traveling or living in Puerto Rico, contact the nearest authorized dealer. If the authorized dealer cannot help you, contact:

FORD MOTOR COMPANY
Customer Relationship Center
1555 Fairlane Drive
Fairlane Business Park #3
Allen Park, Michigan 48101
U.S.A.
Telephone: (800) 841-FORD (3673)
FAX: (313) 390-0804
Email: prcac@ford.com
www.ford.com.pr

If your vehicle must be serviced while you are traveling or living in the Middle East, contact the nearest authorized dealer. If the authorized dealer cannot help you, contact:

FORD MOTOR COMPANY
Customer Relationship Center
1555 Fairlane Drive
Fairlane Business Park #3
Allen Park, Michigan 48101
U.S.A.

Ford: 80004443673
Lincoln: 80004441067
If calling from the UAE: 80004441066
If calling from the Kingdom of Saudi Arabia: 8008443673
If calling from Kuwait: 22280384

FAX: +971 4 3327266
Email: menacac@ford.com
www.me.ford.com

Customer Assistance

If you buy your vehicle in North America and then relocate to any of the above locations, register your vehicle identification number (VIN) and new address with Ford Motor Company Export Operations & Global Growth Initiatives by emailing **expcac@ford.com**.

If you are in another foreign country, contact the nearest authorized dealer. In the event your inquiry is unresolved, communicate your concern with the dealership's Sales Manager, Service Manager or Customer Relations Manager. If you require additional assistance or clarification, please contact the respective Customer Relationship Center as previously listed.

Customers in the U.S. should call 1-800-392-3673.

ORDERING ADDITIONAL OWNER'S LITERATURE

To order the publications in this portfolio, contact Helm, Incorporated at:

HELM, INCORPORATED
47911 Halyard Drive
Plymouth, Michigan 48170
Attention: Customer Service

Or to order a free publication catalog, call toll free: 1-800-782-4356

Monday-Friday 8:00 a.m. - 6:00 p.m. EST

Helm, Incorporated can also be reached by their website:

www.helminc.com

(Items in this catalog may be purchased by credit card, check or money order.)

Obtaining a French Owner's Manual

French Owner's Manual can be obtained from your authorized dealer or by contacting Helm, Incorporated using the contact information listed previously in this section.

REPORTING SAFETY DEFECTS (U.S. ONLY)

If you believe that your vehicle has a defect which could cause a crash or could cause injury or death, you should immediately inform the National Highway Traffic Safety Administration (NHTSA) in addition to notifying Ford Motor Company.

If NHTSA receives similar complaints, it may open an investigation, and if it finds that a safety defect exists in a group of vehicles, it may order a recall and remedy campaign. However, NHTSA cannot become involved in individual problems between you, your dealer, or Ford Motor Company.

To contact NHTSA, you may call the Vehicle Safety Hotline toll-free at 1-888-327-4236 (TTY: 1-800-424-9153); go to www.safercar.gov; or write to:

Administrator

1200 New Jersey Avenue,
Southeast

Washington, D.C. 20590

Customer Assistance

You can also obtain other information about motor vehicle safety from www.safercar.gov.

REPORTING SAFETY DEFECTS (CANADA ONLY)

If you believe that your vehicle has a defect which could cause a crash or could cause injury or death, you should immediately inform Transport Canada and Ford of Canada.

Transport Canada Contact Information	
Website	http://www.tc.gc.ca/eng/motorvehiclesafety/reporting-defects-motor-vehicles.html (English)
Website	http://www.tc.gc.ca/fra/securiteautomobile/signaler-defauts-vehicules-automobiles.html (French)
Phone	1-800-333-0510

Ford of Canada Contact Information	
Website	www.ford.ca
Phone	1-800-565-3673

Fuses

FUSE SPECIFICATION CHART

Engine Compartment Fuse Box



WARNING: Always disconnect the battery before servicing high current fuses.



WARNING: To reduce risk of electrical shock, always replace the cover to the power distribution box before reconnecting the battery or refilling fluid reservoirs.

The engine compartment fuse box is in the engine compartment. It has high-current fuses that protect your vehicle's main electrical systems from overloads.

If you disconnect and reconnect the battery, you need to reset some features. See **Changing the 12V Battery** (page 239).

Replace fuses with the same type and rating. See **Changing a Fuse** (page 201).

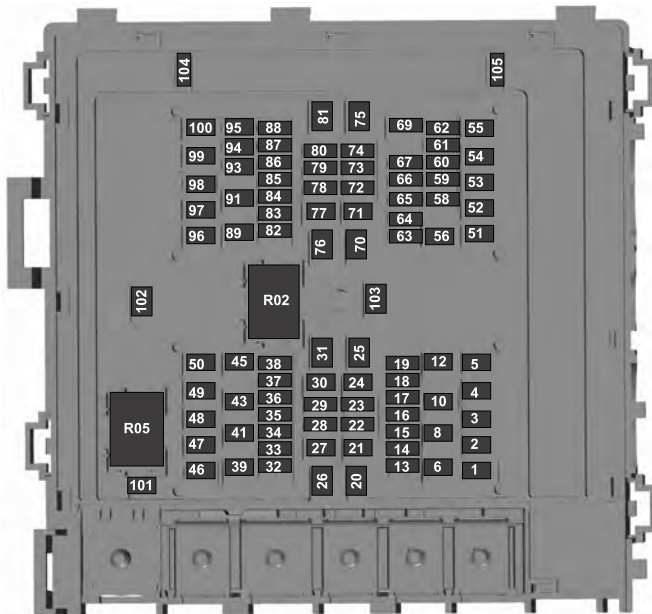

E251921

Fuses

Fuse Number	Fuse Rating	Protected Component
1	20 A	Horn.
2	40 A	Blower motor. Blower motor control.
3	—	Not used.
4	30 A	Starter motor.
5	—	Not used.
6	20 A	Upfitter relay 4.
8	—	Not used.
10	—	Not used.
12	—	Not used.
13	10 A	Run/start spare.
14	10 A	Adaptive cruise control.
15	10 A	Blower motor relay.
16	20 A	Air dryer.
17	10 A	Powertrain control module - ignition status run power. Glow plug control module - ignition status run power (diesel).
18	10 A	Anti-lock brake system run/start.
19	10 A	Transmission control module. Ignition status run power (diesel).
20	30 A	Windshield wiper motor.
21	—	Not used.
22	—	Not used.
23	10 A	Alternator 2 (dual alternator only).
24	40 A	Body control module run power 2 bus.
25	50 A	Body control module run power 1 bus.
26	—	Not used.
27	20 A	Body builder battery feed.

Fuses

Fuse Number	Fuse Rating	Protected Component
28	—	Not used.
29	10 A	Alternator 1 A-Line.
30	—	Not used.
31	60 A	Hydromax pump.
32	20 A	Powertrain control module.
33	20 A	Canister vent solenoid (gas). Canister purge solenoid (gas). Variable cam timing actuator 11 (gas). Heated exhaust gas oxygen sensor (gas). Urea tank power (diesel). Exhaust gas recirculation cool bypass valve (diesel).
34	10 A	A/C clutch relay. Customer access vehicle power 3 feed. Variable oil pump (diesel). Cooling fan (diesel). Fan clutch (gas).
35	20 A	Coil on plug (gas) Urea tank (diesel). Glow plug controller (diesel). Nitrogen oxide sensor control module (diesel). Particulate matter sensor (diesel).
36	10 A	Fuel volume control valve (diesel). Fuel pressure regulator (diesel).
37	—	Not used.
38	—	Not used.
39	—	Not used.
41	30 A	Trailer brake control module.
43	—	Not used.
45	—	Not used.
46	10 A	A/C clutch solenoid.
47	40 A	Upfitter relay 1.
48	20 A	Upfitter run and accessory feed.

Fuses

Fuse Number	Fuse Rating	Protected Component
49	30 A	Pump electronics module (gas). Fuel pump (diesel).
50	15 A	Injector power (gas).
51	20 A	Power point #1.
52	—	Not used.
53	30 A	Trailer tow park lamp.
54	—	Not used.
55	20 A	Upfitter relay 3.
56	—	Not used.
58	5 A	USB power.
59	—	Not used.
60	10 A	Dual fuel tank selector switch (diesel).
61	—	Not used.
62	—	Not used.
63	20 A	Driver seat compressor.
64	20 A	Passenger seat compressor.
65	—	Not used.
66	10 A	Four pack solenoid differential lock.
67	10 A	Hydromax relay power.
69	—	Not used.
70	40 A	Inverter.
71	30 A	Anti-lock brake system valves.
72	10 A	Brake on-off switch (hydraulic brakes). Stop lamp air pressure switch 1 and 2 (air brakes).
73	—	Not used.
74	15 A	Heated mirror.
75	—	Not used.

Fuses

Fuse Number	Fuse Rating	Protected Component
76	60 A	Body control module battery feed.
77	30 A	Body control module voltage quality monitor power feed.
78	10 A	Transmission module (diesel).
79	5 A	Hydromax pump monitor.
80	10 A	Trailer tow backup signal.
81	—	Not used.
82	5 A	Upfitter switch (factory location for ignition power).
83	5 A	Upfitter switch (optional location for power at all times).
84	—	Not used.
85	—	Not used.
86	—	Not used.
87	—	Not used.
88	10 A	Cargo lamps.
89	—	Not used.
91	—	Not used.
93	—	Not used.
94	—	Not used.
95	20 A	Stop lamps. Trailer tow stop lamps.
96	—	Not used.
97	—	Not used.
98	30 A	Trailer tow battery charge.
99	40 A	Upfitter relay 2.
100	25 A	Glow plug controller (diesel).
101	—	Not used.
102	—	Not used.
103	—	Not used.

Fuses

Fuse Number	Fuse Rating	Protected Component
104	—	Not used.
105	15 A	Trailer tow stop and turn relay.

Note: Spare fuse amperage may vary.

Relay Number	Fuse Rating	Protected Component
R02	—	Not used.
R05	—	Not used.

Passenger Compartment Fuse Box

The fuse panel is in the passenger footwell. Remove the panel cover to access the fuses.

Pull the fuse panel cover toward you to remove it. When the clips of the panel disengage, let the panel fall easily.

Use the provided fuse puller tool to remove a fuse. It is on the fuse panel cover.

Replace fuses with the same type and rating. See **Changing a Fuse** (page 201).

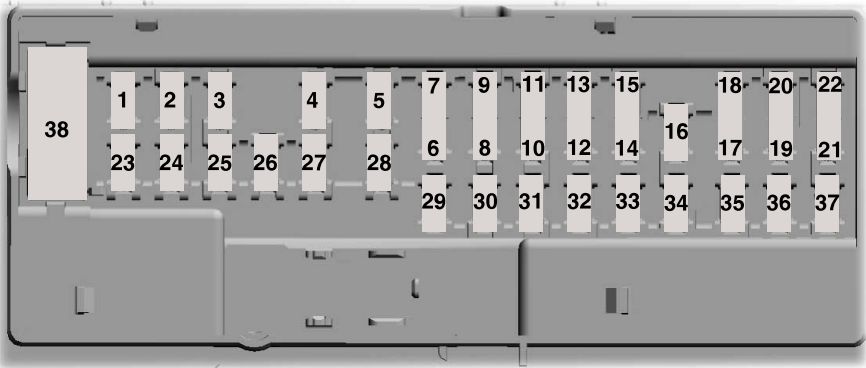

E145984

Fuses

Fuse Number	Fuse Rating	Protected Component
1	—	Not used.
2	10 A	Right-hand and left-hand front door lock switch. Telescopic mirror switch. Right-hand and left-hand front window switch (two window units). Right-hand and left-hand front window motor. Inverter.
3	7.5 A	Power mirror switch.
4	20 A	Ancillary translator module.
5	—	Not used.
6	—	Not used.
7	10 A	Smart data link connector power. Air brake diagnostic connector.
8	—	Not used.
9	—	Not used.
10	—	Not used.
11	—	Not used.
12	7.5 A	Smart data link connector. Enterprise wired-in-device.
13	7.5 A	Cluster. Steering column control module.
14	—	Not used.
15	15 A	Climate control module.
16	—	Not used.
17	—	Not used.
18	7.5 A	Yaw sensor. Electronic stability control and non-electric stability control.
19	—	Not used.

Fuses

Fuse Number	Fuse Rating	Protected Component
20	5 A	Ignition switch.
21	5 A	Exhaust brake switch.
22	—	Not used.
23	30 A	Left-hand front window motor.
24	—	Not used.
25	—	Not used.
26	30 A	Right-hand front motor window.
27	—	Not used.
28	—	Not used.
29	15 A	Relay folding mirror.
30	5 A	Brake signal for air brake. Customer access stop lamp signal. Brake on-off isolation relay. Trailer tow stop lamp relay.
31	10 A	Upfitter interface module. Remote radio frequency receiver.
32	20 A	Radio.
33	—	Not used.
34	—	Not used.
35	5 A	Tow haul switch.
36	15 A	Lane departure warning camera.
37	—	Not used.
38	30 A	Left-hand front power window switch (four window units).

Note: Spare fuse amperage may vary.

Fuses

CHANGING A FUSE

Fuses



WARNING: Always replace a fuse with one that has the specified amperage rating. Using a fuse with a higher amperage rating can cause severe wire damage and could start a fire.

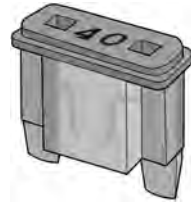

E217331

If electrical components in the vehicle are not working, a fuse may have blown. Blown fuses are identified by a broken wire within the fuse. Check the appropriate fuses before replacing any electrical components.

Fuse Types

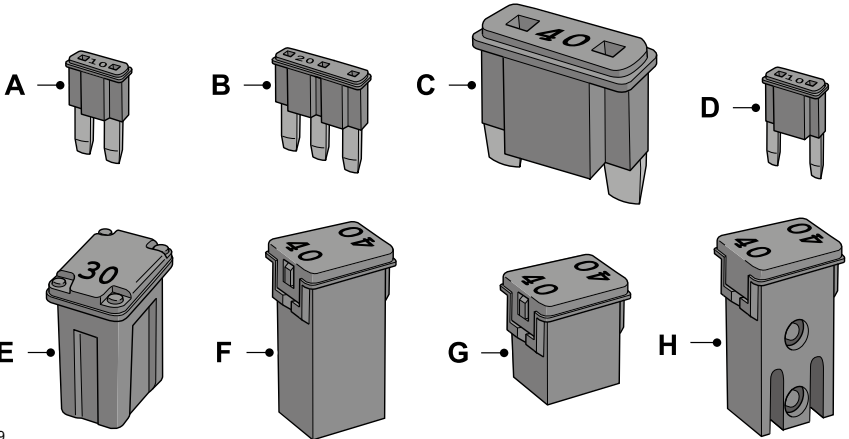

E267379

- A Micro 2.
- B Micro 3.
- C Maxi.
- D Mini.
- E M Case.
- F J Case.

Fuses

- G J Case Low Profile.
- H Slotted M Case.

Vehicle Inspection Guide

VEHICLE INSPECTION INFORMATION

To make sure your vehicle is ready to operate, conduct a pre-trip inspection at the beginning of each work period. Follow the steps listed in this section to verify a proper vehicle inspection procedure.



WARNING: Exercise great caution when working on a vehicle equipped with an automatic fan clutch. The fan starts in motion only after the engine coolant reaches a predetermined temperature or the refrigerant pressure (if equipped with air conditioning) reaches a predetermined setting. The fan starts at this point with no advance warning. Never reach near, or permit objects to protrude into, the fan blade radius while the engine is running as this could result in vehicle damage, personal injury or death.



WARNING: Do not operate the vehicle if any suspension conditions listed in the following charts are evident. Loss of steering or suspension could result in property damage, personal injury or death.



WARNING: If a wheel must be changed, obtain expert tire service help. Mounting and un-mounting of tires should only be performed by a qualified technician using necessary safety procedures and equipment, otherwise the result could be property damage, personal injury or death.

Note: Always make sure you apply the parking brake before starting the engine.

Engine compartment (with engine off)	
Engine oil	Use the dipstick to verify the oil level is in the proper operating range. See Engine Oil Dipstick (page 217).
Engine coolant	Look through the plastic reservoir and verify the coolant level is within the proper operating range. Do not remove the pressure cap until the coolant has cooled. See Engine Coolant Check (page 226).
Power steering fluid	Verify that the fluid level is in the proper operating range. See Power Steering Fluid Check (page 238).
Brake fluid	Remove the master cylinder caps and inspect the fluid level. See Brake Fluid Check (page 237).

Vehicle Inspection Guide

Engine compartment (with engine off)	
Belts (fan, alternator, water pump and air conditioning compressor)	Inspect for glazing, fraying or cracking. There should be no more than 5-7 cracks per rib, per 1 in (2.5 cm)
Fluid leaks	Inspect for signs of fluid puddles or dripping fluid on the ground under the engine, or the underside of the engine.
HVAC air inlet	Inspect for debris that may have collected on the HVAC air inlet grille or inside the exterior module as this may reduce system performance.

Engine starting (with parking brake applied)	
Safety and emergency equipment	Before entering the cab, verify that the vehicle is equipped with spare electrical fuses (if used), three red reflective triangles, a properly charged and rated fire extinguisher and wheel chocks.
	Walk around the vehicle and verify all steps and grab handles, inside and out (as well as behind), are tight and clean. Use extreme caution and a three-point stance at all times.
	Inspect door latches for proper closing, latching and locking.
Starting the engine	Set the parking brake. Make sure the gearshift lever is in neutral (N) or park (P) (if equipped with a park position).
	Diesel engine: Turn the key to the on position. Turn the key to start when the wait to start indicator light in the instrument cluster turns off.
	Gasoline engine: Turn the key to start, and then release it as soon as the engine starts.
Engine oil pressure	Verify pressure builds to normal operating range.
Low air pressure warning tone (if equipped with an air compressor)	A tone indicating low air pressure should sound immediately after the engine starts but before the compressor has built-up pressure. The tone should stop when the air pressure reaches 70 psi (483 kPa). Let the air pressure build to governed cutout pressure, which should occur between 115–130 psi (793–896 kPa).
Accelerator	Press the accelerator and verify that it operates smoothly, without any binding or irregular feel. Release the pedal and verify the engine returns to idle speed immediately.

Vehicle Inspection Guide

Engine starting (with parking brake applied)	
Voltmeter	Check the gauge (diesel engine) or indicator light (gasoline engine) to verify the alternator is charging.
Steering linkage free play	Inspect for excessive free play in the steering linkages. The steering wheel should have less than 2 in (5 cm) of free play at its rim.
Parking brake	Verify the parking brake holds the vehicle by gently trying to pull forward with the parking brake applied.
Air brakes	Verify operation using the following procedure. Chock the wheels, if necessary. Push in the parking brake and, on tractors, push in the tractor parking brake knob:
	1. Verify the air compressor or governor cutout pressure is approximately 120 psi (827 kPa).
	2. Turn off the engine, and then turn the key back to the on position (without starting the engine).
	3. Without the brake pedal applied, note the air pressure drop for one minute. It should be less than 2 psi (14 kPa) for single vehicles and 3 psi (21 kPa) for combination vehicles.
	4. Press and hold the brake pedal with 90 psi (621 kPa) or more. Make sure there is no more than a 3 psi (21 kPa) per minute leak for single vehicles and a 4 psi (28 kPa) minute leak for combination vehicles.
	5. Pump the brake pedal to deplete the system of air pressure. The warning light and tone should turn on at 57 psi (393 kPa).
6. Pump the brake pedal and make sure the parking brake and trailer parking brake knobs pop out at 20 psi (138 kPa) or higher.	
Automatic transmission fluid	Verify that the fluid level is in the proper operating range. See Automatic Transmission Fluid Check (page 236).

Front of vehicle	
Lights	Verify all exterior lights illuminate and are clean.
	Check headlights function on high and low beam.
	Verify reflectors are clean, unbroken and of proper color (red on rear, amber elsewhere).

Vehicle Inspection Guide

Front of vehicle	
	Verify running lights are clean and unbroken.
Steering gear	Inspect for any missing or loose fasteners, power steering fluid leaks and damage to power steering hoses.
Steering linkage	Verify connecting links, arms and rods are not worn or cracked.
	Verify joints, sockets and boot seals are not worn or loose.
	Verify cotter keys, nuts and bolts are not loose or missing.
Tow hooks	Inspect front and rear tow hooks for damage or loose mounting. This is particularly important on vehicles that use them frequently.

Front suspension	
Springs	Inspect for missing, broken or shifted leaves, or leaves that may be in contact with (or nearly contacting) a tire, rim, brake drum, frame or body component.
	Note: Never apply grease to spring pads.
Spring mounts	Make sure there the following items are properly tightened and that there are no cracks, breaks, wear, damage to spring hangers, bolts, bushings, axle mounting bolts, and nuts.
Shock absorbers	Inspect for any cracks, leaks, or missing or broken bolts or bushings.

Vehicle Inspection Guide

Front brakes	
Hoses	Inspect for cracked, worn or frayed hoses, and that all couplings are secure.
Brake chambers	Verify that there are no cracks or dents, and that the chambers are securely mounted.
Slack adjusters	Inspect for broken, loose or missing parts. Note: The angle between the push rod and adjuster arm should be approximately 90 degrees when the brakes are applied. When pulled by hand, the push rod should not move more than approximately 1 in (2.5 cm).
Drums	Verify that there are no cracks, dents, holes, and no loose or missing bolts and that the brake linings are not worn, dangerously thin or contaminated by lubricant.

Front wheels	
Rims	Inspect for damaged or bent rims. They should not have welding repairs, and there should be no rust trails, which indicate it is loose on the wheel.
Lug nuts	Verify all lug nuts are present and not loose (look for rust trails around the lug nuts). There should be no cracks radiating from the lug bolt holes or distortion of the bolt holes.
Hub oil seals	Inspect wheel hub oil seal for leaks and, if sight glass is present, verify the oil level is adequate.
Oil-lubricated front wheel bearings	Inspect for proper lubrication level if the hubcap has a transparent window. If the hubcap does not have a transparent window, remove the rubber fill-plug and inspect for proper level.

Fuel area	
Fuel tank(s)	Verify the tank(s) and cap(s) are secure and that there are no leaks from the tank(s).
Leaks	Inspect for leaks from the tank(s).

Vehicle Inspection Guide

Diesel Exhaust Fluid (DEF) area	
DEF tanks	Verify the tanks and caps are secure and that there are no leaks from the tanks.
Leaks	Inspect for leaks from the tanks.

Underbody	
Driveshaft	Verify that the driveshaft is not bent or cracked and that all driveshaft couplings are secure.
Exhaust system	Verify that the visible outside parts are securely mounted and that there are no cracks, holes or severe dents.
Frame	Inspect for cracks or bends in longitudinal frame members. Verify there are no loose, cracked, bent, broken or missing crossmembers or crossmember fasteners.

Rear of vehicle	
Air hoses and electrical lines	Verify there are no cuts, cracks, chafing or wear on the air hoses and electrical line insulation. Listen for audible air leaks.
	Verify air and electrical lines are not tangled, crimped or pinched or being dragged against any truck parts. None of the air or electrical line should be spliced or taped.
	Inspect for corrosion on pins and in electrical sockets to verify continuity and reduced heat build-up potential.
Deck plate	Verify the deck plate is clean, bolted securely to the frame and is clear of loose objects.
Turns signals, brake lights and flashers	Verify that both brake lights illuminate when the pedal is applied, each signal flashes and that the four-way flashers work properly.
Lights and reflectors	Verify all exterior lights illuminate and are clean.
	Verify reflectors are clean, unbroken and of proper color (red on rear, amber elsewhere).
	Verify running lights are clean and unbroken.
	Note: Inspect rear running lights separately from signal, flasher and brake lights.

Vehicle Inspection Guide

Tractor-coupling system	
Mounting bolts	Inspect for loose or missing mounting brackets, clamps, bolts or nuts. Verify solid attachment of both fifth wheel and the slide mounting.
Platform	Inspect for cracks or breaks in the platform structure.
Safety latch	Verify engagement of the safety latch.
Release arm	Verify the safety latch is in the engaged position, and that any safety latch is in place.
Kingpin and apron	Verify the kingpin is not bent or worn, the apron lies flat on the fifth-wheel skid plate and that the visible part of the apron is not bent, worn, cracked or broken.

Rear suspension	
Springs (if equipped)	Inspect for missing, broken or shifted leaves, or leaves that may be in contact with (or nearly contacting) a tire, rim, brake drum, frame or body component.
Spring mounts (if equipped)	Inspect for any cracked or broken spring hangers; broken missing or loose bolts; missing or damaged bushings; broken, loose or missing axle mounting parts.
Torsion arm and shock absorbers	Verify torsion arm is not cracked, broken or missing.
	Inspect the shock absorber for cracks or leaks. There should be no missing or broken mounting bolts or worn bushings.
Air suspension (if equipped)	Inspect for missing, broken or leaking components. Inspect for any cracked, broken or loose bolts; missing or damaged bushings; broken, loose or missing axle mounting parts.

Vehicle Inspection Guide

Rear brakes	
Hoses	Inspect for cracked, worn or frayed hoses, and that all couplings are secure.
Brake chambers	Verify that there are no cracks or dents, and that the chambers are securely mounted.
Slack adjusters	Inspect for broken, loose or missing parts. Note: The angle between the push rod and adjuster arm should be approximately 90 degrees when the brakes are applied. When pulled by hand, the push rod should not move more than approximately 1 in (2.5 cm).
Drums	Verify that there are no cracks, dents, holes, and no loose or missing bolts and that the brake linings are not worn, dangerously thin or contaminated by lubricant.

Rear wheels	
Spacers	Check for even separation of dual wheels, and that the tires are not touching each other.
Rims	Inspect for damaged or bent rims. They should not have welding repairs, and there should be no rust trails, which indicate it is loose on the wheel.
Lug nuts	Verify all lug nuts are present and not loose (look for rust trails around the lug nuts). There should be no cracks radiating from the lug bolt holes or distortion of the bolt holes.

Trailer

If you are pulling a trailer, perform an inspection of the trailer similar to that of the tractor. The inspection should follow trailer manufacturer recommendations and should include at a minimum: general condition, landing gear, doors, sides, lights, reflectors, suspension, brakes, tires, wheels, cargo placement, stability and tie-downs.

Transmission

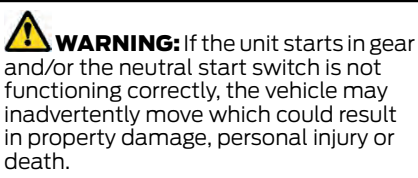

Regularly inspect the transmission's neutral start switch. The engine should only start in neutral (N) or park (P) (if equipped with a park position).

Vehicle Inspection Guide

Inspect the transmission fluid level and shift linkage for proper operation.

Maintenance

GENERAL INFORMATION



WARNING: Making modifications to various parts, components and systems of the vehicle, such as brake and steering systems, can adversely affect the quality, reliability and operation of your vehicle and could result in property damage, personal injury or death. Such modifications must be avoided.



WARNING: Failure to properly perform maintenance and servicing procedures could result in vehicle damage, personal injury or death.



WARNING: Take care when performing any maintenance, system check or service on your vehicle. Some of the materials may also be hazardous if used, serviced or handled improperly and could result in property damage, personal injury or death.

If the owner or operator of the vehicle is a skilled technician and intends on performing the vehicle maintenance and service, he is strongly urged to purchase a service manual.

Always use care when performing vehicle maintenance, repairs or system checks. Improper or incomplete service could result in your vehicle not working properly which may result in personal injury or damage to your vehicle or equipment. It is the operator's responsibility to see that your vehicle receives proper care and maintenance. If you have any questions about performing service, have the service done by a qualified technician.

To help you service your vehicle, we provide scheduled maintenance information which makes tracking routine service easy. See **Scheduled Maintenance** (page 319).

If your vehicle requires professional service, an authorized dealer can provide the necessary parts and service. Check your warranty information to find out which parts and services are covered.

Use only recommended fuels, lubricants, fluids and service parts conforming to specifications. Motorcraft® parts are designed and built to provide the best performance in your vehicle.

Servicing Guidelines



WARNING: The use of inferior parts can adversely affect the quality and reliability of your vehicle and could result in property damage, personal injury or death.

When servicing your vehicle:

- Always wear safety glasses for eye protection.
- Always set the parking brake or chock the wheels.
- Always use support stands, not a jack, when working under a raised vehicle.
- Always turn off the ignition unless a procedure requires the engine to be running.
- Always avoid contact with hot metal parts. Allow the components to cool before working with, or around, them.
- Always operate the engine in a well-ventilated area.
- Do not wear loose-fitting clothing, hanging jewelry, watches or rings.
- Do not smoke.
- Do not work on the brakes or the clutch unless you take the proper precautions to avoid inhaling friction material dust.

Maintenance

Quality service parts are available through an authorized dealer. If dealer parts are not used, make sure the replacement parts are of equivalent quality.

Working with the Engine Off

1. Set the parking brake and shift to neutral (N) or park (P).
2. Switch off the engine.
3. Block the wheels.

Working with the Engine On



WARNING: To reduce the risk of vehicle damage and/or personal burn injuries, do not start your engine with the air cleaner removed and do not remove it while the engine is running.

1. Set the parking brake and shift to neutral (N) or park (P).
2. Block the wheels

Supporting Your Vehicle for Service



WARNING: Do not use a jack when working under a vehicle. It may give way, causing the vehicle to fall and result in property damage, personal injury or death. Always use floor stands to support the vehicle.

Prepare your vehicle for service repairs by doing the following:

1. Park your vehicle on a level, concrete floor.
2. Set the parking brake and block the wheels to prevent your vehicle from moving.
3. Select a jack with a rated capacity sufficient to lift and hold up your vehicle.

4. Raise your vehicle with the jack applied to the axle(s). Do not use the bumper as a lifting point.
5. Support your vehicle with floor stands under the axle(s). When servicing the axle or the suspension, support your vehicle with floor stands under the frame side-members, preferably between the axles.

OPENING AND CLOSING THE HOOD



WARNING: Before opening the hood, fully apply the parking brake, shift into park (P) or neutral (N) and switch the ignition off.



WARNING: Do not stand under the hood when you raise or lower it. Failure to follow this warning could result in serious personal injury or death.



WARNING: If the engine is running while the hood is open, stay clear of moving engine components. Failure to follow this warning could result in serious personal injury or death.

Maintenance

Opening the Hood

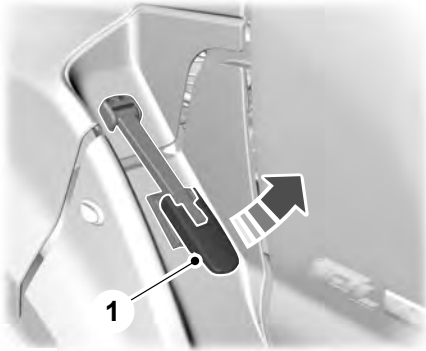

E209159

1. Lift and release the hood latches on both sides of your vehicle.

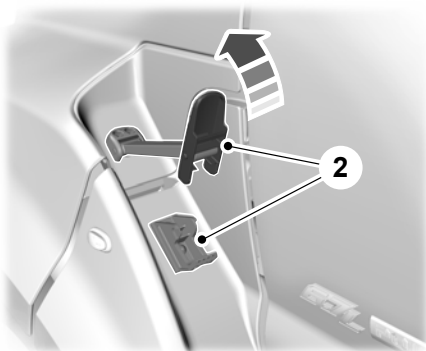

E209160

2. Fully disengage the hood latches on both sides of your vehicle.

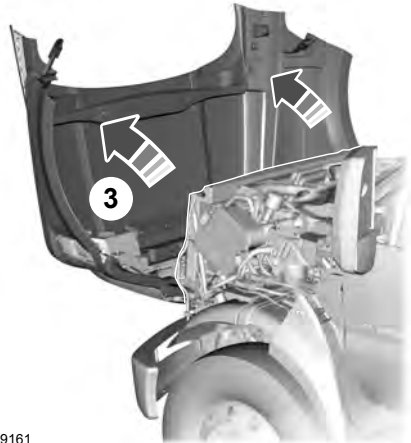

E209161

3. Tilt the hood fully forward until held by the gas struts.

Note: *Open the hood from the front of the grille.*

Closing the Hood

1. Push the hood rearward above the grille until fully closed.
2. Engage the hood latches on both sides of your vehicle.
3. Fully close the hood latches on both sides of your vehicle.

Maintenance

UNDER HOOD OVERVIEW - 6.7L DIESEL

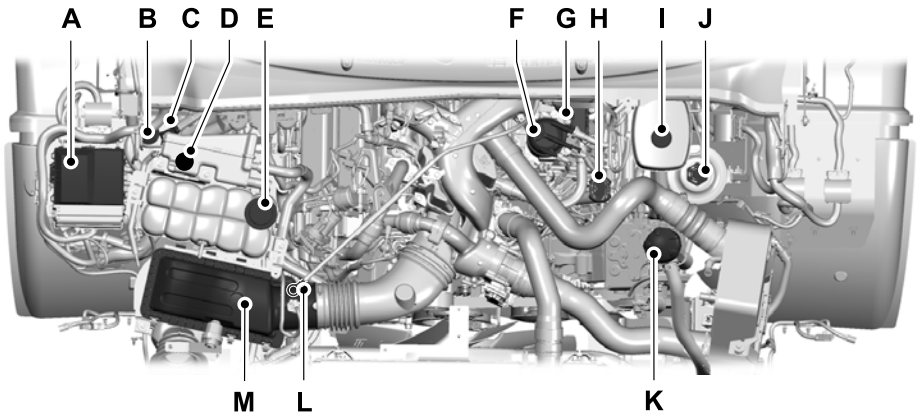

- A Engine compartment fuse box. See **Fuses** (page 193).
- B Windshield washer fluid reservoir. See **Washer Fluid Check** (page 242).
- C Automatic transmission fluid dipstick. See **Automatic Transmission Fluid Check** (page 236).
- D Secondary Cooling System Reservoir. See **Engine Coolant Check** (page 231).
- E Engine coolant reservoir. See **Engine Coolant Check** (page 231).
- F Secondary fuel filter. See **Draining the Fuel Filter Water Trap** (page 225).
- G Engine oil separator. See **Changing the Engine Oil and Oil Filter** (page 219).
- H Engine oil filler cap. See **Engine Oil Check** (page 218).
- I Brake fluid reservoir. See **Brake Fluid Check** (page 237).
- J Power steering fluid reservoir. See **Power Steering Fluid Check** (page 238).
- K Air brake compressor. See **Brake System Inspection** (page 248).
- L Engine oil dipstick. See **Engine Oil Dipstick** (page 217).
- M Air cleaner assembly. See **Changing the Engine Oil and Oil Filter** (page 219).

Maintenance

UNDER HOOD OVERVIEW - 7.3L

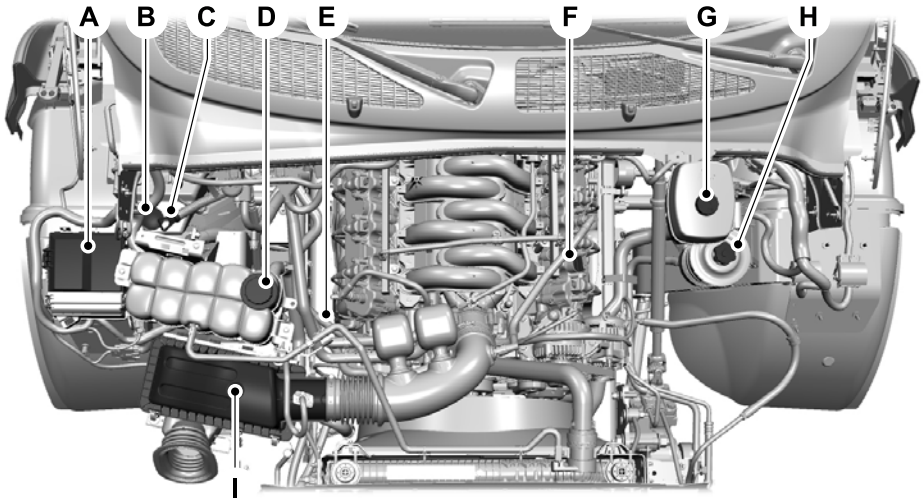

- A Engine compartment fuse box. See **Fuses** (page 193).
- B Windshield washer fluid reservoir. See **Washer Fluid Check** (page 242).
- C Automatic transmission fluid dipstick. See **Automatic Transmission Fluid Check** (page 236).
- D Engine coolant reservoir. See **Engine Coolant Check** (page 226).
- E Engine oil dipstick. See **Engine Oil Dipstick** (page 217).
- F Engine oil filler cap. See **Engine Oil Check** (page 217).
- G Brake fluid reservoir. See **Brake Fluid Check** (page 237).
- H Power steering fluid reservoir. See **Power Steering Fluid Check** (page 238).
- I Air cleaner assembly. See **Changing the Engine Air Filter** (page 223).

Maintenance

ENGINE OIL DIPSTICK - 7.3L

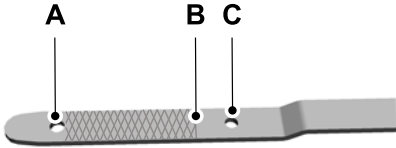

E250320

- A Minimum.
- B Nominal.
- C Maximum.

ENGINE OIL DIPSTICK - 6.7L DIESEL

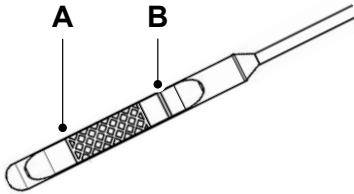

E206879

- A Minimum.
- B Maximum.

ENGINE OIL CHECK - 7.3L

To check the engine oil level consistently and accurately, do the following:

1. Make sure the parking brake is on. Make sure the transmission is in park (P) or neutral (N).
2. Run the engine until it reaches normal operating temperature.
3. Make sure that your vehicle is on level ground.
4. Switch the engine off and wait 15 minutes for the oil to drain into the oil pan. Checking the engine oil level too soon after you switch the engine off may result in an inaccurate reading.
5. Open the hood. See **Maintenance** (page 212).
6. Remove the dipstick and wipe it with a clean, lint-free cloth. See **Maintenance** (page 212).
7. Replace the dipstick and remove it again to check the oil level. See **Maintenance** (page 212).
8. Make sure that the oil level is between the maximum and minimum marks. If the oil level is at the minimum mark, add oil immediately. See **Capacities and Specifications** (page 281).
9. If the oil level is correct, replace the dipstick and make sure it is fully seated.

Note: Do not remove the dipstick when the engine is running.

Note: If the oil level is between the maximum and minimum marks, the oil level is acceptable. Do not add oil.

Note: The oil consumption of new engines reaches its normal level after approximately 3,000 mi (5,000 km).

Adding Engine Oil

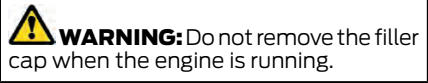

WARNING: Do not remove the filler cap when the engine is running.

Do not use supplemental engine oil additives because they are unnecessary and could lead to engine damage that may not be covered by the vehicle Warranty.

Maintenance



E142732

Only use oils certified for gasoline engines by the American Petroleum Institute (API). An oil with this trademark symbol conforms to the current engine and emission system protection standards and fuel economy requirements of the International Lubricants Specification Advisory Committee (ILSAC).

To top up the engine oil level do the following:

1. Clean the area surrounding the engine oil filler cap before you remove it.
2. Remove the engine oil filler cap.
3. Add engine oil that meets the correct specification.
4. Recheck the oil level.
5. If the oil level is correct, replace the dipstick and make sure it is fully seated.
6. Replace the engine oil filler cap. Turn it clockwise until you feel a strong resistance.

Note: Do not add oil further than the maximum mark. Oil levels above the maximum mark may cause engine damage.

Note: Make sure you install the oil filler cap correctly.

Note: Soak up any spillage with an absorbent cloth immediately.

ENGINE OIL CHECK - 6.7L DIESEL

To check the engine oil level consistently and accurately, do the following:

1. Make sure the parking brake is on. Make sure the transmission is in park (P) or neutral (N).
2. Run engine until it reaches normal operating temperature.
3. Make sure that your vehicle is on level ground.
4. Switch the engine off and wait 15 minutes for the oil to drain into the oil pan. Checking the engine oil level too soon after you switch the engine off may result in an inaccurate reading.
5. Open the hood. See **Opening and Closing the Hood** (page 213).
6. Remove the dipstick and wipe it with a clean, lint-free cloth. See **Under Hood Overview** (page 215).
7. Replace the dipstick and remove it again to check the oil level. See **Engine Oil Dipstick** (page 217).
8. Make sure that the oil level is between the maximum and minimum marks. If the oil level is at the minimum mark, add oil immediately. See **Capacities and Specifications** (page 288).
9. If the oil level is correct, replace the dipstick and make sure it is fully seated.

Note: Do not remove the dipstick when the engine is running.

Note: If the oil level is between the maximum and minimum marks, the oil level is acceptable. Do not add oil.

Note: The oil consumption of new engines reaches its normal level after approximately 3,000 mi (5,000 km).

Maintenance

Adding Engine Oil



WARNING: Do not remove the filler cap when the engine is running.

Do not use supplemental engine oil additives because they are unnecessary and could lead to engine damage that may not be covered by the vehicle Warranty.

To top up the engine oil level do the following:

1. Clean the area surrounding the engine oil filler cap before you remove it.
2. Remove the engine oil filler cap. See **Under Hood Overview** (page 215). Turn it counterclockwise and remove it.
3. Add engine oil of the proper viscosity and grade that meets Ford specifications. See **Capacities and Specifications** (page 288). You may have to use a funnel to pour the engine oil into the opening.
4. Recheck the oil level.
5. If the oil level is correct, replace the dipstick and make sure it is fully seated.
6. Replace the engine oil filler cap. Turn it clockwise until you feel a strong resistance.

Note: Do not add oil further than the maximum mark. Oil levels above the maximum mark may cause engine damage.

Note: Make sure you install the oil filler cap correctly.

Note: Soak up any spillage with an absorbent cloth immediately.

Engine lubrication for severe service operation

The following conditions define severe operation for which engine operation with SAE 5W-40 oil which meets Ford specification, WSS-M2C171-F1, is recommended. Oil and oil filter change intervals will be determined by the Intelligent Oil Life Monitor™ as noted previously.

CHANGING THE ENGINE OIL AND OIL FILTER



WARNING: Do not handle a hot oil filter with bare hands.



WARNING: Continuous contact with used motor oil has caused cancer in laboratory mice. Protect your skin by washing with soap and water.

If your vehicle is equipped with a diesel engine, an Intelligent Oil Life Monitor™ calculates the proper oil change service interval. When the information display indicates: OIL CHANGE REQUIRED, change the engine oil and oil filter. See **Information Displays** (page 70).

The engine oil filter protects your engine by filtering harmful, abrasive or sludge particles and particles significantly smaller than most available will-fit filters. See **Motorcraft Parts** (page 283).

1. Unscrew the oil filter and oil pan drain plug and wait for the oil to drain.
2. Replace the filter.
3. Reinstall the oil pan drain plug.
4. Refill the engine with new oil. See **Capacities and Specifications** (page 288).

Maintenance

5. For diesel engines, you need to reset the Intelligent Oil Life Monitor™. See **Information Displays** (page 70).

Engine lubrication for severe service operation

The following conditions define severe operation for which engine operation with SAE 5W-40 API CJ-4 is recommended. Oil and oil filter change intervals will be determined by the Intelligent Oil Life Monitor™ as noted previously.

- Frequent or extended idling (over 10 minutes per hour of normal driving).
- Low-speed operation/stationary use.
- If vehicle is operated in sustained ambient temperatures below -9°F (-23°C) or above 100°F (38°C).
- Frequent low-speed operation, consistent heavy traffic less than 25 mph (40 km/h).
- Operating in severe dust conditions.
- Operating the vehicle off road.
- Towing a trailer over 1,000 mi (1,600 km).
- Sustained, high-speed driving at Gross Vehicle Weight Rating (maximum loaded weight for vehicle operation).
- Use of fuels with sulfur content other than ultra-low sulfur diesel (ULSD).
- Use of high-sulfur diesel fuel.

OIL CHANGE INDICATOR RESET

Base Cluster

Use the information display controls on the steering wheel to reset the oil change indicator.

From the main menu scroll to:

Message	Action and Description
Settings	Press the right arrow button, then from this menu scroll to the following message.
Vehicle	Press the down arrow button, then from this menu scroll to the following message.
Oil Life Reset	Press the right arrow button, then from this menu scroll to the following message.
Oil Life Hold to Reset	Press and hold the OK button until the instrument cluster displays the following message.
Oil Life Hold OK to Reset	Reset Complete
	If the instrument cluster displays the following message, repeat the process. Reset Cancelled

High Series Cluster

Use the information display controls on the steering wheel to reset the oil change indicator.

Maintenance

From the main menu scroll to:

Message	Action and Description
Truck Info	Press the down arrow button, then from this menu scroll to the following message.
Maintenance Monitor	Press the OK button.
Oil Life: xxx%	Press the down arrow button, then from this menu scroll to the following message.
Oil Life	Press the OK button.
Oil Life Hold OK to Reset	Press and hold the OK button until the instrument cluster displays the following message. Oil Life: 100% When the oil change indicator resets, the instrument cluster displays 100%. Repeat the process if the oil change indicator does not reset.

CHANGING THE ENGINE AIR FILTER - 6.7L DIESEL

Air Filter Restriction Gauge



WARNING: To reduce the risk of vehicle damage and personal burn injuries, do not start your engine with the air cleaner removed and do not remove it while the engine is running.

Note: Operating your vehicle in heavy snowfall or extreme rain conditions may allow excessive amounts of snow or water into the air intake system. This could plug or soak the air filter and cause the engine to lose power or shut down.



E163372

The restriction gauge, on the upper housing of the air filter assembly, measures the vacuum inside the air filter. The more the air filter is dirty or clogged, the higher the vacuum reading.

Check the air filter restriction gauge whenever you open the hood to perform general engine maintenance or at least every 7,500 mi (12,000 km). If you operate your vehicle in extremely dusty conditions, check and reset the gauge at least every 500 mi (800 km), or two weeks, whichever comes first. Change the air filter when the restriction gauge reads near the change filter line and the gauge is yellow. If you allow the restriction gauge to reach maximum restriction, you can affect your engine performance and fuel economy.

Note: Do not blow out the air filter element with compressed air since the compressed air could damage the filter paper.

Note: Do not rely on filter appearance alone. A filter which appears to be dirty may have several thousand miles (kilometers) of life remaining.

Maintenance



E163373

After installation of the new filter element, reset the gauge by pressing the reset button on top of the gauge.

We recommend the following actions after operating the vehicle up to 200 mi (320 km) in heavy snowfall or extreme rain:

- Snow: At the earliest opportunity, open the hood and clear all the snow and ice from the air filter housing inlet. Do NOT remove the foam filter and reset the air filter restriction gauge.
- Extreme rain: The air filter dries after about 15–30 minutes at highway speeds. At the earliest opportunity, open the hood and reset the air filter restriction gauge.

Air Filter Replacement

When replacing the air filter element, use a Motorcraft® air filter element. See **Motorcraft Parts** (page 283).

Note: Failure to use the correct air filter element may result in severe engine damage.

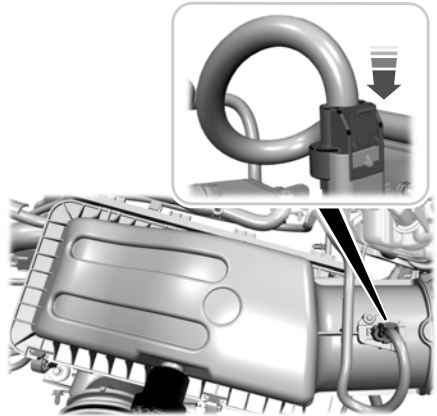

1. Locate the mass airflow sensor electrical connector on the air inlet tube. Disconnect the electrical connector. Unlock the locking clip on the connector, then squeeze and pull the connector off the air inlet tube.

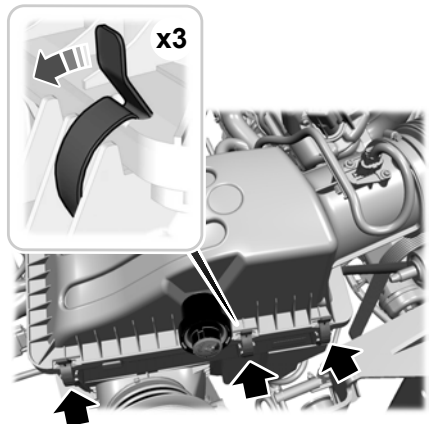

Maintenance

- Remove the clips that secure the air filter housing cover. Push the air filter cover forward and away from you when pulling up slightly to release it.
- Remove the air filter element from the air filter housing.



E163376

- Remove and install a new foam filter, if needed. See **Scheduled Maintenance** (page 319). If you do not replace the foam filter, be sure the existing foam filter is in place.

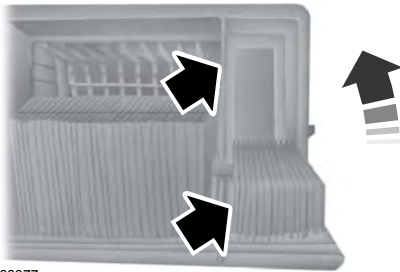

E163377

- Install a new air filter element. Be sure that the groove seal on the pleated paper filter traps both sides of the vertical partition of the air box.

- Engage the clips to secure the air filter housing cover to the air filter housing. Be careful not to crimp the filter element edges between the air filter housing and cover. Ensure that you align the tabs on the edge properly into the slots.
- Reconnect the mass airflow sensor electrical connector to the inlet tube. Make sure the locking tab on the connector is in the locked position.

CHANGING THE ENGINE AIR FILTER - 7.3L

WARNING: To reduce the risk of vehicle damage and personal burn injuries, do not start your engine with the air cleaner removed and do not remove it while the engine is running.

Note: Operating your vehicle in heavy snowfall or extreme rain conditions may allow excessive amounts of snow or water into the air intake system. This could plug or soak the air filter, and cause the engine to lose power or shut down.

When replacing the air filter element, use a Motorcraft® air filter element. See **Motorcraft Parts** (page 283).

Note: Failure to use the correct air filter element may result in severe engine damage, and may void the vehicle warranty.

Change the air filter element at the correct interval. See **Scheduled Maintenance** (page 319).

Maintenance

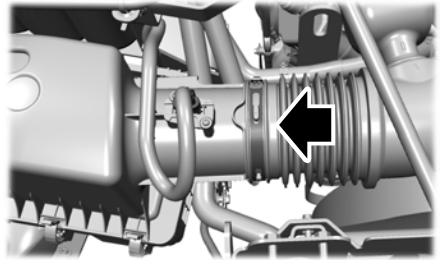
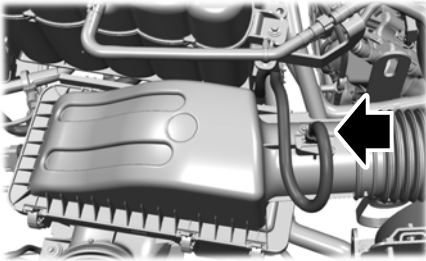

1. Locate the mass air flow sensor electrical connector on the air outlet tube. Disconnect the mass air flow sensor electrical connector.

3. Clean the area from around the air tube to the air cover connection to prevent debris from entering the system. Next, loosen the bolt on the air tube clamp so the clamp is no longer snug to the air tube. It is not necessary to completely remove the clamp.
4. Pull the air tube off from the air cleaner housing.

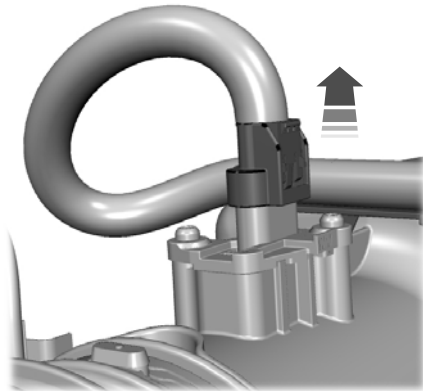

2. Reposition the locking clip on the connector, squeeze the connector and pull it off the air outlet tube.

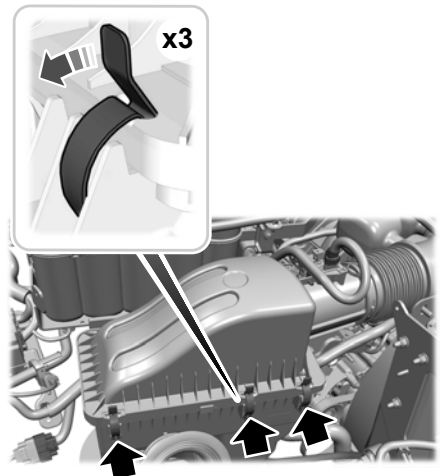

Maintenance

5. Remove the clips that secure the air filter housing cover. Push the air filter cover toward the center of the vehicle and up slightly to release it.
6. Remove the air filter element from the air filter housing.
7. Install the new air filter element.
8. Engage the clips to secure the air filter housing cover to the air filter housing. Be careful not to crimp the filter element edges between the air filter housing and cover. Ensure that you align the tabs on the edge properly into the slots.
9. Slip the air tube onto the air filter housing and tighten the air-tube clamp bolt snugly. Do not over tighten air-tube clamp bolt.

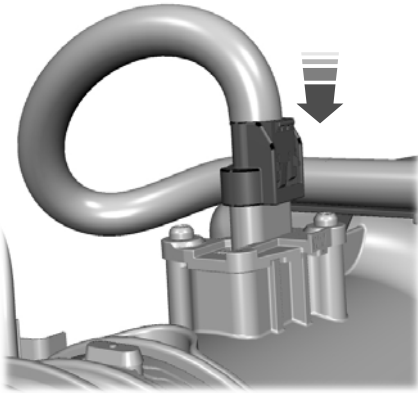

10. Reconnect the mass air flow sensor electrical connector to the outlet tube. Make sure the locking tab on the connector is in the locked position.

DRAINING THE FUEL FILTER WATER TRAP - 6.7L DIESEL

Your vehicle is equipped with a diesel fuel conditioner module located on the frame-rail under the driver-side floorboard near the transmission.



You should drain water from the module assembly whenever the warning light comes on and the message center directs you to drain the water separator. This will occur when approximately 8.45 fl oz (250 ml) of water accumulates in the module. If you allow the water level to exceed this level, the water may pass through to the engine and may cause fuel injection equipment damage.

Draining the Diesel Fuel Conditioner Module (DFCM)



WARNING: Do not drain the water-in-fuel separator while the engine is running. Failure to follow this warning may result in fire, serious injury, death or property damage.

Note: If you drain the diesel fuel conditioner module while the system is running air will enter into the fuel system. The engine will not operate properly if air enters the system.

Note: With fuel tank levels above 3/4 tank it may be necessary to loosen the bowl three turns before opening the drain. This will actuate an anti-siphon valve at the fuel and water separator inlet and prevent the fuel from siphoning out of the tank.

Note: A loose drain valve can allow air to enter the fuel system and cause drivetrain issues. The engine will not operate properly. Be sure that you fully tighten the drain valve.

1. Stop your vehicle and shut off the engine.

Maintenance

2. Locate the diesel fuel conditioner module and place an appropriate container under the drain port.

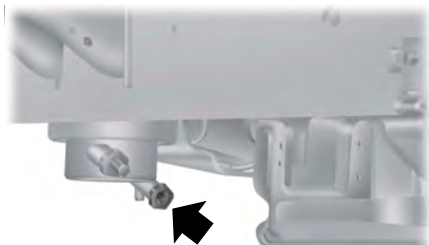



E163360

3. Rotate the drain counterclockwise until the O-ring is visible. Allow the diesel fuel conditioner module to drain for approximately 25 seconds or until clean fuel is observed. Rotate the drain clockwise to tighten it. If no liquid drains, there may be a clog in the drain. Have the conditioner module serviced by an authorized dealer.
4. Make sure that you fully tighten the drain valve and then remove the container from under your vehicle.
5. Restart the engine. If the **Water in Fuel Drain Filter** message and light continues to illuminate, have the fuel system checked and repaired.

ENGINE COOLANT CHECK - 7.3L

 **WARNING:** Do not remove the coolant reservoir cap when the engine is on or the cooling system is hot. Wait 10 minutes for the cooling system to cool down. Cover the coolant reservoir cap with a thick cloth to prevent the possibility of scalding and slowly remove the cap. Failure to follow this instruction could result in personal injury.

 **WARNING:** Do not put coolant in the windshield washer reservoir. If sprayed on the windshield, coolant could make it difficult to see through the windshield.

 **WARNING:** To reduce the risk of personal injury, make sure the engine is cool before unscrewing the coolant pressure relief cap. The cooling system is under pressure. Steam and hot liquid can come out forcefully when you loosen the cap slightly.

 **WARNING:** Do not add coolant further than the **MAX** mark.

When the engine is cold, check the concentration and level of the coolant at the intervals listed in the scheduled maintenance information. See **Scheduled Maintenance** (page 319).

Note: Make sure that the coolant level is between the **MIN** and **MAX** marks on the coolant reservoir.

Note: Coolant expands when it is hot. The level may extend beyond the **MAX** mark.

Maintenance

Maintain coolant concentration within 48% to 50%, which equates to a freeze point between -30°F (-34°C) and -34°F (-37°C). Check the coolant concentration using a refractometer. We do not recommend the use of hydrometers or coolant test strips for measuring coolant concentration.

Adding Coolant



WARNING: Do not add engine coolant when the engine is on or the cooling system is hot. Failure to follow this instruction could result in personal injury.



WARNING: Do not remove the coolant reservoir cap when the engine is on or the cooling system is hot. Wait 10 minutes for the cooling system to cool down. Cover the coolant reservoir cap with a thick cloth to prevent the possibility of scalding and slowly remove the cap. Failure to follow this instruction could result in personal injury.

Note: *Automotive fluids are not interchangeable. Do not use coolant or windshield washer fluid outside of its specified function and vehicle location.*

Note: *Do not use stop leak pellets, cooling system sealants, or non-specified additives as they can cause damage to the engine cooling or heating systems. Resulting component damage may not be covered by the vehicle Warranty.*

It is very important to use prediluted coolant approved to the correct specification in order to avoid plugging the small passageways in the engine cooling system. See **Capacities and Specifications** (page 288). Do not mix different colors or types of coolant in your vehicle. Mixing of engine coolants or using an incorrect coolant may harm the engine or cooling system components and may not be covered by the vehicle Warranty.

Note: *Coolants marketed for all makes and models may not be approved to our specifications and may cause damage to the cooling system. Resulting component damage may not be covered by the vehicle Warranty.*

If the coolant level is at or below the minimum mark, add prediluted coolant immediately.

For vehicles with overflow coolant systems with a non-pressurized cap on the coolant recovery system, add coolant to the coolant recovery reservoir when the engine is cool. Add prediluted coolant to the maximum level. For all vehicles which have a coolant degas system with a pressurized cap, or if it is necessary to remove the coolant pressure relief cap on the radiator, follow these steps to add engine coolant:

1. Turn the engine off and let it cool.
2. Unscrew the cap slowly. Any pressure escapes as you unscrew the cap.
3. Fill the coolant reservoir slowly with prediluted engine coolant to within the minimum and maximum range on the engine coolant reservoir. If you removed the radiator cap in an overflow system, fill the radiator until the coolant is visible and the radiator is almost full. If coolant is added to bring the level within the minimum and maximum range when the engine is not cold, the system may remain underfilled.

Maintenance

4. Replace the coolant reservoir cap. Turn the cap clockwise until it contacts the hard stop.
5. Check the coolant level in the coolant reservoir the next few times you drive your vehicle. If necessary, add enough prediluted engine coolant to bring the coolant level to the proper level.

Note: *If prediluted coolant is not available, use the approved antifreeze concentrate diluting it to 50/50 with distilled water. See **Capacities and Specifications** (page 288). Using water that has not been deionized may contribute to deposit formation, corrosion or plugging of the small cooling system passageways.*

If you have to add more than 1.1 qt (1 L) of engine coolant per month, have your vehicle checked as soon as possible. Operating an engine with a low level of coolant can result in engine overheating and possible engine damage.

Note: *During normal vehicle operation, the coolant may change color from orange to pink or light red. As long as the coolant is clear and uncontaminated, this color change does not indicate the coolant has degraded nor does it require the coolant to be drained, the system to be flushed, or the coolant to be replaced.*

Note: *In case of emergency, you can add a large amount of water without coolant in order to reach a vehicle service location. Water alone, without coolant, can cause engine damage from corrosion, overheating or freezing. When you reach a service location, you must have the cooling system drained, flushed and refilled using the correct specification prediluted coolant or antifreeze concentrate. See **Capacities and Specifications** (page 288).*

Do not use the following as a coolant substitute:

- Alcohol.
- Methanol.

- Brine.
- Any coolant mixed with alcohol or methanol antifreeze.

Alcohol and other liquids can cause engine damage from overheating or freezing.

Do not add extra inhibitors or additives to the coolant. These can be harmful and compromise the corrosion protection of the coolant.

Recycled Coolant

We do not recommend the use of recycled coolant as an approved recycling process is not yet available.

Dispose of used engine coolant in an appropriate manner. Follow your community's regulations and standards for recycling and disposing of automotive fluids.

Severe Climates

If you drive in extremely cold climates:

- It may be necessary to increase the coolant concentration above 50%.
- A coolant concentration of 60% provides improved freeze point protection. Coolant concentrations above 60% decrease the overheat protection characteristics of the coolant and may cause engine damage.

If you drive in extremely hot climates:

- You can decrease the coolant concentration to 40%.
- Coolant concentrations below 40% decrease the freeze and corrosion protection characteristics of the coolant and may cause engine damage.

Vehicles driven year-round in non-extreme climates should use prediluted engine coolant for optimum cooling system and engine protection.

Maintenance

Coolant Change

Change the coolant at specific mileage intervals as listed in the scheduled maintenance information. The information display may display a message to change coolant at this time. Add prediluted coolant approved to the correct specification. See **Capacities and Specifications** (page 281).

Engine-driven Cooling Fan (Fan Clutch)

Your vehicle comes with an engine driven cooling fan drive, also called a fan clutch. This fan drive changes the fan speed to match the vehicle's changing cooling air flow requirements. Fan speed, fan noise level and fuel consumption all will increase based on the driving conditions that include trailer towing, hill climbing, heavy loads, high speed and high ambient temperature, individually or in combination.

The fan drive is designed to provide the minimum fan speed, and resulting minimum fan noise and fuel consumption required to meet the ever changing vehicle cooling air flow requirements. You will hear the amount of fan noise increasing and decreasing as the engine power requirements and vehicle driving conditions change as you drive. This is to be expected as being normal to the operation of your vehicle. High levels of fan noise might also be heard when your engine is first started, and should normally decrease after driving for a short time.

Fail-Safe Cooling

Fail-safe cooling allows you to temporarily drive your vehicle before any incremental component damage occurs. The fail-safe distance depends on ambient temperature, vehicle load and terrain.

How Fail-Safe Cooling Works

If the engine begins to overheat, the coolant temperature gauge moves toward the red zone:



A warning lamp illuminates and a message may appear in the information display.



If the engine reaches a preset over-temperature condition, the engine switches to alternating cylinder operation. Each disabled cylinder acts as an air pump and cools the engine.

When this occurs, your vehicle still operates, however:

- Engine power is limited.
- The air conditioning system turns off.

Continued operation increases the engine temperature, causing the engine to completely shut down. Your steering and braking effort increases in this situation.

When the engine temperature cools, you can re-start the engine. Have your vehicle checked as soon as possible to minimize engine damage.

When Fail-Safe Mode Is Activated



WARNING: Fail-safe mode is for use during emergencies only. Operate your vehicle in fail-safe mode only as long as necessary to bring your vehicle to rest in a safe location and seek immediate repairs. When in fail-safe mode, your vehicle will have limited power, will not be able to maintain

Maintenance

high-speed operation, and may completely shut down without warning, potentially losing engine power, power steering assist, and power brake assist, which may increase the possibility of a crash resulting in serious injury.



WARNING: Do not remove the coolant reservoir cap when the engine is on or the cooling system is hot. Wait 10 minutes for the cooling system to cool down. Cover the coolant reservoir cap with a thick cloth to prevent the possibility of scalding and slowly remove the cap. Failure to follow this instruction could result in personal injury.

Your vehicle has limited engine power when in the fail-safe mode, drive your vehicle with caution. Your vehicle does not maintain high-speed operation and the engine may operate poorly.

Remember that the engine is capable of shutting down to prevent engine damage. In this situation:

1. Pull off the road as soon as safely possible and switch the engine off.
2. If you are a member of a roadside assistance program, we recommend that you contact your roadside assistance service provider.
3. If this is not possible, wait a short period for the engine to cool.
4. Check the coolant level. If the coolant level is at or below the minimum mark, add prediluted coolant immediately.
5. When the engine temperature cools, you can re-start the engine. Have your vehicle checked as soon as possible to minimize engine damage.

Note: *Driving your vehicle without repair increases the chance of engine damage.*

Engine Coolant Temperature Management (If Equipped)



WARNING: To reduce the risk of crash and injury, be prepared that the vehicle speed may reduce and the vehicle may not be able to accelerate with full power until the coolant temperature reduces.

If you tow a trailer with your vehicle, the engine may temporarily reach a higher temperature during severe operating conditions, for example ascending a long or steep grade in high ambient temperatures.

At this time, you may notice the coolant temperature gauge moves toward the red zone and a message may appear in the information display.

You may notice a reduction in vehicle speed caused by reduced engine power in order to manage the engine coolant temperature. Your vehicle may enter this mode if certain high-temperature and high-load conditions take place. The amount of speed reduction depends on vehicle loading, grade and ambient temperature. If this occurs, there is no need to pull off the road. You can continue to drive your vehicle.

The air conditioning may turn on and off during severe operating conditions to protect the engine from overheating. When the coolant temperature decreases to the normal operating temperature, the air conditioning turns on.

If the coolant temperature gauge moves fully into the red zone, or if the coolant temperature warning or service engine soon messages appear in your information display, do the following:

Maintenance

1. Pull off the road as soon as safely possible and shift the transmission into park (P).
2. Leave the engine running until the coolant temperature gauge needle returns to the normal position. After several minutes, if the temperature does not drop, follow the remaining steps.
3. Switch the engine off and wait for it to cool. Check the coolant level.
4. If the coolant level is at or below the minimum mark, add prediluted coolant immediately.
5. If the coolant level is normal, restart the engine and continue.

ENGINE COOLANT CHECK - 6.7L DIESEL



WARNING: Do not remove the coolant reservoir cap when the cooling system is hot. Wait 10 minutes for the cooling system to cool down. Cover the coolant reservoir cap with a thick cloth to prevent the possibility of scalding and slowly remove the cap. Failure to follow this instruction could result in personal injury.



WARNING: Do not put coolant in the windshield washer reservoir. If sprayed on the windshield, coolant could make it difficult to see through the windshield.



WARNING: To reduce the risk of personal injury, make sure the engine is cool before unscrewing the coolant pressure relief cap. The cooling system is under pressure. Steam and hot liquid can come out forcefully when you loosen the cap slightly.



WARNING: Do not add coolant further than the **MAX** mark.

When the engine is cold, check the concentration and level of the coolant at the intervals listed in the scheduled maintenance information. See **Scheduled Maintenance** (page 319).

Note: Make sure that the coolant level is between the **MIN** and **MAX** marks on the coolant reservoir.

Note: Coolant expands when it is hot. The level may extend beyond the **MAX** mark.

Maintain coolant concentration within 48% to 50%, which equates to a freeze point between -30°F (-34°C) and -34°F (-37°C). Coolant concentration should be checked using a refractometer. We do not recommend the use of hydrometers or coolant test strips for measuring coolant concentration.

Adding Coolant



WARNING: Do not add engine coolant when the engine is hot. Failure to follow this instruction could result in personal injury.



WARNING: Do not remove the coolant reservoir cap when the cooling system is hot. Wait 10 minutes for the cooling system to cool down. Cover the coolant reservoir cap with a thick cloth to prevent the possibility of scalding and slowly remove the cap. Failure to follow this instruction could result in personal injury.

Note: Automotive fluids are not interchangeable. Do not use coolant or windshield washer fluid outside of its specified function and vehicle location.

Maintenance

Note: Do not use stop leak pellets, cooling system sealants, or non-specified additives as they can cause damage to the engine cooling or heating systems. Resulting component damage may not be covered by the vehicle Warranty.

It is very important to use prediluted coolant approved to the correct specification in order to avoid plugging the small passageways in the engine cooling system. See **Capacities and Specifications** (page 288). Do not mix different colors or types of coolant in your vehicle. Mixing of engine coolants or using an incorrect coolant may harm the engine or cooling system components and may not be covered by the vehicle Warranty.

Note: Coolants marketed for all makes and models may not be approved to Ford specifications and may cause damage to the cooling system. Resulting component damage may not be covered by the vehicle Warranty.

If the coolant level is at or below the minimum mark, add prediluted coolant immediately.

For vehicles with overflow coolant systems with a non-pressurized cap on the coolant recovery system, add coolant to the coolant recovery reservoir when the engine is cool. Add prediluted coolant to the maximum level. For all vehicles which have a coolant degas system with a pressurized cap, or if it is necessary to remove the coolant pressure relief cap on the radiator, follow these steps to add engine coolant:

1. Turn the engine off and let it cool.
2. Unscrew the cap slowly. Any pressure escapes as you unscrew the cap.
3. Fill the coolant reservoir slowly with prediluted engine coolant to within the minimum and maximum range on the engine coolant reservoir. If you removed the radiator cap in an overflow system, fill the radiator until

the coolant is visible and the radiator is almost full. If coolant is added to bring the level within the minimum and maximum range when the engine is not cold, the system may remain under filled.

4. Replace the coolant reservoir cap, turn it clockwise until you feel a strong resistance.
5. Check the coolant level in the coolant reservoir the next few times you drive your vehicle. If necessary, add enough prediluted engine coolant to bring the coolant level to the proper level.

Note: If prediluted coolant is not available, use the approved antifreeze concentrate diluting it to 50/50 with distilled water. See **Capacities and Specifications** (page 288). Using water that has not been deionized may contribute to deposit formation, corrosion or plugging of the small cooling system passageways.

If you have to add more than 1.1 qt (1 L) of engine coolant per month, have your vehicle checked as soon as possible. Operating an engine with a low level of coolant can result in engine overheating and possible engine damage.

Note: During normal vehicle operation, the coolant may change color from orange to pink or light red. As long as the coolant is clear and uncontaminated, this color change does not indicate the coolant has degraded nor does it require the coolant to be drained, the system to be flushed, or the coolant to be replaced.

In case of emergency, you can add a large amount of water without prediluted coolant in order to reach a vehicle service location. On arrival do the following:

1. Drain the cooling system.
2. Chemically clean the cooling system. We recommend Motorcraft Premium Cooling System Flush.

Maintenance

3. Refill with prediluted coolant as soon as possible.

Water alone, without prediluted coolant, can cause engine damage from corrosion, overheating or freezing.

Do not use the following as a coolant substitute:

- Alcohol.
- Methanol.
- Brine.
- Any coolant mixed with alcohol or methanol antifreeze.

Alcohol and other liquids can cause engine damage from overheating or freezing.

Do not add extra inhibitors or non-specified additives to the coolant. These can be harmful and compromise the corrosion protection of the coolant.

Engine and Secondary Cooling System Refill Procedure

The following procedure should be used when refilling the engine or secondary cooling systems after it has been drained or become extremely low:

1. Before you remove the cap, turn the engine off and let it cool.
2. When the engine is cool, wrap a thick cloth around the cap. Slowly turn cap counterclockwise until pressure begins to release.
3. Step back when the pressure releases.
4. When you are sure that all the pressure has been released, use the cloth to turn the cap counterclockwise and then remove it.
5. Slowly add prediluted engine coolant to the coolant reservoir until the coolant level is within the minimum and maximum range as listed on the reservoir.
6. Reinstall the pressure relief cap.

7. Start and run the engine at 2000 rpm for 2 minutes.
8. Shut engine off, and remove the pressure relief cap as previously outlined.
9. If required, add prediluted engine coolant to the coolant reservoir until the coolant level is within the minimum and maximum range as listed on the reservoir.
10. Engine cooling system: Repeat steps 5 through 9 until the coolant level has stabilized (is no longer dropping after each step) and the upper radiator hose at the radiator is warm to the touch (indicating that the engine thermostat is open and coolant is flowing through the radiator).
11. Check the secondary cooling system. Repeat steps 1 through 10 until the coolant level has stabilized (is no longer dropping after each step) and the lower passenger side of the secondary radiator is warm to the touch (indicating secondary thermostat is open and coolant is flowing through the entire system).
12. Check the coolant level in both systems before you drive your vehicle the next few times.
13. If necessary, add prediluted engine coolant to the coolant reservoirs until the coolant level is within the minimum and maximum range as listed on the reservoir. After any coolant has been added, check the coolant concentration.

Recycled Coolant

We do not recommend the use of recycled coolant as an approved recycling process is not yet available.

Maintenance

Dispose of used engine coolant in an appropriate manner. Follow your community's regulations and standards for recycling and disposing of automotive fluids.

Three products are available to confirm the life and health of the coolant, one tool, a test kit and a coolant inhibitor additive:

Severe Climates

If you drive in extremely cold climates:

- It may be necessary to increase the coolant concentration above 50%.
- A coolant concentration of 60% provides improved freeze point protection. Coolant concentrations above 60% decrease the overheat protection characteristics of the coolant and may cause engine damage.

If you drive in extremely hot climates:

- You can decrease the coolant concentration to 40%.
- Coolant concentrations below 40% decrease the freeze and corrosion protection characteristics of the coolant and may cause engine damage.

Vehicles driven year-round in non-extreme climates should use prediluted engine coolant for optimum cooling system and engine protection.

Checking Coolant Corrosion Inhibitor Additive Strength

At specific mileage intervals as listed in the scheduled maintenance information chapter, the coolant corrosion inhibitor additive should be checked. An information message may display in the optional information display at this time. The purpose of checking is to verify the correct engine coolant concentration (freeze point protection) and corrosion inhibitor additive level (strength) of the coolant for maximum engine performance and protection.

Maintenance

- **Robinair® Coolant and Battery Refractometer 75240** – Recommended refractometer to test coolant concentration. (Rotunda tool part number: ROB75240).
- **Rotunda 328-R071-ELC (Antifreeze Coolant ELC Contamination Kit)** – Evaluates the corrosion inhibitor additive strength.
 - The first step is once the coolant concentration is verified to be in the range of 40 – 60%. Test the corrosion inhibitor additive strength. If the test results show the cooling system does not have excessive contamination and the corrosion inhibitor additive strength is sufficient then no further action is required. If the test results for the Engine Coolant Circuit show the cooling system has excessive contamination or the corrosion inhibitor additive strength is not sufficient then add 47 fl oz (1.4 L) of Motorcraft Specialty Orange Engine Coolant Revitalizer. If the test results for the Secondary Coolant Circuit show the cooling system has excessive contamination or the corrosion inhibitor additive strength is not sufficient then add 16 fl oz (0.47 L) of Motorcraft Specialty Orange Engine Coolant Revitalizer.
- **Motorcraft Specialty Orange Engine Coolant Revitalizer** – Additive to boost the corrosion inhibitor level based upon the test results of the Antifreeze Coolant ELC Contamination Kit. The Revitalizer may be added two times over the life of the coolant. If additional dosages are required, the cooling system must be flushed and refilled per the instructions in the Workshop Manual.

Make sure to follow the proper coolant and additive specifications. See **Capacities and Specifications** (page 281).

Coolant Change

At specific mileage intervals, as listed in the scheduled maintenance information, the coolant should be changed. The information display may display a message to change coolant at this time. Add prediluted coolant approved to the correct specification. See **Capacities and Specifications** (page 281).

Engine-driven Cooling Fan (Fan Clutch)

Your vehicle may have an engine driven cooling fan drive (also called a fan clutch). This fan drive changes the fan speed to match the vehicle's changing cooling air flow requirements. Fan speed, fan noise level and fuel consumption all will increase based on the driving conditions that include trailer towing, hill climbing, heavy loads, high speed and high ambient temperature, individually or in combination.

The fan drive is designed to provide the minimum fan speed (and resulting minimum fan noise and fuel consumption) required to meet the ever changing vehicle cooling air flow requirements. You will hear the amount of fan noise increasing and decreasing as the engine power requirements and vehicle driving conditions change as you drive. This is to be expected as being normal to the operation of your vehicle. High levels of fan noise might also be heard when your engine is first started, and should normally decrease after driving for a short time.

Maintenance

AUTOMATIC TRANSMISSION FLUID CHECK

The transmission does not consume fluid. However, check the fluid level if the transmission is not working properly, for example if the transmission slips, shifts slowly or if there are signs of fluid loss.

Replace the transmission fluid and filter on your vehicle at the specified service interval. See **Scheduled Maintenance** (page 319).

Automatic transmission fluid expands when warmed. To check the fluid level consistently and accurately, do the following:

1. Drive the vehicle until it reaches normal operating temperature. This may take up to 20 mi (30 km). Make sure that the transmission fluid temperature gauge on the instrument cluster is within normal operating temperature 196–215°F (91–102°C) before checking.
2. Make sure that your vehicle is on level ground.
3. With the engine running, parking brake engaged and your foot on the brake pedal, move the gearshift lever through all of the gear ranges. Allow sufficient time for each gear to engage.
4. Make sure the parking brake is on. Make sure the transmission is in park (P) or neutral (N) and leave the engine running.
5. Open the hood. See **Opening and Closing the Hood** (page 213).
6. Remove the dipstick and wipe it with a clean, lint-free cloth. See **Under Hood Overview** (page 215).
7. Replace the dipstick and remove it again to check the fluid level.

8. If the fluid level is correct, replace the dipstick and make sure it is fully seated.

Note: *If the fluid level is between the maximum and minimum marks, the fluid level is acceptable. Do not add fluid.*

Transmission Fluid Level

Low Fluid Level



E163740

If the fluid level is at or below the minimum mark, add fluid immediately. See **Capacities and Specifications** (page 288).

Note: *If there is no indication of fluid on the dipstick, have your vehicle checked immediately.*

Correct Fluid Level

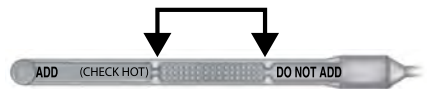

E163742

Make sure that the fluid level is between the maximum and minimum marks.

Maintenance

High Fluid Level



E163744

Do not add fluid further than the maximum mark. Fluid levels above the maximum mark could cause shift or engagement concerns and possible damage.

Note: *An overheating condition can cause high fluid levels.*

Adding Transmission Fluid

Do not use supplemental transmission fluid additives, treatments or cleaning agents. The use of these materials could affect transmission operation and result in damage to internal transmission components and could lead to transmission damage that the vehicle Warranty does not cover.

Use only recommended transmission fluid that meets our specifications. See **Capacities and Specifications** (page 288).

Note: *Use of a non-approved automatic transmission fluid could cause internal transmission component damage.*

If necessary, add fluid in 8 fl oz (250 ml) increments through the filler tube until the level is correct.

If an overfill occurs, remove excess fluid and have your vehicle checked as soon as possible.

BRAKE FLUID CHECK

 **WARNING:** Do not use any fluid other than the recommended brake fluid as this will reduce brake efficiency. Use of incorrect fluid could result in the loss of vehicle control, serious personal injury or death.

 **WARNING:** Only use brake fluid from a sealed container. Contamination with dirt, water, petroleum products or other materials may result in brake system damage or failure. Failure to adhere to this warning could result in the loss of vehicle control, serious personal injury or death.

 **WARNING:** Do not allow the fluid to touch your skin or eyes. If this happens, rinse the affected areas immediately with plenty of water and contact your physician.

 **WARNING:** The brake system could be affected if the brake fluid level is below the **MIN** mark or above the **MAX** mark on the brake fluid reservoir.

Maintenance

For detailed interval information, see Scheduled Maintenance in your Owner's Manual or your local maintenance guide.

POWER STEERING FLUID CHECK

Check the power steering fluid. See **Scheduled Maintenance** (page 319). If adding fluid is necessary, use only MERCON LV ATF

Check the fluid level when it is at ambient temperature.

1. Check the fluid level in the reservoir. It should be between the MIN and MAX range. Do not add fluid if the level is within this range.
2. If the fluid level is low, add fluid to bring the fluid level up to between the MIN and MAX range.
3. Switch the engine on.
4. While the engine idles, turn the steering wheel left and right several times.
5. Switch the engine off.
6. Recheck the fluid level in the reservoir. Do not add fluid if the level is between the MIN and MAX range.
7. If the fluid is low, add the proper type of fluid in small amounts, continuously checking the level until it is between the MIN and MAX range. See **Capacities and Specifications** (page 288). Be sure to put the cap back on the reservoir.



E170684

1. Park your vehicle on a level surface.
2. Look at the brake fluid reservoir to see where the brake fluid level is relative to the **MIN** and the **MAX** marks on the reservoir.

Note: If the brake fluid level is between the **MIN** and the **MAX** marks on the reservoir, it is acceptable.

Note: If the brake fluid level is below the **MIN** mark or above the **MAX** mark, have your vehicle checked as soon as possible.

Note: To avoid fluid contamination, the reservoir cap must remain in place and fully tight, unless you are adding fluid.

Only use fluid that meets our specifications. See **Capacities and Specifications** (page 281).

Brake Fluid Service Interval

Brake fluid absorbs water over time which degrades the effectiveness of the brake fluid. Change the brake fluid at the specified intervals to prevent degraded braking performance.

Maintenance

CHANGING THE 12V BATTERY



WARNING: This vehicle may be equipped with more than one battery, removal of cable from only one battery does not disconnect the vehicle electrical system. Be sure to disconnect cables from all batteries when disconnecting power. Failure to do so may cause serious personal injury or property damage.



WARNING: Batteries normally produce explosive gases which can cause personal injury. Therefore, do not allow flames, sparks or lighted substances to come near the battery. When working near the battery, always shield your face and protect your eyes. Always provide proper ventilation.



WARNING: When lifting a plastic-cased battery, excessive pressure on the end walls could cause acid to flow through the vent caps, resulting in personal injury and damage to the vehicle or battery. Lift the battery with a battery carrier or with your hands on opposite corners.



WARNING: Keep batteries out of reach of children. Batteries contain sulfuric acid. Avoid contact with skin, eyes or clothing. Shield your eyes when working near the battery to protect against possible splashing of acid solution. In case of acid contact with skin or eyes, flush immediately with water for a minimum of 15 minutes and get prompt medical attention. If acid is swallowed, call a physician immediately.

Note: *If your battery has a cover/shield, make sure it is reinstalled after the battery has been cleaned or replaced.*

Note: *Battery posts, terminals and related accessories contain lead and lead compounds. Wash hands after handling.*

Note: *Electrical or electronic accessories or components added to the vehicle by the dealer or the owner may adversely affect battery performance and durability.*

Your vehicle is equipped with a Motorcraft maintenance-free battery which normally does not require additional water during its life of service.

For longer, trouble-free operation, keep the top of the battery clean and dry. Also, make certain the battery cables are always tightly fastened to the battery terminals.

If you see any corrosion on the battery or terminals, remove the cables from the terminals and clean with a wire brush. You can neutralize the acid with a solution of baking soda and water.

It is recommended that the negative battery cable terminal be disconnected from the battery if you plan to store your vehicle for an extended period of time.

Because your vehicle's engine is electronically controlled by a computer, some control conditions are maintained by power from the battery. When the battery is disconnected or a new battery is installed, the engine must relearn its idle and fuel trim strategy for optimum driveability and performance. To begin this process

1. With the vehicle at a complete stop, set the parking brake.
2. Put the gearshift in park (P) or neutral (N) and turn off all accessories.
3. Start the engine. Run the engine until it reaches normal operating temperature.
4. Allow the engine to idle for at least one minute.

Maintenance

5. Turn the air conditioning (if equipped) on and allow the engine to idle for at least one minute.
6. Release the parking brake. With your foot on the brake pedal and with the air conditioning on, put the vehicle in drive (D) and allow the engine to idle for at least one minute.
 - If you do not allow the engine to relearn its idle trim, the idle quality of your vehicle may be adversely affected until the idle trim is eventually relearned.
7. Drive the vehicle to complete the relearning process
 - The vehicle may need to be driven 10 mi (16 km) or more to relearn the idle and fuel trim strategy along with the ethanol content for flexible fuel vehicles.

If the battery has been disconnected or a new battery has been installed, the clock and radio settings must be reset once the battery is reconnected.

Always dispose of automotive batteries in a responsible manner. Follow your local authorized standards for disposal. Call your local authorized recycling center to find out more about recycling automotive batteries.

Battery Management System (If Equipped)

The battery management system (BMS) monitors battery conditions and takes actions to extend battery life. If excessive battery drain is detected, the system may temporarily disable certain electrical features to protect the battery. Those electrical accessories affected include the rear defrost, heated/cooled seats, climate control fan, heated steering wheel, audio and navigation system. A message may be shown in the information displays to alert

the driver that battery protection actions are active. These messages are only for notification that an action is taking place, and not intended to indicate an electrical problem or that the battery requires replacement.

Electrical accessory installation

To ensure proper operation of the BMS, any electrical devices that are added to the vehicle should not have their ground connection made directly at the negative battery post. A connection at the negative battery post can cause inaccurate measurements of the battery condition and potential incorrect system operation.

Note: *Electrical or electronic accessories added to the vehicle by the dealer or the owner may adversely affect battery performance and durability, and may also affect the performance of other electrical systems in the vehicle.*

When a battery replacement is required, the battery should only be replaced with a Ford recommended replacement battery which matches the electrical requirements of the vehicle. After battery replacement, or in some cases after charging the battery with the external charger, the BMS requires eight hours of vehicle sleep time (key off with doors closed) to relearn the new battery state of charge. Prior to relearning the state of charge, the BMS may disable electrical features (to protect the battery) earlier than normal.

ADJUSTING THE HEADLAMPS

Vertical Aim Adjustment

The headlamps on your vehicle are properly aimed at the assembly plant. If your vehicle has been in an accident, the alignment of your headlamps should be checked by your authorized dealer.

Maintenance

Headlamp Aiming Target

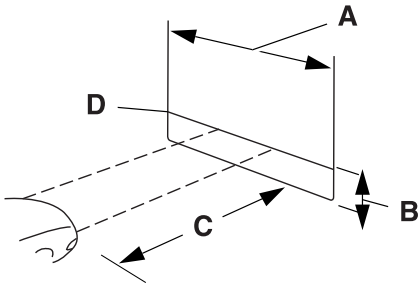

- A 8 feet (2.4 meters)
- B Center height of lamp to ground
- C 25 feet (7.6 meters)
- D Horizontal reference line



E142465

4. On the wall or screen you will observe a flat zone of high intensity light located at the top of the right hand portion of the beam pattern. If the top edge of the high intensity light zone is not at the horizontal reference line, the headlamp will need to be adjusted.

Vertical Aim Adjustment Procedure

1. Park the vehicle directly in front of a wall or screen on a level surface, approximately 25 ft (7.6 m) away.
2. Measure the height of the headlamp bulb center from the ground and mark an 8 ft (2.4 m) horizontal reference line on the vertical wall or screen at this height.

Note: To see a clearer light pattern for adjusting, you may want to block the light from one headlamp while adjusting the other.

3. Turn on the low beam headlamps to illuminate the wall or screen and open the hood.



5. Locate the vertical adjuster on each headlamp. Using a Phillips #2 screwdriver, turn the adjuster either clockwise or counterclockwise in order to adjust the vertical aim of the headlamp.
6. Repeat Steps 3 thru 5 to adjust the other headlamp.
7. Close the hood and turn off the lamps.

Horizontal Aim Adjustment

Horizontal aim is not required for this vehicle and is not adjustable.

Maintenance

WASHER FLUID CHECK



WARNING: If you operate your vehicle in temperatures below 40°F (5°C), use washer fluid with antifreeze protection. Failure to use washer fluid with antifreeze protection in cold weather could result in impaired windshield vision and increase the risk of injury or accident.

Add fluid to fill the reservoir if the level is low. Only use a washer fluid that meets Ford specifications. See **Capacities and Specifications** (page 281).

State or local regulations on volatile organic compounds may restrict the use of methanol, a common windshield washer antifreeze additive. Washer fluids containing non-methanol antifreeze agents should be used only if they provide cold weather protection without damaging the vehicle's paint finish, wiper blades or washer system.

FUEL FILTER - 7.3L

Your vehicle is equipped with a lifetime fuel filter that is integrated with the fuel tank. Regular maintenance or replacement is not needed.

CHECKING THE WIPER BLADES



E142463

Run the tip of your fingers over the edge of the blade to check for roughness.

Clean the wiper blades with washer fluid or water applied with a soft sponge or cloth.

CHANGING THE WIPER BLADES

You can manually move the wiper arms when the ignition is off. This allows for ease of blade replacement and cleaning under the blades.



E165804

1. Pull the wiper blade and arm away from the glass.

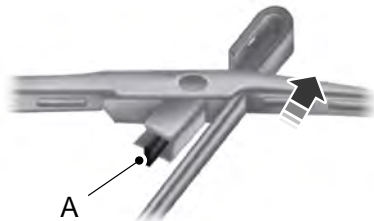

E165794

2. Release the wiper blade lock (A) and separate the wiper blade from the wiper arm.
3. Install in the reverse order.

Maintenance

Note: Make sure that the wiper blade locks into place. Lower the wiper arm and blade back on the windshield. The wiper arms will automatically return to their normal position when you turn the ignition on.

- Replace wiper blades at least once per year for optimum performance.
- You can improve poor wiper quality by cleaning the wiper blades and the windshield.

REMOVING A HEADLAMP



E163822

1. Remove the four bolts from the headlamp assembly.
2. Pull the assembly straight out disengaging one snap clip from the fender.
3. Disconnect the electrical connector by squeezing the release tab and pushing the connector forward, then pulling it rearward.

CHANGING A BULB



WARNING: Bulbs can become hot. Let the bulb cool down before removing it. Failure to do so could result in personal injury.

Headlamp bulbs must be marked with an authorized D.O.T. marking for North America to make sure they have the proper lamp performance, light brightness, light pattern and safe visibility.

Install in the reverse order unless otherwise stated.

Headlamp Bulbs

1. Switch all of the lamps and the ignition off.
2. Remove the headlamp. See **Removing a Headlamp** (page 243).
3. Release the clip and remove the bulb.

Note: Do not touch the bulb glass.

Note: If the bulb is accidentally touched, it should be cleaned with rubbing alcohol before being used.

Front Clearance and Identification Lamp (If Equipped)



E163825

1. Switch all of the lamps and the ignition off.
2. Remove the screw and lens from the lamp assembly.
3. Press the bulb in and turn the bulb counterclockwise to remove it.

Maintenance

Brake Lamp, Rear Lamp, Rear Direction Indicator, License Plate Lamp and Reverse Lamp



E163828

1. Switch all of the lamps and the ignition off.
2. Remove the four screws and the lamp lens from lamp assembly.
3. Remove the bulb by pulling it straight out.

CHANGING THE ENGINE-MOUNTED AND DIESEL FUEL CONDITIONER MODULE FUEL FILTERS - 6.7L DIESEL



WARNING: Do not dispose of fuel in the household refuse or the public sewage system. Use an authorized waste disposal facility.

Your vehicle has two fuel filters. The first filter mounts on top of the engine on the left-hand side. The second filter is inside the diesel fuel conditioner module. The module is mounted between the inboard side of the fuel tank and the frame rail.

Regular fuel filter changes are an important part of engine maintenance; failing to keep with the scheduled maintenance could lead to engine performance issues and fuel injection system damage. See **Scheduled Maintenance** (page 319).

Use only recommended service parts conforming to specifications. See **Motorcraft Parts** (page 283).

Note: Using fuel that has high levels of impurities may require more frequent filter replacements than the service interval specifies.

Diesel Fuel Conditioner Module Filter

Removal

1. Access the underside of your vehicle.

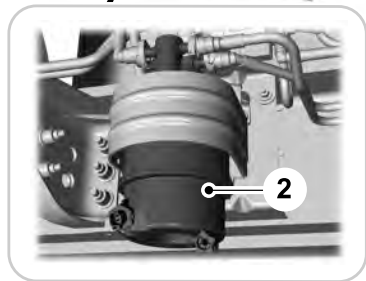
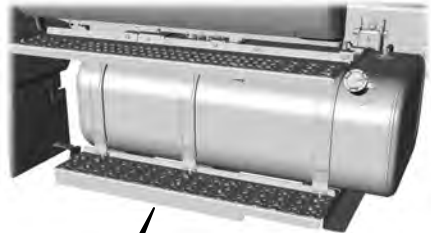

E250852

2. The diesel fuel conditioner module is on the left-hand frame rail.

Maintenance

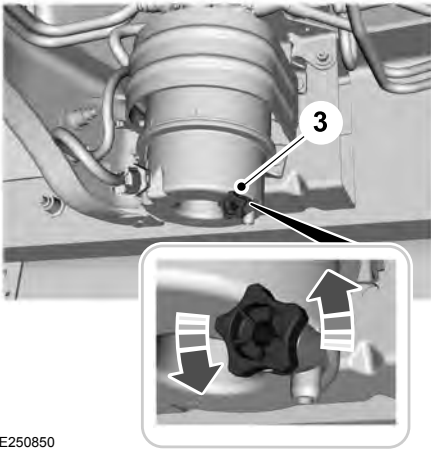

E250850

3. Drain the diesel fuel conditioner module. Turn the drain plug counterclockwise until it stops. Do not use any tools to loosen the drain plug. Drain the filter, approximately 0.5 gal (2 L), into an appropriate container. Do not re-use the fuel drained from the module.

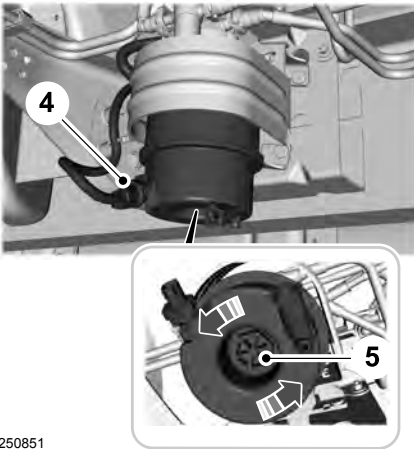

E250851

4. Disconnect the electrical connector.
5. Fully loosen the lower portion of the diesel fuel conditioner module housing using the nut cast into the lower portion.

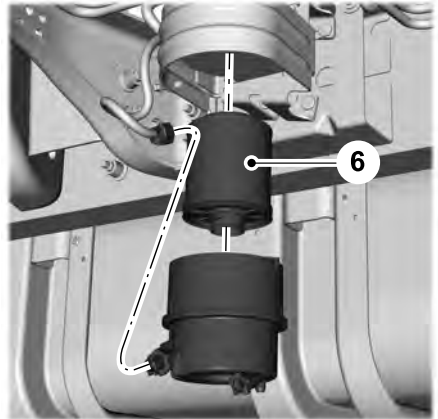

E250849

6. Remove the lower portion of the diesel fuel conditioner module housing and the diesel fuel conditioner module filter.

Installation

1. Install a new filter in the bowl and press until it snaps on the bottom.

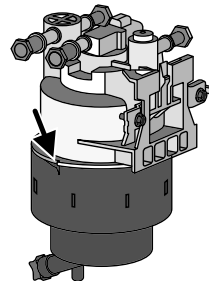

E163362

Maintenance

2. Install the lower portion of the housing on the top portion. Tighten by hand until you feel a strong resistance. Continue to tighten with a 32mm socket wrench until the mechanical stop on the bottom meets the top.
3. Connect the electrical connector.
4. Tighten the drain plug, turn it clockwise until it stops and you feel a strong resistance. Do not use any tools to tighten the drain plug.
5. Switch the ignition on for 30 seconds and then switch the ignition off. Repeat this operation six times in a row to purge any trapped air from the fuel system.

Engine-mounted Fuel Filter

Although the fuel system is not fully pressurized when the vehicle is off, some residual pressure may remain in the fuel system since it can take some time for the pressure to completely bleed off. Therefore, we recommend you place an absorbent cloth below the filter connectors to absorb any fuel that may drain.

The engine-mounted fuel filter is a plastic disposable cartridge.

Removal

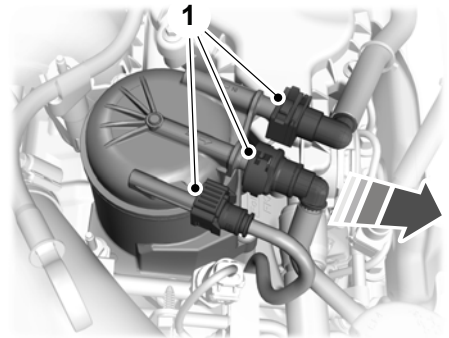

E226215

1. Disconnect the fuel lines by squeezing the connector tabs and pulling the lines straight off.

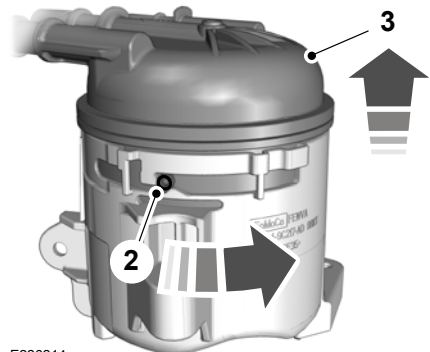

E226214

2. Rotate the filter fully counterclockwise until the peg is at the far end of the slot.
3. Pull the filter straight up from the bracket and discard the filter.

Installation

1. Install the new filter into the filter bracket. Turn the filter clockwise to lock it in place.

Maintenance

2. Reconnect the fuel lines.
3. Switch the ignition on for 30 seconds and then switch the ignition off. Repeat this operation six times in a row to purge any trapped air from the fuel system.

ELECTRICAL SYSTEM INSPECTION

Periodically inspect electrical connectors on the outside of the cab and on the engine and frame for corrosion and tightness. Exposed terminals, such as the fuel sender, cranking motor, alternator and feed-through studs, should be cleaned and re-coated with a lubricant sealing grease such as Motorcraft Silicone Brake Caliper Grease and Dielectric Compound XG-3, or equivalent. This should include the ground cable connector for batteries, engine and cab as well as the jump-starting stud.

Accessory Feed Connections

Vehicle electrical systems are complex and often include powertrain components, such as engine and transmission controls, instrument panels and ABS. While most systems operate on battery voltage (12 volts), some systems can be as high as 90 volts or as low as five volts. See the Electrical Circuit Diagram Manuals, available from your vehicle's manufacturer, to make sure that any extra body lights and accessory connections to circuits are both appropriate and not overloaded. Do not make modifications to any vehicle control system without first contacting an authorized dealer.

AIR INDUCTION SYSTEM INSPECTION



WARNING: When performing maintenance to any turbocharged engine with engine air inlet piping disconnected, keep loose clothing, jewelry and long hair away from the engine air inlet piping. A turbocharger compressor air inlet protective shield should be installed over the turbocharger air inlet to reduce the risk of personal injury or death.

Perform a complete inspection of the air induction system annually.

In areas where road salt is used, disassemble the joints of each aluminum component and inspect for salt build-up and presence of chlorine that can cause aluminum particles to flake off and enter the engine combustion chambers. If evidence of corrosion is found (usually at the pipe connections), use a wire brush to clean the inside of the pipes and inside the rubber hoses.

If pitting is evident at the joint ends of the intake pipes, use Motorcraft Silicone Gasket and Sealant TA-30 to seal the joints. Make sure no excess material, which can pull into the engine, is on the inside of the pipes. If the service condition of the pipes, hoses or clamps is questionable, replace the defective part(s).

Make sure to clean all dust and debris out of the pipes and couplings with a clean, damp rag before reassembly.

Chassis-mounted Charge Air Cooler

Visually inspect the core assembly for debris and clogging of external fins with the engine off.

Maintenance

Before engine operation, remove any debris blocking the core.

- Turbocharger-to-charge air cooler.
- Charge air cooler-to-intake manifold pipe.
- Mounting bracket.
- Chassis-mounted charge air cooler core.

Inspect air intake piping:

- Check for accumulation of salt deposits (where applicable). If present, disassemble and clean the complete air intake piping system. If pitting is evident on the intake piping, use Motorcraft Silicone Gasket and Sealant TA-30 to seal joints against leakage.
- Check for loose hoses and clamps.
- Check for ruptured or collapsed hoses.
- Check air cleaner housing for cracks.

EXHAUST SYSTEM INSPECTION

Note: *If your vehicle is equipped with a catalytic converter or muffler, do not blend waste oil with diesel fuel. Operate only on ultra-low sulfur (less than 15 parts per million sulfur) diesel fuel with a cetane value of 45 or higher.*

If your diesel engine is equipped with a catalytic converter, it is important to review the maintenance schedule to make sure proper functioning of the catalytic converter. Also, take precautions not to damage the catalytic converter when servicing your engine or storing your vehicle.

BRAKE SYSTEM INSPECTION



WARNING: Always wear a respirator approved by the National Institute of Occupational Studies of Health (NIOSH) or Mine Safety and Appliance (MSA) during all brake service procedures. Wear the respirator from removal of the wheels through assembly. Never use compressed air or dry brushing to clean brake parts or assemblies. Clean brake parts and assemblies in open air. During assembly, carefully place all parts on the floor to avoid getting dust in the air. Use an industrial vacuum cleaner with a HEPA filter system to clean dust from the brake drums, backing plates and other brake parts. After using the vacuum, remove any remaining dust with a rag soaked in water and wrung until nearly dry. Never use compressed air or dry sweeping to clean the work area. Use an industrial vacuum cleaner with a HEPA filter system and rags soaked in water and wrung until nearly dry. Dispose of used rags with care to avoid getting dust in the air. Use an approved respirator when emptying vacuum cleaners and handling used rags. Worker clean-up: Wash your hands before eating, drinking or smoking. Vacuum your work clothes after use and then launder them separately, without shaking them, to prevent fiber dust getting into the air.

Your vehicle is equipped with non-asbestos brake linings. However, exposure to excessive amounts of brake material (whether asbestos or non-asbestos, fiberglass, mineral wool, aramid or carbon) may be a serious health hazard.

Maintenance

Air Brakes



WARNING: Do not manually adjust the automatic slack adjusters to correct excessive push rod stroke as it may result in reduced brake effectiveness and a vehicle crash. Excessive push rod stroke indicates that a problem exists with the automatic adjuster, with the installation of the adjuster, or with foundation brake components that manual adjustment does not remedy. Seek service from a qualified facility for excessive push rod stroke.

Inspection and Adjustment

Establish a regular schedule for periodic cleaning, lubrication and adjustment inspection based on vehicle use. Exact maintenance intervals are difficult to predetermine due to vehicle applications and operating conditions. If you are uncertain of the proper schedule for your vehicle, contact an authorized dealer.

Regular inspections should include:

- Periodic checking (every service interval) of push rod travel or brake adjustment. This is essential for effective braking. Brake chamber push rods on original equipment chambers now incorporate an orange paint marker near the base of the push rod

as a stroke indicator to aid in adjustment checks. If the push rod is clean and the brakes are out of adjustment, you can see the orange marker protruding from the chamber when the brakes are applied.

- Checking the brake lining (every service interval). When brake linings or blocks wear within 0.063 in (1.6 mm) they must be replaced.
- Periodic checking (every service interval) of the air compressor filter. Check the filter minder and when the indicator is near or on the red line marked **Service**, replace the filter and reset the service filter minder.

Do not back off or disconnect the front brakes so that they are less effective, letting the rear brakes do all the stopping of your vehicle. Do not overlook the brakes on the trailer either. Brake condition on the trailer is just as important as the tractor. Proper brake balance on trucks and tractor-trailers is essential for effective braking.

Once a year, inspect the entire brake system:

- Rubber components for deterioration. A qualified technician should inspect these components and replace them as necessary. Replacement intervals vary according to the severity and length of vehicle service.
- Condition of brake drums, brake chambers and slack adjusters.
- System for air leaks.
- Hose or pipes for rust, damage and deterioration.
- Operation of service and parking brakes.

Periodically inspect parts such as air brake chamber diaphragm, air compressor and air cleaner. Replace any parts if you can consider them unserviceable.

Maintenance

Air Dryer

Climactic conditions affect performance of desiccant or after-cooler type air dryers. You must establish a maintenance schedule for each specific operation.

The use of an air dryer on a vehicle does not eliminate the need to drain the air reservoirs periodically.

Inspect for moisture in the air system by opening reservoirs, draincocks or valves and checking for presence of water. The presence of small amounts of water due to condensation is normal and is not an indication that the dryer is not functioning properly.

Replace or rebuild the desiccant cartridge when you determine that the desiccant is contaminated and does not have adequate water absorption capacity. The desiccant change interval may vary. A general recommendation is to replace the desiccant every 12 months (yearly). If experience has shown that extended or shortened life has resulted for a particular installation, then the yearly interval can be increased or decreased accordingly.

Draining the Air Brake Reservoir



WARNING: Failure to drain air brake reservoirs can result in a reduction or loss of braking ability due to fluid accumulation in the reservoir and/or possible freeze-up during cold weather.

Completely drain all the air brake reservoirs daily by opening the draincock at the ends of the tanks. (Where accessible.

Pull-chains are used when the drains are undercab or otherwise inaccessible.) Close the draincock after draining. Manually drain

any air tanks equipped with automatic moisture ejector valves, as required, to maintain a dry air system. Contact an authorized dealer if you are unsure of the air reservoir locations or the draining procedure.

Hydraulic Brakes

Establish a regular schedule for periodic cleaning, lubrication and adjustment inspection based on vehicle use. Exact maintenance intervals are difficult to predetermine due to vehicle applications and operating conditions. If you are uncertain of the proper schedule for your vehicle, contact an authorized dealer.

Regular inspections should include:

- Checking the brake lining (every service interval). Establish inspection intervals that provide for lining replacement before damage to the disc occurs. Excessive lining wear may expose the backing plate to the disc causing scoring of the disc faces. A qualified technician should perform this

Maintenance

inspection and keep to instructions provided by the service manual. Hydraulic brake systems are power-assisted. There is a great reduction in braking capabilities without engine assist.

- Proper fluid level. The level should be at the bottom edge of the ring on each reservoir fill port. Do not fill the master cylinder to the top of the reservoir. If fluid level requires attention to maintain a proper master cylinder level, this is an indication of either severe operation (pad wear) or fluid leakage. A more frequent and thorough brake inspection is required.
- Brake lines, hoses and fittings. Repair or replace brake line tubes, hoses or fittings as required. Inspect these components every 4,000 mi (6,000 km) for the following.
 - Lines for kinks, dents, corrosion or rupture.
 - Hoses for abrasions, kinks, soft spots or rupture, collapse, cracks, twists or loose frame supports. When replacing a hose, be sure there is adequate clearance to the hose to avoid an abrasion to the new hose.
 - All connections for leaks.

Driveline Parking Brake



WARNING: Use wheel chocks and exercise caution when inspecting under the vehicle. A vehicle roll-away could result in property damage, personal injury or death.

A qualified technician should adjust the parking brake and keep to the instructions in the service manual.

AXLE INSPECTION

Front Axle

Maintaining the front axle alignment to specifications is very important. A qualified technician should check and maintain the alignment.

Regular inspections should include:

- Toe-in inspection and adjustment (if necessary), particularly with radial tires.
- Checking for proper tightness of axle mounting U-bolt nuts, attaching or mounting bolts and nuts.
- Checking the axle for damage, binding, worn parts and adequate lubrication.
- Checking the kingpins for excessive wear. Also, perform this check during other scheduled maintenance, for example as tire rotation or service, wheel bearing service and alignment. See the workshop manual for proper procedures.

Toe-in

It is essential to maintain correct toe-in and tire pressure for optimum tire wear.

Inspecting steer axle tires in the first 3,000–10,000 mi (5,000–16,000 km) generally shows if tires are wearing normally.

Rapid outside shoulder wear on both tires indicates too much toe-in.

Rapid inside shoulder wear on both tires indicates too much toe-out.

In P&D-type service, there can be a left-to-right steer tire tread life differential up to 40% depending on routes and other variables.

Maintenance

Follow the tire manufacturer's recommended cold inflation pressure for the tire size, load range (ply rating) and steer axle loading typical for their operation (each steer axle tire equals ½ steer axle loading).

Special applications may warrant a setting based on experience with the type of tire operating loads and conditions. Radial tires are more sensitive to toe-in setting than bias ply tires. Fine tuning school bus alignment to line-haul truck standards does not drastically improve tire tread life.

STEERING SYSTEM INSPECTION



WARNING: Failure to maintain the steering system in proper condition can cause reduced steering ability resulting in property damage, personal injury or death.

Note: *Have any steering problems immediately corrected by a qualified service technician.*

Ask your service technician to examine the steering mechanism. Only minor adjustments may be necessary.

Regular inspections should include:

- Checking the tie rod, drag link end clamp bolts and ball joints for proper tightness.
- Checking for installation and spread of cotter pins and tightness of nuts at both ends of the tie rod and drag link.
- Checking that the pitman arm (steering arm at steering gear) mounting is tight and locked. Check system for leaks or hose chafing. Repair immediately, if necessary.

- Maintaining proper steering gear and power steering pump lubricant levels.
- Checking steering column joint bolts and steering linkage, particularly for body-to-chassis clearance.

Steering Column Joint Bolts

As a good maintenance practice, check steering column joint bolt tightness every 60,000 mi (96,000 km) or annually, whichever occurs first. Do not overtighten the bolts.

Hydraulic System

Whenever draining and refilling the power steering's hydraulic system for any reason, bleed air from the system before returning the vehicle to service. Failure to bleed the hydraulic system properly can result in degradation of power system performance.

Consult an authorized dealer who is aware of the proper procedures for filling and bleeding the system.

SUSPENSION SYSTEM INSPECTION

Note: *Do not adjust air suspension height to any setting other than the specified setting. Altering the height setting changes the driveline angle and may result in unwarrantable component damage, such as transmission component damage.*

Verify drive axle air suspension height and height control valve performance at engine oil change intervals.

Periodically check:

- Condition of spring leaves for evidence of fatigue, bending or breakage.
- Condition of suspension mounting brackets and bushings.
- Torque rod mounting fasteners for tightness.

Maintenance

- For proper suspension alignment. Maintain proper alignment at all times.
 - U-bolts. After the chassis has been operating under load for 1,000 mi (1,600 km) or six months (whichever comes first), the U-bolt nuts must be re-torqued. Re-torque the U-bolt nuts every 37,000 mi (60,000 km) thereafter. Clean and lubricate the U-bolt and nut threads and seats to make sure a like new condition when re-torquing. See **Spring U-Bolt Check** (page 253).
2. Set the parking brake and shift into position neutral (N) or park (P). Turn the engine off.
 3. Clean any dirt from around the axle filler plug.
 4. Remove the filler plug and inspect the lubricant level. It should be at the bottom of the filler plug opening.
 5. Add lubricant, if necessary, through the filler plug opening.
 6. Clean and install the filler plug securely.

FRAME AND TOW HOOK INSPECTION

Your vehicle's chassis is manufactured with frame rails of either HSLA steel or heat-treated steel. Handle each in a specific manner to make sure maximum service life. Consult the service manual or an authorized dealer before attempting frame repair or modification.

It is important, particularly on vehicles that use tow hooks frequently, to inspect the front and rear tow hooks for damage or a loose mounting.

REAR AXLE FLUID CHECK

Your rear axle may have an optional synthetic lubricant that allows the use of extended service intervals. A tag on the filler plug identifies the use of the synthetic lubricant.

Only use a lubricant that meets manufacturer specifications. Use of a non-approved rear axle lubricant may cause internal axle component damage. See **Capacities and Specifications** (page 288).

Checking the Fluid Level

1. Park your vehicle on level ground.

Changing the Fluid

Note: *Drain the rear axle while the lubricant is warm.*

1. Park your vehicle on level ground.
2. Set the parking brake and shift into position neutral (N) or park (P). Turn the engine off.
3. Clean any dirt from around the axle filler and drain plugs.
4. Remove the filler and drain plugs. Drain the lubricant into a suitable container. Dispose of all used automotive fluids in a responsible manner following your local authorized standards.
5. Clean and install the drain plug securely.
6. Add lubricant through the filler plug opening.
7. Clean and install the filler plug securely.

SPRING U-BOLT CHECK

Check and tighten the U-bolt nuts after your vehicle has been operated under load for 1,000 mi (1,600 km) or six months, whichever occurs first.

Check and tighten the U-bolt nuts every 37,000 mi (60,000 km).

Check and tighten the U-bolt nuts with your vehicle at curb height and unloaded.

Maintenance

Inspect the U-bolt threads for rust and debris. Clean the threads if contaminated.

U-bolt Nut Torque

Front Axle

Note: Check and tighten the U-bolt nuts evenly using a criss-cross pattern in the following stages.

Stage	lb.ft (Nm)
1.	40 (60)
2.	90 (125)
3.	170 (225)
4.	240 (325)

Rear Axle

Note: Check and tighten the U-bolt nuts evenly using a criss-cross pattern in the following stages.

Stage	lb.ft (Nm)
1.	60 (75)
2.	90 (125)
3.	170 (225)
4.	240 (325)
5.	320 (440)

Vehicle Care

GENERAL INFORMATION

Your dealer has many quality products available to clean your vehicle and protect its finishes.

CLEANING PRODUCTS

Materials

For best results, use the following products or products of equivalent quality:

For additional information and assistance, we recommend that you contact an authorized dealer.

Name	Specification
Motorcraft® Bug and Tar Remover, ZC-42 (U.S. & Canada)	
Motorcraft® Custom Bright Metal Cleaner, ZC-15 (U.S. & Canada)	ESR-M5B194-B
Motorcraft® Detail Wash, ZC-3-A (U.S. & Canada)	ESR-M14P4-A
Motorcraft® Engine Shampoo and Degreaser, ZC-20 (U.S.)	ESR-M14P3-A
Motorcraft® Engine Shampoo, CXC-66-A (Canada)	
Motorcraft® Premium Leather and Vinyl Cleaner, ZC-56 (U.S. & Canada)	
Motorcraft® Multi-Purpose Cleaner, CXC-101 (Canada)	
Motorcraft® Premium Windshield Wash Concentrate with Bitterant, ZC-32-B2 (U.S.)	WSS-M14P19-A
Motorcraft® Premium Quality Windshield Washer Fluid, CXC-37-A/B/D/F (Canada)	WSS-M14P19-A
Motorcraft® Professional Strength Carpet & Upholstery Cleaner, ZC-54 (U.S. & Canada)	
Motorcraft® Premium Glass Cleaner, CXC-100 (Canada)	ESR-M14P5-A
Motorcraft® Spot and Stain Remover, ZC-14 (U.S.)	
Motorcraft® Ultra-Clear Spray Glass Cleaner, ZC-23 (U.S.)	ESR-M14P5-A
Motorcraft® Wheel and Tire Cleaner, ZC-37-A (U.S. & Canada)	

Vehicle Care

CLEANING THE EXTERIOR

Wash your vehicle regularly with cool or lukewarm water and a neutral pH shampoo, we recommend Motorcraft Detail Wash.

- Never use strong household detergents or soap, for example dish washing or laundry liquid. These products can discolor and spot painted surfaces.
- Never wash your vehicle when it is hot to the touch, or during strong or direct sunlight.
- Dry your vehicle with a chamois or soft terry cloth towel to eliminate water spotting.
- Immediately remove fuel spillages, bird droppings, insect deposits and road tar. These may cause damage to your vehicle's paintwork or trim over time. We recommend Motorcraft Bug and Tar Remover.
- Remove any exterior accessories, for example antennas, before entering a car wash.
- When filling with AdBlue®, remove any residue on painted surfaces immediately.

Note: *Suntan lotions and insect repellents can damage painted surfaces. If these substances come in contact with your vehicle, wash the affected area as soon as possible.*

Cleaning the Headlamps

Note: *Do not scrape the headlamp lenses or use abrasives, alcoholic solvents or chemical solvents to clean them.*

Note: *Do not wipe the headlamps when they are dry.*

Exterior Chrome Parts

- Apply a high quality-cleaning product to bumpers and other chrome parts. Follow the manufacturer's instructions. We recommend Motorcraft Custom Bright Metal Cleaner.
- Do not apply the cleaning product to hot surfaces. Do not leave the cleaning product on chrome surfaces longer than the time recommended.
- Using non-recommended cleaners can result in severe and permanent cosmetic damage.

Note: *Never use abrasive materials, for example steel wool or plastic pads as they can scratch the chrome surface.*

Note: *Do not use chrome cleaner, metal cleaner or polish on wheels or wheel covers.*

Exterior Plastic Parts

For routine cleaning we recommend Motorcraft Detail Wash. If tar or grease spots are present, we recommend Motorcraft Bug and Tar Remover.

Stripes or Graphics (If Equipped)

Hand washing your vehicle is preferred however, pressure washing may be used under the following conditions:

- Do not use water pressure higher than 2,000 psi (14,000 kPa).
- Do not use water hotter than 179°F (82°C).
- Use a spray with a 40° wide spray angle pattern.
- Keep the nozzle at a 12 in (305 mm) distance and 90° angle to your vehicle's surface.

Note: *Holding the pressure washer nozzle at an angle to the vehicle's surface may damage graphics and cause the edges to peel away from the vehicle's surface.*

Vehicle Care

Underbody

Regularly clean the underside of your vehicle using water. Keep body and door drain holes free of debris or foreign material.

Under Hood

For removing black rubber marks from under the hood we recommend Motorcraft Wheel and Tire Cleaner or Motorcraft Bug and Tar Remover.

WAXING

Regular waxing is necessary to protect your car's paint from the elements. We recommend that you wash and wax the painted surface once or twice a year.

When washing and waxing, park your vehicle in a shaded area out of direct sunlight. Always wash your vehicle before applying wax.

- Use a quality wax that does not contain abrasives.
- Follow the manufacturer's instructions to apply and remove the wax.
- Apply a small amount of wax in a back-and-forth motion, not in circles.
- Do not allow wax to come in contact with any non-body (low-gloss black) colored trim. The wax will discolor or stain the parts over time.
 - Roof racks.
 - Bumpers.
 - Grained door handles.
 - Side moldings.
 - Mirror housings.
 - Windshield cowl area.
- Do not apply wax to glass areas.
- After waxing, your car's paint should feel smooth, and be free of streaks and smudges.

CLEANING THE ENGINE

Use a vacuum cleaner to remove debris from the screen area below the windshield.

Note: *If you are not familiar with the parts around the engine, do not wash the engine compartment. Avoid frequent engine washes.*

When washing the engine compartment:

- Never wash or rinse the engine while it is hot or running.
- Never wash or rinse any ignition coil, spark plug wire or spark plug well.
- Cover the battery, power distribution box, and air filter assembly to prevent water damage.

Note: *If your vehicle has an engine cover, remove the cover before application of shampoo and degreaser.*

- Spray an approved engine shampoo and degreaser on all parts that require cleaning and rinse with water.

CLEANING THE WINDOWS AND WIPER BLADES

Car wash chemicals and environmental fallout can result in windshield and wiper blade contamination. Dirty windshield and wipers will result in poor windshield wiper operation. Keep the windshield and wiper blades clean to maintain windshield wiper performance.

Vehicle Care

To clean the windshield and wiper blades:

- Clean the windshield with a non-abrasive glass cleaner. When cleaning the interior of the windshield, avoid getting any glass cleaner on the instrument panel or door panels. Wipe any glass cleaner off these surfaces immediately.
- For windshields contaminated with tree sap, chemicals, wax or bugs, clean the entire windshield using steel wool (no greater than 0000 grade) in a circular motion and rinse with water.
- Clean the wiper blades with isopropyl rubbing alcohol or windshield washer concentrate.

Note: Do not use razor blades or other sharp objects to clean or remove decals from the inside of the heated rear window. The vehicle warranty does not cover damage caused to the heated rear window grid lines.

CLEANING THE INTERIOR



WARNING: Do not use cleaning solvents, bleach or dye on the vehicle's seatbelts, as these actions may weaken the belt webbing.



WARNING: On vehicles equipped with seat-mounted airbags, do not use chemical solvents or strong detergents. Such products could contaminate the side airbag system and affect performance of the side airbag in a crash.

For fabric, carpets, cloth seats and seats equipped with side airbags:

- Remove dust and loose dirt with a vacuum cleaner.
- Remove light stains and soil with Motorcraft Professional Strength Carpet & Upholstery Cleaner.

- If grease or tar is present on the material, spot-clean the area first with Motorcraft Spot and Stain Remover. In Canada, use Motorcraft Multi-Purpose Cleaner.
- If a ring forms on the fabric after spot cleaning, clean the entire area immediately (but do not oversaturate) or the ring will set.
- Do not use household cleaning products or glass cleaners, which can stain and discolor the fabric and affect the flame retardant abilities of the seat materials.

Mirrors

Do not clean the housing or glass of any mirror with harsh abrasives, fuel or other petroleum or ammonia-based cleaning products.

CLEANING THE INSTRUMENT PANEL AND INSTRUMENT CLUSTER LENS



WARNING: Do not use chemical solvents or strong detergents when cleaning the steering wheel or instrument panel to avoid contamination of the airbag system.

Note: Follow the same procedure as cleaning leather seats for cleaning leather instrument panels and leather interior trim surfaces.

Clean the instrument panel and cluster lens with a clean, damp and soft cloth, then use a clean, dry and soft cloth to dry these areas.

Vehicle Care

- Avoid cleaners or polishes that increase the gloss of the upper portion of the instrument panel. The dull finish in this area helps protect you from undesirable windshield reflection.
 - Do not use any household cleaning products or glass cleaners as these may damage the finish of the instrument panel, interior trim and cluster lens.
 - Wash or wipe your hands clean if you have been in contact with certain products such as insect repellent and suntan lotion to avoid possible damage to the interior painted surfaces.
 - Do not allow air fresheners and hand sanitizers to spill onto interior surfaces. If a spill occurs, wipe off immediately. Your warranty may not cover these damages.
6. Dry the area with a clean, soft cloth.

REPAIRING MINOR PAINT DAMAGE

Authorized dealers have touch-up paint to match your vehicle's color. Your vehicle color code is printed on a sticker on the front, left-hand side door jamb. Take your color code to your authorized dealer to make sure you get the correct color.

Before repairing minor paint damage, use a cleaner such as Motorcraft Bug and Tar Remover to remove particles such as bird droppings, tree sap, insect deposits, tar spots, road salt and industrial fallout.

Read the instructions before using cleaning products.

CLEANING THE WHEELS

1. Regularly clean them with a wheel cleaner. We recommend that you use Ford approved wheel cleaner if available.
2. Remove dirt and brake dust with a sponge.
3. Remove tar and grease with a bug and tar remover. We recommend that you use Ford approved bug and tar remover if available.
4. Thoroughly rinse the wheels with water after cleaning.

If you intend on parking your vehicle for an extended period after cleaning the wheels with a wheel cleaner, drive your vehicle for a few minutes before doing so. This reduces the risk of corrosion of the brake discs, brake pads and linings.

Do not clean the wheels when they are hot.

Note: *Some car washes could damage wheel rims and covers.*

If a staining liquid like coffee or juice has been spilled on the instrument panel or on interior trim surfaces:

1. Wipe up spilled liquid using a clean, soft cloth as quickly as possible.
2. Use Motorcraft Premium Leather and Vinyl Cleaner or a commercially available leather cleaning product for automotive interiors. Test any cleaner or stain remover on an inconspicuous area.
3. Alternatively, wipe the surface with a clean, soft cloth and a mild soap and water solution. Dry the area with a clean, soft cloth.
4. If necessary, apply more soap and water solution or cleaning product to a clean, soft cloth and press it onto the soiled area. Allow this to set at room temperature for 30 minutes.
5. Remove the soaked cloth, then with a clean, damp cloth, use a rubbing motion for 60 seconds on the soiled area.

Vehicle Care

Note: *Using non-recommended cleaners, harsh cleaning products, chrome wheel cleaners or abrasive materials could damage wheel rims and covers.*

VEHICLE STORAGE

If you plan on storing your vehicle for 30 days or more, read the following maintenance recommendations to make sure your vehicle stays in good operating condition.

We engineer and test all motor vehicles and their components for reliable, regular driving. Under various conditions, long-term storage may lead to degraded engine performance or failure unless you use specific precautions to preserve engine components.

General

- Store all vehicles in a dry, ventilated place.
- Protect from sunlight, if possible.
- If vehicles are stored outside, they require regular maintenance to protect against rust and damage.

Body

- Wash your vehicle thoroughly to remove dirt, grease, oil, tar or mud from exterior surfaces, rear-wheel housing and the underside of front fenders.
- Periodically wash your vehicle if it is stored in exposed locations.
- Touch-up exposed or primed metal to prevent rust.
- Cover chrome and stainless steel parts with a thick coat of auto wax to prevent discoloration. Re-wax as necessary when you wash your vehicle.
- Lubricate all hood, door and luggage compartment hinges and latches with a light grade oil.

- Cover interior trim to prevent fading.
- Keep all rubber parts free from oil and solvents.

Engine

- Change the engine oil and filter prior to storage because used engine oil contains contaminants which may cause engine damage.
- Start the engine every 15 days for a minimum of 15 minutes. Run at fast idle with the climate controls set to defrost until the engine reaches normal operating temperature.
- With your foot on the brake, shift through all the gears while the engine is running.
- We recommend that you change the engine oil before you use your vehicle again.

Fuel system

- Fill the fuel tank with high-quality fuel until the first automatic shutoff of the fuel pump nozzle.

Cooling system

- Protect against freezing temperatures.
- When removing your vehicle from storage, check coolant fluid level. Confirm that there are no cooling system leaks and that fluid is at the recommended level.

Disconnecting Your 12 Volt Battery

- Check and recharge as necessary. Keep connections clean.
- If storing your vehicle for more than 30 days without recharging the battery, we recommend that you disconnect the battery cables to maintain battery charge for quick starting.

Vehicle Care

Note: *It is necessary to reset memory features if you disconnect the battery cables.*

Brakes

- Make sure the brakes and parking brake release fully.

Tires

- Maintain recommended air pressure.

Miscellaneous

- Make sure all linkages, cables, levers and pins under your vehicle are covered with grease to prevent rust.
- Move vehicles at least 25 ft (7.5 m) every 15 days to lubricate working parts and prevent corrosion.

Removing Vehicle From Storage

When your vehicle is ready to come out of storage, do the following:

- Wash your vehicle to remove any dirt or grease film build-up on window surfaces.
- Check windshield wipers for any deterioration.
- Check under the hood for any foreign material that may have collected during storage such as mice or squirrel nests.
- Check the exhaust for any foreign material that may have collected during storage.
- Check tire pressures and set tire inflation per the Tire Label.
- Check brake pedal operation. Drive your vehicle 15 ft (4.5 m) back and forth to remove rust build-up.

- Check fluid levels (including coolant, oil and gas) to make sure there are no leaks, and fluids are at recommended levels.
- If you remove the battery, clean the battery cable ends and check for damage.

Contact an authorized dealer if you have any concerns or issues.

Wheels and Tires

TIRE CARE

Glossary of Tire Terminology

***Tire label:** A label showing the original equipment tire sizes, recommended inflation pressure and the maximum weight the vehicle can carry.

***Tire Identification Number:** A number on the sidewall of each tire providing information about the tire brand and manufacturing plant, tire size and date of manufacture. Also referred to as DOT code.

***Inflation pressure:** A measure of the amount of air in a tire.

***Standard load:** A class of P-metric or Metric tires designed to carry a maximum load at set pressure. For example: For P-metric tires 35 psi (241 kPa) and for Metric tires 36 psi (248 kPa). Increasing the inflation pressure beyond this pressure does not increase the tire's load carrying capability.

***Extra load:** A class of P-metric or Metric tires designed to carry a heavier maximum load at 42 psi (290 kPa). Increasing the inflation pressure beyond this pressure does not increase the tire's load carrying capability.

***kPa:** Kilopascal, a metric unit of air pressure.

***PSI:** Pounds per square inch, a standard unit of air pressure.

***Cold tire pressure:** The tire pressure when the vehicle has been stationary and out of direct sunlight for an hour or more and prior to the vehicle being driven for 1 mi (1.6 km).

***Recommended inflation pressure:** The cold inflation pressure is found on the Safety Compliance Certification Label, located in the driver's door jam.

***Bead area of the tire:** Area of the tire next to the rim.

***Sidewall of the tire:** Area between the bead area and the tread.

***Tread area of the tire:** Area of the perimeter of the tire that contacts the road when mounted on the vehicle.

***Rim:** The metal support (wheel) for a tire or a tire and tube assembly upon which the tire beads are seated.

Information Contained on the Tire Sidewall

Both United States and Canada Federal regulations require tire manufacturers to place standardized information on the sidewall of all tires. This information identifies and describes the fundamental characteristics of the tire and also provides a U.S. DOT Tire Identification Number for safety standard certification and in case of a recall.

Wheels and Tires

Information on P Type Tires

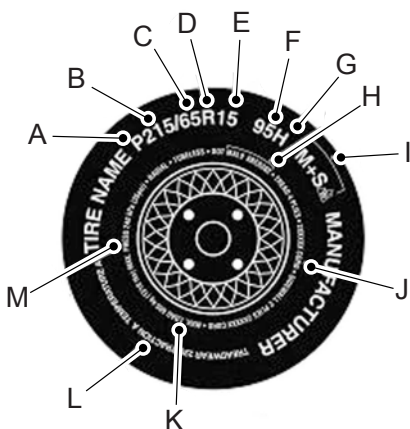

E142543

P215/65R15 95H is an example of a tire size, load index and speed rating. The definitions of these items are listed below. (Note that the tire size, load index and speed rating for your vehicle may be different from this example.)

A. P: Indicates a tire, designated by the Tire and Rim Association, that may be used for service on cars, sport utility vehicles, minivans and light trucks. **Note:** If your tire size does not begin with a letter this may mean it is designated by either the European Tire and Rim Technical Organization or the Japan Tire Manufacturing Association.

B. 215: Indicates the nominal width of the tire in millimeters from sidewall edge to sidewall edge. In general, the larger the number, the wider the tire.

C. 65: Indicates the aspect ratio which gives the tire's ratio of height to width.

D. R: Indicates a radial type tire.

E. 15: Indicates the wheel or rim diameter in inches. If you change your wheel size, you have to purchase new tires to match the new wheel diameter.

F. 95: Indicates the tire's load index. It is an index that relates to how much weight a tire can carry.

Note: You may not find this information on all tires because it is not required by federal law.

G. H: Indicates the tire's speed rating. The speed rating denotes the speed at which a tire is designed to be driven for extended periods of time under a standard condition of load and inflation pressure. The tires on your vehicle may operate at different conditions for load and inflation pressure. These speed ratings may need to be adjusted for the difference in conditions. The ratings range from 81–186 mph (130–299 km/h). These ratings are listed in the following chart.

Note: You may not find this information on all tires because it is not required by federal law.

Wheels and Tires

Letter Rating	Speed Rating
L	75 mph (120 km/h)
M	81 mph (130 km/h)
N	87 mph (140 km/h)
Q	99 mph (159 km/h)
R	106 mph (171 km/h)
S	112 mph (180 km/h)
T	118 mph (190 km/h)
U	124 mph (200 km/h)
H	130 mph (210 km/h)
V	149 mph (240 km/h)
W	168 mph (270 km/h)
Y	186 mph (299 km/h)

Note: For tires with a maximum speed capability over 149 mph (240 km/h), tire manufacturers sometimes use the letters ZR. For those with a maximum speed capability over 186 mph (299 km/h), tire manufacturers always use the letters ZR.

H. U.S. DOT Tire Identification Number: This begins with the letters DOT and indicates that the tire meets all federal standards. The next two numbers or letters are the plant code designating where it was manufactured, the next two are the tire size code and the last four numbers represent

the week and year the tire was built. For example, the numbers 317 mean the 31st week of 1997. After 2000 the numbers go to four digits. For example, 2501 means the 25th week of 2001. The numbers in between are identification codes used for traceability. This information is used to contact customers if a tire defect requires a recall.

I. M+S or M/S: Mud and Snow, or

AT: All Terrain, or

AS: All Season.

J. Tire Ply Composition and Material Used: Indicates the number of plies or the number of layers of rubber-coated fabric in the tire tread and sidewall. Tire manufacturers also must indicate the ply materials in the tire and the sidewall, which include steel, nylon, polyester, and others.

K. Maximum Load: Indicates the maximum load in kilograms and pounds that can be carried by the tire.

L. Treadwear, Traction and Temperature Grades:

***Treadwear** The treadwear grade is a comparative rating based on the wear rate of the tire when tested under controlled conditions on a specified government test course. For example, a tire graded 150 would wear 1½ times as well on the government course as a tire graded 100.

Wheels and Tires

***Traction:** The traction grades, from highest to lowest are AA, A, B, and C. The grades represent the tire's ability to stop on wet pavement as measured under controlled conditions on specified government test surfaces of asphalt and concrete. A tire marked C may have poor traction performance.

***Temperature:** The temperature grades are A (the highest), B and C, representing the tire's resistance to the generation of heat and its ability to dissipate heat when tested under controlled conditions on a specified indoor laboratory test wheel.

M. Maximum Inflation

Pressure: Indicates the tire manufacturers' maximum permissible pressure or the pressure at which the maximum load can be carried by the tire. This pressure is normally higher than the vehicle manufacturer's recommended cold inflation pressure which can be found on the Safety Compliance Certification Label. The cold inflation pressure should never be set lower than the recommended pressure on the vehicle label.

The tire suppliers may have additional markings, notes or warnings such as standard load or radial tubeless.

Additional Information Contained on the Tire Sidewall for LT Type Tires

Note: *Tire Quality Grades do not apply to this type of tire.*

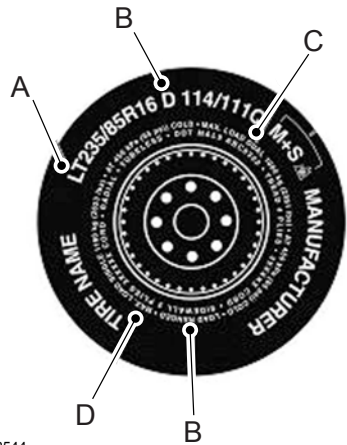

E142544

LT type tires have some additional information beyond those of P type tires; these differences are described below.

A. LT: Indicates a tire, designated by the Tire and Rim Association, that is intended for service on light trucks.

B. Load Range and Load Inflation Limits: Indicates the tire's load-carrying capabilities and its inflation limits.

Wheels and Tires

C. Maximum Load Dual lb (kg) at psi (kPa) cold: Indicates the maximum load and tire pressure when the tire is used as a dual; defined as four tires on the rear axle (a total of six or more tires on the vehicle).

D. Maximum Load Single lb (kg) at psi (kPa) cold: Indicates the maximum load and tire pressure when the tire is used as a single; defined as two tires (total) on the rear axle.

Information on T Type Tires

T145/80D16 is an example of a tire size.

Note: *The temporary tire size for your vehicle may be different from this example. Tire Quality Grades do not apply to this type of tire.*



E142545

T type tires have some additional information beyond those of P type tires; these differences are described below:

A. T: Indicates a type of tire, designated by the Tire and Rim Association, that is intended for temporary service on cars, sport utility vehicles, minivans and light trucks.

B. 145: Indicates the nominal width of the tire in millimeters from sidewall edge to sidewall edge. In general, the larger the number, the wider the tire.

Wheels and Tires

C. 80: Indicates the aspect ratio which gives the tire's ratio of height to width. Numbers of 70 or lower indicate a short sidewall.

D. D: Indicates a diagonal type tire.

R: Indicates a radial type tire.

E. 16: Indicates the wheel or rim diameter in inches. If you change your wheel size, you have to purchase new tires to match the new wheel diameter.

Inflating Your Tires

Safe operation of your vehicle requires that your tires are properly inflated. Remember that a tire can lose up to half of its air pressure without appearing flat.

Every day before you drive, check your tires. If one looks lower than the others, use a tire gauge to check pressure of all tires and adjust if required.

At least once a month and before long trips, inspect each tire and check the tire pressure with a tire gauge (including spare, if equipped). Inflate all tires to the inflation pressure recommended by Ford Motor Company.

You are strongly urged to buy a reliable tire pressure gauge, as automatic service station gauges may be inaccurate. Ford recommends the use of a digital or dial-type tire pressure gauge rather than a stick-type tire pressure gauge.

Use the recommended cold inflation pressure for optimum tire performance and wear. Under-inflation or over-inflation may cause uneven treadwear patterns



WARNING: Under-inflation is the most common cause of tire failures and may result in severe tire cracking, tread separation or blowout, with unexpected loss of vehicle control and increased risk of injury. Under-inflation increases sidewall flexing and rolling resistance, resulting in heat buildup and internal damage to the tire. It also may result in unnecessary tire stress, irregular wear, loss of vehicle control and accidents. A tire can lose up to half of its air pressure and not appear to be flat!

Always inflate your tires to the Ford recommended inflation pressure even if it is less than the maximum inflation pressure information found on the tire. The Ford recommended tire inflation pressure is found on the Safety Compliance Certification Label or Tire Label. Failure to follow the tire pressure recommendations can cause uneven treadwear patterns and adversely affect the way your vehicle handles.

Wheels and Tires

Maximum Inflation Pressure is the tire manufacturer's maximum permissible pressure and the pressure at which the maximum load can be carried by the tire. This pressure is normally higher than the manufacturer's recommended cold inflation pressure which can be found on the Safety Compliance Certification Label or Tire Label. The cold inflation pressure should never be set lower than the recommended pressure on the Safety Compliance Certification Label or Tire Label.

When weather temperature changes occur, tire inflation pressures also change. A 10°F (6°C) temperature drop can cause a corresponding drop of 1 psi (7 kPa) in inflation pressure. Check your tire pressures frequently and adjust them to the proper pressure which can be found on the Safety Compliance Certification Label or Tire Label.

To check the pressure in your tire(s):

1. Make sure the tires are cool, meaning they are not hot from driving even a mile.

Note: *If you are checking tire pressure when the tire is hot, for example, driven more than 1 mi (1.6 km), never bleed or reduce air pressure. The tires are hot from driving and it is normal for pressures to increase above recommended cold pressures. A hot tire at or below recommended cold inflation pressure could be significantly under-inflated.*

Note: *If you have to drive a distance to get air for your tire(s), check and record the tire pressure first and add the appropriate air pressure when you get to the pump. It is normal for tires to heat up and the air pressure inside to go up as you drive.*

2. Remove the cap from the valve on one tire, then firmly press the tire gauge onto the valve and measure the pressure.
3. Add enough air to reach the recommended air pressure.

Note: *If you overfill the tire, release air by pressing on the metal stem in the center of the valve. Then recheck the pressure with your tire gauge.*

4. Replace the valve cap.
5. Repeat this procedure for each tire, including the spare.

Wheels and Tires

Note: *Some spare tires operate at a higher inflation pressure than the other tires. For T type mini-spare tires, see the Dissimilar spare wheel and tire assembly information for a description. Store and maintain at 60 psi (412 kPa). For full-size and dissimilar spare tires, see the Dissimilar spare wheel and tire assembly information for a description. Store and maintain at the higher of the front and rear inflation pressure as shown on the Safety Compliance Certification Label or Tire Label.*

6. Visually inspect the tires to make sure there are no nails or other objects embedded that could poke a hole in the tire and cause an air leak.
7. Check the sidewalls to make sure there are no gouges, cuts or bulges.

Tire Inflation Information



WARNING: An inflated tire and rim can be very dangerous if improperly used, serviced or maintained. To reduce the risk of serious injury, never attempt to re-inflate a tire which has

been run flat or seriously under-inflated without first removing the tire from the wheel assembly for inspection. Do not attempt to add air to tires or replace tires or wheels without first taking precautions to protect persons and property.

All tires with Steel Carcass Plies (if equipped):

This type of tire utilizes steel cords in the sidewalls. As such, they cannot be treated like normal light truck tires. Tire service, including adjusting tire pressure, must be performed by personnel trained, supervised and equipped according to Federal Occupational Safety and Health Administration regulations. For example, during any procedure involving tire inflation, the technician or individual must utilize a remote inflation device, and ensure that all persons are clear of the trajectory area.

Wheels and Tires

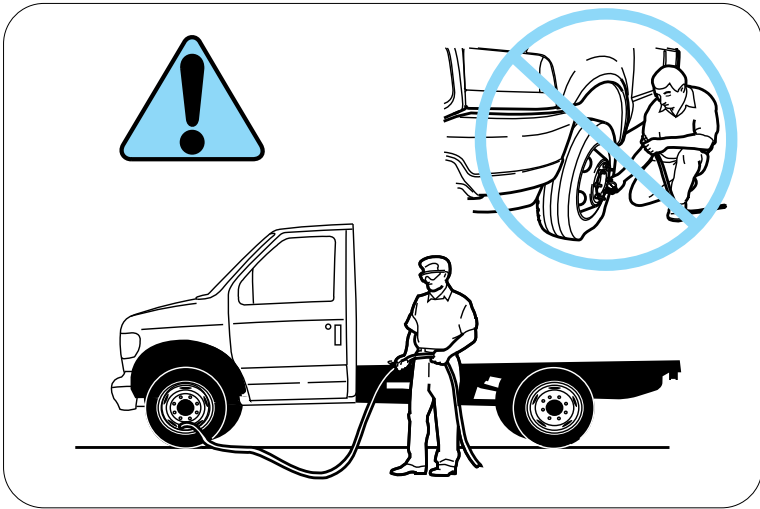

E161437

Wheels and Tires

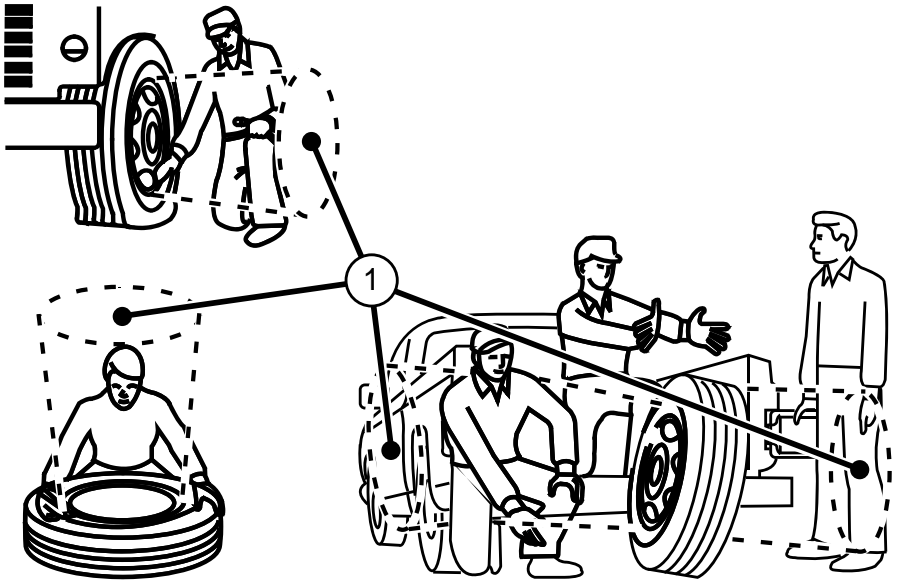

E161438

1 Stay out of trajectory

Inspecting Your Tires and Wheel Valve Stems

Periodically inspect the tire treads for uneven or excessive wear and remove objects such as stones, nails or glass that may be wedged in the tread grooves. Check the tire and valve stems for holes, cracks, or cuts that may permit air leakage and repair or replace the tire and replace the valve stem. Inspect the tire sidewalls for cracking, cuts, bruises and other signs of damage or excessive

wear. If internal damage to the tire is suspected, have the tire demounted and inspected in case it needs to be repaired or replaced. For your safety, tires that are damaged or show signs of excessive wear should not be used because they are more likely to blow out or fail.

Wheels and Tires

Improper or inadequate vehicle maintenance can cause tires to wear abnormally. Inspect all your tires, including the spare, frequently, and replace them if one or more of the following conditions exist:

Tire Wear

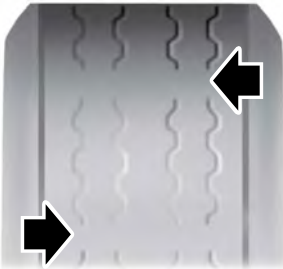

E142546

When the tread is worn down to one sixteenth of an inch (2 millimeters), tires must be replaced to help prevent your vehicle from skidding and hydroplaning. Built-in treadwear indicators, or wear bars, which look like narrow strips of smooth rubber across the tread appears on the tire when the tread is worn down to one sixteenth of an inch (2 millimeters).

When the tire tread wears down to the same height as these wear bars, the tire is worn out and must be replaced.

Damage

Periodically inspect the tire treads and sidewalls for damage, such as bulges in the tread or sidewalls, cracks in the tread groove and separation in the tread or sidewall. If damage is observed or suspected have the tire inspected by a tire professional. Tires can be damaged during off-road use, so inspection after off-road use is also recommended.

Age



WARNING: Tires degrade over time depending on many factors such as weather, storage conditions, and conditions of use (load, speed, inflation pressure) the tires experience throughout their lives.



WARNING: In general, tires should be replaced after six years regardless of tread wear. However, heat caused by hot climates or frequent high loading conditions can accelerate the aging process and may require tires to be replaced more frequently.



WARNING: You should replace your spare tire when you replace the road tires or after six years due to aging even if it has not been used.

Wheels and Tires

U.S. DOT Tire Identification Number

Both United States and Canada Federal regulations require tire manufacturers to place standardized information on the sidewall of all tires. This information identifies and describes the fundamental characteristics of the tire and also provides a U.S. DOT Tire Identification Number for safety standard certification and in case of a recall.

This begins with the letters DOT and indicates that the tire meets all federal standards. The next two numbers or letters are the plant code designating where it was manufactured, the next two are the tire size code and the last four numbers represent the week and year the tire was built. For example, the numbers 317 mean the 31st week of 1997. After 2000 the numbers go to four digits. For example, 2501 means the 25th week of 2001. The numbers in between are identification codes used for traceability. This information is used to contact customers if a tire defect requires a recall.

Tire Replacement Requirements

Your vehicle is equipped with tires designed to provide a safe ride and handling capability.



WARNING: Only use replacement tires and wheels that are the same size, load index, speed rating and type (such as P-metric versus LT-metric or all-season versus all-terrain) as those originally provided by Ford. The recommended tire and wheel size may be found on either the Safety Compliance Certification Label (affixed to either the door hinge pillar, door-latch post, or the door edge that meets the door-latch post, next to the driver's seating position), or the Tire Label which is located on the B-Pillar or edge of the driver's door. If this information is not found on these labels, then you should contact your authorized dealer as soon as possible. Use of any tire or wheel not recommended by Ford can affect the safety and performance of your vehicle, which could result in an increased risk of loss of vehicle control, vehicle rollover, personal injury and death.

Wheels and Tires

 **WARNING:** To reduce the risk of serious injury, when mounting replacement tires and wheels, you should not exceed the maximum pressure indicated on the sidewall of the tire to set the beads without additional precautions listed below. If the beads do not seat at the maximum pressure indicated, re-lubricate and try again.

 **WARNING:** When inflating the tire for mounting pressures up to 20 psi (1.38 bar) greater than the maximum pressure on the tire sidewall, the following precautions must be taken to protect the person mounting the tire:

 **WARNING:** To reduce the risk of serious injury, when mounting replacement tires and wheels, you should not exceed the maximum pressure indicated on the sidewall of the tire to set the beads without additional precautions listed below. If the beads do not seat at the maximum pressure indicated, re-lubricate and try again.

- Stand at a minimum of 12 ft (3.66 m) away from the wheel and tire assembly.
- Use both eye and ear protection.

 **WARNING:** For a mounting pressure more than 20 psi (1.38 bar) greater than the maximum pressure, a Ford dealer or other tire service professional should do the mounting.

 **WARNING:** Always inflate steel carcass tires with a remote air fill with the person inflating standing at a minimum of 12 ft (3.66 m) away from the wheel and tire assembly.

Important: Remember to replace the wheel valve stems when the road tires are replaced on your vehicle

It is recommended that the two front tires or two rear tires generally be replaced as a pair.

Replacing a Tire That is Greenhouse Gas Certified

The tires installed on this vehicle at the factory as original equipment are certified for Greenhouse Gas and Fuel Efficiency regulations. Replacement tires must be of equal or lower rolling resistance level (TRRL or Crr). Consult with your tire supplier(s) for appropriate replacement tires.

Wheels and Tires

Safety Practices



WARNING: If your vehicle is stuck in snow, mud or sand, do not rapidly spin the tires; spinning the tires can tear the tire and cause an explosion. A tire can explode in as little as three to five seconds.



WARNING: Do not spin the wheels at over 34 mph (55 km/h). The tires may fail and injure a passenger or bystander.

Driving habits have a great deal to do with your tire mileage and safety.

- Observe posted speed limits
- Avoid fast starts, stops and turns
- Avoid potholes and objects on the road
- Do not run over curbs or hit the tire against a curb when parking

Highway Hazards

No matter how carefully you drive there's always the possibility that you may eventually have a flat tire on the highway. Drive slowly to the closest safe area out of traffic. This may further damage the flat tire, but your safety is more important.

If you feel a sudden vibration or ride disturbance when driving, or you suspect your tire or vehicle has been damaged, immediately reduce your speed. Drive with caution until you can safely pull off the road. Stop and inspect the tires for damage. If a tire is under-inflated or damaged, deflate it, remove wheel and replace it with your spare tire and wheel. If you cannot detect a cause, have the vehicle towed to the nearest repair facility or tire dealer to have the vehicle inspected.

Tire and Wheel Alignment

A bad jolt from hitting a curb or pothole can cause the front end of your vehicle to become misaligned or cause damage to your tires. If your vehicle seems to pull to one side when you're driving, the wheels may be out of alignment. Have an authorized dealer check the wheel alignment periodically.

Wheel misalignment in the front or the rear can cause uneven and rapid treadwear of your tires and should be corrected by an authorized dealer. Front-wheel drive vehicles and those with an independent rear suspension may require alignment of all four wheels.

The tires should also be balanced periodically. An unbalanced tire and wheel assembly may result in irregular tire wear.

Wheels and Tires

Tire Rotation

Note: If your tires show uneven wear ask an authorized dealer to check for and correct any wheel misalignment, tire imbalance or mechanical problem involved before tire rotation.

Note: Your vehicle may be equipped with a dissimilar spare wheel and tire assembly. A dissimilar spare wheel and tire assembly is defined as a spare wheel and tire assembly that is different in brand, size or appearance from the road tires and wheels. If you have a dissimilar spare wheel and tire assembly it is intended for temporary use only and should not be used in a tire rotation.

Rotating your tires at the recommended interval helps your tires wear more evenly, providing better tire performance and longer tire life.

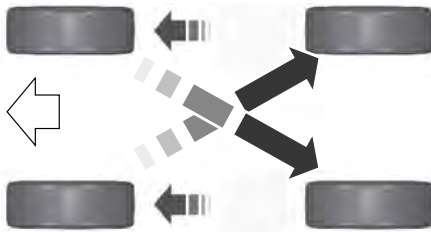

E142548

Rear-wheel drive vehicles

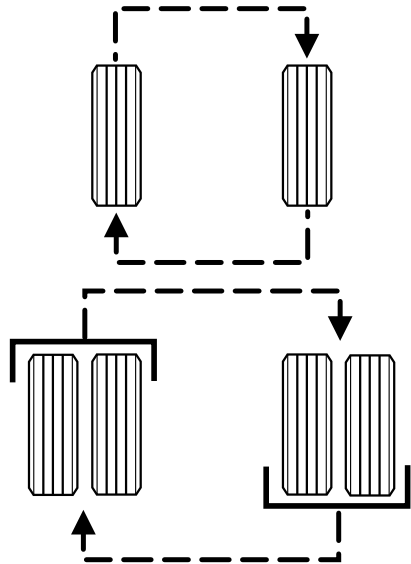

E161439

Dual rear wheel vehicles (six tire rotation)

Note: For vehicles with directional tires marked by an arrow on the tire sidewall, tire rotation is not recommended.

If your vehicle is equipped with dual rear wheels it is recommended that the front and rear tires (in pairs) be rotated only side to side. We do not recommend splitting up the dual rear wheels. Rotate them side to side as a set. After tire rotation, inflation pressures must be adjusted for the tires new positions in accordance with vehicle requirements.

Wheels and Tires

Sometimes irregular tire wear can be corrected by rotating the tires.

USING SNOW CHAINS



WARNING: Snow tires must be the same size, load index, and speed rating as those originally provided by Ford. Use of any tire or wheel not recommended by Ford can affect the safety and performance of your vehicle, which could result in an increased risk of loss of vehicle control, vehicle rollover, personal injury, and death. Additionally, the use of non-recommended tires and wheels could cause steering, suspension, axle, transfer case, or power transfer unit failure. It is also strongly advised to follow the Ford recommended tire inflation pressure found on the Safety Compliance Certification Label (affixed to either the door hinge pillar, door-latch post, or the door edge that meets the door-latch post, next to the driver's seating position), or Tire Label which is located on the B-Pillar or the edge of the driver door. Failure to follow the tire pressure recommendations can cause uneven treadwear patterns and adversely affect the way your vehicle handles.

The tires on your vehicle have all-weather treads to provide traction in rain and snow. However, in some climates, you may need to use snow tires and cables. If you need to use cables, it is recommended that steel wheels (of the same size and specifications) be used, as cables may chip aluminum wheels.

Note: *The suspension insulation and bumpers help prevent vehicle damage. Do not remove these components from your vehicle when using snow tires and chains.*

Follow these guidelines when using snow tires and chains:

- If possible, avoid fully loading your vehicle.
- Use only SAE Class S chains.
- Install chains securely, verifying that the chains do not touch any wiring, brake lines or fuel lines.
- Drive cautiously. If you hear the chains rub or bang against your vehicle, stop and retighten the chains. If this does not work, remove the chains to prevent damage to your vehicle.
- Remove the tire chains when they are no longer needed. Do not use tire chains on dry roads.

If you have any questions regarding snow chains or cables, please contact your authorized dealer.

CHANGING A ROAD WHEEL

If you get a flat tire while driving, do not apply the brake heavily. Instead, gradually decrease your speed. Hold the steering wheel firmly and slowly move to a safe place on the side of the road.

Tire Change Procedure



WARNING: Do not work on your vehicle when the jack is the only support as your vehicle could slip off the jack. Failure to follow this instruction could result in personal injury or death.

Wheels and Tires

WARNING: To help prevent your vehicle from moving when changing a wheel, shift the transmission into park (P), set the parking brake and use an appropriate block or wheel chock to secure the wheel diagonally opposite to the wheel being changed. For example, when changing the front left wheel, place an appropriate block or wheel chock on the right rear wheel.

WARNING: Do not get under a vehicle that is supported by a jack.

WARNING: Do not attempt to change a tire on the side of the vehicle close to moving traffic. Pull far enough off the road to avoid the danger of being hit when operating the jack or changing the wheel.

Note: Passengers should not remain in the vehicle when the vehicle is being jacked.

Park on a level surface, set the parking brake and activate the hazard flashers.

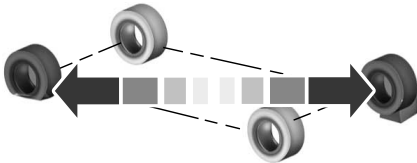

E142551

1. Turn the engine off and block the wheel that is diagonally opposite of the flat tire using a wheel chock.

2. Loosen each wheel lug nut $\frac{1}{2}$ turn counterclockwise, but do not remove them until the wheel is raised off the ground.
3. Replace the flat tire with the spare tire, making sure the valve stem is facing outward on all front and inboard rear wheels. If you are replacing the outboard wheel, the valve stem must be facing inward. Reinstall the lug nuts until the wheel is snug against the hub. Do not fully tighten the lug nuts until the wheel has been lowered.
4. Lower the wheel and fully tighten the lug nuts in the order shown below. See **Technical Specifications** (page 279).
5. Unblock the wheels.



E161441

8-lug nut torque sequence.



E169375

10-lug nut torque sequence.

Wheels and Tires

TECHNICAL SPECIFICATIONS

Wheel Lug Nut Torque Specifications



WARNING: When you install a wheel, always remove any corrosion, dirt or foreign materials present on the mounting surfaces of the wheel or the surface of the wheel hub, brake drum or brake disc that contacts the wheel. Make sure to secure any fasteners that attach the rotor to the hub so they do not interfere with the mounting surfaces of the wheel. Installing wheels without correct metal-to-metal contact at the wheel mounting surfaces can cause the wheel nuts to loosen and the wheel to come off while your vehicle is in motion, resulting in loss of vehicle control, personal injury or death.

Bolt size	lb.ft (Nm) ¹
M22 x 1.5	450–500 lb.ft (610–678 Nm)

¹ Torque specifications are for nut and bolt threads free of dirt and rust. Use only Ford recommended replacement fasteners.

On vehicles equipped with single rear wheels, retighten the lug nuts to the specified torque at 100 miles (160 kilometers) after any wheel disturbance (such as tire rotation, changing a flat tire, wheel removal).

On vehicles equipped with dual rear wheels, retighten the lug nuts to the specified torque at 100 miles (160 kilometers) and again at 500 miles (800 kilometers) of new vehicle operation and after any wheel disturbance (such as tire rotation, changing a flat tire, wheel removal).

It is important to follow the proper wheel mounting and lug nut torque procedures.



E161443

On all two-piece flat wheel nuts, apply one drop of motor oil between the flat washer and the nut. Do not apply motor oil to the wheel nut threads or the wheel stud threads.

Wheels and Tires



E145950

A Wheel pilot bore

Inspect the wheel pilot hole and mounting surface prior to installation. Remove any visible corrosion or loose particles.

Capacities and Specifications

ENGINE SPECIFICATIONS - 6.7L DIESEL

Engine	6.7L V8 Diesel Engine
Displacement.	406 in ³ (6,651 cm ³)
Required fuel.	Low Sulfur Diesel up to B20
Firing order.	1-3-7-2-6-5-4-8
Compression ratio.	15.8:1

Drivebelt Routing Single Alternator

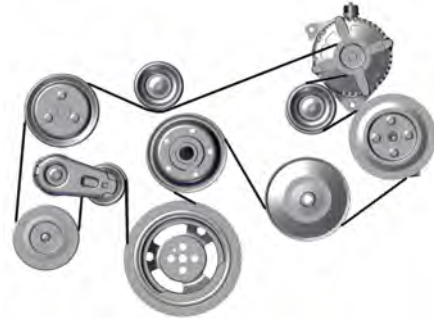

E224819

Single Alternator With Air Brake Compressor

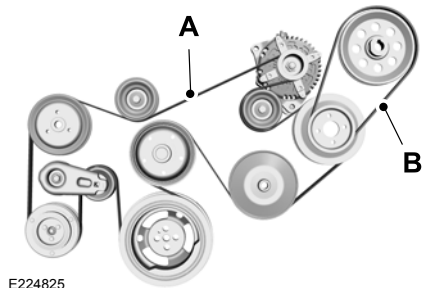

E224825

- A Drivebelt closest to the engine.
- B Drivebelt furthest from the engine.

Capacities and Specifications

Dual Alternator



E224820

Dual Alternator With Air Brake Compressor

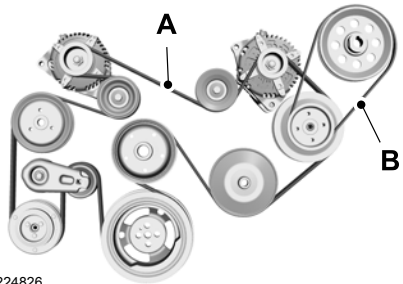

E224826

- A Drivebelt closest to the engine.
- B Drivebelt furthest from the engine.

Note: The belt routings show vehicles with air conditioning. When vehicles do not have air conditioning, an idler pulley is in place of the A/C compressor.

ENGINE SPECIFICATIONS - 7.3L

Engine	7.3L V8 Engine
Displacement.	445 in ³ (7,293 cm ³)
Required fuel.	Minimum 87 octane
Firing order.	1-5-4-8-6-3-7-2
Ignition system.	Coil near spark plug with spark plug wire
Spark plug gap.	0.049 in (1.25 mm) - 0.053 in (1.35 mm)
Compression ratio.	10.5:1

Capacities and Specifications

Drivebelt Routing

Single Alternator

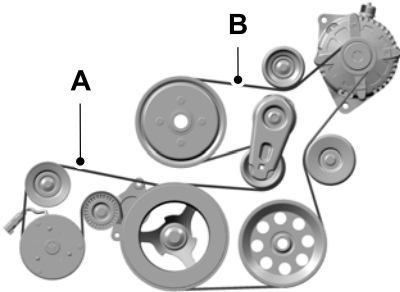

- A Drivebelt closest to the engine.
- B Drivebelt furthest from the engine.

Dual Alternator

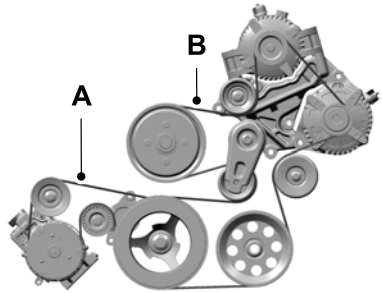

- A Drivebelt closest to the engine.
- B Drivebelt furthest from the engine.

MOTORCRAFT PARTS - 6.7L DIESEL

Component	Part Number
Engine oil filter. ¹	FL-2051S
Oil separator filter.	FL-2077
Foam pre-filter.	FA-1909
Air filter.	FA-1923
Fuel filter kit (2 included - engine and frame rail mounted).	FD-4626
Transmission filter.	FT-187
Two Batteries (standard)(1500 CCA).	BH-31-XL
Two Batteries (optional)(1800 CCA).	BH-31-XT

Capacities and Specifications

Component	Part Number
Three Batteries (optional)(2700 CCA).	BH-31-XT
Windshield wiper blade.	WW-2248

¹If a Motorcraft® oil filter is not available, use an oil filter that meets industry performance specification SAE/USCAR-36.

We recommend Motorcraft® parts that are available at your authorized dealer or at www.fordparts.com. These parts are engineered for your vehicle, and meet or exceed our specifications. Use of other parts could impact vehicle performance, emissions and durability. Your warranty could be void for any damage related to use of other parts.

Capacities and Specifications

MOTORCRAFT PARTS - 7.3L

Component	Motorcraft Part Number
Air filter element.	FA-1923
One battery (standard)(900 CCA).	BH-31-XT
Two batteries (optional)(except for Limited Series)(1800 CCA total).	BH-31-XT
Engine oil filter. ¹	FL-820-S
Spark plug. ²	SP-586
Transmission fluid filter.	FT-187
Windshield wiper blade.	WW-2248

¹If a Motorcraft® oil filter is not available, use an oil filter that meets industry performance specification SAE/USCAR-36.

²For spark plug replacement, contact your authorized dealer. Replace the spark plugs at the recommended intervals. See **Normal Scheduled Maintenance** (page 323).

We recommend Motorcraft® parts that are available at your authorized dealer or at www.fordparts.com. We engineer these parts for your vehicle and to meet or exceed our specifications. Use of other parts could impact vehicle performance, emissions and durability. Your warranty could be void for any damage related to use of other parts.

Capacities and Specifications

VEHICLE IDENTIFICATION NUMBER

The vehicle identification number is located on the left-hand side of the instrument panel.

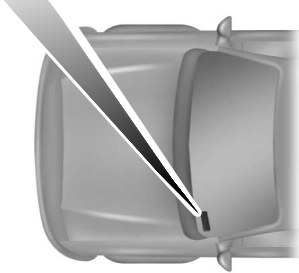

E142476

Please note that in the graphic, XXXX is representative of your vehicle identification number.

The Vehicle Identification Number contains the following information:

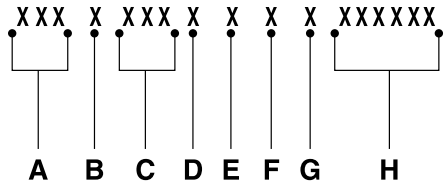

- A World manufacturer identifier
- B Brake system, Gross Vehicle Weight Rating, Restraint Devices and their locations
- C Make, vehicle line, series, body type
- D Engine type
- E Check digit
- F Model year
- G Assembly plant
- H Production sequence number

Capacities and Specifications

TRANSMISSION CODE DESIGNATION

The transmission code is on the Safety Compliance Certification Label. The following table shows the transmission code along with the transmission description.

MFD. BY FORD MOTOR CO.

DATE: XX/XX GVWR: XXXX KG (XXXX LB)
 FRONT GAWR: REAR GAWR:
 XXXX KG (XXXX LB) WITH XXXX KG (XXXX LB) WITH
 XXXXXXXXXXXXXXXX TIRES XXXXXXXXXXXXXXXX TIRES
 XXXXXXXX RIMS XXXXXXXX RIMS
 AT XXXX kPa/ XXX PSI COLD AT XXXX kPa/ XXX PSI COLD

THIS VEHICLE CONFORMS TO ALL APPLICABLE FEDERAL MOTOR VEHICLE SAFETY AND THEFT PREVENTION STANDARDS IN EFFECT ON THE DATE OF MANUFACTURE SHOWN ABOVE.

VIN: XXXXXXXXXXXXXXXX XXXXX
 TYPE: XXXX XXXXX



EXT PNT: XX XXXXXX RC: XY DSO: XXXX
 WB INT TR TP/PS TR AXLE TR SPR XXXX
 XXX XX XXX X XX X XXXX XXXX
 XXXXXXXXXXXXXXXX XX =XXXX-XXXXXX-XX



E167814

Description	Code
Six-speed automatic transmission 6R140 (Gas)	P
Six-speed automatic transmission 6R140 (Diesel)	G

Capacities and Specifications

CAPACITIES AND SPECIFICATIONS - 6.7L DIESEL

Use oil and fluid that meets the defined specification and viscosity grade.

If you do not use oil and fluid that meets the defined specification and viscosity grade, it could result in:

- Component damage that your vehicle warranty does not cover.
- Longer engine cranking periods.
- Increased emission levels.
- Reduced engine performance.

- Reduced fuel economy.
- Reduced brake performance.

Note: We recommend an engine block heater at temperatures below -10°F (-23°C).

Air Conditioning System



WARNING: The air conditioning refrigerant system contains refrigerant under high pressure. Only qualified personnel should service the air conditioning refrigerant system. Opening the air conditioning refrigerant system can cause personal injury.

Capacities

Variant	Refrigerant	Refrigerant Oil
All.	26.49 oz (0.751 kg)	3.38 fl oz (100 ml)

Materials

Name	Specification
Motorcraft® R-134a Refrigerant(U.S.) R-134a Refrigerant / Frigorigène R-134a(Canada) YN-19(U.S.) CYN-19-R(Canada)	WSH-M17B19-A
Motorcraft® PAG Refrigerant Compressor Oil(U.S.) Motorcraft® PAG Refrigerant Compressor Oil / Huile PAG pour compresseur frigorifique Motor- craft®(Canada) YN-12-D(U.S. & Canada)	WSH-M1C231-B

Automatic Transmission

Note: Only use *MERCON LV* transmission fluid for automatic transmissions that require *MERCON LV* transmission fluid. The use of any other fluid could cause transmission damage.

Capacities and Specifications

Capacities

Variant	Quantity
All.	16.3 qt (15.4 L) ¹

¹ Approximate dry fill capacity. Actual amount could vary during fluid changes.

Materials

Name	Specification
Motorcraft® MERCON® LV Automatic Transmission Fluid (U.S.) Motorcraft® MERCON® LV Automatic Transmission Fluid / Huile pour boîte automatique MERCON® LV Motorcraft® (Canada) XT-10-QLVC (U.S.) CXT-10-LV6 (Canada)	WSS-M2C938-AMERCON® LV,

Engine Coolant

Capacities

Variant	Quantity
Primary cooling system.	35.1 qt (33.2 L)
Secondary cooling system.	15.1 qt (14.3 L)

Materials

Name	Specification
Motorcraft® Yellow Prediluted Antifreeze/ Coolant (U.S.) Motorcraft® Yellow Prediluted Antifreeze/Coolant / Antigel/liquide de refroidissement prédilué jaune Motorcraft® (Canada) VC-13DL-G (U.S.) CVC-13DL-G (Canada)	WSS-M97B57-A2

Capacities and Specifications

Engine Oil

We recommend Motorcraft motor oil for your vehicle. If Motorcraft motor oil is not available, use motor oil of the recommended viscosity grade that meets our specification WSS-M2C171-F1. You can find the list of approved motor oils at www.motorcraft.com.

Do not use engine oil additives as they could lead to engine damage not covered by your vehicle warranty.

The use of correct oil viscosities for diesel engines is important for satisfactory operation. Determine which oil viscosity grade best suits the temperature range you expect to encounter for the next service interval from the SAE Viscosity Grades chart.

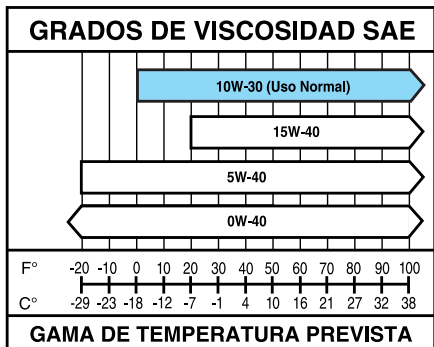
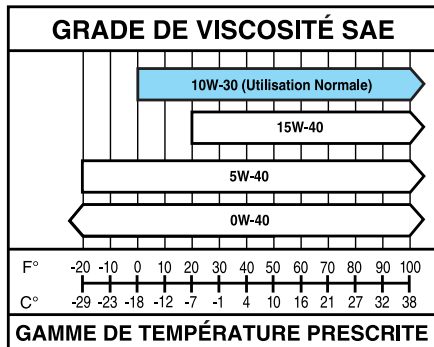
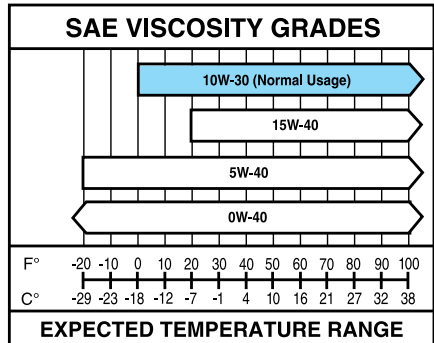

Capacities and Specifications

Capacities

Variant	Including the Oil Filter
All.	15.0 qt (14.2 L)

Materials

Name	Specification
Motorcraft® SAE 10W-30 Super Duty Diesel Motor Oil(U.S.) Motorcraft® Super Duty Motor Oil SAE 10W-30 / Huile moteur Super Duty SAE 10W-30 Motor- craft®(Canada) XO-10W30-QSDF(U.S.) CXO-10W30-LSD12(Canada)	WSS-M2C171-F1

Alternative Engine Oil for Extremely Cold Climates

To improve engine cold start performance, we recommend that you use the following alternative engine oil in extremely cold climates, where the ambient temperature reaches -22.0°F (-30°C) or below.

Materials

Name	Specification
Engine Oil - SAE 0W-40	WSS-M2C171-F1

Alternative Engine Oil for Biodiesel Fuel Blends (B20 Max)

Capacities and Specifications

Materials

Name	Specification
Motorcraft® SAE 5W-40 Full Synthetic Diesel Motor Oil(U.S.) (Canada) XO-5W40-5Q3SD(U.S.)	WSS-M2C171-F1
Motorcraft® SAE 15W-40 Super Duty Diesel Motor Oil(U.S.) Motorcraft® Super Duty Motor Oil SAE 15W-40 / Huile moteur Super Duty SAE 15W-40 Motor- craft®(Canada) XO-15W40-QSDF(U.S.) CXO-15W40-LSD12(Canada)	WSS-M2C171-F1

Alternative Engine Oil for Severe Duty Service

Materials

Name	Specification
Motorcraft® SAE 5W-40 Full Synthetic Diesel Motor Oil(U.S.) (Canada) XO-5W40-5Q3SD(U.S.)	WSS-M2C171-F1

Fuel Tank

Capacities

Variant	Quantity
Small.	50 gal (189.2 L)
Medium.	55 gal (208.2 L)
Large.	65 gal (246 L)
With dual tanks - Driver side tank.	65 gal (246 L)
With dual tanks - Passenger side tank.	50 gal (189.2 L)

Capacities and Specifications

Diesel Exhaust Fluid (DEF) Tank

Capacities

Variant	Quantity
All.	8.0 gal (30.2 L)

Materials

Name	Specification
Motorcraft® Diesel Exhaust Fluid(U.S.) Motorcraft® Diesel Exhaust Fluid / Fluide pour échappement diesel Motorcraft®(Canada) PM-27-GAL,PM-27-JUG(U.S.) CPM-27-J(Canada)	WSS-M99C130-A

Grease

Materials

Name	Specification
Motorcraft® Premium Long-Life Grease(U.S.) Motorcraft® Premium Long-Life Grease / Graisse longue durée de qualité première Motor- craft®(Canada) XG-1-E1(U.S. & Canada)	ESA-MIC75-B
Motorcraft® Multi-Purpose Grease Spray(U.S.) Motorcraft® Multi-Purpose Grease Spray / Graisse tout usage en aérosol Motorcraft®(Canada) XL-5-A(U.S. & Canada)	ESB-MIC93-B

Hydraulic Brake System

Note: We recommend using DOT 5.1 Motor Vehicle Brake Fluid or equivalent meeting WSS-M6C65-A3. Use of any fluid other than the recommended fluid could cause reduced brake performance and not meet our performance standards. Keep brake fluid clean and dry. Contamination with dirt, water, petroleum products or other materials could result in brake system damage and possible failure.

Capacities and Specifications

Materials

Name	Specification
Motorcraft® DOT 5.1 Motor Vehicle Brake Fluid(U.S.) Motorcraft® DOT 5.1 Motor Vehicle Brake Fluid / Liquide de frein automobile DOT 5.1 Motor- craft®(Canada) PM-21(U.S. & Canada)	WSS-M6C65-A3

Power Steering System

Capacities

Variant	Quantity
With air brakes.	5.2 qt (4.9 L)
With hydraulic brakes.	6.1 qt (5.8 L)

Materials

Name	Specification
Motorcraft® MERCON® LV Automatic Transmission Fluid(U.S.) Motorcraft® MERCON® LV Automatic Transmission Fluid / Huile pour boîte automatique MERCON® LV Motorcraft®(Canada) XT-10-QLVC(U.S.) CXT-10-LV6(Canada)	WSS-M2C938-AMERCON® LV,

Locks

Materials

Name	Specification
Motorcraft® Penetrating and Lock Lubricant(U.S.) Motorcraft® Penetrating Fluid / Liquide dégrissant Motorcraft®(Canada) XL-1(U.S.) CXC-51-A(Canada)	-

Capacities and Specifications

Front Wheel Bearing Oil

Capacities

Variant	Quantity
8500 lb axle.	6–7 fl oz (177–207 ml)
All except 8500 lb axle.	12–13 fl oz (355–385 ml)

Materials

Name	Specification
Motorcraft® SAE 75W-140 Synthetic Rear Axle Lubricant (U.S.) Motorcraft® SAE 75W-140 Synthetic Rear Axle Lubricant / Lubrifiant synthétique pour pont arrière SAE 75W-140 Motorcraft® (Canada) XY-75W140-QL (U.S.) CXY-75W140-1L (Canada)	WSL-M2C192-A

Rear Axle

Capacities

Variant	Quantity
S-140 (13.5K, 17.5K, 19K single-speed).	9.5 qt (9 L)
21060S (21K single-speed).	11.2 qt (10.6 L)
21065T/P (21K two-speed).	17.5 qt (16.6 L)
S23-172 (23K single-speed).	14.3 qt (13.5 L)
S26-190 (26K single-speed).	18.5 qt (17.5 L)

Capacities and Specifications

Materials

Name	Specification
Motorcraft® SAE 80W-90 Premium Rear Axle Lubricant(U.S.) Motorcraft® SAE 80W-90 Premium Axle Lubricant / Lubrifiant pour essieux de très haute qualité SAE 80W-90 Motorcraft®(Canada) XY-80W90-QL(U.S.) CXY-80W90-1L(Canada)	WSP-M2C197-A

Alternative Rear Axle Fluid for Severe Duty Service

Materials

Name	Specification
Motorcraft® SAE 75W-140 Synthetic Rear Axle Lubricant(U.S.) Motorcraft® SAE 75W-140 Synthetic Rear Axle Lubricant / Lubrifiant synthétique pour pont arrière SAE 75W-140 Motorcraft®(Canada) XY-75W140-QL(U.S.) CXY-75W140-1L(Canada)	WSL-M2C192-A

Washer Reservoir

Capacities

Variant	Quantity
All.	Fill as required.

Capacities and Specifications

Materials

Name	Specification
Motorcraft® Premium Windshield Wash Concentrate with Bitterant(U.S.) Motorcraft® Premium Quality Windshield Washer Fluid / Liquide lave-glace de haute qualité Motorcraft®(Canada) ZC-32-B2(U.S.) CXC-37-A/B/D/F(Canada)	WSS-M14P19-A

CAPACITIES AND SPECIFICATIONS - 7.3L

Use oil and fluid that meets the defined specification and viscosity grade.

If you do not use oil and fluid that meets the defined specification and viscosity grade, it could result in:

- Component damage that your vehicle warranty does not cover.
- Longer engine cranking periods.
- Increased emission levels.

- Reduced engine performance.
- Reduced fuel economy.
- Reduced brake performance.

Air Conditioning System



WARNING: The air conditioning refrigerant system contains refrigerant under high pressure. Only qualified personnel should service the air conditioning refrigerant system. Opening the air conditioning refrigerant system can cause personal injury.

Capacities

Variant	Refrigerant	Refrigerant Oil
All.	26.46 oz (0.75 kg)	4.06 fl oz (120 ml)

Capacities and Specifications

Materials

Name	Specification
Motorcraft® R-134a Refrigerant (U.S.) R-134a Refrigerant / Frigorigène R-134a (Canada) YN-19 (U.S.) CYN-19-R (Canada)	WSH-M17B19-A
Motorcraft® PAG Refrigerant Compressor Oil (U.S.) Motorcraft® PAG Refrigerant Compressor Oil / Huile PAG pour compresseur frigorifique Motor- craft® (Canada) YN-12-D (U.S. & Canada)	WSH-M1C231-B

Automatic Transmission

Note: Only use MERCON® LV transmission fluid for automatic transmissions that require MERCON® LV transmission fluid. The use of any other fluid could cause transmission damage.

Capacities

Variant	Quantity
Six-speed automatic transmission (6R140).	16.3 qt (15.4 L) ¹

¹ Approximate dry fill capacity. Actual amount could vary during fluid changes.

Materials

Name	Specification
Motorcraft® MERCON® LV Automatic Transmission Fluid (U.S.) Motorcraft® MERCON® LV Automatic Transmission Fluid / Huile pour boîte automatique MERCON® LV Motorcraft® (Canada) XT-10-QLVC (U.S.) CXT-10-LV6 (Canada)	WSS-M2C938-AMERCON® LV,

Capacities and Specifications

Engine Coolant

Capacities

Variant	Quantity
All.	23.4 qt (22.13 L)

Materials

Name	Specification
Motorcraft® Yellow Prediluted Antifreeze/ Coolant(U.S.) Motorcraft® Yellow Prediluted Antifreeze/Coolant / Antigel/liquide de refroidissement prédilué jaune Motorcraft®(Canada) VC-13DL-G(U.S.) CVC-13DL-G(Canada)	WSS-M97B57-A2

Engine Oil



E142732

An oil that displays this symbol conforms to current engine, emission system and fuel economy performance standards of ILSAC.

We recommend Motorcraft® motor oil for your vehicle. If Motorcraft® oil is not available, use motor oils of the recommended viscosity grade that meet API SP requirements and display the API Certification Mark for gasoline engines.

Do not use supplemental engine oil additives because they are unnecessary and could lead to engine damage that your vehicle warranty does not cover.

Capacities

Variant	Including the Oil Filter
All.	8.0 qt (7.57 L)

Capacities and Specifications

Materials

Name	Specification
Motorcraft® SAE 5W-30 Synthetic Blend Motor Oil(U.S.) Motorcraft® SAE 5W-30 Super Premium Motor Oil / Huile moteur de très haute qualité SAE 5W-30 Motorcraft®(Canada) XO-5W30-Q1SP(U.S.) CXO-5W30-LSP6(Canada)	WSS-M2C961-A1

Alternative Engine Oil for Extremely Cold Climates

To improve engine cold start performance, we recommend that you use the following alternative engine oil in extremely cold climates, where the ambient temperature reaches -22.0°F (-30°C) or below.

Materials

Name	Specification
Engine Oil - SAE 0W-30 - Synthetic Blend	WSS-M2C963-A1

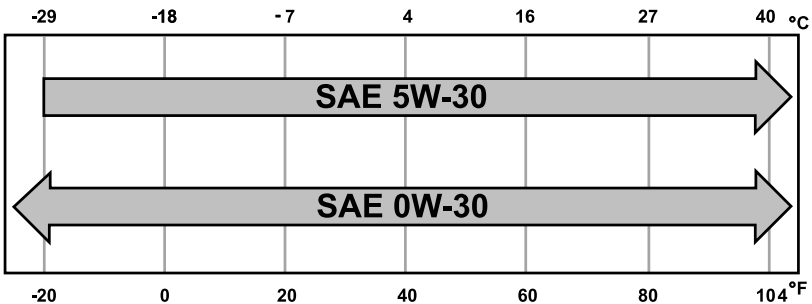

Capacities and Specifications

Fuel Tank

Capacities

Variant	Quantity
Small.	50 gal (189.2 L)
Large.	60 gal (227.1 L)

Grease

Materials

Name	Specification
Motorcraft® Premium Long-Life Grease(U.S.) Motorcraft® Premium Long-Life Grease / Graisse longue durée de qualité première Motor- craft®(Canada) XG-1-E1(U.S. & Canada)	ESA-MIC75-B
Motorcraft® Multi-Purpose Grease Spray(U.S.) Motorcraft® Multi-Purpose Grease Spray / Graisse tout usage en aérosol Motorcraft®(Canada) XL-5-A(U.S. & Canada)	ESB-MIC93-B

Hydraulic Brake System

Note: We recommend using DOT 5.1 Motor Vehicle Brake Fluid or equivalent meeting WSS-M6C65-A3. Use of any fluid other than the recommended fluid could cause reduced brake performance and not meet our performance standards. Keep brake fluid clean and dry. Contamination with dirt, water, petroleum products or other materials could result in brake system damage and failure.

Capacities and Specifications

Materials

Name	Specification
Motorcraft® DOT 5.1 Motor Vehicle Brake Fluid(U.S.) Motorcraft® DOT 5.1 Motor Vehicle Brake Fluid / Liquide de frein automobile DOT 5.1 Motor- craft®(Canada) PM-21(U.S. & Canada)	WSS-M6C65-A3

Power Steering System

Capacities

Variant	Quantity
With air brakes.	5.2 qt (4.9 L)
With hydraulic brakes.	6.1 qt (5.8 L)

Materials

Name	Specification
Motorcraft® MERCON® LV Automatic Transmission Fluid(U.S.) Motorcraft® MERCON® LV Automatic Transmission Fluid / Huile pour boîte automatique MERCON® LV Motorcraft®(Canada) XT-10-QLVC(U.S.) CXT-10-LV6(Canada)	WSS-M2C938-AMERCON® LV,

Locks

Materials

Name	Specification
Motorcraft® Penetrating and Lock Lubricant(U.S.) Motorcraft® Penetrating Fluid / Liquide dégrissant Motorcraft®(Canada) XL-1(U.S.) CXC-51-A(Canada)	-

Capacities and Specifications

Front Wheel Bearing Oil

Capacities

Variant	Quantity
8500 lb axle.	6–7 fl oz (177–207 ml)
All except 8500 lb axle.	12–13 fl oz (355–385 ml)

Materials

Name	Specification
Motorcraft® SAE 75W-140 Synthetic Rear Axle Lubricant (U.S.) Motorcraft® SAE 75W-140 Synthetic Rear Axle Lubricant / Lubrifiant synthétique pour pont arrière SAE 75W-140 Motorcraft® (Canada) XY-75W140-QL (U.S.) CXY-75W140-1L (Canada)	WSL-M2C192-A

Rear Axle

Capacities

Variant	Quantity
S-140 (13.5K, 17.5K, 19K single speed).	9.5 qt (9 L)
21060S (21K single speed.)	11.2 qt (10.6 L)
21065T/P (21K two speed.)	17.5 qt (16.6 L)
S23-172 (23K single speed.)	14.3 qt (13.5 L)

Materials

Name	Specification
Motorcraft® SAE 80W-90 Premium Rear Axle Lubricant (U.S.) Motorcraft® SAE 80W-90 Premium Axle Lubricant / Lubrifiant pour essieux de très haute qualité SAE 80W-90 Motorcraft® (Canada) XY-80W90-QL (U.S.) CXY-80W90-1L (Canada)	WSP-M2C197-A

Capacities and Specifications

Alternative Rear Axle Fluid for Severe Duty Service

Materials

Name	Specification
Motorcraft® SAE 75W-140 Synthetic Rear Axle Lubricant(U.S.) Motorcraft® SAE 75W-140 Synthetic Rear Axle Lubricant / Lubrifiant synthétique pour pont arrière SAE 75W-140 Motorcraft®(Canada) XY-75W140-QL(U.S.) CXY-75W140-1L(Canada)	WSL-M2C192-A

Washer Reservoir

Capacities

Variant	Quantity
All.	Fill as required.

Materials

Name	Specification
Motorcraft® Premium Windshield Wash Concentrate with Bitterant(U.S.) Motorcraft® Premium Quality Windshield Washer Fluid / Liquide lave-glace de haute qualité Motorcraft®(Canada) ZC-32-B2(U.S.) CXC-37-A/B/D/F(Canada)	WSS-M14P19-A

Capacities and Specifications

BULB SPECIFICATION CHART

Replacement bulbs are specified in the chart below. Headlamp bulbs must be marked with an authorized "D.O.T." for

North America and an "E" for Europe to ensure lamp performance, light brightness and pattern and safe visibility. The correct bulbs will not damage the lamp assembly or void the lamp assembly warranty and will provide quality bulb illumination time.

Function	Number of Bulbs	Trade name
Headlamps	2	H13/9008
Side marker lamp - front	2	W5W
Park/Turn lamp- front	2	3157NA
Tail/stop/turn/side marker	2	3157
Reverse	2	3157
License plate lamp	1	3157
High-mount brake lamp	1	912
Map lamp	2	12V6W
Dome/reading lamps	3	578
Interior visor lamp	2	2825
Mirror turn signal	2	2825
Mirror clearance lamp	2	2825
Front clearance lamps and front identification lamps	5	194

Note: To replace instrument panel lights, see an authorized dealer.

Connected Vehicle

CONNECTED VEHICLE REQUIREMENTS

Connected service and related feature functionality requires a compatible vehicle network.

Some remote features require a subscription. For additional information, see the FordPass app. Some restrictions, third party terms and message or data rates may apply.

CONNECTED VEHICLE LIMITATIONS

Evolving technology, evolving cellular networks or evolving regulations could affect functionality and availability, or continued provision of some features. These changes could even stop some features from functioning.

CONNECTING THE VEHICLE TO A MOBILE NETWORK

What Is the Connectivity Device



The connectivity device enables access to a range of features built into your vehicle.

Disabling the Connectivity Device

To disable the connectivity device, contact the Ford Customer Relationship Center.

Note: *Disabling your connectivity device is permanent.*

Connecting FordPass to the Connectivity Device

1. Open the FordPass app on your device and log in.
2. Add your vehicle or select your vehicle if already added.
3. Select the option for vehicle details.
4. Select the option to activate your vehicle.

CONNECTED VEHICLE – TROUBLESHOOTING

Symptom	Possible Cause and Resolution
I cannot confirm the connection of my FordPass account to the connectivity device.	– Contact the Ford Customer Relationship Center to check that the FordPass account is connected to the device.
	– Weak network signal. <ul style="list-style-type: none">• Move your vehicle closer to a place where the network signal is not obstructed.

Audio System (If Equipped)

GENERAL INFORMATION



WARNING: Driving while distracted can result in loss of vehicle control, crash and injury. We strongly recommend that you use extreme caution when using any device that may take your focus off the road. Your primary responsibility is the safe operation of your vehicle. We recommend against the use of any

hand-held device while driving and encourage the use of voice-operated systems when possible. Make sure you are aware of all applicable local laws that may affect the use of electronic devices while driving.

Radio Frequencies and Reception Factors

Note: *Listening to loud audio for long periods of time could damage your hearing.*

Radio Reception Factors

Distance and strength	The further you travel from an AM or FM station, the weaker the signal and the weaker the reception.
Terrain	Hills, mountains, tall buildings, bridges, tunnels, freeway overpasses, parking garages, dense tree foliage and thunderstorms can interfere with the reception.
Station overload	When you pass a ground-based broadcast repeating tower, a stronger signal may overtake a weaker one and result in the audio system muting.

AUDIO UNIT



WARNING: Driving while distracted can result in loss of vehicle control, crash and injury. We strongly recommend that you use extreme caution when using any device that may take your focus off the road. Your primary responsibility is the safe operation of your vehicle. We recommend against the use of any hand-held device while driving and encourage the use of voice-operated systems when possible. Make sure you are aware of all applicable local laws that may affect the use of electronic devices while driving.



Note: *Depending on your vehicle option package, the controls may look different from what you see here.*

Note: *Some features, such as satellite radio, may not be available in your location. Check with an authorized dealer.*

Audio System (If Equipped)

Accessing the Sound Settings



Press the button to adjust the sound settings. You can also activate and set the sensitivity of the adaptive or speed compensated volume.

Accessing the System Settings



Press the button.

Adjusting the Volume

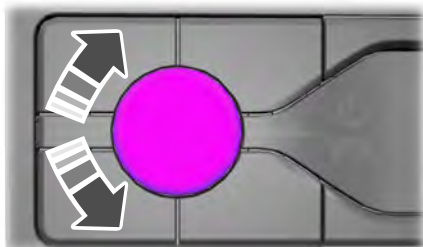

E260697

Turn to adjust the volume.

Changing Radio Stations

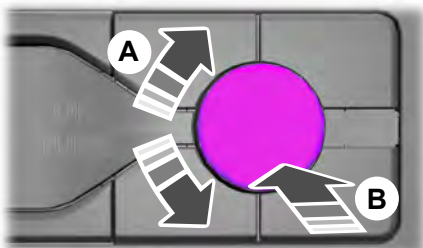

E260687

- A Auto or Manual tuning.
- B Station name tuning.

Note: You can change between auto or manual tuning with the rotary control using the system settings.

Note: You can change radio stations using the seek buttons.

Note: You can recall radio stations using the numeric preset buttons.

Pausing or Playing Media



In media mode, press and release the button to pause playback. Press the button again to resume playback.

In radio mode, press the button to mute the signal. Press the button again to restore the signal.

Returning to the Previous Screen



Press and release the button.

Scrolling Through the Menu Options

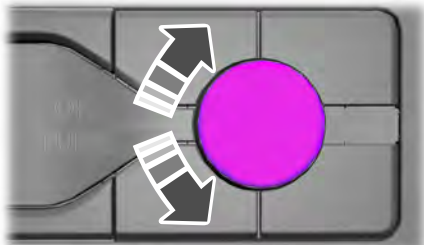

E260782

Selecting Media



Press the button to select media mode.

Repeatedly press the button, or rotate the right-hand rotary control to scroll through the available media sources.

Audio System (If Equipped)

Selecting a Menu Option

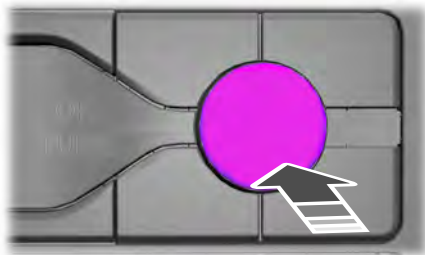

E260781

Switching the Audio Unit On and Off

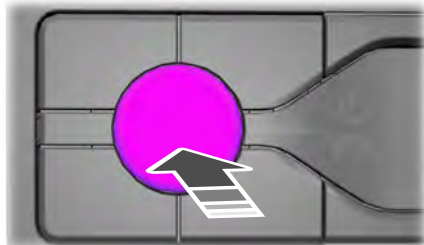

E260686

Selecting the Radio



Press the button to select radio mode.

Press the button again to display the available radio sources. Repeatedly press the button, or rotate the right-hand rotary control to scroll through the available radio sources.

Setting a Memory Preset

Tune to a station then press and hold one of the numbered memory preset buttons. The audio mutes briefly while the system saves the station and returns once the station is stored.

Press and release the button.

Using a Cell Phone



Press the button to either answer an incoming phone call or to make a phone call.



Press and hold the button to end a phone call.

Using Seek, Fast Forward and Reverse



Press and release the button to skip to the next track.

Press and hold the button to fast forward through the track.



Press and release the button to return to the beginning of a track.

Repeatedly press the button to return to previous tracks.

Press and hold the button to rewind.

In radio mode, select a frequency band and press and release either button. The system stops at the first station it finds in that direction.

Audio System (If Equipped)

In satellite radio mode, press and release to select the next or previous satellite radio station. If you select a specific category, such as jazz, rock or news, press to find the next or previous station in the category you select.

DIGITAL RADIO

Note: *HD Radio broadcasts are not available in all markets.*

HD Radio technology is the digital evolution of analog AM/FM radio. Your system has a special receiver that allows it to receive digital broadcasts, where available, in addition to the analog broadcasts, it already receives. Digital broadcasts provide a better sound quality than analog broadcasts with free, crystal-clear audio and no static or distortion. For more information, and a guide to available stations and programming, please visit www.hdradio.com.

When HD Radio is on and you tune to a station broadcasting HD Radio technology, you may notice the HD Radio logo on your screen. When this logo is available, you may also see Title and Artist fields on-screen.

The multicast indicator appears in FM mode, only, if the current station is broadcasting multiple digital broadcasts. The highlighted numbers signify available digital channels where new or different content is available. HD1 signifies the main programming status and is available in analog and digital broadcasts. Other multicast stations, HD2 through HD7, are only available digitally.

When HD Radio broadcasts are active, you can access the following functions:

- **Memory presets** allow you to save an active channel as a memory preset. Touch and hold a memory preset slot until the sound returns. There is a brief mute while the radio saves the station. Sound returns when finished. When switching to an HD2 or HD3 memory preset, the sound mutes before the digital audio plays, because the system has to reacquire the digital signal.

Note: *As with any saved radio station, you cannot access the saved station if your vehicle is outside the station's reception area.*

Audio System (If Equipped)

HD Radio Reception and Station Troubleshooting

Potential reception issues	
Reception area	If you are listening to a multicast station and you are on the fringe of the reception area, the station may mute due to weak signal strength.
	If you are listening to HD1, the system switches back to the analog broadcast until the digital broadcast is available again. However, if you are listening to any of the possible HD2-HD7 multicast channels, the station mutes and stays muted unless it is able to connect to the digital signal again.
Station blending	When the system first receives a station, aside from HD2-HD7 multicast stations, it first plays the station in the analog version. Once the receiver verifies the station is an HD Radio station, it shifts to the digital version. Depending on the station quality, you may hear a slight sound change when the station changes from analog to digital. Blending is the shift from analog to digital sound or digital back to analog sound.

In order to provide the best possible experience, use the contact form to report any station issues found while listening to a station broadcasting with HD Radio technology. Independent entities own and operate each station. These stations are responsible for the accuracy of all audio streams and data fields.

Audio System (If Equipped)

Potential station issues		
Issues	Cause	Action
Echo, stutter, skip or repeat in audio. Increase or decrease in audio volume.	This is poor time alignment by the radio broadcaster.	No action required. This is a broadcast issue.
Sound fading or blending in and out.	The radio is shifting between analog and digital audio.	No action required. The reception issue may clear up as you continue to drive.
There is an audio mute delay when selecting HD2 or HD3, multicast preset or Direct Tune .	The digital multicast is not available until the HD Radio broadcast is decoded. Once decoded, the audio is available.	No action required. This is normal behavior. Wait until the audio is available.
Cannot access HD2 or HD3 multicast channel when recalling a preset or from a direct tune.	The previously stored multicast preset or direct tune is not available in your current reception area.	No action required. The station is not available in your current location.
Text information does not match currently playing audio.	Data service issue by the radio broadcaster.	Fill out the station issue form at website listed below. ¹
There is no text information shown for currently selected frequency.	Data service issue by the radio broadcaster.	Fill out the station issue form at website listed below. ¹

¹ <http://hdradio.com/stations/feedback>

HD Radio Technology manufactured under license from iBiquity Digital Corporation and foreign patents. HD Radio and the HD and HD Radio logos are proprietary trademarks of DTS Ford Motor Company and DTS are not responsible for the content sent using HD Radio technology. Content may be changed, added or deleted at any time at the station owner's discretion.

CONNECTING A BLUETOOTH® DEVICE

Pairing a Device



Press the button.

Select Bluetooth and follow the instructions on the screen.

Audio System (If Equipped)

Note: When pairing a new device, you can choose to download contacts, set this as the primary device and enable Emergency Assistance.

STREAMING BLUETOOTH AUDIO

Selecting a Bluetooth Source



Press the button to display the menu.

Repeatedly press the button to scroll to the Bluetooth device.

Press the **OK** button.



Press the button to play the track. Press the button again to pause the track.



Press the button to skip to the next track.

Press and hold the button to fast forward through the track.



Press the button once to return to the beginning of the track.

Repeatedly press the button to return to previous tracks.

Press and hold the button to fast rewind.

Note: Not all functions are supported by all phones.

PLAYING MEDIA FROM A USB DEVICE

Supported Audio File Formats

You can play audio file formats including MP3, WMA, WAV, M4A, M4B, AAC, and FLAC.

Note: The NTFS file system is not supported.

Selecting the USB Device



Press the button to display the menu.

Repeatedly press the button to scroll to your USB device.

Press the **OK** button.

Playing from the USB Device



Press the button to play a track. Press the button again to pause the track.



Press the button to skip to the next track.

Press and hold the button to fast forward through the track.



Press the button once to return to the beginning of a track. Repeatedly press the button to return to previous tracks.

Press and hold the button to fast rewind.

Sorting by Categories

You can also sort and play music by specific categories, for example artist or album.

Press the **OK** button to view the available categories.

USING VOICE RECOGNITION

Phone Voice Service

This system allows you to use the voice recognition features of your phone and focus on your driving.



Press and hold the voice control button on the audio unit.

Audio System (If Equipped)

Note: *This only works when connected via Bluetooth. See **Connecting a Bluetooth® Device** (page 312).*

Note: *When using voice recognition use the language set on the device.*

Note: *We recommend that you check your data plan before using your phone voice service through the system. Using them could result in additional charges.*

Accessories

AUXILIARY SWITCHES (IF EQUIPPED)

For maximum vehicle performance, keep the following information in mind when adding accessories or equipment to your vehicle:

- When adding accessories, equipment, passengers and luggage to your vehicle, do not exceed the total weight capacity of the vehicle or of the front or rear axle (GVWR or GAWR as indicated on the Safety Compliance Certification label). Ask an authorized dealer for specific weight information.
- The Federal Communications Commission (FCC) and Canadian Radio Telecommunications Commission (CRTC) regulate the use of mobile communications systems equipped with radio transmitters, for example, two-way radios, telephones and theft alarms. Any such equipment installed in your vehicle should comply with Federal Communications Commission (FCC) and Canadian Radio Telecommunications Commission (CRTC) regulations, and should be installed by an authorized dealer.
- An authorized dealer needs to install mobile communications systems. Improper installation may harm the operation of your vehicle, particularly if the manufacturer did not design the mobile communication system specifically for automotive use.
- If you or an authorized Ford dealer add any non-Ford electrical or electronic accessories or components to your vehicle, you may adversely affect battery performance and durability. In addition, you may also adversely affect the performance of other electrical systems in the vehicle.



E163431

The auxiliary switch option package provides four switches, mounted in the center of the instrument panel. These switches operate when the ignition is on or from battery power, depending on the switchable power distribution box fuse locations #82 and #83. We recommend, however, that the engine remain running to maintain battery charge when using the auxiliary switches for extended periods of time or higher current draws.

Note: *When your vehicle has a diesel engine, use the auxiliary switches only while the engine is running. The glow plugs also drain battery power when the ignition key is in the on position. Using the auxiliary switches, even for limited amounts of time, can cause your battery to drain quickly and prevent your vehicle from restarting.*

When switched on, the auxiliary switches provide 20 amps or 40 amps of electrical battery power for a variety of personal or commercial uses.

The relays for the auxiliary switches are in the power distribution box under the hood by the right-hand fender. See your authorized dealer for service.

Each switch includes a power lead, a blunt-cut and sealed wire below the instrument panel and to the left of the steering column in the driver footwell area.

The power leads are coded as shown:

Accessories

Switch	Circuit Number	Wire Color	Fuse Amp Rating
AUX 1	CAC05	Yellow	40A
AUX 2	CAC06	Green with Brown Trace	40A
AUX 3	CAC07	Violet with Green Trace	20A
AUX 4	CAC08	Brown	20A

Learn more about auxiliary switches by visiting:

Web Address
www.fleet.ford.com/truckbbas/

Upfitter Interface Module (If Equipped)

The Upfitter Interface Module (UIM) is an electronic control module that operates equipment, such as lift buckets, cranes, motors, salt spreaders and snow plows, with external relays.

If you replace the module, it will require additional programming by the upfitter. Obtain this data directly from the upfitter company. The upfitter contact information is in the vehicle door opening.

For more information on the Upfitter Interface Module and the auxiliary switches, contact your upfitter.

Ford Protect

PROTECT YOURSELF FROM THE RISING COST OF VEHICLE REPAIRS WITH A FORD PROTECT EXTENDED SERVICE PLAN.

Ford Protect Extended Service Plans (U.S. Only)

Ford Protect extended service plan means peace of mind. It's the extended service plan backed by Ford Motor Company, and provides more protection beyond the New Vehicle Limited Warranty coverage. When you visit your Ford Dealer, Insist on Ford Protect extended service plans!

Ford Protect Can Quickly Pay for Itself

One trip to the Service Center could easily exceed the price of your Ford Protect extended service plan. With Ford Protect extended service plan you minimize your risk for unexpected repair bills and rising repair costs.

Up to 1,000+ Covered Vehicle Components

There are four mechanical Ford Protect extended service plans with different levels of coverage. Ask your authorized dealer for details.

1. PremiumCARE - Our most comprehensive coverage. With over 1,000 covered components, this plan is so complete it's probably easier to list what's not covered.
2. ExtraCARE - Covers 113 components, and includes many high-tech items.
3. BaseCARE - Covers 84 components.
4. PowertrainCARE - Covers 29 critical components.

Ford Protect extended service plans are honored by all authorized Ford dealers in the U.S., Canada and Mexico.

That means you get:

- Reliable, quality service at any Ford or Lincoln dealership.
- Repairs performed by factory trained technicians, using genuine parts.

Rental Car Reimbursement

1st day Rental Benefit

If you bring your car into your dealer for service, we'll give you a loaner to use for the day.

Extended Rental Benefits

If your vehicle is kept overnight for covered repairs, you are eligible for rental car coverage, including warranty repairs, and Field Service Actions.

Roadside Assistance

Exclusive 24/7 roadside assistance, including:

- Towing, flat-tire change and battery jump starts.
- Out of fuel and lock-out assistance.
- Travel expense reimbursement for lodging, meals and rental car.
- Assistance for taxi, shuttle, rental car coverage or other transportation.

Transferable Coverage

If you sell your vehicle before your Ford Protect extended service plan coverage expires, you can transfer any remaining coverage to the new owner. Which should give you and your potential buyer a little more peace of mind.

Ford Protect

Less Cost to Properly Maintain Your Vehicle

Ford Protect extended service plan also offers a Premium Maintenance Plan that covers all scheduled maintenance, and selected wear items. The coverage is prepaid, so you never have to worry about the cost of your vehicle's maintenance.

Covered maintenance includes:

- Windshield wiper blades.
- Spark plugs.
- The clutch disc (if equipped).
- Brake pads and linings.
- Shock absorbers.
- Struts.
- Engine Belts.
- Engine coolant hoses, clamps and o-rings.
- Diesel exhaust fluid replenishment (if equipped).
- Cabin air filter replacement every 20,000 mi (32,000 km) (electric vehicles only).

Interest Free Finance Options

Just a 5% down payment will provide you with an affordable, no interest, no fee payment program allowing you all the security and benefits Ford Protect extended service plan has to offer while paying over time. You are pre-approved with no credit check or hassles. To learn more, call our Ford Protect extended service plan specialists at 800-367-3377.

Ford Protect Extended Service Plan
P.O. Box 321067
Detroit, MI 48232

Ford Protect Extended Service Plan (CANADA ONLY)

You can get more protection for your vehicle by purchasing a Ford Protect extended service plan. Ford Protect extended service plan is the only service contract backed by Ford Motor Company of Canada, Limited. Depending on the plan you purchase, Ford Protect extended service plan provides benefits such as:

- Rental reimbursement.
- Coverage for certain maintenance and wear items.
- Protection against repair costs after your New Vehicle Limited Warranty Coverage expires.
- Roadside Assistance benefits.

There are several Ford Protect extended service plans available in various time, distance and deductible combinations. Each plan is tailored to fit your own driving needs, including reimbursement for towing and rental. When you purchase Ford Protect extended service plan, you receive added peace-of-mind protection throughout Canada, the United States and Mexico, provided by a network of participating authorized Ford Motor Company dealers.

Note: *Repairs performed outside of Canada and the United States are not eligible for Ford Protect extended service plan coverage.*

This information is subject to change. For more information; visit your local Ford of Canada dealer or www.ford.ca to find the Ford Protect extended service plan that is right for you.

Scheduled Maintenance

GENERAL MAINTENANCE INFORMATION

Why Maintain Your Vehicle?

Carefully following the maintenance schedule helps protect against major repair expenses resulting from neglect or inadequate maintenance and may help to increase the value of your vehicle when you sell or trade it. Keep all receipts for completed maintenance with your vehicle.

We have established regular maintenance intervals for your vehicle based upon rigorous testing. It is important that you have your vehicle serviced at the proper times. These intervals serve two purposes; one is to maintain the reliability of your vehicle and the second is to keep your cost of owning your vehicle down.

It is your responsibility to have all scheduled maintenance performed and to make sure that the materials used meet the specifications identified in this owner's manual. See **Capacities and Specifications** (page 288).

Failure to perform scheduled maintenance invalidates warranty coverage on parts affected by the lack of maintenance.

Why Maintain Your Vehicle at Your Dealership?

Factory-trained Technicians

Service technicians participate in extensive factory-sponsored certification training to help them become experts on the operation of your vehicle. Ask your dealership about the training and certification their technicians have received.

Genuine Ford and Motorcraft Replacement Parts

Dealerships stock Ford, Motorcraft and Ford-authorized branded re-manufactured replacement parts. These parts meet or exceed our specifications. Parts installed at your dealership carry a nationwide 12-month or 12,500 mi (20,000 km) parts and labor limited warranty.

If you do not use Ford authorized parts they may not meet our specifications and depending on the part, it could affect emissions compliance.

Convenience

Many dealerships have extended evening and Saturday hours to make your service visit more convenient and they offer one stop shopping. They can perform any services that are required on your vehicle, from general maintenance to collision repairs.

Note: *Not all dealers have extended hours or body shops. Please contact your dealer for details.*

Protecting Your Investment

Maintenance is an investment that pays dividends in the form of improved reliability, durability and resale value. To maintain the proper performance of your vehicle and its emission control systems, make sure you have scheduled maintenance performed at the designated intervals.

Diesel Engine

Your vehicle is equipped with the Intelligent Oil-Life Monitor system, which displays a message in the information display at the proper oil change interval. This interval may be up to one year or 10,000 mi (16,000 km).

Scheduled Maintenance

A message appears in the information display when it is time for an oil change. Make sure you perform the oil change within two weeks or 500 mi (800 km) of the message appearing. Make sure you reset the Intelligent Oil-Life Monitor after each oil change. See **Instrument Cluster** (page 63).

If your information display resets prematurely or becomes inoperative, you should perform the oil change interval at six months or 5,000 mi (8,000 km) from your last oil change. Never exceed one year or 10,000 mi (16,000 km) between oil change intervals.

All Vehicles

Your vehicle is very sophisticated and built with multiple, complex, performance systems. Every manufacturer develops these systems using different specifications and performance features. That is why it is important to rely upon your dealership to properly diagnose and repair your vehicle.

Ford Motor Company has recommended maintenance intervals for various parts and component systems based upon engineering testing. Ford Motor Company relies upon this testing to determine the most appropriate mileage for replacement of oils and fluids to protect your vehicle at the lowest overall cost to you and recommends against maintenance schedules that deviate from the scheduled maintenance information.

We strongly recommend the use of only genuine Ford, Motorcraft or Ford-authorized re-manufactured replacement parts engineered for your vehicle.

Additives and Chemicals

This owner's manual and the Ford Workshop Manual list the recommended additives and chemicals for your vehicle. We do not recommend using chemicals or additives not approved by us as part of your vehicle's normal maintenance. Please consult your warranty information.

Oils, Fluids and Flushing

In many cases, fluid discoloration is a normal operating characteristic and, by itself, does not necessarily indicate a concern or that the fluid needs to be changed. However, a qualified expert, such as the factory-trained technicians at your dealership, should inspect discolored fluids that also show signs of overheating or foreign material contamination immediately.

Make sure to change your vehicle's oils and fluids at the specified intervals or in conjunction with a repair. Flushing is a viable way to change fluid for many vehicle sub-systems during scheduled maintenance. It is critical that systems are flushed only with new fluid that is the same as that required to fill and operate the system or using a Ford-approved flushing chemical.

Scheduled Maintenance Services

Maintenance service adjustments must conform to specifications contained in this manual, and those shown on the Important Engine Information decal. Perform the following services at scheduled intervals because they essential to the life and performance of your vehicle. Ford recommends that you perform maintenance on all designated items to achieve best vehicle operation.

Scheduled Maintenance

There are three types of maintenance intervals for general vehicle environments: On-Highway, City and Severe Service. In all applications, monitoring miles (kilometers) and time and when the engine is due for an oil change determine the actual interval. When the engine oil change is required before the truck lubrication interval, perform the lubrication at the same time in order to reduce your vehicle's time out of service.

Air Brake Adjustment



WARNING: Failure to maintain proper air brake adjustment can result in reduction or loss of braking ability.

A qualified service technician, keeping to the instructions in the service manual, should perform air brake inspection and adjustment or repairs.

Cam Brakes - Automatic Slack Adjusters



WARNING: Do not manually adjust the automatic slack adjusters to correct excessive push rod stroke as it may result in reduced brake effectiveness and a vehicle crash. Excessive push rod stroke indicates that a problem exists with the

automatic adjuster, with the installation of the adjuster, or with foundation brake components that manual adjustment does not remedy. Seek service from a qualified facility for excessive push rod stroke.

Inspect standard air brakes equipped with automatic slack adjusters for proper brake adjustment as listed in the maintenance schedule charts.

However, inspect the brakes more frequently when subjecting them to heavy use or adverse operating conditions such as:

- Frequent brake applications while fully loaded.
- Operation on hilly or mountainous terrain.
- Frequent operation on dirt, gravel or mud.

Some aftermarket brake linings also require more frequent inspections.

Owner Checks and Services

Make sure you perform the following basic maintenance checks and inspections every month or at six-month intervals.

Check Every Month

Air filter restriction gauge.¹

Engine oil level.

Fuel and water separator. Drain if necessary, or if indicated by the information display.¹

Function of all interior and exterior lights.

Holes and slots in the tail pipe to make sure they are functional and clear of debris.¹

Scheduled Maintenance

Check Every Month

Tires (including spare) for wear and proper pressure.

Windshield washer fluid level.

¹Diesel engine only.

Check Every Six Months

Battery connections. Clean if necessary.

Body and door drain holes for obstructions. Clean if necessary.

Cooling system fluid level and coolant concentration (freeze-point protection).

Door weatherstrips for wear. Lubricate if necessary.

Hinges, latches and outside locks for proper operation. Lubricate if necessary.

Parking brake for proper operation.

Safety belts and seat latches for wear and function.

Safety warning lamps (brake, ABS, airbag and safety belt) for operation.

Washer spray and wiper operation. Clean or replace blades as necessary.

Tightening Lug Nuts

Single rear wheels

Tighten the lug nuts to the specified torque¹ at 500 mi (800 km) after any wheel disturbance (such as tire rotation, changing a flat tire or wheel removal).

Dual rear wheels

Tighten the wheel lug nuts to the specified torque¹ at 100 mi (160 km), and again at 500 mi (800 km) of new vehicle operation and after any wheel disturbance (such as tire rotation, changing a flat tire or wheel removal).

¹ See **Technical Specifications** (page 279).

Scheduled Maintenance

Multi-point Inspection

In order to keep your vehicle running right, it is important to have the systems on your vehicle checked regularly. This can help identify potential issues and prevent major

problems. We recommend having the following multi-point inspection performed at every scheduled maintenance interval to help make sure your vehicle keeps running great.

Multi-point Inspection	
Accessory drive belt(s)	Horn operation
Battery performance	Radiator, cooler, heater and A/C hoses
Engine air filter	Suspension component for leaks or damage
Exhaust system	Steering and linkage
Exterior lamps operation	Tires (including spare) for wear and proper pressure ²
Fluid levels ¹ ; fill if necessary	Windshield for cracks, chips or pits
For oil and fluid leaks	Washer spray and wiper operation
Hood rest for lubrication	Hazard warning system operation

¹Brake, coolant recovery reservoir, automatic transmission, power steering and window washer.

²If your vehicle is equipped with a temporary mobility kit, check the tire sealant expiration Use By date on the canister. Replace as needed.

Be sure to ask your dealership service advisor or technician about the multi-point vehicle inspection. It is a comprehensive way to perform a thorough inspection of your vehicle. Your checklist gives you immediate feedback on the overall condition of your vehicle.

NORMAL SCHEDULED MAINTENANCE

Intelligent Oil-Life Monitor™ - Diesel Engine Only

Your diesel engine has an Intelligent Oil-Life Monitor that determines when you should change the engine oil based on how you use your vehicle. By using several important factors in its calculations, the monitor helps reduce the cost of owning your vehicle and reduces environmental waste at the same time.

Scheduled Maintenance

This means you do not have to remember to change the oil on a mileage-based schedule. Your vehicle lets you know when an oil change is due by displaying a message in the information display.

The following table provides examples of vehicle use and its impact on oil change intervals. It is a guideline only. Actual oil change intervals depend on several factors and generally decrease with severity of use.

When to Expect the OIL CHANGE REQUIRED Message	
Interval	Vehicle Use and Example
7,500–10,000 mi (12,000–16,000 km)	Normal
	Normal commuting with highway driving No, or moderate, load or towing Flat to moderately hilly roads No extended idling
5,000–7,500 mi (8,000–12,000 km)	Severe
	Moderate to heavy load or towing Mountainous or off-road conditions Extended idling Extended hot or cold operation
3,000–5,000 mi (4,800–8,000 km)	Extreme
	Maximum load or towing Extreme hot or cold operation Use of high sulfur diesel fuel

Note: Use the appropriate special operating condition for maintenance information when using high sulfur diesel fuels, operating your vehicle off-road or in dusty conditions, such as unpaved roads.

Normal Maintenance Intervals

Note: Do not exceed the mileage or time intervals.

Scheduled Maintenance

Gasoline Engines

7,500 mi (12,000 km) or Six Months Whichever Comes First

Rotate the tires, inspect tire wear and measure the tread depth.¹

Inspect the wheels and related components for abnormal noise, wear, looseness or drag.

Perform a multi-point inspection, recommended.

Inspect front oil hubs for leaks and check fluid level through hub cap sight glass.

¹ Rotate the front wheels on vehicles with dual rear wheels when specified. Only rotate the rear wheels if you notice unusual wear.

10,000 mi (16,000 km) /450 Engine Hours or 12 Months Whichever Comes First

Change the engine oil and filter.

15,000 mi (24,000 km) or 12 Months Whichever Comes First

Inspect the automatic transmission fluid level. Consult an authorized dealer for requirements.

Inspect the brake pads, shoes, rotors, drums, brake linings, hoses and the parking brake.

Inspect the engine cooling system concentration, freeze-point protection, level and hoses.

Inspect the exhaust system and heat shields.

Inspect the steering linkage, ball joints, suspension, tie-rod ends, driveshaft and the U-joints. Lubricate any components that have grease fittings.

Brake Fluid Maintenance¹

Every 3 Years

Change the brake fluid.²

¹ Perform this maintenance item every 3 years. Do not exceed the designated time for the interval.

² Brake fluid servicing requires special equipment available at your authorized dealer.

Scheduled Maintenance

Other Maintenance Items	
Every 30,000 mi (48,000 km)	Replace the engine air filter.
Every 60,000 mi (96,000 km)	Replace the front wheel bearing grease and grease seal if you have non-sealed bearings.
Every 97,000 mi (156,000 km)	Replace the spark plugs.
Every 105,000 mi (168,000 km)	Change the rear axle fluid. See Special Operating Conditions Scheduled Maintenance (page 329).
	Inspect the accessory drive belt or belts. ¹
Every 150,000 mi (240,000 km)	Change the automatic transmission fluid and filter. Consult an authorized dealer for requirements.
	Replace the accessory drive belt or belts if not replaced within the last 100,000 mi (160,000 km).
	Replace the front wheel bearings and seals if you have non-sealed bearings.
Every 200,000 mi (320,000 km)	Change the engine coolant. ²

¹ If not replaced, inspect every 15,000 mi (24,000 km).

² Initial replacement at 10 years or 200,000 mi (320,000 km), then every five years or 100,000 mi (160,000 km).

Diesel Engine

Note: Do not exceed the mileage or time intervals.

At Every Oil Change Interval as Indicated by the Information Display ¹
Change the engine oil and filter. ²
Drain the fuel filter water trap.
Refill the diesel exhaust fluid tank.
Rotate the tires, inspect the tires for wear and measure the tread depth. ³
Perform a multi-point inspection, recommended.

Scheduled Maintenance

At Every Oil Change Interval as Indicated by the Information Display¹

Inspect the air filter restriction gauge. Replace the filter if necessary.
Inspect the automatic transmission fluid level. Consult an authorized dealer for requirements.
Inspect the brake pads, shoes, rotors, drums, brake linings, hoses and the parking brake.
Inspect the engine and secondary coolant concentration, freeze-point protection, level and hoses.
Inspect the exhaust system and heat shields.
Inspect the steering linkage, ball joints, suspension, tie-rod ends, driveshaft and the U-joints. Lubricate any components that have grease fittings.
Inspect front oil hubs for leaks and check fluid level through hub cap sight glass.

¹ Do not exceed one year/10,000 mi (16,000 km) or 350 engine hours between service intervals.

² Reset the Intelligent Oil-Life Monitor after engine oil and filter changes. See **Oil Change Indicator Reset** (page 220).

³ Rotate the front wheels on vehicles with dual rear wheels when specified. Only rotate the rear wheels if you notice unusual wear.

Brake Fluid Maintenance¹

Every 3 Years	Change the brake fluid. ²
---------------	--------------------------------------

¹ Perform this maintenance item every 3 years. Do not exceed the designated time for the interval.

² Brake fluid servicing requires special equipment available at your authorized dealer.

Other Maintenance Items¹

Every 22,000 mi (36,000 km)	Replace the engine-mounted and frame-mounted fuel filters. ²
Every 30,000 mi (48,000 km)	Inspect the engine and secondary cooling system coolant concentration, freeze-point protection, additive, corrosion inhibitor, strength, coolant level, and hoses. Add coolant additive if necessary. ³

Scheduled Maintenance

Other Maintenance Items¹	
	Note: When adding coolant additive, do not exceed the specified maximum of 47 fl oz (1.4 L) for the engine and 20 fl oz (473 ml) for the secondary cooling system. Operating the engine with excessive coolant additive may cause overheating which could lead to severe, permanent engine damage.
Every 45,000 mi (72,000 km)	Replace the air inlet foam filter.
At 90,000 mi (144,000 km)	Inspect the accessory drive belt or belts. ⁴
At 100,000 mi (160,000 km)	Change the rear axle fluid. See Special Operating Conditions Scheduled Maintenance (page 329). ⁵
Every 150,000 mi (240,000 km)	Change the automatic transmission fluid and filter. Consult an authorized dealer for requirements.
	Replace the accessory drive belt or belts if not replaced within the last 100,000 mi (160,000 km).
	Replace the front wheel bearings and seals.
At 200,000 mi (320,000 km)	Change the engine and secondary cooling system coolant. ⁶

¹You can perform these maintenance items within 3,000 mi (4,800 km) of the last oil change. Do not exceed the designated distance for the interval.

²Every 22,000 mi (36,000 km) or as indicated by the information display.

³Every 30,000 mi (48,000 km), 1200 engine hours or as indicated by the information display.

⁴Perform follow-up inspections every 15,000 mi (24,000 km) after the initial inspection. Replace the belt or belts at 150,000 mi (240,000 km).

⁵Change the fluid again at 150,000 mi (240,000 km).

⁶Initial replacement at 10 years or 200,000 mi (320,000 km), then every five years or 100,000 mi (160,000 km).

Scheduled Maintenance

SPECIAL OPERATING CONDITIONS SCHEDULED MAINTENANCE

Gasoline Engines

If you operate your vehicle **primarily** in any

of the following conditions, you need to perform extra maintenance as indicated. If you operate your vehicle **occasionally** under any of these conditions, it is not necessary to perform the extra maintenance. For specific recommendations, see your dealership service advisor or technician.

Towing a Trailer	
Inspect frequently, service as required	Inspect and lubricate the U-joints.
	See axle maintenance items under Exceptions .
Every 5,000 mi (8,000 km)	Inspect the wheels and related components for abnormal noise, wear, looseness or drag.
Every 5,000 mi (8,000 km) or six months	Change the engine oil and filter.
	Inspect and lubricate U-joints.
Every 7,500 mi (12,000 km)	Rotate the tires ¹ and inspect them for wear, and measure the tread depth.
Every 60,000 mi (96,000 km)	Replace the spark plugs.

¹Rotate the front wheels on vehicles with dual rear wheels when specified. Only rotate the rear wheels if you notice unusual wear.

Extensive Idling or Low-speed Driving for Long Distances, as in Heavy Commercial Use (Such as Delivery, Taxi, Patrol Car or Livery)	
Inspect frequently, service as required	Replace engine air filter.
Every 5,000 mi (8,000 km)	Inspect the brake system.
	Inspect the wheels and related components for abnormal noise, wear, looseness or drag.
	Lubricate the control arm and steering ball joints if equipped with grease fittings.
Every 5,000 mi (8,000 km) or six months	Inspect and lubricate U-joints.

Scheduled Maintenance

Extensive Idling or Low-speed Driving for Long Distances, as in Heavy Commercial Use (Such as Delivery, Taxi, Patrol Car or Livery)	
Every 5,000 mi (8,000 km), six months or 200 engine hours	Change the engine oil and filter.
Every 7,500 mi (12,000 km)	Rotate the tires ¹ and inspect them for wear, and measure the tread depth.
Every 60,000 mi (96,000 km)	Replace the spark plugs.

¹Rotate the front wheels on vehicles with dual rear wheels when specified. Only rotate the rear wheels if you notice unusual wear.

Operating in Dusty or Sandy Conditions (Such as Unpaved or Dusty Roads)	
Inspect frequently, service as required	Replace the engine air filter.
Every 5,000 mi (8,000 km)	Inspect the wheels and related components for abnormal noise, wear, looseness or drag.
Every 5,000 mi (8,000 km) or six months	Change the engine oil and filter.
	Inspect and lubricate U-joints.
Every 7,500 mi (12,000 km)	Rotate the tires ¹ and inspect them for wear, and measure the tread depth.

¹Rotate the front wheels on vehicles with dual rear wheels when specified. Only rotate the rear wheels if you notice unusual wear.

Off-road Operation	
Inspect frequently, service as required	Inspect the steering linkage, ball joints and U-joints, lubricate if equipped with grease fittings.
	Replace the engine air filter.
Every 5,000 mi (8,000 km) or six months	Change the engine oil and filter.

Scheduled Maintenance

Off-road Operation	
	Inspect the wheels and related components for abnormal noise, wear, looseness or drag.
Every 7,500 mi (12,000 km)	Rotate the tires ¹ and inspect them for wear, and measure the tread depth.

¹Rotate the front wheels on vehicles with dual rear wheels when specified. Only rotate the rear wheels if you notice unusual wear.

Diesel Engine

If you operate your vehicle **primarily** in any of the following conditions, you need to perform extra maintenance as indicated. If you operate your vehicle **occasionally** under any of these conditions, it is not necessary to perform the extra maintenance. For specific recommendations, see your dealership service advisor or technician.

Towing a Trailer or Using a Car-top Carrier	
As required	Change the engine oil and filter as indicated by the information display, and perform the services listed in the scheduled maintenance chart.
	See the axle maintenance items under Exceptions .
Every 15,000 mi (24,000 km) or six months, 600 engine hours	Replace the engine-mounted and frame-mounted fuel filters.
Every 30,000 mi (48,000 km) or 1200 engine hours	Inspect the coolant concentration, freeze-point protection and additive, corrosion inhibitor strength. Add coolant additive if necessary.
Every 60,000 mi (96,000 km) or 2400 engine hours	Flush and refill the coolant. Do not add coolant additive.

Note: When adding coolant additive, do not exceed the specified maximum of 47 fl oz (1.4 L) for the engine and 20 fl oz (473 ml) for the secondary cooling system. Operating the engine with excessive coolant additive may cause overheating which could lead to severe, permanent engine damage.

Note: After the initial coolant flush and fill at 60,000 mi (96,000 km) or 2400 engine hours, flush and fill every 45,000 mi (72,000 km) or 1800 engine hours thereafter.

Scheduled Maintenance

Frequent or Extended Idling, Over 10 Minutes Per Hour of Normal Driving or Frequent Low-speed Operation if You Use Your Vehicle for Stationary Operation	
As required	Change the engine oil and filter as indicated by the information display, and perform the services listed in the scheduled maintenance chart.
Every 15,000 mi (24,000 km), six months or 600 engine hours	Replace the engine-mounted and frame-mounted fuel filters.
Every 30,000 mi (48,000 km) or 1200 engine hours	Inspect the coolant concentration, freeze-point protection and additive, corrosion inhibitor strength. Add coolant additive if necessary.
Every 60,000 mi (96,000 km) or 2400 engine hours	Flush and refill the coolant. Do not add coolant additive.

Note: When adding coolant additive, do not exceed the specified maximum of 47 fl oz (1.4 L) for the engine and 20 fl oz (473 ml) for the secondary cooling system. Operating the engine with excessive coolant additive may cause overheating which could lead to severe, permanent engine damage.

Note: After the initial coolant flush and fill at 60,000 mi (96,000 km) or 2400 engine hours, flush and fill every 45,000 mi (72,000 km) or 1800 engine hours thereafter.

Scheduled Maintenance

Frequent Low-speed Operation, Consistent Heavy Traffic Under 25 mph (40 km/h) or Long Rush-hour Traffic	
As required	Change the engine oil and filter as indicated by the information display, and perform the services listed in the scheduled maintenance chart.
Every 15,000 mi (24,000 km), six months or 600 engine hours	Replace the engine-mounted and frame-mounted fuel filters.
Every 30,000 mi (48,000 km) or 1200 engine hours	Inspect the coolant concentration, freeze-point protection and additive, corrosion inhibitor strength. Add coolant additive if necessary.
Every 60,000 mi (96,000 km) or 2400 engine hours	Flush and refill the coolant. Do not add coolant additive.

Note: When adding coolant additive, do not exceed the specified maximum of 47 fl oz (1.4 L) for the engine and 20 fl oz (473 ml) for the secondary cooling system. Operating the engine with excessive coolant additive may cause overheating which could lead to severe, permanent engine damage.

Note: After the initial coolant flush and fill at 60,000 mi (96,000 km) or 2400 engine hours, flush and fill every 45,000 mi (72,000 km) or 1800 engine hours thereafter.

Scheduled Maintenance

Sustained High-speed Driving at Gross Vehicle Weight Rating, Maximum Loaded Weight for Vehicle Operation	
As required	Change the engine oil and filter as indicated by the information display, and perform the services listed in the scheduled maintenance chart.
Every 15,000 mi (24,000 km), six months or 600 engine hours	Replace the engine-mounted and frame-mounted fuel filters.
Every 30,000 mi (48,000 km) or 1200 engine hours	Inspect the coolant concentration, freeze-point protection and additive, corrosion inhibitor strength. Add coolant additive if necessary.
Every 60,000 mi (96,000 km) or 2400 engine hours	Flush and refill the coolant. Do not add coolant additive.

Note: When adding coolant additive, do not exceed the specified maximum of 47 fl oz (1.4 L) for the engine and 20 fl oz (473 ml) for the secondary cooling system. Operating the engine with excessive coolant additive may cause overheating which could lead to severe, permanent engine damage.

Note: After the initial coolant flush and fill at 60,000 mi (96,000 km) or 2400 engine hours, flush and fill every 45,000 mi (72,000 km) or 1800 engine hours thereafter.

Operating in Sustained Ambient Temperatures Below -9.4°F (-23°C) or Above 100.3°F (38°C)	
As required	Change the engine oil and filter as indicated by the information display, and perform the services listed in the scheduled maintenance chart.
Every 15,000 mi (24,000 km), six months or 600 engine hours	Replace the engine-mounted and frame-mounted fuel filters.

Operating in Dusty or Sandy Conditions, Such as Unpaved or Dusty Roads	
Every 7,500 mi (12,000 km)	Rotate the tires ¹ , inspect the tires for wear and measure tread depth.
	Inspect the brake system pads and rotors.
	Inspect the air filter restriction gauge. Replace the filter if necessary.

Scheduled Maintenance

Operating in Dusty or Sandy Conditions, Such as Unpaved or Dusty Roads	
	Inspect the steering and suspension ball joints and tie rods. Lubricate any grease fittings.
Every 7,500 mi (12,000 km), six months or 300 engine hours	Change the engine oil and filter. ²
	Inspect and lubricate the U-joints.
Every 15,000 mi (24,000 km), 6 months or 600 engine hours	Replace the engine-mounted and frame-mounted fuel filters.
Every 30,000 mi (48,000 km)	Replace the air inlet foam filter.

¹Rotate the front wheels on vehicles with dual rear wheels when specified. Only rotate the rear wheels if you notice unusual wear.

²Reset the Intelligent Oil-Life Monitor after engine oil and filter changes.

Off-road Operation	
As required	Inspect functional holes in each leg of the twin exhaust tips and the holes under the shield just inboard of the right rear tire to make sure they are clean and clear of debris or foreign materials. Refer to the Vehicle Care chapter of your owner's manual for more information.
	Inspect the steering and suspension ball joints and tie rods. Lubricate any grease fittings.
Every 7,500 mi (12,000 km), six months or 300 engine hours	Rotate the tires ¹ , inspect the tires for wear and measure tread depth.
	Inspect the brake system pads and rotors.
	Inspect the air filter restriction gauge. Replace the filter if necessary.
Every 7,000 mi (12,000 km) or 300 engine hours	Change the engine oil and filter. ²

Scheduled Maintenance

Off-road Operation	
Every 15,000 mi (24,000 km), six months or 600 engine hours	Replace the engine-mounted and frame-mounted fuel filters.
Every 30,000 mi (48,000 km)	Replace the air inlet foam filter.

¹Rotate the front wheels on vehicles with dual rear wheels when specified. Only rotate the rear wheels if you notice unusual wear.

²Reset the Intelligent Oil-Life Monitor after engine oil and filter changes.

Using Biodiesel, up to and Including 20% Biodiesel (B20)	
As required	Change the engine oil and filter as indicated by the information display, and perform the services listed in the scheduled maintenance chart.
Every 15,000 mi (24,000 km), six months or 300 engine hours	Replace the engine-mounted and frame-mounted fuel filters.

Using Fuel Other Than Ultra-low Sulfur Diesel Fuel - Vehicles Operated Where Ultra-low Sulfur Diesel Fuel is not Required or Available	
Every 2,500 mi (4,000 km) or three months (if using high sulfur fuel with more than 500 ppm sulfur)	Change the engine oil and filter.
Every 5,000 mi (8,000 km) or six months (if using high sulfur fuel with fewer than 500 ppm sulfur)	Change the engine oil and filter.

Exceptions

There are several exceptions to the Normal Schedule:

Scheduled Maintenance

Rear Axle Maintenance

A rear axle fluid change or level check is not required unless you suspect a leak or the assembly has been submerged in water. During long periods of trailer towing with outside temperatures above 70°F (21°C), and at wide-open throttle for long periods above 45 mph (72 km/h), change the rear axle fluid every 24,000 mi (38,000 km) or three months, whichever comes first.

California Fuel Filter Replacement

If you register your vehicle in California, the California Air Resources Board has determined that the failure to perform this maintenance item does not nullify the emission warranty or limit recall liability before the completion of your vehicle's useful life. We, however, urge you to have all recommended maintenance services performed at the specified intervals and to record all vehicle service.

Hot Climate Oil Change Intervals

The normal oil change interval is 3,000 mi (5,000 km) for gasoline vehicles operating in the Middle East, North Africa, Sub-Saharan Africa or locations with similar climates using American Petroleum Institute (API) oils Certified for Gasoline Engines and displaying the API Certification Mark. If API Certified Oils are not available, then it is acceptable to use API SM or SN oils. If API oils are not available, then the oil change interval is 1,750 mi (3,000 km).

Engine Air Filter Replacement

The life of the engine air filter is dependent on exposure to dusty and dirty conditions. Vehicles operated in these conditions require frequent inspection and replacement of the engine air filter and cabin air filter.

Diesel Particulate Filter

Over time, a slight amount of ash builds up in the diesel particulate filter, which is not removed during the regeneration process. The filter may need to be replaced with a new or remanufactured part at approximately 250,000 mi (400,000 km). Actual mileage varies depending on engine and vehicle operating conditions.

In this case, the engine control system sets a service light (wrench icon) to inform you to bring your vehicle to the dealer for service. If there are any issues with the oxidation catalyst or particulate filter system, a service light (wrench or engine icon) sets by the engine control system to inform you to bring your vehicle into a dealer for service.

SCHEDULED MAINTENANCE RECORD

After the scheduled maintenance services are performed, record the Repair Order #, Distance and Engine Hours in the boxes provided.

Scheduled Maintenance

<input type="radio"/> Repair Order #:	Dealer stamp
<input type="radio"/> Distance:	
<input type="radio"/> Engine hours (optional):	
<input type="radio"/> Multi-point inspection (recommended): <input type="checkbox"/>	
<input type="radio"/> Signature:	

<input type="radio"/> Repair Order #:	Dealer stamp
<input type="radio"/> Distance:	
<input type="radio"/> Engine hours (optional):	
<input type="radio"/> Multi-point inspection (recommended): <input type="checkbox"/>	
<input type="radio"/> Signature:	

Scheduled Maintenance

<input type="radio"/> Repair Order #:	<p>Dealer stamp</p>
<input type="radio"/> Distance:	
<input type="radio"/> Engine hours (optional):	
<input type="radio"/> Multi-point inspection (recommended): <input type="checkbox"/>	
<input type="radio"/> Signature:	

<input type="radio"/> Repair Order #:	<p>Dealer stamp</p>
<input type="radio"/> Distance:	
<input type="radio"/> Engine hours (optional):	
<input type="radio"/> Multi-point inspection (recommended): <input type="checkbox"/>	
<input type="radio"/> Signature:	

Scheduled Maintenance

<input type="radio"/> Repair Order #:	Dealer stamp
<input type="radio"/> Distance:	
<input type="radio"/> Engine hours (optional):	
<input type="radio"/> Multi-point inspection (recommended): <input type="checkbox"/>	
<input type="radio"/> Signature:	

<input type="radio"/> Repair Order #:	Dealer stamp
<input type="radio"/> Distance:	
<input type="radio"/> Engine hours (optional):	
<input type="radio"/> Multi-point inspection (recommended): <input type="checkbox"/>	
<input type="radio"/> Signature:	

Scheduled Maintenance

<input type="radio"/> Repair Order #:	<p>Dealer stamp</p>
<input type="radio"/> Distance:	
<input type="radio"/> Engine hours (optional):	
<input type="radio"/> Multi-point inspection (recommended): <input type="checkbox"/>	
<input type="radio"/> Signature:	

<input type="radio"/> Repair Order #:	<p>Dealer stamp</p>
<input type="radio"/> Distance:	
<input type="radio"/> Engine hours (optional):	
<input type="radio"/> Multi-point inspection (recommended): <input type="checkbox"/>	
<input type="radio"/> Signature:	

Scheduled Maintenance

<input type="radio"/> Repair Order #:	Dealer stamp
<input type="radio"/> Distance:	
<input type="radio"/> Engine hours (optional):	
<input type="radio"/> Multi-point inspection (recommended): <input type="checkbox"/>	
<input type="radio"/> Signature:	

<input type="radio"/> Repair Order #:	Dealer stamp
<input type="radio"/> Distance:	
<input type="radio"/> Engine hours (optional):	
<input type="radio"/> Multi-point inspection (recommended): <input type="checkbox"/>	
<input type="radio"/> Signature:	

Scheduled Maintenance

<input type="radio"/> Repair Order #:	<p>Dealer stamp</p>
<input type="radio"/> Distance:	
<input type="radio"/> Engine hours (optional):	
<input type="radio"/> Multi-point inspection (recommended): <input type="checkbox"/>	
<input type="radio"/> Signature:	

<input type="radio"/> Repair Order #:	<p>Dealer stamp</p>
<input type="radio"/> Distance:	
<input type="radio"/> Engine hours (optional):	
<input type="radio"/> Multi-point inspection (recommended): <input type="checkbox"/>	
<input type="radio"/> Signature:	

Scheduled Maintenance

<input type="radio"/> Repair Order #:	Dealer stamp
<input type="radio"/> Distance:	
<input type="radio"/> Engine hours (optional):	
<input type="radio"/> Multi-point inspection (recommended): <input type="checkbox"/>	
<input type="radio"/> Signature:	

<input type="radio"/> Repair Order #:	Dealer stamp
<input type="radio"/> Distance:	
<input type="radio"/> Engine hours (optional):	
<input type="radio"/> Multi-point inspection (recommended): <input type="checkbox"/>	
<input type="radio"/> Signature:	

Scheduled Maintenance

<input type="radio"/> Repair Order #:	<p>Dealer stamp</p>
<input type="radio"/> Distance:	
<input type="radio"/> Engine hours (optional):	
<input type="radio"/> Multi-point inspection (recommended): <input type="checkbox"/>	
<input type="radio"/> Signature:	

<input type="radio"/> Repair Order #:	<p>Dealer stamp</p>
<input type="radio"/> Distance:	
<input type="radio"/> Engine hours (optional):	
<input type="radio"/> Multi-point inspection (recommended): <input type="checkbox"/>	
<input type="radio"/> Signature:	

Scheduled Maintenance

<input type="radio"/> Repair Order #:	Dealer stamp
<input type="radio"/> Distance:	
<input type="radio"/> Engine hours (optional):	
<input type="radio"/> Multi-point inspection (recommended): <input type="checkbox"/>	
<input type="radio"/> Signature:	

<input type="radio"/> Repair Order #:	Dealer stamp
<input type="radio"/> Distance:	
<input type="radio"/> Engine hours (optional):	
<input type="radio"/> Multi-point inspection (recommended): <input type="checkbox"/>	
<input type="radio"/> Signature:	

Scheduled Maintenance

<input type="radio"/> Repair Order #:	Dealer stamp
<input type="radio"/> Distance:	
<input type="radio"/> Engine hours (optional):	
<input type="radio"/> Multi-point inspection (recommended): <input type="checkbox"/>	
<input type="radio"/> Signature:	

<input type="radio"/> Repair Order #:	Dealer stamp
<input type="radio"/> Distance:	
<input type="radio"/> Engine hours (optional):	
<input type="radio"/> Multi-point inspection (recommended): <input type="checkbox"/>	
<input type="radio"/> Signature:	

Appendices

ELECTROMAGNETIC COMPATIBILITY



WARNING: Do not place objects or mount equipment on or near the airbag cover, on the side of the front or rear seatbacks, or in areas that may come into contact with a deploying airbag. Failure to follow these instructions may increase the risk of personal injury in the event of a crash.



WARNING: Do not fasten antenna cables to vehicle wiring, fuel pipes and brake pipes.



WARNING: Keep antenna and power cables at least 4 in (10 cm) from any electronic modules and airbags.

Note: We test and certify your vehicle to meet electromagnetic compatibility legislation. It is your responsibility to make sure that any equipment an authorized dealer installs on your vehicle complies with applicable local legislation and other requirements. Installation of some aftermarket electronic devices could degrade the performance of vehicle functions, which use radio frequency signals such as broadcast radio receiver, tire pressure monitoring system, push button start, Bluetooth connectivity or satellite navigation.

Note: Any radio frequency transmitter equipment in your vehicle (such as cellular telephones and amateur radio transmitters) must keep to the parameters in the following illustrations and table. We do not provide any other special provisions or conditions for installations or use.

Car

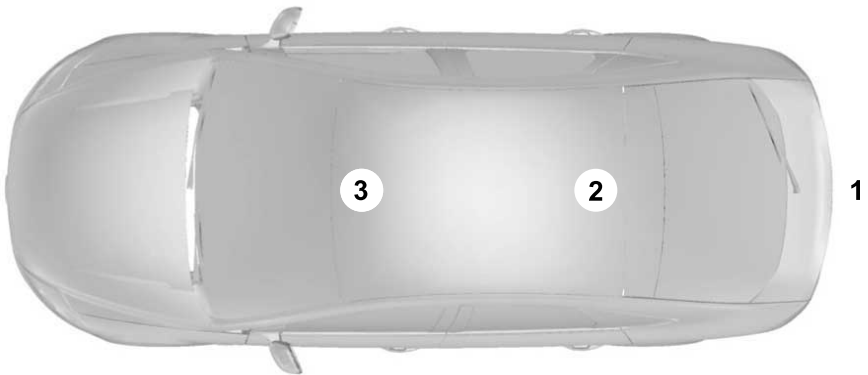

Appendices

Van

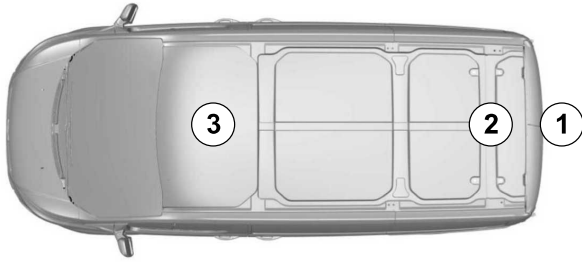

Truck

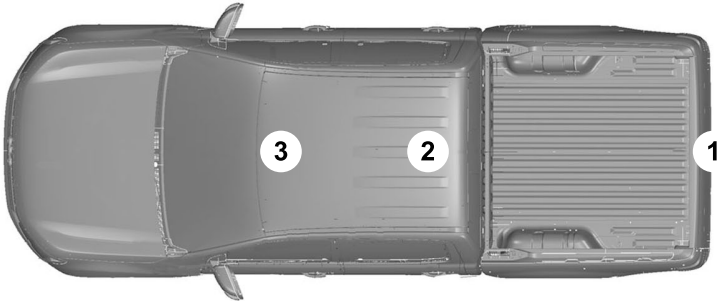

Appendices

Frequency Band MHz	Maximum output power Watt (Peak RMS)	Antenna Positions
1-30	50	1
50-54	50	2, 3
68-88	50	2, 3
142-176	50	2, 3
380-512	50	2, 3
806-870	10	2, 3

Appendices

END USER LICENSE AGREEMENT

VEHICLE SOFTWARE END USER LICENSE AGREEMENT (EULA)

- You ("You" or "Your" as applicable) have acquired a vehicle having several devices, including SYNC ® and various control modules, ("DEVICES") that include software licensed or owned by Ford Motor Company and its affiliates ("FORD MOTOR COMPANY"). Those software products of FORD MOTOR COMPANY origin, as well as associated media, printed materials, and "online" or electronic documentation ("SOFTWARE") are protected by international intellectual property laws and treaties. The SOFTWARE is licensed, not sold. All rights reserved.
- The SOFTWARE may interface with and/or communicate with, or may be later upgraded to interface with and/or communicate with additional software and/or systems provided by FORD MOTOR COMPANY.

IF YOU DO NOT AGREE TO THIS END USER LICENSE AGREEMENT ("EULA") DO NOT USE THE DEVICES OR COPY THE SOFTWARE. ANY USE OF THE SOFTWARE, INCLUDING BUT NOT LIMITED TO USE ON THE DEVICES, WILL CONSTITUTE YOUR AGREEMENT TO THIS EULA (OR RATIFICATION OF ANY PREVIOUS CONSENT).

GRANT OF SOFTWARE LICENSE: This EULA grants you the following license:

- You may use the SOFTWARE as installed on the DEVICES and as otherwise interfacing with systems and/or services provide by or through FORD MOTOR COMPANY or its third party software and service providers.

Description of Other Rights and Limitations

- **Speech Recognition:** If the SOFTWARE includes speech recognition component(s), you should understand that speech recognition is an inherently statistical process and that recognition errors are inherent in the process. Neither FORD MOTOR COMPANY nor its suppliers shall be liable for any damages arising out of errors in the speech recognition process. It is your responsibility to monitor any speech recognition functions included in the system.
- **Limitations on Reverse Engineering, Decompilation and Disassembly:** You may not reverse engineer, decompile, translate, disassemble or attempt to discover any source code or underlying ideas or algorithms of the SOFTWARE nor permit others to reverse engineer, decompile or disassemble the SOFTWARE, except and only to the extent that such activity is expressly permitted by applicable law notwithstanding this limitation or to the extent as may be permitted by the licensing terms governing use of any open source components included with the SOFTWARE.
- **Limitations on Distributing, Copying, Modifying and Creating Derivative Works:** You may not distribute, copy, make modifications to or create derivative works based on the SOFTWARE, except and only to the extent that such activity is expressly permitted by applicable law notwithstanding this limitation or to the extent as may be permitted by the licensing terms governing use of any open source components included with the SOFTWARE.

Appendices

- **Single EULA:** The end user documentation for the DEVICES and related systems and services may contain multiple EULAs, such as multiple translations and/or multiple media versions (e.g., in the user documentation and in the software). Even if you receive multiple EULAs, you are licensed to use only one (1) copy of the SOFTWARE.
- **SOFTWARE Transfer:** You may permanently transfer your rights under this EULA only as part of a sale or transfer of the DEVICES, provided you retain no copies, you transfer all of the SOFTWARE (including all component parts, the media and printed materials, any upgrades, and, if applicable, the Certificate(s) of Authenticity), and the recipient agrees to the terms of this EULA. If the SOFTWARE is an upgrade, any transfer must include all prior versions of the SOFTWARE.
- **Termination:** Without prejudice to any other rights, FORD MOTOR COMPANY may terminate this EULA if you fail to comply with the terms and conditions of this EULA.
- **Internet-Based Services Components:** The SOFTWARE may contain components that enable and facilitate the use of certain Internet-based services. You acknowledge and agree that FORD MOTOR COMPANY, third party software and service suppliers, its affiliates and/or its designated agent may automatically check the version of the SOFTWARE and/or its components that you are utilizing and may provide upgrades or supplements to the SOFTWARE that may be automatically downloaded to your DEVICES.
- **Additional Software/Services:** The SOFTWARE may permit FORD MOTOR COMPANY, third party software and service suppliers, its affiliates and/or its designated agent to provide or make available to you SOFTWARE updates, supplements, add-on components, or Internet-based services components of the SOFTWARE after the date you obtain your initial copy of the SOFTWARE ("Supplemental Components".) SOFTWARE updates may cause you to incur additional charges from your wireless service provider. If FORD MOTOR COMPANY or third party software and services suppliers provide or make available to you Supplemental Components and no other EULA terms are provided along with the Supplemental Components, then the terms of this EULA shall apply. FORD MOTOR COMPANY, its affiliates and/or its designated agent reserve the right to discontinue without liability any Internet-based services provided to you or made available to you through the use of the SOFTWARE.

Appendices

- **Links to Third Party Sites:** The SOFTWARE may provide you with the ability to link to third party sites. The third party sites are not under the control of FORD MOTOR COMPANY, its affiliates and/or its designated agent. Neither FORD MOTOR COMPANY nor its affiliates nor its designated agent are responsible for (i) the contents of any third party sites, any links contained in third party sites, or any changes or updates to third party sites, or (ii) webcasting or any other form of transmission received from any third party sites. If the SOFTWARE provides links to third party sites, those links are provided to you only as a convenience, and the inclusion of any link does not imply an endorsement of the third party site by FORD MOTOR COMPANY, its affiliates and/or its designated agent.
- **Obligation to Drive Responsibly:** You recognize your obligation to drive responsibly and keep attention on the road. You will read and abide with the DEVICES operating instructions particularly as they pertain to safety and you agree to assume any risk associated with the use of the DEVICES.

UPGRADES AND RECOVERY MEDIA:

If the SOFTWARE is provided by FORD MOTOR COMPANY separate from the DEVICES on media such as a ROM chip, CD ROM disk(s) or via web download or other means, and is labeled "For Upgrade Purposes Only" or "For Recovery Purposes Only" you may install one (1) copy of such SOFTWARE onto the DEVICES as a replacement copy for the existing SOFTWARE, and use it in accordance with this EULA, including any additional EULA terms accompanying the upgrade SOFTWARE.

INTELLECTUAL PROPERTY RIGHTS:

All title and intellectual property rights in and to the SOFTWARE (including but not limited to any images, photographs, animations, video, audio, music, text and "applets" incorporated into the SOFTWARE), the accompanying printed materials, and any copies of the SOFTWARE, are owned by FORD MOTOR COMPANY, or its affiliates or suppliers. The SOFTWARE is licensed, not sold. You may not copy the printed materials accompanying the SOFTWARE. All title and intellectual property rights in and to the content which may be accessed through use of the SOFTWARE is the property of the respective content owner and may be protected by applicable copyright or other intellectual property laws and treaties. This EULA grants you no rights to use such content outside its intended use. All rights not specifically granted under this EULA are reserved by FORD MOTOR COMPANY, its affiliates, and third party software and service providers and suppliers. Use of any on-line services which may be accessed through the SOFTWARE may be governed by the respective terms of use relating to such services. If this SOFTWARE contains documentation that is provided only in electronic form, you may print one copy of such electronic documentation.

EXPORT RESTRICTIONS: You acknowledge that the SOFTWARE is subject to U.S. and European Union export jurisdiction. You agree to comply with all applicable international and national laws that apply to the SOFTWARE, including the U.S. Export Administration Regulations, as well as end-user, end-use and destination restrictions issued by U.S. and other governments.

Appendices

TRADEMARKS: This EULA does not grant you any rights in connection with any trademarks or service marks of FORD MOTOR COMPANY, its affiliates, and third party software and service providers.

PRODUCT SUPPORT: Please refer to FORD MOTOR COMPANY instructions provided in the documentation for the DEVICES product support, such as the vehicle owner guide.

Should you have any questions concerning this EULA, or if you desire to contact FORD MOTOR COMPANY for any other reason, please refer to the address provided in the documentation for the DEVICES.

No Liability for Certain Damages: EXCEPT AS PROHIBITED BY LAW, FORD MOTOR COMPANY, ANY THIRD PARTY SOFTWARE OR SERVICES SUPPLIERS, AND THEIR AFFILIATES SHALL HAVE NO LIABILITY FOR ANY INDIRECT, SPECIAL, CONSEQUENTIAL OR INCIDENTAL DAMAGES ARISING FROM OR IN CONNECTION WITH THE USE OR PERFORMANCE OF THE SOFTWARE. THIS LIMITATION SHALL APPLY EVEN IF ANY REMEDY FAILS OF ITS ESSENTIAL PURPOSE. THERE ARE NO WARRANTIES OTHER THAN THOSE THAT MAY BE EXPRESSLY PROVIDED FOR YOUR NEW VEHICLE.

SYNC® Automotive Important Safety Information Read and follow instructions:

- Before using your SYNC® system, read and follow all instructions and safety information provided in this end user manual ("Owner Guide".) Not following precautions found in the Owner Guide can lead to an accident or other serious injuries.

General Operation

- **Voice Command Control:** Certain functions within the SYNC® system may be accomplished using voice commands. Using voice commands while driving helps you to operate the system without removing your hands from the wheel or eyes from the road.
- **Prolonged Views of Screen:** Do not access any function requiring a prolonged view of the screen while you are driving. Pull over in a safe and legal manner before attempting to access a function of the system requiring prolonged attention.
- **Volume Setting:** Do not raise the volume excessively. Keep the volume at a level where you can still hear outside traffic and emergency signals while driving. Driving while unable to hear these sounds could cause an accident.
- **Navigation Features:** Any navigation features included in the system are intended to provide turn by turn instructions to get you to a desired destination. Please make certain all persons using this system carefully read and follow instructions and safety information fully.
- **Distraction Hazard:** Any navigation features may require manual (non-verbal) setup. Attempting to perform such set-up or insert data while driving can distract your attention and could cause an accident or other serious injury. Stop the vehicle in a safe and legal manner before attempting these operations.
- **Let Your Judgment Prevail:** Any navigation features are provided only as an aid. Make your driving decisions based on your observations of local conditions and existing traffic regulations. Any such feature is not a

Appendices

substitute for your personal judgment. Any route suggestions made by this system should never replace any local traffic regulations or your personal judgment or knowledge of safe driving practices.

- **Route Safety:** Do not follow the route suggestions if doing so would result in an unsafe or illegal maneuver, if you would be placed in an unsafe situation, or if you would be directed into an area that you consider unsafe. The driver is ultimately responsible for the safe operation of the vehicle and therefore, must evaluate whether it is safe to follow the suggested directions.
- **Potential Map Inaccuracy:** Maps used by this system may be inaccurate because of changes in roads, traffic controls or driving conditions. Always use good judgment and common sense when following the suggested routes.
- **Emergency Services:** Do not rely on any navigation features included in the system to route you to emergency services. Ask local authorities or an emergency services operator for these locations. Not all emergency services such as police, fire stations, hospitals and clinics are likely to be contained in the map database for such navigation features.

Your Responsibilities and Assumptions of Risk

- You agree to each of the following:(a) Any use of the SOFTWARE while driving an automobile or other vehicle in violation of applicable law or otherwise driving in an unsafe manner presents a significant risk of distracted driving and should not be attempted under any circumstances;(b) Use of the SOFTWARE at excessive volume poses a significant risk of hearing damage and should not be attempted under any circumstances;(c) The SOFTWARE may not be compatible with new or different versions of an operating system, third party software, or third party services, and the SOFTWARE may potentially cause a critical failure of an operating system, third party software, or third party service.(d) Any third party service accessed by or third party software used with the SOFTWARE (i) may charge an additional fee for access, (ii) may not work correctly, on an uninterrupted basis, or error free, (iii) may change streaming formats or discontinue operation, (iv) may contain adult, profane or offensive content; and (v) may contain inaccurate, false or misleading traffic, weather, financial or safety information or other content; and (e) Use of the SOFTWARE may cause you to incur additional charges from your wireless service provider (WSP) and any data or minute calculators that may be included in the software program are for reference only, are not warranted in any way and should not be relied upon in anyway.
- When using the SOFTWARE, you agree to be responsible for and assume the entire risk to the items set forth in Section (a) – (e) above.

Appendices

Disclaimer of Warranty

YOU EXPRESSLY ACKNOWLEDGE AND AGREE THAT USE OF THE DEVICES AND SOFTWARE IS AT YOUR SOLE RISK AND THAT THE ENTIRE RISK AS TO SATISFACTORY QUALITY, PERFORMANCE, COMPATIBILITY, ACCURACY AND EFFORT IS WITH YOU. TO THE MAXIMUM EXTENT PERMITTED BY APPLICABLE LAW, THE SOFTWARE AND ANY THIRD PARTY SOFTWARE OR THIRD-PARTY SERVICES ARE PROVIDED "AS IS" AND "AS AVAILABLE", WITH ALL FAULTS AND WITHOUT WARRANTY OF ANY KIND, AND FORD MOTOR COMPANY HEREBY DISCLAIMS ALL WARRANTIES AND CONDITIONS WITH RESPECT TO THE SOFTWARE, THIRD PARTY SOFTWARE, AND THIRD-PARTY SERVICES, EITHER EXPRESS, IMPLIED OR STATUTORY, INCLUDING, BUT NOT LIMITED TO, THE IMPLIED WARRANTIES AND/OR CONDITIONS OF MERCHANTABILITY, OF SATISFACTORY QUALITY, OF FITNESS FOR AN PARTICULAR PURPOSE, OF ACCURACY, OF QUIET ENJOYMENT, AND NON-INFRINGEMENT OF THIRD-PARTY RIGHTS. FORD MOTOR COMPANY DOES NOT WARRANT (a) AGAINST INTERFERENCE WITH YOUR ENJOYMENT OF THE SOFTWARE, THIRD PARTY SOFTWARE, OR THIRD-PARTY SERVICES, (b) THAT THE SOFTWARE, THIRD PARTY SOFTWARE, OR THIRD-PARTY SERVICES WILL MEET YOUR REQUIREMENTS, (c) THAT THE OPERATION OF THE SOFTWARE, THIRD PARTY SOFTWARE, OR THIRD-PARTY SERVICES WILL BE UNINTERRUPTED OR ERROR-FREE, (d) OR THAT DEFECTS IN THE SOFTWARE, THIRD PARTY SOFTWARE, OR THIRD-PARTY SERVICES WILL BE CORRECTED. NO ORAL OR WRITTEN INFORMATION OR ADVICE GIVEN BY FORD MOTOR COMPANY OR ITS AUTHORIZED REPRESENTATIVE SHALL

CREATE A WARRANTY. SHOULD THE SOFTWARE, THIRD PARTY SOFTWARE, OR THIRD-PARTY SERVICES PROVE DEFECTIVE, YOU ASSUME THE ENTIRE COST OF ALL NECESSARY SERVICING, REPAIR OR CORRECTION. SOME JURISDICTIONS DO NOT ALLOW THE DISCLAIMER OF IMPLIED WARRANTIES OR LIMITATIONS ON APPLICABLE STATUTORY RIGHTS OF A CONSUMER, SO THE ABOVE DISCLAIMER MAY NOT FULLY APPLY TO YOU. THE SOLE WARRANTY PROVIDED BY FORD MOTOR COMPANY SHALL BE FOUND IN THE WARRANTY INFORMATION INCLUDING WITH YOUR OWNER GUIDE. TO THE EXTENT THAT THERE IS ANY CONFLICT BETWEEN THE TERMS OF THIS SECTION AND THE WARRANTY BOOKLET, THE WARRANTY BOOKLET SHALL CONTROL.

Applicable Law, Venue, Jurisdiction

- The laws of the State of Michigan govern this EULA and Your use of the SOFTWARE. Your use of the SOFTWARE may also be subject to other local, state, national, or international laws. Any litigation arising out of or related to this EULA shall be brought and maintained exclusively in a court of the State of Michigan located in Wayne County or in the United States District Court for the Eastern District of Michigan. You hereby consent to submit to the personal jurisdiction of a court in the State of Michigan located in Wayne County and the United States District Court for the Eastern District of Michigan for any dispute arising out of or relating to this EULA.

Appendices

Binding Arbitration and Class Action Waiver

(a) Application. This Section applies to any dispute EXCEPT IT DOES NOT INCLUDE A DISPUTE RELATING TO COPYRIGHT INFRINGEMENT, OR TO THE ENFORCEMENT OR VALIDITY OF YOUR, FORD MOTOR COMPANY, OR ANY OF FORD MOTOR COMPANY'S LICENSORS' INTELLECTUAL PROPERTY RIGHTS. Dispute means any dispute, action, or other controversy between You and FORD MOTOR COMPANY, other than the exceptions listed above, concerning the SOFTWARE (including its price) or this EULA, whether in contract, warranty, tort, statute, regulation, ordinance, or any other legal or equitable basis.

(b) Notice of Dispute. In the event of a Dispute, You or FORD MOTOR COMPANY must give the other a "Notice of Dispute", which is a written statement of the name, address, and contact information of the party giving it, the facts giving rise to the dispute, and the relief requested. You and FORD MOTOR COMPANY will attempt to resolve any dispute through informal negotiation within 60 days from the date the Notice of Dispute is sent. After 60 days, You or FORD MOTOR COMPANY may commence arbitration.

(c) Small claims court. You may also litigate any dispute in small claims court in your county of residence or FORD MOTOR COMPANY'S principal place of business, if the dispute meets all requirements to be heard in the small claims court. You may litigate in small claims court whether or not You negotiated informally first.

(d) Binding arbitration. If You and FORD MOTOR COMPANY, do not resolve any dispute by informal negotiation or in small claims court, any other effort to resolve the dispute will be conducted exclusively by binding arbitration. You are giving up

the right to litigate (or participate in as a party or class member) all disputes in court before a judge or jury. Instead, all disputes will be resolved before a neutral arbitrator, whose decision will be final except for a limited right of appeal under the Federal Arbitration Act. Any court with jurisdiction over the parties may enforce the arbitrator's award.

(e) Class action waiver. Any proceedings to resolve or litigate any dispute in any forum will be conducted solely on an individual basis. Neither you nor FORD MOTOR COMPANY, will seek to have any dispute heard as a class action, as a private attorney general action, or in any other proceeding in which any party acts or proposes to act in a representative capacity. No arbitration or proceeding will be combined with another without the prior written consent of all parties to all affected arbitrations or proceedings.

(f) Arbitration procedure. Any arbitration will be conducted by the American Arbitration Association (the "AAA"), under its Commercial Arbitration Rules. If You are an individual and use the SOFTWARE for personal or vehicle use, or if the value of the dispute is \$75,000 or less whether or not You are an individual or how You use the SOFTWARE, the AAA Supplementary Procedures for Consumer-Related Disputes will also apply. To commence arbitration, submit a Commercial Arbitration Rules Demand for Arbitration form to the AAA. You may request a telephonic or in-person hearing by following the AAA rules. In a dispute involving \$10,000 or less, any hearing will be telephonic unless the arbitrator finds good cause to hold an in-person hearing instead. For more information, see adr.org or call 1-800-778-7879. You agree to commence arbitration only in your county of residence or FORD MOTOR COMPANY'S principal place of business. The arbitrator

Appendices

may award the same damages to You individually as a court could. The arbitrator may award declaratory or injunctive relief only to You individually, and only to the extent required to satisfy Your individual claim.

(g) Arbitration fees and incentives.

- i. Disputes involving \$75,000 or less. FORD MOTOR COMPANY will promptly reimburse your filing fees and pay the AAA's and arbitrator's fees and expenses. If you reject FORD MOTOR COMPANY'S last written settlement offer made before the arbitrator was appointed ("last written offer"), your dispute goes all the way to an arbitrator's decision (called an "award"), and the arbitrator awards you more than the last written offer, FORD MOTOR COMPANY will give you three incentives: (1) pay the greater of the award or \$1,000; (2) pay twice your reasonable attorney's fees, if any; and (3) reimburse any expenses (including expert witness fees and costs) that your attorney reasonably accrues for investigating, preparing, and pursuing your claim in arbitration. The arbitrator will determine the amounts.
- ii. Disputes involving more than \$75,000. The AAA rules will govern payment of filing fees and the AAA's and arbitrator's fees and expenses.
- iii. Disputes involving any amount. In any arbitration you commence, FORD MOTOR COMPANY will seek its AAA or arbitrator's fees and expenses, or Your filing fees it reimbursed, only if the arbitrator finds the arbitration frivolous or brought for an improper purpose. In any arbitration FORD MOTOR COMPANY commences, it will pay all

filing, AAA, and arbitrator's fees and expenses. It will not seek its attorney's fees or expenses from you in any arbitration. Fees and expenses are not counted in determining how much a dispute involves.

(h) Claims or disputes must be filed within one year. To the extent permitted by law, any claim or dispute under this EULA to which this Section applies must be filed within one year in small claims court (Section c) or in arbitration (Section d). The one-year period begins when the claim or dispute first could be filed. If such a claim or dispute is not filed within one year, it is permanently barred.

(i) Severability. If the class action waiver (Section e) is found to be illegal or unenforceable as to all or some parts of a dispute, then that portion of Section e will not apply to those parts. Instead, those parts will be severed and proceed in a court of law, with the remaining parts proceeding in arbitration. If any other provision of that portion Section e is found to be illegal or unenforceable, that provision will be severed with the remainder of Section e remaining in full force and effect.

Telenav Software End User License Agreement

Please read these terms and conditions carefully before you use the TeleNav Software. Your use of the TeleNav Software indicates that you accept these terms and conditions. If you do not accept these terms and conditions, do not break the seal of the package, launch, or otherwise use the TeleNav Software. TeleNav may revise this Agreement and the privacy policy at any time, with or without notice to you. You agree to visit <http://www.telenav.com> from time to time to review the then current version of this Agreement and of the privacy policy.

Appendices

1. Safe and Lawful Use

You acknowledge that devoting attention to the TeleNav Software may pose a risk of injury or death to you and others in situations that otherwise require your undivided attention, and you therefore agree to comply with the following when using the TeleNav Software:

- (a) observe all traffic laws and otherwise drive safely;
- (b) use your own personal judgment while driving. If you feel that a route suggested by the TeleNav Software instructs you to perform an unsafe or illegal maneuver, places you in an unsafe situation, or directs you into an area that you consider to be unsafe, do not follow such instructions;
- (c) do not input destinations, or otherwise manipulate the TeleNav Software, unless your vehicle is stationary and parked;
- (d) do not use the TeleNav Software for any illegal, unauthorized, unintended, unsafe, hazardous, or unlawful purposes, or in any manner inconsistent with this Agreement;
- (e) arrange all GPS and wireless devices and cables necessary for use of the TeleNav Software in a secure manner in your vehicle so that they will not interfere with your driving and will not prevent the operation of any safety device (such as an airbag).

You agree to indemnify and hold TeleNav harmless against all claims resulting from any dangerous or otherwise inappropriate use of the TeleNav Software in any moving vehicle, including as a result of your failure to comply with the directions above.

2. Account Information

You agree: (a) when registering the TeleNav Software, to provide TeleNav with true, accurate, current, and complete information about yourself, and (b) to inform TeleNav promptly of any changes to such information, and to keep it true, accurate, current and complete.

3. Software License

- Subject to your compliance with the terms of this Agreement, TeleNav hereby grants to you a personal, non-exclusive, non-transferable license (except as expressly permitted below in connection with your permanent transfer of the TeleNav Software license), without the right to sublicense, to use the TeleNav Software (in object code form only) in order to access and use the TeleNav Software. This license shall terminate upon any termination or expiration of this Agreement. You agree that you will use the TeleNav Software only for your personal business or leisure purposes, and not to provide commercial navigation services to other parties.

3.1 License Limitations

- **(a)** reverse engineer, decompile, disassemble, translate, modify, alter or otherwise change the TeleNav Software or any part thereof; **(b)** attempt to derive the source code, audio library or structure of the TeleNav Software without the prior express written consent of TeleNav; **(c)** remove from the TeleNav Software, or alter, any of TeleNav's or its suppliers' trademarks, trade names, logos, patent or copyright notices, or other notices or markings; **(d)**

Appendices

distribute, sublicense or otherwise transfer the TeleNav Software to others, except as part of your permanent transfer of the TeleNav Software; or **(e)** use the TeleNav Software in any manner that

- i. infringes the intellectual property or proprietary rights, rights of publicity or privacy or other rights of any party,
- ii. violates any law, statute, ordinance or regulation, including but not limited to laws and regulations related to spamming, privacy, consumer and child protection, obscenity or defamation, or
- iii. is harmful, threatening, abusive, harassing, tortuous, defamatory, vulgar, obscene, libelous, or otherwise objectionable; and (f) lease, rent out, or otherwise permit unauthorized access by third parties to the TeleNav Software without advanced written permission of TeleNav.

4. Disclaimers

- To the fullest extent permissible pursuant to applicable law, in no event will TeleNav, its licensors and suppliers, or agents or employees of any of the foregoing, be liable for any decision made or action taken by you or anyone else in reliance on the information provided by the TeleNav Software. TeleNav also does not warrant the accuracy of the map or other data used for the TeleNav Software. Such data may not always reflect reality due to, among other things, road closures, construction, weather, new roads and other changing conditions. You are responsible for the entire risk arising out of your use of the TeleNav Software. For example but without limitation, you agree not to rely on the TeleNav Software for critical navigation in areas where the well-being or survival of you or others

is dependent on the accuracy of navigation, as the maps or functionality of the TeleNav Software are not intended to support such high risk applications, especially in more remote geographical areas.

- TELENAV EXPRESSLY DISCLAIMS AND EXCLUDES ALL WARRANTIES IN CONNECTION WITH THE TELENAV SOFTWARE, WHETHER STATUTORY, EXPRESS OR IMPLIED, INCLUDING ALL WARRANTIES WHICH MAY ARISE FROM COURSE OF DEALING, CUSTOM OR TRADE AND INCLUDING, BUT NOT LIMITED TO, THE IMPLIED WARRANTIES OF MERCHANTABILITY, FITNESS FOR A PARTICULAR PURPOSE AND NON-INFRINGEMENT OF THIRD PARTY RIGHTS WITH RESPECT TO THE TELENAV SOFTWARE.
- Certain jurisdictions do not permit the disclaimer of certain warranties, so this limitation may not apply to you.

5. Limitation of Liability

- TO THE EXTENT PERMITTED UNDER APPLICABLE LAW, UNDER NO CIRCUMSTANCES SHALL TELENAV OR ITS LICENSORS AND SUPPLIERS BE LIABLE TO YOU OR TO ANY THIRD PARTY FOR ANY INDIRECT, INCIDENTAL, CONSEQUENTIAL, SPECIAL OR EXEMPLARY DAMAGES (INCLUDING IN EACH CASE, BUT NOT LIMITED TO, DAMAGES FOR THE INABILITY TO USE THE EQUIPMENT OR ACCESS DATA, LOSS OF DATA, LOSS OF BUSINESS, LOSS OF PROFITS, BUSINESS INTERRUPTION OR THE LIKE) ARISING OUT OF THE USE OF OR INABILITY TO USE THE TELENAV SOFTWARE, EVEN IF TELENAV HAS BEEN ADVISED OF THE POSSIBILITY OF SUCH DAMAGES. NOTWITHSTANDING ANY DAMAGES THAT YOU MIGHT INCUR FOR ANY

Appendices

REASON WHATSOEVER (INCLUDING, WITHOUT LIMITATION, ALL DAMAGES REFERENCED HEREIN AND ALL DIRECT OR GENERAL DAMAGES IN CONTRACT, TORT (INCLUDING NEGLIGENCE) OR OTHERWISE), THE ENTIRE LIABILITY OF TELENAV AND OF ALL OF TELENAV'S SUPPLIERS SHALL BE LIMITED TO THE AMOUNT ACTUALLY PAID BY YOU FOR THE TELENAV SOFTWARE. SOME STATES AND/OR JURISDICTIONS DO NOT ALLOW THE EXCLUSION OR LIMITATION OF INCIDENTAL OR CONSEQUENTIAL DAMAGES, SO THE ABOVE LIMITATIONS OR EXCLUSIONS MAY NOT APPLY TO YOU.

6. Arbitration and Governing Law

- You agree that any dispute, claim or controversy arising out of or relating to this Agreement or the TeleNav Software shall be settled by independent arbitration involving a neutral arbitrator and administered by the American Arbitration Association in the County of Santa Clara, California. The arbitrator shall apply the Commercial Arbitration Rules of the American Arbitration Association, and the judgment upon the award rendered by the arbitrator may be entered by any court having jurisdiction. Note that there is no judge or jury in an arbitration proceeding and the decision of the arbitrator shall be binding upon both parties. You expressly agree to waive your right to a jury trial. This Agreement and performance hereunder will be governed by and construed in accordance with the laws of the State of California, without giving effect to its conflict of law provisions. To the extent judicial action is necessary in connection with the binding arbitration, both TeleNav and you agree to submit

to the exclusive jurisdiction of the courts of the County of Santa Clara, California. The United Nations Convention on Contracts for the International Sale of Goods shall not apply.

7. Assignment

- You may not resell, assign, or transfer this Agreement or any of your rights or obligations, except in totality, in connection with your permanent transfer of the TeleNav Software, and expressly conditioned upon the new user of the TeleNav Software agreeing to be bound by the terms and conditions of this Agreement. Any such sale, assignment or transfer that is not expressly permitted under this paragraph will result in immediate termination of this Agreement, without liability to TeleNav, in which case you and all other parties shall immediately cease all use of the TeleNav Software. Notwithstanding the foregoing, TeleNav may assign this Agreement to any other party at any time without notice, provided the assignee remains bound by this Agreement.

8. Miscellaneous

8.1

This Agreement constitutes the entire agreement between TeleNav and you with respect to the subject matter hereof.

8.2

Except for the limited licenses expressly granted in this Agreement, TeleNav retains all right, title and interest in and to the TeleNav Software, including without limitation all related intellectual property rights. No licenses or other rights which are not expressly granted in this Agreement are intended to, or shall be, granted or

Appendices

conferred by implication, statute, inducement, estoppel or otherwise, and TeleNav and its suppliers and licensors hereby reserve all of their respective rights other than the licenses explicitly granted in this Agreement.

8.3

By using the TeleNav Software, you consent to receive from TeleNav all communications, including notices, agreements, legally required disclosures or other information in connection with the TeleNav Software (collectively, "Notices") electronically. TeleNav may provide such Notices by posting them on TeleNav's Website or by downloading such Notices to your wireless device. If you desire to withdraw your consent to receive Notices electronically, you must discontinue your use of the TeleNav Software.

8.4

TeleNav's or your failure to require performance of any provision shall not affect that party's right to require performance at any time thereafter, nor shall a waiver of any breach or default of this Agreement constitute a waiver of any subsequent breach or default or a waiver of the provision itself.

8.5

If any provision herein is held unenforceable, then such provision will be modified to reflect the intention of the parties, and the remaining provisions of this Agreement will remain in full force and effect.

8.6

The headings in this Agreement are for convenience of reference only, will not be deemed to be a part of this Agreement, and will not be referred to in connection with the construction or interpretation of this Agreement. As used in this Agreement, the words "include" and "including" and variations thereof, will not be deemed to be terms of limitation, but rather will be deemed to be followed by the words "without limitation".

9. Other Vendors Terms and Conditions

- The Telenav Software utilizes map and other data licensed to Telenav by third party vendors for the benefit of you and other end users. This Agreement includes end-user terms applicable to these companies (included at the end of this Agreement), and thus your use of the Telenav Software is also subject to such terms. You agree to comply with the following additional terms and conditions, which are applicable to Telenav's third party vendor licensors::

9.1 End User Terms Required by HERE North America, LLC

The data ("Data") is provided for your personal, internal use only and not for resale. It is protected by copyright, and is subject to the following terms and conditions which are agreed to by you, on the one hand, and Telenav ("Telenav") and its licensors (including their licensors and suppliers) on the other hand.

© 2013 HERE. All rights reserved.

The Data for areas of Canada includes information taken with permission from Canadian authorities, including: © Her Majesty the Queen in Right of Canada, © Queen's Printer for Ontario, © Canada Post Corporation, GeoBase®, © Department of Natural Resources Canada.

Appendices

HERE holds a non-exclusive license from the United States Postal Service® to publish and sell ZIP+4® information.

©United States Postal Service® 2014. Prices are not established, controlled or approved by the United States Postal Service®. The following trademarks and registrations are owned by the USPS: United States Postal Service, USPS, and ZIP+4

The Data for Mexico includes certain data from Instituto Nacional de Estadística y Geografía.

9.2 End User Terms Required by NAV2 (Shanghai) Co., Ltd

The data (“Data”) is provided for your personal, internal use only and not for resale. It is protected by copyright, and is subject to the following terms and conditions which are agreed to by you, on the one hand, and NAV2 (Shanghai) Co., Ltd (“NAV2”) and its licensors (including their licensors and suppliers) on the other hand. 20xx. All rights reserved

Terms and Conditions

Permitted Use. You agree to use this Data together with the Telenav Software solely for the internal business and personal purposes for which you were licensed, and not for service bureau, time-sharing or other similar purposes. Accordingly, but subject to the restrictions set forth in the following paragraphs, you agree not to otherwise reproduce, copy, modify, decompile, disassemble, create any derivative works of, or reverse engineer any portion of this Data, and may not transfer or distribute it in any form, for any purpose, except to the extent permitted by mandatory laws.

Restrictions. Except where you have been specifically licensed to do so by Telenav, and without limiting the preceding paragraph, you may not use this Data (a) with any products, systems, or applications installed or otherwise connected to or in communication with vehicles, capable of vehicle navigation, positioning, dispatch, real time route guidance, fleet management or similar applications; or (b) with or in communication with any positioning devices or any mobile or wireless-connected electronic or computer devices, including without limitation cellular phones, palmtop and handheld computers, pagers, and personal digital assistants or PDAs.

Warning. The Data may contain inaccurate or incomplete information due to the passage of time, changing circumstances, sources used and the nature of collecting comprehensive geographic data, any of which may lead to incorrect results.

No Warranty. This Data is provided to you “as is,” and you agree to use it at your own risk. Telenav and its licensors (and their licensors and suppliers) make no guarantees, representations or warranties of any kind, express or implied, arising by law or otherwise, including but not limited to, content, quality, accuracy, completeness, effectiveness, reliability, fitness for a particular purpose, usefulness, use or results to be obtained from this Data, or that the Data or server will be uninterrupted or error-free.

Disclaimer of Warranty: TELENAV AND ITS LICENSORS (INCLUDING THEIR LICENSORS AND SUPPLIERS) DISCLAIM ANY WARRANTIES, EXPRESS OR IMPLIED, OF QUALITY, PERFORMANCE, MERCHANTABILITY, FITNESS FOR A

Appendices

PARTICULAR PURPOSE OR NON-INFRINGEMENT. Some States, Territories and Countries do not allow certain warranty exclusions, so to that extent the above exclusion may not apply to you.

Disclaimer of Liability: TELENAV AND ITS LICENSORS (INCLUDING THEIR LICENSORS AND SUPPLIERS) SHALL NOT BE LIABLE TO YOU: IN RESPECT OF ANY CLAIM, DEMAND OR ACTION, IRRESPECTIVE OF THE NATURE OF THE CAUSE OF THE CLAIM, DEMAND OR ACTION ALLEGING ANY LOSS, INJURY OR DAMAGES, DIRECT OR INDIRECT, WHICH MAY RESULT FROM THE USE OR POSSESSION OF THE INFORMATION; OR FOR ANY LOSS OF PROFIT, REVENUE, CONTRACTS OR SAVINGS, OR ANY OTHER DIRECT, INDIRECT, INCIDENTAL, SPECIAL OR CONSEQUENTIAL DAMAGES ARISING OUT OF YOUR USE OF OR INABILITY TO USE THIS INFORMATION, ANY DEFECT IN THE INFORMATION, OR THE BREACH OF THESE TERMS OR CONDITIONS, WHETHER IN AN ACTION IN CONTRACT OR TORT OR BASED ON A WARRANTY, EVEN IF TELENAV OR ITS LICENSORS HAVE BEEN ADVISED OF THE POSSIBILITY OF SUCH DAMAGES. Some States, Territories and Countries do not allow certain liability exclusions or damages limitations, so to that extent the above may not apply to you.

Export Control. You shall not export from anywhere any part of the Data or any direct product thereof except in compliance with, and with all licenses and approvals required under, applicable export laws, rules and regulations, including but not limited to the laws, rules and regulations administered by the Office of Foreign Assets Control of the U.S. Department of Commerce and the Bureau of Industry and Security of the U.S. Department of Commerce. To the extent that any such

export laws, rules or regulations prohibit HERE from complying with any of its obligations hereunder to deliver or distribute Data, such failure shall be excused and shall not constitute a breach of this Agreement.

Entire Agreement. These terms and conditions constitute the entire agreement between Telenav (and its licensors, including their licensors and suppliers) and you pertaining to the subject matter hereof, and supersedes in their entirety any and all written or oral agreements previously existing between us with respect to such subject matter.

Governing Law. The above terms and conditions shall be governed by the laws of the State of Illinois [insert "Netherlands" where European HERE Data is used], without giving effect to (i) its conflict of laws provisions, or (ii) the United Nations Convention for Contracts for the International Sale of Goods, which is explicitly excluded. You agree to submit to the jurisdiction of the State of Illinois [insert "The Netherlands" where European HERE Data is used] for any and all disputes, claims and actions arising from or in connection with the Data provided to you hereunder.

Government End Users. If the Data is being acquired by or on behalf of the United States government or any other entity seeking or applying rights similar to those customarily claimed by the United States government, this Data is a "commercial item" as that term is defined at 48 C.F.R. ("FAR") 2.101, is licensed in accordance with these End-User Terms, and each copy of Data delivered or otherwise furnished shall be marked and embedded as appropriate with the following "Notice of Use," and shall be treated in accordance with such Notice:

Appendices

NOTICE OF USE

CONTRACTOR (MANUFACTURER/
SUPPLIER) NAME: HERE

CONTRACTOR (MANUFACTURER/
SUPPLIER) ADDRESS: c/o Nokia, 425
West Randolph Street, Chicago, Illinois
60606

This Data is a commercial item as
defined in FAR 2.101 and is subject to
these End-User Terms under which this
Data was provided.

© 1987 – 2014 HERE – All rights reserved.

If the Contracting Officer, federal government agency, or any federal official refuses to use the legend provided herein, the Contracting Officer, federal government agency, or any federal official must notify HERE prior to seeking additional or alternative rights in the Data.

I. US/Canada Territory

A. United States Data. The End-User Terms for any Application containing Data for the United States shall contain the following notices:

"HERE holds a non-exclusive license from the United States Postal Service® to publish and sell ZIP+4® information."

"©United States Postal Service® 20XX. Prices are not established, controlled or approved by the United States Postal Service®. The following trademarks and registrations are owned by the USPS: United States Postal Service, USPS, and ZIP+4."

B. Canada Data. The following provisions apply to the Data for Canada, which may include or reflect data from third party licensors ("Third Party Data"), including Her Majesty the Queen in Right of Canada ("Her Majesty"), Canada Post Corporation ("Canada Post") and the Department of Natural Resources of Canada ("NRCan"):

1. Disclaimer and Limitation: Client agrees that its use of the Third Party Data is subject to the following provisions:

a. Disclaimer: The Third Party Data is licensed on an "as is" basis. The licensors of such data, including Her Majesty, Canada Post and NRCan, make no guarantees, representations or warranties respecting such data, either express or implied, arising by law or otherwise, including but not limited to, effectiveness, completeness, accuracy or fitness for a particular purpose.

b. Limitation on Liability: The Third Party Data licensors, including Her Majesty, Canada Post and NRCan, shall not be liable: (i) in respect of any claim, demand or action, irrespective of the nature of the cause of the claim, demand or action alleging any loss, injury or damages, direct or indirect, which may result from the use or possession of such Data; or (ii) in any way for loss of revenues or contracts, or any other consequential loss of any kind resulting from any defect in the Data.

Appendices

2. Copyright Notice: In connection with each copy of all or any portion of the Data for the Territory of Canada, Client shall affix in a conspicuous manner the following copyright notice on at least one of: (i) the label for the storage media of the copy; (ii) the packaging for the copy; or (iii) other materials packaged with the copy, such as user manuals or end user license agreements: "This data includes information taken with permission from Canadian authorities, including © Her Majesty the Queen in Right of Canada, © Queen's Printer for Ontario, © Canada Post Corporation, GeoBase®, © The Department of Natural Resources Canada. All rights reserved."

3. End-User Terms: Except as otherwise agreed by the parties, in connection with the provision of any portion of the Data for the Territory of Canada to End-Users as may be authorized under the Agreement, Client shall provide such End-Users, in a reasonably conspicuous manner, with terms (set forth with other end user terms required to be provided under the Agreement, or as otherwise may be provided, by Client) which shall include the following provisions on behalf of the Third Party Data licensors, including Her Majesty, Canada Post and NRCan:

The Data may include or reflect data of licensors, including Her Majesty the Queen in the Right of Canada ("Her Majesty"), Canada Post Corporation ("Canada Post") and the Department of Natural Resources Canada ("NRCan"). Such data is licensed on an "as is" basis. The licensors, including Her Majesty, Canada Post and NRCan, make no guarantees, representations or warranties respecting such data,

either express or implied, arising by law or otherwise, including but not limited to, effectiveness, completeness, accuracy or fitness for a particular purpose. The licensors, including Her Majesty, Canada Post and NRCan, shall not be liable in respect of any claim, demand or action, irrespective of the nature of the cause of the claim, demand or action alleging any loss, injury or damages, direct or indirect, which may result from the use or possession of the data or the Data. The licensors, including Her Majesty, Canada Post and NRCan, shall not be liable in any way for loss of revenues or contracts, or any other consequential loss of any kind resulting from any defect in the data or the Data.

End User shall indemnify and save harmless the licensors, including Her Majesty, Canada Post and NRCan, and their officers, employees and agents from and against any claim, demand or action, irrespective of the nature of the cause of the claim, demand or action, alleging loss, costs, expenses, damages or injuries (including injuries resulting in death) arising out of the use or possession of the data or the Data.

4. Additional Provisions: The terms contained in this Section are in addition to all of the rights and obligations of the parties under the Agreement. To the extent that any of the provisions of this Section are inconsistent with, or conflict with, any other provisions of the Agreement, the provisions of this Section shall prevail.

Appendices

II. Mexico. The following provision applies to the Data for Mexico, which includes certain data from the Instituto Nacional de Estadística y Geografía (“INEGI”):

A. Any and all copies of the Data and/or packaging containing Data for Mexico shall contain the following notice: “Fuente: INEGI (Instituto Nacional de Estadística y Geografía)”

III. Latin America Territory

A. Third Party Notices. Any and all copies of the Data and/or packaging relating thereto shall include the respective Third Party Notices set forth below and used as described below corresponding to the Territory (or portion thereof) included in such copy:

Territory	Notice
-----------	--------

Argentina	IGN “INSTITUTO GEOGRAFICO NACIONAL ARGENTINO”
Ecuador	“INSTITUTO GEOGRAFICO MILITAR DEL ECUADOR AUTORIZACION N° IGM-2011-01- PCO-01 DEL 25 DE ENERO DE 2011” “source: © IGN 2009 - BD TOPO ®”
Guadeloupe, French Guiana and Martinique	“Fuente: INEGI (Instituto Nacional de Estadística y Geografía)”

IV. Middle East Territory

A. Third Party Notices. Any and all copies of the Data and/or packaging relating thereto shall include the respective Third Party Notices set forth below and used as described below corresponding to the Territory (or portion thereof) included in such copy:

Country	Notice
---------	--------

Jordan	“© Royal Jordanian Geographic Centre”. The foregoing notice requirement for Jordan Data is a material term of the Agreement. If Client or any of its permitted sublicensees (if any) fail to meet such requirement, HERE shall have the right to terminate Client’s license with respect to the Jordan Data.
--------	--

B. Jordan Data. Client and its permitted sublicensees (if any) are restricted from licensing and/or otherwise distributing HERE’s database for the country of Jordan (“Jordan Data”) for use in Enterprise Applications to (i) non-Jordanian entities for use of the Jordan Data solely in Jordan or (ii) Jordan-based customers. In addition, Client, its permitted sublicensees (if any) and End-Users are restricted from using the Jordan Data in Enterprise Applications if such party is (i) a non-Jordanian entity using the Jordan Data solely in Jordan or (ii) a Jordan-based customer. For purposes of the foregoing, “Enterprise Applications” shall mean Geomarketing applications, GIS applications, mobile business asset management applications, call center applications, telematics applications, public organization Internet applications or for providing geocoding services.

Appendices

V. Europe Territory

A. Use of Certain Traffic Codes in Europe

1. General Restrictions Applicable to Traffic Codes. Client acknowledges and agrees that in certain countries of the Europe Territory, Client will need to obtain rights directly from third party RDS-TMC code providers to receive and use the Traffic Codes in the Data and to deliver to End-Users Transactions in any way derived from or based on such Traffic Codes. For such countries, HERE shall deliver the Data incorporating Traffic Codes to Client only after receiving certification from Client of its having obtained such rights.

2. Display of Third Party Rights Legends for Belgium. Client shall, for each Transaction that uses Traffic Codes for Belgium, provide the following notice to the End-User: "Traffic Codes for Belgium are provided by the Ministerie van de Vlaamse Gemeenschap and the Ministère de l'Équipement et des Transports."

B. Paper Maps. With respect to any license granted to Client relating to making, selling or distributing paper maps (i.e., a map fixed on a paper or paper-like medium): (a) such license with respect to Data for the Territory of Great Britain is conditioned on Client's entering into and complying with a separate written agreement with the Ordnance Survey ("OS") to create and sell paper maps, Client's paying to the OS any and all applicable paper map royalties, and Client's complying with the OS copyright notice requirements; (b) such license for selling or otherwise distributing for charge with respect to Data for the Territory of Czech Republic

is conditioned on Client's obtaining prior written consent from Kartografie a.s.; (c) such license for selling or distributing with respect to Data for the Territory of Switzerland is conditioned on Client's obtaining a permit from Bundesamt für Landestopografie of Switzerland; (d) Client is restricted from using Data for the Territory of France to create paper maps with a scale between 1:5,000 and 1:250,000; and (e) Client is restricted from using any Data to create, sell or distribute paper maps that are the same or substantially similar, in terms of data content and specific use of color, symbols and scale, to paper maps published by the European national mapping agencies, including without limitation, Landvermessungämter of Germany, Topografische Dienst of the Netherlands, Nationaal Geografisch Instituut of Belgium, Bundesamt für Landestopografie of Switzerland, Bundesamt für Eich-und Vermessungswesen of Austria, and the National Land Survey of Sweden.

C. OS Enforcement. Without limiting Section IV(B) above, with respect to Data for the Territory of Great Britain, Client acknowledges and agrees that the Ordnance Survey ("OS") may bring a direct action against Client to enforce compliance with the OS copyright notice (see Section IV(D) below) and paper map requirements (see Section IV(B) above) contained in this Agreement.

D. Third Party Notices. Any and all copies of the Data and/or packaging relating thereto shall include the respective Third Party Notices set forth below and used as described below corresponding to the Territory (or portion thereof) included in such copy:

Country(ies) Notice

Appendices

Austria	“© Bundesamt für Eich- und Vermessungswesen”	Spain	“Información geográfica propiedad del CNIG”
Croatia Cyprus, Estonia, Latvia, Lithuania, Moldova, Poland, Slovenia and/or Ukraine	“© EuroGeographics”	Sweden	“Based upon electronic data © National Land Survey Sweden.”
France	“source: © IGN 2009 – BD TOPO ®”	Switzerland	“Topografische Grundlage: © Bundesamt für Landestopographie.
Germany	“Die Grundlagendaten wurden mit Genehmigung der zuständigen Behörden entnommen”	E. Respective Country Distribution. Client acknowledges that HERE has not received approvals to distribute map data for the following countries in such respective countries: Albania, Belarus, Kyrgyzstan, Moldova and Uzbekistan. HERE may update such list from time to time. The license rights granted to Client under this TL with respect to the Data for such countries are contingent upon Client’s compliance with all applicable laws and regulations, including, without limitation, any required licenses or approvals to distribute the Application incorporating such Data in such respective countries.	
Great Britain	“Contains Ordnance Survey data © Crown copyright and database right 2010 Contains Royal Mail data © Royal Mail copyright and database right 2010”	VI. Australia Territory	
Greece	“Copyright Geomatics Ltd.”	A. Third Party Notices. Any and all copies of the Data and/or packaging relating thereto shall include the respective Third Party Notices set forth below and used as described below corresponding to the Territory (or portion thereof) included in such copy:	
Hungary	“Copyright © 2003; Top-Map Ltd.”	Copyright. Based on data provided under license from PSMA Australia Limited (www.pasma.com.au).	
Italy	“La Banca Dati Italiana è stata prodotta usando quale riferimento anche cartografia numerica ed al tratto prodotta e fornita dalla Regione Toscana.”		
Norway	“Copyright © 2000; Norwegian Mapping Authority”		
Portugal	“Source: IgeoE – Portugal”		

Appendices

Product incorporates data which is © 20XX Telstra Corporation Limited, GM Holden Limited, Intelomatics Australia Pty Ltd and Continental Pty Ltd.

B. Third Party Notices for Australia. In addition to the foregoing, the End-User Terms for any Application containing RDS-TMC Traffic Codes for Australia shall contain the following notice: "Product incorporates traffic location codes which is © 20XX Telstra Corporation Limited and its licensors."

AT&T Vehicle Network Carrier Telematics Disclosure

END USER FOR PURPOSES OF THIS SECTION MEANS YOU AND YOUR HEIRS, EXECUTORS, LEGAL PERSONAL REPRESENTATIVES AND PERMITTED ASSIGNS. FOR PURPOSES OF THIS SECTION "UNDERLYING WIRELESS SERVICE CARRIER" INCLUDES ITS AFFILIATES AND CONTRACTORS AND THEIR RESPECTIVE OFFICERS, DIRECTORS, EMPLOYEES, SUCCESSORS AND ASSIGNS. END USER HAS NO CONTRACTUAL RELATIONSHIP WITH THE UNDERLYING WIRELESS SERVICE CARRIER AND END USER IS NOT A THIRD PARTY BENEFICIARY OF ANY AGREEMENT BETWEEN FORD AND UNDERLYING CARRIER. END USER UNDERSTANDS AND AGREES THAT THE UNDERLYING CARRIER HAS NO LEGAL, EQUITABLE, OR OTHER LIABILITY OF ANY KIND TO END USER. IN ANY EVENT, REGARDLESS OF THE FORM OF THE ACTION, WHETHER FOR BREACH OF CONTRACT, WARRANTY, NEGLIGENCE, STRICT LIABILITY IN TORT OR OTHERWISE, END USER'S EXCLUSIVE REMEDY FOR CLAIMS ARISING IN ANY WAY IN CONNECTION WITH THIS AGREEMENT, FOR ANY CAUSE WHATSOEVER, INCLUDING BUT NOT LIMITED TO ANY FAILURE OR

DISRUPTION OF SERVICE PROVIDED HEREUNDER, IS LIMITED TO PAYMENT OF DAMAGES IN AN AMOUNT NOT TO EXCEED THE AMOUNT PAID BY END USER FOR THE SERVICES DURING THE TWO-MONTH PERIOD PRECEDING THE DATE THE CLAIM AROSE.

(ii) END USER AGREES TO INDEMNIFY AND HOLD HARMLESS THE UNDERLYING WIRELESS SERVICE CARRIER AND ITS OFFICERS, EMPLOYEES, AND AGENTS AGAINST ANY AND ALL CLAIMS, INCLUDING WITHOUT LIMITATION CLAIMS FOR LIBEL, SLANDER, OR ANY PROPERTY DAMAGE, PERSONAL INJURY OR DEATH, ARISING IN ANY WAY, DIRECTLY OR INDIRECTLY, IN CONNECTION WITH THIS AGREEMENT OR THE USE, FAILURE TO USE, OR INABILITY TO USE THE DEVICE EXCEPT WHERE THE CLAIMS RESULT FROM THE UNDERLYING CARRIER'S GROSS NEGLIGENCE OR WILLFUL MISCONDUCT. THIS INDEMNITY WILL SURVIVE THE TERMINATION OF THE AGREEMENT.

(iii) END USER HAS NO PROPERTY RIGHT IN ANY NUMBER ASSIGNED TO THE DEVICE.

(iv) END USER UNDERSTANDS THAT FORD AND THE UNDERLYING CARRIER CANNOT GUARANTY THE SECURITY OF WIRELESS TRANSMISSIONS, AND WILL NOT BE LIABLE FOR ANY LACK OF SECURITY RELATING TO THE USE OF THE SERVICES

THE SERVICE IS FOR [END USER'S] USE ONLY AND END USER MAY NOT RESELL THE SERVICE TO ANY OTHER PARTY END USER UNDERSTANDS THAT THE UNDERLYING CARRIER DOES NOT GUARANTEE ANY END USER UNINTERRUPTED SERVICE OR COVERAGE. THE UNDERLYING CARRIER DOES NOT WARRANT THAT END USERS CAN OR WILL BE LOCATED USING THE SERVICE. THE UNDERLYING CARRIER

Appendices

MAKES NO WARRANTY, EXPRESS OR IMPLIED, OF MERCHANTABILITY OR FITNESS FOR A PARTICULAR PURPOSE, SUITABILITY, OR PERFORMANCE REGARDING ANY SERVICES OR GOODS, AND IN NO EVENT SHALL AT&T BE LIABLE, WHETHER OR NOT DUE TO ITS OWN NEGLIGENCE, FOR ANY: (A) ACT OR OMISSION OF A THIRD PARTY; (B) MISTAKES, OMISSIONS, INTERRUPTIONS, ERRORS, FAILURES TO TRANSMIT, DELAYS, OR DEFECTS IN THE SERVICE PROVIDED BY OR THROUGH THE UNDERLYING CARRIER; (C) DAMAGE OR INJURY CAUSED BY SUSPENSION OR TERMINATION BY THE UNDERLYING CARRIER; OR (D) DAMAGE OR INJURY CAUSED BY A FAILURE OR DELAY IN CONNECTING A CALL TO ANY ENTITY, INCLUDING 911 OR ANY OTHER EMERGENCY SERVICE. TO THE FULL EXTENT ALLOWED BY LAW, THE END USER RELEASES, INDEMNIFIES AND HOLDS THE UNDERLYING CARRIER HARMLESS FROM AND AGAINST ANY AND ALL CLAIMS OF ANY PERSON OR ENTITY FOR DAMAGES OF ANY NATURE ARISING IN ANY WAY FROM OR RELATING TO, DIRECTLY OR INDIRECTLY, SERVICES PROVIDED BY THE UNDERLYING CARRIER OR ANY PERSON'S USE THEREOF, INCLUDING CLAIMS ARISING IN WHOLE OR IN PART FROM THE ALLEGED NEGLIGENCE OF THE UNDERLYING CARRIER.

VII. China Territory

Personal Use Only

You agree to use this Data together with [insert name of Client Application] for the solely personal, non-commercial purposes for which you were licensed, and not for service bureau, time-sharing or other similar purposes. Accordingly, but subject to the restrictions set forth in the following paragraphs, you may copy this Data only as necessary for your personal use to (i)

view it, and (ii) save it, provided that you do not remove any copyright notices that appear and do not modify the Data in any way. You agree not to otherwise reproduce, copy, modify, decompile, disassemble or reverse engineer any portion of this Data, and may not transfer or distribute it in any form, for any purpose, except to the extent permitted by mandatory laws.

Restrictions

Except where you have been specifically licensed to do so by NAV2, and without limiting the preceding paragraph, you may not (a) use this Data with any products, systems, or applications installed or otherwise connected to or in communication with vehicles, capable of vehicle navigation, positioning, dispatch, real time route guidance, fleet management or similar applications; or (b) with or in communication with any positioning devices or any mobile or wireless-connected electronic or computer devices, including without limitation cellular phones, palmtop and handheld computers, pagers, and personal digital assistants or PDAs. You agree to cease using this Data if you fail to comply with these terms and conditions.

Limited Warranty

NAV2 warrants that (a) the Data will perform substantially in accordance with the accompanying written materials for a period of ninety (90) days from the date of receipt, and (b) any support services provided by NAV2 shall be substantially as described in applicable written materials provided to you by NAV2, and NAV2's support engineers will make commercially reasonable efforts to solve any problem issues.

Appendices

***rig*Customer Remedies**

NAV2 and its suppliers' entire liability and your exclusive remedy shall be, at NAV2's sole discretion, either (a) return of the price paid, if any, or (b) repair or replacement of the Data that do not meet NAV2's Limited Warranty and that are returned to NAV2 with a copy of your receipt. This Limited Warranty is void if failure of the Data has resulted from accident, abuse, or misapplication. Any replacement Data will be warranted for the remainder of the original warranty period or thirty (30) days, whichever is longer. Neither these remedies nor any product support services offered by NAV2 are available without proof of purchase from an authorized international source.

No Other Warranty:

EXCEPT FOR THE LIMITED WARRANTY SET FORTH ABOVE AND TO THE EXTENT PERMITTED BY APPLICABLE LAW, NAV2 AND ITS LICENSORS (INCLUDING THEIR LICENSORS AND SUPPLIERS) DISCLAIM ANY WARRANTIES, EXPRESS OR IMPLIED, OF QUALITY, PERFORMANCE, MERCHANTABILITY, FITNESS FOR A PARTICULAR PURPOSE, OWNERSHIP OR NON-INFRINGEMENT. Certain warranty exclusions may not be permitted under applicable law, so to that extent the above exclusion may not apply to you.

Limited Liability:

TO THE EXTENT PERMITTED BY APPLICABLE LAW, NAV2 AND ITS LICENSORS (INCLUDING THEIR LICENSORS AND SUPPLIERS) SHALL NOT BE LIABLE TO YOU: IN RESPECT OF ANY CLAIM, DEMAND OR ACTION, IRRESPECTIVE OF THE NATURE OF THE CAUSE OF THE CLAIM, DEMAND OR ACTION ALLEGING ANY LOSS, INJURY OR DAMAGES, DIRECT OR INDIRECT, WHICH MAY RESULT FROM THE USE OR POSSESSION OF THE INFORMATION; OR

FOR ANY LOSS OF PROFIT, REVENUE, CONTRACTS OR SAVINGS, OR ANY OTHER DIRECT, INDIRECT, INCIDENTAL, SPECIAL OR CONSEQUENTIAL DAMAGES ARISING OUT OF YOUR USE OF OR INABILITY TO USE THIS INFORMATION, ANY DEFECT IN THE INFORMATION, OR THE BREACH OF THESE TERMS OR CONDITIONS, WHETHER IN AN ACTION IN CONTRACT OR TORT OR BASED ON A WARRANTY, EVEN IF NAV2 OR ITS LICENSORS HAVE BEEN ADVISED OF THE POSSIBILITY OF SUCH DAMAGES. UNDER NO CIRCUMSTANCES SHALL NAV2'S OR ITS SUPPLIERS' LIABILITY HEREUNDER EXCEED THE PRICE PAID. Certain liability exclusions may not be permitted under applicable law, so to that extent the above exclusion may not apply to you.

Export Control

You agree not to export to anywhere any part of the Data provided to you or any direct product thereof except in compliance with, and with all licenses and approvals required under, applicable export laws, rules and regulations.

IP Protection

The Data are owned by NAV2 or its suppliers and are protected by applicable copyright and other intellectual property law and treaties. The Data are provided solely on the basis of a license to use, not sale.

Entire Agreement

These terms and conditions constitute the entire agreement between NAV2 (and its licensors, including their licensors and suppliers) and you pertaining to the subject matter hereof, and supersedes in their entirety any and all written or oral agreements previously existing between us with respect to such subject matter.

Appendices

Governing Law.

The above terms and conditions shall be governed by the laws of the People's Republic of China, without giving effect to (i) its conflict of laws provisions, or (ii) the United Nations Convention for Contracts for the International Sale of Goods, which is explicitly excluded. Any dispute arising from or in connection with the Data provided to you hereunder shall be submitted to the Shanghai International Economic and Trade Arbitration Commission for arbitration.

Gracenote® Copyright

CD and music-related data from Gracenote, Inc., copyright©

2000-2007 Gracenote. Gracenote Software, copyright © 2000-2007 Gracenote. This product and service may practice one or more of the following U.S. Patents 5,987,525; 6,061,680; 6,154,773; 6,161,132; 6,230,192; 6,230,207; 6,240,459; 6,330,593 and other patents issued or pending. Some services supplied under license from Open Globe, Inc. for U.S. Patent 6,304,523.

Gracenote and CDDDB are registered trademarks of Gracenote. The Gracenote logo and logotype, and the "Powered by Gracenote™" logo are trademarks of Gracenote.

Gracenote® End User License Agreement (EULA)

This device contains software from Gracenote, Inc. of 2000 Powell Street Emeryville, California 94608 ("Gracenote").

The software from Gracenote (the "Gracenote Software") enables this device to do disc and music file identification and obtain music-related information, including name, artist, track, and title information ("Gracenote Data") from online servers

("Gracenote Servers"), and to perform other functions. You may use Gracenote Data only by means of the intended End User functions of this device. This device may contain content belonging to Gracenote's providers. If so, all of the restrictions set forth herein with respect to Gracenote Data shall also apply to such content and such content providers shall be entitled to all of the benefits and protections set forth herein that are available to Gracenote. You agree that you will use the content from Gracenote ("Gracenote Content"), Gracenote Data, the Gracenote Software, and Gracenote Servers for your own personal, non-commercial use only. You agree not to assign, copy, transfer or transmit the Gracenote Content, Gracenote Software or any Gracenote Data (except in a Tag associated with a music file) to any third party. YOU AGREE NOT TO USE OR EXPLOIT GRACENOTE CONTENT, GRACENOTE DATA, THE GRACENOTE SOFTWARE, OR GRACENOTE SERVERS, EXCEPT AS EXPRESSLY PERMITTED HEREIN.

You agree that your non-exclusive licenses to use the Gracenote Content, Gracenote Data, the Gracenote Software, and Gracenote Servers will terminate if you violate these restrictions. If your licenses terminate, you agree to cease any and all use of the Gracenote Content, Gracenote Data, the Gracenote Software, and Gracenote Servers.

Gracenote, respectively, reserve all rights in Gracenote Data, the Gracenote Software, and the Gracenote Servers and Gracenote Content, including all ownership rights. Under no circumstances will either Gracenote become liable for any payment to you for any information that you provide,

Appendices

including any copyrighted material or music file information. You agree that Gracenote may enforce its respective rights, collectively or separately, under this agreement against you, directly in each company's own name.

Gracenote uses a unique identifier to track queries for statistical purposes. The purpose of a randomly assigned numeric identifier is to allow Gracenote to count queries without knowing anything about who you are. For more information, see the web page at www.gracenote.com for the Gracenote Privacy Policy.

THE GRACENOTE SOFTWARE, EACH ITEM OF GRACENOTE DATA AND THE GRACENOTE CONTENT ARE LICENSED TO YOU "AS IS". NEITHER GRACENOTE MAKES ANY REPRESENTATIONS OR WARRANTIES, EXPRESS OR IMPLIED, REGARDING THE ACCURACY OF ANY GRACENOTE DATA FROM THE GRACENOTE SERVERS OR GRACENOTE CONTENT. GRACENOTE COLLECTIVELY AND SEPARATELY RESERVE THE RIGHT TO DELETE DATA AND/OR CONTENT FROM THE COMPANIES' RESPECTIVE SERVERS OR, IN THE CASE OF GRACENOTE, CHANGE DATA CATEGORIES FOR ANY CAUSE THAT GRACENOTE DEEMS SUFFICIENT. NO WARRANTY IS MADE THAT EITHER GRACENOTE CONTENT OR THE GRACENOTE SOFTWARE OR GRACENOTE SERVERS ARE ERROR-FREE OR THAT THE FUNCTIONING OF THE GRACENOTE SOFTWARE OR GRACENOTE SERVERS WILL BE UNINTERRUPTED. GRACENOTE IS NOT OBLIGATED TO PROVIDE YOU WITH ANY ENHANCED OR ADDITIONAL DATA TYPES THAT GRACENOTE MAY CHOOSE TO PROVIDE IN THE FUTURE AND IS FREE TO DISCONTINUE ITS ONLINE SERVICES AT ANY TIME. GRACENOTE DISCLAIM ALL WARRANTIES EXPRESS OR IMPLIED, INCLUDING, BUT NOT LIMITED TO,

IMPLIED WARRANTIES OF MERCHANTABILITY, FITNESS FOR A PARTICULAR PURPOSE, TITLE, AND NON-INFRINGEMENT. NEITHER GRACENOTE WARRANTS THE RESULTS THAT WILL BE OBTAINED BY YOUR USE OF THE GRACENOTE SOFTWARE OR ANY GRACENOTE SERVER. IN NO CASE WILL GRACENOTE BE LIABLE FOR ANY CONSEQUENTIAL OR INCIDENTAL DAMAGES OR FOR ANY LOST PROFITS OR LOST REVENUES FOR ANY REASON WHATSOEVER. © Gracenote 2007.

Radio Frequency Statement

FCC ID: ACJ-SYNCG3-L

IC: 216B-SYNCG3-L

This device complies with Part 15 of the FCC Rules and with RSS-210 of Industry Canada. Operation is subject to the following two conditions:

- (1)** This device may not cause harmful interference, and
- (2)** this device must accept any interference received, including interference that may cause undesired operation.



WARNING: Changes or modifications not expressly approved by the party responsible for compliance could void the user's authority to operate the equipment. The term "IC:" before the radio certification number only signifies that Industry Canada technical specifications were met.

The antenna used for this transmitter must not be co-located or operating in conjunction with any other antenna or transmitter.

Appendices

Taiwan Territory

Note: In accordance with the management approach of low-power radio wave radiation motors:

Article 12: For approved and certified low-power radiation motor models, companies, firms or users must not alter the frequency, increase the power or change the characteristics and functions of the original design without authorization.

Article 14: The usage of low-power radio-frequency motors must not affect aviation safety and interfere with legal telecommunications. Should interference be detected, immediately stop using the device and only resume usage after ensuring that there is no longer any interference. For the legal telecommunication and wireless telecommunication of the telco, the low-power radio frequency motor must be able to tolerate legal limits of interference from telecommunication, industrial, scientific and radio wave equipment.

SUNA TRAFFIC CHANNEL – TERMS AND CONDITIONS

By activating, using and/or accessing the SUNA Traffic Channel, SUNA Predictive or other content or material provided by Intelematics (together, **SUNA Products and/or Services**), you must accept certain terms and conditions. The following is a brief summary of the terms and conditions that apply to you. To view the full terms and conditions relevant to your use of the SUNA Products and/or Services, please consult:

Website
www.sunattraffic.com.au/termsandconditions/

1. Acceptance

By using SUNA Products and/or Services, you will be deemed to have accepted and agreed to be bound by the terms and conditions fully detailed at:

Website
www.sunattraffic.com.au/termsandconditions/

2. Intellectual Property

SUNA Products and/or Services are for your personal use. You may not record, or retransmit the content, nor use the content in association with any other traffic information or route guidance service or device not approved by Intelematics. You obtain no right of ownership in any Intellectual Property Rights (including copyright) in the data that is used to provide SUNA Products and/or Services.

3. Appropriate Use

SUNA Products and/or Services are intended as an aid to personal motoring and travel planning, and do not provide comprehensive or accurate information on all occasions. On occasions, you may experience additional delay as a result of using SUNA Products and/or Services. You acknowledge that it is not intended, or suitable, for use in applications where time of arrival or driving directions may impact the safety of the public or yourself.

4. Use of SUNA Products and Services while driving

You, and other authorised drivers of the vehicle in which SUNA Products and/or Services are available or installed and active, remain at all times responsible for observing all relevant laws and codes of safe driving. In particular, you agree to only actively operate SUNA Products and/or Services when the Vehicle is at a complete stop and it is safe to do so.

Appendices

5. Service Continuity and Reception of the SUNA Traffic Channel

We will use reasonable endeavours to provide the SUNA Traffic Channel 24 hours a day, 365 days a year. The SUNA Traffic Channel may occasionally be unavailable for technical reasons or for planned maintenance. We will try to perform maintenance at times when congestion is light. We reserve the right to withdraw SUNA Products and/or Services at any time.

Also, we cannot assure the uninterrupted reception of the SUNA Traffic Channel RDS-TMC signal at any particular location.

6. Limitation of Liability

Neither Intelematics (nor its suppliers or the manufacturer of your device (the “**Suppliers**”)) shall be liable to you or to any third party for any damages either direct, indirect, incidental, consequential or otherwise arising out of the use of or inability to use SUNA Products and/or Services even if Intelematics or a Supplier has been advised of the possibility of such damages. You also acknowledge that the neither Intelematics nor any Supplier guarantees nor make any warranties that relate to the availability, accuracy or completeness of SUNA Products and/or Services, and to the extent which it is lawful to do so, both Intelematics and each Supplier excludes any warranties which might otherwise be implied by any State or Federal legislation in relation to SUNA Products and/or Services.

7. Please Note

Great care has been taken in preparing this manual. Constant product development may mean that some information is not entirely up-to-date. The information in this document is subject to change without notice.

DECLARATION OF CONFORMITY

Your vehicle could have components that transmit and receive radio waves and are therefore subject to government regulation.

These components must accept any interference received, including interference that could cause undesired operation. For certification labels and declarations of conformity, visit www.wirelessconformity.ford.com.

Index

2

2-Speed Rear Axle.....	129
Axle Shifting.....	129

A

A/C

See: Climate Control.....	79
---------------------------	----

About This Manual.....	7
------------------------	---

Diesel Engine Information.....	8
Minor Troubleshooting Guide.....	9
Warnings.....	8

ABS

See: Brakes.....	130
------------------	-----

ABS driving hints

See: Hints on Driving With Anti-Lock Brakes.....	131
---	-----

Accessories.....	315
------------------	-----

Accessories

See: Replacement Parts Recommendation.....	17
---	----

ACC

See: Using Adaptive Cruise Control.....	148
---	-----

Adjusting the Headlamps.....	240
------------------------------	-----

Horizontal Aim Adjustment.....	241
Vertical Aim Adjustment.....	240

Adjusting the Steering Wheel.....	52
-----------------------------------	----

Air Brakes.....	135
-----------------	-----

Air Chamber Stroke Indication.....	135
Cam Brakes - Automatic Slack Adjusters.....	136
Emergency Air Brake.....	136

Air Conditioning

See: Climate Control.....	79
---------------------------	----

Air Filter

See: Changing the Engine Air Filter - 6.7L Diesel.....	221
See: Changing the Engine Air Filter - 7.3L.....	223

Air Induction System Inspection.....	247
--------------------------------------	-----

Chassis-mounted Charge Air Cooler.....	247
--	-----

Air Suspension.....	169
---------------------	-----

Air Suspension Dump Button.....	169
Connecting and Disconnecting a Trailer with Air Suspension and Air Suspension Dump Button.....	169
Suspension Conversions.....	169

System Indicator Light.....	169
-----------------------------	-----

Appendices.....	348
-----------------	-----

At a Glance.....	22
------------------	----

Audible Warnings and Indicators.....	69
--------------------------------------	----

Headlamps On Warning Chime.....	69
Key in Ignition Warning Chime.....	69
Parking Brake On Warning Chime.....	69

Audio System.....	307
-------------------	-----

General Information.....	307
--------------------------	-----

Audio Unit.....	307
-----------------	-----

Accessing the Sound Settings.....	308
-----------------------------------	-----

Accessing the System Settings.....	308
------------------------------------	-----

Adjusting the Volume.....	308
---------------------------	-----

Changing Radio Stations.....	308
------------------------------	-----

Pausing or Playing Media.....	308
-------------------------------	-----

Returning to the Previous Screen.....	308
---------------------------------------	-----

Scrolling Through the Menu Options.....	308
---	-----

Selecting a Menu Option.....	309
------------------------------	-----

Selecting Media.....	308
----------------------	-----

Selecting the Radio.....	309
--------------------------	-----

Setting a Memory Preset.....	309
------------------------------	-----

Switching the Audio Unit On and Off.....	309
--	-----

Using a Cell Phone.....	309
-------------------------	-----

Using Seek, Fast Forward and Reverse.....	309
--	-----

Autolamps.....	56
----------------	----

Windshield Wiper Activated

Headlamps.....	56
----------------	----

Automatic High Beam Control.....	57
----------------------------------	----

Automatic High Beam Indicator.....	58
------------------------------------	----

Switching the System On and Off.....	57
--------------------------------------	----

Automatic Transmission.....	122
-----------------------------	-----

Brake-Shift Interlock.....	125
----------------------------	-----

If Your Vehicle Gets Stuck in Mud or

Snow.....	126
-----------	-----

Progressive Range Selection - PRS.....	125
--	-----

Understanding the Shift Positions of a
--

6-Speed Automatic Transmission.....	122
-------------------------------------	-----

Understanding Your SelectShift™

Automatic Transmission.....	123
-----------------------------	-----

Automatic Transmission Fluid

Check.....	236
------------	-----

Transmission Fluid Level.....	236
-------------------------------	-----

Auxiliary Power Points.....	89
-----------------------------	----

110 Volt AC Power Point.....	89
------------------------------	----

12 Volt DC Power Point.....	89
-----------------------------	----

Locations.....	89
----------------	----

Index

Auxiliary Switches.....	315
Upfitter Interface Module.....	316
Axle Inspection.....	251
Front Axle.....	251

B

Battery	
See: Changing the 12V Battery.....	239
Bonnet Lock	
See: Opening and Closing the Hood.....	213
Booster Seats.....	32
Types of Booster Seats.....	33
Brake Fluid Check.....	237
Brake Fluid Service Interval.....	238
Brakes.....	130
General Information.....	130
Brake System Inspection.....	248
Air Brakes.....	249
Driveline Parking Brake.....	251
Hydraulic Brakes.....	250
Breaking-In.....	179
Bulb Specification Chart.....	305

C

Canceling the Set Speed.....	155
Capacities and Specifications - 6.7L	
Diesel.....	288
Air Conditioning System.....	288
Alternative Engine Oil for Biodiesel Fuel	
Blends (B20 Max).....	291
Alternative Engine Oil for Extremely Cold	
Climates.....	291
Alternative Engine Oil for Severe Duty	
Service.....	292
Alternative Rear Axle Fluid for Severe Duty	
Service.....	296
Automatic Transmission.....	288
Diesel Exhaust Fluid (DEF) Tank.....	293
Engine Coolant.....	289
Engine Oil.....	290
Front Wheel Bearing Oil.....	295
Fuel Tank.....	292
Grease.....	293
Hydraulic Brake System.....	293
Locks.....	294
Power Steering System.....	294

Rear Axle.....	295
Washer Reservoir.....	296
Capacities and Specifications -	
7.3L.....	297
Air Conditioning System.....	297
Alternative Engine Oil for Extremely Cold	
Climates.....	300
Alternative Rear Axle Fluid for Severe Duty	
Service.....	304
Automatic Transmission.....	298
Engine Coolant.....	299
Engine Oil.....	299
Front Wheel Bearing Oil.....	303
Fuel Tank.....	301
Grease.....	301
Hydraulic Brake System.....	301
Locks.....	302
Power Steering System.....	302
Rear Axle.....	303
Washer Reservoir.....	304
Capacities and Specifications.....	281
Car Wash	
See: Cleaning the Exterior.....	256
Catalytic Converter.....	110
On-Board Diagnostics (OBD-II).....	111
Readiness for Inspection and Maintenance	
(I/M) Testing.....	111
Changing a Bulb.....	243
Brake Lamp, Rear Lamp, Rear Direction	
Indicator, License Plate Lamp and	
Reverse Lamp.....	244
Front Clearance and Identification	
Lamp.....	243
Headlamp Bulbs.....	243
Changing a Fuse.....	201
Fuses.....	201
Changing a Road Wheel.....	277
Tire Change Procedure.....	277
Changing the 12V Battery.....	239
Battery Management System (If	
Equipped).....	240
Changing the Engine Air Filter - 6.7L	
Diesel.....	221
Air Filter Replacement.....	222
Air Filter Restriction Gauge.....	221
Changing the Engine Air Filter -	
7.3L.....	223

Index

Changing the Engine-Mounted and Diesel Fuel Conditioner Module Fuel Filters - 6.7L Diesel.....	244
Diesel Fuel Conditioner Module Filter.....	244
Engine-mounted Fuel Filter.....	246
Changing the Engine Oil and Oil Filter.....	219
Engine lubrication for severe service operation.....	220
Changing the Wiper Blades.....	242
Charging a Device.....	91
Checking the Wiper Blades.....	242
Child Restraint and Seatbelt Maintenance.....	44
Child Restraint Positioning.....	34
Child Safety.....	24
General Information.....	24
Child Safety Locks.....	36
Cleaning Products.....	255
Materials.....	255
Cleaning the Engine.....	257
Cleaning the Exterior.....	256
Cleaning the Headlamps.....	256
Exterior Chrome Parts.....	256
Exterior Plastic Parts.....	256
Stripes or Graphics.....	256
Underbody.....	257
Under Hood.....	257
Cleaning the Instrument Panel and Instrument Cluster Lens.....	258
Cleaning the Interior.....	258
Mirrors.....	258
Cleaning the Wheels.....	259
Cleaning the Windows and Wiper Blades.....	257
Climate Control.....	79
Cold Weather Precautions.....	177
Winter Operating Tips for Arctic Operation -20°F (-29°C) and Below.....	179
Connected Vehicle.....	306
Connecting the Vehicle to a Mobile Network.....	306
Connected Vehicle Limitations.....	306
Connected Vehicle Requirements.....	306
Connected Vehicle – Troubleshooting.....	306
Connecting a Bluetooth® Device.....	312
Pairing a Device.....	312
Connecting the Vehicle to a Mobile Network.....	306
Connecting FordPass to the Connectivity Device.....	306
Disabling the Connectivity Device.....	306
What Is the Connectivity Device.....	306
Coolant Check.....	
See: Engine Coolant Check - 6.7L Diesel.....	231
See: Engine Coolant Check - 7.3L.....	226
Cruise Control.....	148
Cruise Control Indicators.....	155
Cruise Control – Vehicles With: Adaptive Cruise Control.....	52
Cruise Control – Vehicles With: Cruise Control.....	53
Customer Assistance.....	187
D	
Data Recording.....	13
Comfort, Convenience and Entertainment Data.....	15
Event Data.....	14
Service Data.....	13
Services That Third Parties Provide.....	15
Services That We Provide.....	15
Vehicles With a Connectivity Device.....	15
Vehicles With an Emergency Call System.....	16
Vehicles With SYNC.....	16
Daytime Running Lamps.....	57
Declaration of Conformity.....	376
Diesel Particulate Filter.....	116
Oxidation Catalytic Converter and Diesel Particulate Filter System.....	117
Digital Radio.....	310
HD Radio Reception and Station Troubleshooting.....	311
Direction Indicators.....	58
Doors and Locks.....	49
Draining the Fuel Filter Water Trap - 6.7L Diesel.....	225
Draining the Diesel Fuel Conditioner Module (DFCM).....	225
Driver Alert.....	156
Using Driver Alert.....	156

Index

Driving Aids.....	156	Fail-Safe Cooling.....	229
Driving Hints.....	176	Recycled Coolant.....	228
Driving Through Water.....	180	Severe Climates.....	228
Operation in Standing Water.....	180	Engine Emission Control.....	109
DRL		Engine Idle Shutdown.....	96
See: Daytime Running Lamps.....	57	Engine Immobilizer	
E		See: Passive Anti-Theft System.....	51
Economical Driving.....	177	Engine Oil Check - 6.7L Diesel.....	218
Electrical System Inspection.....	247	Adding Engine Oil.....	219
Accessory Feed Connections.....	247	Engine lubrication for severe service	
Electromagnetic Compatibility.....	348	operation.....	219
Electronic Locking Differential.....	128	Engine Oil Check - 7.3L.....	217
Activating the Electronic Locking		Adding Engine Oil.....	217
Differential.....	128	Engine Oil Dipstick - 6.7L Diesel.....	217
Driver-Controlled Electronic Locking		Engine Oil Dipstick - 7.3L.....	217
Differential.....	128	Engine Specifications - 6.7L Diesel.....	281
Servicing a Vehicle with an Electronic		Drivebelt Routing.....	281
Locking Differential.....	129	Engine Specifications - 7.3L.....	282
Emission Law.....	109	Drivebelt Routing.....	283
Noise Emissions Warranty, Prohibited		Entering, Exiting or Climbing on This	
Tampering Acts and Maintenance.....	110	Vehicle.....	20
Tampering With a Noise Control		Environment.....	21
System.....	109	Essential Towing Checks.....	173
End User License Agreement.....	351	Before Towing a Trailer.....	173
VEHICLE SOFTWARE END USER LICENSE		Hitches.....	173
AGREEMENT (EULA)	351	Safety Chains.....	173
Engine Block Heater.....	97	Trailer Brakes.....	173
Using the Engine Block Heater.....	97	Trailer Lamps.....	173
Engine Coolant Check - 6.7L Diesel.....	231	When Towing a Trailer.....	173
Adding Coolant.....	231	Event Data Recording	
Checking Coolant Corrosion Inhibitor		See: Data Recording.....	13
Additive Strength	234	Exhaust Brake.....	136
Coolant Change.....	235	Exhaust Brake Operating	
Engine and Secondary Cooling System		Characteristics.....	137
Refill Procedure.....	233	Exhaust System Inspection.....	248
Engine-driven Cooling Fan (Fan		Export Unique Options.....	19
Clutch).....	235	Exterior Mirrors.....	60
Recycled Coolant.....	233	Auxiliary Convex Mirrors.....	60
Severe Climates.....	234	Clearance Lamps.....	61
Engine Coolant Check - 7.3L.....	226	Foldaway Exterior Mirrors.....	60
Adding Coolant.....	227	Heated Exterior Mirrors.....	61
Coolant Change.....	229	Power Exterior Mirrors.....	60
Engine Coolant Temperature		Signal Indicator Mirrors.....	61
Management.....	230	Telescoping Mirrors.....	61
Engine-driven Cooling Fan (Fan			
Clutch).....	229		

Index

F

Fastening the Seatbelts.....	38
Energy Management Feature.....	41
Fastening the Cinch Tongue.....	39
Lap Belts.....	39
Seatbelt Locking Modes.....	40
Using Seatbelts During Pregnancy.....	40
Using the Seatbelt with Cinch Tongue (Front Center and Rear Center Seats Only).....	38
Federal Highway Administration Regulation.....	20
Fifth Wheel Operation.....	174
Hook-up.....	174
Un-hook.....	174
Flat Tire See: Changing a Road Wheel.....	277
Ford Credit.....	17
US Only.....	17
Ford Protect.....	317
Ford Protect Extended Service Plan (CANADA ONLY).....	318
Ford Protect Extended Service Plans (U.S. Only).....	317
Frame and Tow Hook Inspection.....	253
Front Seat Armrest.....	87
20% Seat Cushion Storage.....	88
Fuel and Refueling.....	99
Fuel Consumption.....	106
Calculating Fuel Economy.....	107
Filling the Fuel Tank.....	107
Fuel Filter - 7.3L.....	242
Fuel Quality - Diesel.....	100
Biodiesel.....	101
Diesel Fuel Additives.....	102
Fuel Requirements - Choosing The Right Fuel: Vehicles Operated Where Ultra Low Sulfur Diesel Fuel Is Not Required	101
Fuel Requirements - Choosing The Right Fuel: Vehicles Operated Where Ultra Low Sulfur Diesel Fuel Is Required (United States/Canada/Puerto Rico/U.S. Virgin Islands And Other Locales)	100
Fuel Quality - Gasoline.....	103
Choosing the Right Fuel.....	103
Fuel Shutoff.....	182
Fuel Tank Selector Switch.....	108

Fuses.....	193
Fuse Specification Chart.....	193
Engine Compartment Fuse Box.....	193
Passenger Compartment Fuse Box.....	198

G

Gauges.....	63
2.3 Inch Display.....	63
8 Inch Display.....	64
Configurable Gauge.....	65
Engine Coolant Temperature Gauge.....	65
Engine Oil Pressure Gauge.....	65
Fuel Gauge.....	65
Gearbox See: Transmission.....	122
General Driving Points.....	176
Backing Up.....	176
General Information.....	176
Parking.....	176
General Information on Radio Frequencies.....	45
Intelligent Access.....	45
General Maintenance Information.....	319
Multi-point Inspection.....	323
Owner Checks and Services.....	321
Protecting Your Investment.....	319
Why Maintain Your Vehicle?.....	319
Why Maintain Your Vehicle at Your Dealership?.....	319
Getting Assistance Outside the U.S. and Canada.....	190
Getting the Services You Need.....	187
Away From Home.....	187

H

Handbrake See: Parking Brake.....	131
Hazard Flashers.....	182
Headlamp Adjusting See: Adjusting the Headlamps.....	240
Headlamp Exit Delay.....	56
Headlamp Removal See: Removing a Headlamp.....	243
Headrest See: Head Restraints.....	82

Index

Head Restraints.....	82
Adjusting the Head Restraint.....	83
Heated Exterior Mirrors.....	81
Heating	
See: Climate Control.....	79
Hill Start Assist.....	134
Switching the System On and Off.....	134
Using Hill Start Assist.....	134
Hints on Controlling the Interior	
Climate.....	80
Defogging the Side Windows in Cold Weather.....	81
General Hints.....	80
Quickly Cooling the Interior.....	80
Quickly Heating the Interior.....	80
Recommended Settings for Cooling.....	80
Recommended Settings for Heating.....	80
Vehicle Stationary for Extended Periods During Extreme High Ambient Temperatures.....	81
Hints on Driving With Anti-Lock Brakes.....	131
Hood Lock	
See: Opening and Closing the Hood.....	213
Horn.....	53
I	
Ignition Switch.....	93
In California (U.S. Only).....	188
Information Display Control.....	53
Information Displays.....	70
General Information.....	70
Information Messages.....	73
Diesel Messages.....	74
Engine.....	77
Fuel.....	77
Key.....	77
Maintenance.....	77
Park Brake.....	78
Installing Child Restraints.....	26
Child Restraints.....	26
Tether Strap Attachment.....	31
Using Cinch Tongue Lap and Shoulder Belts (All Front Center, Super Cab and Crew Cab Rear Center Positions).....	28
Using Lap and Shoulder Belts.....	26
Using Lower Anchors and Tethers for Children (LATCH).....	30
Using Tether Straps.....	30
Instrument Cluster.....	63
Instrument Lighting Dimmer.....	56
Instrument Panel.....	22
Interior Lamps.....	58
Interior Mirror.....	62
Introduction.....	7
J	
Jump Starting the Vehicle.....	183
Connecting the Jumper Cables.....	183
Jump Starting.....	184
Preparing Your Vehicle.....	183
Removing the Jumper Cables.....	184
K	
Keys and Remote Controls.....	45
L	
Lane Keeping System.....	157
Switching the System On and Off.....	158
System Display.....	158
System Settings.....	158
Troubleshooting.....	159
Lighting Control.....	55
Flashing the Headlamp High Beam.....	56
Headlamp High Beam.....	55
Lighting.....	55
General Information.....	55
Load Carrying.....	168
Load Limit.....	168
Unloaded or Lightly Loaded Vehicles.....	168
Locating the USB Ports.....	91
Charge Only USB Ports.....	91
Data Transfer USB Ports.....	91
Locking and Unlocking.....	49
Autolock.....	49
Battery Saver.....	50
Illuminated Entry.....	50
Power Door Locks.....	49
Remote Control.....	49
Smart Unlocks.....	49

Index

Lug Nuts
See: Changing a Road Wheel.....277

M

Maintenance.....212
 General Information.....212
Manual Climate Control.....79
 Directing the Air.....79
 Setting the Blower Motor Speed.....79
 Setting the Temperature.....79
 Switching Defrost On and Off.....79
 Switching Maximum Air Conditioning On
 and Off.....80
 Switching Recirculated Air On and
 Off.....80
 Switching the Air Conditioning On and
 Off.....79
 Switching the Climate Control On and
 Off.....79
Manual Seats.....84
 Manual Lumbar85
 Moving the Seat Backward and
 Forward.....84
 Recline Adjustment.....84
 Tilting the Seatback Forward
 (Two-Passenger Bench Seat).....85
Message Center
 See: Information Displays.....70
Mirrors
 See: Windows and Mirrors.....59
Mobile Communications Equipment.....19
Motorcraft Parts - 6.7L Diesel.....283
Motorcraft Parts - 7.3L.....285

N

Noise Pollution Control.....21
 Air Intake System.....21
 Body.....21
 Cooling System.....21
 Engine.....21
 Exhaust System.....21
 Transmission Enclosure.....21
Normal Scheduled Maintenance.....323
 Intelligent Oil-Life Monitor™ - Diesel Engine
 Only.....323
 Normal Maintenance Intervals.....324

O

Oil Change Indicator Reset.....220
 Base Cluster.....220
 High Series Cluster.....220
Oil Check
 See: Engine Oil Check - 6.7L Diesel.....218
 See: Engine Oil Check - 7.3L.....217
Opening and Closing the Hood.....213
 Closing the Hood.....214
 Opening the Hood.....214
Ordering Additional Owner's
 Literature.....191
 Obtaining a French Owner's Manual.....191
Overhead Console.....92

P

Parking Brake.....131
 Air Brakes.....132
 Hydraulic Brakes.....131
Passive Anti-Theft System.....51
 SecuriLock®.....51
PATS
 See: Passive Anti-Theft System.....51
Perchlorate.....17
Playing Media From a USB Device.....313
 Selecting the USB Device.....313
 Supported Audio File Formats.....313
Power Door Locks
 See: Locking and Unlocking.....49
Power Seats.....85
 Air-Ride Seat.....85
Power Steering Fluid Check.....238
Power Take-Off.....126
Power Windows.....59
 Bounce-Back.....59
 One-Touch Up or Down.....59
 Window Lock.....59
Pre-Collision Assist - Vehicles With: Air
 Brakes.....161
 Blocked Sensors.....162
 Pre-Collision Assist Settings.....162
 Using the Pre-Collision Assist System.....161
Pre-Collision Assist - Vehicles With:
 Hydraulic Brakes.....163
 Adjusting the Pre-Collision Assist
 Settings.....165

Index

Blocked Sensors.....	166	Roadside Assistance.....	181
Distance Indication and Alert.....	165	Vehicles Sold in Canada: Getting Roadside Assistance.....	182
Using the Pre-Collision Assist System.....	164	Vehicles Sold in the United States: Getting Roadside Assistance.....	181
Protecting the Environment.....	21	Vehicles Sold in the United States: Using Roadside Assistance.....	181
Puncture		Roadside Emergencies.....	181
See: Changing a Road Wheel.....	277	Running-In	
R		See: Breaking-In.....	179
Rear Axle Fluid Check.....	253	Running Out of Fuel - Diesel.....	103
Changing the Fluid.....	253	Purging Air From the System.....	104
Checking the Fluid Level.....	253	Starting the Engine.....	104
Rear Axle.....	128	Running Out of Fuel - Gasoline.....	104
General Information.....	128	S	
Rear Seat Armrest.....	88	Safety Precautions.....	99
Rear Seats.....	86	Low Fuel Pressure.....	100
Folding the Rear Seat Back (Crew Cab)		Scheduled Maintenance Record.....	337
.....	87	Scheduled Maintenance.....	319
Folding up the Rear Seat Cushion.....	87	Seatbelt Extensions.....	44
Returning the Seat to the Seating Position.....	87	Seatbelt Height Adjustment.....	41
Recommended Towing Weights.....	172	Seatbelt Reminder.....	42
Refueling - Diesel.....	104	Belt-Minder™.....	42
Fuel Filler Cap.....	105	Seatbelts.....	37
Fuel Fill Rate.....	105	Principle of Operation.....	37
Refueling - Gasoline.....	105	Seatbelt Warning Lamp and Indicator	
Fuel Filler Cap.....	106	Chime.....	42
Remote Control.....	46	Conditions of operation.....	42
Car Finder.....	47	Seats.....	82
Changing the Remote Control Battery.....	46	Security.....	51
Reprogramming the Remote Control.....	46	Selective Catalytic Reductant System - Diesel.....	112
Sounding the Panic Alarm.....	47	Contaminated Diesel Exhaust Fluid or Inoperative Selective Catalytic Reduction System.....	116
Removing a Headlamp.....	243	Diesel Exhaust Fluid Guidelines and Information.....	115
Repairing Minor Paint Damage.....	259	Diesel Exhaust Fluid Level.....	112
Replacement Parts		Diesel Exhaust Fluid Warning Messages and Vehicle Operations.....	114
Recommendation.....	17	Filling the Diesel Exhaust Fluid Tank.....	112
Collision Repairs.....	17	Setting the Cruise Control Speed.....	154
Scheduled Maintenance and Mechanical Repairs.....	17	Changing the Set Speed.....	154
Warranty on Replacement Parts.....	17	Sitting in the Correct Position.....	82
Replacing a Lost Key or Remote Control.....	48	Snow Chains	
Reporting Safety Defects (Canada Only).....	192	See: Using Snow Chains.....	277
Reporting Safety Defects (U.S. Only).....	191		
Resuming the Set Speed.....	155		

Index

Spare Wheel	
See: Changing a Road Wheel.....	277
Special Notices.....	18
New Vehicle Limited Warranty.....	18
Notice to Owners of Pickup Trucks and Utility Type Vehicles.....	18
On Board Diagnostics Data Link Connector.....	18
Special Instructions.....	18
Using your Vehicle as an Ambulance.....	19
Using Your Vehicle With a Snowplow.....	19
Special Operating Conditions Scheduled Maintenance.....	329
Diesel Engine.....	331
Exceptions.....	336
Gasoline Engines.....	329
Speed Control	
See: Cruise Control - Vehicles With: Adaptive Cruise Control.....	148
See: Cruise Control - Vehicles With: Cruise Control.....	154
Spring U-Bolt Check.....	253
U-bolt Nut Torque.....	254
Stability Control.....	144
Principle of Operation - Vehicles With: Air Brakes.....	145
Principle of Operation - Vehicles With: Hydraulic Brakes.....	144
Starter Switch	
See: Ignition Switch.....	93
Starting a Diesel Engine.....	95
Cold Weather Starting.....	95
Diesel Engine Fast Start Glow Plug System.....	95
Starting a Gasoline Engine.....	94
Failure to Start.....	94
Guarding Against Exhaust Fumes.....	94
Important Ventilating Information.....	95
Stopping the Engine When Your Vehicle is Moving.....	94
Stopping the Engine When Your Vehicle is Stationary.....	94
Starting and Stopping the Engine.....	93
General Information.....	93
Steering.....	160
Hydraulic Power Steering.....	160
Steering System Inspection.....	252
Hydraulic System.....	252
Steering Column Joint Bolts.....	252
Steering Wheel.....	52
Storage Compartments.....	92
Streaming Bluetooth Audio.....	313
Selecting a Bluetooth Source.....	313
Sun Visors.....	62
Slide-on-rod.....	62
Suspension System Inspection.....	252
Switching Cruise Control On and Off.....	154
Switching Cruise Control Off.....	154
Switching Cruise Control On.....	154
Switching Off the Engine.....	96
Symbols Glossary.....	10
T	
Technical Specifications	
See: Capacities and Specifications.....	281
The Better Business Bureau (BBB) Auto Line Program (U.S. Only).....	189
Tire Care.....	262
Glossary of Tire Terminology.....	262
Information Contained on the Tire Sidewall.....	262
Tires	
See: Wheels and Tires.....	262
Towing a Trailer.....	171
Load Placement.....	171
Towing Points.....	186
Towing.....	171
Traction Control.....	142
Principle of Operation.....	142
Trailer Brakes.....	138
Trailer Air Supply and Parking Brake Modular Controls.....	138
Trailer Brake Hand Control.....	138
Transmission Code Designation.....	287
Transmission.....	122
Transporting the Vehicle.....	185
U	
Under Hood Overview - 6.7L Diesel.....	215
Under Hood Overview - 7.3L.....	216
USB Ports.....	91
Using Adaptive Cruise Control.....	148
Automatic Cancellation.....	151

Index

Blocked Sensor.....	152	VIN	
Canceling the Set Speed.....	150	See: Vehicle Identification Number.....	286
Changing the Set Speed.....	150	W	
Detection Issues.....	151	Warning Lamps and Indicators.....	66
Following a Vehicle.....	149	Anti-Lock Braking System.....	66
Hilly Condition and Trailer Tow Usage.....	151	Automatic Regeneration Control.....	66
Overriding the Set Speed.....	150	Battery.....	66
Resuming the Set Speed.....	151	Brake System.....	66
Setting the Adaptive Cruise Speed.....	149	Check Suspension.....	66
Setting the Gap Distance.....	150	Cruise Control.....	66
Switching Adaptive Cruise Control		Diesel Exhaust Fluid.....	66
Off.....	151	Direction Indicator.....	66
Switching Adaptive Cruise Control		Door Ajar.....	67
On.....	148	Electronic Locking Differential.....	67
System Not Available.....	152	Engine Coolant Temperature.....	67
Using Snow Chains.....	277	Engine Oil Pressure.....	67
Using Stability Control.....	146	Exhaust Brake On.....	67
Using Traction Control - Vehicles With:		Fasten Seatbelt.....	67
Air Brakes.....	142	High Beam.....	67
System Indicator Light.....	142	Hydromax.....	67
Using Traction Control - Vehicles With:		Low Fuel Level.....	67
Hydraulic Brakes.....	142	Parking Brake Warning.....	67
System Indicator Light.....	143	Parking Lamps.....	67
Using Voice Recognition.....	313	Powertrain Malfunction/Reduced	
Phone Voice Service.....	313	Power/Electronic Throttle Control.....	68
V		Service Engine Soon.....	68
Vehicle Care.....	255	Stability Control Indicator.....	68
General Information.....	255	Traction Control Indicator.....	68
Vehicle Identification Number.....	286	Traction Control System Off.....	68
Vehicle Inspection Guide.....	203	Trailer Anti-Lock Brake System	
Vehicle Inspection Information.....	203	(ABS).....	68
Trailer.....	210	Transmission Tow/Haul.....	69
Transmission.....	210	Two Speed Axle.....	69
Vehicle Storage.....	260	Wait to Start.....	69
Body.....	260	Water in Fuel.....	69
Brakes.....	261	Washer Fluid Check.....	242
Cooling system.....	260	Washers	
Disconnecting Your 12 Volt Battery.....	260	See: Cleaning the Exterior.....	256
Engine.....	260	See: Wipers and Washers.....	54
Fuel system.....	260	Waxing.....	257
General.....	260	What Is Cruise Control.....	154
Miscellaneous.....	261	Requirements.....	154
Removing Vehicle From Storage.....	261	Wheel Nuts	
Tires.....	261	See: Changing a Road Wheel.....	277
Ventilation		Wheels and Tires.....	262
See: Climate Control.....	79	Technical Specifications.....	279

Index

Windows and Mirrors.....	59
Windshield Washers.....	54
Windshield Wipers.....	54
Speed Dependent Wipers.....	54
Wiper Blades	
See: Checking the Wiper Blades.....	242
Wipers and Washers.....	54