

# HUSSMANN®



## ***LTH*** ***Low Temperature*** ***Merchandisers***



## ***Installation &*** ***Operation Manual***

**IMPORTANT**

**Keep in store for  
future reference!**

MANUAL- I/O LTH SC

**P/N 0506146\_F**  
May 2015

**Spanish 0531295**  
**French 0531296**



# ATTENTION

Merchandiser must operate for 24 hours before loading product!

Regularly check merchandiser temperatures.

Do not break the cold chain. Keep products in cooler before loading into merchandiser.

These merchandisers are designed for pre-frozen products only.



IMPORTANT  
KEEP IN STORE FOR FUTURE REFERENCE  
*Quality that sets industry standards!*

12999 St. Charles Rock Road • Bridgeton, MO 63044-2483

U.S. & Canada 1-800-922-1919 • Mexico 1-800-522-1900

[www.husmann.com](http://www.husmann.com)

© 2015 Husmann Corporation



# TABLE OF CONTENTS

v

**ANSI DEFINITIONS** ..... vi

## **INSTALLATION**

NSF Certification ..... 1-1  
Husmann Product Control..... 1-1  
Location ..... 1-1  
Shipping Damage ..... 1-1  
Self Contained Location ..... 1-2  
Unloading ..... 1-3  
Exterior Loading ..... 1-3  
Shipping Skid ..... 1-3  
Model Description ..... 1-4  
Cabinet Leveling ..... 1-4  
Door Seal ..... 1-5  
Serial Plate Location ..... 1-5  
Door Lock ..... 1-5  
Shelf Installation ..... 1-6  
Lamps ..... 1-6  
Door Switch ..... 1-6  
Stocking ..... 1-7  
Condensing Unit Air Flow ..... 1-7  
Load Limits ..... 1-7  
LTH Illustrations ..... 1-8

## **ELECTRICAL / REFRIGERATION**

Plug..... 2-1  
Refrigeration..... 2-2  
Defrost Cycle ..... 2-2  
NOTES ..... 2-4

## **START UP / OPERATION**

### **OPERATING SAFE-NET™ III CONTROLS**

Temperature Control ..... 3-1  
Start-Up / Operation ..... 3-2  
Alarms and Codes ..... 3-2  
Defrost Termination Switch ..... 3-3  
Manual Defrost ..... 3-3  
Temperature Adjustment ..... 3-4  
Control Location ..... 3-5  
Sequence of Operation (Safe-NET III) .. 3-6

Controls and Adjustments ..... 3-7  
Alarms and Codes ..... 3-7  
Thermostatic Expansion Valve ..... 3-8  
TEV Adjustment ..... 3-8

## **MAINTENANCE**

Care and Cleaning ..... 4-1  
Exterior Surfaces ..... 4-1  
Interior Surfaces ..... 4-1  
Cleaning Shelves ..... 4-2  
Cleaning Condenser Coils..... 4-2  
Optional Reversing Condenser Fan ... 4-3  
Cleaning Wash Out Drain ..... 4-4  
Tips and Trouble Shooting ..... 4-4

## **SERVICE**

Replacing Fluorescent Lamps ..... 5-1  
Replacing Display Lamp ..... 5-1  
Replacing Interior Lamps ..... 5-2  
Replacing Electronic Ballasts..... 5-2

## **APPENDIX A — TECHNICAL DATA**

Part Numbers ..... A-1  
Cross Section / Refrigeration Data ..... A-4  
Merchandiser Dimensions ..... A-5  
Electrical Data ..... A-6  
LTH-8 Wiring Diagrams ..... A-8  
LTH-18 Wiring Diagrams ..... A-9  
LTH-45, 68 Wiring Diagrams ..... A-10

## **WARRANTY**

REVISION HISTORY

Revision F

Sensor Location, Page 3-5, 3-6; Removed Type 2, Page 1-1; Added California Warning, Page 1-3; Removed Safe-NET 1 references, Section 2, New Part Numbers, Section 5, New Wiring Diagrams, Section A.

Revision E

Eliminate barcode from the front page  
Eliminate IR Logo from pages 24 (3-6), 25 (3-7), 27 (3-9), 52 (last page).  
Update revision letter (D to E, all pages with the revision) and the Date.  
Removed Picture of LED receptacles on Page 2-1; Changed LED and Fluorescent Electrical requirements on (left Column wording)

\*\*\*\*\*

ANSI Z535.5 DEFINITIONS



• **DANGER** – Indicate[s] a hazardous situation which, if not avoided, will result in death or serious injury.



• **WARNING** – Indicate[s] a hazardous situation which, if not avoided, could result in death or serious injury.



• **CAUTION** – Indicate[s] a hazardous situation which, if not avoided, could result in minor or moderate injury.

• **NOTICE** – *Not related to personal injury* – Indicates[s] situations, which if not avoided, could result in damage to equipment.

Revision D — December 2010

Added Air Flow Drawing, Page, 1-2  
Added Model Description, Page, 1-3  
Added Serial Plate Location, Page 1-5  
Revised Stocking Illustrations, Page 1-7  
Added Sequence of Operation Diagram, Page 3-5  
Added Appendix A

Revision C — June 2009

Added LTH-45 and LTH-68 models  
Updated wiring diagrams  
Added Safe-NET I codes  
Added Safe-NET III information

Revision B —

Added Safe-NET™  
Restructured manual; added Maintenance information

Revision A —

Original Issue

## INSTALLATION

### NSF CERTIFICATION

These merchandisers are manufactured to meet ANSI / National Sanitation Foundation (NSF<sup>®</sup>) Standard #7 requirements. Proper installation is required to maintain certification. Near the serial plate, each case carries a label identifying the type of application for which the case was certified.

**ANSI/NSF-7 Type I - Display Refrigerator / Freezer**  
**Intended for 75°F / 55% RH Ambient Application**

**ANSI/NSF-7 - Display Refrigerator**  
**Intended for Bulk Produce**

### HUSSMANN PRODUCT CONTROL

The serial number and shipping date of all equipment is recorded in Hussmann's files for warranty and replacement part purposes. All correspondence pertaining to warranty or parts ordering must include the serial number of each piece of equipment involved. This is to ensure the customer is provided with the correct parts.

### LOCATION

These merchandisers are designed for displaying products in air conditioned stores where temperature is maintained at or below the ANSI / NSF-7 specified level and relative humidity is maintained at or below 55%.

**Recommended operating ambient temperature is between 65° F (18° C) with a maximum 55% relative humidity to 80 F (26° C) with a maximum 55% relative humidity.**

Placing refrigerated merchandisers in direct sunlight, near hot tables or near other heat sources could impair their efficiency. Like other merchandisers, these self-contained units are sensitive to air disturbances. Air currents passing around merchandisers will seriously impair their operation. Do NOT allow air conditioning, electric fans, open doors or windows, etc. to create air currents around the case. *LTH units in take air and exhaust air through the front of the case, and require no clearance space on top, at the back or either side.*

Product should always be maintained at proper temperature. This means that from the time the product is received, through storage, preparation and display, the temperature of the product must be controlled to maximize the life of the product.

### SHIPPING DAMAGE

All equipment should be thoroughly examined for shipping damage before and during unloading. This equipment has been carefully inspected at our factory. Any claim for loss or damage must be made to the carrier. The carrier will provide any necessary inspection reports and/or claim forms.

#### **Apparent Loss or Damage**

If there is an obvious loss or damage, it must be noted on the freight bill or express receipt and signed by the carrier's agent; otherwise, carrier may refuse claim.

#### **Concealed Loss or Damage**

When loss or damage is not apparent until after equipment is uncrated, retain all packing materials and submit a written response to the carrier for inspection, within 15 days.

## 1-2 Installation

### SELF CONTAINED (LOCATION)

Product should always be maintained at proper temperature. This means that from the time the product is received, through storage, preparation and display, the temperature of the product must be controlled to maximize the life of the product.

BE SURE TO POSITION SELF CONTAINED MERCHANDISERS PROPERLY.

SELF CONTAINED models have vented base panels to allow air circulation through the condensing unit.

Allow for a minimum 36 in. clearance in the front. Blocking or restricting air flow will adversely affect performance and may damage the refrigeration system.

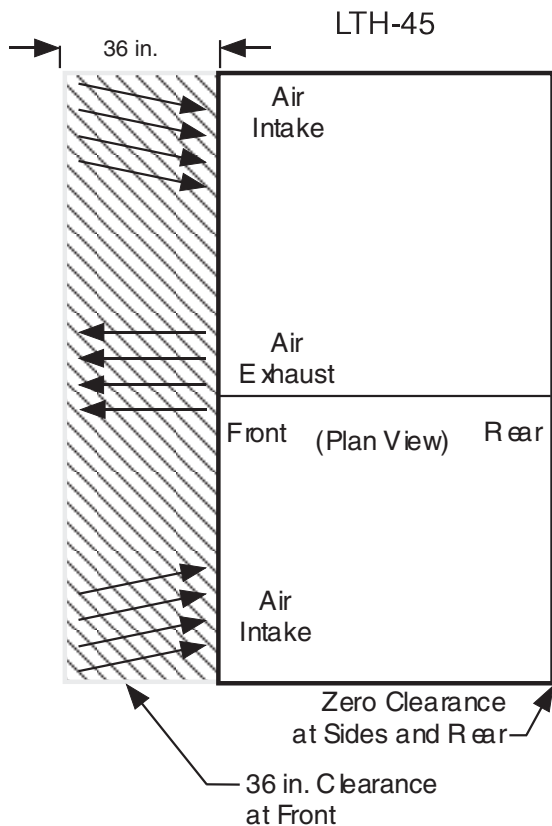
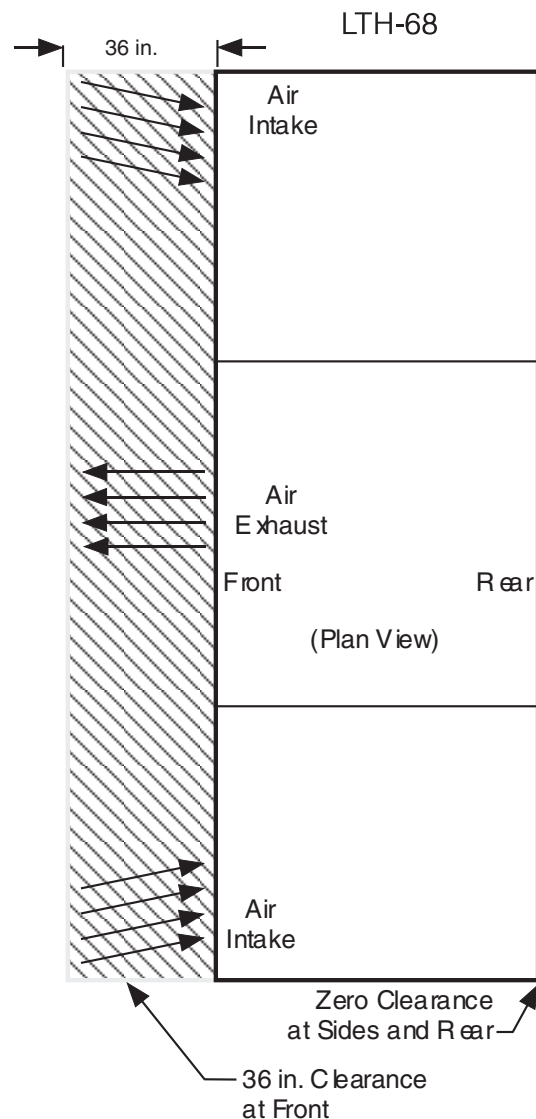
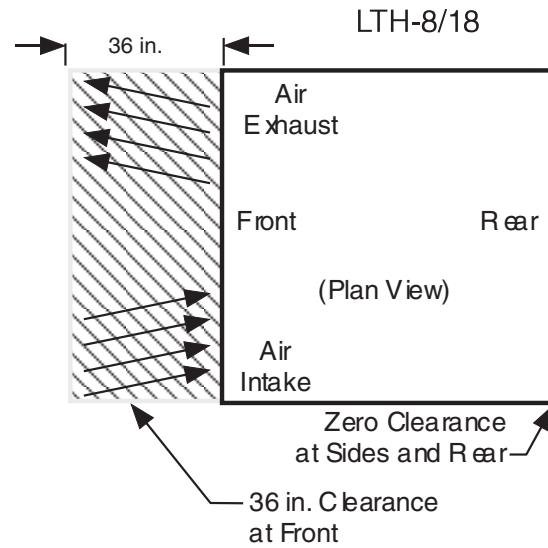



## UNLOADING

### Unloading from Trailer:

Lever Bar (also known as a Mule, Johnson Bar, J-Bar, Lever Dolly, or Pry Lever)

Move the merchandiser as close as possible to its permanent location and remove all packaging. Check for damage before discarding packaging. Remove all separately packed accessories such as kits and shelves.

Improper handling may cause damage to the merchandiser when unloading. To avoid damage:

1. Do not drag the merchandiser out of the trailer. Use a Johnson bar (mule).
2. Use a forklift or dolly to remove the merchandiser from the trailer.



## EXTERIOR LOADING

**Do NOT walk on top of the merchandiser** or damage to the merchandisers and serious personal injury could occur.

MERCHANDISERS ARE NOT STRUCTURALLY DESIGNED TO SUPPORT EXCESSIVE EXTERNAL LOADING such as the weight of a person. Do not place heavy objects on the merchandiser.

## SHIPPING SKID

Each merchandiser is shipped on a skid to protect the merchandiser's base and to make positioning the case easier..

Remove the top of the crate and detach walls from each other. Lift crate from the skid. Unscrew the case from the skid. The merchandiser can now be lifted off the crate skid. ***Lift only at base of skid!*** Remove any braces and/or skids attached (blanket wrapped merchandiser may have skids).

## DO NOT TILT MERCHANDISER ON ITS SIDE OR END WHEN REMOVING SKID.

Once the skid is removed, the merchandiser must be lifted —NOT PUSHED— to reposition. To remove the skid, remove screws attaching skid to the merchandiser.

Check floor where merchandisers are to be set to if it is a level area. Determine the highest part of the floor.

For California Businesses:



This warning is the result of the California State law known as the California Safe Drinking Water and Toxic Enforcement Act of 1986, which is commonly referred to as “Proposition 65.”

This warning does not mean that Hussmann products will cause cancer or reproductive harm, or is in violation of any product-safety standards or requirements. As clarified by the California State government, Proposition 65 can be considered more of a ‘right to know’ law than a pure product safety law. When used as designed, Hussmann believes that our products are not harmful. We provide the Proposition 65 warning to stay in compliance with California State law. It is your responsibility to provide accurate Proposition 65 warning labels to your customers when necessary. For more information on Proposition 65, please visit the California State government website.

## 1-4 Installation

### MODEL DESCRIPTION

LTH merchandisers are low temperature self-contained cabinets, designed for pre-packaged frozen food or products that require frozen temperatures for conservation.

Design features include:

- Self-closing glass doors
- Electronic controls
- CFC free-foam insulation
- Lighted Sign (except LTH-8S)
- Door lock
- Cassette refrigeration system

Available options are:

- Reversing condenser fan motor
- Buzzer alarm

### CABINET LEVELING

This merchandiser must be installed level (from back to front, and side to side) to allow maximum draining of the condensate water as well as proper door alignment and operation. Choose a level area to install case.

LTH-8S and LTH-18 cases have one adjustable cabinet foot at each bottom corner for easy adjustment if required. LTH45 and LTH68 also have an adjustable foot at center front and back. Turn the foot levelers clockwise to add length to each foot for leveling.

When optional 6-inch legs are used, screw the legs tight to the merchandiser base and then adjust the feet.

When optional casters are used, screw them tight to the merchandiser base. Once in final position, lock each caster.

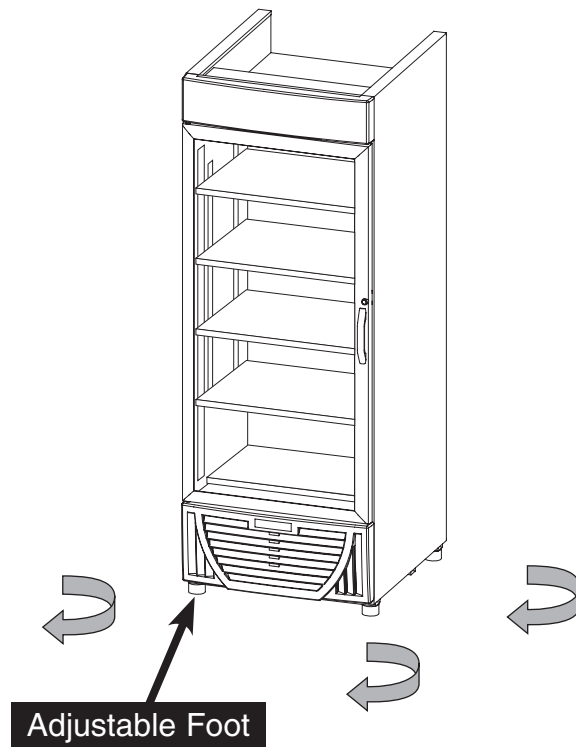

Lock Each Caster

## DOOR SEAL

Check that hinge doors close automatically by opening the door 45 degrees and releasing. Ensure door closes and gasket seals door shut. To adjust the torque applied to the hinged door:

1. Place a wrench on each of the two lower support nuts located at the bottom hinge.
2. Loosen the lower nut while holding the upper nut in place.
3. Torque is increased or decreased by rotating the top nut. After adjustments are made, tighten the bottom nut while holding the upper nut in place. Torque bottom nut to a minimum of 20 ft-lb.

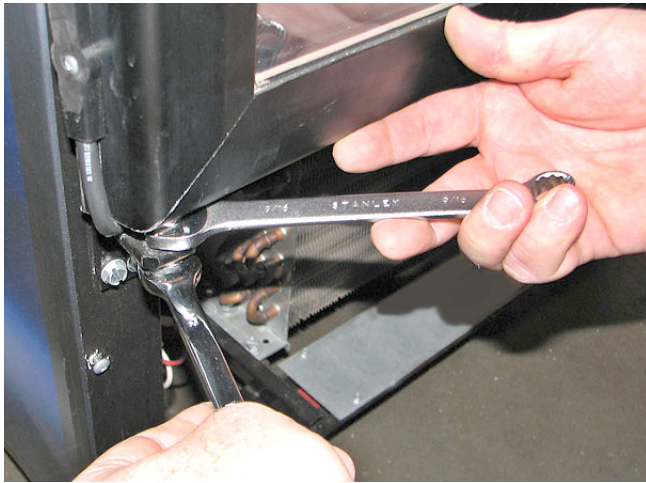

Adjust Door Closing Torque

## SERIAL PLATE LOCATION

The serial plate is located at the interior left side of the merchandiser's cabinet. It contains all pertinent information such as model, serial number, amperage rating, refrigerant type and charge.

## DOOR LOCK

A door lock is standard on all doors. The key is tie-wrapped to the door handle at shipment.

## 1-6 Installation

### SHELF INSTALLATION

After the cabinet is leveled, the shelves may be installed. Wire shelves are adjustable. Shelf spacing can be adjusted by positioning the shelf clips according to individual loading requirements.

LTH-8S merchandisers have three movable wire shelves and one solid shelf. LTH-18, LTH-45 and LTH-68 merchandisers have four movable wire shelves and one solid shelf, per door

NOTE: The movable wire shelves may be reversed so that the wire shelf lip is positioned in the front as a product stop.

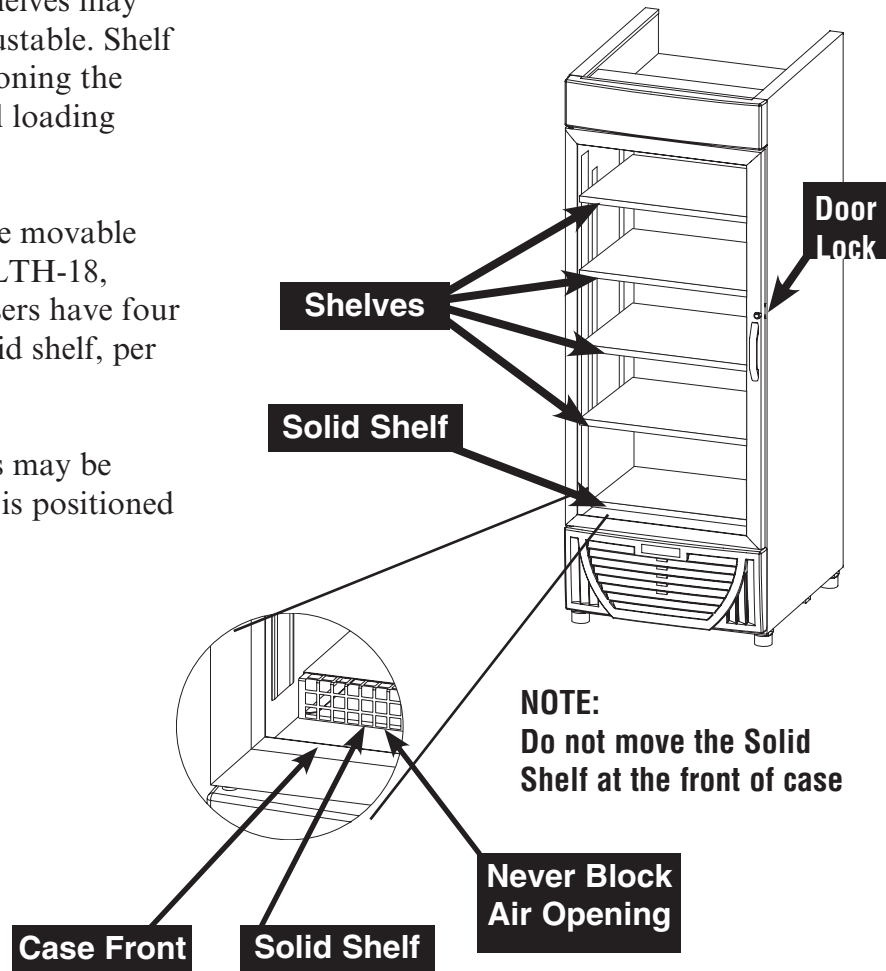

### LAMPS

This merchandiser has a light switch that operates both the display and the interior lamps. Interior lamps are equipped with a plastic shield for safety.

### DOOR SWITCH

The merchandiser's door switch controls the evaporator fan motor. The switch shuts the evaporator fan off when the door is opened. This reduces energy consumption and helps prevent product temperatures from increasing from the door being opened and closed.

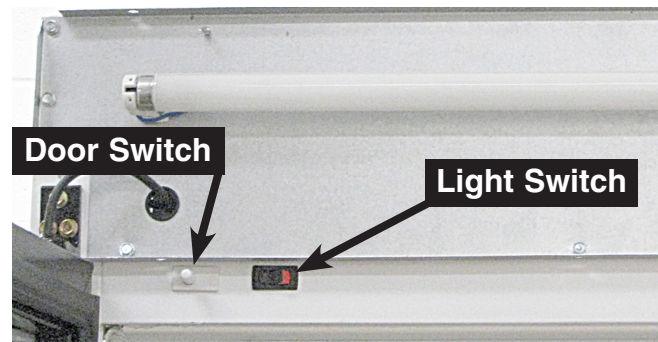

Display Lamp with Cover Removed

## STOCKING

Product should NOT be placed in case until merchandiser is at proper operating temperature. **The LTH merchandisers must remain in operation for at least 24 hours before product may be loaded into case cabinet.** Proper rotation of product during stocking is necessary to prevent product loss. Always bring the oldest product to the front and set the newest to the back.

**AIR EXHAUST AND RETURN GRILLE MUST REMAIN OPEN AND FREE OF OBSTRUCTION AT ALL TIMES.**

Do not allow product, packages, signs, etc. to block air exhaust or return grille. Do not use non-approved shelving, baskets, display racks, or any accessory that could hamper air curtain performance. **DO NOT STOCK PRODUCT IN THE TOP FOUR INCHES OF LTH CASES BECAUSE PRODUCT WILL BLOCK THE COLD AIR FLOW.**

## CONDENSING UNIT AIR FLOW

An optional reversing condenser fan is available for all LTH models. The condenser fan runs in reverse during the defrost cycle to clear the condenser coil of debris that was accumulated during the refrigeration cycle.

## LOAD LIMITS

Product must be within designated load limit to ensure proper refrigeration and air curtain performance.

### At no time should product be stocked:

- **Beyond the front of shelves**
- **Near the air exhaust duct located at the top rear of case**
- **Near or covering the front return air grille**
- **Within four inches of the top of the cabinet (This space must be free of product and other materials.)**

**DO NOT LOAD CASE WITH WARM PRODUCT.**

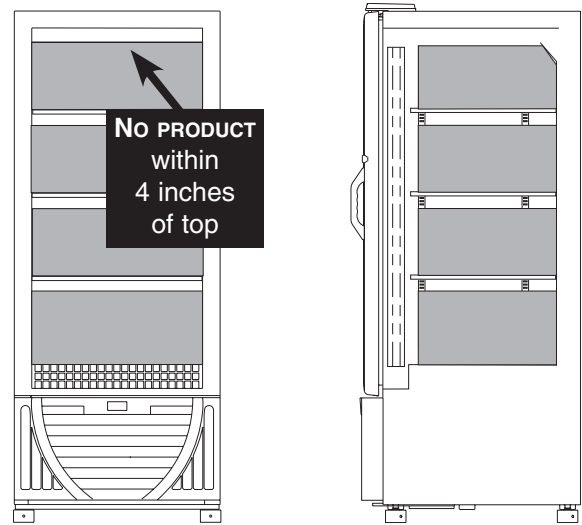

Load Limit for LTH-8S Merchandisers

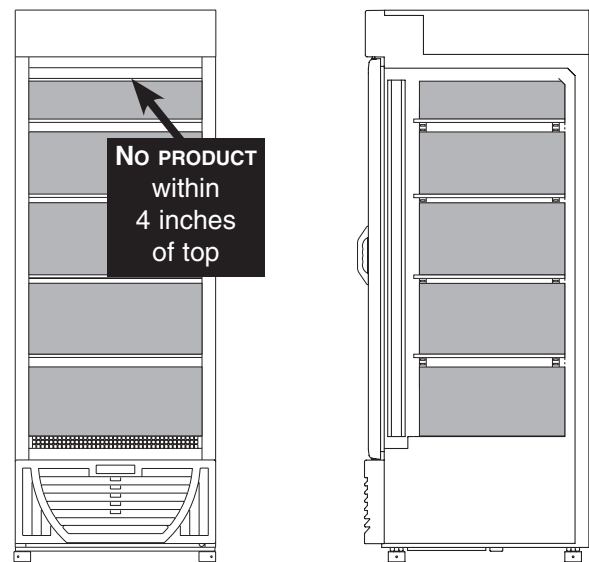

Load Limit for LTH-18, LTH-45 and LTH-68 Merchandisers

**1-8 Installation**

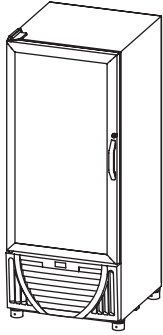

**LTH-8S**

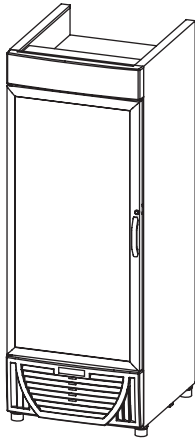

**LTH-18**

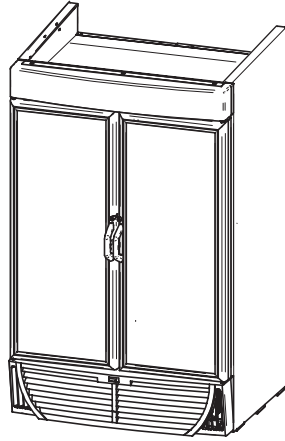

**LTH-45**

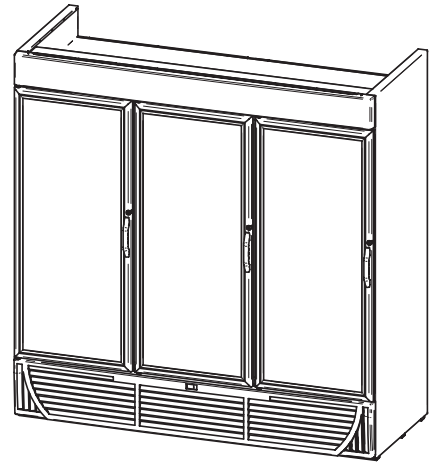

**LTH-68**

## ELECTRICAL / REFRIGERATION

### PLUG

The plug cord is 9 ft long and is located on the right hand rear of the merchandiser. Disconnect power before servicing. LTH merchandisers require a dedicated electrical circuit with ground. 12AWG is the minimum sized acceptable wire.



## WARNING

**Merchandiser must be grounded.  
Do not remove the power supply cord ground.**

- The LTH-8S and LTH-18 require a dedicated 15 AMP/115V circuit with grounded wall receptacle (NEMA 5-15R).
- The LTH-45 requires a dedicated 15 AMP/208-230V circuit with a grounded wall receptacle (NEMA 6-15R).
- The LTH-68 requires a dedicated 20 AMP/208-230V circuit with a grounded wall receptacle (NEMA 6-20R).
- Always use a dedicated circuit with the amperage stated on the unit.
- Plug into an outlet designed for the plug.
- Do not overload the circuit
- Do not use long or thin extension cords. Never use adapters.
- If in doubt, call an electrician.

**ALWAYS CHECK THE SERIAL PLATE FOR COMPONENT AMPERES**

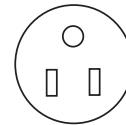

NEMA 5-15R  
Receptacle  
LTH-8S  
LTH-18

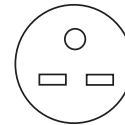

NEMA 6-15R  
Receptacle  
LTH-45

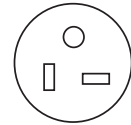

NEMA 6-20R  
Receptacle  
LTH-68



## CAUTION

**Risk of Electric Shock. If cord or plug becomes damaged, replace only with a cord and plug of the same type.**

Nominal Voltage	Minimum Voltage	Maximum Voltage
120	108	132
208-230	188	253



## WARNING

**— LOCK OUT / TAG OUT —**

*To avoid serious injury or death from electrical shock, always disconnect the electrical power at the main disconnect when servicing or replacing any electrical component. This includes, but is not limited to, such items as doors, lights, fans, heaters, and thermostats.*

## 2-2 Electrical / Refrigeration

### REFRIGERATION

Each LTH merchandiser have Safe-NET III controls.

**Safe-NET III Display**

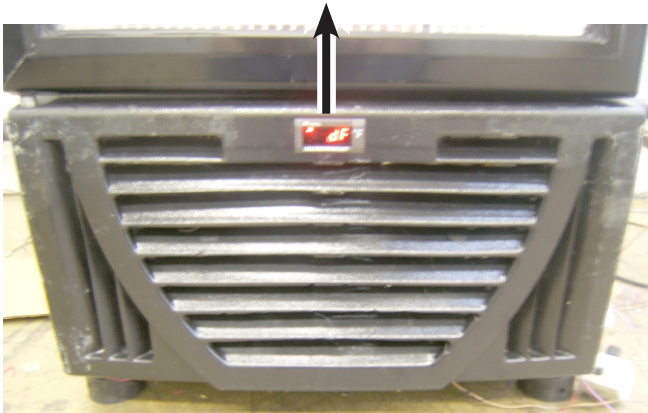

**Safe-NET III Control**

All LTH merchandisers are equipped with a hermetic compressor. The condenser has a fin and tube construction. Cold discharge air flows from the top air duct on the back of the case. Air is returned through the bottom front return air grille.

### DEFROST CYCLE

All LTH merchandisers require defrost cycles for proper operation. The defrost cycles are factory set.

Merchandisers are set to defrost three times each day. During defrost, the evaporator fans operate intermittently to clear any condensation

from the interior side of the door. Defrost is initiated by Safe-NET III control, and is terminated according to coil temperature. In the event the sensor does not terminate the defrost cycle, a fail-safe value is programmed to terminate on time.

All LTH merchandisers are factory set with three defrost cycles, every 8 hours.

With Safe-NET III, the defrost cycle is initiated at start-up and every 8 hours thereafter. If the power is interrupted, the defrost resets to this time. The defrost can be reset to a desired time by unplugging and restarting the merchandiser at the preferred time.

After the defrost cycle, evaporator fans are delayed from starting to prevent water from being blown out of the evaporator pan. Fans are also delayed during initial startup for approximately 10 minutes.



Note: To reduce accumulation of frost on the evaporator coil, the fans will cycle off with each door opening and back on as the door closes.

The evaporator fans also cycle ON and OFF during the defrost. The fans cycle for 10 seconds every two minutes. The fan cycles increase defrost efficiency.



## START UP / OPERATION

### OPERATING Safe-NET III CONTROLS

The Safe-NET III electronic temperature and defrost controller is located in the cassette compartment. The controller comes factory set at position #5 and is ready to go.



**Safe-NET III Controller Location**

The front grille must be removed in order to access this control. To remove the grille, open the door and remove the two plastic screws and retainers on the top of the grille, then tilt out and lift up to remove.



**Remove Plastic Screws**

When removing the grille for this operation or for condenser cleaning, care must be taken not to damage the display interface cable. It may be unplugged during this task.

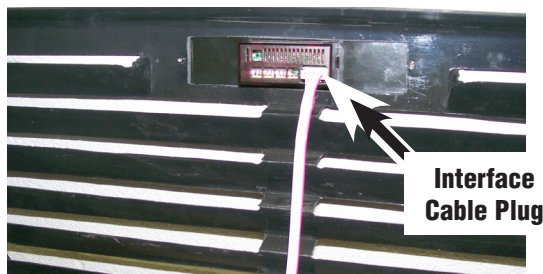

**Unplug Interface Cable**

The temperatures can be adjusted by rotating the knob counter-clockwise for a warmer setpoint, or clockwise for a colder setpoint. The display shows the setpoint for a few seconds when changed, then reverts to showing the sensed temperatures in the merchandiser.

The adjustment knob allows the user to select a pre-configured cold setpoint, warm setpoint or any setpoint within this range. The adjustment knob is also configured with OFF/ON functionality to power off the controller. The off position shuts off the compressor only.

### UNPLUG THE UNIT FOR SERVICE.



**Remove Plastic Screws**

The top, or green, LED indicates the case is in refrigeration mode. The center, or yellow, LED indicates the case is in defrost mode. The bottom (red) LED indicates an alarm condition, such as merchandiser warming up because the door is not closed.

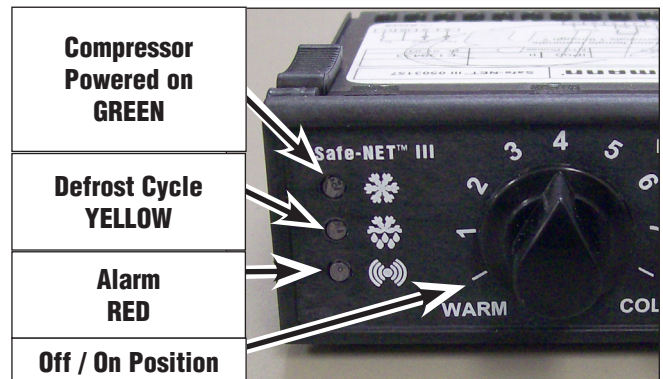

**Safe-NET III Indicators**

## 3-2 START UP / OPERATION

### START-UP / OPERATION

The defrost cycle is initiated at power on. (This cycle will quickly terminate on the initial start-up of a warm merchandiser.) Another defrost cycle will follow every 8 hours thereafter. The defrost times will reset whenever power is interrupted. Therefore, the standard defrost times can be reset by interrupting power (full stop, then start) at the desired time. This will reset the initial time and restart the 8-hour cycle.

During the compressor-on time (1 minute), or compressor-off time (2 minutes), built-in protection time will delay the defrost initiation.

**If you force a defrost cycle during this time, the feature will initiate but not start until the compressor protection mode times out.**

### ALARMS AND CODES

Safe-NET III is available with an audible alarm (located in the display module) that sounds in the event a failure occurs.

#### FLASHING TEMPERATURE OR SENSOR ALARM LED, E1 OR E2

If the Temperature or Sensor Alarm LED (red) on the controller and display is flashing, a temperature sensor has failed (or sensor is disconnected). The display shows E1 if the case sensor has failed (or disconnected) or E2 if the evaporator sensor has failed (it is disconnected).

If the merchandiser sensor fails, refrigeration will run continuously. Turn off, or repeat a duty cycle of a few minutes on and a few minutes off.



### Troubleshooting

Alarm or Code	Indicates	Action
Red LED remains ON after startup	<ul style="list-style-type: none"> <li>Firmware corruption on controller</li> <li>Controller is not operating</li> </ul>	<ul style="list-style-type: none"> <li>Call Service immediately</li> </ul>
Red LED turns on during operation	<ul style="list-style-type: none"> <li>Case temperature is too warm or too cool</li> </ul>	<ul style="list-style-type: none"> <li>Make sure the door is closed</li> <li>Make sure that cold air is not being blocked or deflected</li> <li>Check the temperature using the optional display or a thermometer</li> <li>If the LED does not turn off after one hour, call Service</li> </ul>
Red LED flashes	<ul style="list-style-type: none"> <li>Temperature sensor failure</li> <li>E1 indicates a case temperature failure</li> <li>E2 indicates an evaporator temperature sensor failure</li> </ul>	<ul style="list-style-type: none"> <li>Check the optional display for error code E1 or E2 and call Service immediately</li> </ul>

### DEFROST TERMINATION SWITCH

Merchandisers may use a defrost termination switch, instead of an evaporator sensor to terminate a defrost cycle. The defrost termination switch is temperature activated and senses the completion of defrost.

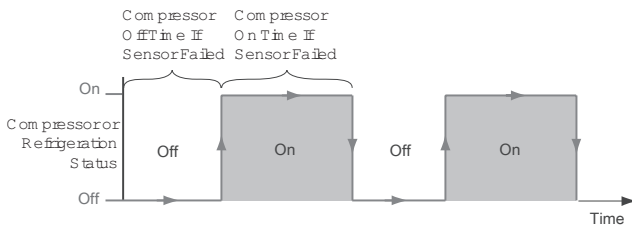

### MANUAL DEFROST

Note:

***This procedure initiates a manual or forced defrost.***

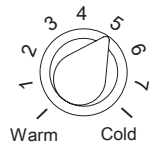

1. Note location of knob setting

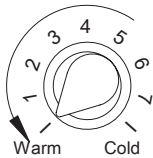

2. Rotate knob fully counter-clockwise until it stops (full warm - "OFF" position)

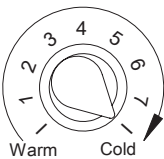

3. After 10 seconds, but before 20 seconds, rotate knob fully clockwise until it stops (full cold position)

### IMPORTANT:

Return the control knob to its original setting (Step 1) once the manual defrost has been initiated.

## 3-4 START UP / OPERATION

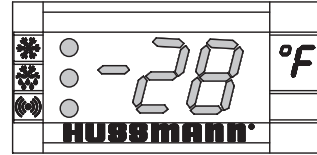
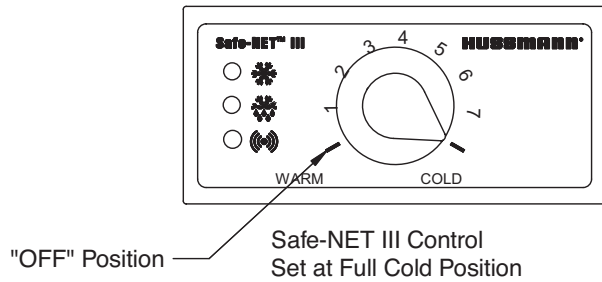

Display - at Full Cold  
Model LTH

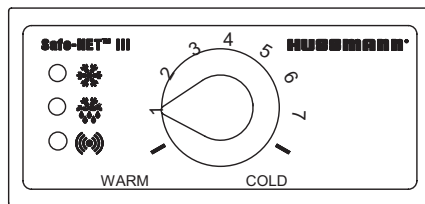

Safe-NET III Control  
# 1 Position

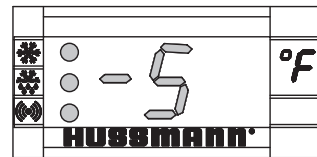

Display - at #1 Position  
Model LTH

## TEMPERATURE ADJUSTMENT

1. Rotate the adjustment knob counter clockwise for a warmer setpoint or clockwise for a colder setpoint.
2. While adjusting the temperature, the display shows the setpoint (cut out value). A few seconds after the temperature is set, the controller reverts to the sensed temperature in the merchandiser.
3. To verify merchandiser settings, turn the dial to warm and cold as shown above. Output readings should be within one degree of the temperatures shown above.

The control has protective settings to prevent short cycling of the compressor.

- A. The compressor may run for up to 60 sec. after Step 2 is completed. Start the 10 sec. count down for Step 3, once the display is blank.
- B. The defrost initiation may be delayed for up to 120 sec. after Step 3 is completed.

## Typical Sensor to Control Configuration

The LTH-8S & LTH-18 sensors are located on the cassette as shown below.  
LTH-45 and LTH-68 have two cassettes, the Sensors are located on the right hand cassette.

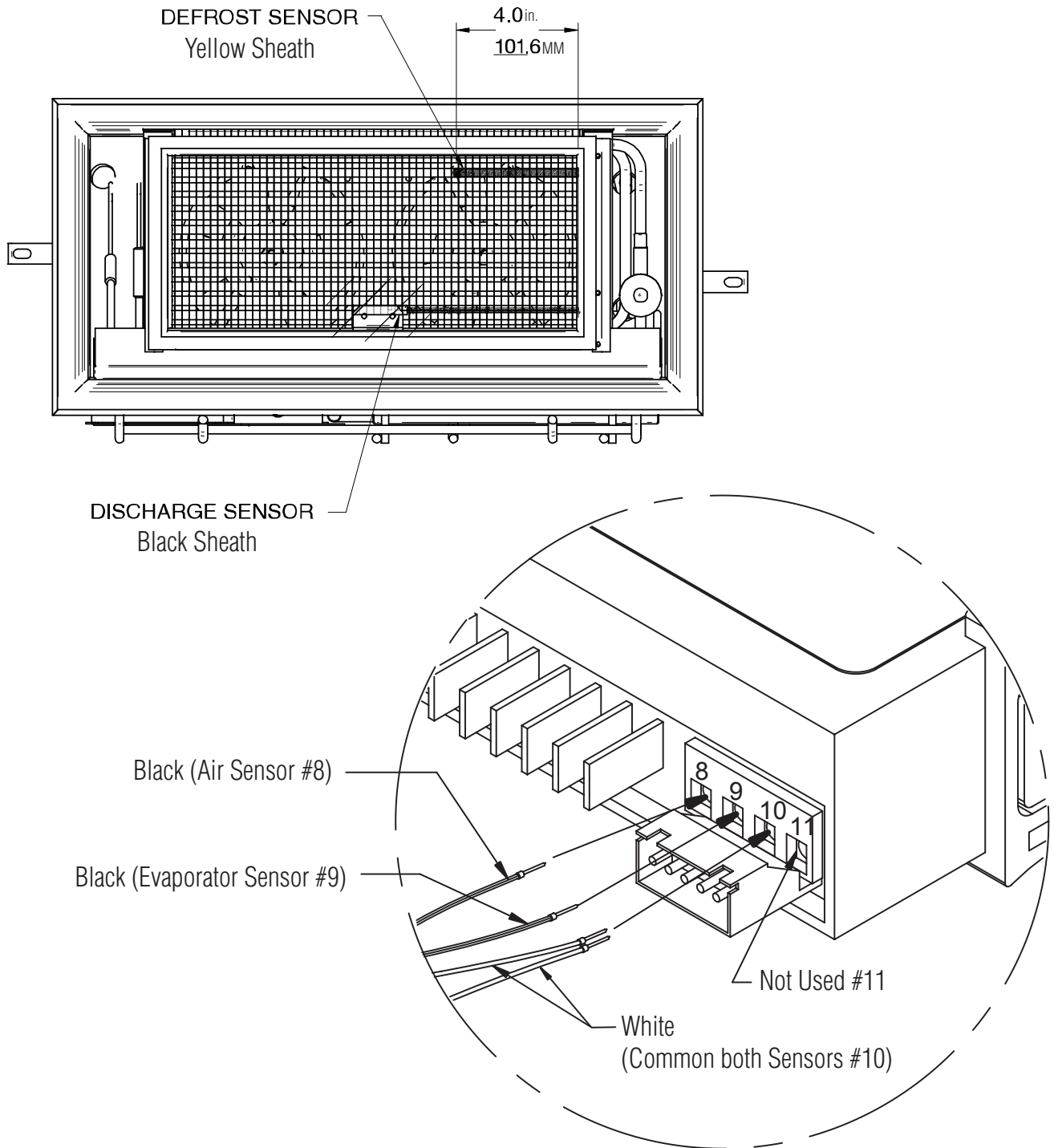

## 3-6 START UP / OPERATION

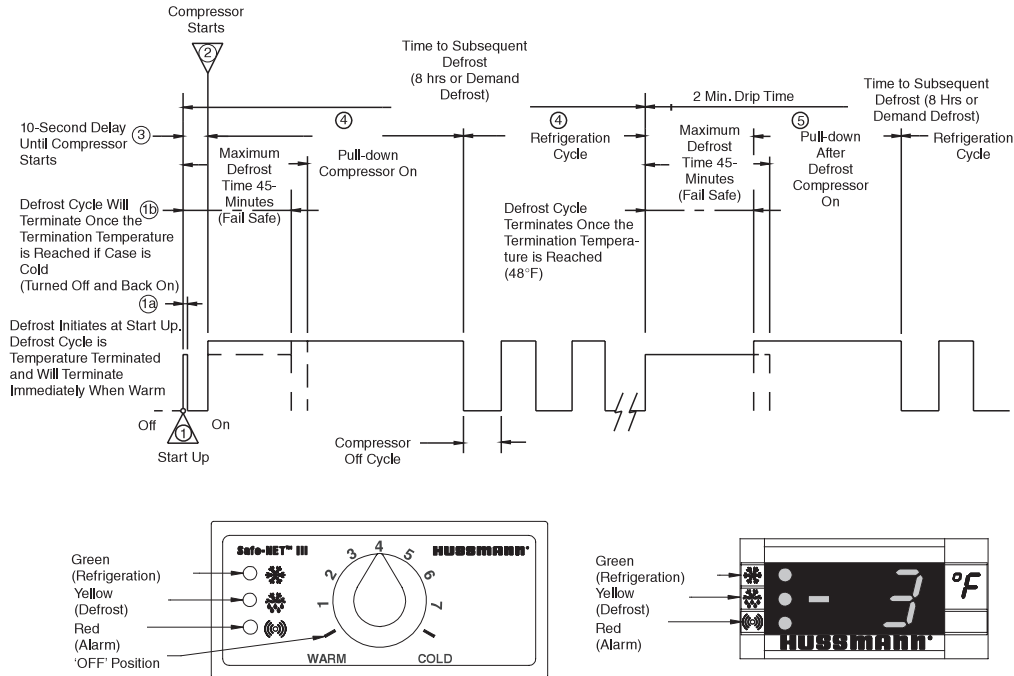

Sequence of Operation — LTH Merchandisers

- ① NOTE: The 65°C Version Controller includes a Parameter Code Number. This number indicates what program has been loaded into the controller. When the Controller is first powered up or is turned off and then back on a 2 digit Parameter Code Number will display for 3 seconds. Then the Self Check will Start.
- ①a. The Safe-NET Parameter Code is 50 for LTH-8S, LTH-45 and LTH-68. The Parameter Code is 75 for the LTH-18. If the case is warm at initial start-up, the defrost will be initiated and will terminate almost immediately. (Display will lock in current temperature when defrost is initiated.)
- ①b. If the case is cold (as if it is turned off and then back on), the defrost cycle will continue until the termination temperature is reached or the fail-safe time has expired.
- ② The compressor will start 10 seconds after the power is applied.
- ③ The compressor will run for 10 minutes. Then, defrost will be initiated.
- ④ During defrost, the display will show the temperature before defrost, and it will continue to show this temperature for 1 hour. Compressor will turn back on once coil is defrosted.
- ⑤ The compressor will continue to run until it reaches its cut-out temperature (pull down).
- ⑥ The refrigeration cycle will continue until the next scheduled (8 hours) or demand defrost.
- ⑦ ③ and ④ will repeat until power is interrupted.

NOTE: If power is interrupted, sequence will start at ④ Defrost will be initiated and the time to subsequent defrost will reset.

## Controls and Adjustments

Refrigeration Controls			Defrost Controls			
Model	Product Application	Discharge Air Temperature	Defrost Frequency (per day)	Type of Defrost	Termination Temperature	Fail safe Time (Minutes)
LTH (All)	Frozen Food	-20° F to -10° F	3	Electric	48° F	50

### Your Case Configuration

Factory Setting	Average product temperature Knob position #5 -10°F
Adjustment knob has OFF position	Yes
Delay before compressor runs after startup	Delay Time 10 sec.
Compressor operation if case sensor fails	Compressor On
What the display shows during defrost?	dF
The case defrosts when the power is turned on	Yes
The method used to end defrost	Evaporator Sensor Temperature
Defrost terminated by termination switch	No

1. The Safe-NET III Controller controls refrigeration temperature. This is factory installed in the control panel. Adjust this control knob to maintain the discharge air temperature shown. Measure discharge air temperatures at the center of the discharge air opening.

Defrosts are time initiated and temperature terminated for self contained. The defrost setting is factory set as shown above.

To ensure a thorough defrost, defrost must be terminated by the temperature termination setting — not by time.

# WARNING

**— LOCK OUT / TAG OUT —**

*To avoid serious injury or death from electrical shock, always disconnect the electrical power at the main disconnect when servicing or replacing any electrical component. This includes, but is not limited to, such items as doors, lights, fans, heaters, and thermostats.*

## 3-8 START UP / OPERATION

### THERMOSTATIC EXPANSION VALVE (TEV)

Each self contained merchandiser has its own evaporator coil and a **pre-set** thermostatic expansion valve (TEV). The TEV has been factory set at design conditions to provide the recommended performance.

Remove the fan panel to expose the thermostatic expansion valve.

### TEV ADJUSTMENT

Expansion valves may be adjusted to fully feed the evaporator. Before attempting to adjust valves, make sure the evaporator is clear or only lightly covered with frost, and the merchandiser is within 10°F of its expected operating temperature.

Adjust the valve as Follows:

- a. Attach a probe to the suction line near the expansion valve bulb.
- b. Obtain a pressure reading from the factory installed Schraeder valve. Convert the pressure reading to a saturated temperature for the refrigerant.

Temperature (b) minus Temperature (a) is the superheat. The valve should be adjusted so that the greatest difference between the two temperatures is 3°F to 5° F.

Make adjustments of no more than 1/2 turn of the valve stem at a time and wait for at least 15 minutes before rechecking the probe temperature and making further adjustments.



## MAINTENANCE



### WARNING

To reduce the risk of fire, electrical shock or injury when cleaning this merchandiser:

- Unplug the merchandiser before cleaning;
- Keep all liquids away from electrical and electronic components;
- Do not use any mechanical device or other means to speed the defrost process, except as recommended by the manufacturer.

### CARE AND CLEANING

Long life and satisfactory performance of any equipment is dependent upon the care it receives. To ensure long life, proper sanitation and minimum maintenance costs, this unit should be thoroughly cleaned, all debris removed and the interiors washed down. Cleaning often will control or eliminate odor buildup. Frequency of cleaning is dependent on usage and local health requirements.



### WARNING

Do not use **HOT** water on **COLD** glass surfaces. This can cause the glass to shatter and could result in personal injury. Allow glass fronts, ends and service doors to warm before applying hot water.

### Exterior Surfaces

The exterior surfaces must be cleaned with a mild detergent and warm water to protect and maintain their attractive finish.

**NEVER USE ABRASIVE CLEANERS OR SCOURING PADS. NEVER USE CAUSTIC SODA, KEROSENE, GASOLINE, THINNER, SOLVENTS, DETERGENTS, ACIDS, CHEMICALS OR ABRASIVES. DO NOT USE AMMONIA-BASED CLEANERS ON ACRYLIC PARTS.**

### Interior Surfaces

**DO NOT USE AMMONIA-BASED PRODUCTS TO CLEAN LIGHT SHIELDS. NEVER USE ABRASIVE CLEANSERS OR SCOURING PADS.**

The interior surfaces may be cleaned with most domestic detergents and sanitizing solutions with no harm to the surface. Always read and follow the manufacturer's instructions when using any cleaning product.

### *Do NOT Use:*

- Abrasive cleansers and scouring pads, as these will mar the finish.
- Coarse paper towels on coated glass.
- Ammonia-based cleaners on acrylic parts.
- A hose on lighted shelves or submerge the shelves in water.
- Solvent, oil or acidic based cleaners on any interior surfaces.
- A hose on rail lights, canopy lights or any other electrical connection.

### *Do:*

- **First turn off refrigeration, then disconnect electrical power.**
- Remove product and loose debris.
- Thoroughly clean all surfaces with soap and hot water. **DO NOT USE STEAM OR HIGH WATER PRESSURE HOSES TO WASH THE INTERIOR. THESE DESTROY MERCHANDISER'S SEALING CAUSING LEAKS AND POOR PERFORMANCE.**
- Take care to minimize direct contact between fan motors and cleaning or rinse water.
- Rinse with hot water, but do **NOT** flood.
- Allow merchandiser to dry before resuming operation.
- Wipe down lighted shelves with a damp sponge or cloth so that water does not enter the light channel. **DO NOT USE A HOSE OR SUBMERGE SHELVES IN WATER.**
- After cleaning is completed, restore power and turn on the merchandiser.



## CAUTION

Product will be degraded and may spoil if allowed to sit in a non-refrigerated area.

### Cleaning Shelves

Shelves and shelf clips are easily removed for cleaning the interior as well as the shelves themselves

### Cleaning Condenser Coils

To maintain peak operating efficiency, the coil should be cleaned at least once each month. A dirty coil slows product cooling significantly and increases energy consumption by as much as 20%. Dirt buildup on coils can also cause the compressor to lock up damaging the condenser unit.

- Remove screws on top of each side of the louvered from grille, then lift off the grille.



**Remove Screws at Top of Grille** (LTH-18 shown)

Detach Safe-NET I electrical wire harnesses. The harnesses are located behind the Safe-NET I controller. The power/relay harness on the left has an eight-slot connector. The sensor cable harness on the right has a four-slot connector. **When re-installing, be sure to plug this harness in the bottom four-slot connection, not the top connection.**

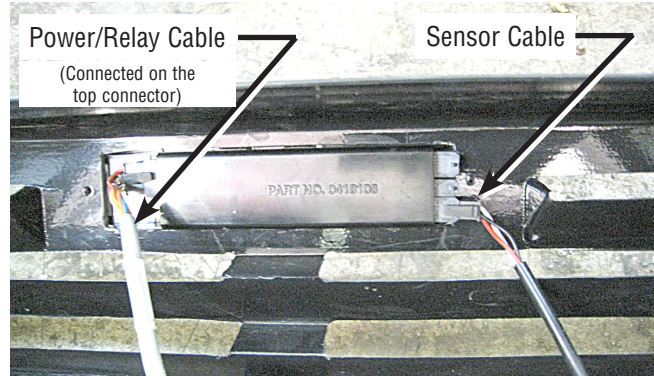

**Disconnect Safe-NET I Harnesses**

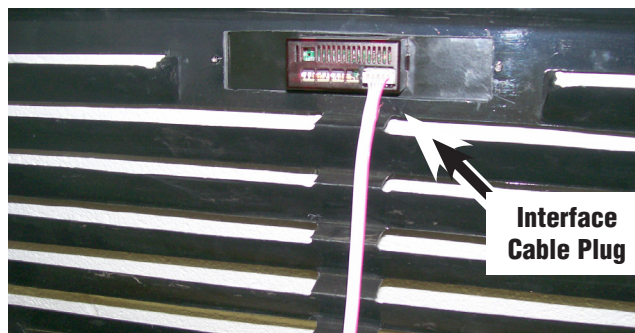

**Unplug Safe-NET III Interface Cable**

Next, detach the merchandiser's electrical wire harness located on the right hand side near the coil. For Safe-NET III, detach the interface cable to the display.

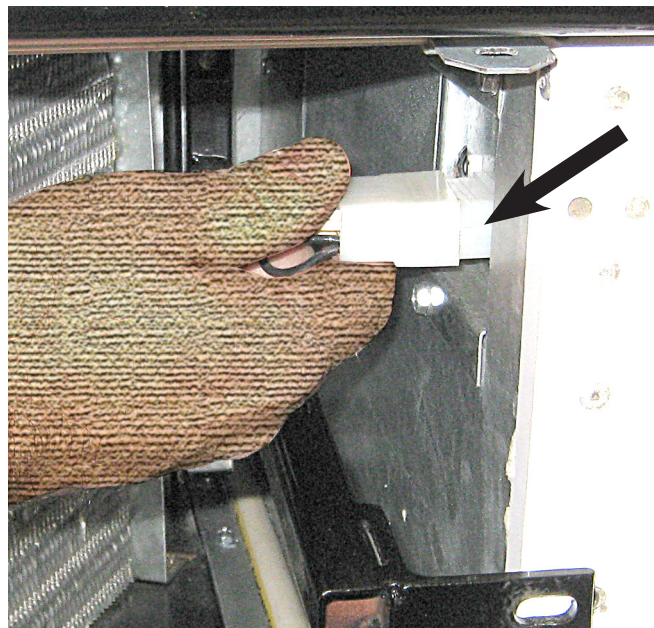

**Unplug Power Harness**

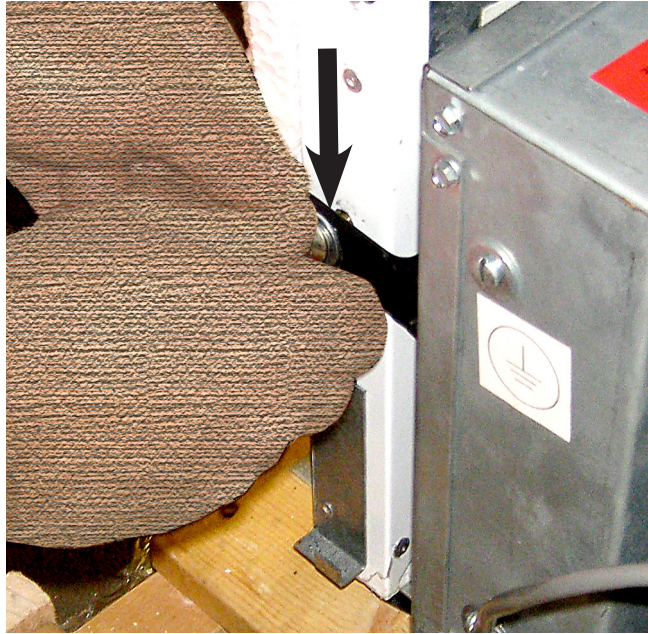

**Remove Screws Holding Cassette**

Remove the two screws securing refrigeration unit cassette in place.

Use the center black bar to pull the refrigeration unit's cassette forward to access the coils.

**USE ONLY THE CENTER BAR TO PULL OUT THE CASSETTE. PULLING ON REFRIGERATION LINES OR OTHER PARTS WILL CAUSE DAMAGE TO THE REFRIGERATION UNIT.**

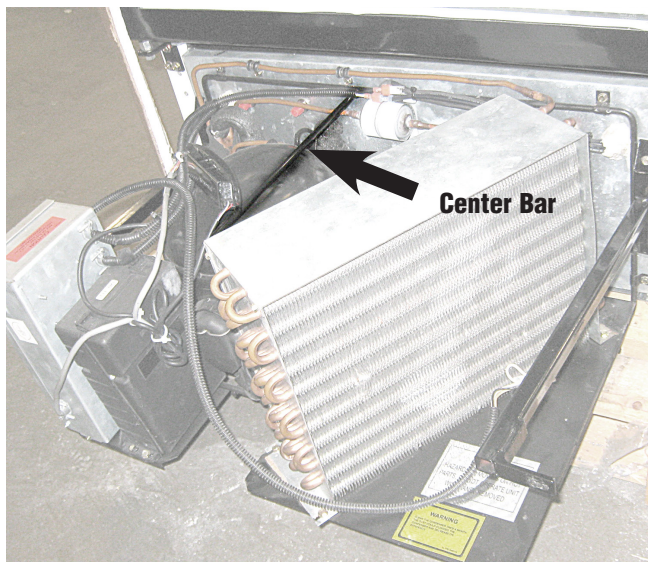

**Use Center Bar to Pull Cassette**

Use a soft hand brush attachment on a vacuum to remove accumulated dust and debris.

Consult an authorized service technician if more extensive cleaning is needed.

If the refrigeration unit is damaged, it can be replaced with a new cassette.

**Optional Reversing Condenser Fan**

If your merchandiser is equipped with the optional reversing condenser fan, you may notice the condenser fan running during the defrost cycle. This is normal in this application. The purpose of reversing the air direction during defrost is to remove lint and dust that accumulates on the condenser fin surfaces during the refrigeration cycle. This feature reduces the need to clean the condenser manually, and increases compressor life because of lower condensing temperatures.

**IMPORTANT INFORMATION**

**For prompt service** when contacting the factory, be sure to have the case model and serial number from the case serial plate.

**⚠ WARNING**

**— LOCK OUT / TAG OUT —**

***To avoid serious injury or death from electrical shock, always disconnect the electrical power at the main disconnect when servicing or replacing any electrical component. This includes, but is not limited to, such items as doors, lights, fans, heaters, and thermostats.***

## 4-4 Maintenance

### Cleaning the Wash Out Drain

The wash out drain is located behind the refrigeration cassette and can be cleaned with water and wiped with a soft cloth. Ensure drain is unobstructed before replacing cassette.

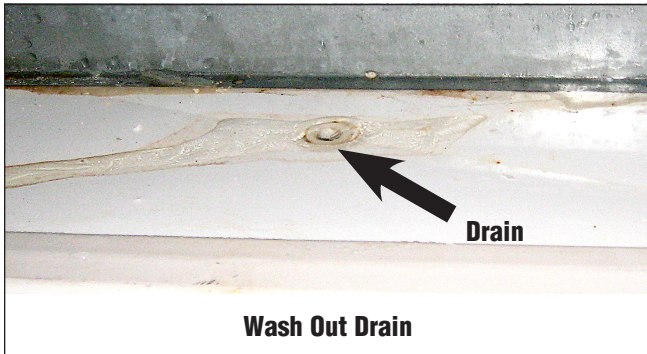

The washout drain flows into an auxiliary waste line.

Next remove the auxiliary waste line cap to drain any excess water. Place a dry towel over the line to absorb water.

Replace cap, cables and cassette.

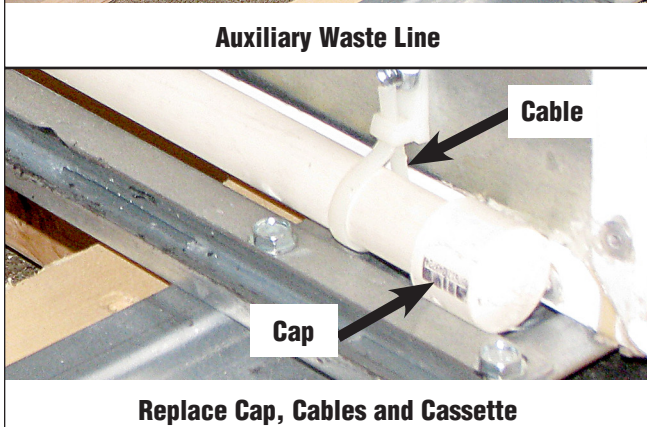

### TIPS AND TROUBLESHOOTING

There are a few simple things to check before calling for service:

1. Product not cold? Refrigeration unit requires 24 hours at initial startup to cool down to operating temperature with **NO PRODUCT LOADED** in merchandiser. Ask when merchandiser was stocked, and what the usage has been. It may take 30 minutes or more for product to chill following stocking.
2. Check the door and door seal for air leaks.
3. Power Supply:  
Is the unit plugged in?  
Is there power to the unit?
4. Location  
What are the ambient conditions—  
temperature and humidity, direct sun, nearby source of heat, such as oven or grill? Is the unit level? Has the unit been moved recently?
5. Shelves and Stocking  
Are the standard shelves in the correct places?  
Is the product stocked properly?  
Is the bottom shelf at the proper location?
6. Confirm that the defrost schedule is properly set using Safe-NET I.  
Check for Safe-NET error messages.

#### IMPORTANT INFORMATION

**For prompt service** when contacting the factory, be sure to have the case model and serial number from the case serial plate.

## SERVICE

! WARNING

— LOCK OUT / TAG OUT —

*To avoid serious injury or death from electrical shock, always disconnect the electrical power at the main disconnect when servicing or replacing any electrical component. This includes, but is not limited to, such items as doors, lights, fans, heaters, and thermostats.*

### REPLACING DISPLAY LAMP

Disconnect power to the merchandiser. Remove plastic pins attaching the display lamp panel. There are three pins at the bottom of the display cover and two on top of the display panel.

Remove the merchandiser's display cover panel and change out the lamp. Replace the display panel cover.

### REPLACING FLUORESCENT LAMPS

Fluorescent lamps have a plastic shield. When the lamp is replaced, keep the lamp shield to install over the new lamp..

The switch under the display lamp cover operates both the display lamp and interior lamps.

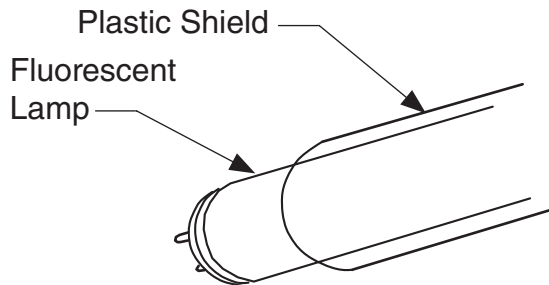

**Remove Plastic Pins Attaching Display Lamp**

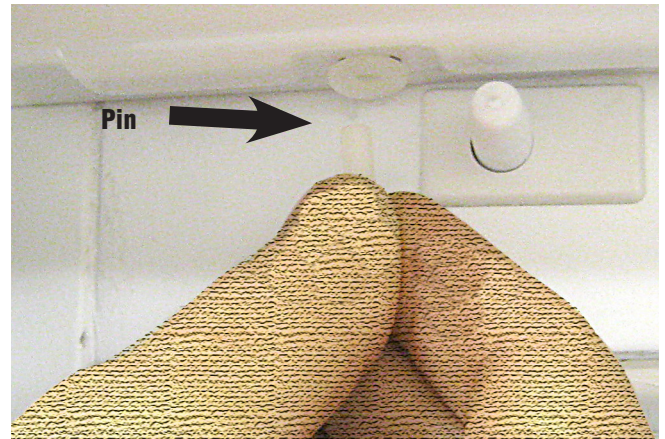

**Remove Plastic Pins Attaching Display Lamp**



**Display Cover Panel Removed**

## 5-2 Service

### REPLACING INTERIOR LAMPS

LTH merchandisers have interior case lamps. The lamps are protected by a clear, plastic shield. Remove the shield to replace lamp. Wedge a small putty knife at the top rear of the lamp, then carefully loosen the shield from the side of the merchandiser.

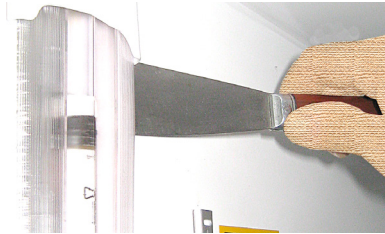

**Wedge Putty Knife at Top Rear of Display Lamp**

Once the shield is out of rear track, the lamp shield can be removed from the merchandiser. Remove lamp shield and change out lamp. Replace lamp shield at bottom corner bracket first.



**Remove Shield from Display Lamp**

For LEDs, follow the same steps to remove the shield. Then pull out the LED fixture respecting the fixture position. Next, bow lamp shield and replace shield into top corner bracket. Smooth shield to ensure a good replacement fit for the lamp shield.



**Bow Shield to Replace**

### REPLACING ELECTRONIC BALLASTS

The electronic ballast or LED power supply for the LTH-8S is located on the refrigeration cassette. This ballast operates the interior lamp.

The electronic ballast or LED power supply for the LTH-18, LTH-45 and LTH-68 is located on the top of the merchandiser under a sheet metal enclosure. (LTH-68 shown.)

To access the ballast or LED power supply, the protective enclosure is removed by removing screws as shown below.

<b>Models</b>		<b>LTH8S</b>	<b>LTH-18</b>	<b>LTH-45</b>	<b>LTH-68</b>
<b>Standard Parts</b>					
<b>Description</b>	<b>Part Number</b>				
Power Cord (NEMA 5-15P)	19S216	X	X		
Power Cord (NEMA 6-15P)	508528			X	
Power Cord (NEMA 6-20P)	1804385				X
Door Switch (fans)	03S121	X	X	X	X
Light Switch	1801241	X	X	X	X
Defrost Sensor (Yellow) 1.5MM	0509123	X	X	X	X
Air Sensor (Black) 1.5MM	0509122	X	X	X	X
Safe-Net III Controller 65C	0524118	X		X	X
Safe-Net III Controller 65C	0551127		X		
Safe-Net III Display (F°) 65C	1H59052001	X	X	X	X
Safe-Net III Display Interface Cable 1M	0509783	X	X	X	X
Safe-Net III Control Harness	0513058	X			
Safe-Net III Control Harness	0507356		X		
Safe-Net III Control Harness	0510339			X	X
Compressor Relay (T92P11A22-120)	1804291	X	X		
Compressor Relay (T92P11A22-240)	0518447			X	X
Heater Relay (T92P7A22-240)	1804241			X	X
Time Relay TGC2030SC2J	0509498			X	X
Pilaster Strip (30")	0501242	X			
Pilaster Strip (42")	0501240		X	X	X
Shelf Clips (insert into pilaster strips)	0403363	X	X	X	X
Fan Delay Thermostat	1701540	X	X	X	X
Defrost Heater Limit Thermostat	0344662	X	X	X	X
Wire Shelf (White) 15.5 X 19.625	0506952	X			
Wire Shelf (White) 22 X 24.5	1201584		X		X
Wire Shelf (White) 22 X 22.688	0506348			X	X
Interior Light Cover	0507791	X			
Interior Light Cover	0506054		X	X	X
Top Hinge Cover	0506914	X			
Feet (Adjustable)	1005319	X	X	X	X
Lamp Shield	0509372	X			
Lamp Shield	1804590		X		
Lamp Shield	1004377			X	X
Lamp (F25T8/SPX41 RS GE)	1801494	X			
Lamp (T5 FQ54W/840 HO)	1804587		X		
Lamp (FO32/841 32W)	1803337			X	X
Light Harness (w/ Lamp holders)	0507004	X			
Light Harness (w/ Lamp holders)	0509570			X	X
Lamp Holder	0506517		X		
Lamp Cap	0506516		X		
Assy Lens Mullion	0510340			X	X

<b>Standard Parts Continued...</b>					
Ballast Modification (w/Connections added)	0507588	X			
Ballast (Robertson RP1420)	1804450		X		
Ballast (WHSG4-UNV-T8-IS)	0509567				X
Door LH Black	7408853	X			
Door LH Black	7408650		X		
Door LH Black	0506156			X	X
Door RH Black	0507741			X	
Door Gasket	1501487	X			
Door Gasket	1501448		X		
Door Gasket	0506159			X	X
Torsion Rod	0507228	X	X	X	X
Door Bushing	0519882	X	X	X	X
Door Lock	0505225	X	X	X	X
Door Handle (Black)	1004348	X	X	X	X
Plastic Lower Front Grille (KO for SNIII)	0506912	X			
Plastic Lower Front Grille (KO for SNIII)	0516530		X		
Plastic Lower Front Grille (KO for SNIII)	0506816			X	
Plastic Lower Front Grille (KO for SNIII)	0506817				X
PTM Bottom Shelf	0518310		X		
PTM Bottom Shelf	0518311			X	X

<b>Models</b>		<b>LTH8S</b>	<b>LTH-18</b>	<b>LTH-45</b>	<b>LTH-68</b>
<b>Upper Lighted Canopy</b>	<b>Part Number</b>				
Plastic Display	1H12756001		X		
Plastic Display	0506944			X	
Plastic Display	0506945				X
Lamp Holder	1803376		X	X	X
Lamp (F17T8/SPX41)	1803689		X		
Lamp (FO32/841 32W) Interior lamps also	1803337			X	
Lamp (F30 T8/CW)	1800278				X
Ballast (QTP2X54T5HO/UNV PSN)	1804574		X		
Ballast (WHSG4-UNV-T8-IS) Interior lamps also	0509567			X	
Ballast (WHSG2-UNV-T8-IS)	0509272				X



Refrigeration	Part Number				
Compressor (Embraco NT2178GKV)	1H12397	X			
Compressor (NT2192GKV)	2000588		X		
Compressor (NT2178GK)	0507909			X	
Compressor (NJ2212GK)	0507805				X
Condenser	1H12549	X			
Condenser (On LTH45 RH Cassette)	2100214		X	X	X
Condenser (On LTH45 LH Cassette)	2100213			X	X
Condenser Fan Motor	0508069	X			
Condenser Fan Motor	1700502		X		
Condenser Fan Motor Assy (Motor,Blade & Mtg Brkt)	0508557			X	X
Condenser Fan Motor	1800566			X	X
Condenser Fan Blade	0501428	X			
Condenser Fan Blade	0500354		X	X	X
Evaporator Fan Motor Assy (Motor,Blade, & Brkt)	0506136	X	X		
Evaporator Fan Blade (FV600CW30P3B)	0501426	X	X	X	X
Evaporator Fan Motor (SSC B138 JHEM1)	1804554	X	X		
Evaporator Fan Motor Assy (Motor,Blade, & Brkt)	0508113			X	
Evaporator Fan Motor	0510149			X	X
Evaporator Fan Motor Assy (Motor,Blade, & Brkt)	0507900				X
Evaporator Coil	1H12309	X			
Evaporator Coil	2200182		X		
Evaporator Coil	0507584			X	
Evaporator Coil	0507382				X
Accumulator	1701752	X	X	X	X
TXV (Sweat)R404A TUB#4	0509121	X			
TXV (Sweat)R404A EXPT52 MOD 068Z3414	1701366		X		X
TXV (Sweat)R404A TUB orifice#5 068U3371	0510392			X	
Filter Drier (Sporlan C-032S)	1701751	X	X	X	
Drier (Danfoss 023Z5129)	0510867				X
Condenser Gasket	1H13191	X			
Condenser Gasket	1501473		X		
Condenser Gasket	0508101			X	
Condenser Gasket	0507803				X
Evaporator Gasket	0506925	X			
Evaporator Gasket	1501343		X		
Evaporator Gasket	0508100			X	
Evaporator Gasket	0507806				X
CRO (CRO-4-0/50)	0518905				X

Heaters	Part Number				
Defrost Heater	1H13190	X			
Defrost Heater	1804360		X		
Defrost Heater	0507931			X	
Defrost Heater	0507383				X
Door Frame AS Heater	0507786	X			
Door Frame AS Heater	1804541		X		
Door Frame AS Heater	0507631			X	X
Case perimeter AS Heater	1804602	X			
Case perimeter AS Heater	1804539		X		
Case perimeter AS Heater (2)	0507630			X	X

Sheel Metal Replacement Parts Painted	All these part numbers below are painted assemblies				
Bottom Solid Shelf Assy	7408890	X			
Bottom Solid Shelf Assy	7408686		X		
Bottom Solid Shelf Assy LH	0506441			X	X
Bottom Solid Shelf Assy RH	0507394			X	X
Bottom Solid Shelf Assy Center	0508065				X
Bottom Shelf Cover (Stainless Steel)	0507863	X			
Bottom Shelf Cover (Stainless Steel)	0506511		X		
Bottom Shelf Cover LH (Stainless Steel)	0507599			X	X
Bottom Shelf Cover RH (Stainless Steel)	0507587			X	X
Bottom Shelf Cover Center (Stainless Steel)	0508067				X
Door Hinge Lower	0521105	X	X	X*	*
Door Hinge Lower	0510152			X**	X**
Hinge Plate Upper Assy (w/ pin)	0508176	X			
Door Hinge Assy Upper	0505093		X	X	X
Door Lock Bracket	0494798	X	X	X	X

\* (1) On LTH45 for LH Dr & (1) on LTH68 for LH Dr

\*\* (1) On LTH-45 for RH Door & (2) on LTH68 for Center & RH Dr.

Dimensions shown as inches and (mm).

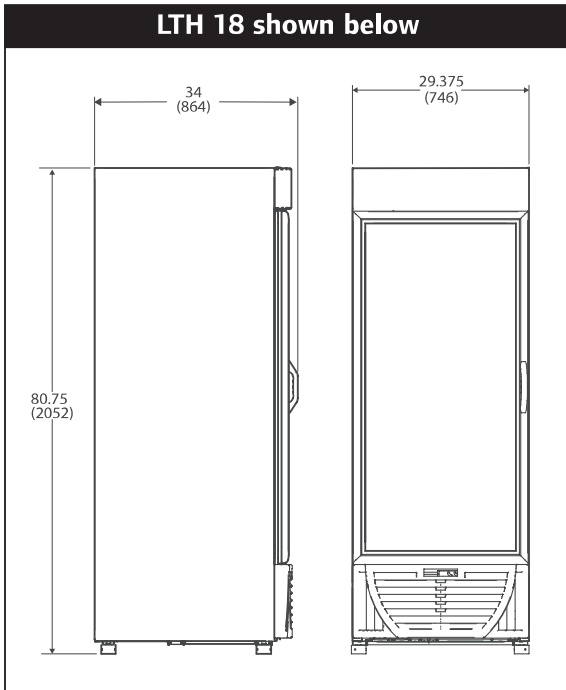

**Note:** This data is based on store temperature and humidity that does not exceed 75°F and 55% R.H. unless otherwise stated. Schedule defrost at night while lights are off.

**REFRIGERATION DATA**

**LTH-8S, LTH-18, LTH-45, LTH-68**

**Thermostat**

**Setting CI/CO (°F)**

Models	LTH-8S, LTH-45, LTH-68
	Position #1 5° F / -5° F
	Positions #7 -18° F / -28° F
Models	LTH-18
	Position #1 0° F / -5° F
	Positions #7 -23° F / -28° F

**Compressor (hp)**

LTH-8S	1/2 hp	LTH-18	1 hp
LTH-45	1/2 hp x 2	LTH-68	3/4 hp x 2

**Condensing Unit Capacity**

LTH-8S	1834	LTH-18	2376
LTH-45	1834 x 2	LTH-68	2376 x 2

at -30° F evaporator and 110° F condenser temperature

**DEFROST DATA**

**Frequency (hr)** 8

**OFFTIME**

**Failsafe (minutes)**

All models 50

**Defrost Termination**

**Temperature (F)** 48

**PHYSICAL DATA**

**Refrigerant Charge**

LTH-8S	10 oz	0.283 kg
LTH-18	17 oz	0.482 kg
LTH-45	12 oz	0.340 kg (each cassette)
LTH-68	15 oz	0.426 kg (each cassette)

**LTH — Dimensions**

Model	Doors	Refrig.	Cu.Ft. Capacity	Dimensions (in inches)						
				Exterior				Interior (useable)		
				L	D*	D End Only	H**	L	D	H
LTH 8S	1	R-404A	10.6	24 <sup>5/8</sup>	27 <sup>5/8</sup>	23 <sup>5/8</sup>	60 <sup>3/4</sup>	20 <sup>5/8</sup>	18 <sup>1/8</sup>	40 <sup>5/8</sup>
LTH 18	1	R-404A	22.0	29 <sup>3/8</sup>	34	30	80 <sup>3/4</sup>	25 <sup>3/8</sup>	23 <sup>1/2</sup>	54
LTH 45	2	R-404A	41.0	52	34	30	80 <sup>3/4</sup>	48	27 <sup>1/2</sup>	56
LTH 68	3	R-404A	68.6	78 <sup>1/4</sup>	34	30	80 <sup>3/4</sup>	73 <sup>1/4</sup>	26 <sup>13/16</sup>	54

\*Note: Depth dimension “D” includes 1 1/2 in. for door handle

\*\*Note: Overall height includes 1 1/2 in. for leveling pods

**LTH — Electrical Data**

Model	Electrical								
	Unit H.P.	Voltage HZ/PH	Run Amps	Fuse Size	Power Cord	NEMA* Plug	A/C Load (BTU/h)	Energy Consumption (kWh/day)	Energy Consumption for optional LEDs (kWh/day)*
LTH 8S	1/2	115/60/1	8.8	15-AMP	Yes	5-15P	3760	11.44	10.84
LTH 18	1	115/60/1	11.5	15-AMP	Yes	5-15P	4321	18.459	31.82
LTH 45	(2) 1/2	208-230/60/1	11.7	15-AMP	Yes	6-15P	8696	33.74	31.82
LTH 68	(2) 3/4	208-230/60/1	13.5	20-AMP	Yes	6-20P	13688	51.03	48.73

\*Estimated energy consumption for optional LEDs

## A-7 APPENDIX A — TECHNICAL DATA

### Electrical Data

*Note: These are rated values for individual components and should not be added together to determine total merchandiser electrical load.*

#### Evaporator Fans 115V, 60Hz Standard for LTH-8S/18, 208-230V for LTH-45/68

	LTH-8S	LTH-18	LTH-45	LTH-68
Number of Motors	1	2	4	4
Amperes	0.4	0.8	1.2	1.2
Watts	16	32	120	120

#### Condensing Unit (115V, 1Ph, 60Hz) Standard for LTH 8S/18, 208-230V for LTH 45/68

	LTH-8S	LTH-18	LTH-45	LTH-68
Compressor LRA	56	45	59.8	59.8
Compressor RLA	10.5	10.2	12	12

### Product Data

<b>LTH-8S Interior Volume (Cu Ft/Case)</b>	10.7 ft <sup>3</sup> /case (301.57 liters /case)
<b>LTH-18 Interior Volume (Cu Ft/Case)</b>	22 ft <sup>3</sup> /case (622.97 liters /case)
<b>LTH-45 Interior Volume (Cu Ft/Case)</b>	41.1 ft <sup>3</sup> /case (1163.7 liters /case)
<b>LTH-68 Interior Volume (Cu Ft/Case)</b>	63.97 ft <sup>3</sup> /case (1811.34 liters /case)

#### ESTIMATED SHIPPING WEIGHT <sup>2</sup>

Case	Weight
<b>LTH-8S</b>	<b>310 lb (141kg)</b>
<b>LTH-18</b>	<b>535 lb (243kg)</b>
<b>LTH-45</b>	<b>1014 lb (460kg)</b>
<b>LTH-68</b>	<b>1036 lb (470kg)</b>

<sup>2</sup> Actual weights will vary according to optional kits included.

LTH-8S

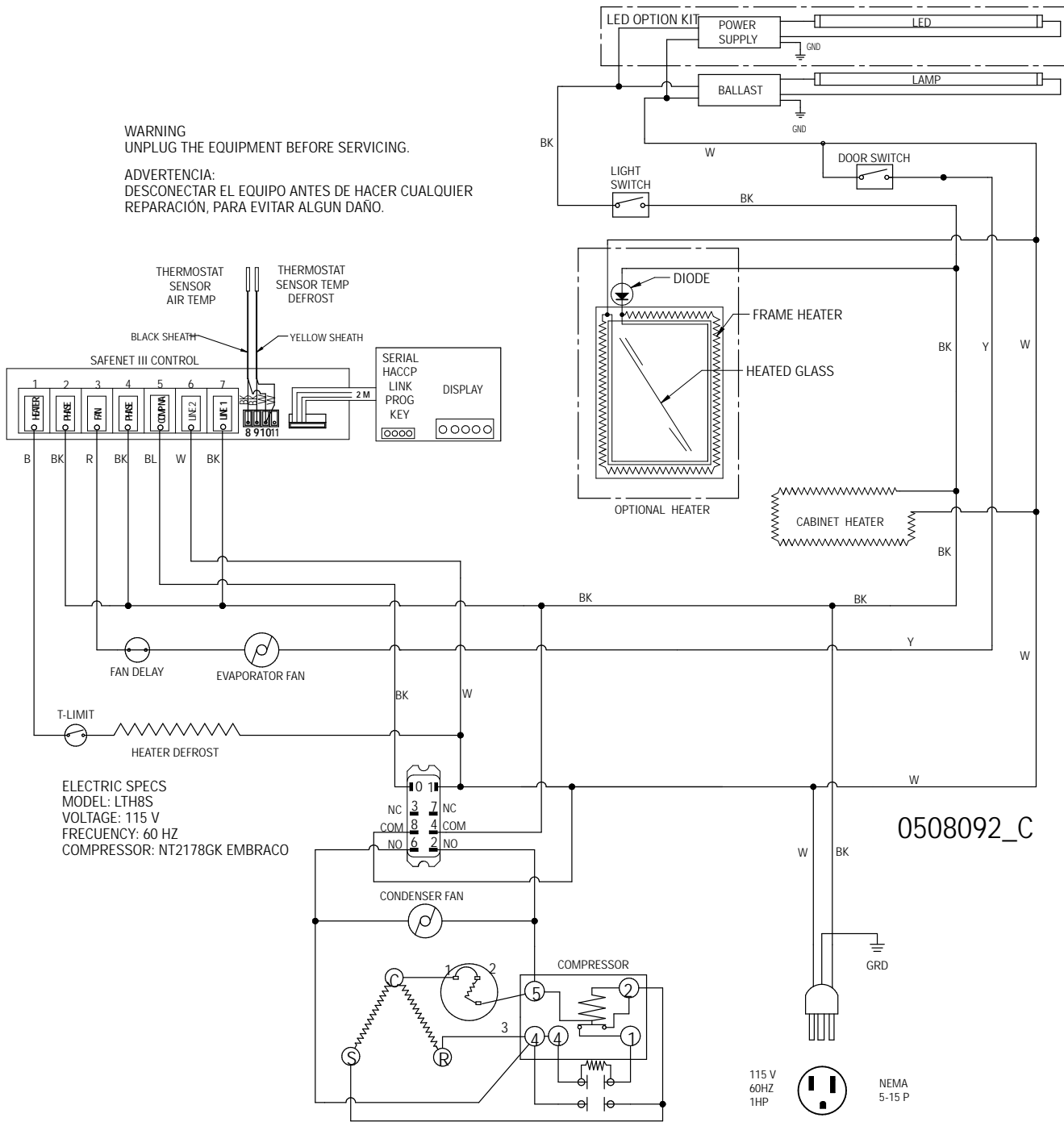

**WARNING**

All components must have mechanical ground, and the merchandiser must be grounded.

Circled Numbers = Parts List Item Numbers

R = Red Y = Yellow G = Green BL = Blue BK = Black W = White

● = 120V Power ○ = 120V Neutral ⊥ = Field Ground  $\overline{\text{mm}}$  = Case Ground

LTH-18

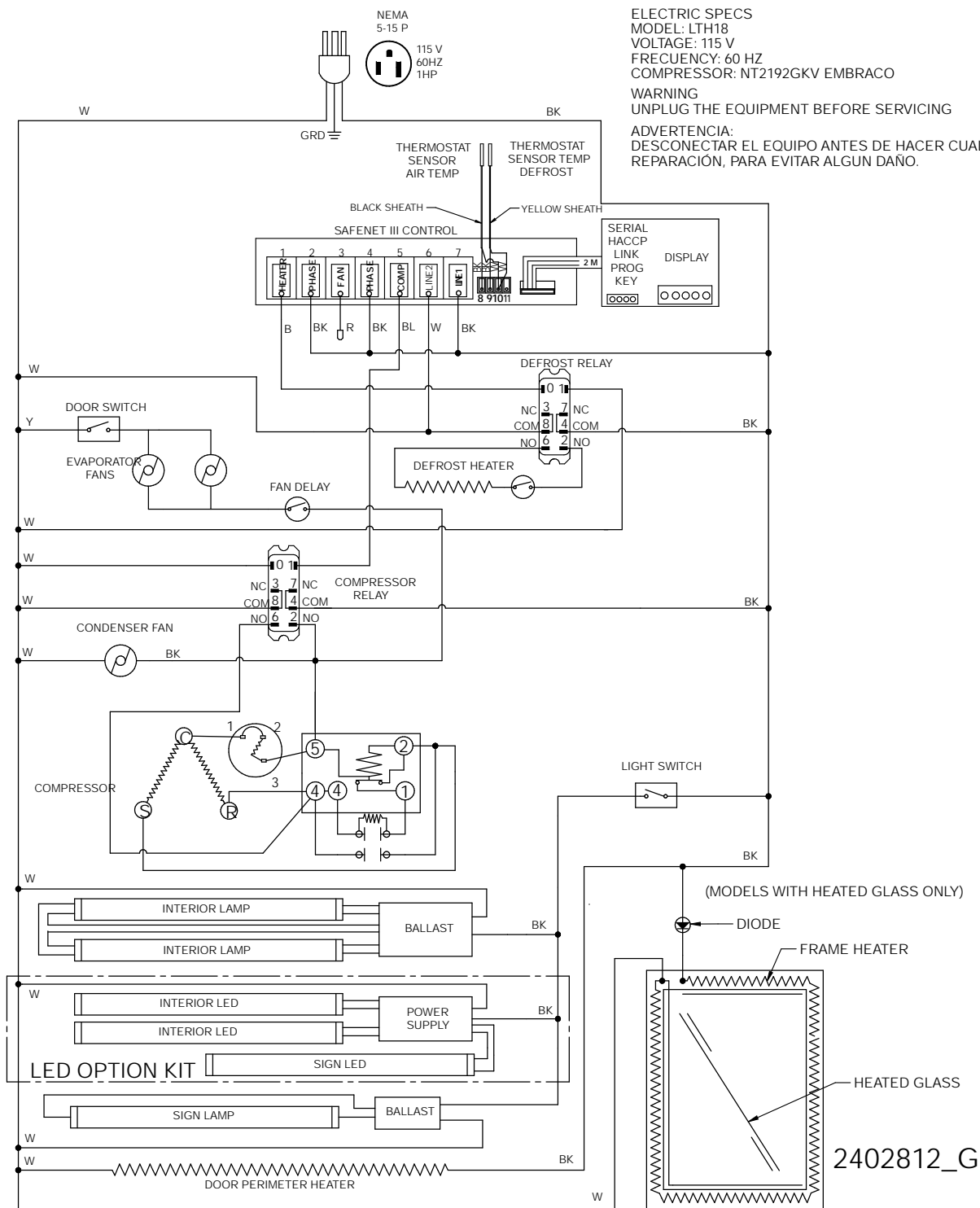

ELECTRIC SPECS  
 MODEL: LTH18  
 VOLTAGE: 115 V  
 FREQUENCY: 60 HZ  
 COMPRESSOR: NT2192GKV EMBRACO  
 WARNING  
 UNPLUG THE EQUIPMENT BEFORE SERVICING  
 ADVERTENCIA:  
 DESCONECTAR EL EQUIPO ANTES DE HACER CUALQUIER  
 REPARACION, PARA EVITAR ALGUN DAÑO.

WARNING

All components must have mechanical ground, and the merchandiser must be grounded.

Circled Numbers = Parts List Item Numbers

R = Red Y = Yellow G = Green BL = Blue BK = Black W = White

● = 120V Power ○ = 120V Neutral ⊥ = Field Ground = Case Ground

LTH-45 and LTH-68

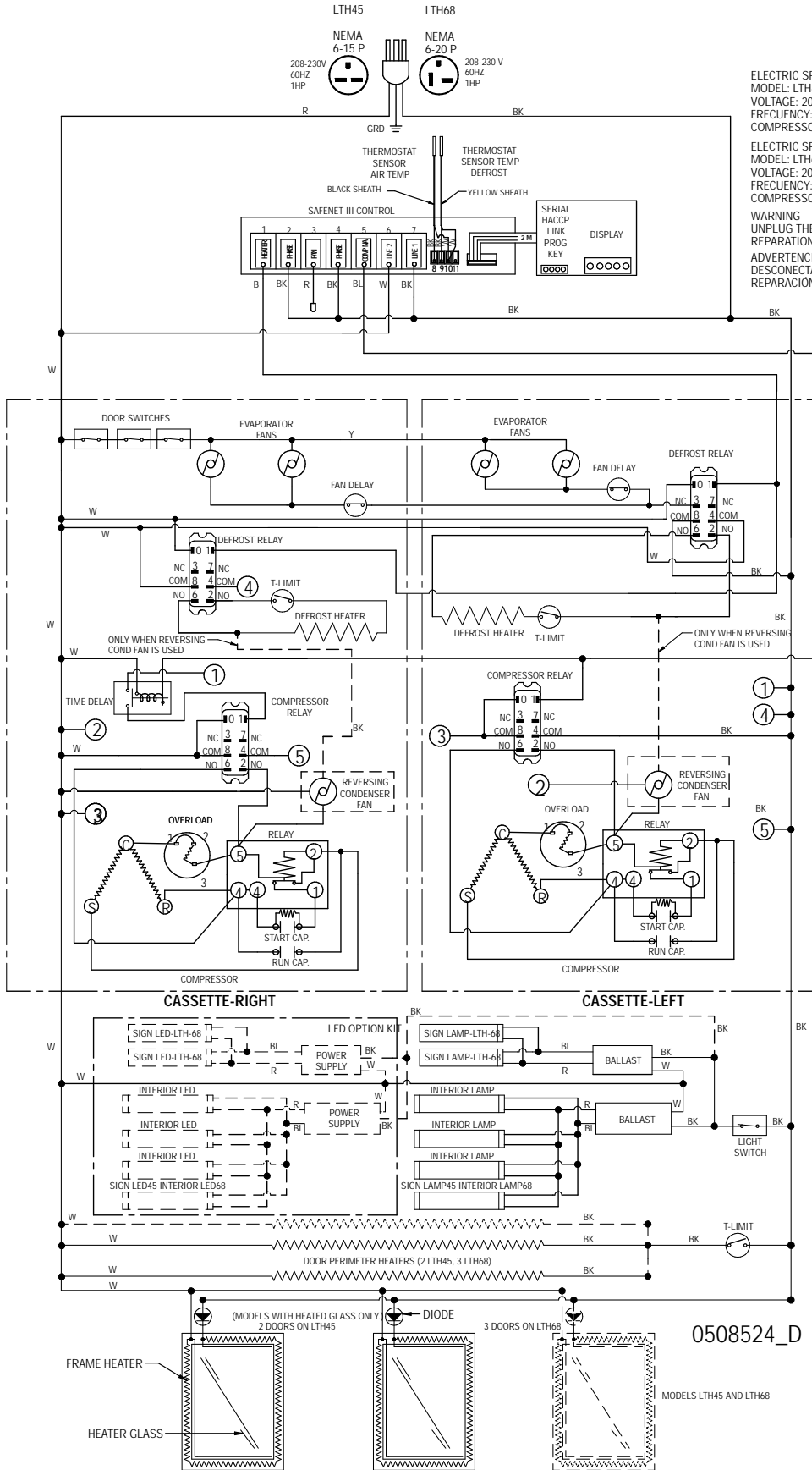

ELECTRIC SPECS  
 MODEL: LTH45  
 VOLTAGE: 208-230 V  
 FREQUENCY: 60 HZ  
 COMPRESSOR: NT2178GK EMBRACO

ELECTRIC SPECS  
 MODEL: LTH68  
 VOLTAGE: 208-230 V  
 FREQUENCY: 60 HZ  
 COMPRESSOR: NJ2212GK EMBRACO

WARNING  
 UNPLUG THE EQUIPMENT BEFORE TO MAKE ANY REPAIRATION TO AVOID ANY DAMAGE  
 ADVERTENCIA:  
 DESCONECTAR EL EQUIPO ANTES DE HACER CUALQUIER REPARACION, PARA EVITAR ALGUN DAÑO.

**WARNING**

All components must have a mechanical ground, and the merchandiser must be grounded.

0508524\_D