

HUSSMANN®



SHM ***Medium Temperature*** ***Self Contained*** ***Specialty Horizontal Merchandiser***



Installation & ***Service*** ***Manual***

IMPORTANT
Keep in store
for future reference!

P/N 0515258_F
October 2013

Spanish 0531303
French 0531304

ATTENTION

Merchandiser must operate for 24 hours
before loading product!

Regularly check merchandiser temperatures.

Do not break the cold chain. Keep products
in cooler before loading into merchandiser.

These merchandisers are designed
for pre-chilled products only.



IMPORTANT
KEEP IN STORE FOR FUTURE REFERENCE
Quality that sets industry standards!

12999 St. Charles Rock Road • Bridgeton, MO 63044-2483

U.S. & Canada 1-800-922-1919 • Mexico 01 800-890-2900

www.hussmann.com

© 2013 Hussmann Corporation

TABLE OF CONTENTS

v

ANSI DEFINITIONS vi

INSTALLATION

Certification 1-1
Husmann Product Control 1-1
Shipping Damage 1-1
Location 1-1
Self Contained Location 1-2
Model Description 1-3
Unloading 1-3
Exterior Loading 1-3
Shipping Skid 1-3
Merchandiser Leveling 1-4
Optional Legs 1-4
Serial Plate Location 1-4
Refrigeration Unit Access 1-4
Sealing Merchandiser to Floor 1-4
Night Curtain Installation 1-5

ELECTRICAL / REFRIGERATION

Merchandiser Electrical Data 2-1
Field Wiring 2-1
Electrical Connections 2-1
Electrical Outlet 2-1
Refrigeration (Self Contained) 2-1
Refrigeration (Remote) 2-2
Line Sizing (Remote) 2-2
Waste Outlet and Waterseal 2-2

START UP / OPERATION

Safe-NET III User Instructions 3-1
User Instructions 3-1
Display 3-2
Start-Up 3-2
Sequence of Operation Diagram 3-3
Temperature Adjustment 3-4
Alarms and Codes 3-4
Defrost Termination Switch 3-4
Manual Defrost 3-4
Full Cold and #1 Position 3-5

Sensor to Control Adjustment 3-6
Controls and Adjustments 3-7
Start Up 3-8
Load Limits 3-8
Stocking 3-8
Thermometer 3-8

MAINTENANCE

Care and Cleaning 4-1
Do NOT Use: 4-1
Do: 4-1
Removing Scratches from Bumper 4-2
Cleaning Under Step Pan 4-2
Cleaning Discharge Honeycomb 4-2
Cleaning Stainless Steel Surfaces 4-3
Cleaning Thermometer 4-3
Cleaning Coils 4-3
Cleaning Evaporation Pan 4-4
Removing Scratches from Bumber 4-4

SERVICE

Replacing Fan Motors and Blades 5-1
Replacing Lights 5-2
Replacing Ballast / Power Supply 5-2

APPENDIX

Part Numbers A-1
Plan View & Dimensions A-2
Cross Section View & Data A-3
Electrical Data & Product Data A-4
Electrical Cont. & Shipping Weight A-5
SHM Self Contained Case Wiring A-6

WARRANTY

REVISION HISTORY

REVISION F — Added Checklists Page 1-7; Added Warning Page 1-3; Cleaning Coils 4-3; Maintaining Fluorescent Lights 4-4. Checklist Page 4-5

REVISION E — JULY 2013

- 1. Included Night Curtain Installation Instructions
Page 1-5 and 1-6

REVISION D — FEBRUARY 2012

- 1. Changed NEMA plug
- 2. Removed Remote Case setup instructions

REVISION C — JANUARY 2012

- 1. Added LED Light Bars
- 2. Removed Remote Models
- 3. New Wiring Diagram SHM-3, SHM-4

REVISION B — DECEMBER 2010

- 1. Revised defrost settings, Page 3-3
- 2. Changed Defrost Frequency (2); Page 3-7
- 3. Revised defrost settings; Page A-3

ORIGINAL ISSUE — NOVEMBER 2010

ANSI Z535.5 DEFINITIONS



• **DANGER** – Indicate[s] a hazardous situation which, if not avoided, will result in death or serious injury.



• **WARNING** – Indicate[s] a hazardous situation which, if not avoided, could result in death or serious injury.



• **CAUTION** – Indicate[s] a hazardous situation which, if not avoided, could result in minor or moderate injury.

• **NOTICE** – *Not related to personal injury* – Indicates[s] situations, which if not avoided, could result in damage to equipment.

INSTALLATION

CERTIFICATION

These merchandisers are manufactured to meet ANSI / National Sanitation Foundation (NSF®) Standard #7 requirements. Proper installation is required to maintain certification. Near the serial plate, each case carries a label identifying the type of application for which the case was certified.

ANSI/NSF-7 Type I - Display Refrigerator / Freezer

Intended for 75°F / 55% RH Ambient Application

ANSI/NSF-7 Type II - Display Refrigerator / Freezer

Intended for 80°F / 55% RH Ambient Application

ANSI/NSF-7 - Display Refrigerator

Intended for Bulk Produce

HUSSMANN PRODUCT CONTROL

The serial number and shipping date of all equipment is recorded in Hussmann's files for warranty and replacement part purposes. All correspondence pertaining to warranty or parts ordering must include the serial number of each piece of equipment involved. This is to ensure the customer is provided with the correct parts.

SHIPPING DAMAGE

All equipment should be thoroughly examined for shipping damage before and during unloading. This equipment has been carefully inspected at our factory. Any claim for loss or damage must be made to the carrier. The carrier will provide any necessary inspection reports and/or claim forms.

Apparent Loss or Damage

If there is an obvious loss or damage, it must be noted on the freight bill or express receipt and signed by the carrier's agent; otherwise, carrier may refuse claim.

Concealed Loss or Damage

When loss or damage is not apparent until after equipment is uncrated, retain all packing materials and submit a written response to the carrier for inspection within 15 days.

LOCATION

These merchandisers are designed for displaying products in air conditioned stores where temperature is maintained at or below the ANSI / NSF-7 specified level and relative humidity is maintained at or below 55%.

Recommended operating ambient temperature is between 65°F (18°C) to 75°F (23.9°C). Maximum relative humidity is 55%.

Placing refrigerated merchandisers in direct sunlight, near hot tables or near other heat sources could impair their efficiency. Like other merchandisers, these merchandisers are sensitive to air disturbances. Air currents passing around merchandisers will seriously impair their operation. Do NOT allow air conditioning, electric fans, open doors or windows, etc. to create air currents around the merchandiser.

1-2 INSTALLATION

SELF CONTAINED LOCATION

Product should always be maintained at proper temperature. This means that from the time the product is received, through storage, preparation and display, the temperature of the product must be controlled to maximize the life of the product.

BE SURE TO POSITION SELF CONTAINED MERCHANDISERS PROPERLY.

SELF CONTAINED models have vented base panels to allow air circulation through the condensing unit.

See illustrations for clearances distances from walls, merchandisers, and any other large objects near the merchandiser's vented base panels. Blocking or restricting air flow will adversely affect performance and may damage the refrigeration system.

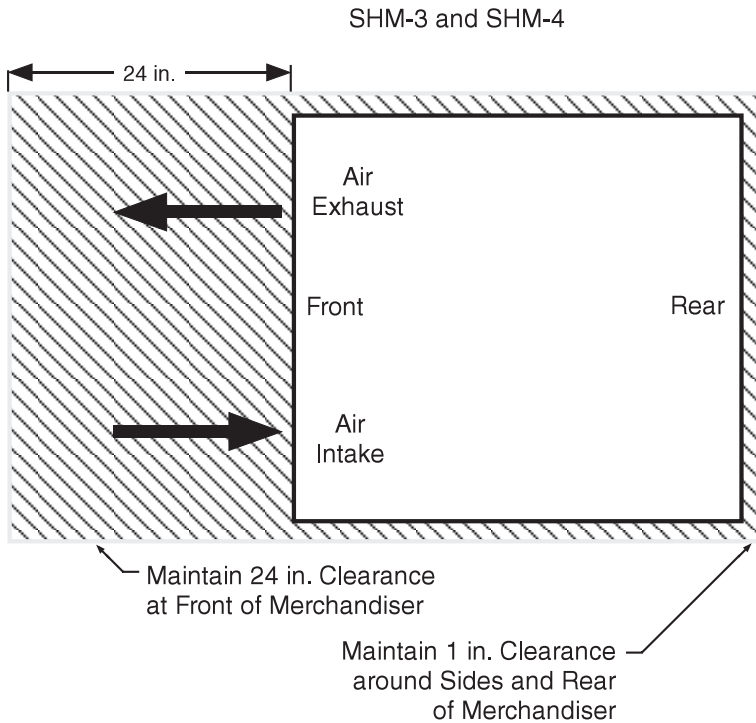
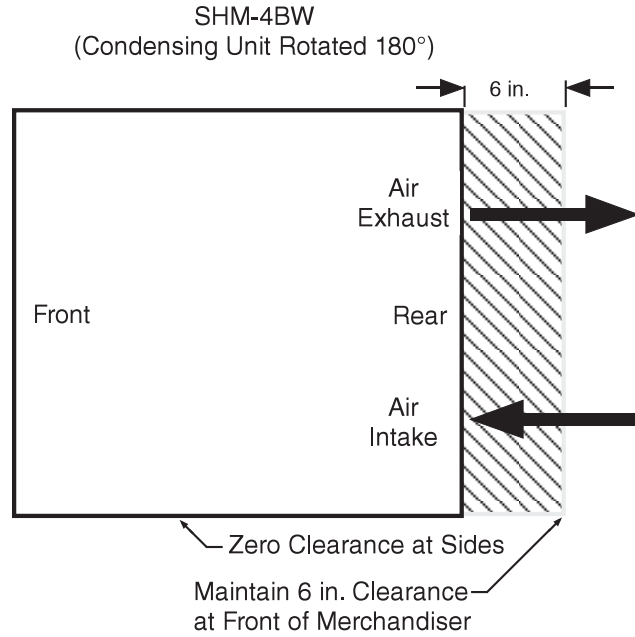

MODEL DESCRIPTION

SHM merchandisers offer versatility for the display of food items such as: fresh fruit, vegetables, cheeses and other delicatessen items. Carefully read and follow the instructions prior to operating the merchandiser.

UNLOADING

Unloading from Trailer:

Lever Bar (also known as a Mule, Johnson Bar, J-bar, Lever Dolly, or Pry Lever)

Move the merchandiser as close as possible to its permanent location and remove all packaging. Check for damage before discarding packaging. Remove all separately packed accessories such as kits and shelves.

Improper handling may cause damage to the merchandiser when unloading. To avoid damage:

1. Do not drag the merchandiser out of the trailer. Use a Johnson bar (mule).
2. Use a forklift or dolly to remove the merchandiser from the trailer.

EXTERIOR LOADING

Do NOT walk on top of merchandisers or damage to the merchandisers and serious personal injury could occur.

MERCHANDISERS ARE NOT STRUCTURALLY DESIGNED TO SUPPORT EXCESSIVE EXTERNAL LOADING such as the weight of a person. Do not place heavy objects on the merchandiser.

SHIPPING SKID

Each merchandiser is shipped on a skid to protect the merchandiser's base, and to make positioning the case easier.

Do not remove the shipping skid until the merchandiser is near its final location. The skid provides protection for both the merchandiser and the floor.

Remove the skid by raising one end of the merchandiser approximately 6 inches. Block the merchandiser securely, and remove the two skid bolts from the raised end. Replace the bolts with (provided) leg levelers. Repeat this procedure at opposing end. Once the leg levelers are secured in place, the merchandiser may be slid off the skid and placed in its final location.

DO NOT TILT MERCHANDISER ON ITS SIDE OR END WHEN REMOVING SKID.

Once the skid is removed, the merchandiser must be lifted —NOT PUSHED— to reposition.

Check floor where merchandisers are to be set to see if it is a level area. Determine the highest part of the floor.



WARNING

Do NOT remove shipping crate until the merchandiser is positioned for installation.



WARNING

Do NOT stand or walk on top of merchandiser. Do not store items or flammable materials atop the unit.

MERCHANDISER LEVELING

BE SURE TO POSITION MERCHANDISERS PROPERLY. Level the merchandiser by all four corners. Merchandiser(s) must be installed level to ensure proper operation of the refrigeration system, and to ensure proper drainage of defrost water. Optional leg levelers can be provided for this purpose.

OPTIONAL LEGS

NSF® approved legs replace the leg levelers if required by local health codes. The legs raise the case 6 inches for cleaning purposes. An optional skirt kit can be provided to snap on the legs.

SERIAL PLATE LOCATION

The serial plate is located on the interior left wall of the merchandiser. It contains all pertinent information such as model, serial number, amperage rating, refrigerant type and charge. This information will be needed to install, service or order parts for the merchandiser.



REFRIGERATION UNIT ACCESS

The lower access panel may be removed by lifting the panel straight upward and over the screws on which it is hanging. The panel is installed by reversing the above procedure.

Ensure lower access panel is flat against the floor when installed to prevent air circulation problems on self contained merchandisers.

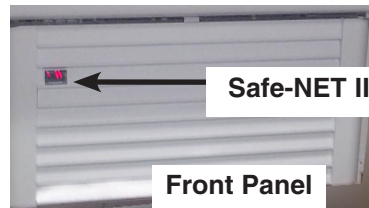

Lift up and out to remove access panel



Safe-NET III display is mounted on left side of access panel. Be careful not to detach Safe-NET III cable from display when removing access panel.



SEALING MERCHANDISER TO FLOOR

If required by local sanitary codes, or if the customer desires, merchandisers may be sealed to the floor using a vinyl cove base trim. The size needed will depend on how much variation there is in the floor, from one end of the merchandiser to the other. Sealing of the lower front and rear panels on self contained models may hamper their removal for servicing or maintenance of the condensing unit.

NOTE: Do not allow trim to cover any intake or discharge grilles located in the lower front panel.

NIGHT CURTAIN INSTALLATION

Night curtains are used to cover the case opening after normal business hours. The curtains improve energy consumption, allowing the refrigeration system to work less.

Fasten night curtain to top panel using (3) #8 x 1/2 in. screws.

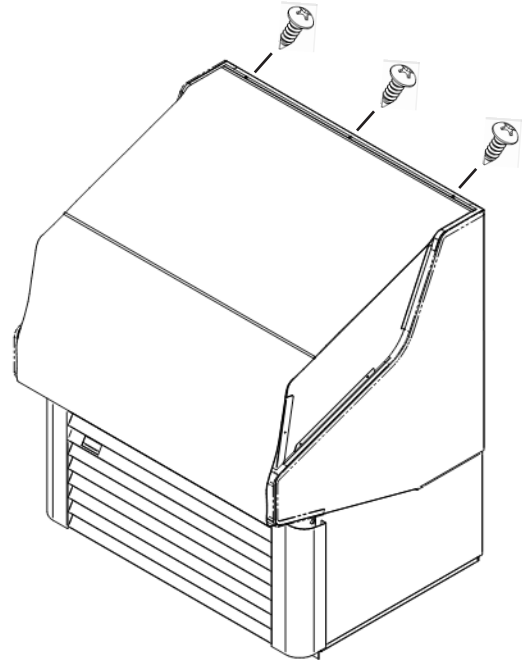
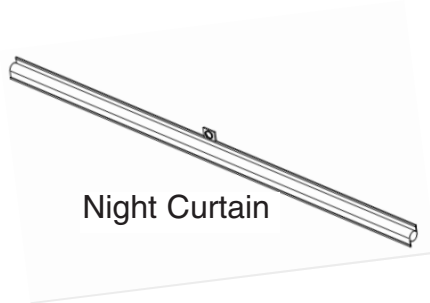

Carefully inspect the night curtain kit to ensure there is no damage from breakage during shipping. Case should be positioned and leveled before installing the night curtain.

Position night curtain on top panel. Measure 1.50 inches to edge of the end night curtain. Center night curtain to length of case.

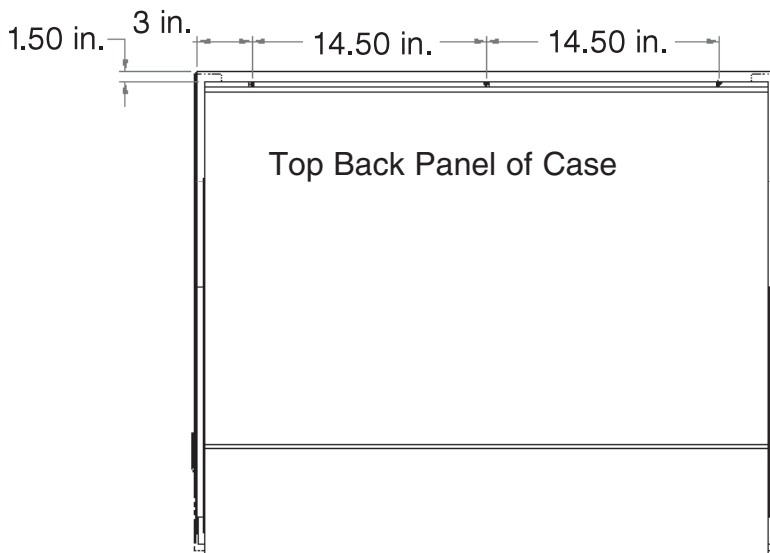

1-6 INSTALLATION

Secure bottom of night curtain using bottom clip as shown below.

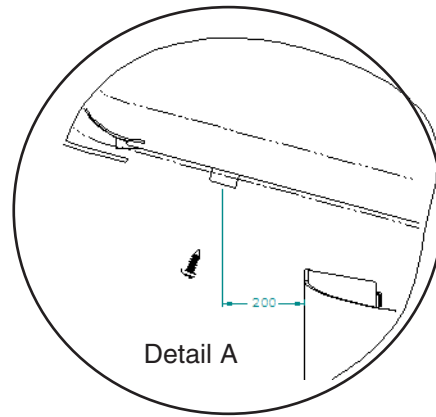
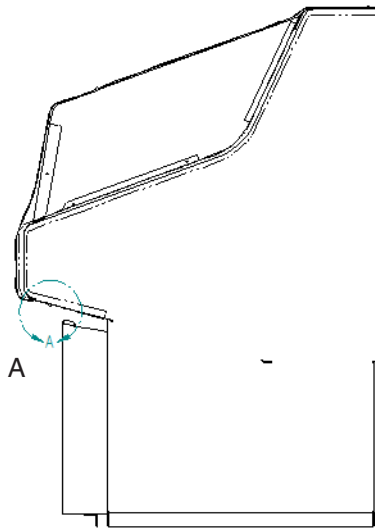

Hussmann Self-Contained Refrigeration Equipment Start Up Check List

Please note that failure to follow this start-up document may void your factory warranty

Step	Startup Activity	Check
1	Locate, read and maintain install/operation manual in a safe place for future reference.	<input type="checkbox"/>
2	Examine unit. Confirm there is NO damage or concealed damage.	<input type="checkbox"/>
3	Level the unit, side to side and front to rear.	<input type="checkbox"/>
4	Remove all shipping brackets/compressor straps/bolts etc.	<input type="checkbox"/>
5	Unit must be run on a dedicated electrical circuit without the use of an extension cord.	<input type="checkbox"/>
6	Ensure that the proper electrical requirements for the equipment are supplied.	<input type="checkbox"/>
7	Verify field electrical connections are tight.	<input type="checkbox"/>
8	Verify all electrical wiring is secured and clear of any sharp edges or hot lines.	<input type="checkbox"/>
9	Verify the condensate drain line is properly trapped and pitched.	<input type="checkbox"/>
10	Verify all required clearances on the sides and back of unit.	<input type="checkbox"/>
11	Verify there are no air disturbances external to the unit. Heat and air registers, fans, and doors etc.	<input type="checkbox"/>
Advise owner/operator that merchandiser must operate at temperature for 24 hrs prior to loading with product.		

Form HSCW01 Rev. 30MAY12 P/N 0525209_B

LEGAL DISCLAIMER:

Hussmann shall not be liable for any repair or replacements made without the written consent of Hussmann, or when the product is installed or operated in a manner contrary to the printed instructions covering installation and service which accompanied such product.

1-8 INSTALLATION

NOTES:

ELECTRICAL / REFRIGERATION

MERCHANDISER ELECTRICAL DATA

Refer to Appendix A of this manual or the merchandiser's serial plate for electrical information.

FIELD WIRING

Field wiring must be sized for component amperes stamped on the serial plate. Actual ampere draw may be less than specified.

ALWAYS CHECK THE SERIAL PLATE FOR COMPONENT AMPERES

ELECTRICAL CONNECTIONS

All wiring must be in compliance with NEC and local codes. All electrical connections (*for remote models*) are to be made in the electrical *Handy Box* located behind the removable base panel at the left end of the merchandiser when facing the discharge air louver.

ELECTRICAL OUTLET:

Before the merchandiser is connected to any wall circuit, use a voltmeter to check that the outlet is at 100% of the rated voltage. The wall circuit must be dedicated for the merchandiser. Failure to do so voids the warranty. Do not use an extension cord. Never plug in more than one merchandiser per electrical circuit.

- Always use a dedicated circuit with the amperage stated on the unit.
- Plug into an outlet designed for the plug.
- Do not overload the circuit
- Do not use long or thin extension cords. Never use adapters.
- If in doubt, call an electrician.

WARNING

— LOCK OUT / TAG OUT —

To avoid serious injury or death from electrical shock, always disconnect the electrical power at the main disconnect when servicing or replacing any electrical component. This includes, but is not limited to, such items as doors, lights, fans, heaters, and thermostats.

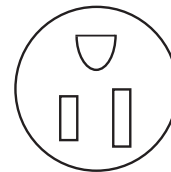

NEMA 5-15R
Receptacle
SHM

Self-contained models have factory -installed power cords attached at the electrical box.

WARNING

Risk of Electric Shock. If cord or plug becomes damaged, replace only with a cord and plug of the same type.

WARNING

Merchandiser must be grounded. Do not remove the power supply cord ground.

REFRIGERATION (Self Contained Models)

Each self contained model is equipped with its own condensing unit and control panel located beneath the display area. The merchandiser refrigeration piping is leak tested. The unit is charged with refrigerant and shipped from the factory with all service valves open.

REFRIGERATION**(Self Contained Models Continued)**

SHM-3 self contained merchandisers use R-404a refrigerant. SHM-4 self contained merchandisers use R-134a refrigerant. All models have a hermetic compressor. The systems employ capillary tubes for refrigerant flow control. The capillary tube is soldered to the suction line pull-out coil for proper heat exchange. **If the capillary should become plugged or damaged, it is best to replace the heat exchanger.**

 **WARNING**

Refrigeration lines are under pressure. Refrigerant must be recovered before attempting any connection or repair.

WATER OUTLET AND WATER SEAL

The condensate water outlet is located in the center of the merchandiser. The outlet has a factory installed, external water seal.

For self contained models, this water seal drains into the condensate evaporator pan located beneath the merchandiser. The pan uses a thermistor that senses water in the pan and adjusts the amount of heat required to evaporate the water. **Ensure the drain hose is properly trapped, and the drain area is not clogged.**

NOTE: All lower base panels must be in place when the refrigerator is operating. If not, air-flow from the condenser will be directed over the evaporator pan and defrost water in the pan may overflow.

 **CAUTION**

When brazing pipes, be sure to use the insulation blanket shipped with the merchandiser to prevent damage to the metal merchandiser bottom.

START UP / OPERATION



**...ATTENTION
INSTALLER**

**It is the contractor's responsibility to
install merchandiser(s) in accordance with
all local building and health codes.**

Safe-NET III™ TEMPERATURE AND DEFROST CONTROLLER

SAFE-NET III™ USER INSTRUCTIONS

Your refrigerated case uses a Hussmann Safe-NET™ III temperature and defrost controller to precisely maintain the temperature and prevent frost buildup on the cooling coil. LEDs indicate when the compressor or refrigeration is on, when the case is in a defrost cycle, if the temperature is outside the desired range, or if there is a sensor failure.

An adjustment knob allows the temperature to be set within the configured range and can power off the controller and compressor. Your controller has been custom-configured to provide the best temperature and defrost control for your chilled or frozen food.

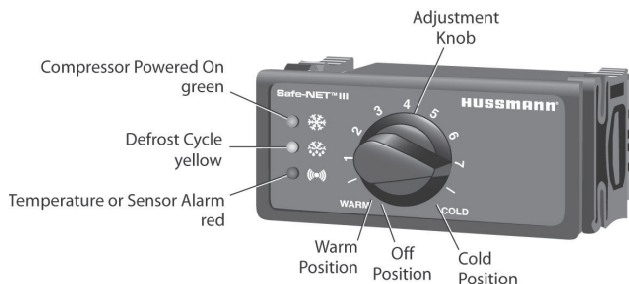

The front of the controller has an adjustment knob and status LEDs. The back of the controller has connections for sensors and switched equipment.

The Safe-NET III controller includes the following features and connections.

- Adjustment knob:
Adjusts the temperature setpoint.
Turn adjustment knob to OFF to turn off refrigeration system. Unplug merchandiser from power before servicing the unit.

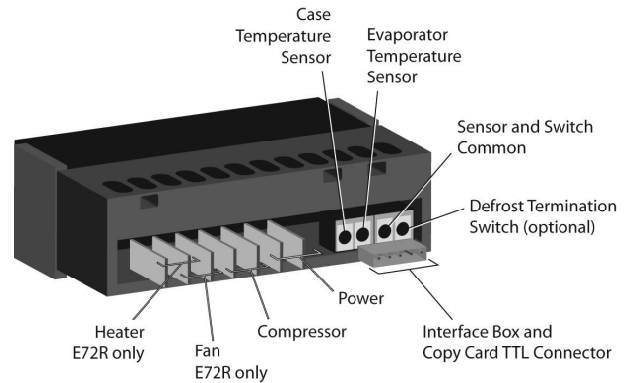

- ❄️ • Controller LEDs:
 - Compressor Powered On LED (green):
Lights while the compressor is running or the refrigeration valve is open.
 - ❄️ Defrost Cycle LED (yellow):
Lights while the refrigeration coil is defrosting.
 - 🔊 Temperature or Sensor Alarm (red):
Lights if the temperature is too warm or too cold. Flashes if a sensor fails.

- Rear connections:
 - Case temperature sensor:
 - Typically senses the temperature of the air in the case.
Used by the controller to determine when to power on or power off the compressor or refrigeration.
 - Evaporator temperature sensor:
 - Senses the temperature of the refrigeration coil.
Terminates a defrost cycle when refrigeration coil ice melts.
 - Compressor or refrigeration relay:
 - Switches on the compressor or refrigeration valve for cooling.

WARNING

The optional evaporator fan remains ON when the adjustment knob is in the Off position.

DISPLAY

The display includes three red LEDs and two digits for temperature, defrost status, and error codes.

The three display LEDs are red, and their behavior matches the LEDs on the controller.

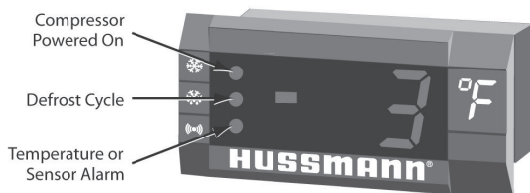

START-UP

1. Plug in the merchandiser.

WARNING

The OFF Position does not disconnect line voltage to the case, refrigeration unit, fan, or heater.

2. Wait for the self check to complete. During the self check, each LED flashes for one second, then all LEDs turn on for two seconds. If the LEDs do not flash, make sure the adjustment knob is not in the Off position.
 - After the self check, all LEDs turn off until the compressor starts. **There may be a delay before the compressor starts.** If the red Temperature or Sensor Alarm LED stays on after the self check.
 - The green Compressor Powered On LED turns on when the compressor starts.

NOTE: Do NOT load product until AFTER merchandiser operates for 24 hours and reaches desired operating temperature.

WARNING

Product will be degraded and may spoil if allowed to sit in a non-refrigerated area.

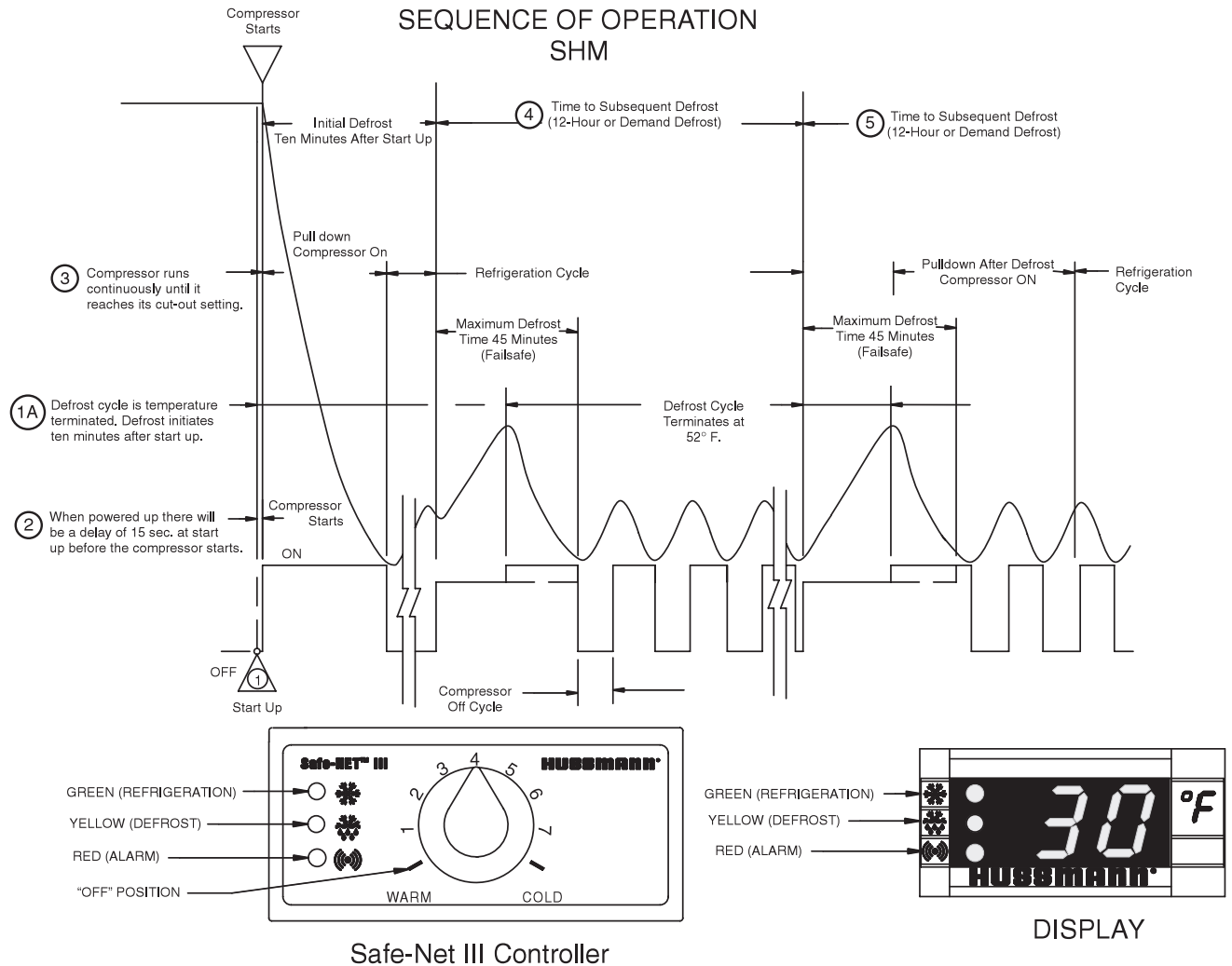

1. Apply power to the merchandiser. Wait for the self check to complete. During the self check, each LED flashes for one second and then all LEDs turn on for two seconds. If the LEDs do not flash, make sure the adjustment knob is not in the "OFF" position.
- 1A. The merchandiser temperature displays at startup. The initial defrost will start after ten minutes if the coil is colder than 52° F. The display will show the temperature before defrost. This reading will remain displayed during defrost and for 50 minutes after defrost. Even though the refrigeration mode has been initiated. (The green LED will be lit.)
2. The compressor will start after a delay — 30 seconds after the power is applied.
3. The compressor will continue to run until it reaches its cut-out temperature (Pulldown).
4. The refrigeration cycle will continue for the next subsequent scheduled (12-hours) or demand defrost.
5. The above process will repeat (steps 3 and 4) until the power is interrupted. The digital display will display the temperature reading for 50 minutes after defrost.
6. If power stops, the process will start over at step 1, and the time to subsequent defrost will reset.

TEMPERATURE ADJUSTMENT

Rotate the adjustment knob counter clockwise for a warmer setpoint or clockwise for a colder setpoint.

- While the temperature is being adjusted, the optional display shows the setpoint (cut out value). A few seconds after the temperature is set, the display reverts to showing the sensed temperature in the merchandiser.

ALARMS AND CODES

FLASHING TEMPERATURE OR SENSOR ALARM LED, E1 OR E2

If the Temperature or Sensor Alarm LED (red) on the controller and display is flashing, a temperature sensor has failed. The display shows E1 if the case sensor has failed or E2 if the evaporator sensor has failed.



If the merchandiser sensor fails, refrigeration will run continuously. Turn off, or repeat a duty cycle of a few minutes on and a few minutes off.

DEFROST TERMINATION SWITCH

Merchandisers may use a defrost termination switch, instead of an evaporator sensor to terminate a defrost cycle. The defrost termination switch is temperature activated and senses the completion of defrost.

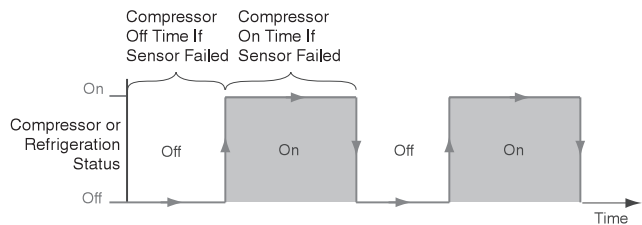

MANUAL DEFROST

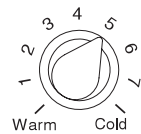

1. Note location of knob setting

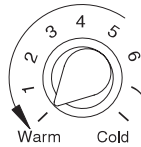

2. Rotate knob fully counterclockwise until it stops (full warm - "OFF" position)

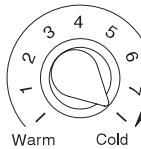

3. After 10 seconds, but before 20 seconds, rotate knob fully clockwise until it stops (full cold position)

Note:

This procedure initiates a manual or forced defrost.

IMPORTANT: Return the control knob to its original setting (Step 1) once the manual defrost has been initiated.

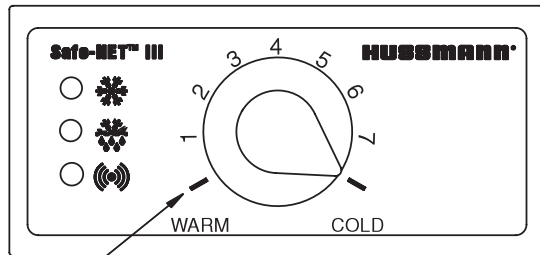

"OFF" Position — Safe-NET III Control Set at Full Cold Position

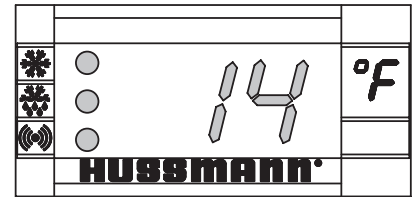

Display - at Full Cold Model SHM

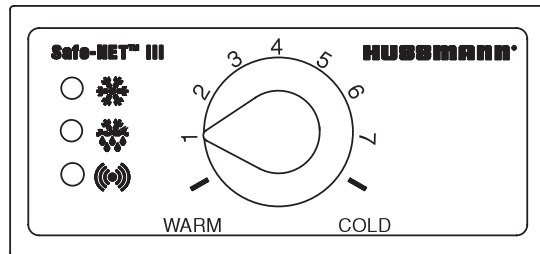

Safe-NET III Control # 1 Position

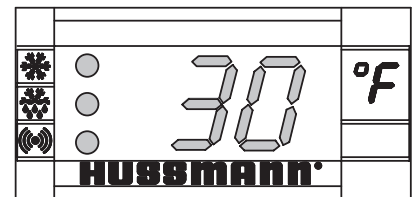

Display - at #1 Position

TEMPERATURE ADJUSTMENT

Rotate the adjustment knob counter clockwise for a warmer setpoint or clockwise for a colder setpoint.

A few seconds after the temperature is set, the display reverts to showing the sensed temperature in the merchandiser.

While the temperature is being adjusted, the optional display shows the setpoint (cut out value).

Typical Sensor to Control Configuration

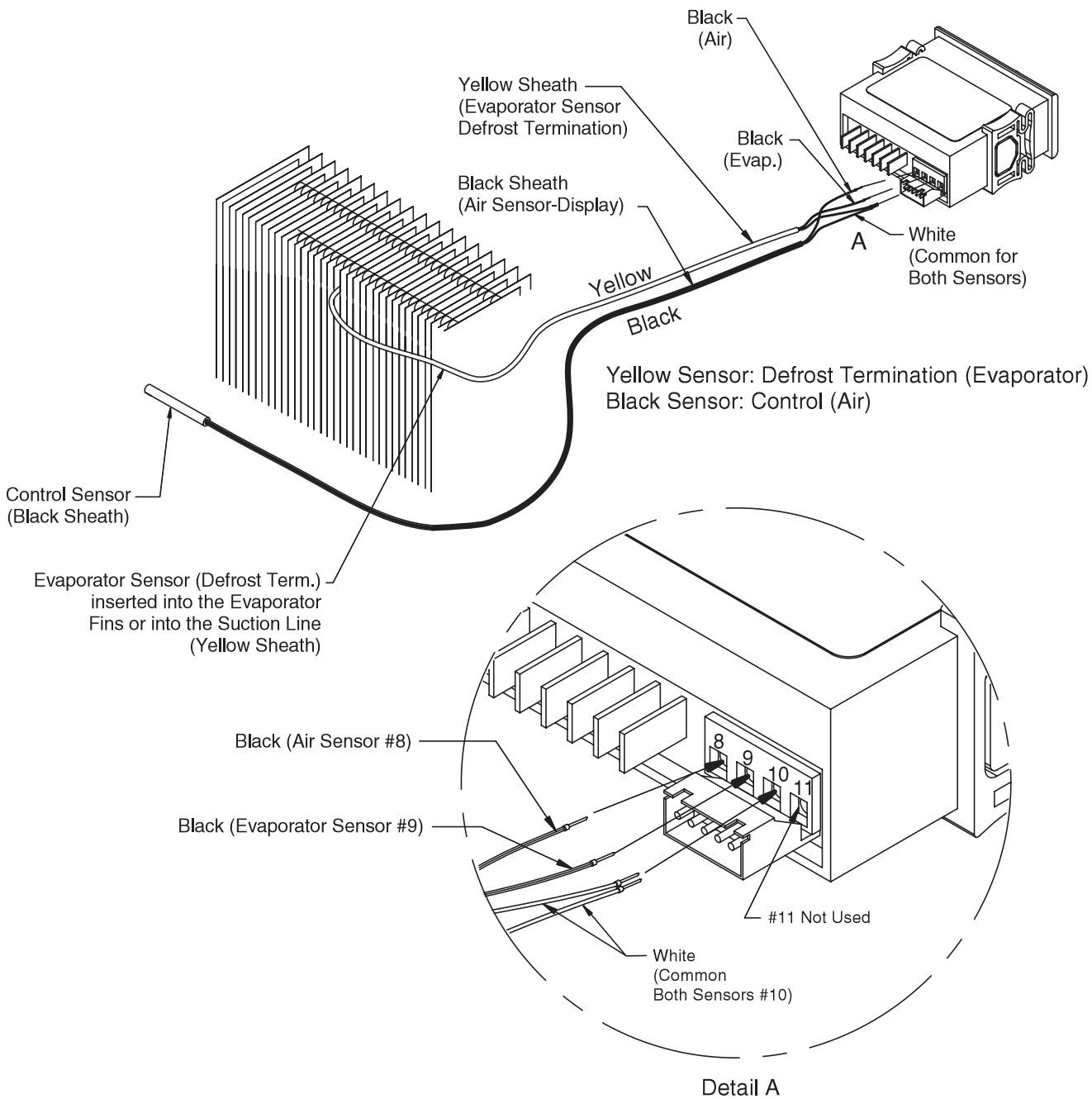

CONTROLS and ADJUSTMENTS

Refrigeration Controls			Defrost Controls			
Model	Product Application	Discharge Air Temperature	Defrost Frequency (per day)	Type of Defrost	Temp. Termination	Failsafe Time (Minutes)
SHM (Remote and Self Contained)	Medium Temp. (Dairy, Deli)	32° F- 38° F	2	Off Time	52° F	45

1. The Safe-NET III Controller controls refrigeration temperature. This is factory installed in the control panel. Adjust this control knob to maintain the discharge air temperature shown. Measure discharge air temperatures at the center of the discharge honeycomb.

Defrosts are time initiated and temperature terminated for self contained and remote. The defrost setting is factory set as shown above.

To ensure a thorough defrost, defrost must be terminated by the temperature termination setting — not by time.

START UP

Follow the Safe-NET III start up procedures as detailed in Section 3 of this manual. A thorough inspection should be made prior to start up to ensure there are no loose nuts, bolts, electrical connections or refrigeration lines rubbing or chaffing.

Turn the power switch to the ON position. Allow the system to reach normal operating temperature prior to loading any product. The merchandiser cabinet has a forced air curtain that flows over the top of the product. Air flows out of the honeycomb diffuser, across the product, and into the return air duct.

LOAD LIMITS

Each merchandiser has a load limit decal. Shelf life of perishables will be short if load limit is violated.



AT NO TIME SHOULD MERCHANDISERS BE STOCKED BEYOND THE LOAD LIMITS INDICATED.

DO NOT BLOCK HONEYCOMB.

STOCKING

Product should **NOT** be placed inside the merchandisers until merchandisers are at proper operating temperature.

Allow merchandiser 24 hours to operate before loading product.

WARNING

Product will be degraded and may spoil if allowed to sit in a non-refrigerated area.

Proper rotation of product during stocking is necessary to prevent product loss. Always bring the oldest product to the front and set the newest to the back.

AIR DISCHARGE AND RETURN FLUES MUST REMAIN OPEN AND FREE OF OBSTRUCTION AT ALL TIMES to provide proper refrigeration and air curtain performance. Do not allow product, packages, signs, etc. to block these grilles. Do not use non-approved shelving, baskets, display racks, or any accessory that could hamper air curtain performance.

Do not allow product to be placed outside of the designated load limits in the illustration.

THERMOMETER

A solar powered thermometer is provided with each merchandiser. Temperature display in Fahrenheit degrees is standard. Celsius display is available as an option. The thermometer is located in the cabinet interior in the top left hand rear corner.

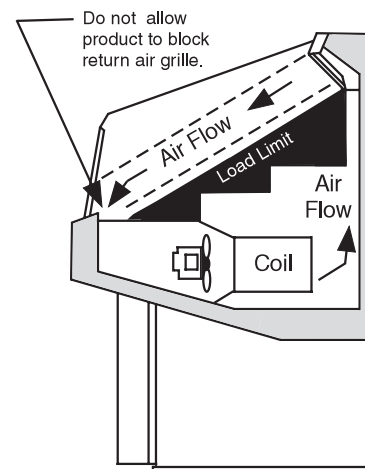

MAINTENANCE

CARE AND CLEANING

Long life and satisfactory performance of any equipment is dependent upon the care it receives. To ensure long life, proper sanitation and minimum maintenance costs, these merchandisers should be thoroughly cleaned, all debris removed and the interiors washed down, weekly.

Exterior Surfaces

The exterior surfaces must be cleaned with a mild detergent and warm water to protect and maintain their attractive finish. **NEVER USE ABRASIVE CLEANSERS OR SCOURING PADS.**

Interior Surfaces

The interior surfaces may be cleaned with most domestic detergents, ammonia based cleaners and sanitizing solutions with no harm to the surface. Self contained models empty into a limited capacity evaporation pan, which will overflow if excess water is used in cleaning.

Do NOT Use:

- Abrasive cleansers and scouring pads, as these will mar the finish.
- Coarse paper towels on coated glass.
- Ammonia-based cleaners on acrylic parts.
- Solvent, oil or acidic based cleaners on any interior surfaces.
- Do not use high pressure water hoses.

WARNING

Product will be degraded and may spoil if allowed to sit in a non-refrigerated area.

Do:

- Remove the product and all loose debris to avoid clogging the waste outlet.
- Store product in a refrigerated area such as a cooler. Remove only as much product as can be taken to the cooler in a timely manner.
- Disconnect electrical power before cleaning.**
- Thoroughly clean all surfaces with soap and hot water. **DO NOT USE STEAM OR HIGH WATER PRESSURE HOSES TO WASH THE INTERIOR. THESE WILL DESTROY THE MERCHANDISERS' SEALING CAUSING LEAKS AND POOR PERFORMANCE.**
- Lift hinged fan plenum for cleaning. Hook chain in rear panel to secure plenum during cleaning. **BE SURE TO REPOSITION THE FAN PLENUM AFTER CLEANING MERCHANDISER.**
- Take care to minimize direct contact between fan motors and cleaning or rinse water.
- Do NOT flood merchandiser with water.

WARNING

Do NOT allow cleaning agent or cloth to contact food product.

NEVER INTRODUCE WATER FASTER THAN THE WASTE OUTLET CAN REMOVE IT.

SELF CONTAINED MODELS EMPTY INTO AN EVAPORATION PAN THAT WILL OVERFLOW IF TOO MUCH WATER IS INTRODUCED DURING CLEANING.

- Allow merchandisers to dry before resuming operation.
- After cleaning is completed, turn on power to the merchandiser.

WARNING

— LOCK OUT / TAG OUT —

To avoid serious injury or death from electrical shock, always disconnect the electrical power at the main disconnect when servicing or replacing any electrical component. This includes, but is not limited to, such items as doors, lights, fans, heaters, and thermostats.

CLEANING DISCHARGE HONEYCOMB

Discharge honeycombs should be cleaned every six months. Dirty honeycombs will cause merchandisers to perform poorly. The honeycombs may be cleaned with a vacuum cleaner. Soap and water may be used if all water is removed from the honeycomb cells before replacing. Be careful not to damage the honeycomb.

1. Using a flat object such as a screw driver, compress the honeycomb and remove it from its retainer.
2. Clean and dry the honeycomb.
3. After cleaning, replace in reverse order. Damaged honeycomb must be replaced.

CAUTION

DO NOT FLOOD!

Use only enough water necessary to clean surface. Water must not drip down the case!

Never use ammonia based cleansers, abrasive cleansers, or scouring pads.

CLEANING STAINLESS STEEL SURFACES

Use non-abrasive cleaning materials, and always polish with grain of the steel. Use warm water or add a mild detergent to the water and apply with a cloth. Always wipe rails dry after wetting.

Use alkaline chlorinated or non-chlorine containing cleaners such as window cleaners and mild detergents. Do not use cleaners containing salts as this may cause pitting and rusting of the stainless steel finish. Do not use bleach.

CLEANING UNDER STEP PAN

Remove all product from the merchandiser and place in cooler. Always disconnect electrical power before cleaning.

1. Place a small screw driver between the front grille and step pan. Gently lift the step pan's front lip up. Grasp the step pan with both hands to remove. Always wear gloves when removing step pan.
2. Use non-abrasive cleaning materials and a mild detergent to clean the step pan.
3. Wipe down the insides of the merchandiser with a mild detergent, and replace step pan.

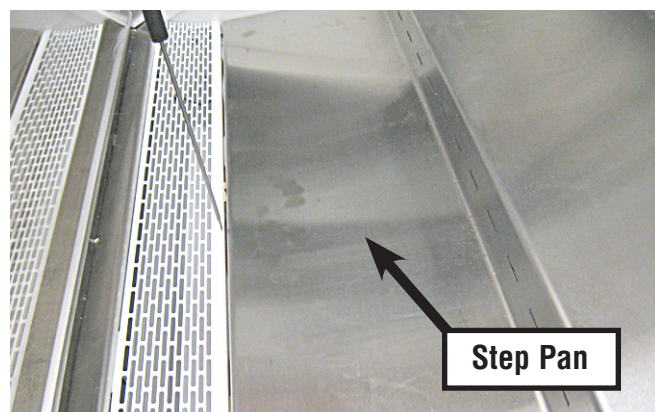

CLEANING THERMOMETER

Remove the two screws holding the thermometer to its mounting bracket. Remove the sensing element from its clip. Clean the element with water and mild detergent solution. Ensure the sensing element is wiped clean of any residue to ensure proper temperature readings.

WARNING

Do NOT use HOT water on Cold glass Surfaces. This can cause the glass to shatter and could result in personal injury. Allow glass fronts, to warm before applying hot water.

CLEANING COILS

Condenser coils should be cleaned at least once per month. Additional cleaning may be needed depending on the operational environment. A dirty condenser blocks normal airflow through the coils.

NEVER USE SHARP OBJECTS AROUND COILS. Use a soft brush or vacuum brush to clean debris from coils. ***Do not puncture coils!*** Do not bend fins. Contact an authorized service technician if a coil is punctured, cracked, or otherwise damaged.

ICE in or on the coil indicates the refrigeration and defrost cycle is not operating properly. Contact an authorized service technician to determine the cause of icing, and to make adjustments as necessary. To maintain product integrity, move all product to a cooler until the unit has returned to normal operating temperatures.

WARNING

SHUT FANS OFF DURING CLEANING PROCESS.

Airflow blockage increases energy consumption and reduces the merchandiser's ability to maintain operating temperature.

To clean the coils, use a vacuum cleaner with a wand attachment and a soft (non-metallic) brush to remove dirt and debris. Do not bend coil fins. Always wear gloves and protective eye wear when cleaning near sharp coil fins and dust particles.



**CLEANING EVAPORATION PAN
(SELF CONTAINED ONLY)**

The condensate water outlet for self contained models empties into a limited capacity evaporation pan.

Debris or dirt accumulation inside the condensate evaporation pan or on the heater coil will reduce the pan’s evaporation capacity and cause premature heater failure. The evaporation pan waste water will overflow and spill onto the floor if the heater is not properly operating.

Remove accumulated debris from the evaporation pan. Wipe down heater coil with a cloth and warm water. Be sure to remove any dirt, debris or liquids from the heater coil.

Water introduced during cleaning will cause the evaporation pan to overflow.

 CAUTION
<p>Evaporation Pan is Hot! and poses risk of bodily injury – Always Wear gloves and protective eye wear when servicing. Turn off evaporation pan heater, and allow pan to cool.</p>

REMOVING SCRATCHES FROM BUMPER

Most scratches and dings can be removed using the following procedure.

1. Use steel wool to smooth out the surface area of the bumper.
2. Clean area.
3. Apply vinyl or car wax and polish surface for a smooth glossy finish.

MAINTAINING FLUORESCENT LAMPS

Fluorescent lamps should not be allowed to run to failure. If a re-lamp schedule is not in place, the tubes should be inspected for signs of degradation (blackened ends). Degraded or failed tubes should be replaced.

Allowing severely degraded lamps to operate may cause a ballast failure or could expose the lamp holder to excessive heat. Replacing degraded bulbs is more cost effective than replacing ballast and lamp-holders. Traditional re-lamp programs are 18-to-24 month intervals. In the absence of a re-lamp program, a yearly inspection of the lighting system is recommended.

1. Inspect all lamp sockets and plug-receptacle connections for signs of arcing. Replace any component that shows signs of arcing.
2. Make sure all unused receptacles have their close-off covers securely installed.
3. Make sure proper cleaning procedures are followed. Lights and fans **MUST** be turned off when a case is cleaned and **MUST** be allowed to dry before turning power back on.
4. Do not use a pressure nozzle to clean inside of case.

<p>PRECAUTION CLEANING PRECAUTIONS</p>
<p>When Cleaning:</p> <ul style="list-style-type: none"> • Do not use high pressure water hoses • Do not introduce water faster than waste outlet can drain • NEVER INTRODUCE WATER ON SELF CONTAINED UNIT WITH AN EVAPORATION PAN • NEVER USE A CLEANING OR SANITIZING SOLUTION THAT HAS OIL BASE (these will dissolve the butyl sealants) or an AMMONIA BASE (this will corrode the copper components of the merchandiser) • TO PRESERVE THE ATTRACTIVE FINISH: <ul style="list-style-type: none"> • Use a water and a mild detergent for the exterior only • Do NOT use a chlorinated cleaner on any surface • Do NOT use abrasives or steel wool scouring pads (these will mar the finish)

Self-Contained Refrigeration Equipment Maintenance Check List

***** Warranty does not cover issues caused by improper installation or lack of basic preventative maintenance. *****	
Record starting date	
Store Name and Number	
Store Address	
Unit Model Number	
Unit Serial Number	
Contractor/Technician	

	Technician									
	PM date									
PM activity-For visual inspection items, denote "ok or complete" in the column to right when PM has been performed. For measured data requested, record data requested in the appropriate column to the right)	Quarterly	Semi-Annually	Q1	Q2	Q3	Q4	Q1	Q2	Q3	Q4
Check in with store manager, record any complaints or issues they have with unit.	X									
Look unit over for any damage, vibrations or abnormal noise.	X									
Verify unit is level side to side and front to rear.	X									
Confirm refrigerant lines properly are secured and not touching or rubbing other lines, wires or frame work.	X									
Verify fan motors and motor mounts are tight.	X									
Confirm fan blade/s are tight and not rubbing or hitting.	X									
Make sure all electrical connections, factory and field, are tight.	X									
Verify electrical connections at lamps are they secure and dry.	X									
Check for and replace any frayed or chaffed wiring.	X									
Check all electrical wiring make sure it is secured and not on any sharp edges or hot lines.	X									
Check for air disturbances external to the unit. Heat and air registers, fans, and doors etc.	X									
Check for water leaks.	X									
Clean evaporator coil/s and fan blade/s. Do not use an acid base cleaner. Rinse off any cleaner residue.		X								
Clean discharge air honeycombs or grilles. Do not use an acid base cleaner. Rinse off any cleaner residue.		X								
Clean condenser coil/s and fan blade/s. Do not use an acid base Cleaner. Rinse off any cleaner residue.		X								
Clean condensate drain pan and drain line.		X								
Verify condensate drain lines are clear and functioning.		X								
Record voltage reading at unit with unit off?		X								
Verify condenser and evaporator fans are working.	X									
Record condenser air inlet temperature	X									
Record condenser air outlet temperature	X									
Is condenser air inlet or air exhaust restricted or recirculating?	X									
Verify there are no visual oil or refrigerant leaks.	X									
Record voltage reading with unit running.		X								
Record compressor amp draw.		X								
Record defrost heater voltage and amp draw.		X								
Record anti-sweat heater voltage and amp draw.		X								
Record case product temperature.	X									
Record unit discharge air temperature.	X									
Record unit return air temperature.	X									
Record ambient conditions around unit (wet Bulb temperature and dry bulb temperature).	X									
Check product loading, do not load beyond the units load limits.	X									
Verify clearances on sides/back of unit.	X									
Check unit controller for proper operation. See controller or 1/0 Manual for proper controller operation.		X								
Confirm door switches function.	X									
Verify unit doors and lids work and are sealed correctly.	X									
Verify that all the panels, shields and covers are in place.	X									

Technician Notes:

4-6 MAINTENANCE

NOTES:

SERVICE

REPLACING FAN MOTORS AND BLADES

Should it ever be necessary to service or replace the fan motors or blades be certain that the fan blades are reinstalled correctly. **THE BLADES MUST BE INSTALLED WITH RAISED EMBOSSED (PART NUMBER ON PLASTIC BLADES) POSITIONED AS INDICATED ON THE PARTS LIST.**

For access to these fans:

1. Remove product and place in a refrigerated area. Disconnect electrical power.
2. Remove bottom step pan.
3. **Disconnect fan from wiring harness.**
4. If it is determined that fan motor needs to be replaced, remove fan motor brackets from the fan plenum as shown.
7. Replace fan motor and/or blades.
8. Install brackets to fan motor and install motor and bracket to the plenum.
9. Reconnect fan motor to wiring harness.
10. Turn on power.
11. Verify that motor is working and blade is turning in the correct direction.
12. Reinstall display pans. Bring merchandiser to operating temperature before restocking.

⚠ WARNING

— LOCK OUT / TAG OUT —

To avoid serious injury or death from electrical shock, always disconnect the electrical power at the main disconnect when servicing or replacing any electrical component. This includes, but is not limited to, such items as doors, lights, fans, heaters, and thermostats.

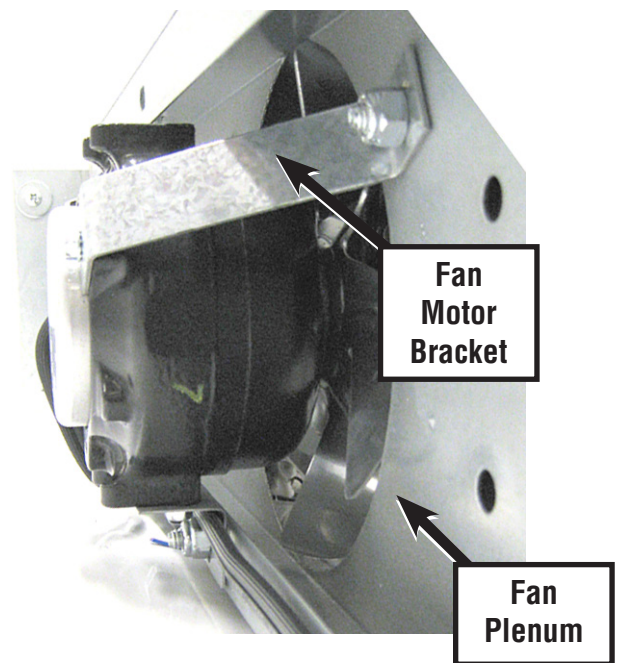

⚠ WARNING

Product will be degraded and may spoil if allowed to sit in a non-refrigerated area.

REPLACING LIGHTS

There is a convenient ON/OFF switch located on the light bar. This switch only controls the lights. ALWAYS disconnect electrical power when replacing lights or lighting parts.

SHM merchandisers are available with optional LED lights. The bulb is sleeved to protect the lights from damage. If these bulbs need to be replaced, slide the prongs clear of the lamp holder. Ensure that the prongs on the replacement bulb twist and lock into place.

REPLACING BALLAST / POWER SUPPLY

LED fixture replacement follows the same steps as fluorescent bulbs. However, LED fixtures have the sleeve built in as a single assembly. The LED power supply is also located in the condensing unit electrical box.

 **WARNING**

Fluorescent lamps contain mercury vapor. Mercury exposure at high levels can harm the brain, heart, kidneys, lungs, and immune system of people of all ages. Do not break or puncture fluorescent lamps. Dispose of, or store, all fluorescent lamps in accordance with Federal (40 CFR 273), State, and local hazardous waste requirements. Refer to:
<http://www.epa.gov/mercury/about.htm>



Hussmann refrigerated merchandisers configured for sale for use in the United States meet or surpass the requirements of the DOE 2012 energy efficiency standards.

Item Part #	Description	Item Part #	Description
FAN ASSEMBLIES AND THERMOSTATS		CONTROL PANEL	
5W Standard	Fan Assembly	SW.4440546	Disconnect Switch 25Amps
MO.4410828	Fan Assembly – 115V	CC.4481520	Compressor Relay
FB.4780800	Fan Blade	SW.4441070	Pressure Control
CT.4483051	Safe Net III Controller		
CC.4482991	Defrost Sensor (Yellow)	REFRIGERATION	
CC.4482992	Air Sensor (Black)	EQ.4671186	Condensing Unit Assembly, SHM-3
CC.4482540	Safe Net III Display (°F)	EQ.4671183	Condensing Unit Assembly SHM-4
EP.4482541	Safe Net III Harness	FI.4611347	Drier
EP.19S216	Power Cord	TM.4910245	Solar Thermometer
HEATERS			
HE.19S678	Condensate Pan Heater 350W, 115V		
HE.19S678	Condensate Pan		
OPTIONAL LIGHT BAR			
TP.4482388	Light Bar Fluorescent SHM-3		
TP.4482391	Light Bar Fluorescent SHM-4		
BU.4441801	LED Fixture for Light Bar SHM-3		
BU.4441800	LED Fixture for Light Bar SHM-4		

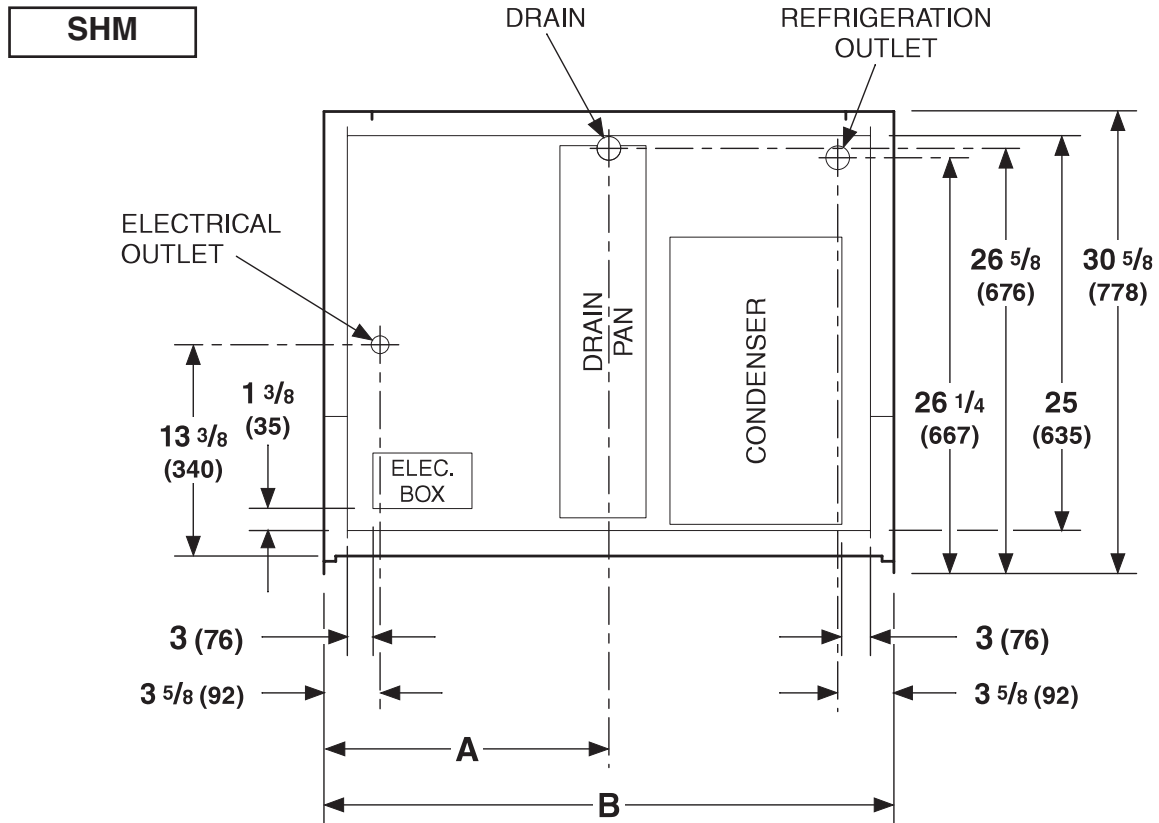

MODEL	"A"	"B"
SHM 300	18"	36"
SHM 400	24"	48"

General

Case Length (<i>Note: Includes One Pair Ends</i>)	5ft (68 3/8) (1737)	10ft (3353)
Optional End Bumpers (<i>One Pair</i>)	2 (51)	2 (51)
Maximum O/S dimension of case back to front (<i>Note: Includes bumper</i>)	43 1/2 (1105)	87 (2210)
Width of skid rail	9 5/8 (244)	19 1/4 (488)

Waste Outlet

LH end of case (<i>from outside of End Assembly</i>) to center of waste outlet	33 1/2 (851)	67 (1702)
---	--------------	-----------

Dimensions shown as inches and (mm).

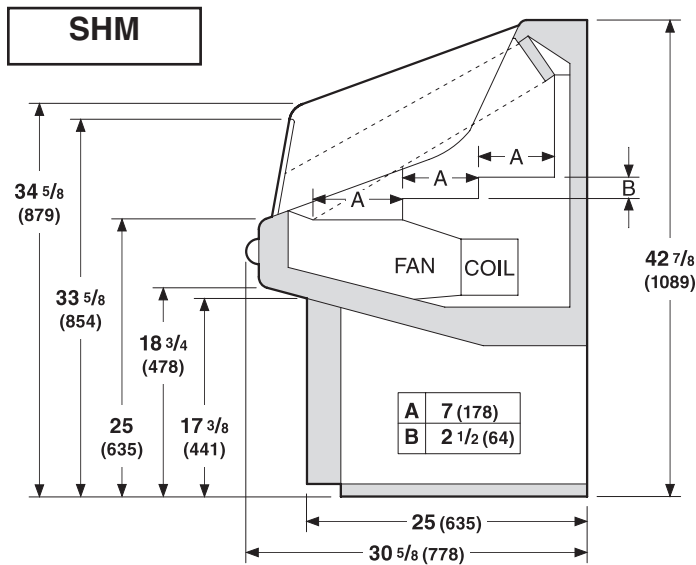

REFRIGERATION DATA

Note: This data is based on store temperature and humidity that does not exceed 75°F and 55% R.H. unless otherwise stated. Schedule defrost at night while lights are off.

	SHM	
	SHM-3	SHM-4
Thermostat Setting CI/CO (°F)		
Position #1	37 / 30	37 / 30
Position #7	37 / 14	37 / 14
Condensing Unit (hp)	1/3	1/2
Condensing Unit Capacity	2300	3535
(Btu/hr at std. rating conditions)		

DEFROST DATA

Frequency (hr)	12
OFFTIME	
Failsafe (minutes)	45
Defrost Termination Temperature	52°F

PHYSICAL DATA

Refrigerant Charge

SHM-3	27.5 oz	1.36 kg
SHM-4	30 oz	0.85 kg
SHM-4BW	32 oz	0.907 kg

Electrical Data

Note: These are rated values for individual components and should not be added together to determine total merchandiser electrical load.

Number of Fans – 5W	SHM 2	
	Amperes	Watts
Evaporator Fans 115V 60Hz Standard	0.6	10
Condensate Pan Heaters (208V)	3	350
 Condensing Unit (208/230V, 1Ph, 60Hz) Standard		
SHM-3		
Compressor LRA	39.0	
Compressor RLA	7.9	
SHM-4		
Compressor LRA	48.0	
Compressor RLA	9.5	

Product Data

<i>ARI Total Display Area</i> ¹ (<i>Sq Ft/Case</i>)	SHM-3 6.29 ft ² /case (0.584 m ² /case)
	SHM-4 8.42 ft ² /case (0.782 m ² /case)

¹Computed using ARI 1200 standard methodology:
Total Display Area, ft² [m²] / Unit of Length, ft [m]

	Nominal HP	Refrigerant Type	Volts	Run Amps	Nema Plugs	Fuse Amps	Hz/Ph
SHM-3	1/3	R404a	115	10.3	5-15P	15	60/1
SHM-4	1/2	R404a	115	9.5	5-15P	15	60/1
SHM-4BW	1/2	R404a	115	10.6	5-15P	15	60/1

*Requires Field Wiring

BW — Condensing Unit Rotated 180 °

ESTIMATED SHIPPING WEIGHT ²			
Case	<i>SHM-3</i>	<i>SHM-4</i>	<i>End</i>
lb (kg)	350 (158)	310 (140)	Included

² Actual weights will vary according to optional kits included.

WARNING:
Unplug merchandiser before attempting to make any electrical connections.

Use this equipment on a ground system only using copper clad or aluminum conductors only. Use minimum 75 °C wire for ampacity determination crankcase heaters must be connected only to its rated voltage.
For 115 volt, connect neutral to terminal "R." Over current protection device rating and type must be in accordance with regulatory agency end product approvals. See System Nameplate.

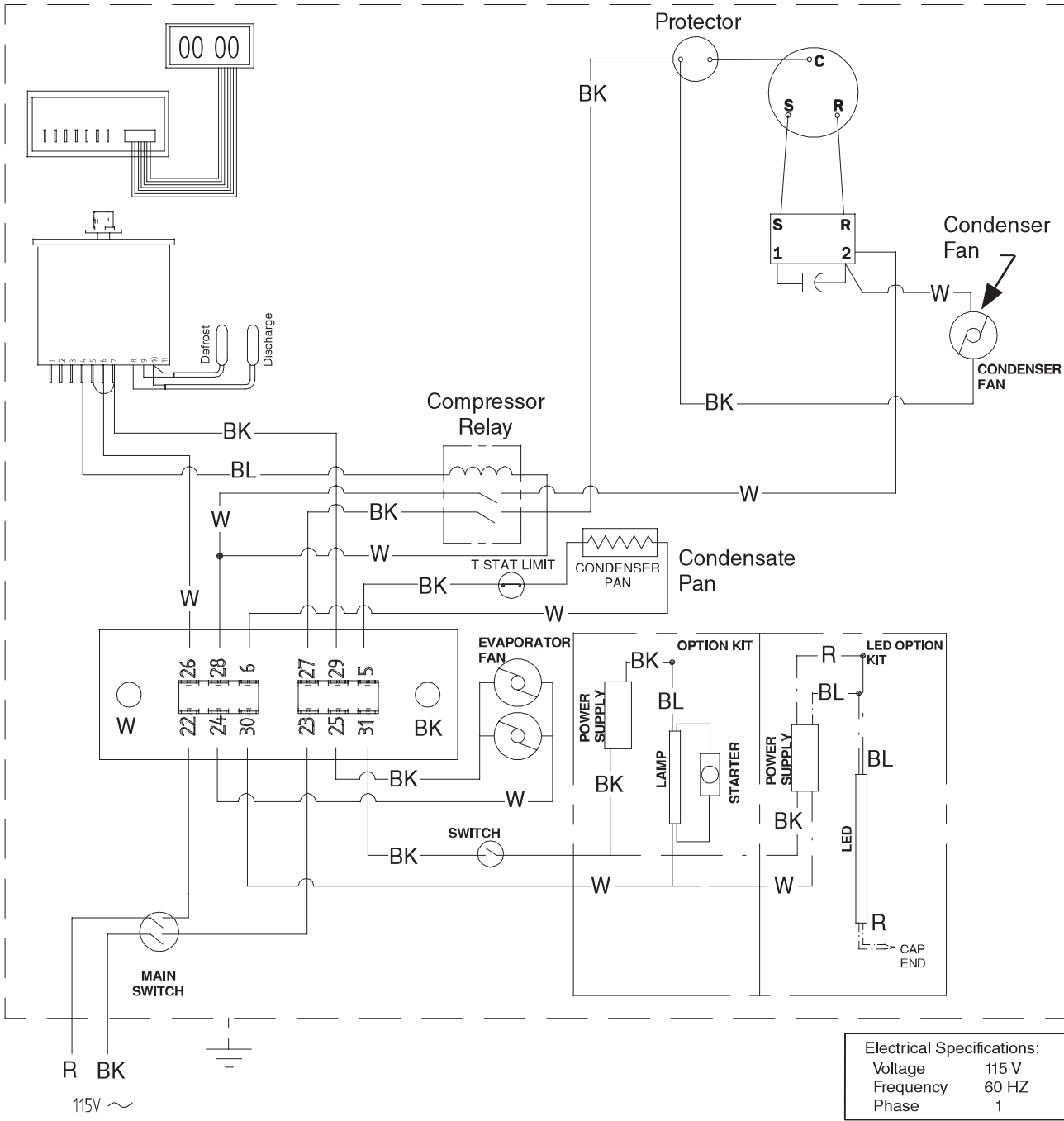

Electrical Specifications:	
Voltage	115 V
Frequency	60 HZ
Phase	1

WARNING

All components must have mechanical ground, and the merchandiser must be grounded.

CIRCLED NUMBERS = PARTS LIST ITEM NUMBERS

R = Red Y = Yellow G = Green BL = Blue BK = Black W = White

● = 120V POWER ○ = 120V NEUTRAL ⊥ = FIELD GROUND ≡ = CASE GROUND

A decorative border with a repeating blue geometric pattern, resembling a stylized knot or lattice, surrounds the central text.

HUSSMANN[®]

**To obtain warranty information
or other support, contact your
Hussmann representative.
Please include the model and
serial number of the product.**

Hussmann Corporation, Corporate Headquarters: Bridgeton, Missouri, U.S.A. 63044-2483 01 October 2012

Husmann Corporation

12999 St. Charles Rock Road
Bridgeton, MO 63044-2483
www.husmann.com