

Hy-Line[®]

BROWN

Parent Stock



Management Guide



Use of the Management Guide

The genetic potential of Hy-Line Brown Parent Stock can only be realised if good poultry husbandry practices and management are used. This management guide outlines successful flock management programmes for Hy-Line Variety Brown Parent Stock based on field experience compiled by Hy-Line International and using an extensive commercial layer flock database of Hy-Line flocks from all parts of the world. Hy-Line International Management Guides are periodically updated as new performance data and/or nutrition information become available.

The information and suggestions contained in this management guide should be used for guidance and educational purposes only, recognising that local environmental and disease conditions may vary and a guide cannot cover all possible circumstances. While every attempt has been made to ensure that the information presented is accurate and reliable at the time of publication, Hy-Line International cannot accept responsibility for any errors, omissions or inaccuracies in such information or management suggestions. Further, Hy-Line International does not warrant or make any representations or guarantees regarding the use, validity, accuracy, or reliability of, or flock performance or productivity resulting from the use of, or otherwise respecting, such information or management suggestions. In no event shall Hy-Line International be liable for any special, indirect or consequential damages or special damages whatsoever arising out of or in connection with the use of the information or management suggestions contained in this management guide.

Always consult [hyline.com](https://www.hyline.com) for the latest performance, nutrition, and management information.

Table of Contents

Summary of Performance Standards	3	Management Events for Parent Stock	21–22
Rearing Period Performance Table	3	Hatching Egg Care	23
Production Period Performance Tables	4–5	Fertility Check	24
Space Recommendations	6	Incubation and Hatching	24
House Preparation	6	Transportation of Hatching Eggs and DOC	25
Brooding Recommendations	7–10	Feed Biosecurity	26
Infrared Beak Treatment (IRBT)	11	Feed Management	26
Precision Beak Trimming	12	Feed Particle Size	27
Floor Systems Management	13	Vitamins and Trace Minerals	27
Perches	14	Water Quality	28
Hy-Line Brown Male Management	15	Rearing Period Nutritional Recommendations	29
Artificial Insemination	16	Production Period Nutritional Recommendations	30
Good Lighting Practices	17	Production Dietary Nutrient Concentrations	31
Light Programs	17–18	Feed Ingredient Tables	32–33
Lighting Considerations	19	Biosecurity	34–35
Use of Shades in Open-Sided Housing	19	Vaccination Recommendations	36–38
Midnight Feeding/Lighting Program	20	Blood Sample Collection	39

Summary of Performance Standards

Female Livability, 1–17 Weeks	96%
Female Livability, 18–75 Weeks	89%
Male Livability, 1–17 Weeks	94%
Male Livability, 18–75 Weeks	88%
Age at 50% Production (days)	151
Peak Percent Hen-Day Production (age)	95.6–98.1% (26 weeks)
Number of Hen-Day Eggs, 18–75 Weeks	335.3–354.8
Number of Hen-Housed Eggs, 18–75 Weeks	315.0–332.7
Number of Settable Hen-Housed Eggs, 22–75 Weeks	295.53
Number of Female Chicks Produced, 22–75 Weeks	116.06
Average Number of Female Chicks / Week, 22–75 Weeks	2.15
Average Percent Hatchability, 22–75 Weeks	78.41%
Female Body Weight, 17 Weeks	1.390–1.463 kg
Female Body Weight, 40 Weeks (mature)	1.82–1.99 kg
Male Body Weight, 17 Weeks	2.066–2.227 kg
Male Body Weight, 40 Weeks (mature)	2.64–2.87 kg
Number of Males / 100 Females	8
Feed Consumption Per Bird Housed, 1–17 Weeks (cumulative)	6.63–7.15 kg
Feed Consumption Per Bird Housed, 18–75 Weeks (average daily total of males and females)	108–117 g
Feed Consumption Per 10 Hatching Eggs, 22–75 Weeks	1.24–1.42 kg
Feed Consumption Per Dozen Hatching Eggs, 22–75 Weeks	1.49–1.70 kg

Performance Summary data is based on results obtained from customers around the world. Please send your results to info@hyline.com. An easy to use record-keeping program, Hy-Line International EggCel, can be found at www.hyline.com.

Rearing Period Performance Table

AGE (weeks)	FEMALE WEIGHT (kg)	MALE WEIGHT (kg)	FEED INTAKE (g / bird / day)	WATER CONSUMPTION (ml / bird / day)	UNIFORMITY
1	0.068 – 0.082	0.077 – 0.081	12 – 13	18 – 26	>85%
2	0.120 – 0.135	0.140 – 0.151	20 – 21	30 – 42	
3	0.185 – 0.206	0.221 – 0.248	25 – 27	38 – 54	
4	0.261 – 0.283	0.323 – 0.369	29 – 32	44 – 64	>80%
5	0.352 – 0.379	0.446 – 0.509	33 – 36	50 – 72	
6	0.455 – 0.482	0.586 – 0.665	37 – 40	56 – 80	
7	0.561 – 0.590	0.737 – 0.831	41 – 45	62 – 90	>85%
8	0.661 – 0.696	0.895 – 1.003	47 – 50	71 – 100	
9	0.761 – 0.801	1.056 – 1.175	52 – 55	78 – 110	
10	0.856 – 0.901	1.214 – 1.342	57 – 61	86 – 122	
11	0.952 – 1.002	1.366 – 1.502	62 – 66	93 – 132	>85%
12	1.037 – 1.092	1.511 – 1.653	67 – 72	101 – 144	
13	1.121 – 1.181	1.644 – 1.792	71 – 76	107 – 152	
14	1.192 – 1.255	1.767 – 1.919	75 – 81	113 – 162	
15	1.262 – 1.329	1.878 – 2.033	77 – 83	116 – 166	>85%
16	1.317 – 1.387	1.978 – 2.136	78 – 84	117 – 168	
17	1.390 – 1.463	2.066 – 2.227	81 – 87	122 – 174	
18	1.480 – 1.555	2.145 – 2.310	82 – 91	123 – 182	>90%

Production Period Performance Table

AGE (weeks)	% HEN-DAY Current	HEN-DAY EGGS Cumulative	HEN-HOUSED EGGS Cumulative	FEMALE % MORTALITY Cumulative	MALE % MORTALITY Cumulative	FEED INTAKE (g /bird / day)	WATER CONSUMPTION ¹ (ml /bird / day)
18	–	–	–			82 – 91	123 – 182
19	–	–	–	1.17	0.46	88 – 96	132 – 192
20	15.9 – 16.6	1.1 – 1.2	1.1 – 1.1	1.39	0.65	92 – 101	138 – 202
21	38.3 – 39.8	3.8 – 3.9	3.7 – 3.9	1.58	0.93	100 – 109	150 – 218
22	66.9 – 69.3	8.5 – 8.8	8.3 – 8.7	1.73	1.22	103 – 113	155 – 226
23	85.4 – 88.4	14.5 – 15.0	14.2 – 14.7	1.85	1.60	105 – 115	158 – 230
24	92.7 – 95.8	20.9 – 21.7	20.6 – 21.3	1.95	1.88	107 – 117	161 – 234
25	95.0 – 97.9	27.6 – 28.5	27.1 – 28.0	2.04	2.27	108 – 118	162 – 236
26	95.5 – 98.3	34.3 – 35.4	33.6 – 34.7	2.11	2.56	108 – 118	162 – 236
27	95.6 – 98.1	41.0 – 42.3	40.2 – 41.5	2.17	2.85	109 – 119	164 – 238
28	95.5 – 98.0	47.7 – 49.1	46.7 – 48.2	2.23	3.14	109 – 119	164 – 238
29	95.3 – 97.7	54.3 – 56.0	53.2 – 54.9	2.29	3.44	109 – 119	164 – 238
30	95.1 – 97.5	61.0 – 62.8	59.7 – 61.5	2.34	3.64	109 – 119	164 – 238
31	94.8 – 97.2	67.6 – 69.6	66.2 – 68.2	2.40	3.94	109 – 119	164 – 238
32	94.4 – 96.9	74.2 – 76.4	72.7 – 74.8	2.46	4.14	109 – 119	164 – 238
33	94.0 – 96.6	80.8 – 83.2	79.1 – 81.4	2.52	4.44	109 – 119	164 – 238
34	93.7 – 96.4	87.4 – 89.9	85.5 – 87.9	2.59	4.65	109 – 119	164 – 238
35	93.3 – 96.1	93.9 – 96.6	91.8 – 94.5	2.67	4.85	109 – 119	164 – 238
36	93.0 – 95.8	100.4 – 103.3	98.1 – 101.0	2.75	5.06	109 – 119	164 – 238
37	92.6 – 95.5	106.9 – 110.0	104.4 – 107.5	2.84	5.27	109 – 119	164 – 238
38	92.2 – 95.2	113.3 – 116.7	110.7 – 114.0	2.94	5.48	109 – 119	164 – 238
39	91.9 – 94.9	119.8 – 123.3	116.9 – 120.4	3.04	5.69	109 – 119	164 – 238
40	91.5 – 94.7	126.2 – 130.0	123.1 – 126.8	3.15	5.91	109 – 119	164 – 238
41	91.1 – 94.4	132.6 – 136.6	129.3 – 133.2	3.27	6.12	109 – 119	164 – 238
42	90.8 – 94.1	138.9 – 143.2	135.4 – 139.6	3.40	6.33	109 – 119	164 – 238
43	90.4 – 93.8	145.2 – 149.7	141.6 – 145.9	3.52	6.45	109 – 119	164 – 238
44	90.0 – 93.5	151.5 – 156.3	147.6 – 152.2	3.66	6.67	109 – 119	164 – 238
45	89.7 – 93.2	157.8 – 162.8	153.7 – 158.5	3.80	6.89	109 – 119	164 – 238
46	89.1 – 92.9	164.1 – 169.3	159.7 – 164.8	3.94	7.10	109 – 119	164 – 238
47	88.7 – 92.6	170.3 – 175.8	165.6 – 171.0	4.08	7.32	109 – 119	164 – 238
48	88.2 – 92.4	176.4 – 182.3	171.5 – 177.2	4.22	7.55	109 – 119	164 – 238
49	87.8 – 92.1	182.6 – 188.7	177.4 – 183.3	4.37	7.67	109 – 119	164 – 238
50	87.3 – 91.8	188.7 – 195.1	183.2 – 189.5	4.52	7.89	109 – 119	164 – 238
51	86.8 – 91.5	194.8 – 201.5	189.0 – 195.6	4.66	8.11	109 – 119	164 – 238
52	86.3 – 91.2	200.8 – 207.9	194.8 – 201.6	4.81	8.34	109 – 119	164 – 238
53	85.8 – 90.9	206.8 – 214.3	200.5 – 207.7	4.96	8.56	109 – 119	164 – 238
54	85.3 – 90.6	212.8 – 220.6	206.1 – 213.7	5.10	8.69	109 – 119	164 – 238
55	84.8 – 90.3	218.7 – 226.9	211.8 – 219.7	5.25	8.92	109 – 119	164 – 238
56	84.3 – 90.0	224.6 – 233.2	217.3 – 225.7	5.39	9.15	109 – 119	164 – 238
57	83.8 – 89.7	230.5 – 239.5	222.9 – 231.6	5.53	9.27	109 – 119	164 – 238
58	83.3 – 89.4	236.3 – 245.8	228.4 – 237.5	5.68	9.50	109 – 119	164 – 238
59	82.8 – 89.1	242.1 – 252.0	233.8 – 243.4	5.83	9.74	109 – 119	164 – 238
60	82.4 – 88.8	247.9 – 258.2	239.3 – 249.2	5.98	9.86	109 – 119	164 – 238
61	81.9 – 88.5	253.6 – 264.4	244.6 – 255.0	6.14	10.10	109 – 119	164 – 238
62	81.4 – 88.2	259.3 – 270.6	250.0 – 260.8	6.30	10.23	109 – 119	164 – 238
63	80.9 – 87.9	265.0 – 276.7	255.3 – 266.6	6.47	10.47	109 – 119	164 – 238
64	80.4 – 87.6	270.6 – 282.9	260.5 – 272.3	6.66	10.60	109 – 119	164 – 238
65	79.9 – 87.3	276.2 – 289.0	265.7 – 278.0	6.86	10.83	109 – 119	164 – 238
66	79.3 – 87.0	281.7 – 295.1	270.9 – 283.6	7.09	10.97	109 – 119	164 – 238
67	78.8 – 86.7	287.3 – 301.1	276.0 – 289.3	7.33	11.10	109 – 119	164 – 238
68	78.3 – 86.4	292.7 – 307.2	281.1 – 294.9	7.61	11.24	109 – 119	164 – 238
69	77.8 – 86.1	298.2 – 313.2	286.1 – 300.4	7.92	11.37	109 – 119	164 – 238
70	77.3 – 85.8	303.6 – 319.2	291.1 – 305.9	8.27	11.51	109 – 119	164 – 238
71	76.8 – 85.5	309.0 – 325.2	296.0 – 311.4	8.67	11.64	109 – 119	164 – 238
72	76.3 – 85.1	314.3 – 331.2	300.8 – 316.8	9.11	11.78	109 – 119	164 – 238
73	75.8 – 84.8	319.6 – 337.1	305.6 – 322.2	9.62	11.92	109 – 119	164 – 238
74	75.2 – 84.5	324.9 – 343.0	310.3 – 327.5	10.20	12.05	109 – 119	164 – 238
75	74.7 – 84.2	330.1 – 348.9	315.0 – 332.7	10.70	12.19	109 – 119	164 – 238

Production Period Performance Table

AGE (weeks)	FEMALE BODY WEIGHT (kg)	MALE BODY WEIGHT (kg)	AVERAGE EGG WEIGHT ² (g/egg)	% SETTABLE	SETTABLE HEN-HOUSED EGGS Cumulative	% HATCH	NUMBER FEMALE CHICKS	
							Current	Cumulative
19	1.50 – 1.62	2.20 – 2.35		–	–	–	–	–
20	1.57 – 1.71	2.27 – 2.42	46.3	–	–	–	–	–
21	1.65 – 1.79	2.32 – 2.48	48.4	–	–	–	–	–
22	1.67 – 1.82	2.38 – 2.52	50.2	50	2.3	70	0.8	0.8
23	1.70 – 1.84	2.42 – 2.56	51.7	60	5.9	75	1.3	2.1
24	1.74 – 1.87	2.46 – 2.61	53.0	70	10.5	79	1.8	3.9
25	1.75 – 1.89	2.49 – 2.65	54.1	80	15.7	80	2.1	6.0
26	1.76 – 1.91	2.51 – 2.68	55.0	90	21.7	81	2.4	8.4
27	1.76 – 1.92	2.52 – 2.71	55.8	94	28.0	82	2.5	11.0
28	1.77 – 1.93	2.53 – 2.73	56.4	96	34.3	82	2.6	13.6
29	1.78 – 1.94	2.54 – 2.76	57.0	96	40.6	83	2.6	16.2
30	1.78 – 1.95	2.55 – 2.78	57.4	96	47.0	83	2.6	18.8
31	1.79 – 1.95	2.56 – 2.79	57.8	97	53.3	84	2.7	21.4
32	1.79 – 1.96	2.58 – 2.81	58.2	97	59.7	84	2.6	24.1
33	1.80 – 1.97	2.59 – 2.82	58.5	97	66.0	84	2.6	26.7
34	1.80 – 1.97	2.60 – 2.83	58.7	97	72.3	84	2.6	29.3
35	1.81 – 1.97	2.61 – 2.84	59.0	97	78.5	84	2.6	32.0
36	1.81 – 1.98	2.62 – 2.85	59.2	97	84.8	84	2.6	34.6
37	1.81 – 1.98	2.62 – 2.86	59.3	97	91.0	84	2.6	37.2
38	1.81 – 1.98	2.63 – 2.86	59.5	97	97.1	84	2.6	39.7
39	1.82 – 1.99	2.63 – 2.87	59.6	97	103.3	84	2.6	42.3
40	1.82 – 1.99	2.64 – 2.87	59.8	97	109.4	84	2.6	44.9
41	1.82 – 1.99	2.64 – 2.88	59.9	97	115.5	84	2.5	47.4
42	1.82 – 1.99	2.65 – 2.89	60.0	97	121.6	84	2.5	49.9
43	1.82 – 1.99	2.66 – 2.89	60.1	97	127.6	83	2.5	52.4
44	1.83 – 2.00	2.67 – 2.90	60.2	96	133.5	83	2.5	54.9
45	1.83 – 2.00	2.68 – 2.91	60.2	96	139.4	83	2.4	57.3
46	1.83 – 2.00	2.69 – 2.92	60.3	96	145.3	83	2.4	59.7
47	1.83 – 2.00	2.70 – 2.93	60.4	96	151.2	82	2.4	62.1
48	1.83 – 2.00	2.71 – 2.94	60.5	96	157.0	82	2.4	64.5
49	1.83 – 2.00	2.72 – 2.94	60.5	96	162.7	81	2.3	66.8
50	1.83 – 2.00	2.73 – 2.95	60.6	96	168.5	81	2.3	69.1
51	1.83 – 2.00	2.74 – 2.96	60.6	96	174.2	80	2.3	71.4
52	1.83 – 2.00	2.75 – 2.97	60.7	95	179.8	80	2.2	73.6
53	1.83 – 2.00	2.76 – 2.97	60.8	95	185.4	80	2.2	75.8
54	1.83 – 2.00	2.77 – 2.98	60.8	95	190.9	80	2.2	78.0
55	1.83 – 2.00	2.77 – 2.99	60.9	95	196.5	79	2.2	80.2
56	1.83 – 2.00	2.78 – 3.00	60.9	95	201.9	78	2.1	82.3
57	1.83 – 2.00	2.79 – 3.00	61.0	94	207.3	78	2.1	84.4
58	1.83 – 2.00	2.80 – 3.01	61.0	94	212.7	77	2.1	86.5
59	1.84 – 2.00	2.81 – 3.02	61.1	94	218.0	76	2.0	88.5
60	1.84 – 2.00	2.81 – 3.02	61.1	93	223.3	75	2.0	90.4
61	1.84 – 2.00	2.82 – 3.03	61.2	93	228.5	74	1.9	92.4
62	1.84 – 2.00	2.82 – 3.04	61.2	93	233.6	73	1.9	94.2
63	1.84 – 2.00	2.83 – 3.04	61.3	93	238.8	73	1.9	96.1
64	1.84 – 2.00	2.84 – 3.05	61.3	92	243.8	73	1.8	97.9
65	1.84 – 2.00	2.84 – 3.06	61.4	92	248.8	72	1.8	99.7
66	1.83 – 2.00	2.85 – 3.06	61.4	91	253.8	72	1.8	101.5
67	1.83 – 2.00	2.85 – 3.07	61.5	91	258.7	71	1.7	103.2
68	1.83 – 2.00	2.85 – 3.08	61.5	90	263.4	71	1.7	104.9
69	1.83 – 2.00	2.86 – 3.09	61.6	90	268.2	71	1.7	106.6
70	1.83 – 2.00	2.86 – 3.09	61.6	90	272.9	70	1.6	108.2
71	1.83 – 2.00	2.86 – 3.10	61.7	90	277.6	70	1.6	109.8
72	1.83 – 2.00	2.87 – 3.11	61.7	90	282.2	70	1.6	111.5
73	1.83 – 2.00	2.87 – 3.11	61.8	89	286.7	70	1.6	113.0
74	1.83 – 2.00	2.87 – 3.12	61.8	89	291.2	70	1.6	114.6
75	1.83 – 2.00	2.87 – 3.13	61.9	88	295.6	70	1.5	116.1

Space Recommendations (check local regulations)

		WEEKS OF AGE																			
		3					17					20				30	40	50	60	70	75
BREEDER COLONY CAGES																					
Floor Space																					
200 cm ² (50 birds / m ²)		400 cm ² (25 birds / m ²)					750 cm ² (13 birds / m ²)														
Nipple																					
1 / 12 birds		1 / 10 birds					1 / 8 birds														
Feeders																					
5 cm / bird		9 cm / bird					12 cm / bird														
SLATS / LITTER																					
Floor Space																					
700 cm ² (14 birds / m ²)		1000 cm ² (10 birds / m ²)					1000 cm ² (10 birds / m ²)														
Nipple / Cup Drinkers																					
1 / 15 birds		1 / 12 birds					1 / 10 birds														
Feeders																					
5 cm / bird		5 cm / bird or 1 pan / 50 birds					12 cm / bird														
Perches																					
—		8 cm / bird					12 cm / bird														
		3					17					20				30	40	50	60	70	75
		WEEKS OF AGE																			

House Preparation



- PS flocks should be placed in environmentally controlled and light tight housing.
- All-in, all-out (single age) management provides the best control for sanitation programs and disease prevention.
- Brooder house should be completely cleaned and disinfected. Confirm effectiveness of cleaning and disinfection with environmental swabs.
- Allow a minimum of 4 weeks downtime between flocks.
- Pre-heat the house to recommended brooding temperature at least 24 hours prior to chick arrival. Complete all preparations to the brooding area for an ideal environment for the PS chicks.
- All feed and manure should be removed from the house before cleaning.
- Thoroughly clean air inlets, fan housing, fan blades and fan louvers.
- Heating the house during washing improves the removal of organic matter.
- Use foam / gel disinfection/detergent to soak into organic matter and equipment.
- Wash the upper portion of the house and work downward toward the manure pit.
- Use high pressure warm water to rinse.
- Allow the house to dry.
- After it is fully dry, apply foam / spray disinfectant followed by fumigation.
- Flush and sanitize water lines.
- Verify effective cleaning and disinfection of the house with environmental swabs tested for *salmonella*.
- Allow the house to dry before repopulating.
- For more information, see [Pre-Housing Cleaning, Disinfection and Maintenance Checklist for Rearing and Layer Houses](#).

Brooding Recommendations

- Brood chicks in groups from similar aged breeder flocks.
- Brood male and female chicks separately from 0–4 weeks.
- Modify temperature as needed to meet chicks' comfort needs.
- Adjust brooding temperature according to relative humidity. Lower temperatures can be used with higher relative humidity.
- Find optimum balance of temperature, humidity and ventilation rate for chick comfort.
- For every 5 percentage point increase above 60% relative humidity, reduce brooding temperatures by 1°C.
- Pre-heat brooding houses prior to chick placement: 24 hours in normal climates, 48 hours in cool climates and 72 hours in cold climates.
- Establish proper house temperature of 33–36°C (air temperature measured at chick level) and 60% humidity 24 hours before chick placement; floor temperature should be 32°C.
- Bright light (30–50 lux) during 0–7 days helps chicks quickly find feed and water and adapt to new environment.
- After first week, reduce temperature weekly 2–3°C until reaching 21°C.
- Chicks' body weight should double between arrival on farm and 7 days of age.

AGE	0–3 days	4–7 days	8–14 days	15–21 days	22–28 days	29–35 days	36–42 days
AIR TEMP. (CAGE)	33–36°C	30–32°C	28–30°C	26–28°C	23–26°C	21–23°C	21°C
AIR TEMP. (FLOOR)	35–36°C	30–32°C	28–30°C	26–28°C	23–26°C	21–23°C	21°C
LIGHT INTENSITY	30–50 lux	33–35°C	28–30°C	26–28°C	23–26°C	21–23°C	21°C
LIGHT HOURS	22 hours or Intermittent Program	30–50 lux 21 hours or Intermittent Program	25 lux 20 hours	29–31°C 25 lux	23–26°C 26–27°C 25 lux	18 hours 17 hours 10–15 lux	16 hours 10–15 lux

CROP FILL – ARE THE CHICKS EATING?

Hours after chick placement	Chicks with feed in crop		
6	75%		
12	85%	<i>Chick with starter feed in crop</i>	<i>Chick without starter feed in crop</i>
24	100%		

Brooding temperatures that are too low or too high will decrease the percentage of chicks with crop fill.

RELATIVE HUMIDITY

Low humidity

- Reduces bird comfort
- Increases dehydration
- May result in pasty vents in chicks
- May increase agitation and possibility of pecking
- Adversely affects feather cover
- Increases dust

Excessive humidity

- Increases ammonia
- Causes poor litter and air quality

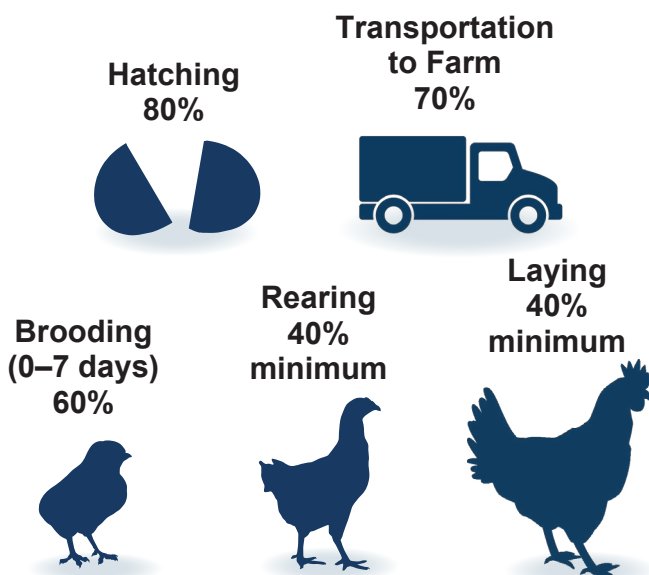

Floor Brooding in Rings

BROODING TEMPERATURE

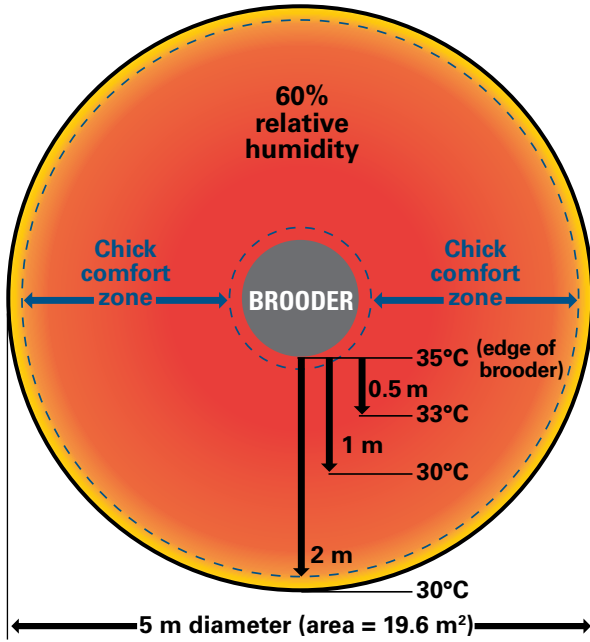

- Provide temperature zones within the brooding ring accessible to the chicks. This allows them to seek their comfort zone.
- Cloacal temperature of the chicks should be 40°C.

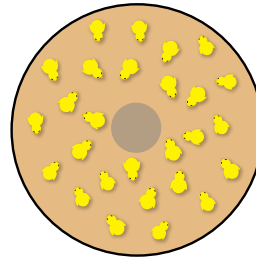

CORRECT
Chicks evenly distributed in brooding area, active and sounding content

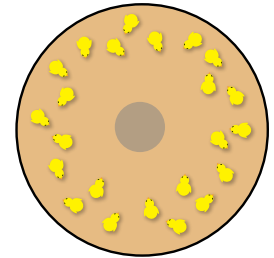

HOT
Chicks spread out, lethargic; appear sleeping

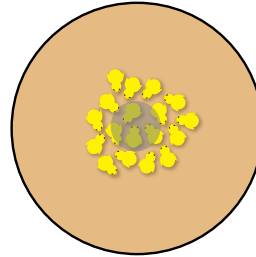

COLD
Chicks gathered into groups sounding distressed

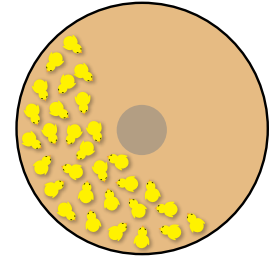

UNEVEN VENTILATION
Chicks congregated in one part of brooding area, avoiding drafts, noise or uneven light distribution

BROODER RING DESIGN

Supplemental chick drinkers

- Drinking water should be tested for quality and cleanliness from source and end of the water line.
- Flush water lines prior to chick arrival.
- Flush water lines weekly during rearing and production periods.
- Clean supplemental chick drinkers frequently to avoid build-up of organic matter that could encourage bacterial growth.
- Use a ratio of 80 chicks / drinker (25 cm diameter).
- Chicks should not have to move more than 1 meter to find water.
- Use vitamins and electrolytes in chicks' water (avoid sugar-based products to prevent growth of microorganisms).

Paper/Litter

- Cover entire floor of brooder ring with paper.
- Put starter feed on paper for 0–3 days. For beak-treated chicks, feed on paper for 0–7 days.
- Remove paper at 7–14 days to avoid the buildup of manure.
- Litter should not be more than 5 cm deep.
- Spread litter after concrete floors have warmed.

Tray feeders

- Use a ratio of 80 chicks / feeder.
- Use good quality crumble starter feed consisting of uniform 1–2 mm particles.

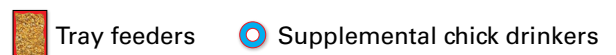
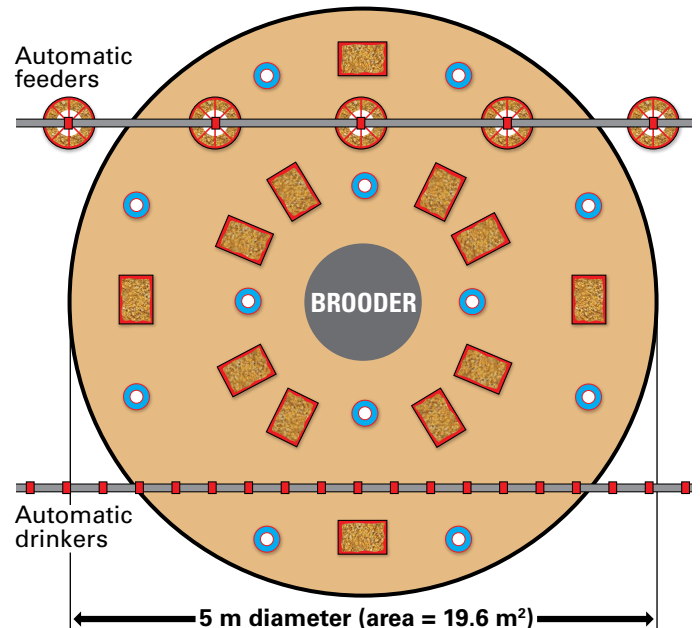

Management

- Enlarge brooder rings at 3 days to increase group size.
- Continue enlarging brooder rings until rings are removed by 14 days.
- Gradually remove supplemental drinkers and tray feeders beginning at 3 days.

Floor Brooding in Pens

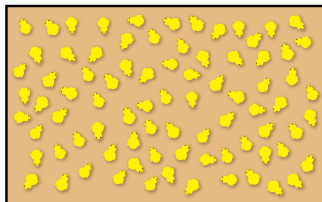
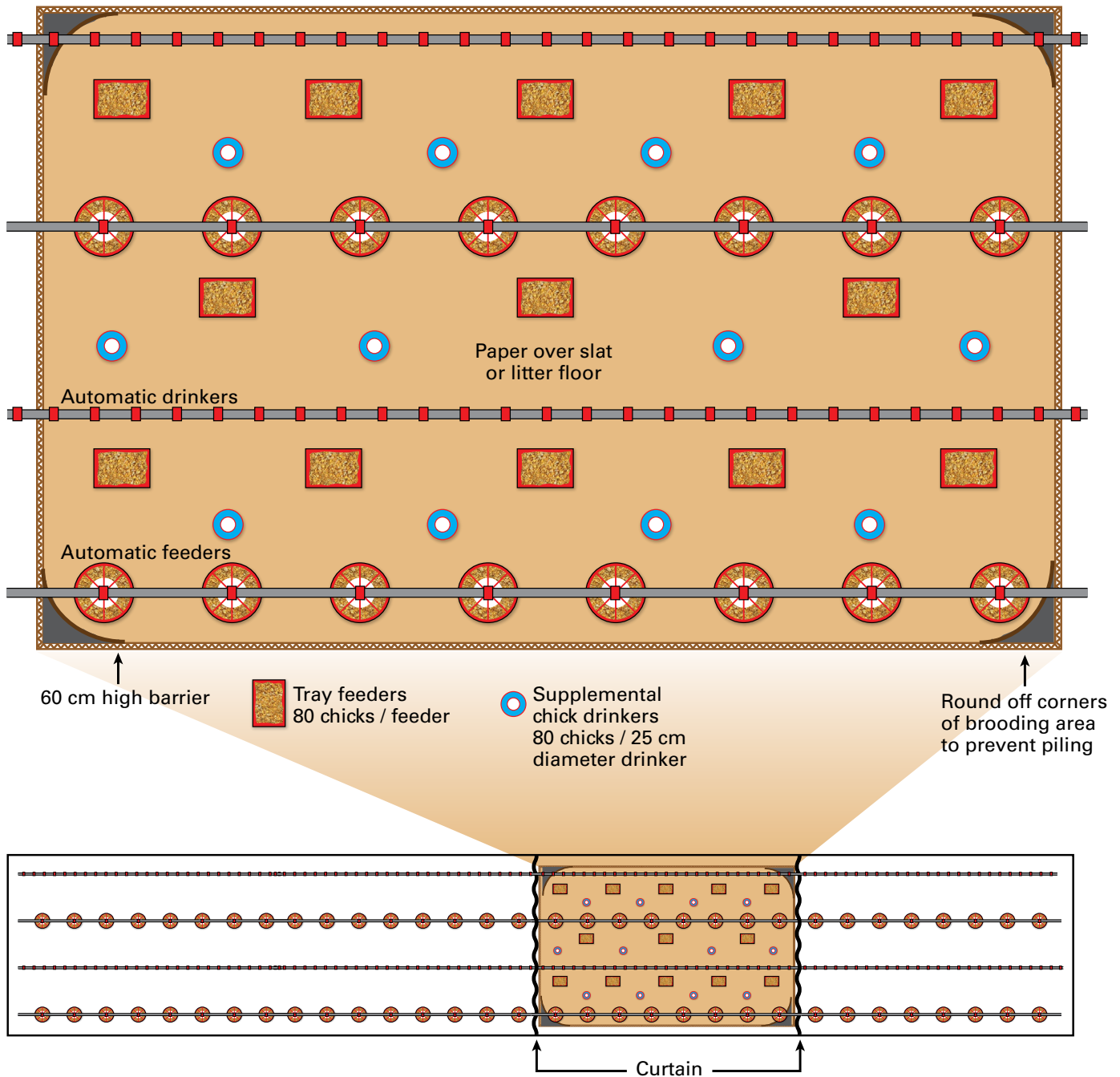

CORRECT

Chicks evenly distributed in brooding area, active and sounding content

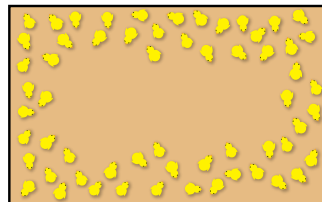

HOT

Chicks spread out, lethargic; appear sleeping

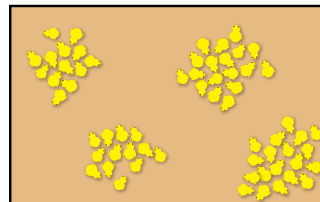

COLD

Chicks gathered into groups sounding distressed

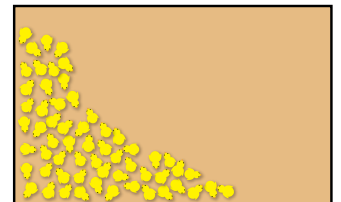

UNEVEN VENTILATION

Chicks congregated in one part of brooding area, avoiding drafts, noise or uneven light distribution

Floor Brooding in Pens *(Continued)*

Supplemental chick drinkers

- Drinking water should be tested for quality and cleanliness from source and end of the water line.
- Flush and sanitize water lines prior to chick arrival.
- Clean supplemental chick drinkers frequently to avoid build-up of organic matter that could promote bacterial growth.
- Use a ratio of 80 chicks / drinker (25 cm diameter).
- Provide one nipple drinker per 12 chicks.
- Chicks should not have to move more than 1 meter to find water.
- Use vitamins and electrolytes in chicks' water (avoid sugar-based products to prevent growth of microorganisms).

Paper

- Cover entire floor of brooder ring or pen with paper.
- Put starter crumble on paper for 0–3 days. For beak-treated chicks, feed on paper for 0–7 days.
- Remove paper at 7–14 days to avoid the build-up of manure.
- Litter should not be more than 5 cm deep.

Cage Brooding

- Parents can be reared in cages, if the birds are moved to colony breeding cages or into cages for artificial insemination.
- Place feed on cage paper 0–3 days to encourage consumption. For beak-treated chicks, feed on paper for 0–7 days.
- Start chicks in upper tiered cages, which are usually warmer and brighter.
- Place feed on the paper in front of permanent feeder to train chicks to move toward feeders.
- From 0–4 weeks, rear males separately to improve male body weight gain.
- By 5 weeks, mix males and females.
- Mix 3–4 females into each male cage.
- Fill automatic feed line to its highest level and adjust chick guards; allow access to automatic feed line from first day.
- Remove paper by 7–14 days of age to avoid build-up of feces.
- Rearing cage should be constructed of 2 mm diameter wire with spacing between wires to provide maximum cell size of 18 mm x 18 mm.
- Cage floors should not be slippery or sloped.
- Rearing cage height should be minimum of 48 cm. If too low, males may experience leg problems and keel bone pressure sores.

Supplemental tray feeders

- Use a ratio of 80 chicks / feeder.
- Use good quality crumble starter feed consisting of uniform 1–2 mm particles.
- Have feed in the permanent feeding system from the first day.

Management

- Place PS chicks into the appropriate brooding pen one at a time after confirming correct line identity.
- Males and females should be brooded together.
- Enlarge brooder rings at 3 days to increase group size.
- Continue enlarging brooder rings until rings are removed by 14 days.
- Gradually remove supplemental drinkers and tray feeders beginning at 3 days.



Cage brooding with feed tray and supplemental drinker

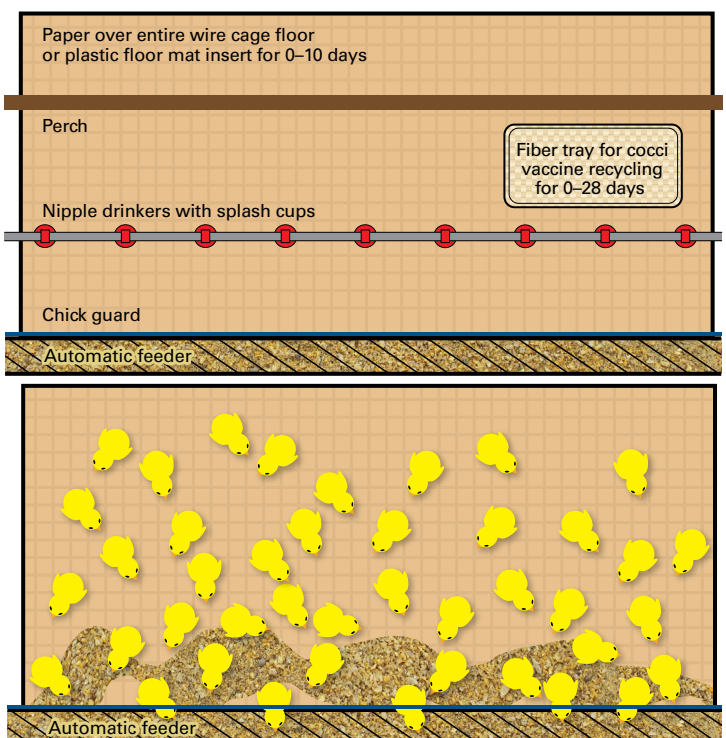

0-3 days: Place feed on cage paper in front of the permanent feeder

Beak Treatment / Trimming *(Check local regulations)*

- Hy-Line Brown Parent Stock is most successfully beak trimmed at hatch by infrared beak treatment or between 7–10 days of age by precision beak trimming.
- Depending on variety and beak, re-trim at 6 weeks or 12–14 weeks of age.
- Roosters should be infrared treated or receive a light beak trim (tipping) at 7–10 days.
- Beak treatment or beak trimming reduces feed wastage and leaves beak less damaging to other birds.

Infrared Beak Treatment (IRBT)

- Infrared beak treatment has been proven a successful, non-invasive method of controlling the growth of the beak in egg type chickens.
- One (properly applied) IRBT should be sufficient.
- Hatchery beak treatment reduces feed wastage and leaves the beak less damaging to other birds.
- Hatchery beak treatment is more efficient and uniform than on-farm practices.
- Over the next 14–21 days, the treated beak tip will soften and wear off gradually.
- Infrared treatment is adjustable to manage differences in breeder flock age, chick size, climate, housing system, and variety of birds.
- For more information, see [Infrared Beak Treatment](#).



Loading chick

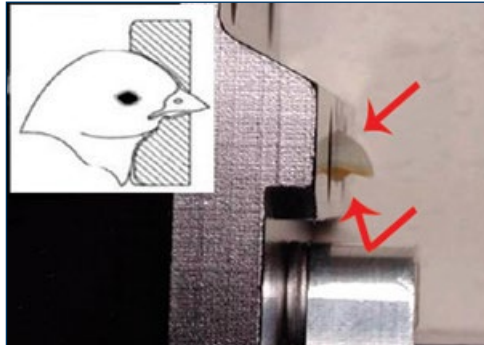

Infrared beak treatment can be modified according to local conditions.

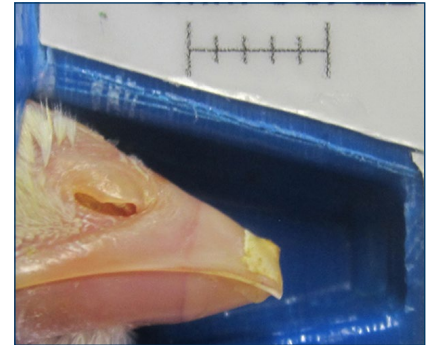

One day post-treatment

Precautions when performing IRBT:

- Water intake is the most important factor for success with IRBT chicks. Chicks require immediate and easy access to water.
- If using nipple drinkers, use only 360° activated nipples for IRBT chicks, as well as supplemental chick drinkers.
- Nipple drinkers with splash cups provide additional support for IRBT chicks.
- Keep feed at the highest level in the feeder for several days after beak treatment.
- Feed on paper for 0–7 days.
- Provide extra light (30–50 lux) on nipple drinkers after beak treatment.

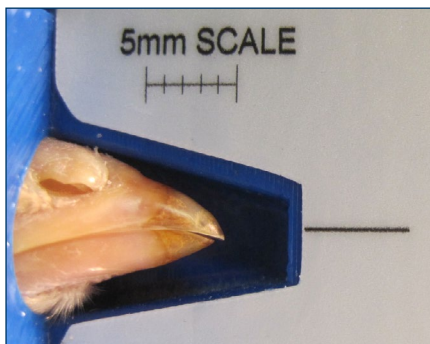

Seven days post-treatment

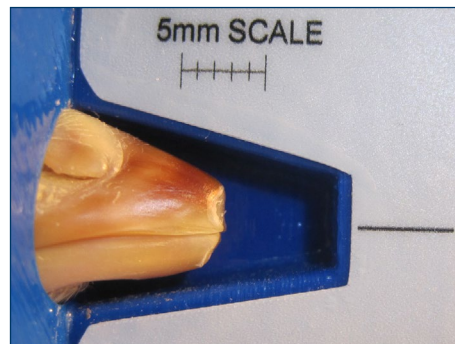

Four weeks post-treatment

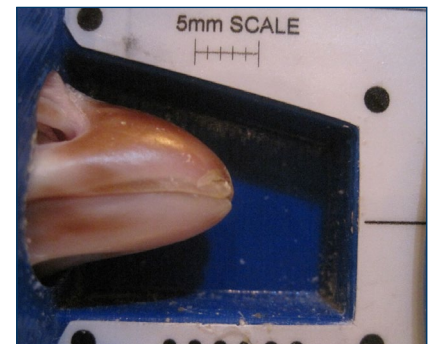

Properly trimmed beak

Precision Beak Trimming

- Cauterize beak for 2 seconds at 650°C.
 - » When cauterizing blade is not hot enough or cauterization time is < 2 seconds, beak will continue to grow unevenly.
 - » If cauterizing blade is too hot or cauterization time is > 2 seconds, sensitive neuromas may form.
- Use a pyrometer to measure blade temperature, which should be approximately 650°C.
- Cauterizing blade color may be used as an approximate indicator of temperature (see below). Check blade temperature/color for each machine and operator every hour.
- Blade temperature variation of up to 40°C is common due to external influences and cannot be detected by the human eye.
- Use a template with guide plate holes for precision beak trim of different size chicks.
- Check that beaks have been properly and evenly trimmed.

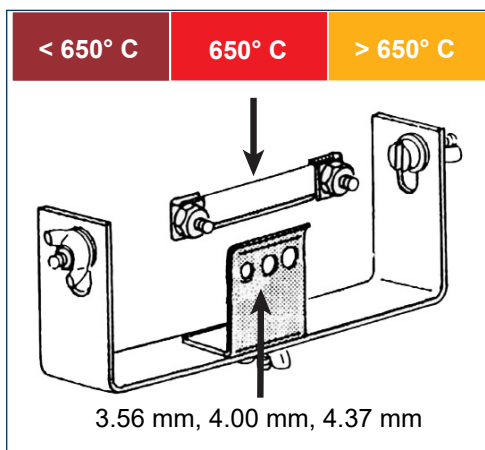

Cauterizing blade and template with guide holes of varying sizes.



Beak trimmer. Photo courtesy of Lyon Technologies, Inc.



Pyrometer indicating proper blade temperature of 650°C.

Precautions when beak trimming birds:

- Water intake is the most important factor in the success of beak trimming. Chicks require immediate and easy access to water.
- Do not beak-trim sick or stressed birds.
- Do not hurry; handle chicks carefully to prevent errors and poor uniformity.
- Provide vitamins and electrolytes containing vitamin K in drinking water 2 days before and 2 days after beak trimming.
- Watch chicks after beak trimming to assess stress. Control the ambient temperature until birds appear comfortable and active.
- Keep feed at the highest level for several days after beak trimming.
- Use only well-trained crews.
- Use 360° activated nipples, supplemental chick drinkers and splash cups to encourage drinking. Lower the pressure to make it easy for the chicks to drink.

Floor Systems Management

REARING PERIOD

- If rearing and laying are to be done in separate houses, use similar feed and water systems.
- From an early age, accustom birds to humans by frequently walking through the house.
- Rearing house should have elevated bird platforms with feed and water stations.
- Rearing house should have perches.
- Solid perches above water and feed lines are preferred.
- Flocks housed in all-slat houses during lay should also be grown on slat or wire floors.
- Schedule feed lines to run as soon as birds are awake and again after most eggs have been laid.
- 0-14 day mortality is typically < 2%.
- During rearing and laying, if mortality exceeds 0.1%/week, perform necropsies and other diagnostics to determine cause(s) of mortality.
- Remove mortality daily and dispose of properly.

TRANSFER

- The flock can be moved into the laying facility at 15–17 weeks of age.
- Complete the vaccination program prior to transfer.
- Light hours and light intensity of rearing and laying houses should be matched at transfer.
- Light intensity should increase weekly for 2 weeks before the flock is transferred to the layer house.
- Place females on slats when placing birds in the laying house.
- Reduce transfer stress by using water-soluble vitamins, vitamin C (ascorbic acid) and probiotics in drinking water 3 days before and 3 days after transfer.
- House males in laying facilities before or at the same time as females. (Hy-Line Brown males may be moved a few days earlier to laying house to give them time to acclimate to new environment before arrival of females.)
- Establish the correct male to female ratios.
- Check every bird and verify correct identification. Check feather color and dubbing in male lines.

NEST TRAINING

- Nest boxes can be placed in the house after brooding and can be parallel or perpendicular to the wall.
- Feed lines should not be directly in front of nests.
- Starting the day of transfer, open some nest box curtains to encourage nest exploration.
- Train females to use nests by frequent morning walks (3–4 times/day) through the house for 8 weeks after birds are moved to the production house.
- While walking, move birds away from resting areas, out of corners, away from walls and toward nests.
- Automatic nests should open two hours before lights-on and close two hours before lights start to dim.
- If using string lights inside the nest, turn on 1 hour before house lights are turned on to attract females. Turn nest lights off 1 hour after house lights come on.
- Discontinue nest light usage after 26 weeks of age.
- During the first week of laying, leave a few eggs in the nest to encourage females to use nests.
- Eliminate dark areas in the laying house to discourage floor eggs.
- If local regulations allow, electric deterrent wires can be used to keep birds away from the walls and corners to control floor eggs.
- Quickly remove floor eggs.
- Be sure all floor eggs are removed before lights go out at night.
- Close nests at night.
- Keep litter levels to a minimum during the nest training period. Litter deeper than 10 cm results in increased floor eggs and broodiness.

Nests

- Nests should be dark, secluded, warm, and free of air drafts.
- Nests should have a well-lit staging area at the entrance to allow for examination and easy access by females.
- Avoid barriers to nests, such as drinker lines positioned too low or swinging.

ASSESSING PULLET QUALITY

Check the physical condition of each bird. Birds with these abnormalities must be euthanized:

- | | | |
|--|--|--|
| ▪ Crooked neck | ▪ Crooked keel | ▪ Leg abnormalities |
| ▪ Crow-headed males with little/no comb and wattle development | ▪ Bleeding feathers or feather follicles | ▪ Eye abnormalities (split pupil, tear-drop pupil, eye notch or gray iris) |
| ▪ Hump back | ▪ Lameness | ▪ Body weight 225 g more or below average flock weight |
| ▪ Curled toes | ▪ Foot pad lesions | |
| ▪ Crossed beak | ▪ Low social ranking - feathers pecked | |

Perches

- Perches are essential for rearing birds that will go into an aviary system.
- Perches enrich the birds' environment and allow expression of normal behaviors.
- Perches encourage jumping habits, which develops leg and breast muscles, increases bone strength, and increases calcium content of bone. Birds able to jump will have better nesting behaviour and be more mobile in multi-tier aviary systems.
- Perches reduce social stress by providing safe resting sites.
- Perches increase living space in the facility.
- Perches allow birds to roost at night.
- Use of perches may reduce piling behavior in flocks.

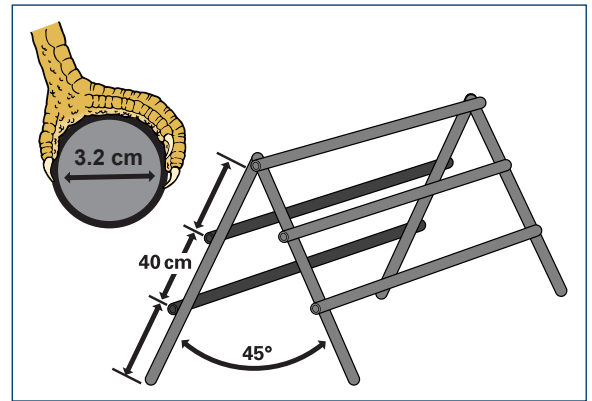

A-frame perch design

Perch Design

- Floor-reared birds should have access to perches and slats no later than 10 days of age.
- Perch height should not exceed 1 m to avoid injuries.
- Provide 10–15 cm perch space per bird (check local regulations concerning perch space).
- Separate perch rails by at least 30 cm to prevent cannibalistic pecking of birds on adjacent rails.
- Place perches on slats to maintain good litter conditions and control floor eggs.
- Avoid slippery perches.
- Perches should support the bottom of the foot and be comfortable for the bird.
- If possible, use the same perch style in rear and lay facilities.
- Do not use perches above water lines during rear if using an electric deterrent over the water line during production.
- Perches should be easy to clean and disinfect between flocks.
- Seal cracks, crevices, and open ends of pipes to reduce hiding areas for red mites (*Dermanyssus gallinae*).
- Perches are ideally placed over feed lines and on the top level in aviaries.



Water line perch



Perch over feeder



Perch in aviary system



Elevated platform



Perch on slats

Hy-Line Brown Male Management

- The Hy-Line Brown male's 18-week body weight is 2.14–2.31 kg.
- The Hy-Line Brown male's adult body weight is 2.64–2.87 kg (40 weeks of age).
- The Hy-Line Brown male should preferably not be beak trimmed. If treatment is required, beak treat in hatchery or tip at 7–10 days of age.
- Achieving male target body weights during rear is critical for optimum mating behavior and fertility.
- Males and females should receive the same feed and lighting schedule.
- For breeder cages having a specific male feeder space, these spaces should not be obstructed by nest boxes or other cage enrichments.
- Male and female breeders should reach sexual maturity at approximately the same time.
- From 0–4 weeks, rear males separately to improve male body weight gain.
- At 5 weeks, mix males and females. In cages, mix 3–4 females into each male cage. If males appear weaker than females, mix males with females at a 1:1 ratio through the growing period.
- Grading males into pens based on body weight can improve male uniformity.
- Males and females must be co-mingled during the rearing period to become socialized and avoid mating problems as adults.
- Keep extra males in a separate pen; do not mix extra males with females.
- Continue culling males as needed during production.
- Maintain a mating ratio of 8 males for every 100 females throughout production in floor and cage systems.
- Too many males results in more fighting, less mating activity, disruption of social groups and lower fertility.

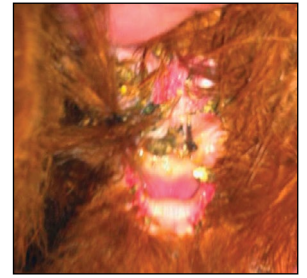

Red vent is indicative of a working Hy-Line Brown male.



MALE EVALUATION – A BEAUTY CONTEST

Tall, masculine appearance with full red comb

Evaluate males at 10 weeks and at transfer.

Cull roosters with:

- Lameness
- More than 200 g below target body weight
- Curled toes
- Foot pad lesions
- Poor feathering
- Poor beaks
- Low social ranking
 - Hide in nests
 - Feather pecked



Artificial Insemination

Artificial insemination can be used for PS in cage housing systems. Roosters and hens are typically housed separately in 1–2 bird cages. **Use experienced personnel for semen collection and hen insemination to avoid injury and bird stress.**

Semen Collection from Roosters

- One rooster's semen is used for approximately 10 hens.
- Do not collect semen from the same rooster more than 2 times per week. Never collect from the same rooster on consecutive days.
- Semen without semen extender can be used up to 30 minutes from the first male collected; semen with extender can be refrigerated up to 4 hours.
- Semen collection is a two-person operation. To collect semen, hold both legs and position the male with the tail facing the person drawing the semen. Gently massage the male's back (lumbar area) in a downward motion starting at the ribcage and ending at the starting part of the tail.



Semen collection

Insemination of the Hen

- Artificial insemination should begin after a majority (70 to 80%) of the eggs are laid.
- Amount of semen to use is 5ml of semen per 125 females, regardless if extender is used. This equals 40 μ L semen volume per female.
- The insemination procedure is a two-person operation.
- Use good quality disposable plastic straws (70 mm) for insemination. Do not attempt to clean and reuse insemination straws.
- Trim the feathers around the vent area.
- The bird handler should gently remove the hen from the cage and, using thumb and forefinger, spread apart the cloaca, resulting in the turning of the cloaca inside out (everting the oviduct).
- The inseminator using an automatic pipette fills the straw with 40 μ L of semen and inserts the insemination straw into the exposed (everted) opening to the oviduct to inseminate the hen.



Insemination of hen

Good Lighting Practices

- In cage housing, measure minimum light intensity at feeder on bottom tier cages, mid-way between lights.
- In floor housing, measure minimum light intensity at level of bird's head.
- Keep light bulbs and bulb covers clean to prevent loss of light intensity.
- Prevent dark areas caused by too much distance between lights or burned out light bulbs.
- Shiny or white surfaces reflect light and increase light intensity.
- Take local conditions into account which may require adaptations of lighting programs.
- Light hours of rearing and production houses should be matched at transfer.
- Light intensity should increase 2 weeks before the flock is transferred to the laying house (but not prior to 14 weeks of age). Final rearing house light intensity should match the laying house intensity.
- Light stimulation period should extend into peaking period (achieve 16 hours of light at about 30 weeks).

Light Program for Light-Controlled Housing

Hy-Line Brown breeders require a slower step-down of light hours from 0–14 weeks to prevent early sexual maturity and promote good body weight uniformity.

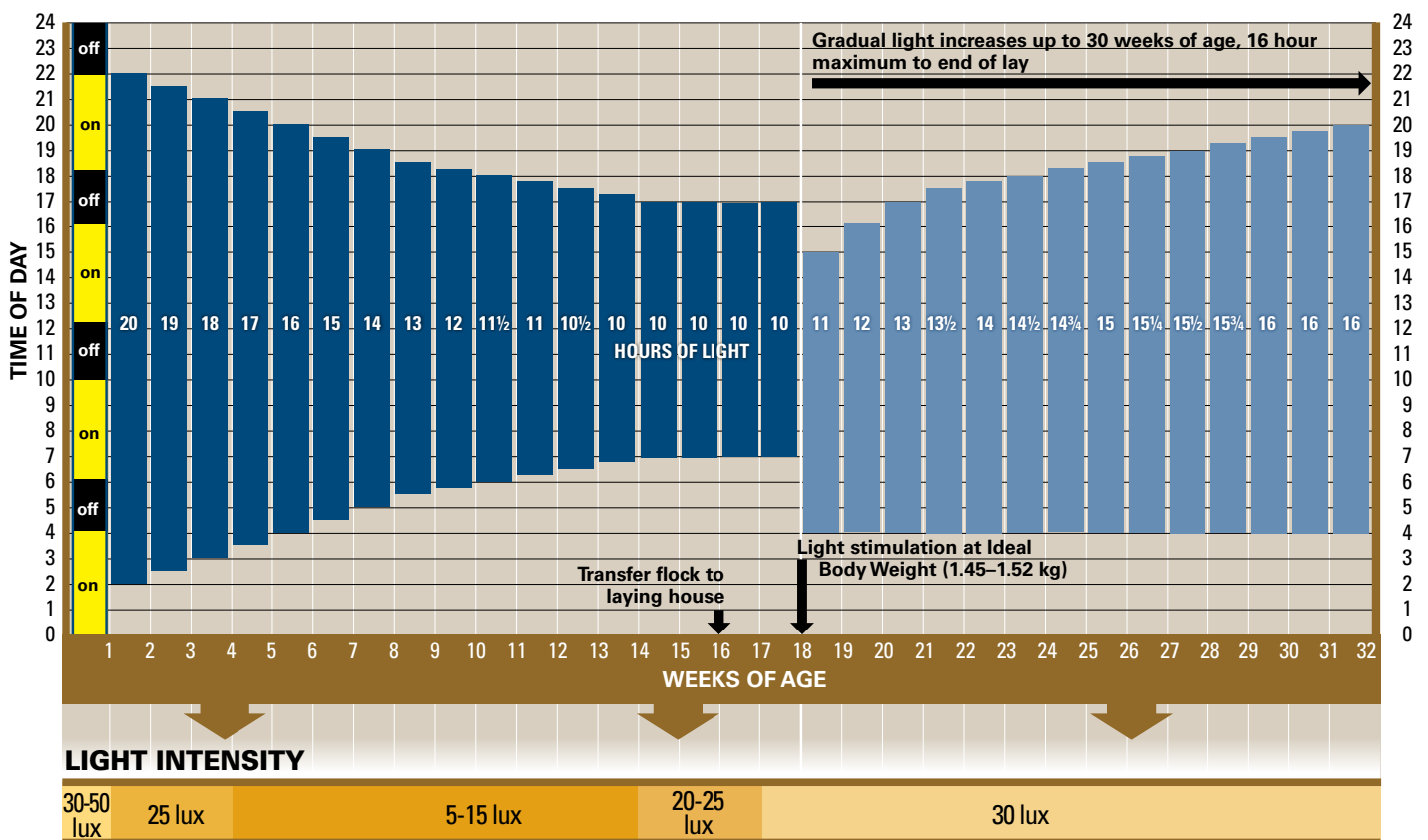

- Light-controlled houses are those which use light traps around fans and air inlets and completely prevent the ingress of light from the outside. Houses that are not light controlled should use lighting programs for open-sided housing.
- An intermittent lighting program for chicks is preferred. If not using an intermittent lighting program from 0–7 days, then use 22 hours of light from 0–3 days and 21 hours of light from 4–7 days.
- “Lights on” time can be varied between houses in laying flocks to facilitate egg collection on multiple flock complexes.
- If the laying flock has a large spread in hatch ages and/or poor uniformity, light stimulate the flock based on the youngest hatch date or lightest birds.
- Use cool lights (3000–5000 K) in rearing facility to ensure sufficient blue-green spectrum.
- Use warm lights (2700–3500 K) in laying flocks to ensure sufficient red spectrum light.
- For more information on poultry lighting, see [Understanding Poultry Lighting](#) and [Impact of Tarp Color on Poultry Lighting](#).

Customized Lighting Programs for Open-Sided Housing www.hyline.com

The Hy-Line International Lighting Program can create custom lighting programs for your location. To prevent early sexual development, the program finds the longest natural day length between 8–17 weeks of age and constructs an artificial lighting program that holds day length constant with artificial lights from 8–17 weeks.

- On the first screen—enter e-mail address and select language.
- On the second screen, use dropdowns for “Select Location of Flock”, “Hatch Date”, “Variety Standards” and “Housing Style.”
- Click on “Create Lighting Spreadsheet.”
- Results will be e-mailed to you.

Lighting Program for : IOWA / DALLAS CENTER 93° 56' W 41° 43' N

Variety: Brown Parent
House Type: Open grow to open lay
Hatch Date: 01-Sep-15 Standard daylight time

Weeks of Age	Date	Sunrise	Lights on	Lights Off	Sunset	Total Hours of Light	Total Sunlight
0	1-Sep-15	5:41	1:45	22:45	18:49	21:00	13:08
1	8-Sep-15	5:48	2:15	22:15	18:37	20:00	12:49
2	15-Sep-15	5:55	2:45	21:45	18:25	19:00	12:30
3	22-Sep-15	6:02	3:15	21:15	18:13	18:00	12:11
4	29-Sep-15	6:10	3:45	20:45	18:01	17:00	11:51
5	6-Oct-15	6:17	4:15	20:15	17:49	16:00	11:32
6	13-Oct-15	6:25	4:45	19:45	17:37	15:00	11:12
7	20-Oct-15	6:33	5:15	19:15	17:27	14:00	10:54
8	27-Oct-15	6:41	5:45	18:45	17:17	13:00	10:36
9	3-Nov-15	6:50	6:00	18:30	17:07	12:30	10:17
10	10-Nov-15	6:58	6:15	18:15	17:00	12:00	10:02
11	17-Nov-15	7:07	6:30	18:00	16:53	11:30	9:46
12	24-Nov-15	7:15	6:45	17:45	16:49	11:00	9:34
13	1-Dec-15	7:23	7:00	17:30	16:46	10:30	9:23
14	8-Dec-15	7:29	7:15	17:15	16:45	10:00	9:16
15	15-Dec-15	7:35	7:15	17:15	16:45	10:00	9:10
16	22-Dec-15	7:39	7:15	17:15	16:48	10:00	9:09
17	29-Dec-15	7:42	7:15	17:15	16:53	10:00	9:11
18	5-Jan-16	7:43	6:45	17:45	16:59	11:00	9:16
19	12-Jan-16	7:41	6:30	18:00	17:06	11:30	9:25
20	19-Jan-16	7:38	6:15	18:15	17:14	12:00	9:36
21	26-Jan-16	7:33	6:15	18:30	17:23	12:15	9:50
22	2-Feb-16	7:27	6:00	18:30	17:32	12:30	10:05
23	9-Feb-16	7:19	6:00	18:45	17:40	12:45	10:21
24	16-Feb-16	7:10	5:45	18:45	17:49	13:00	10:39
25	23-Feb-16	7:00	5:45	19:00	17:58	13:15	10:58
26	1-Mar-16	6:49	5:30	19:00	18:06	13:30	11:17
27	8-Mar-16	6:38	5:30	19:15	18:14	13:45	11:36
28	15-Mar-16	6:26	5:15	19:15	18:22	14:00	11:56
29	22-Mar-16	6:14	5:15	19:30	18:30	14:15	12:16
30	29-Mar-16	6:02	5:00	19:30	18:38	14:30	12:36
31	5-Apr-16	5:51	5:00	19:45	18:46	14:45	12:55
32	12-Apr-16	5:39	4:45	19:45	18:53	15:00	13:14
33	19-Apr-16	5:28	4:45	20:00	19:01	15:15	13:33
34	26-Apr-16	5:18	4:30	20:00	19:09	15:30	13:51
35	3-May-16	5:09	4:30	20:15	19:16	15:45	14:07
36+			4:15	20:15		16:00	

This lighting program is created from a formula based on global location and housing style. This program may need to be further adapted to better fit local conditions. Please email info@hyline.com for further questions or technical assistance.

Same lighting program with sunrise and sunset represented by yellow and red lines and suggested artificial day length indicated by blue bars

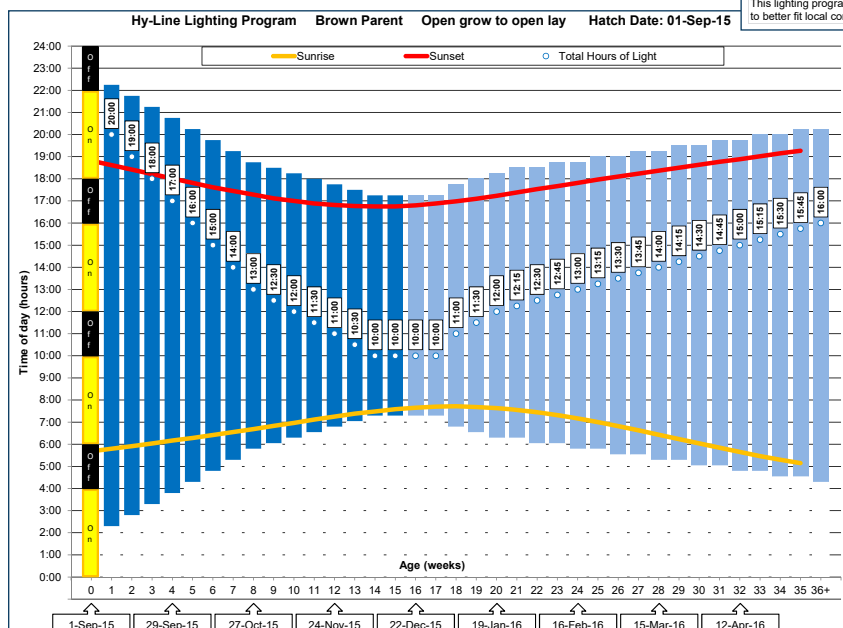

Lighting Considerations

FLOOR

- Light intensity in the house should be brightest over feeding and resting areas and gradually decrease toward nests.
- Avoid dark areas near feeding and resting areas to prevent floor eggs.

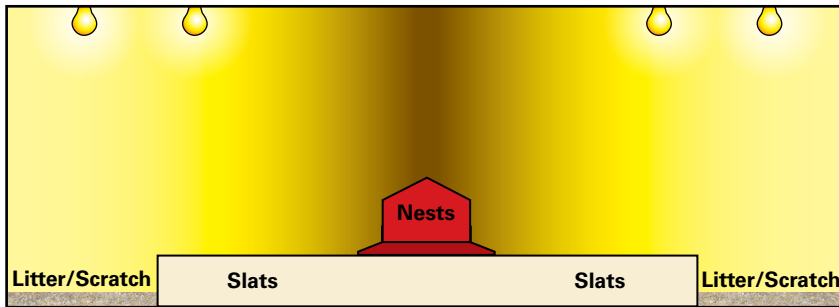

CAGES

- Alternating the height of lights improves light distribution to all cage levels.
- Position lights to minimize bright and dark areas in the house.

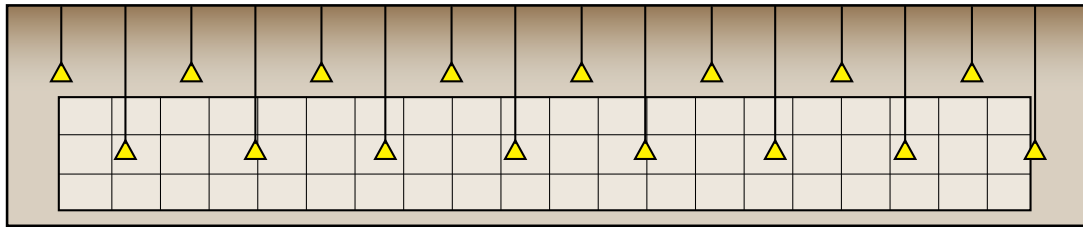

Use of Shades in Open-Sided Housing



- Shades are an effective way to decrease light intensity in an open-sided house.
- Keep shades clean and free of dust to allow air flow.
- Use stir fans when using shades.
- Avoid direct sunlight on birds by using shades or roof overhangs.
- Black shades are preferred.

Midnight Feeding / Lighting Program

- Optional lighting technique that promotes greater feed consumption
- Used whenever more feed intake is desired in rearing or laying flocks
- Increases calcium absorption during night when most egg shell is formed
- Useful to increase feed intake during peak egg production
- Helps maintain feed consumption in hot climates
- Midnight feeding may increase feed intake 2–5 g / day per bird

Good Practices

- Initiate the program by turning lights on for 1–2 hours in the middle of the dark period.
- There must be at least 3 hours of dark before and after the midnight feeding.
- Fill feeders before lights are turned on.
- Light provided during the midnight feeding is in addition to regular day length (i.e. 16 hours + midnight feeding).
- If midnight feeding is removed, reduce light gradually at a rate of 15 minutes per week.

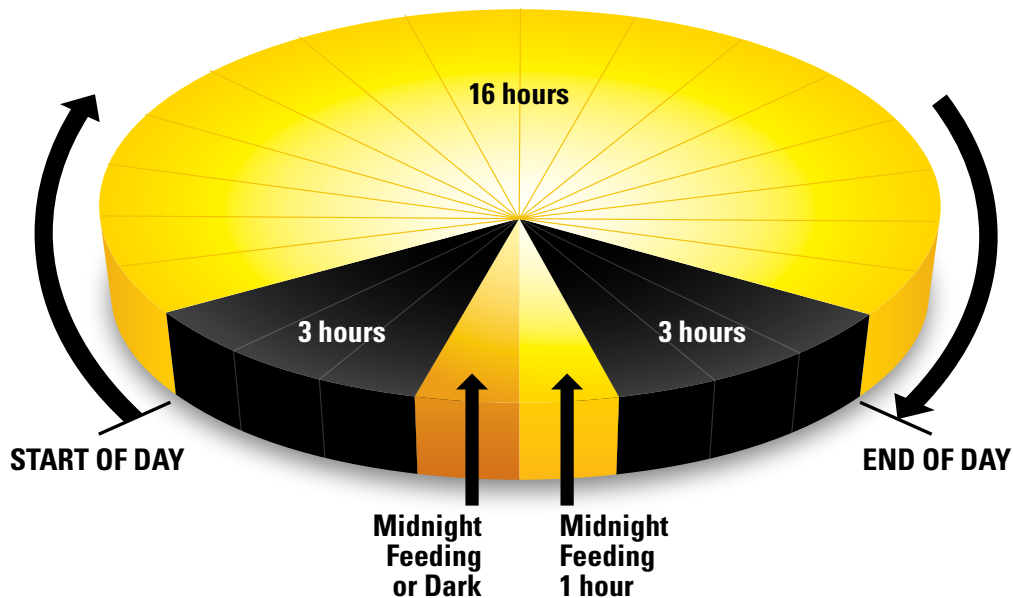

Management Events for Parent Stock



For more information on disease monitoring, see [Salmonella, Mycoplasma, and Avian Influenza Monitoring in Parent Breeder Flocks](#).

Management Events for Parent Stock

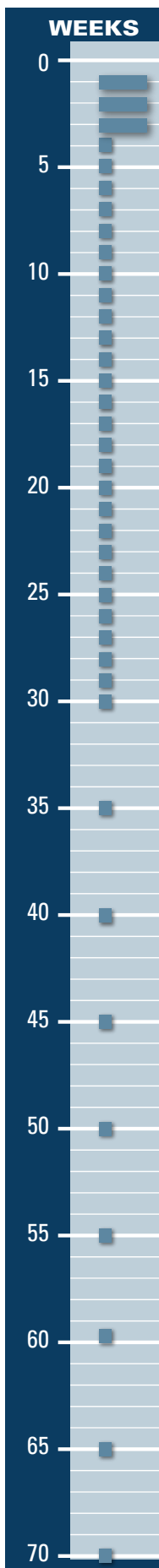

BODY WEIGHT MEASUREMENTS

Arrival

- Check body weights.

0–3 weeks

- Bulk weigh 10 boxes of 10 chicks.

4–29 weeks

- Weigh 100 females and 20 males individually every week.
- In houses with cages, weigh birds in the same cages each time for best accuracy.
- Calculate uniformity.

30–50 weeks

- Weigh 100 females and 50 males individually every 5 weeks.
- In houses with cages, weigh birds in the same cages each time for best accuracy.
- Calculate uniformity.

Over 50 weeks

- Weigh 100 females and 20 males individually every 10 weeks.
- In houses with cages, weigh birds in the same cages each time for best accuracy.
- Calculate uniformity.

CALCULATING UNIFORMITY

- Use individual bird weights.
- Uniformity calculation tool is available at www.hyline.com.

When handling birds for body weights, assess:

- Keel bone—straightness and firmness
- Breast muscle score
- Body fat
- External parasites
- Clinical symptoms of disease
- Breeder pullet quality

Bird Handling—BE GENTLE

- Proper handling of birds during body weight measurements, blood collection, selection, vaccination, and transfer will reduce bird stress and prevent injuries
- Hold birds by both legs or both wings
- Return birds to floor or cage gently—do not drop
- Use experienced personnel that have been trained in proper procedures of bird handling



Hold no more than three birds in one hand.



Hatching Egg Care

Hatching Egg Collection

- Hy-Line PS hatching eggs should weigh a minimum of 50 g from a breeder flock at least 22 weeks of age.
- Use only clean eggs collected from nests for hatching.
- Hatching eggs should be gathered twice daily. A third collection may be needed during extremely hot weather. In open-sided houses, eggs should be collected at least six times per day.
- Eggs should be placed with the air cell up into clean trays or directly onto incubation carts.



Unacceptable hatching eggs

Hatching Egg Identification

- Using food colors, mark each egg with the color assigned to each PS line. Each egg must be marked with the assigned color on the top portion of the egg.
- Label each egg rack with variety, line and date of collection.

Hatching Egg Storage

- Eggs should be stored at 15–18°C with relative humidity of 65–85%.
- Fumigate hatching eggs prior to storing.
- To minimize pre-incubation, eggs should be immediately moved to a temperature and humidity-controlled storage area on the breeder farm with set points equal to the hatchery storage area.
- When necessary to save eggs longer than 10 days, store at 13°C with 70–80% humidity or use SPIDES program.



Eggs in hatcher trays

Fertility Check

FRESH EGG BREAKOUT



Fertile Egg

Blastoderm is always round (doughnut shaped), 4–5 mm

Infertile Egg

Blastodisc is not round with irregular edges, 2–3 mm

FERTILITY CHECK AFTER 72 HOURS INCUBATION

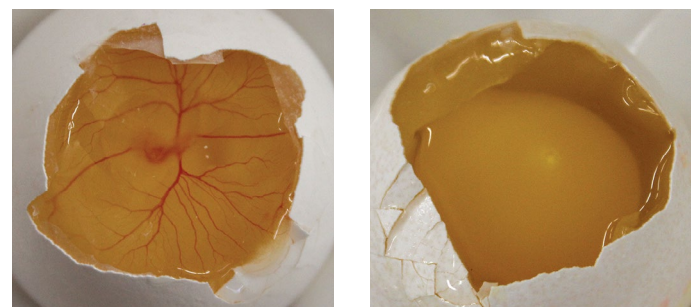

Fertile Egg

Blood vessels developed and embryo becomes visible

Infertile Egg

No development

Incubation and Hatching

- Pre-warm hatching eggs to achieve maximum chick yield and uniformity of hatch time.
 - Warm up eggs to a room temperature of 23–25°C and 55% humidity for 8 to 12 hours.
 - Provide adequate air movement in pre-warming area to reduce condensation and provide uniform temperature to all eggs.
 - In single-stage incubator, use pre-warm setting.
- Under normal conditions, Hy-Line Brown eggs achieve optimum hatch in 21 days and 8 hours.
- Egg age affects hatch time. Allow one additional hour of incubation for every day beyond 10 days of egg age.
- Chick weight at hatch is directly related to the weight of the hatching egg, usually 66% of egg weight.
- Eggs should be grouped in setter according to parent source flock. Maintain these groups so similar size chicks may be placed together in the brooder house.



Transportation of PS Hatching Eggs (HE) and Day-Old Chicks (DOC)

- Use a truck and transporter designed for transportation of chicks and hatching eggs with capabilities of heating, cooling and ventilation.
- For transporting DOC, the transporter should maintain an environmental temperature of 26–27°C. Inside chick boxes, 30–32°C and 50% relative humidity should be maintained.
- For transporting HE, the transporter should maintain an environmental temperature of 15–18°C.
- Precondition the transporter to set the proper temperature for at least 30 minutes before loading.
- Clean and disinfect the transporter between deliveries with verification of cleanliness by negative laboratory results.
- Utilize global positioning system (GPS) monitoring of truck location along the route.



Hatching egg pallet ready for transportation

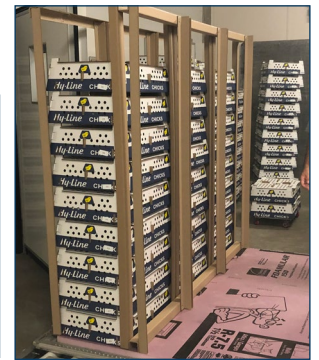

Shipping pallets are constructed of preformed spacers that provide strength and airspace around chick boxes.

Transportation of Hatching Eggs (HE)

- Packaging materials for boxes and shipment pallets must be clean, dry, unused and properly stored.
- Always place HE boxes on a pallet during storage, never directly on the floor.
- Do not tip hatching egg boxes at any time during packing and transportation.
- HE boxes should be placed on the shipment pallet in an alternating pattern for stability. Do not stack HE boxes more than five high.
- The HE shipment pallet should be shrink wrapped and cargo netted for maximum stability.
- Temperature and humidity recorders are placed in selected HE boxes to monitor conditions during transportation.



Proper pallet design

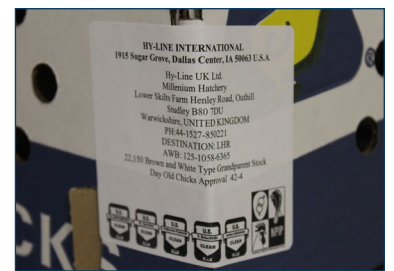

Chick box label



Chick box temperature recorders



Transportation of Day-Old Chicks (DOC)

- DOC are placed in chick boxes in the hatchery after chick processing.
- DOC boxes should be placed on a clean, dry pallet and secured with spacers to provide stability and spaces for ventilation.
- Arrange spacers between chick boxes to ensure adequate air flow. DOC boxes and spacers should be arranged on the pallet so that each DOC box has at least one side open to a larger airspace.
- Temperature and humidity recorders are placed in selected chick boxes to monitor conditions during transportation and chick placement onto the brooding facility. Return temperature recorders to Hy-Line International promptly for evaluation.

For more information on HE and DOC transportation and pallet construction, see <https://www.uspoultry.org/communications/AirCargo/24/index.html>.

Feed Biosecurity

- No animal sourced feed ingredients should be used in a PS flock due to the risk of pathogen contamination.
- Use only ingredients from an approved supplier list, ensuring that the suppliers have an adequate program to control contamination and potential risks.
- Maintain a strict policy for visitors to the feed mill following a downtime period matrix between the feed mill and other production facilities.
- Introduce a personnel hygiene and clothing policy, with frequent evaluation of its efficacy.
- Keep a periodic cleaning (with documentation) of all areas and equipment in the feed mill.
- Take periodic environmental swabs of the feedmill and test finished feed for coliforms and *Salmonella*. Maintain records of the results to establish baselines to identify trends and critical periods.
- Keep a clean and a dirty route inside the feed mill grounds.
- Feed ingredients and internal feed delivery trucks should never cross routes inside the feed mill.
- Heat treatment of finished feed (86°C for 6 minutes) with consecutive chemical and or additive treatment (organic acids, formaldehyde, terpenes, essential oils) is the best way to clean and control subsequent pathogen growth on feed.
- Implement a pest control program and maintain with periodic internal and external audits, monitoring of rodenticide bait activity and an action plan in case of deviation.
- Bulk feed should be delivered in a clean transport; avoid bagged feed and ingredients as an efficient way to reduce pest infestation.
- Audit the feed mill periodically for cleanliness and quality.

Feed Management

- Ideally, each variety should receive its recommended feed formulation.
- If two PS varieties are in the same house and it is only possible to have one feed for both, formulate the feed for the variety having the lowest feed intake.
- Keep feed retention samples in case an investigation of feed quality is needed.
- If a pre-lay diet cannot be used due to multiple flock ages, a developer diet with a higher calcium amount (1.4%) should be used.
- Check the consistency of the feed (particle size, excessive powder or moisture, presence of foreign material, odd coloring or smell) between batches and report any changes in the normal appearance to the feed mill.
- Ensure that the feed formulas are constantly updated by the attending nutritionist after review of flock production data.
- Define acceptable deviations of actual from theoretical ingredient usage and have an action plan in place in case of significant deviation.
- Keep production records for a minimum period of one year to allow traceability.
- Keep an open channel of communication and a complaint form between farms and feed mill. Ensure that all the complaints are documented and verified.
- For more information, see [Feed Granulometry](#).

Feed Particle Size

A sieve shaker separates feed sample into categories based on particle size.

- Use on the farm to check feed particle size from the feed mill—sample taken on delivery or from feed bins.
- Use to assess the uniformity of feed particle size throughout the feeding system—samples are taken from various points.

Too many fine feed particles:

- Feed intake and nutrient absorption decreases
- Dust in house increases

Too many coarse feed particles:

- Birds selectively eat large particles
- Risk of feed separation increases

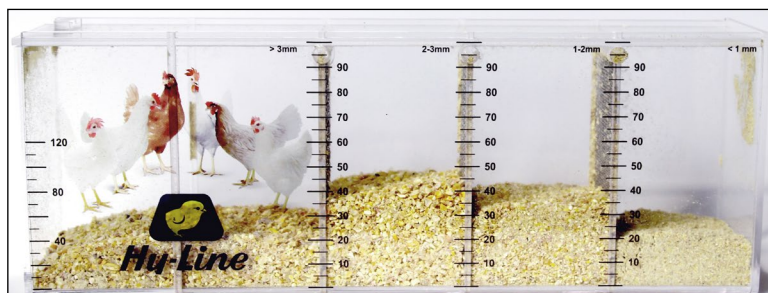

Hy-Line Sieve Shaker

OPTIMAL FEED PARTICLE PROFILE

PARTICLE SIZE	STARTER	GROWER	DEVELOPER	PRODUCTION
< 1 mm	1–3 mm diameter, crumble feed should contain < 10% fine feed particles	< 15%	< 15%	< 15%
1–2 mm		45–60%	25–35%	20–30%
2–3 mm		10–25%	25–40%	30–40%
> 3 mm		–	5–10%	10–15%

For more information, see [Feed Granulometry](#).

Best Practices

- A 3–4 hour gap in mid-day feedings allows birds to consume fine particles.
- Add a minimum of 0.5% liquid oil / fat in meal diets to incorporate and retain small particles in feed.
- Use larger particle size meal or crumble to increase intakes in hot climates.

Vitamins and Trace Minerals

As the vitamin/trace mineral premix is often found in fine feed particles, a minimum level of 1% added liquid oil/fat in diets binds small particles in feed.

ITEM ^{1,2,3,4}	IN 1000 KG COMPLETE DIET	
	Rearing Period	Production Period
Vitamin A, IU	10,000,000	12,000,000
Vitamin D ₃ ⁵ , IU	3,300,000	4,400,000
Vitamin E, g	30.00	85.00
Vitamin K (menadione), g	4.00	5.00
Thiamin (B ₁), g	3.00	4.00
Riboflavin (B ₂), g	8.00	15.00
Niacin (B ₃) ⁶ , g	50.00	65.00
Pantothenic acid (B ₅), g	13.00	21.00
Pyridoxine (B ₆), g	6.00	7.00
Biotin (B ₇), mg	120.00	350.00
Folic acid (B ₉), g	1.20	3.00
Cobalamine (B ₁₂), mg	30.00	35.00
Manganese ⁷ , g	105.00	115.00
Zinc ⁷ , g	100.00	115.00
Iron ⁷ , g	35.00	75.00
Copper ⁷ , g	20.00	23.00
Magnesium ⁷ , g	600.00	500.00
Iodine, g	2.00	3.00
Selenium ⁷ , g	0.30	0.35

¹ Minimum recommendations for rearing and laying periods. Local regulations may limit dietary content of individual vitamins or minerals. Levels of 150-200mg/kg of Vitamin C can be beneficial during periods of stress.

² Store premixes according to supplier's recommendations and observe 'use by' dates to ensure vitamin activity is maintained. Inclusion of antioxidant may improve premix stability.

³ Vitamin and mineral recommendations vary according to activity.

⁴ Where heat treatment is applied to diet, higher levels of vitamins may be required. Consult with vitamin supplier regarding stability through individual production processes.

⁵ A proportion of Vitamin D₃ can be supplemented as 25-hydroxy D₃ according to supplier's recommendations and applicable limits.

⁶ Higher levels of Niacin are recommended in non-cage systems.

⁷ Greater bioavailability and productivity may be possible with use of chelated mineral sources.

Water Quality

- Water is the most important nutrient. Good quality water must be available to birds at all times.
- Water and feed consumption are directly related—when birds drink less, they consume less feed and production quickly declines.
- As a general rule, healthy birds will consume 1.5–2.0 times more water than feed. This ratio increases in high ambient temperatures.
- Test water quality at least 1 time per year. The water source will determine regularity of water testing.
 - Surface water requires more frequent testing, as it is more affected by season and rainfall patterns.
 - Closed wells taking water from aquifers or deep artesian basins will be more consistent in water quality, but are generally higher in dissolved mineral content.
- The presence of coliform bacteria is an indicator that water source has been contaminated with animal or human waste.
- When collecting a well water sample, let water run for 2 minutes prior to collecting the sample. Water samples should be kept below 10°C and submitted to the lab in less than 24 hours.
- Some water sources contain high levels of dissolved minerals such as calcium, sodium and magnesium. When this occurs, amounts of these minerals in water have to be considered when formulating feed.
- Ideal water pH is 5–7 to promote good water sanitation, increase feed consumption and improve upper gastrointestinal health.
- Less than optimum water quality can have a significant impact on gut health which will lead to under utilization of nutrients in feed.

ITEM	MAXIMUM CONCENTRATION (ppm or mg/L)*	COMMENTS
Nitrate NO ₃ ⁻ ¹	25	Older birds will tolerate higher levels up to 20 ppm. Stressed or diseased challenged birds may be more sensitive to effects of Nitrate.
Nitrate Nitrogen (NO ₃ -N) ¹	6	
Nitrite NO ₂ ⁻ ¹	4	Nitrite is considerably more toxic than Nitrate, especially for young birds where 1 ppm Nitrite may be considered toxic.
Nitrite Nitrogen (NO ₂ -N) ¹	1	
Total dissolved solids ²	1000	Levels up to 3000 ppm may not affect performance but could increase manure moisture.
Chloride (Cl ⁻) ¹	250	Levels as low as 14 mg may be problematic if sodium higher than 50 ppm.
Sulfate (SO ₄ ⁻) ¹	250	Higher levels may be laxative.
Iron (Fe) ¹	<0.3	Higher levels result in bad odor and taste.
Magnesium (Mg) ¹	125	Higher levels may be laxative. Levels above 50 ppm may be problematic if sulphate levels are high.
Potassium (K) ²	20	Higher levels may be acceptable depending on sodium level, alkalinity and pH.
Sodium (Na) ^{1,2}	50	Higher concentration acceptable but concentrations above 50 ppm should be avoided if high levels of chloride, sulphate or potassium exist.
Manganese (Mn) ³	0.05	Higher levels may be laxative.
Arsenic (As) ²	0.5	
Fluoride (F ⁻) ²	2	
Aluminum (Al) ²	5	
Boron (B) ²	5	
Cadmium (Cd) ²	0.02	
Cobalt (Co) ²	1	
Copper (Cu) ¹	0.6	Higher levels result in bitter taste.
Lead (Pb) ¹	0.02	Higher levels are toxic.
Mercury (Hg) ²	0.003	Higher levels are toxic.
Zinc (Zn) ¹	1.5	Higher levels are toxic.
pH ¹	5–7	Birds may adapt to lower pH. Below pH 5 may reduce water intake and corrode metal fittings. Above pH 8 may reduce intake and reduce effectiveness of water sanitation.
Total bacteria counts ³	1000 CFU/ml	Likely to indicate dirty water.
Total Coliform bacteria ³	50 CFU/ml	
Fecal Coliform bacteria ³	0 CFU/ml	
Oxygen Reduction Potential (ORP) ³	650–750 mEq	The ORP range at which 2–4 ppm of free chlorine will effectively sanitize water at a favorable pH range of 5–7.

* Limits may be lower as interactions exist between magnesium and sulphate; and between sodium, potassium, chloride and sulphate.

¹ Carter & Sneed, 1996. Drinking Water Quality for Poultry, Poultry Science and Technology Guide, North Carolina State University Poultry Extension Service. Guide no. 42

² Marx and Jaikaran, 2007. Water Analysis Interpretation. Agri-Facts, Alberta Ag-Info Centre. Refer to <http://www.agric.gov.ab.ca/app84/rwqit> for online Water Analysis Tool

³ Watkins, 2008. Water: Identifying and Correcting Challenges. Avian Advice 10(3): 10–15 University of Arkansas Cooperative Extension Service, Fayetteville

Rearing Period Nutritional Recommendations

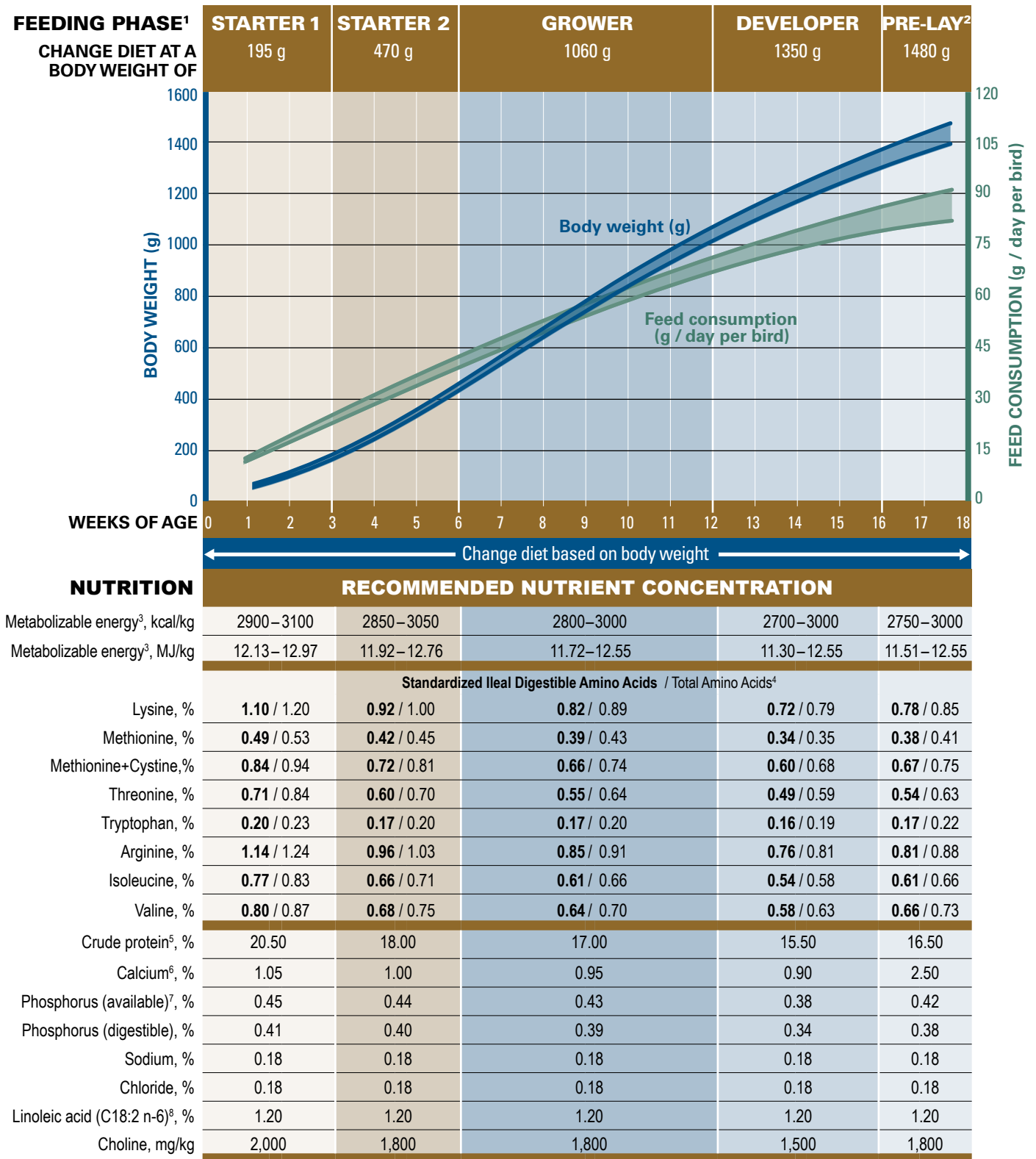

¹ All nutrient requirements are based on the feed ingredient table at the back of this guide.

² Do not feed Pre-Lay Diet earlier than 15 weeks of age. Do not feed Pre-Lay later than first egg as it contains insufficient calcium to support egg production. Implementing a pre-lay diet can be challenging in mixed-age flocks. If it's not possible to use the Pre-Lay diet, the calcium content of the last stage rearing diet (developer) must be increased to 1.4%.

³ Recommended energy range is based on raw material energy values shown in feed ingredient table at back of this guide. It is important that target concentrations of dietary energy are adjusted according to energy system applied to raw material matrix.

⁴ Recommendation for Total Amino Acids is only appropriate to corn and soybean meal diet. Where diets utilize other ingredients, recommendations for Standardized Ileal Digestible Amino Acids must be followed.

⁵ Diets should always be formulated to provide required intake of amino acid. Concentration of crude protein in diet will vary with raw materials used. Crude protein value provided is an estimated typical value only.

⁶ Calcium should be supplied as fine calcium carbonate (mean particle size less than 2 mm). Coarse limestone (2–4 mm) can be introduced in Pre-Lay Diet at up to 50% of total limestone.

⁷ Where other phosphorus systems are used, diets should contain recommended minimum level of available phosphorus.

⁸ Oil levels can be increased to 2.0% in starter diets when given as a mash to control dust and increase feed palatability.

⁹ Avoid excessive body weight gain after 12 weeks.

Production Period Nutritional Recommendations^{1,2}

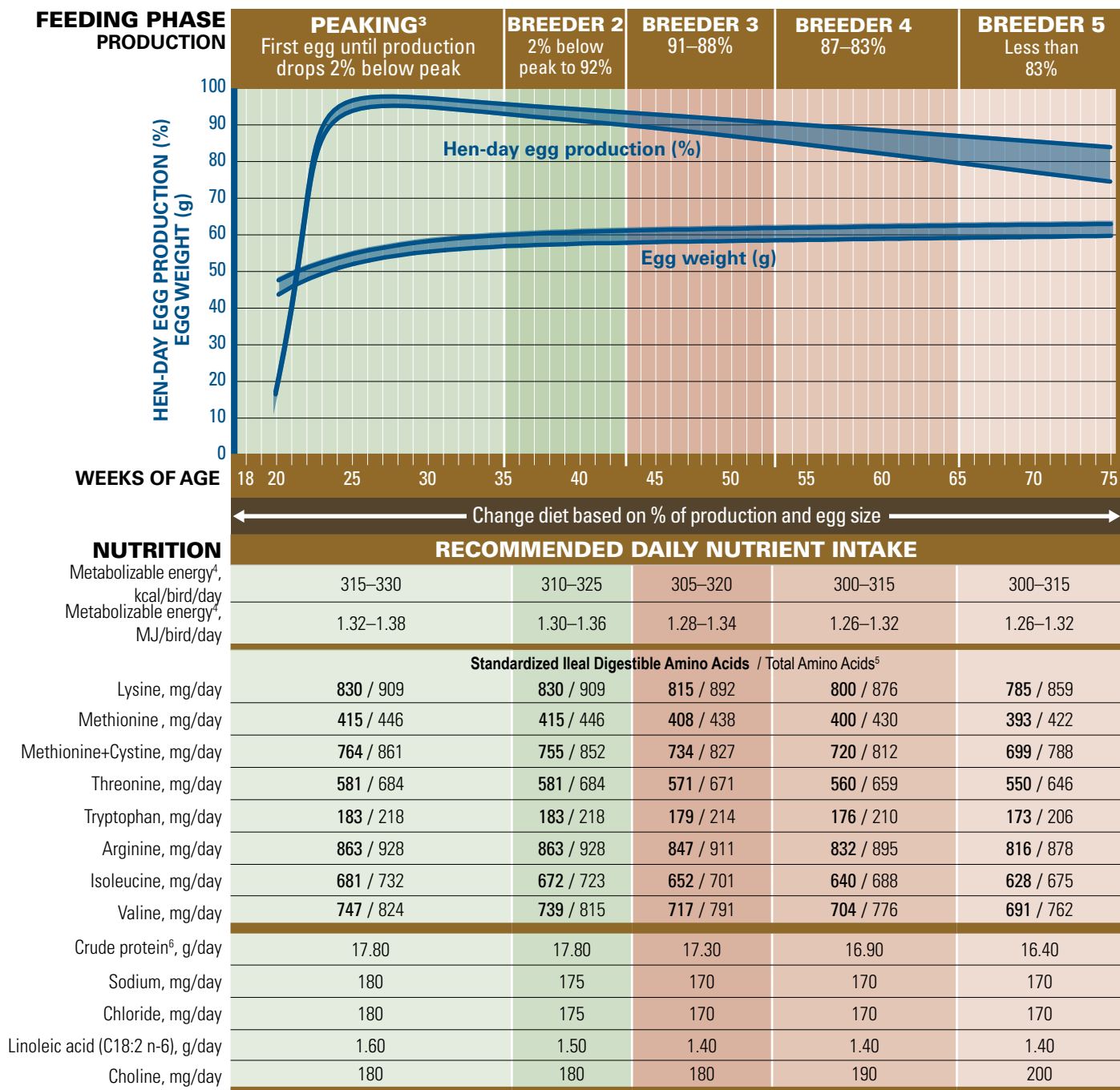

CALCIUM AND PHOSPHORUS				
	Calcium ^{7,8} g/day	Phosphorus (available) ^{7,9} mg/day	Phosphorus (digestible) mg/day	Calcium Particle Size (fine : coarse)
Weeks 18–33	4.00	437	393	40% : 60%
Weeks 34–44	4.15	416	374	35% : 65%
Weeks 45–55	4.30	395	356	30% : 70%
Weeks 56–65	4.45	372	335	25% : 75%
Weeks 66–75	4.60	351	316	25% : 75%

IDEAL PROTEIN REFERENCE					
	PEAKING	BREEDER 2	BREEDER 3	BREEDER 4	BREEDER 5
Lysine	100%	100%	100%	100%	100%
Methionine	50%	50%	50%	50%	50%
M+C	92%	91%	90%	90%	89%
Threonine	70%	70%	70%	70%	70%
Tryptophan	22%	22%	22%	22%	22%
Arginine	104%	104%	104%	104%	104%
Isoleucine	82%	81%	80%	80%	80%
Valine	90%	89%	88%	88%	88%

Production Period Dietary Nutrient Concentrations^{1,2}

FEEDING PHASE PRODUCTION NUTRITION	PEAKING ³ First egg until production drops 2% below peak					BREEDER 2 2% below peak to 92%					BREEDER 3 91–88%					BREEDER 4 87–83%					BREEDER 5 Less than 83%				
	RECOMMENDED CONCENTRATION																								
Metabolizable energy ⁴ , kcal/bird/day	315–330					310–325					305–320					300–315					300–315				
Metabolizable energy ⁴ , MJ/bird/day	1.32–1.38					1.30–1.36					1.28–1.34					1.26–1.32					1.26–1.32				
FEED CONSUMPTION (*Typical Feed Consumption)																									
g/day per bird	90	95	100*	105	110	105	110	115*	120	125	105	111	117*	123	129	105	111	117*	123	129	105	111	117*	123	129
Standardized Ileal Digestible Amino Acids																									
Lysine, %	0.92	0.87	0.83	0.79	0.75	0.79	0.75	0.72	0.69	0.66	0.78	0.73	0.70	0.66	0.63	0.76	0.72	0.68	0.65	0.62	0.75	0.71	0.67	0.64	0.61
Methionine, %	0.46	0.44	0.42	0.40	0.38	0.40	0.38	0.36	0.35	0.33	0.39	0.37	0.35	0.33	0.32	0.38	0.36	0.34	0.33	0.31	0.37	0.35	0.34	0.32	0.30
Methionine+Cystine, %	0.85	0.80	0.76	0.73	0.69	0.72	0.69	0.66	0.63	0.60	0.70	0.66	0.63	0.60	0.57	0.69	0.65	0.62	0.59	0.56	0.67	0.63	0.60	0.57	0.54
Threonine, %	0.65	0.61	0.58	0.55	0.53	0.55	0.53	0.51	0.48	0.46	0.54	0.51	0.49	0.46	0.44	0.53	0.50	0.48	0.46	0.43	0.52	0.50	0.47	0.45	0.43
Tryptophan, %	0.20	0.19	0.18	0.17	0.17	0.17	0.17	0.16	0.15	0.15	0.17	0.16	0.15	0.15	0.14	0.17	0.16	0.15	0.14	0.14	0.16	0.16	0.15	0.14	0.13
Arginine, %	0.96	0.91	0.86	0.82	0.78	0.82	0.78	0.75	0.72	0.69	0.81	0.76	0.72	0.69	0.66	0.79	0.75	0.71	0.68	0.64	0.78	0.74	0.70	0.66	0.63
Isoleucine, %	0.76	0.72	0.68	0.65	0.62	0.64	0.61	0.58	0.56	0.54	0.62	0.59	0.56	0.53	0.51	0.61	0.58	0.55	0.52	0.50	0.60	0.57	0.54	0.51	0.49
Valine, %	0.83	0.79	0.75	0.71	0.68	0.70	0.67	0.64	0.62	0.59	0.68	0.65	0.61	0.58	0.56	0.67	0.63	0.60	0.57	0.55	0.66	0.62	0.59	0.56	0.54
Total Amino Acids ⁵																									
Lysine, %	1.01	0.96	0.91	0.87	0.83	0.87	0.83	0.79	0.76	0.73	0.85	0.80	0.76	0.73	0.69	0.83	0.79	0.75	0.71	0.68	0.82	0.77	0.73	0.70	0.67
Methionine, %	0.50	0.47	0.45	0.42	0.41	0.42	0.41	0.39	0.37	0.36	0.42	0.39	0.37	0.36	0.34	0.41	0.39	0.37	0.35	0.33	0.40	0.38	0.36	0.34	0.33
Methionine+Cystine, %	0.96	0.91	0.86	0.82	0.78	0.81	0.77	0.74	0.71	0.68	0.79	0.75	0.71	0.67	0.64	0.77	0.73	0.69	0.66	0.63	0.75	0.71	0.67	0.64	0.61
Threonine, %	0.76	0.72	0.68	0.65	0.62	0.65	0.62	0.59	0.57	0.55	0.64	0.60	0.57	0.55	0.52	0.63	0.59	0.56	0.54	0.51	0.62	0.58	0.55	0.53	0.50
Tryptophan, %	0.24	0.23	0.22	0.21	0.20	0.21	0.20	0.19	0.18	0.17	0.20	0.19	0.18	0.17	0.17	0.20	0.19	0.18	0.17	0.16	0.20	0.19	0.18	0.17	0.16
Arginine, %	1.03	0.98	0.93	0.88	0.84	0.88	0.84	0.81	0.77	0.74	0.87	0.82	0.78	0.74	0.71	0.85	0.81	0.76	0.73	0.69	0.84	0.79	0.75	0.71	0.68
Isoleucine, %	0.81	0.77	0.73	0.70	0.67	0.69	0.66	0.63	0.60	0.58	0.67	0.63	0.60	0.57	0.54	0.66	0.62	0.59	0.56	0.53	0.64	0.61	0.58	0.55	0.52
Valine, %	0.92	0.87	0.82	0.78	0.75	0.78	0.74	0.71	0.68	0.65	0.75	0.71	0.68	0.64	0.61	0.74	0.70	0.66	0.63	0.60	0.73	0.69	0.65	0.62	0.59
Crude protein ⁶ , %	19.78	18.74	17.80	16.95	16.18	16.95	16.18	15.48	14.83	14.24	16.48	15.59	14.79	14.07	13.41	16.10	15.23	14.44	13.74	13.10	15.62	14.77	14.02	13.33	12.71
Sodium, %	0.20	0.19	0.18	0.17	0.16	0.17	0.16	0.15	0.15	0.14	0.16	0.15	0.15	0.14	0.13	0.16	0.15	0.15	0.14	0.13	0.16	0.15	0.15	0.14	0.13
Chloride, %	0.20	0.19	0.18	0.17	0.16	0.17	0.16	0.15	0.15	0.14	0.16	0.15	0.15	0.14	0.13	0.16	0.15	0.15	0.14	0.13	0.16	0.15	0.15	0.14	0.13
Linoleic acid (C18:2 n-6), %	1.78	1.68	1.60	1.52	1.45	1.43	1.36	1.30	1.25	1.20	1.33	1.26	1.20	1.14	1.09	1.33	1.26	1.20	1.14	1.09	1.33	1.26	1.20	1.14	1.09
Choline, mg/kg	2000	1895	1800	1714	1636	1714	1636	1565	1500	1440	1714	1622	1538	1463	1395	1810	1712	1624	1545	1473	1905	1802	1709	1626	1550

CALCIUM AND PHOSPHORUS CHANGES BASED ON FEED INTAKE

Feed, g/day/bird	Weeks 18–33								Weeks 34–44								Weeks 45–55								Weeks 56–65								Weeks 66–75							
	90	95	100	105	111	117	123	129	100	105	111	117	123	129	100	105	111	117	123	129	100	105	111	117	123	129	100	105	111	117	123	129	100	105	111	117	123	129		
Calcium ^{7,8} , %	4.44	4.21	4.00	3.81	3.60	3.42	3.25	3.10	4.15	3.95	3.74	3.55	3.37	3.22	4.30	4.10	3.87	3.68	3.50	3.33	4.45	4.24	4.01	3.80	3.62	3.45	4.60	4.38	4.14	3.93	3.74	3.57								
Phosphorus (available) ^{7,9} , %	0.49	0.46	0.44	0.42	0.39	0.37	0.36	0.34	0.42	0.40	0.37	0.36	0.34	0.32	0.40	0.38	0.36	0.34	0.32	0.31	0.37	0.35	0.34	0.32	0.30	0.29	0.35	0.33	0.32	0.30	0.29	0.27								
Phosphorus (digestible), %	0.44	0.41	0.39	0.37	0.35	0.34	0.32	0.30	0.37	0.36	0.34	0.32	0.30	0.29	0.36	0.34	0.32	0.30	0.29	0.28	0.34	0.32	0.30	0.29	0.27	0.26	0.32	0.30	0.28	0.27	0.26	0.24								

¹ All nutrient requirements are based on the feed ingredient table at the back of this guide.

² Crude protein, methionine+cystine, fat, linoleic acid, and / or energy may be changed to optimize egg size.

³ Peaking nutrient levels are calculated for birds at peak egg production. Prior to achieving peak egg production, the nutrient requirements will be lower.

⁴ A good approximation of the influence of temperature on energy needs is that for each 0.5°C change higher or lower than 22°C, subtract or add about 2 kcal /bird / day, respectively.

⁵ Recommendation for Total Amino Acids is only appropriate to corn and soybean meal diet. Where diets utilize other ingredients, recommendations for Standardized Ileal Digestible Amino Acids must be followed.

⁶ Diets should always be formulated to provide required intake of amino acid. Concentration of crude protein in diet will vary with raw material used. Crude protein value provided is an estimated typical value only.

⁷ Calcium and available phosphorus requirements are determined by flock age. When production remains higher and diets are fed for longer than ages shown, it is recommended to increase to calcium and phosphorus concentrations of next feeding phase.

⁸ Calcium carbonate particle size recommendation varies throughout lay. Refer to Calcium Particle Size Table. Dietary calcium levels may need to be adjusted based on limestone solubility.

⁹ Where other phosphorus systems are used, diets should contain recommended minimum level of available phosphorus.

Feed Ingredient Tables

INGREDIENT (as-fed basis)	DRY MATTER (%)	CRUDE PROTEIN (%)	FAT—ether extract (%)	CRUDE FIBRE	CALCIUM (%)	PHOSPHORUS total (%)	PHOSPHORUS available (%)	SODIUM (%)	CHLORIDE (%)	POTASSIUM (%)	Sulphur (%)	ME (kcal/lb)	ME (kcal/kg)	ME (MJ/kg)	LINOLEIC ACID (%)	CHOLINE (mg/kg)
Barley, grain	89.0	11.5	1.9	5.0	0.08	0.42	0.15	0.03	0.14	0.56	0.15	1250	2750	11.51	1.1	1027
Beans, broad (vicia faba)	89.0	25.7	1.4	8.2	0.14	0.54	0.20	0.08	0.04	1.20	–	1100	2420	10.13	0.9	1670
Calcium carbonate (38% Ca)	99.0	–	–	–	38.00	–	–	0.06	–	0.06	–	–	–	–	–	–
Canola meal (38%)	91.0	38.0	3.8	11.1	0.68	1.20	0.40	–	–	1.29	1.00	960	2110	8.83	–	6700
Corn, yellow, grain	86.0	7.5	3.5	1.9	0.01	0.28	0.12	0.02	0.04	0.33	0.08	1530	3373	14.11	1.9	1100
Corn gluten meal (60%)	90.0	60.0	2.0	2.5	0.02	0.50	0.18	0.03	0.05	0.45	0.50	1700	3740	15.65	1.8	2200
Cottonseed meal (41%), mech. extd	91.0	41.0	3.9	12.6	0.17	0.97	0.32	0.04	0.04	1.20	0.40	955	2100	8.79	0.8	2807
Cottonseed meal (41%), direct solv.	90.0	41.0	2.1	11.3	0.16	1.00	0.32	0.04	0.04	1.16	0.30	915	2010	8.41	0.4	2706
Dicalcium phosphate (18.5% P)	99.0	–	–	–	22.00	18.50	18.50	0.08	–	0.07	–	–	–	–	–	–
DL-Methionine	99.0	58.1	–	–	–	–	–	–	–	–	–	2277	5020	21.00	–	–
Fat, animal	99.0	–	98.0	–	–	–	–	–	–	–	–	3600	7920	33.14	–	–
Fat, vegetable	99.0	–	99.0	–	–	–	–	–	–	–	–	4000	8800	36.82	40.0	–
Fish meal, anchovy, Peruvian	91.0	65.0	10.0	1.0	–	–	–	0.88	0.60	0.90	0.54	1280	2820	11.80	0.1	5100
Fish meal, white	91.0	61.0	4.0	1.0	–	–	–	0.97	0.50	1.10	0.22	1180	2600	10.88	0.1	4050
Flaxseed	92.0	22.0	34.0	6.5	–	–	–	0.08	–	1.50	–	1795	3957	16.56	54.0	3150
L-Lysine	99.0	93.4	–	–	–	–	–	–	–	–	–	1868	4120	17.24	–	–
L-Threonine	99.0	72.4	–	–	–	–	–	–	–	–	–	1619	3570	14.94	–	–
L-Tryptophan	99.0	84.0	–	–	–	–	–	–	–	–	–	2653	5850	24.48	–	–
Linseed meal flax, expeller	90.0	32.0	3.5	9.5	0.40	0.80	–	0.11	–	1.24	0.39	700	1540	6.44	0.5	672
Linseed meal flax, solvent	88.0	33.0	0.5	9.5	0.35	0.75	–	0.14	–	1.38	0.39	635	1400	5.86	0.1	1760
Meat and bone meal, 50%	93.0	50.0	8.5	2.8	9.20	4.70	4.70	0.80	0.75	1.40	0.40	1150	2530	10.59	0.5	2000
Millet, pearl grain	90.0	12.0	4.2	1.8	0.05	0.30	0.10	0.04	0.64	0.43	0.13	1470	3240	13.56	1.3	789
Mono-dicalcium phosphate (21% P)	99.0	–	–	–	16.00	21.00	–	0.05	–	0.06	–	–	–	–	–	–
Oats, grain	90.0	11.0	4.0	10.5	0.10	0.35	0.14	0.07	0.12	0.37	0.21	1160	2550	10.67	2.4	1070
Peanut meal, solvent	90.0	47.0	2.5	8.4	0.08	0.57	0.18	0.07	0.03	1.22	0.30	1217	2677	11.20	0.5	1948
Poultry byproduct meal (feed grade)	94.0	57.0	14.0	2.5	5.00	2.70	2.70	0.30	0.55	0.60	0.50	1406	3100	12.97	0.7	5980
Rice bran, unextracted	91.0	13.5	5.9	13.0	0.10	1.70	0.24	0.10	0.07	1.35	0.18	925	2040	8.54	5.2	1948
Rice, grain, rough	89.0	7.3	1.7	10.0	0.04	0.26	0.09	0.04	0.06	0.34	0.10	1335	2940	12.30	0.83	5980
Safflower seed meal, expeller	91.0	20.0	6.6	32.2	0.23	0.61	0.20	0.05	0.16	0.72	0.10	525	1160	4.85	–	800
Salt, NaCl	99.0	–	–	–	–	–	–	39.34	60.66	–	–	–	–	–	–	–
Sodium bicarbonate, NaHCO ₃	99.0	–	–	–	–	–	–	27.38	–	–	–	–	–	–	–	–
Sorghum, milo, grain	89.0	11.0	2.8	2.0	0.04	0.29	0.10	0.03	0.09	0.34	0.09	1505	3310	13.85	1.3	678
Soybeans, full-fat, cooked	90.0	38.0	18.0	5.0	0.25	0.59	0.20	0.04	0.03	1.70	0.30	1520	3350	14.02	9.9	2420
Soybean meal, expeller	89.0	42.0	3.5	6.5	0.20	0.60	0.20	0.04	0.02	1.71	0.33	1100	2420	10.13	1.8	2673
Soybean meal, solvent	90.0	44.0	0.5	7.0	0.25	0.60	0.20	0.04	0.02	1.97	0.43	1020	2240	9.37	0.3	2743
Sunflower meal, expeller	93.0	41.0	7.6	21.0	0.43	1.00	0.25	0.20	0.01	1.00	0.10	1050	2310	9.67	6.5	–
Sunflower meal, partially dehul. solv.	92.0	34.0	0.5	13.0	0.30	1.25	0.27	0.20	0.01	1.60	0.38	1025	2260	9.46	0.2	1909
Triticale	90.0	12.5	1.5	2.59	0.05	0.30	0.10	–	0.07	–	0.20	1430	3150	13.18	0.9	460
Wheat, hard grain	88.0	13.5	1.9	3.0	0.05	0.41	0.12	0.06	0.07	0.50	0.10	1440	3170	13.26	1.00	778
Wheat, soft grain	86.0	10.8	1.7	2.8	0.05	0.30	0.11	0.06	0.07	0.40	0.10	1460	3210	13.43	1.00	778
Wheat bran	89.0	14.8	4.0	10.0	0.14	1.17	0.38	0.06	0.14	1.20	0.22	590	1300	5.44	2.10	980
Wheat middlings	89.0	15.0	3.6	8.5	0.15	1.17	0.45	0.06	0.07	0.60	0.16	950	2090	8.74	1.90	110

Nutrient recommendations are based on calculations using these energy and nutrient values (source: 2018–2019 Feedstuffs Reference Issue and field data). Values provided are “typical” based on ingredient surveys. Nutrient values should be confirmed by analysis of the materials being used in order to maintain an accurate formulation matrix.

INGREDIENT (as-fed basis)	CRUDE PROTEIN (%)	LYSINE (%)		METHI-ONINE (%)		CYSTINE (%)		THRE-ONINE (%)		TRYPTO-PHAN (%)		ARGININE (%)		ISOLEU-CINE (%)		VALINE (%)	
	(%)	Total content	Digestible content	Total content	Digestible content	Total content	Digestible content	Total content	Digestible content	Total content	Digestible content	Total content	Digestible content	Total content	Digestible content	Total content	Digestible content
Barley, grain	11.50	0.53	0.41	0.18	0.14	0.25	0.20	0.36	0.28	0.17	0.12	0.50	0.43	0.42	0.34	0.62	0.50
Beans, broad (vicia faba)	25.70	1.52	1.29	0.25	0.18	0.14	0.09	0.98	0.77	0.24	0.16	2.20	1.91	1.00	0.73	1.22	0.88
Canola meal (38%)	91.0	2.02	1.60	0.77	0.69	0.97	0.71	1.50	1.17	0.46	0.38	2.30	2.07	1.51	1.25	1.94	1.59
Corn, yellow, grain	7.50	0.24	0.19	0.18	0.16	0.18	0.15	0.29	0.24	0.07	0.06	0.40	0.36	0.29	0.26	0.42	0.37
Corn gluten meal (60%)	60.00	1.00	0.88	1.90	1.84	1.10	0.95	2.00	1.84	0.30	0.25	1.90	1.82	2.30	2.19	2.70	2.57
Cottonseed meal (41%), mech. extd	41.00	1.52	0.99	0.55	0.40	0.59	0.44	1.30	0.88	0.50	0.39	4.33	3.81	1.31	0.93	1.84	1.36
Cottonseed meal (41%), direct solv.	41.00	1.70	1.11	0.51	0.37	0.62	0.46	1.31	0.89	0.52	0.41	4.66	4.10	1.33	0.95	1.82	1.34
DL-Methionine	58.10	-	-	99.00	99.00	-	-	-	-	-	-	-	-	-	-	-	-
Fish meal, anchovy, Peruvian	65.00	4.90	4.21	1.90	1.63	0.60	0.43	2.70	2.17	0.75	0.59	3.38	2.77	3.00	2.55	3.40	2.82
Fish meal, white	61.00	4.30	3.70	1.65	1.42	0.75	0.54	2.60	2.09	0.70	0.55	4.20	3.44	3.10	2.64	3.25	2.70
Flaxseed	22.00	0.92	0.79	0.35	0.30	0.42	0.30	0.77	0.62	0.22	0.17	2.05	1.68	0.95	0.81	1.17	0.97
L-Lysine	93.40	78.80	78.80	-	-	-	-	-	-	-	-	-	-	-	-	-	-
L-Threonine	72.40	-	-	-	-	-	-	98.50	98.50	-	-	-	-	-	-	-	-
L-Tryptophan	84.00	-	-	-	-	-	-	-	-	98.00	98.00	-	-	-	-	-	-
Linseed meal flax, expeller	32.00	1.10	0.99	0.47	0.37	0.56	0.44	1.10	1.00	0.47	0.43	2.60	2.39	1.70	1.49	1.50	1.29
Linseed meal flax, solvent	33.00	1.10	0.99	0.48	0.38	0.58	0.45	1.20	1.10	0.48	0.44	2.70	2.48	1.80	1.58	1.60	1.38
Meat and bone meal, 50%	50.00	2.60	2.05	0.67	0.57	0.33	0.19	1.70	1.34	0.26	0.13	3.35	2.85	1.70	1.41	2.25	1.85
Millet, pearl grain	12.00	0.35	0.32	0.28	0.25	0.24	0.20	0.44	0.37	0.20	0.18	0.55	0.49	0.52	0.46	0.70	0.62
Oats, grain	11.00	0.40	0.35	0.20	0.17	0.21	0.18	0.28	0.24	0.18	0.14	0.80	0.75	0.53	0.47	0.62	0.55
Peanut meal, solvent	47.00	1.52	1.29	0.50	0.44	0.60	0.47	1.12	0.91	0.42	0.39	4.76	4.28	1.50	1.32	1.80	1.57
Poultry byproduct meal (feed grade)	57.00	2.25	1.80	0.91	0.78	0.90	0.55	1.88	1.50	0.50	0.26	3.50	3.08	2.10	1.79	2.32	1.93
Rice bran, unextracted	13.50	0.50	0.38	0.17	0.13	0.10	0.07	0.40	0.28	0.10	0.08	0.45	0.39	0.39	0.30	0.60	0.46
Rice, grain, rough	7.30	0.24	0.19	0.14	0.13	0.08	0.07	0.27	0.22	0.12	0.11	0.59	0.54	0.33	0.27	0.46	0.39
Safflower seed meal, expeller	20.00	0.70	0.58	0.40	0.35	0.58	0.45	0.47	0.34	0.30	0.24	1.20	1.01	0.28	0.22	1.00	0.87
Sorghum, milo, grain	11.00	0.27	0.21	0.10	0.09	0.20	0.17	0.27	0.22	0.09	0.08	0.40	0.30	0.60	0.53	0.53	0.46
Soybeans, full-fat, cooked	38.00	2.40	2.16	0.54	0.49	0.55	0.45	1.69	1.43	0.52	0.46	2.80	2.60	2.18	1.94	2.02	1.78
Soybean meal, expeller	42.00	2.70	2.43	0.60	0.54	0.62	0.51	1.70	1.44	0.58	0.52	3.20	2.97	2.80	2.49	2.20	1.94
Soybean meal, solvent	44.00	2.70	2.43	0.65	0.58	0.67	0.55	1.70	1.44	0.60	0.53	3.40	3.16	2.50	2.22	2.40	2.11
Sunflower meal, expeller	41.00	2.00	1.74	1.60	1.47	0.80	0.64	1.60	1.31	0.60	0.52	4.20	3.91	2.40	2.14	2.40	2.08
Sunflower meal, partially dehul, solv.	34.00	1.42	1.19	0.64	0.60	0.55	0.43	1.48	1.26	0.35	0.30	2.80	2.32	1.39	1.25	1.64	1.41
Triticale	12.50	0.39	0.35	0.26	0.23	0.26	0.22	0.36	0.31	0.14	0.12	0.48	0.39	0.76	0.70	0.51	0.44
Wheat, hard grain	13.50	0.40	0.32	0.25	0.22	0.30	0.26	0.35	0.29	0.18	0.16	0.60	0.53	0.69	0.61	0.69	0.59
Wheat, soft grain	10.80	0.30	0.24	0.14	0.12	0.20	0.17	0.28	0.23	0.12	0.11	0.40	0.35	0.43	0.38	0.48	0.41
Wheat bran	14.80	0.60	0.43	0.20	0.15	0.30	0.22	0.48	0.35	0.30	0.24	1.07	0.88	0.60	0.47	0.70	0.54
Wheat Middlings	15.00	0.70	0.56	0.12	0.10	0.19	0.14	0.50	0.36	0.20	0.16	1.00	0.80	0.70	0.58	0.80	0.61

Amino acid digestibility is standardised ileal digestibility. Amino acid values are standardised for 88% dry matter (source: 2018–2019 Feedstuffs Reference Issue and field data). Values provided are “typical” based on ingredient surveys. Nutrient values should be confirmed by analysis of the materials being used in order to maintain an accurate formulation matrix.

Biosecurity

Disease outbreaks jeopardize the ability of the PS operation to fulfill the health requirements for PS chicks. Parent stock must be kept in strictly biosecure locations. Biosecurity is the best method of avoiding diseases. Monitoring programs should be in place to confirm that the PS flock is free of all diseases under regulation by both the importing and exporting countries. All flocks should be free of important vertically transmitted diseases like *Mycoplasma gallisepticum*, *Mycoplasma synoviae*, salmonellas, lymphoid leucosis and others under regulation. Parent flocks receive regular veterinary inspections and confirmed free of clinical signs of disease.



Biosecurity Sign

Facility Biosecurity (All visitors should be verified as salmonella negative prior to entering the farm)

TO / FROM	PS Farms	Hatchery, Feed Mill
Highly Pathogenic Avian Influenza areas or Exotic Newcastle affected areas	7 nights	7 nights
Other Poultry Farms	4 nights	4 nights
Industry Convention* (with other poultry farmers or international attendees)	1 night	1 night
Lab Building, Office	Same Day**	Same Day**
Salmonella Positive Locations	3 nights	3 nights
PS Farms, Egg Transfer	Same Day**	Same Day**
Hatchery, Feed Mill	1 night	–

**MUST traffic from youngest to oldest flocks and/or healthy to sick flocks. Visit fewer than four (4) PS flocks per day, assuring youngest to oldest flock movement.

+Including backyard flocks – petting zoos, county and state fairs, agricultural shows, farm stores, any type of birds/poultry flock

Night = Nights in the country of the PS farm or hatchery to be visited, with a change of clothes and shower off site.

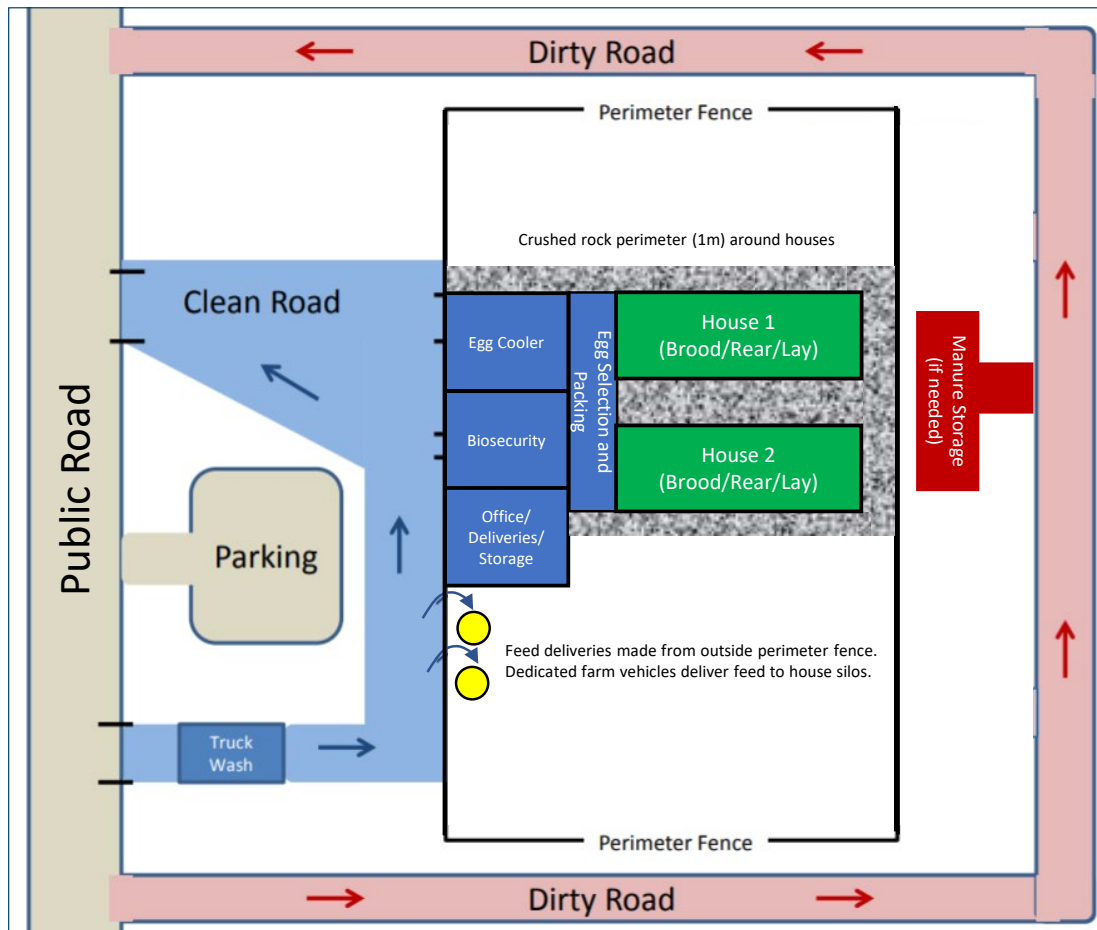

Biosecurity *(continued)*

People and Equipment

- Allow only essential visitors onto PS farm; provide a questionnaire to ensure biosecurity compliance.
- Visits to the PS farm should be documented in a logbook.
- All workers and visitors must shower at the farm and change into clean farm clothes, hair net and footwear before entering the biosecure area.
- Visitor access requires providing negative *Salmonella* results and documented approval of director in charge.
- Visitor and employee vehicles must park outside the biosecure area.
- Do not use outside crews or equipment for vaccination, moving birds, beak trimming, or manure removal.
- Outside equipment and materials must be disinfected before entering the farm and stored in insect- and rodent-proof storage.

Clean Road

- Restrict access.
- Feed, pullets, and materials should enter by clean road.
- All delivery vehicles should go through truck wash or make deliveries off site.
- Feed delivery trucks do not enter the biosecure area. Feed should be augured from the delivery truck over the farm perimeter fence. Farm dedicated vehicles deliver feed to the PS house silos.

Dirty Road

- Use dirty road for manure, litter, dead birds, and moving out end-of-lay hens.

Feed

- Use good quality, tested feed ingredients.
- Use heat treatment (preferred) or chemical treatment of feed for control of *Salmonella* and coliform bacteria.
- Do not use animal source proteins.
- Control traffic and truck sanitation to mill.

Farm Construction

- Use smooth, impermeable materials whenever possible.
- Build in drains for easy washing.
- Use gravel or concrete outside the buildings to help control rodents.
- Houses should be designed to prevent exposure to wild birds, insects and rodents.

Entry into Bird Area

- Clean foot baths containing disinfectant should be placed outside entries to all poultry houses.
- A second change of footwear is required before entering the bird area.
- Workers should be limited to a single house.

Farm Design

- A single-aged PS farm using an all-in, all-out principle is best to prevent transmission of disease.
- Use a perimeter fence around the farm to exclude livestock and traffic, and to mark the biosecure area of the farm.
- Use dedicated vehicles inside the clean area.
- Utilize deterrents to exclude wild birds.
- Use footbaths or shoe changes with Danish-style entry at each house.

Dead Bird Disposal

- Quickly and properly dispose of dead chickens daily.
- Dispose of dead birds by rendering, incineration, or composting.
- Freeze dead birds if they will be disposed off-site.

Water

- Ensure good quality and sufficient quantity of water.
- Test twice annually.
- Treat water as necessary.
- Sanitize water lines routinely.
- Maintain pH at appropriate levels.

Rodents

- Rodents are known carriers of many poultry diseases and the most common reason for re-contamination of a cleaned and disinfected poultry facility. They are also responsible for house-to-house spread of disease on a farm.
- The farm should be free of debris, tall grass and other places that could harbor rodents.
- The perimeter of each house should have a 1 m wide area of crushed rock or concrete to prevent rodents from burrowing into the house.
- Feed and eggs should be stored in rodent-proof areas.
- Bait stations should be placed around the perimeter of the house as well as throughout the house, and maintained with fresh rodenticide.
- Fill all gaps in the entrances, walls and roof which could provide rodent access into the poultry house.

For more information, see "[Code of Practice for the Prevention of Rodent Infestation on Poultry Farms.](#)"

Vaccination Recommendations

Certain diseases are too widespread or difficult to eradicate and require a routine vaccination program. In general, all breeder flocks should be vaccinated against Marek's disease, Newcastle disease (NDV), infectious bronchitis (IB), infectious bursal disease (IBD or Gumboro), chicken anemia virus (CAV), avian encephalomyelitis (AE), and fowl pox. Other vaccinations are added to the program as local disease challenges dictate. **A single program cannot be recommended for all regions. Follow label instructions provided by the vaccine manufacturer. Use only approved vaccines. Consult with local veterinarians to determine the best vaccination program for your area.**

BASIC BREEDER VACCINE APPLICATIONS

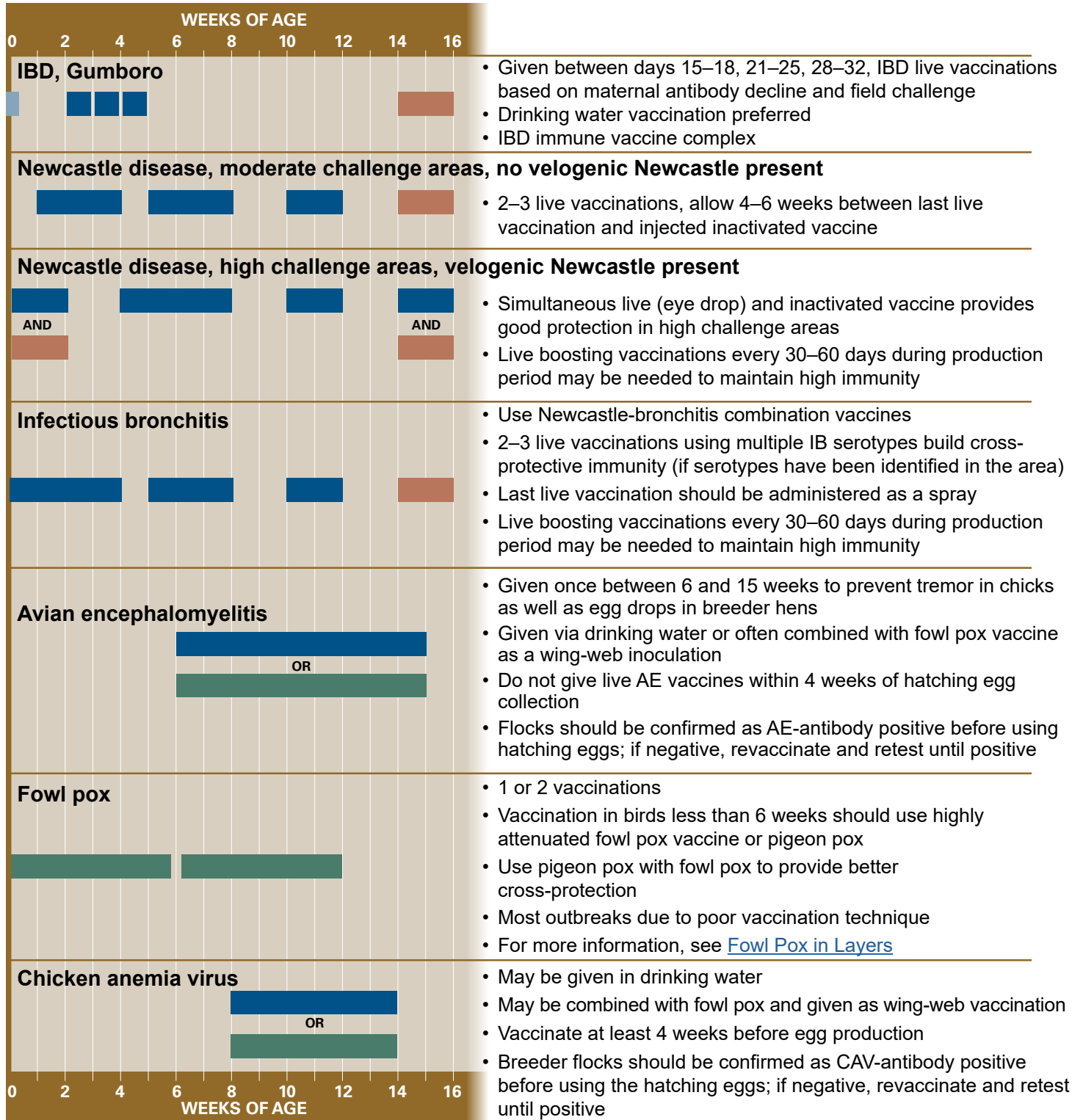

Live hatchery vaccines, given subcutaneous	Live vaccines, administered via wing-web inoculation
Live vaccines, administered by drinking water, spray or eyedrop	Inactivated vaccines, injected via intramuscular or subcutaneous route

Vaccination Recommendations *(continued)*

OPTIONAL BREEDER VACCINE APPLICATIONS

Use if these diseases are prevalent in the area. Follow label instructions provided by the vaccine manufacturer. Use only approved vaccines. Consult a local veterinarian for advice in designing an effective vaccination program for your farm.

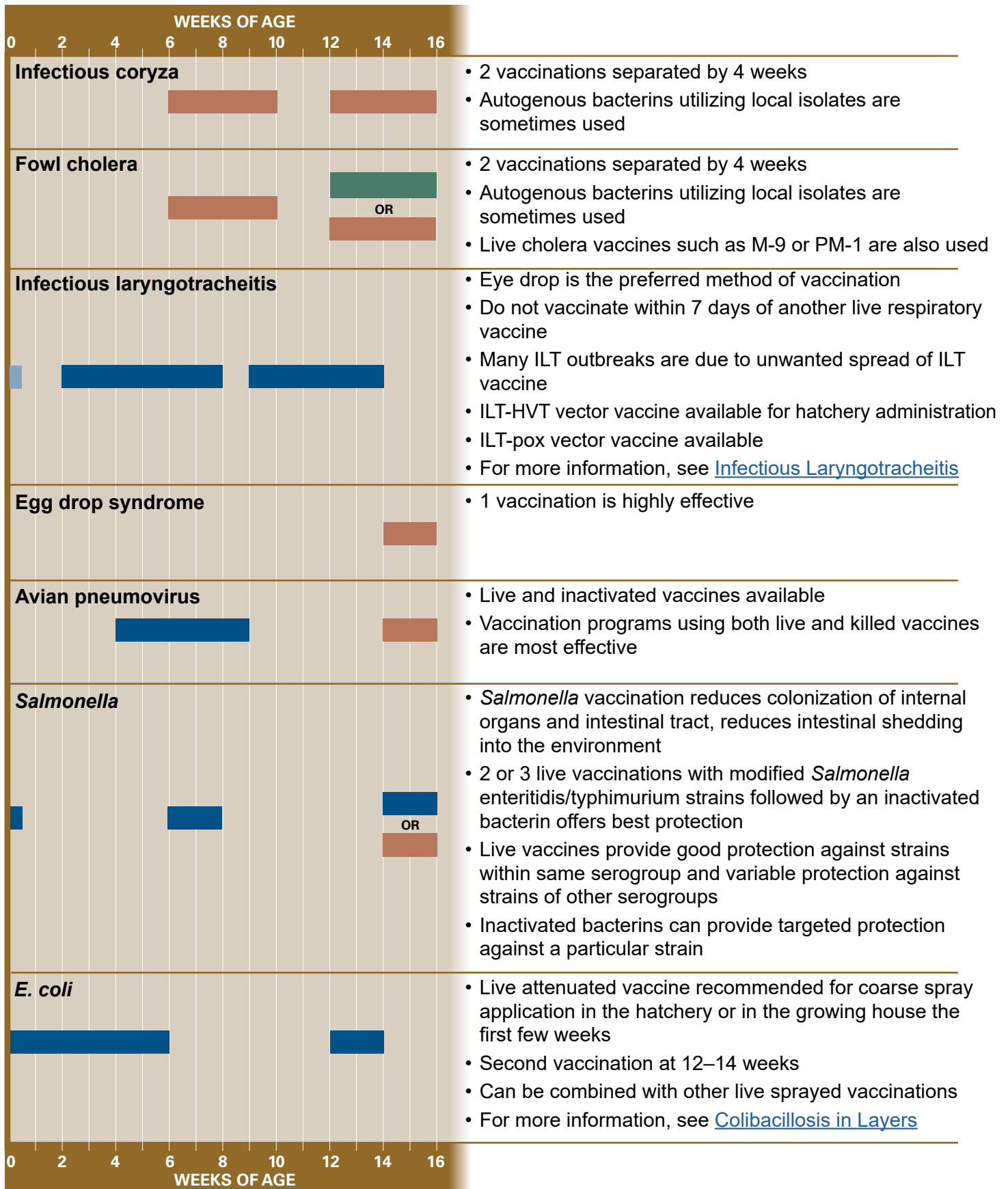

Vaccination Recommendations *(continued)*

RECOMBINANT HVT VACCINES

Vaccines using recombinant vector technology offer the convenience of hatchery administration with no adverse effects caused by some live field vaccinations. For best Marek's disease protection use Rispens vaccine in combination with recombinant HVT vaccine.

CAUTION: Do not use another HVT vaccine when using HVT-vectored vaccines.

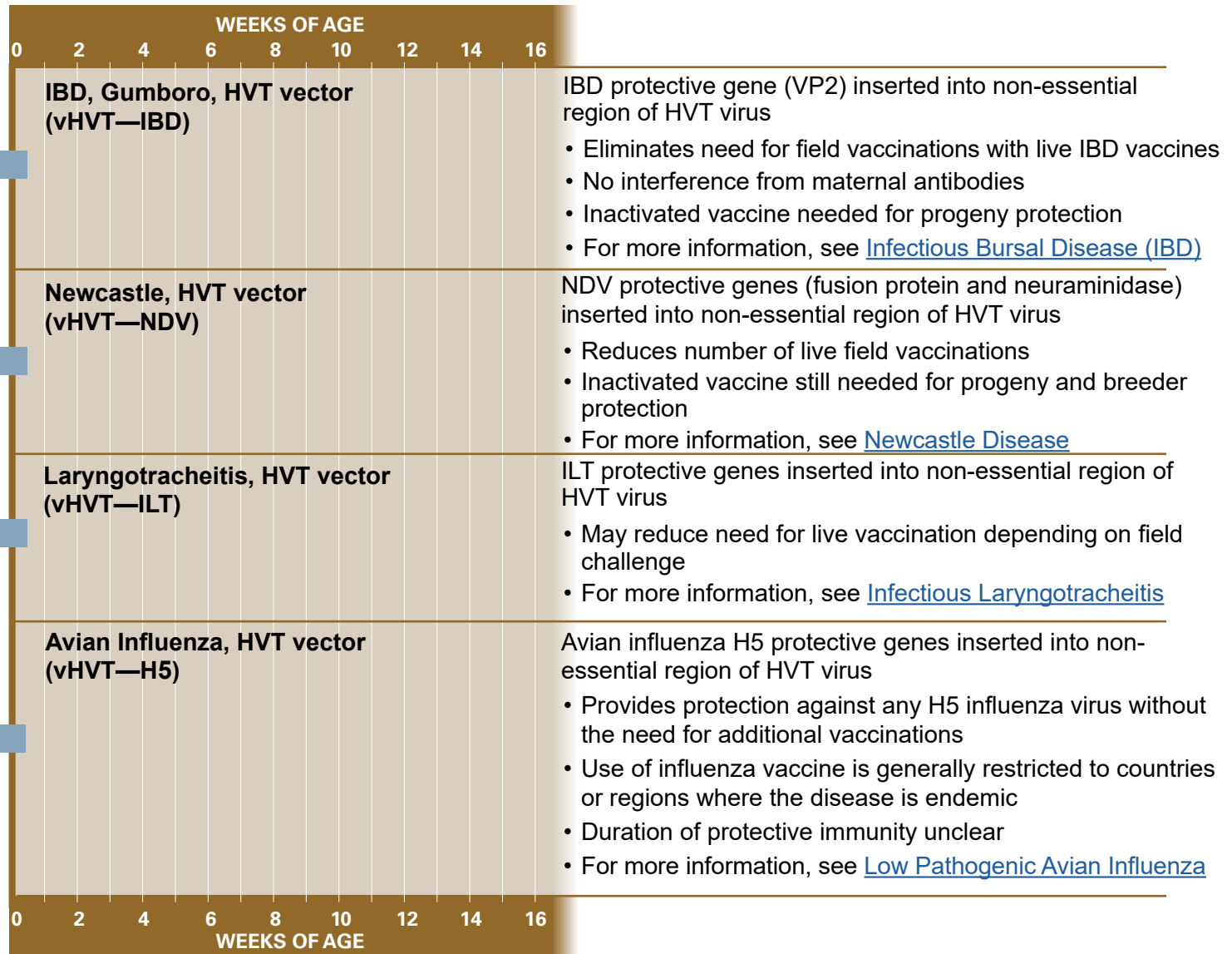

■ <i>Live hatchery vaccines, given subcutaneous</i>	■ <i>Live vaccines, administered via wing-web inoculation</i>
■ <i>Live vaccines, administered by drinking water, spray or eyedrop</i>	■ <i>Inactivated vaccines, injected via intramuscular or subcutaneous route</i>

Blood Sample Collection

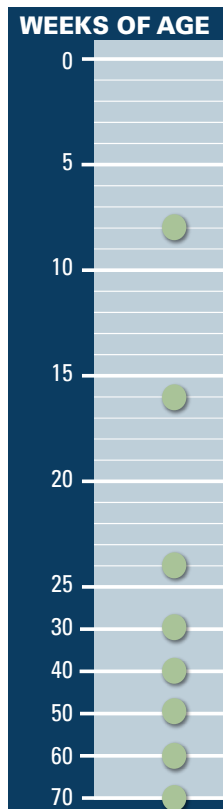

BLOOD SAMPLE COLLECTION

Collect 25 sera samples per flock for titer determination.

8 weeks

- Assess early vaccination technique and disease exposure for IB, NDV, MG, MS, IBD.

16 weeks or at transfer

- Verify flock is antibody positive for CAV and AE; if negative, revaccinate and retest until positive. **Do not use hatching eggs until flock is antibody positive.**
- Assess possible change in disease exposure.

24 weeks

- Collect sera at least 4 weeks after final inactivated vaccination to measure post-vaccination antibody response.
- It is useful to assess response to inactivated vaccine and / or disease challenge after transfer to laying farm for IB, NDV, MG, MS, IBD.

For more information, see [Proper Collection and Handling of Diagnostic Samples](#).

Always consult hyline.com for the latest performance, nutrition, and management information.

RESOURCES AVAILABLE AT WWW.HYLINE.COM

[Corporate Information](#) | [Technical Updates](#) | [Videos](#) | [Interactive Management Guides](#)
[Hy-Line International Lighting Programme](#) | [Hy-Line EggCel](#) | [Body Weight Uniformity Calculator](#)

TECHNICAL UPDATES

Diseases

An Overview of Focal Duodenal Necrosis (FDN)

MG Control in Commercial Layers

Colibacillosis in Layers: An Overview

Fowl Pox in Layers

Avian Urolithiasis (Visceral Gout)

Infectious Bursal Disease (IBD, Gumboro)

Fatty Liver Hemorrhagic Syndrome

Infectious Laryngotracheitis (ILT)

Egg Drop Syndrome (EDS)

Intestinal Dilation Syndrome (IDS)

Newcastle Disease

Mycoplasma Synoviae (MS)

Low Pathogenic Avian Influenza (LPAI)

Diagnostic Samples and Breeder Flock Monitoring

Salmonella, *Mycoplasma*, and Avian Influenza
Monitoring in Parent Breeder Flocks

Proper Collection and Handling of Diagnostic Samples

Management

Growing Management of Commercial Pullets
Understanding the Role of the Skeleton in Egg Production

The Science of Egg Quality

Understanding Poultry Lighting

Understanding Heat Stress in Layers

Infrared Beak Treatment

Feed Granulometry and the Importance of Feed Particle Size in Layers

Impact of Tarp Colour on Poultry Lighting

SPIDES (Short Period Incubation During Egg Storage)

Fly Management: Surveillance and Control

Optimising Egg Size in Commercial Layers

Vaccination Recommendations

Managing Fully Beaked Flocks

Thiamin Deficiency in Pullets

Understanding Nesting Behaviour

Hy-Line International | www.hyline.com

Hy-Line is a brand name. © Registered trademark of Hy-Line International.

© Copyright 2023 Hy-Line International.

BRN PS ENG 030424

