

Management Guide



Hy-Line[®]

W-36

USE OF THE MANAGEMENT GUIDE

The genetic potential of Hy-Line W-36 Parent Stock can only be realized if good poultry husbandry practices and management are used. This management guide outlines successful flock management programs for Hy-Line Variety W-36 Parent Stock based on field experience compiled by Hy-Line International and using an extensive parent flock database of Hy-Line flocks from all parts of the world. Hy-Line International Management Guides are periodically updated as new performance data and/or nutrition information become available.

The information and suggestions contained in this management guide should be used for guidance and educational purposes only, recognizing that local environmental and disease conditions may vary and a guide cannot cover all possible circumstances. While every attempt has been made to ensure that the information presented is accurate and reliable at the time of publication, Hy-Line International cannot accept responsibility for any errors, omissions or inaccuracies in such information or management suggestions. Further, Hy-Line International does not warrant or make any representations or guarantees regarding the use, validity, accuracy, or reliability of, or flock performance or productivity resulting from the use of, or otherwise respecting, such information or management suggestions. In no event shall Hy-Line International be liable for any special, indirect or consequential damages or special damages whatsoever arising out of or in connection with the use of the information or management suggestions contained in this management guide.

Visit www.hyline.com for an interactive online management guide.

TABLE OF CONTENTS

| | | | |
|---|-----|---|-------|
| Summary of Performance Standards | 1 | Lighting Considerations | 20 |
| Performance Tables | 1–3 | Use of Shades in Open-Sided Housing | 20 |
| Transportation to Breeder Farm | 4 | Midnight Feeding / Lighting Program | 21 |
| House Preparation before Arrival of Chicks | 4 | Management Events for Breeders | 22–23 |
| Brooding Recommendations | 5 | Hatching Egg Care | 24 |
| Floor Brooding in Rings | 6 | Fertility Check | 24 |
| Partial House Brooding | 7 | Incubation and Hatching | 25 |
| Cage Brooding | 8 | Feather Sexing | 25 |
| Lighting During Brooding Period | 9 | Phase Feeding to Meet the Hen’s Nutritional Needs | 26 |
| Drinking Systems | 9 | Rearing Period Nutritional Recommendations | 27 |
| Beak Treatment / Trimming | 10 | Transition Period from Rear to Peak Egg Production | 28 |
| Growth and Development | 11 | Production Period Nutritional Recommendations | 29 |
| Rearing Body Weights, Feed Consumption and Uniformity | 12 | Dietary Nutrient Concentrations for Production Period | 30 |
| Space Guidelines | 12 | Water Consumption | 31 |
| Hy-Line W-36 Male Management | 13 | Air Quality | 31 |
| Cage Systems Management | 14 | Calcium Particle Size | 31 |
| Floor Systems Management | 15 | Feed Particle Size | 32 |
| A Day in the Life of a Hy-Line W-36 Breeder Hen | 16 | Vitamins and Trace Minerals | 32 |
| All-Slat Breeder Houses | 16 | Water Quality | 33 |
| Perches | 17 | Disease Control | 34 |
| Good Lighting Practices | 18 | Vaccination Recommendations | 35–37 |
| Light Program for Light-Controlled Housing | 18 | Performance Graphs | 38–39 |
| Customized Lighting Programs for Open-Sided Housing | 19 | Feed Ingredient Tables | 40–41 |

Summary of Performance Standards

| | |
|--|-----------------|
| Female Livability, 1–17 Weeks | 96% |
| Female Livability, 18–75 Weeks | 95% |
| Male Livability, 1–17 Weeks | 85% |
| Male Livability, 18–75 Weeks | 93% |
| Age at 50% Production | 143 Days |
| Peak Percent Hen-Day Production (age) | 93–94% (25 Wks) |
| Number of Hen-Day Eggs, 18–75 Weeks | 335–340 |
| Number of Hen-Housed Eggs, 18–75 Weeks | 326–332 |
| Number of Settable Hen-Housed Eggs, 22–75 Weeks | 303–307 |
| Number of Female Chicks Produced, 22–75 Weeks | 127–129 |
| Average Number of Female Chicks / Week, 22–75 Weeks | 2.3–2.4 |
| Average Percent Hatchability, 22–75 Weeks | 83% |
| Female Body Weight, 17 Weeks | 1.12–1.21 kg |
| Female Body Weight, 40 Weeks (mature) | 1.51–1.55 kg |
| Male Body Weight, 17 Weeks | 1.43–1.55 kg |
| Male Body Weight, 40 Weeks (mature) | 1.95–1.99 kg |
| Number of Males / 100 Females | 10 |
| Feed Consumption Per Bird Housed, 1–17 Weeks (cumulative) | 5.18–5.43 kg |
| Feed Consumption Per Bird Housed, 18–75 Weeks (average daily total of males and females) | 98–104 g |
| Feed Consumption Per 10 Hatching Eggs, 22–75 Weeks | 1.31–1.39 kg |
| Feed Consumption Per Dozen Hatching Eggs, 22–75 Weeks | 1.58–1.67 kg |

Performance Summary data is based on results obtained from customers around the world. Please send your results to info@hyline.com. An easy to use record-keeping program, *Hy-Line International EggCel*, can be found at www.hyline.com.

Performance Tables

Rearing Period

| AGE (weeks) | FEMALE WEIGHT (g) | MALE WEIGHT (g) | FEED INTAKE (g/day per bird) | WATER CONSUMPTION (ml/bird/day) | UNIFORMITY | |
|----------------|-------------------------|-----------------------|---------------------------------|---------------------------------------|------------|------|
| | | | | | Floor | Cage |
| 1 | 61 – 69 | 61 – 69 | 12 – 13 | 18 – 26 | | |
| 2 | 107 – 113 | 117 – 123 | 15 – 16 | 23 – 32 | >85% | >85% |
| 3 | 171 – 179 | 176 – 184 | 18 – 19 | 27 – 38 | | |
| 4 | 225 – 235 | 255 – 265 | 28 – 30 | 42 – 60 | | |
| 5 | 294 – 306 | 369 – 381 | 37 – 39 | 56 – 78 | >80% | >80% |
| 6 | 393 – 407 | 488 – 502 | 40 – 42 | 60 – 84 | | |
| 7 | 472 – 488 | 627 – 643 | 42 – 44 | 63 – 88 | | |
| 8 | 541 – 559 | 721 – 739 | 45 – 47 | 68 – 94 | | |
| 9 | 640 – 660 | 830 – 850 | 47 – 49 | 71 – 98 | >83% | >85% |
| 10 | 704 – 726 | 934 – 956 | 50 – 52 | 75 – 104 | | |
| 11 | 768 – 792 | 1028 – 1052 | 52 – 54 | 78 – 108 | | |
| 12 | 847 – 873 | 1097 – 1123 | 53 – 55 | 80 – 110 | | |
| 13 | 886 – 914 | 1186 – 1214 | 55 – 57 | 83 – 114 | | |
| 14 | 955 – 985 | 1265 – 1295 | 56 – 59 | 84 – 118 | >85% | >85% |
| 15 | 1014 – 1046 | 1354 – 1386 | 58 – 61 | 87 – 122 | | |
| 16 | 1083 – 1117 | 1418 – 1452 | 63 – 66 | 95 – 132 | | |
| 17 | 1152 – 1188 | 1472 – 1508 | 69 – 73 | 104 – 146 | >88% | >90% |
| 18 | 1180 – 1220 | 1540 – 1580 | 76 – 80 | 114 – 160 | | |

Performance Tables *(continued)*

Laying Period

| AGE (weeks) | % HEN-DAY Current | HEN-DAY EGGS | | HEN-HOUSED EGGS | | FEMALE % MORTALITY Cumulative | MALE % MORTALITY Cumulative | FEED INTAKE (g / day / bird) | WATER CONSUMPTION ¹ (ml / bird / day) |
|----------------|-------------------------|--------------|---------------|-----------------|---------------|-------------------------------------|-----------------------------------|------------------------------------|--|
| | | Current | Cumulative | Current | Cumulative | | | | |
| 18 | 9 – 11 | 0.7 – 0.8 | 0.7 – 0.8 | 0.7 – 0.8 | 0.7 – 0.8 | 0.0 – 0.0 | 0.0 – 0.0 | 76 – 80 | 114–160 |
| 19 | 26 – 32 | 1.8 – 2.2 | 2.5 – 3.0 | 1.8 – 2.2 | 2.5 – 3.0 | 0.1 – 0.1 | 0.2 – 0.2 | 82 – 86 | 123–172 |
| 20 | 52 – 61 | 3.6 – 4.3 | 6.1 – 7.3 | 3.6 – 4.3 | 6.1 – 7.3 | 0.2 – 0.2 | 0.5 – 0.5 | 84 – 88 | 126–176 |
| 21 | 74 – 79 | 5.2 – 5.5 | 11.3 – 12.8 | 5.2 – 5.5 | 11.3 – 12.8 | 0.3 – 0.3 | 0.7 – 0.7 | 84 – 88 | 126–176 |
| 22 | 86 – 88 | 6.0 – 6.2 | 17.3 – 19.0 | 6.0 – 6.1 | 17.2 – 18.9 | 0.3 – 0.3 | 0.9 – 0.9 | 88 – 92 | 132–184 |
| 23 | 90 – 91 | 6.3 – 6.4 | 23.6 – 25.3 | 6.3 – 6.3 | 23.6 – 25.3 | 0.4 – 0.4 | 1.1 – 1.1 | 89 – 93 | 134–186 |
| 24 | 92 – 93 | 6.4 – 6.5 | 30.1 – 31.9 | 6.4 – 6.5 | 30.0 – 31.7 | 0.5 – 0.5 | 1.2 – 1.2 | 93 – 97 | 140–194 |
| 25 | 93 – 94 | 6.5 – 6.6 | 36.6 – 38.4 | 6.5 – 6.5 | 36.4 – 38.3 | 0.5 – 0.5 | 1.4 – 1.4 | 93 – 97 | 140–194 |
| 26 | 93 – 94 | 6.5 – 6.6 | 43.1 – 45.0 | 6.5 – 6.5 | 42.9 – 44.8 | 0.6 – 0.6 | 1.6 – 1.6 | 93 – 97 | 140–194 |
| 27 | 93 – 94 | 6.5 – 6.6 | 49.6 – 51.6 | 6.5 – 6.5 | 49.4 – 51.4 | 0.7 – 0.7 | 1.8 – 1.8 | 93 – 97 | 140–194 |
| 28 | 93 – 94 | 6.5 – 6.6 | 56.1 – 58.2 | 6.5 – 6.5 | 55.8 – 57.9 | 0.8 – 0.8 | 1.9 – 1.9 | 98 – 102 | 147–204 |
| 29 | 93 – 94 | 6.5 – 6.6 | 62.6 – 64.8 | 6.5 – 6.5 | 62.3 – 64.4 | 0.8 – 0.8 | 2.1 – 2.1 | 98 – 102 | 147–204 |
| 30 | 93 – 94 | 6.5 – 6.6 | 69.2 – 71.3 | 6.5 – 6.5 | 68.8 – 70.9 | 0.9 – 0.9 | 2.2 – 2.2 | 98 – 102 | 147–204 |
| 31 | 93 – 94 | 6.5 – 6.6 | 75.7 – 77.9 | 6.5 – 6.5 | 75.2 – 77.5 | 1.0 – 1.0 | 2.4 – 2.4 | 98 – 102 | 147–204 |
| 32 | 93 – 94 | 6.5 – 6.6 | 82.2 – 84.5 | 6.4 – 6.5 | 81.7 – 84.0 | 1.0 – 1.0 | 2.6 – 2.6 | 98 – 102 | 147–204 |
| 33 | 93 – 94 | 6.5 – 6.6 | 88.7 – 91.1 | 6.4 – 6.5 | 88.1 – 90.5 | 1.1 – 1.1 | 2.7 – 2.7 | 98 – 103 | 147–206 |
| 34 | 92 – 93 | 6.5 – 6.5 | 95.1 – 97.6 | 6.4 – 6.4 | 94.5 – 96.9 | 1.2 – 1.2 | 2.9 – 2.9 | 98 – 104 | 147–208 |
| 35 | 92 – 93 | 6.4 – 6.5 | 101.6 – 104.1 | 6.3 – 6.4 | 100.8 – 103.3 | 1.3 – 1.3 | 3.0 – 3.0 | 98 – 104 | 147–208 |
| 36 | 91 – 92 | 6.4 – 6.4 | 108.0 – 110.5 | 6.3 – 6.4 | 107.1 – 109.7 | 1.3 – 1.4 | 3.0 – 3.1 | 98 – 104 | 147–208 |
| 37 | 91 – 92 | 6.4 – 6.4 | 114.3 – 117.0 | 6.3 – 6.3 | 113.4 – 116.0 | 1.4 – 1.5 | 3.1 – 3.3 | 98 – 104 | 147–208 |
| 38 | 91 – 92 | 6.3 – 6.4 | 120.7 – 123.4 | 6.3 – 6.3 | 119.7 – 122.4 | 1.4 – 1.5 | 3.3 – 3.4 | 98 – 104 | 147–208 |
| 39 | 90 – 91 | 6.3 – 6.4 | 127.0 – 129.8 | 6.2 – 6.3 | 125.9 – 128.7 | 1.5 – 1.6 | 3.5 – 3.6 | 98 – 104 | 147–208 |
| 40 | 90 – 91 | 6.3 – 6.4 | 133.3 – 136.2 | 6.2 – 6.3 | 132.1 – 134.9 | 1.6 – 1.7 | 3.6 – 3.7 | 98 – 104 | 147–208 |
| 41 | 89 – 90 | 6.2 – 6.3 | 139.5 – 142.5 | 6.1 – 6.2 | 138.2 – 141.1 | 1.7 – 1.8 | 3.7 – 3.8 | 98 – 104 | 147–208 |
| 42 | 89 – 90 | 6.2 – 6.3 | 145.7 – 148.8 | 6.1 – 6.2 | 144.3 – 147.3 | 1.8 – 1.9 | 3.8 – 3.9 | 99 – 105 | 149–210 |
| 43 | 88 – 90 | 6.2 – 6.3 | 151.9 – 155.1 | 6.1 – 6.2 | 150.3 – 153.5 | 1.9 – 2.0 | 4.0 – 4.1 | 99 – 105 | 149–210 |
| 44 | 88 – 89 | 6.1 – 6.2 | 158.1 – 161.3 | 6.0 – 6.1 | 156.3 – 159.6 | 2.0 – 2.1 | 4.1 – 4.2 | 99 – 105 | 149–210 |
| 45 | 87 – 88 | 6.1 – 6.2 | 164.2 – 167.4 | 6.0 – 6.0 | 162.3 – 165.6 | 2.1 – 2.2 | 4.2 – 4.3 | 99 – 105 | 149–210 |
| 46 | 87 – 88 | 6.1 – 6.2 | 170.3 – 173.6 | 6.0 – 6.0 | 168.3 – 171.7 | 2.2 – 2.3 | 4.3 – 4.4 | 99 – 105 | 149–210 |
| 47 | 87 – 88 | 6.1 – 6.2 | 176.3 – 179.8 | 5.9 – 6.0 | 174.2 – 177.7 | 2.2 – 2.4 | 4.4 – 4.5 | 99 – 105 | 149–210 |
| 48 | 86 – 87 | 6.0 – 6.1 | 182.4 – 185.9 | 5.9 – 6.0 | 180.1 – 183.6 | 2.2 – 2.4 | 4.4 – 4.6 | 99 – 105 | 149–210 |
| 49 | 86 – 87 | 6.0 – 6.1 | 188.4 – 191.9 | 5.8 – 5.9 | 185.9 – 189.6 | 2.3 – 2.5 | 4.5 – 4.7 | 99 – 105 | 149–210 |
| 50 | 85 – 87 | 6.0 – 6.1 | 194.3 – 198.0 | 5.8 – 5.9 | 191.8 – 195.5 | 2.4 – 2.6 | 4.6 – 4.8 | 99 – 105 | 149–210 |
| 51 | 85 – 86 | 5.9 – 6.0 | 200.3 – 204.1 | 5.8 – 5.9 | 197.5 – 201.4 | 2.5 – 2.7 | 4.7 – 4.9 | 100 – 106 | 150–212 |
| 52 | 84 – 85 | 5.9 – 6.0 | 206.2 – 210.0 | 5.7 – 5.8 | 203.3 – 207.2 | 2.6 – 2.8 | 4.8 – 5.0 | 100 – 106 | 150–212 |
| 53 | 84 – 85 | 5.9 – 6.0 | 212.1 – 216.0 | 5.7 – 5.8 | 209.0 – 213.0 | 2.7 – 2.9 | 4.9 – 5.1 | 100 – 106 | 150–212 |
| 54 | 84 – 85 | 5.9 – 6.0 | 217.9 – 221.9 | 5.7 – 5.8 | 214.7 – 218.8 | 2.8 – 3.0 | 5.0 – 5.2 | 100 – 106 | 150–212 |
| 55 | 83 – 84 | 5.8 – 5.9 | 223.8 – 227.8 | 5.7 – 5.7 | 220.3 – 224.5 | 2.9 – 3.1 | 5.1 – 5.3 | 100 – 106 | 150–212 |
| 56 | 83 – 84 | 5.8 – 5.9 | 229.6 – 233.7 | 5.6 – 5.7 | 226.0 – 230.2 | 3.0 – 3.2 | 5.2 – 5.4 | 100 – 106 | 150–212 |
| 57 | 82 – 83 | 5.8 – 5.8 | 235.3 – 239.5 | 5.6 – 5.6 | 231.5 – 235.8 | 3.1 – 3.3 | 5.3 – 5.5 | 100 – 106 | 150–212 |
| 58 | 82 – 83 | 5.7 – 5.8 | 241.1 – 245.3 | 5.6 – 5.6 | 237.1 – 241.4 | 3.2 – 3.4 | 5.4 – 5.6 | 100 – 106 | 150–212 |
| 59 | 82 – 83 | 5.7 – 5.8 | 246.8 – 251.1 | 5.5 – 5.6 | 242.6 – 247.1 | 3.3 – 3.5 | 5.5 – 5.7 | 101 – 107 | 152–214 |
| 60 | 81 – 82 | 5.7 – 5.7 | 252.5 – 256.8 | 5.5 – 5.5 | 248.1 – 252.6 | 3.4 – 3.6 | 5.6 – 5.8 | 101 – 107 | 152–214 |
| 61 | 81 – 82 | 5.7 – 5.7 | 258.2 – 262.6 | 5.5 – 5.5 | 253.6 – 258.1 | 3.5 – 3.7 | 5.7 – 5.9 | 101 – 107 | 152–214 |
| 62 | 81 – 82 | 5.7 – 5.7 | 263.9 – 268.3 | 5.4 – 5.5 | 259.0 – 263.7 | 3.6 – 3.8 | 5.8 – 6.0 | 101 – 107 | 152–214 |
| 63 | 81 – 82 | 5.6 – 5.7 | 269.5 – 274.1 | 5.4 – 5.5 | 264.4 – 269.2 | 3.7 – 3.9 | 5.8 – 6.0 | 102 – 108 | 153–216 |
| 64 | 80 – 81 | 5.6 – 5.7 | 275.1 – 279.7 | 5.4 – 5.5 | 269.8 – 274.7 | 3.8 – 4.0 | 5.9 – 6.1 | 102 – 108 | 153–216 |
| 65 | 80 – 81 | 5.6 – 5.7 | 280.7 – 285.4 | 5.3 – 5.4 | 275.2 – 280.1 | 3.9 – 4.1 | 6.0 – 6.2 | 102 – 108 | 153–216 |
| 66 | 79 – 80 | 5.5 – 5.6 | 286.2 – 291.0 | 5.3 – 5.4 | 280.5 – 285.5 | 4.0 – 4.2 | 6.1 – 6.3 | 103 – 109 | 155–218 |
| 67 | 78 – 80 | 5.5 – 5.6 | 291.7 – 296.6 | 5.3 – 5.4 | 285.7 – 290.8 | 4.1 – 4.3 | 6.2 – 6.4 | 103 – 109 | 155–218 |
| 68 | 78 – 79 | 5.4 – 5.5 | 297.1 – 302.1 | 5.2 – 5.3 | 290.9 – 296.1 | 4.2 – 4.4 | 6.3 – 6.5 | 103 – 109 | 155–218 |
| 69 | 77 – 79 | 5.4 – 5.5 | 302.6 – 307.7 | 5.2 – 5.3 | 296.1 – 301.4 | 4.3 – 4.5 | 6.4 – 6.6 | 103 – 109 | 155–218 |
| 70 | 77 – 78 | 5.4 – 5.5 | 308.0 – 313.1 | 5.1 – 5.2 | 301.2 – 306.7 | 4.4 – 4.6 | 6.5 – 6.7 | 104 – 110 | 156–220 |
| 71 | 77 – 78 | 5.4 – 5.5 | 313.3 – 318.6 | 5.1 – 5.2 | 306.3 – 311.9 | 4.6 – 4.8 | 6.6 – 6.8 | 104 – 110 | 156–220 |
| 72 | 76 – 77 | 5.3 – 5.4 | 318.6 – 324.0 | 5.1 – 5.1 | 311.4 – 317.0 | 4.8 – 5.0 | 6.7 – 6.9 | 104 – 110 | 156–220 |
| 73 | 76 – 77 | 5.3 – 5.4 | 324.0 – 329.4 | 5.0 – 5.1 | 316.4 – 322.1 | 5.0 – 5.2 | 6.8 – 7.0 | 104 – 110 | 156–220 |
| 74 | 75 – 76 | 5.3 – 5.3 | 329.2 – 334.7 | 5.0 – 5.0 | 321.4 – 327.2 | 5.2 – 5.4 | 6.9 – 7.1 | 104 – 110 | 156–220 |
| 75 | 75 – 76 | 5.3 – 5.3 | 334.5 – 340.0 | 5.0 – 5.0 | 326.4 – 332.2 | 5.4 – 5.6 | 7.0 – 7.2 | 104 – 110 | 156–220 |

Performance Tables *(continued)*

| AGE (weeks) | FEMALE BODY WEIGHT (kg) | MALE BODY WEIGHT (kg) | AVG. EGG WEIGHT ² (g/egg) | % SETTABLE | SETTABLE HEN-HOUSED EGGS | | % HATCH | NUMBER FEMALE CHICKS | |
|----------------|----------------------------|--------------------------|--|---------------|-----------------------------|---------------|------------|-------------------------|---------------|
| | | | | | Current | Cumulative | | Current | Cumulative |
| 18 | 1.18 – 1.22 | 1.54 – 1.58 | 41.9 | – | – | – | – | – | – |
| 19 | 1.21 – 1.25 | 1.58 – 1.62 | 44.8 | – | – | – | – | – | – |
| 20 | 1.25 – 1.29 | 1.61 – 1.65 | 48.1 | – | – | – | – | – | – |
| 21 | 1.28 – 1.32 | 1.64 – 1.68 | 50.4 | – | – | – | – | – | – |
| 22 | 1.33 – 1.37 | 1.67 – 1.71 | 52.6 | 68 | 4.1 – 4.2 | 4.1 – 4.2 | 74 | 1.5 – 1.5 | 1.5 – 1.5 |
| 23 | 1.38 – 1.42 | 1.70 – 1.74 | 54.2 | 75 | 4.7 – 4.8 | 8.8 – 8.9 | 82 | 1.9 – 1.9 | 3.4 – 3.5 |
| 24 | 1.40 – 1.44 | 1.73 – 1.77 | 55.3 | 83 | 5.3 – 5.4 | 14.1 – 14.3 | 85 | 2.3 – 2.3 | 5.7 – 5.8 |
| 25 | 1.42 – 1.46 | 1.75 – 1.79 | 56.1 | 94 | 6.0 – 6.1 | 20.2 – 20.4 | 86 | 2.6 – 2.6 | 8.3 – 8.4 |
| 26 | 1.43 – 1.47 | 1.78 – 1.82 | 56.7 | 96 | 6.2 – 6.3 | 26.4 – 26.7 | 86 | 2.7 – 2.7 | 11.0 – 11.1 |
| 27 | 1.44 – 1.48 | 1.80 – 1.84 | 57.3 | 96 | 6.2 – 6.3 | 32.6 – 33.0 | 87 | 2.7 – 2.7 | 13.7 – 13.9 |
| 28 | 1.45 – 1.49 | 1.82 – 1.86 | 58.0 | 97 | 6.3 – 6.4 | 38.9 – 39.4 | 87 | 2.8 – 2.8 | 16.4 – 16.6 |
| 29 | 1.46 – 1.50 | 1.84 – 1.88 | 58.4 | 97 | 6.3 – 6.4 | 45.3 – 45.8 | 88 | 2.8 – 2.8 | 19.2 – 19.4 |
| 30 | 1.47 – 1.51 | 1.86 – 1.90 | 58.7 | 98 | 6.3 – 6.4 | 51.6 – 52.2 | 88 | 2.8 – 2.8 | 22.0 – 22.2 |
| 31 | 1.47 – 1.51 | 1.87 – 1.91 | 59.0 | 98 | 6.3 – 6.4 | 57.9 – 58.6 | 88 | 2.8 – 2.8 | 24.8 – 25.0 |
| 32 | 1.48 – 1.52 | 1.89 – 1.93 | 59.4 | 98 | 6.3 – 6.4 | 64.3 – 65.0 | 88 | 2.8 – 2.8 | 27.6 – 27.9 |
| 33 | 1.49 – 1.53 | 1.90 – 1.94 | 59.5 | 98 | 6.3 – 6.4 | 70.6 – 71.4 | 88 | 2.8 – 2.8 | 30.3 – 30.7 |
| 34 | 1.49 – 1.53 | 1.92 – 1.96 | 59.6 | 98 | 6.3 – 6.3 | 76.9 – 77.7 | 88 | 2.8 – 2.8 | 33.1 – 33.5 |
| 35 | 1.50 – 1.54 | 1.93 – 1.97 | 59.9 | 98 | 6.3 – 6.3 | 83.1 – 84.0 | 88 | 2.8 – 2.8 | 35.9 – 36.3 |
| 36 | 1.50 – 1.54 | 1.93 – 1.97 | 60.0 | 98 | 6.2 – 6.3 | 89.3 – 90.3 | 88 | 2.7 – 2.8 | 38.6 – 39.0 |
| 37 | 1.50 – 1.54 | 1.94 – 1.98 | 60.2 | 98 | 6.2 – 6.3 | 95.5 – 96.5 | 88 | 2.7 – 2.8 | 41.4 – 41.8 |
| 38 | 1.51 – 1.55 | 1.94 – 1.98 | 60.5 | 98 | 6.2 – 6.3 | 101.7 – 102.8 | 88 | 2.7 – 2.8 | 44.1 – 44.6 |
| 39 | 1.51 – 1.55 | 1.95 – 1.99 | 60.6 | 98 | 6.1 – 6.2 | 107.8 – 109.0 | 88 | 2.7 – 2.7 | 46.8 – 47.3 |
| 40 | 1.51 – 1.55 | 1.95 – 1.99 | 60.8 | 98 | 6.1 – 6.2 | 113.9 – 115.1 | 88 | 2.7 – 2.7 | 49.5 – 50.0 |
| 41 | 1.51 – 1.55 | 1.95 – 1.99 | 61.0 | 98 | 6.0 – 6.1 | 119.9 – 121.2 | 88 | 2.7 – 2.7 | 52.1 – 52.7 |
| 42 | 1.52 – 1.56 | 1.96 – 2.00 | 61.1 | 98 | 6.0 – 6.1 | 125.9 – 127.3 | 88 | 2.6 – 2.7 | 54.7 – 55.3 |
| 43 | 1.52 – 1.56 | 1.96 – 2.00 | 61.1 | 98 | 6.0 – 6.1 | 131.9 – 133.4 | 88 | 2.6 – 2.7 | 57.3 – 58.0 |
| 44 | 1.52 – 1.56 | 1.96 – 2.00 | 61.3 | 98 | 5.9 – 6.0 | 137.8 – 139.4 | 87 | 2.6 – 2.6 | 59.9 – 60.6 |
| 45 | 1.53 – 1.57 | 1.96 – 2.00 | 61.5 | 98 | 5.9 – 5.9 | 143.7 – 145.4 | 87 | 2.6 – 2.6 | 62.5 – 63.2 |
| 46 | 1.53 – 1.57 | 1.97 – 2.01 | 61.7 | 98 | 5.9 – 5.9 | 149.5 – 151.3 | 87 | 2.6 – 2.6 | 65.0 – 65.8 |
| 47 | 1.53 – 1.57 | 1.97 – 2.01 | 61.8 | 98 | 5.8 – 5.9 | 155.3 – 157.2 | 87 | 2.5 – 2.6 | 67.6 – 68.4 |
| 48 | 1.53 – 1.57 | 1.97 – 2.01 | 61.9 | 98 | 5.8 – 5.8 | 161.1 – 163.0 | 87 | 2.5 – 2.5 | 70.1 – 70.9 |
| 49 | 1.53 – 1.57 | 1.97 – 2.01 | 62.1 | 98 | 5.7 – 5.8 | 166.9 – 168.9 | 87 | 2.5 – 2.5 | 72.6 – 73.4 |
| 50 | 1.54 – 1.58 | 1.97 – 2.01 | 62.3 | 98 | 5.7 – 5.8 | 172.6 – 174.7 | 86 | 2.5 – 2.5 | 75.0 – 75.9 |
| 51 | 1.54 – 1.58 | 1.97 – 2.01 | 62.4 | 98 | 5.7 – 5.7 | 178.2 – 180.4 | 86 | 2.4 – 2.5 | 77.5 – 78.4 |
| 52 | 1.54 – 1.58 | 1.98 – 2.02 | 62.4 | 98 | 5.6 – 5.7 | 183.8 – 186.1 | 86 | 2.4 – 2.4 | 79.9 – 80.8 |
| 53 | 1.54 – 1.58 | 1.98 – 2.02 | 62.5 | 98 | 5.6 – 5.7 | 189.4 – 191.8 | 85 | 2.4 – 2.4 | 82.2 – 83.3 |
| 54 | 1.55 – 1.59 | 1.98 – 2.02 | 62.5 | 98 | 5.6 – 5.7 | 195.0 – 197.4 | 85 | 2.4 – 2.4 | 84.6 – 85.7 |
| 55 | 1.55 – 1.59 | 1.98 – 2.02 | 62.5 | 98 | 5.5 – 5.6 | 200.5 – 203.0 | 84 | 2.3 – 2.3 | 86.9 – 88.0 |
| 56 | 1.55 – 1.59 | 1.98 – 2.02 | 62.5 | 98 | 5.5 – 5.6 | 206.0 – 208.6 | 83 | 2.3 – 2.3 | 89.2 – 90.3 |
| 57 | 1.55 – 1.59 | 1.98 – 2.02 | 62.7 | 98 | 5.4 – 5.5 | 211.4 – 214.1 | 82 | 2.2 – 2.3 | 91.4 – 92.6 |
| 58 | 1.56 – 1.60 | 1.98 – 2.02 | 62.8 | 98 | 5.4 – 5.5 | 216.9 – 219.6 | 82 | 2.2 – 2.2 | 93.7 – 94.8 |
| 59 | 1.56 – 1.60 | 1.99 – 2.03 | 62.9 | 97 | 5.4 – 5.5 | 222.3 – 225.0 | 82 | 2.2 – 2.2 | 95.9 – 97.1 |
| 60 | 1.56 – 1.60 | 1.99 – 2.03 | 63.0 | 97 | 5.3 – 5.4 | 227.6 – 230.4 | 81 | 2.2 – 2.2 | 98.0 – 99.2 |
| 61 | 1.56 – 1.60 | 1.99 – 2.03 | 63.1 | 97 | 5.3 – 5.4 | 232.9 – 235.8 | 81 | 2.1 – 2.2 | 100.2 – 101.4 |
| 62 | 1.56 – 1.60 | 1.99 – 2.03 | 63.2 | 97 | 5.3 – 5.4 | 238.2 – 241.2 | 80 | 2.1 – 2.1 | 102.3 – 103.5 |
| 63 | 1.56 – 1.60 | 1.99 – 2.03 | 63.2 | 97 | 5.2 – 5.4 | 243.4 – 246.5 | 79 | 2.1 – 2.1 | 104.3 – 105.7 |
| 64 | 1.57 – 1.61 | 2.00 – 2.04 | 63.2 | 97 | 5.2 – 5.3 | 248.6 – 251.8 | 79 | 2.0 – 2.1 | 106.4 – 107.7 |
| 65 | 1.57 – 1.61 | 2.00 – 2.04 | 63.3 | 96 | 5.1 – 5.3 | 253.8 – 257.1 | 78 | 2.0 – 2.1 | 108.4 – 109.8 |
| 66 | 1.57 – 1.61 | 2.00 – 2.04 | 63.5 | 96 | 5.1 – 5.2 | 258.9 – 262.2 | 78 | 2.0 – 2.0 | 110.4 – 111.8 |
| 67 | 1.57 – 1.61 | 2.00 – 2.04 | 63.4 | 96 | 5.0 – 5.1 | 263.9 – 267.4 | 77 | 1.9 – 2.0 | 112.3 – 113.8 |
| 68 | 1.57 – 1.61 | 2.00 – 2.04 | 63.4 | 96 | 5.0 – 5.1 | 268.9 – 272.4 | 77 | 1.9 – 1.9 | 114.2 – 115.7 |
| 69 | 1.57 – 1.61 | 2.01 – 2.05 | 63.4 | 96 | 4.9 – 5.1 | 273.8 – 277.5 | 76 | 1.9 – 1.9 | 116.1 – 117.6 |
| 70 | 1.58 – 1.62 | 2.01 – 2.05 | 63.4 | 95 | 4.9 – 5.0 | 278.7 – 282.5 | 76 | 1.9 – 1.9 | 118.0 – 119.5 |
| 71 | 1.58 – 1.62 | 2.01 – 2.05 | 63.4 | 95 | 4.9 – 5.0 | 283.6 – 287.4 | 76 | 1.8 – 1.9 | 119.8 – 121.4 |
| 72 | 1.58 – 1.62 | 2.01 – 2.05 | 63.4 | 95 | 4.8 – 4.9 | 288.4 – 292.3 | 75 | 1.8 – 1.8 | 121.6 – 123.2 |
| 73 | 1.58 – 1.62 | 2.01 – 2.05 | 63.4 | 95 | 4.8 – 4.8 | 293.2 – 297.2 | 75 | 1.8 – 1.8 | 123.4 – 125.1 |
| 74 | 1.58 – 1.62 | 2.01 – 2.05 | 63.4 | 95 | 4.7 – 4.8 | 297.9 – 301.9 | 74 | 1.8 – 1.8 | 125.2 – 126.8 |
| 75 | 1.58 – 1.62 | 2.02 – 2.06 | 63.4 | 95 | 4.7 – 4.8 | 302.6 – 306.7 | 74 | 1.7 – 1.8 | 126.9 – 128.6 |

¹ The chart shows an expected range of feed and water consumption at normal environmental temperatures of 21–27°C. As the environmental temperature increases above this range, water consumption may increase up to double the amounts shown.

² Egg weights after 40 weeks of age assume phase feeding of protein to limit egg size.

Transportation to Breeder Farm

Transportation

- Use a truck designed for transportation of chicks from hatchery to breeder farm.
- Truck should be environmentally controlled, maintaining 26–28°C at 70% relative humidity (measured inside chick box); minimum air flow of 0.7 m³ per minute.
- Provide space between stacks of chick boxes for air flow.
- Due to transportation stress, it is important that receiving truck at the airport, as well as the brooder house, have optimum environmental conditions.
- Temperature recorders are placed in chick boxes during transport. It is important to return these recorders quickly to Hy-Line International for evaluation.

Chick Placement

- Unload boxes quickly and gently place chicks in brooding area.
- Brood chicks in groups from similar aged breeder flocks.



Chick box temperature recorders monitor temperature during transportation from hatchery to breeder farm.





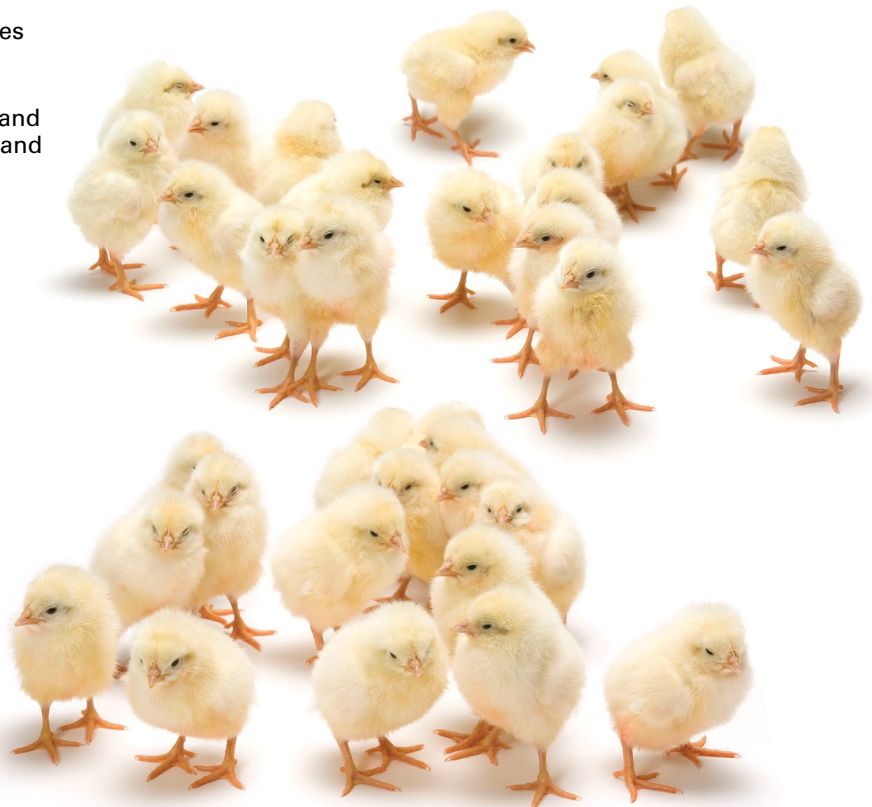

House Preparation before Arrival of Chicks

- Brooding area should be environmentally controlled and properly sealed to eliminate all outside light.
- All-in, all-out (single age) management provides the best control for sanitation programs and disease prevention.
- Brooder house should be completely cleaned and disinfected. Confirm effectiveness of cleaning and disinfection with environmental swabs.
- Allow 4 weeks downtime between flocks.



Brooding Recommendations

- Brood chicks in groups from similar aged breeder flocks.
- Brood male and female chicks separately from 0–4 weeks.
- Modify temperature as needed to meet chicks' comfort needs.
- Adjust brooding temperature according to relative humidity. Lower temperature should be used with higher relative humidity.
- Find optimum balance of temperature, humidity and ventilation rate for chick comfort.
- For every 5 percentage point increase above 60% relative humidity, reduce brooding temperatures by 1°C.
- Pre-heat brooding houses prior to chick placement: 24 hours in normal climates, 48 hours in cool climates and 72 hours in cold climates.
- Establish proper house temperature of 32–35°C (air temperature measured at chick level) and 60% humidity 24 hours before chick placement; floor temperature should be 32°C.
- Bright light (30–50 lux) during 0–7 days helps chicks quickly find feed and water and adapt to new environment.
- After first week, reduce temperature weekly 2–3°C until reaching 21°C.
- Chicks' body weight should double between arrival on farm and 7 days of age.

| | | | | | | | |
|--------------------------|---|---|--|---|---|--|--|
| AGE |  0–3 days |  4–7 days |  8–14 days |  15–21 days |  22–28 days |  29–35 days |  36–42 days |
| AIR TEMP. (CAGE) | 32–33°C | 30–32°C | 28–30°C | 26–28°C | 23–26°C | 21–23°C | 21°C |
| AIR TEMP. (FLOOR) | 33–35°C | 30–32°C | 29–31°C | 27–29°C | 24–27°C | 22–24°C | 21°C |
| LIGHT INTENSITY | 30–50 lux | 31–33°C | 25 lux | 25 lux | 25 lux | 5–15 lux | 5–15 lux |
| LIGHT HOURS | 22 hours or Intermittent Program | 21 hours or Intermittent Program | 20 hours | 19 hours | 18 hours | 17 hours | 16 hours |

Relative humidity

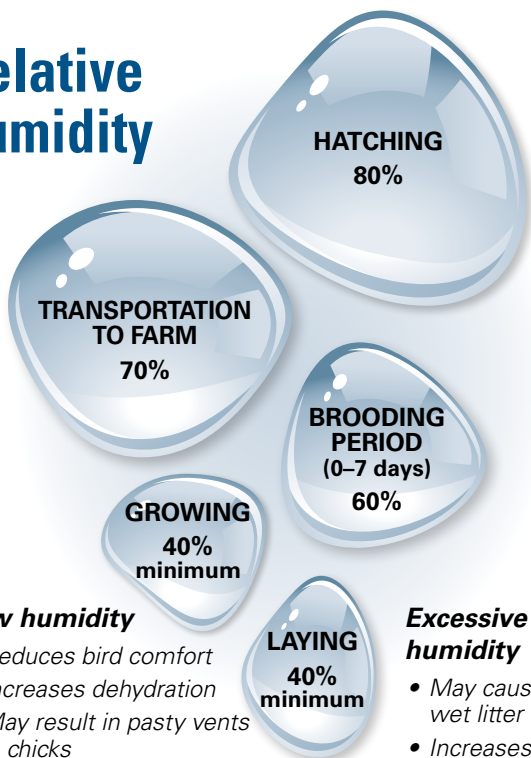



Low humidity

- Reduces bird comfort
- Increases dehydration
- May result in pasty vents in chicks
- May increase agitation and possibility of pecking
- Adversely affects feather cover
- Increases dust

Excessive humidity

- May cause wet litter
- Increases ammonia
- Causes poor air quality

CROP FILL – ARE THE CHICKS EATING?

| Hours after chick placement | Chicks with feed in crop |  |  |
|-----------------------------|--------------------------|---|---|
| 6 | 75% | Chick with starter feed in crop | Chick without starter feed in crop |
| 12 | 85% | | |
| 24 | 100% | | |

Brooding temperatures that are too low or too high will decrease the percentage of chicks with crop fill.

Floor Brooding in Rings

BROODING TEMPERATURE

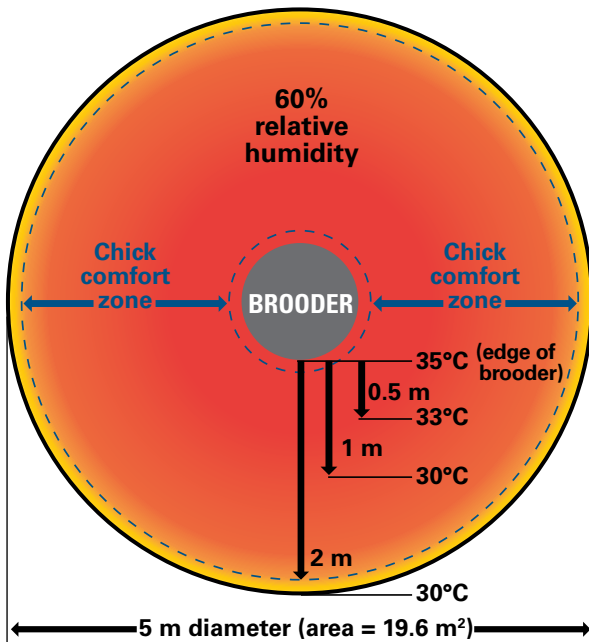

- Provide temperature zones within the brooding ring accessible to the chicks. This allows them to seek their comfort zone.
- Cloacal temperature of the chicks should be 40°C.

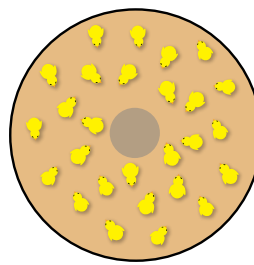

CORRECT
Chicks evenly distributed in brooding area, active and sounding content

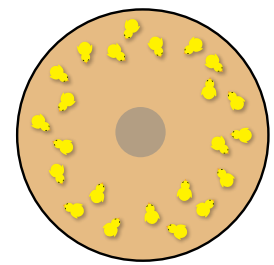

HOT
Chicks spread out, lethargic; appear sleeping

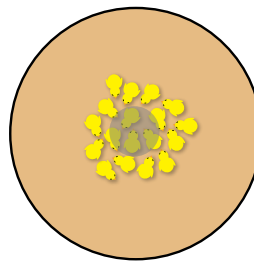

COLD
Chicks gathered into groups sounding distressed

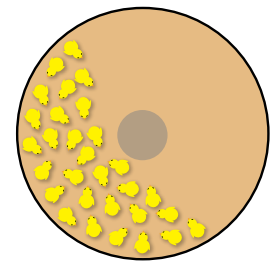

UNEVEN VENTILATION
Chicks congregated in one part of brooding area, avoiding drafts, noise or uneven light distribution

BROODER RING DESIGN

Supplemental chick drinkers

- Drinking water should be tested for quality and cleanliness from source and end of the water line.
- Flush water lines prior to chick arrival.
- Flush water lines weekly during rearing and production periods.
- Clean supplemental chick drinkers frequently to avoid build-up of organic matter that could promote bacterial growth.
- Use a ratio of 80 chicks / drinker (25 cm drinker diameter).
- Chicks should not have to move more than 1 meter to find water.
- Use vitamins and electrolytes in chicks' water (avoid sugar-based products to prevent growth of microorganisms).

Paper/Litter

- Cover entire floor of brooder ring with paper.
- Put starter feed on paper for 0–3 days. For beak-treated chicks, feed on paper for 0–7 days.
- Remove paper at 7–14 days to avoid the buildup of manure.
- Litter should not be more than 5 cm deep.
- Spread litter after concrete floors have warmed.

Tray feeders

- Use a ratio of 80 chicks / feeder.
- Use good quality crumble starter feed consisting of uniform 1–2 mm particles.

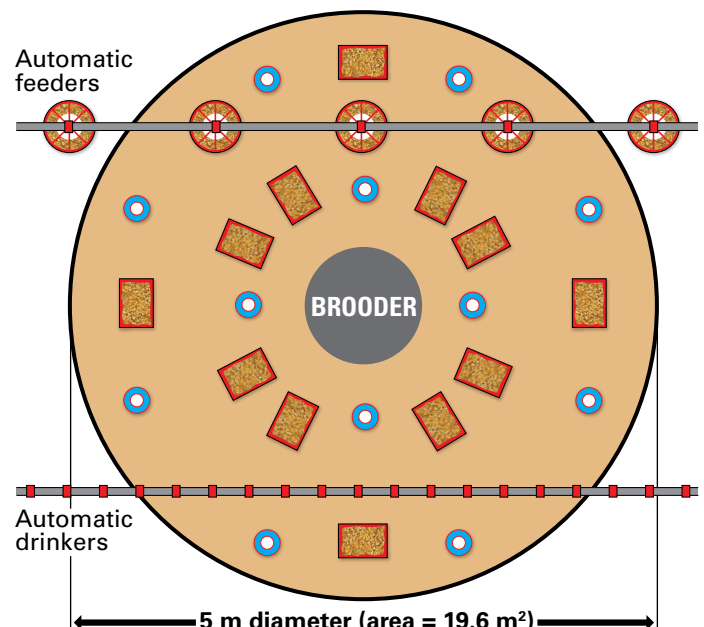

Tray feeders Supplemental chick drinkers

Management

- Enlarge brooder rings at 3 days to increase group size.
- Continue enlarging brooder rings until rings are removed by 14 days.
- Gradually remove supplemental drinkers and tray feeders beginning at 3 days.

Partial House Brooding

(A section of rearing house is partitioned and used for brooding)

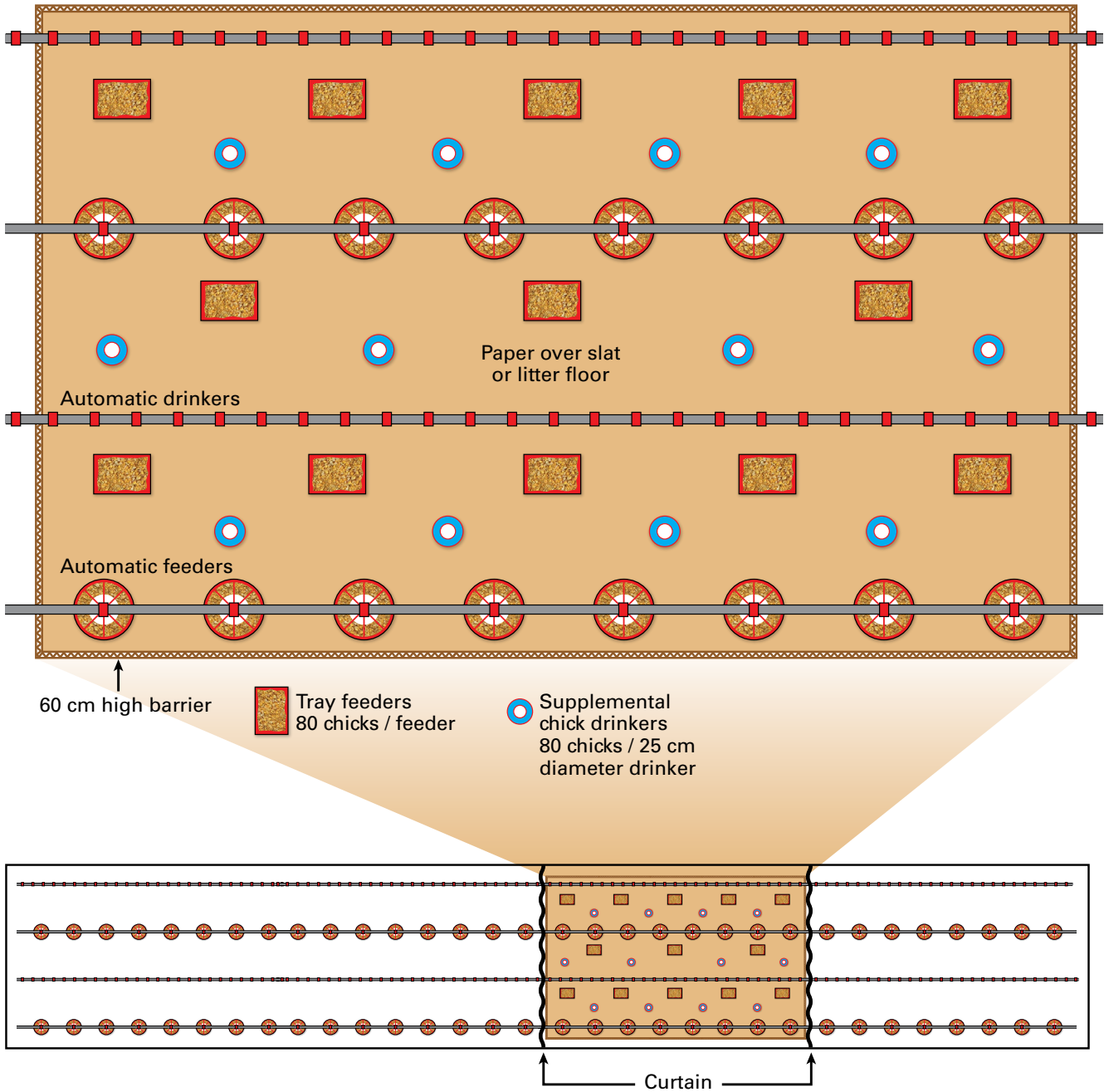

Partial house brooding provides uniform temperature to chicks

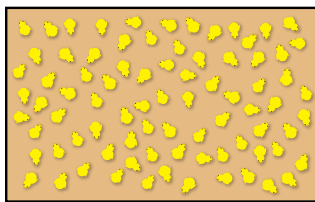

CORRECT

Chicks evenly distributed in brooding area, active and sounding content

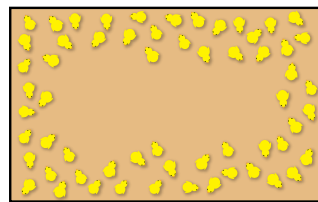

HOT

Chicks spread out, lethargic; appear sleeping

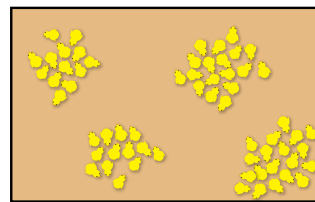

COLD

Chicks gathered into groups sounding distressed

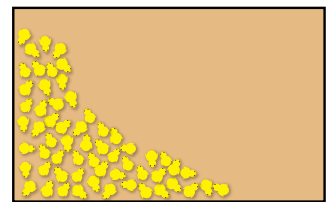

UNEVEN VENTILATION

Chicks congregated in one part of brooding area, avoiding drafts, noise or uneven light distribution

Cage Brooding

- Place feed on cage paper 0–3 days to encourage consumption. For beak-treated chicks, feed on paper for 0–7 days.
- Paper should cover entire floor.
- Place feed in front of permanent feeder to train chicks to move toward feeders.
- Fill automatic feed line to its highest level and adjust chick guards; allow access to automatic feed line from first day.
- Remove paper by 7–14 days of age to avoid build-up of feces.
- Rearing cage should be constructed of 2 mm diameter wire with spacing between wires to provide maximum cell size of 18 mm x 18 mm.
- Cage floors should not be slippery or sloped.
- Rearing cage height should be minimum of 48 cm. If too low, males may experience leg problems and keel bone pressure sores.
- Start chicks in upper tiered cages which are usually warmer and brighter. Ensure there are no shadows on drinkers.
- Chicks from young breeder flocks should be placed in warmer and brighter areas of the house.
- Chicks' body weight should double between arrival on farm and 7 days of age.
- Use vitamins and electrolytes in chicks' water (avoid sugar-based products to prevent growth of microorganisms).
- Pullets reared in cages should be transferred to breeder cages with similar feeder and drinker types.

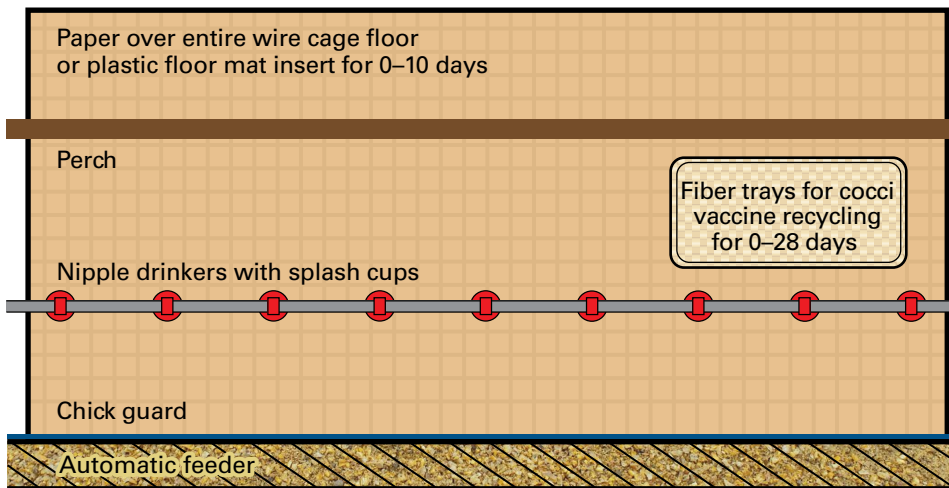

Chick guard adjusted to allow access to feeder from first day

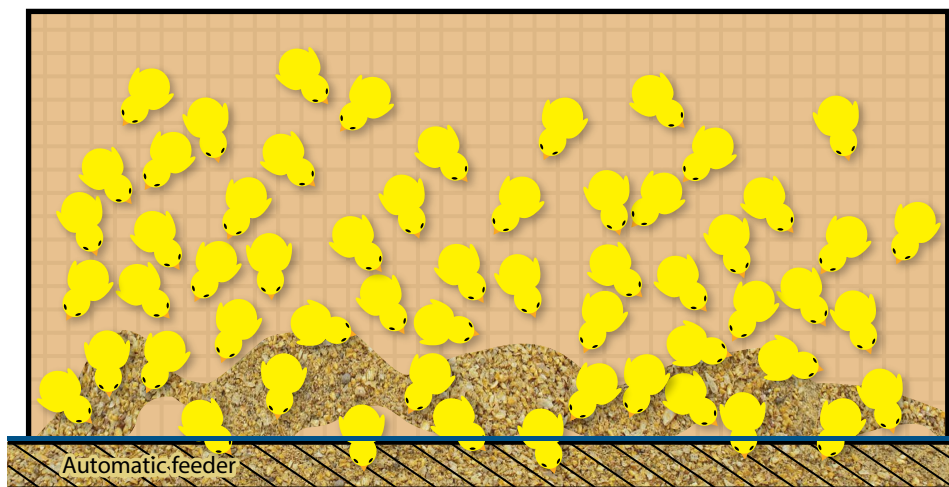

Place feed on paper near automatic feeder to train chicks

Lighting During Brooding Period

- An intermittent lighting program is preferred. If not using an intermittent lighting program from 0–7 days, then use 22 hours of light from 0–3 days and 21 hours of light from 4–7 days.
- Do not use 24 hours of light.
- Bright light (30–50 lux) during 0–7 days helps chicks quickly find feed and water and adapt to the new environment.
- After the first week, begin slow step-down lighting program (see [Light Program for Light-Controlled Housing](#)).

INTERMITTENT LIGHTING PROGRAM FOR CHICKS

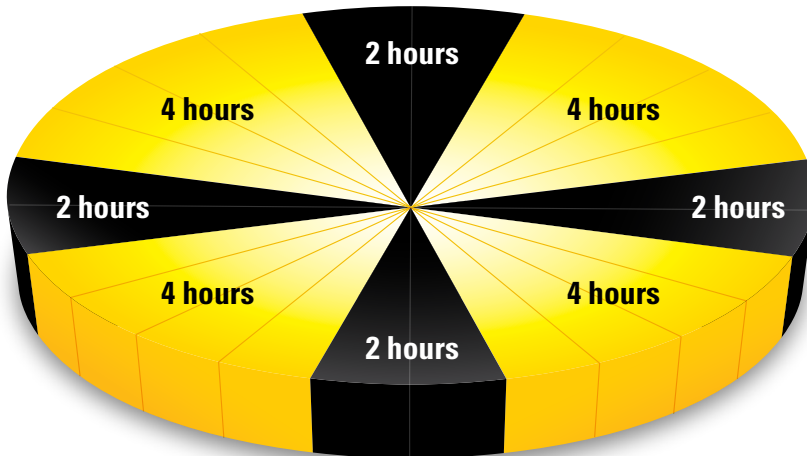

- Preferred lighting technique
- Use from 0–7 days (can be used up to 14 days of age)
- Intermittent dark periods provide rest periods for chicks
- Synchronizes chicks' activities and feedings
- Establishes more natural behavior of rest and activity
- May improve 7 day livability and pullet body weight
- May improve antibody response from vaccinations
- Some dark periods may be shortened or removed to accommodate work schedules

Drinking Systems

- Drinking water should be tested for quality and cleanliness from source and end of the water line.
- Flush water lines weekly during the brooding period, starting the day prior to chick arrival. Flush water lines weekly during rearing and production periods.
- Do not give cold water to chicks. Be careful when flushing water lines for chicks. Allow water time to warm up in the house so chicks are comfortable drinking.
- Flush chick water lines at night to allow water to warm in water lines.
- Maintain water temperature of 20–25°C during brooding period.
- Nipple drinkers should deliver minimum 60 ml per minute/nipple, with easy activation of the drinkers by chicks.
- Use the same drinker type in rearing and laying houses.

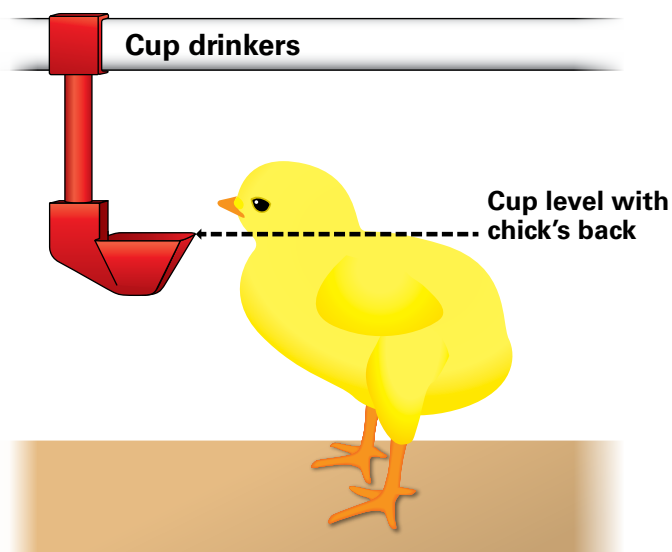

- Cup drinkers should be manually filled during 0–3 days to train chicks to drink.
- Open drinkers (bell, plasjon, supplemental chick drinkers, trough) are easily contaminated and should be cleaned daily.

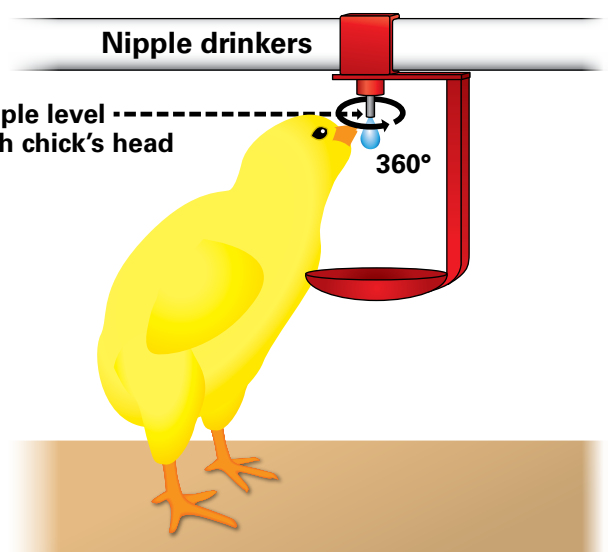

- Adjust nipple water system pressure to create hanging drop to help chicks find water for up to 3 days.
- Splash cups are useful during brooding period and in hot climates.
- 360° activated nipples make drinking easy for chicks.
- Use only 360° activated nipples for hatchery beak-treated chicks, as well as supplemental chick drinkers.

Beak Treatment / Trimming

(Check local regulations concerning use of beak trimming)

- Hy-Line W-36 parent female is most successfully beak trimmed at hatch by infrared beak treatment or between 7–10 days of age by precision beak trimming.
- Hy-Line W-36 male should preferably not be beak trimmed. If treatment is required, beak treat in hatchery or tip at 7–10 days of age.
- Females should be re-trimmed at 6 weeks or 12–14 weeks of age.
- Hatchery beak treatment or 7–10-day beak trimming reduces feed wastage and leaves the beak less damaging to other birds.

HATCHERY INFRARED BEAK TREATMENT (IRBT)

- This provides efficient, uniform beak treatment.
- Beak remains intact until 10–21 days of age when treated portion separates.
- Use only 360° activated nipples for IRBT chicks, as well as supplemental chick drinkers.
- For IRBT chicks, feed on paper for 0–7 days.
- IRBT is adjustable to manage differences in breeder flock age, chick size and variety of birds.
- For more information, see the “[Infrared Beak Treatment](#)” technical update at www.hyline.com.

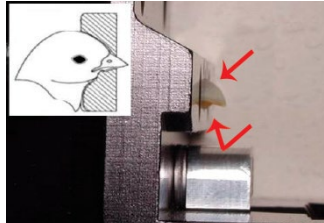

Infrared beak treatment can be modified according to local conditions.

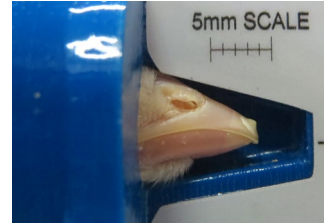

Immediately following infrared beak treatment on day of hatch



7 days after infrared beak treatment

PRECISION BEAK TRIMMING

- Cauterize beak for 2 seconds at 650°C.
 - When cauterizing blade is not hot enough or cauterization time is < 2 seconds, beak will continue to grow unevenly.
 - If cauterizing blade is too hot or cauterization time is > 2 seconds, sensitive neuromas may form.
- Use a pyrometer to measure blade temperature, which should be approximately 650°C.
- Cauterizing blade color may be used as an approximate indicator of temperature.



- Blade temperature variation of up to 40°C is common due to external influences and cannot be detected by the human eye.
- Check that beaks have been properly and evenly trimmed.



Photo courtesy of Lyon Technologies, Inc.



Pyrometer indicating proper blade temperature of 650°C.

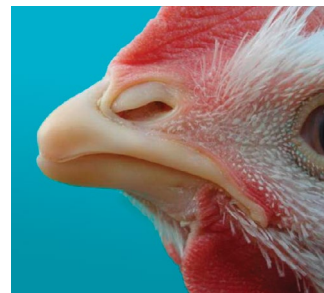

Properly trimmed beaks

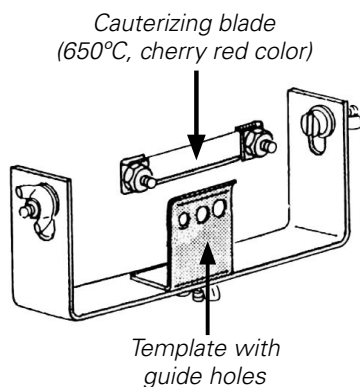

Guide holes correspond to different size and age of chicks

- 3.56 mm
- 4.00 mm
- 4.37 mm

Precautions when using IRBT or beak trimming birds:

- Water intake is the most important factor in the success of IRBT/beak trimming. Chicks require immediate and easy access to water.
- Do not beak-trim sick or stressed birds.
- Do not hurry; handle chicks carefully.
- Provide vitamins and electrolytes containing vitamin K in drinking water 2 days before and 2 days after beak trimming.
- Watch chicks after beak trimming to assess stress. Raise ambient temperature until birds appear comfortable and active.
- Keep feed at the highest level for several days after beak trimming.
- Use only well-trained crews.
- Use 360° activated nipples.
- Nipple drinkers with splash cups provide additional support for IRBT chicks.
- Provide extra light on nipple drinkers after beak treatment.

Growth and Development

- Focus on pullet rearing programs to optimize growth and development.
- The best predictor of future laying performance is the pullet's body weight and body type at the point of lay.
- The design of the rearing facility should closely match that of the layer house to which the flock will be transferred. Drinker and feeder type and perching should match. This makes the transition of the birds from rearing to laying easy and stress-free.
- A pullet flock entering into egg production at correct body weight (females 1.18–1.22 kg) with uniformity higher than 90% performs best in the production period.
- It is important to achieve 6, 12, 18, 24, and 30 week body weight targets to ensure optimum development of the bird's body.
- If possible, exceed pullet body weight standards throughout rear.
- Use a crumble starter feed to promote good feed intake.
- Change rearing diets only when recommended body weights are attained.
- Anticipate rapid rise in ambient temperature and adjust bird's diet accordingly. Birds will eat less when exposed to a rapid temperature increase. (See the "[Understanding Heat Stress in Layers](#)" technical update at www.hyline.com.)
- Stress periods require change in diet formulation to ensure proper nutrient intake.
- By 12 weeks of age, match the feeding schedule to be used in the layer house.
- During the rearing period, run feeders 3–5 times per day. Feed more frequently to encourage feed intake in underweight flocks or in hot weather.
- Manage feeders so that additional feedings do not create excessive fine feed particles. Check feed consumption against the body weight/feed consumption table on p. 12.
- Delay diet changes if birds are underweight or have poor diet uniformity, or until after a stress-inducing event, such as catching birds for an injected vaccination.

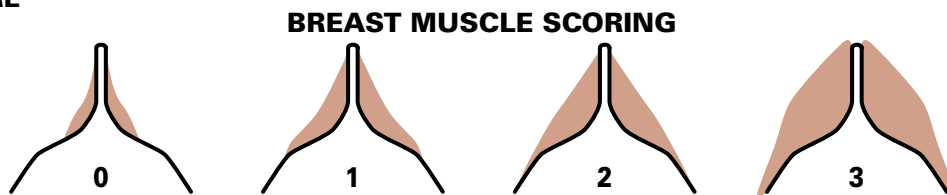
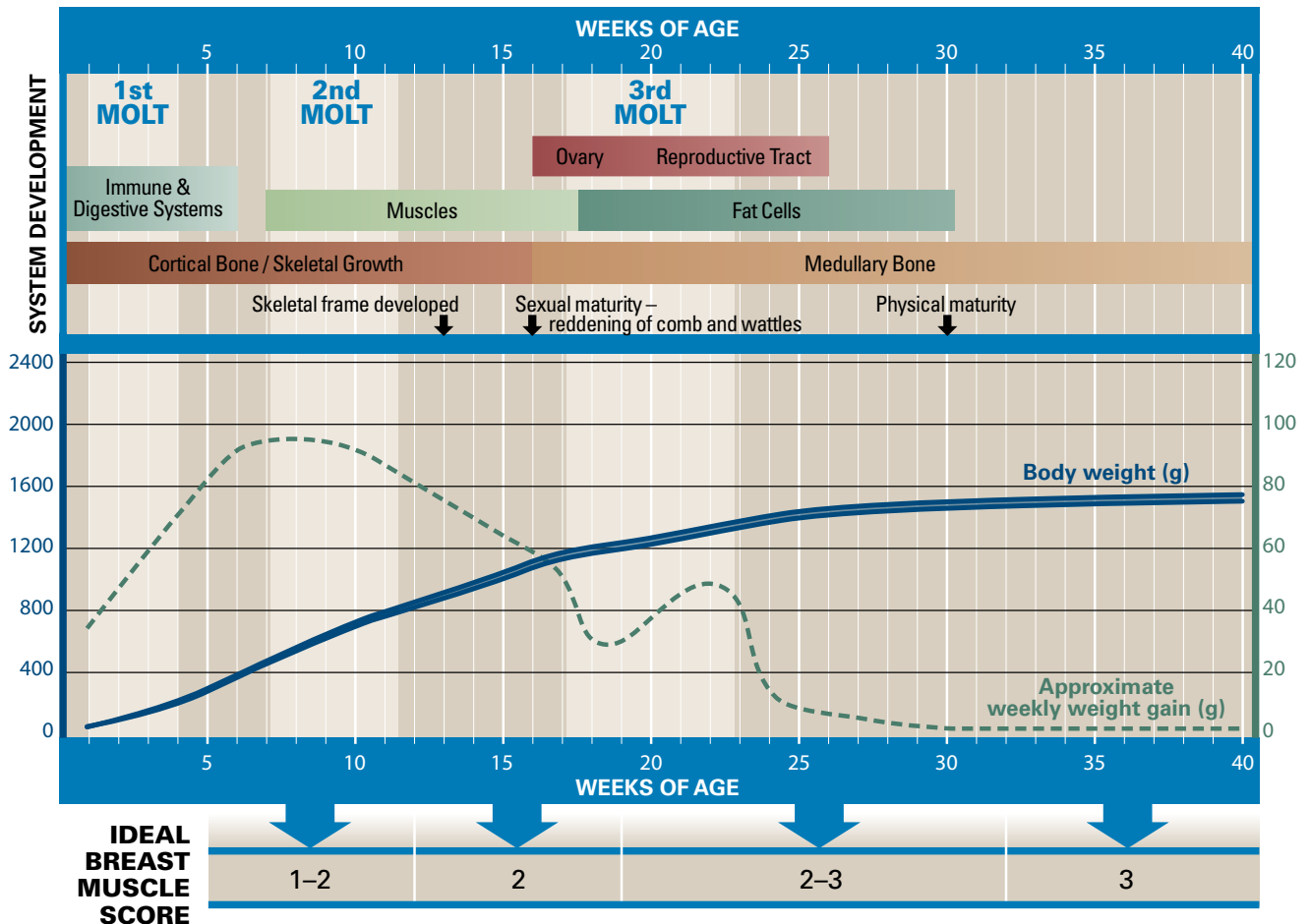
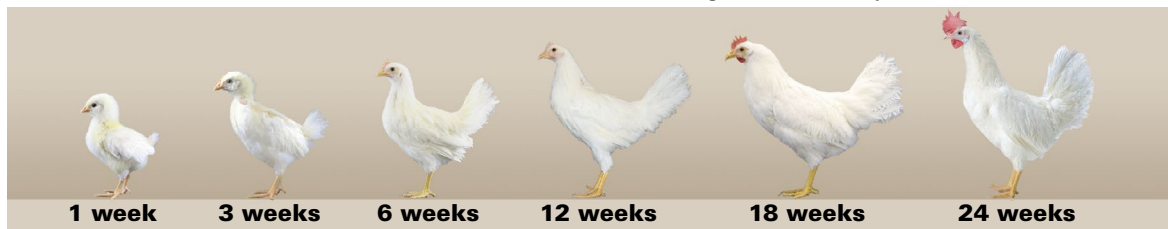

Hens with good muscle development are better able to sustain high egg production

Rearing Body Weights, Feed Consumption and Uniformity

| AGE (weeks) | FEMALE WEIGHT (g) | MALE WEIGHT (g) | FEED INTAKE (g / day per bird) | WATER CONSUMPTION (ml / bird / day) | UNIFORMITY | |
|-------------|-------------------|-----------------|--------------------------------|-------------------------------------|------------|------|
| | | | | | Floor | Cage |
| 1 | 61 – 69 | 61 – 69 | 12 – 13 | 18 – 26 | | |
| 2 | 107 – 113 | 117 – 123 | 15 – 16 | 23 – 32 | >85% | >85% |
| 3 | 171 – 179 | 176 – 184 | 18 – 19 | 27 – 38 | | |
| 4 | 225 – 235 | 255 – 265 | 28 – 30 | 42 – 60 | | |
| 5 | 294 – 306 | 369 – 381 | 37 – 39 | 56 – 78 | >80% | >80% |
| 6 | 393 – 407 | 488 – 502 | 40 – 42 | 60 – 84 | | |
| 7 | 472 – 488 | 627 – 643 | 42 – 44 | 63 – 88 | | |
| 8 | 541 – 559 | 721 – 739 | 45 – 47 | 68 – 94 | | |
| 9 | 640 – 660 | 830 – 850 | 47 – 49 | 71 – 98 | | |
| 10 | 704 – 726 | 934 – 956 | 50 – 52 | 75 – 104 | >83% | >85% |
| 11 | 768 – 792 | 1028 – 1052 | 52 – 54 | 78 – 108 | | |
| 12 | 847 – 873 | 1097 – 1123 | 53 – 55 | 80 – 110 | | |
| 13 | 886 – 914 | 1186 – 1214 | 55 – 57 | 83 – 114 | | |
| 14 | 955 – 985 | 1265 – 1295 | 56 – 59 | 84 – 118 | | |
| 15 | 1014 – 1046 | 1354 – 1386 | 58 – 61 | 87 – 122 | >85% | >85% |
| 16 | 1083 – 1117 | 1418 – 1452 | 63 – 66 | 95 – 132 | | |
| 17 | 1152 – 1188 | 1472 – 1508 | 69 – 73 | 104 – 146 | | |
| 18 | 1180 – 1220 | 1540 – 1580 | 76 – 80 | 114 – 160 | >88% | >90% |

- Monitor body weights weekly from 0–30 weeks and before scheduled diet changes.
- Body weight gains and uniformity may be negatively affected by inappropriate diet changes, bird handling, vaccination and transfer.
- Using multiple hatch dates, causing a range of chick ages, will negatively affect uniformity.
- Flocks should be at 85% uniformity at the time of transfer to the laying facility.



Weigh birds separately after 3 weeks using a digital scale that calculates uniformity.

During the transfer of birds from rearing to laying facilities, there will be some loss of body weight.

Space Guidelines *(check local regulations)*

| | | WEEKS OF AGE | | | | | | | | | | | | | | | | | | |
|---|--|---|--|--|--|--|--|---|--|--|--|--|----|----|----|----|----|----|----|----|
| | | 3 | | | | | | | | | | | 17 | 20 | 30 | 40 | 50 | 60 | 70 | 75 |
| BREEDER COLONY CAGES | | | | | | | | | | | | | | | | | | | | |
| Floor Space | | | | | | | | | | | | | | | | | | | | |
| 200 cm ² (50 birds / m ²) | | 400 cm ² (25 birds / m ²) | | | | | | 750 cm ² (13 birds / m ²) | | | | | | | | | | | | |
| Nipple | | | | | | | | | | | | | | | | | | | | |
| 1 / 12 birds | | 1 / 8 birds | | | | | | 1 / 10 birds | | | | | | | | | | | | |
| Feeders | | | | | | | | | | | | | | | | | | | | |
| 5 cm / bird | | 9 cm / bird | | | | | | 12 cm / bird | | | | | | | | | | | | |
| SLATS / LITTER | | | | | | | | | | | | | | | | | | | | |
| Floor Space | | | | | | | | | | | | | | | | | | | | |
| 700 cm ² (14 birds / m ²) | | 1000 cm ² (10 birds / m ²) | | | | | | 1000 cm ² (10 birds / m ²) | | | | | | | | | | | | |
| Nipple / Cup Drinkers | | | | | | | | | | | | | | | | | | | | |
| 1 / 15 birds | | 1 / 15 birds | | | | | | 1 / 12 birds | | | | | | | | | | | | |
| Feeders | | | | | | | | | | | | | | | | | | | | |
| 5 cm / bird | | 5 cm / bird or 1 pan / 50 birds | | | | | | 12 cm / bird | | | | | | | | | | | | |
| Perches | | | | | | | | | | | | | | | | | | | | |
| — | | 8 cm / bird | | | | | | 12 cm / bird | | | | | | | | | | | | |
| | | 3 | | | | | | | | | | | 17 | 20 | 30 | 40 | 50 | 60 | 70 | 75 |
| | | WEEKS OF AGE | | | | | | | | | | | | | | | | | | |

Requirements vary with type of equipment used and environmental conditions. Density calculations should include all birds—males and females.

Hy-Line W-36 Male Management

- The W-36 male chick is smaller than the female and will benefit from a 1°C warmer brooding temperature.
- The W-36 male's 18-week body weight is 1.54–1.58 kg.
- The W-36 male's adult body weight is 1.95–1.99 kg (40 weeks of age).
- The W-36 male should be infrared beak treated at the hatchery or tipped at 7-10 days of age.
- Achieving male target body weights during rear is critical for optimum mating behavior and fertility.
- Males and females should receive the same feed and lighting schedule.
- For breeder cages having a specific male feeder space, these spaces should not be obstructed by nest boxes or other cage enrichments.
- Male and female breeders should reach sexual maturity at approximately the same time.
- From 0–4 weeks, rear males separately to improve male body weight gain.
- At 5 weeks, mix males and females. In cages, mix 3–4 females into each male cage. If males appear weaker than females, mix males with females at a 1:1 ratio through the rearing period.
- Grading males into pens based on body weight can improve male uniformity.
- Males and females must be co-mingled during rearing period to become socialized and avoid mating problems as adults.
- Keep extra males in a separate pen; do not mix extra males with females.
- Continue culling males as needed during production.
- Maintain a mating ratio of 10 males for every 100 females throughout production in floor and cage systems.
- Too many males results in more fighting, less mating activity and disruption of social groups and lower fertility.



Red vent from a mating W-36 male.

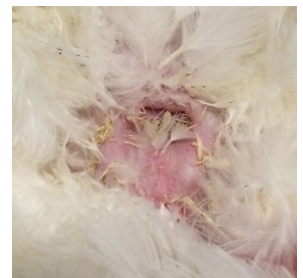

Vent from non-mating rooster.

MALE EVALUATION – A BEAUTY CONTEST

Tall, masculine appearance with full red comb

W-36 males are dubbed in the hatchery to differentiate them from females.

Evaluate males at 10 weeks and at transfer.

Cull roosters with:

- Lameness
- More than 200 g below target body weight
- Curled toes
- Foot pad lesions
- Poor feathering
- Poor beaks
- Low social ranking
 - Hide in nests
 - Feather pecked



Cage Systems Management

(Use cage systems specifically designed for breeders)

Advantages:

- Cleaner hatching eggs
- Better control of enteric diseases (coccidiosis, Gumboro, internal parasites, Salmonella)
- More settable eggs
- Better feed efficiency; less feed waste
- More efficient use of breeder house space
- Lower labor costs
- Lower mortality
- Dry manure (less flies and ammonia)

Disadvantages:

- Higher capital investment
- Less leg strength in cage-reared males
- Lower fertility may occur, especially with smaller colony cages

CAUTION – *it is not advisable to rear breeders in cages and then transfer to a floor production system. Breeders handled in this way may experience displaced pecking behavior and poor nesting behaviors as adults.*

Breeder Cage Enrichment

- Enriched cages address some of the welfare concerns of layers in cages by providing more space with environment enrichment devices, such as perches, nest boxes, scratch areas and abrasive pads for beak and toe shortening.
- As group size increases, there is more competition for feed and water space and less stable social groups. This could lead to behavioral problems like feather pecking and piling. Cage enrichments help prevent these behavioral problems.

TRANSFER

- The flock can be moved into the production facility at 15–17 weeks of age or after administration of the last live vaccines.
- Males may be moved a few days earlier to the production house to give them more time to acclimate to their new environment.
- It is important that rearing and production breeder cages contain similar feed and water systems.
- Any sex slips should be removed around 7 weeks and at transfer.
- Supportive care to reduce stress such as water-soluble vitamins, probiotics and vitamin C should be used 3 days before and 3 days after transfer.
- Light intensity should increase weekly for 2 weeks before the flock is transferred to the laying house.
- Light hours of rearing and laying houses should be matched at transfer.

BREEDER HOUSE

- A breeder cage designed for a colony size of 90 birds will usually have better fertility than those with smaller colony size. Smaller breeder cages with 2 or 3 males are subject to accelerated fertility loss as the flock ages.
- Breeder laying cages should provide 750 cm² of floor space per bird (13 birds / m²).
- Use higher bird density in environmentally controlled houses and all-slat floors and lower density on litter floors and in hot climates.
- Cage should have perching and nesting areas.
- Floor mesh size should be 2.54 cm x 2.54 cm.
- Male feeding area should not be obstructed by nest boxes or other cage enrichments.
- Cage height should be at least 48 cm in rear and 68 cm in production to avoid males hitting their heads on the top of the cage. Males striking their heads on the top of the cage will be reluctant to mate.
- Males in cage systems should be dubbed to avoid being caught in cage wires.
- If mortality exceeds 0.1% / week, perform necropsies and other diagnostics to determine cause(s) of mortality.
- Remove mortality daily.

Colony Breeder Cage

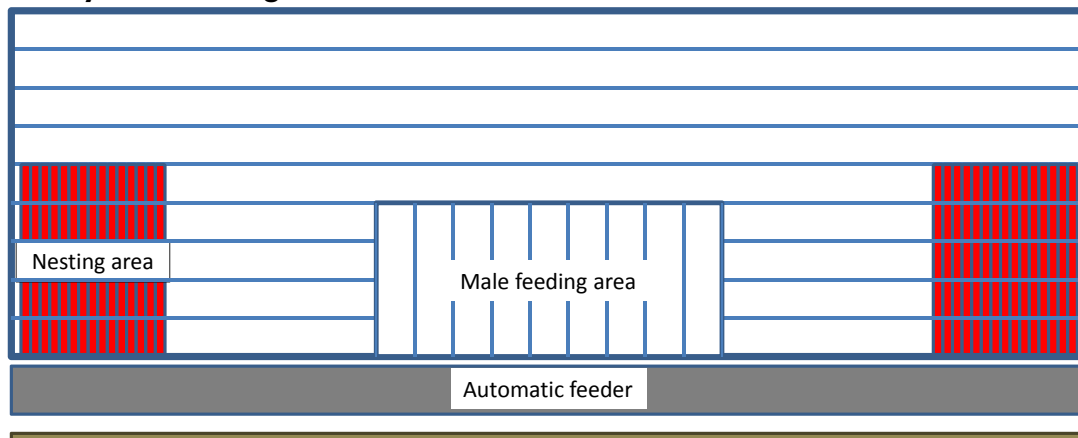

Breeder cages should have a specific male feeder space. These spaces should not be obstructed by nest boxes or other cage enrichments.

Floor Systems Management

REARING PERIOD

- Rear birds on the floor when they will be housed in floor systems during production.
- Equip rearing and production houses with similar feed and water systems.
- Accustom birds to humans by frequently walking through the house.
- Walk through birds briskly at 2 hour intervals.
- Rearing house should have elevated bird walkways with feed and water stations.
- Light intensity should increase weekly for 2 weeks before the flock is transferred to the layer house.
- Birds moving from light-controlled rearing houses into open-sided houses should have higher light intensities the last 2 weeks of rear.
- Light hours of rearing and production house should be matched at transfer.

TRANSFER

- The flock can be moved into the production facility at 15–17 weeks of age or after administration of the last live vaccines.
- Place females on slats when moving to the production house.

NEST TRAINING

- Nest training is essential to minimize the number of out-of-nest eggs.
- Starting the day of arrival, open nest box curtains to encourage nest exploration.
- Train females to use nests by frequent walks through house in the morning for the first 8 weeks after birds are moved to the production house.
- While walking, move birds away from resting areas, out of corners and toward nests.
- During the first week of production, leave a few eggs in the nest to encourage females to use nests.
- Quickly remove floor eggs.
- Be sure all floor eggs are removed before lights go out at night.



Nests should have a staging area at the entrance to allow examination of the nests and easy access by females.

Nests

- Nests should be dark, secluded, warm, and free of air drafts.
- Ensure there is sufficient nest space (6 birds per nest or 120 hens per m² in colony nests).
- Make sure nests are easy to access. Any obstructions should be removed. Feed lines should not be directly in front of nests.
- Turn nest lights on 1 hour before house lights are turned on to attract females. Turn nest lights off 1 hour after house lights come on.
- Discontinue nest light usage after 26 weeks of age.
- False walls or partitions (perpendicular to nests and spaced every 5–7 m) may reduce overcrowding in nests.
- Close nests at night.
- Eliminate dark areas in the house to discourage floor eggs.
- Replace worn nest floor mats.



A good nest floor mat:

- Provides comfort for nesting female
- Cushions egg to prevent damage
- Keeps egg clean
- Separates dirt and feathers from egg surfaces
- Allows egg to roll easily to egg belt

HOUSE MANAGEMENT

- Use < 5 cm litter depth. Litter deeper than 5 cm results in increased floor eggs.
- Flocks housed in all-slat production houses should also be reared on slat or wire floors.
- Use of deterrent wires on slats around house perimeter will discourage egg laying in corners or near walls. Place deterrent wires 5 cm away from the wall of the house and 10 cm above the floor. (Check local regulations regarding the use of deterrent wires.)
- Deterrent wires should be activated as soon as birds are housed.
- Solid perches above water and feed lines are preferred.
- Feed and water lines should not block movement of females to nests.
- Schedule feed lines to run as soon as birds are awake and again after most eggs have been laid.
- If mortality exceeds 0.1% / week, perform necropsies and other diagnostics to determine cause(s) of mortality.
- Remove mortality daily.

A Day in the Life of a Hy-Line W-36 Breeder Hen

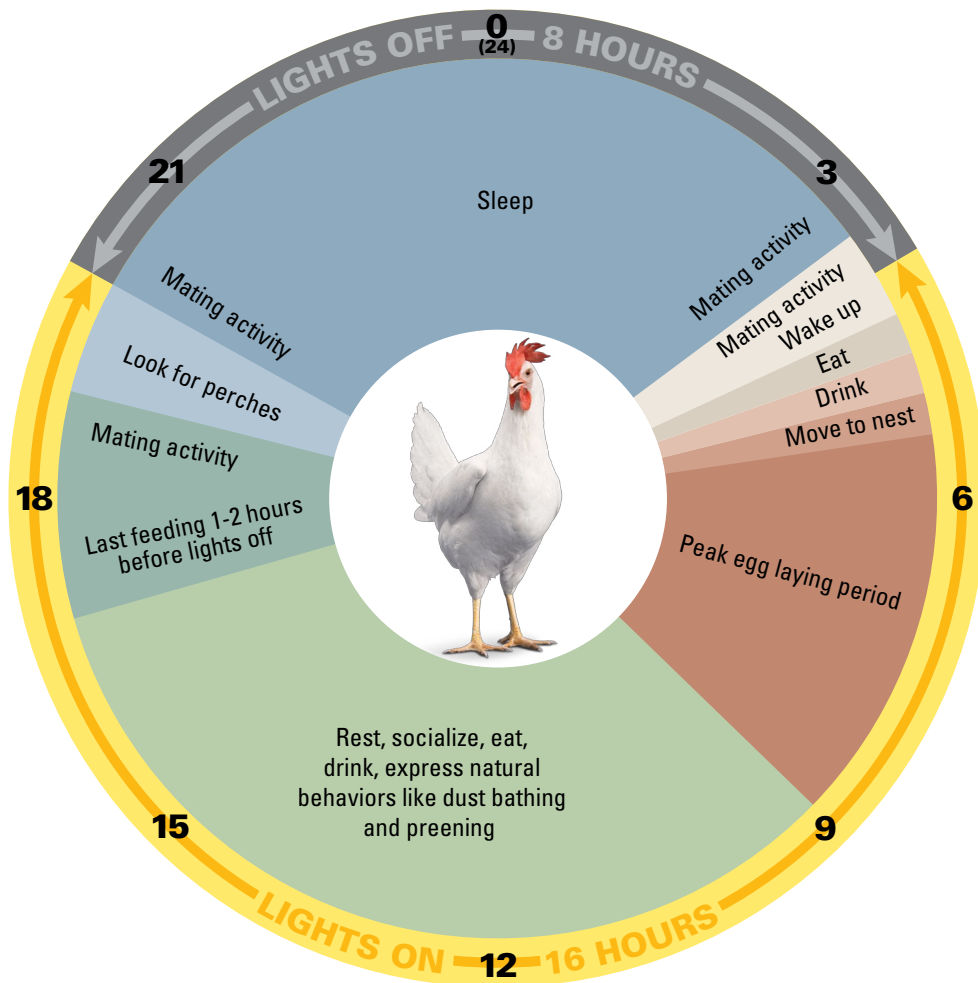

All-Slat Breeder Houses

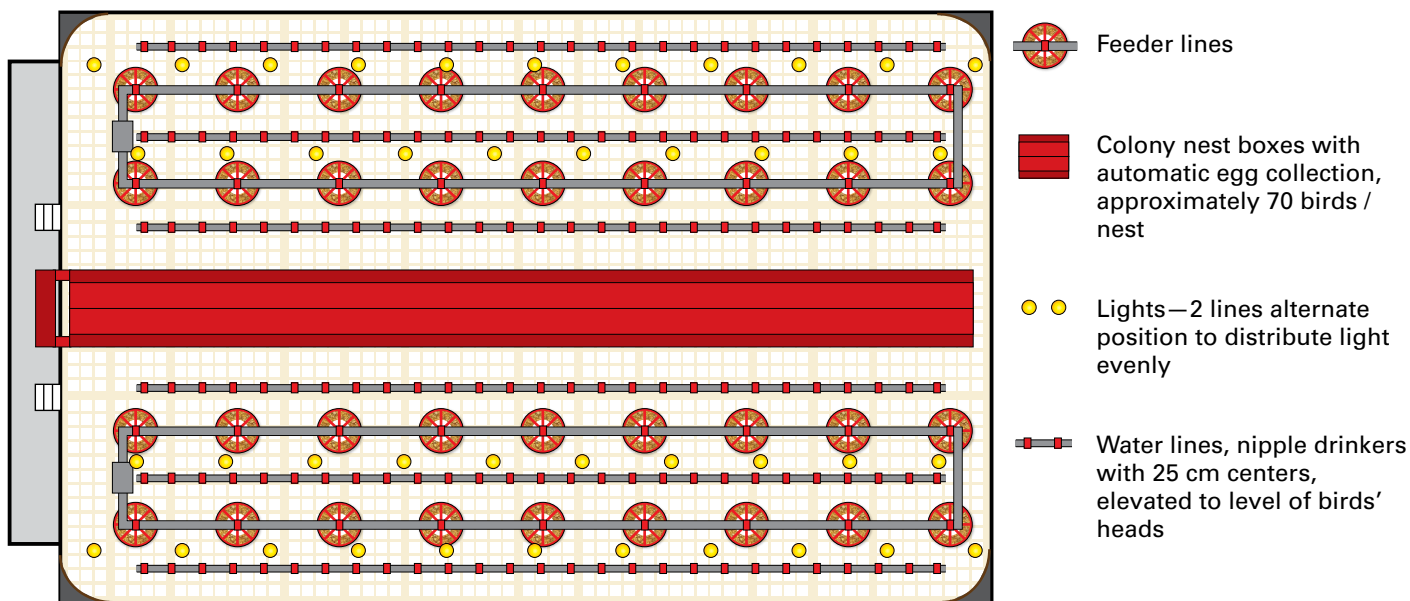

Drawing not to scale. Feed and water lines should not block movement of females to nest (i.e. drinker lines too low, feeder lines too high).

Perches

- Enrich birds' environment and allow expression of normal behaviors
- Allow birds to fully develop leg and breast muscles
- Encourage jumping habits which increase bone strength and calcium content of bone and will be important in good nesting behavior
- Reduce social stress by providing safe resting sites
- Increase living space in house
- Allow birds to roost at night
- May reduce piling behavior in flocks

Perch Design

- Place perches on slats to maintain good litter conditions.
- Breeders should have access to perches by 3 weeks of age.
- Provide 10–15 cm perch space per bird (check local regulations regarding perch space).
- Separate perch rails by at least 30 cm to prevent cannibalistic pecking of birds on adjacent rails.
- Avoid slippery perches.
- Perches should be round or rectangular for better gripping and comfort.
- Perches should support bottom of foot.
- Place perches on slat to maintain good litter conditions and control floor eggs.
- If possible, use the same perch style in rear and lay houses.
- Don't use perches above water lines during rear if using deterrent over water line in production.
- Perches should be easy to clean and disinfect between flocks.
- Seal cracks, crevices and open ends of pipes to reduce hiding areas of red mites (*Dermanyssus gallinae*).

| BIRD DENSITY (birds / m ²) | AVAILABLE PERCH SPACE PER BIRD (cm) |
|---|--|
| 7 | 4 |
| 8 | 6 |
| 9 | 8 |
| 10 | 12 |
| 11 | 13 |
| 12 | 14 |

Perch Dimensions

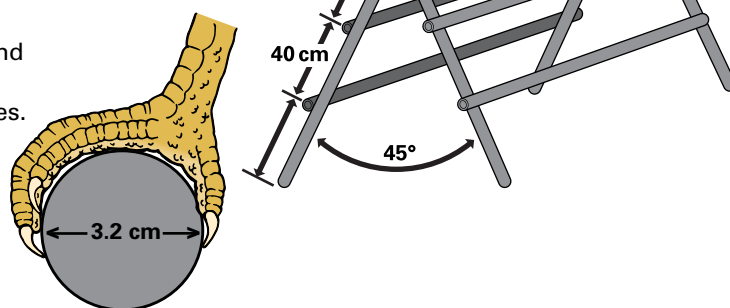

PERCH EXAMPLES



Wall perch



Perch over feeder



A-frame perch with slats



A-frame perch



Elevated platform

Good Lighting Practices

- In cage housing, measure minimum light intensity at feeder on bottom tier cages, mid-way between lights.
- In floor housing, measure minimum light intensity at level of bird's head.
- Keep light bulbs and bulb covers clean to prevent loss of light intensity.
- Prevent dark areas caused by too much distance between lights or burned out light bulbs.
- Shiny or white surfaces reflect light and increase light intensity.
- Take local conditions into account which may require adaptations of lighting programs.
- Light hours of rearing and production houses should be matched at transfer.
- Light intensity should increase 2 weeks before the flock is transferred to the laying house (but not prior to 14 weeks of age). Final rearing house light intensity should match the laying house intensity.
- Light stimulation period should extend into the peaking period (achieve 16 hours of light at approximately 30 weeks).

Light Program for Light-Controlled Housing

(www.hyline.com)

Hy-Line W-36 breeders require a slower step-down of light hours from 0–12 weeks to prevent early sexual maturity and promote good body weight uniformity.

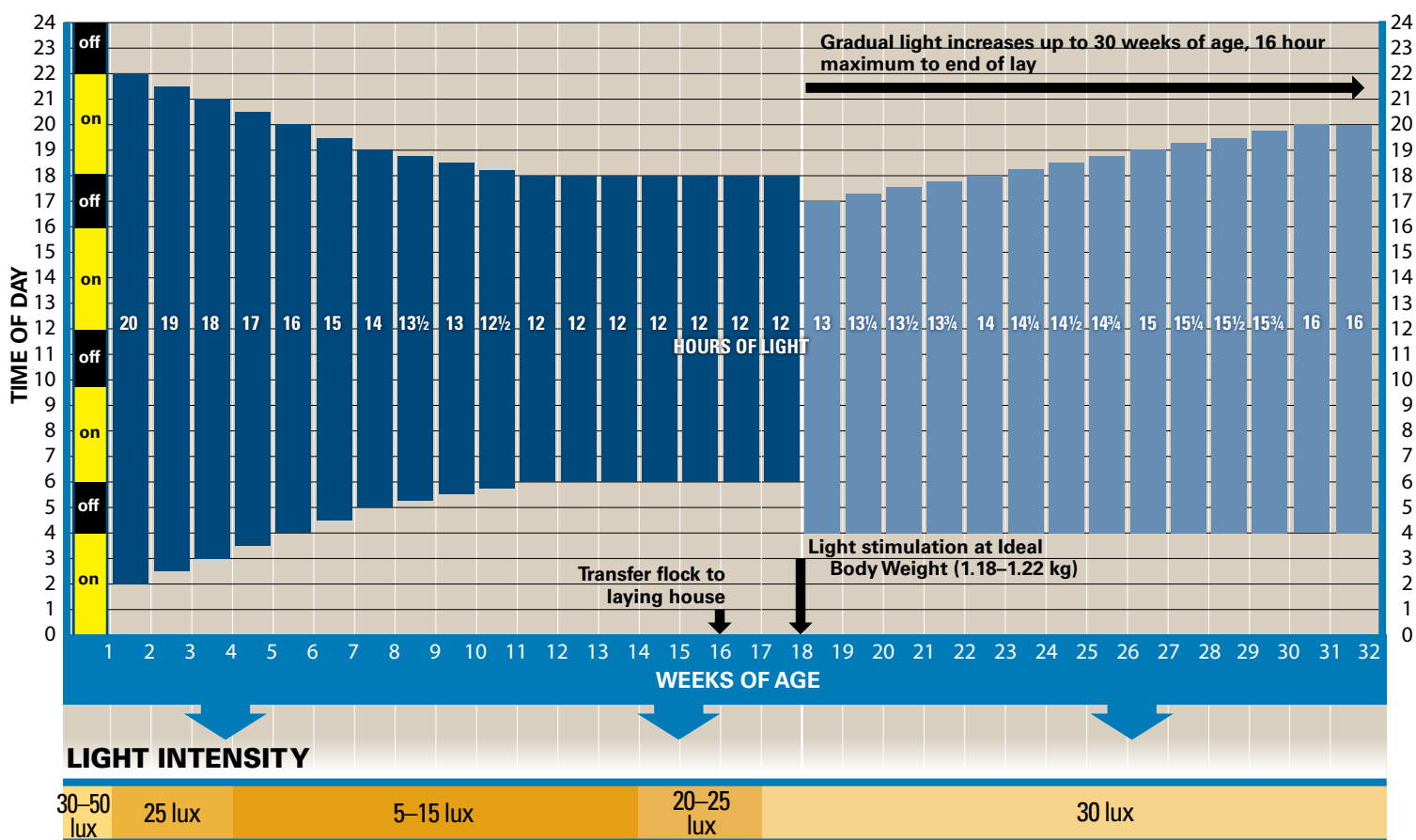

- Light-controlled houses are those which use light traps around fans and air inlets and completely prevent the ingress of light from the outside. Houses that are not light controlled should use lighting programs for open-sided housing.
- An intermittent lighting program for chicks is preferred. If not using an intermittent lighting program from 0–7 days, then use 22 hours of light from 0–3 days and 21 hours of light from 4–7 days.
- “Lights on” time can be varied between houses in laying flocks to facilitate egg collection on multiple flock complexes.
- If the laying flock has a large spread in hatch ages and/or poor uniformity, light stimulate the flock based on the youngest hatch date or lightest birds.
- Use warm lights (2700–3500 K) in laying flocks to ensure sufficient red spectrum light.
- For more information on poultry lighting, see the “[Understanding Poultry Lighting](#)” and “[Impact of Tarp Color on Poultry Lighting](#)” technical updates at www.hyline.com.

Customized Lighting Programs for Open-Sided Housing www.hyline.com

The Hy-Line International Lighting Program can create custom lighting programs for your location. To prevent early sexual development, the program finds the longest natural day length between 12–17 weeks of age and constructs an artificial lighting program that holds days day length constant with artificial lights from 12–17 weeks.

- On the first screen—enter e-mail address and select language.
- On the second screen, use dropdowns for “Select Location of Flock,” “Hatch Date,” “Variety Standards” and “Housing Style.”
- Click on “Create Lighting Spreadsheet.”
- Results will be e-mailed to you.

Lighting Program for : IOWA / DALLAS CENTER 93° 56' W 41° 43' N

Variety: W-36 Parent
House Type: Open grow to open lay
Hatch Date: 01-Sep-15 Standard daylight time

| Weeks of Age | Date | Sunrise | Lights on | Lights Off | Sunset | Total Hours of Light | Total Sunlight |
|--------------|-----------|---------|-----------|------------|--------|----------------------|----------------|
| 0 | 1-Sep-15 | 5:41 | 1:45 | 22:45 | 18:49 | 21:00 | 13:08 |
| 1 | 8-Sep-15 | 5:48 | 2:15 | 22:15 | 18:37 | 20:00 | 12:49 |
| 2 | 15-Sep-15 | 5:55 | 2:45 | 21:45 | 18:25 | 19:00 | 12:30 |
| 3 | 22-Sep-15 | 6:02 | 3:15 | 21:15 | 18:13 | 18:00 | 12:11 |
| 4 | 29-Sep-15 | 6:10 | 3:45 | 20:45 | 18:01 | 17:00 | 11:51 |
| 5 | 6-Oct-15 | 6:17 | 4:15 | 20:15 | 17:49 | 16:00 | 11:32 |
| 6 | 13-Oct-15 | 6:25 | 4:45 | 19:45 | 17:37 | 15:00 | 11:12 |
| 7 | 20-Oct-15 | 6:33 | 5:15 | 19:15 | 17:27 | 14:00 | 10:54 |
| 8 | 27-Oct-15 | 6:41 | 5:30 | 18:45 | 17:17 | 13:15 | 10:36 |
| 9 | 3-Nov-15 | 6:50 | 5:45 | 18:30 | 17:07 | 12:45 | 10:17 |
| 10 | 10-Nov-15 | 6:58 | 6:00 | 18:15 | 17:00 | 12:15 | 10:02 |
| 11 | 17-Nov-15 | 7:07 | 6:15 | 18:00 | 16:53 | 11:45 | 9:46 |
| 12 | 24-Nov-15 | 7:15 | 6:15 | 18:00 | 16:49 | 11:45 | 9:34 |
| 13 | 1-Dec-15 | 7:23 | 6:15 | 18:00 | 16:46 | 11:45 | 9:23 |
| 14 | 8-Dec-15 | 7:29 | 6:15 | 18:00 | 16:45 | 11:45 | 9:16 |
| 15 | 15-Dec-15 | 7:35 | 6:15 | 18:00 | 16:45 | 11:45 | 9:10 |
| 16 | 22-Dec-15 | 7:39 | 6:15 | 18:00 | 16:46 | 11:45 | 9:09 |
| 17 | 29-Dec-15 | 7:42 | 6:15 | 18:00 | 16:53 | 11:45 | 9:11 |
| 18 | 5-Jan-16 | 7:43 | 5:45 | 18:30 | 16:59 | 12:45 | 9:16 |
| 19 | 12-Jan-16 | 7:41 | 5:30 | 18:45 | 17:06 | 13:15 | 9:25 |
| 20 | 19-Jan-16 | 7:38 | 5:15 | 19:00 | 17:14 | 13:45 | 9:36 |
| 21 | 26-Jan-16 | 7:33 | 5:15 | 19:15 | 17:23 | 14:00 | 9:50 |
| 22 | 2-Feb-16 | 7:27 | 5:00 | 19:15 | 17:32 | 14:15 | 10:05 |
| 23 | 9-Feb-16 | 7:19 | 5:00 | 19:30 | 17:40 | 14:30 | 10:21 |
| 24 | 16-Feb-16 | 7:10 | 4:45 | 19:30 | 17:49 | 14:45 | 10:39 |
| 25 | 23-Feb-16 | 7:00 | 4:45 | 19:45 | 17:58 | 15:00 | 10:58 |
| 26 | 1-Mar-16 | 6:49 | 4:30 | 19:45 | 18:06 | 15:15 | 11:17 |
| 27 | 8-Mar-16 | 6:38 | 4:30 | 20:00 | 18:14 | 15:30 | 11:36 |
| 28 | 15-Mar-16 | 6:26 | 4:15 | 20:00 | 18:22 | 15:45 | 11:56 |
| 29 | 22-Mar-16 | 6:14 | 4:15 | 20:15 | 18:30 | 16:00 | 12:16 |
| 30 | 29-Mar-16 | 6:02 | 4:00 | 20:15 | 18:38 | 16:15 | 12:36 |
| 31 | 5-Apr-16 | 5:51 | 4:00 | 20:15 | 18:46 | 16:15 | 12:55 |
| 32 | 12-Apr-16 | 5:39 | 4:00 | 20:15 | 18:53 | 16:15 | 13:14 |
| 33 | 19-Apr-16 | 5:28 | 4:00 | 20:15 | 19:01 | 16:15 | 13:33 |
| 34 | 26-Apr-16 | 5:18 | 4:00 | 20:15 | 19:09 | 16:15 | 13:51 |
| 35 | 3-May-16 | 5:09 | 4:00 | 20:15 | 19:16 | 16:15 | 14:07 |
| 36+ | | | 4:00 | 20:15 | | 16:15 | |

This lighting program is created from a formula based on global location and housing style. This program may need to be further adapted to better fit local conditions. Please email info@hyline.com for further questions or technical assistance.

Same lighting program with sunrise and sunset represented by yellow and red lines and suggested artificial day length indicated by blue bars

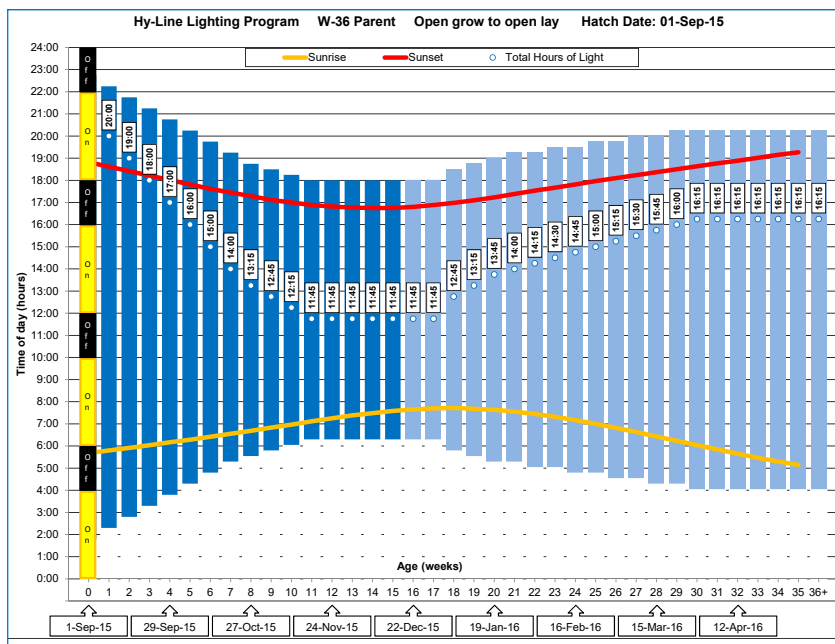

Lighting Considerations

FLOOR

- Light intensity in house should be brightest over feeding and resting areas and gradually decrease toward nests.
- Avoid dark areas near feeding and resting areas to prevent floor eggs.

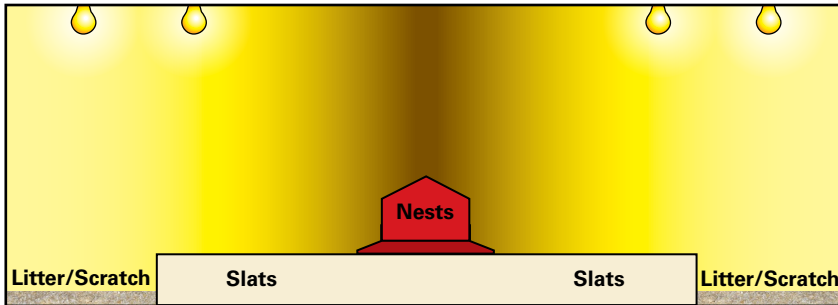

CAGES

- Alternating the height of lights improves light distribution to all cage levels.
- Position lights to minimize bright and dark areas in the house.

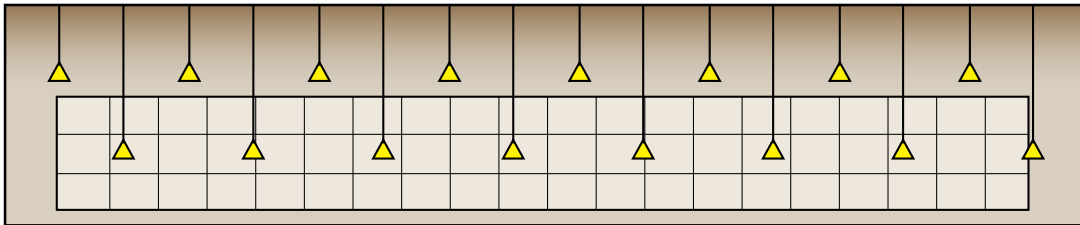

Use of Shades in Open-Sided Housing



- Shades are an effective way to decrease light intensity in an open-sided house.
- Keep shades clean and free of dust to allow air flow.
- Use stir fans when using shades.
- Avoid direct sunlight on birds by using shades or roof overhangs.
- Black shades are preferred.

Midnight Feeding / Lighting Program

- Optional lighting technique that promotes greater feed consumption
- Used whenever more feed intake is desired in rearing or laying flocks
- Increases calcium absorption during night when most egg shell is formed
- Useful to increase feed intake during peak egg production
- Helps maintain feed consumption in hot climates
- Midnight feeding may increase feed intake 2–5 g / day per bird

Good Practices

- Initiate the program by turning lights on for 1–2 hours in the middle of the dark period.
- There must be at least 3 hours of dark before and after the midnight feeding.
- Fill feeders before lights are turned on.
- Light provided during the midnight feeding is in addition to regular day length (i.e. 16 hours + midnight feeding).
- If midnight feeding is removed, reduce light gradually at a rate of 15 minutes per week.

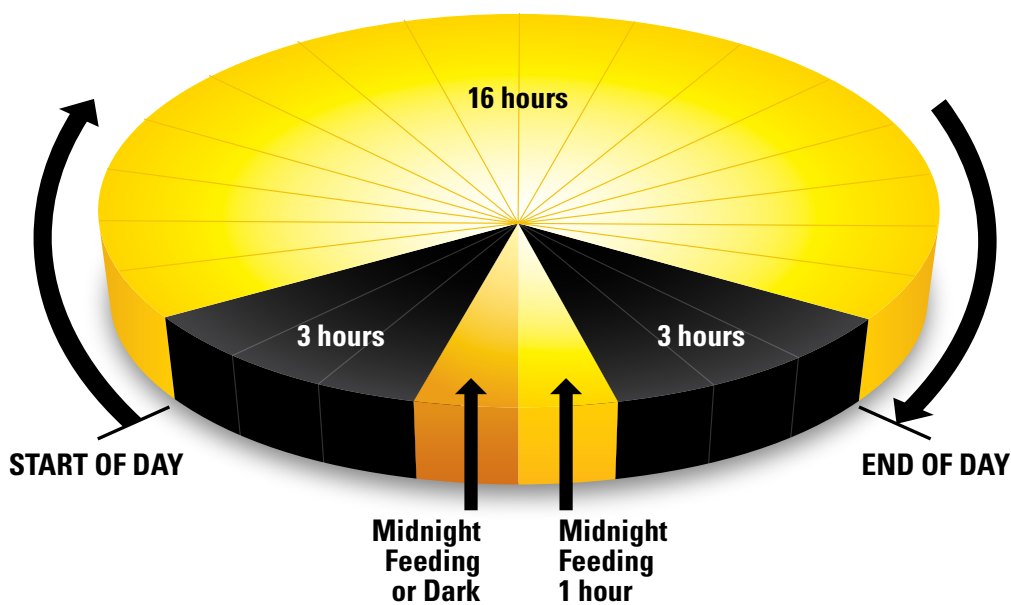

Management Events for Breeders

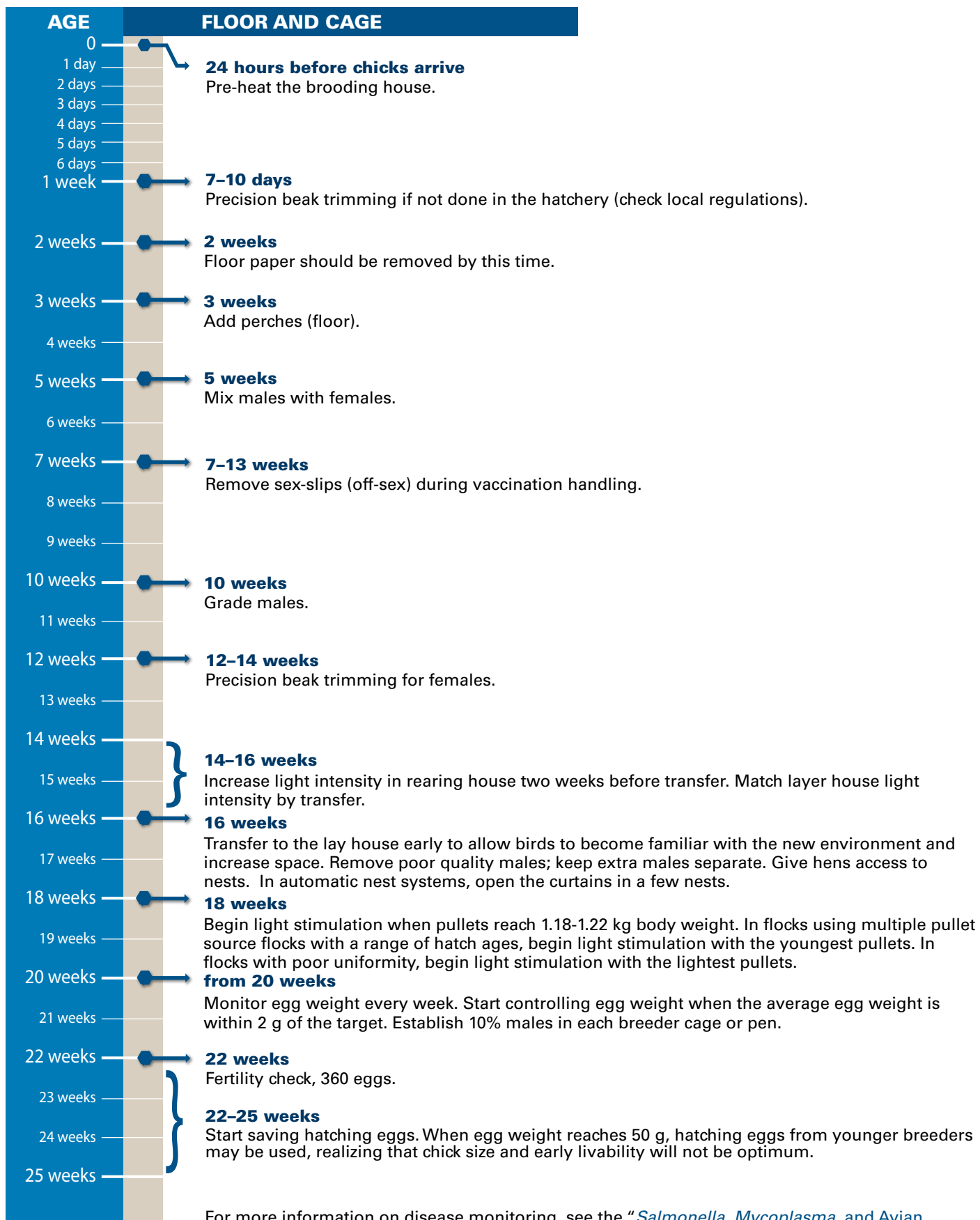

For more information on disease monitoring, see the "[Salmonella, Mycoplasma, and Avian Influenza Monitoring in Parent Breeder Flocks](http://www.hyline.com)" technical update at www.hyline.com.

Management Events for Breeders

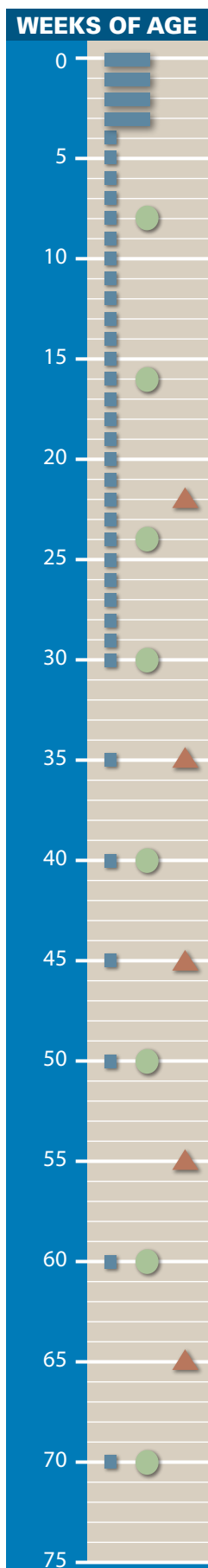

AGES OF BODY WEIGHT MEASUREMENTS

Arrival

- Check body weights.

0–3 weeks

- Bulk weigh 10 boxes of 10 chicks.

4–29 weeks

- Weigh 100 birds individually every week.
- If caged, weigh birds in the same cages each time for best accuracy.
- Calculate uniformity.

30–50 weeks

- Weigh 100 birds individually every 5 weeks.
- If caged, weigh birds in the same cages each time for best accuracy.
- Calculate uniformity.

Over 50 weeks

- Weigh 100 birds individually every 10 weeks.
- If caged, weigh birds in the same cages each time for best accuracy.
- Calculate uniformity.

CALCULATING UNIFORMITY

- Use individual bird weights.
- Uniformity calculation tool is available at www.hylinebodyweight.com.

When handling birds for body weights, assess:

- Keel bone—straightness and firmness
- Breast muscle score
- Body fat
- External parasites
- Clinical symptoms of disease

AGES OF SERA COLLECTION

For more information, see the "[Proper Collection and Handling of Diagnostic Samples](#)" technical update at www.hyline.com.

Collect 25 sera samples per flock for titer determination.

8 weeks

- Assess early vaccination technique and disease exposure for IB, NDV, MG, MS, IBD.

14–16 weeks or at transfer

- Verify that the flock is antibody negative for *Salmonella pullorum*.
- Verify flock is antibody positive for CAV and AE; if negative, revaccinate and retest until positive (do not use hatching eggs until flock is antibody positive).
- Assess possible change in disease exposure.

24 weeks

- Collect sera at least 4 weeks after final inactivated vaccination to measure post-vaccination antibody response.
- It is useful to assess response to inactivated vaccine and / or disease challenge after transfer to lay farm.

AGES OF FERTILITY CHECKS

Bird Handling—BE GENTLE

- Proper handling of birds during body weight measurements, blood collection, selection, vaccination, and transfer will reduce bird stress and prevent injuries.
- Hold birds by both legs or both wings.
- Return birds to floor or cage gently.
- Use experienced personnel that have been trained in proper procedures of bird handling.
- Continually observe crews for proper handling.



Hold no more than three birds in one hand.



Correct way to hold birds when placing or removing from cage.

Hatching Egg Care

- Hy-Line W-36 hatching eggs should weigh a minimum of 50 g from a flock at least 22 weeks of age.
- Eggs from younger flocks may be used, realizing that chick size and early livability will not be optimum.
- Hatch profiles should be optimized based on egg size.
- Hatching eggs should be gathered a minimum of twice daily and more frequently during extremely hot weather.
- Eggs should be in cool storage within 6 hours of laying.
- Eggs should be stored at 15–18°C with relative humidity of 70–80%.
- When necessary to save eggs longer than 10 days, store at 13°C with 70–80% humidity or use SPIDES program. For more information, see the “[SPIDES](#)” technical update at www.hyline.com.
- Best hatches result from eggs 3–7 days of age.
- Store hatching eggs with air cell up (pointed end down).
- Use only eggs laid in nests for hatching.
- Do not use dirty, cracked or malformed eggs for hatching.
- Grade eggs on breeder farm to prevent bringing contaminated eggs to the hatchery.
- Hatching eggs should be sanitized using products specifically developed for this purpose.
- It is extremely important that once eggs are cooled, they are stored at a temperature that does not allow condensation (moisture forming on shell due to exposure to warm humid air).
- The truck taking hatching eggs from farm cooler to hatchery should be capable of keeping eggs cool to avoid condensation.



Unacceptable hatching eggs are dirty, bloody, misshapen, thin-shelled, cracked, or outside the acceptable weight range.



Place hatching eggs onto hatcher trays shortly after arrival at the hatchery. This improves ventilation and proper cooling of eggs for cool storage. Disinfect hatcher trays before placing eggs into cool room.

Fertility Check

FRESH EGG BREAKOUT

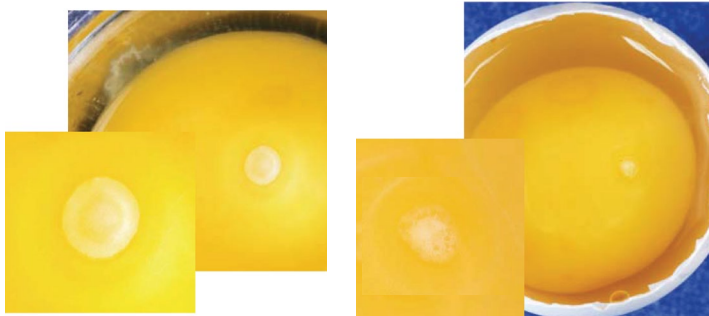

Fertile Egg

Blastoderm is always round (doughnut shaped), 4–5 mm

Infertile Egg

Blastodisc is not round with irregular edges, 2–3 mm

72 HOUR INCUBATION FERTILITY CHECK

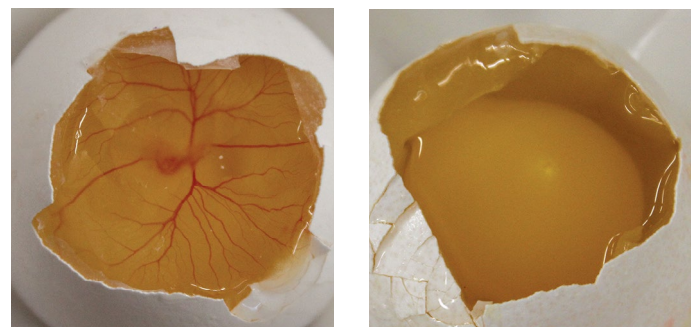

Fertile Egg

Blood vessels develop and embryo becomes visible

Infertile Egg

No development

Fertility checks on fresh eggs can be done to identify cages with low fertility. Poor quality males should be removed and replaced with reserve males.

Incubation and Hatching

- Pre-warm hatching eggs to achieve maximum chick yield and uniformity of hatch time.
 - Warm up eggs to a room temperature of 23–25°C and 55% humidity for 8 to 12 hours.
 - Provide adequate air movement in pre-warming area to reduce condensation and provide uniform temperature to all eggs.
 - In single-stage incubator, use pre-warm setting.
- Under normal conditions Hy-Line W-36 eggs achieve optimum hatch in 21 days and 18 hours.
- Egg age affects hatch time. Allow 1 additional hour of incubation for every day beyond 10 days of egg age.
- Chick weight at hatch is directly related to the weight of the hatching egg, usually approximately 66% of egg weight.
- Eggs should be grouped in setter according to parent source flock. Maintain these groups so similar size chicks may be placed together in the brooder house.



Feather Sexing

Hy-Line W-36 commercial chicks are sexable by their wing feathers. The female commercial chicks show fast feathering (primary wing feathers are longer and thicker than the covert feathers) and male commercial chicks are slow feathering (primary and covert feathers are the same length and thickness). In a small percentage of male chicks covert feathers may be longer than the primary feathers (super slow feathering).

Goal: Sexing errors less than 0.5%

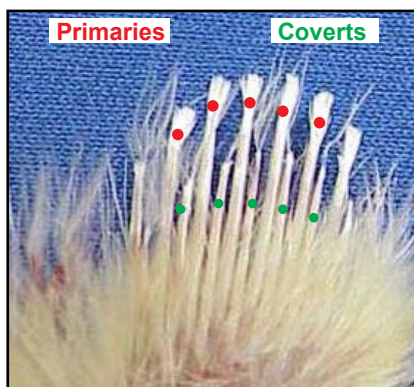

Fast feathering = female chick
 Sight: Coverts are shorter than primaries
 Feel: Coverts are thin and primaries are thick

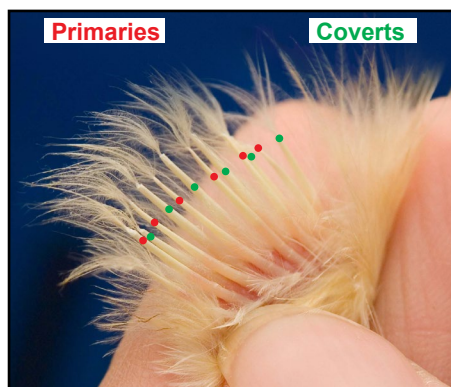

Slow feathering = male chick
 Sight: Coverts and primaries are short and same height
 Feel: Coverts and primaries same thickness

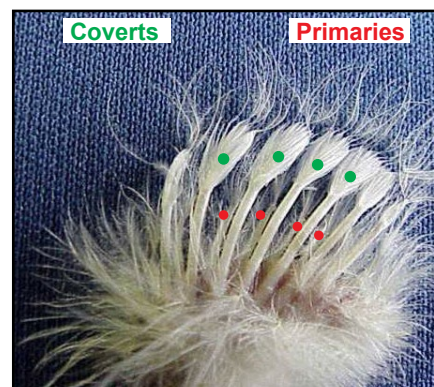

Super slow feathering = male chick
 Sight: Coverts are longer than primary feathers
 Feel: Coverts and primaries same thickness
Occurs in a small number of chicks

The tip of the wing is used for feather sexing

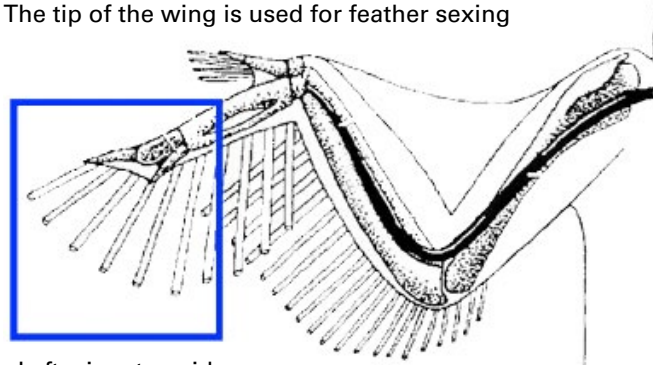

Left wing, top side

Phase Feeding to Meet the Hen's Nutritional Needs

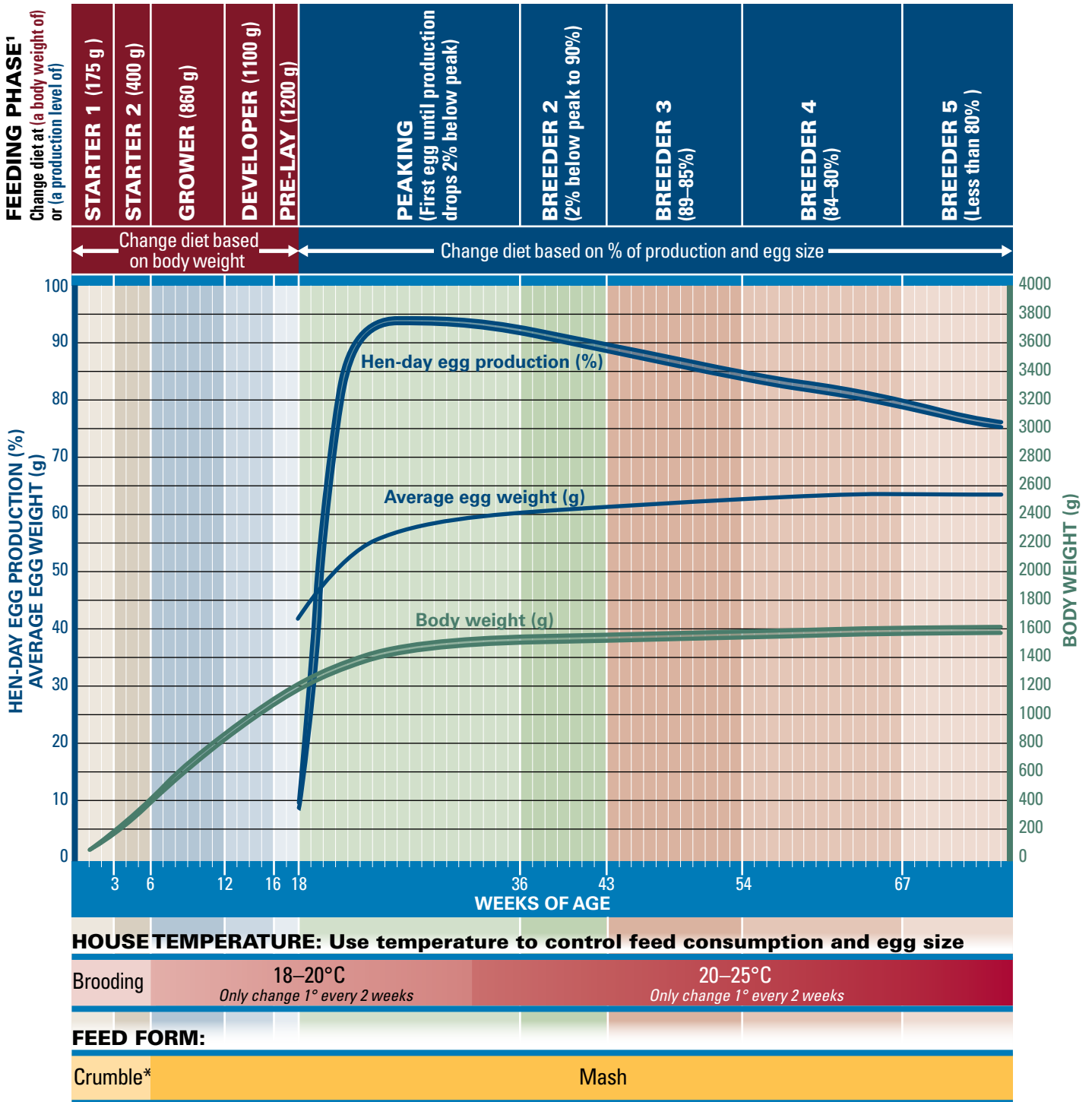

¹ Body weights are approximate. Refer to table on page 12.

* Crumble may be fed longer to encourage body weight gain

Controlling Egg Weight

- Monitor egg weight weekly throughout the life of the flock.
- Egg-weight control is achieved by limiting amino acid and energy consumption.
- Start controlling egg weight when the average egg weight is within 2 g of the target.
- Excessively large hatching eggs are associated with lower hatchability and chick numbers.

Control of Ambient House Temperature

- At housing, an ambient temperature of 18–20°C is desired. Increase house temperature about 1°C every 2 weeks until reaching 25°C, assuming ventilation systems are able to maintain adequate air quality at these temperatures.
- Lower (colder) house temperatures will lead to greater feed intakes and may be counterproductive to egg-weight control, as well as optimal feed efficiency and adult hen body weights.

Rearing Period Nutritional Recommendations

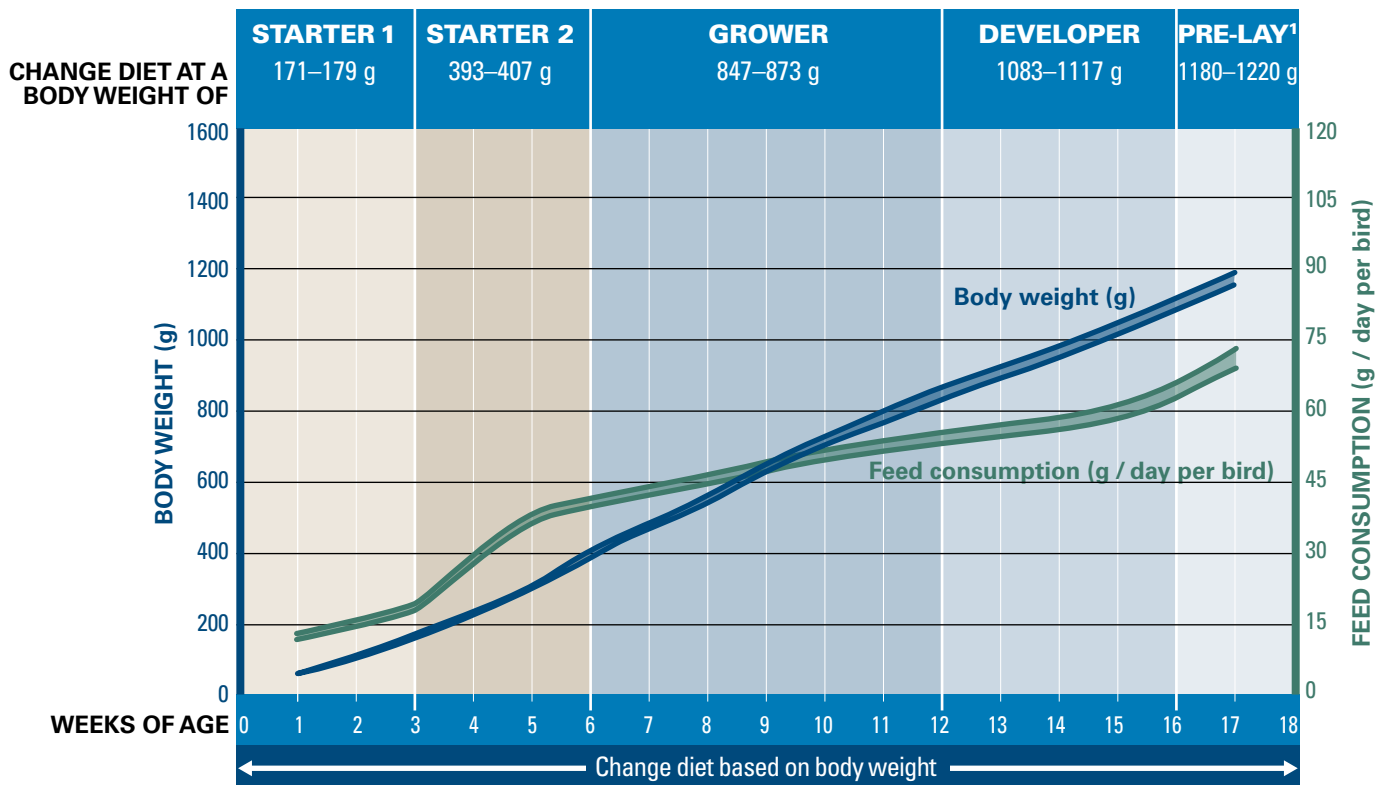

NUTRITION

RECOMMENDED NUTRIENT CONCENTRATION

| | | | | | |
|---|--|-------------|-------------|-------------|-------------|
| Metabolizable energy ² , kcal/kg | 3020–3110 | 3000–3085 | 2975–3065 | 2975–3065 | 2910–2955 |
| Metabolizable energy ² , MJ/kg | 12.65–13.00 | 12.55–12.90 | 12.45–12.85 | 12.45–12.85 | 12.20–12.35 |
| | Standardized Ileal Digestible Amino Acids / Total Amino Acids ³ | | | | |
| Lysine, % | 1.03 / 1.13 | 0.85 / 0.93 | 0.77 / 0.84 | 0.73 / 0.80 | 0.86 / 0.94 |
| Methionine, % | 0.43 / 0.47 | 0.38 / 0.41 | 0.35 / 0.38 | 0.34 / 0.37 | 0.40 / 0.43 |
| Methionine+Cystine, % | 0.68 / 0.77 | 0.64 / 0.72 | 0.59 / 0.66 | 0.58 / 0.65 | 0.71 / 0.80 |
| Threonine, % | 0.67 / 0.79 | 0.56 / 0.66 | 0.52 / 0.61 | 0.50 / 0.58 | 0.60 / 0.71 |
| Tryptophan, % | 0.18 / 0.21 | 0.14 / 0.17 | 0.14 / 0.17 | 0.14 / 0.17 | 0.17 / 0.21 |
| Arginine, % | 1.11 / 1.20 | 0.92 / 0.99 | 0.83 / 0.89 | 0.79 / 0.85 | 0.93 / 1.00 |
| Isoleucine, % | 0.72 / 0.78 | 0.61 / 0.66 | 0.57 / 0.61 | 0.55 / 0.59 | 0.69 / 0.74 |
| Valine, % | 0.74 / 0.82 | 0.63 / 0.69 | 0.60 / 0.66 | 0.58 / 0.64 | 0.73 / 0.81 |
| Crude protein ⁴ , % | 20.00 | 18.00 | 16.00 | 15.50 | 17.50 |
| Calcium ⁵ , % | 1.10 | 1.10 | 1.10 | 1.10 | 2.75 |
| Phosphorus (available) ⁶ , % | 0.50 | 0.49 | 0.47 | 0.46 | 0.50 |
| Sodium, % | 0.18 | 0.18 | 0.18 | 0.18 | 0.18 |
| Chloride, % | 0.18 | 0.18 | 0.18 | 0.18 | 0.18 |
| Linoleic acid (C18:2 n-6) ⁷ , % | 1.00 | 1.00 | 1.00 | 1.00 | 1.00 |

¹ Do not feed Pre-Lay Diet earlier than 15 weeks of age. Do not feed Pre-Lay later than first egg as it contains insufficient calcium to support egg production. Implementing a pre-lay diet can be challenging in mixed-age flocks. If it's not possible to use the Pre-Lay diet, the calcium content of the last stage rearing diet (developer) must be increased to 1.4%.

² Recommended energy range is based on raw material energy values shown in feed ingredient table at back of this guide. It is important that target concentrations of dietary energy are adjusted according to energy system applied to raw material matrix.

³ Recommendation for Total Amino Acids is only appropriate to corn and soybean meal diet. Where diets utilize other ingredients, recommendations for Standardized Ileal Digestible Amino Acids must be followed.

⁴ Diets should always be formulated to provide required intake of amino acid. Concentration of crude protein in diet will vary with raw material used. Crude protein value provided is an estimated typical value only.

⁵ Calcium should be supplied as fine calcium carbonate (mean particle size less than 2 mm). Coarse limestone (2–4 mm) can be introduced in Pre-Lay Diet at up to 50% of total limestone.

⁶ Where other phosphorus systems are used, diets should contain recommended minimum level of available phosphorus.

⁷ Oil levels can be increased to 2.0% in starter diets when given as a mash to control dust and increase feed palatability.

Transition Period from Rear to Peak Egg Production

Frequently formulate to changing feed consumption during transition period until feed consumption is consistent.

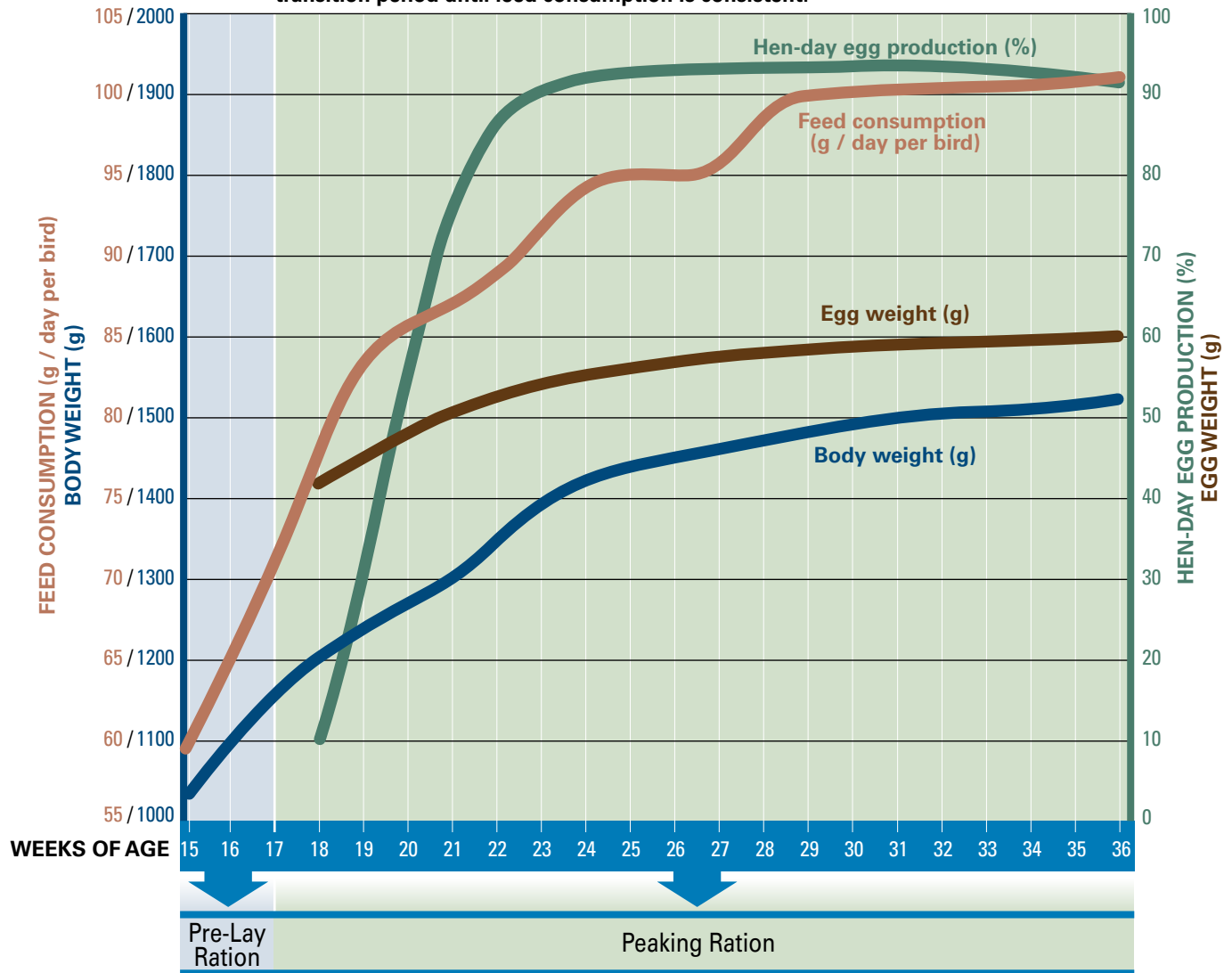

Pre-Lay Ration

- Plan to feed for a maximum of 10–14 days before point of lay.
- Feed when most pullets show reddening of combs.
- It is important to increase medullary bone reserves.
- Begin introducing large particle calcium in Pre-Lay Diet.
- Discontinue pre-lay feeding with the commencement of egg production.

Transition Period

- Occurring during the transition period:
 - Rapidly increasing egg production
 - Increasing egg size
 - Increasing body weight
- Feed consumption may increase slowly during transition:
 - In underweight birds
 - In flocks lacking uniformity
 - During high environmental temperatures
- Poor uniformity prolongs the transition period and may result in low peak and poor persistency of egg production.
- Monitor feed intake carefully during transition and adjust dietary nutrient concentration according to actual feed intakes.

Peaking Ration

- Formulations for low feed intakes (77–88 g/day per bird) should be given as the flock enters egg production to better meet nutrient requirements.
- Begin Peaking Diet with onset of lay (1% egg production).
- Ensure that Peaking Diet is in the feeders when first eggs are laid, not in the feed bin.
- Birds should continue to grow during peaking period. Poor nutrition during this period can lead to loss of body weight and soft bones.
- Feed intake may be reduced if birds are not accustomed to extra large particle calcium (i.e. not using a Pre-Lay Diet).
- Monitor keel bone development during the peaking period. For more information on keel bone scoring, see the “[Understanding the Role of the Skeleton in Egg Production](#)” technical update at www.hyline.com.
- Hy-Line W-36 breeders require early egg weight control through nutrition; egg weight can increase rapidly if uncontrolled.

Production Period Nutritional Recommendations^{1,2}

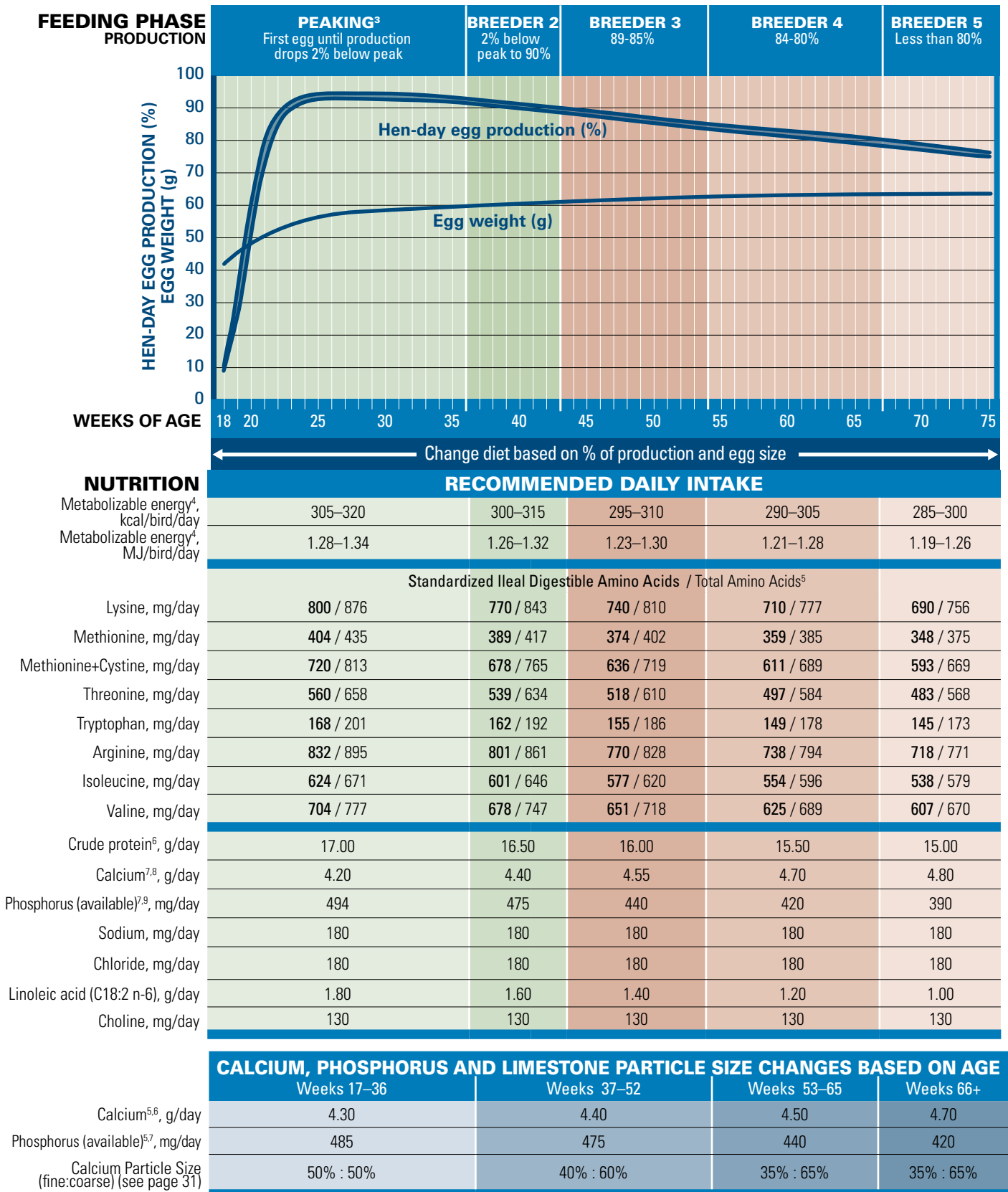

¹ All nutrient requirements are based on the feed ingredient table at the back of this guide.

² Crude protein, methionine+cystine, fat, linoleic acid, and / or energy may be changed to optimize egg size.

³ Peaking nutrient levels are calculated for birds at peak egg production. Prior to achieving peak egg production, the nutrient requirements will be lower.

⁴ A good approximation of the influence of temperature on energy needs is that for each 0.5°C change higher or lower than 22°C, subtract or add about 1.8 kcal/bird/day, respectively.

⁵ Recommendation for Total Amino Acids is only appropriate to corn and soybean meal diet. Where diets utilize other ingredients, recommendations for Standardized Ileal Digestible Amino Acids must be followed.

⁶ Diets should always be formulated to provide required intake of amino acid. Concentration of crude protein in diet will vary with raw material used. Crude protein value provided is an estimated typical value only.

⁷ Calcium and available phosphorus requirements are determined by flock age. When production remains higher and diets are fed for longer than ages shown, it is recommended to increase to calcium and phosphorus concentrations of next feeding phase.

⁸ Calcium carbonate particle size recommendation varies throughout lay. Refer to Calcium Particle Size Table. Dietary calcium levels may need to be adjusted based on limestone solubility.

⁹ Where other phosphorus systems are used, diets should contain recommended minimum level of available phosphorus.

Dietary Nutrient Concentrations for Production Period^{1,2} *(According to Phase and Feed Intake)*

| FEEDING PHASE PRODUCTION | PEAKING ³ First egg until production drops 2% below peak | | | | | BREEDER 2 2% below peak to 85% | | | | | BREEDER 3 84–80% | | | | | BREEDER 4 Less than 80% | | | | |
|---|--|-------|--------------|-------|-------|-----------------------------------|-------|--------------|-------|-------|---------------------|-------|--------------|-------|-------|----------------------------|-------|--------------|-------|-------|
| | NUTRITION | | | | | | | | | | | | | | | | | | | |
| RECOMMENDED CONCENTRATION | | | | | | | | | | | | | | | | | | | | |
| Metabolizable energy ⁴ , kcal/kg | 2822–2910 | | | | | 2822–2910 | | | | | 2822–2910 | | | | | 2822–2910 | | | | |
| Metabolizable energy ⁴ , MJ/kg | 11.84–12.21 | | | | | 11.84–12.21 | | | | | 11.84–12.21 | | | | | 11.84–12.21 | | | | |
| FEED CONSUMPTION (*Typical Feed Consumption) | | | | | | | | | | | | | | | | | | | | |
| g/day per bird | 85 | 90 | 95* | 100 | 105 | 90 | 95 | 100* | 105 | 110 | 95 | 100 | 105* | 110 | 115 | 88 | 93 | 98* | 103 | 108 |
| Standardized Ileal Digestible Amino Acids | | | | | | | | | | | | | | | | | | | | |
| Lysine, % | 0.93 | 0.88 | 0.83 | 0.79 | 0.75 | 0.84 | 0.79 | 0.76 | 0.72 | 0.69 | 0.76 | 0.72 | 0.69 | 0.65 | 0.63 | 0.80 | 0.75 | 0.71 | 0.68 | 0.65 |
| Methionine, % | 0.46 | 0.43 | 0.41 | 0.39 | 0.37 | 0.41 | 0.39 | 0.37 | 0.35 | 0.34 | 0.37 | 0.35 | 0.34 | 0.32 | 0.31 | 0.37 | 0.35 | 0.34 | 0.32 | 0.30 |
| Methionine+Cystine, % | 0.73 | 0.69 | 0.66 | 0.62 | 0.59 | 0.65 | 0.62 | 0.59 | 0.56 | 0.54 | 0.58 | 0.55 | 0.52 | 0.50 | 0.48 | 0.60 | 0.57 | 0.54 | 0.52 | 0.49 |
| Threonine, % | 0.65 | 0.61 | 0.58 | 0.55 | 0.53 | 0.59 | 0.56 | 0.53 | 0.50 | 0.48 | 0.53 | 0.50 | 0.48 | 0.46 | 0.44 | 0.56 | 0.53 | 0.50 | 0.48 | 0.45 |
| Tryptophan, % | 0.20 | 0.18 | 0.17 | 0.17 | 0.16 | 0.18 | 0.17 | 0.16 | 0.15 | 0.14 | 0.16 | 0.15 | 0.14 | 0.14 | 0.13 | 0.17 | 0.16 | 0.15 | 0.14 | 0.14 |
| Arginine, % | 0.99 | 0.94 | 0.89 | 0.85 | 0.80 | 0.90 | 0.85 | 0.81 | 0.77 | 0.73 | 0.81 | 0.77 | 0.73 | 0.70 | 0.67 | 0.85 | 0.81 | 0.76 | 0.73 | 0.69 |
| Isoleucine, % | 0.73 | 0.69 | 0.66 | 0.62 | 0.59 | 0.66 | 0.63 | 0.60 | 0.57 | 0.54 | 0.60 | 0.57 | 0.54 | 0.52 | 0.49 | 0.63 | 0.59 | 0.56 | 0.54 | 0.51 |
| Valine, % | 0.83 | 0.78 | 0.74 | 0.70 | 0.67 | 0.75 | 0.71 | 0.67 | 0.64 | 0.61 | 0.67 | 0.64 | 0.61 | 0.58 | 0.56 | 0.71 | 0.67 | 0.64 | 0.60 | 0.58 |
| Total Amino Acids ⁵ | | | | | | | | | | | | | | | | | | | | |
| Lysine, % | 1.02 | 0.96 | 0.91 | 0.87 | 0.82 | 0.92 | 0.87 | 0.83 | 0.79 | 0.75 | 0.83 | 0.79 | 0.75 | 0.72 | 0.69 | 0.87 | 0.82 | 0.78 | 0.74 | 0.71 |
| Methionine, % | 0.49 | 0.46 | 0.44 | 0.42 | 0.40 | 0.44 | 0.42 | 0.40 | 0.38 | 0.36 | 0.40 | 0.38 | 0.36 | 0.34 | 0.33 | 0.40 | 0.38 | 0.36 | 0.34 | 0.33 |
| Methionine+Cystine, % | 0.83 | 0.78 | 0.74 | 0.70 | 0.67 | 0.74 | 0.70 | 0.66 | 0.63 | 0.60 | 0.65 | 0.62 | 0.59 | 0.56 | 0.54 | 0.68 | 0.65 | 0.61 | 0.58 | 0.56 |
| Threonine, % | 0.77 | 0.72 | 0.69 | 0.65 | 0.62 | 0.69 | 0.65 | 0.62 | 0.59 | 0.57 | 0.62 | 0.59 | 0.56 | 0.54 | 0.52 | 0.65 | 0.62 | 0.59 | 0.56 | 0.53 |
| Tryptophan, % | 0.23 | 0.22 | 0.21 | 0.20 | 0.19 | 0.21 | 0.20 | 0.19 | 0.18 | 0.17 | 0.19 | 0.18 | 0.17 | 0.16 | 0.16 | 0.20 | 0.19 | 0.18 | 0.17 | 0.16 |
| Arginine, % | 1.07 | 1.01 | 0.96 | 0.91 | 0.87 | 0.97 | 0.91 | 0.87 | 0.83 | 0.79 | 0.87 | 0.83 | 0.79 | 0.75 | 0.72 | 0.91 | 0.87 | 0.82 | 0.78 | 0.75 |
| Isoleucine, % | 0.79 | 0.75 | 0.71 | 0.67 | 0.64 | 0.71 | 0.67 | 0.64 | 0.61 | 0.58 | 0.64 | 0.61 | 0.58 | 0.56 | 0.53 | 0.68 | 0.64 | 0.61 | 0.58 | 0.55 |
| Valine, % | 0.91 | 0.86 | 0.82 | 0.78 | 0.74 | 0.82 | 0.78 | 0.74 | 0.71 | 0.67 | 0.74 | 0.71 | 0.67 | 0.64 | 0.61 | 0.78 | 0.74 | 0.70 | 0.67 | 0.64 |
| Crude protein ⁶ , % | 18.82 | 17.78 | 16.84 | 16.00 | 15.24 | 17.22 | 16.32 | 15.50 | 14.76 | 14.09 | 16.05 | 15.25 | 14.52 | 13.86 | 13.26 | 17.05 | 16.13 | 15.31 | 14.56 | 13.89 |
| Sodium, % | 0.21 | 0.20 | 0.19 | 0.18 | 0.17 | 0.20 | 0.19 | 0.18 | 0.17 | 0.16 | 0.19 | 0.18 | 0.17 | 0.16 | 0.16 | 0.20 | 0.19 | 0.18 | 0.17 | 0.17 |
| Chloride, % | 0.21 | 0.20 | 0.19 | 0.18 | 0.17 | 0.20 | 0.19 | 0.18 | 0.17 | 0.16 | 0.19 | 0.18 | 0.17 | 0.16 | 0.16 | 0.20 | 0.19 | 0.18 | 0.17 | 0.17 |
| Linoleic acid (C18:2 n-6), % | 1.18 | 1.11 | 1.05 | 1.00 | 0.95 | 1.11 | 1.05 | 1.00 | 0.95 | 0.91 | 1.05 | 1.00 | 0.95 | 0.91 | 0.87 | 1.14 | 1.08 | 1.02 | 0.97 | 0.93 |
| CALCIUM, PHOSPHORUS AND LIMESTONE PARTICLE SIZE CHANGES BASED ON AGE | | | | | | | | | | | | | | | | | | | | |
| | Weeks 17–36 | | | | | Weeks 37–52 | | | | | Weeks 53–65 | | | | | Weeks 66+ | | | | |
| | 85 | 90 | 95 | 100 | 105 | 90 | 95 | 100 | 105 | 110 | 95 | 100 | 105 | 110 | 115 | 88 | 93 | 98 | 103 | 108 |
| Feed Consumption, g/day per bird | 5.06 | 4.78 | 4.53 | 4.30 | 4.10 | 4.89 | 4.63 | 4.40 | 4.19 | 4.00 | 4.74 | 4.50 | 4.29 | 4.09 | 3.91 | 5.34 | 5.05 | 4.80 | 4.56 | 4.35 |
| Calcium ^{7,8} , % | 0.57 | 0.54 | 0.51 | 0.49 | 0.46 | 0.53 | 0.50 | 0.48 | 0.45 | 0.43 | 0.46 | 0.44 | 0.42 | 0.40 | 0.38 | 0.48 | 0.45 | 0.43 | 0.41 | 0.39 |
| Phosphorus (available) ^{7,9} , % | 50% : 50% | | | | | 40% : 60% | | | | | 35% : 65% | | | | | 35% : 65% | | | | |
| Calcium Particle Size (fine:coarse) (see page 31) | | | | | | | | | | | | | | | | | | | | |

¹ All nutrient requirements are based on the feed ingredient table at the back of this guide.
² Crude protein, methionine+cystine, fat, linoleic acid, and / or energy may be changed to optimize egg size.
³ Peaking nutrient levels are calculated for birds at peak egg production. Prior to achieving peak egg production, the nutrient requirements will be lower.
⁴ A good approximation of the influence of temperature on energy needs is that for each 0.5°C change higher or lower than 22°C, subtract or add about 1.8 kcal /bird /day, respectively.
⁵ Recommendation for Total Amino Acids is only appropriate to corn and soybean meal diet. Where diets utilize other ingredients, recommendations for Standardized Ileal Digestible Amino Acids must be followed.
⁶ Diets should always be formulated to provide required intake of amino acid. Concentration of crude protein in diet will vary with raw material used. Crude protein value provided is an estimated typical value only.
⁷ Calcium and available phosphorus requirements are determined by flock age. When production remains higher and diets are fed for longer than ages shown, it is recommended to increase to calcium and phosphorus concentrations of next feeding phase.
⁸ Calcium carbonate particle size recommendation varies throughout lay. Refer to Calcium Particle Size Table. Dietary calcium levels may need to be adjusted based on limestone solubility.
⁹ Where other phosphorus systems are used, diets should contain recommended minimum level of available phosphorus.

Water Consumption

Water Consumed / 100 Birds per Day

| AGE IN WEEKS | LITERS |
|--------------|-----------|
| 1-3 | 0.8-2.7 |
| 4-6 | 2.5-5.7 |
| 7-9 | 5.7-9.5 |
| 10-15 | 6.8-10.2 |
| 16-20 | 7.2-15.2 |
| 21-25 | 9.9-18.2 |
| 25+ | 15.2-20.8 |

The chart shows an expected range of water consumption at normal environmental temperatures of 21-27°C. As environmental temperature increases above this range, water consumption may increase up to double amounts shown.



Air Quality

Air Movement (m³ / hour per 1000 birds)

| AMBIENT TEMPERATURE (°C) | WEEKS OF AGE | | | | | |
|--------------------------|--------------|-----|------|------|------|-----------|
| | 1 | 3 | 6 | 12 | 18 | 19+ |
| 32 | 340 | 510 | 1020 | 2550 | 5950 | 4650-9350 |
| 21 | 170 | 255 | 510 | 1275 | 2550 | 4250-5100 |
| 10 | 120 | 170 | 340 | 680 | 1870 | 2550-3400 |
| 0 | 70 | 130 | 230 | 465 | 1260 | 850-1300 |
| -12 | 70 | 100 | 170 | 340 | 500 | 600-850 |
| -23 | 70 | 100 | 170 | 340 | 500 | 600-680 |

Acknowledgment: Dr. Hongwei Xin, Professor, Department of Agriculture and Biosystems Engineering and Department of Animal Science, Iowa State University, Ames, Iowa, USA

- Production house should be at 18-25°C and 40-60% humidity.
- The general rule for determining required fan capacity—4 m³ of air movement / kilogram of body weight per hour.
- Ventilation is essential to:
 - Remove moisture from house
 - Remove excessive heat
 - Provide each bird with an adequate supply of oxygen
 - Remove carbon dioxide produced by birds
 - Remove dust particles
 - Dilute aerosolized pathogenic organisms
- Allowable levels of gases at floor level in the house are: ammonia (NH₃) < 25 ppm; carbon dioxide (CO₂) < 5000 ppm; carbon monoxide (CO) < 50 ppm.

Calcium Particle Size

| PARTICLE SIZE | STARTER, GROWER, DEVELOPER | PRE-LAY | WEEKS 17-36 | WEEKS 37-52 | WEEKS 53+ |
|-----------------|----------------------------|---------|-------------|-------------|-----------|
| Fine (0-2 mm) | 100% | 50% | 50% | 40% | 35% |
| Coarse (2-4 mm) | – | 50% | 50% | 60% | 65% |

- Appropriate particle size depends on the solubility of limestone.
- Dietary calcium levels may need to be adjusted based on limestone solubility.
- Limestone dark in color is geologically older, containing more impurities (typically magnesium) and is generally lower in solubility and calcium availability.
- Oyster shell and other marine shells are good sources of soluble calcium.

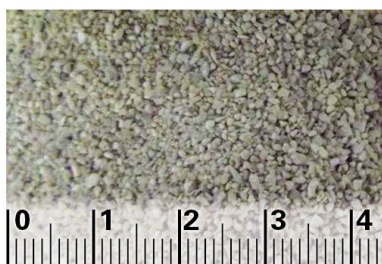

Fine calcium (0-2 mm)



Coarse calcium (2-4 mm)

Photos courtesy of Longcliff Quarries Ltd.

Feed Particle Size

A sieve shaker separates feed sample into categories based on particle size.

- Use on the farm to check feed particle size from the feed mill—sample taken on delivery or from feed bins.
- Use to assess the uniformity of feed particle size throughout the feeding system—samples are taken from various points.

Too many fine feed particles:

- Feed intake and nutrient absorption decreases
- Dust in house increases

Too many coarse feed particles:

- Birds selectively eat large particles
- Risk of feed separation increases

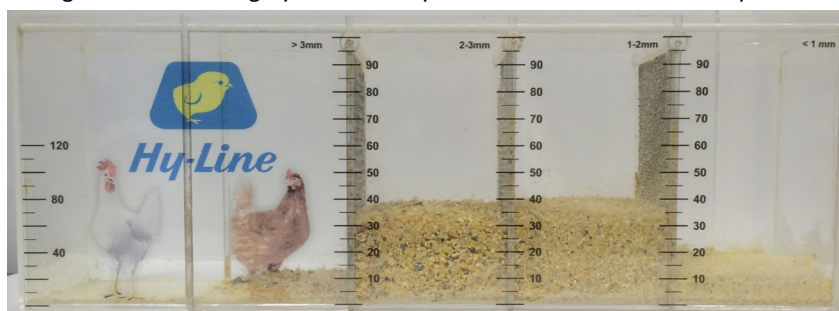

OPTIMAL FEED PARTICLE PROFILE

Hy-Line Sieve Shaker

| PARTICLE SIZE | STARTER | GROWER | DEVELOPER | PRODUCTION |
|---------------|--|--------|-----------|------------|
| < 1 mm | 1–3 mm diameter, crumble feed should contain < 10% fine feed particles | < 15% | < 15% | < 15% |
| 1–2 mm | | 45–60% | 25–35% | 20–30% |
| 2–3 mm | | 10–25% | 25–40% | 30–40% |
| > 3 mm | | – | 5–10% | 10–15% |

For more information, see the “[Feed Granulometry](#)” technical update at www.hyline.com.

Best Practices

- A 3–4 hour gap between mid-day feedings allows birds to consume fine particles.
- Add a minimum of 0.5% liquid oil / fat in meal diets to incorporate and retain small particles in feed.
- Use larger particle size meal or crumble to increase intakes in hot climates.

Vitamins and Trace Minerals

- As the vitamin / trace mineral premix is often found in fine feed particles, a minimum level of 0.5% added liquid oil / fat in meal diets binds small particles in feed.
- Manage feeders to allow birds to consume fine particles during mid-day.

| ITEM ^{1,2,3,4} | IN 1000 KG COMPLETE DIET | |
|---|--------------------------|-------------------|
| | Rearing Period | Production Period |
| Vitamin A, IU | 10,000,000 | 12,000,000 |
| Vitamin D ₃ ⁵ , IU | 3,300,000 | 4,400,000 |
| Vitamin E, g | 30.00 | 85.00 |
| Vitamin K (menadione), g | 4.00 | 5.00 |
| Thiamin (B ₁), g | 3.00 | 4.00 |
| Riboflavin (B ₂), g | 8.00 | 15.00 |
| Niacin (B ₃) ⁶ , g | 50.00 | 65.00 |
| Pantothenic acid (B ₅), g | 13.00 | 21.00 |
| Pyridoxine (B ₆), g | 6.00 | 7.00 |
| Biotin (B ₇), mg | 120.00 | 350.00 |
| Folic acid (B ₉), g | 1.20 | 3.00 |
| Cobalamin (B ₁₂), mg | 30.00 | 35.00 |
| Manganese ⁷ , g | 105.00 | 115.00 |
| Zinc ⁷ , g | 100.00 | 115.00 |
| Iron ⁷ , g | 35.00 | 75.00 |
| Copper ⁷ , g | 20.00 | 23.00 |
| Magnesium ⁷ , g | 600.00 | 500.00 |
| Iodine, g | 2.00 | 3.00 |
| Selenium ⁷ , g | 0.30 | 0.35 |

¹ Minimum recommendations for rearing and laying periods. Local regulations may limit dietary content of individual vitamins or minerals. Levels of 150-200mg/kg of Vitamin C can be beneficial during periods of stress.

² Store premixes according to supplier's recommendations and observe 'use by' dates to ensure vitamin activity is maintained. Inclusion of antioxidant may improve premix stability.

³ Vitamin and mineral recommendations vary according to activity.

⁴ Where heat treatment is applied to diet, higher levels of vitamins may be required. Consult with vitamin supplier regarding stability through individual production processes.

⁵ A proportion of Vitamin D₃ can be supplemented as 25-hydroxy D₃ according to supplier's recommendations and applicable limits.

⁶ Higher levels of Niacin are recommended in non-cage systems.

⁷ Greater bioavailability and productivity may be possible with use of chelated mineral sources.

Water Quality

- Water is the most important nutrient. Good quality water must be available to birds at all times.
- Water and feed consumption are directly related—when birds drink less, they consume less feed and production quickly declines.
- As a general rule, healthy birds will consume 1.5–2.0 times more water than feed. This ratio increases in high ambient temperatures.
- Test water quality at least 1 time per year. The water source will determine the regularity of water testing.
 - Surface water requires more frequent testing, as it is more affected by season and rainfall patterns.
 - Closed wells taking water from aquifers or deep artesian basins will be more consistent in water quality, but are generally higher in dissolved mineral content.
- The presence of coliform bacteria is an indicator that the water source has been contaminated with animal or human waste.
- When collecting a well water sample, let the water run for 2 minutes prior to collecting the sample. Water samples should be kept below 10°C and submitted to the lab in less than 24 hours.
- Some water sources contain high levels of dissolved minerals such as calcium, sodium and magnesium. When this occurs, amounts of these minerals in water have to be considered when formulating feed.
- Ideal water pH is 5–7 to promote good water sanitation, increase feed consumption and improve upper gastrointestinal health.
- Less than optimum water quality can have a significant impact on intestinal health, which will lead to under utilization of nutrients in feed.
- Reduced flock water consumption is often the first sign of health problems and production drops.

| ITEM | MAXIMUM CONCENTRATION (ppm or mg/L)* | |
|--|--------------------------------------|--|
| Nitrate NO ₃ ⁻¹ | 25 | Older birds will tolerate higher levels up to 20 ppm. Stressed or diseased challenged birds may be more sensitive to effects of Nitrate. |
| Nitrate Nitrogen (NO ₃ -N) ¹ | 6 | |
| Nitrite NO ₂ ⁻¹ | 4 | Nitrite is considerably more toxic than Nitrate, especially for young birds where 1 ppm Nitrite may be considered toxic. |
| Nitrite Nitrogen (NO ₂ -N) ¹ | 1 | |
| Total dissolved solids ² | 1000 | Levels up to 3000 ppm may not affect performance but could increase manure moisture. |
| Chloride (Cl) ¹ | 250 | Levels as low as 14 mg may be problematic if sodium is higher than 50 ppm. |
| Sulfate (SO ₄) ¹ | 250 | Higher levels may be laxative. |
| Iron (Fe) ¹ | <0.3 | Higher levels result in bad odor and taste. |
| Magnesium (Mg) ¹ | 125 | Higher levels may be laxative. Levels above 50 ppm may be problematic if sulphate levels are high. |
| Potassium (K) ² | 20 | Higher levels may be acceptable depending on sodium level, alkalinity and pH. |
| Sodium (Na) ^{1,2} | 50 | Higher concentration acceptable but concentrations above 50 ppm should be avoided if high levels of chloride, sulphate or potassium exist. |
| Manganese (Mn) ³ | 0.05 | Higher levels may be laxative. |
| Arsenic (As) ² | 0.5 | |
| Fluoride (F ⁻) ² | 2 | |
| Aluminum (Al) ² | 5 | |
| Boron (B) ² | 5 | |
| Cadmium (Cd) ² | 0.02 | |
| Cobalt (Co) ² | 1 | |
| Copper (Cu) ¹ | 0.6 | Higher levels result in bitter taste. |
| Lead (Pb) ¹ | 0.02 | Higher levels are toxic. |
| Mercury (Hg) ² | 0.003 | Higher levels are toxic. |
| Zinc (Zn) ¹ | 1.5 | Higher levels are toxic. |
| pH ¹ | 5–7 | Birds may adapt to lower pH. Below pH 5 may reduce water intake and corrode metal fittings. Above pH 8 may reduce intake and reduce effectiveness of water sanitation. |
| Total bacteria counts ³ | 1000 CFU/ml | Likely to indicate dirty water. |
| Total Coliform bacteria ³ | 50 CFU/ml | |
| Fecal Coliform bacteria ³ | 0 CFU/ml | |
| Oxygen Reduction Potential (ORP) ³ | 650–750 mEq | The ORP range at which 2–4 ppm of free chlorine will effectively sanitize water at a favorable pH range of 5–7. |

*Limits may be lower as interactions exist between magnesium and sulphate; and between sodium, potassium, chloride and sulphate.

¹ Carter and Sneed, 1996. Drinking Water Quality for Poultry, Poultry Science and Technology Guide, North Carolina State University Poultry Extension Service. Guide no. 42

² Marx & Jaikaran, 2007. Water Analysis Interpretation. Agri-Facts, Alberta Ag-Info Centre. Refer to <http://www.agric.gov.ab.ca/app84/rwqit> for online Water Analysis Tool

³ Watkins, 2008. Water: Identifying and correcting challenges. Avian Advice 10(3): 10–15 University of Arkansas Cooperative Extension Service, Fayetteville

Disease Control

A flock of pullets or layers can only perform up to its genetic potential when disease influence is minimized. The diseases of economic importance vary widely between locations, but in every case the challenge is to identify and control those diseases.

Biosecurity

Biosecurity is the best method of avoiding diseases. A good biosecurity program identifies and controls the most likely ways a disease could enter the farm.

- Human and equipment movement onto the farm should be strictly controlled.
- Visitors to the farm should be limited to those essential for its operation.
- Visits should be documented in a logbook.
- All visitors and workers should shower at a central location before entering.
- Clean boots, clothing and head cover should be provided for workers and visitors.
- Clean footbaths containing disinfectant should be placed outside entries to all poultry houses.
- If possible, avoid using outside crews or equipment for vaccination, moving, and beak trimming.
- Ideally, workers should be limited to a single house.
- For those visiting a number of flocks, flocks visited on one day should be limited. Always progress from younger to older and from healthy to sick flocks. After visiting a sick flock, no other houses should be entered.
- Removal of flocks from the farm is an opportunity for disease to be introduced, as trucks and crews have often been on other farms.
- A single-aged rearing farm using an all-in, all-out principle is best to prevent transmission of disease from older flocks to younger, susceptible flocks.
- Houses should be designed to prevent exposure to wild birds, insects and rodents.
- Quickly and properly dispose of dead chickens.

Rodents

Rodents are known carriers of many poultry diseases and the most common reason for re-contamination of a cleaned and disinfected poultry facility. They are also responsible for house-to-house spread of disease on a farm.

- The farm should be free of debris and tall grass that provide a hiding area for rodents.
- The perimeter of each house should have a 1 m wide area of crushed rock or concrete to prevent rodents from burrowing into the house.
- Feed and eggs should be stored in rodent-proof areas.
- Bait stations should be placed throughout the house and maintained with fresh rodenticide.

Cleaning and Disinfection

Cleaning and disinfection of the house between flocks reduces infection pressure for the next flock.

- Allow a minimum of 2 weeks downtime between flocks.
- All feed and manure should be removed from the house before cleaning.
- Thoroughly clean air inlets, fan housing, fan blades and fan louvers.
- Heating the house during washing improves the removal of organic matter.

- The house should be cleaned of organic matter with a high-pressure spray of warm water.
- Use foam / gel detergent to soak into organic matter and equipment.
- Wash the upper portion of the house before the pit.
- Use high pressure warm water to rinse.
- Allow the house to dry.
- After it is fully dry, apply foam / spray disinfectant followed by fumigation.
- Flush and sanitize water lines.
- Monitoring of poultry houses for presence of Salmonella, particularly *Salmonella enteritidis*, by routine environmental testing is recommended.
- Allow the house to dry before repopulating.

Vertically Transmitted Diseases

- Some diseases are known to be transmitted from infected breeders to progeny.
- Disease-free breeders are the first step in control of these diseases for commercial layers.
- All breeders directly under Hy-Line International's control are free of lymphoid leukosis, *Mycoplasma gallisepticum*, *Mycoplasma synoviae*, *Salmonella pullorum*, *Salmonella gallinarum*, *Salmonella enteritidis*, *Salmonella typhimurium* and other Salmonella species.
- Due to the possibility of horizontal transmission of these diseases, later generations may not remain free.
- It is the responsibility of breeding and commercial flock owners to prevent horizontal transmission of these diseases and to continue testing to be assured of a negative status.



COCCIDIA

This parasitic infection of the intestines may lead to gut damage and, in severe infestations, death. More commonly, poor control of sub-clinical infection reduces feed conversion or leaves pullets with chronic, irreversible gut damage. Pullet flocks may be uneven or underweight at housing and not perform to their full potential in lay. Control of coccidia includes the following measures (check local regulations):

- Use ionophores or chemicals on a step-down program to ensure immunity in pullets.
- Live vaccine use is an alternative to anti-coccidial drug treatments.
- Live vaccines are available that can be administered by spray in the hatchery or by feed or water application during the first few days in the brooder house.
- Control of flies and beetles, which are vectors of coccidial spread.
- Thorough cleaning and disinfection of houses reduces challenge pressure.
- Maintenance of dry litter reduces coccidia oocyst sporulation.

Vaccination Recommendations

Vaccination

Certain diseases are too widespread or difficult to eradicate and require a routine vaccination program. In general, all layer flocks should be vaccinated against Marek's disease, Newcastle disease (NDV), infectious bronchitis (IB), infectious bursal disease (IBD or Gumboro), chicken anemia virus (CAV), avian encephalomyelitis (AE) and fowl pox. Other vaccinations are added to the program as local disease challenges dictate.

A single program cannot be recommended for all regions. Follow label instructions provided by the vaccine manufacturer. Use only approved vaccines. Consult with local veterinarians to determine the best vaccination program for your area.

BASIC BREEDER VACCINE APPLICATIONS

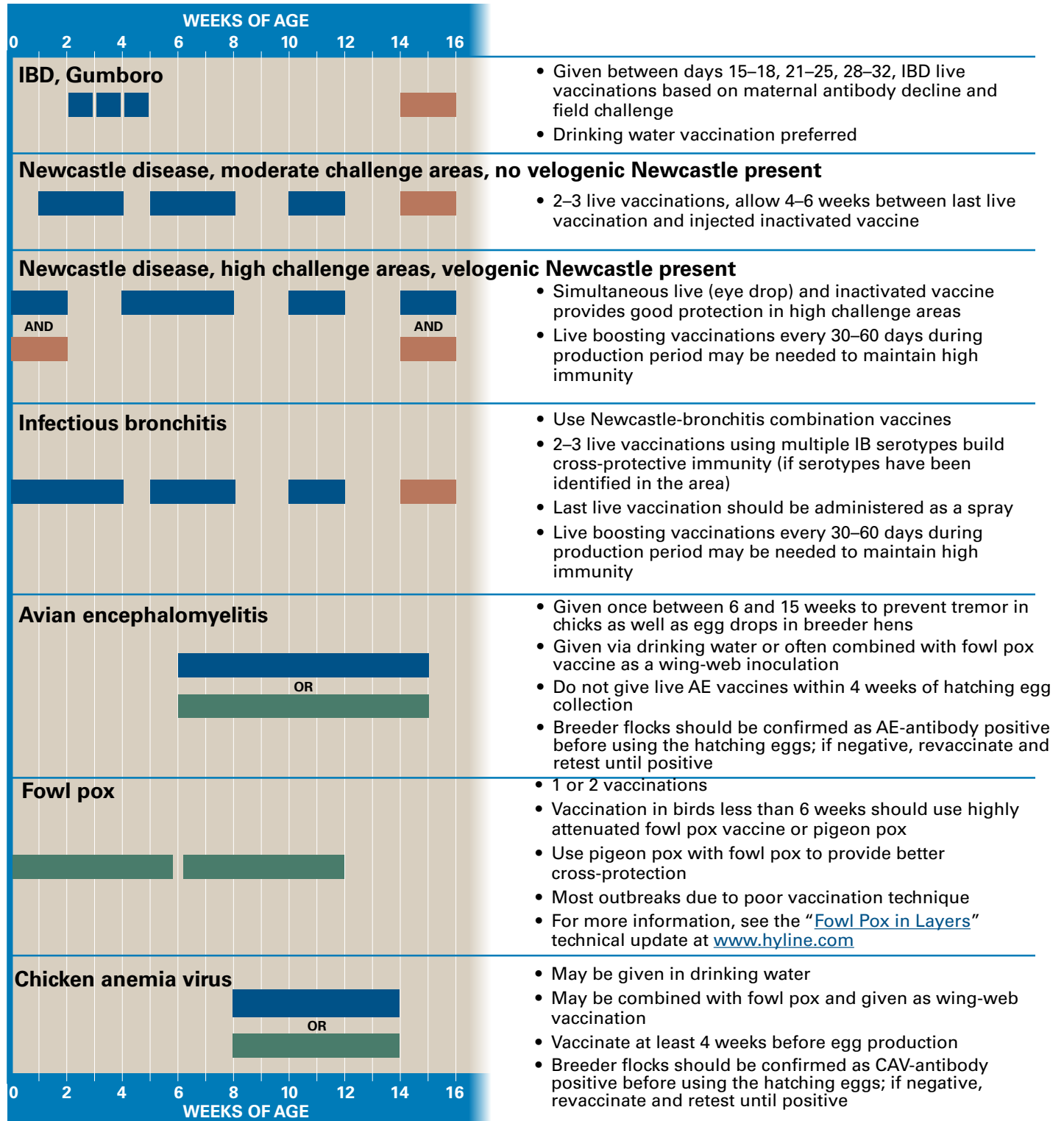

| | |
|---|--|
| Live hatchery vaccines, given subcutaneous | Live vaccines, administered via wing-web inoculation |
| Live vaccines, administered by drinking water, spray or eyedrop | Inactivated vaccines, injected via intramuscular or subcutaneous route |

Vaccination Recommendations *(continued)*

OPTIONAL BREEDER VACCINE APPLICATIONS

Use if these diseases are prevalent in the area. Follow label instructions provided by the vaccine manufacturer. Use only approved vaccines. Consult a local veterinarian for advice in designing an effective vaccination program for your farm.

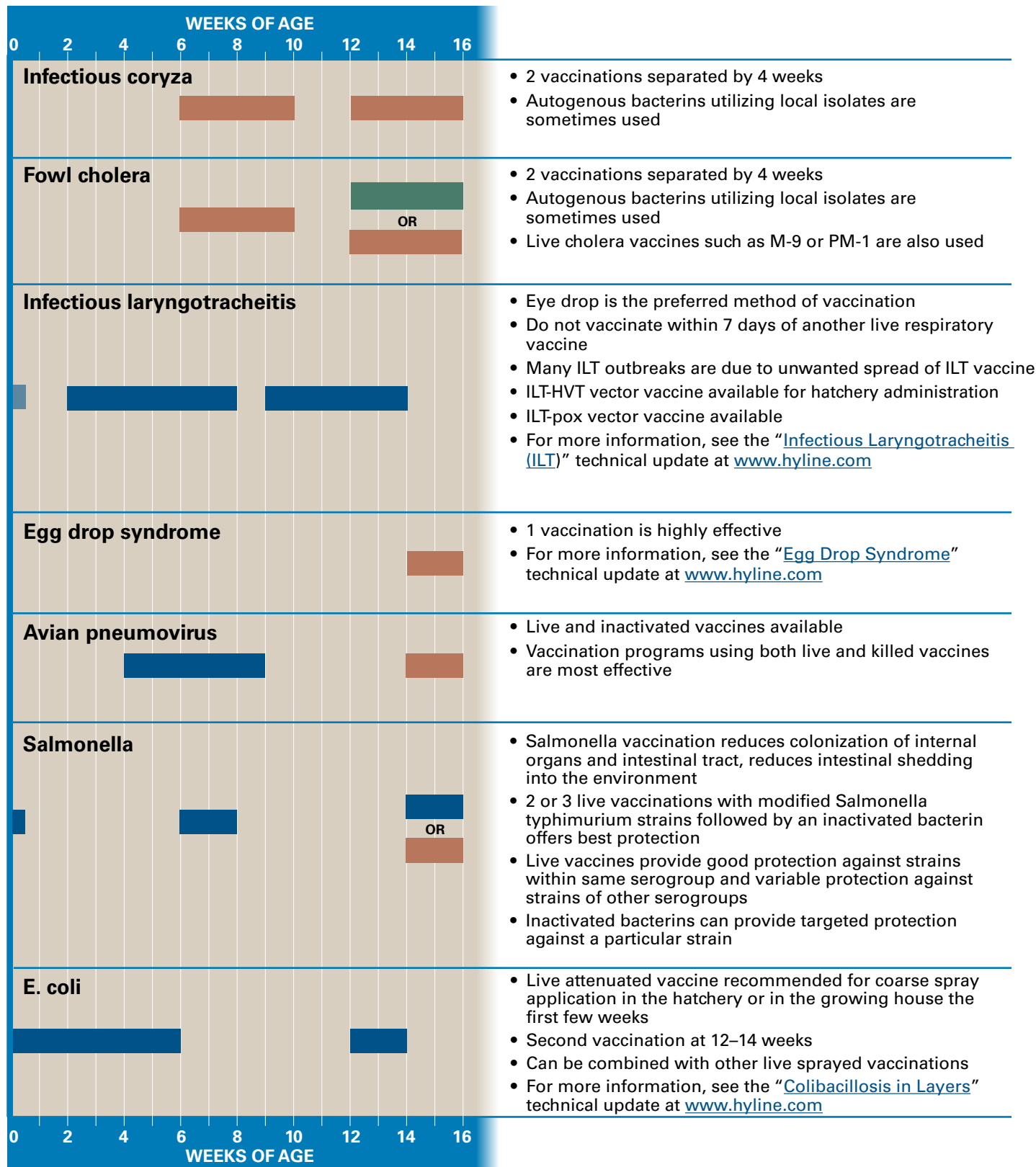

| | |
|---|--|
| Live hatchery vaccines, given subcutaneous | Live vaccines, administered via wing-web inoculation |
| Live vaccines, administered by drinking water, spray or eyedrop | Inactivated vaccines, injected via intramuscular or subcutaneous route |

Vaccination Recommendations *(continued)*

RECOMBINANT HVT VACCINES

Vaccines using recombinant vector technology offer the convenience of hatchery administration with no adverse effects caused by some live field vaccinations. For best Marek's disease protection use Rispens vaccine in combination with recombinant HVT vaccine.

CAUTION: Do not use another HVT vaccine when using HVT-vectored vaccines.

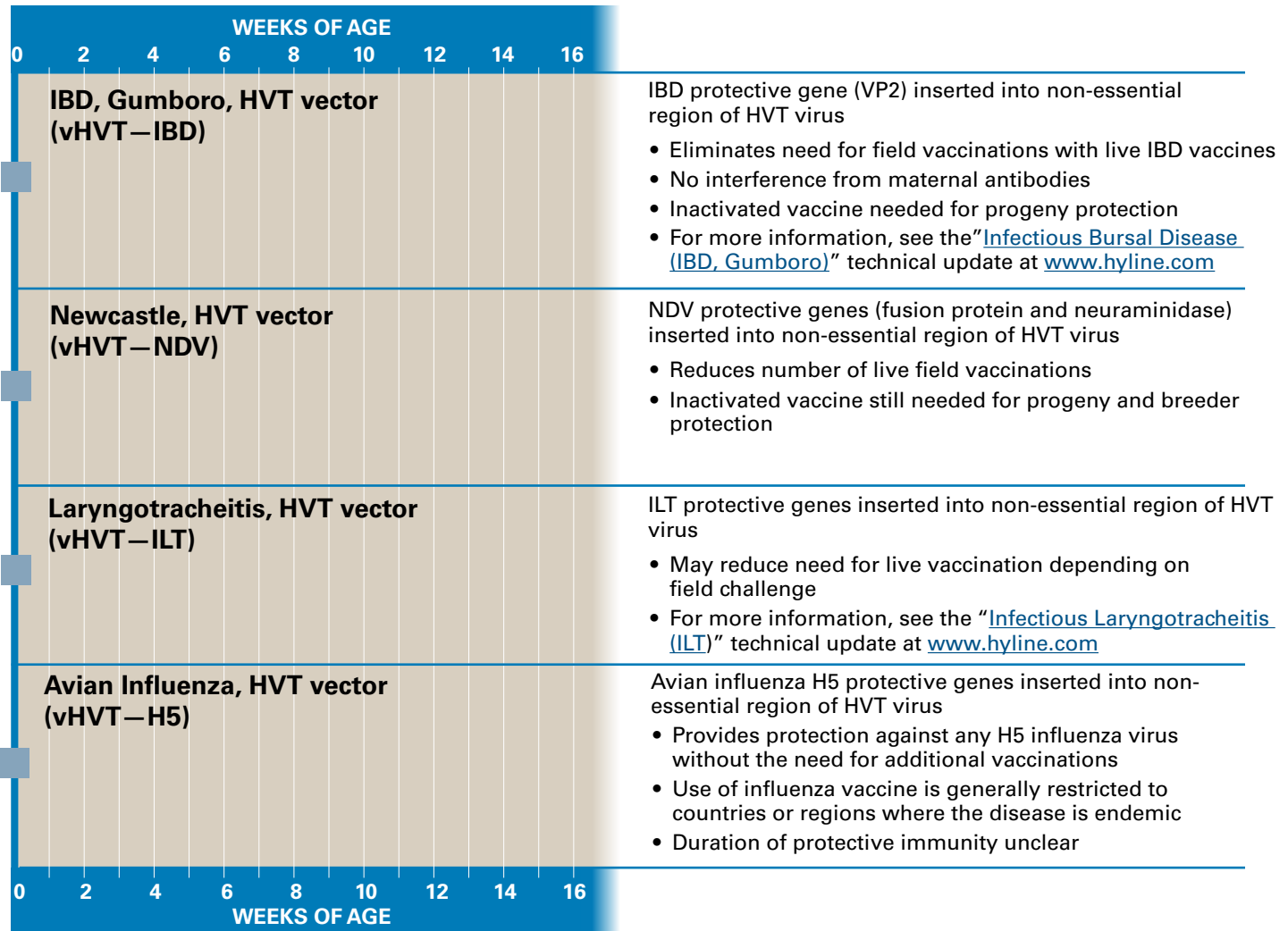

| | |
|---|--|
| Live hatchery vaccines, given subcutaneous | Live vaccines, administered via wing-web inoculation |
| Live vaccines, administered by drinking water, spray or eyedrop | Inactivated vaccines, injected via intramuscular or subcutaneous route |

Performance Graph 1

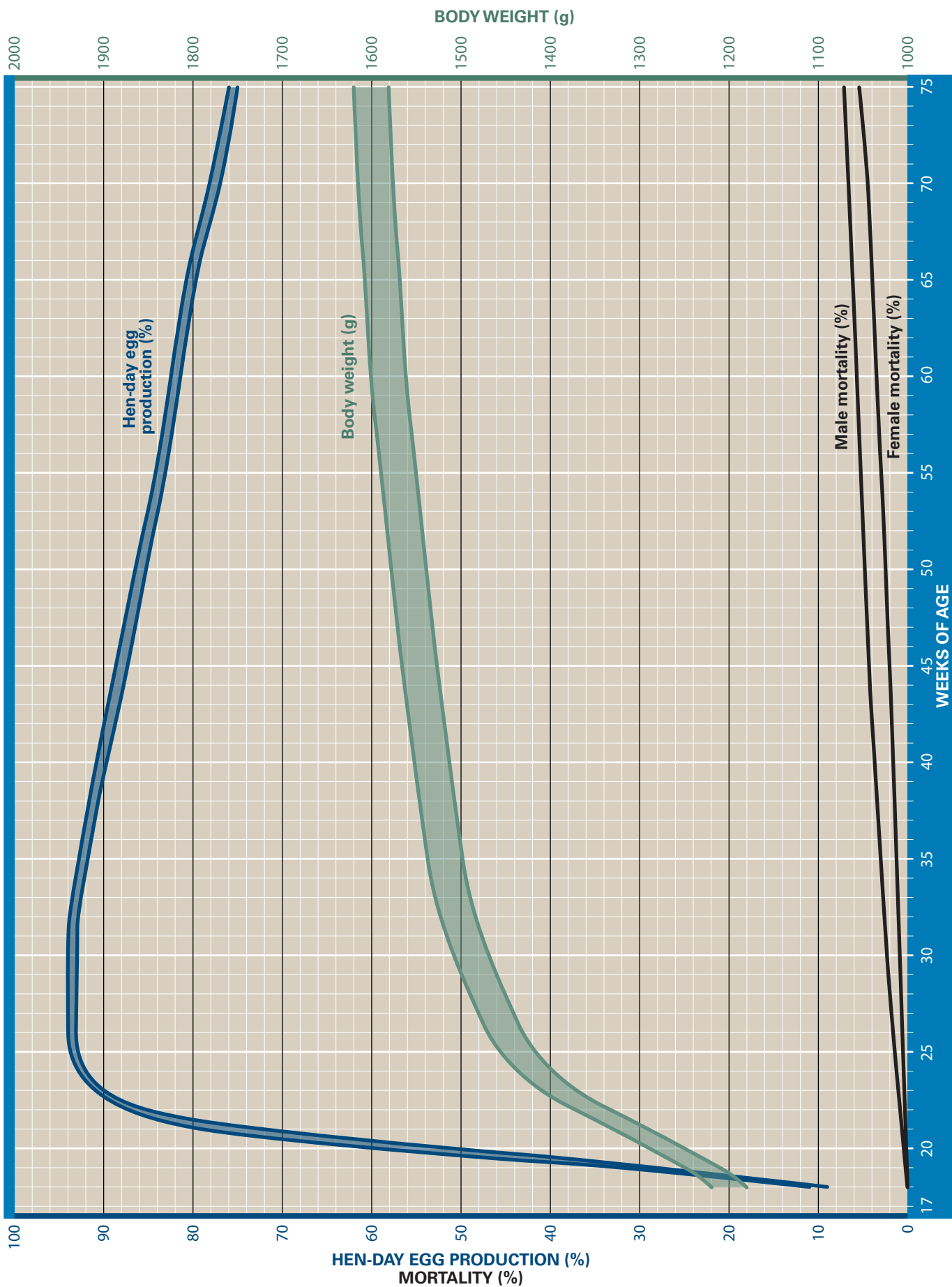

Performance Graph 2

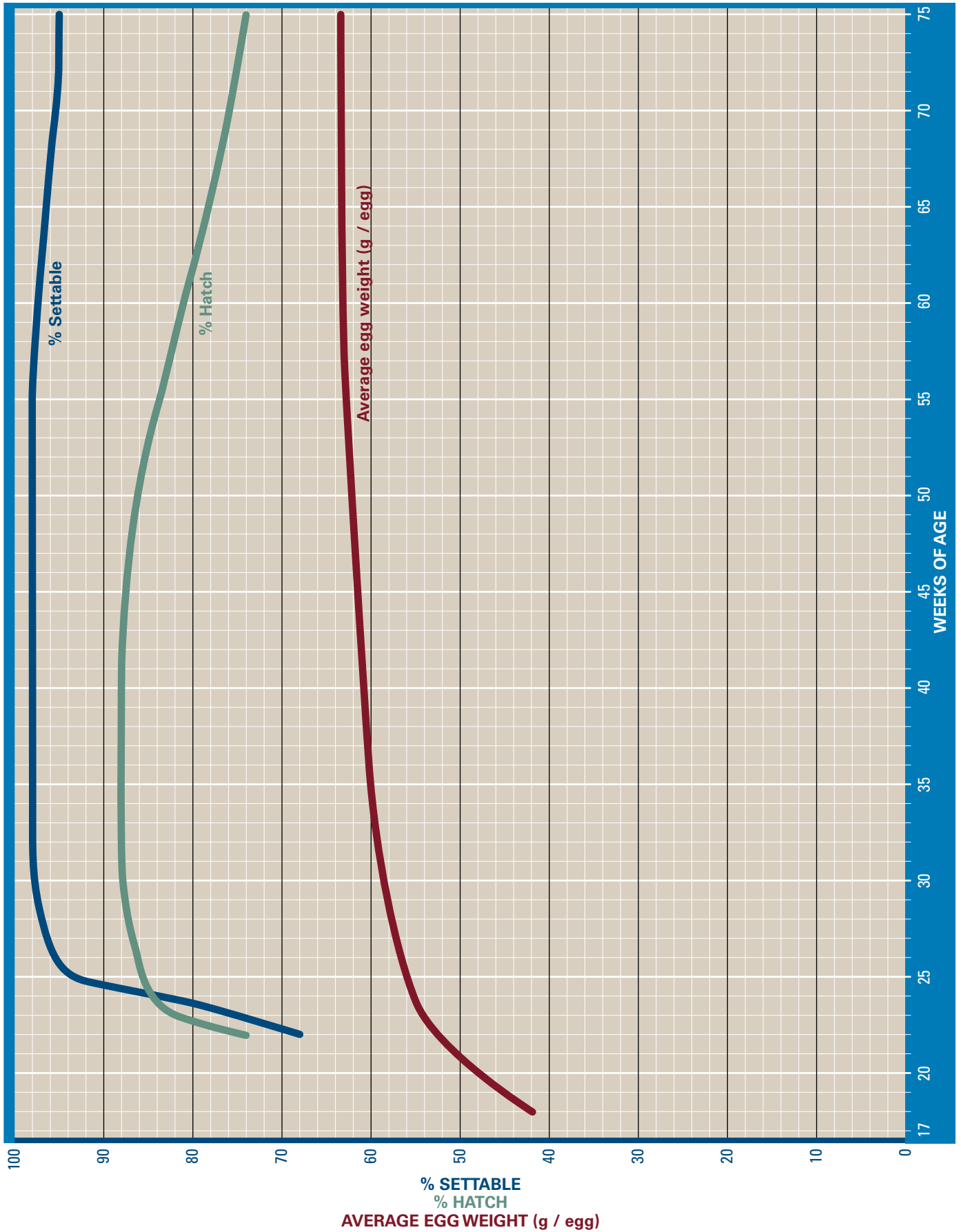

Feed Ingredient Table 1

| INGREDIENT (as-fed basis) | DRY MATTER (%) | CRUDE PROTEIN (%) | FAT-ether extract (%) | CRUDE FIBER (%) | CALCIUM (%) | PHOSPHORUS total (%) | PHOSPHORUS available (%) | SODIUM (%) | CHLORIDE (%) | POTASSIUM (%) | SULFUR (%) | ME (kcal/lb) | ME (kcal/kg) | ME (MJ/kg) | LINOLEIC ACID (%) | CHOLINE (mg/kg) |
|--|----------------|-------------------|-----------------------|-----------------|-------------|----------------------|--------------------------|------------|--------------|---------------|------------|--------------|--------------|------------|-------------------|-----------------|
| Barley, grain | 89.0 | 11.5 | 1.9 | 5.0 | 0.08 | 0.42 | 0.15 | 0.03 | 0.14 | 0.56 | 0.15 | 1250 | 2750 | 11.51 | 1.1 | 1027 |
| Beans, broad (vicia faba) | 89.0 | 25.7 | 1.4 | 8.2 | 0.14 | 0.54 | 0.20 | 0.08 | 0.04 | 1.20 | – | 1100 | 2420 | 10.13 | 0.9 | 1670 |
| Calcium carbonate (38%Ca) | 99.0 | – | – | – | 38.00 | – | – | 0.06 | – | 0.06 | – | – | – | – | – | – |
| Canola meal (38%) | 91.0 | 38.0 | 3.8 | 11.1 | 0.68 | 1.20 | 0.40 | – | – | 1.29 | 1.00 | 960 | 2110 | 8.83 | – | 6700 |
| Corn, yellow, grain | 86.0 | 7.5 | 3.5 | 1.9 | 0.01 | 0.28 | 0.12 | 0.02 | 0.04 | 0.33 | 0.08 | 1530 | 3373 | 14.11 | 1.9 | 1100 |
| Corn gluten meal (60%) | 90.0 | 60.0 | 2.0 | 2.5 | 0.02 | 0.50 | 0.18 | 0.03 | 0.05 | 0.45 | 0.50 | 1700 | 3740 | 15.65 | 1.8 | 2200 |
| Cottonseed meal (41%), mech. extd | 91.0 | 41.0 | 3.9 | 12.6 | 0.17 | 0.97 | 0.32 | 0.04 | 0.04 | 1.20 | 0.40 | 955 | 2100 | 8.79 | 0.8 | 2807 |
| Cottonseed meal (41%), direct solv. | 90.0 | 41.0 | 2.1 | 11.3 | 0.16 | 1.00 | 0.32 | 0.04 | 0.04 | 1.16 | 0.30 | 915 | 2010 | 8.41 | 0.4 | 2706 |
| Dicalcium phosphate (18.5% P) | 99.0 | – | – | – | 22.00 | 18.50 | 18.50 | 0.08 | – | 0.07 | – | – | – | – | – | – |
| DL-Methionine | 99.0 | 58.1 | – | – | – | – | – | – | – | – | – | 2277 | 5020 | 21.00 | – | – |
| Fat, animal | 99.0 | – | 98.0 | – | – | – | – | – | – | – | – | 3600 | 7920 | 33.14 | – | – |
| Fat, vegetable | 99.0 | – | 99.0 | – | – | – | – | – | – | – | – | 4000 | 8800 | 36.82 | 40.0 | – |
| Fish meal, anchovy, Peruvian | 91.0 | 65.0 | 10.0 | 1.0 | – | – | – | 0.88 | 0.60 | 0.90 | 0.54 | 1280 | 2820 | 11.80 | 0.1 | 5100 |
| Fish meal, white | 91.0 | 61.0 | 4.0 | 1.0 | – | – | – | 0.97 | 0.50 | 1.10 | 0.22 | 1180 | 2600 | 10.88 | 0.1 | 4050 |
| Flaxseed | 92.0 | 22.0 | 34.0 | 6.5 | – | – | – | 0.08 | – | 1.50 | – | 1795 | 3957 | 16.56 | 54.0 | 3150 |
| L-Lysine | 99.0 | 93.4 | – | – | – | – | – | – | – | – | – | 1868 | 4120 | 17.24 | – | – |
| L-Threonine | 99.0 | 72.4 | – | – | – | – | – | – | – | – | – | 1619 | 3570 | 14.94 | – | – |
| L-Tryptophan | 99.0 | 84.0 | – | – | – | – | – | – | – | – | – | 2653 | 5850 | 24.48 | – | – |
| Linseed meal flax, expeller | 90.0 | 32.0 | 3.5 | 9.5 | 0.40 | 0.80 | – | 0.11 | – | 1.24 | 0.39 | 700 | 1540 | 6.44 | 0.5 | 672 |
| Linseed meal flax, solvent | 88.0 | 33.0 | 0.5 | 9.5 | 0.35 | 0.75 | – | 0.14 | – | 1.38 | 0.39 | 635 | 1400 | 5.86 | 0.1 | 1760 |
| Meat and bone meal, 50% | 93.0 | 50.0 | 8.5 | 2.8 | 9.20 | 4.70 | 4.70 | 0.80 | 0.75 | 1.40 | 0.40 | 1150 | 2530 | 10.59 | 0.5 | 2000 |
| Millet, pearl grain | 90.0 | 12.0 | 4.2 | 1.8 | 0.05 | 0.30 | 0.10 | 0.04 | 0.64 | 0.43 | 0.13 | 1470 | 3240 | 13.56 | 1.3 | 789 |
| Mono-dicalcium phosphate (21% P) | 99.0 | – | – | – | 16.00 | 21.00 | – | 0.05 | – | 0.06 | – | – | – | – | – | – |
| Oats, grain | 90.0 | 11.0 | 4.0 | 10.5 | 0.10 | 0.35 | 0.14 | 0.07 | 0.12 | 0.37 | 0.21 | 1160 | 2550 | 10.67 | 2.4 | 1070 |
| Peanut meal, solvent | 90.0 | 47.0 | 2.5 | 8.4 | 0.08 | 0.57 | 0.18 | 0.07 | 0.03 | 1.22 | 0.30 | 1217 | 2677 | 11.20 | 0.5 | 1948 |
| Poultry byproduct meal (feed grade) | 94.0 | 57.0 | 14.0 | 2.5 | 5.00 | 2.70 | 2.70 | 0.30 | 0.55 | 0.60 | 0.50 | 1406 | 3100 | 12.97 | 0.7 | 5980 |
| Rice bran, unextracted | 91.0 | 13.5 | 5.9 | 13.0 | 0.10 | 1.70 | 0.24 | 0.10 | 0.07 | 1.35 | 0.18 | 925 | 2040 | 8.54 | 5.2 | 1948 |
| Rice, grain, rough | 89.0 | 7.3 | 1.7 | 10.0 | 0.04 | 0.26 | 0.09 | 0.04 | 0.06 | 0.34 | 0.10 | 1335 | 2940 | 12.30 | 0.83 | 5980 |
| Safflower seed meal, expeller | 91.0 | 20.0 | 6.6 | 32.2 | 0.23 | 0.61 | 0.20 | 0.05 | 0.16 | 0.72 | 0.10 | 525 | 1160 | 4.85 | – | 800 |
| Salt, NaCl | 99.0 | – | – | – | – | – | – | 39.34 | 60.66 | – | – | – | – | – | – | – |
| Sodium bicarbonate, NaHCO ₃ | 99.0 | – | – | – | – | – | – | 27.38 | – | – | – | – | – | – | – | – |
| Sorghum, milo, grain | 89.0 | 11.0 | 2.8 | 2.0 | 0.04 | 0.29 | 0.10 | 0.03 | 0.09 | 0.34 | 0.09 | 1505 | 3310 | 13.85 | 1.3 | 678 |
| Soybeans, full-fat, cooked | 90.0 | 38.0 | 18.0 | 5.0 | 0.25 | 0.59 | 0.20 | 0.04 | 0.03 | 1.70 | 0.30 | 1520 | 3350 | 14.02 | 9.9 | 2420 |
| Soybean meal, expeller | 89.0 | 42.0 | 3.5 | 6.5 | 0.20 | 0.60 | 0.20 | 0.04 | 0.02 | 1.71 | 0.33 | 1100 | 2420 | 10.13 | 1.8 | 2673 |
| Soybean meal, solvent | 90.0 | 44.0 | 0.5 | 7.0 | 0.25 | 0.60 | 0.20 | 0.04 | 0.02 | 1.97 | 0.43 | 1020 | 2240 | 9.37 | 0.3 | 2743 |
| Sunflower meal, expeller | 93.0 | 41.0 | 7.6 | 21.0 | 0.43 | 1.00 | 0.25 | 0.20 | 0.01 | 1.00 | 0.10 | 1050 | 2310 | 9.67 | 6.5 | – |
| Sunflower meal, partially dehul, solv. | 92.0 | 34.0 | 0.5 | 13.0 | 0.30 | 1.25 | 0.27 | 0.20 | 0.01 | 1.60 | 0.38 | 1025 | 2260 | 9.46 | 0.2 | 1909 |
| Triticale | 90.0 | 12.5 | 1.5 | 2.59 | 0.05 | 0.30 | 0.10 | – | 0.07 | – | 0.20 | 1430 | 3150 | 13.18 | 0.9 | 460 |
| Wheat, hard grain | 88.0 | 13.5 | 1.9 | 3.0 | 0.05 | 0.41 | 0.12 | 0.06 | 0.07 | 0.50 | 0.10 | 1440 | 3170 | 13.26 | 1.00 | 778 |
| Wheat, soft grain | 86.0 | 10.8 | 1.7 | 2.8 | 0.05 | 0.30 | 0.11 | 0.06 | 0.07 | 0.40 | 0.10 | 1460 | 3210 | 13.43 | 1.00 | 778 |
| Wheat bran | 89.0 | 14.8 | 4.0 | 10.0 | 0.14 | 1.17 | 0.38 | 0.06 | 0.14 | 1.20 | 0.22 | 590 | 1300 | 5.44 | 2.10 | 980 |
| Wheat middlings | 89.0 | 15.0 | 3.6 | 8.5 | 0.15 | 1.17 | 0.45 | 0.06 | 0.07 | 0.60 | 0.16 | 950 | 2090 | 8.74 | 1.90 | 110 |

Nutrient recommendations are based on calculations using these energy and nutrient values (source: 2018–2019 Feedstuffs Reference Issue and field data). Values provided are “typical” based on ingredient surveys. Nutrient values should be confirmed by analysis of the materials being used in order to maintain an accurate formulation matrix.

Feed Ingredient Table 2

| INGREDIENT (as-fed basis) | CRUDE PROTEIN (%) | | LYSINE (%) | | METHIONINE (%) | | CYSTINE (%) | | THREONINE (%) | | TRYPTOPHAN (%) | | ARGININE (%) | | ISOLEUCINE (%) | | VALINE (%) | |
|---|-------------------|--------------------|---------------|--------------------|----------------|--------------------|---------------|--------------------|---------------|--------------------|----------------|--------------------|---------------|--------------------|----------------|--------------------|---------------|--------------------|
| | Total content | Digestible content | Total content | Digestible content | Total content | Digestible content | Total content | Digestible content | Total content | Digestible content | Total content | Digestible content | Total content | Digestible content | Total content | Digestible content | Total content | Digestible content |
| Barley, grain | 11.50 | 0.53 | 0.41 | 0.18 | 0.14 | 0.25 | 0.20 | 0.36 | 0.28 | 0.17 | 0.12 | 0.50 | 0.43 | 0.42 | 0.34 | 0.62 | 0.50 | |
| Beans, broad (vicia faba) | 25.70 | 1.52 | 1.29 | 0.25 | 0.18 | 0.14 | 0.09 | 0.98 | 0.77 | 0.24 | 0.16 | 2.20 | 1.91 | 1.00 | 0.73 | 1.22 | 0.88 | |
| Canola meal (38%) ¹ | 91.0 | 2.02 | 1.60 | 0.77 | 0.69 | 0.97 | 0.71 | 1.50 | 1.17 | 0.46 | 0.38 | 2.30 | 2.07 | 1.51 | 1.25 | 1.94 | 1.59 | |
| Corn, yellow, grain | 7.50 | 0.24 | 0.19 | 0.18 | 0.16 | 0.18 | 0.15 | 0.29 | 0.24 | 0.07 | 0.06 | 0.40 | 0.36 | 0.29 | 0.26 | 0.42 | 0.37 | |
| Corn gluten meal (60%) | 60.00 | 1.00 | 0.88 | 1.90 | 1.84 | 1.10 | 0.95 | 2.00 | 1.84 | 0.30 | 0.25 | 1.90 | 1.82 | 2.30 | 2.19 | 2.70 | 2.57 | |
| Cottonseed meal (41%), mech. extd | 41.00 | 1.52 | 0.99 | 0.55 | 0.40 | 0.59 | 0.44 | 1.30 | 0.88 | 0.50 | 0.39 | 4.33 | 3.81 | 1.31 | 0.93 | 1.84 | 1.36 | |
| Cottonseed meal (41%), direct solv. | 41.00 | 1.70 | 1.11 | 0.51 | 0.37 | 0.62 | 0.46 | 1.31 | 0.89 | 0.52 | 0.41 | 4.66 | 4.10 | 1.33 | 0.95 | 1.82 | 1.34 | |
| DL-Methionine | 58.10 | – | – | 99.00 | 99.00 | – | – | – | – | – | – | – | – | – | – | – | – | |
| Fish meal, anchovy, Peruvian | 65.00 | 4.90 | 4.21 | 1.90 | 1.63 | 0.60 | 0.43 | 2.70 | 2.17 | 0.75 | 0.59 | 3.38 | 2.77 | 3.00 | 2.55 | 3.40 | 2.82 | |
| Fish meal, white | 61.00 | 4.30 | 3.70 | 1.65 | 1.42 | 0.75 | 0.54 | 2.60 | 2.09 | 0.70 | 0.55 | 4.20 | 3.44 | 3.10 | 2.64 | 3.25 | 2.70 | |
| Flaxseed | 22.00 | 0.92 | 0.79 | 0.35 | 0.30 | 0.42 | 0.30 | 0.77 | 0.62 | 0.22 | 0.17 | 2.05 | 1.68 | 0.95 | 0.81 | 1.17 | 0.97 | |
| L-Lysine | 93.40 | 78.80 | 78.80 | – | – | – | – | – | – | – | – | – | – | – | – | – | – | |
| L-Threonine | 72.40 | – | – | – | – | – | – | 98.50 | 98.50 | – | – | – | – | – | – | – | – | |
| L-Tryptophan | 84.00 | – | – | – | – | – | – | – | – | 98.00 | 98.00 | – | – | – | – | – | – | |
| Linseed meal flax, expeller | 32.00 | 1.10 | 0.99 | 0.47 | 0.37 | 0.56 | 0.44 | 1.10 | 1.00 | 0.47 | 0.43 | 2.60 | 2.39 | 1.70 | 1.49 | 1.50 | 1.29 | |
| Linseed meal flax, solvent | 33.00 | 1.10 | 0.99 | 0.48 | 0.38 | 0.58 | 0.45 | 1.20 | 1.10 | 0.48 | 0.44 | 2.70 | 2.48 | 1.80 | 1.58 | 1.60 | 1.38 | |
| Meat and bone meal, 50% | 50.00 | 2.60 | 2.05 | 0.67 | 0.57 | 0.33 | 0.19 | 1.70 | 1.34 | 0.26 | 0.13 | 3.35 | 2.85 | 1.70 | 1.41 | 2.25 | 1.85 | |
| Millet, pearl grain | 12.00 | 0.35 | 0.32 | 0.28 | 0.25 | 0.24 | 0.20 | 0.44 | 0.37 | 0.20 | 0.18 | 0.55 | 0.49 | 0.52 | 0.46 | 0.70 | 0.62 | |
| Oats, grain | 11.00 | 0.40 | 0.35 | 0.20 | 0.17 | 0.21 | 0.18 | 0.28 | 0.24 | 0.18 | 0.14 | 0.80 | 0.75 | 0.53 | 0.47 | 0.62 | 0.55 | |
| Peanut meal, solvent | 47.00 | 1.52 | 1.29 | 0.50 | 0.44 | 0.60 | 0.47 | 1.12 | 0.91 | 0.42 | 0.39 | 4.76 | 4.28 | 1.50 | 1.32 | 1.80 | 1.57 | |
| Poultry byproduct meal (feed grade) | 57.00 | 2.25 | 1.80 | 0.91 | 0.78 | 0.90 | 0.55 | 1.88 | 1.50 | 0.50 | 0.26 | 3.50 | 3.08 | 2.10 | 1.79 | 2.32 | 1.93 | |
| Rice bran, unextracted | 13.50 | 0.50 | 0.38 | 0.17 | 0.13 | 0.10 | 0.07 | 0.40 | 0.28 | 0.10 | 0.08 | 0.45 | 0.39 | 0.39 | 0.30 | 0.60 | 0.46 | |
| Rice, grain, rough | 7.30 | 0.24 | 0.19 | 0.14 | 0.13 | 0.08 | 0.07 | 0.27 | 0.22 | 0.12 | 0.11 | 0.59 | 0.54 | 0.33 | 0.27 | 0.46 | 0.39 | |
| Safflower seed meal, expeller | 20.00 | 0.70 | 0.58 | 0.40 | 0.35 | 0.58 | 0.45 | 0.47 | 0.34 | 0.30 | 0.24 | 1.20 | 1.01 | 0.28 | 0.22 | 1.00 | 0.87 | |
| Sorghum, milo, grain | 11.00 | 0.27 | 0.21 | 0.10 | 0.09 | 0.20 | 0.17 | 0.27 | 0.22 | 0.09 | 0.08 | 0.40 | 0.30 | 0.60 | 0.53 | 0.53 | 0.46 | |
| Soybeans, full-fat, cooked | 38.00 | 2.40 | 2.16 | 0.54 | 0.49 | 0.55 | 0.45 | 1.69 | 1.43 | 0.52 | 0.46 | 2.80 | 2.60 | 2.18 | 1.94 | 2.02 | 1.78 | |
| Soybean meal, expeller | 42.00 | 2.70 | 2.43 | 0.60 | 0.54 | 0.62 | 0.51 | 1.70 | 1.44 | 0.58 | 0.52 | 3.20 | 2.97 | 2.80 | 2.49 | 2.20 | 1.94 | |
| Soybean meal, solvent | 44.00 | 2.70 | 2.43 | 0.65 | 0.58 | 0.67 | 0.55 | 1.70 | 1.44 | 0.60 | 0.53 | 3.40 | 3.16 | 2.50 | 2.22 | 2.40 | 2.11 | |
| Sunflower meal, expeller | 41.00 | 2.00 | 1.74 | 1.60 | 1.47 | 0.80 | 0.64 | 1.60 | 1.31 | 0.60 | 0.52 | 4.20 | 3.91 | 2.40 | 2.14 | 2.40 | 2.08 | |
| Sunflower meal, partially dehul, solv. | 34.00 | 1.42 | 1.19 | 0.64 | 0.60 | 0.55 | 0.43 | 1.48 | 1.26 | 0.35 | 0.30 | 2.80 | 2.32 | 1.39 | 1.25 | 1.64 | 1.41 | |
| Triticale | 12.50 | 0.39 | 0.35 | 0.26 | 0.23 | 0.26 | 0.22 | 0.36 | 0.31 | 0.14 | 0.12 | 0.48 | 0.39 | 0.76 | 0.70 | 0.51 | 0.44 | |
| Wheat, hard grain | 13.50 | 0.40 | 0.32 | 0.25 | 0.22 | 0.30 | 0.26 | 0.35 | 0.29 | 0.18 | 0.16 | 0.60 | 0.53 | 0.69 | 0.61 | 0.69 | 0.59 | |
| Wheat, soft grain | 10.80 | 0.30 | 0.24 | 0.14 | 0.12 | 0.20 | 0.17 | 0.28 | 0.23 | 0.12 | 0.11 | 0.40 | 0.35 | 0.43 | 0.38 | 0.48 | 0.41 | |
| Wheat bran | 14.80 | 0.60 | 0.43 | 0.20 | 0.15 | 0.30 | 0.22 | 0.48 | 0.35 | 0.30 | 0.24 | 1.07 | 0.88 | 0.60 | 0.47 | 0.70 | 0.54 | |
| Wheat Middlings | 15.00 | 0.70 | 0.56 | 0.12 | 0.10 | 0.19 | 0.14 | 0.50 | 0.36 | 0.20 | 0.16 | 1.00 | 0.80 | 0.70 | 0.58 | 0.80 | 0.61 | |

Amino acid digestibility is standardized ileal digestibility. Amino acid values are standardized for 88% dry matter (source: 2018–2019 Feedstuffs Reference Issue and field data). Values provided are “typical” based on ingredient surveys. Nutrient values should be confirmed by analysis of the materials being used in order to maintain an accurate formulation matrix.

Hy-Line International Welfare Goals and Principles

To promote animal well-being and produce birds of the highest quality, we adhere to the following welfare goals and principles. These goals and principles are the essential building blocks for the humane and professional care of our birds:

- **Feed and Water**
Provide access to good quality water and nutritionally balanced diets at all times
- **Health and Veterinary Care**
Provide science-based health programs and prompt veterinary care
- **Environment**
Provide shelter that is designed, maintained and operated to meet the bird's needs and to facilitate daily inspection
- **Husbandry and Handling Practices**
Provide comprehensive care and handling procedures that ensure the bird's well-being throughout its life
- **Transportation**
Provide transportation that minimizes travel time and stress

RESOURCES AVAILABLE AT WWW.HYLINE.COM

[Corporate Information](#) | [Technical Updates](#) | [Videos](#) | [Interactive Management Guides](#)
[Hy-Line International Lighting Program](#) | [Hy-Line EggCel](#) | [Body Weight Uniformity Calculator](#)

TECHNICAL UPDATES

Diseases

An Overview of Focal Duodenal Necrosis (FDN)
MG Control in Commercial Layers
Colibacillosis in Layers: An Overview
Fowl Pox in Layers
Avian Urolithiasis (Visceral Gout)
Infectious Bursal Disease (IBD, Gumboro)
Fatty Liver Hemorrhagic Syndrome
Infectious Laryngotracheitis (ILT)
Intestinal Dilation Syndrome (IDS)
Newcastle Disease
Mycoplasma Synoviae (MS)
Low Pathogenic Avian Influenza (LPAI)

Diagnostic Samples and Breeder Flock Monitoring

Salmonella, *Mycoplasma*, and Avian Influenza
Monitoring in Parent Breeder Flocks
Proper Collection and Handling of Diagnostic Samples

Management

Growing Management of Commercial Pullets
Understanding the Role of the Skeleton in Egg Production
The Science of Egg Quality
Understanding Poultry Lighting
Understanding Heat Stress in Layers
Infrared Beak Treatment
Feed Granulometry and the Importance of Feed Particle Size in Layers
Impact of Tarp Color on Poultry Lighting
SPIDES (Short Period Incubation During Egg Storage)
Fly Management: Surveillance and Control
Optimizing Egg Size in Commercial Layers
Vaccination Recommendations
Non-Fasting Molt Recommendations
Egg Drop Syndrome (EDS)
Managing Fully Beaked Flocks
Thiamin Deficiency in Pullets

PRODUCT UPDATES

Effects of Nutrient Density on Hy-Line W-36 Performance
Managing the Hy-Line W-36 Commercial Layer in a Single Lay Cycle



Hy-Line

Hy-Line International | www.hyline.com

