



International Colloquium

METHODS OF
EVALUATING PRODUCTS
FOR THE CONSERVATION
OF POROUS BUILDING
MATERIALS IN
MONUMENTS

Rome • 19/21 June 1995



1
UE

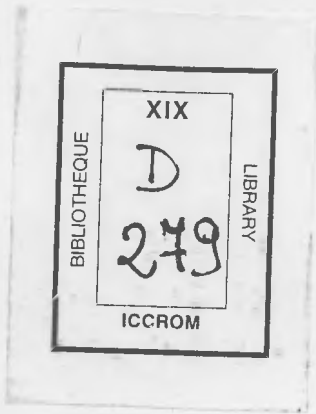

XIX

D

279

BIBLIOTHEQUE

LIBRARY

ICCROM

METHODS OF EVALUATING
PRODUCTS FOR THE CONSERVATION
OF POROUS BUILDING MATERIALS
IN MONUMENTS

International Colloquium
Rome, 19-21 June 1995

PREPRINTS



ICCROM

Rome, 1995

Authors are responsible for the choice and the presentation of the facts contained in their articles and for the opinions expressed therein, which are not necessarily those of the editors, or of the organizations involved in organizing the meeting and publishing the proceedings.

With regard to the selection, applicability or efficacy of the products mentioned, no endorsement or recommendation is implied on behalf of ICCROM, and no criticism is implicit in the non-mention of any product.

51890

ISBN 92-9077-131-3

© ICCROM 1995

Via di San Michele 13
I-00153 Rome RM, Italy

Printed in Italy by O.GRA.RO s.r.l.

Cover design: Studio *PAGE*

Production: Cynthia Rockwell

ORGANIZATION

The international colloquium on Methods of Evaluating Products for Conservation of Porous Building Materials in Monuments has been organized by ICCROM in cooperation with the following partners:

Patrons: Istituto Centrale per il Restauro (Rome); Institut Royal du Patrimoine Artistique (Brussels); UNESCO (Paris ; US-ICOMOS (USA).

Sponsors: CNR-Centro "Gino Bozza" (Milan); Council of Europe (Strasbourg); Kress Foundation (USA); Ministero per i Beni Culturali (Italy); National Technical University (Athens).

Industrial contributors: Angelantoni Industrie S.p.A. ACS, Div. Prove Ambientali (Massa Martano, Perugia) MAPEI S.p.A. (Milan); MBT Europe / MAC S.p.A. (Treviso); RUREDIL S.p.A. (Milan); ZEISS ITALIA S.p.A. (Milan).

It is being hosted in Rome by the Italian Ministry of Cultural Property, at the Museo Nazionale di Arte Orientale.

Scientific and Organizing Committee

Dr Giovanna ALESSANDRINI
CNR - Centro Gino Bozza,
Dipartimento di Energetica,
Politecnico di Milano
Milan, Italy

Ernesto BORRELLI
ICCROM

Dr A. Elena CHAROLA
Great Neck, NY, U.S.A.

Dr E. DE WITTE
Institut Royal du Patrimoine
Artistique, Brussels, Belgium

Prof. R. ESBERT
Dep. de Geologia, Universidad de
Oviedo, Oviedo, Spain

Prof. Vinicio FURLAN
Lab. de Conservation de la Pierre,
Ecole Polytechnique Fédérale de

Lausanne,
Lausanne, Switzerland

Dr Marisa LAURENZI TABASSO
ICCROM

Dr M. MAMILLAN
Comité Pierre de l'ICOMOS,
Bures sur Yvette, France

Prof. U. MATTEOLI
Dip. di Chimica, Università di
Venezia, Venice, Italy

Dr M.P. NUGARI
Istituto Centrale per il Restauro,
Rome, Italy

Dr J. RIEDERER
Staatliche Museen zu Berlin,
Preussischer Kulturbesitz
Rathgen-Forschungslabor,
Berlin, Germany

Dr-Ing. V. ROMANOVSKY

La Rochelle, France

Dr R. ROSSI MANARESI

Centro "Cesare Gnudi,"

Soprintendenza ai Beni Artistici e

Storici dell'Emilia

Bologna, Italy

Dr P. ROTA ROSSI DORIA

CNR, Is.C.O.M. (Istituto Con-

servazione Opere Monumentali)

c/o Dip. Scienza dei Materiali

dell'Università di Lecce,

Lecce, Italy

Dr U. SANTAMARIA

Istituto Centrale per il Restauro,

Rome, Italy

Dr C. SEARLS

ASTM Sub-committee E06.24.01,

W J E Associates, Inc.

Emeryville, CA, U.S.A.

Prof. Th. SKOULIKIDIS

National Technical University,

Faculty of Chemical Engineering,

Dept. of Materials Science and

Engineering,

Athens, Greece

Dr R. SNETHLAGE

Bayer Landesamt für

Denkmalpflege,

Munich, Germany

Secretary:

L. RIZZO VECCHIO

ICCROM

Moderators of the Round Tables

Mortars:

I. PAPAYIANNI (Greece)

F. M. HENRIQUES (Portugal)

Biocidal Treatments:

R. KOESTLER (USA)

O. SALVADORI (Italy)

Cleaning:

L. LAZZARINI (Italy)

V. VERGÈS BELMIN (France)

Consolidation:

H. R. SASSE (Germany)

E. DE WITTE (Belgium)

Water-Repellent Treatments:

A. E. CHAROLA (USA)

J. DELGADO RODRIGUES
(Portugal)

Weathering:

C. PRICE (UK)

T. REICHERT (Germany)

CONTENTS

FOREWORD	ix
----------------	----

I. MORTARS

EXPERIMENTATION OF A CHEMICAL-PHYSICAL METHODOLOGY FOR THE RECONSTRUCTION OF HISTORIC MORTARS	1
---	---

N. Berlucci, R. Ginanni Corradini

POSSIBLE SUBSTITUTES FOR KHORASAN MORTAR IN BYZANTINE AND OTTOMAN MONUMENTS	15
---	----

A. Ersen, M. Karagüler, A. Güleç

THE LESHAN GRAND BUDDHA: INVESTIGATIONS OF TRADITIONAL AND ALTERNATIVE MATERIALS FOR REPAIRS	29
--	----

Jiayu Ma

EVALUATION OF PHYSICAL CHARACTERISTICS OF "MERCULA" ADMIXED CLAY FOR SEALING OF CRACKS IN MUD PLASTER OF MONASTERIES, LADAKH REGION ..	41
--	----

R.K. Sharma, H.O. Gupta, Y.K. Kanotra

LIME MORTAR AND LIME BASED MIXTURES FOR CONSERVATION, RESTORATION, REPAIR AND STRENGTHENING OF BYZANTINE CHURCHES (9TH-14TH CENTURY) IN REPUBLIC OF MACEDONIA	49
---	----

L. Sumanov, T. Staniseva, V. Trajkoska, D. Danilovski, V. Sendova

II. BIOCIDAL TREATMENTS

AN EVALUATION OF BIOCIDAL TREATMENTS ON THE ROCK ART OF BAICAL	69
--	----

N.L. Rebricova, E.N. Ageeva

METHODS FOR THE EVALUATION OF PRODUCTS AGAINST ALGAL BIOCOENOSIS OF MONUMENTAL FOUNTAINS	75
--	----

P. Tiano, M. Camaiti, P. Accolla

BIOLOGICAL MATERIAL TESTING	87
-----------------------------------	----

M. Wilimzig, E. Bock

ASSESSMENT IN A FIELD SETTING OF THE EFFICACY OF VARIOUS BIOCIDES ON SANDSTONE	93
--	----

M.E. Young, R. Wakefield, D.C.M. Urquhart, K. Nicholson, K. Tonge



III. CONSOLIDATION

- METHODE D'EVALUATION DE L'IMPACT DU MOULAGE SUR LES PROPRIETES SUPERFICIELLES D'UNE PIERRE CALCAIRE 103
P. Bromblet, J. Brunet, P. Merindol, D. Bouvier
- COMPARISON OF TRADITIONAL AND MODERN TREATMENTS FOR CONSERVING STONE 111
R.N. Butlin, T.J.S. Yates, W. Martin
- METHODS USED TO EVALUATE THE EFFICACY OF CONSOLIDANTS ON AN AUSTRALIAN SANDSTONE 121
A. Caselli, D. Kagi
- LA TECHNIQUE D'AUSCULTATION MICROSISMIQUE POUR LE DIAGNOSTIC ET L'EVALUATION DES TRAITEMENTS SUR MATERIAUX PIERREUX 131
G. Chiesura, A.M. Mecchi, P. Rota Rossi Doria
- STUDY OF POROSITY AND PHYSICAL PROPERTIES AS METHODS TO ESTABLISH THE EFFECTIVENESS OF TREATMENTS USED IN TWO DIFFERENT SPANISH STONES: LIMESTONE AND SANDSTONE 147
N. Garcia Pascua, M.I. Sanchez De Rojas, M. Frias
- EVALUATION OF CONSOLIDANTS FOR STABILIZATION OF WEAK MAYA LIMESTONE 163
R. Kumar, W.S. Ginell
- CONSOLIDATION OF GOTLAND STONE IN MONUMENTS 179
J.W. Lukaszewicz, D. Kwiatkowski, M. Klingspor
- EXPERIMENTAL EVALUATION OF STONE CONSOLIDANTS USED IN JAPAN 189
T. Nishiura
- EFFECTS OF CONSOLIDANT AND WATER REPELLENT TREATMENTS ON THE POROSITY AND PORE SIZE DISTRIBUTION OF LIMESTONES 203
J.L. Pérez, R. Villegas, J.F. Vale, M.A. Bello, M. Alcalde
- A METHOD OF CONTROLLING TWO MURAL PAINTINGS CONSOLIDANTS 213
B. Provinciali, P. Iazurlo
- LONG TERM EFFECTIVENESS OF TREATMENTS OF SANDSTONE 225
R. Rossi Manaresi, A. Rattazzi, L. Toniolo
- A DATA BANK OF FTIR SPECTRA FOR COMPARING PRODUCTS USED FOR STONE CONSOLIDATION AND PROTECTION 245 X
U. Santamaria, M. Laurenzi Tabasso, P. Rota Rossi Doria, A. Di Francesco
- THE INFLUENCE OF REACTION PARAMETERS ON THE EFFECTIVENESS OF TETRAETHOXYSILANE - BASED STONE CONSOLIDANTS: SOLVENT EFFECTS 259
E. Stevenson Goins, G. Segan Wheeler, S.A. Fleming

EFFICACITE DES PRODUITS EMPLOYES POUR LA CONSERVATION DE LA PIERRE EN FRANCE: PREMIERS RESULTATS D'UNE ENQUETE MENEES AUPRES DES PROFESSIONNELS DE LA CONSERVATION	275
<i>J.M. Vallet, V. Verges-Belmin, V. Romanovsky</i>	

IV. TREATMENTS WITH WATER REPELLENTS

EVALUATION OF THE EFFECTIVENESS OF PROTECTIVE TREATMENTS FOR SLATE FROM THE VAL DI LAVAGNA (ITALY)	285
<i>A. Aldi, G. Alessandrini, A. Casarino, E. Pedemonte, R. Peruzzi</i>	

METHODOLOGY FOR THE EVALUATION OF PROTECTIVE PRODUCTS FOR STONE MATERIALS. PART II: EXPERIMENTAL TESTS ON TREATED SAMPLES	301
<i>L. Appolonia, V. Fassina, U. Matteoli, A.M. Mecchi, M.P. Nugari, D. Pinna, R. Peruzzi, O. Salvadori, U. Santamaria, A. Scala, P. Tiano</i>	

INTERACTION OF SOME PROTECTIVE AGENTS WITH BUILDING MATERIALS	317
<i>G. Biscontin, A. Bakolas, E. Zendri, A. Moropoulou</i>	

SUGGESTED PROPERTIES FOR EVALUATING THE BEHAVIOUR OF A WATER- PROOFED LIMESTONE UNDER AGGRESSIVE ENVIRONMENTAL CONDITIONS	331
<i>R.M. Esbert, J. Alonso, F.J. Alonso, J. Ordaz</i>	

MESURE DE L'EFFET PROTECTEUR DE PRODUITS DE TRAITEMENT FACE AU SO ₂ ATMOSPHERIQUE ET DES CHANGEMENTS DE COULEUR SUR DES ECHANTILLONS DE PIERRE EXPOSES EN SITE REEL	341
<i>F. Girardet, V. Furlan</i>	

STONE-PROTECTING AGENTS AND THEIR CHEMICAL BEHAVIOUR UNDER THE INFLUENCE OF WEATHERING	349
<i>K. Littmann, B. Riecken</i>	

METHOD FOR ASSESSING LIQUIDS FOR THE REMEDIAL TREATMENT OF RISING DAMP	359
<i>L. Mao, D. Kagi</i>	

MODULATION OF STRUCTURAL AND STONE PROTECTIVE PROPERTIES OF FLUORINATED METHACRYLATE POLYMERS	373
<i>U. Matteoli, M. Aglietto, V. Fassina, C. Botteghi, E. Passaglia, F. Ciardelli</i>	

PROTECTIVE MATERIALS FOR STONE – EFFECTS ON STONE PERMEABILITY AND GAS TRANSPORT	389
<i>F. Piacenti, R.G. Carbonell, M. Camaiti, F.E. Henon, E. Luppichini</i>	

TREATMENT OF RISING DAMP. A LABORATORY EVALUATION METHOD	403
<i>R.P.J. Van Hees, J.A.G. Koek</i>	

V. WEATHERING

- EVALUATION OF DEGRADATION AND CONSERVATION OF MARLSTONES BY MEANS OF WATER CAPILLARY ABSORPTION AND FROST TESTS 421 x
C. Atzeni, M.G. Cabiddu, L. Massidda, U. Sanna
- THE USE OF DIFFUSION DENUDERS FOR STUDYING THE REACTIVITY OF MARBLE SURFACES: AN APPLICATION TO THE EVALUATION OF PROTECTIVES 431
F. De Santis, I. Allegrini, D. Pasella
- COMPARISON BETWEEN SEVERAL SPANISH TREATED STONES SUBMITTED TO SALT CRYSTALLIZATION AND FREEZE/THAW ACCELERATED WEATHERING TESTS 443
J.L. Perez, M.A. Bello, R. Villegas, J.F. Vale, M. Alcalde
- LABORATORY SIMULATION OF AGGRESSIVE CLIMATIC CONDITIONS – THEORETICAL BACKGROUND AND EXPERIMENTAL RESULTS 451
B. Riecken, B. Schwamborn
- THE APPLICATION AND THE LIMITS OF THE INTENSIFICATION OF THE CONDITIONS BY ARTIFICIAL WEATHERING OF STONES 461
T. Skoulikidis

FOREWORD

The success of a conservation treatment depends upon many factors. Among the most important of these are a thorough understanding of the object (its values and historical relevance), the conservator's skills and the suitability of the products and technologies employed.

Concerning products and technologies for conservation treatments, those available on the market are but rarely designed to meet the specific, delicate needs of the field of cultural heritage. Therefore, specific evaluation is needed before choosing any product or equipment to be used for this purpose.

In the field of porous building materials from monuments, the extremely wide range of materials and their related properties make the need for preliminary evaluation even more essential.

Numerous product evaluation studies have already been carried out by conservation scientists worldwide, but a common approach to the problem is still far from reality. Yet, such an approach is highly desirable, considering the universal nature of cultural heritage itself.

As an international, intergovernmental organization, ICCROM has organized this colloquium to offer researchers from different countries a platform for discussion, with the aim of fostering studies in this specific and complex field, encouraging a common approach to the problem and, ultimately, promoting the definition of internationally agreed standard methodologies.

In order to provide a more complete basis for this kind of discussion, the preprints are being distributed at the colloquium. They have been produced from texts supplied in camera-ready form, and are intended to offer a timely overview of current developments.

The response to our initiative by so many conservation scientists from a variety of countries gives us a very positive indication that the colloquium is answering a need and that it will help in accomplishing the aims described above.

Marc Laenen
Director General
ICCROM

ELFENDEKLEINER OF A CHEMICAL SYSTEM: METHODOLOGY FOR THE RECOVERY OF WASTE MATERIALS

Dr. [Name], [Institution]

The [Title] of this work is [Title]. The [Title] of this work is [Title]. The [Title] of this work is [Title].

Part One MORTARS

The [Title] of this work is [Title]. The [Title] of this work is [Title]. The [Title] of this work is [Title].

1. Introduction

The [Title] of this work is [Title]. The [Title] of this work is [Title]. The [Title] of this work is [Title].

EXPERIMENTATION OF A CHEMICAL-PHYSICAL METHODOLOGY FOR THE RECONSTRUCTION OF HISTORIC MORTARS

N. BERLUCCHI, R. GINANNI CORRADINI
Il Cenacolo s.r.l., Rome, Italy

Abstract

This paper illustrates an analytical method useable for the reconstruction of historic bedding mortars as found in the masonry walls of 16 historic monuments in Campania.

The laboratory tests on these historic mortars included the following: macroscopic description, thin sections for image processing, X-ray diffraction, calcimetric measurements with insoluble in HCl, porosity measurements with mercury, thermogravimetry and granulometric analyses with sieving (after disaggregation).

At the same time the search continual for quarries, or sources of raw material, most suitable for a supply of aggregates as similar as possible as those found in the historic mortars.

Through the necessary reductions, the weight-value of the lime putty/aggregate ratio was found to use in preparing building mortars.

The analyses mentioned above were carried out on the mortars reconstructed in this way in order to check their actual correspondence to the originals.

The results obtained confirm an over-all good accuracy in the reconstruction of the mortars.

Keywords: reconstruction, historic mortars, image processing, disaggregation, quarry identification, pozzolana.

1 Introduction

This paper presents the results obtained during a partial phase of the research project: **Executive Project for the Interdisciplinary Research on Investigative Procedures and Techniques of Intervention** - Law 84/90, letter C, commissioned by the Ministry of Cultural and Environmental Properties - Technical Scientific Direction: Dr. E. Borea/Arch. A. Pandolfi, I.C.R. - Contracting firm: Il Cenacolo s.r.l. (group chief), SPC s.r.l.

The research was carried out by 12 technicians, working full time for 18 months, who analyzed 16 historic masonry walls of 15 of the monuments in the Neapolitan and Caserta area (fig. 1 and table 1).

This experiment grew from the need for quantitative information on the mechanical characteristics of historic mortars. In fact, frequently it is impossible to collect sufficiently substantial samples to subject to mechanical testing in laboratories, since the samples themselves often not thick enough.

In order to solve this problem, the research project has provided for the construction of particular mortars, called **model mortars**, that are very similar to the chemical-physical and mechanical characteristics of the original ones, but are available in useful quantities and sizes.

The definition of the quality and the quantity of the materials used is useful should it become necessary to construct a mortar as similar as possible to the one used in the monument considered for restoration.

2 Methods and results

Following are the methods used, and the relative results, needed to define the quality and quantity of the raw material to use in reconstructing historic mortars.

The following operations were repeated for each monument.

2.1 Sampling (Phase I)

Sampling 8 bedding mortars, of which 4 were taken from specific sections inside a core obtained by core-boring and 4 in different parts of the wall and at a depth greater than 5 cm to avoid sampling weathered mortars.

2.2 Experiment and Calibration (Phase II)

During this phase, experiments and calibrations were carried out to evaluate the reliability of various techniques and analytical procedures which do not have a broad bibliography.

The following techniques were analyzed especially: image processing as applied to thin sections, calcimetry with insoluble in HCl, the disaggregation system using hexaed $\text{Na}_2\text{-EDTA}$ salt and the accelerated carbonatization system for the laboratory constructed mortars.

The first technique is a new approach for defining descriptive parameters of the compositional characteristics of the mortars; the second, although very standardized, shows aspects not yet resolved in the field of pozzolanic mortars containing silicates soluble in HCl. The third and fourth techniques are still in the experimental stage.

This phase called for the preparation of 30 standard mortars, whose components were known, to be used for testing the above techniques and procedures.

With regard to image processing, two different data acquisition systems (relating to granulometric variation of the aggregate) were evaluated by carrying out 30 thin sections and 84 image processing evaluations. The first method is based on the acquisition, from sizable enlargements, of small, frequent fields, and has shown greater validity for mortars having medium to fine granulometry. The second system is made up of mixed fields (one general from a smaller sized enlargement and two of details) and shows greater validity for mortars from coarse to fine granulometry. In general, however, the contents of the aggregates turned out to be underestimated since the clayey-silt portion (section $< 62 \mu\text{m}$), normally found in a substantial percentage in pozzolana (that is $> 20\%$), was too low to be distinguished easily by the mineralogical microscope.

The calcimetry with insoluble in HCl showed, during testing on historic mortars, a variation ($\Delta\%$) equal to about 20-25% between the total carbonate content and the insoluble with respect to 100%.

Using different analytical techniques (15 calcimetric measurements with insoluble in HCl, 5 thermogravimetric measurements, 4 chromatographic analyses, 5 X-ray diffractions) allowed verification of an over-all good level of reliability for the calcimetric analyses for carbonate contents (over-all deviation less than 8-10%).



Fig. 1 - Location of the monuments and selected quarries

TABLE 1 - MONUMENTS CONSIDERED BY THIS STUDY

MONUMENT	LOCATION	PROVINCE
I Palazzo Filomarino	Naples	Naples
II Chiesa S. Francesco delle Monache	Naples	Naples
III Convento S. Lorenzo Maggiore	Naples	Naples
IV Chiesa S. Maria del Popolo agli Incurabili	Naples	Naples
V Palazzo Serra Cassano	Naples	Naples
VI Ex Ospedale Militare	Naples	Naples
VII Convento S. Lorenzo ad Septimum	Aversa	Naples
VIII Chiesa S. Lorenzo ad Septimum	Aversa	Naples
IX Convento S. Biagio	Aversa	Naples
X Castello Normanno (wall 1)	Casaluce	Naples
XI Castello Normanno (wall 2)	Casaluce	Naples
XII Chiesa S. Domenico	Aversa	Naples
XIII Chiesa S. Pietro ad Montes	Caserta	Caserta
XIV Chiesa Gesù Nuovo	Naples	Naples
XV Palazzina dei Principi	Parco di Capodimonte	Naples
XVI Palazzina Cattaneo	Parco di Capodimonte	Naples

Therefore, the $\Delta\%$ was considered due to the presence of $\text{Ca}(\text{OH})_2$ in the mortars as crystals (portlandite) and of other compounds (clays, zeolites, silicates, etc.) that solubilize without releasing CO_2 due to the effect of HCl.

On the basis of these considerations, the entire $\Delta\%$ was attributed to the aggregate, slightly underestimating the CaCO_3 content by some percentage units (the possible presence of not yet carbonated calcium hydroxide).

The method of disaggregation with heated $\text{Na}_2\text{-EDTA}$ salt was used on 3 standard mortars with differing granulometries; stereomicroscope observations and the definition of the relative experimental granulometry curve, compared to the standard reference curve, showed good reliability for the sand/gravel fraction characteristic of

most of the aggregate. In fact, the remaining fraction (silty-clayey) is not appreciable since it is confused with substances in suspension and is eliminated during washing.

The carbonation system was tested by three different methods: natural carbonatization, accelerated carbonatization in a carbon dioxide saturated environment in the presence of water, and carbonatization in a system combining the two preceding ones. This test led to choosing the third system as most suitable for the purposes of this search for improved water set to meet the final end of work date.

2.3 Diagnostic description of historic mortars (Phase III)

This description was achieved by the chemical-physical tests and investigation done in order to evaluate compositional characteristics of mortars: the type of binder, type of aggregate, the binder/aggregate ratio, the porosity of the mortar.

Groups of 8 mortar samples, from the same portion of masonry, were analyzed by macroscopic description, thin section, X-ray diffraction, calcimetry with insoluble in HCl, as well as mercury porosity measurements. For each of these analytic techniques, the corresponding synthetic definition was described and recognized as **typical mortar**.

The thin sections to be analyzed by image processing (fig. 2) were selected on the basis of the over-all situation described by this research, using at least 3 for each portion of masonry.

The most significant mortar for each site was selected and disaggregated by etching with heated $\text{Na}_2\text{-EDTA}$ salt to extract the aggregate to be analyzed by mechanical sieving. This was done to obtain the granulometry curve and a physical description measuring specific weight of the mortar and the volume weight of the aggregate.

The results (table 2) allowed evaluation both of the compositional characteristics of the aggregate to compare to the material extracted from the selected quarries (Phase IV), as well as the binder/aggregate ratio, expressed in areas (image processing) and in weight (calcimetry).

Usually the error found in physical parameters is about 0.001-0.005 g/cc.

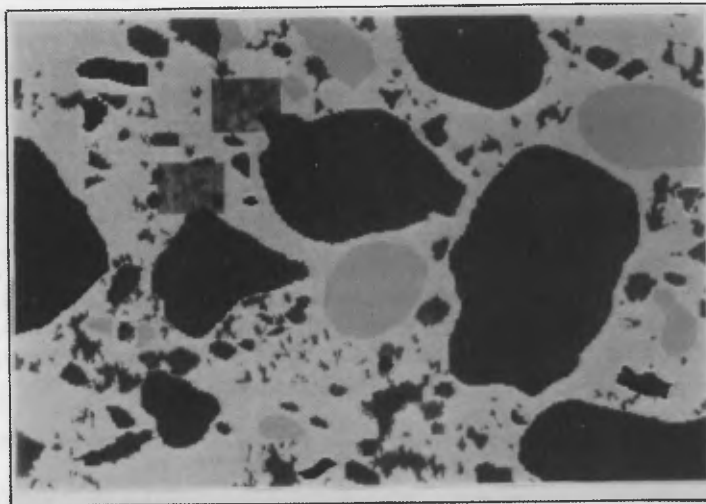

Fig. 2 - Image processing of a general field with two windows for detailed fields.

TABLE 2 - TYPICAL MORTARS: DISTINGUISHING PARAMETERS

Mon.	γ_s^1	γ_s^2	γ	Clm	I.P.	P%	Thin section	Granulometry
I	2.46	2.41	1.90	1/3.3	1/0.3	33.5	Tephra & tufa	s. gravelly-clayish
II	2.48	2.45	2.13	1/4.8	1/0.8	43.0	Tephra	s. with clayish gravel
III	2.58	2.56	2.25	1/5.5	1/1	24.6	Tephra	s. gravelly slightly clayish
IV	2.47	2.44	2.35	1/7.7	1/0.8	36.8	-	s. gravelly-clayish
V	2.49	2.47	1.86	1/5.2	1/0.6	22.3	Tephra	s. with clayish gravel
VI	2.48	2.45	1.76	1/6.3	1/1.1	44.0	Tufa	s. gravelly-clayish
VII	2.56	2.52	2.36	1/4	1/0.8	39.0	Tephra & tufa	s. gravelly slightly clayish
VIII	2.54	2.50	2.21	1/3.6	1/0.4	36.7	-	s. gravelly-clayish
IX	2.46	2.44	2.28	1/6.7	1/0.8	35.8	Tufa	s. gravelly-clayish
X	2.48	2.40	2.20	1/2.4	1/0.4	38.7	Tufa	s. gravelly-clayish
XI	2.50	2.44	2.22	1/3.1	1/1.3	32.1	Tufa	s. gravelly slightly clayish
XII	2.45	2.41	1.99	1/4.5	1/0.8	38.1	-	s. gravelly slightly clayish
XIII	2.56	2.51	2.16	1/2.2	1/0.8	36.9	Tephra & tufa	s. gravelly slightly clayish
XIV	2.51	2.47	1.90	1/4.2	1/0.8	44.0	Tephra	s. gravelly-clayish
XV	2.47	2.43	1.91	1/4.5	1/0.8	55.9	Tufa	s. gravelly-clayish
XVI	2.54	2.5	1.63	1/4.2	1/1.3	20.8	Tufa	s. gravelly-clayish
Common elements							Trachyte	clayish = silty &/or clayish

N.B. γ_s^1 = specific weight of mortar (g/cc); γ_s^2 = specific weight of aggregate (g/cc); γ = volume weight of aggregate (g/cc); Clm (Calcimetry) = CaCO₃/aggregate; I.P. (Image Processing) = Binder/aggregate in areas; P% = Total open porosity; s. = sand

2.4 The Search for the Quarries (Phase IV)

The search for and the identification of the most suitable quarries to supply material similar to that used in making the original mortars, was carried out in two main phases: identification of the quarry and classification of the quarries so identified.

Identifying the quarries meant:

- bibliographic research at public and private organizations, universities and so on for specific documents regarding historic investigation and geological background;
- acquisition of the data obtained from the fact-finding research on historic mortars (Phase III);
- identification of the historic quarries and modern ones as supply areas for raw material and consequent selection of the most probable quarries for use.

Classifying the identified quarries meant:

- taking samples from the selected quarries for chemical-petrographic-granulometric description using macroscopic definition, thin sections, X-ray diffraction, granulometric analysis, real specific weight;
- comparison of the compositional characteristics of the aggregates of the original mortars with raw material from a quarry sample and consequent classification of the most suitable quarries.

There are 8 selected quarries in the Neapolitan area (fig. 1 and Table 3) in correspondence with the two volcanic systems: the Phlegrean Fields and the Somma-Vesuvius. The pozzolanas from the second area differ from the first mostly due to the presence of leucite, greater specific weight, tephritic chemism, generally larger granular dimensions and a tendency toward darker colors.

Values of specific weight show an error about 0.001-0.003 g/cc.

TABLE 3 -SELECTED QUARRIES AND RELATIVE CHARACTERISTICS OF POZZOLANA

System	Name	Prevalent petrography	γ_s	Granulometry
Somma Vesuvius	1) Alveo di Pollena	Trachytes, tephra leucities	2.74	s. with gravel slightly clayish
	2) Somma Vesuviana	Tephra, trachytes	2.65	s. gravelly-clayish
	3) S. Anastasia	Trachytes, tephra	2.69	s. gravelly slightly clayish
Phlegrean Fiends	4) Ponti Rossi	Pumice	2.47	s. with gravelly silt
	5) Baia	Pumice	2.48	s. clayish-gravelly
	6) Fondi di Baia I	Pumice	2.44	s. with gravelly silt
	7) Bacoli	Pumice	2.49	s. clayish gravelly
	8) Monte di Procida	Pumice	2.47	s. with silt slightly gravelly

N.B. s. = sand; γ_s = specific weight of aggregate (g/cc)

For each quarry, the material was identified on a technical card as prescribed by the Normal Recommendations 6/81. The assignment of the quarries to the particular monument was efficacious, considering both granulometry and petrography (Table 4).

TABLE 4- CLASSIFICATION OF SELECTED QUARRIES

MONUMENT	QUARRY	RELIABILITY	
		Petrography	Granulometry
I	6 Fondi di Baia I	good	good
II	6 Fondi di Baia I	good	good
III	3 S. Anastasia	good	good
IV	6 Fondi di Baia I	good	good
V	5 Baia	good	good
VI	6 Fondi di Baia I	good	good
VII	5 Baia	good	good
VIII	5 Baia	good	good
IX	6 Fondi di Baia I	good	good
X	5 Baia	fair	fair
XI	6 Fondi di Baia I	good	good
XII	4 Ponti Rossi	fair	good with slight grinding
XIII	5 Baia	good	good (grinding and artificial recon.)
XIV	5 Baia	good	good
XV	6 Fondi di Baia I	good	scarce (artificial recon. of the curve)
XVI	6 Fondi di Baia I	good	good

2.5 Construction of the Model Mortars (Phase V)

The presence of a calcitic binder, obtained from chemical-physical research testing, led to the discovery of the use of lime putty, widely adopted in ancient times, as raw material for the binder. Therefore, a lime putty was selected from a calcareous quarry in southern Latium that was used after a 6-month rest period. The percentage of quarry contained in the putty equalled 51% of its weight; its volume weight was 1.36 gr/cc.

Enough mains water was used in the preparation of the mixture to achieve a good degree of plasticity in the mortar itself. After the acquired data were processed also by chemical and physical analysis, various hypotheses were introduced to consent the passage from qualitative-quantitative evidence regarding the aspect of the mortars, their composition and binder/aggregate ratio, to a single numerical-putty value for the lime/aggregate ratio, expressed as a weight and that would permit the reconstruction of the mortar required.

Image processing gives binder/aggregate ratios in areas determined by volume by using the calibrated curve previously defined (2.2 Experimentation and Calibration).

This analysis is not useful for defining the smallest fraction of the porosity of the aggregate in the binder, since the enlargements used obviate consideration of particles of less than about 50-60 μm .

In particular, as for the porosity, the entire fraction comprising micropores ($< 0.002 \mu\text{m}$), mesopores (between $0.002 \mu\text{m}$ and $0.05 \mu\text{m}$) and the small fraction of macropores ($> 0.05 \mu\text{m}$), escapes analysis.

Observation through the microscope of a dry lime putty sample showed that, after loss of water, pores larger than those mentioned above did not form. For this reason, the coarser macroporosity revealed by the microscope was attributed entirely to the inability of the binder to fill the intergranular pores typical of all dissolved material.

In this way the amount of the binder analysed by image processing was considered formed by calcium carbonate plus porosity P due to the volume of the water in the lime putty.

It was thought that the shrinkage variations of the binder were negligible, and that therefore it was possible to consider the correspondence between the volume of calcium carbonate and microporosity with the initial lime putty (and relative water content).

As for the aggregate, it was apparent that the extrapolated ratio did not account for the fine fraction of the aggregate. This fraction was not measurable by disaggregation since it was mixed with suspended substances (EDTA for example). In order to obtain the volume of the fine fraction, the following steps were followed:

- a) calculation of the weight of the original, historic aggregate by using the corresponding volume-weight of the aggregate
- b) evaluation of the quantity of the fine fraction, corresponding to 22% in weight, obtained by measuring the average percentage of the fine fraction found in the identified quarries
- c) calculation of the volume of the fine fraction, to add to the extrapolated volume of the aggregate by using the weight of the fine fraction and the weight of the average volume of the fine fraction of the quarries (2.23 gr/cc).

This volume correction of the aggregate compels an equal lessening of the volume of the binder.

A further variation is introduced by the use of pozzolanas that do not perfectly match in volume weight the originals used at the site (different weights for equal volumes). Therefore, the corrected volume for each site was multiplied by the particular volume weight pertaining to the designated quarry, obtaining the weight of that quarry aggregate needed for a volume equal to the volume measured by image processing.

By thus multiplying both the lime putty volume corrected for its volume weight (equal to 1.36 gr/cc) and the volume of the aggregate by the volume weight pertaining to the designated quarry, the result is, respectively, the amount in weight of lime putty and aggregate.

The calcimetric analysis and measurement of the insoluble in HCl resulted in a series of percentage ratios between calcium carbonate and the other mortar components expressed in weight. However, the calcimetry showed a certain percentage of material that solubilizes without producing CO_2 and that prevents reaching 100% when summing up the insoluble to the measured carbonate (2.2 Experimentation and Calibration). Therefore, the corresponding amount of calcium hydroxide was obtained [$\text{CaCO}_3 = 100$; $\text{Ca}(\text{OH})_2 = 74$, molar weights].

To this must be added: the weight of the water in the lime putty on the order of 51% of the total weight.

As for the aggregate, the weight obtained by the calcimetry was multiplied by the ratio of the specific weight of the site aggregate over that of the designated quarry aggregate, in order to obtain the correspondence in volume.

Thus the ratio, lime putty/aggregate, was found that was suitable for reconstructing the mortar.

Once all the **lime putty/aggregate weight ratios** were obtained by image processing and calcimetry with HCl insoluble, the following observation became necessary.

As previously noted (2.2 Experimentation and Calibration) the calcimetric analysis (C) overestimates the aggregate, while image processing (E) underestimates it. It was therefore considered that the two ratios represent the limits between which the real ratio of the typical mortar can be found ($E < \text{Typical} < C$). Since it was not possible to define a priori which one was nearer the real ratio of the typical mortar, two types of mortar were reconstructed using the two different compositional ratios (E,C) obtained from quantitative analyses, with the intention to establish later, by testing, which of the two was most similar to the standard site mortar. For some sites where the discrepancy between the two ratios was less than 12%, a single mortar was reconstructed with a new binder/aggregate ratio given by the arithmetic average between the calcimetric derived ratio and the image processing derived one (EC).

In this way, an error of less than 6% was introduced and was held as acceptable given the great variability of the typical mortar parameters and of this kind of process. Two families were formed, therefore: one where the discrepancy relative to the quantity of lime putty was less than 12% and one where the discrepancy was greater than 12%.

The following histogram shows the absolute deviation of the amounts of lime putty, found through image processing, with respect to the values found through calcimetry (Fig. 3).

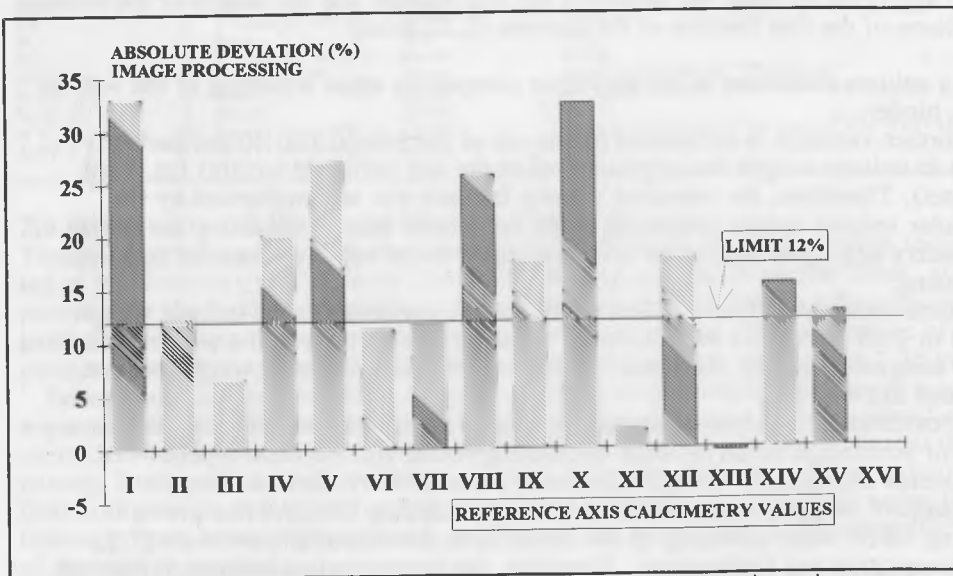

Fig. 3 - Histogram of absolute deviations among binder/aggregate ratios, using quarry aggregate, and obtained with image processing and calcimetry.

The following model mortars were therefore reconstructed for each site:
Mortar Model E and C: sites I, II, IV, V, VIII, IX, XII, XIV, XV
Mortar Model EC: sites III, VI, VII, XI, XIII, XVI
Mortar Model C: site X

The mortars were introduced into PVC tubes (external diameter: 63mm; length 30-35 cm), lightly compacting the mixture. Two test cylinders were obtained from every tube, of about 55 mm in diameter and about 100 cm long. These mortars were aged using a system combining natural carbonation for 20 days and accelerated carbonatization in a carbon dioxide saturated environment for 31 days, before submitting the test pieces to compression tests with modulus of elasticity measurement.

2.6 Verification of Model Mortars (Phase IV)

Control analyses were carried out on 25 model mortars (thin sections, image processing, X-ray diffraction, calcimetry with insoluble in HCl, mercury porosimetry) in order to assign to each site the most suitable mortar among those reconstructed.

- a) Verification of the correspondence among the 25 model mortars that have been reconstructed and the relative theoretical parameters of the project. The results confirm good general construction since the calcimeter divergencies are generally comparable and lower than the acceptance level, that is about 10%. Only the I C and the III EC (Fig. 4) mortars have a significant divergence (14.1% and 12.7% respectively) and were therefore discarded because of poor preparation.

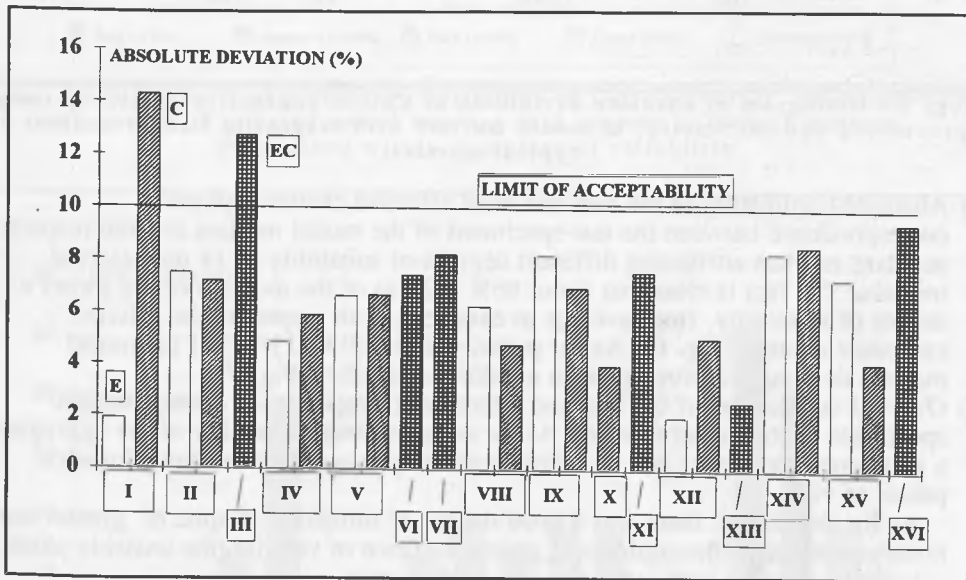

Fig. 4 - Histogram of absolute deviation of CaCO₃ content of model mortars with respect to corresponding projected values

- b) Relative verification, that is, site by site of the best and real correspondence between the test specimens of the model mortars and the respective standard mortars (Fig. 5). Of the 23 model mortars chosen previously, the only ones selected as suitable for each individual site had the least divergence of the contents of calcium carbonate with respect to the standard mortar. Thus all the model mortars E were eliminated and 14 model mortars were selected as being the most representative of the standard mortars. It is evident that about 88% (14/16) of the historic mortars have a model mortar correspondent.

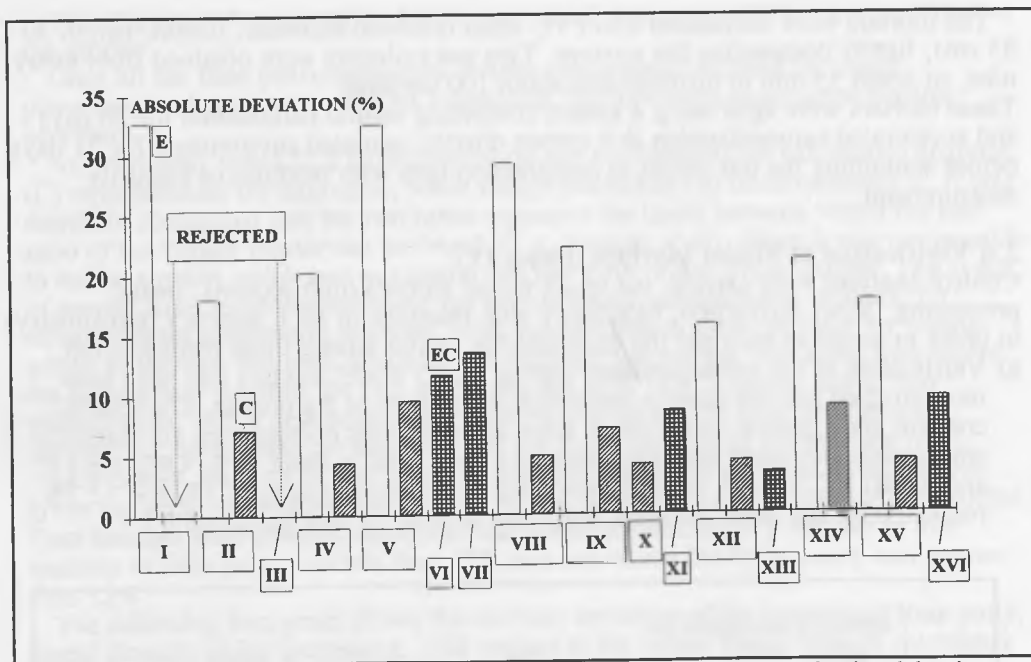

Fig. 5 - Histogram of absolute deviations of CaCO₃ content, obtained by image processing and calcimetry, in model mortars with respect to CaCO₃ content of typical mortars.

- c) Absolute verification of the best and most effective chemical-physical correspondence between the test-specimens of the model mortars and the respective standard mortars attributing different degrees of suitability of 14 pre-selected mortars. The fact is clear that about 86% (12/14) of the model mortars shows a degree of suitability, from average to excellent, with respect to the calcium carbonate content (Fig. 6). As for porosity about 79% (11/14) of the model mortars demonstrate from good to excellent suitability (Fig. 7).
- d) Over-all verification of the best and effective correspondence among the test specimens of the model mortars. As for compositional suitability of the aggregate, a good correspondence is found from both the petrographic and granulometric points of view.

As for the binder, there was a good degree of suitability in spite of greater non-homogeneity of carbonization and greater instance of vaterite (the unstable phase of calcium carbonate) with respect to standard mortars.

Over-all, 64% (9/14) of the selected mortars show through suitability with respect to the nature of the binder, the aggregate, the weight ratios and open porosity. Added to these are the mortars that are suitable except for one factor: 22% (3/14) differ only because of open porosity, while 14% (2/14) only for the calcium carbonate content.

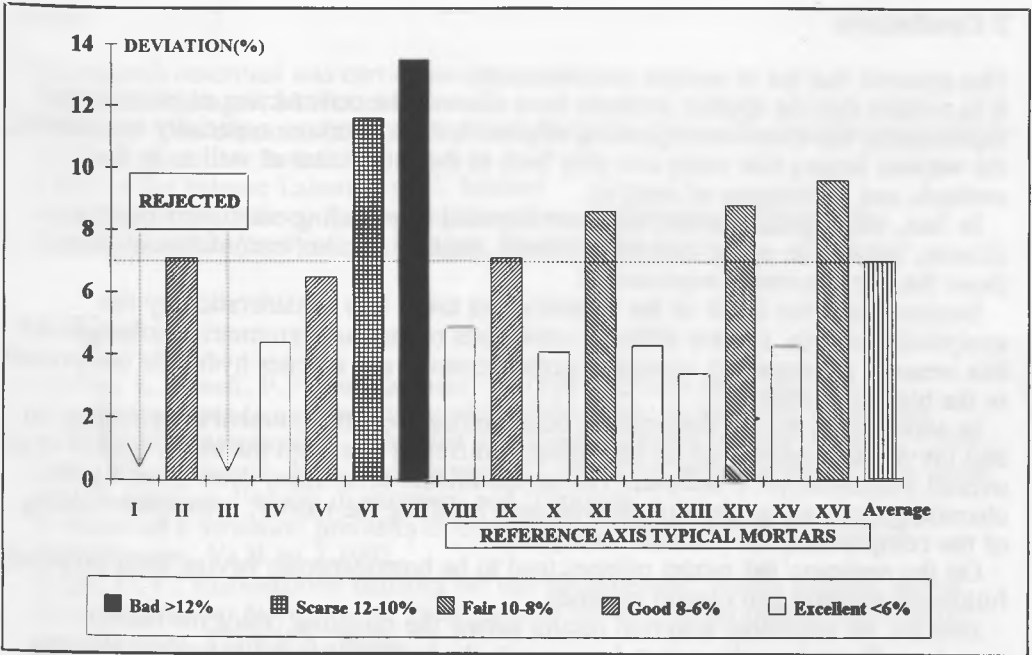

Fig. 6 - Histogram of percentage variations of CaCO₃ content, measured by calcimetry of selected model mortars with respect to typical mortars: determined within 5 degrees of reliability

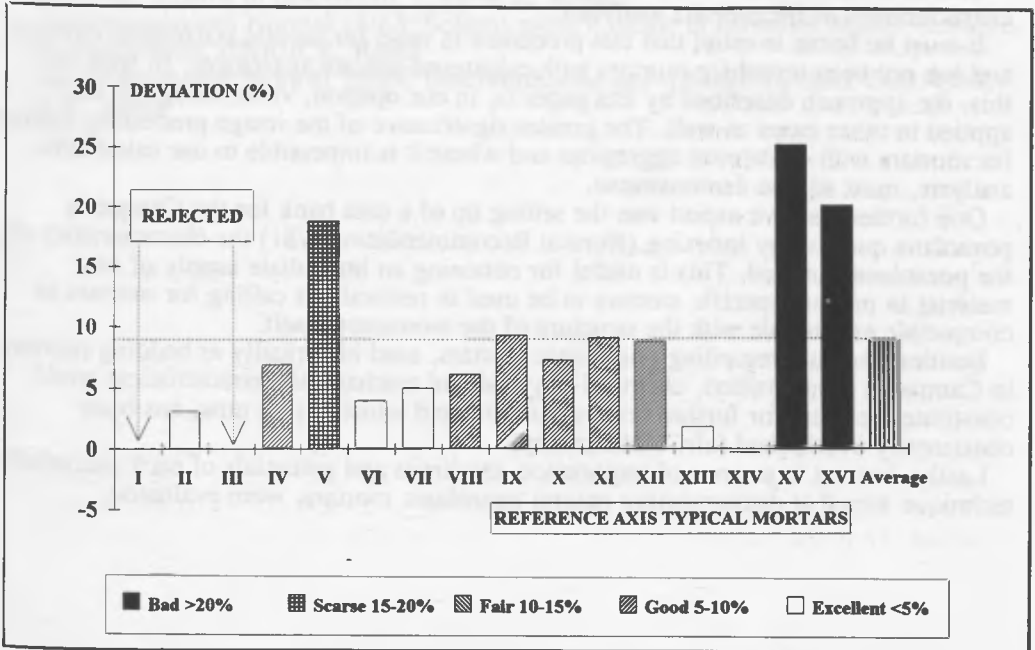

Fig. 7 - Histogram of percentage variations of open porosity, measured by mercury porosimeter, of selected model mortars with respect to typical mortars: determined within 5 degrees of reliability

3 Conclusions

The research has led to various considerations.

It is evident that the applied methods have allowed the construction of mortars that significantly represent corresponding original historic mortars, especially considering the various factors that come into play both at the actual sites as well as in the methods and techniques of analysis.

In fact, the original mortars had been exposed to preparing conditions (such as climate, imbibition of the external masonry, passing of time, etc.) different from those the test specimens experienced.

Besides, even the depth of the masonry, not taken into consideration by the analytical methods, created different conditions of thermohygrometric exchange. All this meant a consequently improved carbonatization and a better hydraulic component in the historic mortars.

In addition the results demonstrate conditioning from the moment of sampling, so that the mortars tested may be considerably different one from the other, in spite of an overall evaluation of 8 samples. The compositional diversities, determined by site characteristics such as the various workmen handling the mortar, incomplete mixing of the components, etc., can be lasting.

On the contrary, the model mortars tend to be homogeneous, having been prepared following uniform and careful methods.

Besides, an inevitable selection occurs during the sampling, since the mortar samples collected are those that demonstrate the best mechanical behaviour and that have resisted the stresses of core boring, the sampling and preparation of the test pieces themselves.

This is an index of the best, not the average, chemical-physical compositional characteristics of the mortars analyzed.

It must be borne in mind that this procedure is valid for natural pozzolanic mortars and has not been tested for mortars with calcareous-silicate aggregates. In spite of this, the approach described by this paper is, in our opinion, valid enough to be applied in other cases as well. The greater significance of the image processing system for mortars with calcareous aggregates and where it is impossible to use calcimetric analysis, must still be demonstrated.

One further positive aspect was the setting up of a data bank for the Campania pozzolana quarries by indexing (Normal Recommendation 6/81) the characteristics of the pozzolana sampled. This is useful for obtaining an immediate supply of raw material to prepare specific mortars to be used in restorations calling for mortars as compatible as possible with the structure of the monument itself.

Besides, the data regarding pozzolanic mortars, used historically as bedding mortars in Campania (composition, chemical-physical and mechanical characteristics) could constitute the basis for further research in this field which, up to now, has been consistently overlooked (cfr. bibliography).

Lastly, but not in a sense of importance, the limits and potentials of each analytical technique aimed at distinguishing natural pozzolanic mortars, were evaluated.

Notes

The research described was carried out by:

- Executive Manager: M. Pouchain
- Research Coordinators: (structural phase) Prof. G. Croci, S. De Vito; (chemical-physical phase) N. Berlucchi
- Chief of the Science Laboratory: C. Molteni
- Researchers: M. Allevi, R. Ginanni Corradini, F. Mattolin, S. Merluzzi
- External consultants: Prof. G. De Casa, Geoplanning s.r.l.

4 References

- Cimitan, L., Rossi, P.P. and Zaninetti, A. (1991): Studio delle tecniche di disgregazione per le indagini diagnostiche delle malte. In *Materiali e Strutture: problemi di conservazione*. Published by L'Erma di Breischneider, Yr.1,no.3,1991.
- Chiari, G., Santarelli, M.L. and Torracca, G. (1992): Caratterizzazione delle malte antiche mediante l'analisi di campioni non frazionati
In *Materiali e Strutture: problemi di conservazione*. Published by L'Erma di Breischneider, Yr.II,no.3,1992
- Hugh, D.Y.: *Elaborazione statistica dei dati sperimentali*. Veschi Editore, Roma.
- *Raccomandazioni Normal 4/80: Distribuzione del volume dei pori in funzione del loro diametro*, CNR-ICR, Roma
- *Raccomandazioni Normal 10/82: Descrizione petrografica dei materiali lapidei naturali*, CNR-ICR, Roma
- *Raccomandazioni Normal 12/83: Aggregati artificiali di clasti e matrice legante non argillosa: schema di descrizioni*. CNR-ICR, Roma
- *Raccomandazioni Normal 14/83: Sezioni sottili e lucide di materiali lapidei: tecniche di allestimento*. CNR-ICR, Roma
- *Raccomandazioni Normal 32/89: Determinazione gas volumetrica della CO₂*. CNR-ICR, Roma

POSSIBLE SUBSTITUTES FOR KHORASAN MORTAR IN BYZANTINE AND OTTOMAN MONUMENTS

A.ERSEN

Technical University of Istanbul, Department of Architecture,
Istanbul, Turkey

M.KARAGÜLER

Technical University of Istanbul, Department of Architecture,
Istanbul, Turkey

A.GÜLEÇ

Ministry of Culture, Restoration and Conservation Laboratory,
Istanbul, Turkey

Abstract

Khorasan mortar is a hydraulic mortar and mainly consists of slaked lime, crushed brick, pozzolanic additives and sand. It had been widely used in Byzantine and Ottoman monuments. Mix designs vary according to the period and structure it had been used.

Physical and mechanical properties of ancient mortars and concretes are different from those of modern ones. Characterization of ancient mortars provide necessary data to determine the criteria for the requirements of conservation mortars. Conservation mortars should not cause additional stresses in the old fabric and should not cause chemical corrosion.

In this research ancient khorasan mortars and concretes are categorized, characterized and different mixes with commercially available materials are produced and tested for their physical, mechanical properties, durabilities. Also risk of transferring water soluble salts is studied.

Keywords: Ancient Mortars, Conservation Materials, Brick, Lime, Pozzolana, Lime-Based Mortars.

1. Introduction

Bearing in mind the high strength, impermeable character and possibility of transferring water soluble salts conservation architects avoid to use Portland cement as a binder in conservation mortars and grouts. Instead limited amounts of white cement or pozzolanic additives are recommended (Peroni, 1982, Ashurst, 1990). In this research ancient mortars sampled from the city walls of Constantinople [5th - 15th C., A.D] and a 15th century Early Ottoman Public bath were tested for their physical and mechanical properties to obtain data for comparison. Also binder: aggregate ratios, grading of the aggregates and petrographic analysis of the aggregates are studied for characterization. State of conservation of the mentioned samples differed from crumbling and powdering ones to sound and strong. Generally it is difficult to take standard samples of mortars of ancient

walls. Difficulties may arise due to the crumbling state of the mortars or aesthetical reasons in well preserved buildings. In case of crumbling mortars it is almost impossible to cut standard sized samples for testing mechanical properties.

Binder: Aggregate ratios of the mortar samples of Tahtakale Public Bath [15th C., A.D.], land walls and sea walls of Constantinople [5th - 8th C., A.D. samples] are respectively 1:1.25-3 and 1:2.25-2.60 resembling the classical 1:3 ratio. Aggregates are always crushed brick and limited amount of river sand (2-8 mm.). Coarse aggregates are occasionally gravel size. The amount of river sand in the total volume of the aggregates is approximately 10 %. Mechanical properties of the mortars sampled from Tahtakale public bath could not be evaluated as they were weak and crumbly. Some of the physical properties can be seen in (Table 1).

Table 1. Some of the Physical Properties of the Mortars Sampled from Tahtakale Public bath

Sampling Place	Unit Weight (g/cm ³)	Ground Specific Gravity (g/cm ³)	Porosity (%)	Water Absorption by Weight (%)
Foundations	1.39	1.99	28.4	30.3
Walls	1.37	1.88	27.3	33.4
Building Materials Laboratory of Department of Architecture, Technical University of Istanbul. Results are average of 10 samples.				

Mortars sampled from the sea and land walls of Constantinople were in a better state of conservation and rather should be defined as khorasan concretes. Thus standard samples could be submitted to tests, the results are of single characteristic samples and are shown in (Table 2).

For the unity and stability of the rampart and the towers of the city walls of Constantinople khorasan concretes had been used (Table 2). In khorasan concretes coarse aggregates and additives are used and as a result better mechanical properties are obtained than khorasan mortars. Diversity of the mechanical properties are due to the original mix designs and the state of conservation of the ancient mortars. Thus it will not be either scientific or ethical to assume a new mix design being the ideal conservation mortar. Characterization of each ancient mortar or concrete case by case is necessitated before intervening ancient masonry.

Tables 1 and 2 shows the physical and mechanical properties of some samples, however all of them are khorasan concretes and high compressive strengths can be explained in this context. Khorasan mortars usually display compressive strengths of 1-4 N/mm².

In this research using the commercially introduced materials and additives different mixes are designed and tested to see the changing parameters and compared with the ancient mortars in regard to general requirements of conservation materials.

Table 2. Physical and Mechanical Properties of Mortars Sampled From the Landwalls and Seawalls of Constantinople

Sample Nr.	Sampling Place	Unit Weight (g/cm ³)	Water Absorption by Weight (%)	Capillary Coefficient (cm./√min)	Compressive Strength (N/mm ²)
S1	Porta	1.37	30.8	0.107	4.69
S2	Pempton	1.39	30.4	0.072	5.08
S3	Landwalls	1.40	30.3	0.073	7.68
S4	5 th-8 th C.	1.39	30.3	0.079	5.72
S5	A.D.	1.43	27.3	0.079	3.99
S6	Rampart West Facade	1.47	25.9	0.077	5.58
II.1	Porta	1.60	19.8	0.076	5.54
II.2	Polyandrion	1.58	20.9	0.054	4.47
II.3	Land Walls 5 th-8 th c. A.D., rampart West Facade	1.62	19.5	0.062	4.31
III.1		1.60	20.2	0.056	6.05
III.2	East Facade	1.59	20.9	0.070	5.73
III.3		1.60	19.5	0.078	4.50
IV.1	Sea Walls 5 th. C., A.D.	1.42	27	0.073	5.20
IV.2	Tower 13	1.28	32	0.105	2.90

Building Materials Laboratory of Department of Architecture, Technical University of Istanbul

2 Experimental Work

2.1 Materials

Maximum particle size 8 mm crushed brick, and maximum particle size 4 mm fine sand are mixed in a suitable ratio to provide the ideal grading of the aggregates according to DIN 1045 standards. Each group is sieved and weighed separately. Physical properties and grading of the aggregates are shown in [Tables 3. and 4].

Table 3. Physical Properties of the Aggregates

Aggregate Type	Khorasan (Crushed Brick)					River Sand		
	4/8	2/4	1/2	0.5/1	0.25/0.5	1/2	0.5/1	0.25/0.5
Mesh Size (mm)	4/8	2/4	1/2	0.5/1	0.25/0.5	1/2	0.5/1	0.25/0.5
Specific Gravity (Surface dry saturated) (kg/dm ³)	2.26	2.26	2.30	2.29	3.35	2.68	2.68	2.68

Table 4. Grading of the Aggregate Mix (Grading of the aggregate mix lies in the vicinity of curves A and B, DIN 1045)

Mesh size (mm)	8	4	2	1	0.5	0.25
Passing (%)	100	74	55	42	26	11

Total volume of the aggregates consist of 79 % khorasan (crushed brick) and 21 % river sand. Quicklime is procured from a traditional lime kiln, slaked in the laboratory for two months and sieved before use (mesh size 0.5 mm). Specific gravity of the ground pumice and the dry slaked lime used in the mixes are respectively 2.38 g/cm³ and 2.18 g/cm³.

Natural pumice used as pozzolana is abundantly available in Turkey, Cappadocia Region, Middle Anatolia, is a suitable pozzolanic material when finely ground. The fineness of the pozzolana was such that it was retained less than 0.6 % on a 90 microns square mesh sieve and less than 8 % on 200 microns sieve. The pozzolanic strength of the ground pumice was 10 N/mm² for compressive and 2.6 N/mm² for flexural strength. Minimum values recommended in the Turkish Standard (TS 25) are 4 N/mm² and 1 N/mm² for compressive and flexural strengths consecutively. Chemical properties of the ground pumice is shown in (Table 5.).

Table 5. Chemical Properties of the Ground Pumice

SiO ₂	Chemical Composition						Specific gravity (kg/dm ³)
	Al ₂ O ₃	Fe ₂ O ₃	CaO	MgO	SO ₃	CaCO ₃	
Soluble: 8.24	1.70	1.60	2.42	0.37	-	3.25	2.38
Insoluble: 81.36							

Brick used is produced in a traditional brick kiln, crushed and sieved in the laboratory.

Table 6. Mix proportions, flow rates and fresh unit weights of the mixes.

Code	Type of Mix	Flow Rate (%)	Fresh Unit Weight (gr/cm ³)
T1	Plain	55	1.74
T2	Pozzolana Less than 0.25 Mesh.	40	1.78
T2A	17 % Pozzolana	23	1.78
T3	32 % Pozzolana	11	1.83
T4	5.0 % PMMA	11	1.78
T5	1.0 % PMMA	-	1.79
T6	0.5 % PMMA	21	1.79
T7	0.25 % PMMA	15.3	1.79
T8	0.2 % Tow By Weight	4	1.81
T9	0.2 % Tow 0.5 % PMMA 17 % Pozzolana	7	1.82
T10	1 % Water Reducer 1 % Air Ent.	40	1.76
TC1	10 % Cement (16 % By Weight)	13.5	1.84
TC2	25 % Cement (47 % By Weight)	10.0	1.88

2.2 Mixes of Khorasan Mortars

Total aggregate volume and the grading of the aggregates are kept constant in all mixes. To evaluate the improvement in physical and mechanical properties, white cement, ground pumice, PMMA, tow, a water reducer and an air entrainer are used as additives in 13 different mixes. The plain sample (T1) is composed of slaked lime (water content 38 %) crushed brick and river sand and produced for comparison. Total volume of the aggregates is designed twice of the volume of the dry slaked lime. 17 % and 32 % of the binder (by weight) is substituted with ground pumice, the same applies to white cement as 16 % and 47 % by weight or 10 and 25 % of the dry slaked lime by volume.

PMMA is used as an additive in ratios of 0.25, 0.5, 1 and 5 % of the dry slaked lime in four different series. Tow is used as a fibrous additive in the plain sample to observe the results separately (0.2 % by weight).

Water reducer, and the air entrainer both 1 % of the dry slaked lime by weight is added to the plain sample to see the effects.

The amount of water in all mixes are kept constant. The pre-absorption water of the crushed brick is pre-absorbed before mixing with the binders. The water coming from the PMMA emulsion is considered for the total amount of water in the mixes.

Type of mixes, flow rates and fresh unit weights are shown in (Table 6.). Samples are produced in 4X4X16 cm. steel moulds.

2.3 Curing Conditions and Tests

Specimens are kept in 20 ± 3 C° temperature and 65 ± 5 % relative humidity laboratory environment. Flexural strengths are obtained by mid-point loading and compressive strengths from modified cube compression tests.

Samples are submitted to flexural and compressive strength tests after 60 days and 2 years. After 2 years samples are also tested for unit weight, specific gravity in ground samples, water absorption by weight, capillary coefficient, ultrasonic pulse velocity, freeze and thaw.

Two specimens for flexural strength and four specimens for compressive strength are tested after 60 days and two years. Other tests are conducted on two specimens.

Freeze and thaw tests are conducted according to Turkish Standard TS 699 (1 cycle= 4 hrs. immersed in water, 4 hrs. in deep-freeze, -20 C°). This procedure is followed until the sample crumbles.

3 Results and Discussion

3.1 Workability and Fresh Unit Weights

As it can be seen in (Table 6.) ground pumice, PMMA and tow reduce the workability of the mixes. Water reducer and air entrainer, 1 % of the dry slaked lime by weight do not influence the workability in a notable way.

3.2 Physical Properties

Unit weights are similar to those of the ancient samples (Tables 1., 2. and 7.). After two years unit weight of the plain samples is 1.35 g/cm^3 , increasing to 1.56 g/cm^3 in 25 % white cement gauged samples. Specific gravities and the specific gravities of the ground samples are used to calculate the open and enclosed pores and total porosities. Figures 1,2 and 3 show that white cement, ground pumice and PMMA reduce the porosity, especially in cases of white cement and ground pumice. Water absorptions of the samples are

approximately 23 % and this value is close to those of the ancient samples. Capillary coefficients decrease in general, except the 10 % white cement gauged samples. The most notable decrease is seen in PMMA added samples.

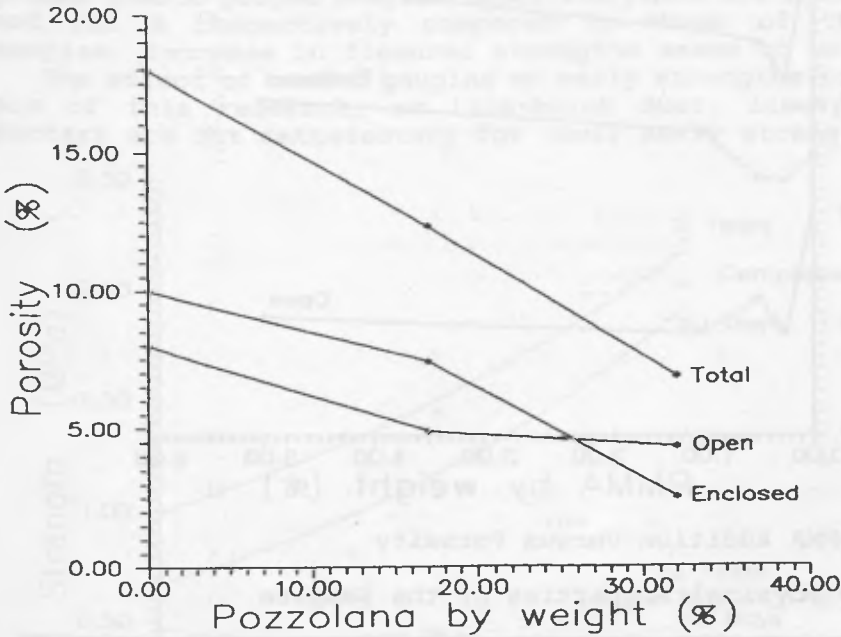

Fig.1 Pozzolana Addition Versus Porosity

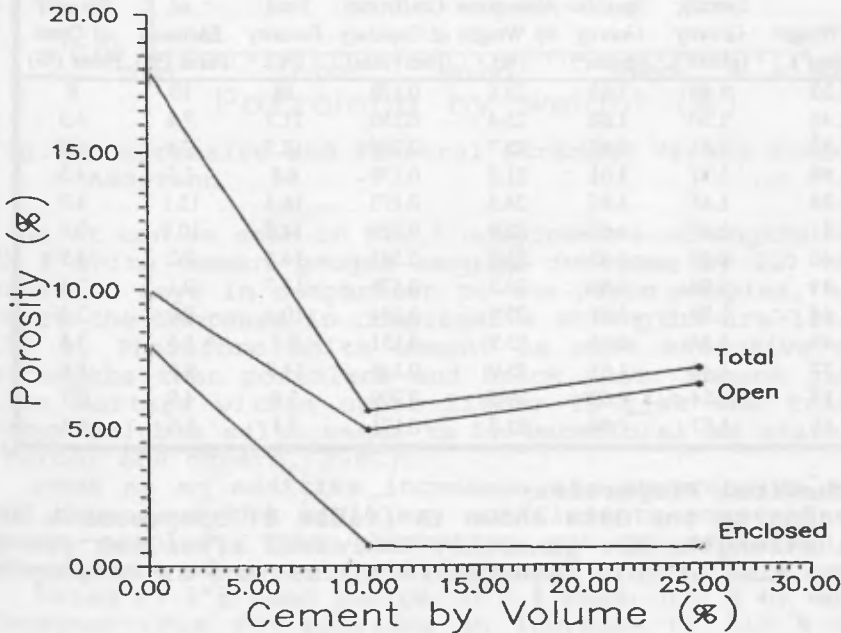

Fig.2 Cement Addition Versus Porosity

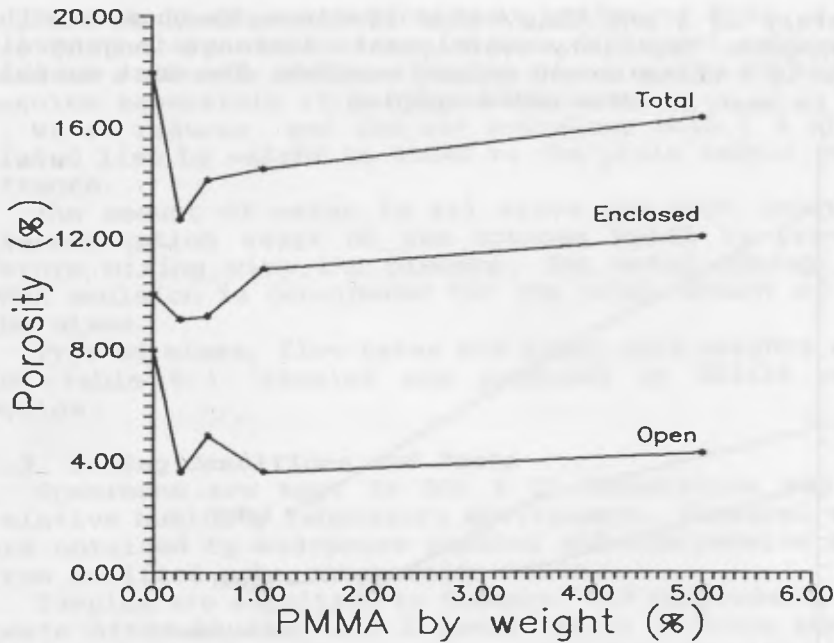

Fig.3 PMMA Addition Versus Porosity

Table 7. Physical Properties of the Samples

Code	Unit Weight (gr/cm ³)	Specific Gravity (gr/cm ³)	Ground Gravity (gr/cm ³)	Water Absorption by Weight (%)	Capillary Coefficient (cm/vmin)	Total Porosity (%)	Porosity of Enclosed Pores (%)	Porosity of Open Pores (%)
T1	1.35	1.48	1.65	23.1	0.178	18	10	8
T2	1.43	1.50	1.62	23.4	0.150	11.7	7.4	4.3
T2A	1.43	1.51	1.63	22.7	0.156	12.3	7.4	4.9
T3	1.50	1.57	1.61	21.5	0.176	6.8	2.5	4.3
T4	1.38	1.45	1.65	24.3	0.173	16.4	12.1	4.3
T5	1.41	1.47	1.65	23.8	0.125	14.5	10.9	3.6
T6	1.40	1.48	1.63	23.8	0.161	14.1	9.2	4.9
T7	1.44	1.50	1.65	23.3	0.175	12.7	9.1	3.6
T8	1.46	1.50	1.63	23.4	0.194	10.4	8.0	2.4
T9	1.49	1.54	1.63	23.9	0.151	9.1	5.5	3.6
T10	1.37	1.46	1.61	25.0	0.146	14.9	9.3	5.6
TC1	1.53	1.54	1.62	23.5	0.209	5.6	4.9	0.7
TC2	1.56	1.57	1.60	21.9	0.171	7.1	6.5	0.6

3.3 Mechanical Properties

According to the data shown in (Table 8) compressive and flexural strengths are generally increased after two years. One of the aims of this research is to test the efficiency of

ground pumice as a pozzolanic additive in lime-based mortars which is ample in Turkey and displays better pozzolanic activity than the brick powder.

Fig.4 shows that compressive strengths of the 17 and 32 % ground pumice gauged samples after two years are increased 44 and 120 % respectively compared to those of the plain samples. Increase in flexural strengths seems to be less.

The effect of cement gauging on early strengths is another aim of this research, as lime-brick dust, lime-pozzolana mortars are not satisfactory for their early strengths.

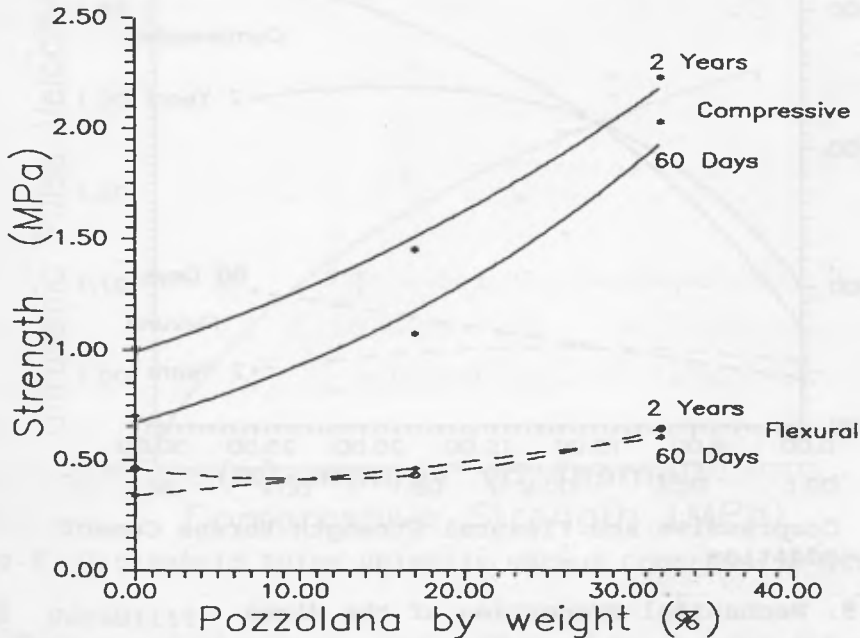

Fig.4 Compressive and Flexural Strength Versus Pozzolana Addition

As it can be seen in Fig.5 compressive strengths of 10 and 25 % white cement gauged samples increase by 221 and 368 % after 60 days in comparison to the plain samples. After two years the increase in compressive strengths are 121 and 135 %. Therefore white cement is more effective on early strengths than pozzolana and brick dust. Cement gauging to lime mortars within upper limits to risk the transfer of water soluble salts seems to be beneficial as stated before (Peroni and others, 1982).

PMMA as an additive increases the compressive strengths and decreases the capillary coefficients compared with the plain samples. This phenomenon can be explained by the improvement of water repellency.

Using 17 % ground pumice, 0.5 % PMMA, 0.2 % by weight tow together (Mix T9) provides an increase by 215 % in early compressive strength and 175 % in compressive strength after

2 years ending with $f_c=2.78 \text{ N/mm}^2$.

This increase ratio is similar to 10 % white cement gauged samples and is the best. Capillary coefficient of this sample is $N= 0.151 \text{ cm./}\sqrt{\text{min}}$ and reduced by 15 % compared with the other mixes, and it can be considered as the optimum.

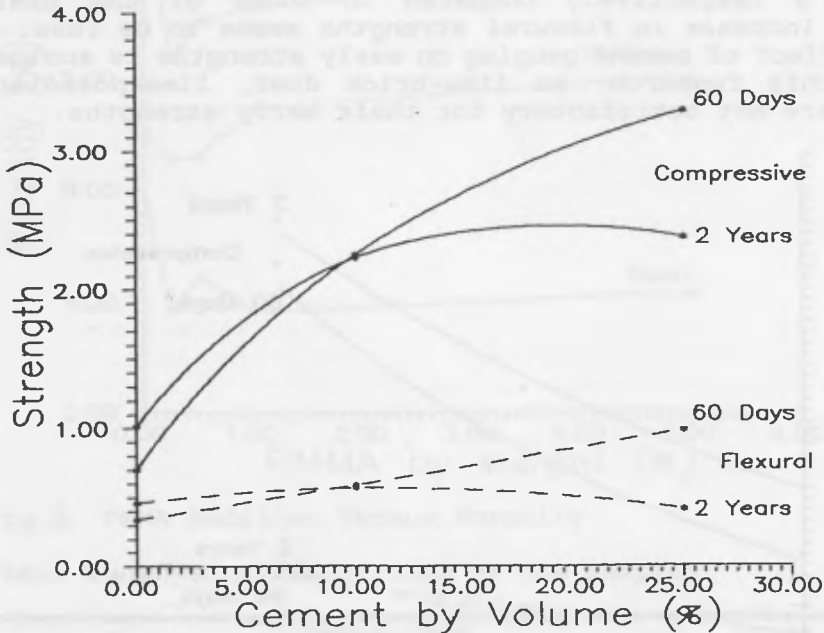

Fig.5 Compressive and Flexural Strength Versus Cement Addition

Table 8. Mechanical Properties of the Mixes

CODE	60 DAYS		2 YEARS		ULTRASOUND VELOCITY (km/sn)
	COMPRESSIVE STRENGTH (N/mm ²)	FLEXURAL STRENGTH (N/mm ²)	FLEXURAL STRENGTH (N/mm ²)	COMPRESSIVE STRENGTH (N/mm ²)	
T1	0.70	0.34	1.01	0.46	1.19
T2	1.19	0.46	1.88	0.55	1.19
T2A	1.07	0.46	1.45	0.43	1.21
T3	2.02	0.60	2.22	0.64	1.32
T4	1.00	0.48	1.68	0.43	1.05
T5	0.82	0.29	1.28	0.44	1.09
T6	0.87	0.34	1.28	0.41	1.11
T7	0.94	0.38	1.62	0.44	1.17
T8	1.29	0.35	2.05	0.36	1.15
T9	2.21	0.59	2.78	0.54	1.32
T10	0.83	0.37	1.59	0.58	1.31
TC1	2.25	0.59	2.23	0.57	1.30
TC2	3.28	0.98	2.37	0.41	1.42

3.4 Ultrasonic Pulse Velocity

Ultrasonic pulse velocities decrease as total porosities increase and increase in U.P.V. correspond to increase in compressive strengths (Table 8 and Fig.6). These results comply with the concept of that increasing porosity decreases strengths.

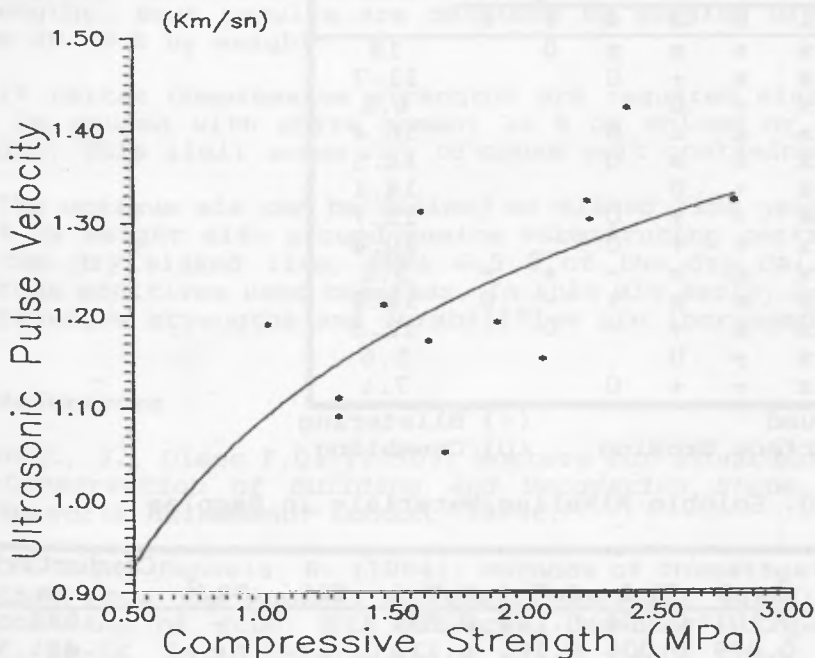

Fig.6 Ultrasonic Pulse Velocity Versus Compressive Strength

3.5 Durability

Freeze and thaw tests are conducted to observe and record the durabilities. The results are shown in (Table 9.). The plain sample with 18 % total porosity resisting 4 cycles seems to be the most durable one. Porosity drastically decreases in cement gauged samples and correlatively these are less durable.

3.6 Soluble Alkaline Materials in Samples

Quantitative analysis by means of an absorption spectrophotometer [Consort] is realized comparing solutions prepared with standard concentrations. Conductivity is measured in 2 g/100 ml concentrated solutions off all samples in distilled water at 25 C°. Total of alkaline elements and conductivity increase in all samples compared to the plain sample (Table 10).

The upper limit can be accepted twice of the amount extractable from the plain sample which is composed of lime, crushed brick and sand. Thus allows the use of other mixes. (Peroni 1982, Tabasso and Sannuri, 1984).

Table 9. Durabilities of the Mixes After Freeze and Thaw Cycles

Code	Freeze and Thaw Cycles						Total Porosity (%)
	1	2	3	4	5	6	
T1	x	x	x	x	0		18
T2	x	x	+	0			11.7
T2A	x	+	0				6.8
T3	x	x	x	0			16.4
T4	x	x	x	0			14.5
T5	x	+	0				14.1
T6	x	+	+	0			12.7
T7	x	+	+	0			10.4
T8	x	x	x	-	+	+	3.1
T9	x	x	x	+	-	0	14.9
T10	x	x	+	-	0		12.3
TC1	x	+	0				5.6
TC2	x	+	+	0			7.1

(x) Sound (-) Blistering
 (+) Surface Erosion (0) Crumbling

Table 10. Soluble Alkaline Materials in Samples

Sample Nr.	Na ⁺ %	K ⁺ %	Ca ⁺⁺ %	Mg ⁺⁺ %	Cl ⁻	SO ₄ ⁻²	Conductivity μ s
T1	0.101	0.004	0.134	0.074	±	+	272
T2	0.079	0.006	0.161	0.113	±	±	431
T3	0.056	0.013	0.064	0.060	±	+	422
T5	0.055	0.012	0.073	0.066	+	±	370
T7	0.046	0.025	0.082	0.041	±	+	445
T9	0.065	0.018	0.113	0.019	±	+	374
T10	0.045	0.009	0.092	0.009	±	±	317
TC1	0.087	0.014	0.217	0.054	±	±	355
TC2	0.062	0.020	0.148	0.094	±	±	433

Ministry of Culture, Conservation Laboratory, Istanbul
 Conductivity of Distilled Water at 25 C° = 14

(±) Concentration of the ion at the limit of perceptibility.
 (+) Presence of the ion.

4 Conclusions

Considering the data derived from the tests of ancient mortars and experimental work on conservation mortars it can be concluded that:

1. Characterization of each ancient mortar is necessary in order to match old and new in repairs. However reasonable

khorasan mortars can be reproduced using commercially introduced materials and can be used in repairs.

2. Natural pozzolanas with adequate pozzolanic activity can substitute brick powder as in the traditional technology. The convenient natural pozzolana increases the early and final strengths. Best results are obtained by gauging dry slaked lime 30-35 % by weight.

3. If better compressive strengths are required slaked lime can be gauged with white cement 25 % by volume or 46 % by weight. This limit seems not to cause salt contamination.

4. The optimum mix can be defined as slaked lime gauged with 17 % by weight with ground pumice substituting certain part of the dry slaked lime, PMMA 0.5 % of the dry $\text{Ca}(\text{OH})_2$ and fibrous additives used together. In this mix early, and final compressive strengths and durabilities are increased.

5. References

Ashurst, J., Dimes F.G. (1990): Mortars for stone buildings. In *Conservation of Building and Decorative Stone*, Vol.2, Butterworth-Heinemann, London, 78-96.

Ciach, T.D., Penkala, B. (1984): Methods of Investigation for Mortars From the Ancient and Early-Medieval Buildings. In "Proceeding of ICOM, 7th Triennial Meeting", Copenhagen, Sept. 10-14, 84.10.5-84.10.7.

Peroni and others (1982): Lime-based mortars for the repair of ancient masonry and possible substitutes, *Mortars, Cements and Grouts Used in the Conservation of Historic Buildings*, ICCROM, Rome, 63-99.

Tabasso, M.L, Sammuri, P. (1984): Evaluation of Mortars for Use in Conservation From the Standpoint of the Release of Soluble Salts. In "Proceeding of ICOM, 7th Triennial Meeting", Copenhagen, Sept. 10-14, 84.10.8-84.10.11

The Leshan Grand Buddha: Investigations of traditional and alternative materials for repairs

Jiayu Ma

Provincial Cultural Relics and Archaeology Institute

Sichuan, China

Abstract

The results are reported of a series of laboratory and *in situ* tests to evaluate traditional and alternative materials for repair to the Leshan Grand Buddha, a massive monument carved *in situ* from a red sandstone cliff. Traditional hammered lime was compared with various mixtures based on cement. Emphasis was placed on finding repair materials with physical characteristics matching those of the sandstone, especially permeability. Four combinations were considered acceptable for use in repair work, including the traditional hammered lime mortar, and their methods of preparation specified.

Keywords: Leshan Grand Buddha; sandstone; air permeability; hammered lime mortar; China; hemp; charcoal ash.

1. GENERAL

The Leshan Grand Buddha is a massive monument carved *in situ* from a red sandstone cliff, to which it remains attached.

It shows deterioration directly attributable to the presence in the rock of water derived from both precipitation and groundwater seeping from the mountain mass. In the past, repairs have been made using cementitious materials, and where the material used for repairs has a permeability less than that of the rock mass, there has been a build-up of water. This has resulted in softening of the sandstone behind the repair zone, with resultant loss of cohesion and peeling of the mending material.

The material traditionally used for repairs was based on hammered lime, but no systematic investigations have been made into the mechanical properties of the materials used. As the traditional materials seem to have been reasonably effective considering the technology used, it was decided to investigate the properties of possible materials, using the traditional material as a reference standard. The key technical properties of the traditional hammered-lime-based material were assessed, and compared with possible alternatives, with a view to finding suitable repair materials with equal or better qualities for repair purposes.

Investigations concentrated on cement-based materials. Particular attention was paid to air permeability values of the materials tested, in view of the need to minimize water accumulation behind repair zones, and thus avoiding peeling of the repair materials, and also slowing deterioration of the sandstone, thus prolonging the potential lifespan of the statue.

Cement-based materials available locally in China all show poor permeability in general, and very little has been published on the air permeability of building materials. Therefore, measurements of air permeability were considered a key topic in this study.

If it is possible to induce the formation of micropores in cementitious materials, then these can in part coalesce to form microchannels and microfissures, and hence establish a permeable network and increase air permeability. Thus, if special attention is paid to measures that promote such microfissure production, the air permeability of the material can be increased. However, there are some negative effects of such fissure development, and so it is necessary to consider all parameters, and strive to ensure overall satisfactory values for normal indexes while increasing permeability.

On this basis, to obtain a suitable air permeability while retaining the necessary strength, technical measures could include producing micropores by adding a microfoaming agent, using a largish cement:water ratio, and using a porous aggregate with better air permeability, and producing microfissures by incorporating fibrous material, using a largish cement:water ratio, and using dry-curing in the initial stages.

The investigation involved several steps.

The first step was to screen a range of materials of various compositions and prepared in various mixing ratios. They were assessed on the basis of a few parameters, including unit weight, compression strength and air permeability, with the red sandstone as a reference standard.

Those materials that fell within acceptable limits were then subjected to more detailed testing, with the traditional hammered lime as a control. At the same time, they were judged for colour, economy, and ease of use.

The materials that seemed, on the basis of the laboratory testing, to have the properties required were then field tested. This involved exposure *in situ* on the cliff from which the Buddha is carved, in order to evaluate durability and weathering properties under the local conditions.

The work was carried out between June 1989 and May 1991.

2. LABORATORY TESTING

2.1 Materials and methods

The cement-based materials, traditional hammered lime and samples of the red sandstone were assessed for unit weight; compression strength; tensile strength of bonds; shearing strength of bonds; dry shrinkage; freezing-thawing; soundness; sulphate attack; abrupt temperature changes; and air permeability.

As the purpose of the study was to identify materials which have properties as similar as possible to the red sandstone of the Grand Buddha, the protocols for the tests could not follow completely the official test procedures and standards of national authorities, which are first and foremost designed for civil engineering requirements.

The raw materials used for the tests were Portland cement, produced in Emei Cement Mill, with an actual index of 325#; sandstone sand; red brick sand; charcoal ash aggregate; pumice aggregate; cut hemp fibre; and cut polypropylene fibres (ca. 2 cm in length). Additives included citric acid (industrial quality); microfoaming agent (produced by Additive Agent Plant, Qiunglai County, Sechuan Province); and calcium lignin sulphonate (produced by Kaishantun, Jilin Province).

2.2 TEST RESULTS

Sixteen combinations of the selected raw materials were tested for unit weight, compression strength and air permeability, and compared with the results of the same tests on the red sandstone. The results of the air permeability measurements are given as Table 1.

On the basis of the air permeability measurements the following combinations were selected for further testing: brick sand + cut hemp + microfoaming agent; pumice sand + cut hemp + microfoaming agent; traditional hammered lime; mixed hammered lime; Portland cement mortar; and the Grand Buddha sandstone as control. The test results are shown in Table 2. The effect of air curing on final (after 28 days) air permeability was measured, and the results are shown in Table 3. The result of adding citric acid in order to slow setting is shown in Table 4.

2.3 ANALYSIS OF RESULTS

2.3.1 Air permeability

In general, concrete with a microfoaming agent added shows less permeability, indicating that air permeability does not necessarily change with changes in porosity. However, it does change relative to overall pore structure, and any factor that leads to connections forming between pores and microfissures has a concomitant influence on overall air permeability.

The coefficients of air permeability vary considerably between combinations, with the Portland cement group very low, indicating that the underlying philosophy guiding the choice of mixtures is appropriate, i.e., that the determining factor in development of air permeability is the addition of microfoaming agent and cut fibre, as they directly produce a large number of micropores and microfissures. At the same time fibre can play a role in refining pore and fissure structure in mortar, which not only benefits the air permeability but also detracts little from other mechanical parameters. If, referring to Table 1, test groups 10 and 12 are compared with either groups 3 and 4 or groups 9, 13 and 16, it can be seen that the addition of either fibre or microfoaming agent alone leads to some improvement in air permeability, but if added jointly there is a large improvement in air permeability as a result of the air-permeable network.

In the tests, only one microfoaming agent was used. For fibre, traditional cut hemp was compared with modern polypropylene fibre. Both had a positive effect on air permeability. The polypropylene is light, but can carry a strong static electric charge, which is counter-productive as the lengths needed have to be processed by hand when it has to be thinned. It is also expensive. Cut hemp is cheap, easily worked and easily obtainable, so it was selected in the final analysis. The microfoaming agent used – calcium lignin sulphonate – is a gas-foaming type water reducer, which can both improve mortar workability and increase strength, as well as increasing air permeability as a result of the introduction of foam. This can be seen if groups 5 and 11 are compared with 3 and 4 in Table 1.

2.3.2 Influence of cement:water ratio and aggregate on air permeability

The quantity of free water in the material will depend on the cement:water ratio. This water gradually evaporates as the material hardens, leaving numerous pores and capillary channels. Hence, other factors being equal, the cement:water ratio has a direct relationship to air permeability, by and large. The test results (group 7 vs group 7') show this. The consistency of the mortars was controlled, with a penetration of about 5 cm. After the consistency is determined, the cement:water ratio is settled accordingly.

Table 1 Preliminary screening of materials for air permeability

Y	Test Group	Mixture by weight										(1)	(2)	(3)
		W 0.5	C 1.0	Y 1.0										
	Grand Buddha red sandstone											2.14	25.9 ⁽⁴⁾	6.92 ~ 12.8 ⁽⁴⁾ 5.06 ~ 22.8 ⁽⁶⁾
1	Y mortar	W 0.5	C 1.0	Y 1.0								1.99	46	2.03
2	YS mortar	W 0.50	C 1.0	Y 0.75	S 1.25							2.13	44	<0.4
3	ZS mortar	W 0.76	C 1.0	Z 1.07	S 1.07							1.82	43.6	<0.76
4	FS mortar	W 0.71	C 1.0	F 0.18	S 2.39							1.88	28.8	<0.76
5	ZM mortar	W 0.73	C 1.0	Z 1.07	S 2.14	M 0.0075						1.79	26.4	1.07
6	TM mortar	W 0.61	C 1.0	T 0.54	S 2.39	M 0.0054						1.78	30.8	<0.4
7	Portland cement mortar	W 0.77	C 1.0		S 4							2.04	21.1 ⁽⁶⁾	0.83
7'		W 0.52	C 1.0		S 2.5							2.16	—	0.31
8	TV mortar	W 0.04	C 1.0	T 0.54	S 1.43							1.90	36.8	0.80
9	ZDV mortar	W 0.79	C 1.0	Z 1.07	S 1.43	D 0.018						1.85	25.0	55.74
10	FV mortar	W 0.74	C 1.0	F 0.21	S 2.39							1.81	23.8	5.77
11	FM mortar	W 0.78	C 1.0	F 0.36	S 2.39	M 0.0075						1.55	16.6	17.0
12	ZV mortar	W 0.75	C 1.0	Z 1.07	S 1.43							1.80	22.4	9.02
13	ZUV mortar	W 0.82	C 1.0	Z 1.07	S 1.43	J 0.014						1.80	23.8	13.11
14	TD mortar	W 2.0	C 1.0	B 1.0		D 0.02						1.38	18.2	5.41
15	YDV mortar	W 0.54	C 1.0	Y 0.75	S 1.25	D 0.011						2.05	38.8	5.01
16	FJMG mortar	W 0.75	C 1.0	F 0.21	S 2.39	M 0.0075						1.81	19.4	30.75

Notes: (1) Unit weight (g/cm³) of air-dried sample. (2) Compression strength (MPa). (3) Coefficient of air permeability (x10⁻¹⁵/m²). (4) Normal to bedding plane. (5) Parallel to bedding plane. (6) Standard curing. (7) With 0.00125 parts by weight of silicone oil added.

Key to materials in this and following tables:

W = water C = cement B = lime Z = brick sand Y = sandstone sand T = charcoal ash F = pumice sand S = river sand D = cut hemp J = polypropylene fibre M = calcium lignin sulphate V = microfoaming agent L = citric acid

Grain size: Grain size in test groups 2, 3, A, B, D, E, 7 and 7' ranges from 0.63 to 2.5 mm, and less than 5 mm for the others; grain size of rock sand, brick sand and pumice sand in all test groups is less than 2.5 mm, and less than 5 mm for charcoal ash.

Lime: lime paste is used in lime batching. Lime paste weight in the table is the dry weight.

Consistency: all mortars are standardized to a penetration of about 5 cm.

Curing: Portland cement – standard curing; other mortars in Table 1 – wet curing 3 days + 25 days dry cure. Table 2 – wet curing 1 day + 27 days dry cure. Total curing period is 28 days unless otherwise specified.

Table 2 Technical properties of the Leshan Grand Buddha red sandstone and of the repair materials

(1)	(2)	(3)	(4)	(5)	(6)	Dry shrinkage ($\times 10^{-6}$) ⁽¹⁵⁾			
						7 days	14 days	28 days	60 days
Y	2.14	25.9 ⁽⁷⁾ 30.7 ⁽⁸⁾ 15.0 ⁽⁹⁾			8.4 ⁽¹⁰⁾ 14.7 ⁽¹¹⁾	1 740	1 820	1 720	1 770
7	2.04	21.1			0.8	340		770	820
A	1.74	7.5	0.54	0.50	69.1	700	800	970	1 130
B	1.73		0.86		61.4	730	900	1 020	1 290
C	1.59				102.0	860	1 050	1 150	1 460
D	1.78	8.2	0.53	0.40	72.4	510	760	1 100	1 450
E	1.71		0.38		67.5	490	680	910	1 170
H	1.20	1.9		0.04	144.3	7 760	8 460	8 560	8 830
I	1.36	2.3		0.03	71.0	1 280	2 080	2 240	2 590

(1)	Sulphate attack ⁽¹²⁾		Freeze/thaw ⁽¹²⁾	Soundness		(14)	
	20% concentration	40% concentration		(13)	(12)		
Y	Disintegration		36.2	Disintegration		7.9	
7							
A	-9.3		12.1	0	-7.7	-56	5.4
B	0		6.9	10.4			
C	1.9		22.6	-9.7			
D	10.5		23.8	-3.4	-2.3	-33	6.7
E	6.0		9.7	-6.0			
H					-22.1	-256	3.3
I					-16.5	-119	4.7

Notes: GENERAL: (1) Test group designation (see below). (2) Unit weight (g/cm^3). (3) Compression strength (MPa). (4) Tensile strength for bonding (MPa). (5) Shear strength for bonding (MPa). (6) Coefficient of air permeability ($\times 10^{-6}/\text{m}^2$). (7) Air-dried; normal to bedding plane. (8) Oven-dried; normal to bedding plane. (9) Saturated; normal to bedding plane. (10) Normal to bedding plane. (11) Parallel to bedding plane. (12) % loss of compression strength. (13) % weight loss. (14) Coefficient of linear expansion in abrupt temperature change ($\times 10^{-6}/^\circ\text{C}$).

TEST GROUPS:

Y = Leshan Grand Buddha sandstone.

7 = Portland cement mortar (W:C:S = 0.77:1:4).

A = Less brick sand + cut hemp + microfoaming agent (W:C:Z:S:D:M:V = 0.81:1:1:1.5:0.02:0.003:0.0001).

B = More brick sand + cut hemp + microfoaming agent (W:C:Z:S:D:M:V = 0.97:1:1.75:0.75:0.02:0.003:0.0001).

C = Full brick sand + cut hemp + microfoaming agent (W:C:Z:D:M:V = 1.17:1:2.5:0.02:0.003:0.0001).

D = Rock sand + cut hemp + microfoaming agent (W:C:Y:S:D:M:V = 0.67:1:1:1.5:0.02:0.003:0.0001).

E = Pumice sand + cut hemp + microfoaming agent (W:C:F:S:M:V = 0.58:1:0.29:2.19:0.005:0.0001).

H = traditional hammered lime (W:B:T:D = 2.2:1:3:0.2).

I = Mixed hammered lime (W:C:B:T:Y:D = 1.88:0.5:1:1.8:1.2:0.1).

(15) The dry shrinkage factor of the sandstone varies with time. This may be due to the presence in the sandstone of some substance sensitive to air temperature and humidity.

Table 3 Effect of curing regime on air permeability after 28 days

(1)	Mixture by weight (5)							(2)	
	W	C	Z	Y	F	S	M	(3)	(4)
a	0.89	1	1			1.50		29.1	12.2
b	0.78	1	1			1.50		22.4	5.6
c	0.78	1				2.5		102.0	66.1
d	0.81	1	1			1.5	0.005	88.0	25.3
e	0.67	1		1		1.5	0.005	41.8	27.5
f	0.58	1			0.29	2.19	0.005	67.5	7.0
g	0.97	1	1.75			0.75	0.005	61.4	20.0
h	1.17	1	1.75			0.75	0.005	111.9	51.2

Notes: (1) Test group. (2) Coefficient of air permeability ($\times 10^{-15} \text{m}^2$). (3) 1 day wet curing, then air-cured. (4) 3 days wet curing, then air-cured. (5) All mixes contain 0.02 parts by weight of D, and 0.0001 parts by weight of V.

Table 4 Effect of additives in delaying setting time

Name of mortar		Mixture by weight								Setting time (hours)	
		W	C	S	Y	D	M	V	L	Initial	Final
7	Portland cement	0.77	1	4						20.0	31.5
D	YDV	0.67	1	1.5	1	0.02	0.003	0.0001		32.0	44.5
D'	YDV slow-setting	0.67	1	1.5	1	0.02	0.003	0.0001	0.0007	50.5	69.0

In general, the porosity and air permeability of the aggregate in the mortar will have an influence on the air permeability of the mortar as a whole, but results so far have not established the extent of that influence. In the tests carried out it was found that, in general, the pores and fissuring of the aggregate influenced the air permeability of the mortar, with air permeability of the mortar increasing in the order river sand \Rightarrow charcoal ash \Rightarrow sandstone sand \Rightarrow red brick sand \Rightarrow pumice sand, but the effect was relatively minor in comparison with the effects of microfoaming agent and fibre. As the aggregate is embedded in a matrix of cement, it is discontinuous in its effect, so the permeability of mortar will depend first and foremost on the continuous matrix medium – the cement. The cement's pore structure will in turn depend on the cement:water ratio and the presence or absence of additives, namely microfoaming agent and fibre. The influence of the porosity of the aggregate will become noticeable only when the cement has reached a certain level of porosity. The final choice for the aggregate used was a combination of river sand, sandstone sand and red brick sand, selected on the basis of strength, colour and local availability. The mortar selected matched well the colour of the Grand Buddha sandstone.

2.3.3 Influence of curing on air permeability

The curing period and the curing method will both affect the air permeability of the mortar. In the tests the curing period was standardized at 28 days, after which it can be assumed that air permeability will be relatively stable. For assessing the effect of curing, test blocks were made from the various mortars, wet cured for either 1 or 3 days, then allowed to cure indoors with natural ambient air conditions. From Table 3 it can be seen that a wet curing period of only 1 day produced much greater air permeability than the 3-day wet cure. It was found that the short wet cure period and early drying had a remarkable influence on appearance and development of microfissures in the mortar. The development of microfissures in this way did not adversely affect the other properties of the mortar, so that the final recommendation was for a wet cure period of only 1 day.

2.4 EFFECT OF OTHER PHYSICAL PARAMETERS ON PERFORMANCE INDEX

From Table 2 it can be seen that the dry compression strength of the Grand Buddha sandstone was not low, but was twice the compression strength when wet, showing that it is softened by water. Also in Table 2, the group A and group D materials – cement based – are of hydraulic materials which are not softened by water, with a compressive strength the same as that of mortar 75#, and the tensile and shear strengths for bonding are adequate for surface mending. The strengths of the hammered lime groups (traditional – group H; mixed – group I) are slightly lower, akin to mortar 25#. The unit weights of the materials are lower than that of the Grand Buddha sandstone, with hammered lime the lowest, facilitating the surface mending.

Resistance to abrupt temperature change is based on coefficient of linear expansion under a standard abrupt temperature change from 10°C to 80°C. From Table 2 it can be seen that the coefficients of linear expansion for A, D, H and I are in the range $3.3 \times 10^{-6}/^{\circ}\text{C}$ to $6.7 \times 10^{-6}/^{\circ}\text{C}$, while that of the Grand Buddha sandstone is $7.9 \times 10^{-6}/^{\circ}\text{C}$ and so very close. Thus in an abrupt temperature change those materials, when used for repair purposes, would deform in a similar manner to the sandstone.

In Table 2, the weight and strength losses due to sulphate attack, and the associated changes under frost/thaw and soundness, can be explained by assuming that outside substances are absorbed into the test pieces and its crystals or newly-formed crystals remain, thus leading to a negative weight loss value. This absorption into the test pieces might also have a

tendency to strengthen the test piece initially. Variability of the test pieces would explain the apparent increase in strength following sulphate attack – it is not possible to do a break test on the same sample before and after sulphate exposure. The strength increase of the frost/thaw-tested specimen may be due to its strength being restored and developed during the thaw cycle, and a density increase in the soundness test sample may outweigh the damage effect. However, there will be a chemical reaction between the sodium sulphate and the calcium hydroxide to produce dihydrate gypsum, and if further reaction occurs between sodium sulphate and hydrous calcium aluminate, hydrous calcium sulphoaluminate will be produced. Assuming that such substances accumulate in the cement and lime, the weight and strength of test pieces will possibly change unexpectedly to give extra-large negative values in soundness tests. Therefore the routine soundness test for natural stone materials is not suitable for use with cementitious and lime materials. However, even though in general this is a problem, all the materials listed in Table 2 can be expected to be obviously more durable than the Grand Buddha sandstone itself.

2.5 CONTROL OF SETTING TIME (SLOW SETTING)

Table 4 gives penetration resistance test results for three mortars: Portland cement (group 7); rock sand + cut hemp + microfoaming agent (group D); and rock sand + cut hemp + slow setting agent + microfoaming agent (group D with 7/10 000 by weight of citric acid added). Tests were carried out at room temperature. Setting time tends to increase at lower temperatures (6-9°C), when conditions are more humid. However, the differences are minor. The calcium lignin sulphonate has a certain slowing effect, but citric acid is much more obvious. Both can be chosen for use.

3. SITE TESTS

On the basis of the laboratory tests, four groups were selected for site testing. They were traditional hammered lime (group H); mixed hammered lime (group I); red brick + cut hemp + microfoaming agent (group A); and rock sand + cut hemp + microfoaming agent mortar (group D).

Samples were used on the cliff face to the left of the head of the Leshan Grand Buddha, using the envisaged construction procedure and repair technology. These samples were for long-term observation of durability.

The procedure was that two types of test cube were made – one with and one without primer – according to the techniques for surface repairs. The cubes were 20 x 20 x 0.5 cm. In addition to the four main test groups, a parallel set was made, to see if it was possible to avoid problems encountered elsewhere with colour changes; vegetable weathering; and hemp attracting mites, with consequent nesting and proliferation, and eating of the fibres. The parallel series had various combinations of pigment addition, herbicide spraying, and polypropylene substitution for hemp.

Table 5 Mixing proportions of the recommended mortars

Mortar		Mixture by weight							
H	Traditional hammered lime	Lime 1.0	T 3.0	D 0.2			+ water as required		
I	Mixed hammered lime	Lime 1.0	C 0.51	T 1.8	Y 1.2	D 0.1			
A	ZDV	W 0.81	C 1.0	Z 1.0	S 1.5	D 0.02	M 0.003	V 0.0001	
D	YDV	W 0.67	C 1.0	Y 1.0	S 1.5	D 0.02	M 0.003	V 0.0001	

Table 6 The main properties of the four materials recommended for repair work on the Lashan Grand Buddha in comparison with the sandstone from which it is carved

(1)	(2)	(3)	(4)	(5)	(6)	(7)	(8)	(9)
Y	2.14	25.9 ⁽¹⁰⁾ 30.7 ⁽¹¹⁾ 15.0 ⁽¹²⁾		1 770	(13)	(13)	7.9	8.3 ⁽¹⁴⁾ 14.70 ⁽¹⁵⁾
H	1.20	1.9	0.04	8 830		-22.1	3.3	144.3
I	1.36	2.3	0.03	2 590		-16.5	4.7	71.0
A	1.74	7.5	0.50	1 130	12.1	-7.7	5.4	69.1
D	1.78	8.2	0.40	1 450	23.8	-2.3	6.7	72.4

Notes: (1) Material (See key below). (2) Unit weight (g/cm³). (3) Compression strength (MPa). (4) Shear strength (MPa). (5) Dry shrinkage (after 60 days). (6) Durability to sulphate attack at 40% (% loss of compression strength). (7) Soundness (% weight loss). (8) Coefficient of linear expansion in abrupt temperature change (x10⁻⁶/°C). (9) Coefficient of air permeability (x10⁻⁶/m²). (10) Air-dried; normal to bedding plane. (11) Oven-dried; normal to bedding plane. (12) Saturated; normal to bedding plane. (13) Disintegration. (14) Normal to bedding plane. (15) Parallel to bedding plane.

Key to Materials:

- Y = Leshan Grand Buddha sandstone.
- H = Traditional hammered lime.
- I = Mixed hammered lime.
- A = Less brick sand + cut hemp + microfoaming agent.
- D = Rock sand + cut hemp + microfoaming agent.

4. CONCLUSIONS

4.1 SELECTION OF REPAIR MATERIALS

Four surface mending materials were selected after laboratory testing and data analysis. The materials include traditional hammered lime. Their mix proportions and main properties are compared with those of the Grand Buddha sandstone in Tables 5 and 6. The tests showed that the materials selected were acceptable on the basis of several criteria.

4.2 LABORATORY TEST RESULTS

4.2.1 Hammered lime

Traditional hammered lime is a lime + charcoal ash + cut hemp mortar, produced by a special technique of hammering. The tests show that its compression and bonding strengths are low; deformation between the wet and dry state is obvious; and hardening is slow, being an air-hardening material. If frequently wetted during the curing process many of its properties will be reduced. Its production process is slow and labour-intensive, requiring the repeated hammering by hand of small batches, and so has poor efficiency. However, to offset its drawbacks, it has good air permeability characteristics, sulphate resistance, frost/thaw resistance, and flexibility. Its response to abrupt temperature change is similar to that of the Grand Buddha sandstone, and the raw materials are cheap and available locally. It also has a long history of traditional use. No major problems occurred in the laboratory and long-term testing of this material for repairs to the Grand Buddha, and so it is reasonable to include it in the list of acceptable materials.

The mixed hammered lime is an improved version of the traditional form, with the addition of a little cement and rock sand, and with less cut hemp. Its strength is increased compared with the traditional hammered lime, and its dry shrinkage and response to abrupt temperature change match more nearly the Grand Buddha sandstone. The hardening speed is greater and water resistance better than the traditional.

4.2.2 Modern cementitious materials

As the mixed hammered lime is also a cement-group material and has been recorded as being used to make repairs to the Grand Buddha in modern times, the other two groups (A and D) recommended for repair work could probably be referred to as new-type cement materials. Their air permeability is not as good as the traditional hammered lime, but approaches that of the mixed hammered lime, and are much greater than that of the Grand Buddha sandstone itself. Compression and bonding strengths are several times those of the hammered limes. Other properties of the new-type materials are mostly good: dry shrinkage and abrupt temperature change response are similar to that of the Grand Buddha sandstone; and water resistance is better. However, unit weight is greater and flexibility less than for the hammered limes.

Nevertheless, production and use of the new-type cement materials is convenient, and quality easily controlled, and so, on the basis of all their properties, they are acceptable for use.

4.2.3 Setting and hardening times

The new-type cement group materials set faster than the hammered limes, but are about 40% slower than Portland cement mortar. The addition of citric acid can double the setting time, which satisfies the requirements for construction and technical performance.

4.2.4 Colour matching

In order to adjust the colour of the repair material to match the sandstone, true iron oxide red and red soil can be added to all four mortars approved for repair work.

4.3 PROPOSED METHOD

4.3.1 Cement-group repair materials

Dissolve the microfoaming agent and calcium lignin sulphonate in the proper proportions by weight into the water. Fine cut the hemp. Screen all sands to meet the standards. Weigh in proportion water, cement, river sand, and sandstone or brick sand. The volume of water containing the additive agents should form part of the total water added. Mix all materials together in a mortar mixer for 3 to 5 minutes and then sprinkle in the proper weight of fine-cut hemp and allow it to distribute evenly during the mixing.

Before applying the mortar, wet the base sandstone in advance; apply the mortar course by course until the requisite thickness is obtained, and cover with plastic sheeting to wet cure for 24 hours. The plastic sheet is removed after the 24 hours and the mortar allowed to dry cure with no further wet curing.

4.3.2 Hammered lime materials

Traditional technology is employed to produce the hammered limes. The lime should be a fully hydrated lime paste; the charcoal ash should be screened; and the cut hemp threadlike. Weigh them together in proportion, and add just sufficient water to enable hand-moulded lumps to be formed that break when dropped. Then hammer the mixture on a hard plate using a hand hammer, until the hammered mortar is quite even, fine and smooth, such that it is sticky and thick but without any feeling of particulate matter, then put the mortar into water for use. Each batch for hammering is between 2 and 3 kg. Cement and pigments can be added after the first hammering.

To use, wet the base sandstone, apply the mortar by trowel, course by course until it reaches the required thickness. Courses should not exceed 5 mm. Then use a patten to compact it. After it is de-watered, the surface is finished using a trowel. Avoid immersion or washing until the mortar has hardened fully.

5. REFERENCES USED

- Bamforth, P.B. 1988. *Magazine of Concrete Research*, 39(138): 3-11.
- Cabrera, J.G. & Lynsdale, C.J. 1988. A new gas permeameter for measuring the permeability of mortar and concrete. *Magazine of Concrete Research*. 40(144): 177-182.
- Collins, R.E. 1976. *Flow of Fluids through Porous Materials*. Tulsa, USA: Petroleum Publishing Co.

4.3.3. Setting and handling time

The new type cement group materials set faster than the previous type but are about 40% slower than Portland cement mortar. The setting time is about 15 minutes for the new type which satisfies the requirements for construction and repair. The setting time is about 15 minutes for the new type and 30 minutes for the old type. The setting time is about 15 minutes for the new type and 30 minutes for the old type. The setting time is about 15 minutes for the new type and 30 minutes for the old type.

4.3. PROPOSED METHOD

4.3.1. Cement group repair materials

Describe the proposed method for the repair of concrete structures. The proposed method involves the use of a cement group repair material. The material is applied to the surface of the concrete structure and is allowed to set. The setting time is about 15 minutes. The material is then finished and cured. The proposed method is simple and easy to use. It is suitable for the repair of concrete structures in both new and old buildings. The proposed method is suitable for the repair of concrete structures in both new and old buildings. The proposed method is suitable for the repair of concrete structures in both new and old buildings.

4.3.2. Hammered test method

Describe the method for testing the strength of concrete structures. The method involves the use of a hammer to test the surface of the concrete structure. The hammer is struck against the surface and the resulting sound is recorded. The sound is then compared to a standard sound level. The method is simple and easy to use. It is suitable for the testing of concrete structures in both new and old buildings. The method is suitable for the testing of concrete structures in both new and old buildings. The method is suitable for the testing of concrete structures in both new and old buildings.

Describe the method for testing the strength of concrete structures. The method involves the use of a hammer to test the surface of the concrete structure. The hammer is struck against the surface and the resulting sound is recorded. The sound is then compared to a standard sound level. The method is simple and easy to use. It is suitable for the testing of concrete structures in both new and old buildings. The method is suitable for the testing of concrete structures in both new and old buildings. The method is suitable for the testing of concrete structures in both new and old buildings.

Collins, R.E. 1976. *Test of Plain Concrete*. McGraw-Hill, New York, N.Y. 177 pp.

Collins, R.E. 1976. *Test of Plain Concrete*. McGraw-Hill, New York, N.Y. 177 pp.

EVALUATION OF PHYSICAL CHARACTERISTICS OF 'MERCULA' ADMIXED CLAY FOR SEALING OF CRACKS IN MUD PLASTER OF MONASTERIES, LADAKH REGION

R.K.SHARMA, H.O.GUPTA & Y.K.KANOTRA
Archaeological Survey of India, Dehradun (U.P.) India

Abstract

Clay is one of the oldest natural occurring building material. The monasteries in the Ladakh Region made of adobe or stone cemented with the local clay and decorated with murals are fine examples of traditional Tibetan architecture. The painted mud plaster in many monasteries has developed cracks, cavities and big gaps. To prevent the further damage to these murals, it is essential to fill up the gaps, cavities and seal the cracks after the structural conservation measures. With a view to encourage the use of original materials for filling up the cracks, cavities and losses, the investigations have been carried out to study the physical characteristics of local soil admixed with different proportions of very fine clay called 'Meracula'. The Atterberg limits of different mix proportions have been evaluated to study their use for reintegration of the painted plaster. It has been observed that the physical characteristics of the local soil are modified by the addition of fine 'Meracula' clay having binding properties. The mineralogical composition of the 'Meracula' fine clay has also been studied to correlate it with its binding characteristics.

Keywords : Meracula, Monasteries, Atterberg Limits, Adobe, Mineralogical Composition, Shrinkage, Cracks, Adhesion.

1 Introduction

Ladakh is a mountainous area with an average elevation of 5300 metres and occupies the north eastern part of the Kashmir Himalayas. The area is surrounded by high peaks and snow mountains that resemble the pillars of the sky having ranges of multi coloured hues. These fine mountains are ornamented with monasteries, temples, caves, castles and stupas built by holy persons and ancestral Dharmrajases in previous ages starting from a time when Ladakh was ruled by Lha Chen Palgyigon (930 AD), the eldest son of Skitde Namgyigon (900 AD). The rich archaeological heritage of Ladakh Region is best known for its monasteries and gomphas predominantly for their mural paintings dating back from 10th century AD. Most of the monasteries are located along the Srinagar - Leh highway and Indus river [1]. The notable monasteries are located at Alchi, Leh, Shey, Lamayuru, Hemis, Phang, Likir, Basgo, Spituk, Thicksay, Changla, Stakna, Stok, Matho Rangdam

gompha and Karsha.

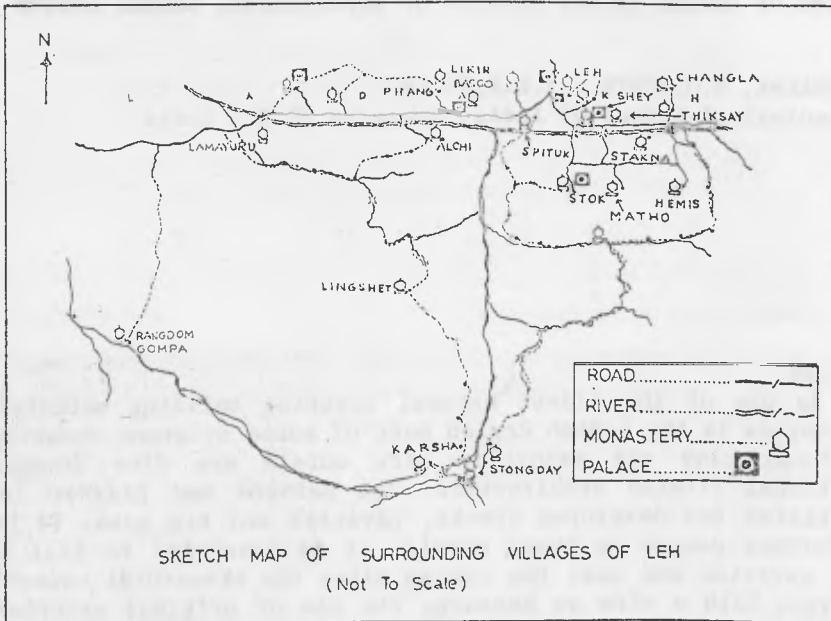

2 Construction Materials And Building Design

The materials used in the construction of the monasteries are generally the local soil and stone. The walls which act as support may be made of sun baked mud bricks or stones lined with local soil. In many cases, the walls about 1 metre thick have been constructed with the help of wooden frame, unbaked stucco bricks or stones cemented with local clay. The roof is made of wood and covered with local soil. Designed as solid, rectangular structure with flat roofs, the buildings exude a sense of strength and dignity and reflect the soaring majesty of the surrounding mountains. The mud plaster admixed with vegetable fibres has been smooth finished on the walls and finally lime coat is given. The walls of these monasteries are decorated with paintings which are mainly on the mud plaster executed in a tempera style. The subject and theme of the paintings are mainly religious depicting Bodhisattvas, Buddhism and jataka stories [2].

3 Conservation Problems

In view of the nature of the construction materials used and the type of construction of these monasteries located in high altitude area, the painted plaster has suffered damage in the form of different types of cracks. The most frequent type of damage involves large and small cracks, hair line cracks, cavities and deformation in the plaster area, major gaps in the plaster, endangered layers of paint, lost layers of paint and impairment of paintings from contamination, mechanical damage and splashes of lime (Plate No.1 & 2). The pattern

and type of cracks which have generally been noticed may be categorised as follows :

1. Zigzag vertical cracks running through the adobe especially under the wooden rafters/beams mainly due to the setting of the heavy roofs. May be due to the earthquakes also ?
2. Horizontal or diagonal course taking cracks due to shrinkage in the mud plaster and wide variation of temperature and relative humidity.
3. Small cracks confined only to the upper most layer of the plaster-which are generally extension of the bigger cracks.
4. Cavities created by the leaching of the soil used for cementing purposes.



Plate No.1 : Sumstek Gumpha, Alchi



Plate No.2 : Shey Palace, Shey

4 Analytical Studies of Mercula Clay

Mercula clay, naturally occurring and abundantly available in the Leh region has been used as a cementing material for the construction of adobe structures. The characteristics of adobe are largely modified by the addition of mercula clay. The physical properties of mercula clay alongwith its chemical and mineralogical composition have been investigated to assess its role for cementing properties (Table 1,2 & Fig.1). The mineralogical composition indicates the predominance of Illite (83%) in the mercula clay with about 23% Al_2O_3 . Illite differs from kaolinite and montmorillonite in the complexity of its formula because of its substitution and the presence of potash. Despite some variation in the ratios of alumina to silica, uniformity prevails within each group [3]. Illite has a basic lattice much like that of montmorillonite with the exception that K ions occupy the position of water between the lattice layers.

Certain physical properties of clay minerals such as plasticity, bonding strength, shrinkage etc. are attributed to the structure and composition of the clay mineral and the type of exchangeable base. Plasticity is dependant upon the thickness of the water film between the flakes and the lubricating property of the water [4]. The plastic

behaviour of mercula clay is further improved by its extra fineness as indicated by its particle size distribution by sieve analysis (Table 2.).

Table 1. Chemical properties of mercula clay

Compound	Chemical Comp. by wt.(%)
SiO ₂	54.15
Al ₂ O ₃	23.23
Fe ₂ O ₃	9.00
CaO	2.13
MgO	3.76
Na ₂ O	2.32
K ₂ O	1.24
TiO ₂ , P ₂ O ₅	Tr.
Loss on ignition	4.05
pH	8.00

Table 2. Physical properties of mercula clay

Property	Value
Specific gravity	2.52
% Passing	
#425 micron	99.99
#212 micron	99.81
#75 micron	95.60
Mineralogical Comp.(%)	
Illite	83.00
Kaolinite	1.80
Montmorillonite	0.70

5 Experimental

The deep wide cracks have created a gap disturbing even the alignment of the painted surface. To prevent the further damage to the mural paintings, it is essential to stitch the crack by filling the gaps not only from the aesthetic requirement but also for the structural stability of the painted plasters. In the past, more than a decade ago the filling of cracks in the Sumstek gompha at Alchi were filled up with plaster of Paris and colour integration was also attended. Though the use of this material for filling up the cracks and gaps has behaved well but with a view to encourage the use of original materials, the investigations have been carried out to study the physical characteristics of the local soil admixed with different proportions of mercula. The material used for the filling of the cracks or cavities should generally meet the following requirements.

1. Good adhesion to the ground and to the crack flanks.
2. Compatibility with the original materials.
3. No shrinkage of the filled material while drying out.
4. Easy injectability in case of fine cracks.

The plastic characteristics and shrinkage behaviour of a soil is dependant upon the water content and percent of the fine particles. These characteristics have been studied by determining the Atterberg Limits of the local soil admixed with different proportions of mercula clay as per IS.SP 36 (Part I):1987. The values for liquid limit (LL), plastic limit (PL) and shrinkage limit (SL) of different mix proportions alongwith plasticity index (PI) and shrinkage index (SI) are reported in Table.3. The plasticity of local soil was found to be affected by addition of mercula clay. Increase in both liquid

and plastic limits has been observed with the increase in proportion of mercula clay. However, the increase in liquid limit is more than the plastic limit indicating that the range of plasticity index is more with the increased percentage of mercula clay. The plasticity index indicates the range in which the soil remains plastic. Upto 25% addition of mercula clay, shrinkage limit values are quite close to the plastic limit, whereas beyond this level, the values of shrinkage limit are on the much higher side and the shrinkage index starts increasing appreciably (Fig.2).

Table 3. Atterberg limits of mercula clay admixed soil

Sample No.	LL (%)	PL (%)	PI	SL (%)	SI
M 0	27	18	9	18	0
M 5	29	19	10	20	1
M 10	31	20	11	21	1
M 25	35	22	13	23	1
M 50	45	23	22	28	5
M 75	53	23	30	31	8
M 100	62	25	37	35	12

Two sets of samples were prepared to study the plastic and shrinkage behaviour of local soil admixed with mercula clay. One set was prepared using water content corresponding to the plastic limit. In the second set, the water content corresponding to Plastic Limit + Plasticity Index was used. This water content gives the mid value of liquid limit and plastic limit in which the soil remains plastic but may undergo shrinkage.

In both the sets no cracks

were developed but the samples in the second set were observed to have suffered minor deformities (Plate No.3).

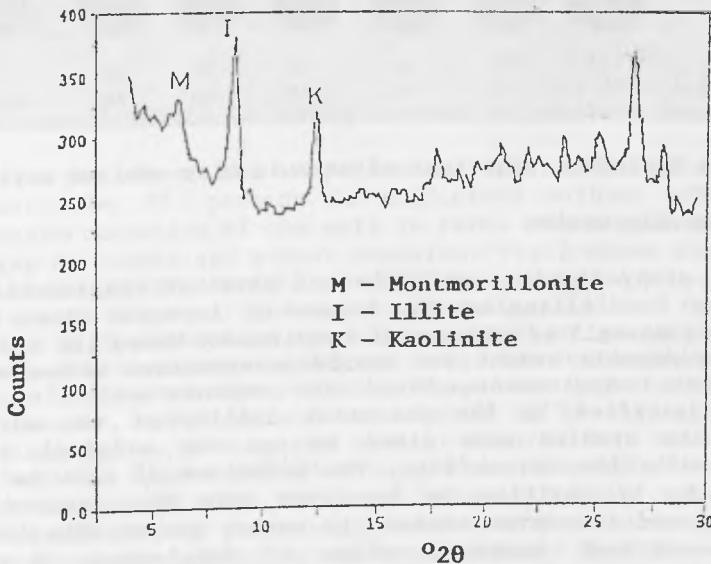

Figure 1. X-ray diffractogram of Mercula Clay

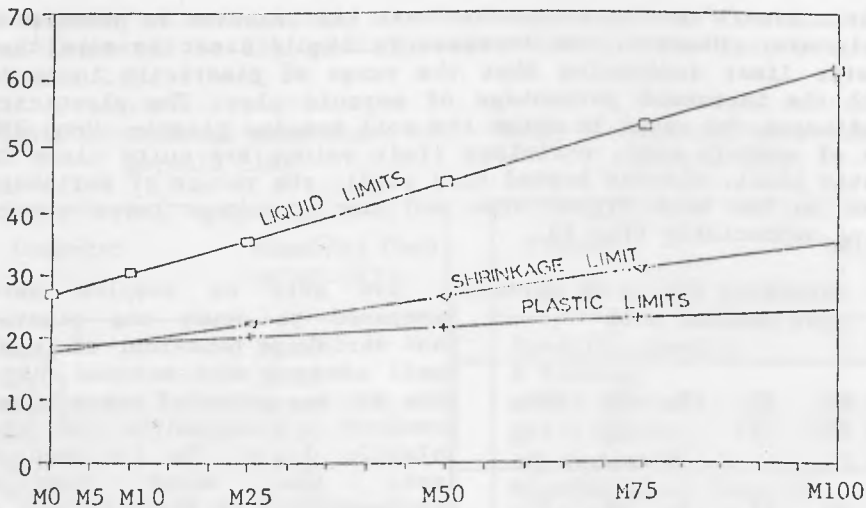

Figure 2. Variation of Atterberg limits

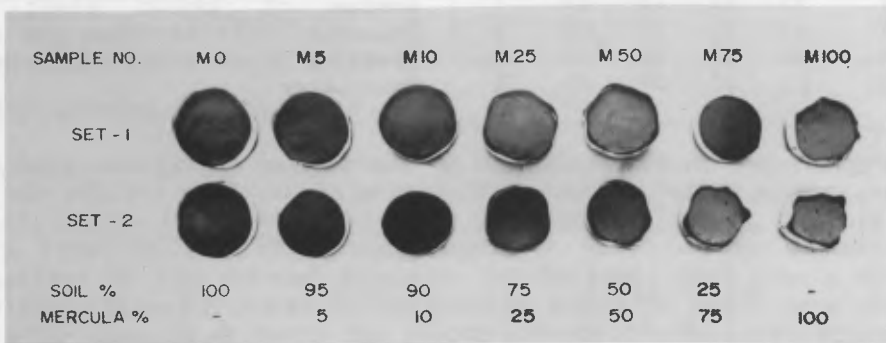

Plate No.3 : Shrinkage behaviour of mercula clay admixed soil samples

6 Results And Discussion

The present study for the evaluation of physical characteristics of mercula clay for filling up the losses of intonaco stems from the architectural as well as structural requirement where the losses have been of considerable extent and should nevertheless be reconstructed from aesthetic requirement. Since the reconstruction of limited losses is justified by the potential utility of the surrounding paintings, the studies were aimed to use the original materials compatible with the surroundings. The behaviour of soil for filling up the cracks or cavities is dependant upon the percent of the mercula clay and the water content to ensure proper adhesion to the crack flanks without change in volume or development of shrinkage cracks. In the case of paintings on clay, addition of small quantity of synthetic emulsion is recommended in order to strengthen the cohesion [5]. In case of monasteries in the Ladakh Region, the use of mercula clay has been made as a cementing material, it was therefore

preferred to carryout the studies without addition of any synthetic emulsion. The shrinkage limit of a clay is expressed as the maximum water content as percentage of the oven dry weight at which any further reduction in water content will not cause a decrease in the volume of the soil mass. It may be seen from Table 3, the shrinkage limit and plastic limit values in case of local soil are identical and as a part of soil is replaced with the mercula clay, both the values show gradual increasing trend but beyond 25% replacement of soil by mercula clay, the shrinkage limit value steeply increases than the plastic limit. The numerical difference of the plastic and shrinkage limit, designated as shrinkage index is seen to be more than one percent when the soil is replaced by mercula clay by more than 25%. The samples with shrinkage index (shrinkage limit minus plastic limit) more than two were observed to undergo deformation while drying and are not considered suitable for filling up the cracks.

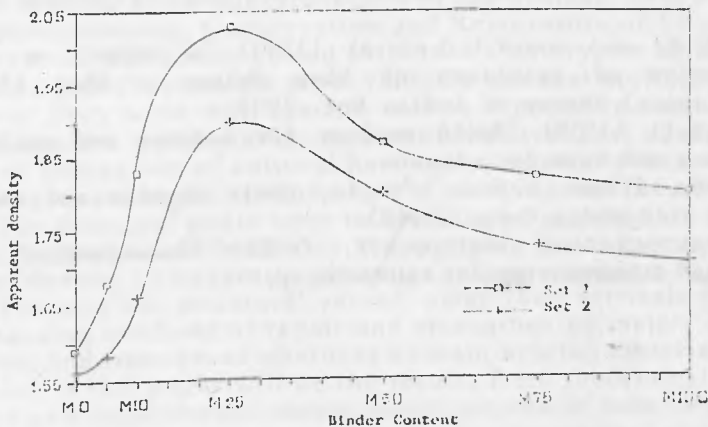

Figure 3. Effect of binder content on apparent density

It is seen from the experimental test specimens that the replacement upto 25 percent is sufficient without affecting the desired characteristics of the soil in terms of its plastic behaviour for sealing of cracks and proper cohesion. Fig.3 shows the change in apparent density (dry basis) of different samples prepared in the laboratory both for set 1 and set 2. The values in both the sets were maximum for M 25 indicating the optimum level of grading for maximum compaction, an important characteristic for structural stability behaviour. In case of finer cracks where the injectability is the main requirement, water content is observed to be required above the plastic limit value. Since, the soil at liquid limit value gives the boundary between liquid and plastic states of consistency of soil, the water content at this level or beyond it would not permit the homogeneous mixture and the mercula clay fine particles may penetrate leaving the coarser particles on the surface. This phenomena would not give the desired filling and adhesion at the surface level and it is recommended that water content less than liquid limit should only be used. The laboratory specimens prepared with water content above

the plastic limit and half of plasticity range while ensuring the injectability allow the soil to remain plastic for the proper sealing of the fine cracks.

On the basis of the laboratory studies, it has been concluded that the replacement of soil by mercula clay by 25% is suitable for filling up the cracks and cavities depending upon the nature and depth of the crack. For wider cracks and cavities, the water content at the shrinkage limit/plastic limit ensures proper adhesion without shrinkage. However, for finer cracks, the water content in between plastic limit and liquid limit allows better injectability.

7 References

- 1 Paldan, Thubstan (1982) **"A guide to the Buddhist Monasteries and Royal Castles of Ladakh"**-Ladakh Culture and environment project. Leh.
- 2 Sharma, R.K. and Gupta, H.O. et al (1993) **"A report on chemical conservation of paintings at Shey Palace - Shey (Ladakh)"**, Archaeological Survey of India. Dec. 1993.
- 3 Dapples, E.C. (1958) **"Basic geology for science and engineering"** John Wiley and Sons Inc. London.
- 4 Puri, A.N., Firman E. Bear, **"Soils, their physics and chemistry"** Reinhold Publishing Corp. (1949).
- 5 Mora, P., Mora, L. and Philippot, P. (1984) **"Conservation of wall paintings"** Butterworths, (C) ICCROM.

LIME MORTAR AND LIME BASED MIXTURES FOR CONSERVATION, RESTORATION, REPAIR AND STRENGTHENING OF BYZANTINE CHURCHES (9TH - 14TH CENTURY) IN REPUBLIC OF MACEDONIA

L. SUMANOV, RZZSK, Skopje, Macedonia
T. STANISEVA, RZZSK, Skopje, Macedonia
V. TRAJKOSKA, ADING, Skopje, Macedonia
D. DANILOVSKI, ADING, Skopje, Macedonia
V. SENDOVA, IZIIS, Skopje, Macedonia

Abstract

Lime mortar and lime-based mixtures for repair, grouting and injection have been studied as an important part of the project "Study for Seismic Strengthening, Conservation and Restoration of Churches Dating from the Byzantine period (9th-14th Century) in Macedonia¹.

Byzantine churches are the most valuable cultural heritage in Macedonia. They were, still are and will be exposed to various damaging factors. Earthquakes, as one of the strongest damaging factors and protection of cultural heritage in seismic-prone regions were the main reasons for proposing and carrying out the above project. The principal goals were to develop an appropriate and scientifically proved methodology and methods for conservation, repair and strengthening of Byzantine churches taking maximum care not to disturb their original structural values, using their intrinsic possibilities and introducing methods of repair and strengthening mainly based on lime mortar and lime-based mixtures as main binding materials.

Presented in this paper will be the results from theoretical, laboratory and experimental ample investigations of lime mortar and lime-based mixtures which were designed for theoretical and dynamic experimental shaking table tests of a Byzantine church model designed to a scale of 1 : 2.75. The results achieved by the final tests of the repaired model proved the theses that the designed methods for repair and strengthening of Byzantine churches based on lime mortar and lime based mixtures with designed characteristics (physical -chemical and mechanical) will enable that the said structures sustain the most strongest earthquakes (with a return period of 1000 years) without collapse, with some allowable and repairable damage to the structural and non-structural elements.

Key words: Byzantine churches, earthquakes, lime mortars, lime-based mixtures with additives, grouting and injection, repair and strengthening, achieved results, conclusions and recommendations.

¹The project was carried out by the Republic Institute for Protection of Cultural Monuments - RZZSK, Skopje, Macedonia and the Institute of Earthquake Engineering and Engineering Seismology - IZIIS, University "St. Cyril and Methodius" - Skopje, Macedonia, fully supported by the J. Paul Getty Trust, L. A, USA through the Getty Conservation Institute - GCI - Marina del Rey, USA.

1 Introduction

The repair and/or strengthening of historical monuments is highly dependent on the earthquake conditions to which they were exposed in their past history and the ground motion to which they are expected to be exposed frequently in future, as well as the materials and methods used for their construction. Due to these reasons, it will be of importance that repair and/or strengthening, as a measure of preservation, conservation and restoration of historical monuments located in seismic prone regions be planned based on detailed studies of the expected seismic hazard, the local soil conditions and the dynamic behaviour of soil media under earthquake loading, the dynamic properties of the structural systems, the strength and deformability characteristics of the structural elements and materials and the dynamic response of the structural systems under the expected ground motions.

For the purpose of development of appropriate methods and techniques for repair and strengthening of Byzantine monuments, in general, and particularly the monuments of this type located within Macedonia, the research project "Study for Seismic Strengthening, Conservation and Restoration of Churches Dating from the Byzantine Period (9th - 14th Century) in Macedonia" has been carried out in the period 1991 - 1994. The research project consisted of three phases performed in three research years.

One of the conclusions at accomplishment of Phase-2 was that detailed investigations (theoretical, laboratory and experimental) should be performed for lime mortars used for the existing Byzantine churches in Macedonia (mortars for construction and fresco-mortars), design of new lime mortars and lime-based mixtures for repair, grouting and injection of existing lime masonry walls and elements as well as the methodology to be implemented for strengthening and repair of damaged and mural paintings (fresco-paintings).

Presented are the results from the previous investigations of the physical-chemical characteristics of lime mortars for construction and fresco-mortars used in a number of more important churches dating from the Byzantine period in Macedonia (9th - 14th century) which were the subject of the research project. The subject of observation were the mortars in the following churches: St Sophia in Ohrid, St Bogorodica Bolnichka (St Mary) in Ohrid, St Gjorgji in the village of Staro Nagorichane, St. Arhangel Mihail in the village of Varosh and St Atanasie in the village of Leshok. A synthesis of all the investigations that have so far been performed in this field has also been made. Presented are the results regarding the physical-chemical characteristics of lime mortars used for construction of the church of St Nikita in the village of Gornjani taken as a church - prototype. These were used as a basis for design of the composition and the characteristics of mortar to be used for the construction of the church model (in scale of 1 : 2.75) which was subjected to dynamic experimental tests. Presented is also the composition and the characteristics of the fresco-mortar used for plastering (one half) of the constructed model as well as the designed mortars and grouts for repair and strengthening of the experimentally damaged model.

Based on the required characteristics of lime mortars for construction, the constituent parts of mortars (binders, fillers, additives

- organic and inorganic) were selected and laboratory tests of their physical-chemical and mechanical characteristics were performed via prisms and incorporation into wall elements (in scale of 1 : 2.75). Mortars with and without additives were discussed on the basis of the obtained results.

Knowing the characteristics of the existing churches, i.e., the physical-chemical and mechanical characteristics of mortars and the theoretically designed and experimentally verified method for repair and strengthening through grouting and injection of lime mortars and lime-based mixtures with given characteristics, the constituent materials of lime mortars and lime mixtures were selected and different types of mortar and mixtures were designed. After an ample laboratory study and in accordance with the required characteristics that have to be satisfied, two types of lime mixtures were adopted and experimentally tested as incorporated elements for repair of damaged wall elements in scale of 1 : 2.75. The behaviour of the wall elements and the incorporated lime mixtures (their mechanical characteristics) were also discussed.

Finally, based on the results from theoretical, laboratory and experimental investigations of lime mortars and lime-based mixtures to be used for construction, repair and strengthening as well as injection of areas around the steel ties and cracks smaller than 2 cm and larger than 1 mm, conclusions were drawn regarding the physical-chemical and mechanical characteristics of mortars that have to be compatible with the existing ones. Given in the recommendations are visions for further investigations the results of which will be even more widely applied in lime mortars and mixtures based on lime as a binding agent.

2 Byzantine churches in Macedonia dating from 9th-14th century

Since 6000 A.D. man has chosen the territory of Macedonia as his living place. Up till now, this was the place where many peoples, civilizations and cultures have been developed, passed by or died out. Each of these has left traces that bear evidence for the history and the achievements of each period and culture. The subject of this presentation is a part of the abundant cultural heritage - achievements of the Byzantine culture in architecture and art expressed through the churches dating from the 9th to the 14th century with anthological values in both fields. They are the subject of interest for the scientists and specialists as well as a subject of care, conservation and restoration as they were and are still exposed to natural damaging factors like earthquakes, floods, settlement, winds, etc. and man-made damaging factors like wars, fires pollution, neglectedness.

Within the period of eleven centuries (4th - 14th century), the territory of Macedonia was first part of the Byzantine Empire, then it was part of the king Samuil's empire (10th - 11th century), after which it fell under the rule of Byzantium, Bulgaria and Medieval Serbia. With the coming of the Turks, Macedonia fell under the Turkish yoke.

The Byzantine churches located on the territory of Macedonia contain one of the richest gallery of Byzantine fresco-paintings respected and preserved as the most valuable cultural heritage in



Macedonia which was another reason that they be taken as the subject of the scientific-research project.

During the period of almost six centuries, the sacral Byzantine architecture was always changeable depending on the construction conditions, the objectives and the needs as well as the possibilities of the masters.

According to the main architectural concept used for these buildings, four types of structures are distinguished:

- Structures with a basilica plan;
- Structures with triconched and tetraconched plan;
- Cross-in-square single-domed and five-domed structures;
- Single nave structures.

More than 65 structures dating from this period exist in Macedonia. Out of these 50 were selected for detailed study. The most characteristic and most numerous churches dating from this period are the cross-in-square single-domed ones. Selected for the needs of the project was the church of St Nikita (14th century) (Fig. 1) used as a prototype for construction of the model to a scale of 1 : 2.75 to be used for the performance of dynamic experimental tests.

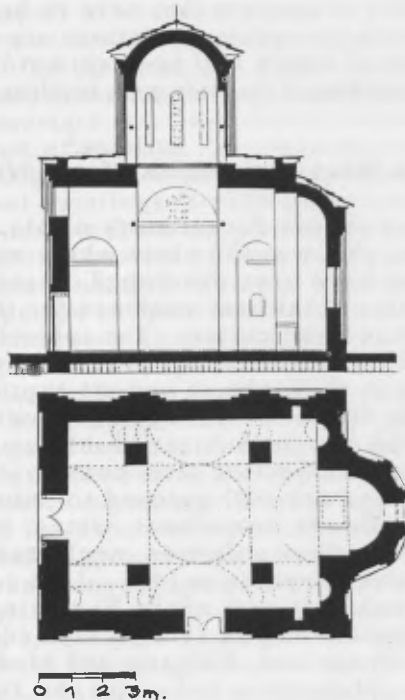

Figure 1. Ground floor and typical cross section of the St Nikita Church - v. Banjani

3 Physical-chemical characteristics of mortars for construction and fresco-mortars incorporated in Byzantine churches

Chemical-quantitative, petrographic and X-ray investigations of a number of samples of mortar taken from masonry and fresco-mortars taken from a number of Byzantine cultural monuments on the territory of Macedonia were performed for the purpose of defining the chemical and mineralogical content as well as petrographic classification of individual fragments of fillers and definition of structural-textural characteristics of mortars in order to reconstruct the original construction materials used by the old masters in construction of these cultural monuments, i.e., preparation of the mortars.

Such a reconstruction is not easily performed because due to the interaction of individual components of these materials in the course of time and the normal aging of the original gels, modification of the mineralogical content and structural-textural characteristics takes place by means of devitrification and recrystallization of the gels.

A cultural monument represents a complex of materials (basis, fresco-mortar, coloured layer), each material having its own specific characteristics and different susceptibility to aging.

These different materials exist under identical conditions and suffer different processes the consequences of which are different.

All the Byzantine churches have thick walls (about 0.8 - 1.0 m) and a thick layer of fresco-mortar (al to 2.5 cm). They surface is well flattened for fresco-painting.

The fresco mortar is placed on stones of different origin (usually lime-stones), bricks or combined stones and bricks connected by mortar.

In order to investigate completely the cultural monuments from chemical-technological aspects, samples of masonry and fresco mortars, pigments, soluble salts, stone, bricks, etc. were taken paying special attention to masonry and fresco-mortars in accordance with the goals set in the scientific-research project.

For systematization of the results and drawing of conclusions, several representative structures were considered. These were the following:

- The church of St Bogordica Bolnichka (St Mary) in Ohrid;
- The church of St Gjorgji in Staro Nagorichane;
- The church of St Arhangel in Varosh
- The church of St Sophia in Ohrid;
- The church of St Nikita in Banjani.

The obtained results from the tests of mortars taken from masonry and fresco-mortars are given in Table 1 and Table 2. These results are taken as an example and were obtained for the samples of masonry and fresco-mortars taken from the church of St Gjorgji in Staro Nagorichane.

Analyzing the tabular presentation of the results from the chemical-quantitative analyses and the results from the mineralogical-petrographic investigations, it may be concluded that the mortars were prepared by usage of lime as a binder and sand as a filler. The binder

consists exclusively of calcite with a grain size distribution of maximum 2 microns.

Table 1.

Characteristics	Location of the taken sample									
	Narthex			naos			apse	prothesis	diaconicon	
Number of samples	1	4	8	16	12	13	11	10	9	
Loss on ignition	39.50	42.38	39.94	41.64	41.30	39.94	45.15	47.79	44.65	
Insoluble residual	2.85	6.00	2.50	4.03	4.00	4.28	2.50	2.50	2.90	
CaO	48.48	46.48	48.26	48.92	50.36	48.70	48.92	48.48	45.90	
MgO	3.96	1.58	6.92	0.79	traces	3.1	0.79	2.37	2.37	
R ₂ O ₃ (Al ₂ O ₃ + Fe ₂ O ₃ +-)	3.20	3.20	2.01	2.50	2.50	1.50	2.18	1.66	2.20	
Total:	98.99	99.64	99.63	98.88	99.16	97.78	99.54	99.80	98.02	
Undefined and loss	2.01	0.36	0.27	1.12	0.84	2.22	0.46	0.20	1.98	
Straw										
Brick										
Salts -SO ₄ ²⁻	-	-	-	-	+	-	-	+ traces	-	
- CL ⁻	+	+	trase	-	-	+	+	+	+	
- NO ₃	-	-	-	-	-	-	-	-	-	
Free Ca(OH) ₂	-	-	-	-	-	-	-	-	-	
Binder-Filler ratio	10 : 1	5.8 : 1	14 : 1	10 : 1	10 : 1	10 : 1	10 : 1	10 : 1	10 : 1	

Table 2.

Characteristics	3	4	7	10	11	13	17	27	29
1. Loss on ignition	22%	21%	20%	24	13	19	21	14	21
2. Insoluble residual	52%	52%	50	44	43	46	46	62	52
3. CaO	20.01	22.2%	25.57	27.60	37.40	20.57	2.8	1.70	22.
4. MgO	0.79	1.8%	0.79	0.79	0.79	1.1	2.37	0.79	1.5
5. R ₂ O ₃ (Al ₂ O ₃ + Fe ₂ O ₃ +-)	4.00	2.00	2.00	2.00	4.00	2.00	3.00	4.00	2.00
TOTAL:	98.80	98.82	98.36	98.39	98.1	98.73	97.05	94.49	98.8
6. Undefined and losses	1.18	1.18	1.64	1.61	1.81	1.27	2.95	2.51	1.18
7. Binder-filler ratio	1:1	1.5:1	1.2:1	1.4:1	6:1	1.1:1	0.7:1	0.8:1	1.1:1

The carbonization level of the binder is high, whereas the degree of recrystallization is moderately high.

The filler is composed of the following minerals: quartz, quartzite, chlorides, muscovite orthoclases, plagioclases, granitoids, gneiss, apatite, biotite, etc.

The filler originates from river deposits and its grain size distribution ranges between 70 microns up to maximum 3 mm.

All the tested mortars are characterized by an extraordinary chemical and mineralogical similarity, almost identity.

There is a certain difference in the filler-binder ratio which can be explained by the everyday preparation of mortars for certain areas. The filler-binder ratio ranges between 0.7 : 1 to 1.5 : 1.

In almost all the mortars, there are no free non-carbonized calcium hydrosilicates and hydroaluminates. An exception is sample 13 which contains a small amount of free calcium hydroxide. This sample was taken from the expansion joint on the wall at the west part of the roof, over the west biforium. It is possible that it dates from a later phase. All mortar samples are characterized by a high carbonization level and a moderately high degree of recrystallization.

It is also interesting to note that the filler of mortar no. 11 taken from the base on which lie the tiles of the uncovered roof on the north-west side is considerably different from the other mortars in respect to its qualitative and quantitative content. Namely, it is mainly composed of quartzites that dominate over the aluminosilicates and rock fragments of the type of granitoids and gneiss. As to the filler-binder ratio, the filler is several times less present in respect to the other samples.

However, it is necessary to point out that the time difference is negligible and may be several months to several years.

It can be concluded that masonry mortars were prepared by using lime as a binder and ashes as a filler, with a grain size distribution varying between 1 mm - 60 mm.

In some of the churches, presence of proteins was detected in masonry mortars (St Nikita - v. Banjani. The filler/binder ratio ranges between 1 : 1 to 3 : 1.

3.1 Fresco-Mortars

Slightly magnesiaed lime was used as a binder in preparation of the fresco-mortars. It was obtained by baking of limestones and sand used as a filler. The binder has a cryptocrystalline structure. The filler is of different origin (riverine, lacustrine and anthropogenic). The filler of anthropogenic origin consists of crushed marble - limestone or marbelized limestones and crushed bricks. Almost in all the fresco-mortars in Byzantine churches, specially prepared straw is also added.

The filler/binder ratio varies from church to church even in a single church. There are no strict rules and this ratio ranges between 1:3 to 1:30.

It should also be pointed out to the negative effects of soluble salts upon the durability and the resistance of masonry and fresco-mortars. The prevailing soluble salts are sulfates, chlorides and nitrates. These originate from the materials incorporated in the structures, the materials used for conservation (cement, hygroscopic moisture and similar) and the biological degradation processes as a result of long moistening of the walls and the roof areas (capillary moisture, atmospheric waters, condensation moisture). In Macedonia, there exists a modern method for removal of the salts with simultaneous measures taken for removal of sources of moisture. This method has successfully

been applied in three Byzantine and post-Byzantine churches (St Nikola Bolnichki - Ohrid, St Andrea - v. Matka).

4 New designed Lime mortars and lime based mixtures for repair, grouting and injection

Lime mortars are the only solution for repair and conservation of damaged Byzantine churches without producing any negative effects regarding the existing state. Application of cement mortars in this case may induce damage to the fresco-paintings. This was the reason for starting with investigation of lime mortars that were used for construction of Byzantine structures for centuries.

4.1 Laboratory Tests

In laboratory conditions, lime mortars were prepared by using slied lime from the shaft at the archaeological site "Stobi", whereas the quicklime was taken from the Valandovo region. Used as a filler was an aggregate of a riverine origin that was most frequently used for construction of churches and was taken from the local deposits.

During the investigations, trials were made with natural materials that were used in the past, for the purpose of getting an insight into their reaction under the same conditions under which the trials were made, compared with synthetically obtained additieves (Table 3, Fig.2). Used were additives for improvement of the characteristics of lime mortars in respect to increased adhesion, higher porosity, better fluidity and workability and finally faster achievement of strength characteristics.

Table 3. Lime mortars for building

Label	Date of preparation	W/L with water	W/L	Dosage	Crushed on 8.06.94			Crushed on 12.09.94		Crushed on 12.10.94		
					γ g/cm ³	β_s MPa	β_p Mpa	γ g/cm ³	β_p Mpa	γ g/cm ³	β_s MPa	β_p Mpa
Ma1 1:1	21.04	0.16	1.32	2 milk	1.06	0.38	0.94	1.10	2.19	1.08	0.88	2.69
Ma2 1:1	21.04	0.16	1.32	eggs	1.15	0.44	0.9	1.13	2.19	1.10	0.80	2.81
Ma3 1:1	21.04	0.16	1.32	eggs 1/6	1.2	0.25	1.25	1.25	1.88	1.23	/	2.63
Ma4 1:1	22.01	0.03	1.06	juice	1.33	0.54	1.00	1.31	2.50	1.30	/	3.36
Ma5 1:1	22.04	0.13	1.25	2-3	1.31	0.38	1.25	1.31	2.9	1.30	1.85	4.69
Mea1 3:1	07.06	0.06	1.46	0.03 L16	/	/	/	1.84	1.25	1.84	/	1.32
Mea2 3:1	07.06	0.05	1.36	2-3	/	/	/	1.84	1.56	1.85	0.78	2.30
Mea3 3:1	07.06	0.06	1.46	3-13	/	/	/	1.80	1.44	1.81	0.57	1.83
Me3 3:1	07.06	0.05	1.36	/	/	/	/	1.84	0.94	1.82	0.44	1.71

(for Ma2 $\tau = 0.550$ after five months)

Factor W/L - water/lime paste

Factor W/L - water/lime/without water

τ - adhesion force of brick/mortar

The investigations took two directions: 1. to prepare lime mortars for construction and plastering to be used for repair and conservation of old churches and construction of new churches; 2. to prepare injection mixtures that will be used for stabilization of the loosened bonds between the existing mortar and the infill.

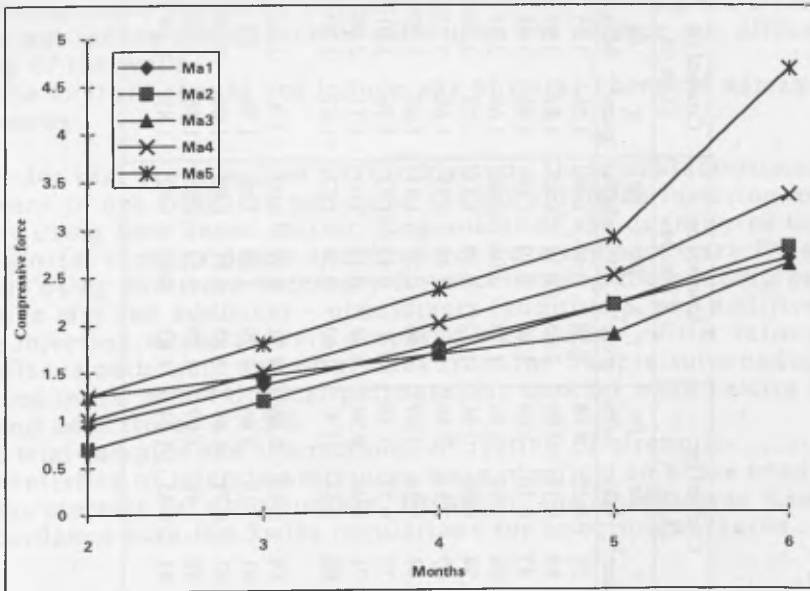

Figure 2.

4.2 Lime Mortars for Construction

The lime mortar was prepared from three parts filler and 1 part lime paste with 50% moisture, measured according to weight. The trial samples had the proportions of 4 x 4 x 16 and were made in steel form works with two layers of filtration paper placed at the bottom in order to simulate the porous structure of the wall. Used were several types of additives of organic and inorganic origin for the purpose of improvement of the consistency and adhesion of mortar as well as accelerating the bonding process. The results are presented in Table 4 which shows that the usage of additives in lime mortars enables improvement of strength and necessary characteristics that should be possessed by the lime mortar to be used for repair of churches.

Used in the investigations were additives of inorganic origin (additive ms and additive tu) acting as accelerators of the binding process, compared to the standard in the course of the same time period. In combination with synthetically obtained additives, these additives serve for improvement of the workability and adhesion of lime mortars and give better results in respect to the standard and also in respect to the trials made with inorganic additives solely.

Table 4. Cumulative table

Label	Dosage	Date of preparation	W/L with water	W/L	Crushed on 22.03.94			Crushed on 18.04.94			Crushed on 17.06.94			Crushed on 13.09.94			Crushed on 13.10.94		
					γ g/cm ³	β_s MPa	β_p MPa	γ g/cm ³	β_s MPa	β_p MPa	γ g/cm ³	β_s MPa	β_p MPa	γ g/cm ³	β_s MPa	β_p MPa	γ g/cm ³	β_s MPa	β_p MPa
Me1	/	20.12.93	0.07	1.14	1.52	0.15	/	1.58	0.25	0.78	1.58	0.44	1.48	1.56	1.25	1.25	1.54	1.30	1.30
Me2	/	25.01.94	0.09	1.18	1.81	0.16	/	1.84	0.15	0.86	1.85	0.38	1.25	1.82	1.09	1.09	1.80	1.30	1.30
Mtf1	10	25.01.94	0.12	1.24	1.42	0.10	/	1.47	0.10	1.09	1.48	0.10	1.09	1.56	1.41	1.41	1.54	1.46	1.46
Mtf2	5 - k	25.01.94	0.06	1.13	1.68	0.80	1.25	1.64	0.79	1.56	1.73	1.03	2.50	1.68	2.81	2.81	1.70	2.83	2.83
MmS1	5	18.01.94	0.27	2.83	1.75	0.16	/	1.74	0.36	0.94	1.72	0.39	1.13	1.78	1.56	1.56	1.80	1.84	1.84
MmS2	5 - k	18.01.94	0.06	1.13	1.63	1.54	2.38	1.67	2.13	3.40	1.63	1.48	3.19	1.68	3.75	3.75	1.70	4.11	4.11
MmS3	2.5 - k	15.02.94	0.15	1.30	1.58	0.68	0.70	1.64	0.71	1.09	1.66	0.56	1.41	1.66	1.57	1.57	1.70	2.43	2.43
MmS4	1 - 10	15.02.94	0.12	1.24	1.76	0.43	0.47	1.77	0.53	1.19	1.8	0.44	1.72	1.76	1.91	1.91	1.76	2.53	2.53
MmS5	2 - p	15.02.94	0.17	1.35	1.74	0.16	1.31	1.71	0.28	0.94	1.71	0.38	1.63	1.71	2.06	2.06	1.71	2.36	2.36
MmS6	2 - p 2.5 - k	15.02.94	0.15	1.3	1.3	0.31	0.25	1.66	0.64	1.4	1.63	0.56	1.72	1.67	1.80	1.80	1.65	2.30	2.30
Mtu1	10	08.02.94	0.27	1.54	1.73	0.37	/	1.69	0.33	0.86	1.71	0.41	1.09	1.8	1.56	1.56	1.68	1.94	1.94
Mtu2	4 - k	08.02.94	0.10	1.20	1.89	0.59	1.31	1.81	1.19	2.66	1.79	1.20	3.28	1.78	3.1	3.1	1.78	4.18	4.18
Mtu3	4 - 10	08.02.94	0.09	1.18	1.76	1.03	/	1.83	0.71	1.41	1.85	0.81	1.88	1.84	2.19	2.19	1.85	2.63	2.63
Mtu4	2.5 - p	09.02.94	0.15	1.31	1.79	0.33	/	1.78	1.48	1.09	1.79	0.55	1.56	1.76	1.72	1.72	1.75	2.50	2.50
Mtu5	2.5 - p 1.25 - 10	09.02.94	0.12	1.24	1.84	0.58	0.78	1.83	0.55	1.31	1.83	0.62	1.72	1.85	2.19	2.19	1.85	2.96	2.96

W/L - water/lime paste,

β_s - bending strength,

β_p - compressive strength

4.3 Lime-Based Injection Mixtures

The starting point in testing of lime based injection mixtures was the fact that these mixtures should have several essential characteristics:

1. Better fluidity and penetration ability enabling filling of cracks under low injection pressure;
2. The mixture should be compatible with the existing material - it should not induce occurrence of salts upon the surface nor diffuse closing of the walls.
3. The mixture should not induce any physical-chemical damage to the frescos.

In order that the injection mixtures satisfy these characteristics, it is necessary to use additives since one cannot obtain an injection mixture only by using lime based mortar. Regardless of the quantity of water used, mortar remains dense and does not have the necessary fluidity without using additives necessary for accelerating the bonding process (additive ms) and additives - plasticizers (additive K and additive 10).

The injection mixtures were prepared with a lime - filler ratio of 1:1. The filler is carbonate and originates from the Skopje surrounding. Detected in its mineralogical-petrographic content were calcite 897 - 98% and admixtures 2 - 3%.

The trial samples and the methods of testing of strength characteristics of injection mixtures were identical to those used for the lime mortars for construction. However, the fluidity was also tested in accordance with the Swiss regulations for injection mixtures.

Table 4.1. Grouts

label	Date of preparation	Dose	W/ lime with H ₂ O	W/ lime	Crushed on 8.06.94			Crushed on 12.09.94		Crushed on 12.10.94.		τ after 5 m.
					γ g/cm ³	β _s MPa	β _p MPa	γ g/cm ³	β _p MPa	γ g/cm ³	β _p MPa	
If1	31.03	2-10	0.20	1.40	1.34	0.68	22.5	1.34	22.4	1.30	22.40	/
If2	31.03	2-10	0.38	1.77	0.78	0.13	1.88	/	2.5	0.80	3.58	/
If3	31.03	2-10	0.07	1.13	1.25	1.76	3.25	1.21	4.1	1.20	6.81	/
If4	18.04	2-10	0.02	1.04	1.64	2.38	34.4	1.60	38.8	1.54	38.50	0.117
If5	20.04	2-10	0.04	1.08	1.66	2.33	32.08	/	30.4	1.65	31.90	0.106
If6	18.04	2-10	0.14	1.28	1.53	/	21.3	1.56	20.	1.56	22.15	0.192
If7	18.04	2-10	0.005	1.01	1.55	/	4.06	/	7.8	1.56	7.86	0.465
Ik1	31.03	2-k	0.73	2.46	/	/	/	/	/	/	/	/
Ik2	31.03	2-k	0.17	1.33	1.53	1.80	3.25	1.23	7.8	/	/	/
Ik3	20.04	2-k	0.05	1.10	1.26	1.45	3.28	1.27	8.3	/	/	0.487

τ - adhesion force

W/L - water/lime factor

β_s - bending strength

β_p - compressive strength

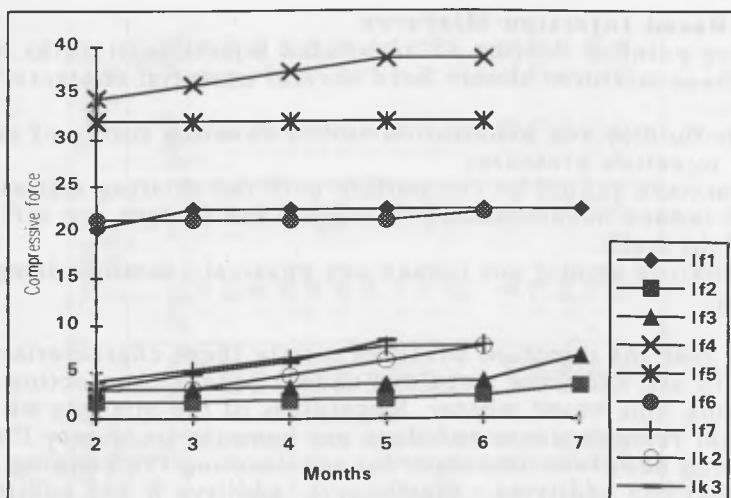

Figure 3.

The results from the investigations are presented in Table 5 and Fig.3. The analysis of the obtained results proves that the required fluidity is achieved in all the cases. It is also proved that these additives improve the strength characteristics

The investigations that have been performed so far and the obtained results point to the fact that the application of additives (within this period which is too short to get a thorough insight into their effects) yields good results in respect to strength and improvement of the necessary characteristics of mortars to be used for repair and conservation of churches. Taking into account the knowledge gained from the investigations that have been performed so far referring to the the property of achieving of the strength characteristics of mortars and injection mixtures by using additives, decisions will be made in practice separately for each monument.

5 Results from experimental tests of wall elements

Apart from the static laboratory tests of samples of the material discussed in the previous chapters, quasi static tests of wall elements were also performed for the purpose of obtaining practical results on the mechanical characteristics of the bearing capacity of masonry, mechanisms of failure and other parameters.

5.1 Experimental Testing of Wall Elements

Wall elements labelled ETA-1, ETA-2, ETA-3 were constructed using lime mortar for building with the same composition as that used for the laboratory trials, i.e., filler (river aggregate) - binder (slaked lime) ratio was 3 : 1. The aggregate was composed of:

- I fraction (0 ÷ 4 mm) - 55%
- II fraction (4 ÷ 8 mm) - 35%
- III fraction (8 ÷ 16 mm) - 10%

The components were dosed according to weight, while the water factor/material ratio (W/M) ranged between 0.17 - 0.2.

The wall elements were subjected to quasi-static tests 60 days after their construction. Two of these (ETA-1 and ETA-2) were tested under axial pressure, whereas the third one (ETA-3) was tested under shear compression. The tests were performed by gradual increase of the applied force up to large damages to elements in order that they be repaired in the next phase.

Apart from the total force, measured during the experiment were also the total displacement of the actuator in the direction of the applied force as well as other quantities of interest. This was achieved by using a corresponding instrumentation.

ETA-1 element was exposed to axial pressure by cyclic loading and unloading which enabled an insight into the occurrence of cracks and the failure mechanism as well as establishment of P- Δ diagrams for the total axial shortening and lateral deformations of the element. From the tests performed for this wall element, the following more important results were obtained:

- Occurrence of the first cracks (point 38) at $\sigma_0 = 105$ KPa;
- Maximal axial stress (point 561): $\sigma_0^{\max} = p_{\max} / F = 77.8 / 0.243 = 320$ kPa

The second wall element (ETA-2) was exposed to axial pressure by a monotonous, gradual increase of the force amplitude up to occurrence of large nonlinear deformations. The following results were obtained:

- Occurrence of the first cracks at $\sigma_0 = 160$ KPa;
- Maximal axial compressive stress: $\sigma_0^{\max} = p_{\max} / F = 80.4 / 0.243 = 331$ kPa

Both elements (ETA-1 and ETA-2) tested under axial pressure are characterized by occurrence of a crack along the central line of their width, resulting in falling off material and widening of the crack of up to 3 cm, up to complete separation of both faces of the wall elements.

In the case of the third element (ETA-3), the force was applied monotonously under an angle of 45% in respect to the expansion joints of the wall up to failure of the element. In this test, the values of the tangential and normal stress (τ_u and σ_0) are equal due to the angle of action of the force in respect to the plate at which the failure takes place.

$$\sigma_0 = \tau_u = P \times \cos 45^\circ / F$$

Taking this into account, one could compute the tensile strength using the following relation:

$$f_t = (-\sigma_0 \pm \sqrt{\sigma_0^2 \pm 4 \xi \tau_u^2}) / 2$$

where ξ is the coefficient of distribution of the tangential stresses along the element cross-section (for $h = a$, $\xi = 1$):

$$\sigma_0^{\max} = \tau_u^{\max} = p^{\max} \times \cos 45^\circ / F = 13 \times 0.707 / 0.243 = 38 \text{ kPa}$$

- Tensile strength - $f_t = 23$ kPa

5.2 Experimental Testing of Repaired Wall Elements

After experimental testing of the wall elements, cracks with a width of 1 - 30 mm occurred. After cleaning of the cracks and their surface treatment, the elements were repaired by free-fall injection of mixtures.

The same mixture was used for the first and the third wall element (ETA-1 and ETA-3), i.e., used as additives were additive-10 (plasticizer) dosed 2% in respect to the whole mixture and microsilica additive dosed 10% in respect to the binder amount. The filler-lime ratio was 1 : 1. Grout (If3) was prepared by W/L - 0.05. Trial samples proportioned 4 x 4 x 16 were tested after 15 days. The following values were obtained for the compressive strength and the bending force:

$$\text{If3 } \gamma = 1606 \text{ gr/cm}^3 \quad \beta_s = 1.95 \text{ MPa} \quad \beta_p = 4.5 \text{ Mpa}$$

As to the second wall element, additive-K was used as a plasticizer dosed 2% in respect to the whole mixture and microsilica additive dosed 10% in respect to the amount of the binder. The filler-lime ratio was 1 : 1.

Grout Ik2 was prepared by W/L = 0.36. The following characteristics of strength were obtained after 15 days:

$$\text{Ik2 } \gamma = 1242 \text{ gr/cm}^3 \quad \beta_s = 0.275 \text{ MPa} \quad \beta_p = 1.3 \text{ Mpa}$$

15 days after repairing, i.e., grouting of the damaged wall elements, they were again subjected to quasi-static tests. Due to the negligible differences between the results obtained by cyclic and monotonous loading of elements ETA-1 and ETA-2, it was decided that the repaired elements be loaded in the same way (cyclic loading and unloading) for the purpose of exploring the effect of both grouts (If3 and Ik2). For this element, it is characteristic that the initial cracks occurred on the face of the element and later along the central line of the element width (characteristic for the nonrepaired element) which points evidently to "swelling" of the element.

Apart from the differences in the failure mechanism, the obtained results also point to considerably higher axial stresses than those recorded for the non-repaired element:

- Occurrence of the first crack at $\sigma_0 = 182 \text{ KPa}$.
- Maximum stress: $\sigma_0^{\max} = P^{\max} / F = 167 \text{ kN} / 0.243 \text{ m}^2 = 685 \text{ kPa}$

Further application of force gave rise to an increase in deformations without an increase in force so that it may be concluded that the compressive strength is $\beta_p = \sigma_0^{\max} = 685 \text{ KPa}$ which is about 100% higher than σ_0^{\max} obtained for the nonrepaired element (ETA-1).

Similar results were obtained for the repaired wall element ETA-2R (Ik2 - 10% ms):

- Occurrence of the first cracks at $\sigma_0 = 188 \text{ KPa}$.
- Maximum stress: $\sigma_0^{\max} = P^{\max} / F = 136 \text{ kN} / 0.243 \text{ m}^2 = 558 \text{ kPa}$

In the beginning, "swelling" was also characteristic for this element, whereas the crack along the width of the element occurred later. When

the maximal force was applied, there was falling off the material and separation of the element faces in the upper zone. However, it is important that a higher compressive strength for about 70% is obtained in comparison with the nonrepaired element ETA-2. Namely, it may be concluded that grout (Ik2 - 10%ms) yields better results.

The third element ETA-3 was repaired by "pasting" of the fallen off corner and injection of mixture (If3 - 10%ms). After being repaired, this element was subjected to shear compression test by monotonous application of force up to failure of the element. The following results were obtained:

$$\sigma_{0\max} = \tau_{u\max} = p_{\max} \times \cos 45^\circ / F = 19\text{kN} \times 0.707 / 0.243\text{m}^2 = 55 \text{ kPa}$$

- Tensile strength $f_t = 34 \text{ KPa}$

It is characteristic for this element that the cracks occurred in the mid of the element, in the direction of the applied force, not at the place of the pasted corner. This speaks for itself that the strength at this part is higher than that at the nondamaged part. The higher tensile strength for about 50% in comparison with that of the nonrepaired element ETA-3 is also evident.

From the aspect of deformability of the element, it may be concluded that under the same force (13kN), the repaired element ETA-3R suffers considerably lower deformations of diagonals (about 0.1 mm) than those of the nonrepaired element ETA-3 (about 0.6 mm). It is also characterized by a greater deformability capacity prior to failure (about 4mm) compared to that of the nonrepaired element (about 1 mm).

From the comparison of the results obtained for both the repaired and nonrepaired wall elements, it may be concluded that grouting leads to complete stabilization of the wall elements, i.e., increase in compressive strength of the wall elements which was one of the objectives of this programme regarding the practical application of grouts in repair of old and damaged churches.

6 CONCLUSIONS AND RECOMMENDATIONS

Detailed investigations of existing lime mortars used for the churches dating from the Byzantine period (9 - 14th century) in Macedonia and laboratory and experimental investigations of newly prepared mortars for building of the model of St Nikita church scaled 1 : 2.75 as well as repair and strengthening of the same model applying the method of strengthening and increasing of the resistance of the churches which are the subject of this scientific-research project have proved the validity of the thesis that it is possible to increase the dynamic characteristics and decrease the vulnerability of the churches preserving at the same time the authentic characteristics of their principal structural systems, using lime mortars, lime-based mixtures and steel ties of high quality in full compliance with the modern and recommended principles in treatment, conservation and restoration of cultural monuments in earthquake-prone regions.

As to lime mortars, the results from the investigations performed in the third phase of the project show that the applied parameters and

methodological approach in preparation and design of the required characteristics of the obtained lime mortars and mixtures based on lime and lime carbonate fillers and additives represent a realistic assumption for their practical application in conservation and strengthening of Byzantine (9-14th c.) churches.

The investigations and the results obtained represent a contribution to establishment of standardization in the following domains:

- Testing and definition of the main components of existing lime mortars in Byzantine churches existing in Macedonia;
- Testing and definition of physical-chemical and mechanical characteristics of existing lime mortars in Byzantine churches existing in Macedonia;
- Testing and definition of the physical-chemical and strength characteristics of the newly designed lime mortars and lime-based mixtures for conservation, repair and strengthening of Byzantine churches in Macedonia.

The obtained results from the investigations performed throughout the realization of the whole project and especially in the third phase, have led to the following conclusions and recommendations:

6.1 Conclusions

- The thesis for application of lime mortars and lime-based mixtures with the same or similar characteristics as those originally applied for the Byzantine churches has been proved valid for conservation, restoration and strengthening of these churches.
- A possibility is given for designing the characteristics of lime mortars and lime-based mixtures for repair and grouting, by applying certain dosages of inorganic and organic carbonate fillers which simulate the same or somewhat improved strength characteristics of the existing ones.
- A proper selection of components and additives makes possible design of lime mortars and lime-based mixtures for repair and conservation of damaged mural paintings - fresco paintings.
- The main methodological approach and the obtained results enable drawing of a general conclusion regarding the main binding material - lime mortar - used for the Byzantine churches. Namely, it is generally concluded that it satisfies the following required purposes:
- The main concept of the originally used binding agent - lime mortar is not disturbed.
- The authentic - principal structural system and structural elements are preserved to the best possible extent.
- The newly designed and incorporated mortars and lime-based mixtures are completely compatible; they have appropriate characteristics when used with high quality steel ties; and, they have highly pronounced reversibility characteristics.
- The obtained results represent a fundamental basis for further investigations both in the domain of standardization of the research methods and definition of the main characteristics of lime mortars and lime-based mixtures for conservation, restoration, repair and strengthening of Byzantine churches in Macedonia and beyond as

well as structures in Macedonia and the Mediterranean where lime-mortar is used as a binding agent.

- The obtained results contribute very much to the rehabilitation of the usage of lime mortars and lime-based mortars as a past experience not only for present but also future needs not only regarding cultural monuments but as a contribution of the past to the present and future regarding usage of lime mortar in modern civil engineering with a wide range of application based on its natural origin, adaptability and flexibility characteristics, long duration and environmental harmlessness.

6.2 Recommendations

- Further investigations should be performed in the sphere of standardization and increasing of the compatibility between existing and newly designed lime mortars.
- Designed lime mortars and lime-based mixtures should be used "in situ" for structures from the Byzantine period in Macedonia (St Bogorodica /St Mary/ - v. Drenovo), experimentally and permanently monitoring the modification of the characteristics of the incorporated mixtures.
- A data bank will have to be created for storing of physical-chemical and strength characteristics of lime mortars (building and fresco mortars) used in all the churches dating from the Byzantine period in Macedonia.
- The obtained results are to be presented in publications, seminars, conferences, etc.

7 Acknowledgment

The results presented in this paper represent part of the research project "Study for Seismic Strengthening, Conservation and Restoration of Churches Dating from the Byzantine period (9th - 14th Century) in Macedonia carried out jointly by the Institute of Earthquake Engineering and Engineering Seismology (IZIIS) in Skopje and the Republic Institute for Protection of Cultural Monuments (RZZSK), Skopje, Republic of Macedonia, fully supported and financed by the Getty Conservation Institute (GCI), Marina del Rey, California, USA.

The authors extend their gratitude to the J. Paul Getty Trust and especially to the Getty Conservation Institute for the financial support and participation in the realization of this project.

8 References

"Study for Seismic Strengthening, Conservation and Restoration of Churches Dating from the Byzantine Period (9th - 14th Century) in Macedonia" - joint research project, IZIIS - Skopje, RZZSK - Skopje, GCI - Marina del Rey, Report IZIIS 500-76-91 (Vol. 1 - 6) - first phase of investigation, Report IZIIS 92-71 (Vol. 7 - 10) - second phase of investigation., Report IZIIS 94 - 68/1 (Vol. 11 - 12) - third phase of investigation

Addresses: IZIIS - P.O.Box 101, 91 000 Skopje, Macedonia;
RZZSK - P.O. Box 225, 91 000 Skopje, Macedonia;
ADING - Novoselski Pat bb. 91000 Skopje, Macedonia
GCI - 4053 Glencoe Avenue, Marina del Rey, 90292, US.

100
101
102
103
104
105
106
107
108
109
110
111
112
113
114
115
116
117
118
119
120
121
122
123
124
125
126
127
128
129
130
131
132
133
134
135
136
137
138
139
140
141
142
143
144
145
146
147
148
149
150
151
152
153
154
155
156
157
158
159
160
161
162
163
164
165
166
167
168
169
170
171
172
173
174
175
176
177
178
179
180
181
182
183
184
185
186
187
188
189
190
191
192
193
194
195
196
197
198
199
200

Part Two

BIOCIDAL TREATMENTS

The biocidal treatments described in this part of the manual are intended to control the growth of algae and other organisms in the water of swimming pools. These treatments are designed to be used in conjunction with the other maintenance procedures described in this manual. The biocidal treatments are described in the following sections:

- Algaecides
- Bactericides
- Fungicides
- Snail and Slug Killers
- Shock Treatments

The biocidal treatments are described in the following sections:

- Algaecides
- Bactericides
- Fungicides
- Snail and Slug Killers
- Shock Treatments

AN EVALUATION OF BIOCIDES TREATMENTS ON THE ROCK ART OF BAICAL

N.L.REBRICOVA, E.N.AGEEVA

SRIR, Biol. Lab. & Dept. Cons. Monum. Sculpt., Moscow, Russia

Abstract

The investigation was made with the aid of conservation the deteriorating rock paintings of Baical. Distribution of lichens and algae on the two archaeological monuments were studied with the identification of their species. It was elucidated that rock art was protected via right and/or negative slope of the surface with the drawings, its south orientation, natural cornices and waterproofing of stone massifs. Biodegradation of petroglyfs occurred as a consequence of drastic changes in ecological situation due to defect in waterproofing. Biocides to control the growth of algae and lichens were tested for a prolonged period of time on separate test sites. The biocides were monitored for initial and long-term effect. Low soluble biocides possessed the most persistence. The method of treatment was worked out which made possible to eliminate thali of the crustose lichens on the stone surface relatively safely. Unfortunately in conditions of high insolation, natural wash out and drastic daily and yearly temperature variations none of the tested biocides or their mixtures provided long-term protection against biodeterioration. For prolongation of the biocide action it was necessary to restore the original monument environment. In certain cases the recurring biocide treatments could be avoid.

Keywords: Rock Art, Lichens, Algae, Cyanobacteria, Biodeterioration, Biocide Treatments

1 Introduction

Our investigations have been performed on the two East Siberian rock art sites: Shishkino and Sagan-Zaba. Shishkino is situated near the west shore of Baical by the Upper Lena. Shishkino is dated from neolit up to 9-10 centuries. Petroglyfs are found on the smooth open surfaces of the red thin fine-grain sandstone with little carbonate cement oriented to the south and covered with the rock desert varnish. They are situated twenty-thirty meters higher the water level (Figs 1,2). Right and/or negative slopes of surfaces with petroglyfs are usually protected by the natural cornices. Their moistening by rain and snow fall and by condensation water seems to be insignificant.

Sagan-Zaba is located on the west shore of Baical near Olchon. It is dated from neolit up to 9-10 centuries. Petroglyfs are arranged on



Fig.1. Rock massif Shishkino with petroglyphs



Fig.2. Shishkino's petroglyphs

the surfaces of the white mid-grain marble oriented to the south. They are situated 0.2 up to 6 m higher water level and covered with patina of different colours (Figs 3,4). Surfaces with drawings are close to vertical with deviation of several degrees of positive or negative angles. The rocks are moist treated in not only in storm weather but also as a result of fog condensation.

2 Lichens and algae found on the rock art sites

The rock massif Shishkino has a vegetation typical for dry environment. Cornices and rock surfaces with positive slope close to petroglyphs are covered with lichens. Foliose constituents of lichen's vegetation were identified as follows: *Xanthoria elegans*, *Physcia* sp., *Acarospora fuscata* and the crustose ones: *Lecanora frustulosa*, *L.subfuscata*, *Caloplaca* sp. *Squamarina lentigera* was identified as an impurity to these dominating forms. Only vertical surfaces of the surfaces with negative slope were free of them. Thali of the crustose lichens *Endocarpon pusillum*, *Aspicilia contorte*, *Lecanora* sp. were observed in the area of petroglyphs on the vertical surfaces where condensation was the only source of moisture (Fig.5).

Lichens developed on the open vertical surfaces also near the drains falling from the massif. Microbiological analysis of the sandstone samples near the thali of *E. pusillum* have shown chemoorganotropic bacteria two-three orders more than the bacteria of samples of the sandstone without lichens.

All the mountain sides of site Sagan-Zaba are covered with epilithic lichens. Grass and bushes grow in the cracks. The crustose lichen *Calo-*



Fig.3. Rock massif Sagan-Zaba with petroglyphs

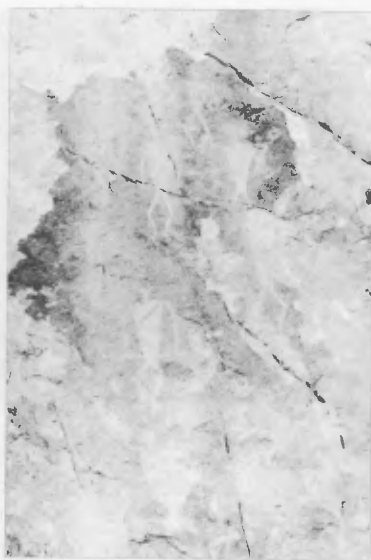

Fig.4. Sagan-Zaba's petroglyphs

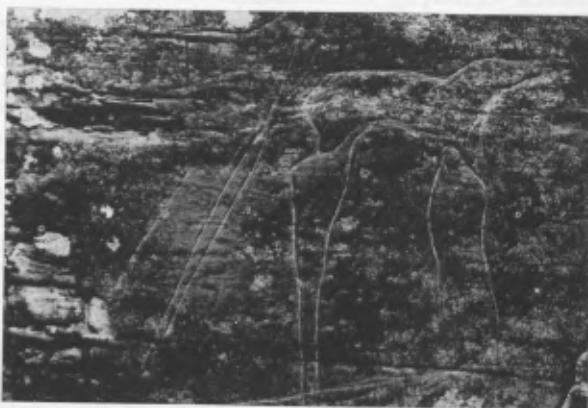

Fig.5. Shishkino, the growth of crustose lichens

placa sp. dominates on the surfaces closed to vertical near the petroglyphs. Contrary to Shishkino, Sagan-Zaba rock art site is situated by the lake. The observations have revealed that the rocks are occupied with algae and cyanobacteria which develop between the marble crystals under the crust, in the cracks not forming the surface layers. The density and porosity of the Sagan-Zaba marble is related to limestone. Algae and cyanobacteria develop on very small spaces between the particles of the rock. These spaces are separated from the open air by the crust of three-five millimetres thick transmitting light and water. At the same time the crust is a good protection from high insolation and

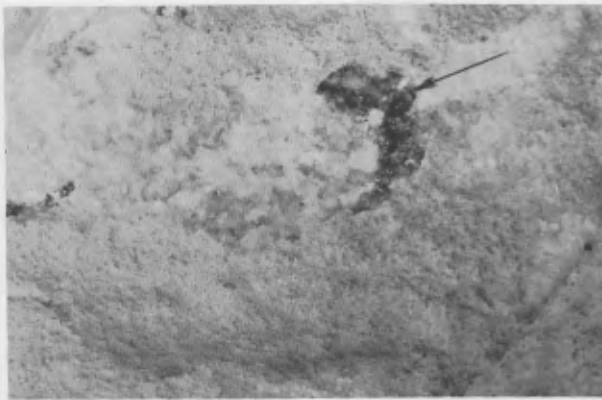

Fig.6. The surface of marble with removed part of the crust

quick desiccation (Fig.6). On the cross-section of the rock the algae and cyanobacteria look like a thin blue-green layer under the crust. Groups of algal cells and cyanobacteria colonies are attached to the marble crystals. The growth of algae and cyanobacteria within the rock is typical for severe climatic conditions.

Microscopic analysis of the marble samples has revealed many cells of cyanobacteria and unicellular green algae from Protococcales. Cyanobacteria presented colonial forms of *Gleocapsa* sp. and *Nostoc* sp. with the slimy envelopes protecting them from unfavourable conditions. The dominating were the cells of *Gleocapsa* sp. Upon moistening the envelopes swell and press on the surrounding marble crystals. Algal growth brings about grayish-black shade to the white marble becoming more intense upon moistening. Individual thalli of *Caloplaca* sp. have been found on petroglyphs. The same species of *Caloplaca* and *Lecanora* sp. exist along originating drains.

Along with the processes of natural weathering and vandalism destruction of the monuments appears to be the result of colonizer's development. Their growth has been provoked by the changes of the environment: the destruction of cornices, the development of new drains on Shishkino and the changes of hydrological regime of Baical on Sagan-Zaba.

Destruction of the stone by the lichens, algae and cyanobacteria is determined by their ability to accept and keep moisture leading to increased pressure on the rock particles. Lichens, algae and cyanobacteria transform minerals to mobile compounds and absorb the mineral elements.

3 Evaluating the effectiveness of the biocide treatments

Effectivity of the biocide treatments has been investigated to conserve petroglyphs. Influence of algicides and lichencides tested previously in the laboratory and field experiments, and used in restoration

Table 1. Tested biocides

Trade name	Active ingredient	Concentrations tested
Catamin AB	Quaternary ammonium salt	3.0%; 5.0%
Perhydrol	Hydrogen peroxide	25%
TBTO	Tinorgano-compound	3.0%; 5.0%

Table 2. Characteristics of the test sites and biocides treatments

Test site/substrat	Algae/lichens at the site	Biocides tested	Evaluating the effectiveness
Vertical surface, marble	Gleocapsa sp.,	Catamin AB, 15 ml/dm ²	Not full inhibition
	Nostoc sp., green algae, Lecanora sp.	Catamin AB + perhydrol, 15 ml/dm ²	Not full inhibition
Slope surface, marble (Fig.7)	Gleocapsa sp.,	TBTO 15 ml/dm ²	Not full inhibition
	Nostoc sp., green algae		
Vertical surface, marble (Fig.8)	Caloplaca sp.	Perhydrol, 15 ml/dm ²	Full inhibition
Slope surface, sandstone, after cleaning	Endocarpon pusillum,	Catamin AB, 12 ml/dm ²	Recolonisation
	Aspicilia contorte,		
	Lecanora sp.	TBTO, 12 ml/dm ²	Absence of growth
		Catamin AB+TBTO, 12 ml/dm ²	Absence of growth

of the stone sculptures was estimated. The alkaline compositions were not applied due to the discoloration of sandstone surface. The recommended concentrations were used (Tab.1). Experiments have been performed on the test sites of the monuments with different types of biodeterioration (Tab.2).

The degree of colonizer's inhibition and long persistence of biocide treatments was estimated. The control of biocide action has been carried out with aid of samples withdrawn from the test sites. The samples were taken at intervals of 1,2,3 days, half of year and one year. Their microscopical analysis has been performed in transmitted light.

Full inhibition is characterized by the absence of chlorophyll in observed cells of algae and phycobionts of lichens. Partial inhibition gave the signs of depression of the algae and phycobionts. It was expressed by the decrease in the amount of the living cells in the sample. The colour of chlorophyll of the intact cells was yellow-green. Uneffectiveness of the biocide has been demonstrated by the absence in cell changes.

Persistence of biocide treatments was tested by means of long-standing observations of recolonisation of test sites. Test sites were treated with biocide after a preliminary cleaning from vegetative growth. The appearance of thali of the crustose lichens has been fixed.

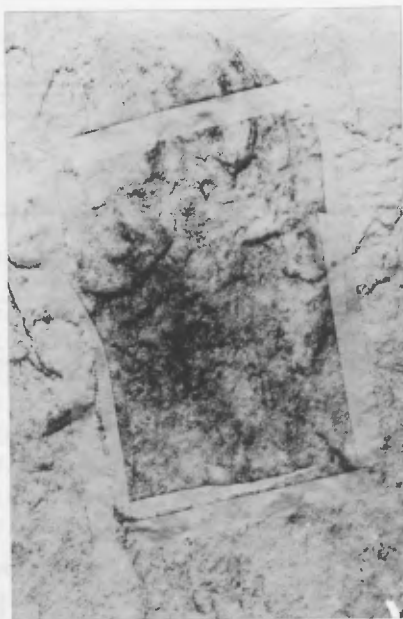

Fig.7. Test site on the marble, algal growth



Fig.8. Test site on the marble, Caloplaca sp.

The experiments performed showed full inhibition of phycobionts as a result of treatment by catamin AB and perhydrol (control per day). Inhibition of lichen by TBTO was gradual. Full inhibition was observed in a year. Perhydrol action on the lichens *Caloplaca* sp. produced the talus darkening. Perhydrol treatment lightened the stone cleaning but the mechanical action was needed. Dead lichen's thali left was weathered during the year and their fragments could be removed with the aid of a brush.

Catamin AB and perhydrol acted immediately on the algae. The action of TBTO was slower, but its action appeared quicker on the algae than on lichens (in a month).

Full inhibition of algae could not be reached as a result of the algae development on the monuments (under crusts, in depth) in some cases. TBTO was the most stable to washing out.

On the sixth year of observations the recolonisation of crustose lichens began via development of thali on the test sites treated by catamin AB. Lichens did not grow on the test sites treated by TBTO or by the mixture of TBTO and catamin AB.

4 Conclusion

Special features of Sagan-Zaba monuments are the overmoistening of the stone, high insolation and drastic temperature variations leading to accelerating ageing of biocides. Hydrophobity partially disappeared on the test site treated by TBTO at the end of the second year of exposure. Only the complex of measures including the restoration of the original ecological environment of its centuries-old existence can be the effective protection of these monuments from biodeterioration.

METHODS FOR THE EVALUATION OF PRODUCTS AGAINST ALGAL BIOCOENOSIS OF MONUMENTAL FOUNTAINS

P. TIANO, M. CAMAITI, P. ACCOLLA

C.N.R. C.S. "Cause Deterioramento e Metodi di Conservazione delle Opere d'Arte",
Firenze, Italy.

Abstract

Algal contaminants in the water of monumental fountains cause a rapid formation of a thick biological patina of mixed biocoenosis. These organisms (species of Bacillariophyceae, Cyanobacteria, Chlorophyceae and related heterotropic bacteria) grow and adhere tightly to stone surfaces inducing physico-chemical and aesthetic weathering. This work examines and describes the methodology used to assess the efficiency and the persistence of the antifouling action of some biocide formulations, which may control the biological patina formation. The biocide (a halogenate pyridine derivative) was applied by itself or together with two different hydrorepellents (an alkyl alkoxysilane and a fluoroelastomer) on marble samples in our laboratory and on the surface of some stones in a monumental fountain located in Florence, Italy. HPLC chromatography, FT-IR spectrophotometry, water capillary absorption, and MIC determinations were used to study the behaviour of the selected formulates after their application. The results are indicative of a light persistence of the activity of the biocide. Only the fluoroelastomer in water emulsion, of the two hydrorepellents that have been used, has a retarding effect on the recolonization of a submerged stone surface.

Keywords : Algae, Biodeterioration, Stone, Monuments, Fountain, Biocide, Antifouling, Waterproofing, HPLC.

1 Introduction

The surface of stone monuments can be colonized by micro and macroflora as a consequence of the environmental conditions to which they are exposed. In the case of the stones in a monumental fountain, all those submerged, or continuously wet, are

usually covered by a thick biological patina consisting mainly of aquatic phototrophic organisms. The distribution of specific microorganisms and their growth rate are related with the water velocity in the fountain (Ricci and Pietrini, 1994).

To prevent the formation of this type of biological patina is very difficult. Only a closed water circulation system with periodic additions of a sterilizing product (as in a swimming-pool) can be useful. This prevention system is not easy to realize, moreover a long time exposure to chlorine (Bernardini, 1993) or other sterilizing agents can produce a negative effect on the stone surface.

Fouling prevention is usually achieved by the application of a biocide, after the restoration of the surface. The concentration of the biocide in water should be extremely low (Rasnowki et al., 1988) so that human beings, pigeons and the other living organisms in contact with the water of the fountain should not be harmed. Another approach is the application of a water-repellent (Tabasso et al., 1991, Zannini et al., 1989). Both treatments have a short lifetime and in outdoor applications frequent maintenance is necessary with most of the products used (Petrini, 1991, Tiano et al., 1994). An attempt to improve the persistence of the efficiency has been made by using a mixture of a biocide (tri-n-butyltin) with an acrylic copolymer (Rasnowki et al., 1988).

This work reports a methodology for the evaluation of the performance of some biocide/water-repellent mixtures used to prevent the growth of algal biocoenosis on stone surfaces in a fountain. The combination of a biocide with a hydrorepellent can improve the persistence of the biocide efficiency, by slowing its loss. The active principle chosen for this study, was a halogenated pyridine which, in previous experiments, has shown its efficiency against algal biocoenosis of monuments (Tiano et al. 1993) and has a very low solubility in water (25 ppm). The water-repellents used were a silicone derivative and a fluoroelastomer.

The specific problems of a monumental fountain are: some of the stone surfaces are constantly under water (either running or stagnant), others are only periodically wetted, while other experience only the impact of the water fall. The variables considered as relevant to evaluate the validity of a preventive treatment under these conditions are: the biocidal and water-repellent activity of the formulates, the persistence of the antifouling action.

2 Materials and Methods

2.1 Monumental fountain

The fountain chosen for this field experiment is the Tacca's Fountain located in Piazza SS. Annunziata, Florence, Italy. Tacca's Fountain is one of a pair of fountains built by P. Tacca and his assistant in 1629 and is placed in front of the Serviti's Lodges. The fountain is fed from the public town water system through sprouts placed in the mouth of the two seamonsters. The water then falls in four streams from the upper basin into the lower basin. The figures and the upper basin are made of bronze while the base and lower basin are made of marble. The water flow was temporarily interrupted and four

vertical areas of stone in the lower basin were carefully dried and cleaned to remove the biological patina and calcareous deposits.

2.2 Test Organisms

A sample of the biological patina was taken from the surface of a submerged stone in the lower basin of the Tacca's Fountain before its cleaning, and characterized. It mainly consisted of: Bacillariophyceae (*Navicules*), Cyanobacteria (*Nostocales*), Chlorophyceae (*Ulothricales*) and related heterotrophic bacteria. This complex biocoenosis was kept as stock culture for the various microbiological tests in the medium BG11 (Tiano et al. 1993). This stock culture was used for the MIC test and applied on some limestone (Pietra Vicenza) samples (5x5x1 cm). The stone surface of the Vicenza specimens was completely colonized and then used as an inoculum in the experiments for the evaluation of the preventive activity of the formulates, both in static and dynamic laboratory tests.

2.3 Stone samples

Dolomitic marble samples of different sizes were cut :

Size 1 - 5x1.5x0.5 cm slices for evaluating the MIC value.

Size 2 - 5x5x1 cm slices for the evaluation of both the persistence of the antifouling action of the formulates and their waterrepellence after weathering tests.

Size 3 - 10x5x0.5 cm slices for the evaluation of the efficacy of the formulates under static and dynamic conditions.

2.4 Biocide formulates

Type and concentration of the formulates used:

i) Algo: Algophase [2,3,5,6, tetrachloro 4 (methyl sulphonyl pyridine)], 0.2 - 0.5 - 1 - 2 % in acetone.

ii) Algo+Hydro: Algophase (0.2 - 0.5 - 1 - 2 % in acetone) + Hydrophase VR-100 [Alkyl alkoxy silane], 7% in acetone.

iii) Algo+AkeoCO: Algophase (0.2 - 0.5 - 1 - 2 % in acetone) + Akeogard CO [vinylidene fluoride hexafluoropropene copolymer], 2.5 % in acetone.

iv) Algo+AkeoTN: Algophase (0.2 - 0.5 - 1 - 2 % in acetone) + Akeogard TN 50 [vinylidene fluoride, hexafluoropropene and tetrafluoroethylene], 5% water emulsion.

2.5 Treatment

Different formulates (and pure acetone as reference solution) were applied by brush on one of the wider faces of all the stone samples. For "in situ" treatments, a 10x10 cm plastic frame was used to apply by brush the different formulates.

In all cases, the amount of the formulate applied corresponded to 1 ml per 25 cm² of surface.

2.6 Water weathering test

The water exposure of a stone in a fountain was simulated as follows:

a) *Leaching action*

Sets of 3 (5x5x1 cm) stone slices were used to test every formulate and acetone as reference solution. Each set of samples was then placed in different crystallization vessels (\varnothing 13.5 cm). The stones, placed in an upright position, were kept under water (about 800 ml of town water), with magnetic stirring, and the water level was kept constant by periodic additions.

b) *Mechanical impact*

Sets of 12 (5x5x1 cm) stone slices were used to test every formulate and the reference solution. All the samples were layed on a large stone slab (60x 60 x 2 cm), with the treated surface up. The slab was then placed on a roof directly below a water spray at a distance of 120 cm. This system provided a beam of water of about 1.3 l/min, on a total surface of about 0.5 m².

2.7 Microbiological evaluation of the efficiency of the biocide

a) MIC (Minimal Inhibition Concentration)

One stone slice (5x1.5x0.5 cm) treated with every formulate and the reference solution was put into a test tube containing 20 ml of the BG 11/ water (1/1) culture medium. 1 ml of the stock culture was then added to each tube (approx. 10⁶ organisms in every ml) and all the tubes were then incubated (in triplicate) for 30 days at 25°C under a constant irradiation of 100 $\mu\text{E}/\text{m}^2/\text{sec}$ (PAR).

b) Antifouling activity of the formulates in laboratory tests

The formulates containing the Algophase at a concentration of 1 % and the reference solution were applied on stone 10x5x1 cm samples. Two samples for every treatment were then placed (one horizontally and the other vertically) in a plastic box (20x14x10 cm) containing water (about 800 ml). A source of microorganisms was then placed inside each box, using a specimen of the Vicenza stone previously colonized by test organisms (see 2.2). Two types of experimental conditions were then examined:

b1) *Static*

For the static test, the water level in the plastic box was kept constant, at about 1 cm under the edge of the vertical sample, by periodic water addition.

b2) *Dynamic*

For the dynamic test the same water level as above was kept constant by one overflow system with a water flow rate of approximately 0.5 l/min.

c) Antifouling activity of the formulates "in situ" tests

The various formulates (at 1 and 2 % Algophase concentration) and the reference solution were applied in duplicate to the four clean areas of stone in the lower basin of the Tacca's Fountain. After 5 days the water system was turned on and all the areas treated were completely submerged in water.

The qualitative evaluation of all microbiological tests was made by a visual check of the growth and settlement intensity of the algal biocoenosis on the sample surfaces. The control time intervals were:

- every 7 days for 1 month for test 2.7 a
- every 30 days for 1 year for test 2.7 b
- every 90 days for 1 year for test 2.7 c

2.8 Water-repellence evaluation

The water-repellence of the different formulates once applied on the stone was measured both before and after the two weathering tests. It was determined by the water capillary absorption method reported in Doc. Normal 11/85 (AA.VV., 1986).

The determinations were made after 3, 6 and 12 months of water immersion and after 20, 80, 320, 640, 1180 hours of water mechanical impact.

2.9 Permanence of the biocide

The amount of the Algophase present on the treated surface was determined on each sample (*test 2.6 a* and *b*), before and after each step of the weathering. This was achieved by extracting both the water-repellent and the biocide, and then evaluating the concentration of the latter by HPLC and FT-IR. The extraction was performed by placing the samples in a Soxhlet, with refluxing acetone until no more product was recovered (4 hours).

The weight of the extract was determined and the percentage of the Algophase was calculated using calibration curves.

The presence of the Algophase was checked also in the water of *test 2.6 a*. The water of each crystallization vessel was collected and changed at various time intervals (7, 15, 30, 180 and 360 days) and an HPLC determination was carried out on acetone solution of the vacuum dried residue (60 °C).

a) HPLC

These determinations were made using a HPLC Perkin-Elmer (mod LC250) chromatograph equipped with a low pressure mixing pump, two detectors (a Diode array Mod. LC 235 and a refraction index mod LC30) and the following arrangements:

a 1) *Algo/Hydro*

Analytical C18 column (length 200 mm), eluent mixture Eptane/Acetone 95/5, detectors Diode Array (DA) at 335 nm and Refraction Index (RI), flow of 1 ml/min.

a 2) *Algo/AkeoCO* and *Algo/AkeoTN*

Gel permeation PL gel styrene-divinylbenzene column, 500Å (length 200 mm), eluent methanol, detector RI, flow of 1 ml/min.

b) FT-IR spectroscopy

The determinations were made using a FT-IR Perkin-Elmer mod. Sys 2000 spectrophotometer, an acetone solution of the sample (10% concentration), and a 100 µ cell equipped with KBr windows.

3 Results and Discussion

3.1 Biocidal efficiency

The evaluation of the biocide efficiency, in the range of concentrations of the formulates tested (Table 1), shows a value of MIC < 1% for all the formulates apart from that with Akeogard TN which shows a value of MIC < 0.2%.

Table 1. Biological implantation (+) on stone surface treated with different concentrations of the active biocide principle. Observations made after 30 days of incubation in test tubes sown with 1 ml of the Test Organisms.

Formulates	Concentration of the active biocide principle (%)			
	0.2	0.5	1	2
Algophase	+++	++	---	---
Algo + Hydro	+++	++	---	---
Algo + AkeoCO	+++	++	---	---
Algo + AkeoTN	---	---	---	---

Table 2. Biological coverage of stone surfaces treated with the formulates after various time intervals. Samples submerged by water and contaminated with the Test Organisms in laboratory simulation.

Formulates	Conc. (%)	Orient.	Biological coverage (%) after months of water contact in conditions									
			Statics					Dynamics				
			1	3	6	9	12	1	3	6	9	12
Algophase	1	horiz.	-	20	50	50	70	-	-	-	50	50
		vertic.	-	-	20	20	50	-	-	-	-	20
Algo + Hydro	1+7	horiz.	-	20	50	70	100	-	-	20	50	70
		vertic.	-	-	20	50	50	-	-	-	-	50
Algo + AkeoCO	1+2.5	horiz.	-	20	20	50	50	-	-	-	20	50
		vertic.	-	-	-	20	20	-	-	-	-	20
Algo + AkeoTN	1+5	horiz.	-	20	20	20	50	-	-	-	20	20
		vertic.	-	-	-	-	20	-	-	-	-	20
Ref. Acetone	pure	horiz.	-	20	50	70	100	-	-	20	50	70
		vertic.	-	-	20	50	50	-	-	-	-	20

The data on the colonization of the stone from the laboratory simulation (Table 2) show both a delay and a lighter biological growth when the water is flowing (dynamic condition) and the surface is vertical. When the water is not in movement the force of gravity induces a faster and higher algal implantation on all the treated samples, especially on those placed horizontally. The biocidal activity, under running water, is

more evident on the samples treated with the formulates containing only Algophase or mixed with a fluoroelastomer. A visible algal implantation is recorded on these samples after 9 months for the horizontal surfaces and after 1 year for the vertical ones.

In field conditions (Tab.3) all the reference and treated surfaces show the implantation of a heavy green biological patina after just 1 year of the treatment. This patina is lighter only on the areas treated with the AkeoTN both with and without the Algophase in 1 and 2% concentration.

Table 3. Tacca's fountain, lower basin. Evolution in time of the biological coverage (%) of the stone areas treated with 1 ml/cm² of formulates.

Formulates	Conc. (%)	Biological coverage (%) after months		
		3	6	12
Algophase	1	-	50	100
	2	-	20	100
Algo + Hydro	1 + 7	-	50	100
	2 + 7	-	50	100
Algo + AkeoCO	1 + 2.5	-	50	100
	2 + 2.5	-	50	100
Algo + AkeoTN	1 + 5	-	20	70
	2 + 5	-	20	70
Hydrophase	7	-	70	100
Akeogard CO	2.5	-	50	100
Akeogard TN	5	-	20	70
Reference acetone	pure	-	70	100

3.2 Water-repellent activity

The data on the water-repellency of the formulates before and after weathering are reported in Table 4 for the leaching test and in Table 5 for the mechanical impact test.

Table 4. Amount of water absorbed by capillarity (after 60'). Determined on stone samples before and after several months of water immersion.

Formulates	Conc. (%)	Applied (g/m ²)	Amount (mg/cm ²) of water absorbed after months			
			0	3	6	12
Algophase	1	2.2	4.10	6.87	7.18	6.81
Algo+Hydro	1 + 7	15.8	2.46	6.15	6.46	6.41
Algo + AkeoCO	1 + 2.5	9.8	2.05	6.47	6.46	6.15
Algo + AkeoTN	1 + 5	23.8	1.23	2.83	1.23	5.13
Ref. Acetone	pure	-	4.41	6.87	7.18	6.81

The long term immersion in water induces the formation of a thick pale yellow calcareous patina on all the samples. This is due to the high mineral content of the water used and to its continuous evaporation and refilling during the test. The Algo+Hydro and the Algo+AkeoCO formulatates show an evident loss of the water-repellence just after 3 months, while the Algo+AkeoTN retains a slight water-repellence even after 12 months (Table 4).

The mechanical impact exerted by the water falling from an altitude of 120 cm induces a light increase in the absorption of the water only in the reference samples and in those treated with the Algophase alone. The formulatates containing the water-repellent maintained the same activity throughout all the experiments (Table 5). In fact, up to now the length of the water mechanical impact test has not been sufficient to induce any change in the water-repellence of the treated surfaces.

Immediately after the treatment (time 0 in tables 4 and 5), the formulatates show a different level of waterrepellence, independent from the biocide action. The capillarity protection degree is 70 % for Akeogard TN and about 50% for the others.

Table 5. Amount of water absorbed by capillarity (in 60'), determined on stone samples before and after several hours of water mechanical impact.

Formulatates	Conc. (%)	Applied (g/m ²)	Amount (mg/cm ²) of water absorbed after hours					
			0	20	80	320	640	1180
Algophase	1	2.7	4.10	4.10	4.41	4.41	4.52	4.91
Algo + Hydro.	1 + 7	16.7	2.40	2.41	2.40	2.42	2.43	2.48
Algo + AkeoCO	1 + 2.5	13.0	2.40	2.40	2.41	2.43	2.45	2.49
Algo + AkeoTN	1 + 5	24.4	1.20	1.20	1.20	1.22	1.21	1.22
Ref. Hydrophase	7	20.2	2.40	2.40	2.42	2.45	2.48	2.50
Ref. Akeogard CO	2.5	9.0	2.40	2.40	2.40	2.40	2.43	2.48
Ref. Akeogard TN	5	30.5	1.20	1.20	1.21	1.22	1.21	1.23
Ref. Acetone	pure	-	4.10	4.41	4.41	4.80	4.84	4.98

3.3 Biocide evaluation

The weight of the Algophase and of the formulatates, before and after the weathering tests, is reported in Table 6. The Hydrophase formulatate provides very small extraction before weathering, and even smaller one after both 1180 hours and 360 days of water immersion. This behaviour is probably due to the increasing difficulty found in dissolving the silicone product. We must consider not only the time of the test (1180 hours) but also the real time elapsed between the initial treatment and the moment of the Soxhlet extraction (about one year).

Table 6. Weight of the formulates determined in the acetone extracts of the samples submitted to the weathering tests.

Formulates	Applied (g)	Amount (g) after hours of shower						After bleach 360 days
		0	20	80	320	640	1180	
Algo	0.011	0.011	0.010	0.009	0.004	0.003	0.003	0.000
Algo+AkeoCO	0.035	0.034	0.030	0.023	0.021	0.022	0.023	0.022
Algo+Hydro	0.080	0.021	0.015	0.007	0.006	0.006	0.006	0.002
Algo+AkeoTN	0.065	0.061	0.061	0.060	0.058	0.057	0.056	0.052
AkeoCO	0.025						0.023	0.020
Hydro	0.070						0.011	0.003
AkeoTN	0.052						0.049	0.048

In the case of the Algophase alone the continuous loss of product could be attributed to its solubility (low) in water. The small decrease of the amount of the fluoroelastomer formulates recovered could be attributed to the mechanical abrasion of the surface, since these products are totally insoluble in water.

The amount of the formulates extracted from the bleaching test samples after 360 days of water immersion is comparable to that determined from the water impact samples after 1180 hours.

The determination of the Algophase by FT-IR are not reported because the reproducibility of the results was not good enough.

The calibration curves determined by HPLC, in order to avoid the influence of the dilution of the mixture, were made considering both the peaks of the components of the mixture.

For the Algo+Hydro formulate the curve was drawn by plotting the percentage of Algophase in the formulate (w%) versus the ratio of the peak height of Algophase (detected by DA) with that of Hydrophase (detected by RI). The contemporary use of the two detectors has been necessary in order to detect both components of the mixture independently. The curve obtained fitted the following relation:

$$y = 19.04 \ln(x) - 12.561 \quad r^2 = 0.96$$

The calibration curves for the Algo+AkeoCO and Algo+AkeoTN formulates were drawn by plotting the value of the area % of Algophase (detected by RI) versus the percentage concentration of Algophase in the formulate (w%). The curves obtained fitted the following relations:

$$y = 113.33(0.085x)/(1+0.085x) \quad r^2 = 0.98 \quad \text{for Algo/AkeoCO}$$

$$y = 106.08(0.214x)/(1+0.214x) \quad r^2 = 0.98 \quad \text{for Algo/AkeoTN.}$$

The percentages and the amounts (mg) of the active biocide in the coformulate are reported in Table 7. The data on the amount of Algophase determined before and during the water impact test, shown a slight loss of the Algo+AkeoTN formulate and a progressive loss for AkeoCO. With the fluoroelastomers, the amount (Table 6) of the formulates recovered was almost the same, while the w% of the active principle determined was quite different. This behaviour may be due to the two solvents used for their application. In the case of water emulsion (AkeoTN) it is probably the different distribution of the fluoroelastomer on the surface that strongly reduce the contact between the active principle and the water.

The amount (mg) of the Algophase in the Algo+Hydro formulate shows an immediate and drastic decrease just after the first hours of mechanical weathering, even if the percentage of the biocide in the formulate is only slightly decreased. This result, considering that the amount of the extract is about 10% of that applied, seems to indicate that most of the active principle is blocked inside the cross-linked silicon polymer, becoming therefore not soluble and not available.

The amount of the active principle, in the samples treated with the Algophase alone, gradually decreases up to 3 mg (after 1180 hours of weathering), which corresponds to about 30% of the amount applied. This product could no more be recovered after 360 days of bleaching. This probably means that after one year of contact with water the Algophase, even if sparingly soluble, is anyway washed away from the stone.

Table 7 - Percentage and amount of Algophase determined by HPLC in the acetone extracts of the samples before and after water mechanical impact.

Formulate		Algophase applied	Amount of Algophase after shower (hours)					
			0	20	80	320	640	1180
Algo	mg	11	11	10	9	4	3	3
Algo+AkeoCO	%	29	28	16	8	9	4	2
	mg	10.2	9.5	4.8	1.8	1.9	0.9	0.5
Algo+ Hydro	%	13	6	2	9	6	3	8
	mg	10.4	1.3	0.3	0.6	0.4	0.2	0.5
Algo+AkeoTN	%	17	18	23	20	25	20	17
	mg	11.1	11.0	14.0	12.0	14.5	11.4	9.5

In the extracts of the samples, after 360 days of contact with water, it was impossible to detect any Algophase. The same result was obtained with the water residues.

4 Conclusions

A method for determining the presence of a specific product on the surface of the stone arises from this work. But the presence of the product on the treated surfaces is only part of the problem, the other being the persistence of its performances, as in our case, as biocidal or as water-repellent.

The microbiological data indicate, in the concentrations tested and with the formulates used, that the biocide efficiency was clearly reduced after a few months of antifouling action, allowing the growth of a new biological patina. This result must be correlated to the progressive decrease of the amount of the Algophase present on the samples. The best antifouling action (about one year) was recorded when the fluoroelastomer AkeoTN is present.

The mixing of a biocide with a hydrorepellent does not increase the durability of its efficacy. In fact, even though its permanence does increase, when mixed with AkeoTN or Hydro, this does not correspond to a better availability of the biocide action.

The water-repellent activity may be lost after about one year of water immersion. But this is not influenced when the water contact is not continuous.

To have a quantitative evaluation of the active principle it is necessary to extract the formulates from the samples, and the HPLC is a valid method to determine its amount for sensibility and repeatability.

From our experiments we have also obtained information about the solubility (reversibility) of the polymers used. The results obtained show that, with the time intervals tested, only the fluoroelastomer can be extracted completely, while the silicon derivatives becomes quite insoluble in a very short time. The high solubility shown by the fluoroelastomers was confirmed by the complete removal (for the AkeoTN) of the calcareous patina from the stone surface after the acetone extraction. This patina, on the other hand, remained unchanged, after acetone extraction, for the samples treated with the silicon polymer (Hydrophase).

Application of the fluoroelastomer AkeoTN on the monumental fountain does not prevent nor the biological implantation neither the calcareous patina formation, but, once its solvent is applied, the polymer re-dissolves, taking away the calcareous patina.

Acknowledgements

Many thanks Dr. L. Tomaselli (CNR, C.s. sui " Microorganismi Autotrofi", Florence, Italy) for the assistance in the microbiological laboratory tests.

5 References

- AA.VV., (1986): Doc. NORMAL 11/85 Assorbimento d'acqua per capillarità. Coefficiente di assorbimento capillare. ICR e CNR Eds. Roma, 1-7.
- Bernardini, C. (1993): Biocidi e prevenzione microbiologica, alcune osservazioni di cantiere. *Kermes* 16, 12-19.

- Pietrini, A.M. (1991): Un'indagine conoscitiva sulla microflora. In *"Fontana di Trevi la storia, il restauro"*. Ed. Carte Segrete, Roma, 187-173.
- Rasnowski, W., Matracka, W. and Uhacz K. (1988): The conservation of monumental stone fountains on the example of Neptun fountain in Gdansk. In *"Proceedings of VIth International Congress on Deterioration and Conservation of Stone"*. N. Copernicus University Press Dpt., Torun, 12-14.09.1988, 740-747.
- Ricci, S. and Pietrini, A.M (1994): Caratterizzazione della microflora algale presente sulla Fontana dei Quattro Fiumi, Roma. In *"III International Symposium on the Conservation of Monuments in the Mediterranean Basin"*. V. Fassina, H. Ott, F. Zezza Eds., Venice, 22nd-25th June, 1994, 353-357.
- Tabasso, L., Nugari, M.P. Pietrini, A.M, and Santamaria U. (1991): Sperimentazione per la scelta di un protettivo da applicare ai materiali costitutivi. In *"Fontana di Trevi. La storia, il restauro"*. Ed. Carte Segrete, Roma, 167-173.
- Tiano, P., Accolla, P. and Tomaselli L. (1993): The effectiveness of some biocides against algal biodeterioration. In *"Proceeding of the International UNESCO/RILEM Congress on Conservation of Stone and Other Materials"*. M.-J.Thiel Ed, Paris, June 29-July 1, 1993, 573-580.
- Tiano, P. Accolla, P. and Tomaselli, L. (1994): Biocidal treatments on algal biocoenosis. Control of the lasting Activity. *Science and Technology for Cultural Heritage*, 3. (in press).
- Zannini, A., Zambon, L. and Pagnin, P. (1989): Restoration of the "Vasca del Pincio". In Rome. In *"Proceeding of the Symposium on Science, Technology and European Cultural Heritage"*. Bologna, 13rd-16th June, 1989, 745-746.

BIOLOGICAL MATERIAL TESTING

M. WILIMZIG AND E. BOCK

Microbiology, Univ. Hamburg, Germany.

Abstract

Bacteria, fungi and algae are known to be involved in the deterioration of building materials which should be classified as microbial influenced corrosion (MIC). Their growth in stones and mortar is influenced by the presence of available water, nutrient supplement and the composition of the mineral material. The use of fastening and hardening chemicals or plaster and mortar could change these growth conditions.

Simulation experiments have shown that the supplementation of mortar with low concentrations of copper and zinc were able to decrease cell growth of bacteria and fungi. This effect was measured within three months of simulation time.

Simulation experiments are not restricted to mortar or stone analysis. Also chemical treatments of stones and the influence of mortar on stones and stone combinations can be analyzed. The use of simulation technique has the advantage to shorten the experimental time.

Keywords: Microorganisms, MIC, Biodeterioration, Simulation experiments, Chemical treatment, Increase and decrease of cell numbers of microorganisms.

1 Introduction

Like soil and aquatic environments, stones are natural habitants for microorganisms. They grow on and in the surface of masonry and influence the physical and chemical weathering. The reasons for microbially influenced corrosion (MIC) are the production of organic and inorganic acids and extrapolymeric substances.

Lithoautotrophic bacteria like nitrifiers oxidize ammonia to the inorganic acids nitrous and nitric acid. These are able to solubilize binding material like calcium carbonate and enhance the salt content of the stone (E. Bock and W. Sand, 1993).

Exo and endolithic microorganisms grow in microcolonies out of up to several thousands cells embedded in a slime

layer. This layer consisting of polysaccharides and/or protein protects the organisms against freezing, dryness and toxic agents. Furthermore, it is able to plug the pores of stones. Therefore, the water exchange between interior and exterior is hampered. At the stone surface, the biofilm could function as a trap for soot and dust particles. This shows that the film is involved in the development of black crusts.

R. Mansch and E. Bock (1994) showed for the first time that the cell growth of nitrous acid producing bacteria enhances the gypsum-formation in test stones when SO_2 was present in the atmosphere. Within the nitrifying biofilm the production of NO_2 , formed by chemodenitrification of nitrite, catalyzed the chemical oxidation of SO_2 to sulfate. Gypsum crystals were visible in colonized test blocks but not in uncolonized control blocks.

Growth of microorganisms in stones is influenced by different parameters like water, nutrient supplement and the composition of the mineral material. The treatment of a stone with hardening or hydrophobing agents or the inbrought of mortar or plaster changes the growth conditions for the stone habitating microorganisms.

For example bacteria prefer to grow on and in stones at pH-values between 6 and 8, while fungi grow better at pH-values between 5 and 6 (Bock and Sand, 1993). Quarzitic sandstones with low pH-values are normally colonized with low numbers of bacteria. Only at the stone areas nearby the mortar joints high bacterial cell numbers were found (M. Wilimzig and E. Bock, 1994). Due to the pH-buffering between the quarzitic sandstone and the alkaline mortar the organisms will find a zone for optimal growth. Since it is not possible to state how a chemical treatment influences the microbial stone flora, simulation experiments may be helpful.

Colonization of stones is a slow process. On outdoor test blocks stone an autochthonic flora of deteriorating nitrifiers has only been found after five years of exposition to normal climate (Mansch, 1994). In contrast to this, in indoor simulation experiments they were present in stones after a two months incubation time.

2 Methods

In order to accelerate the growth rates of microorganisms a humid chamber (Weiss-Technik, Germany) with a constant temperature of 28°C and a relative humidity of 95% (Bock et al., 1989) was used.

The test (3x3x3 cm) blocks were prepared as follows. Watered calcium carbonate (Sumpfkalk) was mixed with quarzitic sand in a ratio 1:3. The latter was supplemented with calculated amounts of $\text{CaSO}_4 \cdot 5 \text{H}_2\text{O}$ and $\text{ZnSO}_4 \cdot 7 \text{H}_2\text{O}$ to give the final concentrations that are shown in fig. 2.

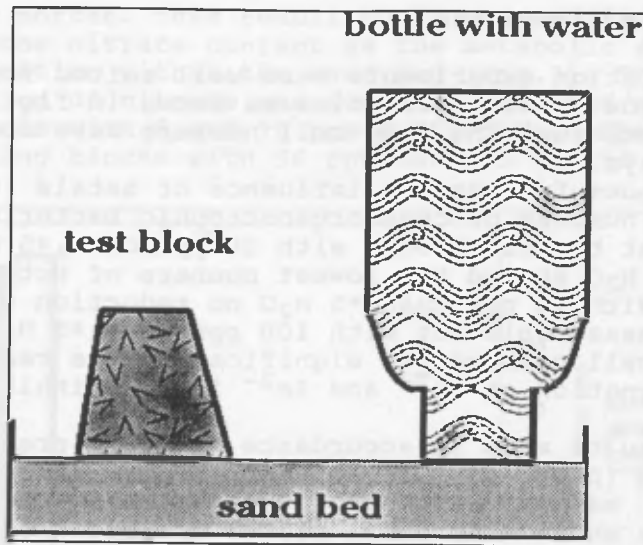

Fig.1: Experimental setup, the test blocks were incubated on an humidified sand bed which was watered by an upright bottle filled with distilled water

After seven days of setting and hardening the test blocks were incubated for about four weeks in an atmosphere containing 30% CO₂/70% N₂ for carbonizing. At a pH-value below 8 they were placed on a humidified quartzite sand bed, which was watered by an upright bottle filled with distilled water (fig. 1). At the start the test blocks were inoculated with pure cultures of nitrifying bacteria originating from natural building stones. Every second week the test blocks were supplemented with 100 µl ammonia (100 mg/l).

Each experiment was done in three replications. After 32, 85 and 296 days the cell numbers of nitrifiers, chemoorganotrophic bacteria and fungi were counted and the nitrate content in the test blocks and in the sand bed was determined.

The cell numbers of ammonia- and nitrite-oxidizers were determined by the MPN-technique (most probable number technique). It is well known that by the means of this method the cell numbers are underestimated (Wolters et al., 1988).

Chemoorganotrophic bacteria and fungi were quantified by means of the Koch'sche plate technique.

Nitrate was measured by the HPLC-technique with UV-light detection (Kontron, Germany).

Cell numbers are given as geometric means. Nitrate concentrations are arithmetic means.

3 Results and discussion

The simulation experiments were well suited for shortening the experimental time as shown in fig. 2. After 85 days of exposure the same cell numbers were counted as after 296 days.

Fig. 2 shows further the influence of metals (Cu and Zn) on the cell numbers of chemoorganotrophic bacteria and fungi in test blocks. Blocks with 50 ppm $\text{CuSO}_4 \cdot 5 \text{H}_2\text{O}$ and 50 ppm $\text{ZnSO}_4 \cdot 7 \text{H}_2\text{O}$ showed the lowest numbers of both types of organisms. With 10 ppm $\text{CuSO}_4 \cdot 5 \text{H}_2\text{O}$ no reduction of cell number was measurable but with 100 ppm $\text{CuSO}_4 \cdot 5 \text{H}_2\text{O}$ the reduction of cell numbers was significant. This result shows that a combination of Cu^{2-} and Zn^{2-} is more inhibitory than Cu^{2-} alone.

These results were in accordance to those presented by T. Warscheid (pers. comm.). He described an integral inventory of masonry which showed the disappearance of black crusts where ever metal plates made of brass were leached. Black crusts indicate building surfaces where microorganisms grow in high cell numbers (M. Wilimzig et al., 1993).

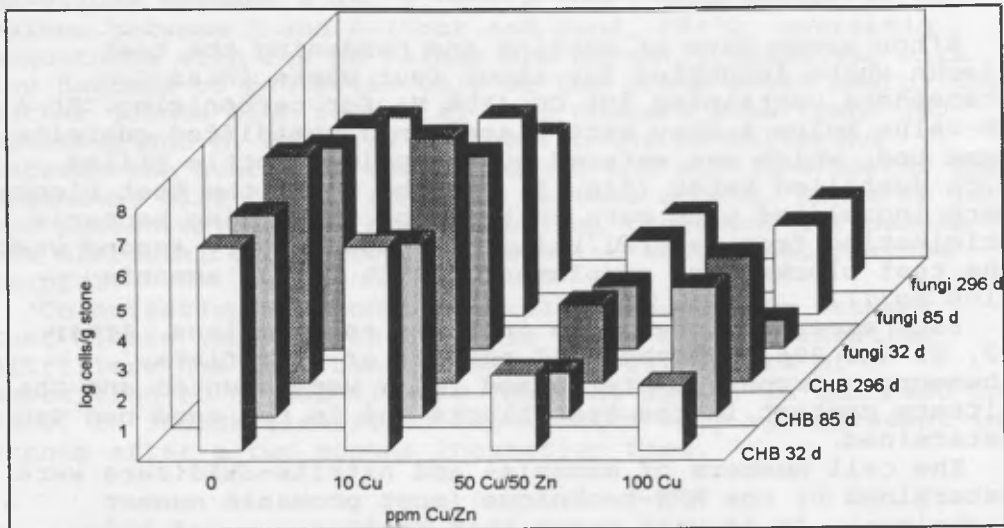

Fig.2: Cell numbers of chemoorganotrophic bacteria and fungi in the test blocks with different Cu- and Zn-concentrations after different incubation times

After a time of 296 days not only chemoorganotrophic bacteria and fungi but also ammonia- and nitrite-oxidizers were counted as shown in fig. 3. The cell numbers of both nitrifying organisms decreased after the addition of 50 ppm $\text{CuSO}_4 \cdot 5 \text{H}_2\text{O}$ /50 ppm $\text{ZnSO}_4 \cdot 7 \text{H}_2\text{O}$ respectively 100 ppm $\text{CuSO}_4 \cdot 5 \text{H}_2\text{O}$

H₂O to the mortar. This result could be verified by measuring the nitrate content as the metabolic endproduct of nitrification within the sand bed (fig.3). The highest concentration of nitrate was found in the sand under the mortar blocks with 0 and 10 ppm CuSO₄*5 H₂O. When supplementing blocks with 50 ppm CuSO₄*5 H₂O/50 ppm ZnSO₄*7

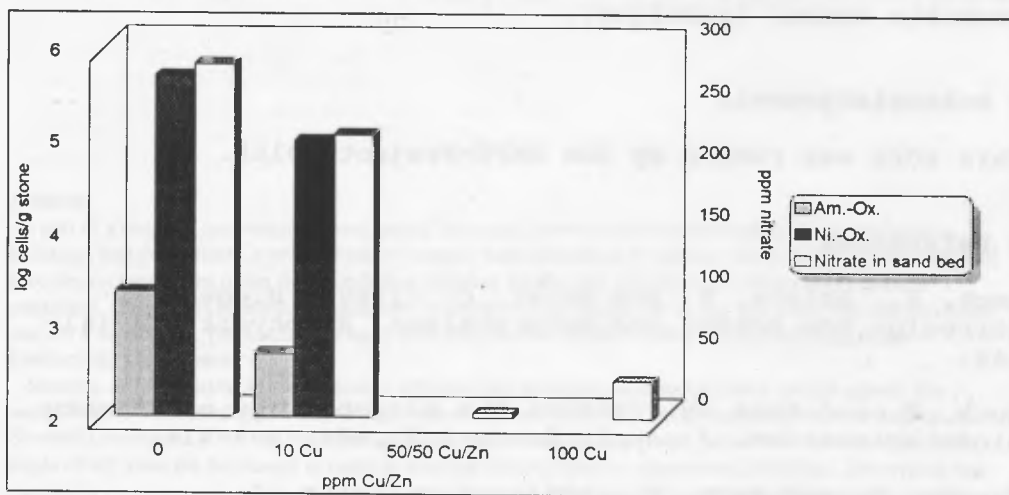

Fig.3: Cell numbers of ammonia- and nitrite-oxidizers and the nitrate concentrations in the sandbed after 296 days of incubation in the test blocks with different Cu- and Zn-concentrations

H₂O and 100 ppm CuSO₄*5 H₂O low amounts of nitrate were found. So there was a direct correlation between the cell numbers of nitrifiers and the nitrate content measured in the sand bed. High cell numbers (blocks with 0 and 10 ppm CuSO₄*5 H₂O) correlated with high nitrate concentrations in the sand, vice versa low cell numbers in the test blocks (50 ppm CuSO₄*5 H₂O/ZnSO₄*7 H₂O and 100 ppm CuSO₄*5 H₂O) correlated with low nitrate values.

From these data, it is apparent that simulation experiments could accelerate the experimental time. Outdoor experiments in the urban area of Duisburg (Germany) showed that stone deteriorating nitric acid producing organisms needed more than five years to develop an autochthonic microflora (Mansch, 1994) on the test specimens. Shorter exposure times led to results that were not reproducible. So the best and shortest way to get information how microorganisms may be influenced by heavy metals or other chemicals within the stones are to do simulation experiments under optimal growth conditions for the microorganisms.

4 Abbreviations

Cu = $\text{CuSO}_4 \cdot 5 \text{H}_2\text{O}$, Zn = $\text{ZnSO}_4 \cdot 7 \text{H}_2\text{O}$, Am.-Ox. = Ammonia-Oxidizers, Ni.-Ox. = Nitrite-Oxidizers, CHB = Chemoorganotrophic bacteria, ppm = parts per million, MIC = microbial influenced corrosion, HPLC = high pressure (performance) liquid chromatography, MPN-technique (most probable number technique).

5 Acknowledgements

This work was funded by the BMFT-Project 5016E.

6 References

- Bock, E., Ahlers, B. and Meyer, C. (1989): Biogene Korrosion von Beton- und Natursteinen. *Bauphysik*, 4, 141-144.
- Bock, E. and Sand, W. (1993): The microbiology of masonry biodeterioration. *J. Appl. Bacteriol.*, 74, 503-514.
- Mansch, R. and Bock, E. (1994): Simulation of microbiologically and chemically influenced corrosion of natural sandstone. In *Microbiologically Influenced Corrosion Testing, ASTM STP 1232*, Jerrey R. Kearns and Brenda J. Little, Eds., American Society for Testing Materials, 203-216.
- Mansch, R. (1994): Wechselwirkungen zwischen Nitrifikanten und Schadgasen bei der Verwitterung von Naturstein. PhD-thesis at the University of Hamburg.
- Wilimzig, M. and Bock, E. (1994): Befall von Mörtel mit Bakterien und Pilzen. *Werkstoffe und Korrosion*, 45, 117-118.
- Wilimzig, M., Fahrig, N., Meyer, C. and Bock, E. (1993): Biogene schwarze Krusten auf Gesteinen. *Bautenschutz und Bausanierung*, 16, 22-25.
- Wolters, B., Sand, W., Ahlers, B., Sameluck, F., Meincke, M., Krause-Kupsch, T., Bock, E. (1988): Nitrification - the main source for nitrate deposition in building stones. In: *Proceedings of the sixth international congress on the deterioration and conservation of stone*, Nicholas Copernicus University, Torun, Poland, 24-31

ASSESSMENT IN A FIELD SETTING OF THE EFFICACY OF VARIOUS BIOCIDES ON SANDSTONE

M.E. YOUNG, R. WAKEFIELD, D.C.M. URQUHART, K. NICHOLSON and K. TONGE
Masonry Conservation Research Group, The Robert Gordon University, Aberdeen, Scotland, UK.

Abstract

As part of a research commission investigating biological growths and biocide treatments on sandstone buildings and monuments, a programme of research was undertaken to evaluate the performance of a range of biocides on sandstones under field conditions of urban weathering. The biocides chosen for evaluation contained: (1) alkylaryl trimethyl ammonium chloride, (2) dodecylamine lactate and dodecylamine salicylate and (3) a copper salt. The sandstones used were Blaxter, Cat Castle, Clashach, Corsehill, Leoch and Locharbriggs sandstones.

Samples of fresh sandstone were treated with biocides according to manufacturers' specifications. The samples were inoculated with a mixed algal culture isolated from field samples taken from a wide range of Scottish sandstones. A test rig was constructed on which samples were held, isolated from each other, at an angle of 60° from the horizontal in order to simulate sloping masonry surfaces on buildings. The test-rig was located in Aberdeen and was exposed to urban weathering. Monitoring of algal growth was done using a Minolta CR-210 chroma meter. The amount of algal growth was monitored by measuring changes in coloration.

Algal growth was first measured on control samples after 42 weeks exposure. Slight growth of algae on some biocide treated samples occurred after about 52 weeks. Algal growth continued to be monitored up to 100 weeks exposure. The amount of algal growth on control samples was found to be correlated with the sandstone porosity. On biocide treated samples growth was inhibited for some time depending both on the biocide type and on the clay mineralogy of the sandstone.

Keywords: Biocide, sandstone, porosity, clay, algae, colour.

1 Introduction and methodology

The aim of the experiments described below was to determine the effective life spans of some typical biocides when applied to sandstones under field conditions and to investigate whether sandstone type had any influence on the rate of algal growth and/or the effective life span of the biocides investigated.

The rate of green algal growth on six different sandstone types, both fresh (control) and biocide treated, was monitored using a chroma meter. All six sandstones have been used in buildings in Scotland (Table 1). The biocides used in the experiments (Table 2) were applied according to manufacturers specifications.

The test rig on which the samples were held was located in Aberdeen and samples were exposed to urban weathering. Six different fresh sandstone types (Blaxter, Cat Castle, Clashach, Corsehill, Leoch and Locharbriggs) were treated with three different biocides. A north and south facing test rig was designed in which samples (50 x 50 x 15 mm) were held at an angle of 60° from the horizontal in order to simulate sloping masonry surfaces on buildings. Each sample was held in an aluminium bracket (Figure 1).

Table 1. Characteristics of sandstones used in experiments.

Stone	Sandstone type	Porosity (%)	Average grain size	Calcareous	Colour
Blaxter	quartz arenite	19.6	medium	No	buff
Cat Castle	sub arkose	11.5	coarse	No	buff
Clashach	sub arkose	14.0	fine-medium	Yes	buff
Corsehill	sub arkose	18.6	fine	Yes	red
Leoch	litharenite	1.5 [†]	medium	Yes	grey
Locharbriggs	quartz arenite	24.9	medium-coarse	No	red

Porosity data from Leary (1984) except,

[†]: Porosity data from analysis by the Macaulay Land Use Research Institute, Aberdeen.

Table 2. Biocides used in experiments.

Biocide number	Biocidal chemical	Type	Recommended dilution
1	alkylaryl trimethyl ammonium chloride	quaternary ammonium	1 + 4 (parts water)
2	dodecylamine lactate and dodecylamine salicylate	amine	1 + 19 (parts water)
3	copper compound	toxic metal	none

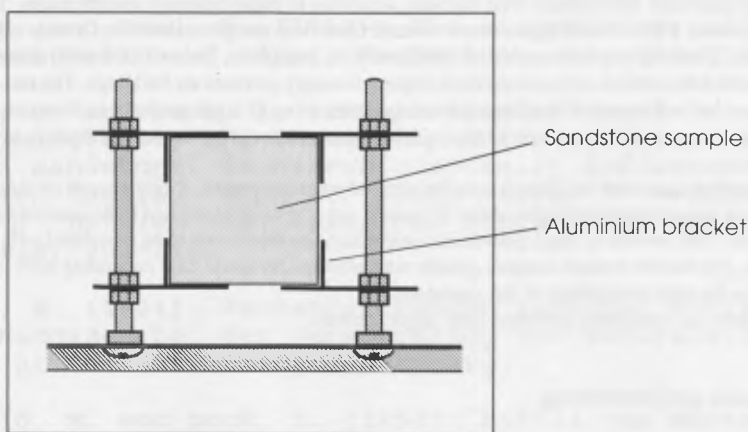

Fig. 1. Aluminium bracket used for mounting sandstone specimens (50x50x15mm) in test-rig.

This isolated individual sandstones, avoided introduction of any extraneous material (e.g. run-off from mortar) and prevented run-off from one stone coming into contact with another. The samples were inoculated with a mixed algal culture (*Chlamydomonas* sp., *Chlorococcum* sp., *Botrydiopsis* sp., *Tetraspora* sp. and *Hormidium* sp.) isolated from field samples taken from a wide range of Scottish sandstones.

The extent of algal growth on samples was monitored by the use of a chroma meter (Minolta CR-210). This is a hand held device for measuring reflected-light colour. The colour scale used here is $L^*a^*b^*$. L^* measures the light level on a scale of 0 (black) to 100 (white). a^* and b^* are chromaticity coordinates; the a^* data run on a scale of -60 (green) to +60 (red). The b^* data run on a scale of -60 (blue) to +60 (yellow). Growth of green algae is reflected in an increase in measured green coloration, the more intense the green colour, the greater the degree of algal growth. Samples must be dry when colour measurements are taken as degree of wetness affects their colour.

2 Results

Samples in the test rig were treated with 3 different biocides (1, 2 and 3). Another set of samples were left untreated as controls. The colour changes, with respect to a* colour (red-green), on both fresh (control) samples and biocide treated samples over a two year period are shown in Figure 2. All data were from north-facing samples. Similar results were obtained on south-facing samples although the amount of algal growth was less. Initially there were obvious colour changes on some of the samples treated with Biocide 3, in this case a shift towards increased blue and green hues. This biocide includes a blue coloured, copper containing solution and this initially caused the colour of treated prisms to be noticeably bluer and greener than untreated prisms or those treated with other biocides. The effect was most visually noticeable on lighter coloured sandstones, but over about 29 weeks the colour gradually faded until no colour differences were visible or detectable by chroma meter although the biocide did not cease to be effective. Colour readings quoted below as indicating the amount of algal growth were taken following 29 weeks so as to exclude any colour changes attributable to the biocide itself.

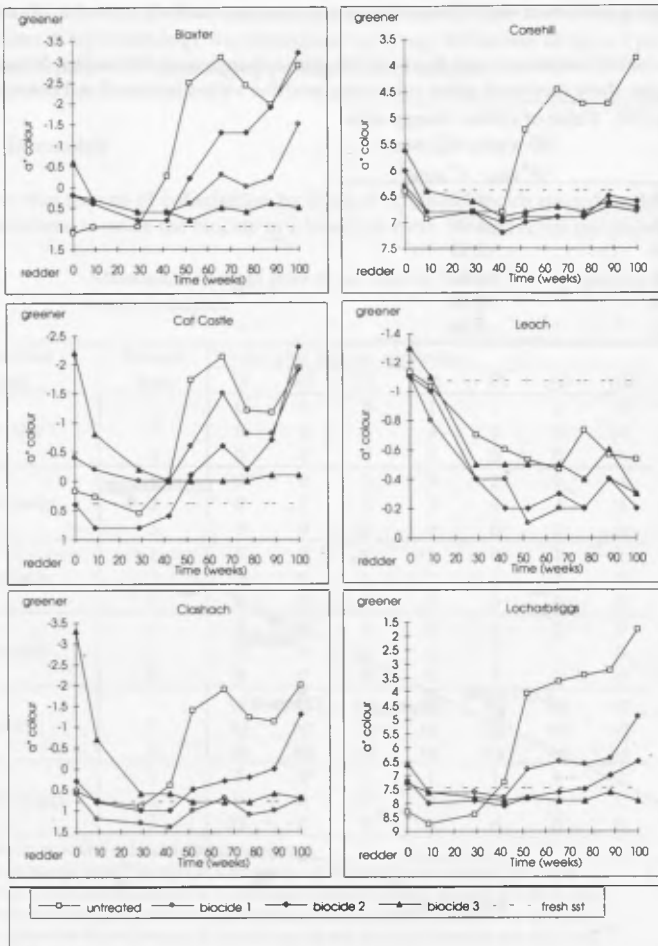

Fig 2. Colour analysis data (a* colour, red-green) for test rig sandstone samples.

Algal growth did not begin to be established on any samples until about 42 weeks of exposure. The amount of algal growth varied throughout the year being greater during autumn and winter, when there was more rainfall and higher humidity. The time taken for algal growths to become established and the amount of algal growth varied between sandstone types. On Leoch sandstone no algal growths occurred on any sample during the course of the experiment. The first occurrence of algal growths on biocide treated samples occurred after 52 weeks when growth of algae was observed on Biocide 1 treated Cat Castle and Locharbriggs sandstones and on Biocide 2 treated Blaxter and Cat Castle sandstone. On Blaxter and Cat Castle sandstones both Biocides 1 and 2 had become virtually ineffective by 100 weeks but Biocide 3 continued to be effective. On Locharbriggs and Clashach sandstones algal growth was largely prevented by biocide treatments up to 100 weeks. On Corsehill sandstone all three biocide treatments continued to prevent algal growth for up to 100 weeks. Biocide 3 prevented algal growth on all samples up to 100 weeks of exposure.

On untreated (control) sandstones, after 100 weeks exposure there was more green algal growth on sandstones with higher porosities (Table 3 and Figure 3). On the sandstone with the lowest porosity (Leoch, 1.5%) there was no growth over the course of the experiment. A good correlation (Fig. 3) was found between sandstone porosity and the amount of algal growth (as measured by colour change). On biocide treated sandstones the amounts of algal growth over the 100 week exposure were not similarly related to porosity.

Table 3. Porosity of control sandstones and degree of a^* colour change over 100 weeks. Negative colour changes show increased green coloration, positive values increased red coloration.

Sandstone type	Porosity (%)	Value of colour change after 100 weeks exposure ($a^*_{final} - a^*_{initial}$)
Locharbriggs	24.9	-6.53
Blaxter	19.6	-4.00
Corsehill	18.6	-2.53
Clashach	14.0	-2.53
Cat Castle	11.5	-2.10
Leoch	1.5	+0.60

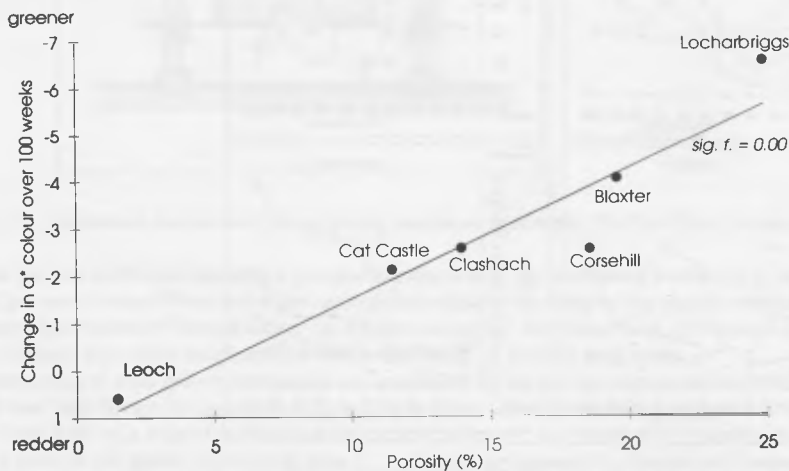

Fig 3. Relationship between porosity and colour change (algal growth) over 100 weeks exposure for sandstone control samples.

Since the amount of algal growth on untreated (control) samples varied between sandstone types, it was not possible to make a comparison of the effectiveness of biocide treatments simply by measuring the absolute amount of algal growth. The amount of algal growth on biocide treated samples must be measured relative to the amount on the relevant untreated sandstone. Table 4 therefore shows the amount of algal growth (as measured by colour changes) on the biocide treated samples, measured as a percentage of the amount on the untreated control samples and identified within percentage bands. The starting point for the data is taken as 29 weeks after biocide treatment when no growth had yet occurred on any treated or untreated samples but colour changes due to biocide application were no longer measurable.

The data on Table 4 show that Biocide 3 remained active in preventing algal growth throughout the 100 week exposure. The other two biocides varied in their effectiveness on different sandstone types. On Cat Castle sandstone the amount of growth on Biocides 1 and 2 treated samples after 100 weeks was similar to that on control samples. By contrast, on Corsehill sandstone there was little or no algal growth up to 100 weeks after biocide treatment. These data indicate that the differences in the effective lifespans of individual biocides on sandstones were not simply caused by differences in the rate of growth of algae due to differences in porosity. It would seem likely that the effective lifespan of a biocide is affected by the mineralogy of the sandstone. Tables 5 and 6 show mineralogical data from the sandstones. The mineralogy was determined from thin sections. Clay mineralogy was determined by X-ray diffraction of the < 2 µm component of the sandstones, separated by centrifuging powdered stone samples.

3 Discussion

It is likely that the rate of colonisation by algae of different biocide treated sandstones is related to the ability of the sandstone to retain the biocide in a bioactive form. In sandstones the main minerals present are quartz,

Table 4. Abundance of algal growth on biocide treated test rig samples compared to that on untreated control samples.

Sandstone type	Biocide type	Weeks after biocide application						
		29	42	52	66	77	88	100
Blaxter	1	0	0	0	1	1	2	3
	2	0	0	2	3	3	4	4
	3	0	0	0	0	0	0	0
Cat Castle	1	0	0	2	3	2	2	4
	2	0	2	2	3	3	4	4
	3	0	0	0	0	0	0	0
Clashach	1	0	0	1	1	0	1	1
	2	0	0	1	2	2	2	4
	3	0	0	0	0	0	0	0
Corsehill	1	0	0	0	0	0	0	0
	2	0	0	0	0	0	1	0
	3	0	0	0	0	0	0	0
Leoch	1	ng	ng	ng	ng	ng	ng	ng
	2	ng	ng	ng	ng	ng	ng	ng
	3	ng	ng	ng	ng	ng	ng	ng
Locharbriggs	1	0	0	1	1	1	1	2
	2	0	0	0	0	0	1	1
	3	0	0	0	0	0	0	0

ng : no growth on control or biocide treated samples

0 : growth on biocide treated samples as a percentage of that on control samples was < 10%

1 : growth on biocide treated samples as a percentage of that on control samples was 10 < 25%

2 : growth on biocide treated samples as a percentage of that on control samples was 25 < 50%

3 : growth on biocide treated samples as a percentage of that on control samples was 50 < 75%

4 : growth on biocide treated samples as a percentage of that on control samples was > 75%

Table 5. Mineralogical data for sandstones in thin section (amounts shown in wt%).

Mineral	Blaxter	Cat Castle	Clashach	Corsehill	Leoch	Locharbriggs
quartz	89	87	75	66	28	93
plagioclase	1	2	5	2	5	1
K-feldspar	2	5	5	10	15	3
muscovite	1	tr	tr	tr	5	tr
biotite	0	0	0	0	3	0
calcite	0	0	10	2	5	0
dolomite	0	0	0	10	0	0
kaolinite	5	5	0	0	0	0
other clays	tr	0	5	10	0	2
opaques	2	1	tr	tr	3	1
rock fragments	0	0	0	0	36	0

tr: trace

Table 6. Clay mineralogy of sandstones used in these experiments.

Sandstone	Clay type	Amount
Blaxter	kaolinite	M
	interstratified vermiculite-chlorite	m
	illite	m
Cat Castle	kaolinite	M
	illite	m
	interstratified illite-smectite	tr
Clashach	interstratified illite-smectite	M
Corsehill	smectite	M
	illite	M
	kaolinite	m
Leoch	interstratified chlorite-swelling chlorite	M
	kaolinite	M
	illite	M
Locharbriggs	illite	M
	interstratified illite-smectite	tr

M: major

m: minor

tr: trace (>1%)

feldspars, micas and clays. Grant and Bravery (1981) showed that biocide efficacies differed depending on stone type (limestone or sandstone). They found that higher than recommended concentrations of biocides need to be applied to sandstones compared with limestones to achieve the same inhibitory effects and they suggested that differences in mineralogy may have accounted for the observed differences. It is known that quaternary ammonium compounds are strongly adsorbed onto some siliceous surfaces including glass, clays and silicate minerals and they remain bioactive while bound to the substrate (Fitzgerald, 1971; Isquith *et al.*, 1972; Mackrell and Walker, 1978; Richardson, 1973; Walters *et al.*, 1973).

Differences in biocide efficacy on the sandstones used here also appear to be due to differences in mineralogy. There was no connection between the amount of algal growth and the quartz, feldspar or mica content but there did appear to be a relationship between algal growth and clay type. Clay minerals vary widely in their ability to adsorb chemicals and a variety of clays occur in these sandstones (Table 6). On both Blaxter and Cat Castle sandstones the biocides performed relatively poorly whereas on Locharbriggs and Clashach sandstones and especially on Corsehill sandstone the biocides remained effective in preventing algal growth for much longer. Both Blaxter and Cat Castle sandstones contained clay minerals which were dominantly kaolinite. Kaolinite is a clay with a very low ability to adsorb chemicals. In Locharbriggs sandstone the clays were dominantly illite and in Clashach sandstone, illite-smectite. Corsehill sandstone contained smectite and illite. Illites and especially smectites are clay minerals which are able to adsorb relatively large amounts of applied chemicals and they may hold biocides, in a bio-active form, for longer than other sandstones with less adsorbent clay minerals.

4 Conclusions

It has been shown that algal growths can be cultivated in the external environment in a test-rig using relatively small sandstone samples. Differences in amount of algal growth can be assessed by measuring colour change on the samples. In these experiments, on untreated sandstones the amount of algal growth was correlated with sandstone porosity. On biocide treated sandstones algal growth was not only inhibited for a period (which varied according to which biocide was used) but was shown to be inhibited for different periods on different sandstone types. Differences in the effective lifespan of biocides appeared to be related to the clay mineralogy of the sandstone. Sandstones containing significant amounts of relatively highly adsorbent clay minerals such as smectites retained biocides in an active form for longer than those containing less adsorbent clay minerals such as illite. On sandstones in which the dominant clay mineral was kaolinite the effective lifespan of biocides was shortest.

5 Acknowledgements

This work was undertaken as part of a research project examining algal growth on building sandstones and the effectiveness of biocide treatments. The research programme was funded by Historic Scotland. Analysis of clay mineralogy was done at the Macaulay Land Use Research Institute, Aberdeen.

6 References

- Fitzgerald, G.P. (1971): Algicides. In "Water Resources Centre Eutrophication Information program"; Literature Review. No. 2, University of Wisconsin.
- Grant, C. and Bravery, A.F. (1981): Laboratory evaluation of algicidal biocides for use on constructional materials. 2. Use of the vermiculite bed technique to evaluate a quaternary ammonium biocide. *International Biodeterioration Bulletin*. 17, 125-131.
- Isquith, A.J., Abbott, E.A. and Walters, P.A. (1972): Surface-bonded antimicrobial activity of an organosilicon quaternary ammonium chloride. *Applied Microbiology*. 24, 859-863.
- Leary, E. (1984): *The Building Sandstones of the British Isles*, Building Research Establishment.
- Mackrell, J.A. and Walker, J.R.L. (1978): The biodegradation of quaternary ammonium compounds. *International Biodeterioration Bulletin*. 14, 77-83.
- Nugari, M.P., D'Urbano, M.S. and Salvadori, O. (1993): Test methods for comparative evaluation of biocide treatments. In "Proceedings of the International RILEM/UNESCO Congress on Conservation of Stone and Other Materials", Vol. 2, Thiel, M.-J. (ed.), Paris, June 29-July 1 1993, SPON, London, pp565-572.
- Richardson, B.A. (1973): Control of biological growths. *Stone Industries*. 8, 2-6.
- Walters, P.A., Abbott, E.A. and Isquith, A.J. (1973): Algicidal activity of a surface-bonded organosilicon quaternary ammonium chloride. *Applied Microbiology*. 25, 253-256.

Clay mineral	Relative adsorption capacity	Relative adsorption capacity	Relative adsorption capacity	Relative adsorption capacity
Illite	0.1	0.1	0.1	0.1
Smectite	0.1	0.1	0.1	0.1
Chlorite	0.1	0.1	0.1	0.1
Vermicular	0.1	0.1	0.1	0.1
Amphibole	0.1	0.1	0.1	0.1
Other	0.1	0.1	0.1	0.1

Table 5. Mineralogical data for sandstones used in this study.

It has been shown that algal growth can be estimated in the laboratory using a range of small sandstone samples. Differences in amount of algal growth can be assessed by measuring colour change on the samples. In these experiments on uncoated sandstones the amount of algal growth was correlated with sandstone porosity. On bicide treated sandstones algal growth was not only inhibited for a period (which varied according to which bicide was used) but was shown to be inhibited for different periods on different sandstone types. Differences in the effective thickness of bicide film appeared to be related to the clay mineralogy of the sandstone. Sandstones containing significant amounts of relatively highly adsorbent clay minerals such as smectites retained bicides in an active form for longer than those containing less adsorbent clay minerals such as illite. On sandstones in which the dominant clay mineral was kaolinite the effective thickness of bicide was shorter.

2. Acknowledgements

This work was undertaken as part of a research project examining algal growth on building sandstones and the effectiveness of bicide treatments. The research programme was funded by Historic Scotland. Analysis of clay mineralogy was done at the Macaulay Land Use Research Institute, Aberdeen.

References

Blaxter, G.P. (1971) Algal growth on building sandstones. *Journal of Applied Microbiology*, **12**, 1-10.

Cat Castle, G.P. (1971) Algal growth on building sandstones. *Journal of Applied Microbiology*, **12**, 1-10.

Grant, C. and Blaxter, G.P. (1981) Laboratory evaluation of algal bicides for use on sandstones. *Journal of Applied Microbiology*, **51**, 1-10.

Jacobs, A.J., Abbott, E.A. and Walker, T.A. (1975) Surface-bound microbial activity of an epifaunal gastropod gastropod *ammonium chloride*. *Applied Microbiology*, **29**, 1-10.

Macaulay Land Use Research Institute (1984) The Building Sandstones of the British Isles. Building Research Establishment, York.

MacNeil, I.A. and Walker, T.A. (1978) The biodegradation of organic ammonium compounds on sandstone surfaces. *Journal of Applied Microbiology*, **44**, 1-10.

Richardson, B.A. (1978) The biodegradation of organic ammonium compounds on sandstone surfaces. *Journal of Applied Microbiology*, **44**, 1-10.

Richardson, B.A. (1979) The biodegradation of organic ammonium compounds on sandstone surfaces. *Journal of Applied Microbiology*, **45**, 1-10.

Richardson, B.A. (1980) The biodegradation of organic ammonium compounds on sandstone surfaces. *Journal of Applied Microbiology*, **46**, 1-10.

Richardson, B.A. (1981) The biodegradation of organic ammonium compounds on sandstone surfaces. *Journal of Applied Microbiology*, **47**, 1-10.

Richardson, B.A. (1982) The biodegradation of organic ammonium compounds on sandstone surfaces. *Journal of Applied Microbiology*, **48**, 1-10.

Richardson, B.A. (1983) The biodegradation of organic ammonium compounds on sandstone surfaces. *Journal of Applied Microbiology*, **49**, 1-10.

Richardson, B.A. (1984) The biodegradation of organic ammonium compounds on sandstone surfaces. *Journal of Applied Microbiology*, **50**, 1-10.

Richardson, B.A. (1985) The biodegradation of organic ammonium compounds on sandstone surfaces. *Journal of Applied Microbiology*, **51**, 1-10.

Richardson, B.A. (1986) The biodegradation of organic ammonium compounds on sandstone surfaces. *Journal of Applied Microbiology*, **52**, 1-10.

Richardson, B.A. (1987) The biodegradation of organic ammonium compounds on sandstone surfaces. *Journal of Applied Microbiology*, **53**, 1-10.

Richardson, B.A. (1988) The biodegradation of organic ammonium compounds on sandstone surfaces. *Journal of Applied Microbiology*, **54**, 1-10.

Richardson, B.A. (1989) The biodegradation of organic ammonium compounds on sandstone surfaces. *Journal of Applied Microbiology*, **55**, 1-10.

Richardson, B.A. (1990) The biodegradation of organic ammonium compounds on sandstone surfaces. *Journal of Applied Microbiology*, **56**, 1-10.

Richardson, B.A. (1991) The biodegradation of organic ammonium compounds on sandstone surfaces. *Journal of Applied Microbiology*, **57**, 1-10.

Richardson, B.A. (1992) The biodegradation of organic ammonium compounds on sandstone surfaces. *Journal of Applied Microbiology*, **58**, 1-10.

Richardson, B.A. (1993) The biodegradation of organic ammonium compounds on sandstone surfaces. *Journal of Applied Microbiology*, **59**, 1-10.

Richardson, B.A. (1994) The biodegradation of organic ammonium compounds on sandstone surfaces. *Journal of Applied Microbiology*, **60**, 1-10.

Richardson, B.A. (1995) The biodegradation of organic ammonium compounds on sandstone surfaces. *Journal of Applied Microbiology*, **61**, 1-10.

Richardson, B.A. (1996) The biodegradation of organic ammonium compounds on sandstone surfaces. *Journal of Applied Microbiology*, **62**, 1-10.

Richardson, B.A. (1997) The biodegradation of organic ammonium compounds on sandstone surfaces. *Journal of Applied Microbiology*, **63**, 1-10.

Richardson, B.A. (1998) The biodegradation of organic ammonium compounds on sandstone surfaces. *Journal of Applied Microbiology*, **64**, 1-10.

Richardson, B.A. (1999) The biodegradation of organic ammonium compounds on sandstone surfaces. *Journal of Applied Microbiology*, **65**, 1-10.

Richardson, B.A. (2000) The biodegradation of organic ammonium compounds on sandstone surfaces. *Journal of Applied Microbiology*, **66**, 1-10.

Richardson, B.A. (2001) The biodegradation of organic ammonium compounds on sandstone surfaces. *Journal of Applied Microbiology*, **67**, 1-10.

Richardson, B.A. (2002) The biodegradation of organic ammonium compounds on sandstone surfaces. *Journal of Applied Microbiology*, **68**, 1-10.

Richardson, B.A. (2003) The biodegradation of organic ammonium compounds on sandstone surfaces. *Journal of Applied Microbiology*, **69**, 1-10.

Richardson, B.A. (2004) The biodegradation of organic ammonium compounds on sandstone surfaces. *Journal of Applied Microbiology*, **70**, 1-10.

Richardson, B.A. (2005) The biodegradation of organic ammonium compounds on sandstone surfaces. *Journal of Applied Microbiology*, **71**, 1-10.

Richardson, B.A. (2006) The biodegradation of organic ammonium compounds on sandstone surfaces. *Journal of Applied Microbiology*, **72**, 1-10.

Richardson, B.A. (2007) The biodegradation of organic ammonium compounds on sandstone surfaces. *Journal of Applied Microbiology*, **73**, 1-10.

Richardson, B.A. (2008) The biodegradation of organic ammonium compounds on sandstone surfaces. *Journal of Applied Microbiology*, **74**, 1-10.

Richardson, B.A. (2009) The biodegradation of organic ammonium compounds on sandstone surfaces. *Journal of Applied Microbiology*, **75**, 1-10.

Richardson, B.A. (2010) The biodegradation of organic ammonium compounds on sandstone surfaces. *Journal of Applied Microbiology*, **76**, 1-10.

Richardson, B.A. (2011) The biodegradation of organic ammonium compounds on sandstone surfaces. *Journal of Applied Microbiology*, **77**, 1-10.

Richardson, B.A. (2012) The biodegradation of organic ammonium compounds on sandstone surfaces. *Journal of Applied Microbiology*, **78**, 1-10.

Richardson, B.A. (2013) The biodegradation of organic ammonium compounds on sandstone surfaces. *Journal of Applied Microbiology*, **79**, 1-10.

Richardson, B.A. (2014) The biodegradation of organic ammonium compounds on sandstone surfaces. *Journal of Applied Microbiology*, **80**, 1-10.

Richardson, B.A. (2015) The biodegradation of organic ammonium compounds on sandstone surfaces. *Journal of Applied Microbiology*, **81**, 1-10.

Richardson, B.A. (2016) The biodegradation of organic ammonium compounds on sandstone surfaces. *Journal of Applied Microbiology*, **82**, 1-10.

Richardson, B.A. (2017) The biodegradation of organic ammonium compounds on sandstone surfaces. *Journal of Applied Microbiology*, **83**, 1-10.

Richardson, B.A. (2018) The biodegradation of organic ammonium compounds on sandstone surfaces. *Journal of Applied Microbiology*, **84**, 1-10.

Richardson, B.A. (2019) The biodegradation of organic ammonium compounds on sandstone surfaces. *Journal of Applied Microbiology*, **85**, 1-10.

Richardson, B.A. (2020) The biodegradation of organic ammonium compounds on sandstone surfaces. *Journal of Applied Microbiology*, **86**, 1-10.

THE BOARD OF DIRECTORS OF THE COMPANY HAS REVIEWED THE FINANCIAL STATEMENTS AND HAS APPROVED THEM FOR ISSUANCE TO THE SHAREHOLDERS.

FOR THE BOARD OF DIRECTORS: _____
CHAIRMAN OF THE BOARD OF DIRECTORS

Notes

The accompanying financial statements have been prepared on the basis of the accounting records maintained by the Company. The financial statements have been prepared in accordance with the accounting principles generally accepted in the United States of America. The financial statements have been prepared on a consolidated basis and include the accounts of the Company and its subsidiaries. The financial statements have been prepared on a going concern basis. The financial statements have been prepared on a historical cost basis. The financial statements have been prepared on a cash basis. The financial statements have been prepared on a accrual basis. The financial statements have been prepared on a fair value basis. The financial statements have been prepared on a cost of sales basis. The financial statements have been prepared on a depreciation basis. The financial statements have been prepared on a amortization basis. The financial statements have been prepared on a impairment basis. The financial statements have been prepared on a valuation basis. The financial statements have been prepared on a measurement basis. The financial statements have been prepared on a recognition basis. The financial statements have been prepared on a derecognition basis. The financial statements have been prepared on a cancellation basis. The financial statements have been prepared on a extinguishment basis. The financial statements have been prepared on a settlement basis. The financial statements have been prepared on a termination basis. The financial statements have been prepared on a completion basis. The financial statements have been prepared on a expiration basis. The financial statements have been prepared on a termination basis. The financial statements have been prepared on a completion basis. The financial statements have been prepared on a expiration basis.

Part Three

CONSOLIDATION

The consolidated financial statements of the Company and its subsidiaries are prepared on the basis of the accounting records maintained by the Company. The consolidated financial statements have been prepared in accordance with the accounting principles generally accepted in the United States of America. The consolidated financial statements have been prepared on a consolidated basis and include the accounts of the Company and its subsidiaries. The consolidated financial statements have been prepared on a going concern basis. The consolidated financial statements have been prepared on a historical cost basis. The consolidated financial statements have been prepared on a cash basis. The consolidated financial statements have been prepared on a accrual basis. The consolidated financial statements have been prepared on a fair value basis. The consolidated financial statements have been prepared on a cost of sales basis. The consolidated financial statements have been prepared on a depreciation basis. The consolidated financial statements have been prepared on a amortization basis. The consolidated financial statements have been prepared on a impairment basis. The consolidated financial statements have been prepared on a valuation basis. The consolidated financial statements have been prepared on a measurement basis. The consolidated financial statements have been prepared on a recognition basis. The consolidated financial statements have been prepared on a derecognition basis. The consolidated financial statements have been prepared on a cancellation basis. The consolidated financial statements have been prepared on a extinguishment basis. The consolidated financial statements have been prepared on a settlement basis. The consolidated financial statements have been prepared on a termination basis. The consolidated financial statements have been prepared on a completion basis. The consolidated financial statements have been prepared on a expiration basis. The consolidated financial statements have been prepared on a termination basis. The consolidated financial statements have been prepared on a completion basis. The consolidated financial statements have been prepared on a expiration basis.

The consolidated financial statements of the Company and its subsidiaries are prepared on the basis of the accounting records maintained by the Company. The consolidated financial statements have been prepared in accordance with the accounting principles generally accepted in the United States of America. The consolidated financial statements have been prepared on a consolidated basis and include the accounts of the Company and its subsidiaries. The consolidated financial statements have been prepared on a going concern basis. The consolidated financial statements have been prepared on a historical cost basis. The consolidated financial statements have been prepared on a cash basis. The consolidated financial statements have been prepared on a accrual basis. The consolidated financial statements have been prepared on a fair value basis. The consolidated financial statements have been prepared on a cost of sales basis. The consolidated financial statements have been prepared on a depreciation basis. The consolidated financial statements have been prepared on a amortization basis. The consolidated financial statements have been prepared on a impairment basis. The consolidated financial statements have been prepared on a valuation basis. The consolidated financial statements have been prepared on a measurement basis. The consolidated financial statements have been prepared on a recognition basis. The consolidated financial statements have been prepared on a derecognition basis. The consolidated financial statements have been prepared on a cancellation basis. The consolidated financial statements have been prepared on a extinguishment basis. The consolidated financial statements have been prepared on a settlement basis. The consolidated financial statements have been prepared on a termination basis. The consolidated financial statements have been prepared on a completion basis. The consolidated financial statements have been prepared on a expiration basis. The consolidated financial statements have been prepared on a termination basis. The consolidated financial statements have been prepared on a completion basis. The consolidated financial statements have been prepared on a expiration basis.

FOR THE BOARD OF DIRECTORS: _____

CHAIRMAN OF THE BOARD OF DIRECTORS

METHODE D'EVALUATION DE L'IMPACT DU MOULAGE SUR LES PROPRIETES SUPERFICIELLES D'UNE PIERRE CALCAIRE

P. BROMBLET, J. BRUNET, **P. MERINDOL et **D. BOUVIER

*Laboratoire de Recherche des Monuments Historiques, Champs sur Marne, France

**Atelier de restauration Mérimod, Avignon, France

Résumé

Dans la perspective de mouler la frise préhistorique d'un abri sous-roche à Angles sur l'Anglin (France), une étude a été réalisée pour évaluer l'impact du moulage sur la coloration et les propriétés pétrophysiques superficielles de la roche. Des essais de moulage ont été effectués sur des éprouvettes avec plusieurs types de produits de moulage (silicones et terre) et de démoulage (savon, alcool polyvinylique, talc). Les cinétiques d'évaporation et d'imbibition capillaire, les perméabilités à la vapeur d'eau et à l'air et les variations colorimétriques ont été mesurées avant et après moulage. Les résultats permettent de montrer que tout moulage modifie de manière significative les propriétés superficielles de la roche. Les modifications concernent la couleur et les capacités de transfert de l'eau, de la vapeur d'eau et de l'air à travers la surface moulée. L'importance des modifications varie selon les produits utilisés et leur concentration. L'ensemble des tests mis en oeuvre constitue donc une bonne méthode d'évaluation de l'impact du moulage et permet de sélectionner les produits les moins perturbants.

Mots-clés : moulage, propriétés pétrophysiques, colorimétrie, silicone, pierre, calcaire, sculpture.

1 Introduction

Une étude de faisabilité a été réalisée en vue du moulage d'une frise préhistorique située aux environs d'Angles sur l'Anglin, près de Poitiers. Cette frise magdalénienne a été sculptée sur la paroi d'un abri sous-roche d'environ 20 m² à la base d'une falaise ayant une dizaine de mètres de haut et a été découverte par Saint Mathurin de et Garrod (1950). Dégagées des sédiments qui les recouvraient, les sculptures sont visibles depuis une cinquantaine d'années. La roche en surface est saine, suffisamment recouverte de concrétions calcitiques pour que le moulage ne puisse pas provoquer des arrachements. Par contre, à certaines périodes de l'année, l'eau provenant d'infiltrations ou de condensations mouille la paroi. Etant donné ce contexte et pour ne pas nuire à la conservation des sculptures, le moulage devait modifier le moins possible les capacités d'humectation et de séchage de la roche, c'est à dire ses propriétés de stockage et de transfert des fluides, de la vapeur d'eau et de l'air. Or, les produits de moulage silicone (RTV) couramment employés de nos jours sont réputés pour colorer la pierre par migration d'huiles silicones (Bourbon, 1992). Ces huiles sont hydrophobes et on pouvait craindre que le moulage entraîne la formation d'une sorte de barrière étanche superficielle, comme cela a déjà été constaté par Matteini, Moles et Tosini (1993). Afin d'évaluer l'impact du moulage sur les propriétés superficielles de la pierre, un protocole fut défini qui comprenait d'une part des mesures colorimétriques, d'autre part les cinétiques d'imbibition capillaire et d'évaporation, les perméabilités à la vapeur d'eau et à l'air.

Les tests ont été réalisés sur des essais de moulage avec différents produits de moulage silicone et différents agents de démoulage. Pour comparaison, les mêmes tests ont aussi été réalisés sur un essai d'estampage à la terre. Les résultats obtenus sont présentés et discutés ici de manière à montrer l'intérêt de chacun des tests mis en oeuvre.

2 Matériel et méthodes

2.1 Prélèvements

Les sculptures et les gravures ont été faites dans un seul banc calcaire sur une hauteur d'environ 2 m. La roche est constituée d'un calcaire oolithique à ciment sparitique, de couleur jaunâtre. Pour disposer d'un volume de roche suffisant, nous avons prélevé un bloc éboulé à la base du banc sculpté. Ce bloc de taille importante (0.5 m³) a été découpé en atelier en 3 grandes plaques de 7 cm d'épaisseur. 12 éprouvettes de dimensions 15 x 7 x 7 cm ont été sciées dans ces trois plaques. La porosité à 48h mesurée sur chaque éprouvette varie entre 14 et 18 %, ce qui confirme la bonne homogénéité apparente du matériau. Enfin, l'absorption d'eau à basse pression a été mesurée à la pipette de Karsten sur les faces sciées des éprouvettes et elle s'est avérée être beaucoup plus élevée (6 ml d'eau absorbé en 2 minutes) que celle mesurée sur la paroi concrétionnée (0.15 ml d'eau absorbé en 2 minutes).

2.2 Protocole expérimental

Le protocole comprend des mesures colorimétriques (colorimètre Minolta Chromameter CR 100) et les tests pétrophysiques suivants : cinétique d'imbibition capillaire (norme NF B 10-502, 1980), cinétique d'évaporation (préconisation RILEM/UNESCO 1978, test II-5), perméabilité à la vapeur d'eau (préconisation RILEM/UNESCO 1978, test II-2) et perméabilité à l'air sous charge constante.

Les tests pétrophysiques ont été réalisés sur 3 éprouvettes de références A, B, C non moulées.

Sur les 9 autres éprouvettes, différents couples agent de moulage/produit de moulage ont été appliqués puis retirés après 24h. Le démoulage a été immédiatement suivi d'un rinçage à l'eau tiède. Les essais pétrophysiques ont été réalisés 1 mois après le démoulage, à raison de 2 mesures par test et par éprouvette. 5 mesures colorimétriques ont été effectuées avant et après moulage, en déplaçant la tête de mesure de 4 cm de diamètre, de 2.5 cm entre chaque mesure.

2.3 Choix des produits

Comme il n'était pas possible d'envisager de tester tous les produits actuellement commercialisés, un premier tri a été effectué à partir d'essais rapides pour éliminer les produits inapplicables, par exemple trop liquides (le moulage final comprendra des parties en surplomb), ou trop colorants. Les silicones RTV à polyaddition ont été volontairement écartés de la sélection car, ainsi que cela est indiqué sur leurs fiches techniques, leur polymérisation est inhibée par de nombreuses substances naturelles susceptibles d'être présentes localement sur la paroi. La liste des produits finalement sélectionnés est donnée dans le tableau 1. Les essais de moulages sont décrits dans le tableau 2.

Tableau 1. liste des produits sélectionnés pour les tests

Fonction	Nature	Nom	abréviation	Firme
Agents de démoulage	savon gras liquide	Teepol	sav	Prolabo
	alcool polyvinylique	Rhodoviol	al	
	silicate de magnésium	talc	t	
Produits de moulage	silicones à polycondensation	EL M 3100	3100	Wacker
		RTV M 4506	4506	Wacker
		RTV 585	585	Rhône-Poulenc
	terre à modeler d'atelier		T	Ets Bermann

Tableau 2. liste des couples agent de démoulage/produit de moulage appliqués sur les éprouvettes

Eprouvette	Agent de démoulage	Concentration dans l'eau (vol%)	Produit de moulage
terre	talc	sec	Terre brune humidifiée
al5/585	alcool polyvinylique	5	RTV 585
al5/4506	" "	5	RTV EL M 4506
al8/4506	" "	8	RTV EL M 4506
sav/4506	savon liquide	70	RTV EL M 4506
al3/3100	alcool polyvinylique	3	RTV EL M 3100
al6/3100	" "	6	RTV EL M 3100
al8/3100	" "	8	RTV EL M 3100
sav/3100	savon liquide	70	RTV EL M 3100

3 Colorimétrie

3.1 Résultats (tableau 3)

Après moulage, les paramètres "L" (luminance), "a" (axe vert - rouge), "b" (axe bleu - jaune) ne varient quasiment pas sur l'éprouvette moulée avec la terre. Néanmoins, on distingue à l'œil une légère coloration brune irrégulière qu'une observation à la loupe binoculaire permet d'attribuer à de petits résidus terreux piégés dans les pores superficiels de la roche.

Sur l'ensemble des autres éprouvettes, moulées avec des silicones, on note une baisse de "L" comprise entre 2 et 8 % qui correspond à un assombrissement bien visible et plus ou moins intense. Le paramètre "a" très légèrement négatif augmente et se rapproche de 0 après moulage. Les variations de "a", importantes en valeur relative, restent en réalité imperceptibles à l'œil car limitées à quelques dixièmes en valeur absolue. La coloration jaunâtre de la pierre se traduisait avant moulage par un "b" positif qui, après moulage, augmente encore. Visuellement, on constate effectivement un jaunissement net de la plupart des éprouvettes. Les variations de "L" et de "b" sont relativement bien corrélées. Enfin, des mesures ont été réalisées avant et après l'application du savon et de l'alcool polyvinylique à 8 %. Ce dernier s'est avéré plus colorant ($dL, db_{\text{alcool}} = -7.5 \%, +60 \%$ et $dL, db_{\text{savon}} = -8 \%, +42 \%$). Après rinçage à l'eau, la marque laissée par le savon s'estompe et devient difficile à discerner alors que celle laissée par l'alcool polyvinylique s'atténue mais reste visible ($dL, db_{\text{alcool}} = -6 \%, +52 \%$ et $dL, db_{\text{savon}} = -5 \%, +32 \%$).

3.2 Commentaires

Il est possible d'établir le classement suivant, en allant des modifications les plus faibles aux plus importantes : **terre > al/3100 > sav/3100 > al/585 > al/4506 ou sav/4506**. Les différentes concentrations de l'alcool polyvinylique n'influencent pas de manière significative la coloration de la roche. L'assombrissement et le jaunissement sont liés principalement au produit de moulage.

Les trois produits de moulage testés avaient, après ajout de leur catalyseur, des teintes bleue pâle (3100), brun clair (585) et blanche (4506). Aucun résidu de ces produits teintés n'a pu être discerné aux plus forts grossissements de la loupe binoculaire. Les colorations observées sur les éprouvettes moulées avec ces RTV ne proviennent donc pas de résidus des produits, mais seulement de la migration de certaines de leurs composantes. Les différences de coloration selon le RTV peuvent être dues à la quantité de produit ayant migré ou au pouvoir colorant de ces phases. Avec le savon, bien qu'il soit moins colorant lui-même que l'alcool polyvinylique, la coloration est plus intense car il freine moins la migration des huiles silicones. L'alcool polyvinylique à la plus forte concentration (8 %) parvient à

Tableau 3. colorimétrie des éprouvettes moulées avant et après moulage

Mesures colorimétriques	Avant moulage			Après moulage		
	L	a	b	L	a	b
terre	80.20	-0.68	13.08	80.48	-0.50	13.28
écart-type	0.14	0.16	0.71	0.26	0.14	0.97
al5/585	79.66	-0.66	13.52	75.82	-0.14	18.36
écart-type	0.22	0.05	0.28	0.16	0.13	0.26
al5/4506	80.30	-0.58	12.42	73.88	0.06	21.28
écart-type	0.47	0.04	0.33	0.30	0.05	0.51
al8/4506	79.82	-0.64	13.00	74.10	0.02	20.28
écart-type	0.40	0.11	0.48	0.29	0.04	0.28
sav/4506	79.38	-0.58	12.84	73.66	0.02	21.14
écart-type	0.54	0.15	0.28	0.40	0.11	0.88
al3/3100	79.50	-0.54	13.24	77.08	-0.18	15.72
écart-type	0.58	0.11	0.32	0.38	0.13	0.34
al6/3100	79.10	-0.60	12.92	76.70	-0.10	15.16
écart-type	0.14	0.07	0.35	0.07	0.14	0.21
al8/3100	80.68	-0.76	12.14	78.88	-0.48	14.48
écart-type	0.26	0.15	0.63	0.37	0.19	0.55
sav/3100	79.12	-0.40	13.76	74.32	0.14	18.78
écart-type	0.25	0.07	0.82	1.85	0.40	1.87

protéger partiellement la roche des effets du seul RTV 3100. Enfin, l'estampage à la terre provoque un faible brunissement dû au fait que de petits résidus terreux demeurent accrochés à la surface de la roche.

4 Cinétique d'imbibition capillaire

4.1 Résultats (tableau 4)

A 30 h, les coefficients de capillarité diminuent très faiblement pour les éprouvettes moulées avec la terre et avec le RTV 585. Les diminutions sont plus fortes avec le RTV 4506 et surtout avec le RTV 3100. La nature de l'agent de démoulage influence aussi les résultats. Ainsi, comparé au savon, l'alcool polyvinylique associé au RTV 3100 ralentit considérablement l'absorption capillaire aux concentrations les plus fortes et les plus faibles. La diminution est bien plus limitée avec le savon.

A 60 h, la plupart des coefficients de capillarité deviennent comparables à ceux qui avaient été mesurés sur les éprouvettes non moulées, voire dans certains cas, supérieurs. Des baisses importantes persistent encore avec les RTV 3100 et 4506 et l'alcool polyvinylique à 8 % ainsi que dans une moindre mesure avec le RTV 3100 et l'alcool polyvinylique à 6 %.

A 120 h, seuls les RTV 3100 et 4506 associés à l'alcool polyvinylique à 8 % occasionnent encore des baisses notables de l'absorption capillaire. L'emploi de la terre réduit très peu les coefficients de capillarité et les autres essais utilisant les silicones ont tendance à augmenter l'absorption capillaire.

Tableau 4. coefficients de capillarité des éprouvettes de référence (A, B, C) et variation de ce coefficient sur les éprouvettes après moulage

Eprouvettes non moulées	Coef. de capillarité en g /cm ² /mn ^{1/2} à 30 heures	Coef. de capillarité en g /cm ² /mn ^{1/2} à 60 heures	Coef. de capillarité en g /cm ² /mn ^{1/2} à 120 heures
A	2.03	1.45	1.03
B	2.27	1.66	1.18
C	2.36	1.72	1.23
moyenne	2.22	1.61	1.15
écart-type	0.17	0.14	0.10
Eprouvettes après moulage	variation du coefficient de capillarité		
terre	-2% -7%	-3% -9%	-3% -9%
al5/585	-15% -9%	18% 15%	18% 15%
al5/4506	-32% -33%	-3% 1%	15% 14%
al8/4506	-67% -63%	-52% -47%	-25% -19%
sav/4506	6% -22%	27% 1%	28% 9%
al3/3100	-48% -47%	-15% 6%	15% 17%
al6/3100	-66% -67%	-24% -40%	3% 0%
al8/3100	-69% -58%	-58% -38%	-26% 2%
sav/3100	-30% -21%	-5% 6%	22% 37%

4.2 Commentaires

Sur les éprouvettes non moulées, les résultats sont relativement bien groupés.

Sur les éprouvettes moulées, la diminution initiale d'absorption capillaire à 30 h peut être attribuée soit à un colmatage partiel de la porosité superficielle des éprouvettes par l'agent de démoulage, soit aux propriétés hydrophobes des composants des silicones qui ont diffusé dans la pierre. Le fait que la diminution dépende, à une concentration d'agent démoulant donnée, du type de RTV utilisé, vient étayer plutôt cette dernière hypothèse. Mais l'effet du colmatage semble aussi intervenir puisque l'alcool polyvinylique réduit systématiquement beaucoup plus la capillarité que le savon.

Au fur et à mesure du temps, la diminution de l'absorption capillaire s'atténue, s'annule et finalement l'absorption capillaire à 120h dépasse l'absorption initiale dans les moulages avec les silicones. L'explication la plus simple de cette inversion est que l'agent de démoulage au contact prolongé de l'eau, a été solubilisé puis est allé tapisser la porosité en supprimant l'effet hydrophobe des huiles silicones. Le colmatage serait alors réduit et, au contraire, on peut supposer que les agents de démoulage de par leurs propriétés tensioactives ont augmenté la mouillabilité des parois des pores, facilitant ainsi la pénétration de l'eau dans les plus petits interstices et réduisant la proportion de la porosité piégée non librement accessible à l'eau (Mertz, 1992). Dans le cas de l'estampage à la terre, on constate une réduction limitée mais permanente de la capillarité de l'éprouvette.

5 Cinétique d'évaporation

5.1 Résultats (tableau 5)

Les flux sont plus lents sur l'ensemble des éprouvettes moulées. Les ralentissements les plus importants, de l'ordre de 40 %, sont liés à l'application des plus faibles concentrations d'alcool polyvinylique (3 %) et à l'estampage à la terre. A de fortes concentrations d'alcool, la diminution des flux d'évaporation reste importante, de l'ordre de 25 à 30 % pour les RTV 4506 et 3100. Finalement, les meilleurs résultats sont obtenus avec des concentrations moyennes, à 5 ou 6 % d'alcool polyvinylique. Avec le savon, on constate une évolution du flux dans le temps : le flux est faiblement réduit tant que la vitesse d'évaporation est élevée. Par la suite, il diminue considérablement, mais il ne concerne plus alors que de faibles proportions d'eau résiduelle. La même constatation peut être faite pour le RTV 585 et l'alcool à 5 %, tandis qu'au contraire, les réductions s'atténuent avec le temps pour le RTV 4506 et l'alcool à 5 %.

5.2 Commentaires

Ces résultats montrent que les agents de démoulage et les produits de moulage agissent sur l'évaporation. L'examen des courbes d'évaporation (non présentées) indique que l'on a un changement de régime d'évaporation marqué par une nette décroissance de la vitesse d'évaporation au bout de 30 à 40 h selon les éprouvettes et que la majeure partie de l'eau initiale s'est évaporée avant le changement de phase. Ce changement correspond au passage d'un mode de séchage par ascension capillaire des solutions et évaporation superficielle à un séchage par diffusion à partir d'un front d'évaporation qui s'enfonce dans le matériau (Hammecker, 1993). Une grande partie de l'évaporation s'effectue donc par alimentation capillaire dans l'ensemble des éprouvettes.

L'évaporation diminue que l'on utilise l'alcool polyvinylique à forte ou faible concentration. A forte concentration, on conçoit que l'alcool polyvinylique agit directement en colmatant partiellement la porosité. A faible concentration, l'alcool laisse pénétrer les huiles silicones hydrophobes et ce sont elles qui stoppent l'ascension capillaire des solutions jusqu'à la surface des éprouvettes. Les baisses sont moindres avec le savon qu'avec l'alcool, ce qui tendrait à prouver que le colmatage est le facteur de baisse prépondérant. Nous sommes pour le moment incapables d'expliquer les évolutions de flux constatées avec le savon, avec les RTV 585 et 4506 après 25.5 h. Enfin, on remarque que les particules terreuses piégées à la surface de la pierre au cours de l'estampage réduisent nettement l'évaporation alors qu'elles modifieraient peu l'absorption capillaire, peut être en raison de leur forte capillarité.

Tableau 5. flux d'évaporation des éprouvettes de référence (A, B, C) et variation de ce flux sur les éprouvettes après moulage

Eprouvettes non moulées	Flux en g/cm ² à 8.5 h	Flux en g/cm ² à 25.5 h	Flux en g/cm ² à 93 h	Flux en g/cm ² à 165 h	Flux en g/cm ² à 336 h
A	5.01E-02	1.72E-01	3.31E-01	3.31E-01	3.32E-01
B	3.84E-02	1.31E-01	2.06E-01	2.06E-01	0.2
C	3.55E-02	1.37E-01	2.24E-01	2.24E-01	2.24E-01
moyenne	4.14E-02	1.47E-01	2.54E-01	2.54E-01	2.54E-01
écart-type	7.74E-03	2.21E-02	6.79E-02	6.77E-02	6.80E-02
Eprouvettes après moulage	Variation du flux d'évaporation				
terre	-18%	-16%	-35%	-35%	-41%
	-36%	-22%	-45%	-45%	-37%
al5/585	6%	-23%	-38%	-39%	-20%
	-3%	1%	-13%	-13%	-34%
al5/4506	-27%	-18%	-7%	-7%	-17%
	-12%	-18%	-6%	-6%	-26%
al8/4506	-16%	-32%	-28%	-28%	-33%
	-24%	-25%	-24%	-24%	-13%
sav/4506	-10%	-13%	-24%	-24%	-17%
	-12%	-10%	-33%	-32%	-13%
al3/3100	-42%	-50%	-41%	-41%	-24%
	-41%	-45%	-36%	-36%	-32%
al6/3100	-17%	-5%	-17%	-17%	-28%
	-8%	-15%	-26%	-26%	-25%
al8/3100	-11%	-34%	-33%	-33%	-39%
	-17%	-33%	-29%	-29%	-13%
sav/3100	-19%	-16%	-34%	-34%	-35%
	-5%	-21%	-13%	-13%	-45%

6. Perméabilité à la vapeur d'eau

6.1 Résultats (tableau 6)

Après moulage, le coefficient de perméabilité à la vapeur d'eau a diminué pour l'ensemble des éprouvettes. Les éprouvettes moulées avec l'alcool polyvinylique en forte concentration et avec la terre subissent les plus fortes baisses. Les plus faibles baisses sont obtenues avec le savon comme agent de démoulage. Le RTV 3100 abaisse moins cette propriété que les RTV 4506 et 585.

6.2 Commentaires

La perméabilité à la vapeur d'eau est limitée principalement par l'effet de colmatage de l'alcool polyvinylique à 8 % et de la terre. Concernant la terre, la réduction de la perméabilité à la vapeur d'eau est du même ordre de grandeur que celle mesurée dans les tests d'évaporation. Cette réduction n'est peut être pas liée uniquement au colmatage, car les minéraux argileux peuvent aussi piéger les molécules d'eau par adsorption.

7 Perméabilité à l'air

7.1 Résultats (tableau 6)

Les coefficients de perméabilité à l'air des éprouvettes avant moulage varient d'un facteur 3. Avec une telle dispersion sur seulement 3 mesures, la moyenne a une signification limitée et la discussion des résultats après moulage doit être faite avec beaucoup de précautions.

Après moulage, le coefficient de perméabilité à l'air diminue plus ou moins selon les produits. Les baisses sont nettes et vraisemblables pour les essais réalisés avec les plus fortes concentrations d'alcool

polyvinylique (8 %). Avec le savon, on ne mesure pas de telles baisses. On ne discerne pas de relation entre le type de produit de moulage et les variations de perméabilité à l'air.

7.2 Commentaires

L'essai de perméabilité à l'air évalue la capacité du matériau à être traversé par un flux d'air. Aucun effet hydrophobe ou d'adsorption ne peut être invoqué pour expliquer une baisse de la perméabilité à l'air. Cet essai ne peut mesurer que l'effet d'un colmatage de la porosité. Il est donc possible d'affirmer que les baisses enregistrées avec l'alcool polyvinylique à 8 % et semble-t-il avec la terre sont dues à un colmatage partiel de la porosité. Etant donné le faible nombre de mesures réalisées et la dispersion des valeurs obtenues, il n'est pas possible d'attribuer un rôle de bouche-pores aux autres produits.

Tableau 6. coefficients de perméabilité à la vapeur d'eau et à l'air des éprouvettes de référence (A, B, C) et variation de ces coefficients sur les éprouvettes après moulage

Eprouvettes non moulées	K vap en sec. x 10-4	K air en millidarcy
A	3.5	2129
B	3.9	794
C	3.0	1119
moyenne	3.5	1347
écart-type	0.5	568
Eprouvettes après moulage	variation de K vapeur d'eau	variation de K air
terre	-69%	-22%
	-40%	-30%
al5/585	-31%	-44%
	-26%	-6%
al5/4506	-23%	-46%
	-31%	-44%
al8/4506	-77%	-57%
	-69%	-58%
sav/4506	-23%	-38%
	-17%	-4%
al3/3100	-31%	-15%
	-26%	-15%
al6/3100	-23%	46%
	-29%	10%
al8/3100	-43%	-60%
	-46%	-53%
sav/3100	-17%	-11%
	-20%	0%

8 Discussion et conclusions

Les tests utilisés ont chacun des limites et des avantages et fournissent des indications complémentaires sur l'effet des produits de moulage sur les propriétés superficielles de la pierre..

Ainsi, la colorimétrie est une mesure très précise et les variations mises en évidence sont statistiquement très significatives. Les variations de couleur mesurées montrent qu'il y a eu migration de certaines phases à partir des silicones RTV de moulage. L'effet sur la coloration de la pierre dépend du produit : il est le plus réduit pour le RTV 3100. Cet effet doit être lié à plusieurs facteurs comme, par exemple, la proportion d'huiles silicones, leur pouvoir colorant, leur capacité à migrer plus ou moins dans le matériau, la durée de polymérisation. L'alcool polyvinylique semble le plus efficace pour réduire ces migrations. L'estampage à la terre est l'essai qui modifie globalement le moins la couleur bien que des résidus bruns demeurent dans les pores superficiels et brunissent localement la pierre. Ce brunissement pourrait être évité en utilisant une terre dont la teinte serait voisine de celle de la pierre.

Les essais pétrophysiques présentent tous l'inconvénient d'une plus grande dispersion des valeurs liée à la fois à des hétérogénéités du matériau et à des incertitudes dans la mesure. Il faudrait multiplier les prélèvements et les analyses pour améliorer la fiabilité des mesures. Cependant, malgré la dispersion des valeurs, il est possible de comparer la plupart des résultats obtenus dans la mesure où elles sont suffisamment différentes pour indiquer les grandes tendances sans aucune ambiguïté.

La perméabilité à l'air donne des valeurs très dispersées et n'autorise pas des comparaisons fines. Seules les baisses les plus importantes peuvent être prises en compte. C'est pourtant un essai très intéressant car il met en évidence, sans équivoque possible, le colmatage causé par l'alcool polyvinylique aux plus fortes concentrations et dans une moindre mesure, par les résidus terreux.

Le test de perméabilité à la vapeur d'eau montre bien aussi l'effet de colmatage de l'alcool polyvinylique à 8 % et des résidus terreux. Avec la terre, la réduction de la perméabilité à l'air est nettement moins importante que la réduction de la perméabilité à la vapeur d'eau, ce qui laisse supposer que les particules argileuses n'interviennent pas uniquement sur les transferts d'eau par colmatage, mais aussi par adsorption de surface.

Les tests d'imbibition capillaire et d'évaporation ont un pouvoir discriminant certain. Les résultats des deux tests sont concordants et montrent que l'effet du moulage peut varier selon les produits.

Les RTV 3100 et 4506 avec l'alcool polyvinylique à 8 % et à 3 % induisent de fortes baisses de capillarité ou de flux d'évaporation quelle que soit la durée d'évaporation ou d'imbibition. Ces baisses doivent être attribuées à l'effet du colmatage par l'alcool polyvinylique ou aux propriétés hydrophobes des huiles silicones qui ont migré dans la roche.

Dans les essais avec le savon, avec l'alcool polyvinylique peu concentré, le moulage, après une faible baisse initiale due à la pénétration des huiles silicones, induit une augmentation de la capillarité, quel que soit le RTV. Nous formulons l'hypothèse que lorsque le colmatage est limité, les agents de démoulage peuvent se solubiliser, tapisser les parois des pores et finalement conduire à une augmentation des transferts d'eau en augmentant la mouillabilité et en favorisant l'accès des solutions.

En conclusion, cette étude montre que le moulage modifie les propriétés superficielles de la pierre. Cela étant admis, les tests réalisés s'avèrent très utiles pour classer les produits en fonction des modifications qu'ils induisent et pour choisir les moins perturbants, de façon à limiter l'impact du moulage sur la conservation des sculptures.

9 Références

Bourbon, M. (1992): Les moulages. In "La conservation de la pierre monumentale en France". Presses du CNRS, Paris, 125-126.

Hammecker, C. (1993): Importance des transferts d'eau dans la dégradation des pierres en oeuvre. Thèse Univ. Strasbourg, 254 pp.

Matteini, M., Moles, A. et Tosini, I. (1993): Il calco diretto dei manufatti storico-artistici mediante elastomeri siliconici: materiali e procedure. OPD Restauro, Rivista dell'Opificio delle Pietre Dure e Laboratori di Restauro di Firenze, 5, note, 81-86.

Mertz, J. D. (1991): Structures de porosité et propriétés de transport dans les grès. Sci. Géol. Mém., 90, 149 pp.

Saint Mathurin de, S. et Garrod, D. A. E. (1950): Les sculptures d'Angles sur l'Anglin. Congrès Préhistorique de France, Paris, n°13.

10 Remerciements

Les auteurs remercient pour leur collaboration Mrs X. Guthertz et P. Fouchet du Service Régional de l'Archéologie, Mme G. Pinçon et Mr F. Lévêque, chargés de l'étude archéologique du site. Les analyses pétrophysiques ont été réalisées au Laboratoire d'Etudes des Matériaux à Illkirsch. Cette étude a été financée par le Ministère de la Culture et de la Francophonie.

Comparison of Traditional and Modern Treatments for Conserving Stone

R N BUTLIN*, T J S YATES* and W MARTIN*

* Building Research Establishment +English Heritage

Abstract

The two main groups of consolidants for architectural stonework in use in the UK today are silanes and alkaline earth hydroxides, predominantly calcium hydroxide. The silanes may be described as "modern" and the earth hydroxides as "traditional". The evaluation of these materials has, to date, been based almost entirely on laboratory studies and limited practical applications. This paper describes ongoing work on the monitoring and performance assessment of both groups. It suggests methods for measuring performance and focuses on areas for future research.

Introduction

In R.J. Schaffer's seminal work, *The Weathering of Natural Building Stones*, first published in 1932, he discusses various attitudes to preventative and remedial measures to ameliorate the effects of a combination of decay agencies on architectural stonework. He includes the following extract from the records of a Royal Commission, appointed in 1861 to inquire into the decay of the stonework of the Houses of Parliament in London.

" With regard to the processes which have actually been applied, whether experimentally or extensively, your committee are decidedly of the opinion that the discovery of a proper mode of treating stones in a state of decay has not yet been made, and there is no evidence whatever on the building itself to induce them to believe that the decay, where decay has arisen, has been arrested, or that permanently the decay has been prevented by any of the processes yet applied"

Schaffer goes on to say, in 1932, "it is hardly an exaggeration to say that little, if any progress, has been made since 1861"

Today in the UK, whilst it would be inaccurate to suggest that little, if any progress had been made since 1932, it would be reasonable to state that consolidation of architectural stonework has reached a plateau in terms of understanding and acceptance. Misconceptions exist concerning the operating characteristics and limitations of the available treatments and questions concerning long-term performance and retreatment have barely been addressed. A major UK amenity society, the Society for the Protection of Ancient Buildings (SPAB) has called for a moratorium on the use of alkoxysilane based treatments.

Whilst laboratory and museum based examples of consolidation exercises help to define the potential of various treatments it is the on-site evaluation and assessment of such materials in use on the longer term which bears most weight in helping to define the likely success or failure rates and therefore the appropriateness of a treatment regime. It also is essential in bringing current and future research on the subject into clear focus.

It has been the apparent lack of such on-site evaluation which has so characterised the debate concerning stone consolidants in the UK and elsewhere, for the last twenty years.

It is in this area therefore that English Heritage, the UK government's agency for heritage conservation in England, has been focusing its resources in an attempt to provide a framework for the evaluation of stone consolidants in use. This has taken the form of the production of guidelines, setting out performance requirements for masonry consolidants, justifications for use and lessons for good practice.

It has also involved the long-term monitoring of a number of sites treated with Brethane and an assessment programme evaluating the performance of lime based treatments at 10 sites around England.

This is entirely appropriate as the two main groups of materials used for stone consolidation in the UK are the alkoxysilanes and the alkaline earth hydroxides. The silanes, which are now almost exclusively used on non-calcareous stones are predominantly either Wacker OH (TEOS) or Brethane (MTMOS). Limestones have become the domain of the earth hydroxides, calcium hydroxide in particular (lime treatment).

This massive preponderance of calcium hydroxide based "lime method" treatment of limestones is unique to the UK where, since their initial development by Professor Robert Baker at sites such as Wells cathedral in the early 1970s, the obvious appeal of using a consolidant (limewater) composed as closely as possible to the material to be consolidated has led to its almost ubiquitous specification for the treatment of decayed limestone surfaces. Whilst increasingly employed by an ever growing number of practitioners in the field, the current assessment programme is the first of its kind. An important basis for the selection of sites for assessment has been the requirement that the work be documented sufficiently well enabling the variations in the treatment as carried out to be defined.

The lime method, of which limewatering is but one part, consists of a broad raft of conservation processes. The limewatering is usually complemented by the placing of non hydraulic lime based grouts and support fillings, with or without the addition of pozzolanic materials. Cleaning, originally carried out through the application of a paste of freshly slaked lime to a pre-wetted stone surface has now been abandoned as the method was considered too unpredictable and potentially destructive; it is now achieved by a combination of hand sprays, selective paper pulp poultices and air abrasive cleaning. The process is usually completed with the application of a shelter coat consisting of lime and stone dust mortar rendered down by the addition of water to a consistency of single cream. Casein is added to the shelter coat mix to aid adhesion and a biocide is employed to reduce the propensity of the casein to support biological growth. The shelter coat, brushed onto the pre-wetted stone surface is worked in with a hessian pad until it is compacted within the stone pores but allowing the underlying stone to grin through.

Essentially a craft-based method sensitive to expert care in its application, the lime method has undergone continual refinement by practitioners in the field. Any evaluation of such a technique has therefore to consider the contribution made by each of these processes to the treatment overall and the identification and development of the necessary evaluative tools is a high priority.

Tests on traditional consolidants

In a series of trials carried out by the Building Research Establishment (BRE), samples of Douling limestone cut from mullions of the unglazed West Cloister at Wells Cathedral were cleaned by three different methods (water, lime poultice, air abrasion) and some treated with limewater, some with 'sheltercoat' (a sacrificial coating) and some with both (Ashurst & Ashurst 1988).

A description of laboratory tests and the analysis of results has already been reported (Price & Ross 1984). The samples (see Fig. 1) were exposed on the north-west tower of Wells Cathedral. Over this period of time, photographic records of the samples were kept and final weight changes determined. After the trials were complete, the colour of the surfaces was recorded quantitatively using a spectro-colorimeter.

A preliminary analysis of the weight changes over 7 years exposure indicated a 3-4% weight loss for water cleaned samples, a range of 2-5% loss for poulticed samples and 4-5% for the air-abraded samples. Again, a preliminary analysis indicates that some samples treated with shelter coat after cleaning and after limewater treatment fare better than those cleaned and limewashed – although there are exceptions.

The results of colour measurements are complicated by the fact that biological growth occurred on the stone specimens. There is some indication from multiple quantitative measurements that the strongest colour is found on a water washed, limewater treated sample and that the darkest colour is found in a poulticed, limewater and sheltercoated sample. The use of detailed colour measurement for investigating stone subject to different treatment or weathering has great potential and will be investigated further.

A new technique for investigating the presence of treatments on stone has also been applied to one of the Wells samples. This technique uses 'impedance spectroscopy' (IS) and is a means of assessing the dielectric frequency response of materials. A variety of electrical properties of the material can be assessed across a range of frequencies (20Hz - 1 MHz). The response curve is indicative of either structural or physical/chemical processes occurring in the sample. Measurement of impedance spectra to determine the properties of minerals and mineral grain assemblages, such as those present in sandstone and limestone, can now be readily carried out using proprietary laboratory equipment developed for the electronics industry.

Where there is a significant difference in the dielectric constant (ϵ) it is possible to differentiate between the presence and absence of different materials, for example the change in the dielectric response due to progressive air drying of a sandstone specimen ($\epsilon = 10$) saturated with water ($\epsilon = 80$). The presence of consolidants and surface treatments is also detectable.

The technique can also detect changes in the physical form of a material. Limewash has the same dielectric constant as limestone. A sample from one of the Wells mullions was dry cut into a series of sections perpendicular to the front face. The cut faces were gently abraded to remove any contamination from the saw blade. Impedance measurements on these sections showed there is a qualitative difference between Section 1, the limewashed face and the remaining Sections (2-5) in Figure 2. The measured differences could be due to the roughness of the external limewashed face in comparison to the smoother sawn surfaces or a lack of parallelism in the samples. Calculations indicate that there is a significant difference in the



Figure 1.

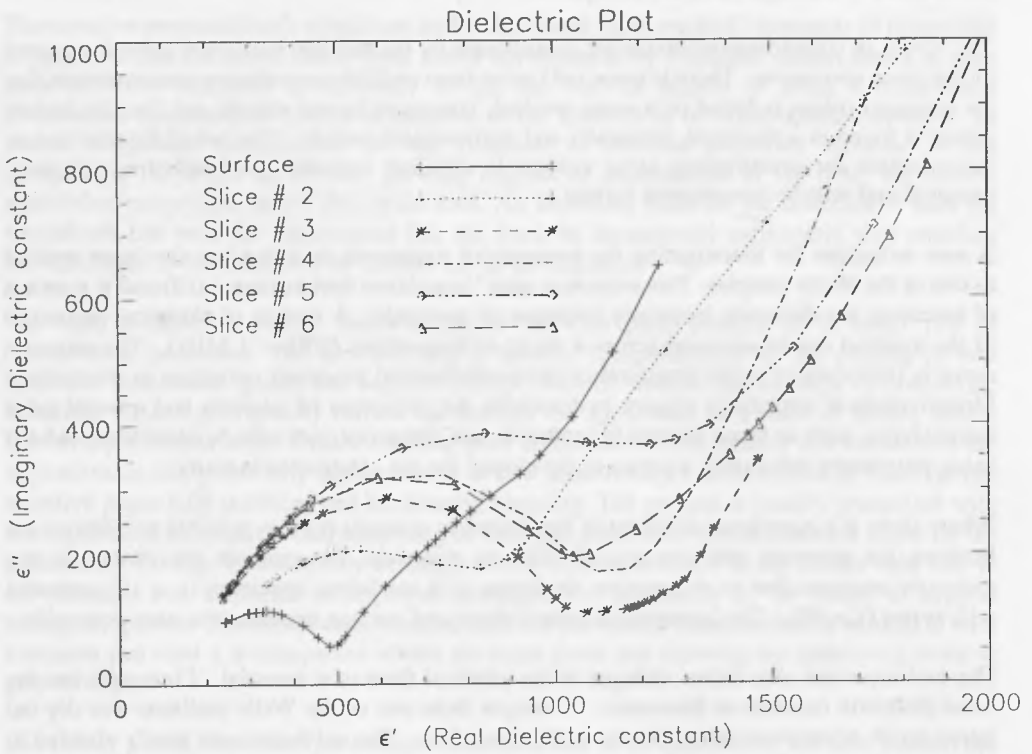

Figure 2.

measurements made on sample 1 in comparison to the other samples and that samples 2-5 are not significantly different from each other. This would suggest that the limewash treatment is detectable using impedance spectroscopy. One reason for this difference may be the different affinities for water between the limewash and the natural stone. The very large dielectric constant of water ($\epsilon = 80$) makes the impedance spectra very sensitive to the presence of water. If a coating has a different affinity to water then this should be detectable. Further studies are continuing on fresh material to confirm these ideas.

Future Research

This and other testing methodologies will be considered for development to enable long-term monitoring of the lime treatments to be more than just a visual surface condition assessment and to allow questions, posed by the results of the first survey, concerning the performance of individual processes in the treatment to be more fully explored. It seems likely at this stage that the question of the value of the limewatering phase may be the most salient of these, with the design and function of mortar capping repairs being another.

Much of the design for the lime treatment survey has been developed from the more established field trials of Brethane carried out with BRE which are described below.

Field trials using Brethane

Brethane is a three-component product based on an alkoxyalkylsilane which was developed at the Building Research Establishment during the 1970s and was marketed from 1983 onwards. The advantage of this system is that it overcomes the problem of largescale loss of impregnation material associated with other uncatalysed systems. It polymerises *in situ* to form a protective coating both on the exposed surface and on the internal pore walls. The polymer binds fragile decayed stone onto underlying sound stone. In the case of calcareous stones, it may protect the stone from chemical attack by acidic air pollutants.

The system also has some practical disadvantages, however, two of which are: that once it is mixed and applied, the conservator only has a limited amount of time in which to carry out any other procedures to the surface that may be applicable to a complex conservation problem, and, as currently formulated, the action of the catalyst may be destabilised by the presence of sodium chloride salt contamination in the stonework.

Brethane trials at English Heritage Sites

Detailed records of the application of Brethane and its performance at a number of buildings have been kept by English Heritage and BRE and an analysis of these records and the treated buildings is being undertaken.

The records of monitoring the effect of applying Brethane at 54 sites in the UK have been examined and the period and frequency of visits tabulated. Ten sites were identified for analysis of data trends. These sites have been revisited and the complete set of records analysed for trends in the visual appearance and surface decay of stonework by comparing treated areas to similar untreated areas of stone. The 10 sites were:

1. George III Temple, Audley End House, Essex
2. Berry Pomeroy Castle, Devon
3. Bolsover Castle, Derbyshire
4. Chichester Cathedral, West Sussex
5. Goodrich Castle, Hereford and Worcestershire
6. Howden Minster, North Yorkshire
7. Kenilworth Castle, Warwickshire
8. Rievaulx Abbey, North Yorkshire
9. Sandbach Crosses, Cheshire
10. Tintern Abbey, Gwent

Results

The treated stonework at each site was compared to a similar untreated area at the same site. Seven categories for assessment were defined together with criteria for awarding a performance 'score' in each category. A scoring system was based on

- (a) appearance of treated stonework on soiling (colour, state of cleaning, biological decay, decay relative to untreated stone)
- (b) condition of stonework (degree of powdering, scaling).
- (c) water repellence of treated stonework.

The overall observations for each site are given in Tables 1,2.

Table 1 shows the results of comparing Brethane treated and control areas soon after application. The table clearly shows that treatment with Brethane reduced biological growth, decay and water absorption. Table 2 shows the results from the most recent survey. The results show that although the treated areas are still benefiting from the use of Brethane, its effectiveness is declining. At most sites the biological growth has returned, water absorption has increased and the surface has started to decay after a period of stabilisation. The initial decline of biological growth is caused by the toxic effects of the silane monomer. The recolonisation of biological growths may be enhanced in some areas by the presence of a stable surface where Brethane was applied. All of these indicate that the Brethane in the immediate surface layer (1 - 2 mm) has weathered – probably by a combination of rain, frost and UV – and that the surface is now behaving a similar manner to the untreated control areas. The results also suggest that the Brethane is more successful when applied to limestones than sandstones. This may be due to the generally higher porosity and higher saturation coefficients of the particular limestones involved. It could also be due to the different decay mechanisms associated with limestones and sandstone – chemical versus mechanical decay. If Brethane is more successful at countering chemical decay (for example the effects of acid deposition) then it may be that its water repellent qualities may be as important as its stone strengthening properties.

Depth of Penetration of Consolidants

In 1985 cores were removed from the treated areas at Howden Minster, Kenilworth Castle, Berry Pomeroy Castle, and St.Catherine's Chapel, Abbotsbury. These cores were analysed

using FTIR spectroscopy and IR spectroscopy to establish if it were possible to measure the depth to which the Brethane had penetrated the stone. The results (Butlin *et al* 1991) show that it is possible to detect the presence of Brethane and that it has penetrated to a depth of up to 80 mm.

Conclusions

A number of conclusions can be drawn from this monitoring programme. The most important is that Brethane is generally successful in reducing the rate of degradation of stone and there is no evidence that treatment will have any detrimental effect. In addition it is clear that Brethane has reduced the rate of weight loss of stone blocks over the period studied. Initially, the reduction in decay rate can be substantial but the 'effectiveness' declines as the surfaces of untreated samples stabilise. It also seems that poorly durable stone that has a high porosity and a high saturation coefficient can be treated more effectively than a durable stone such as Portland. Integrated studies of the effectiveness of the stone preservative treatment Brethane have now been in progress for more than 20 years. The use of Brethane at a large number of English Heritage sites has been monitored since 1976 and a present series of exposure trials at St. Paul's Cathedral have been in progress for more than 14 years (Butlin *et al* 1991). These studies have demonstrated that chemical preservative treatments can substantially reduce the rate at which the stone samples decay. Brethane, for example, reduced the rate of weight loss for Tercé limestone (a stone of low durability) by more than 60%.

Future Research

Many issues related to stone consolidation demand further research. These include:

Tracing techniques. An immediate requirement is the identification and development of a suitable method for the reliable determination of consolidant deposition in stones naturally containing high levels of silica.

Retreatment. The results of the monitoring to date also point, not unexpectedly, to the need to critically examine the question of retreatment of silane applications, assessing the effects on both the consolidant and the stone of retreatment.

The deterioration noted is restricted to the first 1-2 mm. If the polymer is unaltered behind this layer, it might be possible to consider retreatment of a more superficial kind, even a lime shelter coat, presuming lack of substantial residual hydrophobicity of treated surface.

These issues are presently being examined by English Heritage and the Building Research Establishment in a continuing research programme. Current programmes also include:

- The analysis of the deterioration of the weathered Brethane consolidant and stone and comparisons of this to other silanes in use.
- The production of a national register of treated sites, initially encompassing silane cases but eventually expanded to include other types including lime treatments.

Summary

The debate in the UK concerning the use of stone consolidants has thus far suffered from a lack of reliably gathered information on the performance of treatments in use. It has also been polarised between supporters of "modern" treatments, silanes and "traditional" treatments, the lime-based methods. The assessment programmes being run by English Heritage aim to provide evaluation of in-use performance and to identify clearly areas requiring further research and development.

The lime method as described is very sensitive to practice parameters and under constant refinement in the field with some of the potentially more destructive procedures having been modified or eliminated. It remains true however that the contribution of each of the component processes is still largely unmeasured. Methodologies to enable such measurements are being developed.

Brethane has proven to reduce rates of deterioration in treated stones on the monitored sites, however this and broadly similar silane based treatments have been seen to perform below expectations elsewhere. A fundamental problem of polymer identification in certain stone types hinders pathology in these cases.

Evidence gathered to date suggests that both consolidant types have a relatively short service life in exposed weathering conditions; therefore research into the implications and frequency of retreatment is essential. Retreatment may not necessarily involve the application of the original consolidant and the use of lime-based shelter coats to protect weathered polymer consolidants will be investigated.

Acknowledgements

The provision of the section on impedance measurement by Dr S Massey is acknowledged.

References

Ashurst J, Ashurst N. (1988): *Practical building conservation, vol. 1. stone masonry*, Gower Technical Press, Aldershot.

Price C.A., Ross K. (1984): The cleaning and treatment of limestone by the 'lime method'. Part II A technical appraisal of stone conservation techniques employed at Wells Cathedral. *Monumentum*, 1984.

Butlin R.N. et al (1991). Studies of preservative treatments on historic buildings. In: *Proceedings of the European Symposium on Science, Technology and European Cultural Heritage*, Bologna 1989.

Schaffer R.J. (1932): *The weathering of natural building stones*, Garston, Building Research Establishment.

Table 1. Condition of treated stonework relative to untreated areas based on the first surveys undertaken at least 12 months after treatment.

Site	Yrs	Soiling	Biological Growth	Decay	Water Absorption
1. Audley End House	4	x	x	x	x
2. Berry Pomeroy Castle	3	x	x	x	x
3. Bolsover Castle	1	x	x	x	x
4. Chichester Cathedral	2	*	x	x	x
5. Goodrich Castle	2	*	x	x	x
6. Howden Minster	1	*	x	x	x
7. Kenilworth Castle	1	*	x	*	x
8. Rievaulx Abbey	1	x	x	x	x
9. Sandbach Crosses	5	nd	nd	nd	nd
10. Tintern Abbey	3	0	x	x	x

Yrs = No. of years since treatment

x = BETTER

* = SAME

0 = WORSE

nd = not determined

Table 2. Condition of treated stonework relative to untreated areas based on the 1991-2 survey.

Site	Yrs	Soiling	Biological Growth	Decay	Water Absorption
1. Audley End House	15	*	x	x	x
2. Berry Pomeroy Castle	9	*	x	x	x
3. Bolsover Castle	10	*	x	x	x
4. Chichester Cathedral	14	*	x	x	*
5. Goodrich Castle	14	*	*	*	*
6. Howden Minster	8	0	*	*	x
7. Kenilworth Castle	8	*	x	*	x
8. Rievaulx Abbey	13	x	x	*	*
9. Sandbach Crosses	16	nd	nd	nd	nd
10. Tintern Abbey	15	*	*	*	*

YRS = No. of years since treatment

x = BETTER

* = SAME

0 = WORSE

nd = not determined

METHODS USED TO EVALUATE THE EFFICACY OF CONSOLIDANTS ON AN AUSTRALIAN SANDSTONE

A. CASELLI

Tech-Dry Building Protection Systems Pty. Ltd., Melbourne, Australia

D. KAGI

Department of Chemistry and Biology, Victoria University of Technology, Melbourne, Australia

Abstract

Test methods employed to evaluate the viability of consolidating Bacchus Marsh sandstone from the Old Treasury Building in Melbourne, Australia are detailed. The parameters measured included; depth of weathering, depth of consolidation, depth of impregnation, capillary water absorption, water vapour permeability, compressive strength, Brinell surface hardness, visual appearance and durability in both artificial and natural environments. The results showed that consolidation satisfactorily strengthens the stone and makes it more resistant to weathering.

Keywords: Stone Consolidation, Stone Preservatives, Laboratory Evaluation Methods, Weathering.

1 Introduction

The Old Treasury building in Melbourne, Australia, is an imposing stone building built between 1858 and 1862. The building, which is heavily influenced by the Italian Renaissance style is considered to be one of the finest conservative classical structures in Australia. The conservation of the building is therefore of national importance.

The stone of the building is Bacchus Marsh sandstone. This stone is an even-grained stone made up of small grains of angular quartz in a clay-rich matrix. It is very soft and friable, and has an uneven light-brown appearance. This stone is classified as being of low durability. This inferior durability was recognised only after the building was constructed.

Many architectural elements on the building were weathered. The chemical consolidation of the weathered elements was envisaged as a way of retaining the original fabric of the building. Given the importance of the structure it was very difficult to obtain sizeable pieces of stone for testing purposes. Fortunately, the replacement of an original balustrade made available a sample of stone on which consolidation trials could be undertaken. The visual appearance and pattern of decay indicated that the sample was representative of the majority of the stone on the building. The sample contained approximately 0.3 square metres of weathered vertical stone face which could be used for testing purposes.

The consolidation of the samples of stone was carried out in the laboratory with several liquid materials. The properties of the treated stone samples were investigated by test methods and by artificial and natural weathering.

2 Test programme

2.1 Aim of test programme

The aim of the test programme was to select a consolidant which would satisfactorily strengthen the weathered areas without causing long-term deleterious effects. To assess the qualities of consolidated stone, some of the test methods focused on the natural and artificial weathering of samples. The viability of the application of consolidants in on-site conditions was also considered.

2.2 Consolidants tested

The consolidants tested were as follows:

Stone strengthener OH (OH)

Stone strengthener OH followed by Wacker 280 (OH + W280)

Stone strengthener H (H)

Brethane (Br)

The Stone Strengtheners and Wacker 280 are products of Wacker-Chemie GmbH. Brethane was supplied by Colebrand Pty. Ltd. The materials were used as supplied by the manufacturer except for W280 which was diluted to 6.7% V/V in white spirit.

2.3 Parameters measured

The parameters measured in the study were:

Depth of weathering.

Depth of consolidation.

Depth of impregnation.

Capillary water absorption.

Water vapour permeability.

The strength of consolidated stone.

2.4 Sample preparation

The balustrade block was cut into sample blocks as shown in Table 1. The blocks were dried at 105°C and conditioned at 20°C and 50% RH until constant weight was achieved.

2.5 Application of consolidants

The consolidants were flood applied to the selected surface using a squeeze bottle. The excess consolidant was allowed to drain freely away. The liquids were applied in cycles each consisting of five individual flood applications 5-10 minutes apart. The time between cycles was 40 minutes. The materials

Table 1. Description of sample blocks

Block size (mm)	Area of weathered Face (cm ²)	Consolidant applied to:	Tests performed
270x150x140 (Blocks A,B,C,D,E)	405	Weathered face only	All tests stated in 2.3. Part of these blocks were subjected to artificial weathering
130x190x140 (Blocks F,G,H,I,J)	247	Entire block	Strength and water absorption after natural weathering
49 Diameter x 63 long cores (Cores J1-M6)	Unweathered stone	Entire core	Compressive strength

were applied until no further significant absorption took place. Saturation generally occurred after 20 to 30 individual flood applications. The surfaces were washed with white spirit after the last application.

The liquids were applied to the vertical weathered faces only for the blocks of dimensions 270x150x140mm. All other stone samples were flooded on all faces. The samples were allowed to cure for two months before commencing the tests.

3 Test methods

3.1 Depth of weathering, consolidation depth and capillary water absorption

The capillary water absorption of stone is influenced by the presence and quantity of pore-blocking materials such as natural binder or consolidants. The measurement of capillary water absorption at depth increments from the surface is therefore a convenient way of estimating the depth of weathering and the penetration depth of consolidants.

The test method used to measure the parameters of depth of weathering, consolidation depth and capillary water absorption was to remove 50mm diameter cores in a plane perpendicular to the weathered (treated) surface. The extracted cores were sliced into approximately 5mm thickness discs. The discs were dried, weighed and laid on a water-saturated sponge as used in DIN 52617E. The capillary water absorption of each disc was measured after 24 hours.

The consolidation depth of samples consolidated with OH and H was additionally measured using the 1,5-diphenylthiocarbazone method (Weber and Höhl, 1988). The consolidation depth for Brethane was measured using the droplet test as this treatment effects water repellency.

3.2 Impregnation depth

The depth of impregnation was measured by splitting a core sample and observing the droplet effect at the split face.

3.3 Water vapour permeability

Water vapour permeabilities were carried out by the wet cup method outlined in DIN 52615 and AFNOR standard NFT 30 704. Due to the limited amount of sample available, discs of dimensions 49mm diameter x 10mm thickness were used. The discs were cut from cores removed perpendicular to the weathered (treated) faces of the blocks. The discs corresponded to a depth increment of 0-10mm in all samples except for the unweathered disc which came from within the main sample. The discs were mounted over jars with an opening diameter of 49mm which contained 70 ml of distilled water. The edges of the discs were sealed with wax-film tape and adhesive tape. The mounted specimens were placed in an environment of 3% relative humidity and 35°C. Weighings were commenced after 48 hours.

3.4 Strength of consolidated stone

Non-destructive tests using Brinell hardness values of the surface of the consolidated and unconsolidated stone were measured. These values should relate directly to the compressive strength of the surface. This method was chosen due to the relatively non-destructive nature of the test. Thus the Brinell hardness values of the samples subjected to weathering could be measured on the same sample before and after weathering. Any deterioration of the consolidant during weathering should be reflected in the lowering of the Brinell hardness.

Destructive testing in the form of unrestrained axial compressive strengths of unweathered and treated stone samples were performed to measure the increase in compressive strength. The tests were performed on both dry and completely water-saturated samples to ascertain the wet/dry compressive strength ratio. The length to diameter ratio of the cores was rather low (1.28:1) due to lack of sufficient stone. The absolute compressive strengths of the samples therefore are artificially high, but a comparison between the samples appears valid.

4 Results

4.1 Absorption rate of consolidant into stone

The absorption rate of the consolidants into the blocks and the deposition rate of solid binder is presented in Table 2 and Table 3. The initial absorption of consolidant, and final deposition of binder for block samples B-I (Table 2) was in the order: OH>H>Brethane. The order for core samples J1-M6 (Table 3) was OH \approx H>Brethane for percentage absorption, and H>OH>Brethane for percentage of binder deposited. Blocks C and G were impregnated with W280 three weeks after consolidation with OH.

Table 2. The absorption rate of consolidant and binder deposited in blocks

Block	Consolidant	Absorption (l/m ²)	Dry binder deposited (kg/m ²)
B	OH	6.5	3.3
C	OH	4.9	2.3
D	H	3.2	1.3
E	Brethane	1.9	1.2
F	OH	3.5	1.7
G	OH	3.4	1.5
H	H	2.9	1.2
I	Brethane	1.6	0.9

Table 3. The absorption rate of consolidant and binder deposited in cores

Cores	Consolidant	% Absorption by mass	% Dry binder deposited by mass
J1-J6	OH	8.9	3.7
K1-K6	OH	8.7	3.5
L1-L6	H	8.5	4.2
M1-M6	Brethane	5.2	3.3

4.2 Depth of weathering

Cores were removed from the untreated reference block A. The cores were cut into slices and the capillary water absorption measured as outlined in 3.1. From Fig. 1 it is clear that the depth of weathering was 15-20mm as shown by the water absorption of the untreated sample.

4.3 Depth of consolidation

Cores were removed from blocks B-E and treated as described in 3.1. The results of the capillary water absorption of each slice are presented in Fig. 1. The penetration depths are summarised in Table 4.

The liquid OH was the only material which penetrated beyond the weathered depth. Both H and Brethane did not penetrate sufficiently to bind the weathered 20mm thick layer onto the sound backing stone.

4.4 Depth of impregnation

The depth of impregnation of W280 in sample C was measured by the droplet effect to be 4-5mm.

Table 4. Penetration depth of consolidants into the stone samples

Product	Penetration depth
OH	30-40mm
H	15-20mm
Brethane	13-20mm

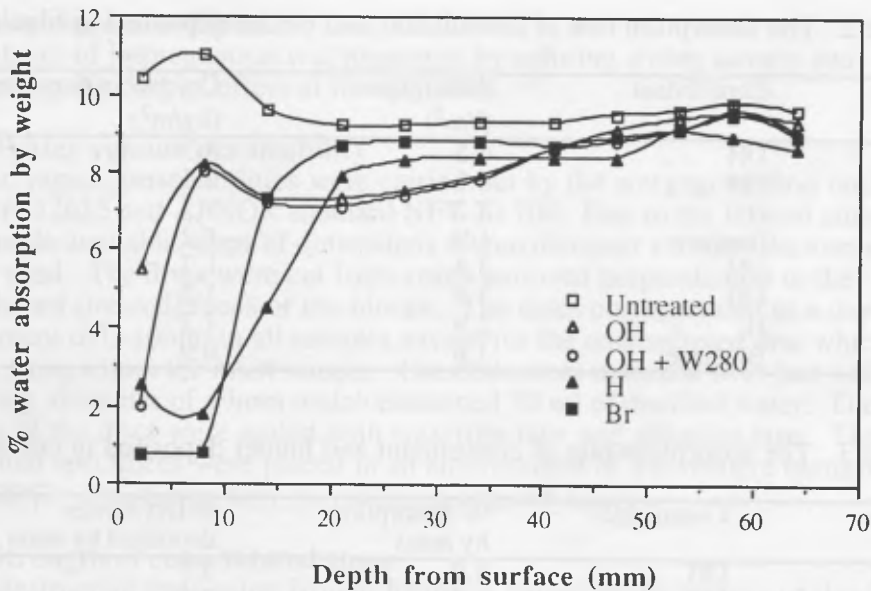

Fig. 1. Depth of weathering and consolidation depth

4.5 Water vapour permeability

The water vapour permeability was measured for the consolidated stone and weathered and unweathered stone. Fig. 2 shows the comparative water vapour permeabilities. Consolidation with OH reduced the water vapour permeability by 17% (relative to unweathered stone). Impregnation with W280 further reduced the permeability with a total reduction of 25%. The greater reduction of permeability brought about by H (40%) and Brethane (61%) is most probably due the high organo-silicon content of these two products.

4.6 Capillary water absorption

The capillary water absorption of discs 50mm in diameter and 10mm thick was measured. From Table 5, the order of reduction of water absorption was: Brethane > H > OH + W280 > OH. All products, with the exception of OH, drastically reduced the capillary water absorption.

Table 5. Capillary water absorption of treated and untreated discs.

Sample	Mean capillary water absorption (% by weight)
Weathered	10.1
Unweathered	9.2
OH	5.9
OH + W280	1.6
H	1.8
Brethane	0.4

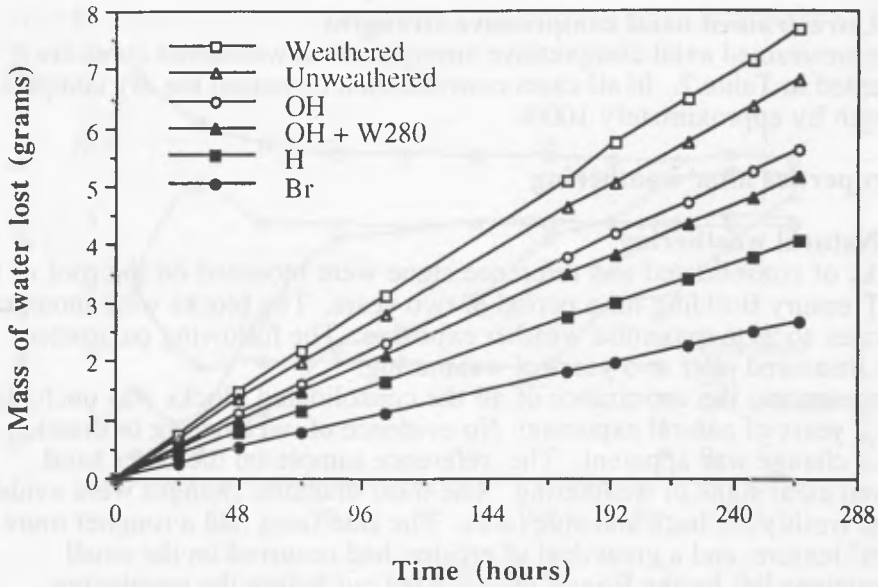

Fig. 2. Relative water vapour permeabilities

4.7 Brinell hardness

The Brinell surface hardness values (BH) measured before and after consolidation are presented in Table 6.

Table 6. Brinell hardness values before and after consolidation

Sample	BH Untreated	BH Consolidated	% Increase in BH
Untreated	7	---	---
OH	8	21	160
OH + W280	8	20	150
H	9	21	133
Brethane	10	17	70

Table 7. Unrestrained axial compressive (comp.) strengths of unweathered cores

Sample	Dry comp. strength (MPa)	Increase in dry comp. strength	Wet comp. strength (MPa)	Wet/Dry
Untreated	17.8	-----	9.0	0.51
OH	35.0	97%	21.5	0.61
OH + W280	36.0	102%	22.6	0.63
H	35.4	99%	22.3	0.63
Brethane	35.0	97%	22.3	0.64

4.8 Unrestrained axial compressive strengths

The unrestrained axial compressive strengths of unweathered cores are presented in Table 7. In all cases consolidation increased the dry compressive strength by approximately 100%.

5 Properties after weathering

5.1 Natural weathering

Blocks of consolidated and reference stone were mounted on the roof of the Old Treasury Building for a period of two years. The blocks were mounted on crates so as to maximise weather exposure. The following parameters were measured after two years of weathering:

Appearance: the appearance of all the consolidated blocks was unchanged after 2 years of natural exposure. No evidence of weathering or drastic colour change was apparent. The reference sample on the other hand showed clear signs of weathering. The most dramatic changes were evident on the freshly cut back and side faces. The side faces had a rougher more "open" texture, and a great deal of erosion had occurred on the small indentations left by the Brinell tests carried out before the weathering procedure. The small indentations became much larger and resembled the effects of alveolar erosion. The weights of the consolidated blocks were essentially unchanged. However, the reference block, lost 10.5 g (0.2% of the initial mass).

Brinell hardness: the Brinell surface hardness of the samples before and after natural weathering are presented in Table 8.

Table 8. Brinell hardness before and after natural weathering

Sample	BH Before treatment	BH Consolidated before weathering	BH Consolidated after weathering
Untreated	10	---	10
OH	11	23	24
OH + W280	10	26	24
H	12	24	29
Brethane	11	18	23

The results show that no loss in Brinell hardness occurred due to the weathering.

Water Absorption: the water absorption profiles after weathering are presented in Fig. 3. Failure of the consolidant or impregnant would be characterised by an increased water absorption, especially in the first 5-10mm layer from the surface. The only sample which showed an increase in water absorption in the first 5mm layer was sample H. The water absorption increased from 2.4% to 5.8%.

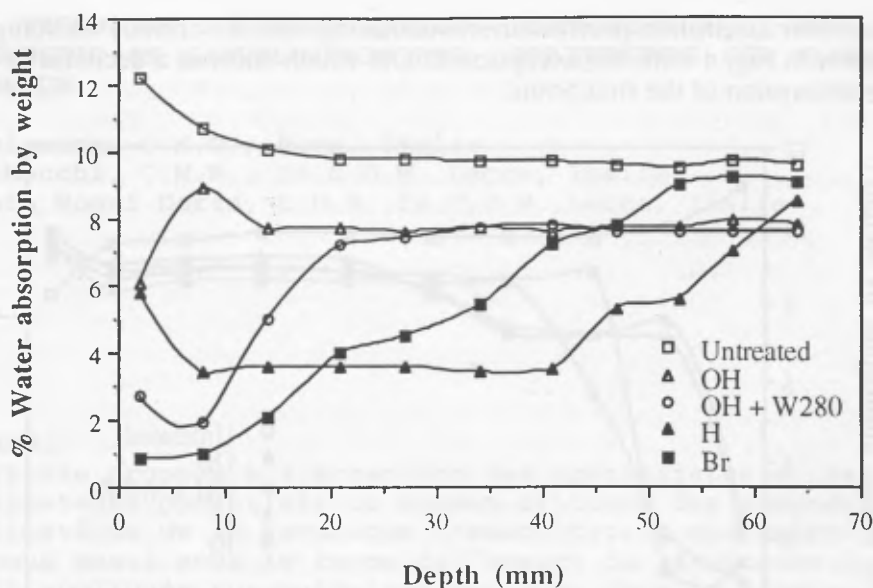

Fig. 3. Water absorption after natural weathering

5.2 Artificial weathering

Blocks measuring 70x105x60mm thick were cut from each of the main blocks (A), and (B-E) after consolidation, and mounted into the aluminium sample frames of a QUV Weathering Tester. The consolidated faces of the blocks were subjected to sequential periods of ultraviolet light followed by condensation. The programmed conditions were; 4 hours UV B irradiation at 70°C followed by 4 hours condensation at 50°C. The samples were continuously cycled in this manner for 2000 hours. After 2000 hours of weathering no change in appearance could be noted. The Brinell surface hardness of the samples are presented in Table 9. The hardness of samples OH and H decreased by approximately 25%. These surfaces were still about 100% harder than the untreated surfaces. Samples H and Brethane were unchanged.

Table 9. Brinell surface hardness before and after artificial weathering

Sample	BH Before treatment	BH Consolidated before weathering	BH Consolidated after weathering
Untreated	7	---	7
OH	8	21	16
OH + W280	8	20	16
H	9	21	19
Brethane	10	17	19

The water absorption profiles after weathering were essentially unchanged as shown in Fig. 4 with the exception of OH which showed a decrease in water absorption of the first 5mm.

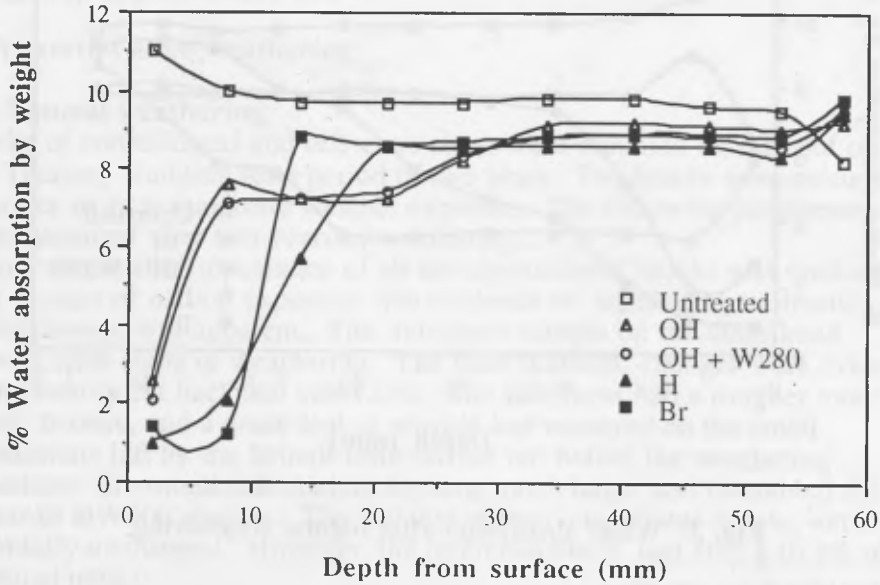

Fig. 4. Water absorption after artificial weathering

6 Conclusions

The test methods used showed that Bacchus Marsh sandstone from the Old Treasury Building may be successfully consolidated. Weathering trials showed that the materials did not weather out, nor did they appear to cause any deleterious effects. The increase in compressive strength achieved by the consolidants was around 100% which was sufficient to stabilise the friable weathered surfaces. The most suitable consolidant was found to be OH due to its ability to penetrate past the weathered zone of the stone. The liquids H and Brethane were not suitable as consolidants as the test methods showed that these materials did not penetrate past the weathered zone. Additionally, Brethane is a multi-component system which would be very difficult to prepare and apply on the building site.

7 Reference

Weber, H. and Höhl, H. (1988): Verfahren zur Bestimmung der Eindringtiefe von Steinfestigungsmitteln auf der Basis von Kieselsäurester Verbindungen. *Bautenschutz und Bausanierung* 11, 200-204.

LA TECHNIQUE D'AUSCULTATION MICROSIsmIQUE POUR LE DIAGNOSTIC ET L'EVALUATION DES TRAITEMENTS SUR MATERIAUX PIERREUX

G.Chiesura, C.N.D., Roma, Italie

A.M.Mecchi, C.N.R., Is.C.O.M.,Lecce, Italie

P.Rota Rossi Doria, C.N.R.,Is.C.O.M.,Lecce, Italie

Résumé.

L'article propose à l'attention des spécialistes et des utilisateurs potentiels un examen critique des nombreuses applications de la technique d'auscultation microsiémique (connue aussi sous le terme de "mesure de la vitesse du son") appliquée sur matériaux employés dans le domaine des biens architecturaux. Le but est de bien préciser, ou cela est possible, les applications les plus performantes de la technique ainsi que les améliorations qu'il semble possible et opportun d'introduire dans l'instrumentation, dans les procédures d'opération et les traitements des résultats.

Abstract.

A critical review of the specialized literature dealing with the application of microsiemic technique ("pulse velocity" or "ultrasonic velocity" measurements) in the fields of historic building is presented.

The most promising exploitation of the technique and some possible improvements in the equipment, codes of practice and data processing are specified.

Keywords: Microsiemic, Pulse Velocity, Ultrasonic Velocity, Historic Building, Diagnosis, Treatments.

1 Introduction.

La technique de l'auscultation microsiémique (couramment dite des "ultrasons") est largement utilisée pour évaluer l'état des matériaux pierreux, et notamment les changements induits dans leur caractéristiques physico-mécaniques soit par les agents de dégradation, soit par les traitements de

consolidation. Lorsque cette technique est appliquée, la vitesse des ondes de compression ("ultrasoniques") est le paramètre le plus couramment pris en compte, assez souvent le seul. Les descriptions de la technique sont nombreuses (Mamillan, 1972 et 1988; Chiesura, 1985).

Après 40 ans d'application², nous estimons qu'il soit utile, et sous certains aspects nécessaire, se pencher sur ce qui a été publié dans la littérature, avec un but de révision critique et afin de contribuer à une meilleure application de la dite technique. Cette révision est limitée, pour le moment, aux matériaux pierreux, tandis que l'analyse des applications sur structures fera l'objet d'une prochaine étape.

La recherche bibliographique dont il est question a été faite auprès des bibliothèques de l'ICCROM (Rome), du CEBTP de Paris et de CND de Rome, ces deux derniers Organismes étant spécialisés dans la recherche et l'application de la technique en question. En outre, nous avons examiné les éditions de quelques journaux internationaux et les Actes des Congrès les plus importants à partir de 1982.

Du fait que les publications les plus importantes antérieures à la date susdite sont souvent citées dans les articles plus récents, nous pensons avoir sélectionné un échantillon significatif de la littérature sur le thème en objet.

Des 200 textes repérés, nous en avons sélectionné 50, qui composent la bibliographie et qui ont été à la base de cette revue critique. Les critères de sélection ont été essentiellement: la qualité scientifique, un caractère de nouveauté, l'ampleur de la base expérimentale et de la bibliographie.

Du point de vue de leur application les travaux peuvent être classés en deux groupes différents:

A) Etudes qui sont dédiées essentiellement à la mise au point de méthodologies pour formuler des diagnostics et des projet d'intervention: caractérisation des matériaux, effets de vieillissement naturel et artificiel, détection des mécanismes d'altération, d'indices de qualité et durabilité, établissement de corrélations entre la vitesse du son et d'autres paramètres physiques. Dans cette catégorie se situe environ le 85% des articles.

B) Recherches concernant plus spécifiquement l'application de la technique microsismique à un tri des produits de consolidation et/ou à l'évaluation des leurs effets. Dans ce groupe se situe environ le 23% des articles.

Un telle disproportion numérique peut être expliquée par des considérations diverses.

L'insuffisance des techniques non destructives pour le diagnostique en situ, et la nécessité toujours croissante d'en disposer de plus en plus fiables, a produit une expérimentation intense, qui a eu le confort de résultats satisfaisants, grâce aussi à la possibilité (très importante) de "valider" la méthode en situ par des essais en laboratoire.

Par contre, pour le choix et l'évaluation des effets des produits de consolidation, les laboratoires disposent d'une large gamme de techniques, et la microsismique n'a d'intérêt que pour sa spécificité d'être non destructive (ce qui n'est pas négligeable car elle permet de réduire le nombre d'échantillons).

Il faut aussi considérer que la technique microsismique a eu son origine, et a trouvé ses premières applications, dans des secteurs très différents par rapport à celui de la conservation des pierres: par conséquence, la plus faible quantité des recherches dans le domaine de la consolidation s'explique aussi par le fait d'être d'un intérêt limité aux spécialistes de cette branche moins vaste.

2 Remarques générales.

Si on examine les textes retenus du point de vue des objectifs des recherches, on doit signaler des articles (Crnovic, 1982; Guerrero et al., 1989; Azzoni et al., 1992; Karpuz & Gunhan Pasamehmetoglu, 1992) qui sont dédiés spécifiquement au classement et à l'individuation d'indices de qualité des pierres de carrière destinées à la construction. Toutes ces études, qui se situent dans le cadre d'une approche méthodologique établi en France déjà en 1951 (Mamillan, 1958), sont à remarquer car ils sont utiles pour l'établissement de paramètres de diagnostique à la mise au point d'une technologie de la substitution.

A ce sujet, il faut remarquer que la substitution est très souvent pratiquée sans une expérience adéquate.

Un des textes signalés (Azzoni et al., 1992) porte sur plus de 500 échantillons de marbres et diorites; les auteurs proposent aussi une classification des méthodes d'essais suivant leur "capacité en diagnostique", soit leur pouvoir résolutif dans les problèmes de diagnostic. La mesure de la vitesse du son figure en quatrième position (pour l'étude des marbres), après les essais mécaniques de rupture à la compression, à la traction, et la dureté ponctuelle.

Toujours du point de vue méthodologique, semblent assez prometteuses soit:

a) l'analyse comparée sur pierres similaires (par composition minéralogique et structure des pores) qui font partie d'ouvrages exposés à des milieux différents (Martinet et al., 1993) ou bien mises en oeuvre sur des parties diverses d'un ouvrage ayant des altérations diversifiées (Martin-Patino et al., 1992), soit
b) l'étude des effets du vieillissement naturel sur des échantillons divers du même matériau, exposés sur des longues périodes dans des milieux différents (Simon & Snethlage, 1993).

Une mention à part mérite l'application de la technique au marbres, dont l'anisotropie joue un rôle important soit dans les processus de dégradation soit dans l'efficacité des consolidations. Le problème est souvent traité d'une manière remarquable (Accardo et al., 1981; Laurenzi Tabasso et al., 1988, 1 et 2; Calleja et al. 1989; U. Zezza, 1991; Navarro et al., 1994); partout on trouve une résolution très fine dans la définition de l'anisotropie par la mesure de la vitesse du son.

Une bonne corrélation est obtenue entre les mesures microsismiques et les altérations visibles, surtout lorsqu'il est possible d'effectuer une comparaison entre les mesures "par transparence" et celles "de surface" (Galan et al., 1991): ceci permet de rédiger un "mappage" non subjectif de la dégradation et un projet d'intervention détaillé, ce qui est d'une importance non négligeable lorsqu'il s'agit de monuments complexes ou d'une grande extension (Rodrigues-Navarro et al., 1994).

A propos du traitement d'un grand nombre de données, il apparaît intéressant de signaler les articles concernant des traitements statistiques poussés (Mamillan, 1988), l'emploi du "formal concept analysis" comme aide à l'anamnèse d'une situation pathologique (Simon et al., 1994) et le recours à la tomographie (Montoto et al., 1994).

3 Corrélations entre la vitesse du son et d'autres paramètres.

La recherche de fonctions de corrélation entre la vitesse du son et d'autres propriétés physiques des pierres a toujours été une des préoccupations majeures des chercheurs, ne serait que pour l'avantage de disposer d'une technique non destructive, qu'on puisse appliquer "in situ", qui soit possible corréler à des paramètres des pierres qui ne peuvent être connus que par des mesures destructives, sur échantillons.

Nombreux sont les articles qui publient des graphiques de corrélation entre la vitesse du son et la résistance en compression de différents types de pierres.

Les premiers datent de 1958 (Mamillan, 1958), où l'on propose une liaison directe entre la vitesse du son et la "compacité" de la pierre, l'inverse étant la "porosité" et la "fissuration". (On fait aussi mention à une corrélation entre la vitesse du son et le prix au m³ de 6 types différents de pierres). Depuis, les recherches dans le domaine des corrélations entre la vitesse du son et d'autres paramètres (en particulier l'absorption d'eau, la densité apparente et la résistance mécanique) s'intensifient (Accardo et al., 1981; Esbert et al., 1989; Christaras, 1991; Verges-Belmin et al., 1991; Villegas et al., 1994; Galan & Carretero, 1994).

Pour ce qui concerne la précision des mesures de la vitesse du son, surtout en comparaison avec la précision de la mesure d'autres paramètres physiques (par ex: la densité, la porosité, l'absorption d'eau, etc.), nous citons l'exemple d'une procédure exemplaire basée sur le recours à la statistique (Mamillan, 1988): où il est question d'un chapitre dédié à la "Dispersion des méthodes d'essais", sur éprouvettes de pierres calcaires. L'auteur obtient une erreur de l'ordre de 0,5% dans la mesure de la vitesse du son, tandis que dans la mesure de la densité il semble que l'erreur soit de 1%, et de 7,5% dans la mesure de la dureté superficielle (par la mesure de la largeur de la rayure). L'article est remarquable pour le large emploi de la statistique, et intéressant pour les nombreuses corrélations qui sont fournies, dans un cadre de souci de grande rigueur. Les corrélations (Coefficient c) plus "fiables" sont celles de la vitesse du son avec la rupture en compression ($c = 0,950$), avec la densité apparente ($c = 0,939$) et avec la dureté superficielle ($c = 0,931$).

4 La technique pour l'évaluation des effets des traitements de consolidation.

La technique microsismique est aussi employée pour l'évaluation des effets des traitements de consolidation, et il apparaît qu'elle est en mesure d'apporter des résultats intéressants surtout lorsqu'elle est utilisée avec d'autres paramètres: la porosité et la distribution des pores, les variations du poids, la résistance à la compression, la dureté superficielle et la profondeur de pénétration du produit de consolidation dans la pierre (Nishiura et al., 1984; Laurenzi Tabasso et al. 1988 et 1990;

Verges-Belmin et al. 1991; Galan, 1994; F.Zezza, 1994, Villegas et al 1994).

Les résultats obtenus (Rossi Manaresi & Ghezzi, 1978) sur du grès avant et après traitement par différents types de produits, donnent une corrélation entre l'augmentation de la résistance à compression et l'augmentation de la vitesse du son de ce genre: Résistance + 118% + 68% + 53% + 43% / Vitesse du son respectivement: + 65%, + 55%, + 50% + 10%.

Pour en venir à des recherches plus récentes (Laurenzi Tabasso et al, 1990) nous signalons les résultats de mesures ultrasoniques sur des tufs volcaniques italiens, avant et après traitement. D'après les données fournies, la vitesse du son dénonce une augmentation de l'ordre de 105,7% après traitement, alors que l'absorption d'eau par capillarité dénonce une diminution de l'ordre de 77% et 95% et la porosité intégrale ouverte une diminution de l'ordre de 60%. L'augmentation en poids a été de 15%.

Sur d'autres échantillons du même matériau, lorsque la résistance à la compression simple augmente de 131% (de l'ordre de 0.37 KN/cm²), la vitesse du son augmente de 37,4%; lorsqu'elle augmente de 125% la vitesse augmente de 8,5% et lorsqu'elle augmente de 94 % la vitesse du son augmente de 5,2%, les autres paramètres étant pratiquement inchangés. Rappelons que les valeurs de vitesse sont la moyenne des vitesses dans les trois directions et que le matériau est très anisotropique.

Dans un autre article (Laurenzi Tabasso et al., 1988) les mêmes auteurs font état des résultats, entre autres, de la détermination de la résistance à la compression simple sur échantillons de marbre et tufs traités par deux différents produits. Sur marbre, une augmentation de résistance de 102% comporte une augmentation de vitesse de 152% et pour une augmentation de 16% de la résistance la vitesse augmente de 80%; sur tuf une augmentation de résistance de 850% comporte une augmentation de la vitesse de l'ordre de 105%, et pour une augmentation de résistance de 50% la vitesse augmente de 21%.

Dans le tableau comparatif des résultats obtenus avec deux produits de traitement, on voit clairement que la vitesse augmente dans la même proportion que le poids et la résistance (surtout dans le marbre), et d'une manière bien plus sensible que les paramètres corrélés à l'absorption d'eau.

Il faut tout de même remarquer que, compte tenu des difficultés inévitables qu'on rencontre lorsque l'on veut caractériser le système complexe "pierre-produit" qui se forme dans le matériau, un examen superficiel des résultats des essais peut amener à des conclusions erronées.

Il apparaît donc nécessaire de souligner ceci :

- Entre une pierre traitée et une non traitée, la vitesse du son met bien en évidence une différence de comportement seulement lorsque le produit est pénétré en profondeur; dans ce sens la technique se révèle un instrument plus sensible dans le cas de pierres poreuses ou très altérées. Par contre, la mesure de la dureté superficielle est plus performante dans le cas des pierres consolidées en surface (signalons par ailleurs une très bonne corrélation entre la vitesse du son avec des mesures "de surface" et la dureté superficielle), (Verges-Belmin et al, 1991; Villegas et al, 1994; Galan & Carretero, 1994).

- L'augmentation de la vitesse des ultrasons dans les échantillons traités témoigne d'un remplissage des pores, mais ceci n'assure pas que le but principal du traitement est atteint, à savoir : "la cohésion du matériau altéré et l'adhérence entre ceci et le matériau sain sous-jacent" (doc. NORMAL - 20/85, Commission C.N.R. Ministère Italien des Biens Culturels). Il s'agit d'un problème fondamental, dont il est question déjà dans les premières recherches systématiques sur l'efficacité des traitements de conservation (Rossi Manaresi & Ghezzi, 1978), et il a été étudié d'une manière approfondie dans le cadre d'une ample révision critique des méthodes d'évaluation des traitements (Laurenzi Tabasso et al., 1991).

Dans cette dernière étude il est mis en évidence, aux effets d'une interprétation correcte des résultats de la mesure de la vitesse du son, qu'il est nécessaire d'évaluer l'incidence de la nature chimique des produits de consolidation utilisés. En effet, il faut remarquer que les recherches sur les applications spécifiques des mesures microsismiques à des produits de type différent sont presque totalement absentes, tout au moins dans la littérature du secteur de la conservation.

Il faut aussi remarquer que les études sur les effets de la consolidation prévoient presque toujours l'exécution de vieillissements artificiels, surtout lorsque ces effets simulent des mécanismes qui intéressent la "masse" du matériau, tels que la cristallisation de sels et la sensibilité au gel. Ces procédures de vieillissement non seulement permettent une évaluation par comparaison du comportement des matériaux traités, mais ils augmentent la signification des résultats des essais (mesures microsismiques, mécaniques, d'absorption d'eau, porosimétriques, etc.) qui sont exécutés avant et après le dit vieillissement: ils rendent donc plus facile l'interprétation la plus correcte des phénomènes en étude.

5 Conclusions.

On peut affirmer avec raison que la technique microsismique est un outil souvent indispensable pour le diagnostic en situ. Même si, en raison des multitudes des compositions et des structures des pierres, on est pas encore arrivés à l'établissement de paramètres et de valeurs "limites" d'indices de qualité et de durabilité, valables partout, cette technique permet néanmoins des évaluations qualitatives et des "suivis" sur place qui sont devenus irremplaçables.

Il est à souligner que les résultats de la dite technique sont d'autant plus significatifs que le nombre d'autres paramètres mesurés augmente, et augmente ainsi la possibilité de détecter et de suivre des "tendances de comportement" du matériau. Dans ce sens, les caractéristiques mécaniques (densité apparente, absorption d'eau, porosité et distribution des pores, résistance mécanique à la compression et de la surface) sont celles qui montrent la meilleure corrélation avec la vitesse du son.

D'une importance primaire est aussi la valeur "statistique" des résultats des mesures microsismiques, qui augmente avec le numéro des données comparables à prendre en compte.

De ce point de vue, il nous semble important de souligner que seulement le 38% des articles examinés signalent d'une manière explicite les Normes ou les Recommandations de référence: parmi les plus citées les ASTM 597, ASTM 2845, ASTM D3967-86, AFNOR NF B 10-505 (1973), Recommandations RILEM TC 25-PEM, Recommandations NORMAL-22/86 seule document - à notre connaissance - qui a pour but de régler l'application de la technique en question aux procédures dans le domaine des Monuments).

De plus, dans le 58% des cas les auteurs ne décrivent pas l'appareillage de mesure et la méthodologie adoptée.

Ce manque de coordination et d'homogénéité dans l'application de la technique, la diversité des matériaux examinés (marmes, granits, calcaires, grès, tufs, etc) ainsi que leur différent état (pierre de carrières, massifs, matériau de récupération, prélèvement des monuments, etc.), si d'un coté expliquent l'impossibilité d'extrapoler des paramètres quantitatifs ayant une validité générale à partir des résultats des recherches, de l'autre coté rendent urgent le recours à un véritable "code of practice".

Ce modèle de comportement devrait comprendre:

- a) la référence systématique à des Normes ou à des procédures codifiées;
- b) l'utilisation de transducteurs (d'émission et de réception) de type ponctuel, de façon à réduire au minimum (3 à 5 mm²) la surface de contact avec le matériau et, surtout, de façon à rendre la forme du signal indépendante de la pression du transducteur sur le matériau;
- c) l'utilisation d'un appareillage permettant de visualiser le signal en réception (oscilloscope), et d'effectuer la mesure du temps par réglage manuel ou par réglage automatique contrôlable: la mesure du temps par simple comptage automatique aveugle est décidément à proscrire;
- d) l'utilisation d'un appareillage permettant d'enregistrer (sur support magnétique) soit le signal d'émission soit le signal en réception, pour leur visualisation et pour tout traitement ultérieur.

En effet, nous avons montré d'avoir le confort de plusieurs auteurs lorsque nous affirmons que l'examen de la forme des signaux apporte des renseignements complémentaires très importants sur l'état du matériau et notamment sur son évolution. Or, si l'on veut disposer de signaux comparables, il faut absolument que les conditions de mesures soient comparables, et donc que la forme des signaux soit indépendante de toute condition autre que l'état du matériau (par exemple, la pression du transducteur sur le matériau, l'interposition de produits de couplage, etc.).

De plus, le traitement des signaux dans le domaine fréquentiel apporte des renseignements précieux concernant l'énergie y contenue ("spectre fréquentiel"), et donc sur la perte d'énergie du signal en réception par rapport à l'énergie introduite à l'émission, lorsque le matériau s'est dégradé.

La comparaison entre les valeurs du rapport de l'énergie introduite et celle reçue est un autre élément de jugement important sur l'évolution de l'état du matériau, soit en négatif pour une progression de la pathologie, soit en positif pour l'intervention bénéfique d'une consolidation. Mais pour cela, il faut s'assurer que le signal traité soit bien celui qui a intéressé le matériau et non celui relatif aux caractéristiques d'émission du transducteur et/ou à la bande limitée du récepteur.

Il semble donc que le temps soit arrivé pour que, tout d'abord, les fabricants et les utilisateurs de la technique microsismique abandonnent les transducteurs actuellement en usage et qu'une nouvelle génération d'instruments soit utilisée afin de permettre d'exploiter au maximum les possibilités de diagnostic de la méthode.

Il faut ensuite s'appliquer à l'étude d'autres paramètres que la seule vitesse des ondes de compression (longitudinales), mais pour cela il est nécessaire de disposer de signaux d'une fiabilité totale et de logiciels de traitement assez performants, ce qui implique un investissement non négligeable en ressources financières et en matière grise.

De plus, il est à notre avis nécessaire que les Maîtres d'Oeuvre et les Maîtres d'Ouvrages favorisent l'application expérimentale correcte de la méthode microsismique, soit en demandant son utilisation, soit en exigeant le respect de Normes et Réglementations, soit en prévoyant les budgets nécessaires.

Liste des Revues et des Actes des Congrès qui ont été examinés pour la rédaction de cet article:

- Studies in Conservation, the Journal of the International Institute for conservation of historic and artistic works, 1990-1994.
- Durability of Building Materials, International Journal, Elsevier Science Publisher, 1982-1988.
- Science and Technology for Cultural Heritage, International Journal, CNR, Gardini Editori e Stampatori, Pisa, 1992-1994.
- Int. Congress "Deterioration and Conservation of Stone", Lausanne 1985, Torun 1988, Lisbon 1991.
- Int. Symposium "The Conservation of Monuments in the Mediterranean Basin", Bari 1989, Geneve 1991, Venice 1994.
- Int. Conference "Non-destructive testing, microanalytical methods and environment evaluation for study and conservation of works of art", Rome 1983, Perugia 1988, Viterbo 1992.
- Int. Symposium "The engineering geology of ancient works, monuments and historical sites", Athens 1988.
- European Symposium "Science, technology and european cultural heritage", Bologna 1989.
- Congres Int. "Adhesifs et Consolidants", Paris 1984.
- Int. Meeting "Lavas and vulcanic tuffs", Easter Island, 1990.

R E F E R E N C E S

- ACCARDO, G., MASSA, S., ROSSI-DORIA, P., SAMMURI, P. and TABASSO, M. (1981): Artificial weathering of Carrara marble: relationships between the induced variations of some physical properties. In "The Conservation of Stone", Preprints of the Contributions to the International Symposium, Bologna, Oct., 27-30 1981, 243-273.
- ALMESBERGER, D. and TONCIC, M. (1994): Impiego dei Controlli non distruttivi per la diagnosi strutturale dei monumenti in pietra, esempi ed applicazioni. In "The conservation of monuments in the Mediterranean Basin". Proceedings of the 3th International Symposium, Venice, June, 22-25, 1994, 53-63.
- AZZONI, A., BAILO, F., RONDENA, E. and ZANINETTI, A. (1992): Mechanical, chemical and petrographical evaluation of stone degradation induced by different laboratory techniques. In Proceedings of the 7th International Congress on Deterioration and Conservation of Stone, Lisbon, Portugal, June 15-18, 1992, 827-836.
- BELLO, M.A., MARTIN, L. and MARTIN, A. (1992): Decay and treatment of macael white marble. In Studies in Conservation, The journal of the international institute for conservation of historic and artistic works, vol. 37, n. 3, August, 1992, 193-200.
- BOUINEAU, A. (1978): L'interet des essais non-destructifs pour l'etude de la restauration des monuments et des sculptures. In "Deterioration and Protection of Stone Monuments", International Symposium RILEM/UNESCO, Paris, June, 1978, IV, 7.15.
- CALLEJA, L., MONTOTO, M., GARCIA, B.P., SUAREZ DEL RIO, L.M., MARTINEZ HERNANDO, A. and MENENDEZ VILLAR, B. (1989): An ultrasonic method to analyse the progress of weathering during cyclic salt crystallization laboratory tests. In "The conservation of monuments in the Mediterranean Basin", Proceedings of the 1th International Symposium, Bari, June, 7-10, 1989, 309-312.
- CHIESURA, G., LAURENZI TABASSO, M. and MASSA, S. (1983): Misure ultrasonore nella diagnosi delle opere d'arte: la colonna Traiana di Roma. 1th International Conf. on non-destructive testing for conservation of works of art, Rome, I/9.1 - I/9.24.
- CHIESURA, G. (1985): L'auscultation des matériaux par ultrasons sur monuments d'époque romaine à Rome: quelques exemples d'application. In Proceedings of the 5th International Congress on Deterioration and Conservation of Stone, Lausanne, Sept. 25-27, 1985, 67-77.
- CHRISTARAS, B. (1989): Weathering of granites and mechanical behaviour changing in northern Greece. In "The conservation of monuments in the Mediterranean Basin", Proceedings of the 1th International Symposium, Bari, June, 7-10, 335-339.
- CHRISTARAS, B. (1991): Old stone bridges in Epirus, Greece: hardness test using a thin section lapping machine. In "The conservation of monuments in the Mediterranean Basin", Proceedings of the 2nd International Symposium, Genève, Nov. 19-21, 1991, 453-462.
- CRNKOVIC, B. (1982): Nondestructive method in determination of technical properties of natural stones. In "Durability of building materials", vol. 1, 1982, 35-47.

ESBERT, R.M., VALDEON, L., ORDAZ, J., ALONSO, F.J. and GROSSI, C.M. (1989): Ultrasonic velocity and humidity in monumental stones. In "Science, Technology and European Cultural Heritage", Proceedings of the European Symposium, Bologna, June, 13-16, 1989.

GALAN, E. and CARRETERO M. I. (1994): Estimation of the efficacy of conservation treatments applied to a permotriassic sandstone. In "The conservation of monuments in the Mediterranean Basin", Proceedings of the 3th International Symposium, Venice, June, 22-25, 1994, 947-954.

GALAN, E., GUERRERO, A., VAZQUEZ, A., MAERT, F. and ZEZZA, F. (1991): Marble weathering: Relation between ultrasonic data and macroscopic observations. The case of the columns of the court of the Lions at the Alhambra in Granada, Spain. In "The conservation of monuments in the Mediterranean Basin", Proceedings of the 2nd International Symposium, Genève, Nov. 19-21, 1991, 193-207.

GARCIA DE MIGUEL, J.M., SANCHEZ CASTILLO, L. and GONZALEZ AGUADO, M.T. (1994): Characterization and Deterioration Causes of the Novelda Stone. In "The conservation of monuments in the Mediterranean Basin", Proceedings of the 3th International Symposium, Venice, June, 22-25, 1994, 547-554.

GUERRERO, M.A., VAZQUEZ, M.A., GALAN, E. and ZEZZA, F. (1989): The physical-mechanical properties and ultrasonic data as criteria for evaluation of calcareous stone decay. In "The conservation of monuments in the Mediterranean Basin", Proceedings of the 1th International Symposium, Bari, June, 7-10, 1989, 309-312.

HEGAO, S., CHENGJUANG, Z., XINHUA, L., GUODONG, F., CHENGZONG, C., SHICHUM, W., JIQIONG, C. and SONGRONG, L. (1988): New application of sonic detection in examining the effectiveness of reinforcement of Dazu carved stone, China. In "The Engineering Geology of Ancient Works, Monuments and Historical Sites", Proceedings of an International Symposium Organized by the Greek National Group of IAEG, Athens, Sept. 19-23, 1988, 983-987.

HEIMAN, J.L. (1988): How useful is short-term testing in the assessment of the long-term durability of sandstone?. In Proceedings of the 6th International Congress on Deterioration and Conservation of Stone, Torun, Sept. 12-14, 1988, 356-366.

KARPUZ, C. and GUNHAN PASAMEHMETOGLU, A. (1992): Rock mechanics characteristics of Ankara andesites in relation to their degree of weathering. In Proceedings of the 7th International Congress on Deterioration and Conservation of Stone, Lisbon, Portugal, June 15-18, 1992, 39-46.

KOACS, E. (1988): Structural reasons the decay of the building and decorative stone. In Proceedings of the 6th International Congress on Deterioration and Conservation of Stone, Torun, Sept. 12-14, 1988, 132-137.

KOHLER, W. (1988): Preservation Problems of Carrara Marble Sculptures Potsdam-Sanssouci (Radical Structural Destruction of Carrara Marble). In Proceedings of the 6th International Congress on Deterioration and Conservation of Stone, Torun, Sept. 12-14, 1988, 653-662.

LAURENZI TABASSO, M., MECCHI, A.M., SANTAMARIA, U. and VENTURI, G. (1988): Consolidation of stone 1: Comparison between a treatment with a methacrylic monomer and the corresponding polymer. In "The Engineering Geology of Ancient Works, Monuments and Historical Sites", Proceedings of an International Symposium Organized by the Greek National Group of IAEG, Athens, Sept. 19-23, 1988, vol. 2, 933-938.

LAURENZI TABASSO, M., MECCHI, A.M., SANTAMARIA, U. and VENTURI, G. (1988): Consolidation of stone 2: Comparison between a treatment with a methacrylic monomer and with alkoxy-silanes. In "The Engineering Geology of Ancient Works, Monuments and Historical Sites", Proceedings of an International Symposium Organized by the Greek National Group of IAEG, Athens, Sept. 19-23, 1988, vol. 2, 939-942.

LAURENZI TABASSO, M., MECCHI, A.M. and SANTAMARIA, U. (1990): Interaction between volcanic tuff and products used for consolidation and waterproofing treatment. In "Lavas and Volcanic tuffs", Proceedings of the International Meeting, Easter Island, Chile, Oct., 25-31, 1990, 173-190.

LAURENZI TABASSO, M., MECCHI, A.M. and SANTAMARIA, U. (1991): Confronto monomeri e polimeri per il consolidamento del marmo e revisione critica della metodologia per la valutazione dei trattamenti. In "The conservation of monuments in the Mediterranean Basin", Proceedings of the 2nd International Symposium, Geneva, Nov. 19-21, 1991, 355-369.

MALESANI, P.G., MANGANELLI DEL FA', C. and SABATINI, G. (1984): Sulla utilizzazione degli ultrasuoni per indagini sullo stato di degrado di opere in materiale lapideo. In "Materiali Lapidei, problemi relativi allo studio del degrado e della conservazione", Bollettino d'Arte, Suppl. n. 41, 1984, 129-132.

MAMILLAN, M. (1958): Méthode de classification des pierres calcaires. Supplement aux "Annales de l'Institut Technique du Batiment et des Travaux Publics", Mai 1958, 270-526.

MAMILLAN, M. (1972): Connaissances actuelles pour mesurer le degré d'altération des pierres et l'efficacité des méthodes de traitement. In 1er Colloque International sur la détérioration des pierres en ceuvre, La Rochelle, 47-56.

MAMILLAN, M. (1972): Méthodes d'essais physiques pour évaluer l'altération des pierres des monuments. In 1er colloque International sur la détérioration des pierres en ceuvre, La Rochelle, 19-30.

MAMILLAN, M. (1988): Méthodes d'Evaluation des Dégradations des Monuments en Pierre. In Proceedings of the 6th International Congress on Deterioration and Conservation of Stone, Torun, Sept. 12-14, 1988, 456-465.

MAMILLAN, M. (1993): Methods for the evaluation of the state of the alteration of stone in monuments. In "Conservation of Stone and Other Materials", Proceedings of the International RILEM/UNESCO Congress. Paris, June 29 - July 1, 1993, 775-779.

MARTIN-PATINO, M.T., MADRUGA, F. and SAAVEDRA, J. (1992): Characterization of the sandstone of the Salamanca Cathedrals. Forms of weathering. In Proceedings of the 7th International Congress on Deterioration and Conservation of Stone, Lisbon, Portugal, June 15-18, 1992, 315-324.

MARTINET, G., RASPLUS, L., MACAIRE, J.J. and LE ROUX, A. (1993): Etude comparative des mécanismes d'altération des grés en oeuvre. In "Conservation of Stone and Other Materials", Proceedings of the International RILEM/UNESCO Congress, Paris, June 29 - 1 July, 1993, 328-335.

MAZUREK, J. (1985): The ultrasonic examination of structure changes in the stone historical monuments. In Proceedings of the 5th International Congress on Deterioration and Conservation of Stone, Lausanne, Sept., 25-27, 1985, vol. 1, 55-65.

MONTOTO, M., CALLEJA, L., PERZ, B. and ESIBERT, R. M. (1991): Evaluation in situ of the state of deterioration of monumental stones by non-destructive ultrasonic techniques. In "Materials Issues in Art and Archaeology II", Proceedings Symposium, San Francisco, California, April 17-21, 1990, Materials Research Society, vol. 185, Vandiver, P.B., Druzik, J., Wheeler, G.S., Editors, Pittsburg, Pennsylvania, 273-284.

MONTOTO, M., VALDEON, L., COTTE, P., CORRAL, N., LOPEZ, T., SANCHEZ, B. and ESBERT, R.M. (1994): Non-destructive characterization of the state of deterioration of Megaliths by ultrasonic tomography: a petrophysical interpretation. In "The conservation of monuments in the Mediterranean Basin", Proceedings of the 3th International Symposium, Venice, June, 22-25, 1994, 3-9.

MORATTI, E. and CHRISTARAS, B. (1991): Weathering of marly and biogenic limestones used in the antiquities of Crete, Greece. Stratigraphy and mechanical consideration. In "The conservation of monuments in the Mediterranean Basin, Proceedings of the 2nd International Symposium, Geneve, Nov., 19-21, 1991, 483-492.

MOROPOULOU, A., ZEZZA, F., AIRES BARROS, L., CHRISTARAS, B., FASSINA, V., FITZNER, B., GALAN, E., VAN GRIEKEN, R. and KASSOLI-FOURNARAKI, A. (1994): Marine spray and polluted atmosphere as factors of damage to monuments in the Mediterranean Coastal Environment - a preliminary approach to the case of Demeter Sanctuary in Eleusis. In "The conservation of monuments in the Mediterranean Basin", Proceedings of the 3th International Symposium, Venice, June, 22-25, 1994, 275-285.

NISHIURA, T., FUKUDA, M. and MIURA, S. (1984): Utilisation des résines synthétiques pour la protection des pierres contre le cycle gel-degel. In "Adhesifs et Consolidants", 10ème Congres International, Paris, Sept, 2-7, 1984, 165-168.

QUEISSER, A., PLATEN, H.V. and FURST, M. (1985): Rebound and ultrasonic investigations on freestones of Bamberg area, F.R. Germany. In Proceedings of the 5th International Congress on Deterioration and Conservation of Stone, Lausanne, Sept., 25-27, 1985, vol. 1, 79.

RODRIGUEZ-NAVARRO, C., SEBASTIAN-PARDO, E. and ZEZZA, U. (1994): Petrophysical - Mechanical parameters for decay evaluation of building stones. A case study: Jaen Cathedral (Andalusia, Spain). In "The conservation of monuments in the Mediterranean Basin", Proceedings of the 3th International Symposium, Venice, June, 22-25, 1994, 595-603.

ROSSI-MANARESI, R. (1975): Treatments for sandstone consolidation. In "The Conservation of Stone I, Proceedings 7th International Symposium, Bologna, June, 19-21, 1975, 547-571.

ROSSI-MANARESI, R. and GHEZZO, C. (1978): The biocalcareneite of the Agrigento Greek Temples: causes of alteration and effectiveness of conservation treatments. In "Deterioration and Protection of Stone Monuments", International Symposium RILEM/UNESCO, Paris, June, 5-9, 1978, III, 7.9, 1-31.

SIMON, S. and SNETHLAGE, R. (1993): The first stages of marble weathering, preliminary results after short-term exposure of nine months. In "Conservation of Stone and Other Materials", Proceedings of the International RILEM/UNESCO Congress, Paris, June 29 - 1 July, 1993, 51-58.

SIMON, S., VERGES-BELMIN, V., BLANC, A. and SNETHLAGE, R. (1994): The marble columns in the cloister of the Primatial church St. Trophime in Arles, France. In "The conservation of monuments in the Mediterranean Basin", Proceedings of the 3th International Symposium, Venice, June, 22-25, 1994, 11-17.

SPRY, A.H. (1983): Australian building sandstones. In Amdel Report, CSIRO Division of Building Research, Frewville, South Australia, 1983.

VALDEON, L., KING, M.S. and DE FREITAS, M.H. (1992): Ultrasonic methods for quantifying the degradation of building stones. Proceedings of the 7th International Congress on Deterioration and Conservation of Stone. Lisbon, Portugal, June, 15-18, 1992, 697-703.

VERGES-BELMIN, V., ORIAL, G., GARNIER, D., BOUINEAU, A. and COIGNARD, R. (1991): Impregnation of badly decayed Carrara marble by consolidating agents: Comparison of seven treatments. In "The conservation of monuments in the Mediterranean Basin", Proceedings of the 2nd International Symposium, Geneve, Nov. 19-21, 1991, 421-437.

VILLEGAS, R., VALE, J.F. and BELLO, M. A. (1994): Evaluation of Consolidants by means of ultrasonic and surface hardness measurements. In "The conservation of monuments in the Mediterranean Basin", Proceedings of the 3th International Symposium, Venice, June, 22-25, 1994, 919-923.

ZEZZA, U. and VENIALE, F. (1988): Ultrasonic investigations on quarry and free-stones of historical Monuments in Lombardy, Italy. In Proceedings of the 6th International Congress on Deterioration and Conservation of Stone, Torun, Sept., 12-14, 1988, 303-312.

ZEZZA, U. (1991): Decay evolution depending on the textural anisotropy of marbles in monuments. In "The conservation of monuments in the Mediterranean Basin", Proceedings of the 2nd International Symposium, Geneve, Nov. 19-21, 1991, 289-302.

ZEZZA, F., (1994): Stone Decay Diagnosis and Control of Treatments by Computerized Analytical Techniques. In "The conservation of monuments in the Mediterranean Basin", Proceedings of the 3th International Symposium, Venice, June, 22-25, 1994, 77-81.

1978, 303-312. Proceedings of the 7th International Symposium on the Conservation of Stone, Rome, June 19-21, 1975, 547-571.

1978, 303-312. Proceedings of the 7th International Symposium on the Conservation of Stone, Rome, June 19-21, 1975, 547-571.

1978, 303-312. Proceedings of the 7th International Symposium on the Conservation of Stone, Rome, June 19-21, 1975, 547-571.

1978, 303-312. Proceedings of the 7th International Symposium on the Conservation of Stone, Rome, June 19-21, 1975, 547-571.

1978, 303-312. Proceedings of the 7th International Symposium on the Conservation of Stone, Rome, June 19-21, 1975, 547-571.

1978, 303-312. Proceedings of the 7th International Symposium on the Conservation of Stone, Rome, June 19-21, 1975, 547-571.

1978, 303-312. Proceedings of the 7th International Symposium on the Conservation of Stone, Rome, June 19-21, 1975, 547-571.

1978, 303-312. Proceedings of the 7th International Symposium on the Conservation of Stone, Rome, June 19-21, 1975, 547-571.

1978, 303-312. Proceedings of the 7th International Symposium on the Conservation of Stone, Rome, June 19-21, 1975, 547-571.

1978, 303-312. Proceedings of the 7th International Symposium on the Conservation of Stone, Rome, June 19-21, 1975, 547-571.

1978, 303-312. Proceedings of the 7th International Symposium on the Conservation of Stone, Rome, June 19-21, 1975, 547-571.

STUDY OF POROSITY AND PHYSICAL PROPERTIES AS METHODS TO ESTABLISH THE EFFECTIVENESS OF TREATMENTS USED IN TWO DIFFERENT SPANISH STONES: LIMESTONE AND SANDSTONE

N. GARCIA PASCUA*, M.I. SANCHEZ DE ROJAS⁺, M. FRIAS⁺

*Istituto di Geologia Applicata e Geotecnica, Politecnico di Bari, Italy

⁺Instituto c.c. Eduardo Torroja (C.S.I.C.), Madrid, Spain

Abstract

The study of the microstructure through the porosity analysis allows a rock description for its classification, to know its weathering state and the effect due to use of chemical treatments. The porosity analysis permits a quantitative registration of a phenomenologically recognizable weathering and the changes caused in the material by consolidation and protection.

The combined application of analytical (physico-mechanical properties) and technical (microscopy and Hg porosimetry) methods can provide all the information to establish the characteristics of the stone and to take into account effective preservation measures. A reliable pore space description is obtained only through the combination of information from scanning electron microscopy and mercury porosimetry.

The use in the restoration field of mercury porosimetry can enable to establish criteria for the evaluation of the effectiveness in the application of different chemical treatments (consolidant and water-repellents).

Keywords: Sandstone, Limestone, Consolidants, Water-repellents, Pore-size distribution, Porosity, Scanning electron microscopy.

1 Introduction

The mineral composition and its distribution are the necessary characteristics describing a stone material, under petrographical point of view. The stone behaviour depends of its geometrical configuration, for this reason, it is very important to define the texture, fabric and porosity of the stone material studied.

Natural stones have different properties even in an unweathered state. Using them as construction material they are subject to the deterioration influences of weathering. Therefore the knowledge of stone characteristics is relevant for weathering and for the investigation of alterations due to weathering (Poschlod, 1989).

The laboratory tests supply basic stone properties; both stone samples of the building in various weathering states as well as unweathered and treated stone samples are studied, the investigations are essentially focused on microstructure analysis. The different tests realized to determinate the porosity of stone have shown that especially the porosity characteristics and their changes due to deterioration or use of treatments enable to distinguish different behaviour in the same stone or to judge the different type of stone.

The processes responsible for the deterioration of natural stones cause a modification in the structure, but the same situation occurs when chemical products are used for repairs. These processes mainly occur in the interfaces of the minerals, the pore space therefore represents the preferred area for the physico-chemical and biological weathering action, and, furthermore, it is necessary to remember the behaviour of a material in response to moisture transport. In the pores system is a place to placed the chemical treatments, unless it be a superficial product.

Thus, the exact measurement of the pore space, and its knowledge, is an important condition for the study of the status of the stone:

- * For description of weathering process.
- * For the quantitative recording of the weathering status.
- * For the treatment of porous building materials with consolidants or water-repellents.

These informations can be obtained by direct measurements such as electron microscopy and evaluated by means of image analysis systems. However, a series of indirect measurements (mercury porosimetry and the nitrogen adsorption) allow the measurement of the pore spaces that are accessible for a measuring medium. By means of calculation models the required porosity characteristics can be obtained from these measurements (Fitzner, 1991). It is just as important to discover the percentage of empty spaces present in the sample as their distribution and sizes.

The determination of pore-size permit record the porosity modification of the stone during the use of treatments. The manner in which is carried out the control of effectiveness is based only in the variation produced in the original physical properties of the stone support when their surfaces are treated with the chosen products. This fact means a thorough previous study of the materials must be done in order to check the variations that occur later, taking account that the sought effect of the treatments is not always the same (Mamillan, 1990). A consolidant must be required to achieve an improvement in the union between the weathered and unweathered stone, or in some cases between the zone of detachment and undecay part of the block, and this type of treatments can go through to the material until deeper zone. On the other hand, with the use of water-repellents which must protect the stone form the contact with water, the deep obtain in the porous system is less because its aim is form a film on the sample surface (Meng, 1993).

The object of this work is to establish the effectiveness of various restoration treatments applied to different stone materials, taking into account the variations that arise in the pore-size distribution and the original appearance of these materials. To do this, techniques such as the mercury porosimeter and Scanning electron microscopy are employed.

2 Mercury Porosimetry

The individual pore characteristics controls the later behaviour of the stone either weathering phenomena or treatment processes but, at the same time, the pore system is modified by these mechanisms (Fitzner, 1993). It is very difficult to measure the pore space due to different porosity properties and to the varying pore-size distribution (volumetric distribution of the open pores, assumed to be a circular section, according to their size expressed as percentage of the total volume, RILEM I.5).

The properties of the pore structure (total porosity, pore-size, pore form and pore-size distribution) allow a:

- * Classification of the rocks.
- * Knowledge of the degree of decay and its manifestations.
- * Statements on formation aspects of secondary minerals in the pore system, especially salts.
- * The deep caught up for the treatments and its arrangement in the pore structure, for control the effectiveness.

The technique of mercury porosimetry consists essentially in measuring the extent of mercury penetration into an evacuated solid (assumed to be a circular section pores) as a function of the applied hydrostatic pressures (Lowell, 1979). The pressures involved in porosimetry are so high that the question as to whether the pore structure is damaged by mercury intrusion naturally arises there is some investigations that conclude that any deformation caused by compression was elastic and therefore not permanent but more recent work have indicated, however, that the increase in pore volume brought about by high intrusion pressures may be caused by fracture of the pore walls that gives access to pores previously closed, and is characterized by an irreversible change in the cumulative volume curve (Gregg and al., 1982).

The extremely large differences of pore size require an application of various procedures of measurement (Meng, 1992). According to the classification adopted by the IUPAC, the pores can be divided into three groups, according to their size: micropores with radius < 2nm; mesopores with radius between 2nm and 50nm; macropores for radius > 50nm.

Mercury porosimetry allows almost all pore sizes present in the stone to be measured, and for this reason is the most frequently employed. There are very different commercial mercury porosimeters achieve maximum pressures in the range 50.000-60.000 psia which corresponds to pore radii of 1.8 nm and maximum pore radii measurement is 7.500nm for the majority of them. The measuring principle is based on the Washburn equation:

$$P = 2 \sigma \cos \theta / r,$$

where, r is the radius of the pores (μm); σ the surface tension Hg-air (normal value: 480 din/cm); θ the contact angle Hg-solid and P the pressure (Kg/cm^2). The contact angle of mercury normally lies between 135 and 150° , the exact value depending on the purity and structure of the solid surface, 140° is valid for all solids. When presuming cylindrical pores and substituting the constants, the above expression is reduced to (Gregg, 1982):

$$r = 7.5 / P$$

This method determinates entry radii of the pores and not the real pore-radius, this have an important problem with the so-called ink bottles pores, that means large pores with small entries, in this case the distribution of the pore entry radii alone will not be enough for establish a "real pore-size distribution".

The information obtained with the use of mercury porosimeter is supported by Scanning electron microscopy studies, SEM (Sasse et al., 1993). SEM is the most effective technique for studying the formation of the polymer microlayer visible on stone surfaces and cracked sections, the topography of the inner surface features can be study to recognize the presence of the treatments applied.

3 Treatments

Four treatments were selected for this work. They fall within two types of treatment, the first one has a consolidant effect between the decayed parts of the stones and the second one with a protective effect by the presence of hidrophobic characteristics.

In the first group (consolidants) two products with a different chemical composition have been chosen: a copolymerized of vinyl acetate and dibutyle maleinate (Mowilith 35/73, Hoecht) and a ethyl silicate (Minersil SH, Prolab); and for the two treatments with water-repellent properties the chemical composition is very similar both of them are polysiloxane, but the degree of polymerisation is different: dimethylpolysiloxane (Minerxan, Prolab) and Polymethylsiloxane (H-224, Rhone Poulenc). Everything use white spirit like a solvent, except Mowilith which use water and isopropylic alcohol, (Garcia Pascua et al., 1993).

4 Description of the stone materials

4.1 Sandstone

The Villamayor sandstones form part of a group of detritus sediments from continental facies deposited in fluvial avenues of fluvio-laustrine formations under a subtropical climate, sometimes arid and at others extremely rainy. It is a Paleogenous formation formed by medium and thin detritus facies of the middle and upper Eocene (Arribas et al., 1984).

No single type of so-called Villamayor sandstone exists since slight variations in mineralogical composition, grain size or color and give rise to different types of stone, whose later behaviour when used for building will be different, as will be their response to application of restoration treatments.

This type of stone material is of a siliceous nature, which the major elements coexisting with the silica are alluminium and iron (Sánchez de Rojas et al., 1989). As for the mineralogy, the basic constituent minerals are quartz, potassium feldspars, plagioclases, micas and clay minerals, the latter acting as a cement matrix. The presence of various clay minerals, aside from the different proportions in which they occur, has given rise to differences of behaviour by the sandstone.

Its physical properties are, in average values: porosity accessible to water: 32.91 %; bulk density: 1.77 g/cm³; real density: 2.64 g/cm³; water absorption amount by total immersion: 13.76 % and capillarity coefficient: 0.65 g/cm²s^{1/2}.

4.2 Limestone

It is a bioclastic Miocenic limestone whose composition, determined by X-ray diffractometry, is calcite, quartz and dolomite. This limestone has a detritic texture, poorly cemented. The kinds of fossil found are algae, foraminera and equinoderms. In some samples clay minerals have been observed, mainly smectite (Esbert et al., 1989), the same type present in Villamayor sandstone.

Its physical properties are (average values): porosity accessible to water: 31.70 %; bulk density: 1.81 g/cm³; real density: 2.65 g/cm³; water absorption amount by total immersion: 11.89 % and capillarity coefficient: 0.51 g/cm²s^{1/2}.

4.3 Physical behaviour of the stone materials

As can be deduced from their physical properties, both types of petrous material are highly porous and therefore they absorb an important amount of water. For this reason, the study of variations in the original physical behaviour of the petrous material can be considered as a first step in establishing the effectiveness or otherwise of treatments used in conservation or restoration work carried out (Garcia Pascua et al., 1994).

The variations, expressed as a percentage, that arise in the original properties of the sandstone and limestone described above, when the four treatments chosen for this work were applied are show in Table 1.

Table 1. Percentage of variation in physical properties of untreated sandstone (S) and limestone (L) following application of the selected treatments

Physical properties	Polyvinyl acetate		Ethyl silicate		Dimethyl-polysilox.		Polymethyl-siloxane	
	S	L	S	L	S	L	S	L
Porosity ac. to water (%)	2.5	1.6	7.6	19.3	7.8	10.0	4.9	7.1
Bulk density (g/cm ³)	-1.1	0.0	-1.7	-7.7	-0.6	-1.1	-0.6	-0.5
Real density (g/cm ³)	0.4	0.7	0.8	1.1	3.4	3.4	1.5	2.6
Water absor. coef. (total immers.) (%)	20.3	3.3	21.8	19.3	25.4	59.5	42.1	64.3
Water absor. coef. (capillar.) (g/cm ² s ^{1/2})	78.5	80.4	38.5	97.1	83.1	96.1	90.8	98.6

The lower the number obtained, the more its behaviour parallels that of untreated material and, theoretically and always taking into account the type of product, implies lower effectiveness. From the results obtained it can only be established that variations occur,



although to different degrees, according to the treatment used. Thus on the one hand the consolidants (Minersil SH and Mowilith 35/75) show a behaviour that is different, as might be expected, from that of the hydrofugants (Minerxan and H 224), particularly when used on limestone. In all cases the amount of the determined property decreases, save in the case of bulk density where the amount increases with the use of chemical products, this being the reason for the minus sign before the numerical data.

In general terms, the application of a treatment implies an alteration of initial behaviour if we consider the fact that a totally foreign substance is placed on the surface of the stone or, in some cases, to a greater depth, and that to a greater or lesser degree it acts as a film that may even line the walls of the pores and thus influence not only the amount of porosity, which decreases in all cases, but also the amounts for all other characteristics.

However, these results (Table 1) cannot be considered as a method to establish the effectiveness of the treatments used, and to explain this the example of the use of polyvinyl acetate can be used. This product causes practically no changes in the initial characteristics of both petrous materials (low percentage), which may indicate on the one hand that its use would be appropriate and effective because it does not alter the material to which it is applied. However, if we remember that its job is to consolidate the material and aid in the reintegration of weathered parts, we may deduce from the results obtained that, for example, the amount of empty spaces has not decreased as is shown by the porosity figures and the water absorption coefficients, and therefore they are not signs of this consolidation effect.

Similarly, it may be said that the effectiveness of ethyl silicate is important, always taking into account porosity results (high percentage), since the diameter of the pores decreases to a certain extent, which may indicate that it acts as a reintegrator between weathered parts. However, this decrease in porosity may also arise with the application of hydrofugants, which leads us to believe that what occurs is the already mentioned placement on the surface or at little depth, like a film, and this impedes the entry of water into the interior, thus giving lower porosity figures.

The action of each treatment is different. It is only possible to affirm that a different behaviour is found between consolidants and hydrofugants, as is expected. However, it is difficult to establish the degree of effectiveness of each of them based simply on these physical results, since it is impossible to generalize to a single behaviour for consolidants or for hydrofugants, since each one acts in a different manner.

These results must be confirmed or rejected by the use of such techniques as electronic microscopics or Hg porosimetrics, or by carrying out other tests, e.g. natural and artificial ageing cycles, in order to check their effectiveness with the passage of time or under extreme conditions.

5 Study of the efficiency of the treatments using mercury porosimetry

It is important with highly porous materials to study all the parameters which affect the value obtained from same: form of pores, dimensions and their distribution curve in the sample, in order to determine the differences arising before and after use of the different treatments chosen, and thus establish whether a product is more or less efficient. It is possible through mercury porosimetry to know the amount of mercury entering the

corresponding pores for each diameter (accumulated intrusion volume, continuous line on figures 1 and 2); moreover, it is possible to know the amount of mercury which enters a set pore size, so that the maximum points on the curve obtained correspond to the more frequent pore sizes (increase in intrusion volume, discontinuous line), all this data finally allows us to know the distribution of the existing pore sizes in the sample.

5.1 Measurement conditions

The mercury porosimetry used is Micromeritics AutoPore II 9220 which reaches a pressure of 60.000 (414 MPa), the equivalent to setting pore sizes up to 1.8nm. The samples, in cylinder form, with a weight between 3-4g and 2-3cm high, are dried at 60°C till constant mass (the drying temperature of 60°C is chosen instead of a higher one in order to avoid deterioration of the organic materials used to treat the stone, RILEM). After drying, cooling and weighing, the samples are put in a vessel connected to a pump which produces a vacuum in order to remove the air contained in the pores of the sample.

The maximum pressure applied to the samples in the study is 25.000 psia, which corresponds to a pore diameter of 0.0087µm. The contact angle of the mercury with the solid is 141.3°C and the value of the mercury-solid surface tension is 480 din/cm.

5.2 Sandstone

The results obtained for treated and untreated sandstone with the four products selected are shown in table 2 and figure 1.

Table 2. Results obtained with mercury porosimetry

State of the stone	Total intrus. volume (mL/g)	Median pore diameter (µm)	Porosity (%)	Bulk density (g/cm ³)	Real density (g/cm ³)
Untreated	0.22	65.40	36.24	1.65	2.59
Polyvinyl acetate	0.20	64.82	33.96	1.70	2.58
Ethyl silicate	0.16	54.48	29.09	1.79	2.52
Dimethyl-polysiloxane	0.20	48.94	33.92	1.73	2.61
Polymethyl-siloxane	0.19	65.34	31.85	1.71	2.51

As may be expected, the data obtained by mercury porosimetry show that the untreated material is the most porous: greater amount of total porosity, greater amount of total intrusion volume, as well as their also being greater medium pore diameter. As to the results obtained for treated sandstone, one must point out that the decrease arising through the use of the treatments, especially for the consolidants, may only be mentioned in the case of ethyl silicate as far as the total intrusion volume is concerned, that is to say, in the other cases there is an insignificant difference, which is only slightly lower than that entering the original untreated sandstone (0.19-0.20mL/g).

(a) PORE-SIZE DISTRIBUTION
UNTREATED SANDSTONE

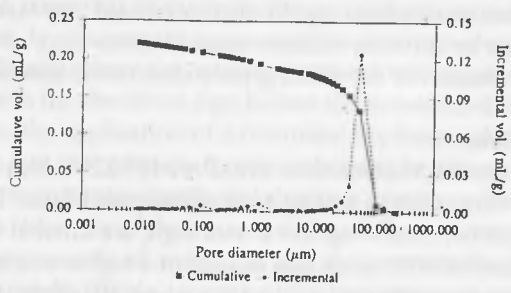

(b) PORE-SIZE DISTRIBUTION
POLYVINYL ACETATE

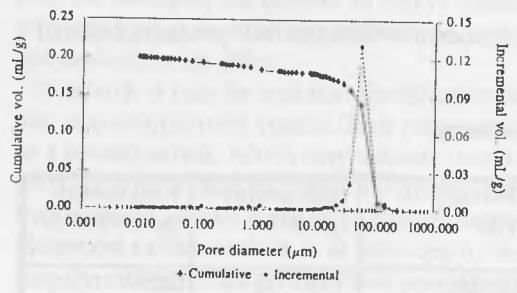

(c) PORE-SIZE DISTRIBUTION
ETHYL SILICATE

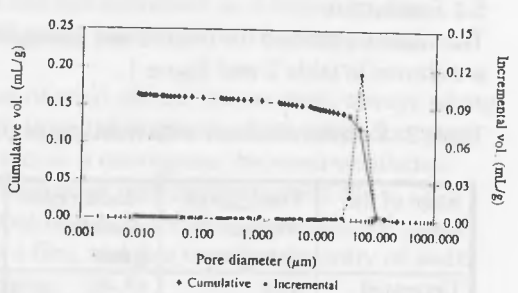

(d) PORE-SIZE DISTRIBUTION
DIMETHYLPOLYSILOXANE (MINERXAN)

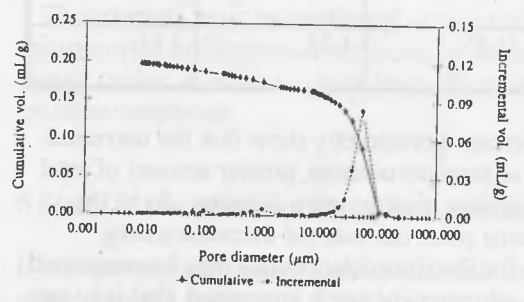

(e) PORE-SIZE DISTRIBUTION
POLYMETHYLSILOXANE (H-224)

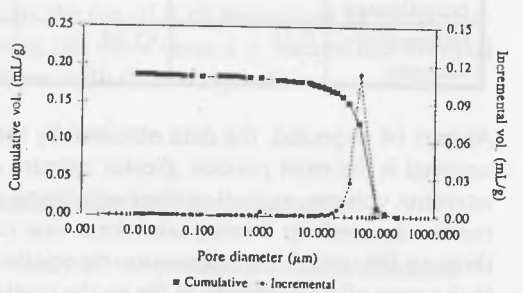

Fig. 1. Pore-size distribution of sandstone: (a) untreated; (b) and (c) treated with consolidants; (d) and (e) treated with water-repellents.

Practically the same happens if one compares the results obtained from setting the median pore diameter where the greater variation arises with the use of dimethylpolysiloxane, a product with water-repellent properties, as one must mention that this treatment brings about the greatest increase in the real density value.

However, what will really provide information on what happens within the pore system through use of the different treatments is study of the pore-size distribution (Fig. 1), which indicates that, practically throughout this type of sandstone, there are pores of an approximate diameter of $100\ \mu\text{m}$ (maximum $50\text{-}70\ \mu\text{m}$) and that after application on the such projects, whatever their effect may be, the dimensions of same are not reduced, nor is their amount, this particular being obtained from the height of the maximum volume increase curve, there being practically no pores smaller than $10\text{-}20\ \mu\text{m}$.

The maximums obtained from the data on volume increase show that, in the case of the consolidants (fig. 1 b and c), these are slightly displaced toward values nearer to the $10\ \mu\text{m}$ level. Small maximums around $1\ \mu\text{m}$ and $0.1\ \mu\text{m}$ are distinguished in untreated sandstone (fig. 1 a) although they disappear in the case of the two consolidants and the polymethylsiloxane (fig. 1 e).

All these may be used to conclude that in the case of the sandstone, the use of the treatments selected in this work practically does not change the original existing internal porous structure of the sandstone as far as the large pores are concerned, however, when the pores are smaller than $10\ \mu\text{m}$, there are variations involving practical disappearance of the pores of such sizes.

In none of the cases is the use of the treatments aimed at radical alteration of the behaviour and nature of the original untreated material, which in many cases shows a considerable degree of alteration; thus, the fact that only the smallest pores are affected by use of the treatments may be taken as a primary criteria to be followed in choice of said treatments. However, as far as pores of greater diameter are concerned, previous surveys have shown that there are only slight variations; slight, although significant when having to consider that the settings taken during the mercury porosimetry to measure effectiveness or efficiency by being able to be used as a criteria to decide on one treatment or another.

In the case of this sandstone, none of the products selected for this study would be "efficient," if one considers it a very porous material with large sized pores, although, if one aims at using treatments to obtain improvements which do not involve later alterations, one may say from the results obtained in pore-size distribution alone that dimethylpolysiloxane would not be efficient, as its graph is practically the same as for untreated sandstone.

5.3 Limestone

The results shown in table 3 and figure2, allow one to say that this type of stone material has a smaller average pore size than that of the sandstone, as shown by the total volume of mercury which enters the pore system (0.14 mL/g for the limestone and 0.22 mL/g for the sandstone), the porosity value (27.73% compared with 36.24%) and the median pore diameter (44.56 μm for the limestone and 65.4 μm for the sandstone).

Table 3. Results obtained with mercury porosimetry

State of the stone	Total intrus. volume (mL/g)	Median pore diameter (μm)	Porosity (%)	Bulk density (g/cm^3)	Real density (g/cm^3)
Untreated	0.14	44.56	27.73	1.94	2.68
Polyvinyl acetate	0.14	42.56	27.26	1.99	2.73
Ethyl silicate	0.11	34.52	21.93	2.03	2.60
Dimethyl-polysiloxane	0.13	34.77	25.80	1.99	2.68
Polymethyl-siloxane	0.13	39.02	25.55	2.01	2.69

Just as in the case of the sandstone studied above, again the untreated material is more porous (table 3); however, there are no differences either when comparing the results obtained before and after the treatment, either in the case of the porosity, total intrusion volume, or average diameter of the pores.

Yet again, ethyl silicate is the substance which shows a slightly different behaviour to that of untreated limestone; this fact is fairly logical if one considers that the effect of this product is to act as a consolidant and it this lies between the weathered or fractured parts, acting as a reintegrator; however, the same does not happen with the other products with the same effect selected (polyvinyl acetate) the characteristics of which fully remind one of those in untreated stone, that is to say, both are consolidant, although one of them acts as such by lying in the internal structure of the material so the number of empty spaces decreases, while the with the other, the stone material remains totally unchangeable and thus, even altered if it had already been so before beforehand. However, just as in the case of the sandstone, the variations obtained are fairly slight.

The water-repellents have not shown an important variation in relation to the initial behaviour found in the original limestone either, as one can only mention a slight decrease in the average diameter of the pores in both, which thus involves a slight decrease in the porosity value, this being greater with dimethylpolysiloxane (34.77%). Yet again, the aim is that through the pore-size distribution it be possible to establish differences between behaviour of the treatments applied to this limestone (figure2). In general terms, the aspect of the distribution curve does not vary when considering the treated or untreated material; in all cases the maximum is located within an interval between 30-45 μm , although depending on the treatment, it is slightly displaced toward the lower limit for the ethyl silicate (consolidant, fig. 2 c) and the dimethylpolysiloxane (water-repellent, fig. 2 d).

(a) PORE-SIZE DISTRIBUTION
UNTREATED LIMESTONE

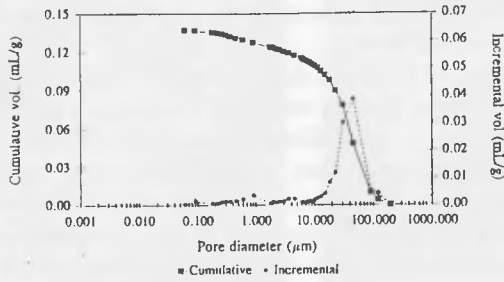

(b) PORE-SIZE DISTRIBUTION
POLYVINYL ACETATE

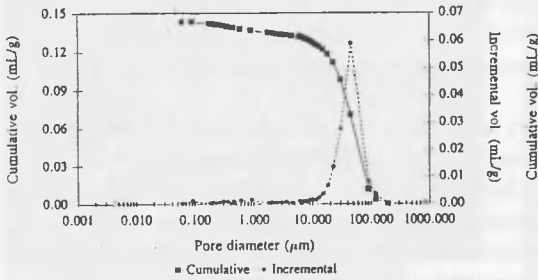

(c) PORE-SIZE DISTRIBUTION
ETHYL SILICATE

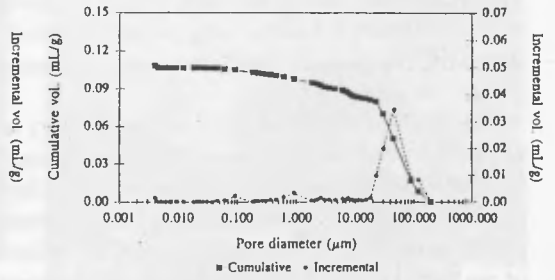

(d) PORE-SIZE DISTRIBUTION
DIMETHYLPOLYSILOXANE (MINERXAN)

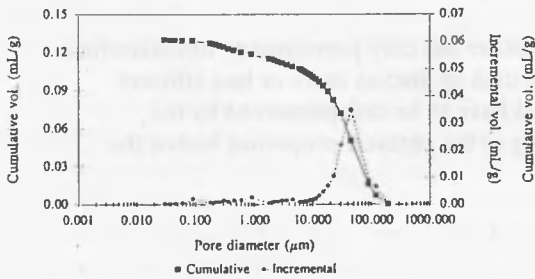

(e) PORE-SIZE DISTRIBUTION
POLYMETHYLSILOXANE (H-224)

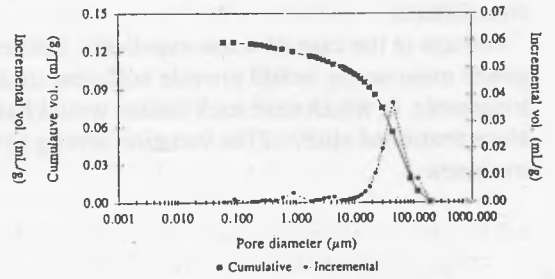

Fig.2. Pore-size distribution of limestone: (a) untreated; (b) and (c) treated with consolidants; (d) and (e) treated with water-repellents.

The behaviour of polyvinyl acetate (fig. 2 b) in the mercury porosimetry study practically rules it out by demonstrating low efficiency as consolidant, as is shown by its high porosity and pore sizes which are practically the same as those of untreated limestone (greater height of the volume increase maximum).

In the case of this limestone, the pore-size distribution curves show similar conclusions to those obtained for the sandstone, such as minimum alteration of the original behaviour of the material, even with the use of consolidants, the large pore diameters are maintained although the width of the maximum decreases, which indicates that said pores are slightly closed when the treatments studied are deposited in them, although in the case of the polyvinyl acetate, this lesser pore width is countered by their high number.

There are practically no pores smaller than 10 μm , and the small maximums located in the untreated limestone are maintained, even after application of the restoration products.

6 Study through Scanning electron microscopy (SEM)

The study carried out through SEM allows us to confirm the results already obtained through mercury porosimetry. It is sufficient to show the images of the sandstone before and after the treatments to show that their presence inside the sample is not easily noted. This sandstone, just as has been stated, is characterised by the presence of the clay materials which act as the only cement matrix between the grains of quartz and the feldspars, the fibrous, laminate aspect of these clays may be seen in figure 3 a and in greater detail in figure 3 b.

Only in the case of the ethyl silicate is there a variation in the initial aspect of the sample after the treatment, as shown in figures 4 a and 4 b, where the mineral grains seem "clearer" after disappearance of part of the clays which covered them; one may also note a rigid layer being formed, covering grains sometimes and joining them on others. This phenomenon is not detected in any of the other treatments studied, as shown in the images of the polyvinyl acetate (figure 5 a) which show the clay material fibres in detail and the dimethylpolysiloxane (figure 5 b). This brief study confirms the already established fact that only the use of ethyl silicate is detected when applied to specific types of sandstone and limestone, which may indicate to a certain extent that it is the most efficient product, above all, when one takes into account that the methods followed to do so demonstrate the structural behaviour of the products, a factor which is a requisite in the use of consolidants.

Perhaps in the case of water-repellents, neither mercury porosimetry, nor electronic sweep microscopy would provide sufficient data to discuss more or less efficient treatments, in which case such results would have to be complemented by the aforementioned study of the variation arising in the physical properties before the treatment.

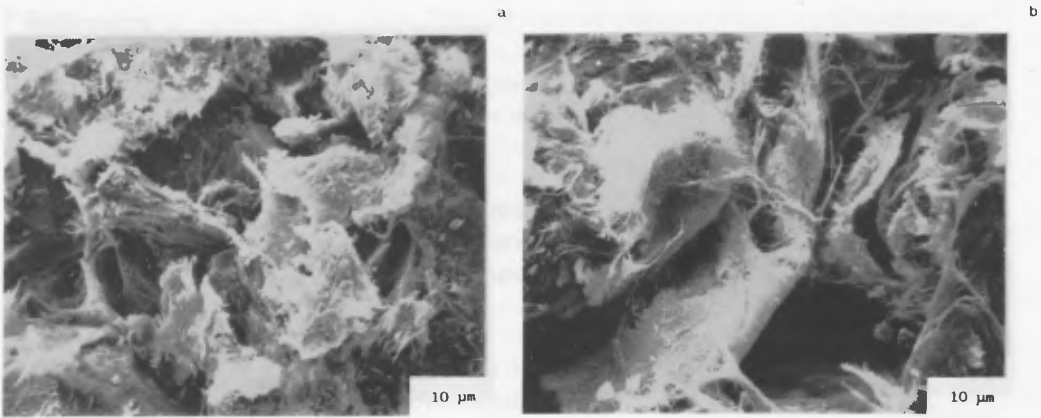

Fig.3. SEM micrographs of untreated sandstone sample: (a) x 160 and (b) x 320.

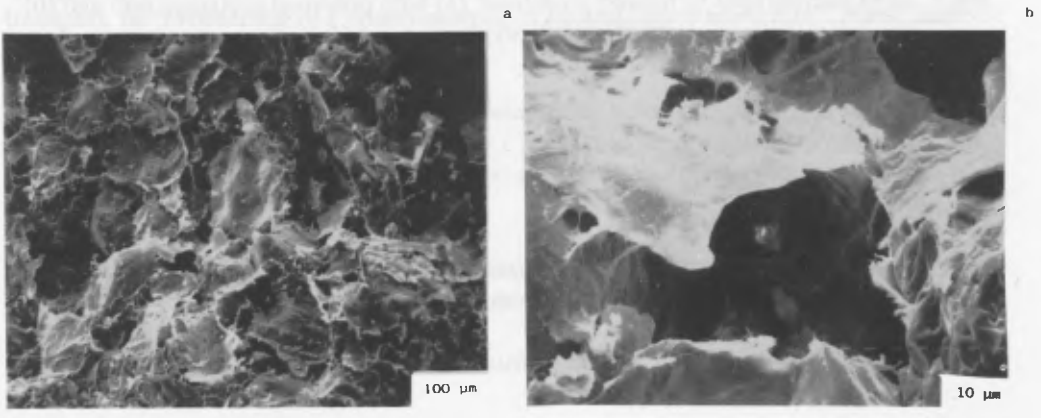

Fig.4. SEM micrographs of treated sandstone with ethyl silicate: (a) x 40 and (b) x 320.

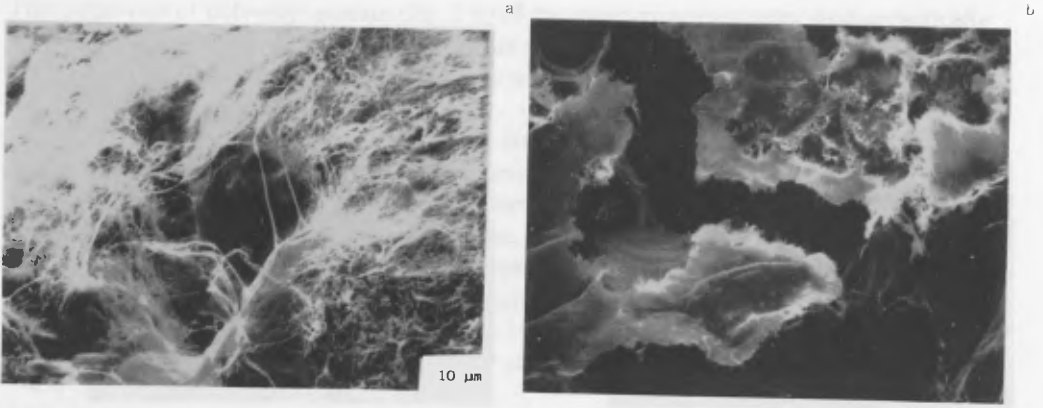

Fig. 5. SEM micrographs of treated sandstone: (a) with polyvinyl acetate, x 640 and (b) with dimethylpolysiloxane, x 160.

7 References

- Poschold, K. (1989): Pore structure and properties of marbles. In *"Proceeding of 1° Int. Symp. on The conservation of monuments in the Mediterranean Basin"*. Bari, June 7-10, 1989, 259-262.
- Fitzner, B. (1991): Mapping, measurements and microstructure analysis - combined investigations for the characterization of deteriorated natural stones. In *"First course C.U.M. University School of Monument Conservation: Weathering and air pollution"*. Portese, Sept. 2-9, 1991, 195-216.
- Mamillan, M. (1990): Methodes d'évaluation des dégradations des monuments en pierre. In *"Analytical methodology for the investigation of damaged stone"*. Pavia.
- Meng, B. (1993): Characterization of pore structure for the interpretation of moisture transport. In *"Proceeding of Conservation of stone and others materials"*. Paris, June 29-July 1, 1993, 155-162.
- Fitzner, B. (1993): Porosity properties and weathering behaviour of natural stones - methodology and example. In *"Second course C.U.M. University School of Monument Conservation: Stone material in monuments: diagnosis and conservation"*. Heraklion, May 24-30, 1993, 43-54.
- RILEM (1980): Recommended testes to measure the deterioration of stone and to assess the effectiveness of treatment methods. *Matériaux et Constructions*, 13, 75, 175-253.
- Lowell, S. (1979): Introduction to powder surface area. *A Wiley Interscience Publication*, 181-195.
- Gregg, S.J. and Sing, K.S. (1982): Adsorption, surface area and porosity. *Academic Press, London*, 320 pp.
- Meng, B. (1992): Moisture-transport-relevant characterization of pore structure. In *"Proceeding of 7th Int. Cong. on Deterioration and conservatio of stone"*. Lisbon, June 15-18, 1992, 387-396.
- Sasse, H.R., Honsinger, D. and Schwamborn, B. (1993): Pins-new technology in porous stone conservation. In *"Proceeding of Conservation of stone and others materials"*. Paris, June 29-July 1, 1993, 705-716.
- Garcia Pascua, N. (1993): La investigación de tratamientos de restauración para materiales pétreos: su actuación, comportamiento y eficacia en arenisca". *Doctoral Thesis (Ph.D.)*, Madrid, 1993, unpublished, 902 pp.

Arribas,A., Polo,V. and Jimenez,E. (1984): La "enfermedad de la piedra" en la arenisca de Villamayor. Diagnóstico, tratamiento y conservación. In "*Estudio sobre la alteración de la piedra de Villamayor*". *Caja de Ahorros y M.P. de Salamanca*, 5-170.

Sánchez de Rojas,M.I., Luxán,M.P., García Pascua,N. and Frias, M. (1989): Estudio físico-químico de la arenisca en cantera. In "*Proceeding III Congreso de Geoquímica de España*". Soria, Sept. 17-22, 1989, II, VIII/51-56.

Esbert,R.M., Grossi,C.M., Valdeón,L., Ordaz,J., Alonso,F.J. and Marcos,R.M. (1989): Studies for stone conservation at the cathedral of Murcia (Spain). In "*Proceeding of 1° Int. Symp. on The conservation of monuments in the Mediterranean Basin*". Bari, June 7-10, 1989, 437-441.

García Pascua,N., Sánchez de Rojas,M.I. and Frias,M. (1994): Deterioration of the differences in the physical properties of the treated Villamayor sandstone under natural and artificial ageing. In "*Proceedings of 3rd Int. Symp. on The conservation of monuments in the Mediterranean Basin*". Venice, June 22-25, 1994, 937-945.

EVALUATION OF CONSOLIDANTS FOR STABILIZATION OF WEAK MAYA LIMESTONE

RAKESH KUMAR AND WILLIAM S. GINELL

The Getty Conservation Institute, Marina del Rey, California 90292, USA

Abstract

In order to stabilize weak Maya limestone in a hot, humid tropical climate, consolidating materials such as an acrylic emulsion, an acrylic-epoxy solution, acrylic solution, a polyurethane dispersion, an epoxy solution and a silane-silicon ester solution were applied to the samples of limestones which were then exposed to artificial and natural aging conditions. The relative effectiveness of the consolidants was evaluated by determination of the water and particle abrasion resistance of the aged samples. Dilute epoxy and acrylic-epoxy resin systems in hydrophilic solvents were found to penetrate and stabilize the weak, moist limestone.

Keywords: Water-compatible consolidants, Tropical environment, Abrasion resistance, Natural and artificial aging, Water abrasion, limestone, evaluation methods.

1 Introduction

Much of the limestone used in the construction of Maya buildings from the period 700-1000 AD[1] at Xunantunich, Belize, is highly porous, mechanically weak and in an advanced state of deterioration. It is thought that the principal causes for the deterioration of the structural materials following archaeological excavation are the inherently poor quality of these materials, active microfloral growth, cyclic changes in the humidity and temperature in the region, and exposure to the erosive effects of wind and water. In addition, much of the masonry immediately beneath the exterior surface is damp throughout the year.

One widely reported means of stabilizing the stone has been through consolidation. Stone consolidants have a long history of use [2]. In the recent past a number of materials have been proposed as consolidants for the dry calcareous stone commonly used in historic buildings and monuments, but it should not be assumed that a stone consolidant effective at one site will

prove equally effective at another site where the environment, type of stone, and mechanism and degree of stone decay are different.

The effectiveness of consolidating materials is best determined by carrying out diagnostic tests following natural aging tests or, if this is not possible, after artificial aging under conditions that produce the deteriorating effects of the natural environment. It is important to know which performance criteria the consolidated stone are required to meet and how they can be evaluated. Since the artificial aging test conditions are intended to reproduce the environmental conditions responsible for deterioration, the resulting properties of the material studied after aging should serve to assess the relative effectiveness of the consolidants in the field. However, synergistic effects are likely to occur in complex environments and one is always unsure whether or not the real environment has been simulated adequately. The results of long term aging in the natural environment provides convincing information regarding the suitability of a consolidant, but this option is not always feasible. Comparison of the results obtained from natural and artificial aging can serve to validate the chosen laboratory procedures and environments.

This paper describes the consolidants selected for testing, the natural and artificial aging conditions and procedures used, the evaluation techniques, and the relative effectiveness of the consolidants tested.

2 Selection of the Materials

2.1 Stone

Weak limestone from the Xunantunich site was chosen as the substrate for the testing of stone consolidants. Both newly quarried limestone from a reopened quarry and rubble stone from a current excavation were used. The limestone is of marine origin and is inhomogenous. Chemically and petrographically it is a fine grained, almost pure, calcite with minor amounts of magnesium, iron, aluminum and silica impurities (<2%). The hardness is quite variable with unevenly distributed layers of soft and hard calcite. The porosity of this type of stone as measured by mercury intrusion porosimetry varied from 26 to 56%.

2.2 Consolidants

The consolidants selected for testing are shown below and include water-borne and water-compatible materials that could be applied to damp stone, and water-immiscible solvent-type systems that can be used only on dry stone.

- Acrylic polymer in toluene [Acryloid B-67]
- Acrylic emulsion in water [Rhoplex (Primal) AC-33]
- Polyurethane dispersion in water [Bayhydrol 121]
- Acrylic-epoxy in isopropanol/water solution [Neocryl-520 + ERL-4221]

- Acrylic-epoxy in isopropanol/water solution [Carboset-5141H + ERL 4221]
- Cycloaliphatic epoxy in isopropanol [Eponex 1510 + Jeffamine T-403]
- Alkoxysilane and ethylsilicate in 2-butanone [ProSoCo Conservare-H]

Acryloid B-67 was selected, rather than the more commonly used Acryloid B-72, because of its superior resistance to water swelling, and the possibility of its use on completely dry stone. Rhoplex AC-33 and Conservare-H were included for comparison because of their prior use as conservation materials in Mesoamerica. Bayhydrol 121, which is a dispersion of very fine polyurethane particles in water, was selected to achieve deep penetration into the stone. Acrylic emulsion particles are large and tend to remain on the stone surface. The acrylic-epoxy systems consist of solutions of alkali-soluble acrylic polymers that react by crosslinking with a soluble epoxy resin (ERL-4221, a cycloaliphatic epoxy) and cure to form stable, water insoluble products [3]. Eponex 1510 was selected because of its low color formation, considerable resistance to UV degradation[4] and its solubility in isopropanol, a water-compatible solvent.

3 Evaluation methods

3.1 Depth of penetration of consolidants into stone

The consolidants were applied to the limestone samples both by spraying and by capillary rise methods. After curing for 15 days in air, the samples were dry-sectioned and penetration depths were determined using an iodine-vapor exposure technique [5], [6]. In this technique, a vertical section of consolidated stone is exposed to iodine vapor in a closed glass chamber. Iodine vapor is physically adsorbed on the consolidated areas and turns dark yellow or brown leaving the unconsolidated area unaffected.

3.2 Curing of consolidant under high relative humidity conditions.

Consolidant curing in limestone under high relative humidity conditions may be retarded if the curing process requires evaporation of water. This applies to both emulsions and dispersions where polymer droplet coalescence and film formation can occur only after water loss. In the case of the single phase acrylic-epoxy system, cross-linking cannot occur while the water/alcohol solvent is present. However, the cycloaliphatic epoxy-hardener system will cure in the presence of the water/alcohol solvent.

Since most of the stone at Xunantunich is moist throughout the year, experiments were carried out to determine if these consolidants would cure in a high relative humidity environment. Samples of powdered limestone equilibrated at 100% relative humidity, were treated with the above consolidants and placed in a chamber at 100% RH for 30 days to determine if curing would occur. Consolidation was evident by the formation of a solid mass.

3.3 Materials aging

3.3.1 Natural aging carried out "in-situ"

A combination of several environmental factors affect the stone masonry and cause substantial damage to the structures at Xunantunich. Some of the factors that are thought to be of importance are driving rain, flowing water, cyclic changes in humidity and temperature, wind-driven particulates, solar radiation and microfloral biodeterioration. Any potential solution to this problem needs to be evaluated for a long-term period under natural aging conditions. However, the length of time over which the tests are carried out is never sufficient to obtain results that allow the future durability of the products to be established with a high degree of certainty.

Excavated limestone structures at Xunantunich are exposed to large climatic variations within the site. Some structures are exposed to full sunlight, high temperatures, wind, and driving rainfall and some are always in the jungle shade, with little wind, a long time of wetness, and a high humidity environment. Particular consolidants suitable for stone masonry exposed to sun and wind might not be appropriate for masonry that is always in the shade. Because of such wide variations in the environment at the site, it was decided to conduct long-term evaluation tests at both environmental extremes: full sun (dry, windy) and jungle shade (high humidity, little wind).

The 172 limestone samples (approx. 5X5X5 cm) were prepared from limestone blocks that were obtained either from a quarry close to the site or from excavated rubble. The samples were treated with the consolidants by spraying until no further absorption occurred. The concentrations of consolidants were kept at 3% with the exception of Conservare-H, which was used as supplied, and acrylic-epoxy (~11%). The treated samples were mounted on aluminum racks, wired in place and exposed to the two environmental extremes: full sun (dry, windy) and jungle shade (high humidity, little wind). The climatic conditions at both locations were continuously monitored throughout the year by solar-powered meteorological stations that were capable of data storage for six months. These stations installed at Xunantunich were designed to obtain data on rainfall, relative humidity, wind speed and direction, solar radiation and air, ground, and sample temperatures. The data obtained were used to guide the selection of artificial aging conditions for laboratory tests.

After one year of exposure at Xunantunich, half of the samples were retrieved and subjected to tests in the laboratory to evaluate the relative effectiveness of the consolidants. The remainder were left for another year of exposure.

3.3.2 Artificial aging in the laboratory

Because the specific environmental factors responsible for limestone degradation at Xunantunich had not been identified, it was difficult to designate the artificial aging conditions to which laboratory samples should

be exposed to simulate natural aging. The synergistic effects of combined environments and both the frequency and amplitude of their cyclic variations further complicated the selection of appropriate test conditions. However, the meteorological data collected at the site provided maximum and minimum values of temperature and relative humidity and an attempt was made in one set of tests to subject the laboratory samples to a similar diurnal cycle at zero light intensity. In another test, the major cyclic variables were light intensity, temperature and condensing moisture.

Limestone collected from Xunantunich was cut into 5 X 5 X 2.5 cm samples and treated in the laboratory with some of the same consolidant solutions that were tested in the *in-situ* evaluation test. Samples were immersed in the respective consolidant solution leaving 1 cm of the upper stone surfaces open to air for 10 minutes. Samples were then removed and the excess consolidant on the stone surfaces was wiped off with absorbent paper.

The exposure testing was done using a Hotpack oven and a QUV chamber. One set of samples was placed in the oven and subjected to an aging cycle of 12 hours at 21°C and 85% RH followed by 12 hours at 44°C and 25% RH for one year. Another set was placed in a QUV chamber for exposure to a cycle of 12 hours of UV radiation at low RH and 44°C, followed by 12 hours of darkness at 21°C and water condensation for one year. Both consolidant-treated and untreated stone samples were exposed for a period of one year.

3.4 Change in appearance of the samples after one year of natural and artificial aging.

An important requirement for an acceptable consolidant is that the appearance of the treated surface should not be appreciably different from the untreated stone. Changes in appearance of the naturally and artificially aged consolidated limestone samples was assessed visually. Qualitative comparison between untreated and consolidated stone were made to evaluate color and surface texture changes and for the naturally aged sample set, the extent of microfloral growth.

3.5 Microabrasion resistance

Resistance to mechanical erosion is one indicator of the bond strength between adjacent particles of stone. How effectively a stone consolidant acts to restore strong bonding can be measured by the abrasion resistance of the treated stone. However, the abrasion resistance can also be interpreted in terms of the hardness, or energy absorbance or toughness characteristics of the consolidant. One method for evaluation of the overall relative effectiveness of the treatment is the microabrasive blasting technique [7].

The relative abrasion resistance was measured by determination of the mass of stone removed by the action of a grained abrasive blast under defined conditions. This test was carried out in the laboratory on treated and untreated limestone samples. A minimum of three holes were blasted in

each sample but additional locations were sampled if the mass loss variation from hole-to-hole was large owing to natural inhomogeneities in the stone sample.

An S.S. White Airbrasive unit Model-H was used under the following standard conditions:

Time	- 15 Sec.	Nozzle diameter	- 0.046 cm
Pressure	- 5 bar	Nozzle distance	- 1.25 cm
Powder flow	- 75 Volts	Abrasive powder	- 50 micron aluminum oxide

3.6 Water abrasion resistance

Since rain water at Xunantunich is believed to be one of the major causes of damage to limestone, it was important to evaluate the relative durability of the consolidation treatment with respect to the effects of wind-driven rain. A system for water abrasion resistance testing was developed which would produce an accelerated simulation of the effects of wind-driven rain.

The system consisted of circulating water pump, pressure regulator and nozzle that directed a stream of water normal to the stone sample surface through a hole in a mask that defined the area to be eroded. The water pressure and flow rate were maintained constant during the timed run. The constant run time was determined experimentally as the time required to produce a significant weight loss in untreated limestone (about 0.5 grams).

Each sample was dried in an oven at 60°C for 24 hours or to constant weight. The masked sample was mounted at a fixed distance below the water nozzle. After the specified water impingement time, the sample was dried again to constant weight. The operating parameters for the system were:

Water pressure	-	1.4 x 10 ⁵ Pa
Distance of the sample from nozzle	-	5 cm
Nozzle diameter	-	0.47 cm
Time	-	1 hour
Exposed area for water abrasion	-	1.59 cm diameter
Water flow rate		250 cc/second

Both consolidated and untreated control samples, aged artificially in the Hotpack oven for one year were tested for water abrasion resistance.

3.7 Porosity and pore size distribution

An important criterion for an acceptable consolidant for outdoor stone is that the change in porosity following consolidation should not be large enough to affect seriously water vapor transport through the stone. The changes in limestone porosity and pore size distribution were measured following consolidation using a Micromeritics mercury intrusion porosimeter, Model 9320.

4 Results and Discussion

4.1 Depth of penetration

In controlled laboratory tests, the depths of penetration of solutions of epoxy resin, acrylic-epoxy, Acryloid B-67 and alkoxysilane into the limestone were found to vary between 16 and 30 mm. Because of the small size of the polyurethane dispersion particles, penetration to a depth of 15 mm was found. However, the Rhoplex AC 33 emulsion particles were much larger and did not penetrate deeply into the stone, but formed a surface layer. Except in the case of Conservare-H and Acryloid B-67 (where capillary rise resulted in deeper penetration), both treatment methods (spraying and capillary rise) gave nearly the same depth of consolidant penetration.

4.2 Consolidant curing at high R.H.

The results, shown in Table 1, indicate that only Eponex 1510 and Conservare-H were able to consolidate the powdered limestone in a high humidity environment. The other water-borne systems were not effective consolidants under these conditions.

Table 1. Consolidation of limestone at high relative humidity

Consolidant	Consolidation
Acrylic-epoxy (11%) Acrylic-epoxy (3%) Acryloid B-67 (3%) Bayhydrol (3%)	No
Rhoplex AC-33 (3%) Conservare-H (3%)	Poor
Conservare-H (10%)	Good
Eponex1510 (10%) Eponex1510 (3%) Conservare-H (neat)	Very good

Knowing the consolidating effect of any treatment in a high humidity environment with respect to time may be an important guideline in selecting consolidating materials for the stabilization of stone that is continually moist. Although consolidation treatments would be performed during the season when the stone surface is relatively dry, curing of consolidant that had penetrated into the continually moist region would be dependent on the consolidant type.

4.3 Natural aging

4.3.1 Erosion loss

No surface erosion was noticed on the samples treated with acrylic-epoxies and Eponex 1510 and aged in-situ in both sunny and shaded areas. The exposed edges of the samples, which were most vulnerable to erosion, were also unchanged. In both shaded and sunny areas, surfaces of the samples treated with Rhoplex AC-33, Acryloid B-67 and Conservare-H were eroded. The Bayhydrol treated samples appeared to be more resistant to erosion than the acrylics. As expected, the untreated control samples in both sunny and shady locations were heavily eroded. One particular sample was cracked in many places and the lower corner had chipped off.

4.3.2 Appearance change

Light gray/black to green microbiological growths were evident on the sample surfaces that were exposed in the shaded area. Orange and light brown discolorations were found on the samples treated with acrylic-epoxies, Acryloid B-72, and Conservare-H, whereas samples treated with Eponex 1510 and Bayhydrol were yellowish green. Untreated samples were light green and tan.

In the sunny area, patchy light gray deposits were found on samples treated with acrylic-epoxies, Rhoplex AC-33, Conservare-H, Acryloid B-67 and B-72. Other than light graying or darkening of the surface, samples treated with Eponex 1510 showed no major discoloration. The initial darkening that occurred on treatment of the samples with Eponex 1510 and acrylic epoxies seems to have disappeared after exposure.

4.3.3 Microabrasion tests

The results of the microabrasion tests on samples exposed in the sunny and shady areas for one year are shown in Tables 2 and 3, respectively. The sample weight losses have been normalized to that of the exposed untreated stone.

Under both environmental test conditions, Eponex 1510 was found to impart greater erosion resistance to the limestone than the other consolidants. This superiority should be even more noticeable for wet stone than for the dry stone that was evaluated by the microabrasion test because of the higher relative water resistance of epoxy compared to that of the other consolidants. Although present at a much lower loading level in the limestone than the acrylic-epoxy (3% versus 11% solutions), Eponex 1510 was the more effective consolidant.

Conservare-H performed much better in the sunny area than in the shade. This might be due to a more complete dehydration of the deposited silica gel and formation of hard silica at the higher temperatures and lower relative humidity in the sun than in the shade.

Table 2. Abrasion resistance of naturally aged (sunny area) consolidated limestone

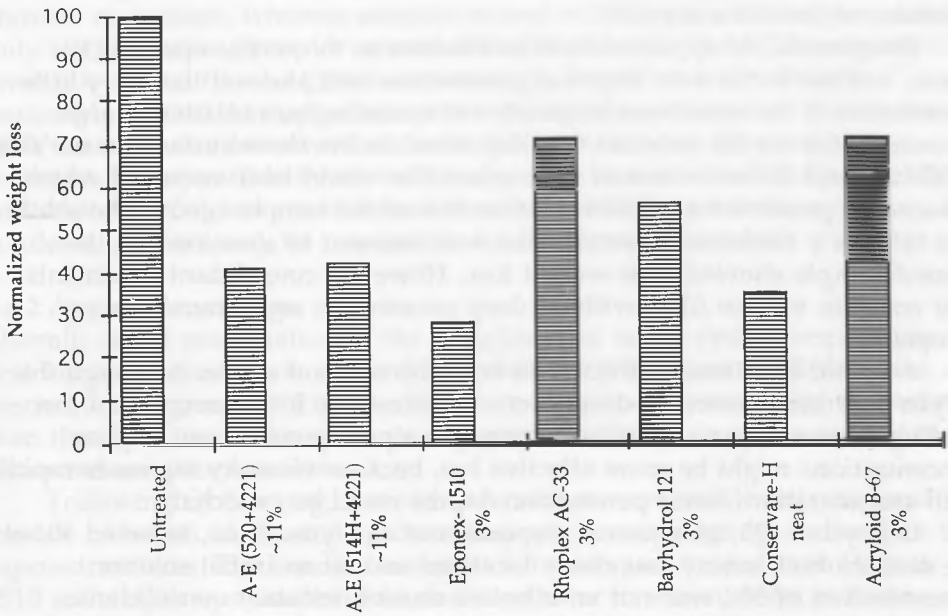
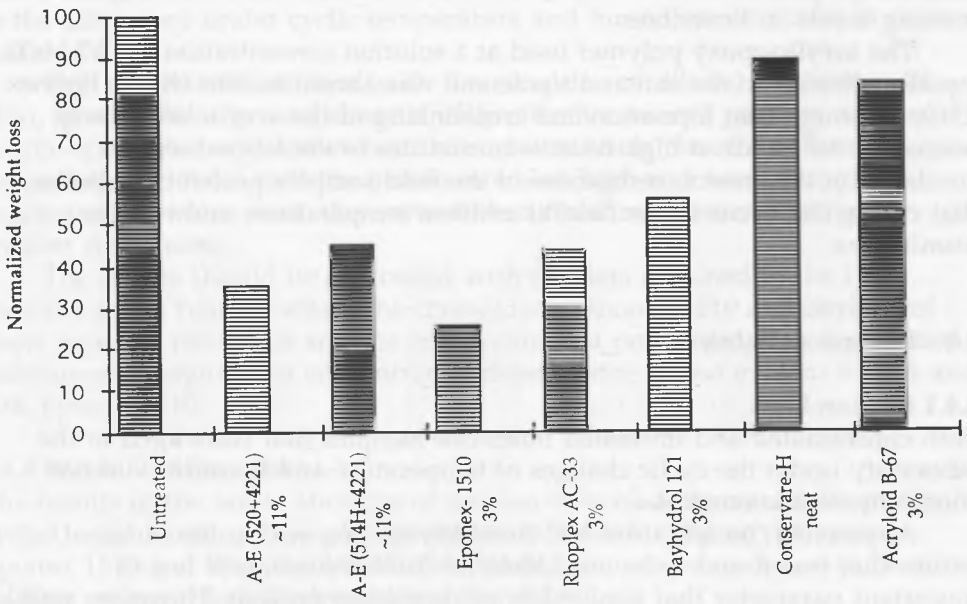

Table 3. Abrasion resistance of naturally aged (shady area) consolidated limestone



The effectiveness of alkoxy-silanes and ethylsilicates when used as consolidants for stones other than silicates (limestone, for example) has been questioned and its apparent effectiveness in this case could be attributed to the hardness of the silica deposit.

Rhoplex AC-33 appeared to be as effective as the acrylic-epoxy in the shade, but not in the sun. Depth of penetration tests showed that very little penetration of the stone was achieved and accordingly, a relatively large amount of the acrylic polymer was deposited on the stone surface. In the sun, oxidation and delamination of the surface film could have occurred which reduced its protective capabilities below that of the sample aged in the shade. The relatively thick tough, acrylic film was resistant to abrasion and the treated sample showed little weight loss. However, consolidant treatments that result in surface films without deep penetration are generally not acceptable.

Acryloid B-67 was ineffective in both the sun and shade. Although the acrylic polymer penetrated deeply into the stone, the low strength and low loading concentration combined to produce a poor consolidant. Higher concentrations might be more effective but, because viscosity increases rapidly with concentration, lower penetration depths could be expected.

Bayhydrol 121, an aqueous dispersion of a polyurethane, behaved about the same in both sunny and shady locations and, at an initial solution concentration of 3%, was not an effective erosion-resistant consolidant. Because of the small size of the dispersion particles, the penetration depth was good. Increasing the concentration should not affect the penetration depth and because polyurethane is a tough polymer that is resistant to erosion, the performance of Bayhydrol should be reevaluated at higher loading levels in limestone.

The acrylic-epoxy polymer used at a solution concentration of 11%, was equally effective in the sun and shade and was almost as effective as Eponex 1510. Although film formation and crosslinking of the acrylic and epoxy resins did not occur at high relative humidities in the laboratory, the similarity in the erosion resistances of the field samples probably indicates that curing did occur in the field at ambient temperatures and relative humidities.

4.4 Laboratory aging

4.4.1 Erosion loss

Both consolidated and untreated limestone samples that were aged in the laboratory under the cyclic changes of temperature and humidity did not show any visible erosion.

Apparently, temperature and humidity cycling within the range of values that was found to be most likely at Xunantunich, was not an important parameter that resulted in stone surface erosion. However, visible

erosion seems to have occurred on some samples that were aged in the QUV chamber where the limestone was exposed to UV radiation and to condensing moisture. Samples treated with acrylic epoxy resin and Bayhydrol showed no erosion, whereas samples treated with Eponex 1510 experienced only slight erosion. Samples treated with Rhoplex AC-33 and Conservare-H were not resistant to the QUV weathering cycle and were found to be noticeably eroded. Untreated samples were significantly eroded during the QUV test. It is not known whether the UV radiation, or the condensing moisture, is responsible for the erosion in each case. It is not likely that UV could affect a Conservare-H treated limestone, and hence in this case condensing water may be responsible for the observed erosion.

4.4.2 Appearance change

Overall, visual examination of the samples aged under cyclic temperature and humidity conditions showed that some darkening occurred. Samples treated with Eponex 1510, Bayhydrol and acrylic epoxies were slightly darker than the other treated samples. As expected, no change in appearance of the untreated samples was noticed.

Following QUV aging, sample surfaces that were not directly exposed to the UV radiation and water condensation cycles were slightly darker than the exposed surfaces. The exposed surfaces of the samples treated with Eponex 1510 and acrylic-epoxies that had darkened after treatment seem to have returned to their original appearance.

4.4.3 Microabrasion tests

The relative microabrasion resistance of consolidated limestone samples aged in the laboratory under cyclic temperature and humidity conditions is shown in Table 4.

The results indicate that, with the exception of diluted Conservare-H (3%), all consolidants were about equally effective, except, perhaps, for the acrylic-epoxy that was somewhat more resistant than the others. It is interesting to note that in the instances where high and low solution concentrations were used, there was little difference between measured erosion resistances.

The results should be contrasted with the data obtained in the QUV chamber tests (Table 5) where the consolidants Eponex 1510 and Bayhydrol show superior resistance and the others exhibit a range of decreasing erosion resistances. A significant concentration dependence is also evident for 3% and 10% Eponex 1510.

4.4.4 Water abrasion test

The results of the water abrasion or erosion tests on temperature/humidity cycled, aged limestone samples are shown in Table 6. The acrylic epoxy, Eponex 1510 and Rhoplex AC-33 consolidated samples were found to be more erosion resistant than Bayhydrol and Acryloid B-67.

Table 4. Abrasion resistance of laboratory aged (Hotpack oven) consolidated limestone

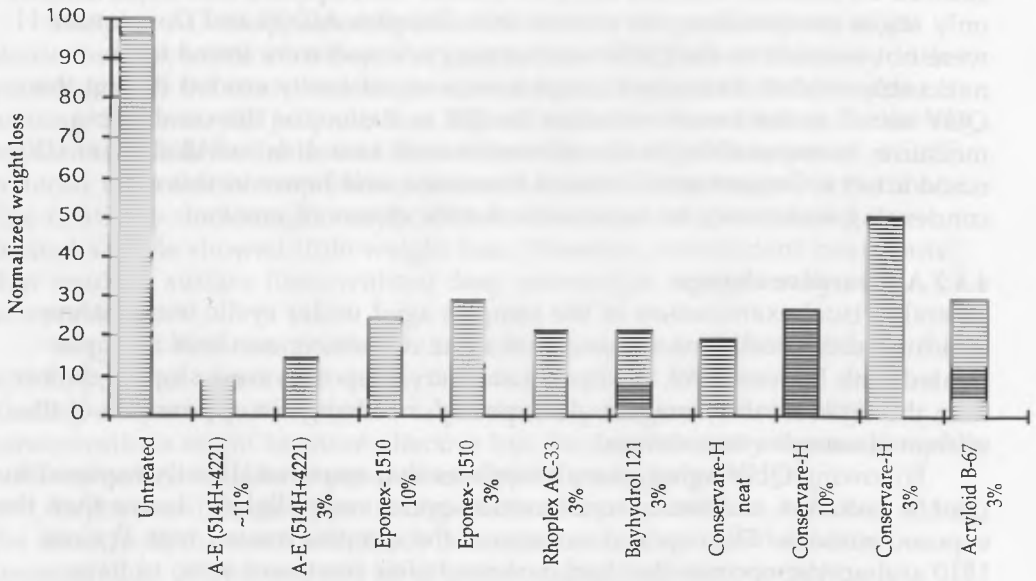
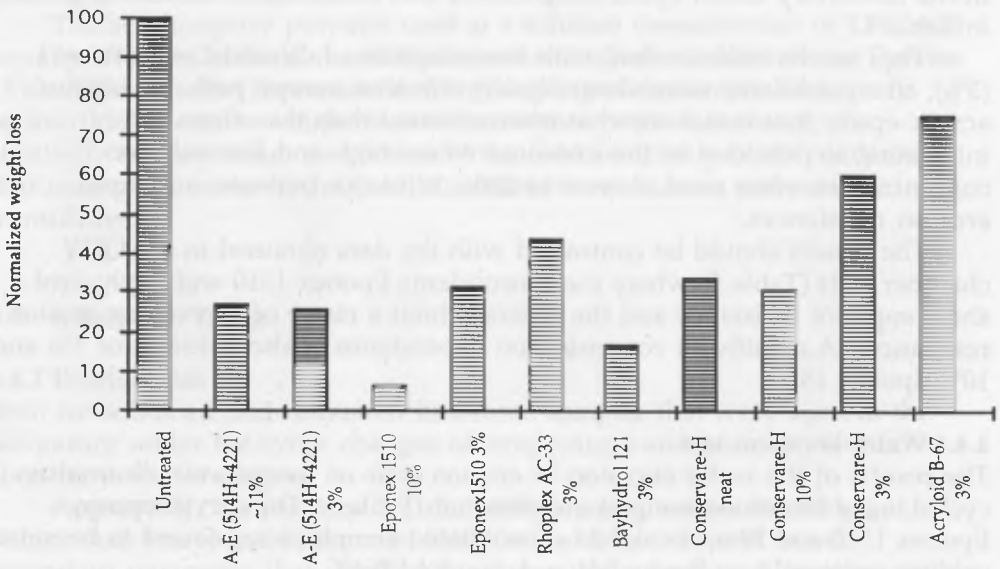

Table 5. Abrasion resistance of laboratory aged (QUV) consolidated limestone



The resistance of Rhoplex AC-33 may be due to the formation of a flexible, tough, surface layer that was not affected by the artificial aging cycle. A similarly treated sample, when subjected to the QUV cycle, did not perform as well when compared with epoxy-containing polymers.

Resistance to water jet impingement includes not only a mechanical erosion factor but also a dependence on solubility and wetting of the limestone. Further work on this type of test needs to be performed to gain an understanding of the relative contribution of these parameters to the observed mass loss. However, the test is fast and revealed differences in erosion resistance that were not observed following natural aging.

Table 6. Water abrasion resistance of consolidated oven-aged limestone

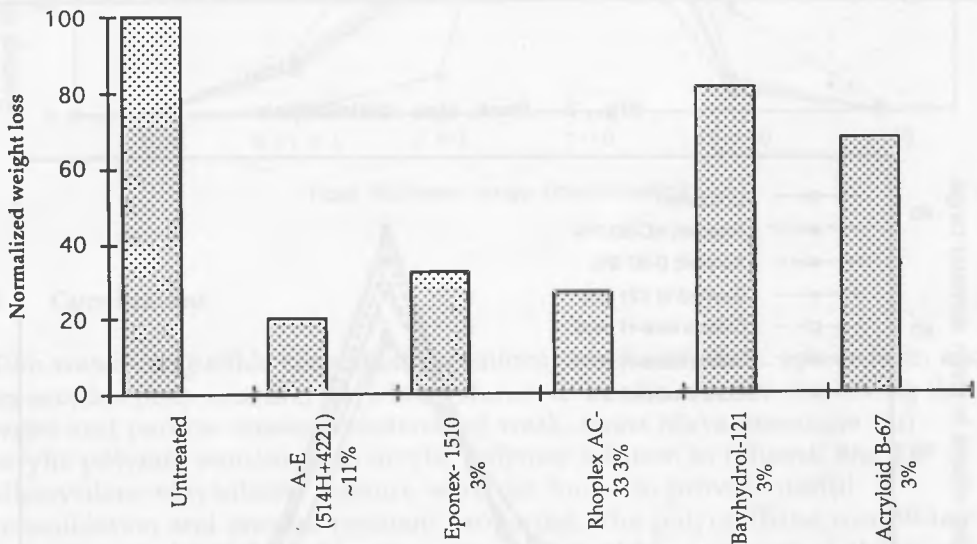

4.5 Porosity changes

Measurement of the porosity of limestone samples following consolidation showed that the porosity was reduced in all cases. However, the final porosity was not reduced sufficiently to impair water vapor diffusion through the limestone (Table 7).

The pore size distribution measurements that are shown in Figure 1 indicate that for some consolidants, the smaller pores have been filled or blocked by the consolidant thus raising the volume percent of larger pores.

In Figure 2, the consolidants that improve the erosion resistance of the limestone significantly seem to affect the pore size distribution in different ways. In one case (Eponex 10%), the 1-10 μ m pores are being filled and

Table 7. Porosity change

Consolidant treatment	% Porosity after treatment	% Porosity reduction
Control (Untreated)	56	-
A-E (514H+4221) -11%	45	20
A-E (514H+4221) -3%	47	16
Eponex 1510 -10%	37	34
Eponex 1510 -3%	42	25
Rhoplex AC-33 -3%	51	9
Acryloid B-67 -3%	55	2
Bayhydrol 121 -3%	52	7
Conservare-H -neat	33	41
Conservare-H -10%	48	14
Conservare-H -3%	49	13

Fig. 1 Pore size distribution

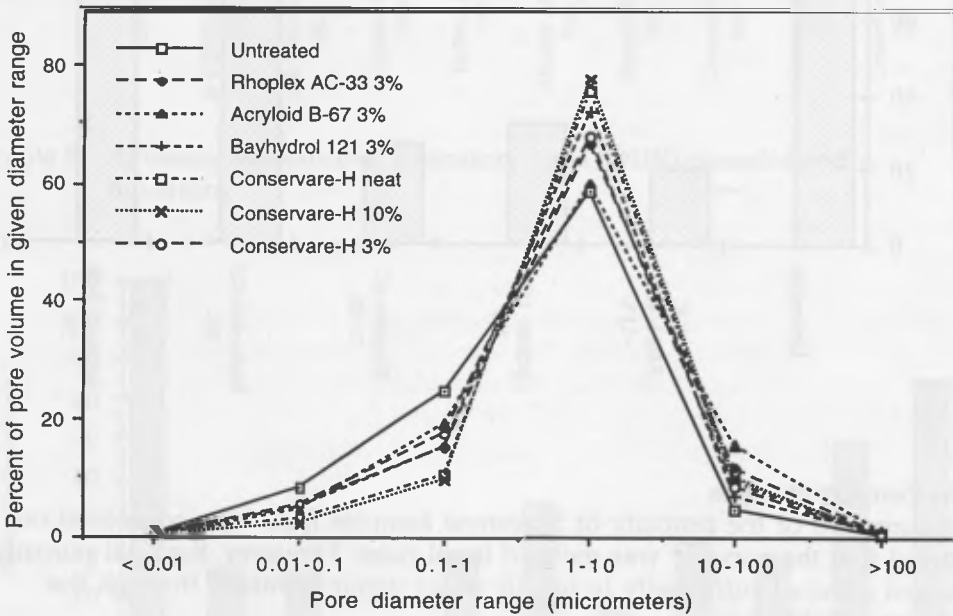

converted to 0.1-1.0 μ m diameter pores; for acrylic-epoxy, the percent of pore volume in the 1-10 μ m range decreased while that in the 10-100 μ m range increased; and for Eponex 3%, the original pore size distribution remained essentially unchanged although the total pore volume decreased 25%. These effects are under investigation.

Fig. 2 Pore size distribution

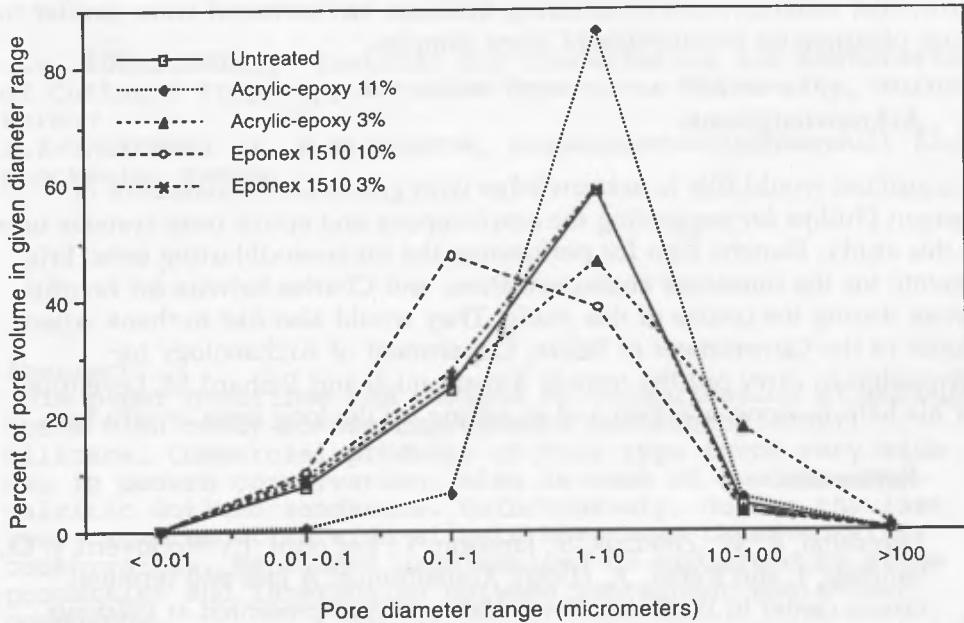

6 Conclusions

Two water-compatible consolidant solutions, a cycloaliphatic epoxy resin and an acrylic-epoxy mixture, have been shown to be effective for improving the water and particle erosion resistance of weak, moist Maya limestone. An acrylic polymer emulsion, an acrylic polymer solution in toluene, and an alkoxy silane-ethylsilicate mixture were not found to provide useful consolidation and erosion resistant properties. The polyurethane consolidant that was tested had desirable properties and should be reevaluated at higher stone loading concentrations.

Microabrasion and water impingement abrasion test methods have been used to screen potential consolidants for use on weak or deteriorated limestone. These methods are useful where the principal degradation mechanism is water or particle erosion or the stone is too highly deteriorated for modulus of rupture measurements.

A comparison between natural aging in sunny and shady tropical environments and two types of laboratory simulation artificial aging has been carried out. Cyclic variation of temperature and relative humidity over a range of values typical of the tropical environment failed to yield limestone erosion resistance results comparable to those observed in the natural

environment. However, the results obtained on artificial aging in a cyclic ultraviolet radiation and condensing moisture environment were similar to those obtained on insitu-exposed stone samples.

7 Acknowledgments

The authors would like to acknowledge with gratitude the assistance of Morgan Phillips for suggesting the acrylic-epoxy and epoxy resin systems used in this study, Blanche Kim for performing the microsandblasting tests, Eric Doehnè for the limestone characterization, and Charles Selwitz for helpful advice during the course of this study. They would also like to thank Allan Moore of the Government of Belize, Department of Archaeology for permission to carry out the tests at Xunantunich and Richard M. Leventhal for his help in stone selection and in setting up the long term, in-situ tests.

8 References

1. Leventhal, R. M., Zeleznik, S., Jamison, T., LeCount, L., McGovern, J. O., Sanchez, J. and Keller, A. (1993): Xunantunich: A late and terminal classic center in the Belize River Valley, Paper presented at *Palenque Mesa Redonda, Aniversario Katun*, Palenque, Mexico, 1973-1993, June 1993.
2. Lewin, Semour Z. (1966): "The preservation of natural stone, 1839-1965, An Annotated Bibliography," *Art and Archaeology Technical Abstract*, 6, 185-277.
3. Phillips, M. W. (1987): Alkali-soluble acrylic consolidants for plaster: A preliminary investigation, *Studies in Conservation*, 32, 145-152.
4. Bauer, R. S. (1982): Formulating weatherable epoxy resin for maximum performance, Paper presented at the *Water-borne and Higher Solids coating Symposium*, New Orleans, Louisiana, USA, February 17-19, 1982, 1-15.
5. Kumar, R. and Ginell, W. S. (1994): A new technique for determining the depth of penetration of consolidants into limestone using iodine vapor, Paper presented at *American Institute for Conservation Meeting*, Nashville, Tennessee, June 6-11.
6. Ginell, W. S., Kumar, R. and Doehne, E. (1994): Conservation Studies on Limestone from the Maya site at Xunantunich, Belize, *Materials Issues in Art and Archaeology IV*, Cancun, Mexico, May 16-20.
7. Phillips, M. W. (1982): Acrylic precipitation consolidants, Paper presented at Congress on Science and Technology in the Service of Conservation, Washington D. C., 56-60.

CONSOLIDATION OF GOTLAND STONE IN MONUMENTS

J.W. LUKASZEWICZ, Institut for Conservation and Restoration of Cultural Property, Nicholas Copernicus University, Torun, Poland

D.KWIATKOWSKI & M.KLINGSPOR, StenKonserveringsKonsult AB, Stockholm, Sweden

Abstract

This paper describes the results of consolidation of porous stone with ready-to-use impregnants containing ethyl silicate. Commercial products of this type found very wide use in modern conservation, also in case of Swedish clay-calcitic Gotland sandstone. Unfortunately, during the last years some negative side effects have been observed after conservation. Mentioned problems can be explained by stone properties and interaction between impregnant and stone compounds.

Keywords: Gotland sandstone, Consolidation, Ethyl silicate, Polycondensation, Negative side effects.

1 Introduction

Out-door exposed stone monuments undergo natural or accelerated weathering. This refers specially to sedimentary rocks which are less resistant. Those relatively soft, unhomogenous stones are often found as sculpture material in architecture. One example is the Gotland sandstone.

From the Middle Ages sandstone was quarred on Gotland Island, placed east from the Swedish coast. Especially, since the days of the Hanseatic League it has been very often used as a material for architectonic details and sculptures both in Sweden and northern Poland. Even today, this stone material is still easily available on the Swedish market.

It is quite easy to carve the soft Gotland sandstone and create fine ornaments. Unfortunately, this advantage appears later as a big disadvantage. Stone monuments deteriorate extremely fast when exposed to rain, snow and frost action, especially in a polluted atmosphere, resultant to the industrial development in our century.

2 The properties of the stone and the state of monuments before conservation

The fine-grained Gotland sandstone is a soft sedimentary rock containing mainly quartz and feldspars. In smaller quantities: clay minerals, calcite, mica and iron compounds. The binder consists of calcium carbonate in the form of micryte, clay minerals and silica. The stone composition can be varied in some range. The original, greenish colour of the stone is given by the presence of a clay mineral, glauconite.

The porosity of this sandstone is between 5-20% by weight and mechanical resistance (compressive strenght) is between 4-5 MPa.

The composition and high open porosity cause intensive weathering processes on the Gotland sandstone. The weak stone binder is not resistant to the physical and chemical action of water even in a clean atmosphere. It can be destroyed by frost or salt cristallisation, as well as other porous stones. Gotland stone deterioration can also be caused by expansion of swelling clay minerals and dissolution of calcium carbonate in the presence of CO₂.

The decay phenomenon is accelerated in the presence of acidic air pollutants. The calcareous and clay minerals binding the stone can easily be attacked by sulphuric acid, the main compound of acid rains.

Sculptures and reliefs exposed to rain are often very deeply decayed because of the quite effective water-absorbtion. The secondary porosity, caused by dissolution of the binder, is permanently increasing. A higher water-absorbtion in the errodred parts accelerates all negative phenomena. The chemical and physical dissolution of the binder make the superficial layer of the stone weaker and finally lead to a total destruction of the original surface. Deterioration of Gotland sandstone occurs in the form of intensive sanding and exfoliation.

3 Stone consolidation

Badly deteriorated reliefs and sculptures can not be saved without effective consolidation. Impregnation of porous stones based on capillary forces give the possibility to introduce low-viscous liquids into the depth of 10 to 20 cm in a relatively short time.

3.1 Consolidants

Nowadays, the altered Gotland sandstone is consolidated with orthosilicic acid esthers (mainly ethyl silicate). Polish and Swedish conservators mainly use German ready-to-use products (Steinfestiger OH from Wacker-Chemie GmbH or Funcosil OH from Remmers GmbH).

Commercial impregnants were originally designed for the building industry, where they found quite extensive application. Since over twentyfive years silanes are also used in conservation. Many years of experience show that commercial impregnants containing solutions of ethyl silicate are very effective consolidants. The impregnant has very low molecular weight and viscosity, therefore it easily penetrates into the pores.

Ethyl silicate, helped by the catalyst, reacts with atmospheric water, producing silica gel ($\text{SiO}_2\text{-aqua}$) as a final product of polycondensation. Wacker-Chemie describes that the best conditions for gel formation gives a temperature between $+10$ and $+20^\circ\text{C}$ and a relative humidity higher than 40%. The reaction can be completed within two weeks. However, if the temperature or humidity is lower, the time for formation of the silica will be prolonged. It is observed, especially during the last years, that the silica binder produced in the deteriorated stone structure gives a significant improvement of the strenght.

3.2 Preconsolidation

Preconsolidation is a preliminary treatment, based on a limited, partial impregnation to preserve the most decayed parts of a stone sculpture. The procedure is carried out by injection of the consolidant into the worst desintegrated parts.

3.3 Total consolidation

Total, deep consolidation refers to badly deteriorated porous stones, with deeply weathered (sanding) structure. The deep impregnation *in situ* can be arranged in different ways. The most efficient is the "permanent flow" impregnation which requires special arrangements. A simplified way of this treatment is the "wet-to-wet" method. The impregnating liquid is permanently applied with low-pressure sprayers on the whole surface until the moment it stops penetrating into the stone structure, which means it is saturated.

With this method the average liquid consumption range between 5-15 liters per square meter. The self-distribution of the impregnant into the stone structure depends on the porosity and the degree of stone deterioration. Always more consolidating liquid is absorbed in the worst decayed parts because of the increased "secondary porosity". When the impregnation is completed the excess of liquid is to be removed and the surface should be washed off with a solvent.

After treatment the monument should be left protected with a foil to prevent too fast evaporation of the liquids. At least a 3 week-period is needed to complete the reaction. The silica binder in the stone pores should be a fully hydrophylic product by then.



Fig.1: Dark spots still visible two years after preconsolidation treatment

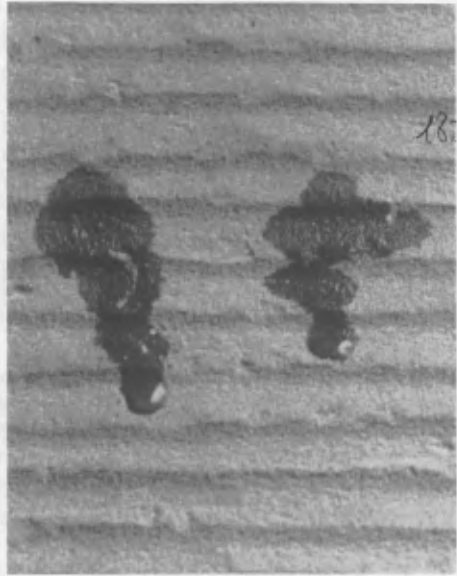

Fig.2: A slight hydrophobic effect observed almost five years after impregnation

4 The state of monuments after conservation

The effect of stone consolidation is good and seems to be longlasting. Unfortunately, during the last years some negative side effects have been observed on consolidated Gotland sandstone.

Previous partial impregnation often gives darker appearance. This phenomenon often goes together with insignificant sealing of the stone pores. Sometimes the impregnated areas can be recognized on the stone surfaces years after treatment (fig.1).

A slight hydrophobic effect (partial water-repellency) can be present on the surface of treated stones. It seems to be rather longlasting and can be observed even long time after conservation (fig.2).

Another negative phenomenon shows as white deposits on the stone surface. Often, about a year or only a winter season after impregnation, residues appears as a very fine powder (fig.3). It is insoluble in water, but can be washed and brushed away. It is observed that rainwater running on the monuments surfaces can wash it away, making visible traces (fig.4,5).

Chemical analyses show the presence of gipsum in the white deposits. The instrumental analyses (IR + SEM/EDX) confirm presence of gipsum (IR spectra 3550, 3400, 1640, 1615, 1140-1120, 670, 600cm⁻¹) and indicate silica (IR spectra 1100-1000, 800, 690, 520, 460cm⁻¹).



Fig.3: After the winter season white deposits appeared on the surface

One of the samples IR indicates also the presence of organic hydrocarbon groups (IR spectra 2960, 2920, 2850 cm^{-1}). This sample was taken about eight months after impregnation. The presence of organic rests (probably $-\text{OC}_2\text{H}_5$ groups still present in silica gel) can give the conclusion that polycondensation in the stone pores was not completed even after that time.

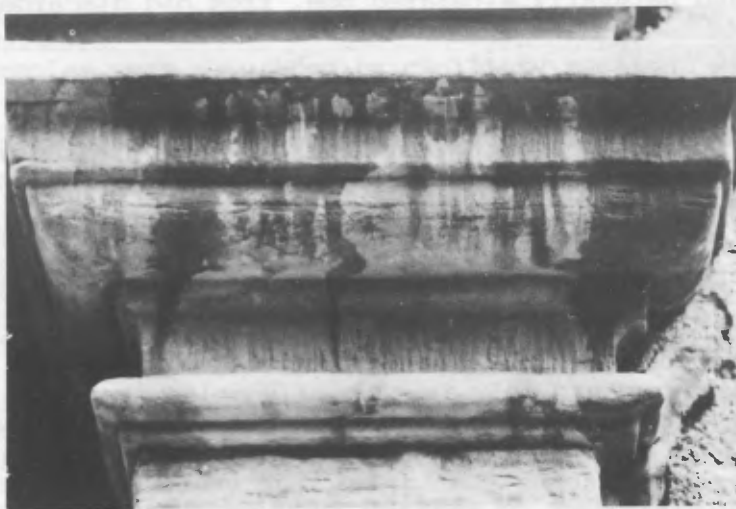

Fig.4: Some years after conservation the rain has partially washed away the white deposits



Fig.5: Some years after conservation the rain has partially washed away the white deposits

5 Experimental

The experiments were performed with the use of Steinfestiger OH /W-OH/ (Wacker-Chemie) and Funcosil-Steinfestiger OH /R-OH/ (Remmers). The products were applied on samples of Gotland sandstone, both freshly taken from a quarry and naturally altered one, from old discarded objects.

5.1 The influence of hardening conditions on the colour shade of treated sandstone

Stone samples were impregnated through capillary suction for 10 minutes to half-way. After treatment samples were stored under different conditions: dried at 333K for 4 hours, other left in laboratory conditions (40-50% RH, temp.297K) and some placed in 75% RH (temp.293K).

The treated parts of all samples got darker. The effect was a little more intensive in case of increased humidity. Furthermore, the wetability was evaluated with a water-drop (20 mm³ of volume) infiltration. The drops penetrated into the stone structure only in case of samples stored in the higher humidity (infiltration after 18 sec.). The other samples were water-repellent.

5.2 The influence of ageing conditions on the properties of treated stones

The stone samples were totally impregnated with capillary suction and stored in the atmosphere of 75% RH.

Table 1. The absorption of consolidants and the content of silica gel

Kind of samples	Consolidant	Consolidant absorption (%)	Content of silica gel (%)
fresh stone	W-OH	6,3	2,2
	R-OH	6,7	2,6
altered old stone	W-OH	5,9	2,1
	R-OH	7,5	2,9

The liquid-absorption (% by weight) was measured (table 1). After the storing period the samples underwent laboratory ageing tests:

Water action

Samples were saturated with water through capillary suction and left partially immersed for free evaporation of water from the surface. Other samples were treated with wetting - drying cycles (total saturation and drying at 333K).

As a result of long-term water transport through the capillaries, a fine white deposit was observed on the surface of both the treated and untreated stones from quarry. It was not present on the "old" stone samples.

In case of wetting - drying tests the same deposits started to form on the surface of the "fresh" stone samples after 15 cycles. It was not observed on the "old" stone.

Action of sulphuric acid

Considerable concentration of sulphuric oxides in the atmosphere in Stockholm is responsible for the accumulation of sulphuric compounds on the surface of outdoor stone monuments.

The samples were saturated by capillary suction with diluted solution of sulphuric acid (0,02 %) and subsequently dried at 333K.

An intensive white deposit appeared on the surface of treated and untreated samples of "fresh" stone just after 5 cycles. The same process passed on the surfaces of all the samples made of "old" stone, but more slowly.

The white deposits were identified as gypsum with different amounts of calcium carbonate, what confirms the results of analyses made from sandstone monuments *in situ*.

Freezing resistance

The samples were saturated with water through capillary suction and underwent freezing - melting cycles (temperature 253-353K).

Already after 7 cycles, just one of all sandstone samples started to decay in some areas. It was an untreated sample of

"old" stone, which was weaker, since lack of binder. Other samples did not show any changes, even after 15 cycles.

6 Conclusions

Based on the above describes studies and practical experience it is ascertained that consolidation with orthosilicic acid esthers producing silica gel improves the mechanical properties of Gotland sandstone. That treatment also give a good protection against frost action.

However, application of hydrophyllic commercial impregnants should not change the original wettability of porous sandstones. To retain this quality the impregnated stones have to be stored under specific conditions, e.g. in an increased humid atmosphere. Normal relative humidity is not sufficient to obtain a pure, hydrophyllic final product of polycondensation. This phenomenon does not disturb the consolidation effect, it just gives a slight water-repelleny.

Unfortunately, it is found that impregnation of Gotland sandstone can give changes of the surface colour shade. This is probably an effect given by the present clay minerals. The specific constitution of those minerals change the reflecting index strongly after absorbtion of the consolidant.

The laboratory ageing tests confirmed the possibility for deposits formation on the surface of Gotland sandstone. White deposits are forming very quickly on freshly cutted stones. On altered ones it appears in a very small amount or it is not visible. The deposits consists of gipsum and calcium carbonate.

It is proved however, that this phenomenon is not directly connected with consolidation, as it is observed also on untreated stone.

The deposits on the surfaces is a result caused by the presence of binder minerals in the stone, not resistant to weathering processes. After consolidation treatment, the calcareous binder is still not well protected against physical dissolution or chemical decay. This is the reason why water always can cause migration of the binder. It can then be much easier attacked by sulphuric acid, even in a slightly polluted atmosphere. Gypsum and secondary calcium carbonate are transported out from the stone and form fine deposits.

Described negative phenomenon depends on the quantity of calcium carbonate in the stone. Because of the lack of calcareous compounds in a surface layer of altered stones the intensity of the process is lower, but under certain circumstances it can always occur.

White deposits can be formed and are visible on the surface

of monuments after cleaning and consolidation. The conservation treatments - when not finished with a hydrophobic agent - make the stone pores open for free water transportation.

As the deposits sometimes occur after consolidation with extreme intensity, it could be explained by possible changes of the physical properties of the capillaries. For this reason the examinations will be continued.

7 Acknowledgements

The authors would like to thank Mrs Barbara Galkowska for technical help.

8 References

- Andersson, T., (1988): Deterioration of Architecture in Scandinavia - Effects of Air Pollution on Stone. In *"Durability of Building Materials"*. Elsevier Science Publishers B.V., Amsterdam, 571-580,
- Domaslowski, W., Lukaszewicz, J.W. (1988): Possibilities of silica application in consolidation of stone monuments. In *"Proceedings of VIth International Congress on Deterioration and Conservation of Stone"* Torun 12-14.09.1988, 563-576
- Löfvendahl, R., and others, (1992): Building stone and sculptural decorations. In *"Air pollution and Swedish Heritage, progress 1988-1991 "* . The Central Board of National Anitquities and National Historical Museums, 1992, 67-69.

EXPERIMENTAL EVALUATION OF STONE CONSOLIDANTS USED IN JAPAN

TADATERU NISHIURA

Director, Division of International Cooperation for Conservation, Tokyo National Research Institute of Cultural Properties, Tokyo, Japan

Abstract

This paper gives three evaluating tests of stone consolidants commonly available for conservation of historical monuments in Japan. The first two test was to evaluate penetrating ability of testing resins into stone samples. The third test evaluated added cohesive strength caused by impregnation of resins. As a result of penetrating ability test we found that a silicone resin, Wacker OH has greater penetrating ability than other tested resins. From the data collected through the third test we found that SS-101 provide greater cohesive strength to treated stones than Wacker OH. However, both of them would not be sufficient enough to consolidate severely deteriorated stones.

Keywords: Stone, Consolidant, Conservation, Evaluation
Silicone resin

1 Introduction

Over the last few years our research team has been conducting a series of tests in evaluating commercially available resins for stone consolidation. In order to determine the overall performance of consolidants, we need to investigate their penetrating ability, added cohesion strength and newly achieved durability after consolidants been impregnated to the stone. This paper concerns the first two: penetrating ability and cohesive strength given by consolidants. The test on added durability is currently in data collection phase.

In recent years organic silicone resin has been widely used for conservation purposes. Therefore, consolidants concerned in this paper are the silicone resins commonly used in Japan. This paper presents two tests for evaluating penetrating ability and one for cohesion strength.

2 Test of penetrating ability

Test for penetrating ability were performed in two phases: when samples are dry and when samples contains moisture simulating stone left in outdoor environment.

2.1 Testing consolidants

Following consolidants are used for the experiments.

Table 1. Silicone resin consolidants for penetrating ability test

Conso- lidants	Maker	Active Ingredient	Solvent	Remarks (catalyst)
SS-101	Colcoat, Co.	Methyl-triethoxysilane (Oligomer) solution	MEK (Ac- etone)	Two separate type (catalyst is mixed when used)
SS-201	Colcoat, Co.	Tetraethoxysilane (oligomar): Methyl- tri-ethoxy-silane (oligomar) =3:1 Solution	MEK (Ac- etone)	Single type (Tin Compound)
SS-301	Colcoat, Co.	Modified Tetraethoxysilane Solution	MEK (Ac- etone)	Single type (Tin Compound)
HAS 6	Colcoat, Co.	Tetraethoxysilane Hydrolysis	Ethanol	Single type (No catalyst)
Wacker OH	Wacker, Chemie	Tetraethoxysilane (Oligomer) Solution	Toluene (Meth- anol)	Single type (Tin Compound)

2.2 Evaluation of penetrating ability of dry samples -test(1)

2.2.1 Sample stone for test(1)

Stone samples used to test consolidants' penetrating ability are as follows:

Table 2. Stone samples used for penetrating ability test(1)

Key	Common Name	Petrographical classification	Remark
O	Oya Stone	Pumice Tuff	
E	Echizen Stone	Sandy Tuff	
Sa	Shirakawa Stone	Coarse Andesite	parallel to the grain
Sb	Shirakawa Stone	Coarse Andesite	perpendicular to the grain

Sizes of samples are

- 1) Oya stone: ϕ 5x5 cm cylinder
- 2) Echizen Stone
Shirakawa Stone : 5x5x7(h)cm block

2.2.2 Test method (1)

All samples are kept in an oven with controlled temperature at 60°C until they reach their constant weight. As seen in Fig.1 place a synthetic fiber pad with water in a plastic container. Each test samples is individually placed on top of the water saturated pad to allow water to penetrate from the bottom surface of the samples by capillary suction.



Fig. 1

At scheduled timing, level of water and the amount of water sucked up are measured and recorded by height and by weight of the samples respectively. Once the data is collected, time of suction $< \text{min.}^{1/2} >$ suction level by height $< \text{mm} >$; time of suction $< \text{min.}^{1/2} >$ - suction by weight $< \text{g/cm}^2 >$ are plotted on regression lines on charts. Then find inclination degree of these lines $\text{SW}_1(\text{h})$ and $\text{SW}_1(\text{w})$.

All samples are again kept in the oven of the same condition to dry until they reach their constant weight. In the same manner as water test, pour testing resins in each separate plastic container to perform resin test on the samples. We also calculate the inclination degree for SR₁(h) and SR₁(w) following the same procedure as water test.

Find penetrating velocity coefficient PV₁(w) and PV₁ (h) by comparing each sample's SW₁(h) and SR₁(h); SW₁(w) and SR₁(w). Calculations are as follows:

$$PV_1(h) = SR_1(h) / SW_1(h) \times 100$$

$$PV_1(w) = SR_1(h) / SW_1(w) \times 100$$

We performed experiments on four test stones of each stone type by each resin: Total of 80 stone samples were tested. By evaluating compared value of penetrating velocity coefficients for water and resin on a same sample we could achieve reliable results despite the irregularity of the sample stones.

2.2.3 Results of test(1)

Table 3. and Fi.2. present results of the test(1)

Table 3. Results of the test(1): dry samples.

consolidants	PV ₁ (h)				PV ₁ (w)			
	O	E	Sa	Sb	O	E	Sa	Sb
SS-101	251.4 (±66.2)	68.4 (±4.7)	61.9 (±2.9)	82.1 (±4.6)	164.5 (±19.2)	68.3 (±10.5)	59.4 (±1.8)	76.3 (±2.1)
SS-201	104.1 (±24.1)	34.1 (±3.0)	46.1 (±6.5)	51.9 (±12.4)	144.4 (±30.4)	40.2 (±2.9)	57.7 (±3.7)	52.7 (±10.4)
SS-301	240.3 (±25.2)	72.1 (±10.2)	80.7 (±3.7)	84.7 (±10.3)	139.2 (±30.2)	61.8 (±2.5)	75.2 (±4.2)	71.5 (±5.0)
HAS 6	229.0 (±92.8)	80.9 (±8.8)	34.8 (±4.7)	60.6 (±21.8)	72.6 (±18.8)	36.8 (±7.7)	36.2 (±7.7)	38.0 (±2.9)
Wacker OH	291.2 (±29.0)	52.3 (±9.1)	65.6 (±14.2)	80.4 (±7.6)	118.5 (±9.8)	56.7 (±3.0)	62.1 (±4.0)	84.7 (±7.9)

It is apparent from the table 3. and Fig.2. that the resin HAS6 has low penetrating ability overall. SS-201 follows

next and the rest do not show much difference in performance. Since SS-201 was manufactured on an experiment basis as an alternative product to Wacker OH, we can conclude that Wacker OH surpassed in penetrating ability among tested ethyl-silicate consolidants.

Oya stone samples presented peculiar results as seen in the table 3: penetrating velocity of resins on Oya stone samples were greater than that of water. For example, $PV_1(h)$ value of Wacker OH is closer to 300 while $PV_1(w)$ values of all but HAS6 are over 100. This peculiar phenomenon may have resulted from the natural characteristic of Oya stone which is highly porous even among tuffs, however, exact cause was not determined during this test.

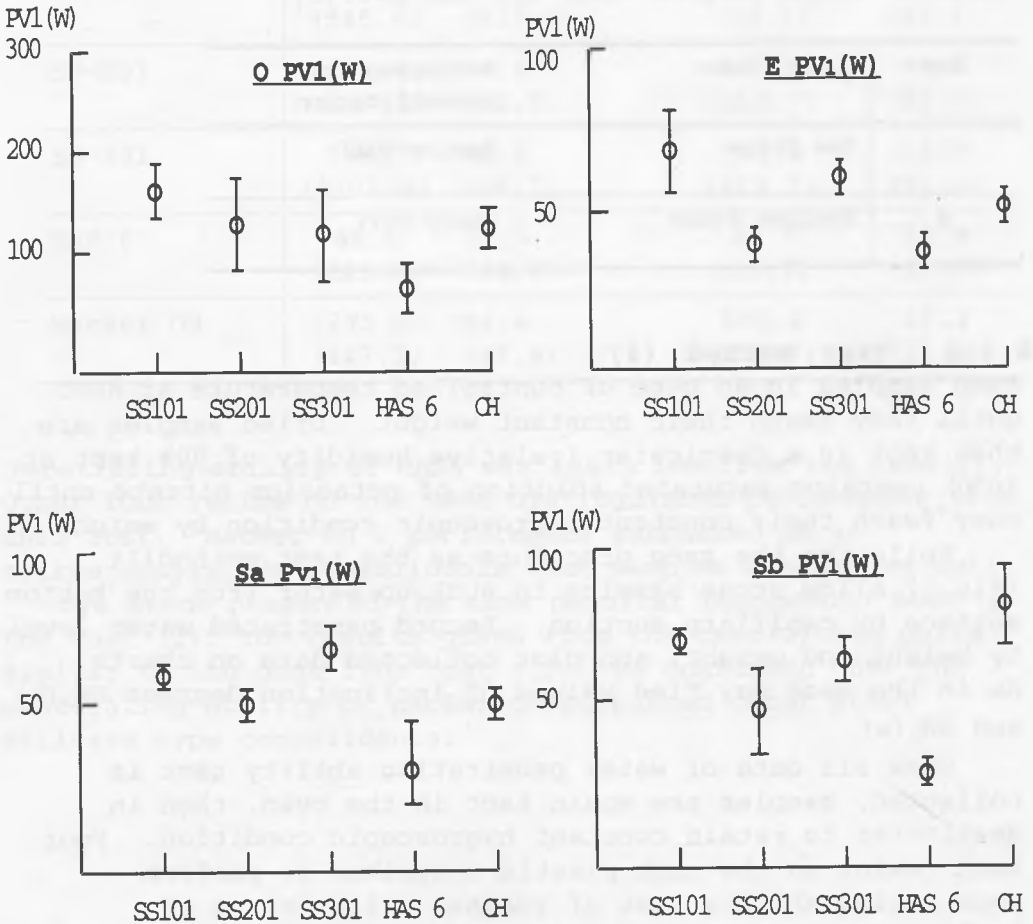

Fig.2. $PV_1(w)$ results by test samples

2.2.3 Evaluation of penetrating ability of moist samples - test(2)

The results given from the previous test do not represent performances of resins which are applied on stones of outdoor monuments, because stones stays in common atmospheric condition, which most of monuments usually are, contain certain level of moisture at all time. Therefore, test(2) is almost the same test as 2.3 but is performed on the controlled moist stone samples. Tested consolidants are exactly the same.

2.3.1 Stone samples for test (2)

Following table shows stone samples used for the test(2).

Table 4. Stone samples used for the test(2)

Key	Common Name	Petrographical classification
O	Oya Stone	Pumice Tuff
E	Echizen Stone	Sandy Tuff

2.3.2 Test method (2)

Keep samples in an oven of controlled temperature at 60°C until they reach their constant weight. Dried samples are then kept in a desiccator (relative humidity of 90% kept at 20°C) contains saturated solution of potassium nitrate until they reach their constant hygroscopic condition by weight.

Following the same procedure as the test method(1) (Fig.1) allow stone samples to suck up water from the bottom surface by capillary suction. Record penetrated water level by height and weight, and plot collected data on charts. As in the same way find values of inclination degrees $SW_2(h)$ and $SW_2(w)$.

Once all data of water penetrating ability test is collected, samples are again kept in the oven, then in desiccator to retain constant hygroscopic condition. Pour each resins in the each plastic container to perform penetrating ability test of resins. Find values of inclination degrees $SR_2(h)$ and $SR_2(w)$.

Find penetrating velocity coefficient $PV_2(h)$ and $PV_2(w)$

by comparing each sample's $SW_2(h)$ and $SR_2(h)$, $SW_2(w)$ and $SR_2(w)$. Calculations are:

$$PV_2(h) = SR_2(h) / SW_2(h) \times 100$$

$$PV_2(w) = SR_2(w) / SW_2(w) \times 100$$

2.4.2 Results of test(2)

Table 5 and Fig.3 present result of the test(2).

Table 5. Results of test(2) for moist samples

Consolidants	PV ₂ (h)		PV ₂ (W)	
	O	E	O	E
SS-101	277.1 (±46.6)	88.7 (±10.4)	128.9 (±9.2)	52.2 (±1.6)
SS-201	335.4 (±157.6)	44.6 (±4.0)	116.1 (±13.7)	45.6 (±3.8)
SS-301	399.7 (±102.4)	64.1 (±8.7)	161.4 (±13.3)	56.9 (±3.2)
HAS 6	86.1 (±28.6)	38.0 (±4.8)	23.7 (±1.7)	15.9 (±0.9)
Wacker OH	295.0 (±47.3)	58.4 (±7.9)	110.2 (±19.7)	43.3 (±2.6)

Penetrating ability of HAS6 was again low from the test(2). Other four resins do not have distinguished performance from this test. Wacker OH's performance surpassed as an tetraethoxysilane consolidants when samples are dry as well.

Oya stone presented the same peculiar phenomenon seen in the test (1). The results given from the test(2) are quite similar to the ones from test (1). We confirmed that the penetrating ability of Wacker OH surpassed other ethyl silicate type consolidants.

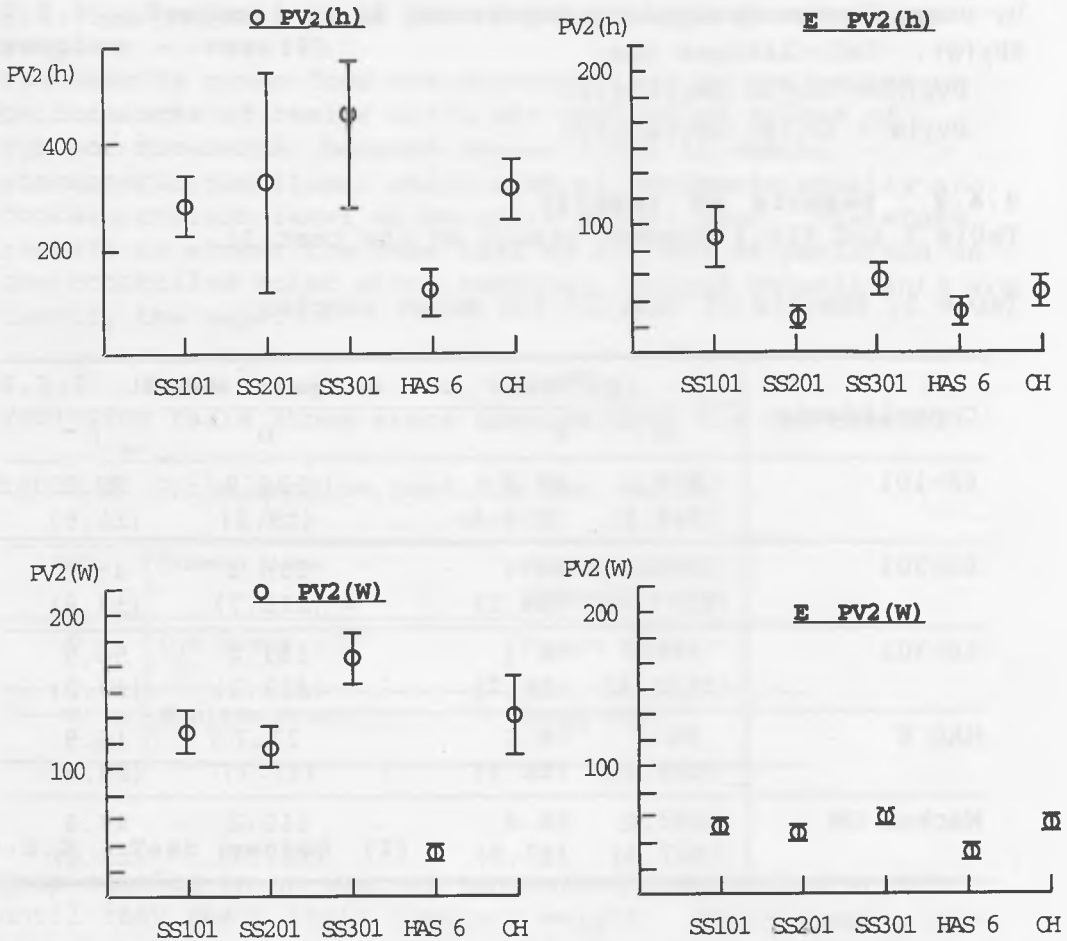

Fig. 3. PV₂(w) and PV₂(h) results by test samples

3 Test of increased cohesion strength after impregnation of consolidants

In order to evaluate cohesion strength or bonding effect given by impregnated silicon resins we conducted the following test (3). Prepare specimens with silica granules, then impregnate consolidants to such specimens. Since silica granules naturally do not carry cohesive strength any added cohesive strength measured after the impregnation should be the direct reflection of the ability of each

consolidants.

3.1 Testing consolidants

We selected two most commonly used resins for conservation of monuments as testing resin. Acrylic resin and epoxy resin were employed to the test for comparing purposes.

Table 6. Testing consolidants

Commercial Name	Maker	Chemical component	Solution	Remarks
SS-101	Colcote Co. Japan	Solution of Methyl tri-ethoxy silane oligomer	Toluene (Methanol)	2 separate type solution, Mix tin compound catalyst at the time of use.
Wacker OH	Wacker Chemie Germany	Solution of Tetraethoxy-silane oligomer solution	MEK (acetone)	Single type solution
Paraloid B-72	Röhm & Haas USA	Co-polymer of Ethyl-methacrylate and methylacrylate	Toluene	15% solution
Araldite CY230	Ciba Geigy Co Switzerland	Epoxy resin	Toluene	15% solution

3.2. Standard silica granules used for specimens

Standard silica granules employed to make specimens were passed through a 0.3mm sieve but were retained on a 0.15mm sieve.

3.3. Test method

3.3.1 Preparation of specimens

Pour silica granules into a plastic cylinder (\emptyset 30mm; 50mm height) covered with nylon netting at the bottom upto the height of 35 mm (about 30g). (Fig.4)

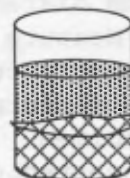

Fig.4

As seen in the Fig.5. place a synthetic resin fiber pad which is soaked in testing resin in a glass petri dish. Place granules filled cylinder on the pad to allow resin to suck up from the bottom surface by capillary suction. Descicater was employed to create controlled environment and to prevent evaporation of solvent. Each test specimen was left on the pad for 30 minutes, then left under regular laboratory environment for 15 days.

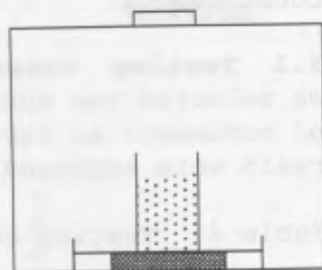

Fig.5

Four specimens were prepared for each resin: total of 16 specimens were to be tested.

Consolidated specimens were taken out from plastic cylinder and left in a laboratory for another 30 days. Following Table 8. shows weight increase of specimens after the total curing process.

Table 8. weight increase of cured specimens

SS-101	11.4 %
Wacker OH	12.0 %
Paraloid B-72	4.4 %
Araldite CY230	4.4 %

3.3.2. Airbrush perforating test

As seen in the Fig.-6., perforate specimens with oxidized aluminum granules ($\emptyset 50 \mu\text{m}$) sprayed by airbrush with a nozzle size of $\emptyset 1\text{mm}$ to the height of 5,10,15, 20, 25, 30 mm of the specimens. Each spraying lasted for 5 seconds (about $1\text{g}/\text{sec.}$) from 10mm distance.

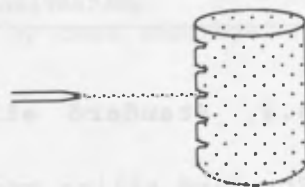

Fig.6

Measure the depth of perforation caused by spraying and collected data as cohesion strength index. Perforating test was performed eight times from four directions on each specimen. However, specimen impregnated with Wacker OH presented deep initial perforation, therefore only 4 index were collected on the each specimen.

3.3.3 Split test

Shimazu Autograph was used as the apparatus for the split test (pressure velocity 5mm/min.) Apply pressure toward the center of a specimen (Fig. 7) with the test apparatus to measure the maximum splitting tensile strength according to the following equation.

$$\sigma = \frac{2 P}{\pi d l}$$

σ : Splitting tensile strength

(kg/cm²)

P : Maximum weight (kg)

d : Diameter of the specimen

l : length of the specimen

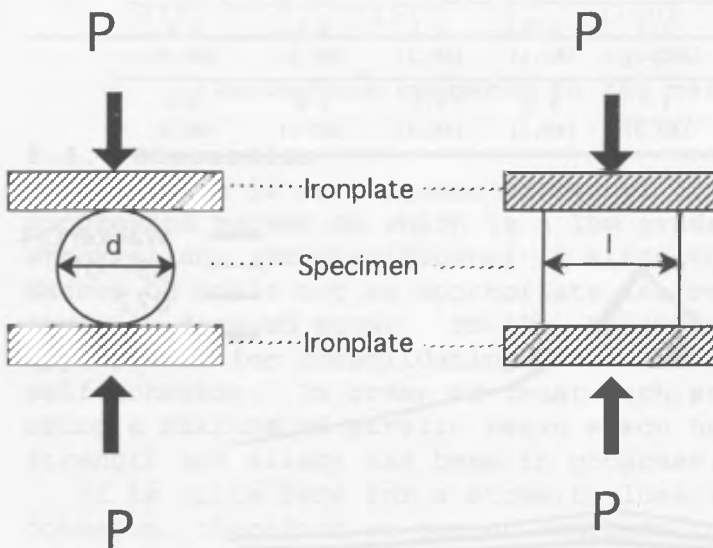

Fig. 7 Split test diagram

3.3.4 Results

Test results of airbrush perforation appear on the Table 9 and Fig.8.

Effect on cohesion strength of Wacker OH is apparently low comparing to other testing resins. Performance of epoxy resin and acrylic resin was predicted to be high, however,

performance of SS-101 was higher than expected. All test specimen showed a tendency that added cohesion strength was greater in upper and lower part of specimen than middle part. This was happened perhaps because evaporating effect of solvents. Solutions tend to move towards top and bottom surface.

Table 9. Results of airbrush perforation test

consolidants	Height of perforation from the bottom surface (mm)					
	5	10	15	20	25	30
SS-101	5.9 (±0.3)	6.6 (±0.2)	7.1 (±0.3)	6.7 (±0.4)	6.3 (±0.4)	5.4 (±0.4)
Wacker OH	17.2 (±0.3)	19.2 (±0.2)	26.3 (±0.6)	22.2 (±1.1)	18.8 (±0.8)	16.0 (±0.6)
Paraloid B-72	4.7 (±0.2)	5.5 (±0.1)	6.0 (±0.1)	5.1 (±0.2)	4.4 (±0.1)	3.4 (±0.0)
Araldite CY230	4.3 (±0.3)	4.7 (±0.3)	4.6 (±0.3)	4.5 (±0.3)	3.8 (±0.4)	3.3 (±0.3)

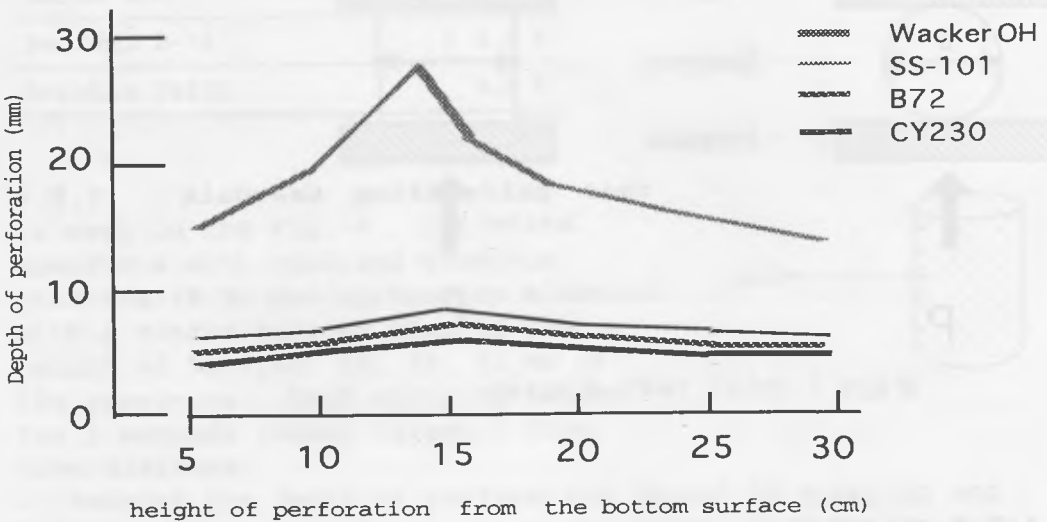

Fig.8. Results of airbrush perforation test

Splitting test results are shown in the Table 10. Strength of SS-101 specimens were approximately 20-30% of Acrylic and

Epoxy resin. Strength of Wacker OH were average of 3~4% of the average of records resulted from epoxy and acrylic resin specimens. In the nature of split test results becomes much greater when specimen changes its shape than specimen stays in shape. Since epoxy and acrylic resin have flexibility by nature values shown in the test should be greater than actual strength. On the other hand, values of SS-101 and Wacker OH are fairly reliable since they do not have much flexibility. When these two values are compared, values show result of SS-101:Wacker OH = 7:1. It is obvious that strength which Wacker OH attribute to stone is small.

Table 10. Results of split test

SS-101	Wacker OH	Paraloid B-72	Araldite CY230
2.50(±0.36) [21]	0.34(±0.02) [3]	11.70(±0.56) [100]	7.96(±1.13) [68]

kg/cm² (standard deviation)

[Percentage compared to the value of Paraloid B-72]

3.5. Discussion

SS-101 which is an oligomer of Methyl triethoxysilane suppressed Wacker OH which is a low grade polymer of tetra ethoxysilane (Ethylesilicate) in strength. Consequently, Wacker OH would not be appropriate for consolidating severely decayed stone. SS-101, however, would also not be appropriate for consolidating stones which no longer process self cohesion. In order to treat such stone, researches on using a mixture of acrylic resin which has better cohesion strength and silane has been in progress.

It is quite rare for a stone to lose all of its self-cohesion, therefore we cannot conclude that application of Wacker-OH is impractical.

4. Conclusion

Hydrophobic solution Metyl-triethoxysilane oligomer (commercial name SS-101) has been used commonly in Japan. Though solution of Tetra-ethoxysilane prepolymer (commercial name HAS-6) has been utilized in Japan as well, its inferior penetrating ability has been noted as a problem. Solution

of Tetra-ethoxysilane oligomer (commercial name Wacker OH) has been widely used all over the world. Wacker OH is also used in Japan because it is known to have superior penetrating ability and it is most applicable when the treated surface do not require hydrophobic surface treatment.

As a result of above mentioned tests, it is proved that the penetrating ability of Wacker OH is superior. It is particularly superior when it is compared with HAS-6, which applied to be used most commonly in the past. According to the test results, we also found that Wacker OH does not give strong cohesive strength. Most of stones no matter how deteriorated they are rarely lose all of their natural cohesion. Since the purpose of consolidants is to amplify their weakened cohesive strength, the great ability of consolidation is perhaps not expected. In case when the great cohesive strength is required for consolidation, recently a consolidant which is a mixture of acrylic resin and silicon resin is utilized for some stone monuments.

We are not able to determine that the practicality of Wacker OH is not sufficient. As I mentioned in the introduction,, we need to investigate their penetrating ability, added cohesion strength and newly achieved durability after consolidants been impregnated to the stone in order to determine the overall performance of consolidants. Consequently, it is not appropriate to bring forth conclusive evaluation of consolidants used in Japan.

5. Acknowledgements

The author wishes to thank Professor Fujio Oishi of Kanagawa University for his invaluable advice in the course of the research. Thanks are also due to Mr. Takanao Kitahara, Mr. Takashi Eto, University of Kanagawa and Mr. Yasuhisa Kurumadzuka for assisting experiments, and Ms. Namiko Yamauchi for compiling the report.

EFFECTS OF CONSOLIDANT AND WATER REPELLENT TREATMENTS ON THE POROSITY AND PORE SIZE DISTRIBUTION OF LIMESTONES

J.L. PÉREZ*; R. VILLEGAS**; J.F. VALE**; M.A. BELLO* and M. ALCALDE**

* Department of Analytical Chemistry, 41012-Seville, Spain

** Department of Chemical and Environmental Engineering, 41012-Seville, Spain

Abstract

Some of the main stones used in Spanish southern monuments were treated with the main commercial types of conservation products and submitted to salt crystallization and freeze/thaw weathering tests with the aim to compare the behaviour and to point out on the comparison of the tests for demonstrate that the results obtained from both tests are not comparable. For the salt crystallization test, sodium sulphate was employed and the freeze/thaw test was carried out on a climatic chamber. Conservation products tested are siliconic, acrylic and acryl-siliconic types. The results obtained indicate that in several cases, the application of a protective agent accelerates the deterioration process and this fact demonstrates the need to carry out weathering tests previously the application of the products on the monument.

Keywords: Consolidant, Water repellent, Pore size distribution, Alterability, Accelerated weathering test.

1 Introduction

The porosity and pore size distribution of a stone is a very important factor that determines its alterability and patterns of deterioration. The application of a conservation treatment may modify these characteristics due to the deposition of the active agent in the open pores of the stone.

Most authors agree that pores with size below $0,1 \mu\text{m}$ (micropores) are those which determine in great part the alterability of stone, specially when the weathering mechanisms are salt crystallization and freeze-thaw. So, if a treatment fills partially macropores and transforms them into micropores, it could produced an increment of the weathering of the stone, the contrary that it is desired.

So, the measurement of the pore size distribution of the stone before and after the application of conservation products could be an instrument to evaluate the behaviour of stone treatments.

In this paper, the effects of eight treatment products on the pore size distribution of three types of limestone have been studied. Besides, based on previous works (1, 2, 3)

we have tried to relate the changes on pore size distributions with deterioration produced on accelerated weathering tests (salt crystallization and polluted atmosphere attack).

2 Treatments

Eight treatment products whose characteristics and concentrations are shown on Table I, have been applied by immersion of the samples.

Table I. Treatment products applied

Product	Company	Active agent	Dilution
Strengtheners OH	Wacker	Ethyl silicate	50% ready to use
Tegovakon V	Goldschmidt	Ethyl silicate	50% ready to use
BS 28	Wacker	Organosilicone (nothing else specified)	5% in Xylen
290 L	Wacker	Oligomeric Organosiloxane	5% in Xylen
Baysilone	Bayer	Silicone resin	5% ready to use
Tegosivin HL100	Goldschmidt	Monomeric organosilicic	10% in Xylen
Consolid. 55050	Ard Raccanello	Acrylsiliconic resin	10% ready to use
Paraloid B72	Röhm & Haas	Metacrylate and etilmeta-crylate copolymer	10% (w/v) in 1,1,1 trichloroetane

3 Types of Stone

Three types of limestone have been studied. Their main characteristics are shown on Table II.

Table II . Characteristics of the stones

Stone	Cathedral	Type	Av. Comp., %		% Porosity	
			SiO ₂	CaCO ₃	Macro	Micro
Pto de Santa María	Sevilla	Calcitic sandstone	30	67	27	8
Granada	Granada	Limestone	3	95	19	6
Almería	Almería	Dolomitic limestone	7	53	17	27
			38% MgCO ₃			

4 Experimental procedure

Cubic samples (5 cm) of stone have been treated with the products and little pieces have

been cut from the surface of the cubes to carry out the measurements. The pore structure of the stones were studied by mercury porosimetry (Porosizer 9320, Micromeritics, Inc., Norcross, G.A.)

5 Results

5.1 Puerto de Santa María stone

On figures 1 to 3 appear the curves corresponding to pore size distribution of Puerto de Santa María samples treated with the eight products and non treated.

Comparing the two organosilicic consolidants (graphic 1) it can be seen that Tegovakon does not affect appreciably the pore size distribution, while Strengthener OH causes a considerable decrease on the volume of pores of every sizes. On the accelerated weathering tests carried out with these samples the best behaviour corresponds to Tegovakon, that does not modify pore size distribution.

The four water repellent treatments have two different behaviours: one of them, BS 28, produces a decrease on porosity in the whole interval, while the rest do not modify significantly pore size distribution. The one which has the best behaviour on the accelerated weathering tests is BS 28, in spite of its effect on pore size distribution.

The acrylic and acrylsiliconic products also differs in their effects: ARD decreases the quantity of pores below $7 \mu\text{m}$ and Paraloid B72 does not change the distribution (possibly due to its low penetration depth, only 2-3 mm).

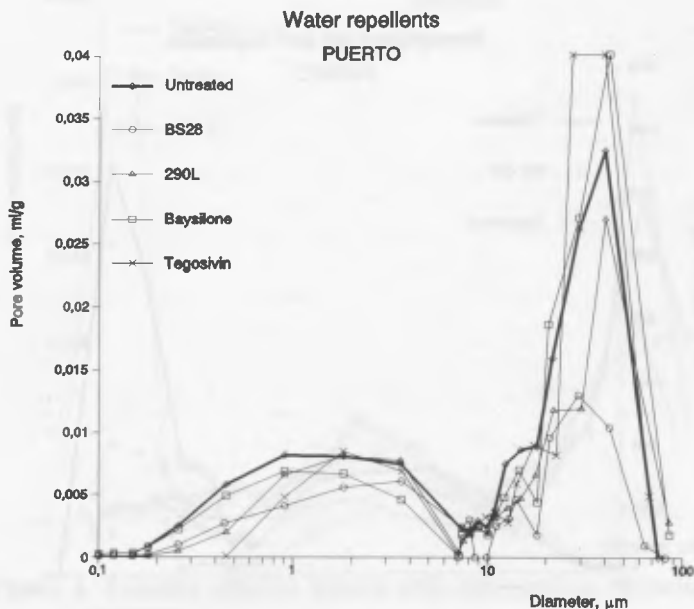

Figure 1. Puerto de Santa María samples treated with organosilicic consolidants

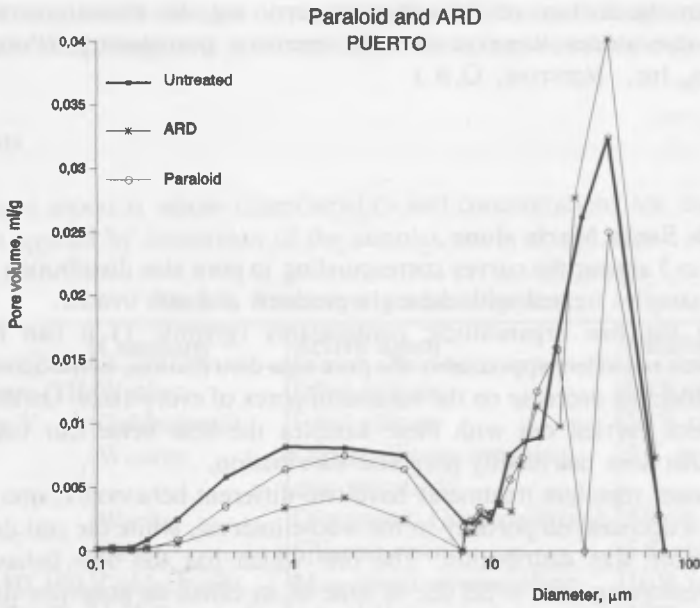

Figure 2. Puerto de Santa María samples treated with organosilicic water repellents

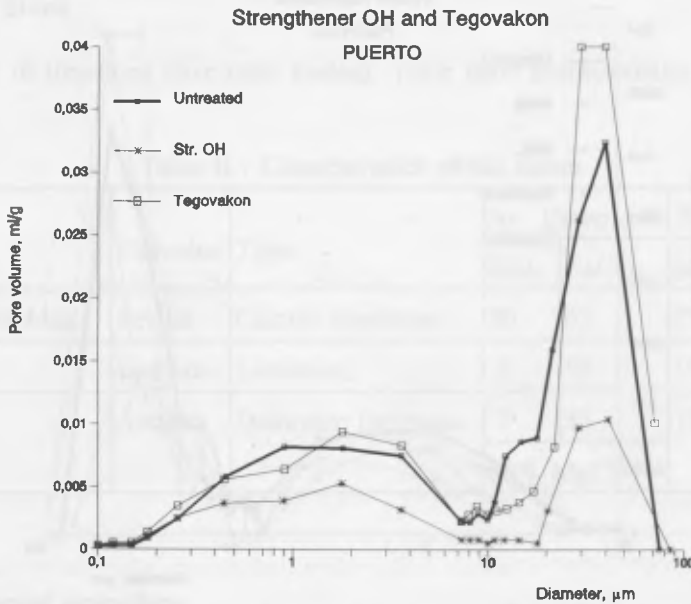

Figure 3. Puerto de Santa María samples treated with Acrylic products

5.2 Granada stone

On figures 4 to 7 appear the curves corresponding to pore size distribution of Granada samples treated with the eight products and non treated. Three untreated samples have been studied, with different total open porosity, in order to compare each treated sample with the one that has more similar porosity.

The samples treated with the two organosilicic consolidants have the same total porosity and equal to untreated 2. These products have opposed behaviours: Tegovakon affects pores higher than $7\ \mu\text{m}$, while Strengthener OH affects pore below $7\ \mu\text{m}$. They have very similar behaviour on the weathering tests, although the above mentioned differences on pore size distribution.

The sample treated with ARD is similar to untreated 2 and the sample treated with Paraloid to untreated 1. While Paraloid B72 causes a great decrement of the pore volume of every size, ARD affects more slightly only pores with size below $7\ \mu\text{m}$. Between them, ARD has better behaviour on accelerated weathering tests.

The organosilicic water repellents have to be compared as follows: BS 28 with untreated 3, Baysilone with untreated 2, and Tegosivin and 290 L with untreated 1. It could be seen that all of them affect slightly pores higher than $7\ \mu\text{m}$ and on a great extend pores below this size; only Baysilone does not cause any decrement on this range of pores. However, the best behaviour for what respect to alterability, corresponds to BS 28.

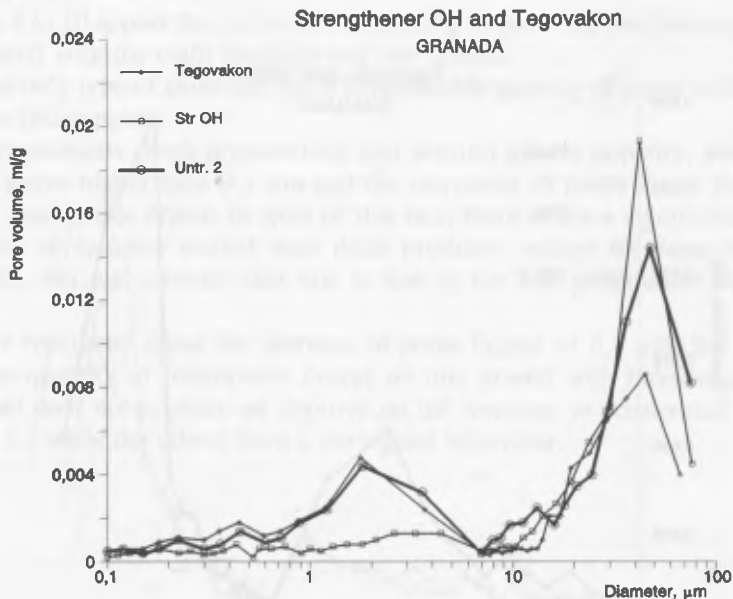

Figure 4. Granada samples treated with organosilicic consolidants

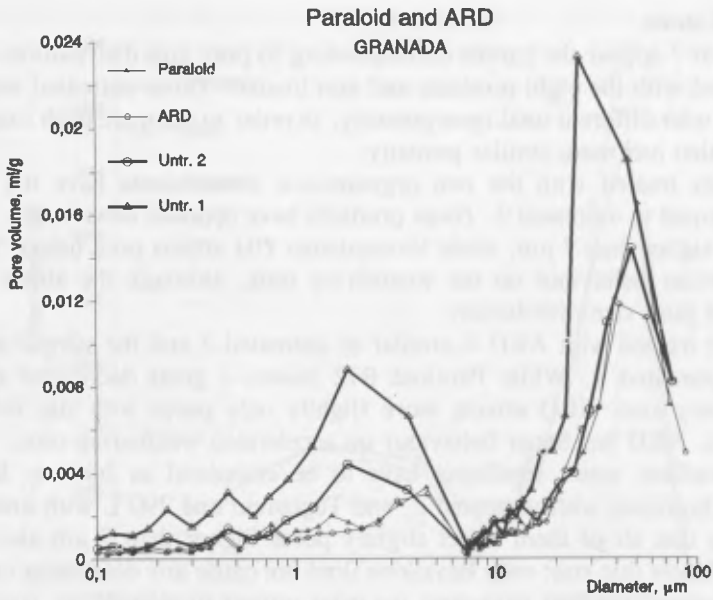

Figure 5. Granada samples treated with acrylic products

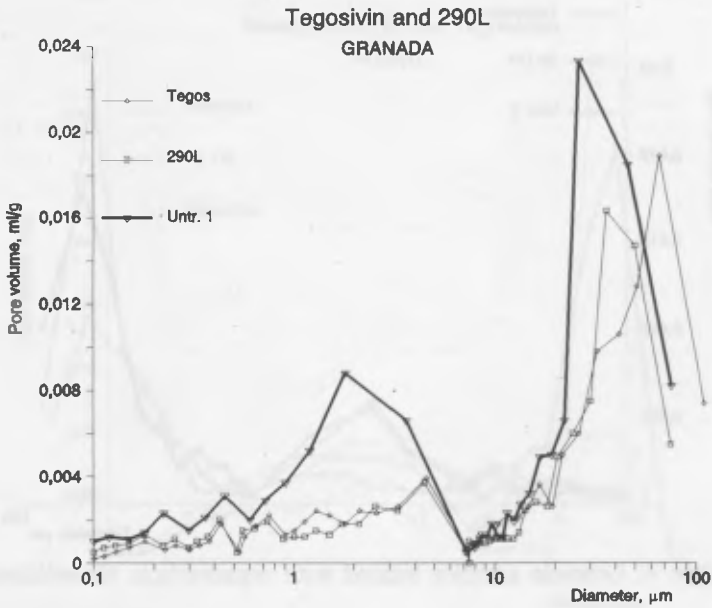

Figure 6. Granada samples treated with organosilicic water repellents

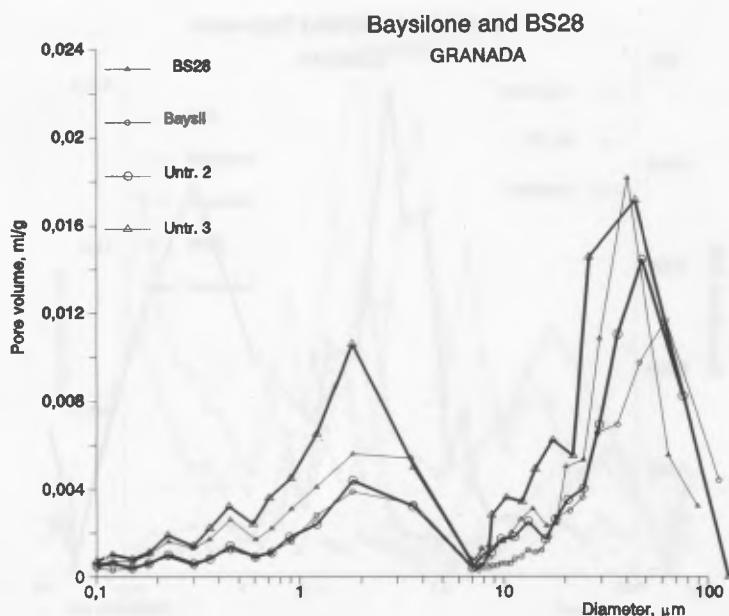

Figure 7. Granada samples treated with organosilicic water repellents

5.3 Almería stone

On graphics 8 to 10 appear the curves corresponding to pore size distribution of Almería samples treated with the eight products and non treated.

This is the only type of stone that has a considerable quantity of pores with size lower than $0,1 \mu\text{m}$ (micropores).

All the consolidants (both organosilicic and acrylic) affects porosity, producing the decrease of pores higher than $0,1 \mu\text{m}$ and the increment of pores lower than $0,1 \mu\text{m}$, which is an undesirable effect. In spite of this fact, there is not a significant increment of alterability of samples treated with these products, except on those treated with Paraloid B72, but we consider that this is due to the low penetration depth of this treatment.

The water repellents cause the decrease of pores higher of $0,1 \mu\text{m}$, but there is no effect on the quantity of micropores except on this treated with Baysilone. The only treatment that does not produce an improve on the response to accelerated weathering tests is 290 L, while the others have a very good behaviour.

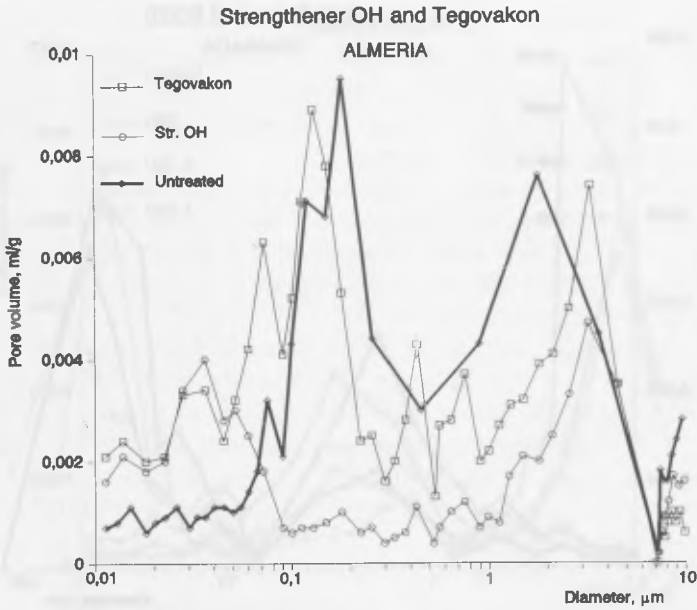

Figure 8. Almería samples treated with organosilicic consolidants

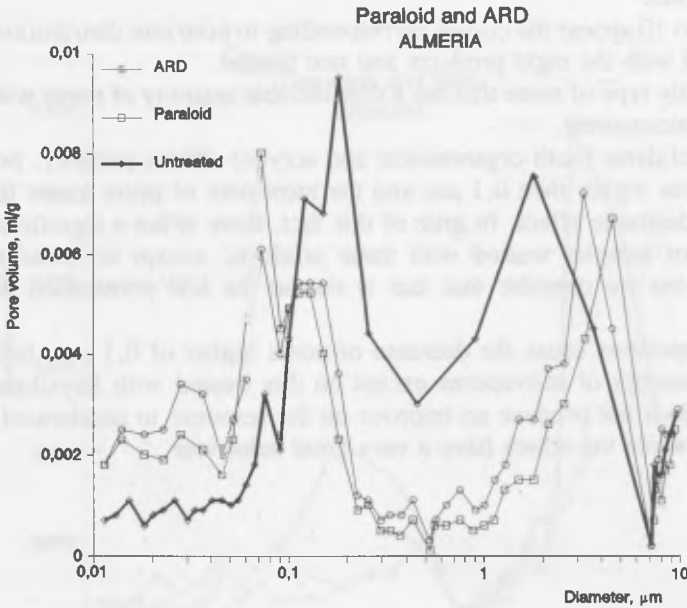

Figure 9. Almería samples treated with acrylic products

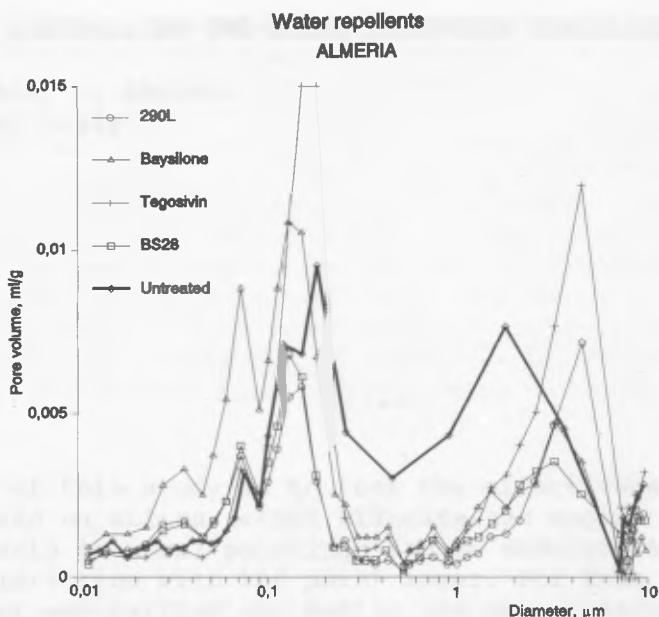

Figure 10. Almería samples treated with organosilicic water repellents

6 Conclusions

- 1.- The effect of a treatment product on the pore size distribution of stones depends on the characteristics of each stone, so that the changes due to the same product are different for different lythotypes.
- 2.- The changes in pore size distribution of a stone depends on the properties of the treatment. Even products with the same composition of active agent (Strengthen OH and Tegovakon V) affects porosity in different ways.
- 3.- The relation between alteration and changes in pore size distribution is not very evident, although it could be thought that treated samples have better behaviour when porosity results less affected.

7 References

- Villegas, R., Vale, J.F., Alcalde, M. (1991): Study of water-repellent treatments applied on limestones from Andalusian Cathedrals. *Materiales de Construcción*, V.41, 223, 19-27.
- Villegas, R., Vale, J.F.(1993): Evaluation of water-repellent treatments applied to stones used in Andalusian Cathedrals. II. Salt crystallization test. *Materiales de Construcción*, V.43, 230, 5-13.
- Villegas, R., Vale, J.F.(1993): Evaluation of hydrophobic treatments applied to stones used in Andalusian Cathedrals. III. Accelerated weathering test with polluted atmosphere. *Materiales de Construcción*, V.43, 232, 25-37.

A METHOD OF CONTROLLING TWO MURAL PAINTINGS CONSOLIDANTS

B. PROVINCIALI, P. IAZURLO
I.C.R., Rome, Italy

Abstract

The purpose of this study is to test the effectiveness of two products based on silica (ethyl silicate and sodium silicate) as consolidants to mural paintings and to observe their possible interaction with the paint layer. For this purpose an experiment was carried out making use of a fresco sample developed in fixed and controlled conditions. At the conclusion of the test both the products were proved to be inappropriate for conservation purposes in the mural paintings field.

Keywords: Ethyl Silicate, Sodium Silicate, Mural Paintings, Consolidation, Artificial Ageing, Colours Measurements.

1 Introduction

Products based on silica (ethyl silicate, sodium silicate) have frequently been used as mural paintings consolidants. At the present time we emphasize the absence of a standardized method to evaluate the effectiveness of these products, both the real capacity to produce the re-establishment of cohesion in the different layers of the manufacture and the absence of damaging effects towards the same work of art. A parameter to evaluate the effectiveness of a product is the durability - ie the capacity to maintain for a sufficient time the effect obtained, without causing an acceleration of damage.

The basic question is the frequent absence of a scientific approach directed to investigate the nature and to evaluate the effectiveness of a product in accordance with pre-established parameters: there is in fact a tendency to evaluate such questions empirically, on the basis of individual experiences, by analysis that is often only visual and connected to the particular conditions of conservation.

The application of a consolidant product on the fresco surface does not represent a standardized situation because the work of art, that can be characterized as a chemical-physical opened system, is influenced by many factors which are difficult to control. As an example of the above we can show a table which depicts some cases of application of the consolidants products on mural paintings (table 1).

An experiment was carried out taking into account the need to control these parameters and so making use of simulations realized in fixed and controlled conditions: a small mural was made with predetermined materials, methods and conditions. On this fresco, appropriately aged in a climatic chamber, tests of consolidation were carried out.

2 Experimental

2.1 Materials and methods

The fresco was prepared on a support tile in terracotta, 35x35 cm. On this support the plaster was laid out, mixing slaked lime and pozzolan in the ratio of 1:3.

The relative humidity of the laboratory on the day the fresco was made was 63%, and the temperature was 21°C.

Then, the plaster surface was divided into five strips of equal width on which was laid out a fresco with the following powder pigments: yellow ochre, green earth, ivory black, white sangiovanni and ultramarine blue (all the used pigments are Maimeri colours, produced by F.lli Maimeri & C., Mediglia, MI). Below the blue a layer of black was laid out.

After the laying of the fresco, the sample was left carbonated for over three weeks, taking care to keep the layer of cotton wool saturated with water and supported in order to avoid rapid evaporation of the water contained in the plaster.

2.2 Artificial ageing of the sample

In order to produce decay on the fresco sample an artificial ageing was carried out using a Kottermann climatic chamber, with forced air circulation. The fresco sample was put into a plastic box filled up with distilled water and sealed at the edges by polystyrene in order to ensure that the evaporation only took place on the surface of the sample. The temperature inside the chamber was 28°C and the relative humidity was 45%. The sample remained in the ageing chamber for two weeks.

After that period the support appeared compact but crossed by cracks intersecting the whole thickness of the sample.

Table 1. A list of some applications of ethyl and sodium silicates on mural paintings

SODIUM SILICATE		
Case	Results	References
The product mixed to anim glue and skim milk is suggested like consolidant to mural paintings.		Brenzani, L. (1913)
Restoration of romano fresco scovered in Austria.	No good. It is noted presence of efflorescences.	Kottulinsky, L. (1981)
ETHYL SILICATE		
Case	Results	References
Consolidation of adobe friezes from excavations of Garagay and Chan Chan in Peru.	Very good, still after ten years.	Chiari, G. (1980) Chiari, G. (1987)
Consolidation by Strenghtener H of an ancient chaolitic mural painting from Teleilat Ghassul, Jordan.	The reaction of hydrolysis takes place very slowly.	Schwartzbaum, P. et al. (1980) Lewin, S. and Schwartzbaum, P. (1983)
Consolidation by Monumentique of painted plaster fragments from Chur, Czechoslovakia.	No side effects.	Lengler, J. M. (1982)
Some cases of restoration of sgraffitos Fassades in Austria by methyl and ethyl silicate.	Satisfactory results.	Baatz, W. (1985)
A method of use of ethyl and methyl silicate based on a vacuum system to consolidate movable paintings.	Good results when the product is used correctly.	Small, S. and Hebrard, M. (1987)
A restoration of a painting in the chapel of Sta. Maria in Pntresina.	Good results because of the good penetration of the product.	Emmenegger, O. (1987)
Restoration of the ancient strupture of Schwyz, in Switzerland.	Satisfactory results.	Bamert, M. (1990)

The pigments showed risings and lack of cohesion (especially the white), except for green and ultramarine blue which had good cohesion and showed adhesion to the plaster.

2.3 Application of consolidants

Along the opposite edges of the fresco sample two areas 13 cm wide were delimited, including all the colours and crossing vertically the five painted strips.

On a specific area sodium silicate was applied, on another ethyl silicate. Rhodorsil RC 70 (Rhône-Poulenc) was used like ethyl silicate, and a 30% solution of sodium silicate was prepared using the powdered product (Merck, Riedel-De Haen) stirred and dissolved in boiling distilled water.

In both areas two layers of products were applied in an equal surface of 13x35 cm: 33 cc of sodium silicate and 37 cc of ethyl silicate.

The area treated with ethyl silicate was covered by a plastic foil, to avoid rapid evaporation of the product.

After the application we waited for a week, the necessary time for the polymerization of the two products.

2.4 Artificial ageing of the sample after treatment

The sample was put in an Angelantoni fog chamber, at a temperature of 25-30°C.

Five ageing cycles were carried out, each 24 hours long, divided into 6 hours of spraying with nebulized distilled water at pH 5.5 and conductivity of $15 \mu\text{S}/\text{cm}^{-1}$, and 18 hours of condensing. The quantity of condensation formed was about $1 \text{ cc}/\text{cm}^2/24 \text{ h}$.

After this ageing period no radical changes were found in the sample, except for a whitening of the ultramarine blue in the area treated with sodium silicate.

2.5 Results and discussion

Before the application of the products colour measurements were carried out on the sample at fixed points, by a Minolta CM 1000 spectrophotometer; such measurements, compared with others taken after the treatment and the further ageing of the sample permitted an evaluation of chromatic changes due to the consolidating action of the two products applied (figs. 1-5, table 2).

The area treated with ethyl silicate shows the same small shining spots on all five colours. All the colours show, following the application, a tone intensification, so that their reflectance value has increased.

As regards the consolidating action of the product, the cohesion of the pigments (white, yellow and black) appears

Spectrophotometric measurements of ultramarine blue on the sample area

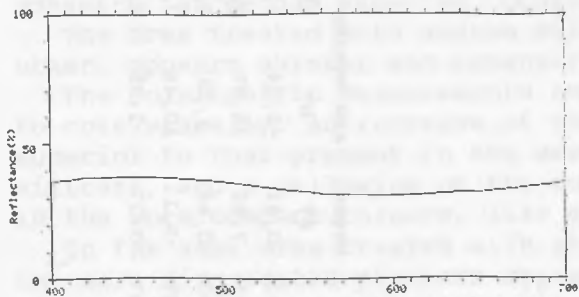

Fig. 1. Before treatment

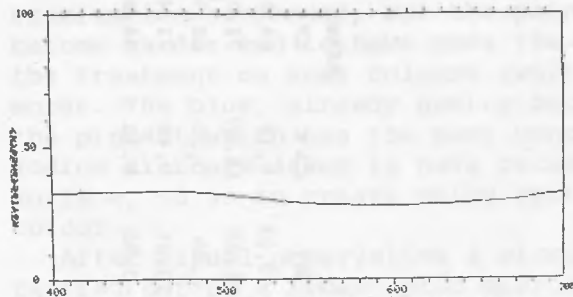

Fig. 2. After treatment with sodium silicate

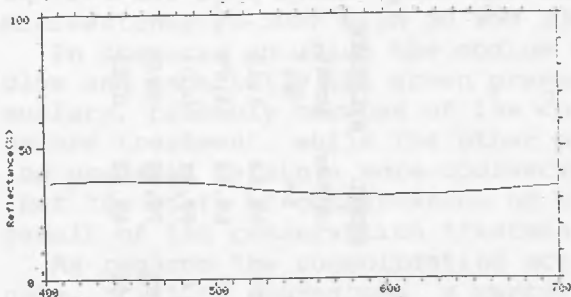

Fig. 3. After treat. with sodium silicate and ageing

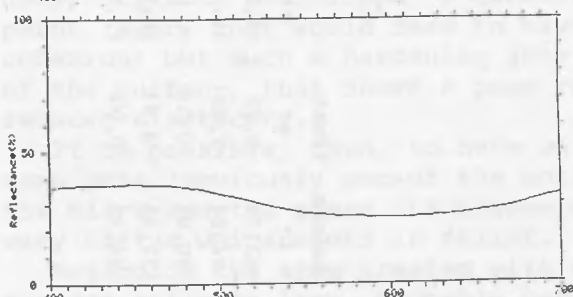

Fig. 4. After treatment with ethyl silicate

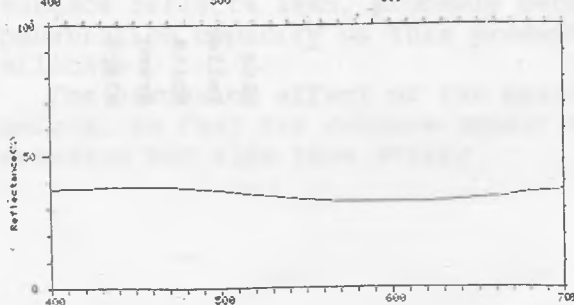

Fig. 5. After treat. with ethyl silicate and ageing

Table 2. Colorimetric measurements

	SODIUM SILICATE									
	Before treat.		After treat.		After treat. and ageing					
	L*	a*	b*	L*	a*	b*	L*	a*	b*	ΔC
Blue	65,19	0,30	-7,10	63,73	0,23	-5,56	61,38	0,34	-5,47	4,14
Yellow	79,23	3,46	28,06	76,88	3,95	29,10	76,90	3,88	28,76	2,47
White	93,15	-0,03	2,94	88,09	0,53	4,72	87,76	0,46	4,32	5,59
Green	73,14	-9,01	9,05	69,09	-9,53	12,46	69,72	-9,43	11,46	4,20
Black	49,02	0,01	-1,43	38,56	0,18	-1,39	38,05	0,26	-0,53	11,01

	ETHYL SILICATE									
	Before treat.		After treat.		After treat. and ageing					
	L*	a*	b*	L*	a*	b*	L*	a*	b*	ΔC
Blue	63,76	0,22	-6,26	59,64	1,15	-13,24	64,51	0,41	-5,54	1,06
Yellow	74,64	7,82	38,30	67,72	4,79	21,88	72,75	7,59	35,49	3,39
White	90,85	-0,16	4,14	90,91	0,02	4,09	88,90	0,44	3,38	2,18
Green	72,36	-8,81	10,82	71,92	-8,88	10,65	71,49	-9,11	10,46	0,99
Black	46,72	0,00	-1,40	42,72	0,22	-0,50	44,87	0,07	-1,09	1,88

improved but not greatly. On the other hand, the lack of adhesion, as we had expected, continues.

The area treated with sodium silicate, compared with the other, appears shinier and intensified in tone.

The colorimetric measurements confirm what it is possible to note visually: an increase of the reflectance value, superior to that present in the area treated with ethyl silicate, and a yellowing of the colours, visible especially in the more compact colours, like green and blue.

In the same area treated with ethyl silicate, cohesion of the more disgregated pigments appears improved, as visual examination concurred, but the paint layer seems to have become harder and to have made the risings, present before the treatment on some colours (white, black and yellow), worse. The blue, already having become grey with ageing, is the pigment which has the most unhomogeneous aspect: the sodium silicate seems to have become absorbed unevenly by the surface, so as to create shiny spots darker than the original colour.

After visual observation a microscopical analysis was carried out by a fiber-optic microscope (Mitsubishi Microwatcher VS-30H) with 50 and 200x lenses.

In the area on which the sodium silicate was applied the blue and especially the green present a very reflective surface, probably because of the compactness of the colours before treatment, while the other pigments, very decohesed and powdered retain a more opalescent aspect. This confirms that the state of conservation of the manufact influences the result of the conservation treatment.

As regards the consolidating action, it is possible to note, still by microscope, a certain hardening effect on the paint layer, that would seem to have improved its own cohesion; but such a hardening goes with a general stiffening of the surface, that shows a poor resistance to cutting and a reduced elasticity.

It is possible, then, to note on all the pigments of the same area (obviously except the white one) and especially on the black and the green the presence of silica in the form of very little white clots in relief.

Regarding the area treated with ethyl silicate, the surface reflects less, probably because of the better penetration capacity of this product compared to sodium silicate.

The hardening effect of the paint layer is worse than before, so that the colours appear not only more lacking in cohesion but also less stiff.

It is possible to observe at least on all the pigments, especially in the area treated with sodium silicate, the presence of silica in the form of little spots and reticulate filaments, also here in relief. Such filaments were formed predominantly along the borders of microfractures already to be found on the paint layer.

3 Conclusions

As it is possible to observe in the table 2, in which the colorimetric measurements expressed in CIE ANLAB 1976 system are compared with the relevant differences in colour [$\Delta C = (\Delta a^2 + \Delta b^2 + \Delta c^2)^{1/2}$], the treatment with sodium silicate produced before ageing a general reduction of colour brightness and only a few changes of colour hue (a^* , b^*). After ageing this phenomenon remains unchanged (Figs. 1-3).

As regards the treatment with ethyl silicate, immediately after application, a general darkening of colour was noted, while after ageing a considerable whitening (increase of brightness) occurred, especially in the blue, in the yellow and in the black can be observed (Figs. 4-5).

This proves that, when sodium silicate was used in the past even in mural paintings, the first effect from an aesthetic point of view was a good one. In fact, the layer of silica formed on the surface after the reaction of polymerization, at first is so reflecting as not to produce scattering of light and so perception of whitening.

This study has confirmed, however, that sodium silicate is an inappropriate product for conservation and damaging to the work of art on which it is applied. The solution's pH, measured at the moment of application, was equal to 13. The surface layer formed after hydrolysis and condensation is the cause of stress because of discontinuity between the paint layer and this vitreous layer that, besides, as it is not permeable, isolates the painting. Moreover, the possibility for the silica to rehydrate itself and hydrolyze again after some time could produce a scattering effect in the surface, which was absent before.

As regards the consolidating effect, it is possible to note a certain surface hardening that, while increasing the paint layer cohesion, has produced a stiffening, reducing the elasticity of the same layer.

As far as the ethyl silicate is concerned, it is possible to verify the formation of a shiny surface layer, less firm than that found in the area treated with sodium silicate, because of this product's better penetration.

Observation with the Microwatcher emphasizes the presence of little silica spots and gratings on the surface, in bigger proportion than the area treated with sodium silicate, especially along cracks in the paint layer. The formation of this kind of silica is due to the chemical characteristics of the product: although the product has a good penetration (due to its low viscosity and low surface tension), the high speed of ethyl silicate evaporation causes a deposition of silica gel in surface layer. As ethyl silicate solvent acts faster than the time necessary to produce hydrolyzation, it happens that the solvent, in evaporating, brings the ethyl silicate back to the surface, where it changes into amorphous silica gel.

The consolidating action of the product seems to be lower than that of sodium silicate: in fact some areas of the paint layer did not show a notable improvement of their cohesion after treatment.

It is moreover possible to note an increased sensitivity to water in the silica layer formed because of the treatment with ethyl silicate: thus, rehydration of silica in this product is much faster than that of sodium silicate, which seems to need longer hydrolyzing times.

According to our experiment, and considering the complete irreversibility of the product, we do not believe the use of ethyl silicate appropriate to the conservation of mural paintings. We do not want, of course, to give definitive indications regarding the use of such a product, baring in mind the limits of this experiment; however, it will be necessary in the future to analyze this study in depth from different points of view: for instance experiencing various methods of the product application, studying with several techniques the penetration capacity and the effects that it produces on paint layers after longer ageing times (superior to those tested in this case), and lastly comparing the effects on different plasters, on various pigments, with different states of conservation and with natural ageing.

Concluding, this study, apart from scientific results, intends to stimulate discussion to propose a method of study and verification that is standardized in parameters and in technique on different products being tested.

4 Acknowledgements

The authors would like to thank the Laboratorio di Prove sui Materiali of Istituto Centrale per il Restauro, where this study was carried out, and particularly dott. Giuseppina

Vigliano and dott. Ulderico Santamaria for their assistance, support and guidance. The authors would also like to acknowledge the restorer Costanza Mora of Laboratorio di Restauro di dipinti su tavola of the same Institute.

5 References

- AA.VV. (1981): Alkoxysilanes in the conservation of art and architecture: 1861-1981. "Art and archeology technical abstracts". Supplement, vol. 18, I.I.C., 1, 150-203.
- Baatz, W. (1985): Some basic consideration on the conservation and restauration of sgraffito fassades. *5th International Restorer Seminar. Budapest, 1985*, 1, 201-205.
- Bamert, M. (1990): Die Bemalung des Rathauses Schwitz fur das 600-Jahr-Jubilaum der Eidgenoissenschaft von 1891 durch Ferdinand Wagner. "Das Denkmal und die Zeit. Alfred A. Schmidt zum 70. Gebreertstag gewidmet von Schulerinnen und Schulern, Freunden und Kollingen. Herausgegeben von Bernhard Anderes, George Carlen, P. Rinald Fischer, Josef Grunenfeder, Heinz Horat". Luzern, 212-226.
- Brenzani, M. (1935): Le tecniche, la conservazione, il restauro delle pitture murali. Società An. Tipografica Leonardo da Vinci, Città di Castello, 38 and 72.
- Chiari, G. (1980): Treatment of adobe friezes in Peru. *3rd International Symposium on Mudbrick (Adobe) Preservation. Ankara, sept. 29-oct.4, 1980*, 39-45.
- Chiari, G. (1987): Consolidation of adobe with ethyl silicate: control of long term effects using SEM. *5th Meeting of Experts on the conservation of earthen architecture. Rome, oct. 22-23, 1987*, Ed. Craterre, Villefontaine, 25-32.
- Emmenegger, O. (1975): The cemetery chapel of Sta. Maria Pontresina. *4th Triennial Meeting. ICCM Committee for Conservation. Venice, 1975*, 1-11.
- Iazurlo, P. and Provinciali, B. (1994): Il ciclo pittorico di San Silvestro a Tivoli. Uno studio per la conservazione. *Tesi di diploma I.C.R.*, 176-229.
- Kottulinsky, L. (1981): Bericht ueber die Restaurierung eines roemischen Freskos. "Arbeitsblatter fur Restauratoren". 7/2, 90-95.
- Lazzarini, L. and Tabasso Laurenzi, M. (1986): Il restauro della pietra. Ed. Cedam, Padova 190-198.
- Lengler, J. M. (1982): Eine neue methode zur bergung ausgegrabener wandmalerein. "Arbeitsblatter fur Restauratoren". 2, 96-103.
- Lewin, S. Z. and Schwartzbaum, P. (1983): Investigation of long term effectiveness of ethyl silicate based consolidant

on mudbrick, Adobe. *International Symposium and training workshop on the Conservation of Adobe*. Lima, sept. 10-12 1983, UNESCO, 83-88.

Schwartzbaum, P., Silver, C. S. and Wheatley, C. (1980): The conservation of a chaolitic mural painting on mud brick from the site of Teleilat Ghassul, Jordan. *3rd International Symposium on Mudbrick (Adobe) Preservation*. Ankara, sept. 29-opt. 4, 1980, 177-200.

Small, S. and Hebrard, M. (1987): Le silicate d'etyle et silicate de methile. In "La consolidation des peintures murales - Atelier de Restauration des oeuvres d'art". ICCROM, Rome, 139-143.

LONG TERM EFFECTIVENESS OF TREATMENTS OF SANDSTONE

R. ROSSI MANARESI¹, A. RATTAZZI¹, L. TONIOLO²

¹ Fondazione Cesare Gnudi, Bologna, Italy

² Centro CNR "Gino Bozza", Milano, Italy

Abstract

This paper concerns the evaluation of the performance of treatments for the conservation of sandstone applied on-site 20 years ago. The treatments investigated are the acrylate-silicone mixture Paraloid B72-DRI FILM 104, Rhodorsil XR 893 (methyphenilsiloxane) and Wacker H (ethylsilicate + alkyltrialkoxysilane). Measurements of water absorption under low pressure (pipe method) were carried out on-site. FTIR analysis was carried out on the resins aged for 20 years in the laboratory and/or extracted from the treated monuments. The results achieved are discussed also taking into consideration the present state of preservation of the treated works.

Keywords: Sandstone, Conservation treatments, Water absorption on-site, FTIR analysis.

1 Introduction

The sandstone quarried close to Bologna, widely used in the historical buildings of this city, is a porous stone (porosity > 10%) with a high calcium carbonate content (30-40%) mainly in the form of calcitic cement.

Dissolution of the stone cement by meteorological acid water was shown to be the main cause of structural alteration. The decrease in cement is responsible for an increase in porosity and loss of cohesion, while crystallization near the surface of neo-formed gypsum and calcite is responsible for the formation of a crust, that subsequently exfoliates and crumbles (Rossi Manaresi, 1970 and 1971-72).

Experimental research was carried out 20 years ago in order to find effective conservation treatments for this stone. Various products intended both to increase stone cohesion and provide water repellency were tested in the laboratory. At the same time on-site treatments with the same products were taken into consideration (Rossi Manaresi, 1976).



Fig.1 - Coriolani tomb, detail before treatment.



Fig.2 - Coriolani tomb, same detail as in Fig.1, today.
B72-DF104 applied in 1974.

The macroscopic effects of seven years of natural weathering on-site have already been observed and discussed (Rossi Manaresi, 1981). Those observations showed that some of the treatments were not advisable, due to the unpleasant irreversible discoloration that had developed or the evident not long-lasting conservative effect. The observed poor durability of some treatments has been found to be strictly related to the poor penetration of the preservative, as seen from measurements made 20 years ago, just after treatment. It was also deduced, by comparison with the results of the laboratory tests, that the poor penetration and consequent poor durability of the treatment was due to the method of application (spraying) or to the nature of the impregnant not able to penetrate more than 1 cm.

Three of the treatments that had passed the preceding screening are taken into consideration in the present paper. Besides observing the macroscopic effects produced by 20 years of natural weathering, research was carried out on-site in order to evaluate the present protective effect of the treatments, and the uniformity of impregnation obtained when the products were applied.

A parallel analytical research was carried out on the resins aged for twenty years in the laboratory and/or extracted from the treated monuments, in order to evaluate the effect of ageing on the products used.

The aim of this study was to establish how effectiveness, durability and aesthetic effect of the conservative treatment of this stone may depend on the characteristics of the product, the way it ages and the method of application.

The results obtained are also of more general interest because the products discussed in this paper are still used today in Italy, as well as in other countries, for stone conservation treatments.

2 Treatments and state of preservation

The treated monuments taken into consideration, the chemical nature of the products and the commercial names (with abbreviations used in this note), the composition or concentration of the applied solutions and the method of application are indicated under the following sub-headings. The state of preservation before treatment, after treatment and today are also described.

2.1 Tomb of Francisco Coriolani (1555)

This tomb, located in the cloister of the St. Domenico Convent, was treated with a solution containing Paraloid B72 (B72), methylacrylate-ethylmethacrylate copolymer (Rhöm & Haas) and DRI Film 104 (DF104), methylsilicone by General Electric. The composition of the applied solution was the

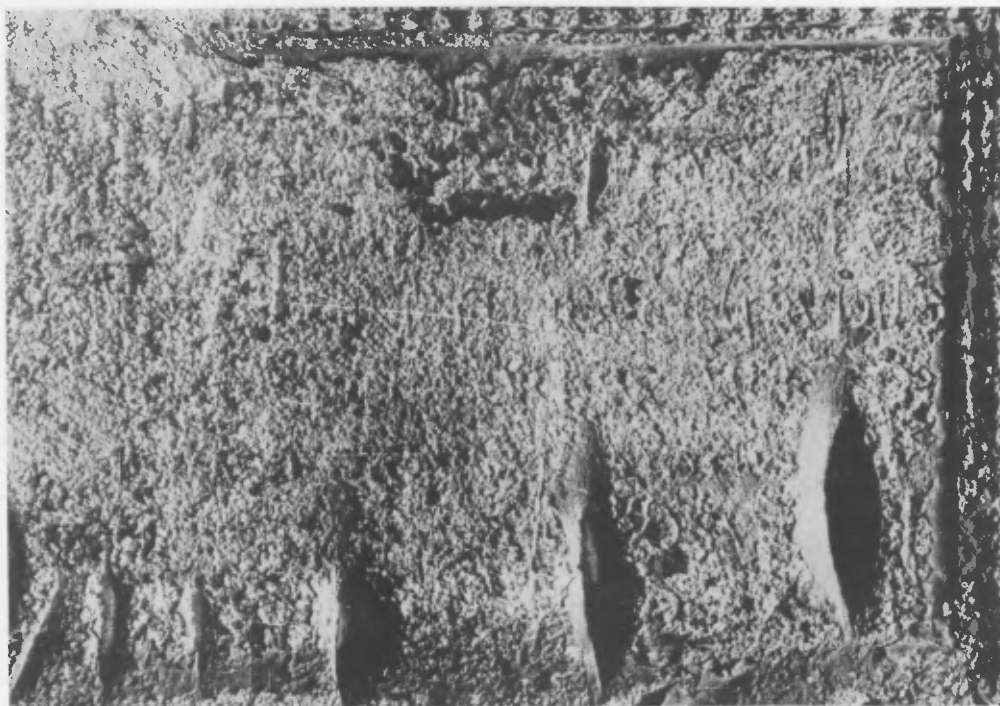

Fig.3 - Rose tomb-slab, before treatment.



Fig.4 - Rose tomb-slab, today. Wacker H applied in 1974.

following:

- 10% (v/v) of 30% B72 in 1:1 toluene-xylene mixture
- 10% (v/v) of 70% DF 104 in white spirit
- 80% (v/v) of trichloroethane.

Ottorino Nonfarmale, who proposed the B72-DF104 mixture, also developed the application procedure that mainly consisted in the following operation:

Japanese paper glued to the surface.

Impregnation with the resin solution applied by dabbing with a brush.

After 2-3 days, stone dampened with trichloroethane and raised parts manually pushed on the surface; then, after a day, new impregnation with the resin solution.

The process of dampening with solvent, pushing and impregnating was repeated five times (Nonfarmale, 1976).

After this treatment all the exfoliated crusts were found to be reattached and the original smooth carved surface reformed, without losing any stone particles. The impregnation depth, evaluated by testing a core taken just after treatment, was greater than 4.5 cm (length of the core).

Today the appearance of the surface of the tomb is exactly as it was immediately after treatment (Figs. 1,2).

2.2 Tomb-slab of Guilielmo Rose (1524)

This tomb, also located in the cloister of St. Domenico, was treated with Strengthener H (ethylsilicate + alkyltrialkoxysilane) by Wacker-Chemie (Wacker H).

The product was applied as supplied: three applications by dabbing with a brush on the right part of the tomb slab covered with Japanese paper; one application on the left part using cotton padding impregnated with the Wacker H. The penetration depth in the right part, evaluated as cited above, was greater than 5 cm (length of the core).

The recovery of the original smooth surface, even in the area first covered with Japanese paper, was not so good as in the Coriolani tomb.

Today old exfoliated crusts appear hard but not perfectly attached to the surface (Figs 3,4). White discolorations appearing just after treatment have hardly decreased with time.

2.3 Palazzo del Podestà

The carved ornaments in the central upper part of the facade (1484-1494) were treated with Rhodorsil XR-893 (Rhodorsil) a methylphenylsiloxane by Rhône-Poulenc.

The commercial product was diluted with toluene (final solution 15%) and applied by slow, prolonged percolation.

An impregnation in depth seemed to be achieved (more than 4 cm in the core tested) but the aesthetic result was



Fig.5 - Palazzo del Podestà, detail after Rhodorsil treatment (1974).



Fig.6 - Palazzo del Podestà, same detail as in Fig.5, today. Note the exfoliated crust still preserved.

very poor because no operation was done to reattach the raised parts in these very deteriorated surfaces.

Comparison of the present state of preservation with that recorded by photographs taken just after treatment



Fig.7 - Palazzo d.Podestà, detail after Rhodorsil treatment.

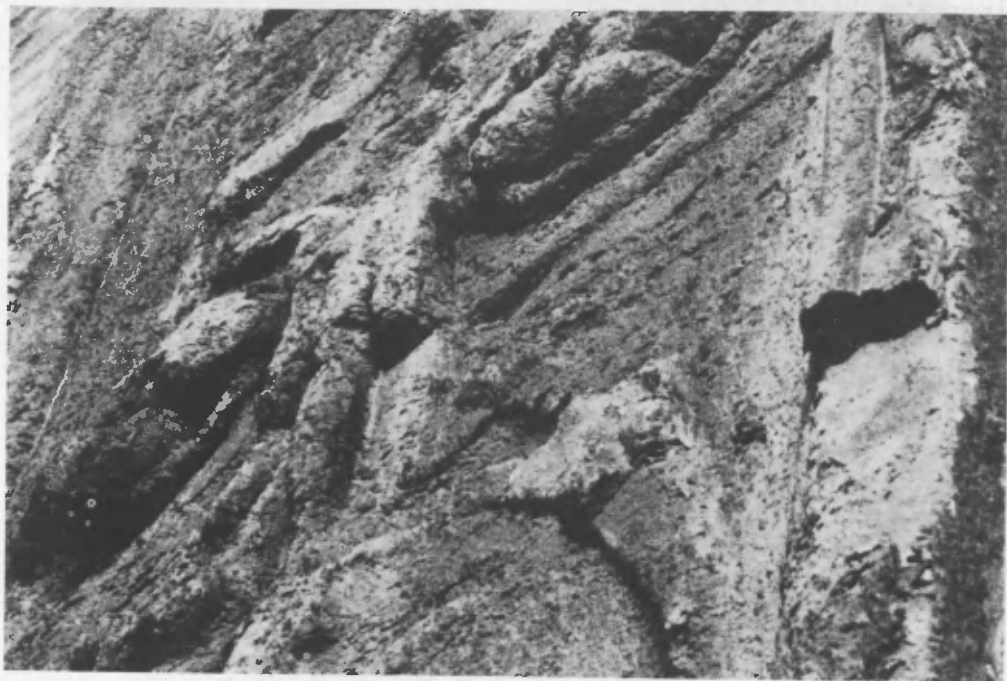

Fig.8 - Palazzo del Podestà, same detail as in Fig.7, today. Note the erosion of details.

(or seven years after treatment) seems to suggest different situations: in some areas the old detached crusts are still present (Figs. 5,6); in other areas erosion of the surface has occurred and some carved details disappeared (Figs. 7,8). However in the absence of a scaffold, this

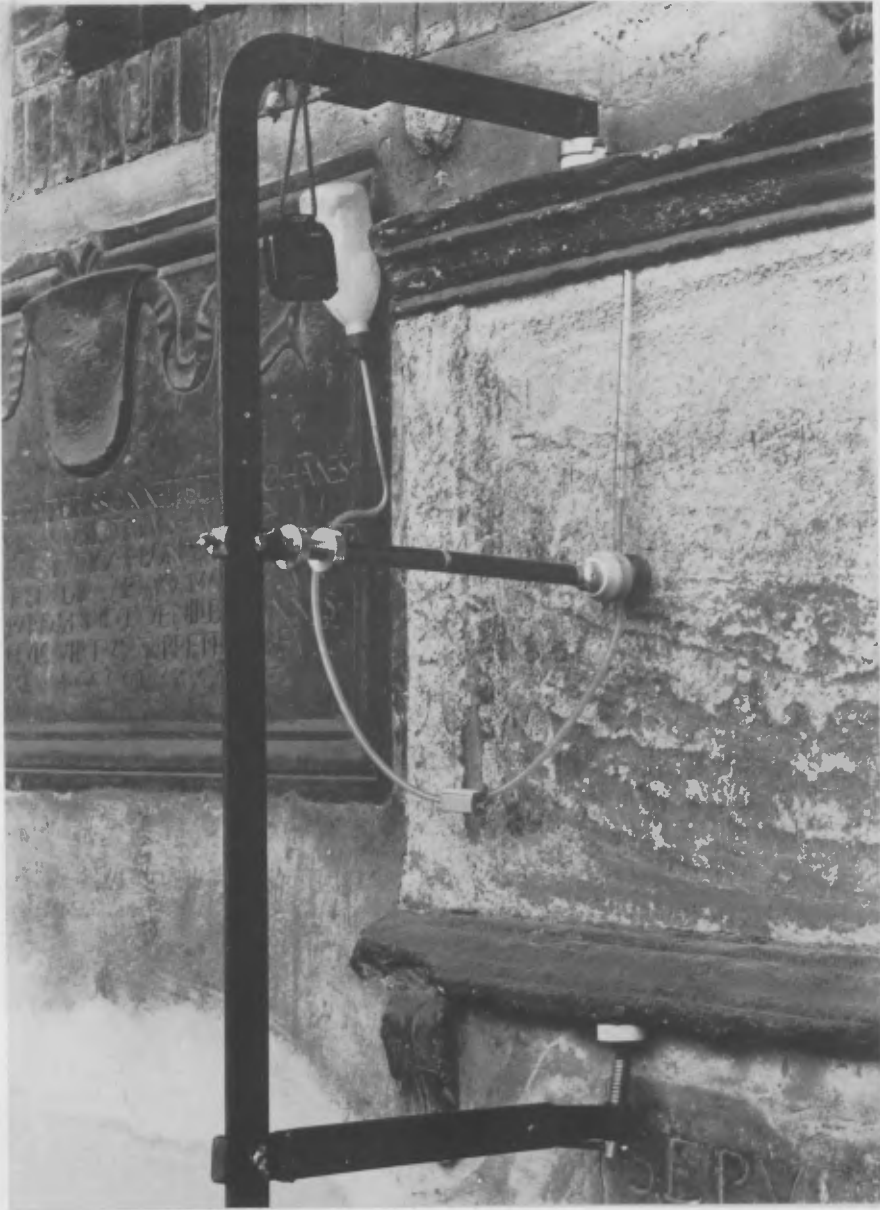

Fig.9 - The apparatus for water-absorption measurement applied on the untreated Coo tomb-slab.

observation was only possible in the lower part of the treated monuments.

3 Testing and analytical techniques

3.1 Water-absorption measurements on-site

Measurements of water absorption under low pressure (pipe method) were carried out with a technique based on the method described by a RILEM Commission (RILEM 25 P.E.M Commission, 1978).

The apparatus used is that devised by the "Commissione NORMAL". It consists of a cylindrical vessel whose open extremity can be applied to the stone by the interposition of a sealing ring. The cylinder wall has two opposite holes, one of them allows water to be supplied from the bottom, while the upper one is connected to a graduated pipette ("Commissione Normal", 1993).

To obtain a water-tight connection between the cylinder and the stone a neoprene ring was interposed and a particular device was purposely built (Fig. 9) to mechanically press the cylinder on the stone.

When, due to the architectonic design, it was not possible to use this device, Plastic-Fermit, a sealer by Nissen & Volk (kindly provided by Stefan Simon, Olching, Germany) was used instead of the neoprene ring and manual pressure was exerted on the cylinder.

The size of the two cylinders (pipes) used was such that the absorption area was either 3.8 cm² or 9.62 cm².

Two graduated pipettes with different capacities and different graduations (one graduation representing 0.01 ml or 0.1 ml) were also used. By taking an adequate zero point in the pipette, the height of the water column, and therefore the pressure exerted, was the same for both pipettes (at least at the beginning of the measurements).

The apparatus was filled with water as rapidly as possible (20-30 sec) and the quantity of water absorbed was read on the graduated pipette at intervals of one minute.

In the treated area the measurements were prolonged for 10-15 min, but the water absorbed in 8 min is reported here for a comparison with the untreated stone that rapidly absorbs a relatively enormous quantity of water.

3.2 FTIR analysis

FTIR analysis was carried out on the following three types of samples:

The newly prepared products.

The original impregnant solutions preserved for twenty years in open flat vessels in the laboratory.

The resin extracted from the treated areas by poulticing with a cotton pad holding chloroform.

Actually not all the above aged products were analyzed by FTIR spectrophotometry, due to various technical problems.

No discoloration was found in any of the products aged in the laboratory. But, they showed different physical characteristics: B72-DF104 is a rubber-plastic mass; Rhodorsil is a very hard film; Wacker H is powdered. It was possible to prepare KBr pellets of Rhodorsil and Wacker H, but rather difficult to obtain suitable preparations of B72-DF104, owing to its rubber-like aspect.

Moreover, it was not possible to extract Wacker H from the monument because it becomes insoluble.

FTIR analysis was carried out using a Perkin Elmer 1725X instrument. Films of the polymer products prepared on KBr plates or KBr pellets were analyzed; the transmission spectra were recorded from 4000 to 400 cm^{-1} , with 4 cm^{-1} resolution.

4 Results and discussion

4.1 Water absorption at low pressure

The measurement of water absorption was carried out on many



Fig.10 - Palazzo del Podestà, detail untreated.

spots of each treated monument and also in untreated areas, i.e. the untreated parts of the ornaments in the upper part of the facade of the Palazzo del Podestà (Fig. 10) and the 16th century tomb-slab of Arturo Coo (Fig. 9) which is beside the Rose slab treated with Wacker H. These two tomb-slabs are included in the same frame and may be considered two parts of the same work.

No untreated area was available in the Coriolani tomb that had been entirely treated. The results concerning the Coo tomb-slab can be considered as a reference because the date is roughly the same; the exposition and type of macroscopic decay before treatment are also similar (Figs. 1,3).

The results obtained by the water-absorption test are expressed as Degree of Absorption, DA (ml/cm^2) defined as the quantity of water absorbed per surface unit in 8 minutes.

The results of the measurements made on the same treated work or the same untreated area are variable, frequently highly variable. Mean values are probably not very informative. It seems more useful to report the lowest and the highest DA values obtained for each treatment and each untreated area (Table 1).

Table 1. Degree of Absorption, DA (ml/cm^2)

Site/treatment	Lowest DA	Highest DA
B72-DF104	0.001	0.005
Rhodorsil	0.005	0.040
Wacker H		
(Japanese paper)	0.158	0.474
(cotton padding)	0.211	0.658
Untreated		
(Palazzo del Podestà)	0.60	3.50
(Coo tomb-slab)	0.95	3.24

The variability of the DA values obtained is particularly great in the untreated areas where the quantity of water absorbed depends on the state of the stone in the spot where the test was carried out. For instance, the highest and the lowest DA values for the Palazzo del Podestà are those recorded in two points observable in Fig. 10: where the crust was still present covering a stone portion without cohesion, the quantity of water absorbed was very great, while in an area where the crust had already fallen down together with the powdered stone underneath, the water absorbed was much more limited, probably similar to that absorbed by the not altered stone.

An experimental error in this test is due to the

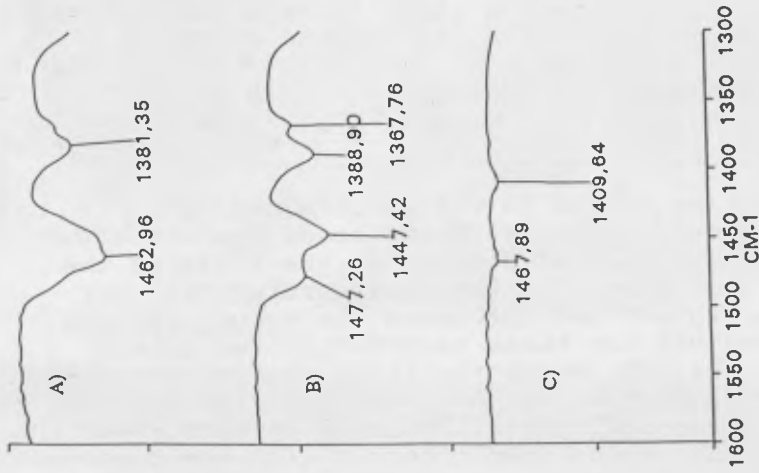

Fig.11

FTIR transmission spectra of the B72-DF104 mixture: between 1600 and 1300 cm^{-1} (Fig.11); between 1200 and 900 cm^{-1} (Fig.12). A) Sample extracted from the stone monument; B) Reference fresh laboratory sample; C) DF104 reference sample; D) B72 reference sample.

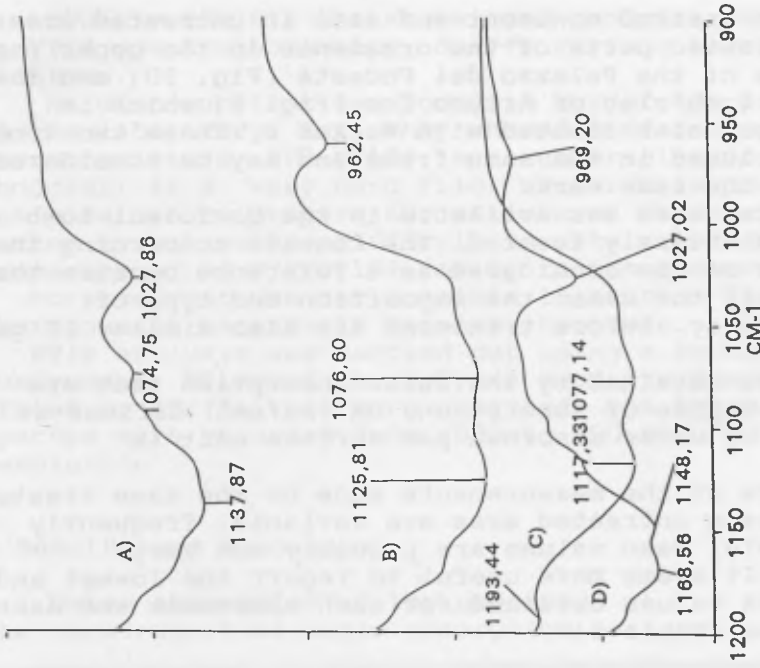

Fig.12

variation in the pressure depending on the progressive decrease in height of the column of water. This error can be great in the case of the untreated stone where, in the 8 minutes considered, about the entire column of water was absorbed. However, the great difference in the results for untreated and treated areas indicates that the hydrophobicity provided by the three treatments is still effective, particularly that due to the B72-DF104 mixture and to Rhodorsil.

In the case of measurements carried out in the treated areas, the water pressure can be considered roughly constant because the quantity of water absorbed is extremely small and, when necessary, the variation in the height of the water column was kept small by using the larger size graduated pipette. Therefore the variations in DA can be better discussed in terms of differences among the different treatments.

The best results are those given by the B72-DF104 treatment which provided the highest hydrophobicity, not decreased by ageing. Moreover the fact that the tests made on about 15 spots in the Coriolani tomb gave practically the same results shows that the impregnation was very uniform.

The water repellency supplied by Rhodorsil is still quite good. But the DA values are relatively more variable. This may indicate that the impregnation was slightly less uniform, presumably as a consequence of the different method of application.

The laboratory tests carried out 20 years ago showed that the hydrophobicity given to the stone by Wacker H was slightly smaller than that due to the other two treatments, but not so much smaller as indicated by the DA values: the hypothesis that the original water-repellent effect of Wacker H probably decreased by ageing can be put forward.

In addition the results for the Wacker H treatment confirm the great importance of the method of application. Where the impregnant was repeatedly applied by dabbing with a brush the hydrophobicity is considerably higher than in the area where application by using cotton padding took place.

4.2 FTIR Analysis

4.2.1 The B72 - DF104 mixture

The FTIR investigation indicates that the B72-DF104 mixture has changed considerably, in particular as regards the acrylic resin. In the spectral region between 1600 and 1300 cm^{-1} , where the contribution of the silicone resin is not so relevant, the considerable change in the original doublets of the acrylic polymer is clearly evident (Fig.11).

The C=O stretching around 1730 cm^{-1} has not changed by ageing, but the absorption peaks from 1150 to 1000 cm^{-1} are

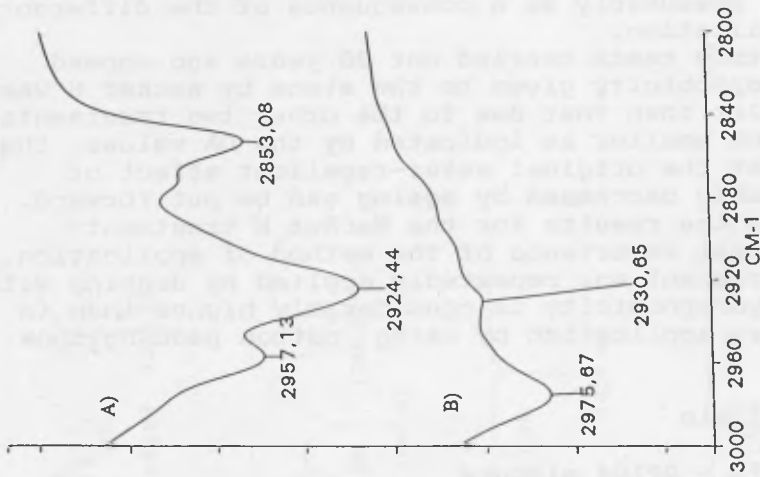

Fig. 13

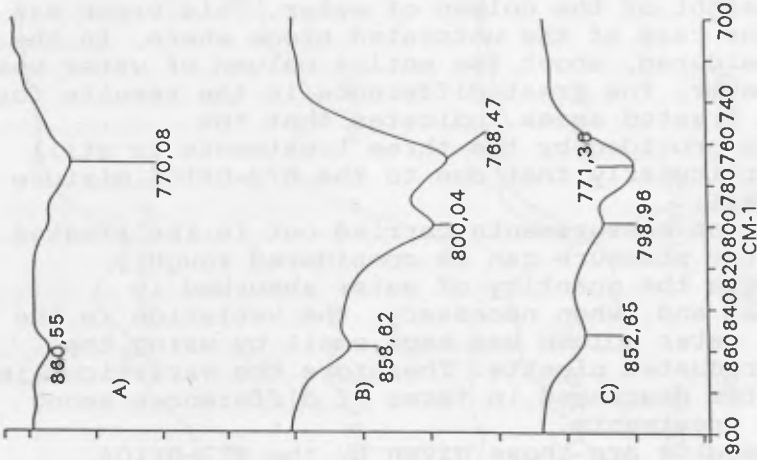

Fig. 14

FTIR transmission spectra of the B72-DF104 mixture: between 3000 and 2800 cm^{-1} (Fig. 13); between 900 and 700 cm^{-1} (Fig. 14). A) Sample extracted from the stone monument; B) Reference fresh laboratory sample; C) DF104 reference sample; D) B72 reference sample.

distorted. In fact, in the newly prepared product the Si-O-Si stretching at 1077 and 1120 cm^{-1} are overlaid by the C-O-C stretching of the acrylic polymer (Fig. 12), but the contribution of the silicon resin prevails. In the aged mixture from the monument the contribution of DF104 is slightly less (Fig. 12), in accordance with other Authors (Charola, Tucci, Koestler, 1986).

Moreover the critical change in the C-H stretching region between 2980-2850 cm^{-1} (Fig. 13, note the increase in the 2925 cm^{-1} peak related to the $-\text{CH}_2$ asymmetric stretching) indicates the increase in the $-\text{CH}_2$ contribution, probably due to an oxidation process of the acrylic methyl group.

Finally, the extraction of the B72-DF104 mixture from the monument was not exhaustive, owing to the cross-linking of the polymers. In particular, the decrease of the silicone resin in the extracted mixture is evident, even though the DF104 is chemically well conserved (Fig. 14): the 860, 800 and 768 cm^{-1} peaks are unaltered in the spectrum of the mixture extracted.

4.2.2 Rhodorsil XR 893

Rhodorsil XR 893 is no longer available. Therefore the spectra of the aged products were compared with the spectrum of Rhodorsil 991 (Fig. 15, kindly provided by

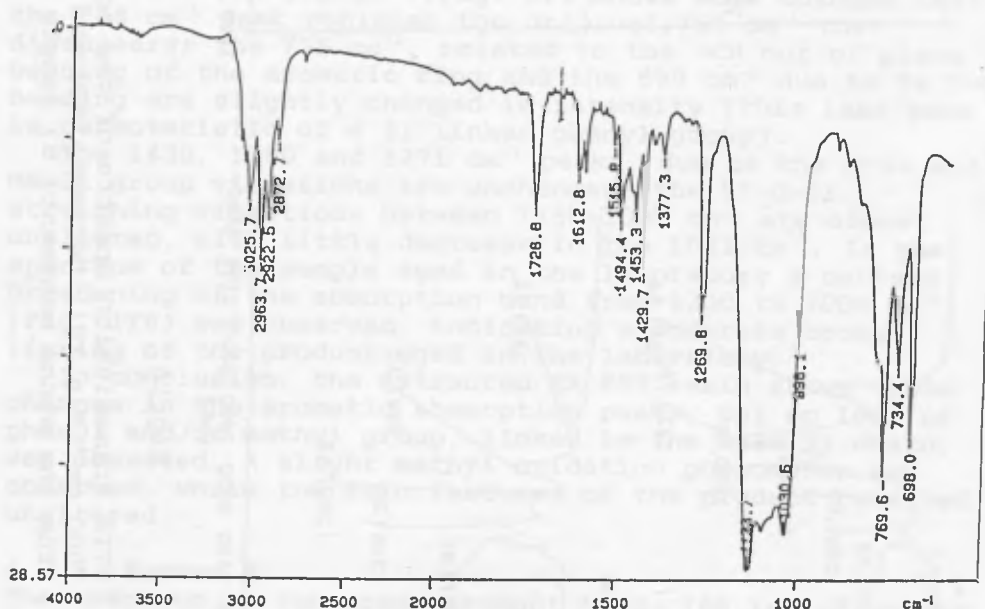

Fig.15 - FTIR transmission spectra of Rhodorsil 991 (kindly provided by Rhône Poulenc) between 4000 and 600 cm^{-1} .

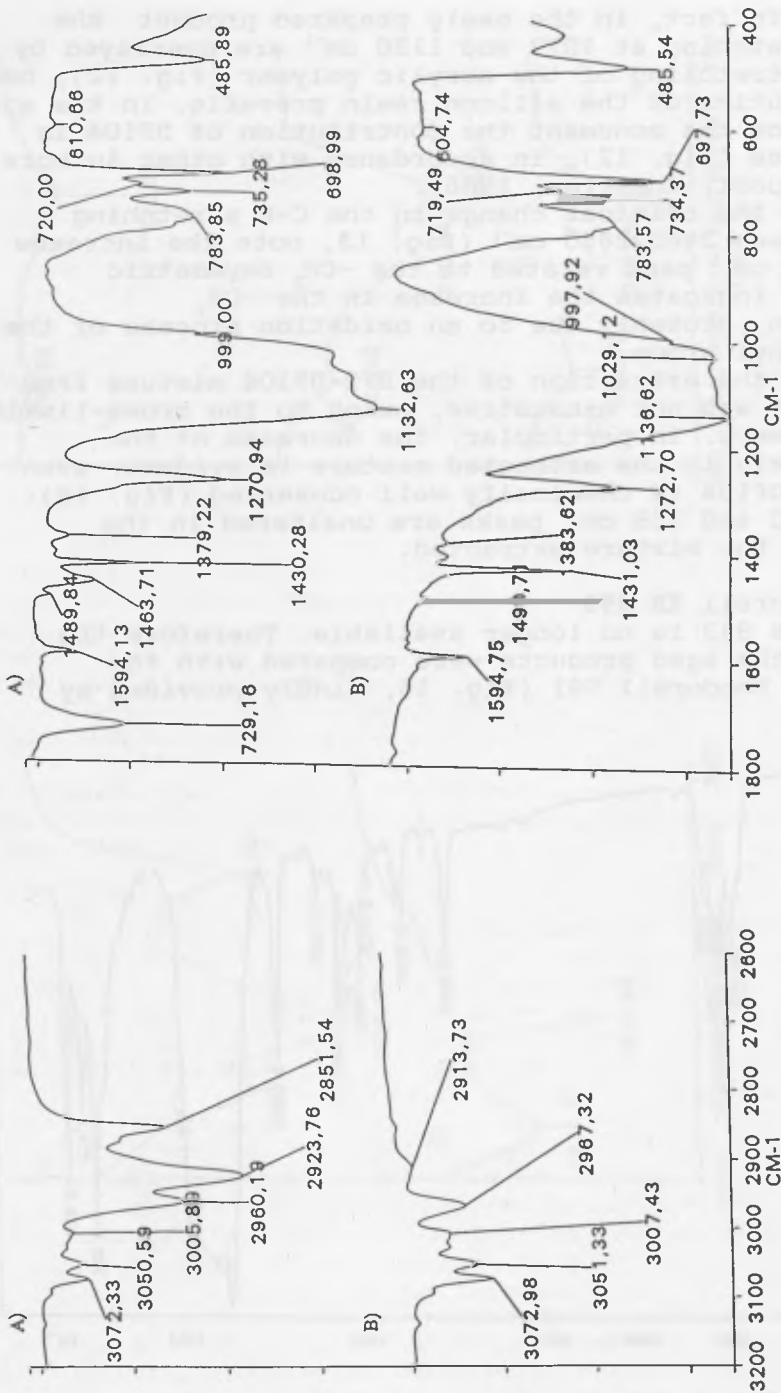

Fig.17

Fig.16

FTIR transmission spectra of the aged Rhodorsil XR 893 between 3200 and 2600 cm^{-1} (Fig.16); between 1800 and 400 cm^{-1} (Fig.17). A) Sample extracted from the stone monument; B) Sample naturally aged in the laboratory.

Rhône Poulenc) that is the product that substitutes the XR 893 today.

In the C-H stretching region (Fig. 16), the 2925 cm^{-1} peak, related to the stretching vibrations of the $-\text{CH}_2$ group is considerably more intense in the sample from the monument than in the 991 resin (Fig. 15) and the in laboratory aged sample (Fig. 16B). This indicates oxidation of the methyl group. Evidently, the contact with the polluted environment and the acid rain catalyzes the oxidation of the methyl group.

The intensity of the 1729 cm^{-1} peak (Fig. 17), due to the C=O stretching is slightly greater in the product extracted from the monument (spectrum A) than in the reference (Fig. 15), but the frequency does not change. The carbonyl peak disappears completely in the spectrum of the sample aged in the laboratory (Fig. 17B).

In the spectral region between 1600 and 400 cm^{-1} , no meaningful differences between the product aged in the monument and that aged in the laboratory were observed, except for the 1464 cm^{-1} peak (Fig. 17A). But considerable differences are observed between the aged samples and the 991 resin. The C=C vibration of the benzene ring (skeletal vibration) at 1594 and 1490 cm^{-1} (Fig. 17) are changed regarding the relative intensities and the position of the original peaks (Fig. 15), indicating some changes to the phenyl group substitution. The aromatic bending region between 900 and 675 cm^{-1} (Fig. 17) shows some changes too: the 784 cm^{-1} peak replaces the original 769 cm^{-1} that disappears; the 735 cm^{-1} , related to the $-\text{CH}$ out of plane bending of the aromatic ring and the 699 cm^{-1} due to the C=C bending are slightly changed in intensity (this last peak is characteristic of a Si linked phenyl group).

The 1430 , 1380 and 1271 cm^{-1} peaks, due to the O-Si and Me-Si group vibrations are unchanged. The Si-O-Si stretching vibrations between 1150 - 1000 cm^{-1} are almost unaltered, with little decrease in the 1031 cm^{-1} . In the spectrum of the sample aged in the laboratory a certain broadening of the absorption band from 1200 to 1000 cm^{-1} (Fig. 17B) was observed, indicating a moderate cross-linking of the product aged in the laboratory.

In conclusion, the extracted XR 893 resin shows some changes in the aromatic absorption peaks, but no loss of phenyl and/or methyl group, linked to the main Si chain, was observed. A slight methyl oxidation phenomenon was observed, while the main features of the product remained unaltered.

4.2.3 Wacker H

The spectrum of the fresh product (Fig. 18B is, of course not comparable to that of the aged one (Fig. 18A): the polymerization of the $\text{MeSi}(\text{OR})_3$ and the reaction of the $\text{Si}(\text{OR})_4$ with water, give a completely different final product.

The spectrum A (Fig. 18), related to the in laboratory aged sample, is probably what is present in the stone today: a methylsiloxane polymer as indicated by the $\text{CH}_3\text{-Si}$ peak at 1278 cm^{-1} , and a matrix of amorphous silica SiO_2 , as evident from the broad and undefined absorption band between 1200 and 1000 cm^{-1} .

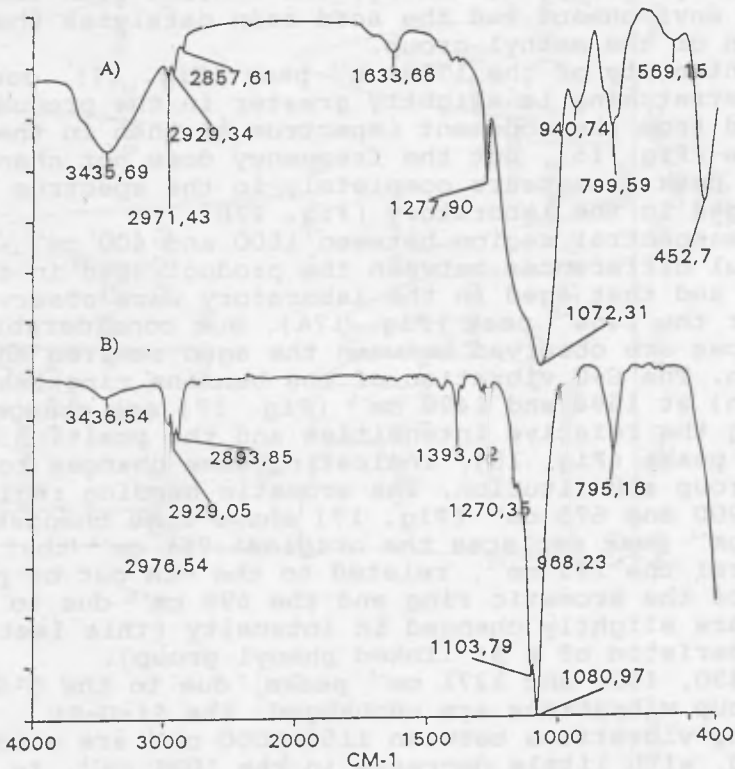

Fig.18 - FTIR transmission spectra of Wacker H between 4000 and 400 cm^{-1} . A) Sample naturally aged in the laboratory; B) Reference fresh sample.

5 Conclusions

The B72-DF104 mixture appears to be a very effective and durable preservative of this sandstone. The water repellency it supplied to the stone is still maximum; all the previously raised crusts are still there, well reattached to the surface; and no new alteration has developed.

The B72-DF104 mixture ages with considerable chemical alteration, overall due to the ageing of the acrylate; but this does not seem to have a determining influence on the

durability of the conservative effectiveness. The effectiveness of this mixture is probably due to its rubber-plastic character, more important for the conservative purpose than the preservation of its chemical characteristics.

The ageing of Rhodorsil seems to involve a relatively lower chemical alteration. Rhodorsil seems to preserve its high hydrophobicity and to have a rather good aggregating effect, as suggested by the appearance of the product aged in the laboratory and the fact that many of the impregnated crusts, still raised in the treated surface, did not crumble away in the long period of twenty years. However new decay processes certainly took place in the treated surface: this may be due first of all to a not uniform impregnation.

Rhodorsil should be applied more properly for better recovery of the original smooth surface (a necessity also for aesthetic purposes) and by dabbing with a brush, a procedure which seems to guarantee more uniform impregnation with respect to the application by percolation. In this case a better comparison between Rhodorsil and the B72-DF104 mixture would be possible, in particular regarding the physical characteristics of the two aged products - hard or plastic - as a factor that may have an influence on the conservative effectiveness.

Wacker H seems relatively less effective and less durable than the other two treatments tested. Its water repellency is relatively lower and may have decreased since application. Moreover Wacker H seems to be not very effective for fixing raised parts to the surface and this is probably due to the fact that it becomes brittle, as suggested by the sample aged in the laboratory.

Finally the considerable importance of the method of application both for conservative and aesthetic purposes should be emphasized. This is a fact already well known, confirmed again by the results of this research.

Acknowledgment

This work was part of a research project by the Istituto Beni Culturali della Regione Emilia Romagna, supported by the Consiglio Nazionale delle Ricerche, Progetto Strategico Beni Culturali.

References

- Charola, A.E., Tucci, A., Koestler, R.J. (1986): On the reversibility of treatments with acrylic/silicone resin mixtures. *Journal American Institute Conservation*, 25, 83-92.
- Commissione NORMAL, Sottogruppo Sperimentazione Protettivi (1993): Metodologia per la valutazione di prodotti impiegati come protettivi per materiale lapideo. *L'Edilizia*, VII, 57-71.

- Nonfarmale, O. (1976): A method of consolidation and restoration for decayed sandstone. In *"The Conservation of Stone I, Proceedings of the International Symposium, Bologna June 19-21, 1975"*, Bologna, 401-411.
- RILEM 25 P.E.M Commission (1978): Experimental Methods. In *"Deterioration and Protection of Stone Monuments, Preprints of the UNESCO-RILEM International Symposium, Paris June 5-9, 1978"*, test N.° II.3.
- Rossi Manaresi, R. (1970): Indagini sul'alterazione delle arenarie di alcuni monumenti bolognesi. *Atti della Accademia de' Fisiocritici di Siena, serie XIV, 2, 285-305.*
- Rossi Manaresi, R. (1971-72): Le arenarie dei monuenti di Bologna: indagine sulla alterazione e prospettive di conservazione. *Atti della Accademia delle Scienze di Ferrara, 49, parte 3, 61-81.*
- Rossi Manaresi, R. (1976): Treatments for sandstone consolidation. In *"The Conservation of Stone I, Proceedings of the International Symposium, Bologna June 19-21, 1975"*, Bologna, 547-571.
- Rossi Manaresi, R. (1981): Effectiveness of conservation treatments for the sandstone of monuments in Bologna. In *"The Conservation of Stone II, Preprints of the International Symposium, Bologna October 27-30, 1981, 665-688.*

A DATA BANK OF FTIR SPECTRA FOR COMPARING PRODUCTS USED FOR STONE CONSOLIDATION AND PROTECTION

U. SANTAMARIA

I.C.R., Rome, Italy

M. LAURENZI TABASSO

ICCROM, Rome, Italy

P. ROTA ROSSI DORIA, A. DI FRANCESCO (Fellowship holder)

C.N.R., Is.C.O.M., Lecce, Italy

Abstract

FTIR spectra are proposed as a "finger-print" for a first-level characterization of products used for stone consolidation and protection. A data bank has been originated which includes 23 products offered on the Italian market and 17 organic solvents. The products were analyzed in their original concentration, diluted "ready to use", after two months of ripening and after artificial and natural weathering. Some of the experimental results are illustrated as an example of the potential of the data bank as a reference for the analysis of unknown products. The effects of artificial and natural ageing on one of the products tested are also discussed.

Keywords: FTIR, Consolidation, Protection, Artificial/Natural Weathering, Silicate Esters, Alkyl-alkoxy-silanes, Poly-siloxanes, Acrylic Resins, Epoxy Resins, Fluorinated Polymers

1. Introduction

The study is primarily aimed at creating a data bank of products currently used for consolidation and water-repellent treatments for porous building materials. Such a data bank is based on Fourier Transform infrared (FTIR) spectrometric data of the products concerned.

Further to this main scope, the study has been planned to reach some additional goals: to analyse the "setting" process of some of the examined products through their IR spectra; to investigate the ageing behaviour of the listed products, in both natural and artificial conditions; to gather information on possible correlations between the two weathering conditions, if any.

The broad range of products offered nowadays on the market, at least in Western countries, makes it sometimes rather difficult, even for an experienced conservator or a conservation scientist, to understand what lies behind an

enticing brand name and a vague chemical description of the product offered.

A data bank where some information on the chemical features of each listed product is given, not extensive but enough to clearly differentiate it from other similar available chemicals, can help customers to select the right product for their conservation problems.

The Absorbance spectrum in the IR range is proposed as a kind of "finger-print", useful for a first chemical characterisation and discrimination of each given product.

The FTIR spectrometers, readily available nowadays, allow rapid collection, analysis and storage of spectra. Once data of known products are available, they can be subsequently used as a reference for unknown products, provided the conditions for the spectrum collection are optimised and standardised. Moreover, companies that produce or sell chemicals used for conservation purpose could also be asked to provide each batch with its FTIR spectrum in order to facilitate the customer's understanding of the product features and the eventual checking of the stock purchased.

The advantage of the proposed data bank in respect to the commercially available reference spectra is the possibility of using it as a reference also when analysing stones previously treated with unknown products. In that case, knowing the spectrum of the fresh product is not enough when a chemical transformation occurs during the setting process; moreover, the ageing of the product could have induced variations in the IR spectrum.

To overcome these problems, the data bank includes, along with spectra of the fresh products as sold on the market, spectra of the same products "ready to use", e.g. diluted according to the manufacturer's suggestions, spectra of the products after setting, and, finally, spectra after natural or artificial ageing. A set of spectra of the most commonly used solvents is included as well.

Careful analysis of the collected data and comparison of the spectra obtained for each product also made it possible to reach the other objectives of the study, mentioned above.

In the following paragraphs, the flow-chart of the study and the list of products examined, along with the experimental technicalities, will be given. Only a few cases will be illustrated in detail, when the FTIR spectra showed unexpected features. The effects of the naturally and artificially induced weathering will be briefly discussed.

2. Experimental

Up to now, the stored data concern 23 products, chosen among the most commonly used in Italy for the treatment of stone in monuments. The majority of them are silicone-based products, some are acrylic resins (in water emulsion and in organic

solvents), some are fluorine-containing polymers and one is a cyclo-aliphatic epoxy resin. Their trade names and the manufacturers' names are given in Table I, where the examined solvents are listed as well, along with the analytical procedure adopted for each product. Table II gives the chemical compositions and solvents declared by the manufacturer.

A Nicolet 10PC spectrophotometer, equipped with a DTGS detector, was used for the spectra collection. Each spectrum was acquired from 128 - 512 scanning, with a resolution of 4 cm^{-1} , and apodized through the Happ-Genzel function. The sample spectra (S) were referred to the background (B), and the resulting spectra (S/B) were expressed in Absorbance units. The IR40 software, by Nicolet Instrument Corporation, was used. It allows the comparison of any unknown spectrum, with twenty spectra stored in the Data Bank, ranked in order of decreasing similarity.

As stated in par.1, not only the fresh products, as sold on the market were analysed, but also the diluted ones and the products after setting and ageing.

The experimental steps are given in the following flow-chart:

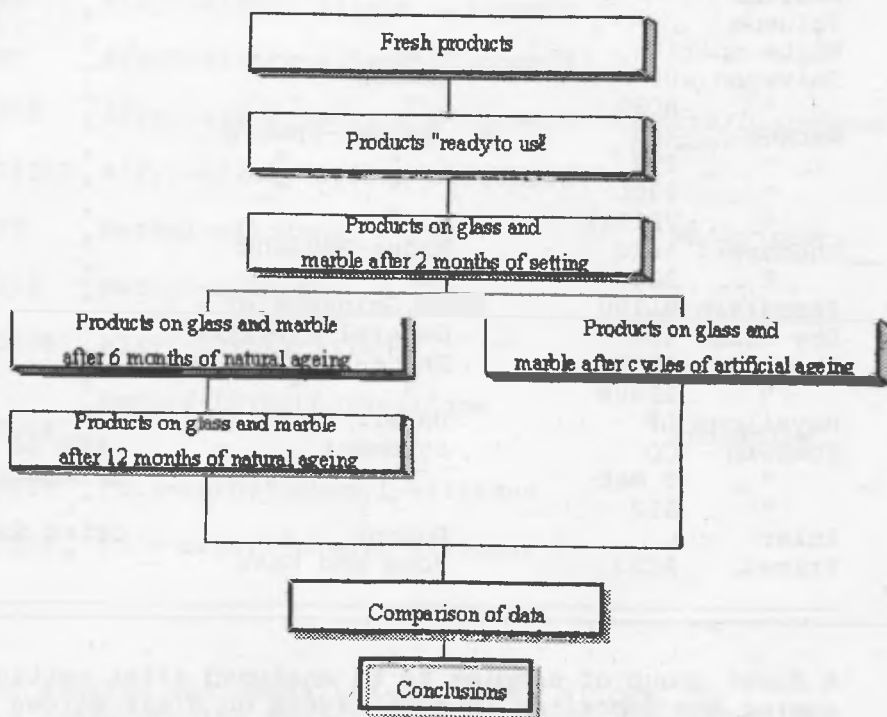

Table I. List of products and solvents

Product		Manufacturer	FTIR technique		
Wacker	OH	Wacker-Chemie	transm.liquid film		
Rhodorsil	RC70	Rhône-Poulenc	"	"	"
"	RC80	" "	"	"	"
Paraloid	A21	" " "	transm.liquid film		
"	B72	" " "	"	"	"
Eurostac	2101	Stac	"	"	"
"	2102	"	"	"	"
Chloroform		Carlo Erba	"	"	"
1,2 Dichloroethane		" " "	"	"	"
1,1,1 Trichloroethane		" " "	"	"	"
1,2,2Trichloroethylene		" " "	"	"	"
Delifrene HP			"	"	"
Methyl alcohol		Carlo Erba	"	"	"
Ethyl alcohol		" " "	"	"	"
Isopropyl alcohol		" " "	"	"	"
Ciclohexanol		" " "	"	"	"
Diethyl ether		" " "	"	"	"
Acetone		Arpi	"	"	"
2-Butanone		Carlo Erba	"	"	"
Ethylglycol acetate		" " "	"	"	"
Benzene		" " "	"	"	"
Toluene		" " "	"	"	"
White spirit		Arpi	"	"	"
Solvesso 100		Exxon	"	"	"
"	RC90	" "	"	"	"
Wacker	280	Wacker-Chemie	"	"	"
"	290	" "	"	"	"
"	290L	" "	"	"	"
"	VP1311	" "	"	"	"
Rhodorsil	4673	Rhône-Poulenc	"	"	"
"	224	" "	"	"	"
Tegosivin	HL100	Th.Goldschmidt	"	"	"
Dry Film	104	General Electric	"	"	"
Rhodorsil	10336	Rhône-Poulenc	"	"	"
"	11309	" "	"	"	"
Baysilone	LF	Bayer	"	"	"
Fomblin	CO	Syremont	ATR of dried film		
"	Y Met	"	transm.liquid film		
"	S12	"	"	"	"
Imlar		Dupont	dried film on KBr		
Primal	AC33	Rohm and Haas	"	"	"

A first group of samples to be analysed after setting and ageing was deposited in thin layers on glass slides (considered as inert support) in order to obtain the ageing of

the whole deposited amount. In the case of ethyl-silicate products, emery glasses were used to assure a sufficient adhesion to the support. The samples were kept under laboratory conditions, in closed but not sealed containers, for two months, to allow the ripening or setting process to occur.

Table II. Chemical composition of products and solvents

Product	Chemical composition declared by the manufacturer	Solvent declared by the manufacturer
Wacker OH	Ethyl silicate 75%	?
Rhône Poulenc RC70	" " 70%	
" " RC80	tin-siloxane	White spirit
" " RC80	Ethyl silicate 70%	" "
" " RC80	tin-siloxane	" "
" " RC90	poly-methyl-siloxane	" "
" " RC90	Ethyl silicate 70%	" "
" " RC90	tin-siloxane	" "
Wacker 280	Poly-methyl-phenyl-siloxane	
" 280	Alkyl-alkoxy-silane oligomers	?
" 290	Alkyl-alkoxy-silane oligomers	
" 290L	Alkyl-alkoxy-silane oligomers	?
" 290L	Alkyl-alkoxy-silane oligomers	Naphtha/Diacetone alcohol
" VP1311	Alkyl-alkoxy-silane oligomers	?
Rhodorsil 224	Methyl-siloxane	White spirit
" 4673	Methyl-siloxane	?
" 4673	pre-polymerized	
Tegosivin HL100	Alkyl-alkoxy-silane	?
General Electric DF104	Methyl-trimethoxy-silane	Aromatics
Rhodorsil 10336	Poly-methyl-phenyl-siloxane	"
" 11309	Poly-methyl-phenyl-siloxane	"

A second group of samples was deposited on marble slices, to create conditions closer to the reality. The marble supports

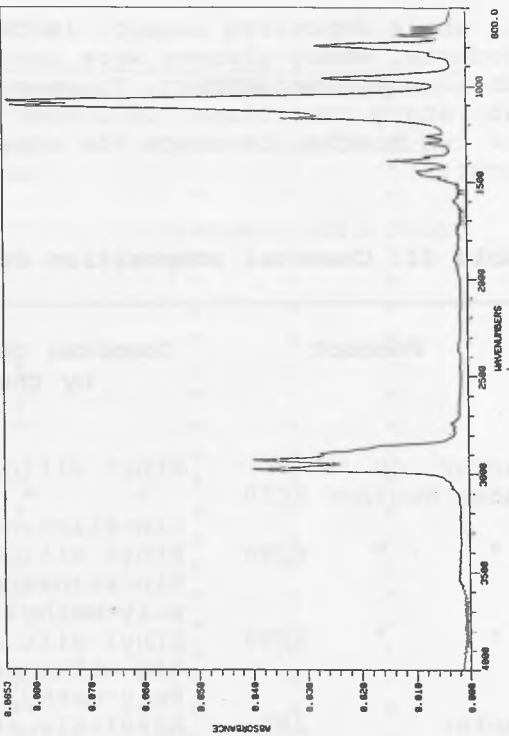
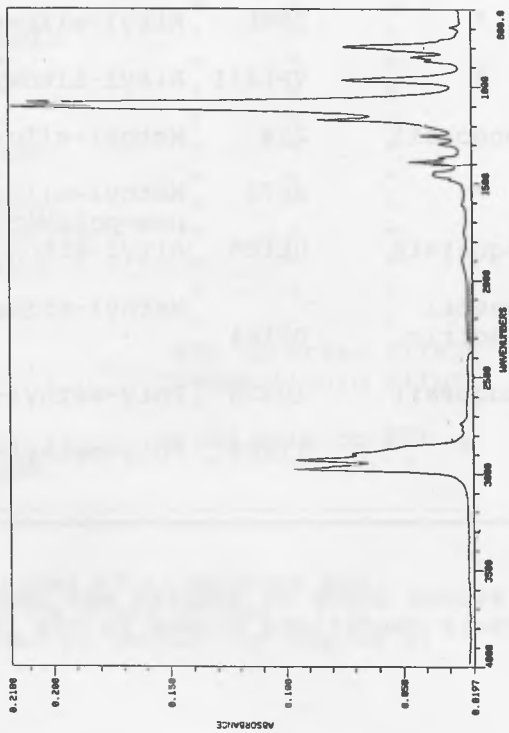
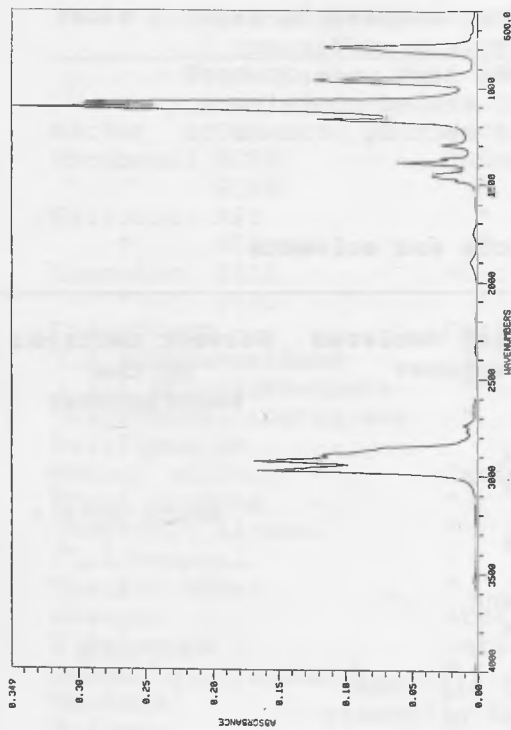

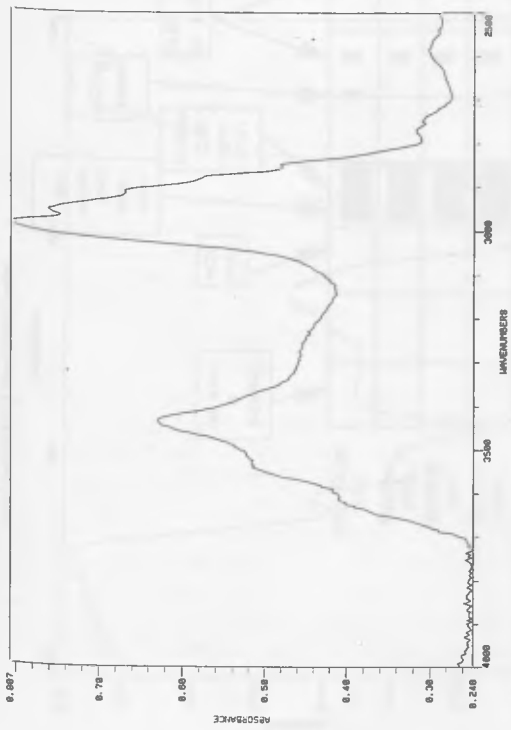

Fig.10- Paraloid B72, 12 months natural aging

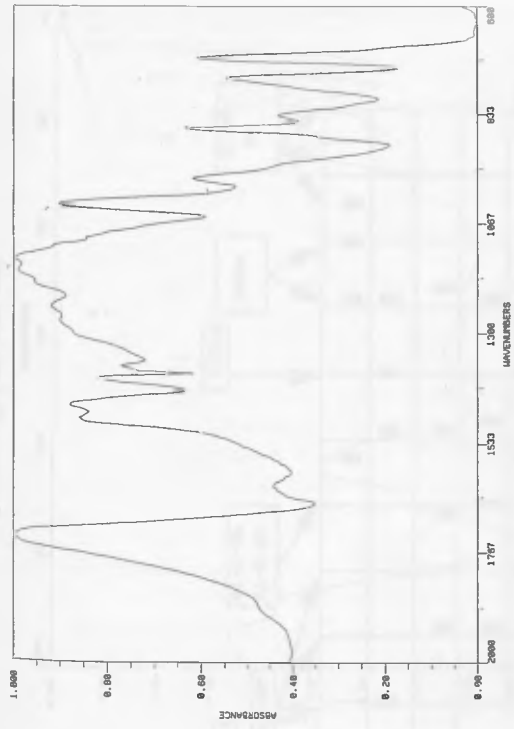

Fig.11- Paraloid B72, 12 months natural aging

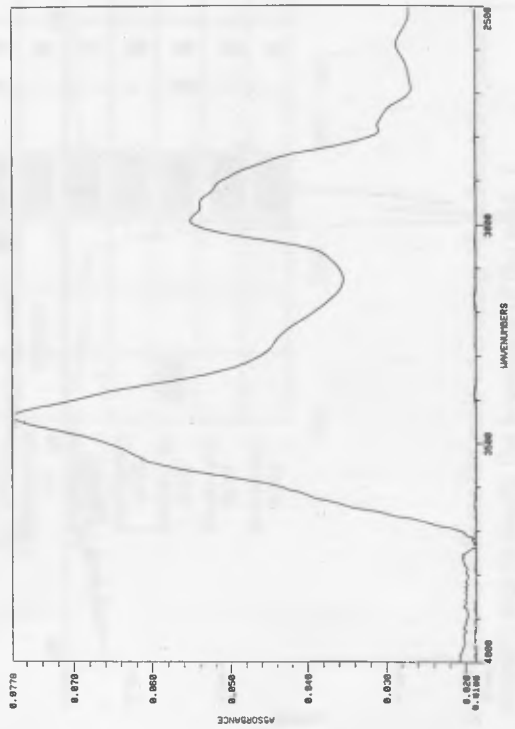

Fig.12- Paraloid B72, artificial aging

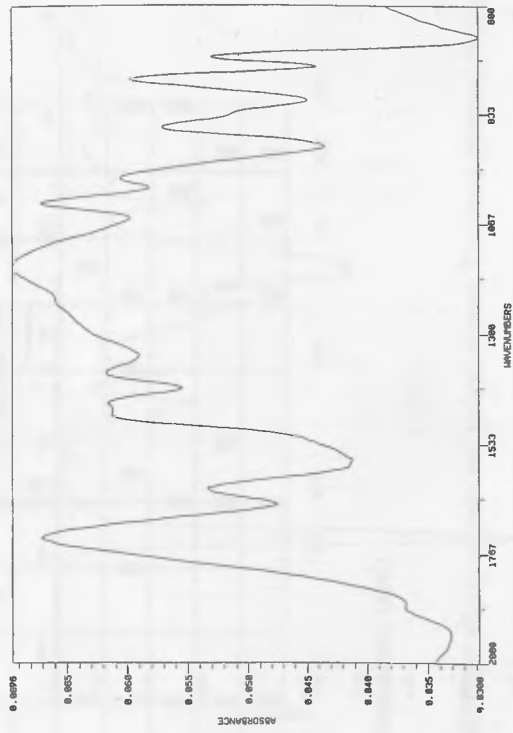

Fig.13- Paraloid B72, artificial aging



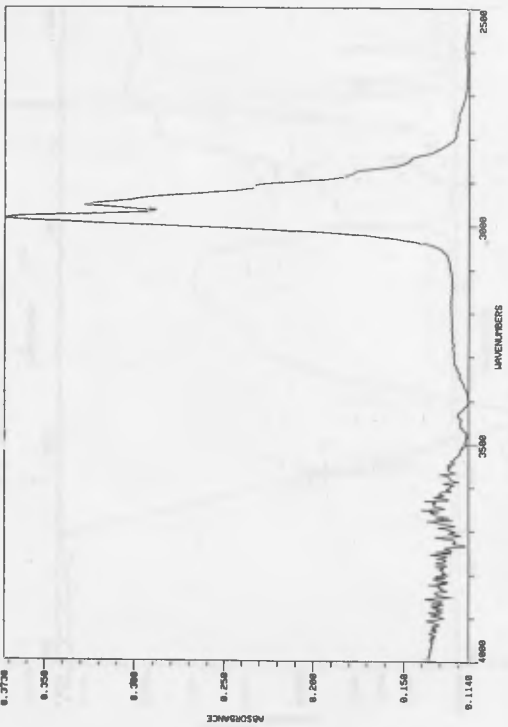

Fig. 8- Paraloid BTZ, r11amed

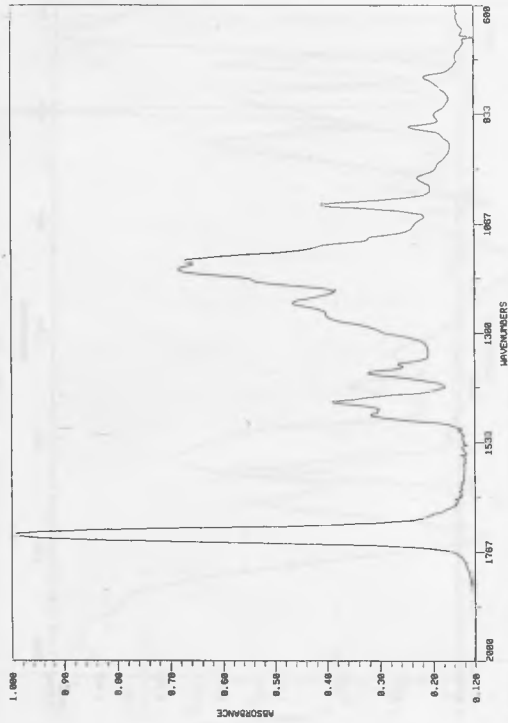

Fig. 7- Paraloid BTZ, r11amed

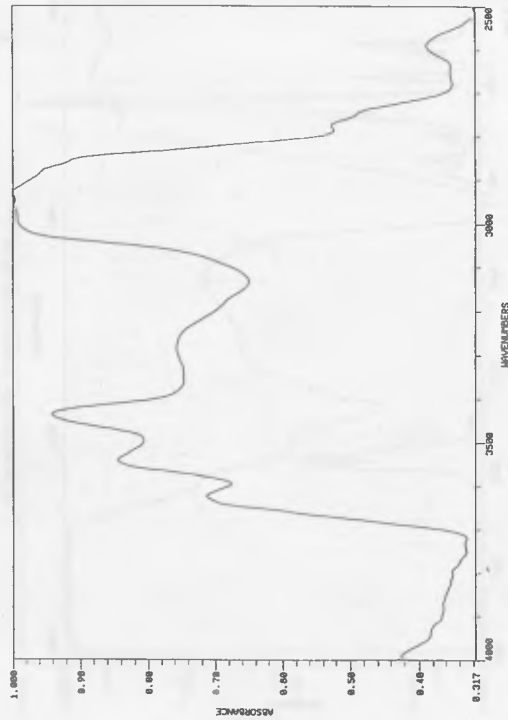

Fig. 6- Paraloid BTZ, 8 months natural aging

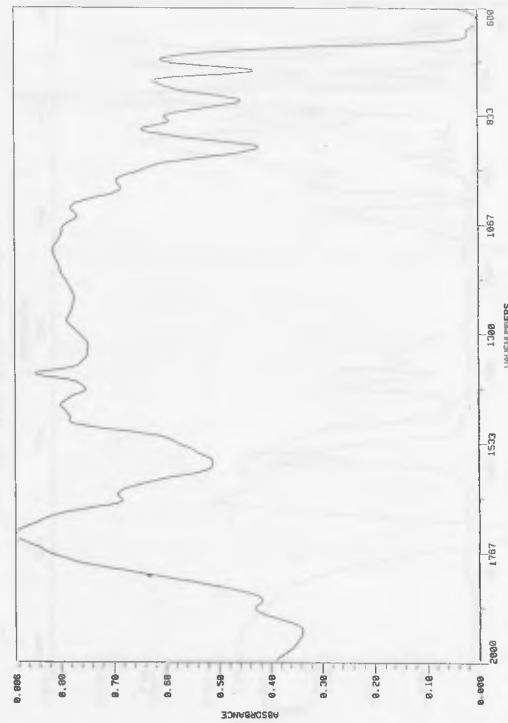

Fig. 9- Paraloid BTZ, 8 months natural aging

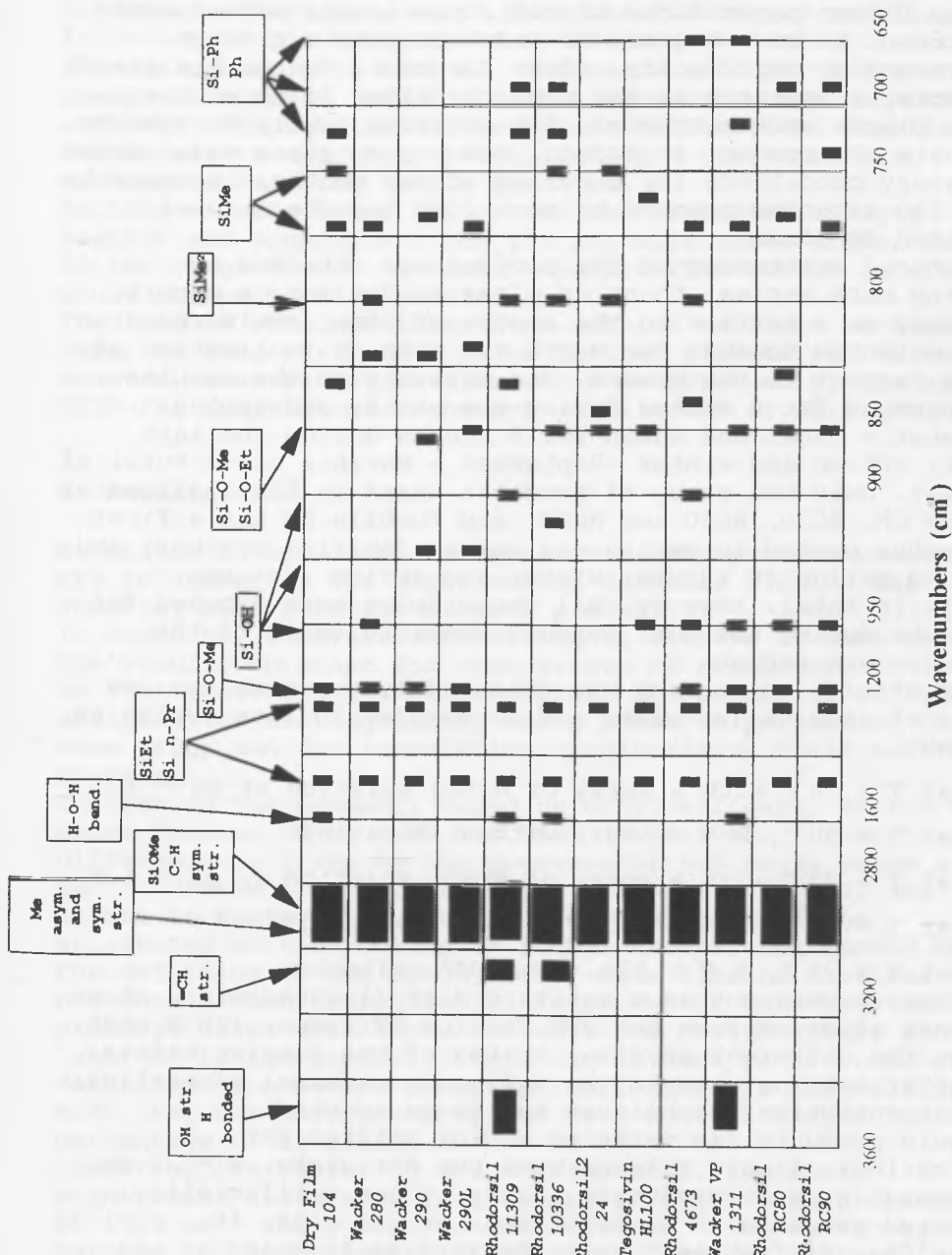

Fig. 5- Marks indicate the most interesting Absorbance frequencies of the different alkoxy-silanes and polysiloxanes. The mark darkness indicates the intensity and its length the broadness of the peak.

have been prepared according to NORMAL Doc. 20/85: each 5x5x2 cm marble piece (from a Carrara quarry) was put in a Petri dish on filter paper disks SS 5891, previously wetted with the product to be analysed, in order to obtain a first penetration by capillarity. After one hour, the marble pieces were totally immersed in the product. After 24 hours the marble pieces were extracted, the surfaces gently blotted to eliminate the product in excess, and put on glass rods, under laboratory conditions for a period of two months, in order to allow the ripening process to occur, as for the samples deposited on glass.

The natural weathering of the samples was obtained by exposing both series, those on glass slides and on marble, outdoors, on a terrace in the centre of Rome, sheltered from rain, oriented towards the North and with an inclination of 45° in respect to the ground. The majority of the samples were exposed for 6 months during the winter and spring (December - June) and again for 6 months during the late summer, autumn and winter (September - March), for a total of one year. Only the group of products based on Ethyl-silicates (Wacker OH, RC70, RC80 and RC90) and Fomblin CO had a first six months period in spring and summer (April - October) and a second period in autumn, winter and spring (October - April). In total, however, all the samples were exposed for 12 months during the four seasons characteristic of the Mediterranean region.

The artificial weathering was obtained by exposing the two series of samples (on glass and on marble) to five cycles as follows:

- 1 h at T = 30°C with a spray of H₂SO₄ solution at pH = 3.3
- 1 h at T = 30°C, R H = 100%, without spraying
- 1 h at T = 30°C with a spray of H₂SO₄ solution at pH = 3.3
- 1 h at T = 30°C, R H = 100%, without spraying
- 20 h at T = 25°C, R H = 30%, under UV radiation.

The samples were put on a rotating disk (1 round/min), at a distance of 35 cm from two UPK Philips UV lamps, 125 W each. Due to the different physical states of the samples before and after setting, and to the different chemical properties, several analytical techniques had to be adopted:

- Liquid products (as marketed and/or diluted for application): liquid film between two KBr disks, d = 25 mm
- ripened (or set) products, naturally and artificially weathered products on glass slides: on KBr disk, in transmittance; Fomblin CO was analysed as film in transmittance, Acrylic resins were analysed as film in ATR; details for each product are given in Table I.

Analysis of the samples on marble supports was rather difficult due to the strong interference of calcite peaks in

spectral ranges characteristic of many of the analysed products. After several trials, both in transmittance and in diffused reflectance, which gave unsatisfactory results, the following triple measurement method was chosen:

1°, *Background* with KBr; 2°, *Reference* with KBr and marble powder in a fixed rate; 3° *Sample* (product + marble powder) with KBr. Through the autosubtract mathematical function, the Reference spectrum, multiplied by a constant, was subtracted from the Sample spectrum.

In this way the range $1500 - 600 \text{ cm}^{-1}$ resulted clearly legible and significant for the products under study, while in the range $3000 - 1500 \text{ cm}^{-1}$ the interference of calcite could not be totally removed.

The results obtained from these samples will not be discussed here, as they still need to be further elaborated. It seems, however, that better results could be obtained by the use of FTIR-PAS analytical technique (Philippart et al., 1993).

3. Results

As stated in par.1, it is impossible, and perhaps useless, to try to summarise the experimental results, listing the spectral peculiarities of each product.

It could be, however, interesting to discuss in some detail the results obtained for some groups of products.

In fact these results can highlight the potential of FTIR analysis for distinguishing among products pertaining to the same group and for formulating hypothesis on their setting process.

Concerning the products based on ethyl-silicate, Wacker OH, Rhône-Poulenc RC70, RC80 and RC90 (Figs.1-4), a first difference is given by the presence of two small peaks at 700 cm^{-1} , 1230 cm^{-1} , characteristic for RC80 and RC90, and absent in Wacker OH and RC70: the first peak can be attributed to the rocking of phenyl groups, the second one to the deforming of the Si-CH₃ bond; this finding confirms the presence of non-hydrolyzable groups, which make the two products water-repellent. The observed phenyl groups are inherent to the product itself in the case of RC90, which is described as a methyl-phenyl-polisiloxane. In the case of RC80 they are more probably due to a solvent with a low percentage of aromatics.

Comparing the Wacker OH and RC70 spectra, the most significant difference is given by a rather strong absorption at 1710 cm^{-1} and a minor one at 1210 cm^{-1} in Wacker OH; further to that, the splitting of the peak at 1450 cm^{-1} , and an inversion of the double peak at 1370 cm^{-1} (with respect to the same peak of RC70) is observed.

These differences can be interpreted as the effect of a ketonic solvent in Wacker OH.

These two products, as well as RC80 and RC90, do not show any Absorbance in the region around 3500 cm^{-1} , typical of silanol, thereby indicating in all four products the absence of already hydrolysed groups.

The analysis of the spectra obtained for the alkoxy-silanes, pre-polymerised siloxanes and polysiloxanes is summarised in Fig.5, where for each product the frequencies of Absorbance that were found more interesting for the comparison and the corresponding structures are graphically indicated (Lipp et al., 1991; Charola et al., 1984).

From the data reported in Fig.5 several significant differences among the products studied are evident. These differences can be useful when analysing unknown products. However, as stated by Lipp and Lee Smith (1991), it must be stressed that "Identification is achieved only when the unknown spectrum shows a perfect match to an authentic reference spectrum of a well characterised standard." In the case of acrylic products in water emulsion, the elimination of water was incomplete both after a short drying under IR lamp and after two months' ripening. The OH Absorbance is too broad and strong and the resulting spectra are rather noisy. Improvement of their legibility under vacuum drying must be tried.

Some interesting observations on the weathering mechanism of the acrylics examined can be made through comparison of the spectra obtained before and after ageing (both natural and artificial). As an example, we mention Paraloid B72, a EMA/MA (70/30) co-polymer: the spectral response of all the weathered samples, with respect to the fresh ones, is strongly affected by the presence of residual water (Figs. 6-13). This produces a broadening of the peaks, especially in the range $3700 - 3400\text{ cm}^{-1}$ and $1800 - 1000\text{ cm}^{-1}$. The FTIR spectra obtained with these weathered samples do not allow any hypothesis on changes of the chemical structure that could be related to the observed hydrophilic behaviour.

However, this is in good agreement with other experimental results obtained on samples of limestone treated with the same acrylic resin and submitted to wetting - drying cycles. In that case, a clear trend towards an increasing affinity with water was produced by the cycles and tested through water absorption measurements (Charola et al., 1985).

Apart from the already mentioned broadening of the peaks influenced by the effect of water, the effects produced on Paraloid B72 by artificial weathering seem to be similar to the effects the 6-month natural ageing, as demonstrated by the spectral response at 1416 cm^{-1} : only the sample aged 1 year shows a splitting of the peak of the C-H bending of the methyl and ethyl groups. As this bending is also present in the spectrum of the fresh product, it cannot be attributed to any chemical modification but, probably, to a sterical effect present in the fresh product, cancelled by the interaction of

the deposited layer with the glass substrate and, afterwards reproduced after 1 year of outdoor exposure. This hypothesis, however, should be better investigated.

4. Conclusions

Analysis of the results obtained in creating the data bank stresses the advantages of such a catalogue as a reference point for unknown products and for checking the products offered on the market, before using them for conservation purposes. In fact it makes it possible and easy to obtain a first distinction and comparison with the most common types of polymers and pre-polymers produced by the chemical industry as consolidants and water repellents.

It is evident, however, that, in order to be useful, such a data bank should be continuously updated to follow the market evolution and to improve the analytical technique, especially as concerns samples from treated stones.

A common effort among different laboratories to feed the bank with new or updated information is highly desirable: this would share the work load and multiply the number of potential users.

The simplest way to exchange the available information is through the exchange of diskettes, but it is more advantageous that a network be established in order to facilitate access to and use of the data. The use of Modem equipment or, even better, communication via Internet or similar electronic means, seems at present the best way to reach the aim.

The above proposal should be discussed in detail by the potential partners, starting from the methodology of spectra collection, to the criteria for listing the products (trade name, manufacturer and/or supplier, etc.), to the technicalities of the networking itself.

The benefit of having such a data bank be international in scope is even too obvious to mention.

As already stated in the introduction, easy access to this FTIR spectra collection would also make it desirable that the characteristics of each product, either marketed directly by the chemical industry or sold by a dealer and claimed to be useful for the conservation of stones in monuments, be illustrated not only by a technical card but also by the FTIR spectrum of each batch.

Such information would help the conservation scientist to identify the chemism of each product and would give the conservator a better quality guarantee.

Concerning the study of the samples naturally and artificially weathered, it must be stressed that the experimental results need to be implemented with new and more systematic measurements on samples exposed for periods longer

than one year. Already, however, it is evident that the comparison of spectra collected after different ageing periods appears to be very promising. It allows one to register at least some of the modifications induced and helps in evaluating the durability of any given product. Furthermore, the comparison among the spectra of the same product aged on an inert support and on marble (not yet accomplished) could help to understand whether the product performance is influenced by a porous, calcite support.

Finally, from the experimental results it can also be inferred that five days of artificial weathering, which included cyclic sprays with a sulphuric solution at pH = 3.3, thermo-hygrometric fluctuations and exposure to UV radiation, produced in the majority of the cases spectral variations which are similar to those produced by natural weathering and, frequently, intermediate between those registered after six months and one year of outdoor exposure.

This finding seems to encourage the exposure of products to mild artificial weathering conditions during testing, in order to obtain results closer to reality, even if a slightly longer testing time is required.

5. References

- Charola A.E., Wheeler G.E., and Freund, G.G. (1984): The influence of Relative Humidity in the polymerization of Methyl-trimethoxy-silane. In *Preprints of the IIC Congress on Adhesives and Consolidants. Paris, Sept. 2-8, 1984, 177-188.*
- Charola A.E., Laurenzi Tabasso, and M., Santamaria, U., (1985): The effect of water on the hydrophobic properties of an acrylic resin. In "Proceedings of the Vth International Congress on Deterioration and Conservation of Stone". *Lausanne, Sept. 25-27, 1985, 739-747.*
- Hummel, D.O., (1978): Atlas of Polymer and Plastics analysis, 2nd Edition. *Verlag Chemie, International, New York.*
- NORMAL Doc. 20/85 (1986): Interventi conservativi: Progettazione, Esecuzione e Valutazione Preventiva. CNR - ICR, Roma
- Lipp, E.D., and Lee Smith, A. (1991): Infrared, Raman, Near-Infrared, and Ultraviolet Spectroscopy. In "The Analytical Chemistry of Silicones". Lee Smith A. Editor. *John Wiley & Sons, New York, 305-345.*
- Philippart, J.L., Lemaire J., Prédiction du Comportement à Long Term en Vieillissement Climatique de Polysiloxanes Initialement Adaptés à l'Hydrofugation et à la Consolidation des Pierres. In "Preprints of the 1er Colloque du Programme Franco-Allemand de Recherche pour la Conservation des monuments historiques". *Karlsruhe, 24-25 March, 1993, 165 - 170.*
- Pouchert, C.J., The Aldrich Library of FT-IR Spectra, Ed. I. (1985). *Aldrich Chemical Co., Milwaukee, W.I.*

THE INFLUENCE OF REACTION PARAMETERS ON THE EFFECTIVENESS OF TETRAETHOXYSILANE - BASED STONE CONSOLIDANTS: SOLVENT EFFECTS

ELIZABETH STEVENSON GOINS

The Metropolitan Museum of Art, New York, USA

GEORGE SEGAN WHEELER

The Metropolitan Museum of Art, New York, USA

SANDRA A. FLEMING

ATT Bell Laboratories, Murray Hill, USA

Abstract

Acid catalyzed solutions of water, tetraethoxysilane (TEOS) and ethanol are prepared, refluxed and later stripped of acid and ethanol. Aliquots of the stripped solution are subsequently re-dissolved in several solvents: ethanol, n-butanol, 1,1,1 trichloroethane, methylethylketone, acetone and tetraethoxysilane. These solvents are chosen for their relative strengths as Lewis acids or bases. Limestone and sandstone cores are consolidated with these solutions as well as a commercial product known in Europe as Wacker OH, and in the United States as Conservare OH. One month after treatment these cores are subjected to a three - point bend test through which the modulus of rupture (MOR) is determined. The modulus of rupture data show that specific solvent effects are noted for sandstone; for limestone the most important factor is the amount of tetraethoxysilane present in the consolidant.

Keywords: Lewis acid, Lewis base, Solvent effects, Modulus of rupture, Stone Consolidation, Tetraethoxysilane, TEOS

1. Introduction

The treatment of deteriorated stone remains a problematic area for the conservation community. Research on the conservation of stone often focuses on sandstones, limestones and marbles due to their frequent use and their tendency to deteriorate. Over the past three decades, significant advances have been made in the consolidation of sandstone with

alkoxysilanes, while their performance on carbonate rocks is less clear cut and confusion exists.

In order to evaluate the relative effectiveness of stone consolidants, mechanical testing is often used. One such test, the three-point bend, determines the modulus of rupture and was modified for the testing of consolidated stone (Fleming and Wheeler 1989). MOR testing shows that the alkoxysilanes give larger strength increases to sandstone while increases in MOR values for carbonate rocks are modest by comparison (Wheeler et al. 1992). The interpretation of the disparity in performance on the different substrates has been attributed to the lack of bonding between the alkoxysilane consolidant and the carbonate substrate.

While this interpretation may be correct, the consolidant - stone interaction is too complicated to be able to explain from MOR data alone. In order to consider this problem we may think of the consolidated stone as a type of "composite". Two possibilities then exist: 1). there is adhesion between the substrate and the consolidant or 2). there is no adhesion between the two. If we think of the first case, where adhesion exists between the stone and the alkoxysilane, there are several parameters which might influence the mechanical strength. Obviously, an increase in the degree of adhesion to the substrate will increase the mechanical strength (Plueddemann 1991). There is a point, however, at which the strength of the filler material gains importance. At this point, failure of the composite occurs not at the interface, but within the fill material itself. When weak filler such as calcium carbonate is used, increasing the degree of adhesion will not necessarily result in increased mechanical strengths (Plueddemann 1991). Finally, the strength of the alkoxysilane gel may also affect the apparent mechanical strength. Depending upon the hydrolysis and condensation environments, gels derived from alkoxysilane solutions exhibit varying degrees of mechanical strength (Brinker and Scherer 1990). If the gel - stone interface and stone (filler) are both stronger than the gel then failure will occur within the consolidant phase. If there is no adhesion between the consolidant and substrate then any increases in mechanical strength would be due to the strength of the gel which acts as a kind of second filler.

Obviously, a consolidated stone sample is not a "real" composite and as such is even more complicated. Some factors that may be present to varying degree are 1). non - homogeneous substrate, i.e. quartz or clay in limestone, calcite in sandstone etc. 2). uneven consolidant distribution within porous substrate 3). presence of impurities, i.e. salts, pollutants. When interpreting MOR data it is necessary to understand the nature of the alkoxysilane - stone interaction. Is the failure occurring in the gel phase or the mineral phase or is it a combination? Is the gel structure the same for both substrates? Is the alkoxysilane bonding to the surface or is it acting as a second "filler"?

The bonding or adhesion of polymers to solid substrates such as minerals has been described by Fowkes (1983, 1987) as involving Lewis acid - base interactions. According to Fowkes, adhesion occurs only when there is an exothermic, interfacial, acid - base reaction. This reaction is, in part, mediated by the solvent carrying the polymer; the solvent may have acid - base characteristics. The overall process of adhesion of the polymer to the substrate

may be regarded as a competitive triangle of relative acid - base interactions between the solvent - polymer, solvent - substrate, and the polymer - substrate. In the simplest cases, basic polymers do not absorb on basic substrates and acidic polymers do not absorb on acidic substrates; obviously, polymers and substrates must be opposites in their acid - base properties. However, when the solvent has an acidic or basic character the adsorption process becomes more complicated. As an example Fowkes (1987) used the interaction of a PMMA (a model basic polymer) and a silica (a model acidic surface) substrate. As the solvent for the PMMA solution became more basic it (the solvent) began to form acid - base complexes with the SiOH sites on the silica surface. On the other hand, when the solvent for the PMMA solution became more acidic, the solvent began to form acid - base complexes with the carbonyl (basic) oxygens of the PMMA and less PMMA is adsorbed onto the SiOH sites (see figure 1). The stronger the acid - base character of the solvent, the less polymer is deposited on the substrate and the weaker is the solid - polymer composite. The most effective way of maximizing the amount of polymer onto a surface is to minimize solvent - polymer and solvent - substrate interactions (i.e. use a neutral solvent) and maximize the acid - base interaction between the polymer and the substrate.

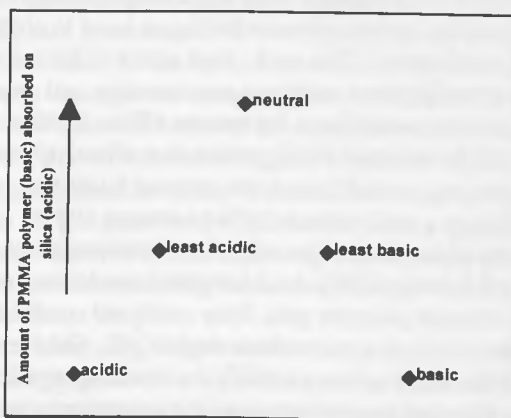

Figure 1: Both acidic (proton donors or electron receptors) and basic (electron donors or proton receptors) solvents interfere with the ability of the basic PMMA polymer to deposit from solution on an acidic silica substrate. Acidic solvents interact with basic sites (C=O) on PMMA and therefore interfere with the carbonyl's attraction to acidic sites (SiOH) on silica. Basic solvents are attracted to acidic sites on silica and also interfere with the carbonyl's attraction to silica's acidic sites (after Fowkes 1983).

There is, however, a problem when applying this theory to the alkoxy silane consolidants. The sols derived from the reaction of alkoxy silanes with a water / solvent mixture are thought to contain acidic sol groups. However, alkoxy silane consolidants seem to work best on silica surface and are reportedly inert towards carbonate surfaces (Plueddemann 1991). (Recent work by Goins (1994) has demonstrated that calcite surfaces are less clearly basic

than previously thought.) This would seem to be an indication that the adsorption mechanism of alkoxysilane sols on a silica substrate does not involve acid - base interaction between the polymer and the surface. It is likely, though, that there are acid - base interactions between the alkoxysilane sol clusters (groups of partially condensed silanols) and the solvent, as well as between solvents and mineral substrates.

Solvents are usually added to alkoxysilane solutions to:

- prevent liquid - liquid phase separation during the initial hydrolysis reaction
- control the concentration of silicate and water that influence the gelation kinetics
- added as co - solvents with alcohol to bring about the rapid, crack free drying of monolithic gels

The alkoxysilane hydrolysis reaction is influenced by the presence of labile protons within the solution. As the hydrolysis is catalyzed by hydroxyl ($\text{pH} > 7$) or hydronium ($\text{pH} < 7$) ions, solvent molecules that bind to hydroxyl or hydronium ions can inhibit catalysis under basic or acidic conditions respectively (Brinker and Scherer 1990). The solvent may also affect the condensation reaction of the alkoxysilane solution. Brinker and Scherer (1990) use the terms protic and aprotic to describe solvents with labile protons and without, respectively. Protic solvents will hydrogen bond to nucleophilic deprotonated silanols (base catalyzed mechanism) whereas aprotic solvents hydrogen bond to electrophilic protonated silanols (acid catalyzed mechanism). This acid - base effect of the solvent then tends to result in protic solvents retarding base catalyzed condensation and promoting acid catalyzed condensation. Aprotic solvents would have the reverse effect. In other words, the solvent may form complexes with the external SiOH groups thus effectively stabilizing them. On the other hand, the solvent may actually repel the external SiOH groups of the cluster towards the interior and form a particulate sol (Plueddemann 1991).

The different structures of the sol groups will effect the mechanical properties of the resulting gel (Brinker and Scherer 1990). Acid catalyzed conditions lead to smaller sol clusters which result in stronger polymer gels. Base catalyzed conditions or high water ratios lead to larger sol clusters which give particulate, weaker gels. Gel formation is complicated though and the aging of the sol or gel may modify the resulting structure yet again. During the condensation of the alkoxysilane sol (solution) the solvent may promote depolymerization processes. Solution systems that depress depolymerization during condensation lead to polymeric (strong) gels. In environments where depolymerization is promoted, as in systems with a high alcohol content, restructuring occurs leading to highly branched colloidal clusters and particulate gels.

The solvents physical properties can have a great influence upon the resulting gel. For instance, the solvent's vapor pressure and surface tension greatly effect the film formation and degree of cracking (Brinker and Scherer 1990). Also, solubility parameters may influence the viscosity of the solution. Domaslawski (1987) in his work on organic polymer migration in stone states that "The viscosity depends on the molecules dimensions, solution concentration, the quality of solvent etc." The effect of the solvent upon these parameters for

the alkoxy silane sol are unknown. The solvent type, for example, will affect the size of the sol clusters but how this will change the viscosity is not known.

This paper will evaluate the influence of the solvent type upon the mechanical properties (i.e. MOR) of limestone and sandstone consolidated with TEOS derived gels. A range of solvents, including acidic, basic and neutral, will be tested.

2. Experimental

2.1 Materials and testing

Two stones are used for the mechanical testing program. Monks Park, a purely calcitic limestone, and Ohio Massillian, a primarily quartz bearing sandstone, were chosen for their "poor" mechanical properties (i.e. low original modulus of rupture). The two stone types have similar pore size distributions and open porosity. Blocks of each stone type were core drilled perpendicular to the bedding plane according to the procedure outlined by Wheeler et al. (1991). The resulting stone cores are dried in a convection oven at 60°C for 48 hours.

For each treatment type ten cores of each stone type are used. The cores are placed in glass Petrie dishes (120 mm diameter and 15 mm depth) and the consolidant solution is carefully poured into the dishes so that the solution reaches slightly higher than one half the diameter of the cores (20 - 25 ml). The cores are allowed to sit in the consolidant bath for 30 minutes and then removed from the bath and the excess solution is blotted off. The treated samples are cured for 30 days at ambient laboratory conditions (approximately 20°C and 40% relative humidity). Mechanical testing is carried out by the determination of the modulus of rupture via a three-point bend configuration in accordance with ASTM c674-81 (Pardenek, Fleming and Klein 1988). The highest and lowest values within the sample set (ten cores) are dropped and the remaining values are averaged together for the reported MOR values (see Table 3).

A 2:1:3 molar ratio of water, TEOS and ethanol was prepared and the solution pH was adjusted to 3-4 by the drop wise addition of HCl as catalyst. The addition of the acid catalyst insures that the hydrolysis reaction will go to completion, i.e. there will be no un-reacted monomer. The catalyzed solution was then refluxed for two hours. In order to remove HCl and excess ethanol or water, the solution was roto-evaporated after the procedure described by Vega and Scherer (1989). This procedure consists in roto-evaporating the solution at 50°C until approximately 50% (w/w) of the original solution is left. The concentrated solution is then re-diluted in ethanol and roto-evaporated again. This process is repeated four times. The final roto-evaporation is allowed to continue until the concentrated solution is 38-40% (w/w) of the original solution. The final, concentrated solution is weighed and distributed evenly amongst 6 Nalgene containers.

Concentrated solutions in these containers are then re-diluted in the solvents shown in Table 1. The degree of dilution is determined in the following manner: the difference

Protic Solvents	Vapor pressure (Torr)	viscosity (cP)	surface tension (dyne cm ⁻¹)	solubility parameter (cal ^{1/2} cm ^{-3/2})	Dielectric constant (ohm ⁻¹ cm ⁻¹)	Lewis acid/base character
<i>Ethanol</i>	59.03	1.0826	22.32	12.78	20.45	acid
<i>n-butanol</i>	6.83	3.159	24.67	11.60	17.51	< acid
Aprotic Solvents						
<i>1,1,1 trichloro-ethane</i>	123.7	0.903	25.56	8.5	7.29	neutral
<i>MEK</i>	90.60	0.378	23.97	9.3	18.51	< base
<i>Acetone</i>	181.72	0.3029	22.68	10.0	20.56	base
Other Solvents						
TEOS	5.0	0.934				sl. basic?

Table 1: Physical properties of the solvents used to re-dissolve acid catalyzed 2:1:3 molar mixture of water:TEOS:ethanol sol after roto-evaporation. While each of these properties may influence the ability of this sol to consolidate stone, this work focuses on the Lewis acid-base character of the solvent.

between the weight of the starting and final solution is assumed to be due to the loss of ethanol and is converted to a unit volume (ml). This amount is divided by the number of solvent types (6) and each solution is diluted with the molar equivalent of the solvent type to replace the ethanol lost from the roto-evaporation. Each solvent is weighed out and added to the concentrated solution and stirred. The final, re-diluted solutions are used immediately. In addition to these six solutions, the commercial formulation Wacker OH (Wacker-Chemie) is tested.

2.2 Fourier Transform Infrared Spectroscopy (FT-IR)

The original catalyzed 213 solution of water, TEOS, ethanol and HCl, the stripped 213 solution, and the stripped solution re-dissolved in each of the six solvents was analyzed by FTIR spectroscopy. A BIORAD FTS - 40 spectrometer fitted with the Harrick liquid attenuated total reflectance (ATR) accessory employing a 45° ZnSe cell produced excellent spectra at 4 cm⁻¹ resolution and sixty - four scans. The purpose of these analyses was to determine if the stripping process (roto - evaporation) or the various solvents altered the silanol (SiOH) content. Changes in silanol content might alter the degree of attachment to solid substrates, particularly for silicate mineral substrates.

3. Results

3.1 FT-IR

Before proceeding to FT-IR analyses the original HCl catalyzed 2:1:3 water, TEOS, ethanol was examined for the presence of TEOS monomer. Acid catalysis normally insures complete hydrolysis if sufficient water is present; gas - chromatography - mass spectrometry (GC-MS) demonstrated that no monomer remained in the solution after several hours reaction time. Of course, GC-MS also showed that this solution contained large quantities of ethanol. Most of the ethanol is removed by the roto-evaporation procedure along with residues of water (if any is present) and HCl. The efficiency of ethanol removal can be judged in Figure 2 which shows the FT-IR spectra of the roto-evaporated sol re-dissolved in ethanol (top spectrum) and methylethylketone (bottom). The large absorbance at 880 cm^{-1} in the top spectrum can be assigned to the CH_3 or CH_2 deformation in ethanol. Band assignments are made according to Matos et al. (1992) - see Table 2. On the other hand, only a small absorbance at 880 cm^{-1} is seen in the bottom spectrum obtained from the same sol re-diluted in methylethylketone (MEK). These spectra also confirm the absence of TEOS monomer established by GC-MS: TEOS absorbances at 1390 , 1199 and 785 cm^{-1} are

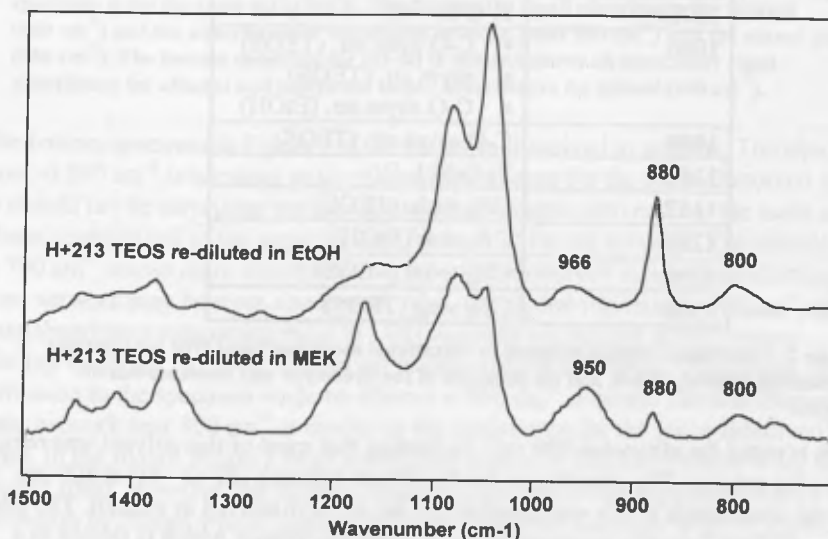

Figure 2: The top spectrum ($1500 - 700\text{ cm}^{-1}$) is the acid catalyzed, 2:1:3 molar mixture of water:TEOS:EtOH after roto-evaporation and re-dissolution in ethanol. As would be expected, a large absorbance appears at 880 cm^{-1} for ethanol. The bottom spectrum is the same sol re-dissolved in MEK. Here the absorbance for ethanol at 880 cm^{-1} is small, indicating that most of the ethanol has been removed by roto-evaporation.

missing from the spectra.

Figures 3 and 4 show the region 700 - 1000 cm^{-1} for the spectra of the stripped "213" sol re-dissolved in each of the six solvents. In Figure 3, three features can be discerned from the top spectrum of the acid catalyzed "213" sol re-dissolved in ethanol: 1). the substantial absorbance at 880 cm^{-1} for ethanol; 2). the absorbance near 800 cm^{-1} for the Si - O - Si symmetric stretch indicating the growth of the silicate network; 3). the absorbance at 960 cm^{-1} for the Si - O stretch of silanol (Si - OH).

The middle spectrum of Figure 3 is the same "213" sol re-dissolved in MEK. Only a small

IR region (cm^{-1})	Assignment
785-790	SiO ₄ asym. str (TEOS)
799	Si-O-Si sym. str.
810	Si-O-C rock. (TEOS)
880	CH ₃ or CH ₂ def. (EtOH)
950-970	Si-O str. (silanol)
961	CH ₃ rock. (TEOS)
1047	C-O sym. str. (EtOH)
1078	Si-O-Si T.O.
1080	<ul style="list-style-type: none"> • C-O sym. str. (TEOS) • asym str. (TEOS) • C-O asym str. (EtOH)
1099	C-O asym str. (TEOS)
1163	Si-O-Si L.O.
1167	CH ₃ rock. (TEOS)
1275	CH ₂ def. (EtOH)
1296	CH ₂ twist (TEOS)
1390	CH ₂ wag (TEOS)

Table 2: Absorbance regions assigned to vibrational mode and band type for solutions containing ethanol, TEOS, and the products of the hydrolysis and condensation of TEOS.

absorbance is noted for ethanol at 880 cm^{-1} indicating that most of this solvent was removed in the stripping process. The absorbance for the silicate network (Si -O - Si) at 800 cm^{-1} is similar to the absorbance at this wavenumber for the sol re-dissolved in ethanol. The silanol region (near 950 cm^{-1}) in this spectrum shows a larger absorbance which is shifted to a lower wavenumber (943 cm^{-1}). Some of this absorbance comes from MEK itself which has an absorbance peak at 943 cm^{-1} ; however, the shoulder to this absorbance appearing on the left is from silanol. The size of the shoulder indicates a silanol content similar to or slightly greater than the silanol content for the sol re-dissolved in ethanol.

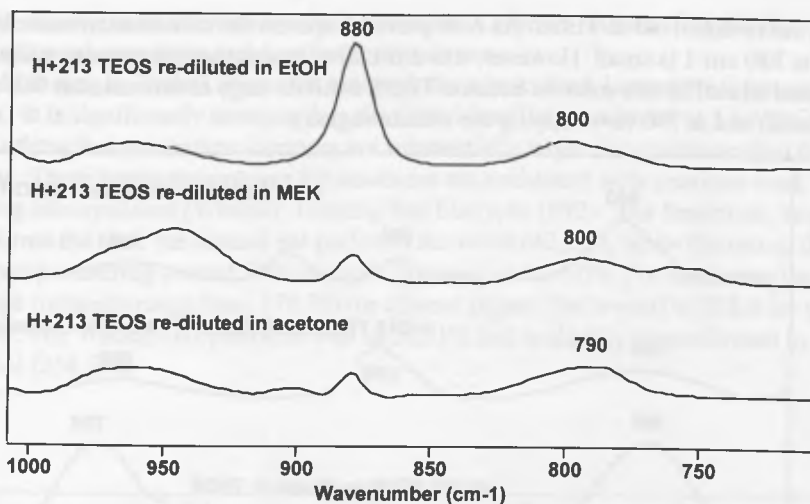

Figure 3: The top spectrum is, again, the 213 sol re-dissolved in ethanol. The middle spectrum is for the same sol in MEK. Notable are the small absorbance for ethanol (880 cm^{-1}) and the absorbance of the silicate network (near 800 cm^{-1}) and the silanol moieties (960 cm^{-1}). The bottom spectrum for the sol in acetone shows an expectedly small absorbance for ethanol and somewhat larger absorbances for silanol (960 cm^{-1}).

The bottom spectrum in Figure 3 is for the sol re-dissolved in acetone. The absorbance for ethanol at 880 cm^{-1} is identical to the ethanol absorbance for the sol re-dissolved in MEK. This should not be surprising because the residual ethanol derives from the same sol which has been re-dissolved to the same dilution for each of the six solvents. The silicate region near 790 cm^{-1} shows more absorbance for the sol re-dissolved in acetone indicating that the silicate network may be more condensed. Also, the silanol region near 960 cm^{-1} exhibits greater absorbance suggesting more Si - OH moieties are present in this system.

The top spectrum in Figure 4 is the sol re-dissolved in n-butanol. Once again, the contribution to the spectrum made by ethanol at 880 cm^{-1} is small. The absorbance for the silicate network near 800 cm^{-1} is similar to the absorbance for the sol re-dissolved in ethanol. In the silanol region a large absorbance is seen at 950 cm^{-1} which is for the solvent n-butanol itself. However, the sloping baseline at the left of this peak indicates a contribution by silanol which is estimated to be similar to that seen in the 213 sol in ethanol. The next spectrum down in Figure 4 is for the sol re-dissolved in 1,1,1 trichloroethane. In this spectrum the absorbance by the residual ethanol in the sol is obscured by absorbance for "1,1,1" at 875 cm^{-1} . The silicate regions (800 cm^{-1}) for the "1,1,1" sol is similar to the sol in ethanol and in n-butanol. The silanol absorbance (960 cm^{-1}) for the "1,1,1" sol is somewhat larger than ethanol and n-butanol sols. The bottom spectrum in Figure 4 is for the

stripped sol re-dissolved in TEOS. As with previous spectra the contribution made by ethanol at 880 cm^{-1} is small. However, it is difficult to assess the absorbances made by silicate and silanol in this solution because TEOS exhibits large absorbances at 960 cm^{-1} (like silanol) and at 790 (overlapping the silicate region).

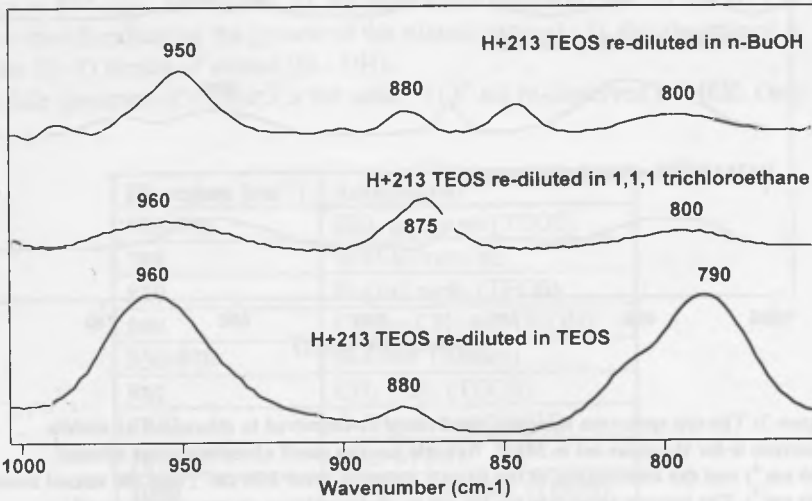

Figure 4: The top spectrum is for the 213 sol re-dissolved in n-butanol. Again, the absorbance for ethanol is small and the silicate network absorbance is similar to the sol re-dissolved in other solvents. The silanol region (960 cm^{-1}) appears to be much larger and shifted to the right. However, the added absorbance and shift comes from the solvent itself. In a similar way, the ethanol peak (880 cm^{-1}) in the middle spectrum, the sol re-dissolved in 1,1,1 trichloroethane, is obscured by 1,1,1's absorbance in that region. The silicate network and silanol absorbances are similar to those found in the acetone and MEK sols. The bottom spectrum is for the sol re-dissolved in TEOS. The absorbance of ethanol is small (880 cm^{-1}) while those in the silicate and silanol regions are obscured by the large contributions made by TEOS in those same regions.

3.2 MOR

The results of the three-point bend testing are shown in Table 3. The table indicates the treatment solution in the left column using a shorthand notation: 1). untreated is self-explanatory; 2). OH is Wacker OH; 3). TEOS is the acid catalyzed 2:1:3 molar solution of water: TEOS: ethanol, stripped, and re-dissolved in TEOS; 4). ethanol, the same solution re-dissolved in ethanol, etc. The second column of Table 3 is the actual modulus of rupture values produced by the test for the untreated and treated limestone cores. These values are given in mega Pascals (MPa). The third column is the percentage increase in MOR for

limestone which can be attributed to each treatment. Columns four and five are the equivalent to columns three and four but for sandstone.

The MOR data in Table 3 show that although the Monks Park Limestone is not strong - 6.2 MPa - it is significantly stronger than the Ohio Massillian sandstone at 2.6 MPa. The data also show that percentage increases are substantially larger for sandstone than for limestone. These larger percentages for sandstone are consistent with previous work employing alkoxysilanes (Wheeler, Fleming and Ebersole 1992). For limestone, Wacker OH performs the best, the ethanol sol performs the worst (42.2%), while the rest of the sols form a group centering around 50% strength increases or 9.3 MPa. For sandstone the percentage increases range from 178.7% for ethanol (again, the lowest) to 258.6 for the TEOS sol. The Wacker OH performs well at 242.1% and is slightly outperformed by the "1,1,1" sol (254.6%).

	Limestone		Sandstone	
	MOR (MPa)	%Increase MOR	MOR (MPa)	%Increase MOR
Untreated	6.2±0.6		2.6±0.1	
OH	10.4±0.4	67.5	9.0±0.5	242.1
TEOS	9.6±1.1	55.3	9.4±1.0	258.6
Ethanol	8.8±0.5	42.2	7.3±0.3	178.7
n-butanol	9.3±0.6	50.0	7.9±0.5	199.6
1,1,1 Trichloro ethane	9.2±1.2	49.4	9.3±0.3	254.6
MEK	9.5±1.2	53.7	8.8±0.4	233.8
Acetone	9.1±1.0	47.9	7.7±0.4	193.5

Table 3: Modulus of rupture data for treated and untreated sandstone and limestone cores. The sandstone (2.6MPa) is inherently much weaker than the limestone (6.2 MPa). Increases in MOR are substantially higher for sandstone. The MOR values are the averages of ten core samples (the highest and lowest values are thrown out) for each treatment.

4. Discussion

The increase in MOR of sandstone cores consolidated with the TEOS sol used in this work appears to be affected by the Lewis acid - base properties of the solvent used for re-dissolution of the roto-evaporated sol. Figure 5 is a bar graph of the percentage increases in MOR of the sandstone cores on the y-axis and the re-dissolution solvents on the x-axis. The solvents are organized from left to right in the following manner: most acidic - ethanol, least acidic - n-butanol, neutral - 1,1,1 trichloroethane, least basic - methylethylketone, most basic - acetone. According to Fowkes' acid - base adhesion theory the most basic and most acidic solvents should give the lowest adhesion and the lowest percent increase in MOR, the less basic/acidic solvents would perform slightly better, and the neutral solvent would perform the best. Figure 5 is completely consistent with Fowkes' theory.

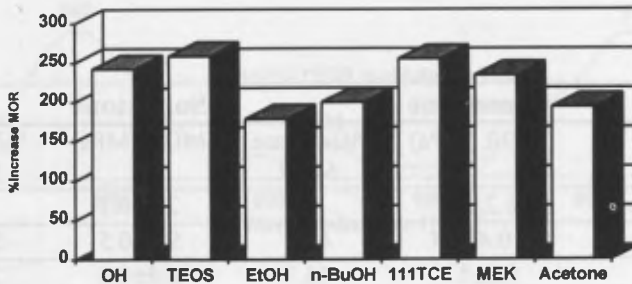

Figure 5: Bar graph of the % Increase MOR for sandstone provided by various treatments. The treatments are indicated by the re-dissolution solvents on the x-axis. The solvents are organized, ignoring OH and TEOS, from left to right in the following manner: EtOH-most acidic; n-BuOH-least acidic, 111TCE (1,1,1trichloroethane)-neutral; MEK-least basic; acetone-most basic. The % increase in MOR are consistent with Fowkes acid-base theory of adhesion: neutral solvents give the best performance and performance is reduced by increasing the acid or base character of the solvent. OH (Wacker OH) and the TEOS sol, on the left of the bar graph, give increases similar to 111TCE. The OH solvent system is somewhat basic while TEOS is probably neutral or mildly basic.

The solvents on the extreme left of figure 5 are Wacker OH and the sols re-dissolved in TEOS. Both the Wacker OH and the TEOS sol perform well. Wacker OH contains MEK (16% by volume) and acetone (8% by volume); evaluating its performance from Lewis acid - base solvent properties alone, Wacker OH should not perform as well as the neutral "1,1,1" sol because MEK and acetone are basic solvents. In fact, Wacker OH is almost as good as the "1,1,1" sol.

It is difficult to guess at the Lewis acid - base properties of TEOS. Un-reacted it would not have acid properties; the electron configuration on the ethoxy group may give a slightly

basic character to TEOS but less basic than the carbonyl group in MEK. With that in mind, the TEOS sol should perform better than MEK and near the performance of 1,1,1

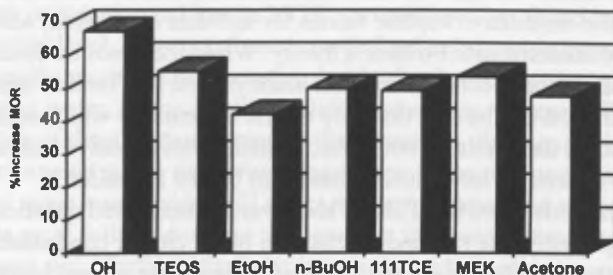

Figure 6: Bar graph of the % Increase MOR for limestone provided by various treatments. The arrangement is the same as Figure 6 except that the y-axis scale has a maximum of 70 (Figure 5 has a maximum of 300). On the right, the solvents EtOH through acetone show no consistent trend in relation to acid-base character. On the left, the OH and TEOS sols perform the best.

trichloroethane: the TEOS sol out performs MEK and out performs “1,1,1” but by only 4%.

Increases in MOR for limestone follow a less consistent trend than for sandstone when viewed from the stand point of the Lewis acid - base properties of the solvent. Figure 6 is a bar graph for the percentage increase in limestone organized in the same manner as Figure 5. In contrast to sandstone the neutral solvent does not perform best - MEK does. Furthermore, the range of difference in performance among the solvents is only 11.5% with most of the solvents yielding increases near 50%. It is, in fact, difficult to draw conclusions about differences in performance given that the standard deviation in the MOR of untreated limestone is 0.6 MPa (i.e. 6.2 ± 0.6) and the standard deviation for the five treatments on the right of the bar graph is only 0.3 MPa.

The TEOS sol and Wacker OH results are shown on the left of the x-axis. Both of the solutions outperform all others for limestone although the TEOS sol by only 1.6%. Wacker OH reaches a value of 67.5% which is clearly greater than all other solutions tested. Wacker OH and the TEOS - sol are distinguished by their higher silica concentration: Wacker OH is approaching 18 molal in silica, the TEOS sol 9 molal, and the rest of the solutions are 3.3 molal. In the case of Monks Park limestone, it appears that more silica means higher increases in MOR and the effect of solvent is either less dramatic or non-existent.

Why should the solvent effect be less dramatic in limestone than in sandstone? To attempt to answer this question, we return to the clearest distinction that can be made in the data: the increases in MOR for sandstone by far exceed the increases for limestone. It has been consistently stated in the literature that the better performance of alkoxysilane consolidants

on sandstones is due to the bonding of the alkoxy silane-derived species to the silicate minerals in sandstone. The acid - base effects of solvents described in Fowkes's theory pertain to resins and substrates between which there are adhesive interactions (i.e. bonding). For sandstone, the modulus of rupture values for solvents of different acid -base character are completely consistent with Fowkes's theory. While it can not be concluded from these results that bonding does occur between the alkoxy silane sols used in this work and the sandstone substrate, it can be said that they mimic systems for which adhesive bonding does occur. In limestone, these sols do not mimic systems with adhesive interactions: increases in MOR appear to depend on how much consolidant can be deposited.

Underlying the conclusion cited above are several unanswered questions and fundamental issues of testing. Firstly, the rate and mechanism of sol cluster condensation are known to be pH dependent, but the effect of quartz, feldspars, and calcite are not known (Danehey et al. 1992). Differences in rates and mechanisms alter the nature of the gel - ranging from more pliant films to isolated particles. As suggested in the introduction, these factors may influence the increase in MOR of treated stone cores.

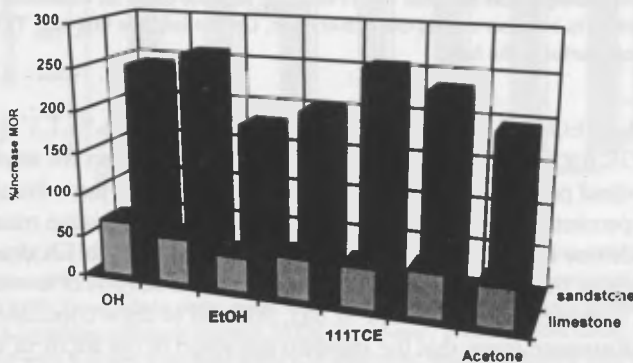

Figure 7: Two level bar graph of % increase in MOR for limestone (foreground) and sandstone (background) shown on the same y-axis scale. All the alkoxy silane treatment solutions provide much larger increases to sandstone than to limestone.

Secondly, the solutions or sols are not fully characterized. Ideally, the molecular weight distribution and the geometry of sol clusters should be determined in each solvent. In this way, the full effect of the solvent could be assessed.

Thirdly, the FT-IR results suggest that minor differences in the silicate network and silanol content exist in different solvents. It is not known how these minor differences may affect the MOR.

Fourthly, how useful is MOR testing in assessing stone consolidants? One advantage is

that many samples can be easily prepared and tested. Another advantage is that the stones used in the testing program are freshly quarried and cut in order to have a narrower range of variability in specific physical properties, such as MOR, than would deteriorated stone. These stones are high in porosity and low in MOR - properties often found in deteriorated stone. On a fundamental level, however, there is no defined relationship between MOR testing and either specific modes of deterioration (acid rain, dry deposition, salt crystallization, freezing water, hygric swelling, biological effects, thermal effects) or specific manifestations of deterioration (granular disintegration, flaking, scaling, spalling, cracking). The environments which may bring about these forms of deterioration, and in which a consolidated stone must reside, will affect the performance and service life of the consolidant itself. To more fully understand and interpret the results of the three-point bend testing, all of the issues and questions cited above must be addressed and answered.

5. References

- Brinker, C.J. and Scherer, G.W. (1991): Sol - gel science. *Academic Press: New York*, 908 pp.
- Danehey, C., Wheeler, G.S., Su, S.H. (1992). The influence of quartz and calcite on the polymerization of MTMOS. In "The Deterioration and Conservation of Stone, vol.3." Rodrigues, J.D., Henriques, F., Jeremias, F.T., editors. *Laboratório Nacional de Engenharia Civil: Lisbon*, 1043-1052.
- Domaslowski, W. (1987-1988): The mechanism of polymer migration in porous stones. *Wiener Berichte uber Naturwissenschaft in der Kunst*, 4-5, 402-425.
- Fowkes, F.M. (1983): Acid - base interactions in polymer adhesion. In "Physicochemical aspects of polymer surfaces". Volume 2. Mittal, K.L. editor. *Plenum Press, New York*, 583-603.
- Fowkes, F.M. (1987): Role of acid-base interfacial bonding in adhesion. *Journal of Adhesion Science Technology*, 1, 7-21.
- Goins, E.S. (1994): The acid/base surface characterization of sandstone, limestone and marble and its effect upon the polymerization of tetraethoxysilane. *Papers from the Institute of Archaeology*, 5, 19-28.
- Matos, M.C., Ilharco, L.M., and Almeida, R.M. (1992): The evolution of TEOS to silica gel and glass by vibrational spectroscopy. *Journal of Non-Crystalline Solids*, 147 and 148, 232-237.
- Pardenek, S.A., Fleming, J.W., and Klein, L.C. (1988): The mechanical properties of wet silica gels. In "Ultrastructure processing of advanced ceramics." Mackenzie, J.D. and Ulrich, D.R., editors. *Wiley, New York*, 379-389.
- Plueddemann, E.P. 1991. Silane coupling agents. *Plenum Press: London*.
- Vega, A.J. and Scherer, G.W. (1989): Study of structural evolution of silica gel using ^1H and ^{29}Si NMR. *Journal of Non-Crystalline Solids*, 111, 153-166.

Wheeler, G.S., Fleming, S.A. (1990). Modulus of rupture for room temperature gels derived from methyltrimethoxysilane. In *"The Engineering geology of ancient works, monuments and historical sites."* Marinos, P.G. and Koukis, G.C., editors. Balkema: Rotterdam, 2083-2085.

Wheeler, G.S., Shearer, G.L., Fleming, S., Kelts, L.W., Vega, A., and Koestler, R.J. (1991): Toward a better understanding of B72 acrylic resin/methyltrimethoxysilane stone consolidants. In *"Materials Issues in Art and Archaeology II"*. Vandiver, P.B., Druzik, J., Wheeler, G.S., editors. Materials Research Society, Pittsburgh, PA, 181-192.

EFFICACITE DES PRODUITS EMPLOYES POUR LA CONSERVATION DE LA PIERRE EN FRANCE : PREMIERS RESULTATS D'UNE ENQUETE MENEES AUPRES DES PROFESSIONNELS DE LA CONSERVATION

JM. VALLET, Cercle des Partenaires du Patrimoine, Laboratoire de Recherche des Monuments Historiques, Champs sur Marne, France

V. VERGES-BELMIN, Laboratoire de Recherche des Monuments Historiques, Champs sur Marne, France

V. ROMANOVSKY, La Rochelle, France

Résumé

Une enquête sur l'efficacité des produits employés pour la conservation de la pierre a été menée courant 1994 auprès des professionnels de la conservation. Plusieurs critères ont été retenus, concernant le matériau traité, la méthodologie employée avant et après traitement, le traitement proprement dit, l'efficacité du traitement dans le temps. Les premières réponses recueillies portent surtout sur les produits consolidants, produits généralement efficaces mais qui modifient souvent l'aspect de la pierre.

Mots-clé : enquête, conservation, France, pierre, produits, vieillissement, durabilité

1 Introduction

Les enquêtes, qui sont quelquefois utilisées en conservation (anonyme, 1994 ; Pallot-Frossard, 1993 ; de Tapol, 1993), permettent d'appréhender de manière synthétique des problèmes économiques ou techniques complexes. Leur dépouillement permet de dégager des réponses ou éléments de réponses qui, en raison de leur nombre important, ont un caractère statistique et peuvent servir de base à de futures recherches sur un problème donné.

Une enquête sur l'efficacité des produits employés pour la conservation de la pierre en France est menée depuis janvier 1994. Cette enquête a pour objectifs d'une part de savoir où et comment les produits sont utilisés et d'autre part, d'améliorer les connaissances sur leur durabilité. Elle doit aussi permettre d'effectuer un recensement des monuments traités et de mettre en évidence les éventuelles limites d'application de ces produits.

Les résultats de cette enquête permettront in fine de mieux conseiller les professionnels de la conservation quant à l'utilisation de ces produits.

2 Méthodologie

Cette enquête a été diffusée sous forme d'une lettre-questionnaire à 450 professionnels de la conservation regroupés en quatre groupes (tableau 1) : maîtres d'oeuvre et d'ouvrage, responsables administratifs et conseillers scientifiques, entreprises de maçonnerie des monuments historiques, restaurateurs de sculpture sur pierre.

Deux envois en nombre (janvier et octobre 1994) suivis d'une relance systématique par téléphone un mois après chaque envoi ont été effectués. Une lettre d'accompagnement signée par la sous direction du Patrimoine (ministère de la Culture et de la Francophonie) expliquait à la population interrogée les tenants et aboutissants de cette enquête.

Le formulaire de l'enquête a été bâti dans l'optique finale d'un traitement statistique des données (cf. appendice), la plupart des questions étant de type qcm (choix fermé).

Tableau 1 : Qualification et nombre de personnes consultés pour chaque groupe

groupe	qualification	nombre	total
maîtres d'oeuvre et maîtres d'ouvrage	Architecte en Chef des Monuments Historiques	55	194
	Architecte des Bâtiments de France	113	
	Conservateur Régional des Monuments Historiques	26	
responsables administratifs et conseillers scientifiques	Inspecteur des Monuments Historiques	23	54
	Direction Régionale des Affaires Culturelles	26	
	ingénieurs LRMH + autres	5	
entreprises de maçonnerie des monuments historiques		103	103
restaurateurs		99	99

Différents critères ont été retenus :

- la nature du matériau de construction de l'édifice choisi comme étant représentatif d'un ou de plusieurs types de traitements mis en œuvre et des effets observés après application ;
- les techniques de nettoyage, les études préliminaires ;
- la méthodologie employée (procédés d'application, surfaces couvertes) ;
- les caractéristiques des produits utilisés ;
- les conclusions émises sur l'efficacité dans le temps du traitement et ses effets secondaires.

D'autres critères, tels la localisation du monument (ruralité, climat), l'âge du matériau, l'emplacement de la zone traitée (situation extérieure ou non, orientation) et la porosité de la pierre, peuvent par ailleurs être extraits a posteriori. Ceux-ci serviront dans un deuxième temps, à l'exploitation des données de l'enquête. Ils permettront de mieux comprendre les raisons de l'efficacité ou de l'absence d'efficacité des produits appliqués.

3 Résultats et discussion

20,5 % des personnes interrogées ont répondu, au 8 décembre 1994, à l'enquête. 34 % des personnes ayant répondu déclarent ne pas avoir utilisé de produits (réponses "négatives"). Le nombre de réponses total est faible mais correspond apparemment, en pourcentage, à la moyenne habituellement rencontrée dans ce type d'étude (de Tapol, 1993 ; anonyme, 1994).

Compte tenu des dates d'application récentes (généralement inférieures à 10 ans), ces premiers résultats donnent plutôt une image des traitements actuellement effectués en France.

Ces réponses ne représentent que 1/3 des départements français (figure 1). Elles proviennent essentiellement du bassin de Paris, de la vallée du Rhône et ses abords alpins, ce qui explique (Blanc et Lorenz, 1992) que le matériau traité est à 88 % de type sédimentaire (tableau 2) et à 69 % calcaire (figure 2).

Tableau 2 : Matériaux des monuments traités, classés selon leur appartenance aux grands types de roches

Type de roche	sédimentaire	métamorphique	ignée	"autres" (briques...)
Répartition (%)	88	6	4	2

Le Bassin Aquitain, les Pyrénées, la Bretagne, le Massif Central, le centre des Alpes, les Vosges ont fait l'objet de peu à pas de réponse : les matériaux de construction, caractéristiques de ces régions où ils sont extraits et mis en oeuvre, sont pour la plupart réputés durs et/ou non calcaires (ex. : granites, roches volcaniques, grès...) ; ils semblent donc, aux yeux des utilisateurs, inutiles à traiter, les matériaux du Bassin Aquitain mis à part. Par ailleurs, l'absence de réponses dans ces régions ne nous permet pas d'affirmer qu'aucun traitement n'y a été effectué. De plus, la gestion par région du patrimoine culturel en France, conduit à des politiques de conservation propres à chacune d'elle, ce qui peut expliquer la formulation de réponses "négatives" ou l'absence de réponse dans certaines régions.

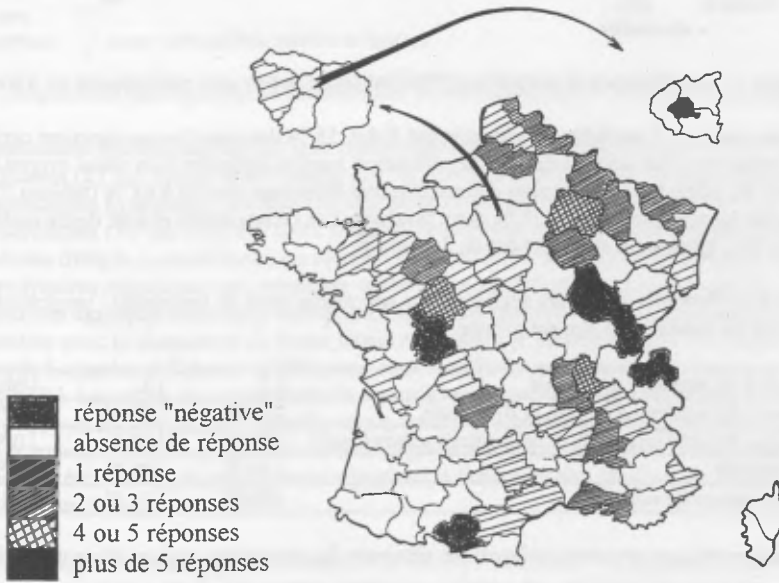

Figure 1 : Localisation et densités des réponses à l'échelle de la France et des départements français

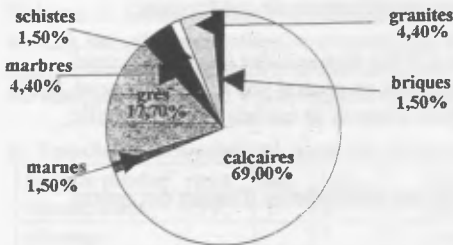

Figure 2 : Types de matériaux traités recensés dans l'enquête

Afin d'optimiser les propriétés des traitements, 80 % des utilisateurs procèdent à un nettoyage préliminaire (figure 3). Les traitements chimiques (25 %), la microabrasion (24 %), le lavage à l'eau (basse pression ou ruisselante ; 19 %) et à un degré moindre, la nébulisation (12 %) et le

brossage ou le grattage (12 %) sont couramment utilisés. Certaines méthodes de nettoyage sont plus anecdotiques (ex. : scalpel, nettoyage à l'air comprimé) ou encore peu utilisées (ex. : laser).

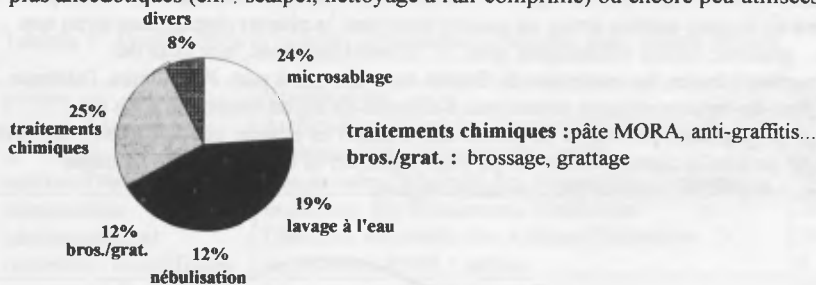

Figure 3 : Grands types et proportion d'utilisation de nettoyages préliminaire au traitement

En moyenne, 2,1 produits ont été cités par fiche. 55 % des enquêtes ne signalent cependant l'utilisation que d'un seul produit. Cette utilisation semble dépendre d'un choix propre à chaque groupe. En effet, le groupe maître d'oeuvre/maître d'ouvrage choisit à 65 % (tableau 3) de faire appliquer un seul produit et à 35 % deux produits. Les restaurateurs et à un degré moindre les entreprises, appliquent souvent plus de 2 produits.

Tableau 3 : Produits différents appliqués sur une même zone de traitement : proportion de réponses en fonction de chaque groupe

nombre de produits appliqués	1	2	plus de 2
groupe des maîtres d'oeuvre et d'ouvrage	65 %	35 %	0 %
groupe des administratifs et conseillers scientifiques	75 %	25 %	0 %
entreprises	64 %	29 %	7 %
restaurateurs de sculpture	25 %	31 %	44 %

Plusieurs raisons peuvent expliquer les réponses du groupe des maîtres d'oeuvre et d'ouvrage :

- soit une réticence pour l'application successive de plusieurs produits sur une même surface, par manque de documentation sur les interactions pouvant exister entre différents produits ;
- soit les traitements connexes ont été omis, les maîtres d'oeuvre et d'ouvrage qui ont commandé les travaux, n'étant pas les applicateurs et réalisateurs de ces travaux.

Les produits rencontrés sont surtout des silicates (26 %) ainsi que des résines, silicones (17,5 %), époxy (15 %) et acryliques (8 %). Ils montrent en général une bonne efficacité, après un Tmo¹ total de 6,2 ans et malgré des modifications d'aspect de surface (aspect mouillé, coloration...) souvent signalées (tableau 4).

Tableau 4 : Proportions de cas rencontrés indiquant une modification d'aspect des quatre principaux types de produits

type de produit/résine	silicate d'éthyle	silicone	époxy	acrylique
modification d'aspect (%)	53	43,5	29	9

¹ : T(m)o est le temps (moyen) d'observation après application, des modifications des surfaces traitées et est exprimé en années

Les produits appliqués sont essentiellement des consolidants, qui peuvent être anciens (44 %, $1 \leq T_o \leq 150$ ans, $T_{mo} = 9,4$ ans, figure 4). Les hydrofuges sont comparativement moins employés et d'utilisation plus récente (20 %, $1 \leq T_o \leq 12$ ans, $T_{mo} = 3,7$ ans).

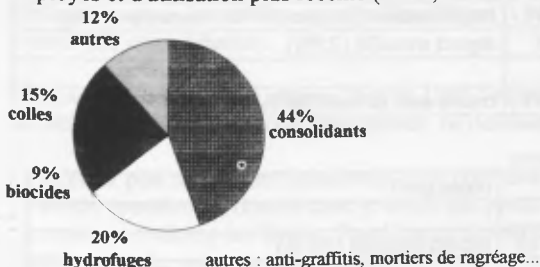

Figure 4 : Répartition des réponses en fonction des différentes familles de produits appliqués

Les consolidants utilisés (tableau 5a) sont essentiellement des silicates d'éthyle (54 %), des résines silicones (15 %), époxy et acryliques (16 %). Les produits signalés comme étant ou ayant des caractéristiques hydrofuges (tableau 5b) sont pour l'essentiel des résines silicones (50 %), époxy et acryliques (14 %). Pour ces deux familles de produits, les bons résultats enregistrés pour le silicate d'éthyle (consolidant), les résines silicones (hydrofuges) et une méfiance dans les produits polymères organiques qui entraînent souvent des modifications d'aspect (cas des résines époxy), peuvent expliquer cette large utilisation. Les effets observés après consolidation (tableau 5a) concordent avec le classement de Rossi Doria et al cités par Honeyborne (1990) et les remarques de Lazzarini et Tabasso (1986) pour cette famille de produits et avec les travaux de Riederer (1976). Les effets des traitements de consolidation sont dans littérature et pour certains produits, controversés (ex. silicate d'éthyle, résine époxy ; Honeyborne, 1990 ; Riederer, 1981). Ainsi, les premiers résultats significatifs de cette enquête vont, pour le silicate d'éthyle (produit pour lequel ont été fournies de nombreuses réponses), à l'encontre des résultats de Clarke et Ashurst cités dans Honeyborne (1990).

Les colles utilisées dans une époque récente ($1 \leq T_o \leq 10$ ans, $T_{mo} = 3$ ans) sont pour 70 % des résines époxy et pour 10 % des résines acryliques (tableau 5c). Malgré l'absence de modification des résines acryliques après un T_{mo} (4 ans) plus long que pour les résines époxy (3 ans), ces dernières, qui modifient l'aspect de la pierre (coloration) ont été plus employées.

Tableau 5 : Effets estimés (%) pour chacun des types de traitements. Dans certains cas (ex. colles), les valeurs calculées ne donnent que des tendances (nombre d'observations faible). Les traitements ont été estimés à l'observation comme ayant des effets positifs (pos.), nuisibles (nég.) ou étant sans effet (ind.). Ils n'ont pas été clairement formulés (?) dans quelques enquêtes.

a : Famille des consolidants, pour 100 observations

type de produit	pos.	ind.	nég.	?	remarques
silicate d'éth.	39	3	8	3	modif. d'aspect (55%): mouillé (18%), coloré (18%)
silicates			3	2	nég.: silicate de K, fluosilicate de Zn
rés. silicones	3			12	
rés. epoxy	2		2	7	modif. d'aspect (7%) : origine diverse
rés. acrylique			3	3	faible résistance mécanique (25%)
autres	2		3	5	

Nota : éth. = éthyle, rés. = résine et modif. = modification

b : Famille des hydrofuges, pour 100 observations

type de produit	pos.	ind.	nég.	?	remarques
silicates				3	
résines silicones	39	3		11	modification d'aspect (71%) : mouillé (36%)
résines époxy	4		4	7	aspect mouillé (25%)
résines acrylique	11				
autres	7			11	traces noir et vert (20 %)

c : Famille des colles, pour 100 observations

type de produit	pos.	ind.	nég.	?	remarques
polyvinyl	5				
résines epoxy	35			35	aspect mouillé (14 %)
résines acrylique	10				
autres	5	5		5	

d : Famille "Autres", pour 100 observations

type de produit	pos.	ind.	nég.	?	remarques
anti-graffiti	13				aspect mouillé
mortiers	37		25	13	
divers			12		modification d'aspect

Les autres produits employés ($1 \leq T_o \leq 11$ ans, $T_{mo} = 5,2$ ans, tableau 5d) sont surtout des mortiers de réparation (75 %) et des produits anti graffiti (12,5 %).

Les biocides signalés sont tous des produits ayant l'ammonium quaternaire comme matière active. Leurs effets sont positifs et semblent être durables ($1 \leq T_o \leq 15$ ans, $T_{mo} = 3,6$ ans).

Certaines limites d'application de produits sont indiquées dans quelques enquêtes. Ainsi, l'application de silicate d'éthyle sur les calcaires gréseux, de résines époxy sur les molasses auraient des effets nuisibles. Par ailleurs, un mortier de réparation à base de calcite et d'hydroxychlorure de zinc a toujours été présenté dans les enquêtes le citant comme étant un produit nuisible.

4 Conclusions

Le nombre de courriers reçus à ce jour montre l'intérêt modéré qu'ont porté les professionnels de la conservation à cette enquête. Le faible taux de réponses rend ainsi difficile une interprétation poussée des résultats. Des relances téléphoniques seront poursuivies jusqu'en mars 1995, afin de collecter le plus grand nombre possible de réponses.

Il est cependant possible de dégager dès à présent une tendance générale :

- les produits utilisés sont, en général, des produits consolidants (surtout des silicates d'éthyle) ;
- ces produits sont efficaces mais modifient souvent l'aspect de la pierre, comme cela est signalé après une durée d'observation moyenne de 6,2 ans ;
- les monuments traités ont subi en général un nettoyage préliminaire ;
- le matériau traité le plus utilisé est essentiellement calcaire ;
- des limites d'application des produits, liées à la nature du matériau à traiter pourraient exister, des résultats négatifs ayant été notamment enregistrés lors d'application de silicate d'éthyle sur des calcaires gréseux et de résine époxy sur de la molasse.

Les réponses reçues donnent une image actuelle mais très partielle de l'utilisation des produits. En général, les réponses portent sur des traitements effectués depuis 10 ans, les temps d'observation après traitement sont donc de faible durée. De plus, la durabilité des produits appliqués ne peut être totalement appréhendée par la seule observation visuelle des surfaces traitées (ex. consolidation).

L'ensemble des résultats obtenus fera en 1995 l'objet d'un traitement statistique des données par analyse factorielle des correspondances. Ils devraient permettre, in fine, de :

- recenser puis choisir des monuments-type pour une étude ultérieure de ces traitements ;
- mieux connaître l'efficacité dans le temps des produits employés ;
- mettre en évidence les limites d'application des différents types de produit en fonction du pétrotypage de la pierre de construction ;
- mieux conseiller les professionnels dans l'utilisation de ces produits.

5 Références

- Anonyme (1994) : La profession de restaurateur d'oeuvres d'art. In "*développement culturel*", suppl. L. info. n° 371, Bul. Dép. E. Pros., juin 1994, 104, Min. Cult. Franc., 6 pp.
- Blanc, A. et Lorenz, C. (1992) : Les sources des pierres monumentales en France : le cadre géologique et le problème des carrières. In "*la conservation de la pierre monumentale en France*", coordonnés par J. Philippon, D. Jeannette et RA. Lefèvre, Presses du CNRS, France, 27-48.
- De Tapol, B. (1993) : Produits, faits, modes en peinture murale. Evolution et répartition des produits de restauration utilisés dans les peintures murales de 1850 à 1992 : un premier tri concernant France, Espagne, Angleterre et Pologne. In "*Les anciennes restaurations en Peintures Murales*", Dijon, 25-27 mars 1993, SFIIC, Champs sur Marne, 273-288.
- Honeyborne, D. (1990) : Consolidants as preservatives ? : Part 1 Surface treatments in general. In "*Conservation of Building and Decorative Stone*", J. Ashurst and F. G. Dimes Eds, Edition Butterworth-Heinemann, London, 2, 156-169.
- Lazzarini, L. et Tabasso, M.L. (1986) : La restauration de la pierre. *ERG*, copyright CEDAM, Padova, 264 pp.
- Pallot-Frossard, I. (1993) : Le vitrail: conservation, restauration, création. *Monumental*, 3, 7-70.
- Riederer, J. (1976) : Further progress in german stone conservation. In "*Proceedings of The Conservation of Stone I*", Bologne, June 19-21, 1975, R. Rossi-Manaresi Editor, Centro per la Conservazione delle sculture all'aperto, Bologne, 369-374.
- Riederer, J. (1981) : The preservation of historical monuments in Sri Lanka. In "*preprints of the contribution to the International Symposium : The Conservation of Stone 2*", Bologne, October 37-30, 1981, R. Rossi-Manaresi Editor, Centro per la Conservazione delle sculture all'aperto, Bologne, 737-756.

6 Remerciements

Les auteurs remercient C. Jatton et G. Oriol (LRMH) pour leur participation à ce travail, ainsi que toutes les personnes qui ont répondu à cette enquête.

Ce travail a été financé par le Cercle des Partenaires du Patrimoine (ASFA, Caisse des Dépôts et Consignation, Calcia-Ciments Français, CGE, EdF, GdF, Lafarge-Coppée, Lyonnaise des Eaux-Dumez, Pont-à-Mousson) et le ministère de la Culture et de la Francophonie.

ENQUETE SUR L'EFFICACITE DES PRODUITS EMPLOYES POUR LA CONSERVATION DE LA PIERRE

1- Rédacteur du questionnaire :

- a- NOM :
- b- ADRESSE :
- c- QUALITE :
- d- TEL :
- e- FAX :

2- Responsable du traitement :

- a- NOM :
- b- ADRESSE :
- c- QUALITE :
- d- TEL :
- e- FAX :

DONNEES GENERALES

- 3- **Mouvement type :**
- a- Edifice :
- b- Adresse (si nécessaire) :
- c- Ville :
- d- Département :

4- Familles de produits :

RENSEIGNEMENTS RELATIFS AU MONUMENT TRAITÉ

- 5- **Matériau de construction :** a : calcaire b : molasse c : grès d : grès e : autre
- 6- **Nom de la pierre et/ou de la carrière :**
- 7- **Surfaces couvertes :** a : 0-5m² b : 5-10 m² c : 10-100 m² d : > 100 m²
- 8- **Nettoyage ou non avant traitement :** a : oui b : non c : je ne sais pas
- d- nature du nettoyage :

9- Analyses et protocoles préliminaires au traitement :

- a- L.R.M.H. (préciser l'adresse, si possible)
- b- Laboratoire associé :
- c- Autres (laboratoire(s) (préciser l'adresse, si possible))

Remarque : Journez la page S.V.P.

RENSEIGNEMENTS RELATIFS AUX PRODUITS DE TRAITEMENT

10- Famille	a : consolidant (s)	b : hydrolyse (s)	c : biocide (s)	d : colle (s)	e : autre (s) <i>(préciser, si possible)</i>
11- Nom commercial du produit <i>(préciser la fiche technique, si possible)</i>					
12- Caractéristiques					
a : nature chimique					
b : référence technique					
c : entropée de distribution					
13- Procédé d'application					
a : pulvérisation					
b : pinceau					
c : injection					
d : autre					
e : nombre d'applications					
f : quantité utilisée au m ²					
14- Date d'application					

17- Commentaires :

- 15- **Effets de traitement :** (ex. coloration, aspect mouillé...)
- a- au moment du traitement :
- b- dates successives des observations, après le traitement et constatations sur les effets du traitement :

- b1 : positifs 19 19 19
- b2 : indifférents
- b3 : nuisibles
- b4 : aucun

c- autres dates :

16- Remarques générales propres au traitement :

(une réponse supplémentaire à ce questionnaire sera le bienvenu)

... ..

... ..

... ..

... ..

... ..

... ..

... ..

... ..

... ..

... ..

Part Four

TREATMENTS WITH WATER REPELLENTS

... ..

... ..

... ..

... ..

... ..

... ..

... ..

... ..

... ..

... ..

... ..

... ..

... ..

EVALUATION OF THE EFFECTIVENESS OF PROTECTIVE TREATMENTS FOR SLATE FROM THE VAL DI LAVAGNA (ITALY)

A. ALDI*, G. ALESSANDRINI*, A. CASARINO**, E. PEDEMONTE**, R. PERUZZI*

* Centro CNR "Gino Bozza" per lo Studio delle Cause di Deterioramento e dei Metodi di Conservazione delle Opere d'Arte, Milano, Italia

** Istituto di Chimica Industriale-Università di Genova, Genova, Italia

Abstract

A series of laboratory tests were carried out to evaluate the significance of the application methods stipulated in the NORMAL guidelines for the evaluation of the effectiveness of protective treatments for stone material.

The tests for accelerated artificial weathering adopted in the present work - not yet included among the NORMAL Commission's guidelines - may be taken as a proposal for an application method. The sample stone chosen was Ligurian slate, a material that has rarely been studied from the point of view of conservation and for its particular structural and textural characteristics. The results are complemented by a critical analysis of the analytical methods adopted. Overall, the method recommended by the Commission for establishing most appropriate products and defining their performance characteristics was confirmed, though certain shortcomings arose which require further assessment in the further NORMAL Commission activity.

Keywords: Protection, Methods, Laboratory Tests, Artificial Weathering, Slate.

1 Introduction

Today conservation science imposes that consolidant and/or protecting substances be applied on the surface of stonework only after they have gone through a series of laboratory tests. While this idea is sufficiently understood by those operating in the sector, it is equally evident from the bibliography on the subject that such trials have been carried out by researchers without applying a real system, and as such the type of tests applied for determining a particular product's effectiveness

have tended to vary. By the same account, methods sometimes vary even within the same test. Reasons are not given for the choice of assessment parameters over another; at times, moreover, tests involving a single evaluation are considered sufficient.

In 1985, however, the NORMAL Commission, the Italian scientific standards authority for the artistic works conservation, as discussed in greater depth elsewhere in this volume (AA.VV., 1995), after a series of tests made by several laboratories across the country working in parallel, has decided that the product must be tested by different methods, each concentrating on some particular feature of the product under examination (e.g., for water-repellent properties, alterations in chromatic values, etc.); the purpose of this round of laboratory tests was to submit each product to a variety of different trials, and to conduct each test according to a set of standard procedure.

The scope of this report is to apply the NORMAL Commission procedure to a specific lithotype that was not included in the NORMAL test guideline as a means of pinpointing possible incongruences or shortcomings in the proposed NORMAL method.

2 Materials

The lithotype chosen was Ligurian slate, a sedimentary marl composed of layered calcite and phyllosilicates (Fratini et al., 1988). For this specific paper, slate from a quarry in the Val di Lavagna in the province of Genoa was employed.

There are three reasons behind this choice:

- the stone's widespread use throughout Liguria since Roman times; from the 13th century on, this slate was widely used for doorways, frames, external details and flooring in both civil and religious architecture; today it is extensively used for roofing and for cladding parts of buildings most exposed to wind and rain (Conte, 1967);
- by contrast, the scant interest in this lithotype on the part of scientific experts, as can be inferred from the somewhat slender bibliography (Fratini et al., 1988);
- the particular structural and compositional characteristics of the stone (Fratini et al., 1988).

The main cause of slate's decay is chemical dissolution caused by acid rain-washing, through which the material loses its calcium carbonate and increases in phyllosilicate content. Slate thus altered begins to show surface flaking with the consequent transformation of the material's texture and porosity; this process facilitates the capillary absorption of water, which causes further detachment of material in thin flakes (Fratini et al., 1988).

The protective treatments tested here (see Table 1) belong to the same class of products that have been subjected to NORMAL Commission (AA.VV., 1995); this was decided so as not to introduce any further variables to the experiment. The only

exception was the inclusion in the tests of an acrylic resin, given enduring and widespread employment of this type of product in the conservation field.

Table 1. Protective treatments

Code	Products	Composition	Treatment time
WW	1311 (Wacker Chemie)	Alkylalkoxysiloxane 12.5 % in water	24 h
AK	Akeogard BA (Syremont)	Isobutylamide of perfluoropolyetheric ac. + Perfluoropolyether 50 % in trichlorotrifluoroethane	24 h
TF	Stoneshield (Porei Performance Products SA)	polytetrafluoroethylene in trichloroethane + Fluorinated compound in methylchloroform	24 h
WS	280 (Wacker Chemie)	Oligomeric alkylsiloxane 7.5 % in white spirit	24 h
P	Paraloid B 72 (Rohm & Haas)	Ethyl metacrylate copolymer 3 % in trichloroethane	24 h

3 The experiment

3.1 Treatments

Each product was applied to three sets of samples - Set 1, Set 10, Set 20 - each of which comprised five samples (measuring 5x5x1 cm, prewashed in deionized water). Depending on the tests to which they were to be subjected, these samples were in part treated for capillary absorption (Set 1, Set 20), in part for immersion (Set 10) (NORMAL Commission, 1993). At the end of each treatment the samples were left for two months in environmental conditions.

3.2 Qualification tests

For each of the tests described below (performed both before and after treatment), besides to criticize on the method adopted, indications on the behaviour of each product are also supplied. As there are still no "quality codes" to indicate products on the basis of their performance parameters (colour, hydro-repellence, and so forth), one is obliged to adhere to comparative quality judgments between the different products put to the test.

For a better understanding of the results obtained in each tests, we have also recorded the percentage variation of the

parameters measured both before and after treatment. In practice, the assessment of the degree of protection involves not merely the absolute values of the parameters, but equally the variations induced by the products. The percentage variation, d , is expressed thus:

$$d = \frac{V_{bt} - V_{at}}{V_{bt}} \cdot 100 \quad (1)$$

d = percentage variation of the parameter (%);

V_{bt} = value of the parameter before treatment;

V_{at} = value of the parameter after treatment.

The results laid out in the tables include the average values with the standard deviations, σ , or through semi-dispersion, \pm :

$$\pm = \frac{\text{max. value} - \text{min. value}}{2} \quad (2)$$

3.2.1 Weight variation

Table 2 shows weight changes resulting from treatment, determined by weighing each sample, dried at 60°C, before and after treatment (AA.VV., 1995).

Table 2. Weight variation

Treat.	Set 1	Set 10	Set 20
	ΔM (%)		
WW	-0.075±0.003	-0.502±0.040	-0.039±0.005
AK	0.099±0.011	0.176±0.026	0.143±0.015
TF	0.023±0.001	0.070±0.023	0.016±0.004
WS	0.021±0.008	0.074±0.003	0.047±0.002
P	0.023±0.005	0.047±0.006	0.022±0.002

ΔM - weight increase (%)

For each product we envisaged an equal weight change for Sets 1 and 20, which were all treated for capillarity; however, readings were different, except for the samples treated with Paraloid B 72 (P). It should nonetheless be pointed out that similar anomalies were also observed in the case of experiments carried out by the NORMAL Commission (AA.VV., 1995); these may therefore derive from the application method of the product which needs a little more fine-tuning, taking account also of the environmental conditions in which the experiments are performed.

The product 1311 (WW) showed a surprising drop in weight: Set 10 of the samples, in particular, which were completely immersed in the micro-emulsion, registered the greatest weight loss of all. Collateral tests carried out on other samples of slate and marble confirmed the reductions in samples mass, which were greater than those experienced by the similar samples immersed for the same amount of time in deionized water (the acidity of the microemulsion is around pH=5.5). This proves that the product 1311 reacts chemically with the stone material.

3.2.2 Colour

The colour measurements were taken with a Minolta Chroma Meter CR 200 reflectance colorimeter using two systems for the evaluation:

- the CIELAB 1976 system (NORMAL Commission, 1993), which enables a quantitative assessment of the chromatic variations of the samples induced by treatment. Five measurements were made on each sample (both before and after treatment): from the maximum to the minimum value of the parameters L*, a*, b* a ΔE is calculated, which represents the chromatic dishomogeneity of the sample, before (ΔE_{SBT}) and after treatment (ΔE_{SAT}). The difference ΔE between the average values of the same parameters before and after treatment represents the chromatic variation caused by product;
- the CIE 1931 system, which affords qualitative readings on the chromatic variations (e.g., lightness, saturation).

These results are showed in Tables 3.

Table 3. Colorimetric measurements

Treat.	Before treatment				After treatment				ΔE_{SBT}	ΔE_{SAT}	ΔE
	Y	x	y	S	Y	x	y	S			
WW	8.99	0.3013	0.3085	4	11.46	0.3142	0.3206	2	1.4	3.5	5.6
	$\sigma=0.16$	$\sigma=0.3006$	$\sigma=0.0004$	$\sigma=0$	$\sigma=0.69$	$\sigma=0.0009$	$\sigma=0.0007$	$\sigma=1$	$\sigma=0.4$	$\sigma=1.8$	$\sigma=0.9$
AK	8.54	0.3009	0.3087	4	4.85	0.3077	0.3137	1	1.0	1.0	8.9
	$\sigma=0.37$	$\sigma=0.0006$	$\sigma=0.0006$	$\sigma=0$	$\sigma=0.13$	$\sigma=0.0002$	$\sigma=0.0001$	$\sigma=0$	$\sigma=0.5$	$\sigma=0.5$	$\sigma=0.7$
TF	9.11	0.3014	0.3092	4	6.26	0.3105	0.3150	1	2.4	4.4	10.7
	$\sigma=1.00$	$\sigma=0.0016$	$\sigma=0.0013$	$\sigma=0$	$\sigma=0.50$	$\sigma=0.0045$	$\sigma=0.0004$	$\sigma=0$	$\sigma=1.1$	$\sigma=2.2$	$\sigma=0.8$
WS	11.67	0.2997	0.3085	5	5.89	0.3076	0.3087	1	1.7	1.8	11.8
	$\sigma=0.44$	$\sigma=0.0006$	$\sigma=0.0006$	$\sigma=0$	$\sigma=0.12$	$\sigma=0.0014$	$\sigma=0.0003$	$\sigma=0$	$\sigma=0.5$	$\sigma=0.58$	$\sigma=0.9$
P	9.84	0.3001	0.3083	4	6.64	0.3076	0.3141	1	1.6	2.6	6.9
	$\sigma=0.48$	$\sigma=0.0005$	$\sigma=0.0006$	$\sigma=0$	$\sigma=0.46$	$\sigma=0.0014$	$\sigma=0.0005$	$\sigma=1$	$\sigma=0.3$	$\sigma=0.7$	$\sigma=1.2$

Y - lightness, CIE 1931 System (%)

X, y - chromaticity coordinates, CIE 1931 System

S - saturation, CIE 1931 System (%)

ΔE - total colour difference, CIELAB 1976 System

ΔE_{SBT} - colour difference in sample before treatment, CIELAB 1976 System

ΔE_{SAT} - colour difference in sample after treatment, CIELAB 1976 System

σ - standard deviation

The products Akeogard BA (BA), Stoneshield (TF) and 280 (WS) caused the greatest chromatic alteration.

All the products induce a fall in colour saturation of between 4 % to 1 %. With Akeogard BA, Stoneshield, 280 and Paraloid B 72 (P), considering the Y values (Y=5-6 %) and saturation (S=1), one can affirm that the stone becomes decidedly "black": the untreated material is a dark grey colour.

Only the product 1311 (WW) causes a slight increase in lightness.

The products Stoneshield, 1311 and Paraloid B 72 make chromatic variations in patches on the samples, as can be inferred from the Δ ESAT value; this may be due to an uneven distribution of the products on a smooth, compact surface.

The Δ ESAT value is extremely useful nonetheless in assessing anomalies in the treatment.

3.2.3 Contact angle

The contact angle readings offer a means of assessing the degree of water-repellence on the surface (NORMAL Commission, 1993), and were carried out in accordance with NORMAL guideline 33/89 (NORMAL, 1991 a) using a Lorentzen Wettre Surface Wettability Tester (fitted to a horizontally pivoted table) on the samples of Set 1. The results are shown in Table 4.

Table 4. Contact angle

Treat.	θ	σ
WW	117	6
AK	99	4
TF	128	6
WS	104	4
P	90	5

θ - contact angle (degree)

σ - standard deviation

The product Stoneshield (TF) performed well, and likewise the product 1311 (WW); the product 280 (WS) was acceptable. Akeogard BA (BA) provided a lower degree of water-proofing to the material's surface; Paraloid B 72 (P) gave a contact angle that was at the limit of water-repellence.

As far as the product 280 is concerned, it afforded a lower water-repellence level than it does with other lithotypes (Alessandrini et al., a; Alessandrini et al., b; Alessandrini et al., c). Furthermore, additional tests carried out on Set 20, which had already been tested for water absorption (see 3.2.5), offered levels ranging from 120° to 130°. It is assumed that the low values recorded for Set 1 are due to the fact that the readings were taken before the product was completely polymerised. Similar behaviour of the siliconic products in their water absorption performance were also noted in the course of the NORMAL Commission tests (AA.VV., 1995). This confirms the observation in 3.2.1 above concerning the need to perfect the operative methods for treatment, particularly as regards the laboratory environment, and indications of the time that must elapse before evaluation tests.

3.2.4 Protection ratio

Each of the samples was tested for capillary water absorption after one hour. This reading makes it possible to calculate the protection ratio (NORMAL Commission, 1993; AA.VV., 1995):

$$RP = \frac{QBT - QAT}{QBT} \cdot 100 \quad (3)$$

RP = protection ratio (%);

QBT = absorbed water before treatment (mg/cm²);

QAT = absorbed water after treatment (mg/cm²).

The test for water absorption over a fixed period allows to determine the characteristics of each sample before treatment, and after treatment (as with the variation in weight) to assess of the effectiveness of the treatment carried out. The evaluation of protection ratio, however, is a valid means of assessing the effectiveness of a given protective treatment.

The results are shown in Table 5.

Table 5. Water absorption by capillarity after one hour and protection ratio

Treat.	Series 1			Series 10			Series 20		
	QBT	QAT	RP	QBT	QAT	RP	QBT	QAT	RP
WW	1.12±0.11	0.89±0.06	20±12	1.40±0.24	0.81±0.08	41±13	1.19±0.06	0.82±0.13	30±12
AK	1.28±0.06	0.41±0.07	68± 5	1.74±0.21	0.25±0.04	86± 2	1.28±0.08	0.09±0.10	93± 8
TF	1.14±0.15	0.49±0.07	55± 3	1.50±0.16	0.35±0.08	79± 6	1.36±0.10	0.44±0.05	66± 6
WS	1.37±0.48	0.38±0.09	71± 7	1.77±0.08	0.32±0.06	82± 4	1.44±0.06	0.27±0.04	81± 2
P	1.33±0.08	0.54±0.09	60± 3	1.42±0.10	0.76±0.06	46± 5	1.20±0.17	0.65±0.08	46±10

QBT - absorbed water before treatment (mg/cm²)

QAT - absorbed water after treatment (mg/cm²)

RP - protection ratio (%)

The products Akeogard BA (BA) and 280 (WS) gave excellent results; Stoneshield's (TF) performance was fair, though less effective; the products Paraloid B 72 (P) and 1311 (WW) yielded the poorest results. Besides, it should be noted that differences in effectiveness from set to set were observed for the various products, particularly with Akeogard BA. In the latter's case, the differences between Set 1 and Set 20 - both of which were treated for capillarity - can be explained by the relative weight variations: the small quantities of water absorbed by Set 20 probably depends on an excess of the product on the sample's surface, which tends to impede the penetration of water. This may also explain the lack of correspondence between the contact angle readings: Akeogard BA is only moderately effective as a water-repellent. Similarly, for 1311 and Stoneshield there is no correspondence with the contact angle values: from this, one may infer that their effectiveness as waterproofing lasts only for a short time of contact between water and stone (the contact angle is measured after 15 minutes from the application of the water droplets); after one hour, it

seems that the products cease to provide an effective water repellence and hence permit the absorption of water.

The good performance ratings of the product 280 are in accordance with the contact angle readings carried out on Set 20 of the samples (see 3.2.3).

3.2.5 Water absorption by capillarity

The test was carried out in accordance with NORMAL Commission guideline 11/85 (NORMAL, 1986 a; NORMAL Commission, 1993) on samples in Set 20, which were weighed after 10', 20', 30', 1h, 4h, 24h, 48h, 72h and 96h. The results are shown in Table 6 and Fig. 1.

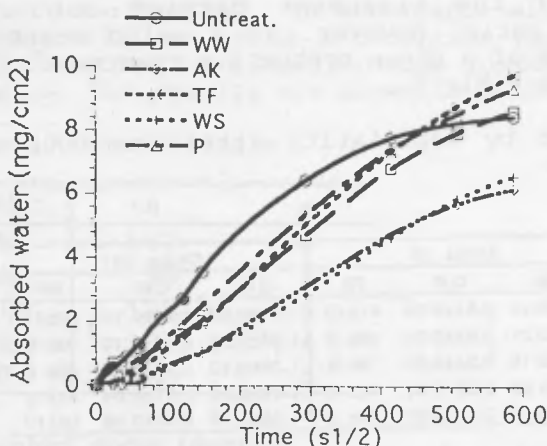

Fig. 1. Water absorption by capillarity: absorbed water vs. time

Table 6. Water absorption by capillarity

Treat.	Q ₁₀		d ₁₀	Q ₉₆		d ₉₆
	before treat.	after treat.		before treat.	after treat.	
WW	0.50±0.06	0.71±0.17	-39±34	8.09±0.76	8.44±0.43	- 5±11
AK	0.51±0.04	0.03±0.03	94±12	7.93±0.60	6.16±0.34	22± 3
TF	0.53±0.06	0.11±0.02	79± 4	8.96±1.23	9.74±0.62	9± 8
WS	0.62±0.05	0.10±0.02	84± 2	8.88±0.52	6.55±0.45	26± 1
P	0.48±0.07	0.12±0.02	77±17	8.31±1.22	9.35±0.36	13±20

Q₁₀ - absorbed water after 10' (mg/cm²)

d₁₀ - percentage variation of Q₁₀ (%)

Q₉₆ - absorbed water after 96h (mg/cm²)

d₉₆ - percentage variation of Q₉₆ (%)

During the first hour of absorption, the product Akeogard BA (BA) performed particularly well; similarly, Stoneshield (TF), 280 (WS) and Paraloid B 72 (P) gave very good results. The absorption rates of samples treated with the product 1311 (WW) were similar to untreated material. By extending the water

absorption time the products' behaviour showed a variation, at least in part: Akeogard BA and 280 performed best; the performance of the product 1311 was similar to that of Stoneshield, as both reduced the slate's characteristic absorption to a small degree. Paraloid B 72, however, gave poor results, as if the product had not been applied.

From the results listed in Table 6 and Fig. 1, one can make certain inferences. In the first hour, Akeogard BA inhibited absorption (see 3.2.4 above); after the first hour, however, the product allowed the greatest absorption, perhaps because the product is forced to the interior of the material, and partly because a certain amount of the product (perhaps the excess) is mechanically removed during the test itself. Initially, Stoneshield inhibits water absorption owing to its high repellence (Table 4), though as the test proceeds it allows for greater absorption (see 3.2.4). Initially, Paraloid B 72 inhibits absorption owing to the film of the product on the surface; but with extended contact the water passes through this film and penetrates the stone.

The test therefore provides an excellent demonstration of the behaviour of the individual products in terms of their relative water-absorption.

3.2.6 Water absorption by total immersion

The test was carried out in accordance with NORMAL Commission guideline 7/81 (NORMAL, 1981; NORMAL Commission, 1993) on the samples from Set 10; weight measurements were taken after 10', 30', 1h, 4h, 24h and 48h. The results are shown in Table 7 and Fig. 2.

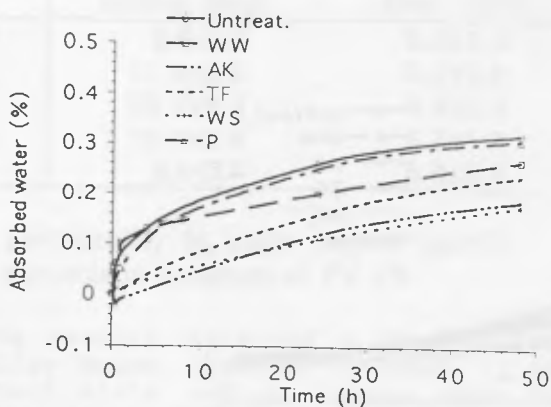

Fig. 2. Water absorption by total immersion: absorbed water vs. time

The product 280 (WS) offered the best performance; other products that performed well were Stoneshield (TF) and Akeogard BA (BA). For this last product, the notable diversity between the absorption curve and CI values is explained by the fact that the product tends to come away during the test itself; this also explains why, during the first few minutes, the curve values are

negative. Calculated by means of the initial weight of the samples, the curve values are lower than their real values; while the CI values, calculated by means of the final dry weight, represent the effective quota of water absorbed. The product 1311 (WW) did not perform well, and the effects of Paraloid B 72 (P) were nil.

Table 7. Water absorption by total immersion

Treat.	CI		d
	before treat.	after treat.	
VW	0.32±0.03	0.26±0.02	20±3
AK	0.33±0.03	0.24±0.03	29±4
TF	0.36±0.01	0.23±0.03	37±6
WS	0.35±0.01	0.18±0.02	48±6
P	0.33±0.01	0.29±0.02	13±4

CI - water absorption (%)

d - percentage variation of CI (%)

3.2.7 Evaporation

The test was carried out in accordance with NORMAL Commission guideline 29/88 (NORMAL, 1991 b; NORMAL Commission, 1993) immediately following the total immersion absorption test, on the same samples; weight readings were taken after 10', 15', 30', 1h, 3h, 6h, 24h and 48h. The results are shown in Table 8 and Fig. 3.

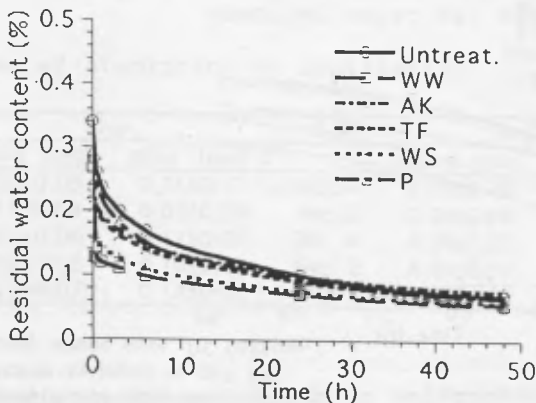

Fig. 3. Evaporation: residual water content vs. time

The product Paraloid B 72 (P) showed no alteration to the evaporation capacity of the slate samples. Similarly, 1311 (WW) offered little variation to the evaporation rates. From the rate of the curve one can infer, nonetheless, that initially the

material's surface dries rapidly, subsequently the small amount of water absorbed is released gradually. Akeogard BA (BA), Stoneshield (TF) and the product 280 (WS) reduced the capacity of evaporation.

Table 8. Evaporation

Treat.	IA		d
	before treat.	after treat.	
WW	0.34±0.04	0.30±0.01	11±9
AK	0.35±0.01	0.47±0.02	-37±8
TF	0.34±0.01	0.45±0.03	-34±8
WS	0.36±0.01	0.46±0.02	-28±6
P	0.35±0.02	0.37±0.02	- 7±2

IA - drying index

d - percentage variation of IA (%)

3.2.8 Permeability to water vapour

The test was carried out in accordance with NORMAL Commission guideline 21/85 (NORMAL, 1986 b; NORMAL Commission, 1993) on the samples from Set 1. The results are shown in Table 9.

Table 9. Permeability to water vapour

Treat.	PV		d
	before treat.	after treat.	
WW	8.6±0.9	6.3±1.5	26±26
AK	11.4±3.2	5.2±1.2	55± 7
TF	10.5±2.9	5.8±2.0	45±11
WS	10.8±2.6	6.2±1.9	39±30
P	9.4±0.4	8.8±0,5	7± 3

PV - permeability to water vapour (g/m²)

d - percentage variation of PV (%)

The product Paraloid B 72 (P) proved to be perfectly permeable; hence, the film of resin is permeable to water both in liquid state and as vapour (see 3.2.5 and 3.2.6). The products 1311 (WW) and 280 (WS) reduce the material's permeability to water vapour in different degrees according to the samples; Akeogard BA (BA) and Stoneshield (TF) impair the material's permeability considerably.

3.2.9 UV radiation weathering

The test was carried out in a Mazzali Umidotest climatic chamber lit by two 125 W Philips HPK lamps; the samples of Set 1, together with five untreated samples, were laid on a flat surface 25 cm from the axis of the lamps in a zone illuminated

by 10,000 lux. The test lasted 144 hours at T=35°C and RH=40 %. The effects of radiation were recorded through repeated colorimetric and contact angle readings.

This test of weathering, like the subsequent one (see 3.2.10 below), has not yet been ratified by the NORMAL Commission; consequently, this current set of tests could therefore serve as a possible proposal for the Commission. The results are shown in Tables 10 and 11.

Table 10. UV radiation weathering: colorimetric measurements

Treat.	ΔE_{BUV}	ΔE_{AUV}	ΔE
Untreat.	1.7±0.8	1.6±0.1	0.3±0.1
WW	3.5±1.8	2.9±1.9	2.2±0.6
AK	1.0±0.5	1.3±0.7	3.1±0.5
TF	4.4±2.2	2.0±1.2	6.2±0.8
WS	2.8±0.9	1.4±0.5	1.9±0.6
P	2.6±0.7	1.2±0.3	5.2±1.1

ΔE_{BUV} - colour difference in sample before UV radiation

ΔE_{AUV} - colour difference in sample after UV radiation

ΔE - total colour difference

Table 11. UV radiation weathering: contact angle

Treat.	θ	σ	θ	σ
	before UV		after UV	
WW	117	6	87	10
AK	99	4	95	7
TF	128	6	42	6
WS	104	4	83	7
P	90	5	45	10

θ - contact angle (degree)

σ - standard deviation

The UV radiation has little effect on the samples' colour, apart from a slight reduction of the chromatic unevenness (as can be inferred from the ΔE_{SAUV} readings in Table 10). Except for Akeogard BA (BA), all the products tested showed an impairment in water-repellence (Table 11). After radiation, the products 1311 (WW) and 280 (WS) continued to afford some albeit minimal protection to the slate. Stoneshield (TF) and Paraloid B 72 (P), however, were so damaged that the contact angle were lower (42-45°) than untreated slate (around 60°). The radiation has therefore induced a drastic alteration of the products, which lose their protective capability.

3.2.10 Acid fog weathering

The test was carried out in a Weiss salt-fog chamber, in which the samples of Set 10, together with five untreated one, were subjected to an acid fog of H₂SO₄ 0.1 N added with NaCl 0.2 N. The salt was added in consideration of the sea environment that prevails in Liguria. Cyclic tests were carried out as follows:

- 2 hours of exposure to acid fog, T=35°;
- 1½ hours of exposure to an IR lamp, T=50°;
- 17 hours in environmental conditions.

The cycles were repeated twice each day. A total of 30 cycles were carried out overall. To evaluate the effects of weathering, readings of sample weight variations were taken, together with colorimetric and capillary water absorption at fixed period readings. The results are shown in Tables 12, 13 and in Fig. 4, except for the weight values, which were negligible.

Table 12. Acid fog weathering: colorimetric measurements

Treat.	Before acid fog				After acid fog				ΔESBA	ΔESAA	ΔE
	Y	x	y	S	Y	x	y	S			
Untr.	9.36 σ=0.51	0.3005 σ=0.0005	0.3087 σ=0.0005	4 σ=1	15.78 σ=0.31	0.3150 σ=0.0009	0.3235 σ=0.0010	3 σ=0	1.7 σ=0.8	1.5 σ=0.7	10.6 σ=0.8
WW	11.38 σ=1.18	0.3140 σ=0.0019	0.3203 σ=0.0015	1 σ=1	15.27 σ=0.51	0.3176 σ=0.0011	0.3248 σ=0.0011	4 σ=1	3.5 σ=1.8	4.2 σ=1.8	5.8 σ=1.6
AK	4.85 σ=0.13	0.3007 σ=0.0002	0.3137 σ=0.0001	1 σ=0	16.25 σ=0.41	0.3146 σ=0.0011	0.3232 σ=0.0011	3 σ=1	1.0 σ=0.5	1.4 σ=0.6	21.1 σ=0.3
TF	6.26 σ=0.50	0.3105 σ=0.0045	0.3150 σ=0.0004	1 σ=0	12.85 σ=3.79	0.3142 σ=0.0036	0.3219 σ=0.0042	3 σ=1	4.4 σ=2.2	3.8 σ=2.1	12.1 σ=6.3
WS	5.33 σ=0.36	0.3078 σ=0.0038	0.3142 σ=0.0032	1 σ=1	14.19 σ=0.36	0.3152 σ=0.0010	0.3235 σ=0.0009	3 σ=1	2.8 σ=0.9	1.8 σ=1.0	17.1 σ=0.9
P	6.73 σ=0.67	0.3075 σ=0.0013	0.3140 σ=0.0009	1 σ=0	14.77 σ=0.15	0.03195 σ=0.0010	0.3270 σ=0.0009	5 σ=1	2.6 σ=0.7	4.0 σ=2.2	14.3 σ=1.0

- Y - lightness, CIE 1931 System (%)
- x, y - chromaticity coordinates, CIE 1931 System
- S - saturation, CIE 1931 System (%)
- ΔE - total colour difference, CIELAB 1976 System
- ΔESBA - colour difference in sample before acid fog, CIELAB 1976 System
- ΔESAA - colour difference in sample after acid fog, CIELAB 1976 System
- σ - standard deviation

The colorimetric readings in Table 12 show that all the samples tested underwent considerable variations - the least with product 1311 (WW) and the most with Akeogard BA (BA). In all samples, untreated and treated, this chromatic variation consists in a lightening of hue, while in treated samples also in an increase in saturation which returns to the original values for untreated slate. In all cases, furthermore, the main wavelength had altered: the original wavelength was 480 nm, and after the acid weathering it changed to 570 nm.

From the readings for water absorption in Table 13 and Fig. 4, it can be seen that the products 1311 and 280 (WS) resist well. The performance of Stoneshield (TF) was inferior, albeit acceptable. Akeogard BA (BA) and Paraloid B 72 (P) provided no resistance to acid attack. After 30 cycles the water absorption rate of samples treated with Paraloid B 72 was greater than that recorded before treatment, indicating that the stone material itself had also been attacked.

Table 13. Acid fog weathering: water absorption by capillarity after one hour

Treat.	0 cycles	10 cycles	20 cycles	30 cycles
	Q			
Untreat.	1.07±0.10	1.49±0.11	1.64±0.19	1.93±0.06
WW	0.81±0.08	0.54±0.10	0.57±0.13	0.56±0.05
AK	0.25±0.04	0.90±0.05	1.11±0.06	1.31±0.04
TF	0.35±0.08	0.69±0.21	0.92±0.30	0.91±0.23
WS	0.32±0.06	0.70±0.15	0.72±0.08	0.76±0.15
P	0.76±0.06	1.32±0.05	1.55±0.09	1.76±0.07

Q - absorbed water (mg/cm²)

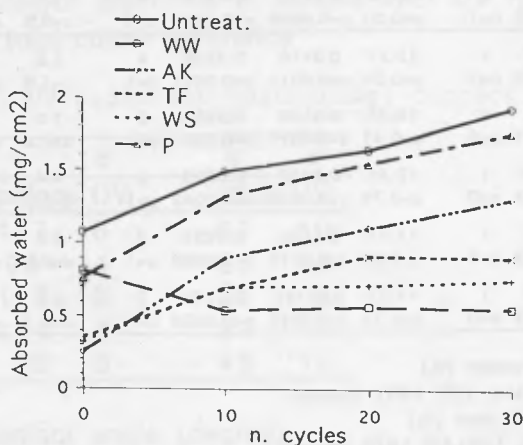

Fig 4. Acid fog weathering: absorbed water vs. cycles

3. Conclusions

The main purpose of the task in hand was to apply and re-verify the method proposed by the NORMAL Commission on a specific and previously untested lithotype (in this case slate). In this way it could be verified if the recommended method was in fact suitable for choosing the available one among the tested products.

The objective of the lab tests was reached and in fact the results confirm the following:

- a) the method adopted is appropriate for choosing a product to be applied to Ligurian slate; the tests clearly showed up the various behavioural characteristics of each product;
- b) the significance of the parameters chosen in advance for an effective protection make it possible to identify the most appropriate product;
- c) the significance of the individual methods of analysis recommended by the NORMAL Commission;
- d) the impossibility as yet, of defining the "ideal" product. The market actually offers products that belong to different chemical classes, and do not fully address all the requisites of a supposedly ideal product (water-repellence, good permeability to water vapour, chemical stability, etc.) (NORMAL, 1985). This means that the choice must be "mediated" from among the results of the individual performance characteristics and, given the lack of a specific quality code, the final choice will be based on comparisons among the performance characteristics of the range of product. Hence, regarding the slate, from the point of view of water-repellence the most effective product was Stoneshield; however, if the requisite is to reduce the overall absorption of water, the more suitable products are 280 and Akeogard BA. If, on the other hand, the product must guarantee greater permeability to water vapour in order to allow the stone to dry out, the recommended products are 1311 and Paraloid B 72; the product 280 - and particularly Akeogard BA - showed a marked resistance to ultraviolet radiation compared to the other products tested. Whereas in the acid tests, the products that came out best were 280 and 1311, followed closely by Stoneshield; Akeogard BA posed insufficient resistance;
- e) given the points indicated in d) above, the final assessment remains somewhat subjective, and is closely tied to the researchers specific experience. In the case examined here, evaluating the incidence of each parameter measured, the products that satisfactorily address the requirements for slate are 280 and Akeogard BA, though their opposite resistance to UV radiation and acid attack must not be overlooked. The product Paraloid B 72 is undoubtedly insufficient on any account;
- f) the experiments carried out in this research project, moreover, show up the possible "weak points" of the NORMAL method, points that are crucial to the viability of the analytical results obtained from the various behavioural tests: the method of application of the protective product on the chosen stone (not forgetting the environmental conditions) and the time lapse between treatment and the start of the evaluation tests.

4. References

- A.A.V.V. (1995): Methodology for the evaluation of protective products for stone materials-Part II: Experimental tests on treated samples, in this volume.
- Alessandrini, G., Fantasma, F., Peruzzi, R. (in press a): Noto calcarenite (SR): protective treatments and the evaluation of their effectiveness.
- Alessandrini, G., Peruzzi, R., et al. (in press b): Trattamenti conservativi su marmo di Candoglia.
- Alessandrini, G., Peruzzi, R., et al. (in press c): Trattamenti conservativi su Nero di Saltrio.
- Commissione NORMAL Sottogruppo Sperimentazione Protettivi (1993): Metodologia per la valutazione di prodotti impiegati come protettivi per materiale lapideo: parte I-Tests e trattamento dei campioni. *L'Edilizia*, Novembre, 57-71.
- Conte, G. (1967): L'ardesia ligure nell'architettura, *Vitali e Ghinada*, Genova.
- Fratini, F., Manganelli Del Fà, C., Scala, A. (1988): Alterazione e conservazione dell'ardesia. *Arkos*, 2, 14-23.
- Raccomandazione NORMAL 7/81 (1981): Assorbimento d'acqua per immersione totale-Capacità di imbibizione, *CNR-ICR*, Roma.
- Raccomandazione NORMAL 20/85 (1985): Interventi conservativi, progettazione, esecuzione e valutazione preventiva, *CNR-ICR*, Roma.
- Raccomandazione NORMAL 11/85 (1986 a): Assorbimento d'acqua per capillarità-Coefficiente di assorbimento capillare, *CNR-ICR*, Roma.
- Raccomandazione NORMAL 21/85 (1986 b): Permeabilità al vapor acqueo, *CNR-ICR*, Roma.
- Raccomandazione NORMAL 33/89 (1991 a): Misura dell'angolo di contatto, *CNR-ICR*, Roma.
- Raccomandazione NORMAL 29/88 (1991 b): Misura dell'indice di asciugamento (drying index), *CNR-ICR*, Roma.

METHODOLOGY FOR THE EVALUATION OF PROTECTIVE PRODUCTS FOR STONE MATERIALS. PART II: EXPERIMENTAL TESTS ON TREATED SAMPLES

L. APPOLONIA, V. FASSINA, U. MATTEOLI, A.M. MECCHI, M.P. NUGARI, D. PINNA, R. PERUZZI, O. SALVADORI, U. SANTAMARIA, A. SCALA AND P. TIANO

NORMAL Commission - "Protectives Experimentation Subgroup"

Abstract

The "Protectives Experimentation Subgroup" of the NORMAL Commission has been concerned, since 1985, in the elaboration of a methodology for the correct evaluation of the effectiveness of protectives used for stone conservation. The research was carried out at the same time by seven laboratories and results were compared. Three lithotypes with different porosity, composition and structure were chosen: Marble, Sandstone and Biocalcarene. The methodology, previously pointed out, also allows to test the behaviour of samples treated with polymeric products selected from those usually used for stone conservation: organic derivatives of silicon and organic fluorinated compounds. The results confirm the excellence of the methods employed and underline the influence of environmental parameters (T and RH%), especially during the treatment of the samples.

Keywords: Methodology, Protectives, Alkylsiloxane, Fluorinated, Stone, Works of Art

1 Introduction

A good conservation of the stone cultural heritage is very often due to the correct performance of various interventions in order to eliminate or reduce damages present on the works of art, owing to many different causes. The protection of stone is very important both for prevention on monuments in a good state of conservation and as last

step during the restoration of more damaged works of art. In fact, the use of appropriate water repellent products can slow down the alteration processes and chemical, physical and mechanical damages caused by water movements. Only rarely these products have been conceived for building trade and even in fewer cases their characteristics account for the specificity required by monuments; thus they need appropriate experimentation before use. Since many different tests, each one performed with various methodologies, have been employed up to now to evaluate the protectives used in the field of conservation, the results obtained cannot be compared. Some years ago in Italy, the NORMAL Commission was created with the aim of establishing common methods for the study of stone deterioration and for the control of efficiency of conservative treatments for buildings of historic and artistic interest (Alessandrini and Pasetti, 1991). The "Protectives Experimentation Subgroup", operating inside the NORMAL Commission, has carried out for some years many experiments to find a methodology useful to verify the reliability of the chosen tests and to elaborate scientific criteria for the evaluation of protectives for stone.

The first part of the above mentioned methodology was discussed in a previous paper (AA. VV., 1993); reported there is the criteria for the choice of: i) the necessary parameters for a correct evaluation of protectives; ii) the methods for the determination of these parameters; iii) the different protectives to be used. The experimentation was performed in the same way and time by seven Italian laboratories on untreated samples of three different lithotypes.

In the present paper are described the results of the tests carried out by the same laboratories on samples treated with the chosen protectives.

2 Materials and methods

Laboratories and researchers who carried out the experimentation are listed below:

- A) Laboratorio Prove sui Materiali dell'Istituto Centrale del Restauro, Roma (U. Santamaria) e dell'IsCOM, Lecce (BA) (A.M. Mecchi);
- B) Centro CNR sulle Cause di Deperimento e Metodi di Conservazione delle Opere d'Arte, Milano (R. Peruzzi);
- C) Centro CNR sulle Cause di Deperimento e Metodi di Conservazione delle Opere d'Arte, Firenze (A. Scala, P. Tiano);
- D) Laboratorio Indagini Biologiche dell'Istituto Centrale del Restauro, Roma (M.P. Nugari) e della Soprintendenza per i Beni AA.SS., Venezia (O. Salvadori);
- E) Centro "C. Gnudi" della Soprintendenza per i Beni AA.SS., Bologna (D. Pinna);
- F) Laboratorio di Analisi, Soprintendenza per i Beni CC.AA., Aosta (L. Appolonia, D. Vaudan);
- G) Laboratorio Scientifico, Soprintendenza per i Beni AA.SS., Venezia (V. Fassina).

2.1 Lithotypes

Marble - Dolomitic Marble from Yugoslav Macedonia with a dolomite content over 99%. Total porosity varies from 1.5 to 2.5% and saturation index from 60 to 80%.

Sandstone - A marly-arenaceous stone from Firenzuola (FI) classified as feldspathic greywacke with partially carbonatic and clayey matrix composed by quartz, feldspars, micas and clasts of eruptive and metamorphic rocks. Total porosity varies from 3.5 to 6.0% and saturation index from 60 to 80%.

Biocalcarenite - Biocalcarenite (Lecce Stone) composed by Foraminifera with calcareous shell, glauconite grains and very little fragments of quartz. The clasts are bound by a micritic calcitic cement, with a low clay content. Total porosity varies from 30 to 40% and saturation index from 80 to 90%.

2.2 Protectives

According to the indications of manufactures and after preliminary tests, the products listed below were applied on samples at different concentrations using solvents with a high degree of purity:

- 1) **Rhodorsil 224** (Rhône Poulenc Italia S.p.A.) - Polymethylsiloxane applied using white spirit as solvent (6.9% in weight). This treatment has been carried out in all laboratories;
- 2) **Dri Film DF 104** (General Electric Company) - Polymethylsiloxane applied at different concentrations (11.5% in weight on Marble and Biocalcarenite and 15.0% in weight on Sandstone). A, B and C laboratories used 1,1,1-trichloroethane as solvent, while E, F and G used white spirit. This treatment has been carried out in all laboratories except D;
- 3) **Fomblin YR** (Ausimont S.p.A.) - Neutral perfluoropolyether applied using trichlorotrifluoroethane as solvent (50% in weight), traded by Syremont as Akeogard PF. This treatment has been carried out in all laboratories except D;
- 4) **Fomblin S12** (Ausimont S.p.A.) - Mixture of isobutylamide of a perfluoropolyetheric acid (40%) and of neutral perfluoropolyether (60%) applied using trichlorotrifluoroethane as solvent (50% in weight) and traded by Syremont as Akeogard BA. This treatment has been carried out in all laboratories;
- 5) **Tegosivin HL 100** (Tego Italiana S.r.l.) - Polyalkylsiloxane applied using white spirit as solvent (7.5% in weight). This treatment has been carried out in all laboratories except C and E;
- 6) **290 L** (Wacker Chemie BHS Italia S.p.A.) - Alkylsiloxane prepolymer applied using white spirit as solvent (7.5% in weight). This treatment has been carried out in all laboratories except A, B, D and E.

2.3 Treatment

Five samples (5x5x2 cm) were used for each lithotype and each product. They were conditioned for 24 hours at 25 °C and 50% RH. The adopted methodology, reported in a previous paper (AA. VV., 1993), is here summarised: on a multi-layer filter paper of 1 cm thickness (Whatman n° 4), soaked up almost to its top of protective, the samples were laid touching with the face on which the parameters had been measured before treatment. After the chosen time (Tab. 1), samples were turned, placed again on the bed and completely covered for 5' with the protective product up to 1 cm over the samples surface. The samples were then dried still in this upside down position on small glass balls for 30 days in the laboratories.

Table 1. Time of treatment by capillary absorption with various protective products

Product	Time (hours)		
	Marble	Sandstone	Biocalcarenite
RP 224	48	24	1
DF 104	6	4	4
YR	6	8	8
S12	4	6	6
HL 100	24	6	1
290 L	6	6	1

2.4 Tests

2.4.1 Amount of protective product

The amount of protective product absorbed by the samples was determined calculating the difference between dry weights before and after treatment. The weighings were made 1 month after the application of the product and repeated roughly 1 year later, after the various tests.

2.4.2 Amount of water absorbed by capillarity versus time

The determination of the amount of water absorbed in time was carried out with the method described in the NORMAL Document 11/85 (AA. VV., 1986). In the case of treated Marble samples, the test was repeated approximately 2 years later, protracting the time of the experiment for 96 hours.

2.4.3 Amount of water absorbed by capillarity after a determinate time t. Protection Degree ($E_c\%$)

Measures were carried out as described in paragraph 2.4.2, weighing the samples once after:

- 60' for Marble and Sandstone;

- 20' for Biocalcarenite.

Capillarity Protection Degree ($E_c\%$) is defined as ratio percent between the difference of the amount of water absorbed by capillarity at time t by a sample before (A_1) and after (A_2) treatment and the amount of water absorbed at the same time before (A_1) treatment:

$$E_c\% = (A_1 - A_2 / A_1) \cdot 100$$

2.4.4 Amount of water absorbed at low pressure after a determinate time t .

Protection Degree ($E_p\%$)

The amount of water absorbed at low pressure, determined as previously reported (AA. VV., 1993), is defined as Absorption Degree (AD) and expressed in $\mu\text{l}/\text{cm}^2$. The time set for the measurement is:

- 30' for Marble and Sandstone;
- 20' for Biocalcarenite.

Protection Degree at low pressure ($E_p\%$) is defined as ratio percent between the difference of the Absorption Degree at time t by a sample before (AD_1) and after (AD_2) treatment and that at the same time before (AD_1) treatment:

$$E_p\% = (AD_1 - AD_2 / AD_1) \cdot 100$$

3 Results and discussion

3.1 Amount of protective product

The average amount of protective product absorbed by the samples in various laboratories is reported in Table 2.

The weight of the product absorbed generally tends to diminish in time both because of the slow evaporation of the solvent and, in the case of silicon-based products, because of their progressive polymerisation. This behaviour is stressed for treated Sandstone samples which present, with RP 224 and HL 100, losses of weight reaching 50% after 1 year. This phenomenon can probably be caused both by high clayey content, typical of this stone, and by scarce interconnection between the pores which prevent a rapid escape of the solvent, slowing down the evaporation. This seems confirmed by results obtained with DF 104 (Tab. 2): the greater volatility of 1,1,1-trichloroethane (used by laboratories A, B and C) compared to that of white spirit (used by laboratories E, F and G) allows a quicker stabilisation of weights and, consequently, a more reliable measurement of the amount of protective absorbed by the samples. With Marble, the loss of weight is lower owing to the smaller amount of product and solvent absorbed

and the capillary structure of the pores which allows a quicker evaporation of the solvent.

Table 2. Amount of protective product* determined in the various laboratories after (1) and (12) months from the treatment

Laboratory	Marble											
	RP 224		DF 104		YR		S12		HL 100		290 L	
	(1)	(12)	(1)	(12)	(1)	(12)	(1)	(12)	(1)	(12)	(1)	(12)
A	0.010	0.010	0.050	0.040	0.24	0.20	0.25	0.23	0.020	0.019	-	-
B	0.013	0.008	0.057	0.053	0.29	0.22	0.28	0.24	0.014	0.009	-	-
C	0.019	0.019	0.070	0.063	0.25	0.22	0.27	0.24	-	-	0.016	0.013
D	0.013	0.009	-	-	-	-	0.25	0.22	0.030	0.026	-	-
E	-	0.019	-	0.038	0.25	0.24	0.24	0.23	-	-	0.023	0.023
F	0.040	0.036	0.063	0.063	0.25	0.24	0.23	0.22	0.023	0.016	-	-
G	0.025	0.019	0.039	0.034	0.24	0.22	0.24	0.22	0.029	0.024	0.027	0.018

Laboratory	Sandstone											
	RP 224		DF 104		YR		S12		HL 100		290 L	
	(1)	(12)	(1)	(12)	(1)	(12)	(1)	(12)	(1)	(12)	(1)	(12)
A	0.13	0.08	0.11	0.12	1.06	0.87	0.87	0.66	0.24	0.11	-	-
B	0.11	0.06	-	0.16	0.73	0.70	0.70	0.64	0.15	0.07	-	-
C	0.16	0.10	0.16	0.15	0.81	0.80	0.65	0.65	-	-	0.09	0.08
D	0.07	0.06	-	-	-	-	0.46	0.46	0.15	0.14	-	-
E	0.11	0.04	0.25	0.17	0.78	0.73	0.73	0.67	-	-	0.13	0.07
F	0.20	0.09	0.29	0.25	0.82	0.82	0.68	0.74	0.16	0.10	-	-
G	0.11	0.08	0.21	0.16	0.48	0.49	0.57	0.57	0.20	0.10	0.15	0.09

Laboratory	Biocalcarenite											
	RP 224		DF 104		YR		S12		HL 100		290 L	
	(1)	(12)	(1)	(12)	(1)	(12)	(1)	(12)	(1)	(12)	(1)	(12)
A	0.57	0.40	1.50	1.50	12.4	12.1	12.7	12.2	0.73	0.72	-	-
B	0.60	0.54	2.30	2.20	11.8	11.7	7.0	6.8	0.75	0.67	-	-
C	0.62	0.57	2.10	2.15	12.7	12.0	10.9	10.6	-	-	0.46	0.43
D	0.52	0.53	-	-	-	-	10.7	10.5	0.87	0.87	-	-
E	0.40	0.34	1.20	1.13	10.8	10.7	10.3	10.1	-	-	0.78	0.74
F	0.93	0.90	4.63	4.30	6.40	6.40	9.8	9.6	0.83	0.83	-	-
G	0.67	0.59	1.05	0.99	9.03	9.03	6.8	6.6	0.87	0.82	0.62	0.59

* g of protective absorbed for 100 g of stone sample

In the case of Biocalcarenite the solvent evaporates very rapidly due to the high porosity of this lithotype and the product weights are stabilised in a short time (1 month), except for RP 224 which, even after long times, still shows moderate differences of weight, probably caused by its slower rate of polymerisation.

The high variability of the amount of protective product absorbed, by samples of the same lithotype in the various laboratories, is pointed out by the lastingness of high weight differences once having evaporated all the solvent (i.e. at constant weight) (Tab. 2). This highlights that the influence of environmental parameters (T and RH%) is particularly important during treatment. Differences in relative humidity of the environment and consequently of the sample seem to influence highly both the

absorption kinetic of protective product and its polymerisation rate. High differences in temperature can instead cause, before product application, partial evaporation of the solvent and, consequently, greater concentration of the product and smaller absorption of protective by capillarity.

In order to assess the influence of the environmental parameters during treatment, a new experimentation was carried out. Samples were chosen among many others for their homogeneity determined by repeated preliminary tests of capillarity. To evaluate the new methodology of treatment, three Marble samples (5x5x2 cm) were treated in each laboratory. This lithotype was chosen since it showed the greatest weights variability and the smallest amount of protective absorbed, so both the above mentioned influence of temperature and relative humidity and the experimental errors had to be considered as important. Among the six protective products listed in paragraph 2.2, RP 224 and S12 were chosen because representative of each of the two classes of compounds employed (alkylsiloxane and fluorinated) and because used for treatment in all laboratories.

Marble samples were then treated following this method:

- a) the samples were conditioned in a drier containing a solution saturated with $\text{Mg}(\text{NO}_3)_2$ (52% RH at 20 °C); the drier was then placed in a thermostatic chamber at 20 °C for 24 hours with the tap turned off;
- b) 400 ml of RP 224 (6.9% in white spirit) were slowly poured into a crystallisation vessel (22 cm diameter) containing 50 sheets of filter paper (Wathman n° 4, 18.5 cm diameter);
- c) 400 ml of S12 (50% in trichlorotrifluoroethane) were slowly poured into a crystallisation vessel identical to the previous one;
- d) the two crystallisation vessels, containing the filter paper imbibed with the protectives, were kept for 30' at 20 °C;
- e) the samples, conditioned as described in a), were transferred from the drier to the crystallisation vessels containing the products and laid on the filter paper imbibed with the protective;
- f) the crystallisation vessels were then placed into two driers containing a solution saturated with $\text{Mg}(\text{NO}_3)_2$ (52% RH);
- g) the driers were left in a thermostatic chamber at 20 °C during the absorption by capillarity of the protective (4 h for S12 and 48 h for RP 224);
- h) after these time intervals, the samples were dried, in a upside-down position, on small glass balls in two crystallisation vessels kept in laboratory. The one containing samples treated with S12 was left at room temperature recording the thermohygrometric changes of the laboratory; the other containing samples treated with RP 224 was left in a drier with the tap open and containing a solution saturated with NH_4Cl (79.5% RH at 20 °C) (checking the saturated solution from time to time);
- i) after two weeks of conditioning at 80% RH, the wet weight of samples treated with RP 224 was checked, repeating the operation after two other weeks of permanence in the drier;

- l) the wet weight of samples treated with S12 was on the contrary checked weekly for 4 weeks;
- m) after 4 months from the treatment, the dry weight of samples was calculated to determine the effective amount of protective product absorbed and the capillarity protection degree ($E_c\%$).

In Table 3 is shown the amount of protective product absorbed by the samples and the capillarity protection degree at 60' obtained with this new methodology of treatment. The results of the different laboratories are in excellent accordance and confirm as appropriate the new methodology. A proof of the high influence of environmental parameters on the amount of product absorbed and on its ways of distribution into the lithotype clearly comes out from data of the E laboratory (Tab. 3): they are different from the others because it has not been possible, for occasional reasons, to operate at the set conditions of temperature and relative humidity.

Table 3. Amount of protective product (Q)* and capillarity protection degree ($E_c\%$) determined on samples of Marble after 4 months from treatment

Laboratory	Protective Product			
	RP 224		S12	
	(Q)	(E_c)	(Q)	(E_c)
A	0.013	-	0.11	-
B	0.011	91	0.13	85
C	0.012	95	0.10	84
D	0.015	91	0.10	74
E	0.023	91	0.17	86
F	0.011	96	0.17	96
G	0.016	92	0.12	82

* g of protective absorbed for 100 g of stone sample

The tests programmed for the evaluation of protectives were carried out on the samples treated with the old methodology. In fact, though these samples show differences, sometimes high, in the amount of protective product absorbed, nevertheless they can be usually used to verify the parameters and methods chosen to determine them. The results are hereinafter described.

3.2 Amount of water absorbed by capillarity versus time

3.2.1 Biocalcarenit

Figures 1, 2 and 3 show the plot of capillary absorption average values versus time on samples of Biocalcarenit. Since silicon containing products (DF 104, RP 224, HL 100 and 290 L) show the same trend, only HL 100 curves (Fig. 1) are reported as example. It is possible to observe that the data obtained by the various laboratories are very similar; the sheaf of curves is in fact so restricted that these almost coincide. The amount of

water absorbed by the treated samples remains very small in time assuring a high and lasting protection. The protection furnished by the silicon containing products is always excellent even if the amount of protective absorbed on samples is often very different among the various laboratories (Tab. 2); this result can be explained admitting that the treatment is frequently over dimensioned, smaller protective amounts being sufficient to assure good protection.

Fluorinated products show (Fig. 2 for S12 and Fig. 3 for YR) a greater scattering of curves obtained in the various laboratories, scattering in most cases related to the amount of protective absorbed (Tab. 2). These differences can probably be attributed to the fact that total protection had not been reached. The different trend of capillarity curves for the two classes of products is very significant: i) alkylsiloxane products (Fig. 1) show straight lines very close to the abscissas axis; ii) fluorinated products (Figs. 2 and 3) show curves similar to those obtained for non treated samples, though a reduction, sometimes high, of water absorbed by capillarity is observed.

Data obtained seem therefore to confirm the hypothesis that alkylsiloxane products form on this lithotype a sort of continuous and resistant protective layer which, at least for some hours (96), prevents the penetration of water; fluorinated products instead seem to act in a different manner: they slow down the speed of water entry, but do not form a barrier able to prevent its penetration. In other words, silicon-based products arrange mostly on the surface of the sample, while fluorinated ones penetrate more deeply filling the pores and then diminishing the available volume.

3.2.2 Sandstone

Sandstone samples furnish capillarity curves very similar between both the various laboratories and the different protectives. These homogeneous results are obtained in spite of the striking differences in the amount of product absorbed which is often over dimensioned. In Fig. 4 are shown for example the curves relevant to Sandstone samples treated with RP 224. It is possible to observe that excellent levels of protection (although lower than those observed for Biocalcarenite) persist even after 72 hours and the curves maintain an almost linear trend with low gradient. Sandstone samples treated with S12 (Fig. 5), behave as those treated with silicon-based products. Samples treated with YR (Fig. 6) present instead data scattering among the various laboratories and lower protection, probably related to an insufficient amount of protective used.

3.2.3 Marble

Since measures carried out on Marble samples to plot capillarity curves had given results very different from one laboratory to the other, a new set of measurements was repeated after two years to verify the reliability of the first results. With Marble samples in fact, the mistakes due to the manual skill of the operator were stressed because of the small amount of water absorbed by treated samples and therefore of the very small weight differences to be measured. However, the second set of tests shows that differences among the various laboratories are not due to manual mistakes or methodological problems, but to real differences existing among treated samples. In

fact, curves obtained with the new test are identical to those of the first measurements, even if the operator changes.

With Marble samples, a particular trend of the curves is observed because fluorinated products (Fig. 7 for S12 taken as example) show sheaves of curves more homogeneous than those of alkylsiloxane products (Fig. 8 for RP 224 taken as example). The mobility of fluid fluorinated protectives would in fact allow a better arrangement into the samples leading to an excellent protection which remains unaltered in time (96 hours). On the contrary, alkylsiloxane products do not spread uniformly on samples, probably because they scarcely penetrate into the stone. Moreover the amount of water in Marble, due to its low porosity, is often insufficient for a proper polymerisation process, rendering it more troublesome and slow.

The efficiency of silicon-based products seems to be strongly related to the conditions of treatment and to degree and way of polymerisation. RP 224 on Marble (Fig. 8) can in fact from time to time furnish: i) an excellent and long-lasting protection demonstrating the good arrangement and polymerisation of the protective product (C, F and G laboratories); ii) a good initial protection followed by a loss of efficiency down to very low levels (D and E laboratories); iii) a scarce protection bound to a rapid loss of efficiency of the protective, probably because it forms a thin superficial layer which does not allow any protection when crossed (A and B laboratories).

3.3 Protection Degree

Table 4 shows the values of protection degree calculated through the water absorption either by capillarity ($E_c\%$) or at low pressure ($E_p\%$).

($E_c\%$) data obtained by the various laboratories for the same product are rather homogeneous. If data of Tables 2 and 4 and capillarity curves are compared, it is possible to emphasise that a lower amount of absorbed protective is often related to a lower protection degree. This is more clear in the case of samples treated with an amount of fluorinated product insufficient to achieve maximum protection.

($E_p\%$) data are generally less homogeneous owing primarily to real difficulties in the standardisation of this test caused by the presence of many variables not easy to control; however, this is the only water absorption test usefully applied in building sites so that its normalisation is essential.

Though sometimes different, data in Table 4 are useful to draw some conclusions. Fluorinated products assure less protection to lithotypes (as Biocalcarenite) having high porosity and pores of great size, while furnish better protection to lithotypes (as Marmo) having low porosity and intercommunicating pores through which good penetration and arrangement of fluid protectives is achieved. Moreover the fact that ($E_p\%$) values with the respect to ($E_c\%$) ones are lower for silicon-based compounds and higher for fluorinated products seems to confirm the different arrangement of the two classes of protectives on samples of Marble: i) more superficial and "layer-forming" that of alkylsiloxane products which assure a better protection towards capillarity; ii) less superficial and more spread into the pores that of the fluorinated ones which allow a better efficiency towards liquids under pressure.

Table 4. Capillarity (E_c %) and low pressure (E_p %) protection degree determined after 1 year from treatment

Laboratory	Marble											
	RP 224		DF 104		YR		S12		HL 100		290 L	
	(E_c)	(E_p)	(E_c)	(E_p)	(E_c)	(E_p)	(E_c)	(E_p)	(E_c)	(E_p)	(E_c)	(E_p)
A	89	57	89	61	92	94	94	74	57	71	-	-
B	89	91	95	96	93	100	95	100	87	66	-	-
C	95	90	93	95	93	95	95	98	-	-	94	97
D	93	86	-	-	-	-	93	96	95	77	-	-
E	91	86	91	94	89	96	87	99	-	-	91	97
F	96	98	94	100	92	99	97	98	90	91	-	-
G	96	87	94	86	96	90	94	91	95	89	95	87
Laboratory	Sandstone											
	RP 224		DF 104		YR		S12		HL 100		290 L	
	(E_c)	(E_p)	(E_c)	(E_p)	(E_c)	(E_p)	(E_c)	(E_p)	(E_c)	(E_p)	(E_c)	(E_p)
A	85	64	85	40	55	39	69	64	81	52	-	-
B	77	76	81	84	42	72	71	75	74	84	-	-
C	82	54	85	52	45	52	72	70	-	-	82	51
D	88	70	-	-	-	-	75	61	89	67	-	-
E	81	64	86	33	58	30	73	59	-	-	84	45
F	86	80	88	34	61	57	81	73	82	55	-	-
G	89	57	90	68	59	58	82	53	89	62	91	52
Laboratory	Biocalcarenit											
	RP 224		DF 104		YR		S12		HL 100		290 L	
	(E_c)	(E_p)	(E_c)	(E_p)	(E_c)	(E_p)	(E_c)	(E_p)	(E_c)	(E_p)	(E_c)	(E_p)
A	99	100	99	100	84	73	95	84	99	100	-	-
B	99	100	99	100	73	79	75	72	99	100	-	-
C	99	100	99	99	77	76	93	73	-	-	99	97
D	99	100	-	-	-	-	93	91	99	100	-	-
E	99	100	99	100	84	84	93	83	-	-	99	100
F	99	100	99	100	32	56	96	71	97	100	-	-
G	99	67	99	97	69	75	89	63	99	100	99	93

Sandstone samples present an evident lowering of protection degree with all the tested products probably due to the particular composition and structure-texture of this lithotype, very different from that of the others two. The good homogeneity of results obtained by various laboratories confirms, also in this case, the excellence of the proposed methodology. The few exceptions showed in Table 4, often owing to the different amount of protective absorbed by the samples (Tab. 2), can probably be attributed either to a not complete polymerisation of the product when the tests were made or, more simply, to experimental mistakes during the tests.

4 Conclusions

The results obtained confirm the validity of the parameters chosen for a correct evaluation of a protective for stone materials and prove the methodology suggested by the "Protectives Experimentation Subgroup" as suitable also for the examination of treated samples. In fact, the homogeneity of the results obtained by the various laboratories is very good except for the treatment steps which required some modifications to reach the wished accuracy and precision.

From the data obtained is possible to draw some conclusions of great importance for the treatment on works of art of stone: some silicon-based products have, more than others, to be applied on materials containing a discrete degree of humidity to allow their polymerisation. In fact for these products, rate and way of polymerisation on stone strongly influence the kind and degree of protection. Products which remain fluid, as the fluorinated ones, allow a different kind of protection which is scarcely effective for some lithotypes, while can be preferable for others.

Since the complete evaluation of a protective product is also related to its durability, the Subgroup cannot draw definitive conclusions on tested protectives before setting up the experiments necessary to complete the methodology. In any case the results seem to confirm the great difficulties encountered in "building" the ideal protective for all lithotypes and situations; the data obtained show in fact that an excellent protection can only be reached after a careful evaluation of the many parameters which point out the protective more suitable for each case.

5 References

AA.VV. - Commissione NORMAL (1986): Assorbimento d'acqua per capillarità - Coefficiente di assorbimento capillare. *Documento NORMAL 11/85*.

AA.VV. - Commissione NORMAL - Sottogruppo Sperimentazione Protettivi (1993): Metodologia per la valutazione di prodotti impiegati come protettivi per materiale lapideo - Parte I - Tests e trattamento dei campioni. *L'Edilizia*, 7, 57-71.

Alessandrini, G. and Pasetti, A. (1991): Il degrado dei materiali lapidei e i relativi problemi di normativa. *L'Edilizia*, 3, 139 -145.

Fig. 1 - Capillary absorption curves determined by the various laboratories on biocalcarenite samples treated with product 5 (Tegosivin HL 100).

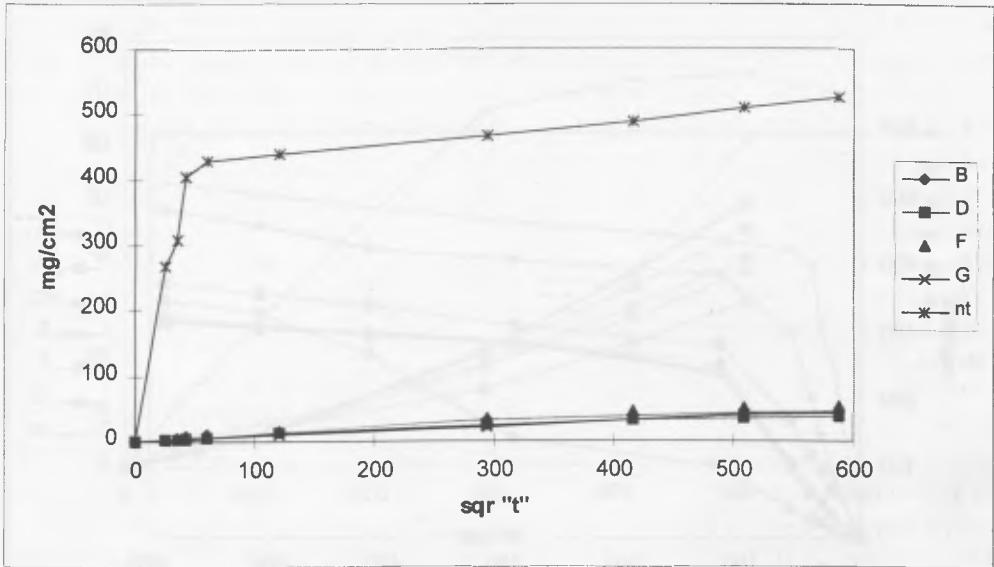

Fig. 2 - Capillary absorption curves determined by the various laboratories on biocalcarenite samples treated with product 4 (Fomblin S12).

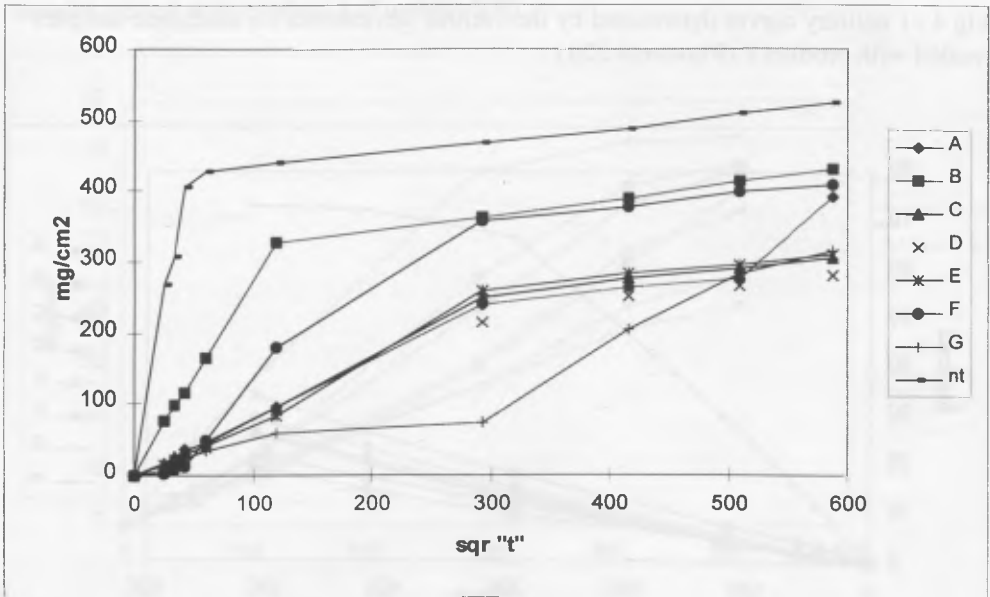

Fig.3 - Capillary absorption curves determined by the various laboratories on bioalcalarenite samples treated with product 4 (Fomblin S12)

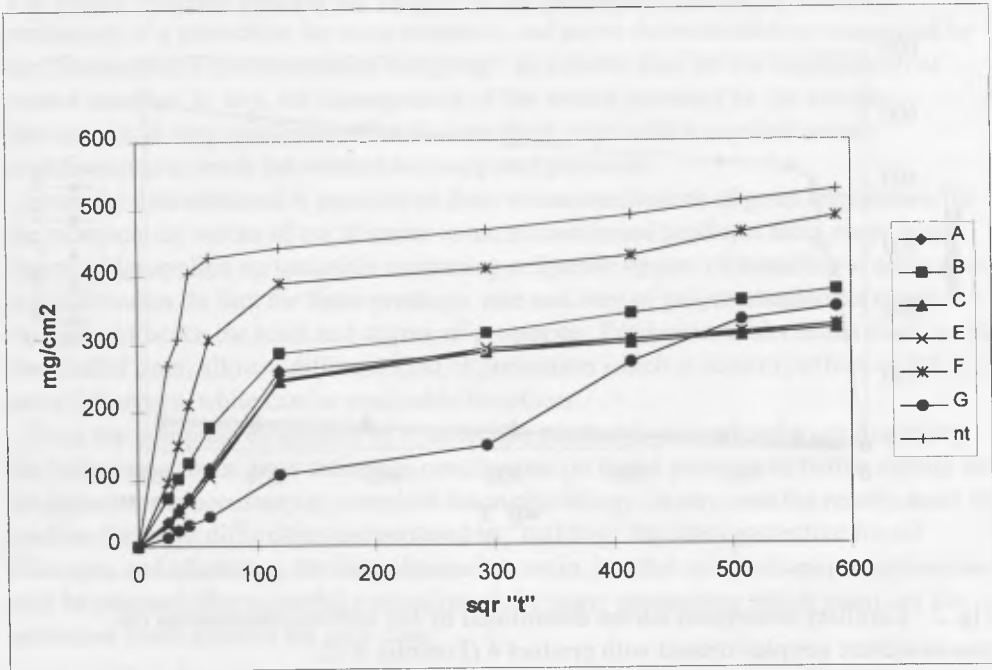

Fig.4 - Capillary curves determined by the various laboratories on sandstone samples treated with product 1 (Rhodorsil 224)

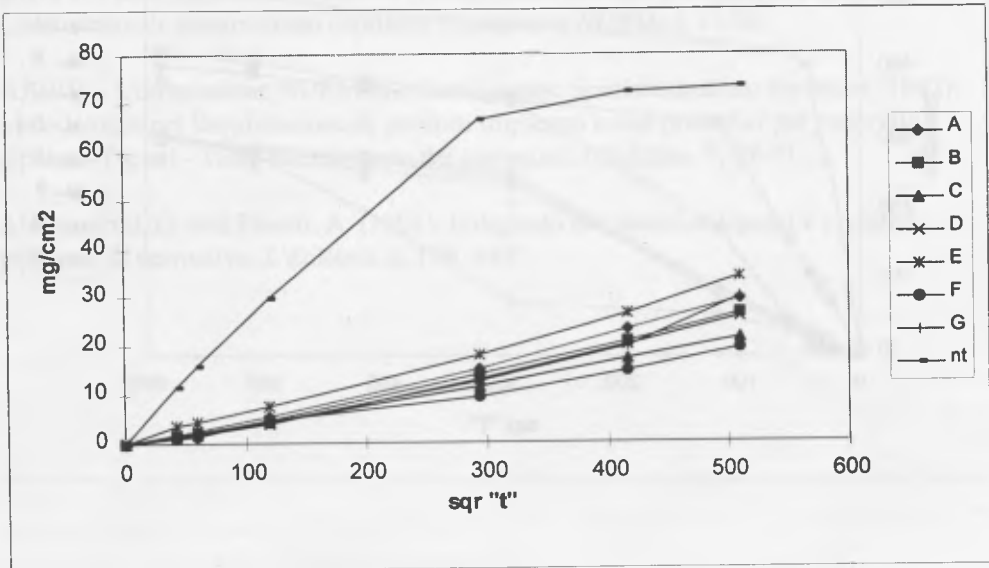

Fig. 5 - Capillary absorption curves determined by the various laboratories on sandstone samples treated with product 4 (Fomblin S12).

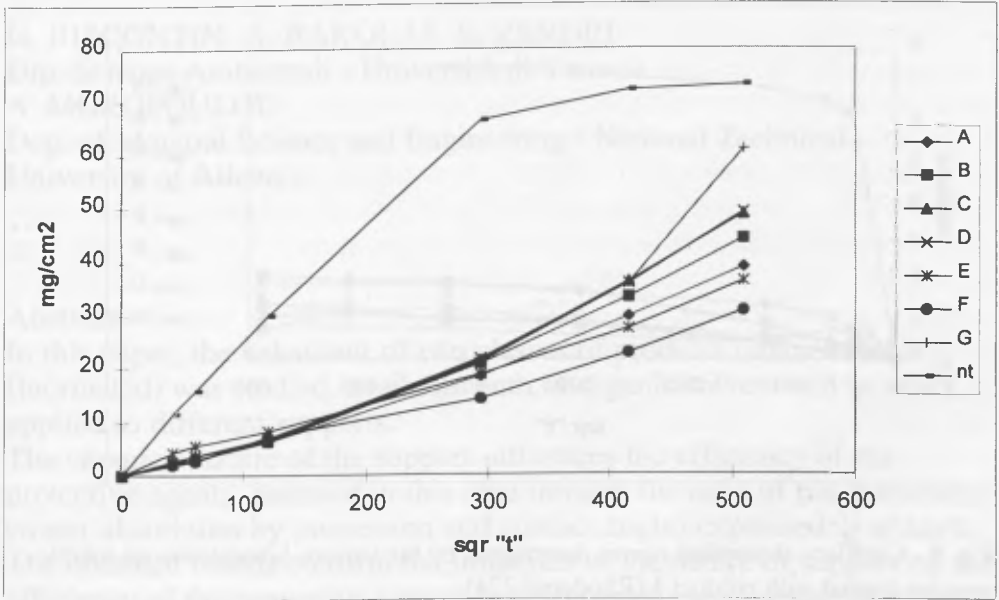

Fig. 6 - Capillary absorption curves determined by the various laboratories on sandstone samples treated with product 3 (Fomblin YR).

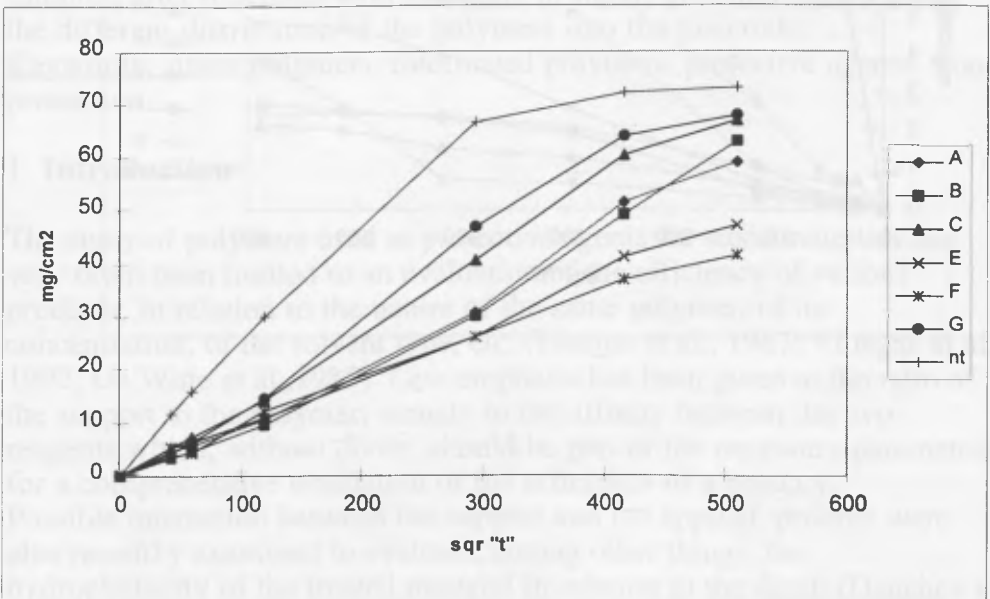

Fig. 7 - Capillary absorption curves determined by the various laboratories on marble samples treated with product 4 (Fomblin S12).

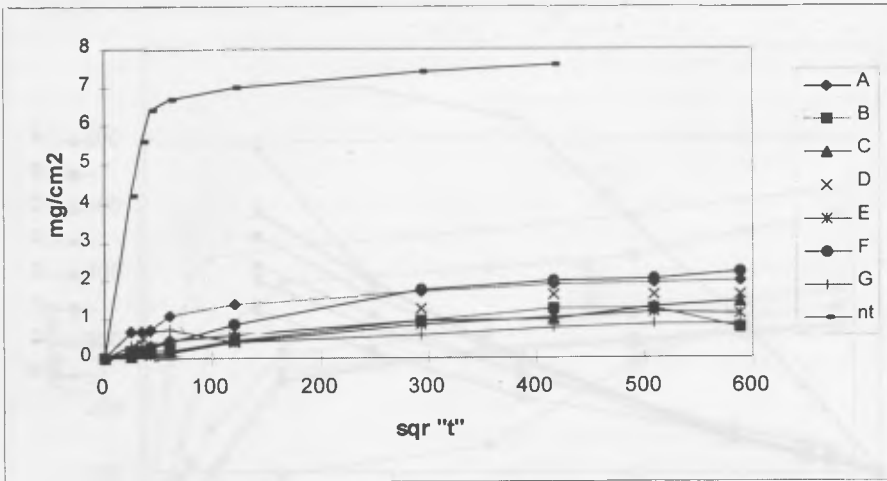
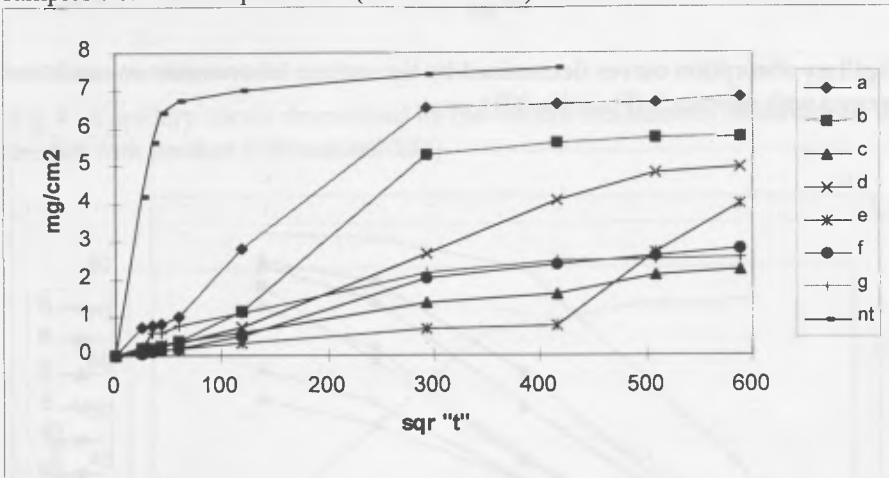

Fig. 8 - Capillary absorption curves determined by the various laboratories on marble samples treated with product 1 (Rhodorsil 224).



INTERACTION OF SOME PROTECTIVE AGENTS WITH BUILDING MATERIALS

G. BISCONTIN, A. BAKOLAS, E. ZENDRI

Dip. Scienze Ambientali - Università di Venezia

A. MOROPOULOU

Dep. of Material Science and Engineering - National Technical University of Athens

Abstract

In this paper, the behaviour of two classes of products (silanes and fluorinated) was studied, available both in organic solvent and in water, applied to different supports.

The chemical nature of the support influences the efficiency of the protective agents, assessed in this case through the ratio of two parameters (water absorption by immersion and contact angle) expressed as $\phi/\Delta m\%$. The obtained results confirm the influence of the nature of support on the efficiency of the protective agents, both in organic solvent and in water. Moreover the behaviour of products applied to wet supports was examined.

The porosity measurements performed on Vicenza stone and brick samples, after treatment with polymers in water, give indications about the different distribution of the polymers into the materials.

Keywords: silane polymers, fluorinated polymers, protective agents, stone protection.

1 Introduction

The study of polymers used as protective agents for stone materials has very often been limited to an evaluation of the efficiency of various products, in relation to the nature of the same polymer, of its concentration, of the solvent type, etc. (Fassina et al., 1987; Villegas et al., 1992; De Witte et al., 1985). Less emphasis has been given to the ratio of the support to the polymer, namely to the affinity between the two reagents which, without doubt, should be part of the necessary parameters for a comprehensive evaluation of the efficiency of a product.

Possible interaction between the support and the applied product were also recently examined to evaluate, among other things, the hydrophobicity of the treated material in relation to the depth (Danehey et al., 1992; Biscontin et al., 1993). First results show a difference in

behaviour of products used on the same supports, evaluated in terms of protective efficiency. This is considered evidence of the fact that the support does not play a passive role compared to the protective treatment nor is it only a "sponge" for the polymer in terms of porosity, but interacts with the product itself. In reference literature, precise indications are effectively shown on the effects of, for example, silicate compounds (montmorillonites, bentonites, kaolinites and other clay minerals) on the polymerization process which are activated and accelerated by the presence of the above mentioned minerals (Theng, 1974). It was decided to make a more detailed study on the interaction between support-protective agent to determine, firstly, in which protective agents and in which supports this relationship could occur and, subsequently, to define the parameters of influence.

In this report, two classes of products in particular were studied (silanes and fluorinated), available both in organic solvent and in water, applied to supports characterized by different chemical composition and porosity rates. Parameters considered to be indicative for the evaluation of the performance of these products were chosen from those thought able to put the two reagents into direct relationship. For this reason, it was decided to use the coefficient of water absorption by immersion, angle of contact and porosity. Also determined were the rate of transpirability, capillary water absorption and chromatic variations, though not reported on in this study, as it was preferred to concentrate on the ratio of the polymer, the solvent and the nature of the support.

2 Materials and methods

The materials chosen as supports were Vicenza stone (Cattaneo et al., 1976), Carrara marble (Carobbi, 1973), Istria stone (Artini, 1962) with regard to carbonatic stone supports; brick for supports for silicatic nature and concrete. Among materials that are traditionally studied, concrete has, since its advent, become part of those materials considered traditional (AA.VV., 1993).

The supports were cut into slab forms in dimensions of 5 x 5 x 1 cm and mean porosity was determined, as shown in the Table 1.

The polymers were chosen from a range of products already in use and available both in organic solvent and in water. Products used were: propyl-trimethoxy silane in aqueous solution and a silane of similar composition (octyl-trimethoxy silane) dissolved in white spirit of various concentrations; for the fluorinated polymers, vinylidene fluoride, hexafluoropropene, tetrafluoroethylene dissolved in delifrene (87.5 % of

1,1,2 trichloro-trifluoroethane and 12.5% acetone), and vinylidene fluoride - hexafluoropropene in aqueous emulsion. In the case of fluorinated polymers, only one concentration of the product was taken into consideration in the two solvents equal to 5%, being an elastomer and therefore not needed high levels of use (Fratini et al., 1989).

The various materials treated with the above mentioned products was done by brushing the slabs with the protectives and determining the quantity of product absorbed, by weight an ratio on the surface of the sample itself. In Table 2 conditions of polymer application and the initials of distinction for various products are shown, which will be used throughout the discussion of results.

Table 1. Mean porosity of examined supports

materials	Porosity (%)	Cum.Vol. (mm ³ /g)
Carrara Marble	1,1	3,95
Istria stone	0,2	0,70
Vicenza stone	28,5	128,7
brick	47,5	305,7
concrete	8,5	37,5

Table 2. Polymer type and concentration of product applied

Product	Initials	Solvent	Concentr. %
propyl-trimethoxy silane	SA	water	5%, 10%, 15%, 30%
octyl-trimethoxy silane	SS	white spirit	10%, 20%, 30%
vinilydene fluoride-hexafluoropropene	FS	delifrene	5%
vinilydene fluoride-hexafluoropropene-tetrafluoroethylene	FA	water	5%

The measurements performed on the samples, both before and after treatment with these products, are relative to the coefficient of water absorption by total immersion in water (NORMAL, 1981), angle of contact (NORMAL, 1989) and porosity of samples (NORMAL, 1980). In the majority of cases, the surface to be protected has a certain percentage of humidity that, in the case of brick masonry, may even reach considerable values (Dingethal et al., 1982). It was therefore thought

important to examine the variations in the behaviour of the particular products studied, in relation to the support even under conditions of application that were not ideal. Samples of various materials contained noted quantities of water and treated with the polymers under examination were prepared to this end. It was considered sufficient to use only one concentration of the product (SA 15 %, SS 30% and FA and FS 5%) at least during the first phase of experimentation. The coefficient of water absorption by immersion was subsequently determined.

3 Results and discussion

Table 3 shows the values relative to the coefficient of water absorption by total immersion, defined by the value of $\Delta M/M\%$, that evaluates both the water tightness capacity of the polymer compared to a given support as well as the values of the angle of contact, which function essentially due to the nature of the polymer and to the type of support, but is independent of the quantity of product absorbed by the material (Matsunaga, 1977). This parameter defines the hydrophobic capacity of the polymer when applied to a given support. Table 3 shows the results of the rate of water absorption by immersion, expressed as $\Delta M/M\%$ relative to the samples treated with the protective in various concentrations. In the fourth column of Tab.3, the value of $M\%$ is given, calculated by percentage of difference between the sample before treatment and the sample after treatment. The higher the percentage value of $\Delta M\%$ is, the less the difference in terms of water absorbed between the untreated samples and the treated ones. The terms of the coefficient of water absorption by total immersion ($\Delta M/M\%$) and angle of contact (ϕ), which is shown in the table as the mean value determined for each product applied on single supports (ϕ_m), indicate two different properties that may however be put together in a single representative index. Therefore the ratio between the angle of contact and the rates of water absorption by immersion, was determined, using the percentage values of a $\Delta M\%$ calculated according to the above mentioned indications. The significance of this parameter is essentially to allow a more rapid evaluation of the ratio between the product and the support, using a single datum, representative of the two important characteristics already mentioned, water tightness and hydrophobicity. The mean value of the angle of contact (ϕ_m) relative to each product applied onto different supports revealed that, as had already been noted in reference literature, said values do not significantly move away from each other, by varying the amount of the same product absorbed by the sample. On the other hand, ϕ_m undergoes changes, some times consistent ones, by

varying the products and, in small measure, also with the support. The fifth column of Tab. 3 shows the values of the ratio, indicated as $\phi m/\Delta M\%$. In order to use these rates significantly, a criteria of "acceptability" of the same value needs establishing, based on a series of data and hypotheses. In this sense, there is a standard that sets limits of traspirability and water tightness for the evaluation of plaster (DIN n° 18550). Minimum values of $\Delta M\%$ and ϕ were therefore established, below those of which the protective effects the initial characteristics of the untreated support material by very little. For angles of contact a minimum lower limit was set at 90° , whereas for $\Delta M\%$ the limit is 90%.

Tab.3. Values of $\Delta M/M\%$, $\Delta M\%$ (difference in percentage among $\Delta M/M\%$ before treatment and after treatment with the products), $\phi m/\Delta M\%$ and ϕm (angle of contact), as regards the various supports treated with the polymers being examined

Support: <i>product</i>	brick <i>quantity</i> (g/m^2)	$\Delta M/M\%$	$\Delta M\%$	$\phi m/\Delta M\%$	ϕm
SA 5%	178,0	2,6	10,2	13,3	136
SA 10%	202,0	3,0	11,8	11,5	
SA 15%	185,0	2,7	10,6	12,8	
SA 30%	492,0	1,9	7,5	18,1	
SS 10%	252,0	1,8	7,1	16,3	116
SS 20%	325,0	1,8	7,1	16,3	
SS 30%	424,0	1,4	5,5	20,1	
FA 5%	156,0	23,6	92,5	1,1	104
FS 5%	162,0	12,6	49,4	2,3	115

Support: <i>product</i>	Vicenza stone <i>quantity</i> (g/m^2)	$\Delta M/M\%$	$\Delta M\%$	$\phi m/\Delta M\%$	ϕm
SA 5%	243,0	7,1	68,3	1,9	133
SA 10%	242,0	7,3	70,2	1,9	
SA 15%	155,0	7,0	67,3	2,0	
SA 30%	329,0	5,8	55,8	2,4	
SS 10%	268,0	8,3	79,8	1,5	120
SS 20%	217,0	7,7	74,0	1,6	
SS 30%	239,0	7,7	74,0	1,6	
FA 5%	174,0	9,9	95,2	1,3	125
FS 5%	179,0	6,2	59,6	2,1	126

Support: <i>product</i>	Concrete <i>quantity</i> (g/m ²)	$\Delta M/M\%$	$\Delta M\%$	$\phi m/\Delta M\%$	ϕm
SA 5%	63,0	4,7	77,0	1,6	123
SA 10%	89,0	4,7	77,0	1,6	
SA 15%	96,0	4,5	73,8	1,7	
SA 30%	94,0	3,2	52,5	2,3	
SS 10%	87,0	1,8	29,5	3,7	109
SS 20%	75,0	3,5	57,4	1,9	
SS 30%	78,0	1,6	26,2	4,2	
FA 5%	12,0	4,5	73,8	1,6	119
FS 5%	19,0	2,4	39,3	2,8	110

Support: <i>product</i>	Carrara Marble <i>quantity</i> (g/m ²)	$\Delta M/M\%$	$\Delta M\%$	$\phi m/\Delta M\%$	ϕm
SA 5%	38,0	0,07	43,7	2,9	127
SA 10%	34,0	0,05	31,2	4,0	
SA 15%	41,0	0,06	37,5	3,4	
SA 30%	47,0	0,08	50,0	2,5	
SS 10%	43,0	0,08	50,0	2,5	125
SS 20%	35,0	0,08	50,0	2,5	
SS 30%	35,0	0,08	50,0	2,5	
FA 5%	44,0	0,10	62,5	2,0	123
FS 5%	63,0	0,08	50,0	2,4	120

Support: <i>product</i>	Istria stone <i>quantity</i> (g/m ²)	$\Delta M/M\%$	$\Delta M\%$	$\phi m/\Delta M\%$	ϕm
SA 5%	34,0	0,20	71,4	1,7	125
SA 10%	39,0	0,16	57,1	2,2	
SA 15%	41,0	0,10	35,7	3,5	
SA 30%	46,0	0,10	35,7	3,5	
SS 10%	29,0	0,09	32,1	3,6	117
SS 20%	27,0	0,17	60,7	1,9	
SS 30%	35,0	0,15	53,5	2,2	
FA 5%	36,0	0,18	64,3	1,7	111
FS 5%	42,0	0,16	57,1	2,1	118

A first observation regards the mean values of the angle of contact recorded on the various samples of treated material. It was generally

noted that the polymers in aqueous solvent have θ values superior to those same polymers in organic solvents, although in some cases this difference was very small. On the other hand, the products used, though of quite similar composition, present differences of structure that surely affect the values of the angle of contact. It is furthermore interesting to note that the products applied to the Carrara marble have values very similar to one another. Whereas, for the other supports, quite consistent differences can be noted as in brick, for example.

The rates of angle of contact and of $\Delta M\%$ are in any case higher than the limits that were pre-established indicating that, at different intensities, the products applied effectively affect the initial characteristics of the supports. Examining now the values of $\theta/M\%$, one can see that, in the case of Vicenza stone this ratio assumes lower values than in relation to those evaluated for brick, in both silane in water and in organic solvent. Analogous results were however obtained in the case of fluorinated products, both in delifrene and in water, which seem to be little affected by the variations in the nature of the support.

Examining also the results obtained from the measurements carried out on other supports, it can be stated that the silanes in water show results little better than those in solvents, even in the Carrara marble, whereas the concrete shows the opposite results. Istria stone does not show substantial difference in performance between the two products.

The fluorinated products, as has already been observed, do not seem affected by the type of support, and the rates of $\theta/\Delta M\%$ are between 1.1 and 1.8; the product in solvent seems slightly more efficient than it does in water. From the $\theta/\Delta M\%$ values, it can therefore be reasonably stated that there is effectively a relationship between support, product and also solvent type.

It is thus clear that in not very porous supports, the amount of absorbed product is much lower than that absorbed by more porous products and, that this fact may affect the results obtained that are, in any case, more than indicative of the behaviour of the products in relation to the support. In Table 4, the results of the tests relative to the determination of the coefficient of water absorption by total immersion are shown, performed on samples pretreated with water. The values of $\Delta M/M\%$ relative to the measurements taken on wet samples ($\Delta M/M\%b$) are compared to those taken on dry samples ($\Delta M/M\%a$), already shown in Table 3 and reported here again for convenience sake. The value of $\theta/M\%$ ratio is not given, as the measurement of the angle of contact performed on supports wetted with water has no significance.

The first observation regards the amount of product absorbed by the samples. Silane, in both water and in solvent, is absorbed by the wet

sample in an inferior quantity compared to that absorbed by the dry sample and the difference is even more noteworthy in the silane solvent applied to samples of brick, Vicenza stone and concrete. In Vicenza stone, an increase in quantity of SA absorbed by the wet sample was determined. In marble and Istria stone, the difference in absorption rate between the two silanes is less pronounced.

Table 4. Values of $\Delta M/M\%$ relative to supports wetted with water and treated with various polymers

Support	% H ₂ O absorb.	product	quant. prod. g/m ²	$\Delta M/M\%$ a	$\Delta M/M\%$ b
brick	0	--	--	25,5	25,5
	14,3	SA 15%	148	2,7	1,6
	13,3	SS 30%	289	1,4	2,5
	12,4	FA 5%	342	23,6	23,6
	12,3	FS 5%	185	12,6	24,7
Vicenza stone	0	--	--	10,4	10,4
	6,0	SA 15%	181	7,0	9,2
	5,3	SS 30%	151	7,7	9,0
	5,7	FA 5%	170	9,9	9,4
	4,7	FS 5%	148	6,2	9,7
concrete	0	--	--	6,1	6,1
	3,4	SA 15%	48	4,5	3,2
	3,5	SS 30%	36	1,6	3,2
	3,3	FA 5%	44	4,5	3,7
	2,5	FS 5%	58	2,4	3,8
Carrara marble	0	--	--	0,16	0,16
	0,05	SA 15%	32	0,06	0,06
	0,04	SS 30%	29	0,08	0,10
	0,04	FA 5%	43	0,10	0,10
	0,04	FS 5%	48	0,08	0,11
Istria stone	0	--	--	0,28	0,28
	0,18	SA 15%	23	0,10	0,06
	0,17	SS 30%	24	0,15	0,02
	0,18	FA 5%	34	0,18	0,18
	0,13	FS 5%	29	0,16	0,18

The absorption rate of the fluorinated polymers, both in water and in solvent, applied to brick and concrete, seems to be helped by the presence of water in the samples. Whereas for marble and Vicenza stone and Istria stone, a decrease in the content of the product is noted, even through it is less pronounced than that for the silane products.

It is however very significant that the products in water are generally less affected by the presence of humidity in the samples compared to the polymers in organic solvent.

In analyzing the various rates of $\Delta M/M\%$, silane in water (SA), besides not being affected by the presence of humidity in the sample, improves its protective performance in some cases, in terms of water repellence compared to the performance of those samples that were not wet. More particularly, values of $\Delta M/M\%$ were recorded lower than $\Delta M/M\%$ on brick, concrete and Istria stone.

Silane in solvent (SS) is negatively affected by the presence of water in the samples, except for the application on Istria stone that shows a $\Delta M/M\%$ value much lower than that determined on the dry sample.

The fluorinated polymer in water (FA), when compared to that in delifrene, has water absorption rates slightly lower than the latter. The opposite is true for dry samples, confirming the general improvement of the protective properties of the product in solvent applied to the wet supports.

The validity of this observation is however limited to the immersion tests on the samples which, in our case, took place over 24 hours. In fact, preceding studies determined that products in aqueous solvent undergo an abrupt decrease in protective performance with the increasing length of time in immersion tests (Biscontin et al., 1992). On the other hand, the objective of this study is not to define the protective performance of the polymers, but to evaluate the eventual relationships between the products and the supports, even under particular experimental conditions.

Summed up, products in organic solvents applied to supports wetted with water are absorbed in a lesser quantity by the samples and consequently are able to furnish a more limited protective action than dry supports.

In this case, the solvent play an important rote but does not substantially change that which has already been shown, namely that there is a reaction between the support and the product applied.

Porosity Measurements

A certain relationship between the products and the supports was determined on the basis of tests carried out. In particular, silane polymers were seen to respond differently to various types of supports, especially with regard to Vicenza stone and brick. It was thought to be of interest to define whether the distribution of the product in the support was partly responsible for the results. Tests were therefore conducted on the measurement of total porosity and on the distribution of the pore size in relation to the cumulative volume, on samples of Vicenza stone and brick, treated with silane in aqueous solvent (SA at 30%).

Figures 1 and 2 show the distribution of the cumulative volume in relation to brick treated with SA (Figure 1) and the same to Vicenza stone treated with SA (Figure 2) and the same.

A decrease in porosity is shown in brick following the treatment which goes from 47% on the untreated sample to 40% on the treated one. The pore size distribution is similar in both cases, although a slight decrease in the percentage of from 0.4 to 0.7 μm is shown, and an increase, also contained, is shown in the percentage of pores at a rate of 0.1-0.3 μm .

For Vicenza stone, treated with SA, a decrease in porosity from 28.5 to 22.5% is registered. The distribution curves indicate a similar rate, though differences in distribution in ranges between 0.1 and 0.3 μm were detected and, in particular, between 5 and 12 μm , in which the percentage of pores in the treated sample is inferior to that of the untreated stone.

The variations in porosity and of pore size distribution in relation to cumulative volume determined by samples of brick and Vicenza stone treated with SA, essentially indicate that brick undergoes a decrease in porosity of a percentage inferior to that of Vicenza stone and that the range of pore size distribution varies so as to suggest a distribution of the polymer on the walls of the same pores without occluding them.

Moreover it can be supposed that the polymer has been deposited on the walls of the pores from 0.4 - 0.7 μm .

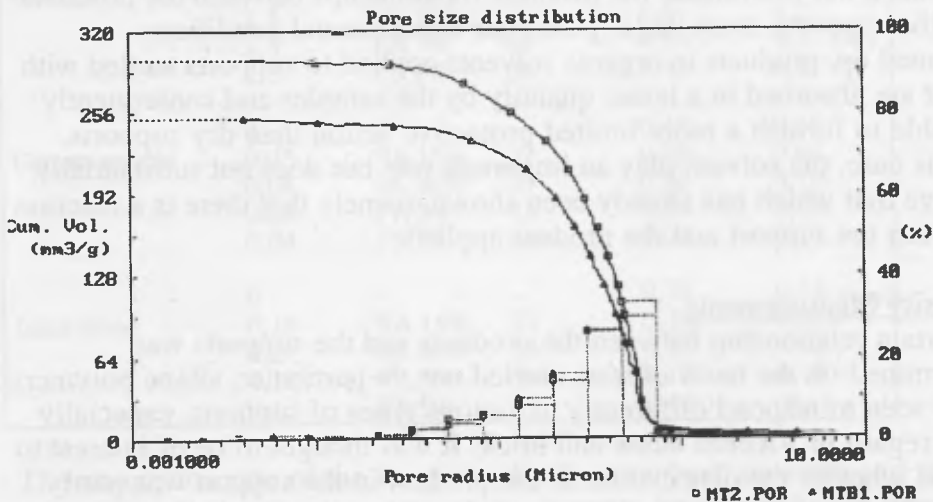

Fig.1. Pore size distribution of the brick before treatment (a) and after treatment (b) with SA.

In Vicenza stone, the consistent percentage of decrease in pores of large dimensions may indicate the closing of pre-existing small pores in the untreated material. Also the thickness of the polymer coating is such to provoke a shift in the distribution of small sized pores and the formation, though limited, of new small pores. The mechanism of absorption of the product seems therefore to be bound more to the physical characteristics of the support than to the presence of forces of attraction between the two reagents, responsible probably for the formation of the coating, more or less homogeneous, of the product on the walls of the pores as observed in brick.

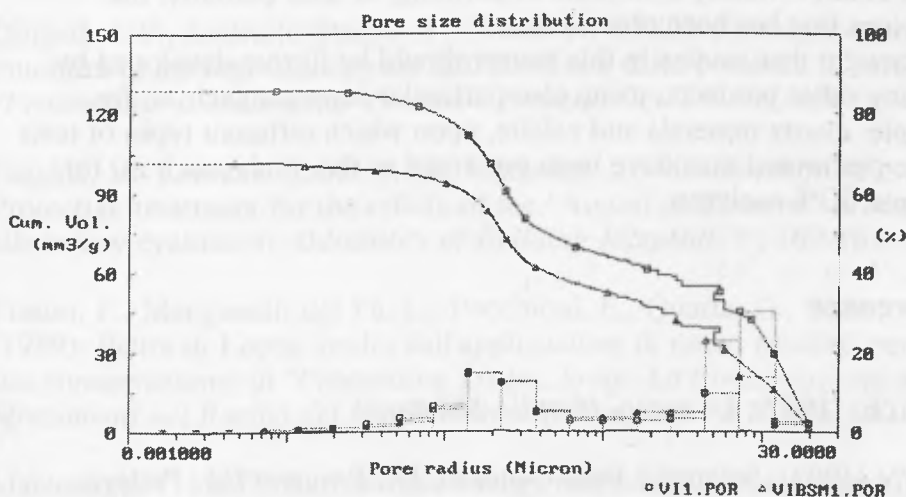

Fig.2. Pore size distribution of Vicenza stone before treatment (a) and after treatment (b) with SA

4 Conclusion

It can be confirmed from these observations that, in all probability, the support material is non inert in relation to the polymers but interacts with them with regard to its own chemical nature and that of the product itself. Silane polymers were shown to increase their protective performance, expressed in terms of water absorption and angle of contact, passing from carbonatic supports to silicatic ones. The porous structure of the materials is modified by the presence of the product in a different way and probably in relation to the type of interaction that occurs between the two systems.

In the case of reduced interaction, the polymer does not cover the surfaces of the pores but occludes them, as is shown by the porosity rates measured on Vicenza stone sample treated with the silane SA.

The fluorinated products (FA and FS) act in a similar way, that is non selectively to the, varying of supports, probably because of the scarce interaction created between the material and the polymer.

To verify these observations, NMR analyses in solid state were performed on the samples purposefully prepared in mixtures of brick dust and silane polymers in aqueous solvent. From the first results obtained, the presence of compounds different from the initial ones were non detected, perhaps due to the technique used in the preparation of the sample itself.

Better analytic conditions are now being sought for this type of analysis which could certainly contribute to defining, at least partially, the behaviour that has been observed.

It is thought that studies in this matter should be further developed by examining other products, using also particular supports such as, for example, quartz minerals and calcite, upon which different types of tests can be performed than have been presented in this study, such as, for example, XPS analyses.

References

Artini, E. (1962): *Le rocce, Hoepli , Milano.*

AA.VV.(1993): *Scienza e Beni Culturali, IX, Progetto Ed., Padova..*

Biscontin, G., Maravelaki, P., Zendri, E., Glisenti, A. (1992): *Syliconic and acrylic resins dispersed in water as protectives for stone surface. In Mat. Res. Soc. Symp. Proc. ,Vol. 267,935-941.*

Biscontin, G., Maravelaki, P., Zendri, E., Glisenti, A., Tondello, E. (1993): *Investigation into the interaction between aqueous and organic solvent protection and building materials, in "Proceeding of RILEM/UNESCO, Conservation of Stone and Other Materials". Paris, June 29-July 1, 689-696.*

Carobbi, G.(1973): *Trattato di mineralogia, Vol.II, UTET Sansone, Firenze.*

Cattaneo, A., De Vecchi, G., Menegazzo Vitturi, L. (1976): Le pietre tenere dei Colli Berici, *Soc. Coop. Tipografia, Padova*.

Danehey, C., Wheeler, G.S., Su, S.C.H. (1992): The influence of quartz and calcite on the polymerisation of methyl-trimethoxysilane, in "*Proceeding of 7th Congress on Deterioration and Preservation of Stone*". Lisbon, June 15-18, 1043-1052.

De Witte, E., Charola, A.E., Sherry, R.P. (1985): Preliminary tests on commercial stone consolidants, in "*Proceeding of 5th Congress on Deterioration and Preservation of Stone*". Lausanne, Sept. 25-27, 709-718.

Dingethal, P., Andriolo-Stagno, P., Weber H. (1982): Patologia e cura di murature in mattoni danneggiate dall'umidità e dalla presenza di sali. In "*Proceeding Il Mattone di Venezia*". Venezia, Oct. 29, 397-414.

Fassina, V., Laurenzi Tabasso, M., Lazzarini, L., Mecchi, A.M. (1987): Protective treatment for the reliefs of the "Arconi di S.Marco" in Venice: laboratory evaluation, *Durability of Building Material*, 5, 167-181.

Fratini, F., Manganelli del Fà, C., Pecchioni, E., Quarta, G., Scala, A. (1989): Pietra di Lecce, studio sull'applicazione di nuovi prodotti per la sua conservazione, in "*Proceeding 1st Int. Symp. La Conservazione dei Monumenti nel Bacino del Mediterraneo*". Bari, June 7-10, 495-500.

Matsunaga, T. (1977): Surface free energy analysis of polymers and its Relation to surface composition. *Journal of Applied Polymer Science*, 21, 2847-2854.

Norme DIN - Intonaci, 18550.

Raccomandazioni NORMAL (1980), *Distribuzione del raggio dei pori in funzione del loro diametro*, 4/80, ed. Comas Grafica, Roma..

Raccomandazioni NORMAL (1981), *Assorbimento di acqua per imbibizione totale - Capacità di Imbibizione*, 7/81, ed. Comas Grafica, Roma..

Raccomandazioni NORMAL (1989), *Misura dell'angolo di contatto*, 33/89, ed. Comas Grafica, Roma..

Theng, B.K. (1974): The chemistry of clay-organic reactions, *John Wiley & Sons, New York*.

Villegas, R., Vale, J.F. (1992) : Evaluation of the behaviour of water repellent treatments for stone, in "*Proceeding of 7th Congress on Deterioration and Preservation of Stone*". Lisbon, June 15-18, 1253-1262.

SUGGESTED PROPERTIES FOR EVALUATING THE BEHAVIOUR OF A WATERPROOFED LIMESTONE UNDER AGGRESSIVE ENVIRONMENTAL CONDITIONS

R. M. ESBERT, J. ALONSO, F.J. ALONSO, J. ORDAZ
Department of Geology, University of Oviedo (Spain)

Abstract

The behaviour of two stone protectors, a siloxane and a copolymer, applied to a carbonate rock - Hontoria limestone - widely used as a building stone in some Spanish monuments, is studied in this paper. The variations of two properties - contact angle and water vapour permeability - before and after the experimental attack with sulphur dioxide, have been analyzed. These properties have proved to be useful for evaluating the efficiency and durability of both waterproofing products.

Keywords: Stone protection, Water-repellent, Limestone, Contact angle, Water vapour permeability, Limestone, Sulphur dioxide.

1 Introduction

Before applying a protector on the surface of a monumental stone it is necessary to have a knowledge of its degree of efficiency and future evolution of the product, as well as the resistance of the treated stone against the weathering agents (durability).

In relation to these premises, the present paper tries to prove that the determination and comparison of the values of two physical properties - contact angle and water vapour permeability - can be enough to have a first approximation about the evolution of some of the most common water-repellents used for protecting carbonate stones, especially those located in aggressive environments, mainly polluted by sulphur dioxide.

The carbonate rock selected for this study (Hontoria limestone) can be considered - within the sedimentary materials used in the Spanish architectural heritage - a rock type, due to its composition, texture, porosity and geometry of the pore system.

Similar experiments with other carbonate rocks (micritic limestones, marls and crystalline dolomites) are being carried out in our laboratory.

2 Rock material

Hontoria stone is a cretaceous limestone, extracted from the quarries of Hontoria de la Cantera (Burgos) and widely used as building stone in several Spanish monuments and historic buildings (e.g., Burgos and León cathedrals), located mainly in the region of Castilla-León (Central-northern part of Spain).

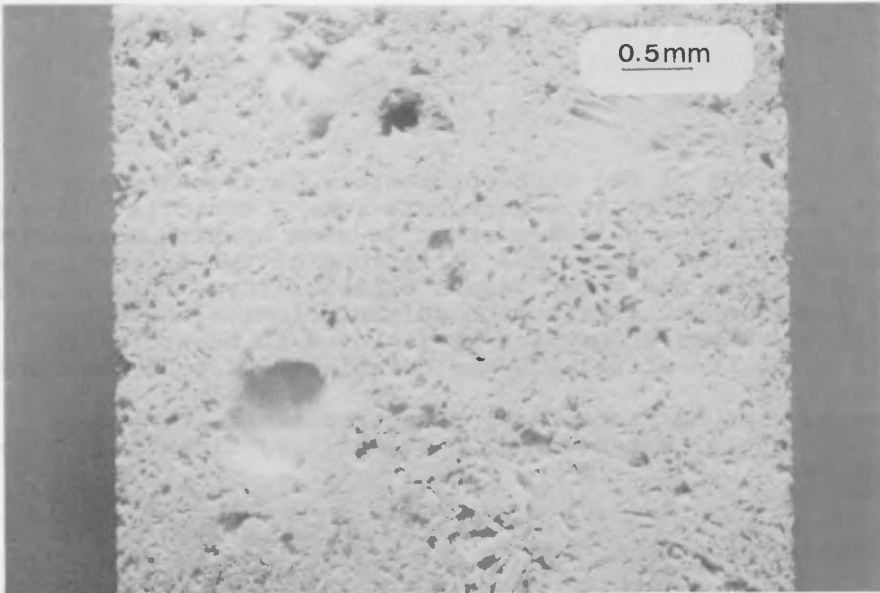

Fig. 1. Macroscopic aspect of Hontoria limestone. Note the abundance of voids and its heterometry.

This is a bioclastic limestone with many voids (Fig. 1) and formed almost exclusively by calcium carbonate (98% calcite, 2% quartz). Its texture is grainy, with grains of fossil remains (bioclasts) standing out, slightly cemented by esparite. The grain size is variable, ranging from 0.5 cm up to 1 cm (Fig. 2). The rock shows a certain degree of recrystallization. It can be petrologically classified as a bioesparite.

The voids are one of the most characteristic features of this stone, conditioning to a great extent its physical properties, especially the hydric ones (Valdeón et al., 1992), as well as its alterological behaviour (Esbert and Montoto, 1990; Alonso et al., 1994).

The open porosity is high, about 25%, and the structure of the pore system is basically formed by large pores - of some hundred of microns - mainly linked by much smaller pore conducts, of a few microns (Figs. 3 and 4).

The complexity and connectivity of the Hontoria stone pore system is evidenced when observing resin casts of the stone surface with the scanning electron microscope (Menéndez et al., 1988) (Fig. 5). More petrographical details and physical properties of Hontoria limestone can be found in Marcos et al. (1994).



Fig. 2. An aspect of the texture of Hontoria limestone under the polarizing microscope. Differences in grain size are clearly observed.

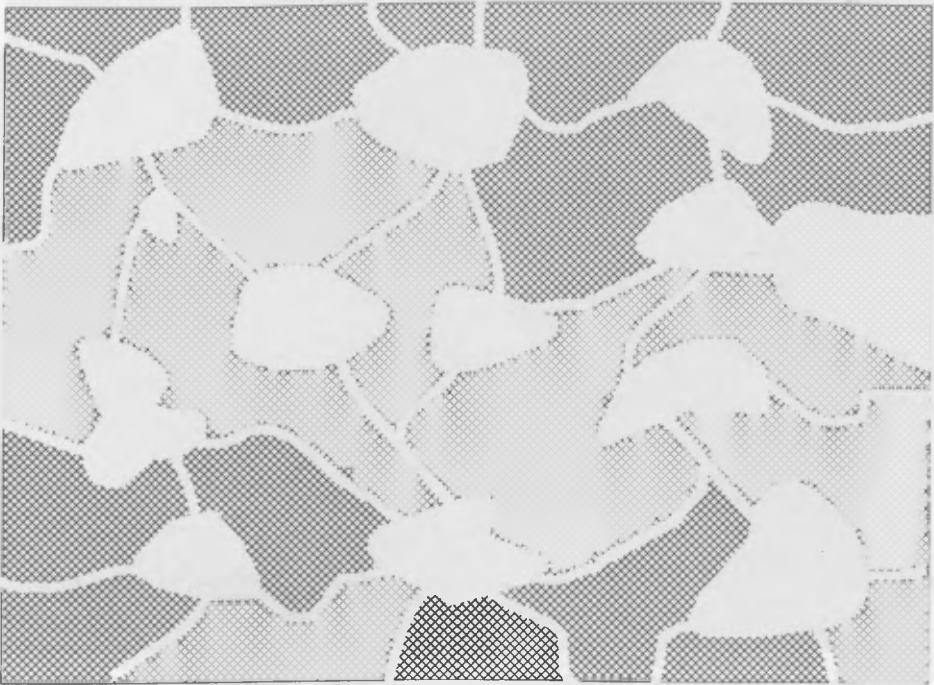

Fig. 3. Idealized scheme of the pore system model of Hontoria stone: large pores connected by smaller pore conducts.



Fig. 4. Pores of different sizes in Hontoria limestone, observed with the scanning electron microscope (SEM).

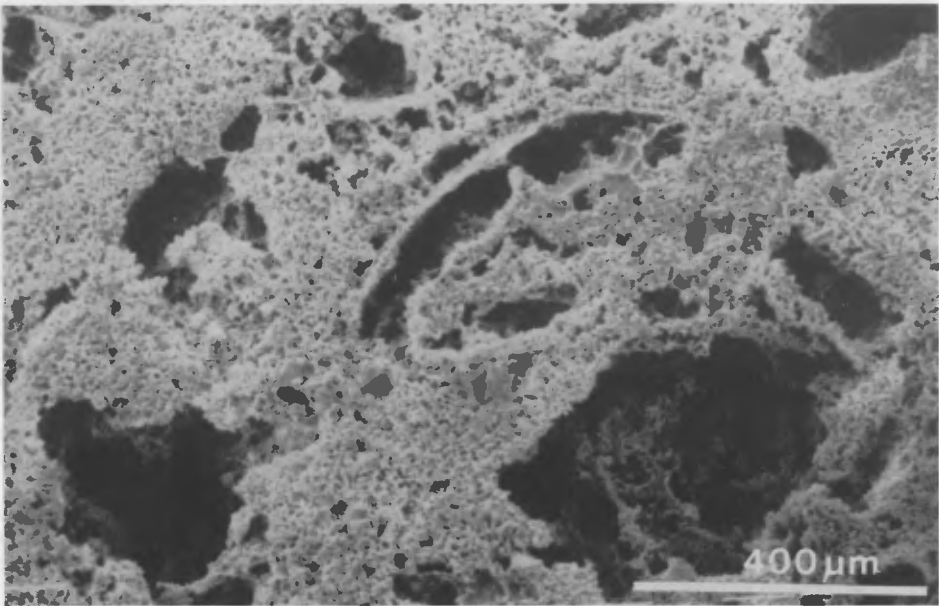

Fig. 5. Aspect of a resin cast of the void space of the Hontoria stone (SEM).

3 Protectors

3.1. Characteristics

The two water-repellents studied were silicoorganic products, although with different compositions: a siloxane (Tegosivin HL-40, made by Goldschmidt) and a copolymer or siloxane-acrylate (Baysilone LF, made by Bayer). Both products are commonly used nowadays in restoration works.

3.2. Application

The protectors were applied with a brush on specimens sliced 5x5x1 cm. The siloxane was dissolved in white spirit (10%), and the copolymer in 1:1:1 trichloroethane at the same concentration, following the suggestions of the respective manufacturers.

The products were applied in three coats, with 24-hour intervals between them. Once applied, the treatments were left to polymerize in a climatic chamber under room conditions. The distribution of the products on the surface of the stone was checked by means of SEM and EDX (Fig. 6).

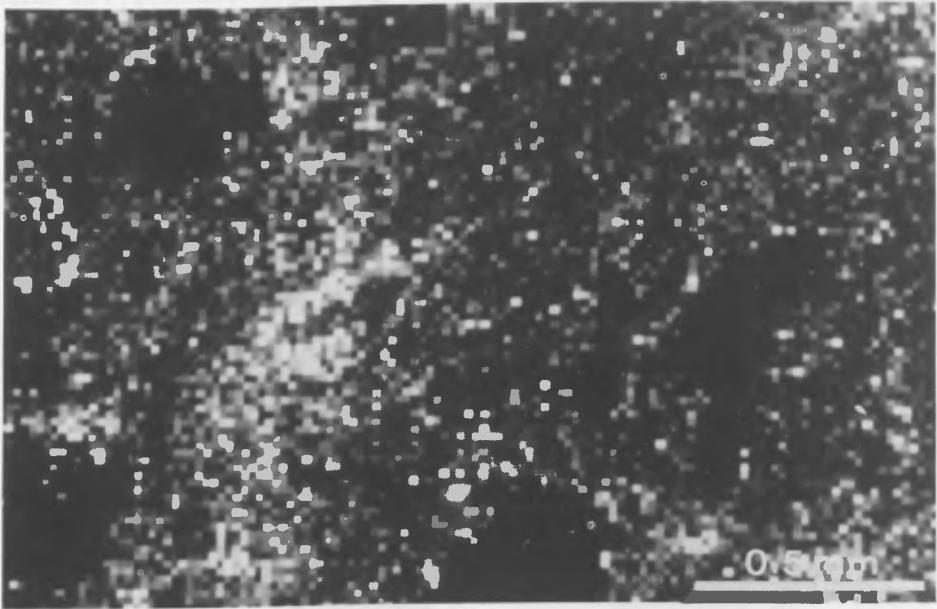

Fig. 6. Distribution of the siloxane (HL-40), in white, on the surface of Hontoria stone (SEM-EDX).

4. Pore system: Treated and non-treated stones

The pore size distribution and other parameters related to the pore system of the Hontoria limestone were obtained by using mercury intrusion techniques.

The tests were carried out on non-treated specimens (NT) and those treated with the two protectors: Baysilone (LF) and Tegosivin (HL-40). Specimens of 2x2x0.5 cm were used, making two tests for each specimen. Table I shows the average values obtained. Pore size distribution curves are shown in Fig. 7.

TABLE I. Pore system values

HONTORIA STONE	NT	HL-40	LF
Porosity accessible to Hg (%)	25.7	23.2	24.3
Relative trapped porosity (%)	48	52	52
Mean pore-throat radius (μm)	2.2	2.2	2.2
Pores below $0.1 \mu\text{m}$ (%)	1.5	0.3	0.3
Specific surface (m^2/g)	0.27	0.15	0.17

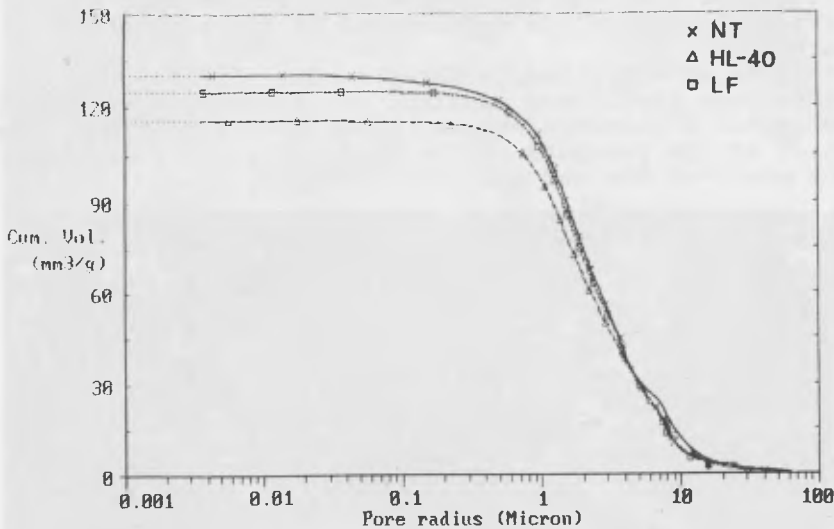

Fig. 7. Pore size distribution of Hontoria limestone, before and after application of the protectors.

Both products slightly reduce the porosity (Baysilone by about 5% and Tegosivin by 10%), and the connectivity among the pores decreases (the trapped porosity increases 4% with the treatments).

The average pore-throat radius does not vary significantly. The most important changes take place in the fraction of the smaller pores (less than $0.01 \mu\text{m}$ of radius), that show a significant reduction (of about five times). Consequently, the specific surface also decreases.

5 Test with SO_2

Treated and non-treated specimens of Hontoria stone were subjected to the action of sulphur dioxide in a climatic chamber. The concentration of SO_2 , used in the test was 10 ppm - a concentration above the values usually found in urban environments. The experimental conditions were: 80% relative humidity and 20°C temperature. The gas attack was maintained

for 8 days (192 hours). The untreated faces of the specimens were covered with polyurethane with the aim of exposing only the waterproofed face to the SO₂ attack.

6 Properties determined

The physical properties measured in relation to the efficiency and durability of the water-repellent treatments were the contact angle and the water vapour permeability.

6.1. Contact angle

The contact angle that forms a drop of distilled water with the hydrophobic surface was determined with the help of a reticulated magnifying lens. The measurements were made on treated specimens, before and after the SO₂ test. Four specimens of each type were selected and ten measurements - 10 drops of 5 µl, placed from a height of 1 cm - were made in each specimen. Table II shows the average values for this property.

TABLE II. Contact angle (°).

HONTORIA STONE	HL-40	LF
Non-tested	115.2	115.9
SO ₂ tested	110.4	111.0

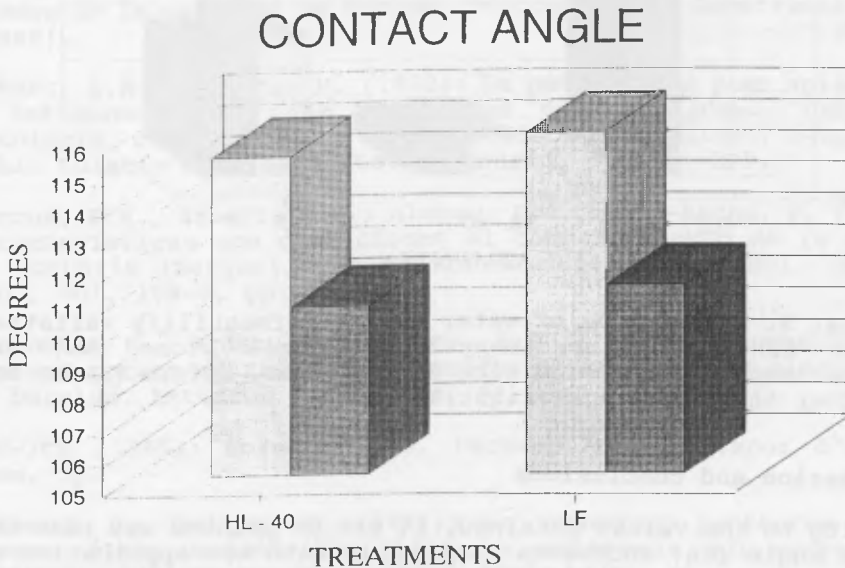

Fig. 8. Histograms of contact angle variation in specimens of Hontoria limestone waterproofed with HL-40 and LF, before (left) and after (right) SO₂ attack.

6.2. Water vapour permeability

The water vapour permeability was measured according to the CNR-ICR (1985) recommendations. The test was performed in a climatic chamber in order to keep the temperature steady. Four specimens of each type (non-treated and treated, before and after the SO₂ attack) were measured. Table III shows the average values obtained.

TABLE III. Water vapour permeability.

HONTORIA STONE	K _v (g/m ² 24h)		
	Non-treated	HL-40	LF
Non-tested	189.2	136.8	154.8
SO ₂ tested	175.0	135.6	150.9

WATER VAPOUR PERMEABILITY

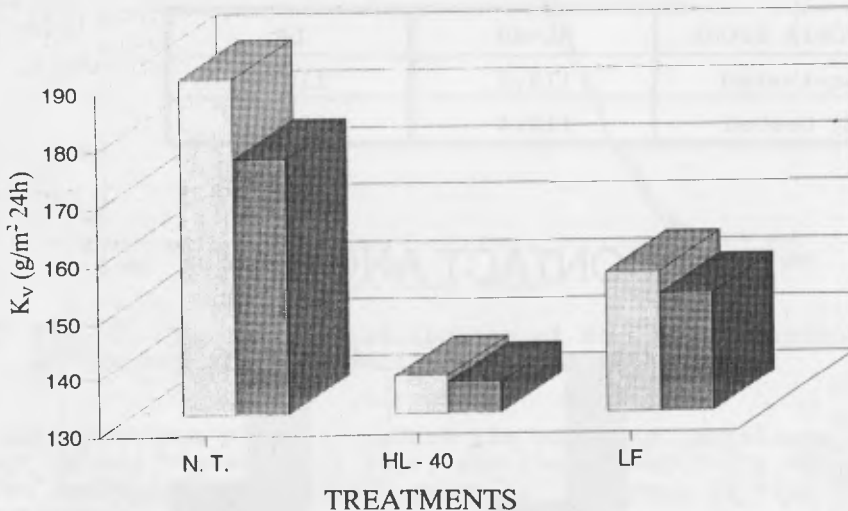

Fig. 9. Histograms of water vapour permeability variation for non-treated specimens of Hontoria stone (NT) and specimens waterproofed with HL-40 and LF, before (left) and after the SO₂ attack (right).

7 Discussion and conclusions

According to the values obtained, it can be pointed out that the contact angle (CA) increases remarkably with the application of the protectors, the difference between them being very slight (Fig. 8). After the attack with SO₂, a clear reduction of the CA, of about 5%, is also evident in both tested specimens.

The water vapour permeability (K_v) decreases after the treatments, especially in the case of HL-40 (about 28%) (Fig. 9).

After the SO₂ test, the Kv decreases more in the non-treated specimens (about 8%) than in the treated ones. For the last ones the Kv reduction is relatively more marked in the specimens waterproofed with LF.

The variations in the values of CA, after the treatments and the SO₂ attack, do not allow a clear discrimination between clearly differential behaviours of the two protectors under aggressive environments. In this sense, Kv seems to be more suitable when detecting possible differences in the future behaviour of both protectors, because of its sensitivity to the changes induced in the pore space microstructure (Quénard and Sallée (1991)).

In any case, the analysis and comparison of the values of these two properties - CA and Kv - have proved to be useful for evaluating the efficiency and durability of the water-repellents applied on Hontoria limestone. We hope that this main conclusion can be corroborated once we have finished current research on other types of carbonate rock, subjected to more aggressive conditions.

Acknowledgments

The authors wish to thank the "Comisión Interministerial de Ciencia y Tecnología" (CICYT, Project PAT 91-1093) and the "Consejería de Cultura" of the Castilla and León Government.

References

- Alonso, F.J., Díaz-Pache, F., Esbert, R.M. (1994): Interacción piedra-ambiente: Formas de alteración desarrolladas sobre la piedra de la catedral de Burgos. Informes de la Construcción (In press).
- Esbert, R.M., Montoto, M. (1990): La petrografía y su aplicación a los estudios de las patologías de la piedra. "Curso de patología, conservación y restauración de edificios", T-1, Serv. Publ. Colegio de Arquitectos de Madrid, pp. 211-229.
- Marcos, R.M., Esbert, R.M., Alonso, F.J., Díaz-Pache, F. (1993): Características que condicionan el comportamiento de la caliza de Hontoria (Burgos) como piedra de edificación. Bol. Geol. y Min., Vol. 104-5, pp. 123-133.
- Menéndez, B., Ordaz, J., Alonso, F.J. (1988): Observación del sistema poroso de rocas carbonatadas al microscopio electrónico de barrido. Estudios Geológicos, 44, pp. 189-197.
- CNR-ICR (1985): Normal 21/85. Permeabilidad al vapor d'acqua. Roma, 5p.
- Quénard, D., Sallée, H. (1991): Le transfert isotherme de la vapeur d'eau condensable dans le matériaux microporeux de bâtiment. Cahiers du CSTB, 2525. Paris, 20p.
- Valdeón, L., Esbert, R.M., Grossi, R.M. (1992): Hydric properties of some Spanish building stones: A petrophysical interpretation. Mat. Res. Soc. Symp. Proc., Vol. 267, pp. 911-916.

MESURE DE L'EFFET PROTECTEUR DE PRODUITS DE TRAITEMENT FACE AU SO₂ ATMOSPHÉRIQUE ET DES CHANGEMENTS DE COULEUR SUR DES ÉCHANTILLONS DE PIERRE EXPOSÉS EN SITE RÉEL

F. GIRARDET et V. FURLAN

École Polytechnique Fédérale de Lausanne - Département des Matériaux
Laboratoire de Conservation de la Pierre
CH-1015 Lausanne

Résumé

L'efficacité de cinq produits de traitement du commerce, proposés pour protéger les matériaux pierreux de la pollution atmosphérique, a été évaluée par la mesure de la prise en soufre d'éprouvettes de grès calcareux, traitées et non traitées, après exposition in situ pendant deux années.

Au moyen d'un colorimètre Minolts, on a également mesuré les modifications de couleur liées aux traitements et à leur évolution au cours du temps.

Il en résulte que l'effet protecteur des produits vis-à-vis du SO₂ atmosphérique est en général faible et, dans le meilleur des cas, ne dépasse guère un facteur de deux.

La colorimétrie constitue une méthode sensible et précise pour quantifier objectivement tout changement d'aspect et de couleur.

1 Introduction

L'évaluation en laboratoire de l'effet protecteur d'un produit de traitement pose toujours des problèmes délicats et difficiles à résoudre, car elle implique non seulement l'application de tests aptes à déterminer l'efficacité du produit à court et long terme (durabilité du traitement) mais aussi des vérifications pour détecter les éventuels effets secondaires nuisibles que le traitement en question peut engendrer.

Même si l'on réduit le problème uniquement à l'efficacité, l'évaluation doit être faite au moyen d'essais aptes à reproduire des conditions réelles. Une telle démarche est compliquée et peut conduire, par des simplifications dangereuses, à des tests d'exécution facile mais peu significatifs et peu réalistes ou à exagérer l'intensité des facteurs d'altération pris en considération.

L'évaluation du comportement des produits après exposition in situ, démarche jugée généralement trop longue et subjective, peut, à notre avis, fournir des résultats significatifs. A condition toutefois de disposer de méthodes d'investigations suffisamment sensibles et précises permettant mieux que l'appréciation visuelle de détecter et mesurer les modifications des matériaux.

La méthode que nous avons appliquée pour évaluer l'efficacité d'un certain nombre de produits proposés pour protéger la pierre face à la pollution atmosphérique est relativement simple et fournit des résultats significatifs après une année. Cette méthode est basée sur la détermination du flux de soufre sec qui, sous forme de polluant atmosphérique gazeux, interagit et est fixé par la pierre après un temps d'exposition donné. La comparaison entre les flux fixés par la pierre traitée et non traitée permet de déterminer avec précision le réel pouvoir protecteur des produits.

Pour évaluer de manière objective les modifications d'aspect et de couleur en relation avec les traitements, nous avons testé une méthode de mesure colorimétrique. L'apparition sur le marché d'appareils portatifs, peu coûteux mais performants, en fait une méthode bien adaptée pour caractériser la couleur d'un matériau et suivre son évolution dans le temps. Ceci est particulièrement important dans les cas des produits de traitement susceptibles non seulement de modifier la couleur des matériaux mais aussi leur capacité à retenir les salissures.

2 Matériaux et méthodes

2.1 Produits de traitement

Sur le marché on trouve actuellement de nombreux produits proposés pour protéger les matériaux de construction et notamment la pierre. La notion de protection couramment évoquée couvre généralement un éventail de propriétés très diverses (hydrofugation, diminution de l'accrochage des salissures, etc.) et notamment la capacité de protéger la pierre de l'action de la pollution atmosphérique et du SO₂ en particulier.

Il est prétendu également que les produits n'ont pratiquement pas d'incidence sur l'aspect et la couleur des matériaux. Nous avons choisi cinq produits, couramment utilisés en Suisse, deux à base de silanes, un de siloxane et deux de résines acryliques, dans le but de mesurer leur réelle capacité d'empêcher la sulfatation de la pierre et les éventuelles modifications de couleur suite à leur application.

2.2 Pierre

La pierre utilisée comme matériau à protéger est un grès tendre calcaireux, la Molasse de Berne, caractérisé par une forte réactivité au SO₂ atmosphérique (Furlan V. et Girardet F., 1992).

2.3 Mesure de l'effet protecteur des produits de traitement face au SO₂ atmosphérique

La méthode de mesure est basée sur la détermination du flux de soufre sec atmosphérique capté et fixé par la pierre, sous forme de sulfate (Girardet F. et Connor M., 1992), au cours du temps. Très schématiquement des éprouvettes de pierre de 20x10x2 cm, traitées selon les prescriptions des fabricants des produits et non traitées,

ont été exposées dans un parc à Bâle, sous un avant-toit les protégeant de l'action directe de la pluie et du rayonnement solaire (fig. 1).



Figure 1 : Eprouvettes exposées sous un avant-toit dans un site urbain (banlieue).

Le site d'exposition est caractérisé par une température et une humidité relative moyennes annuelles respectivement de 10°C et 78%, et une concentration moyenne annuelle de SO₂ de l'atmosphère, pendant la période d'exposition, de 25 µg. Les dosages du soufre fixé par la pierre est effectué au moyen d'un analyseur Leibold CSA 2003 sur les poudres obtenues par fraisage des éprouvettes en pas de 0.2 à 0.2 mm. Ce procédé permet à la fois de déterminer le flux de soufre total, exprimé en gS/m² année, reçu par la pierre et son profil de distribution.

Simultanément au soufre on détermine également le carbone total.

2.4 Mesures colorimétriques

Ces mesures ont été effectuées avec un colorimètre portable Minolta CR 310. La couleur est exprimée de manière objective, selon les normes CIE, indépendamment de la lumière ambiante. Les données sont archivées sous forme numérique. Les variations de couleur peuvent être présentées par des moyens graphiques aisément interprétables

3 Résultats

3.1 Effet protecteur de produits

Le graphique de la figure 2 donne les flux de soufre captés et fixés par la pierre traitée avec les cinq produits ainsi que par la pierre non traitée après un et deux ans d'exposition in situ.

Dans la partie inférieure du graphique sont reportés les facteurs d'atténuation (rapports entre le flux de soufre fixé par la pierre non traitée et traitée) relatifs aux cinq produits testés.

Réduction de la prise en soufre sur de la molasse traitée, exposée en site urbain, (banlieue)

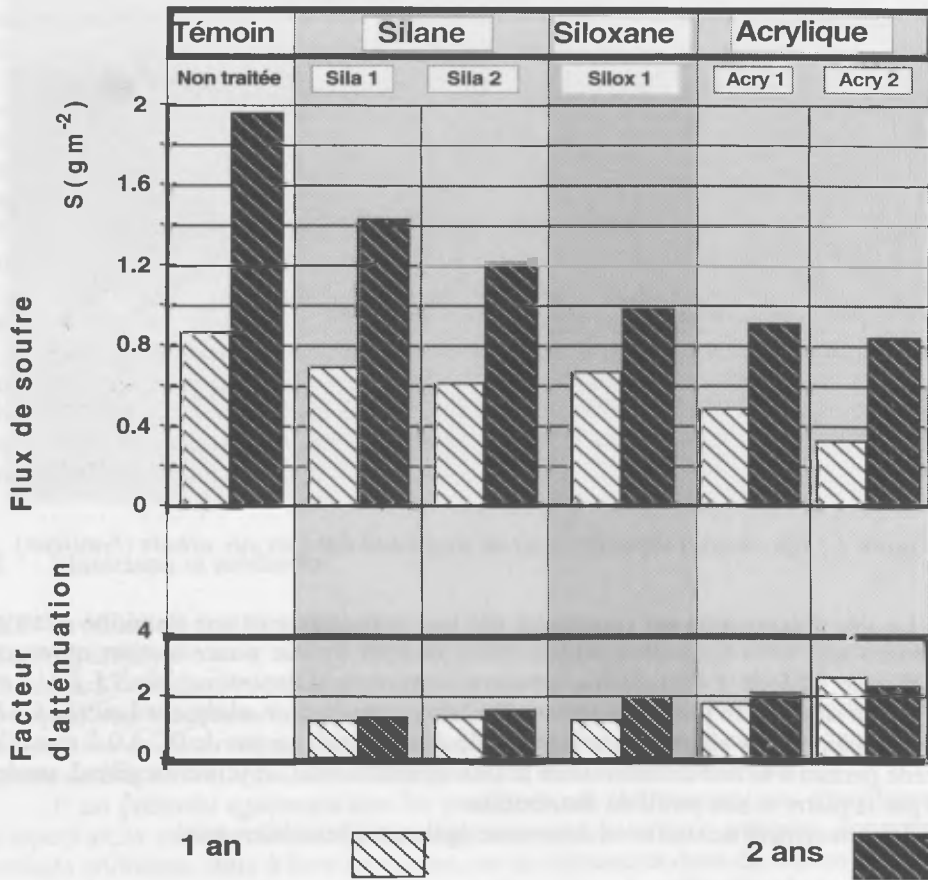

Figure 2 : Influence des produits de traitement sur la prise en soufre.

Dans l'ensemble, on peut constater que ces produits ont une faible capacité de protection de la pierre face aux polluants du soufre gazeux. Dans le meilleur des cas, le facteur d'atténuation est légèrement supérieur à deux.

Le graphique de la figure 3 donne les courbes de répartition du soufre et du carbone après deux ans d'exposition in situ ainsi que le poids sec des produits appliqués par m² de pierre.

Il est à noter que le soufre, à l'état de sulfate, est essentiellement fixé dans les deux premiers dixièmes de mm. Les courbes de répartition du carbone correspondent à la teneur en carbone (carbonates) de la pierre à laquelle s'ajoute le carbone apporté par les produits de traitement. Ces courbes donnent une indication sur la répartition des produits de traitement dans le premier mm de pierre.

Molasse traitée avec divers produits de protection, exposée 2 ans en site urbain, (banlieue)

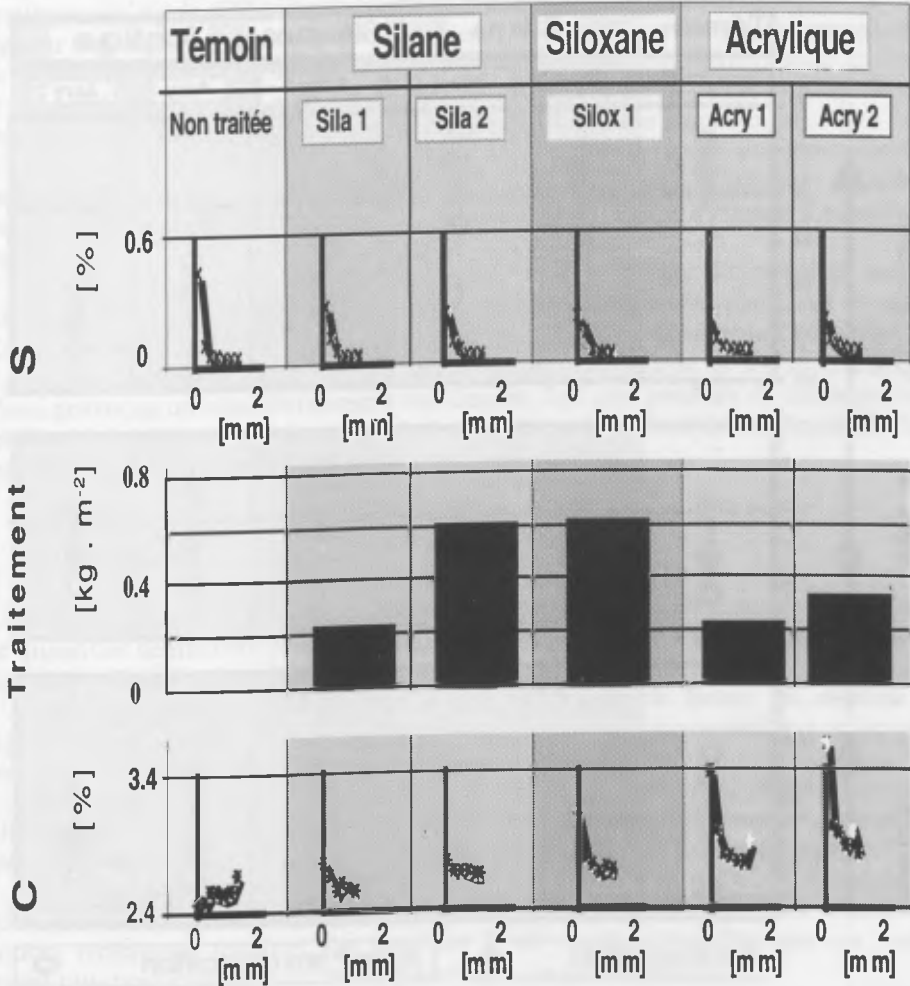

Figure 3 : Courbes de distribution du soufre et carbone et quantités de produits appliqués par m² de pierre.

On constatera simplement que la meilleure protection est assurée par les produits formant un abondant dépôt superficiel, ce qui est particulièrement typique des produits filmogènes tels que les acryliques.

Variation de la couleur d'une molasse traitée avec divers produit de traitements, après 2 ans d'exposition en site urbain, (banlieue)

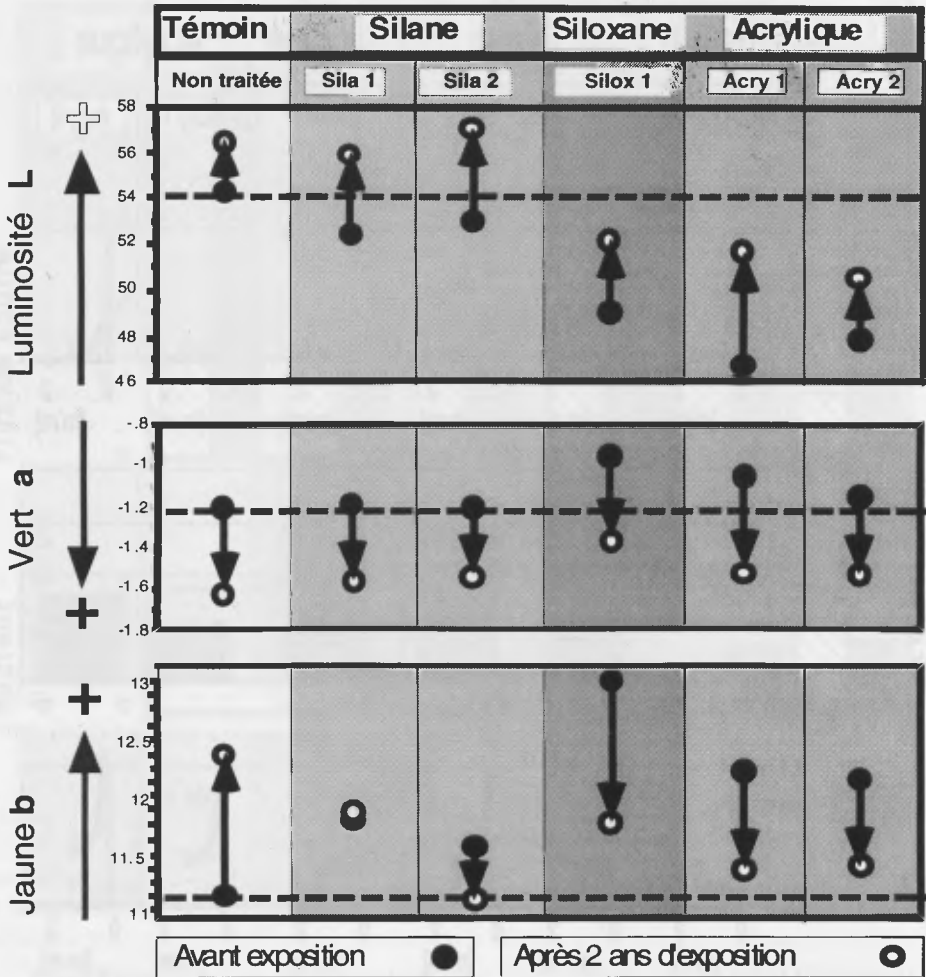

Figure 4 : Représentation graphique des variations de couleur déterminées selon la norme Lab CIE (1976).

3.2 Variations de couleur en relation avec les traitements

Sur la figure 4 sont reportées, selon la norme Lab de la CIE, les variations de luminosité et de couleur de la pierre, consécutives aux traitements avant et après exposition in situ pendant deux ans.

Tous les traitements diminuent la luminosité de la pierre mais particulièrement le siloxane et les acryliques. La composante "a" de la couleur varie relativement peu, tandis que la composante "b" (jaunissement) augmente sensiblement et en particulier dans le cas du siloxane. Après exposition in situ, la luminosité augmente de manière pratiquement égale (3%) sur l'ensemble des éprouvettes. La composante "a" de la couleur augmente aussi mais plus faiblement (léger verdissement). La composante "b" de la couleur, dans le cas des pierres traitées, diminue particulièrement pour le siloxane et les acryliques et tend à se rapprocher de la couleur de la pierre non traitée avant exposition. A l'inverse, la pierre non traitée subit un notable jaunissement.

On constate donc que les produits de traitement, après avoir provoqué un jaunissement et un assombrissement initial de la pierre, s'opposent ensuite au jaunissement naturel du matériau qui, au contraire, traité, a tendance à retrouver sa couleur initiale.

L'augmentation générale de luminosité après deux ans d'exposition peut être attribuée à un léger empoussiérage dans lequel prédominent les particules de couleur claire (pollens et particules minérales) en relation avec l'environnement immédiat.

Il est à noter que pour un grès tendre tel que la Molasse de Berne, l'absorption d'eau provoque un assombrissement conséquent. Les cinq produits de traitement testés inhibent ce changement. La mesure de la couleur permet donc de bien quantifier aussi les modifications d'aspect en relation avec la prise d'eau.

4 Conclusions

La méthode de mesure du flux de soufre sec fixé par une pierre exposée in situ permet de quantifier de manière précise et réaliste l'effet protecteur d'un produit de traitement face aux polluants gazeux du soufre.

Pour une pierre très réactive telle que la Molasse de Berne, les résultats sont significatifs déjà après une année d'exposition même si l'atmosphère est relativement peu polluée (cas du site d'exposition).

Parmi les cinq produits testés, les deux à base de résines acryliques, formant un film superficiel, se sont révélés les plus efficaces. Toutefois, l'atténuation de la prise en composés soufrés (exprimés en g S/m²) ne dépasse guère un facteur de deux.

L'écran protecteur constitué par ces produits face à la pollution atmosphérique nous paraît donc bien modeste par rapport à ce qu'on pourrait s'attendre à la lecture des notices techniques relatives aux produits. Il est possible toutefois que ces produits soient plus performants sur d'autres pierres que les grès calcareux.

La mesure de la couleur réalisée aux moyens de colorimètres portatifs et précis tels que les appareils actuellement sur le marché donne des résultats objectifs et archivables. Elle permet notamment de bien capter les variations d'aspect et de couleur inhérentes aux traitements ainsi que leur évolution au cours du temps. Cette méthode paraît également bien adaptée pour étudier le salissement des matériaux en relation avec la pollution atmosphérique (particules) locale.

5 Références

Furlan, V. et Girardet, F. (1992)

Pollution atmosphérique et réactivité des pierres.

Actes du 7th International Congress on Deterioration and Conservation of stone, Ed. J. Delgado Rodriguez, Lisbon, 267-276.

Girardet, F. et Connor, M. (1992)

Investigations sur la dégradation des monuments par la pollution.

Dossier Chimie et Art relatif aux travaux présentés lors de la 12e Journée du GACHI, Lausanne, EPFL, 5 décembre 1991, Analisis Magazine, 20, 5, 26-32.

STONE-PROTECTING AGENTS AND THEIR CHEMICAL BEHAVIOUR UNDER THE INFLUENCE OF WEATHERING

K. LITTMANN, B. RIECKEN
University of Technologie, Aachen, Germany

Abstract

New polymeric agents are developed for the conservation of natural stone. They are designed to build-up a protective microlayer on the inner surface of the stones. In this paper, the chemical formulation of some of these agents is described and examples of durability tests are given. It can be shown that chemically weak spots of the molecules lead to failures in durability. By complex test procedures these spots are detected. As a consequence the protecting agents can be optimized in their molecular design.

Keywords: Natural Stones, Weathering, Chemical Stability, Protecting Agents, Degradation under Weathering, Effectiveness of Preservation Materials

1 INTRODUCTION

To retard the deterioration of capillary porous stone buildings and sculptures, attempts are made to develop cold curing polymer systems which build up a protective microlayer on the inner surfaces of the stones in order to strengthen and protect the porous structure without stopping the transport processes of water vapour through the pores. The concept of open-pore polymer impregnation is the so called „Aachen Concept“ /1/. This concept is presented by H.R. Sasse in this proceedings.

Protective agents which are designed for the „Aachen Concept“ have to fulfil many very diverse demands. The chemically and technically oriented requirements can be summarized by the following criteria /2,3,4/:

- cold curing (complete crosslinking/ hardening at temperatures above 10°C)
- low viscosity (less than 10 mPa·s)
- slow viscosity increase over a period of several days
- filmforming
- entropic elasticity of film
- 20 to 30% content of active agent
- environmentally uncritical solvent (optimum: water)

Agents, which fulfil these demands are presented in the following. Their chemical formulation and the properties of natural stones, treated with these agents, will be discussed.

2 CHEMICAL PROPERTIES OF THE PROTECTING AGENTS

The stone protecting agents studied in this work are supplied by major German chemical companies. They represent research products and are not commercially available yet. The possibility of an industrial production of successful tested agents, however, is a main criterion for the development of the production in the laboratory scale.

The technological features of the fluid are of prior importance for the success of an application. The probability to achieve a high penetration depth in a porous stone is mostly given for systems with low viscosity. Furthermore, a low increase of viscosity during the first 4 to 40 hours supports a good penetration behaviour. Suitable materials should therefore reveal a viscosity of less than 5 mPa s. According to building site usability and ecological demands they should be water-based or, where this is not possible, the solvent content should be as low as possible, but not exceed 75% by volume. At the time, the development of water-based systems like emulsions or micro-emulsions, is of first priority.

In principle, all types of polymers can be used as effective content of the prepolymeric solutions or emulsions as long as the above-mentioned features can be reached /2/. Tests have been carried out so far with different types of

- Epoxi resins,
- Acrylic esters,
- Polyurethanes,
- Silanes/Siloxanes
- and silica esters /4/.

Three different agents will be discussed here:

- a polyurethane-based system, which consists of alternating carbon-backbone hard segments and silicone soft segments /5/ ;
- an epoxi-system built up mainly by aliphatic resins and hardener;
- a commercial available silica ester, which contains silanes to achieve hydrophobic properties.

All test products are under further development at the time, the results in this paper represent the results of earlier development steps. This is unavoidable due to the fact, that some of the results are results of durability tests lasting more than three years. Recent results of the development of protecting agents are described in /4/.

2.1 Polyurethane system

The polyurethane-based system consists of two significant molecule parts. One is a so-called hard segment, which is built up by an isophorondiisocyanate. The other segment, the so-called soft segment, is built up by an oligodimethylsiloxane. The agent is dissolved by 30 m.-% in butylacetate. This agent is referred to as protecting agent 87 in the following. Figure 1 shows the chemical structure of the protecting agent.

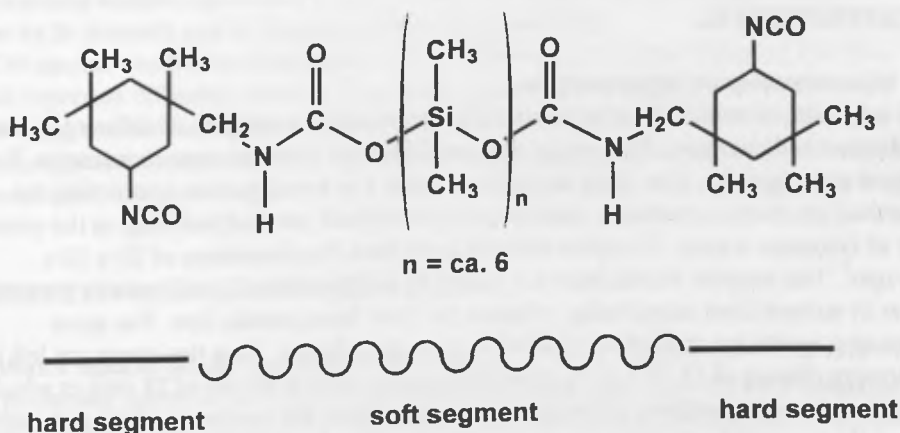

Fig. 1. Chemical structure of polyurethane protecting agent 87

2.2 Epoxi system

The epoxi system is based on an aliphatic diglycidylether as resin and hexamethylene diamine as hardener. This formulation was chosen to achieve a minimum viscosity in comparison to the usual phenolic epoxide resins /8/. The agent is dissolved in methyl-ethyl-ketone by 25 m.-%. This agent is referred to as protecting agent 133 in the following. Figure 2 shows the chemical structure.

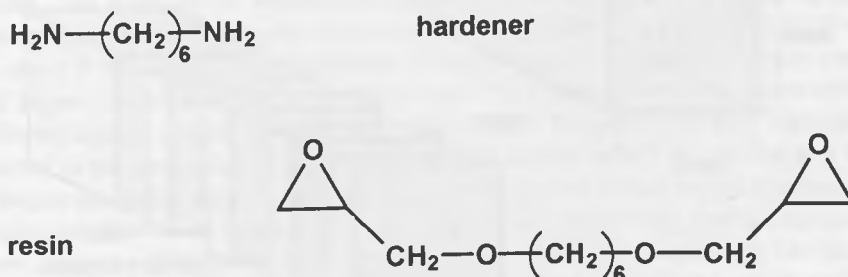

Fig. 2. Chemical structure of an epoxi protecting agent



2.3 Silica ester system

The silica ester system consists of a common tetraethoxysilane with oligosiloxanes added for hydrophobic properties. These stone protecting systems are widely used since more than thirty years. As they are not filmforming, they don't meet the requirements of the Aachen Concept. The tests with these agents are used as references to the Aachen Concept materials. This agent is referred to as protecting agent 89 in the following.

3 EXPERIMENTAL

3.1 Measurements on stone samples

The substrate, on which the experiments are carried out, are samples of different types of sandstones and one type of limestone, representative for German stone monuments. For general investigations, new stone samples are used. For investigations concerning the behaviour on stone monuments, weathered material from selected buildings in the eastern part of Germany is used. The stone samples used have the dimensions of 50 x 50 x 100 mm³. The samples' lateral faces are sealed by a conventional epoxy-resin to prevent water or solvent from evaporating, whereas the front faces remain free. The stone protecting agents are applied by capillary suction for 4 hours. Then the stones are left in laboratory climate of 23 °C / 50 % relative humidity. After a period of 28 days in which at first time-depending suction of the fluid appears and then the hardening of the polymeric film in the stone, the sample is either exposed to artificial or natural weathering conditions or stored as a reference sample in laboratory climate 23 °C / 50 % relative humidity. For the measurement of capillary water-uptake the samples are immersed in a water bath for 24 hours and the free capillary water-uptake through the impregnated surface is measured in kg/m². For the tests concerning mechanical properties and contact angle after weathering or storing, the sample is sawn into segments.

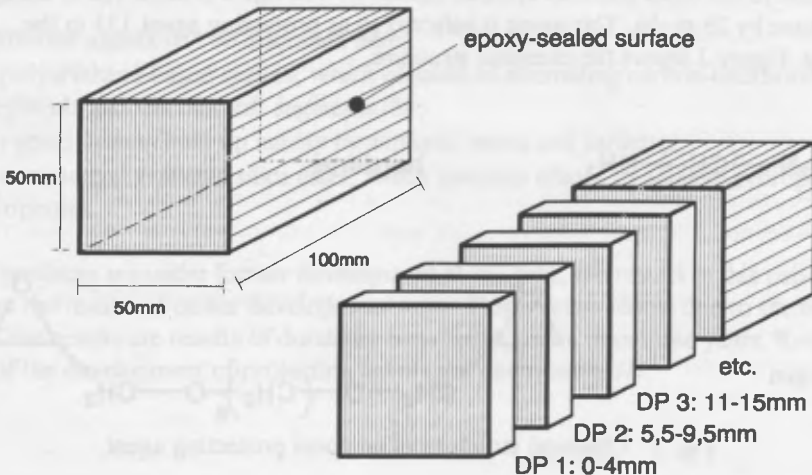

Fig. 3: Stone sample and its preparation into segments

These segments have the dimensions $4 \times 50 \times 50 \text{ mm}^3$, the contact angle measurements are carried out on the sawn surface by means of a goniometer microscope. For the measurements of the bending strength, discs of 45 mm diameter are prepared from the slices and biaxial bending tests are performed. Fig. 3 shows a stone sample and its preparation schematically.

3.2 Weathering

The artificial weathering is carried out in a complex weathering device described in a paper by B. Riecken and B. Schwamborn in this proceedings.

The natural weathering takes place at four different weathering stations in Europe, which represent different climates. The results presented in this paper refer to the weathering stations in Duisburg, Germany and Corsica, France /9/. These places stand for moderate, moist climate with high industrial pollution and warm, dry seaside climate, respectively.

4 SELECTED RESULTS AND DISCUSSION

4.1 Water uptake before and after weathering

The protecting agents 87 and 89, polyurethane and silica ester show different behaviour concerning the development of the hydrophobic properties under weathering on different stones. Four different stones are mentioned: Obernkirchener sandstone, OK, Sander Schilfsandstone, SS, Ebenheider sandstone and Krensheimer Muschelkalk, KM, a limestone. The first three mentioned sandstones vary mainly in their porous structure. The sandstones and the limestone differ in their type of binder, the sandstones being mainly set together by clay-type binder, the limestone by calcite-binder. The sandstones represent a neutral substrate ($\text{pH} \sim 7$), whereas the limestone is a basic substrate ($\text{pH} \sim 9$). Figure 4 shows the water-uptake of the different stones, treated with the hydrophobic silica ester 89 before and after one year of artificial weathering.

It is easy to be seen, that the weathering causes a degradation of the hydrophobic properties on all tested stones. The highest rate of degradation can be detected on the limestone. This is due to the well-known fact, that several siloxane hydrophobing agents, as present in the agent 89, are not durable on basic substrates /7/, which have a pH-value above about 9. The effect of a degradation of the hydrophobic properties is very low in the case of stones treated with the polyurethane agent 87. Figure 5 shows the water-uptake of the different stones, treated with the polyurethane agent 87 before and after artificial weathering in the same scale as Figure 4. The water uptake before weathering is in the same magnitude as the water-uptake of the agent 89-treated stones before weathering. On the sandstones there is no increase of water uptake after weathering, even a decrease is observed because of hardening reactions of the agent during the weathering. On the limestone it is detected, that the degradation of the hydrophobic effect is much smaller compared to that of the agent 89-treated stones after weathering. It can be concluded, that the „built-in“ hydrophobic parts of the polyurethane agent 87 are much more stable than „mixed-to“ hydrophobic agents in the case of the silica ester agent 89.

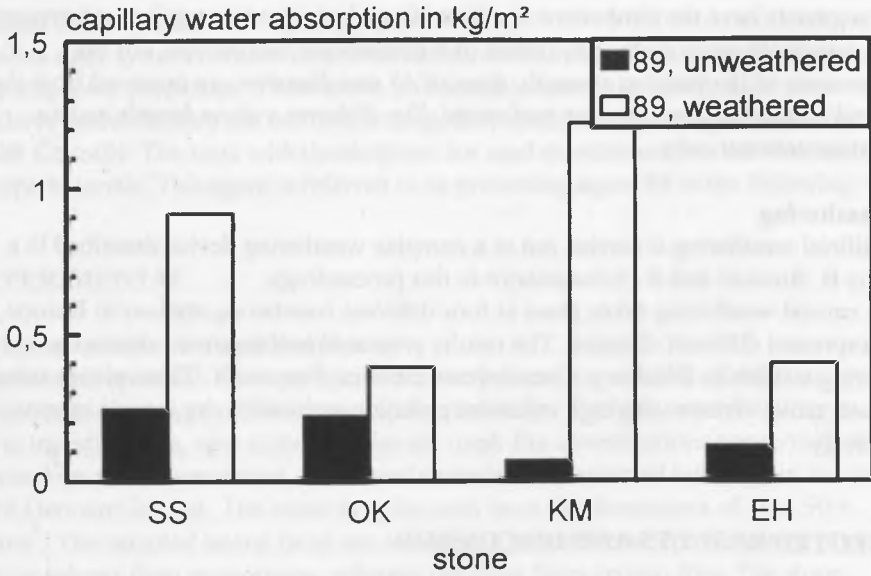

Fig. 4. Water-uptake of different sandstones SS, OK and EH and one limestone KM, treated with the hydrophobic silica ester 89, before and after artificial weathering

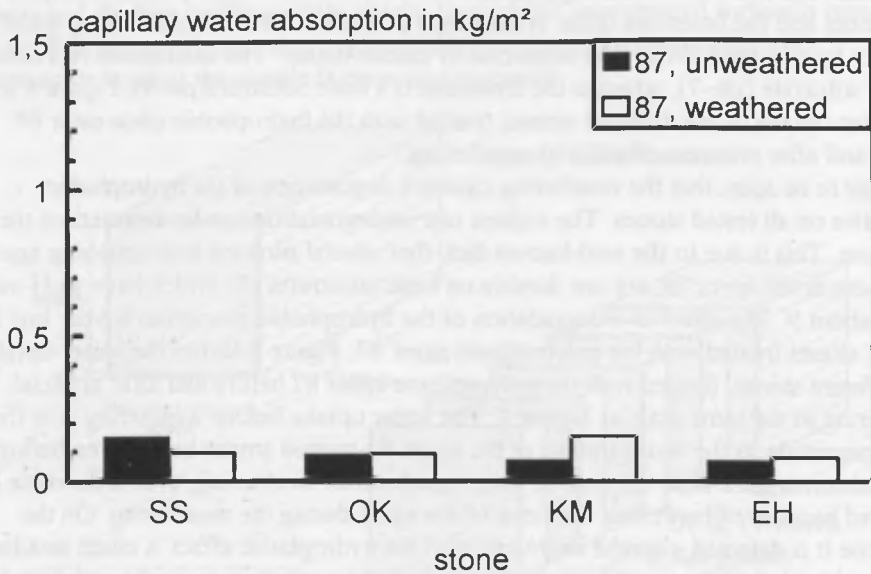

Fig. 5. Water-uptake of different sandstones SS, OK and EH and one limestone KM, treated with the the polyurethane agent 87, before and after artificial weathering.

4.2 Contact angle and bending strength of epoxide agent 133 before and after weathering

Looking at the hydrophobic properties of the epoxide agent 133 by the means of contact angle measurements on impregnated Ebenheider sandstone, it can be seen, that the agent is only weakly water repellent. Figure 6 shows the contact angle of a water drop versus the stone depth. The contact angle after laboratory storing (L 0) is about 50° on the impregnation surface of the stone, rapidly going down to zero in stone depth. After natural weathering for three years, there is hardly any contact angle above 0° detectable concerning the Duisburg weathering (F 1), and only very small contact angles concerning the Corsica weathering (F 2).

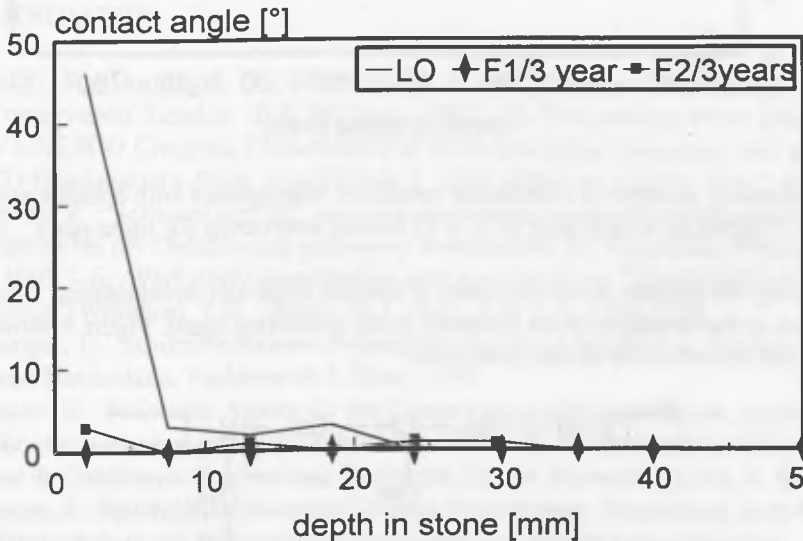

Fig. 6. Contact angle of Ebenheider sandstone impregnated with epoxide agent 133, before (L 0) and after (F 1; F 2) natural weathering for three years.

To get further information about the weathering effect on this epoxy-treated stones, bending strength measurements were carried out on unweathered and weathered samples. Figure 7 shows the bending strength of the samples after the above-mentioned weathering conditions L 0, F 1 and F 2. It can be seen, that the bending strength does not suffer under the weathering conditions F 2. The values are even higher than after laboratory storing. This can only partly be related to the higher bending strength of the untreated stone sample. The value in the diagram at 90 mm represents the untreated stone area, being higher than in the other samples in the untreated region. The weathering condition F 1 leads in contrast to F 2 to a decrease of the bending strength from 10 mm to the end of the impregnated stone depth. It is obvious that there are positive and negative influences from the climatic conditions.

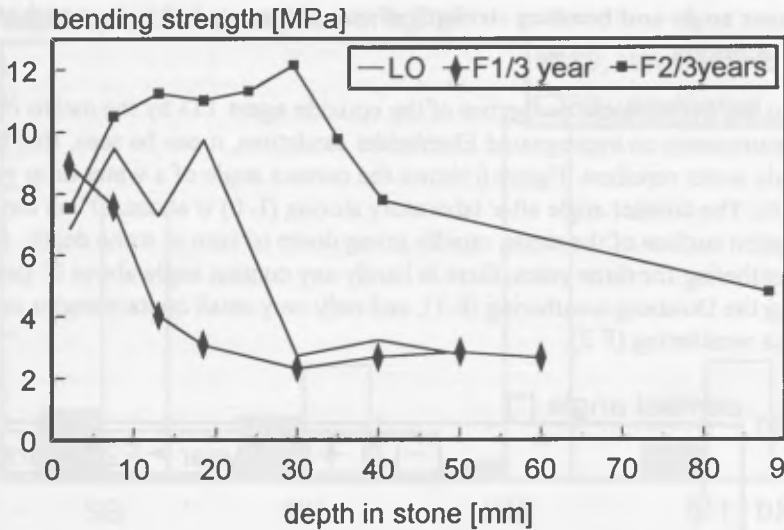

Fig. 7. Bending strength of Ebenheider sandstone impregnated with epoxide agent 133, before (L 0) and after (F 1; F 2) natural weathering for three years.

Investigating the reasons of the decreases of contact angle and strengthening, one has to take a look at the structure of the hardened stone-protecting agent. Figure 8 shows a cut-out from the net-structure of the epoxi-resin.

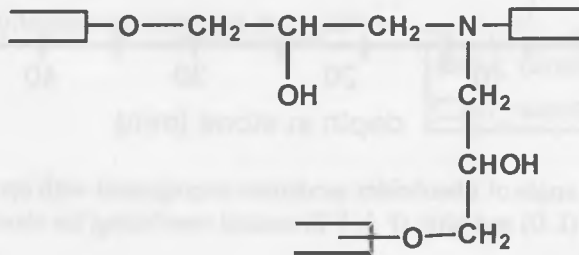

Fig. 8. Cut-out from the structure of the epoxi-stone protecting agent 133

The structure of the hardened resin has some spots of highly hydrophilic properties, which are the hydroxylic and the aminic groups. It was shown by Heßland /8/, that the agent swells extremely under the influence of low concentrated acids. This is not to be expected, because the resin has a relatively high degree of cross-linking. It can only be explained by protonation of the above mentioned groups. When protonation occurs, the cross-linking decreases caused by degradation reactions. Taking into account, that the wet industrial atmosphere in Duisburg, F 1, causes much more pollution by acids like SO_2 or NO_x , it is easily to be understood, that a degradation of the polymer, detected by decrease of the strengthening properties, takes place under this conditions in contrast to the dry warm atmosphere in Corsica, where some additional crosslinking may occur.

In consequence of the degradation reactions, the epoxy protecting agents were modified/4/. They now contain mainly aromatic, bisphenol-A-like structures. By this modification the values of water-uptake and swelling are minimized, so that the main reason for the degradation reactions is eliminated.

5 ACKNOWLEDGEMENT

The experiments were sponsored by the Federal German Ministry for Research and Development. Detailed information is available under the work number BAU 5014M.

6 BIBLIOGRAPHY

- /1/ Sasse, H.-R. ; Honsinger, D. ; Schwamborn, B.: "PINS" - New Technology in Porous Stone Conservation. London : E & FN Spon, 1993. - In: Proceedings of the International RILEM/ UNESCO Congress Conservation of Stone and Other Materials, held at UNESCO Headquarters, Paris, June 29-July 1, 1993 (Thiel, M.J.(Ed)), Vol 2, S. 705-716
- /2/ Littmann, K. ; Schwamborn, B.: Anwendung mikroskopischer und makroskopischer Prüfverfahren bei der Optimierung polymerer Schutzstoffe für Naturstein. Ehningen : Expert, 1993. - In: Werkstoffwissenschaften und Bausanierung, Tagungsbericht des 3. Int. Kolloquiums, (Wittmann, F.H. ; Bartz, W.J. (Ed)), Teil 3, S. 1763-1772
- /3/ Honsinger, D.: Strukturmerkmale Polymerimprägnierter Sandsteine. Aachen, Technische Hochschule, Fachbereich 3, Diss., 1990
- /4/ Littmann, K.: Polymeric Agents for the Conservation of Natural Stone. Augsburg : Verlag für chemische Industrie H. Ziolkowsky, 1994. - In: ConChem International Exhibition & Conference Proceedings, Karlsruhe, 22.-24. November 1994, S. 521-530
- /5/ Wagener, S.: Feuchtigkeitshärtende Urethan-Prepolymere: Beurteilung ihrer Eignung für den Bautenschutz mit Hilfe polymerchemischer und oberflächenanalytischer Untersuchungen. Aachen, Technische Hochschule, Fachbereich 1, Diss., 1992
- /6/ Höcker, H.; Littmann, K. ; Sasse, H.-R. ; Wagener, S.: Development of Polymers for the Consolidation of Natural Stone. London : E & FN Spon, 1993. - In: Proceedings of the International RILEM/ UNESCO Congress Conservation of Stone and Other Materials, held at UNESCO Headquarters, Paris, June 29-July 1, 1993 (Thiel, M.J.(Ed)), Vol 2, S. 681-688
- /7/ Roth, M.: Silicate - Siliconharze - Silane - Siloxane : Silicon-Bautenschutzmittel für die Oberflächenimprägnierung von mineralischen Baustoffen. In: Baugewerbe 62 (1982), Nr. 2, S. 38-42
- /8/ Heßland, A.H.H.: Epoxidharze und ihre Eignung für den Bautenschutz : Oberflächenanalytische Charakterisierung und Quellverhalten. Aachen, Technische Hochschule, Fachbereich 4, Dissertation, 1991
- /9/ Littmann, K. ; Riecken, B. ; Sasse, H.R. ; Schwamborn, B.: Neuentwickelte polymere Tränkstoffe in realitätsnaher Prüfung. Berlin : Ernst & Sohn, 1993. - In: Jahresberichte Steinerfall - Steinkonservierung Band 3 - 1991, (Snethlage, R. (Ed)), S. 85-94

METHOD FOR ASSESSING LIQUIDS FOR THE REMEDIAL TREATMENT OF RISING DAMP

L. MAO and D. KAGI

Department of Chemistry and Biology, Victoria University of Technology,
Melbourne, Australia

Abstract

A test method for assessing liquids for the remedial treatment of rising damp in monuments was developed in the course of an investigation to develop aqueous solutions to treat rising damp in porous building materials. Several water-based and organic solvent-based liquids such as a methyl silicate, a microemulsion and solutions of silicones were tested on bricks and mortar by using this method. A novel solution was developed which performs satisfactorily under these test criteria.

Keywords: Rising Damp, Test Method, Bricks, Mortar, Water-based.

1 Introduction

In order to develop a method to evaluate the efficacy of liquid materials for the installation of a damp-course in the conservation practice of remedial treatment of rising damp in porous building materials in monuments, the researcher is faced with many problems. The real walls exhibiting rising damp are complex and different. That is, the wall may be composed of different materials - bricks, mortar, sandstone, limestone etc. In brick walls, each brick in each wall may be a different substrate in terms of reactivity with liquids and different walls have completely different brick substrates. The mortar may be a different composition and age. The pH of the wall and the substrates in the wall may be different from one wall to another. In addition, the level of water saturation and salt contamination may be different. Salt type may also be different. The selection of real walls to initially test liquid materials and obtain meaningful results is a difficult task. In addition, there is the delivery system of the liquid to the wall substrates to consider. This may be either by transfusion or pressure injection.

The experimental problems can be partially overcome by developing a method involving medium-scale model walls. However, even with confining experiments to model walls, the variables are many and the experimental work to obtain meaningful results is vast. To overcome and classify these variables, we have chosen to develop a method based on small-scale isolated building materials in order to test liquid materials. In the course of this method

investigation we have developed a novel water-based solution which we have compared by this test method with available water-based materials and a solvent-based material. Other workers have undertaken methods for the evaluation of liquids for the remedial treatment of rising damp. In particular, a test procedure to assess a silicone microemulsion on single bricks has been published (Roth, 1993).

Rising damp is a common problem causing deterioration of walls in historic buildings. In the remedial treatment of rising damp, the organic solvent-based silane/siloxane materials have given satisfactory results in practice (Schamberg and Fritsch, 1986). However, the environmental and the physiological effects of organic solvents are causing increasing concerns. In addition, organic solvents are flammable and expensive. These major deficiencies of solvent-based materials justify the increasing demand for water repellent materials which may be delivered to the substrate in water where the performance of the treated substrate is similar to that achieved with organic solvent-based materials.

An experimental method of testing damp-proof materials on porous building materials was developed, together with a novel water-based material for treating rising damp. The design of such an experimental method was aimed at simulating in the laboratory the conditions of the natural process of rising damp before and after the remedial treatment. This would enable the performance of various water repellent materials to be evaluated. As the work was carried out in Australia, the simulation of the conditions was oriented towards a simulation of conditions prevailing in Australia in walls exhibiting rising damp. A survey of walls exhibiting rising damp in Melbourne and Sydney showed most walls to be bricks and mortar with the pH of the walls in the range between 8.2 and 9.6. The level of water saturation was found to be less than 50% and on average 30%. In the test method presented herein the technique of transfusion or impregnation rather than pressure injection was examined.

2 Brief review of water-based damp-proof materials

Water-based water repellent materials have been available for years. Up to now a number of ways have been found whereby silicone materials can be made either dissolved or dispersed in water. These materials are siliconates, silicone emulsions and microemulsions. Silicone emulsions may be silane/siloxane mixtures dispersed in water by surfactants. If applied to building materials, the emulsions tend to separate on the surface, leaving silane/siloxane active ingredients near the surface. Although silicone emulsions may be used in surface treatment, it is not appropriate to use such materials in the remedial treatment of rising damp due to the lack of penetration of the active materials. Alkali metal methyl siliconates which are miscible with water in any desired proportion have not been generally successful in treating rising damp in Australia. Apart from being alkaline and corrosive, siliconates may not impart water repellency in the absence of carbon dioxide (Roth et al., 1972). Microemulsions are a newly developed

approach to cope with these difficulties (Roth, 1993; Roth and Bernbacher, 1992). However, the materials are expensive, and an alkaline substrate is necessary for unfolding the water repellent effect.

3 Experimental methods

3.1 Preparation of brick samples

The bricks of interest to this research are those found within old walls which exhibit rising damp. In general, these bricks are porous and permeable. However, each brick may be an inherently different substrate in terms of properties. It is not possible to collect these bricks from walls with rising damp. To deal with this experimentally, old hand-made bricks were collected and the bricks used for the tests were selected for their high permeability. Each brick was cut into four portions shown as the dotted lines in Fig. 1. The four aliquots were subjected to a water absorption test aimed at eliminating impermeable bricks. Apart from the moisture level which may be variable, these four aliquots obtained from one brick were inherently identical in moisture absorption characteristics.

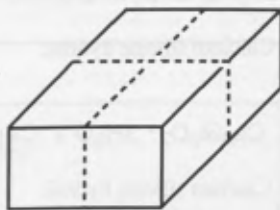

Fig. 1. Cutting configuration of brick sample.

After the bricks were cut, the four aliquots of each brick were then immersed in water for 24 hours to allow the substrates to become fully saturated with water. After they were weighed for their wet mass, they were then dried in an oven at 100°C. These samples were then cooled in air followed by weighing again to obtain the dry mass. After the wet and dry mass of each sample was known, partially saturated mass was then calculated accordingly (Equation 1). Apart from the dry substrates used in the test, the partially saturated

$$m_{25\% \text{ (or } 50\%)} = (m_{\text{wet}} - m_{\text{dry}}) \times 0.25 \text{ (or } 0.5) + m_{\text{dry}} \quad (1)$$

samples were prepared at discrete levels of approximately 25% and 50% respectively to simulate the conditions in Australian walls. Before the preparation started, the mass of 25% and 50% of saturation of each sample was calculated, together with the dry and wet mass. These permeable bricks were subjected to the next stage where bricks at 0%, 25% and 50% of saturation were prepared by drying or adding additional water to the desired levels, and then wrapping in polyethylene bags for at least 2 days to achieve equilibration.

3.2 Preparation of mortar samples

In contrast to the collection of permeable bricks, mortar samples present a different problem. Mortar is often a layer bonded on the surface of the bricks, so it is very difficult to obtain samples of a size large enough to be useful in the test. In addition, the fragility of mortar in a wall exhibiting rising damp poses further problems in the handling of samples. Therefore, the mortar samples have to be produced in the laboratory rather than be collected from damp walls.

Unlike bricks, the composition of mortar is somewhat consistent. Sand and carbonated lime are commonly found in old mortars along with cementitious materials. As Portland cement is one of a few inorganic binders which does not disintegrate in water, the addition of Portland cement and carbonated lime powder as binding agents to sand is necessary in mortar sample preparation to hold the sample together. When the mortar samples for tests were prepared, bricklayer's sand, limestone powder, and Portland cement were mixed together. Experiments showed a minimum of 2% cement by weight has to be incorporated in the sand and carbonated lime mixture to yield a desirable binding effect. Apart from the calcium silicate which leads to the formation of

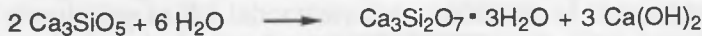

Tricalcium silicate

Calcium silicate hydrate

(2)

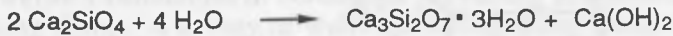

Dicalcium silicate

Calcium silicate hydrate

the binding effect, the hydration of cement produces calcium hydroxide (Equation 2). When cement is mixed with water, the slurry is highly alkaline. However, in an old wall exhibiting rising damp, the excessive alkali (calcium hydroxide) produced from lime and cement has been completely neutralised through the process of carbonation as a result of long-term water rise and aeration (Equation 3). In addition, the rise of ground water contributes to the

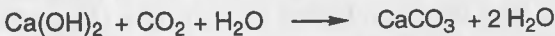

Calcium hydroxide

Calcium carbonate

(3)

decline of alkalinity. A survey has been conducted and shows the pH of mortar in damp walls in Melbourne lies between 9.2 to 9.6 and in Sydney the pH lies between 8.2 to 8.8. If mortar prepared in the laboratory is expected to be equivalent to that found in a wall exhibiting rising damp, the pH of the mortar would have to be controlled between 8.2 and 9.6. However, the occurrence of carbonation in a damp wall is a very slow process and the manipulation of pH by carbonation is difficult in the laboratory. To achieve neutralisation at the interior of the sample, acids were incorporated in the final mix for the preparation of samples. The choice of acids is critical with regard

to the resulting mortar sample. Strong acids can react with calcium silicate as well as neutralising the excessive alkali. In contrast, weak acids may neutralise the alkali leaving the calcium silicate intact. This principle has been demonstrated in the nature of carbonation of mortar in a damp wall. If the result of the addition of the acid is to be similar to carbonation, the acid must possess comparable acidity to carbonic acid. Amongst a number of inorganic acids, calcium tetrahydrogen diphosphate has a mild acidity (pKa 7.21) close to carbonic acid (pKa 6.37). In this regard, the addition of the acid will not lead to disintegration of the binder. In addition, the incorporation of calcium tetrahydrogen diphosphate does not contribute undesired salinity to the mortar sample because the neutralisation product is calcium hydrogen phosphate which is insoluble in water.

Bricklayer's sand, limestone powder, Portland cement, calcium tetrahydrogen diphosphate and water were the ingredients in the preparation of the mortar. The relative proportions of these materials in the preparation is illustrated in Table 1 and were kept constant except that the proportion of calcium tetrahydrogen diphosphate was varied to correspond to the desired pH. The mixing of these materials followed a sequence in which sand, water

Table 1. The composition of prepared mortar samples

Material	Weight in Each Batch
Sand	20.0 kg
Limestone Powder	5.0 kg
Cement	500.0 g
Calcium tetrahydrogen diphosphate	400.0 g (pH 9.6) or 600.0 g (pH 8.2)
Water	6.0 kg

and Portland cement were mixed into a slurry first, followed by the phosphate which was added after one hour. Limestone powder was then incorporated and mixed thoroughly. After the final mix was prepared, the slurry was poured into a frame (115x80x30mm) for casting. After the frame was removed, the sample was covered with polyethylene film for four weeks to achieve complete hydration of the cement. These samples were then dried at 100°C in an oven followed by cooling in air.

Mortar samples were prepared by the above procedure and the samples prepared from one batch possessed identical characteristics. To simulate rising damp in walls, the substrates must be partially saturated with water before and after treatment with the damp-proof liquid. After the treatment with damp-proof materials, results can be compared one to another provided their moisture levels are at the same level. To prepare these partially saturated samples, a simple way is to add equal percentages of water into the samples to obtain samples with equal moisture levels. It was established that for mortar samples the maximum water absorption was 14% of the dry weight of a mortar sample. By immersing mortar samples in water until the weight increased by

0.035 or 0.070 of their dry weight, samples at a moisture level of 25% and 50% of saturation were prepared respectively. These samples were wrapped in polyethylene bags for at least two days before the treatment was conducted to effect equilibration.

To further simulate conditions in damp walls, the sample bricks and mortar may be impregnated with salt mixtures. However, it must be recognised that the concentration of salts in normal damp walls is not very high at the point of application of liquid for damp-proof course installation. The variables of salt type and concentration were not examined comprehensively in this study. However, preliminary results showed that the low level of salt contamination which occurs in the bricks and mortar of damp walls would not affect the following results appreciably.

3.3 Treatment of brick and mortar samples with damp-proof materials

The transfusion or impregnation of liquids into substrates rather than pressure injection was examined for these samples. Only four liquid materials may have their performance compared on bricks at one time due to there being a limit of four aliquots from one brick. However, with mortar samples, the number of identical substrates is not limited. When the moisture level of samples had equilibrated, each sample was weighed and then placed in a Petri dish containing 25 g of a solution or an emulsion. The time of impregnation was determined as when the first sample had completely absorbed the liquid. When the one sample had imbibed its solution or emulsion completely, the impregnation of the rest was also ceased along with the first one regardless of the remaining liquid. Each sample was then weighed again and absorption rates of different liquids may be compared. The impregnated samples were wrapped in polyethylene film and left in the air. The water repellent effect usually developed over one week.

The drying of treated samples is considered to be the most important stage in simulating in the laboratory the treatment of a damp wall. Treated samples in the laboratory must be placed in an environment comparable to the conditions experienced by bricks and mortar in a damp wall. The performance of the different damp-proof liquids in the presence of water in the substrates was compared by keeping the four aliquots of one brick or the mortar samples at equal moisture levels. In treatments with solvent-based materials, the addition of solvents contributes no additional moisture to the damp wall. Before the water repellency is unfolded, the moisture in the masonry stays at a constant level while the solvent evaporates and migrates. After the bricks and mortar were treated with solvent-based materials, the samples were wrapped completely with polyethylene film and left in the air with the treated side down. The wrapping with film was to emulate the condition in a treated damp wall. This treatment allowed the solvent to evaporate slowly without losing water from the substrate. The drying time was set at one week for solvent to evaporate before these samples were unwrapped for the water absorption test.

With respect to water-based liquids, the equilibrium between water rise and evaporation is no longer in place when aqueous liquids are delivered to the masonry. Water rise comes to a halt due to the upper layers of the bricks and

mortar being more saturated with water. The loss of water through migration and evaporation will persist for a period of time until water starts to rise again. In simulating such an event, the treated samples were wrapped with polyethylene film. However, the side opposite the treated side was left unwrapped. Upon exposure of this one side to the air, the samples dried slowly. The drying time of the samples of brick and mortar were set at one week before unwrapping. However, for 25% and 50% saturated brick and mortar samples, because the moisture lost through evaporation is critical as regards to simulating damp walls, the weight of each sample was monitored daily and the drying stopped when the weight declined to the level presiding in the sample before the impregnation. In the case of samples which lost this weight in less time than a week, the samples were then wrapped entirely to stop additional water evaporation.

3.4 Evaluation of damp-proof effect

When the samples were unwrapped, they were placed on a water-saturated sponge with the treated side up. Under such conditions, water may evaporate as well as rise. After several days of standing on the sponge, the weight of the samples tended to stabilise. It was visually evident whether the treated portion of the sample was achieving drying under these conditions. To evaluate the damp-proof effect each brick or mortar sample was broken vertically and the beading effect together with the depth of penetration of the water repellent liquid in the substrate was examined.

In the evaluation of the water repellency of a capillary surface, the assessment of the beading effect has been widely accepted as an effective approach (Schamberg et al., 1992). The contact angle of a drop of water on the substrate surface clearly displays the hydrophobicity of the surface, which in turn can be used as an indication of the effectiveness of the water repellency. In the assessment of the damp-proof effect of different liquids, the measurement of contact angle is not necessary. Water repellency may be expressed as the result of the beading effect as detailed in the established grade (Table 2). According to the grade, the beading effect measurement should be conducted on a dry substrate. In the present case, the assessment of the damp-proof effect must be made according to the surface beading effect with water present in the substrates. This assessment is valid when the presence of water in the substrate has been stable as a consequence of moisture evaporation and capillary rise achieving equilibrium. The measurement of beading effect is subject to the water repellent effect due to the liquid which has been absorbed and the presence of water in the substrate. Under such circumstances, substrates with good water repellency have little water remaining inside the substrate whereas substrates with poor water repellency have a high level of residual water.

Apart from the beading effect, the depth of penetration is of particular importance in the remedial treatment of rising damp. Potential damp-proofing liquids are expected to penetrate deeply into the interior of the substrate to impart water repellency thereto. The depth of penetration refers to the measurement of how far the water repellent effect extends into the substrate. To estimate the depth of penetration, drops of water were added onto the exposed

Table 2. Grade in beading effect measurement

Grade	Beading effect	Water drop on substrate surface
1	Excellent	no wetting of the surface
2	Good	slight wetting of the surface
3	Fair	wetting of the surface
4	Bad	water drop partly absorbed
5	No effect	no water drop formed or absorbed within 5 minutes

surface of the broken sample. The beading effect of the droplets on the surface produces evidence as to the depth of the water repellent effect. The depth of penetration is recorded as the average of penetration depths measured from several different positions on a substrate.

4 Results and Discussion

The brick and mortar samples at their various moisture levels were prepared. The comparison between several different liquid products were made on the basis that the substrates were identical in composition as well as identical in their moisture levels. To meet the criteria, the number of impregnating liquids which can be compared each time on one substrate is limited by the number of prepared identical substrates. For brick substrates which were cut into four aliquots from one brick, a maximum of four impregnating liquids were able to be compared when these four aliquots were equal in moisture level. For mortar substrates, the number of impregnating liquids is not subject to such a limitation.

In the remedial treatment of rising damp, the use of a silane/siloxane (Wacker 290) has been successful in practice in Australia whereby 5% Wacker 290 in aliphatic hydrocarbon solvent (the following concentrations are all by volume) is sufficient to install a horizontal water repellent layer in damp walls by a transfusion method. In the laboratory, substrates were treated with 5% Wacker 290 or with water-based liquid water repellent materials. Wacker 290 provides a guideline for the performance of both solvent-based and water-based damp-proof materials to be evaluated. The comparison of these results infers the possibility of using these liquid materials in the treatment of rising damp. Materials expected to treat rising damp effectively should produce similar results to Wacker 290 when these materials are tested on mortar and bricks under equivalent experimental conditions.

Wacker 290 contains a tin catalyst. It was found in this study that without such a tin catalyst, solvent-based materials exhibited difficulty in depositing on wet capillary surfaces. This was possibly due to the fact that the condensation reaction is inherently reversible (Equation 4). The addition of curing agents such as tin catalyst will impart a cured surface film.

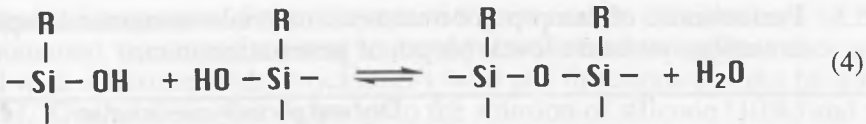

In the development of water-based damp-proof materials, the commercial products potassium methyl silicate (Wacker BS 15) and silicone microemulsion (Wacker 550) were tested on brick and mortar substrates along with the Wacker 290 solvent-based solution, and a novel aqueous silicone solution developed at Victoria University of Technology (Kagi et al., 1994). The dry and partially wet substrates were treated with impregnating liquids composed of 5% Wacker 290 in aliphatic hydrocarbon solvent, 20% Wacker BS 15 in water, 20% Wacker 550 in water and a 10% solution of the silicone in water respectively. In the experiments, the level of water present in the brick and mortar substrates was 0% (air dry), 25%, 50% and 70% of saturation respectively. In addition to the moisture level prior to the treatment, the drying process after treatment with the water-based liquid is important. The difference in drying methods as discussed above allowed the treatment with water-based materials to be compared with solvent-based treatment. On completion of the tests, the results for Wacker 290 were used as a guideline in judging the performance of the water-based materials.

The test results for mortar substrates (Table 3) showed consistent and reproducible results. The choice of mortar of pH between 8.2 and 9.6 makes no marked difference to the performance of the damp-proof materials. A high level of moisture in the mortar makes water-based damp-proof treatment more difficult than solvent-based materials. The Wacker 290 performed well and exhibited the aquaplane effect (Roth, 1987) where increased penetration was shown in 25% and 50% saturated mortar compared to a dry substrate. Wacker 550 microemulsion separated into its oil and water components under certain conditions. The water-based silicone solution performed well except in very wet conditions.

For brick substrates chosen for their high permeability, a number of bricks were subjected to the tests. The tests using Wacker 290 in brick substrates showed consistent, satisfactory results probably partly due to the presence of a tin catalyst. The brick substrates showed erratic results for the water-based liquids. In many cases the substrate became water repellent on treatment with the water-based liquids. However, these effects were erratic and not predictable from one brick substrate to another. This was probably due to the different surface activity (Janning et al., 1986) and the pH of the brick substrates. Such a result has been reported for the microemulsion (Wacker 550), where on non-alkaline bricks the water repellent effect does not develop (Roth and Bernbacher, 1992). An alkaline pre-treatment was suggested to overcome this problem. For the water-based silicone solution the ideal pH for film-forming on the capillaries is between 8 and 9 and the bricks were of variable pH, some being pH below 7. However, in practice this film-forming problem for the silicone solution in Australian walls exhibiting rising damp may not be of significance as the capillaries of the bricks may be lined with carbonated lime from the mortar lines. This has been confirmed for

Table 3. Performance of damp-proof treatment materials on mortar samples at various moisture levels (depth of penetration in cm)

Dry and partially wet mortar				
	Wacker 290 5% v/v	Wacker 550 20% v/v	Wacker BS 15 20% v/v	Solution 10% v/v
1	saturation of water dry depth of penetration 4.5±0.5 beading effect excellent	dry 7.2±0.1 excellent	dry 6.5±0.1 excellent	dry 8.3±0.1 excellent
2	25% saturation of water depth of penetration 11.0±0.1 beading effect excellent	25% 6.0±0.2 excellent	25% 7.0±0.5 excellent	25% 8.5±0.5 good
3	50% saturation of water depth of penetration 11.0±0.2 beading effect excellent	50% 4.0±0.5 excellent	50% 7.0±0.1 poor	50% 7.0±0.1 good
4	70% saturation of water depth of penetration 9.0±0.2 beading effect fair	70% 2.0±0.5 fair	70% 7.0±0.5 bad	70% 8.5±0.5 bad

isolated bricks from walls exhibiting rising damp and for trials in real brick walls. The occurrence of calcium carbonate in the damp brick layer results from long-term water rise in the walls. The carbon dioxide in water can solubilise calcium carbonate in water by forming calcium hydrogen carbonate (Equation 5). The reaction is reversible and the calcium carbonate may precipitate. Although such a process is very slow, over a long period of time of water rise a thin layer of calcium carbonate may deposit on the capillary surface of the bricks above the mortar. This creates a consistent and active substrate together with an ideal pH for the water-based solution of silicone to unfold the water repellency.

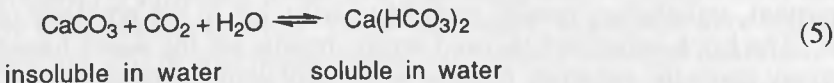

Despite the appearance that the water-based materials Wacker BS 15 and Wacker 550 produce a good beading effect on mortar, both exhibited problems in the depth of penetration. The performance of the methyl silicate at various moisture levels was investigated on brick and mortar substrates. Results were conclusive that a low depth of penetration of silicate occurred when substrates were dry. This poses problems as the moisture level in Australian walls varies from dry to 50% even in the same damp wall. In this regard, the solution of silicone developed was superior to Wacker BS 15 in penetrating dry mortar substrates. In particular, the depth of penetration of the aqueous solution exceeds Wacker BS 15 considerably over a longer period of time when the silicone solution continues to migrate

whereas the migration of the siliconate solution ceases. To illustrate such a phenomenon, a comparison test was conducted where two glass tubes were filled with a mixture of dry bricklayer's sand and limestone powder (at a ratio of 4:1). One of these was dipped into the solution of silicone (10%) and the other into the Wacker BS 15 solution (20%). The distance the solutions rose was plotted versus time (Fig. 2). The distance achieved by the solution of

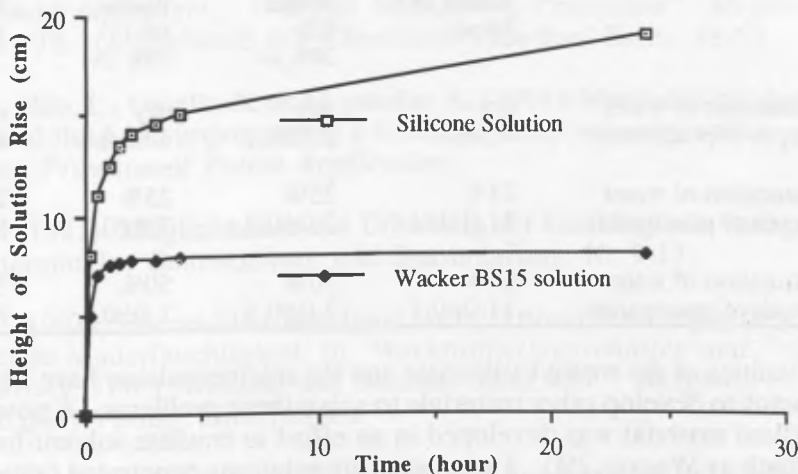

Fig. 2. Comparison of Wacker BS 15 in water (20%) and the silicone solution (10%) through capillary rise.

silicone was around twice that of the siliconate solution. It is considered that dry substrates promote reaction of the siliconates on the capillary surface with the result that the mineral substrates become less permeable toward the aqueous solution. The presence of water in the substrate may reduce the reaction rate on the capillary surface thereby allowing the siliconates to penetrate further. The solutions of silicone react slowly on mortar substrates leading to penetration depths not greatly influenced by the presence or absence of moisture in the substrates.

With regard to the depth of penetration, the microemulsion exhibited a problem. Apart from the low depth of penetration, the results showed that the silane/siloxane travels slower than the water phase of the microemulsion when the microemulsion is delivered into porous building materials. Such an effect was clearly observed when the substrates were treated with the microemulsion and then dried in air immediately after the impregnation took place (Table 4). The penetration depth of the active water repellent material of Wacker 550 was only half the penetration of the liquid into the substrate. This separation of active materials and the aqueous phase is detrimental to the required result in the remedial treatment of rising damp.

Table 4. Depth of penetration of damp-proof treatment materials on mortars after impregnation followed by drying of samples in the air (depth of penetration in cm)

		Dry and partially wet mortar			
		Wacker 290 5% v/v	Wacker 550 20% v/v	Wacker BS 15 20% v/v	Solution 10% v/v
1	saturation of water depth of penetration	dry 4.5±0.1	dry 2.0±0.1	dry 6.0±0.1	dry 8.5±0.1
2	saturation of water depth of penetration	25% 11.0±0.1	25% 2.0±0.2	25% 7.0±0.1	25% 8.5±0.1
3	saturation of water depth of penetration	50% 11.0±0.1	50% 2.0±0.5	50% 7.0±0.1	50% 8.5±0.1

The difficulties of the methyl silicate and the microemulsion have been the major impetus to develop other materials to solve these problems. A novel water repellent material was developed in an effort to emulate solvent-based materials such as Wacker 290. These aqueous solutions penetrated faster than microemulsions in porous building materials without the occurrence of separation. The solutions reacted slowly on the mortar substrates, unfolding good water repellency as well as recording a high depth of penetration. In the treatment of damp substrates, the solutions were able to impart good water repellent effects on mortar substrates, comparable with the results of Wacker 290 solvent-based solutions (Table 3 & Table 4).

5 Conclusions

A test method using bricks and mortar was developed to compare the water repellent effect of liquids for production of a damp-course in substrates. The test results for mortar substrates showed reproducible results. The solvent-based solution of Wacker 290 which contains a tin catalyst performed well and exhibited the aquaplane effect where increased penetration was shown in 25% and 50% saturated mortars over dry substrates. Wacker BS 15 had difficulty on dry substrates and very wet substrates. The Wacker 550 microemulsion had difficulty in terms of penetration depth (rate of penetration) and the microemulsion separated in drier substrates. The water-based silicone solution performed satisfactorily in the test on mortar except at very high levels of moisture. The results for bricks were erratic. This may be explained as a film-forming effect on surfaces with different activity and pH. However, in practice this film-forming problem for the silicone solution in Australian walls exhibiting rising damp may not be of significance as the capillaries of the bricks may be lined with carbonated lime as a result of long-term water rise through the mortar lines. The occurrence of calcium carbonate migration has been confirmed for isolated bricks from walls exhibiting rising

damp and for trials in real brick walls where the brick substrates treated with the water-based silicone solution became water repellent satisfactorily.

6 References

Janning, F., Marschner, H., Rödder, K.-M., Roth, M. and Schamberg, E. (1986): Water repellent treatment of natural stones using silicon-organic chemicals. In "*Goldschmidt informiert.... 1/86 No. 64 Building Protection*". Meyer-Galow E. Editor. Th. Goldschmidt AG, Chemische Fabriken, Essen, 48-59.

Kagi, D., Mao, L., Caselli, A. and Lysenko, A. (1994): Method of producing a water-based fluid and impregnating a course in damp masonry walls. *Australian Provisional Patent Application* .

Roth, M. (1987): Möglichkeiten zur Erhöhung der Eindringtiefe von Imprägniermitteln. *Bautenschutz und Bausanierung*, 10, 9-13.

Roth, M. (1993): Silicon-Microemulsion als Injektionsmittel gegen die aufsteigende Mauerfeuchtigkeit. In "*Werkstoffwissenschaften und Bausanierung, Teil 1, Kontakt und Studium Band 420.*" Wittmann F. H. Editor. Expert Verlag, Sindelfingen.

Roth, M. and Bernbacher, R. (1992): Verfahren zur wasserabweisenden Imprägnierung von Mauerwerk. *European Patent 0518324A1*.

Roth, M., Bosch, E., Braunsperger, K., Gluck, H. and Pirson, E. (1972): Rendering surfaces hydrophobic. *U.S. Patent 3955985*.

Schamberg, E., and Fritsch, H. (1986): A silicone treatment to prevent rising damp. In "*Goldschmidt informiert.... 1/86 No. 64 Building Protection*". Meyer-Galow E. Editor. Th. Goldschmidt AG, Chemische Fabriken, Essen, 69-71.

Schamberg, E., Koerner, G., Fritsch, H., Grasse, M. and Sucker, R. (1992): Preparation for the water-repellent impregnation of porous mineral building materials. *U.S. Patent, 5091002*.

MODULATION OF STRUCTURAL AND STONE PROTECTIVE PROPERTIES OF FLUORINATED METHACRYLATE POLYMERS

U. MATTEOLI¹, M. AGLIETTO², V. FASSINA³, C. BOTTEGHI¹,
E. PASSAGLIA² AND F. CIARDELLI²

¹ Dipartimento di Chimica, Università di Venezia, Venezia (Italy)

² Dipartimento di Chimica e Chimica Industriale, Università di Pisa, Pisa (Italy)

³ Laboratorio Scientifico della Soprintendenza ai Beni Artistici e Storici,
Venezia (Italy)

Abstract

Fluorinated methacrylic polymers can combine good coating properties of acrylic materials with excellent stability and water impermeability of fluoro-containing organic products. In this connection novel systems are presented as those based on homopolymers of partially fluorinated methacrylates or of methyl (α -trifluoromethyl)acrylate. These systems show interesting photostability and good impermeability against liquid water even with a low content of fluorinated side chains. The good protective properties and stability are probably associated to the phase segregation of different units with organization on the external surface (air interface) of fluorinated side chains in order to minimize surface energy. On the other side the possibility of varying composition to a large extent can be used to change glass transition temperature thus allowing to control the thermomechanical properties of the protective film applied to the stone.

The photostability, water repellency and surface protection of the treated stones were determined according to the methods proposed by the NORMAL Subgroup. The obtained results indicate the validity of the cited methods also for evaluating the innovative materials described in the present work.

Keywords: Fluorinated Polymers, Photostability, Water Capillary Absorption, Protection Efficiency.

1 Introduction

New polymeric materials for the protection of monumental stones have been prepared by partial replacement of hydrogen atoms with fluorine atoms in the side chains of common acrylic polymers used in the past for the same

purpose (Biscontin et al., 1991). The new polymers are characterized by a higher stability towards thermal changes and photooxidative reactions and by improved impermeability versus liquid water (Botteghi et al., 1992).

Starting with methacrylate monomers having the general structure (I) it has been possible to introduce various modifications by replacing hydrogen atoms with fluorine in the side chains (Botteghi et al., 1992; Aglietto et al., 1993; Fassina et al., 1994).

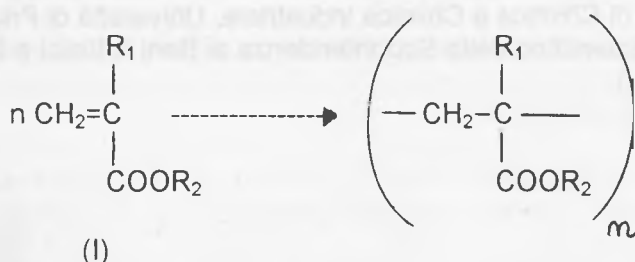

$\text{R}_1 = \text{CF}_3$, $\text{R}_2 = \text{CH}_3$: MTFMA; $\text{R}_1 = \text{CH}_3$, $\text{R}_2 = \text{CH}_2\text{CF}_3$: TFEM; $\text{R}_1 = \text{CH}_3$, $\text{R}_2 = \text{CH}_2\text{CF}_2\text{CF}_3$: PFFPM.

As far as these last are concerned, different structures can be envisaged depending on the length, the branching and the fluorine content of the R_2 group. Finally additional possibilities are offered by copolymerization of the monomers (I) with various non fluorinated monomers which allows to have a variable loading of the fluorinated monomeric units as well as a different distribution along the chain.

Standing the large number of existing possibilities for the production of polymeric materials with a wide range of content and distribution of fluorine atoms along the chain, it was important to compare the behaviour of affordable fluorinated polymers of varied structure with the corresponding non fluorinated analogues. This work accordingly describes a comparison among Paraloid B72 (Charola et al., 1985; Fassina et al., 1987) and polymers of 2,2,2-trifluoroethylmethacrylate, 2,2,3,3,3-pentafluoropropylmethacrylate or methyl (α -trifluoromethyl)acrylate. In order to gain more information the comparison has been extended also to a commonly used polyalkylsiloxane product (Rhodorsil 224). The experimentation has been accomplished treating stone samples of various lithotypes and evaluating the behaviour of the new polymeric materials by the methodology proposed by the NORMAL Subgroup (Many Authors, 1993).

2 Materials and techniques

2.1 Monomers

TFEM and PFPM were prepared, following the experimental procedure reported in literature (Babu & Chien, 1984), from methacryloyl chloride and commercially available fluorinated alcohols, 2,2,2-trifluoroethanol and 2,2,3,3,3-pentafluoropropanol, respectively (Botteghi et al., 1991; Aglietto et al., 1993).

MTFMA was obtained from (α -trifluoromethyl)acrylic acid according to Shaw (Shaw et al., 1973) with some modifications (Aglietto et al., 1995).

2.2 Polymerization

Polymerization experiments were carried out under nitrogen in a glass reactor under magnetic stirring and external heating by a thermostatic bath. The homopolymerizations of TFEM and PFPM were performed at 65°C in dioxane solution or in bulk using α, α' -azobisisobutyronitrile (AIBN) as free radical initiator; in the case of MTFMA homopolymerizations, 4-bis-*t*-butyl-cyclohexylperoxycarbonate (Percadox) was employed.

Polymerization was stopped by pouring the reaction mixture in methanol and the polymer, separated by filtration, was dried under vacuum at room temperature.

Average molecular weights and molecular weight distribution were evaluated by GPC analysis (Perkin Elmer mod. LC-25, solvent THF). The molecular structure of the polymer was checked by FT-IR and NMR analyses. These are in agreement with the formation of macromolecules consisting of head to tail monomeric units derived from polymerization by opening of double bond. In particular the FT-IR spectrum contains the typical bands related to the carbonyl group (1738 cm^{-1}) and the $^1\text{H-NMR}$ spectrum (CDCl_3) show peaks at: $\delta=0.8\text{-}1.1$ ppm (d, $-\text{CH}_3$); $\delta=1.8\text{-}2.1$ ppm (m, $-\text{CH}_2-$); $\delta=4.2\text{-}4.6$ ppm (m, $-\text{OCH}_2-$).

2.3 Artificial weathering

5% by weight CH_2Cl_2 solution of the synthesized polymer was applied by brush on KBr pellets and the solvent was allowed to evaporate in a vacuum drier for 15-30 days. Before and after the weathering all the samples were examined by IR techniques using a FTS40 Biorad Digilab Division instrument. The artificial weathering was carried out by exposing the samples to UV irradiation for 72 hours using a HPK 125 W Philips mercury lamp in a climatic chamber (Climatest Mazzali) maintained at 25°C and 10% relative humidity to avoid the reduction of the clarity of KBr pellets.

All the samples were placed on a slowly rotating plate 30 cm far from the lamp in order to expose them uniformly to UV irradiation. Finally the artificially aged samples were analyzed by IR techniques.

Artificial weathering on stone samples treated by brush with the chosen polymeric materials was carried out using the experimental procedure above described, but under 50% relative humidity.

2.4 Lithotypes

To evaluate the protective efficiency of the new synthesized polymers some tests were carried out on the following lithotypes chosen both for their different origin and porosity and for their wide presence in historical buildings:

-**Carrara Marble** - low porosity (1%); metamorphic limestone.

-**Vicenza Stone** - medium porosity (12-15%); biosparite with an abundant skeletal material in the fine carbonatic matrix.

-**Verona Red** - very low porosity (0.2-0.4%); organogenic limestone formed by compact calcareous nodules surrounded by marly material.

2.5 Protectives

The following solutions were prepared:

10% w/w of poly(2,2,3,3,3-pentafluoropropylmethacrylate) (PPFPM) in trichloromethane;

10% w/w of poly(2,2,2-trifluoroethylmethacrylate) (PTFEM) in trichloromethane;

5% w/w of poly[methyl(α -trifluoromethyl)acrylate] (PMTFMA) in trichloromethane;

5% w/w of methylacrylate-ethylmethacrylate copolymer (Paraloid B72) in trichloromethane;

7% w/w of polymethylsiloxane (Rhodorsil 224) in white spirit.

A better impregnation is generally obtained by capillarity but in our case, due to the small available amount of each new synthesized product, it was necessary to apply the solution by brush. Therefore all polymers were applied by brush on three samples of each lithotype having 5x5x2 cm size. After the application, the surface of the samples was cleaned with pure solvent in order to avoid the formation of surface deposits.

The amount of product used for samples treatment is reported in Table 1.

Table 1. Amount of absorbed polymeric product on various lithotypes (g/m²)

Polymeric product	Carrara Marble	Verona Red	Vicenza Stone
Rh 224	5.3	9.0	81.7
B 72	18.7	22.3	56.3
PTFEM	27.4	29.9	458.3
PPFPM	15.5	15.0	240.7
PMTFMA	2.2	2.6	13.0

3 Results and discussion

3.1 Photostability

Photostability of the polymeric materials was checked by comparison of FT-IR spectra carried out before and after 72 h of UV irradiation of the layer casted on KBr discs.

Some spectral changes, particularly in the CO group region (1738 cm⁻¹), were found for PTFEM and PPFPM, even if less intense than for Paraloid B72 (Fassina et al., 1994). The homopolymer PMTFMA, subjected to the same ageing, shows an outstanding photostability: after prolonged irradiation times (72 h), practically no spectral variations with respect to the unaged material are observed.

3.2 Evaluation of the fluorinated polymeric materials

The protective efficiency of the new fluorinated polymers was compared to that of other commercially available products generally used in stone protection (Charola et al., 1985; Fassina et al., 1987). Thus the assessment of the hydrophobic performances was carried out measuring on the same untreated and treated samples the following properties, according to Normal Recommendations:

- water capillary absorption (Many Authors, 1986),
- contact angle (measured with a Surface Wetting Tester Lorenz & Wettre) (Many Authors, 1991).

3.2.1 Water capillary absorption

a) Carrara Marble (Fig. 1a)

All untreated samples rapidly absorb water reaching maximum value (~10 mg/cm²) already after 4 h. The same samples behave in a completely different manner according to the specific treatment:

- Paraloid B72 and Rhodorsil 224 initially give a good water repellency which after 24 h quickly falls down;
- PMTFMA treated samples show a kinetic of water absorption very similar to that of the untreated samples;
- PPFPM and PTFEM treated samples initially show a good water repellency; after 4 h, the samples treated with PTFEM absorb water at constant rate reaching the asymptotic value after 72 h, those treated with PPFPM absorb water very slowly and reach a non ultimate value after 24 h and a second, definitive asymptotic value after 144 h.

b) Verona Red Stone (Fig. 1b)

This lithotype is completely different from the other two used: it is in fact characterized by very low porosity and by a particular structure lacking of interconnections among various capillary channels. This causes a very slow and different capillary water absorption even on untreated samples (Fig. 1b). The interpretation of the results obtained from samples treated with both non fluorinated and fluorinated polymers is therefore very difficult.

c) Vicenza Stone (Fig. 1c)

Untreated samples of this lithotype are characterized by a rapid water absorption in an amount 40 times larger than Marble due to its larger porosity. However, the treated stone samples show remarkable differences:

- the samples treated with Paraloid B72 and PMTFMA show a trend similar to the untreated ones reaching the asymptotic value after 4h;
- Rhodorsil 224 warrants a good protection for 4 h; successively the capillary water absorption reaches in 96 h a value of 75% with respect to the untreated samples;
- PPFPM furnishes a good protection for 4h, then the water absorption increases constantly but slowly reaching after 144 h only 34% of the value of the untreated ones;
- PTFEM is the only product which maintains his good protective action in time.

It is however important to note that the amount of applied PTFEM and PPFPM was larger than for the other polymers (Table 1).

3.2.2 Water capillary absorption on aged samples

The artificial weathering was carried out only on stone samples treated with PPFPM, PTFEM and Paraloid B72.

a) Carrara Marble (Fig. 2a)

Samples treated with Paraloid B72 and aged show a strong decrease in water repellency. After 4 h an asymptotic value, reaching 90% with respect to the

Fig. 1a. Water Capillary Absorption - Carrara Marble

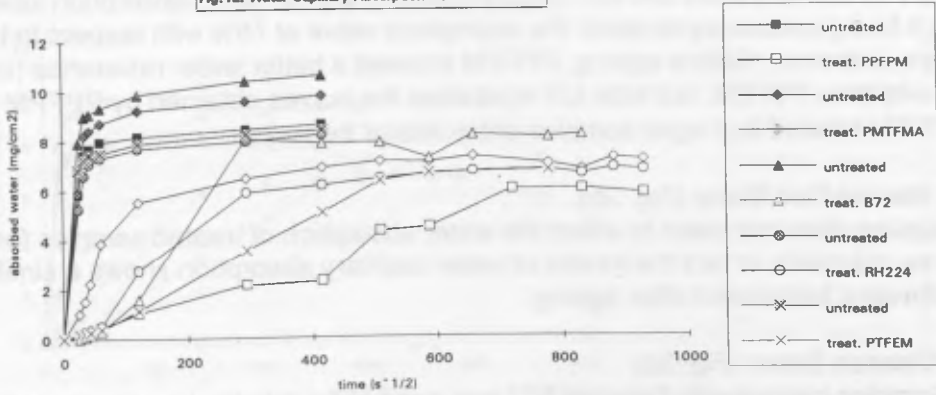

Fig. 1b. Water Capillary Absorption - Verona Red

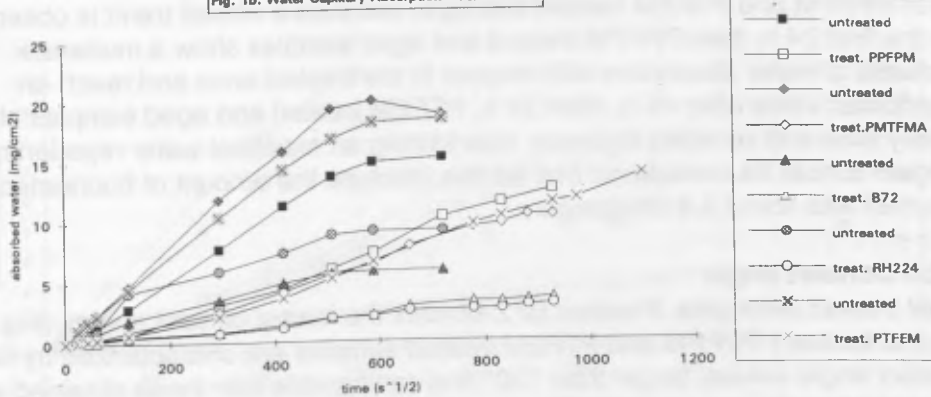
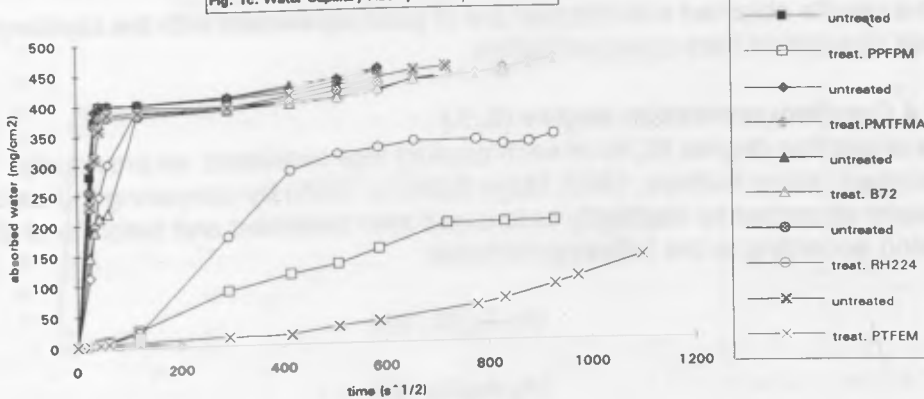

Fig. 1c. Water Capillary Absorption - Vicenza Stone



untreated stones, is observed. On the contrary the stones treated with PPFPM and PTFEM and aged are still characterized by a slow water absorption kinetic, 24 h being necessary to reach the asymptotic value at 75% with respect to the untreated ones. Before ageing, PPFPM showed a better water resistance (until 144 h) than PTFEM, but after UV irradiation the curves obtained by PPFPM or PTFEM treated and aged samples show similar behaviour.

b) Verona Red Stone (Fig. 2b)

Ageing does not seem to affect the water absorption of treated samples for the three polymers, in fact the kinetic of water capillary absorption shows a similar behaviour before and after ageing.

c) Vicenza Stone (Fig. 2c)

Samples treated with Paraloid B72 and aged show a behaviour similar to that of untreated samples, whereas PPFPM and PTFEM treated and aged samples show a low water absorption, especially in the case of PTFEM.

For PPFPM and PTFEM treated and aged samples a similar trend is observed for the first 24 h, then PPFPM treated and aged samples show a moderate increase of water absorption with respect to the treated ones and reach an asymptotic value after 48 h. After 24 h, PTFEM treated and aged samples show a very slow and constant increase, maintaining an excellent water repellency.

Again it must be considered that for this lithotype the amount of fluorinated polymer was about 5-8 times larger.

3.2.3 Contact angle

In all treated lithotypes, Paraloid B72 exhibits the lowest contact angles (Fig. 3). On the contrary PPFPM and PTFEM treated samples are characterized by high contact angle values, larger than 100° and comparable with those obtained with the polyalkylsiloxane material (Rhodorsil 224). Samples treated with PMTFMA show intermediate values for Verona Red and Vicenza Stone, but lower for Carrara Marble.

The results obtained with this test are in good agreement with the capillary water absorption data observed before.

3.2.4 Capillary protection degree ($E_c\%$)

The protection degree ($E_c\%$) of each product was evaluated, as previously described (Many Authors, 1993; Many Authors, 1995) by comparing the amount of water absorbed by capillarity before and after treatment and before and after ageing according to the following formulas:

$$(A_1 - A_2) / A_1 \cdot 100$$

$$(A_1 - A_3) / A_1 \cdot 100$$

Fig. 2a. Water Capillary Absorption - Carrara Marble aged

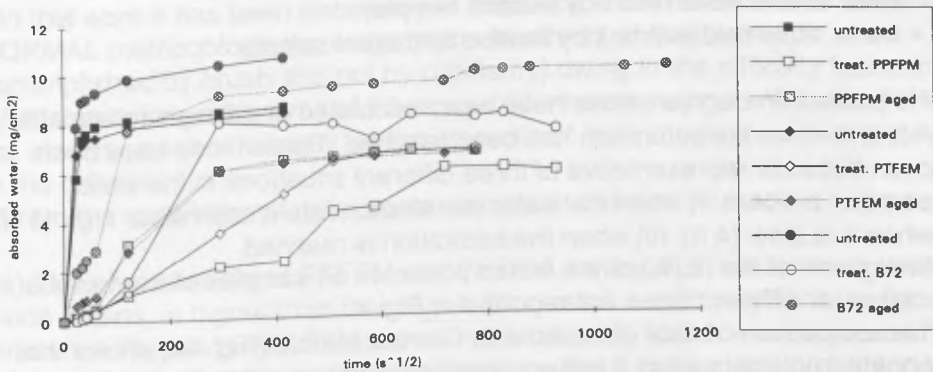

Fig. 2b. Water Capillary Absorption - Verona Red aged

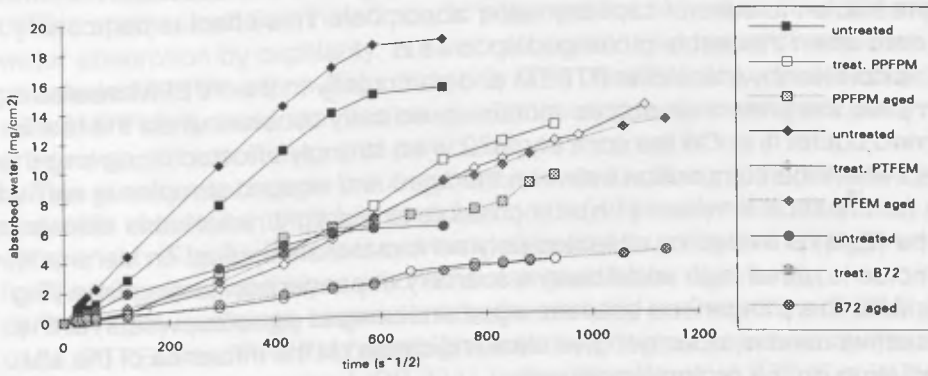
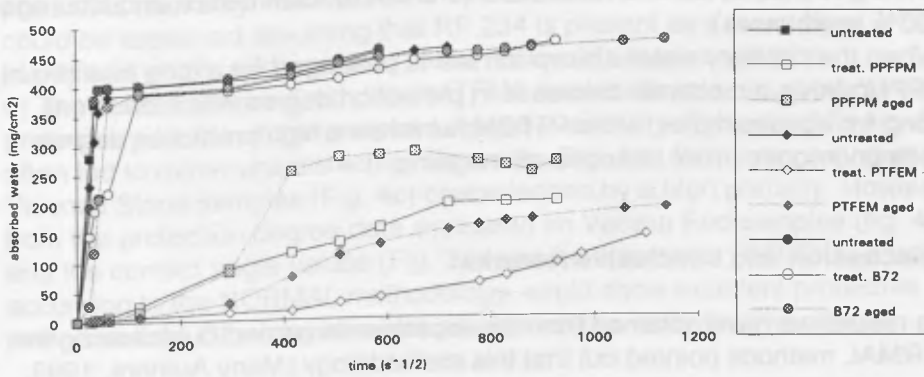

Fig. 2c. Water Capillary Absorption - Vicenza Stone aged



where

A_1 = water absorbed at time t by untreated sample;

A_2 = water absorbed at time t by treated sample;

A_3 = water absorbed at time t by treated and aged sample.

The protection degree values have been calculated at different times: after 1 h, 4 h and when the saturation has been reached. These times have been chosen because representative of three different situations in the water absorption process: i) when the water penetration rate is still rather high (1 h), ii) when it is slow (4 h); iii) when the saturation is reached.

Histograms of the ($E_c\%$) of the tested polymers on samples of the various lithotypes at different times are reported in Fig. 4.

The comparison of data obtained with Carrara Marble (Fig. 4a) shows that fluorinated polymers exert a better protection with respect to the traditional Paraloid B72 and Rhodorsil 224; in particular unaged samples treated with PPFPM show after 48 h the highest value (73%). Generally the protection degree is affected by the ageing of treated samples which causes an appreciable increase of capillary water absorption. This effect is particularly evident when the test is prolonged up to 48 h.

It is noteworthy that in the PTFEM and particularly in the PPFPM treated samples, the protection degree remains practically constant when the test is carried out for 1 h. On the contrary, B72 is so strongly affected by ageing that even when the comparison between the aged and unaged samples is carried out for the short time test (1 h) it is possible to highlight remarkable differences.

The ($E_c\%$) provided by all tested polymeric materials applied on Verona Red samples is rather high and it seems scarcely dependent on testing time (Fig. 4b). Also the comparison between aged and unaged samples, whatever the protective used is, does not give clear indication on the influence of the UV irradiation on the protection degree.

Vicenza Stone samples (Fig. 4c) treated with Paraloid B72 and PMTFMA show a very bad protection degree. Samples treated with PPFPM and PTFEM show a good ($E_c\%$) for short time tests (1 and 4 h), both before and after ageing ($\geq 93\%$ in all cases).

When the capillary water absorption test is prolonged for a long time (96 h), PPFPM shows a moderate decrease in protection degree which becomes strong for aged samples, while PTFEM furnishes a high protection degree which undergoes minor changes after ageing.

4 Discussion and conclusive remarks

The results we have obtained from the experiments carried out following the NORMAL methods pointed out that this methodology (Many Authors, 1993;

Many Authors, 1995) allows a satisfactory evaluation of the new class of protective materials prepared by our research group.

In this work it has been necessary to introduce some modifications to the NORMAL methodology (for example the treatment of samples was accomplished by brush and not by capillarity) owing to the difficulty found in synthesizing large amounts of these new fluorinated polymers. Moreover it was not always possible to apply similar amounts of the various protective materials to the different stones.

From the experimental data, some considerations can be made.

- a) The photostability of PTFEM and PPFPM, having fluorine atoms in the ester side chains, is higher than that of non fluorinated acrylic polymers (as for instance Paraloid B72). The non complete stability could be associated to deterioration phenomena probably involving the C-H bond still present in the polymeric matrix. In fact, the substitution of side chain methyl groups with trifluoromethyl groups seems to give to PMTFMA an outstanding stability towards the combined action of UV light and air.
- b) The synthesized fluorinated acrylic polymers not only slow down the rate of water absorption by capillarity, but also decrease the amount of water which penetrates into the stone (Figs. 1 and 2). The unsatisfactory results obtained with PMTFMA treated samples are due to the extremely small amount of product applied on stones and particularly to Vicenza Stone (Table 1).
- c) The good contact angle values obtained with the fluorinated polymeric materials are similar to those measured on the other polymers taken for comparison (Fig. 3). This fact can be explained assuming that all polymers form a thin superficial layer which ensures good water repellency.
- d) The (E_c %) is strongly dependent on the porosity and structure of lithotype used. PTFEM and PPFPM have high protection degree values similar to those of polyalkylsiloxane product (RP 224), better than Paraloid B72 (Fig. 4). Very interesting seem the results obtained in long time experiments (48 h for Marble and 96 h for Vicenza Stone). In fact in this case the (E_c %) of the silicon-based product is markedly less efficient than the one of PTFEM and PPFPM. This could be explained assuming that RP 224 is present as a layer more superficial which, once crossed, does not avoid water penetration.
- e) The results obtained with the PMTFMA treated samples must be considered preliminary for the aforementioned limited availability of this product which often led to rather unsatisfactory outcomes. This last fact is more evident with Vicenza Stone samples (Fig. 4c) characterized by a high porosity. However, from the protection degree data evaluated on Verona Red samples (fig. 4b) and the contact angle values (Fig. 3) it can be drawn that PMTFMA, if applied according to the NORMAL methodology, could show excellent protective performances. Other experiments are planned to verify this hypothesis.

Fig. 3 Contact angle

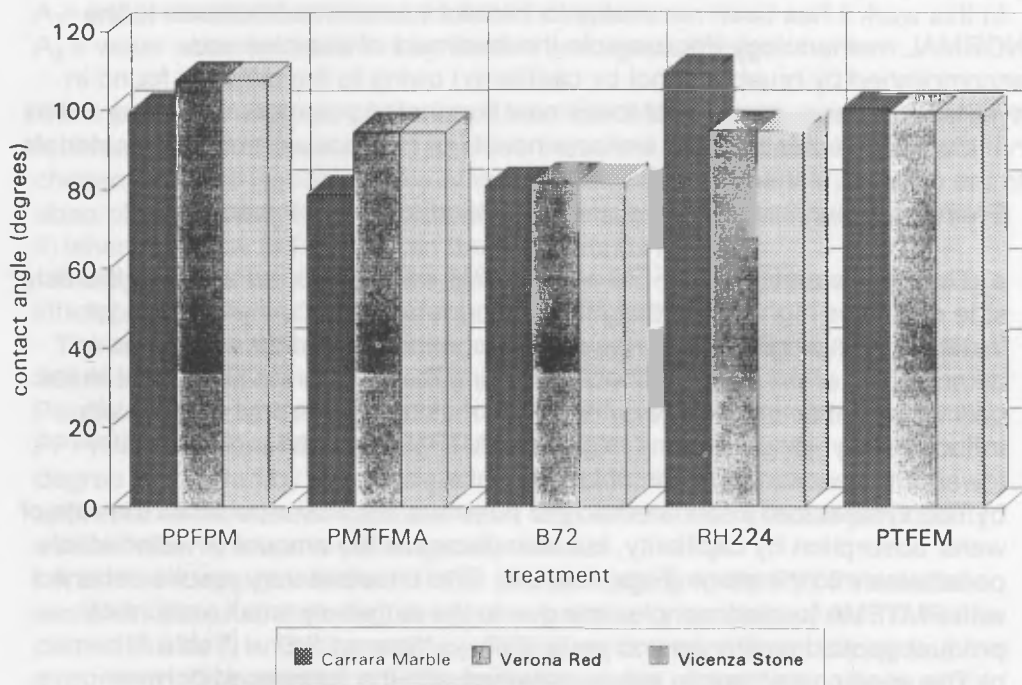

Fig. 4a. Protection Degree - Carrara Marble

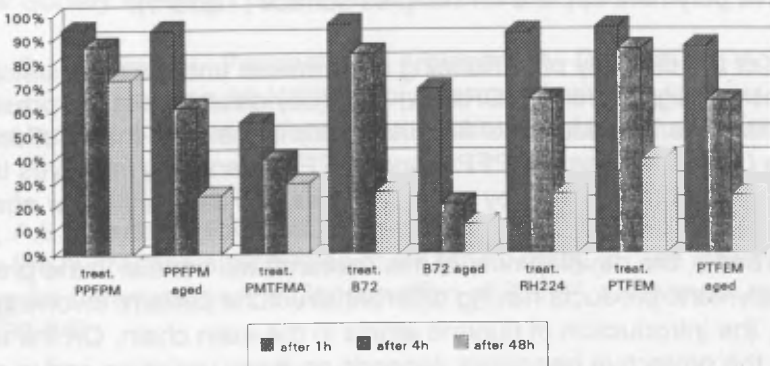

Fig. 4b. Protection Degree - Verona Red

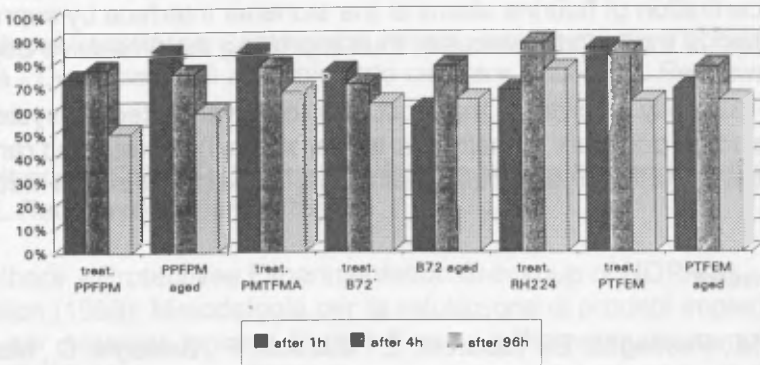
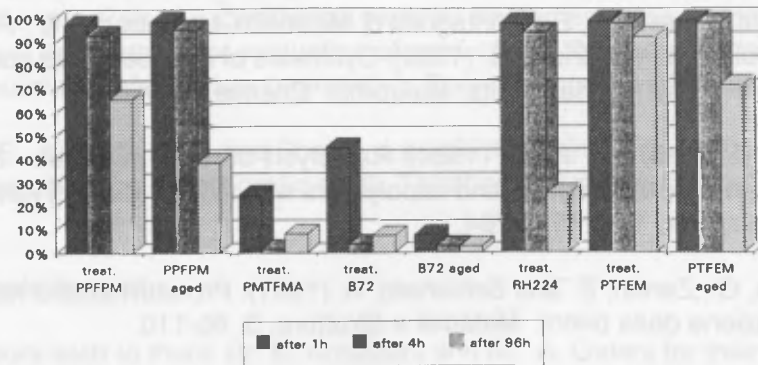

Fig. 4c. Protective Efficiency - Vicenza Stone



f) It is to point out that some difficulties have been encountered in the reliable interpretation of experimental data deriving from the relative amounts of protective polymers applied on samples surface (Table 1).

In spite of the difficulty of performing experiments under strictly similar conditions as suggested by NORMAL, the study described in the present paper confirms that the introduction of fluorine atoms in the side chains of acrylic polymers (as in the case of PPFPM and PTFEM) generally improves the water repellency, as demonstrated by contact angles and capillary water absorption measurements.

On this basis, the development of this research will consist in the preparation of new polymeric products having different structural pattern, involving, for instance, the introduction of fluorine atoms in the main chain. On the other hand, as the protective behaviour depends on many variables and in particular on properties at the polymer/air interface, interesting results can be surely achieved also from the application of macromolecular products bearing long fluorinated side chains. In this case internal phase segregation should maintain high concentration of fluorine atoms at the stone/air interface by supramolecular organization of the macromolecules, thus improving the protective degree of the material.

We are currently involved in the production of novel protective systems as those based on polymers of methyl (α -trifluoromethyl)acrylate and random copolymers of methyl or other alkylmethacrylates with fluorinated methacrylates.

5 References

Aglietto, M., Passaglia, E., Taburoni, E., Ciardelli, F., Botteghi, C., Matteoli, U., Paganelli, S., Arbizzani, R. and Fassina, V. (1993): A new class of fluorinated acrylic polymers: protective materials for stone. In "ICOM Committee for Conservation: 10th Triennial Meeting". Washington, August 22-27, 553-558.

Aglietto, M., Passaglia, E., Montagnini di Mirabello, L., Botteghi, C., Paganelli, S., Matteoli, U. and Menchi, G. (1995): Synthesis of new polymers containing α -(trifluoromethyl)acrylate units. *Makromol. Chemie*, submitted.

Babu, G.N. and Chien, J.C.H. (1984): Radiolysis of resist polymers - 5-Poly (haloalkyl- α -chloroacrylates) and copolymers with methyl methacrylate. *Macromolecules*, 17, 2761-2764.

Biscontin, G., Zendri, E. and Schionato, A. (1991): Protettivi acrilici nella conservazione della pietra. *Materiali e Strutture*, 3, 95-110.

Botteghi, C., Matteoli, U., Paganelli, S., Ciardelli, F. and Merlo, G. (1991): Synthesis of fluorinated polyacrylates and polymethacrylates. In "CISCI Italian Chemical Society Meeting". Chianciano (SI), october 2, 753.

Botteghi, C., Matteoli, U., Paganelli, S., Arbizzani, R., Ciardelli, F., Aglietto, M., Taburoni, E. and Fassina, V. (1992): Polyfluoroalkylmethacrylates as materials for the protection of stones. *Science and Technology for Cultural Heritage*, 1, 111-122.

Charola, A.E., Laurenzi Tabasso, M. and Santamaria, U. (1985): The effect of water on the hydrophobic properties of an acrylic resin. In "Vth International Congress on Deterioration and Conservation of Stone". Lausanne, september 25-27, 739-747.

Fassina, V., Laurenzi Tabasso, M., Lazzarini, L. and Mecchi, A.M. (1987): Protective treatment for the reliefs of the "Arconi di S. Marco" in Venice; laboratory evaluation. *Durability of Building Materials*, 5, 167-181.

Many Authors - NORMAL Commission (1986): Assorbimento d'acqua per capillarità - Coefficiente di assorbimento capillare. *NORMAL Recommendation 11/85*.

Many Authors - NORMAL Commission (1991): Misura dell'angolo di contatto. *NORMAL Recommendation 33/89*.

Many Authors - Protectives Experimentation Subgroup of NORMAL Commission (1993): Metodologia per la valutazione di prodotti impiegati come protettivi per materiale lapideo. Parte I: Tests e trattamento dei campioni. *L'Edilizia*, 7, 57-71.

Many Authors - Protectives Experimentation Subgroup of NORMAL Commission (1995): Methodology for the evaluation of protective products for stone materials. Part II: Experimental tests on treated samples. In *International Colloquium on "Methods of evaluation of products for the conservation of porous building materials in monuments"*. Roma, giugno 19-21, submitted.

Shaw, J.E., Kunerth, D.C. and Sherry, J.J. (1973): A simple quantitative method for the esterification of carboxylic acids. *Tetrahedron Letters*, 689.

6 Acknowledgment

The authors wish to thank Dr. R. Arbizzani and Mr. A. Gaiani for their experimental assistance.

PROTECTIVE MATERIALS FOR STONE - EFFECTS ON STONE PERMEABILITY AND GAS TRANSPORT

F. PIACENTI*, R.G. CARBONELL**, M. CAMAITI*, F.E. HENON**, E. LUPPICHINI*

* C.N.R. - C.S. Cause Deperimento e Metodi di Conservazione Opere d'Arte, Florence, Italy

** Department of Chemical Engineering, North Carolina State University, Raleigh, N.C.-USA

Abstract

This paper describes techniques that can be used to determine flow permeabilities and gas diffusivities in porous systems such as stones, and the absorption and diffusion of gases through polymeric materials. These techniques provide quantitative informations which may be useful for the identification and selection of materials to be considered for stone protection and for the evaluation of the efficacy of the treatments.

Keywords: Permeability, Diffusivity, Stone Protection.

1 Introduction

The importance of preserving the International Cultural Heritage has encouraged many scientists to search for the origins and mechanisms of stone degradation, to develop new methods to detect deterioration, and to find innovative techniques of protection. Stone protection, generally understood as the surface application of a product able to eliminate, or at least reduce, the absorption of water, has undergone a remarkable development in the last few decades, as evidenced by the number of different polymers which have been used for this purpose [Amoroso and Fassina, 1983 - Lazzarini and Laurenzi Tabasso, 1986 - Borselli et al., 1990].

The initial enthusiasm for these products which frequently form films, whose intent was to isolate the stone from the surrounding environment, and therefore from deterioration agents, dropped very soon. In fact, it has been discovered that some of these protective agents can have harmful effects. The presence of blisters, cracks, and detachments of these "protective films", together with the underlying stone matrix, have been frequently observed. This behavior is ascribed to either the difference between the physical properties of the synthetic polymers and the stone (thermal expansion coefficients, elastic moduli, etc.) or, predominantly, to the blockage of pores on the surface of the stone as a result of the application of polymer. Pore blockage can result in a reduction in the transport of gases through the stone, particularly water vapor. This can cause condensation and accumulation of harmful agents inside the stone as well as stresses resulting from temperature changes, resulting in increased deterioration. This experience made evident the need for a "specific protectant" that does not result in pore blockage. The choice of such a protectant needs to be based on a careful evaluation of the properties of the coating applied on the stone.

The methods of testing the protective efficacy of a product have been based until recently on the hydrorepellency and the "non filming" properties of the materials. Nowadays, many laboratories regularly measure hydrorepellence by the "pipette" method [Frediani et al., 1982], and capillary absorption [Doc. NORMAL 11/85, 1986], the permeability to water vapor by the "bicchierino" method [Doc. NORMAL 21/85, 1986], as well as the reversibility [Camaiti et al., 1991] and chemical stability of the system to aging [Piacenti and Camaiti, 1994 - Sasse and Riecken, 1993 - Saleh et al., 1992]. However, few references have been found on the direct evaluation of gas transport properties such as solute diffusivity and solubility in the polymer itself, and gas diffusivity and flow permeability in both untreated and treated stone. The diffusivity and solubility of gases in the polymer are important because the interaction of gases such as CO_2 , H_2O , SO_2 and NO_x with the coating can play an important role on the effectiveness of the protective treatment. In addition, measurements of flow and diffusion properties of the stone can help determine the level of pore blockage that results from the application of protective polymer treatments. This paper describes some basic methods for the evaluation and determination of these gas transport properties and mechanisms.

2 Permeability of stone

The flow permeability of a stone is a parameter that can be used to calculate the gas velocity that results from the application of an applied pressure difference between two stone surfaces. Figure 1 shows a cross section of a stone sample of thickness L and area A subject to a pressure difference $P_1 - P_0$. If P_1 is greater than P_0 , gas will flow from left to right with a volumetric flow rate Q . The gas velocity $\langle v \rangle$ is the ratio of the flow rate Q to the cross sectional area A .

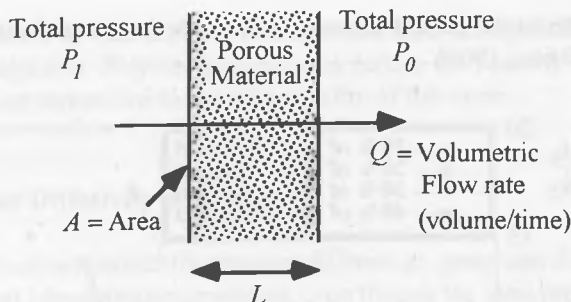

Fig. 1. Flow through a porous medium caused by a pressure gradient

Darcy's Law governs the relationship between the gas volumetric flow rate Q , the pressure difference per unit length of sample, and the gas viscosity μ [De Wiest, 1969]

$$\langle v \rangle = \frac{Q}{A} = \frac{k}{\mu} \cdot \left(\frac{P_1 - P_0}{L} \right) \quad (1)$$

The coefficient of proportionality in equation (1) is the stone permeability k , and it is a function only of the pore structure in the stone. This can be understood by considering the permeability of a bed of spherical particles of diameter d_p . In this case, the permeability takes the form [Dullien, 1992],

$$k = \frac{d_p^2 \cdot \epsilon^3}{150 \cdot (1 - \epsilon)^2} \quad (2)$$

Note that the permeability of this unconsolidated porous medium depends on the particle diameter (an indirect measure of the pore diameter), and the total bed porosity ϵ (volume of pores/volume of bed), and it is not a function of the fluid properties. It is also important to note that k is a very sensitive function of the porosity of the medium. To illustrate this, Figure 2 shows the ratio between the permeability k_1 of a packed bed of spheres with porosity ϵ_1 to the permeability k_2 of a bed with the same size particles, but with porosity ϵ_2 , where ϵ_2 is smaller than ϵ_1 by various percentages. It is clear from this figure that large changes in permeabilities can occur as a result of relatively small changes in porosity.

The permeability values of consolidated materials, such as stone, cannot be calculated a-priori, but must be evaluated experimentally. This can be done by placing thin (≈ 2 mm) cylindrical stone samples of about 1.3 cm diameter in a filter holder across which a pressure drop may be applied. Plastic O-rings can be used to force the gas to flow perpendicular to the stone surface. Table 1 shows results of calculations based on equation

(1), using Helium as the gas and literature values for the permeability of marble and sandstone [De Wiest, 1969].

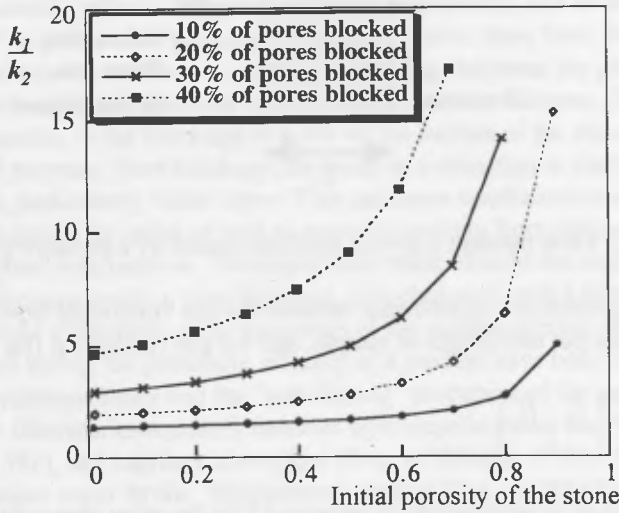

Fig. 2. Reduction in permeability caused by a reduction in the porosity

Table 1. Calculated volumetric flow rates of Helium in marble and sandstone (k marble = 1.777×10^{-11} (cm²), k sandstone = 3.35×10^{-11} (cm²) [De Wiest, 1969], $L = 0.2$ cm, $A = 1.327$ cm², $\mu_{\text{Helium}} = 116.46 \times 10^{-4}$ (g/cm.min) [CRC Handbook of Chemistry and Physics])

$P_1 - P_2$ (atm)	Q in marble (cm ³ /min)	Q in sandstone (cm ³ /min)
0	0	0
1	32.106	66.291
2	64.212	132.58
3	96.319	198.87
4	128.42	265.16
5	160.53	331.46
6	192.64	397.75
7	224.74	464.04
8	256.85	530.33
9	288.96	596.62
10	321.06	662.91

Volumetric flow rates of several cm^3 per minute result from the application of pressure drops of a few atmospheres. Polymer coatings may reduce the porosity of the material, resulting in significant reductions in the permeability of the stone.

3 Gas Solubility and Diffusivity in Polymer

In addition to gas transport caused by pressure differences, gases can diffuse across a material as a result of concentration gradients, even though the total pressure in the system is constant. In the case of a polymeric material, the gases can dissolve in the polymer, and diffuse from regions of high concentration to those of low concentration. Figure 3 illustrates this situation for the case of steady-state (time-independent) diffusion of a gaseous component in a polymeric film exposed to two different partial pressures of the gas on either side.

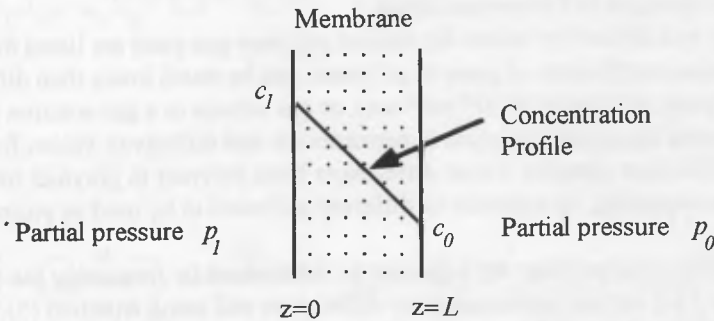

Fig. 3. Gas diffusion through a solid polymer membrane at steady-state

The transport of the gas solute by diffusion is governed by Fick's Law [Crank, 1975], which can be used to calculate the molar flux of gas J (moles/area/time) resulting from the concentration gradient within the polymer,

$$J = D \frac{(c_1 - c_0)}{L} \quad (3)$$

The diffusivity D of the gas in the polymer is a molecular parameter, controlled by the physico-chemical characteristics of the diffusing species and the polymer. The solute at the surface of the polymer can be assumed to be in equilibrium with the gas phase. As a result, the interface concentrations can be related to the partial pressures using an equilibrium distribution coefficient K (solubility coefficient),

$$c_1 = Kp_1 \quad \text{and} \quad c_0 = Kp_0 \quad (4)$$

At low pressures (ideal solution conditions), K is a function of temperature, but will vary significantly for different gas-polymer pairs. Substituting equation (4) into equation (3), the solute flux due to diffusion can be written in terms of the solute permeability P ,

$$J = P \cdot \frac{(p_1 - p_0)}{L} \quad (5)$$

where

$$P = DK \quad (6)$$

In equation (3) D has units of cm^2/sec , while in equation (4) K has units of $\text{moles}/\text{cm}^3/\text{atm}$. As a result, P in equation (6) has units of $\text{moles of gas absorbed}/\text{cm}/\text{sec}/\text{atm}$. However, it is convenient to express the permeability P in units of cm^3 of gas absorbed at standard temperature and pressure (STP)/ $\text{cm}/\text{sec}/\text{cmHg}$.

Permeability and diffusivity values for various polymer-gas pairs are listed in Table 2. Note that diffusion coefficients of gases in polymers can be much lower than diffusion coefficients of gases in liquids ($\approx 10^{-5} \text{ cm}^2/\text{sec}$), or gas solutes in a gas solution ($\approx 10^{-1} \text{ cm}^2/\text{sec}$). Also note the strong variation in permeability and diffusivity values for the same gas in different polymer samples. These differences from polymer to polymer may be relevant when considering the behavior of different polymers to be used as protective agents on stone.

The permeability of a polymer for a gas can be determined by measuring the steady-state solute flux J for various partial pressure differences and using equation (5). However, it is also possible to calculate P from independent measurements of the solubility K and the diffusivity D , using equation (6). K can be determined by measuring the total weight of gas uptake by the polymer at equilibrium at various partial pressures of gas. These gravimetric measurements are usually done using a Cahn electrobalance [Berens and Hopfenberg, 1982 - Balik et al, 1989]. With the same apparatus, D can be determined from the analysis of transient experiments, where the weight of gas uptake is measured as a function of time while the gas partial pressures are equal on both sides of the polymer, as shown in Figure 4.

Table 2. Permeability and diffusivity coefficients of some polymers [Ashworth et al., 1991 - Reimers and Barbari, 1994 - Okamoto et al., 1992]

Polymer	Permeability (cm ³ (STP)/cm.sec.cmHg)			Diffusivity (cm ² /sec)		
	H ₂ O(g)	CO ₂	CH ₄	H ₂ O	CO ₂	CH ₄
1	7.8*10 ⁻⁸ (a)			1.28*10 ⁻⁸ (a)		
2	1.6*10 ⁻⁷ (a)			1.55*10 ⁻⁸ (a)		
3	3.1*10 ⁻⁸ (a)			5.5*10 ⁻⁹ (a)		
4		4.3*10 ⁻⁷ (b)	1.3*10 ⁻⁷ (b)		1.47*10 ⁻⁵ (b)	1.21*10 ⁻⁵ (b)
5		6.9*10 ⁻¹¹ (c)	1.7*10 ⁻¹² (c)		1.09*10 ⁻⁸ (c)	
6		4.2*10 ⁻¹⁰ (c)	1.0*10 ⁻¹⁰ (c)		2.7*10 ⁻⁸ (c)	1.51*10 ⁻⁹ (c)

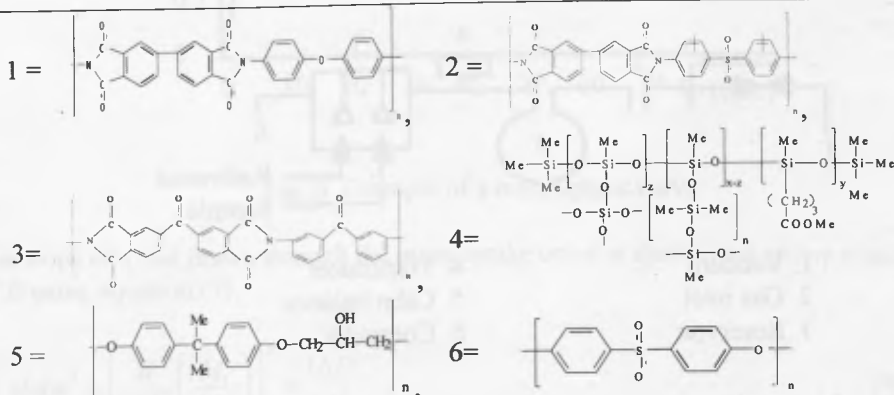

(a)= 50°C and activity 0.5 [Okamoto et al., 1992], (b)= 35°C and atmospheric pressure [Ashworth et al., 1991], (c)= 35°C [Reimers and Barbari, 1994], 4= Ester functionality (mol % Si atoms) 3.4.

Figure 5 is a schematic diagram of the Cahn balance apparatus used in this type of study. The system must be maintained at constant temperature, and it is degassed at the beginning of the experiment. After the initial weight of the sample is registered, the sample gas is supplied at a fixed pressure. The weight change of the sample is recorded as a function of time until equilibrium is reached.

The type of time dependence of gas absorption rates usually observed at low partial pressures is illustrated in Figure 6, showing the ratio of the mass of gas absorbed by the polymer at a given time, M_t , divided by the mass of gas absorbed at equilibrium, M_∞ , as a function of the square root of time.

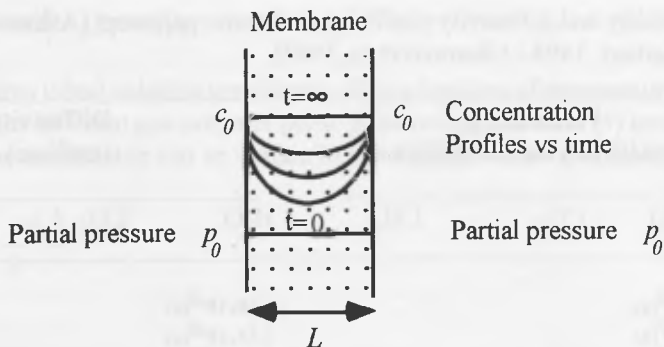

Fig. 4. Transient gas diffusion through a polymer film

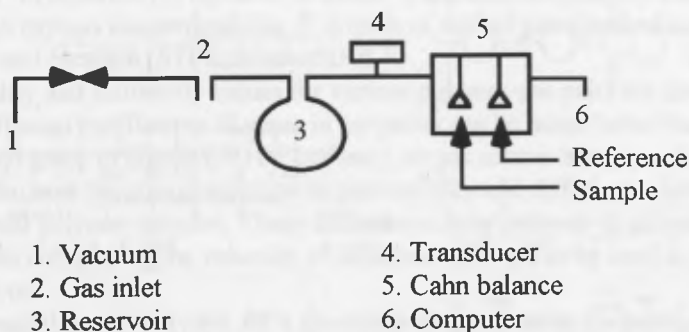

Fig. 5. Schematic apparatus for diffusion experiments

The type of mass absorption behavior indicated in Figure 6 can be predicted by solving the continuity equation for the gas in the polymer, where the diffusion flux is given by Fick's Law [Crank, 1975]. For short times (M_t / M_∞ values ≤ 0.6), the mass uptake at a fixed time M_t takes the form [Crank, 1975],

$$\frac{M_t}{M_\infty} \cong 4 \sqrt{\frac{Dt}{\pi L^2}} \quad (7)$$

while for long times (M_t / M_∞ values ≥ 0.4) it is possible to show [Crank, 1975],

$$\frac{M_t}{M_\infty} \cong 1 - \frac{8}{\pi^2} \exp\left[-\frac{\pi^2 Dt}{L^2}\right] \quad (8)$$

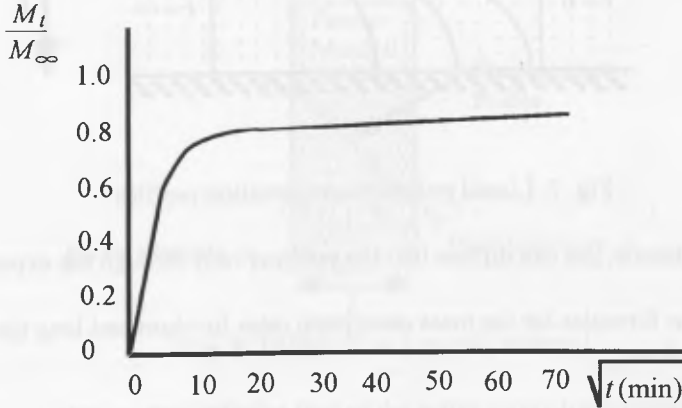

Fig. 6. Example of a mass uptake curve

The slope of a line drawn through the mass uptake curve at short times allows a calculation of D using equation (7),

$$\text{slope}^2 = \left[\frac{d}{d\sqrt{t}} \left(\frac{M_t}{M_\infty} \right) \right]^2 = \frac{16D}{\pi L^2} \quad (9)$$

The diffusivity can also be computed from the slope of a plot of $\ln[1 - M_t / M_\infty]$ versus time for long times using equation (8),

$$\text{slope} = \frac{d}{dt} \left\{ \ln \left(1 - \frac{M_t}{M_\infty} \right) \right\} = \frac{D\pi^2}{L^2} \quad (10)$$

If the polymer is a liquid instead of a solid, it cannot be suspended as indicated in Figure 4. In this case, the liquid rests on a solid support that is impermeable to gas, as shown in Figure 7.

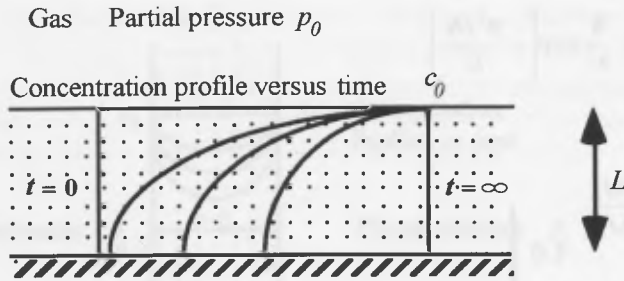

Fig. 7. Liquid polymer concentration profiles

Under these conditions, gas can diffuse into the polymer only through the exposed upper surface.

In this case, the formulas for the mass absorption rates for short and long times take a slightly different form,

$$\frac{M_t}{M_\infty} = 2\sqrt{\frac{Dt}{\pi L^2}} \quad (11)$$

$$\frac{M_t}{M_\infty} = 1 - \frac{8}{\pi^2} \exp\left[-\frac{\pi^2 Dt}{4L^2}\right] \quad (12)$$

Consequently, the formulas used to analyze the data to determine D from short and long time behavior are also different,

$$\text{slope}^2 = \left[\frac{d}{d\sqrt{t}} \left(\frac{M_t}{M_\infty} \right) \right]^2 = \frac{4D}{\pi L^2} \quad (13)$$

$$\text{slope} = \frac{d}{dt} \left\{ \ln \left(1 - \frac{M_t}{M_\infty} \right) \right\} = \frac{\pi^2 D}{4L^2} \quad (14)$$

4 Gas Diffusion in a Porous Material

If a porous material is subjected to two different gas solute partial pressures (concentrations), but equal total pressures on either side, the solute will diffuse through the

porous sample. This is shown schematically in Figure 8. At normal pressures and temperatures, when the pores are significantly larger than the mean free path of the diffusing molecules, the diffusion process is controlled by molecular diffusion within the gas-filled pores, rather than by collisions with the pores (Knudsen diffusion).

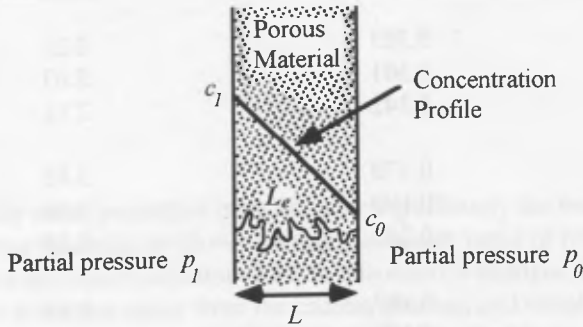

Fig. 8. Diffusion in a porous material

Under these conditions, the diffusive flux of the solute through the porous medium, in the absence of bulk flow, takes the form,

$$\langle J \rangle = D_{eff} \left(\frac{c_1 - c_0}{L} \right) \quad (15)$$

The quantity D_{eff} is called the effective diffusivity, and it is related to the molecular diffusion coefficient of the gas in the mixture D , and the porosity ϵ and tortuosity τ of the porous material,

$$D_{eff} = \frac{\epsilon}{\tau} D \quad (\tau > 1) \quad (16)$$

The tortuosity is a measure of the ratio of the actual path length that the molecule has to travel to get across the porous sample L_e , to the sample thickness L . This is illustrated in Figure 8, indicating that τ is greater than 1. Table 3 contains typical values of τ and ϵ reported for some porous materials. Gas diffusivities in a gas mixtures are on the order of 10^{-1} cm²/sec, so that with tortuosity and porosity values in Table 3, equation (16) implies that effective diffusivities in stone are on the order of 10^{-2} cm²/sec.

Table 3. ϵ and τ values for some porous materials [Blumberg and Schlunder, 1993]

Material	Porosity (ϵ)	Tortuosity (τ)
sintered glass	0.303	2.21
	0.301	2.03
	0.342	2.11
sandstone	0.170	3.45
	0.190	3.04
	0.280	2.10
sand	0.387	1.68
	0.379	1.77
	0.381	1.70

Because polymer coatings may decrease the porosity of a porous material, they may have a significant effect on the effective diffusivity. Some evidence of this effect may be obtained by analyzing water vapor transport using the "bicchierino" method. From these experiments, the molar flux of water vapor through the sample can be related to the time rate of loss of liquid water in the container after the initial transient period (W_{H_2O} = amount of water lost, M_{H_2O} = m.w. of water),

$$\langle J \rangle = \frac{\text{moles}_{H_2O}}{\text{Area} \cdot \text{time}} = - \frac{1}{M_{H_2O}} \frac{dW_{H_2O}}{dt} \quad (17)$$

By substitution of equation (15) into equation (17), an equation is obtained that can be used to compute D_{eff} after the initial transient (condensation) period, from the slope of the weight loss curve,

$$- \frac{1}{M_{H_2O}} \frac{dW_{H_2O}}{dt} = D_{eff} \left[\frac{c_1 - c_0}{L} \right] = \frac{D_{eff}}{RT} \left[\frac{p_1 - p_0}{L} \right] \quad (18)$$

Here the molar concentrations of solute have been related to the partial pressures through the ideal gas law, and p_1 and p_0 are the partial pressures of water at the temperature of the experiment inside and outside the "bicchierino" apparatus respectively (p_0 is usually nearly zero).

From the values obtained for effective diffusivities of both coated, $(D_{eff})_1$, and uncoated, $(D_{eff})_2$, stones, it is possible to estimate porosity variations caused by the polymer coating if it is assumed that τ remains relatively constant,

$$\frac{(D_{eff})_1}{(D_{eff})_2} \cong \frac{\epsilon_1}{\epsilon_2} \quad (19)$$

5 Conclusion

Polymers used for stone protection must not alter significantly the transport of gases through the porous material, or allow absorption of water vapor or other gases into the treated stone. For this reason it is important to characterize changes in the transport properties of the stone that result from the coating process, and the ability of the polymer itself to absorb gaseous components. The techniques described here may provide valuable tools to quantify the effects of coatings on gas transport and gas absorption.

6 Acknowledgements

This work is supported by the William R. Keenan Institute for Engineering, Technology and Science at North Carolina State University and Consiglio Nazionale delle Ricerche - Progetto Strategico Beni Culturali.

7 References

- AA.VV., (1986): Doc. NORMAL 11/85 Assorbimento d'acqua per capillarità. Coefficiente di assorbimento capillare. *CNR-ICR Comas Grafica*, Roma, 1-7.
- AA.VV., (1986): Doc. NORMAL 21/85 Permeabilità al vapor d'acqua. *CNR-ICR Comas Grafica*, Roma, 1-5.
- Amoroso, G.G. and Fassina, V. (1983): Stone decay and conservation, *Elsevier, Amsterdam*, 453 pp.
- Ashworth, A.J., Brisdon, B.J., England, R., Reddy, B.S.R. and Zafar, I. (1991): The permselectivity of the polyorganosiloxanes containing ester functionalities. *Journal of Membrane Science*, 56, 217-228.
- Balik, C.M., Said, M.A. and Hare, T.M. (1989): Residual porosity in polymeric latex films. *Journal of Applied Polymer Science*, 38 (3), 557-569.
- Berens, A.R. and Hopfenberg, H.B. (1982): Diffusion of organic vapors at low concentrations in glassy PVC, polystyrene, and PMMA. *Journal of Membrane Science*, 10, 283-303.

- Blumberg, W. and Schlunder, E.U. (1993): Simultaneous vapor and liquid diffusion in partially wetted porous media. *Drying Technology*, 11 (1), 41-64.
- Borselli, G., Camaiti, M., Pasetti, A., Maravelaki, P. and Matteoli, U. (1990): La Conservazione del Patrimonio Monumentale - Protettivi impiegati nella conservazione dei materiali lapidei: storia, impieghi e sviluppi. *L'Edilizia*, 1/2, 67-78.
- Camaiti, M., Ingoglia, R., Moggi, G., Pasetti, A. and Scala, A. (1991): Controllo della reversibilità di trattamenti protettivi effettuati con polimeri fluorurati su materiali lapidei. Atti del Convegno "Le Pietre nell'Architettura: Struttura e Superfici", Bressanone, June 25-28, 1991, *Libreria Progetto Editore, Padova*, 267-276.
- Crank, J. (1975): The Mathematics of Diffusion, 2nd ed., *Oxford Univ. Press, Oxford*, 414 pp.
- CRC Handbook of Chemistry and Physics (1988): *CRC Press, Inc, Boca Raton, Florida*.
- De Wiest, R.J.M. (1969): Flow through porous media. *Academic Press, London*.
- Dullien, F.A.L. (1992): Porous Media - Fluid Transport and Pore Structure - 2nd ed., *Academic Press, Inc, San Diego - California*, 574 pp.
- Frediani, P., Manganeli Del Fà, C., Matteoli, U. and Tiano, P. (1982): Use of perfluoropolyethers as water repellents: study of their behaviour on pietra serena, a florentine building stone. *Studies in Conservation*, 27, 31-37.
- Lazzarini, L. and Laurenzi Tabasso, M. (1986): Il restauro della pietra, *Cedam, Padova*, 320 pp.
- Okamoto, K.I., Tanihara, N., Watanabe, H., Tanaka, K., Kita, H., Nakamura, A., Kusuki, Y. and Nakagawa, K. (1992): Sorption and diffusion of water vapor in polyimide films. *Journal of Polymer Science: Part B: Polymer Physics*, 30, 1223-1231.
- Piacenti, F. and Camaiti, M. (1994): Synthesis and characterization of fluorinated polyetheric amides. *Journal of Fluorine Chemistry*, 68, 227-235.
- Reimers, M.J. and Barbari, T.A. (1994): Gas sorption and diffusion in hydrogen-bonded polymers. II. Polyethersulfone/Polyhydroxyether blends. *Journal of Polymer Science: Part B: Polymer Physics*, 32 (1), 131-139.
- Saleh, S.A., Helmi, F.M., Kamal, M.M. and El-Banna, A.F.E. (1992): Artificial weathering of treated limestone: Sphinx, Giza, Egypte. Proceedings of 7th Int. Cong. on Deterioration and Conservation of Stone, Lisbon, June 15-18, 1992, 781-789.
- Sasse, H.R. and Riecken, B. (1993): "Venus" - A new concept in laboratory simulation of aggressive climatic conditions. Proceedings of the Int. RILEM/UNESCO Congress on Conservation of Stone and Other Materials, Paris, June 29 - July 1, 1993, *E&FN SPON, London*, 801-807.

TREATMENT OF RISING DAMP. A LABORATORY EVALUATION METHOD

ROB P.J. VAN HEES, JAAP A.G. KOEK
TNO Building and Construction Research, Delft, The Netherlands

Abstract

This paper describes the development and the application of a laboratory method for the evaluation of the effectiveness of injection products for the treatment of rising damp. The method uses small (0.2 x 0.2 x 0.8 m) test walls: to examine the working of the product, and test pieces made solely of brick: to examine the degree of penetration. It was found possible to arrive at an evaluation of the effectiveness and to explain a possible failure within a relatively short time (about 6 months) after the application of a product. A preliminary classification is proposed.

The results of tests on six products are recorded. In the laboratory, silicone micro-emulsion (a water based product) and siloxane (in a hydrocarbon solution) were found to be the most efficient of the six products tested. Siliconate appeared to be very sensitive to the level of carbonation in the substrate. The presence of salts did not appear to produce (additional) hindrance for the penetration and effectiveness of the products.

Keywords: Rising damp, Test methods, Laboratory.

1 Introduction

Within a research programme for the Dutch Building Research Foundation, a method has been developed and applied that makes it possible to evaluate products intended for the treatment of rising damp more speedily and at lower cost. The method consists of two parts. Small test pieces of brick only are used to obtain a first impression and to examine the penetration of the product ('indicative method'). Small test walls (brickwork piers with dimensions 0.2 x 0.2 x 0.8 m) are used to assess the performance. Using the proposed classification method within a relatively short period conclusions can be drawn concerning the effectiveness of the treatment. The applicability of both parts of the method as well as the first results from the testing of six products using the method are discussed below.

2 Indicative method

2.1 General

The aim of the test is to obtain an indication of the effectiveness of chemical treatments for rising damp within a relatively short time and with limited costs. The objectives of this part of the research were:

- to find out whether the indicative method gives a good impression of the results to be expected of the application of the product to test walls;
- to obtain information supplementing the results of the tests on small test walls.

2.2 Description of the method and the test pieces

The test pieces are made by attaching the stretcher faces of two bricks together with an epoxy compound. To prevent the product leaking out of the test piece before taking effect the sides are plastered with a 10 mm thick sand-cement rendering (sand/cement ratio 1:3 v/v). The under side receives a coating of an epoxy compound. In the middle of the upper surface of the test piece a 25 mm diameter hole is drilled to a depth of 105 mm. Two methods of application were compared, see 2.3. In method 'a' (the pouring method) this hole was left open. In method 'b' (the in-practice method) a 60 mm high brick plug was glued into the hole, to permit the attachment of the injection equipment. A 45 mm hollow space was left behind this plug. In this way an even distribution of the product through the test piece could be guaranteed. A sketch of the test pieces is shown in Fig. 1.

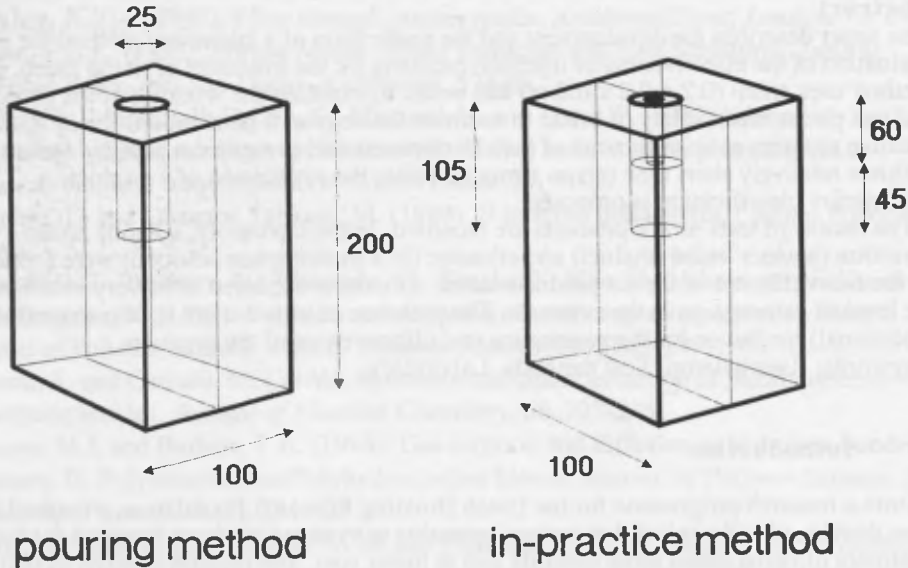

Fig.1 Sketch of the test pieces used for the indicative method.

The test pieces were preloaded with water or with a saline solution. A mixture of Na_2SO_4 (50%), NaCl (20%), KNO_3 (10%) and Na_2CO_3 (20%) was used. The salinity was 3% by weight.

Based on the circumstances to be expected in practice the type of brick to be used can be decided and the preloading of the brick with moisture and/or salts can be varied.



Fig. 2 Application under hydrostatic pressure (siliconate).

2.3 The application of the products

Two methods of application were compared:

- a. the application by pouring;
- b. the method usually used in practice for the product concerned.

In method a. the product is poured in once to fill the hole. Method a. will be referred to as the 'pouring method'.

For method b. -further referred to as the 'in-practice method'- a distinction will be made between products applied under hydrostatic pressure and products, applied under a somewhat higher pressure. A plastic container, fitted onto a pipe (see Fig. 2) is generally used for products applied under hydrostatic pressure. The product to be investigated is poured into the container, in a quantity according to the practical use. For products where a higher pressure will be used, the product is applied with an injection lance for which the injection hole can be closed off tightly.

Application is stopped when the product starts to emanate at all sides of the test piece (see Fig.3). This is in accordance with the usual method of checking, used in practice.

After injection of the product, the test pieces are placed in conditions of 20°C/65% RH. Products that could be detrimentally affected by drying out too rapidly (gels), the test pieces are placed immediately after application in vapour-proof packing.



Fig. 3 Evaluation of the penetration of one of the products. It is clearly to be seen that the penetration depth is very limited in this case.

2.4 Method of evaluation

One month after the application the test pieces are sawn diagonally lengthwise. One half will be examined further, the other half will be retained as a reference. The half required for further examination is dried at 60°C. With acrylic amide gel, the problem arises that part of the water present in the gel is lost during drying. When determining the capillary water absorption, there is thus with such products a measurement error, since a part of the water will be absorbed not by the brick but by the gel.

The effect of the product is evaluated by allowing both treated and untreated test pieces to absorb water by capillary action. The test pieces are placed with the lower surface downwards in a glass container containing a 20 mm layer of water. By weighing the test pieces the quantity of water absorbed after 24 hours is determined; furthermore the part of the test surface that is damp is determined visually. An alternative way of evaluation is a complete moistening of the cut surface. The extent to which the product has been absorbed is evaluated from the damp discolouration. However, this method of evaluation can only be used for water-repellent products.

2.5 Examination of six products

The method described was applied to brick test pieces of a soft mud type. The test pieces were pre-moistened by capillary absorption of the salt cocktail (see 2.2) for 24 hours. The following products have been examined:

- acrylic amide gel
- gelling silane
- siloxane in alcohol
- siloxane in hydrocarbon

- silicate
- silicone micro-emulsion

Acrylic amide and gelling silane were applied by an injection lance under moderate pressure ($>=1$ atm.). The other products were applied under hydrostatic pressure. In case of silicate, cylindrical reservoirs fitted onto a bent pipe were used; the underside of the reservoirs were placed about 150 mm above the opening in the test piece. Siloxane and silicone micro-emulsion were applied using plastic containers with a spout, that was directly inserted in the hole in the test piece.

As a reference the same products were applied to dry brick test pieces as well as to brick test pieces, premoistened with water only (no salt cocktail).

2.6 Results

Using the pouring method hardly any penetration was obtained with products that should be injected under pressure (acrylic amide gel and gelling silane). Because of the limited amount of product entering by means of the pouring method, translation of the results to practice - even for products to be applied under hydrostatic pressure - is difficult. Therefore the pouring method appears to be unsuitable as indicative method of evaluation.

With the 'in-practice method' the products are applied in the correct manner and thus results are obtained that, in principle, can be translated better into practice. This applies, in particular, to tests on test pieces that are wet and contain salts during application. For this reason, further discussion of the results is based on this method of application that corresponds more closely with practice. Fig. 4 shows a summary of the results of the determination of capillary water absorption. These are the results with the test pieces which, like the test walls discussed in 3, have been pre-moistened with the salt cocktail and where the products have been applied by the 'in-practice method'.

The graphs show that for all products, the water absorption of treated test pieces is considerably lower than for untreated test pieces. All products have thus some effect. There appears to be a group of 3 products that are approximately similar: acrylic amide gel, gelling silane and silicone micro-emulsion. Silicate performs considerably better than the middle group and siloxane in alcohol produces a poorer result. Siloxane in hydrocarbon is not shown in the graphs.

The conclusions concerning the applicability of the indicative test method as well as practical conclusions on the basis of this part of the research, will be given later.

N.B.

- a. Siloxane dissolved in a hydrocarbon was only evaluated indicatively, by means of wetting the cut surface. There appeared to be a clearly positive effect. It was remarkable that, both for the indicative method described here and for the evaluation of effectiveness using test walls described in the next section, the product using hydrocarbon as the solvent penetrated into wet (brick) substrates better than the product based on alcohol. This has consequences for the practical application (see section 4).
- b. The tests on test pieces that had not been pre-loaded with salts gave no indication that salts present in the substrate have a deleterious effect on the penetration of the products.
- c. Neither are there indications that wet substrates with either of the products used in this research would cause more problems for the penetration of the products than dry substrates. The only exception is described above.

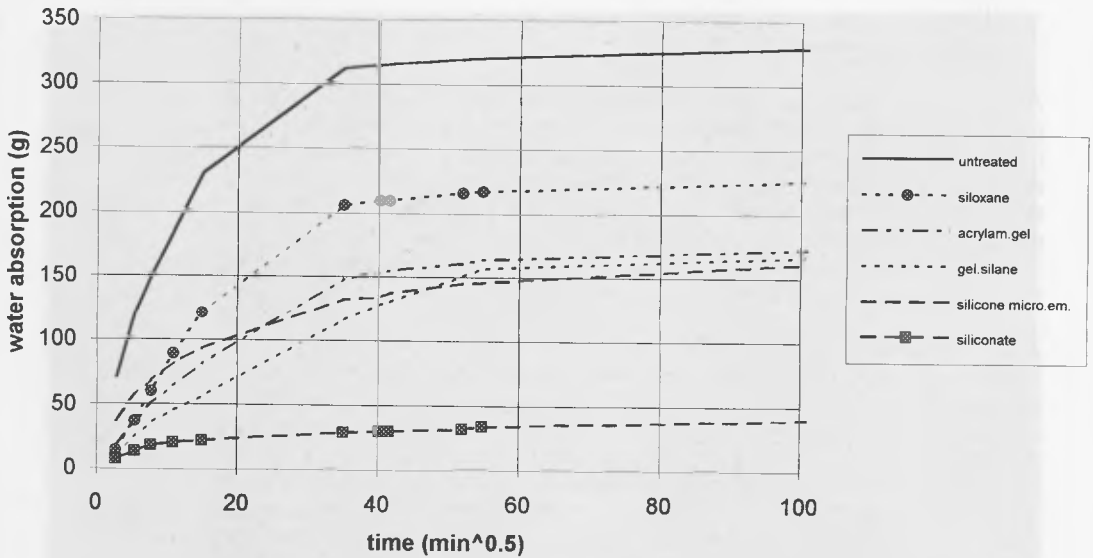

Fig. 4 Indicative method. Capillary absorption in brick test pieces.

3 Research on test walls

3.1 General

This method is intended to assess the effectiveness of products against rising damp in brick masonry structures. Because of their limited dimensions (ca. 0.20x0.20x0.80 m) the test walls can still be handled by two people and various loadings (moisture, salt etc.) can be applied in a relatively simple manner. The aim of the examination was twofold:

- a. to establish if the effectiveness of products can be assessed within a relatively short time, using an evaluation method based on following the suction behaviour of brickwork piers ('topping up'-method);
- b. to evaluate the effectiveness of six different products.

In contrast to the indicative method, in this part the combination of brick and mortar was examined; this is considered essential for the ultimate evaluation of the effectiveness of the products.

3.2 Description of the method

The tests are carried out on 8 courses high brickwork piers (ca. 0.20x0.20x0.80 m). Two parallel sides of the piers and the upper side are completely coated to prevent evaporation through the sides and so to simulate a wider structure. To limit leaking out of the products during injection, the piers at the injection zone level are finished on four sides with a sand/cement plaster with a binder/sand ratio of 1:2, and the joints between the bricks on the underside of the piers are filled with an epoxy compound.

When the mortar has hardened sufficiently and before application of the product the piers are premoistened by capillary absorption. For this, the piers are laid in water with an uncoated side surface downwards for eight hours, with the underside 20 mm below the surface of the water. After eight hours the pier is turned over and moisture soaked in through the other side surface for 16 hours. See Fig. 5.



Fig. 5 Test walls for examination of rising damp. The piers are placed horizontally in a vessel with water (salt solution), for preliminary moistening. The vessel is covered with a plastic foil to prevent evaporation during this operation.

The same salt solution as described in 2.2 is proposed for pre-moistening. Rising damp is maintained in the piers by placing their feet in a vessel with water. The water level in the vessel is kept constant.

3.3 Application of the products

Application should take place in the manner that is usual in practice for the product concerned. The product is applied at the level of the third course of brickwork. One day after application of the product, the pier is placed with its foot again in the vessel of water. The water level in the vessel is kept constant so that the underside of the pier is submerged

in 20 mm of water. Loss of water from the vessel by evaporation is prevented by good sealing of the space between the sides of the pier and the walls of the vessel. See Fig. 6.



Fig. 6 Test walls for examination of rising damp. The piers are placed in a glass vessel with water.

3.4 Method of evaluation

The effectiveness of the product is evaluated by both the behaviour in capillary absorbing water and by the moisture content. In both cases the behaviour of treated and untreated piers of the same age and the same premoistening and salt loading is compared. By comparing the results based on the behaviour in capillary water absorption with those based on the moisture content, the value of the method based on capillary absorption ('topping up-method') could be evaluated for its suitability as a rapid test method. The behaviour in capillary absorption is determined by the quantity of water that must be added to keep the level in the vessel constant. Since evaporation of moisture is prevented by the

sealing between the pier and the walls of the vessel, the water lost can only have been removed by capillary absorption by the wall. To prevent disturbance to the measurements, in the room where the piers are placed, the relative humidity of the air is kept constant (70% +/- 5%).

The moisture content of the brickwork is determined three, six and if necessary twelve months after the application. This is performed by taking drilled samples from the fifth course. After taking the sample the drilled hole is sealed. After gravimetric determination of the moisture content of the samples the hygroscopic moisture content at 93% RH is also measured. If the moisture content found is greater than the hygroscopic moisture content at 93% RH (see also Netherlands Standard NEN 2778 - Damp-proofing in buildings. Methods of determination), it may be concluded that there is an external source of dampness, i.e. case rising damp.

In the examination of six products described below, the test piece absorbed water containing the proposed salt cocktail. The presence of salts may influence the moisture content found in two ways:

- the capillary absorption will be greater because of the presence of salts; larger capillaries that normally would not, or to a lesser extent, absorb water, will fill themselves up.
- Salts have an adverse influence on drying, as a result of their hygroscopic properties.

Therefore, when evaluating the measured moisture content, one must take into account the fact that partly as a result of the presence of salts, the drying process will be very slow.

3.5 Examination of six products

Description of the test pieces and the products

A mortar/brick combination of a soft red mud brick with a lime mortar composed of 1 part shell lime : 3 parts sharp sand was used. This mortar/brick combination was chosen, in consultation with a steering committee, based on a preliminary study of the suction behaviour of 12 mortar/brick combinations. Before impregnation the piers were saturated with water containing 3% by weight of salt. The composition of the salt cocktail is in accordance with the description in 2.2. The same salt solution was used to keep the water level in the vessels constant. The effectiveness of the following products was examined in two successive series of tests:

- acrylic amide gel
- gelling silane
- siloxane in hydrocarbon
- siloxane in alcohol
- silicate
- silicone micro-emulsion

The piers were all injected in threefold. Four untreated brick piers were included in the trial, of which two were saturated with salt solution and two with demineralised water. Two series of test pieces were made. The first series were injected in September 1991. For the first series the climate conditions (RH) in the laboratory were kept constant at 55 +/- 5 %, instead of the now proposed 70%. From series 1, a number of products were found not to meet expectations. For that reason a second series of test pieces was made.

Because part of the failures in series 1 could have been caused by the product running out during application -in particular for the products applied under pressure- the sealing of series 2 was improved by a layer of plaster at the injection zone and the sealing of the joint on the underside of the piers with an epoxy compound (see 3.2). This series of test pieces was treated in December 1992 (series 2). Those piers of series 1, which at that time still

showed rising damp, were injected again in December 1992. This concerned the piers treated with acrylic amide gel, gelling silane and silicate. An RH of approximately 70% was maintained in the measuring room during the testing of series 2.

3.6 Results

The performance of the treatment was evaluated from the **capillary absorption behaviour (topping up-method)** of the piers and from the **moisture content**. The results shown, are the mean for three test pieces. First the conclusion based on the capillary absorption behaviour (topping up of the vessels) will be discussed and then the conclusions based on the moisture content determination. In section 4, both conclusions will be compared. This approach makes it possible also to evaluate the quick method critically.

The capillary absorption behaviour

The capillary absorption behaviour was determined by recording the quantity of liquid that had to be added to maintain the liquid in the vessel at a constant level. Figures 7 and 8 show give the quantity of liquid added.

For series 1 the data concern the last month before and the sixth month after the re-injection. The data for series 2 concern the sixth month after the injection. The quantity of liquid added is given in grams per day.

Fig. 7 shows that in the first series only siloxane in hydrocarbon and silicone micro-emulsion performed clearly better than the blank.

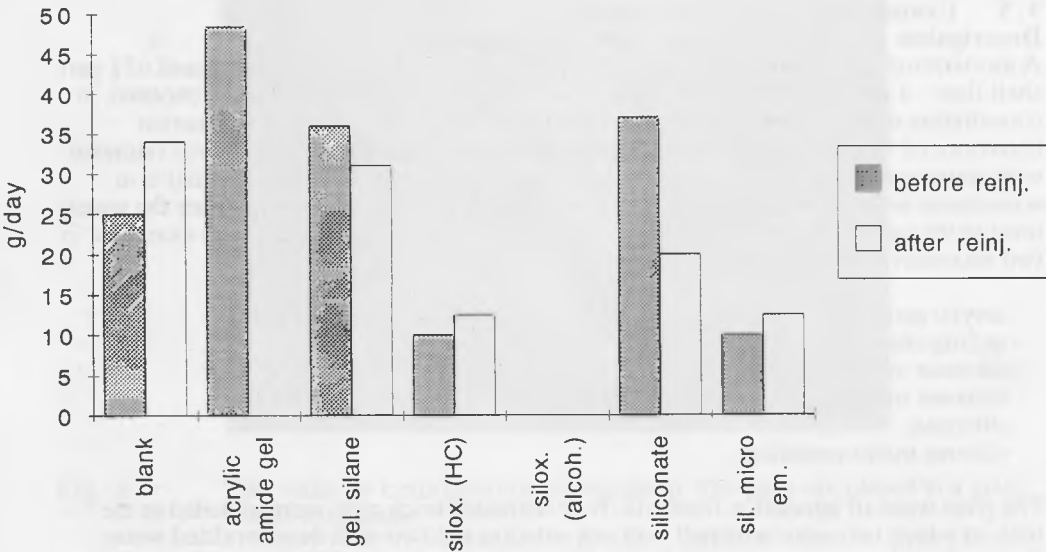

Fig. 7 Results for 'topping up' for series 1; monthly means (g/day). The last month before re-injection is given as well as the sixth month after re-injection. N.B. siloxane and silicones micro-emulsion were not re-injected; the test pieces with acrylic amide gel cracked during re-injection.

After re-injection, a good result was also obtained with silicate, while gelling silane showed a limited improvement. The piers with acrylic amide gel cracked during re-

injection and thus were no longer usable for the evaluation.

Also in the second series the piers with silicone micro-emulsion showed a clearly positive result (Fig. 8); gelling silane and acrylic amide gel showed some positive effect. Siliconate showed a very limited effect. The piers treated with siloxane in alcohol absorbed in general as much water as the untreated ones; no effect was thus observed for this product.

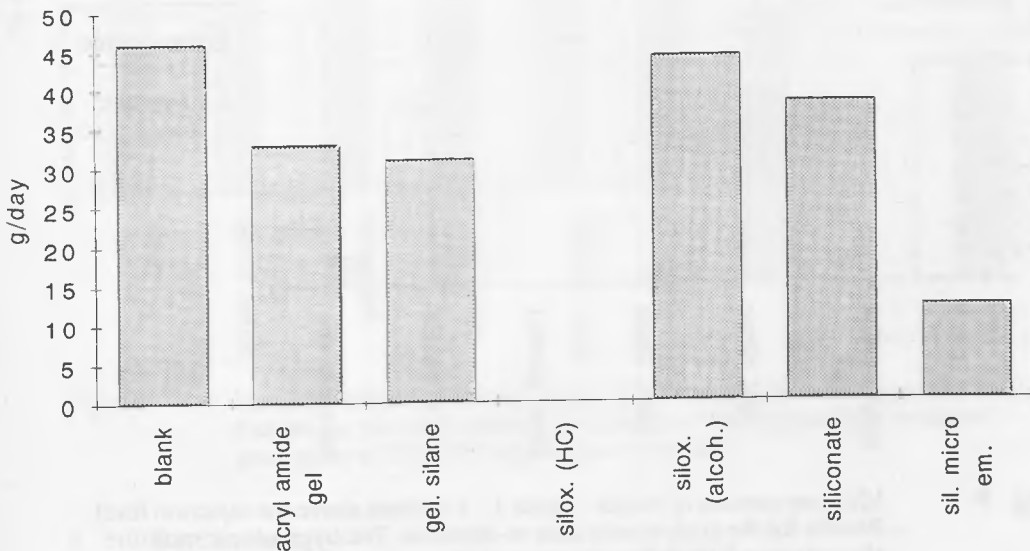

Fig. 8 Results for 'topping up' for series 2. Monthly means (g/day) for the sixth month after injection.

N. B.

The behaviour of siloxane in hydrocarbon when compared with that of siloxane in alcohol was remarkable; the second appeared to have no effect; the first, in contrast, gave together with silicone micro-emulsion the best result. The indicative method on brick samples gave the explanation: the product in alcohol penetrates a damp substrate only poorly.

The moisture content

The moisture content of the piers was determined from drilled samples taken at 5 courses above the injection level, to a depth of 30 - 100 mm. The moisture content was determined gravimetrically. The hygroscopic equilibrium water content was then determined at a relative humidity of 93%. Figures 9 and 10 show the moisture contents found about 6 months after treatment. The figures also include the data concerning the hygroscopic behaviour at 93% RH.

Fig. 9 shows the result for series 1, 6 months after re-injection. Before the re-injection only siloxane in hydrocarbon and silicone micro-emulsion were clearly better than the blanks. The following can be seen from Fig. 9: the moisture content found for blanks, gelling silane and siliconate was higher than the hygroscopic moisture content at 93% RH; there was thus still moisture supply from an external source. For gelling silane, the moisture content was now lower than that of the blank. A positive development was thus

found.

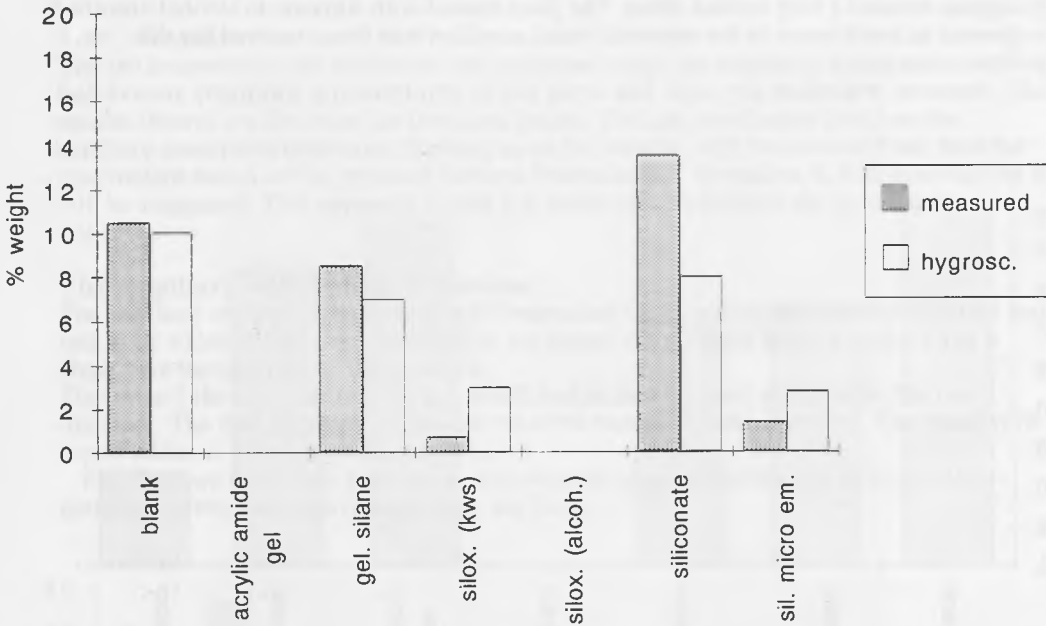

Fig. 9 Moisture content of bricks - series 1 - 5 courses above the injection level. Results for the sixth month after re-injection. The hygroscopic moisture absorption at 93% RH is given as a reference.

The piers with silicate had an even higher moisture content than the blank; in this case the results do not correspond with those from the absorption method. The piers that were not re-injected (i.e. siloxane in hydrocarbon and silicones micro-emulsion) showed generally the same (low) moisture content as before; the moisture content found was below the hygroscopic moisture content at 93% RH; the rising damp has been effectively treated here.

Fig. 10 shows the state of affairs six months after injection concerning the second series of brick piers. Silicone micro-emulsion had clearly the lowest moisture content; the moisture content found was lower than the hygroscopic water content at 93% RH; therefore it may be concluded that treatment with this product had been effective also in the second series. Gelling silane had a moisture content clearly lower than that of the blank, but still higher than the hygroscopic moisture content at 93% RH and thus too high to be already regarded as effective. The piers with acrylic amide gel and silicate still showed a high moisture content that was only a little less than that of the blank. The piers treated with siloxane in alcohol had the same high moisture content as the untreated ones. Based on the results after six months, for the second series only the silicone micro-emulsion can be regarded as successful and gelling silane as having a positive tendency; acrylic amide gel and silicate can be regarded very cautiously as showing a positive tendency.

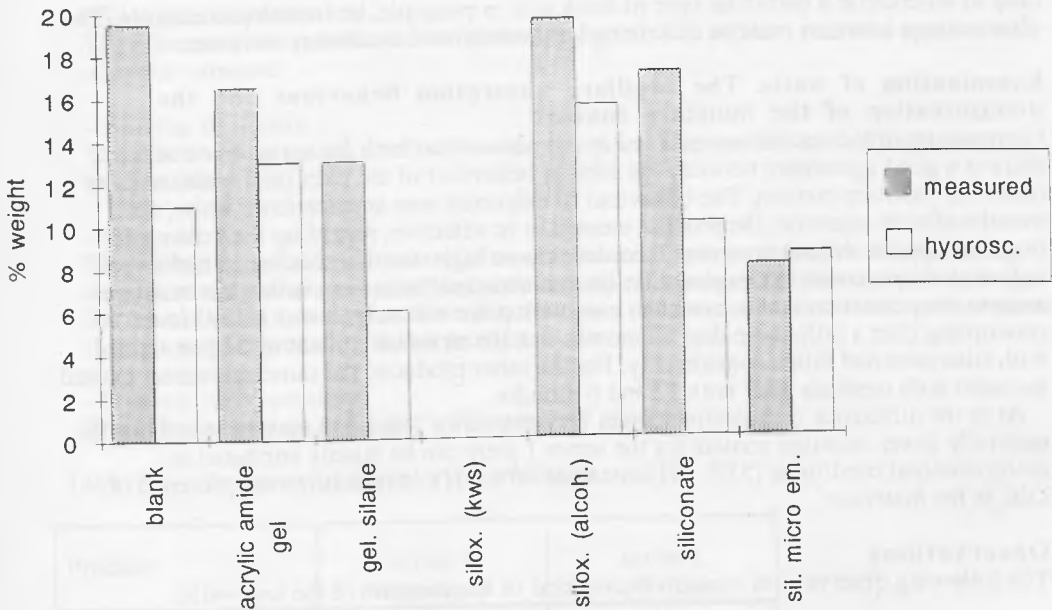

Fig. 10 Moisture content of bricks - series 2 - 5 courses above the injection level. Results for the sixth month after injection. The hygroscopic moisture absorption at 93% RH is given as a reference.

4 Discussion

4.1 Discussion on the test methods

The indicative method

The indicative tests (i.e. method b., the 'in-practice' method) may give a good general understanding of the principle of operation of the chemical products (injection systems): no absolute sealing is achieved, but the movement of water is retarded to a greater or lesser extent. The method has a supportive function in explaining why a product works or does not work in combinations of bricks and mortar. It appeared for example, particularly in series 1 of the trial that products which did not work in the piers, also showed a limited penetration in the the small test pieces. This fact forms an adequate explanation for the failure of the products concerned. The indicative method can certainly not replace the tests on piers (i.e. on combinations of brick and mortar). It appears sometimes that while a product shows a good distribution in the small test piece; at the same time there is a poor result in the piers.

The behaviour of silicate in bricks in the second series has, as an example, been studied more closely. A high effectiveness was found in the small test piece. The behaviour in the piers however, was somewhat disappointing. A drilled core was removed from one of the piers. Examination of the core showed that the product was acting in the bricks, but not in the mortar. The cause appeared to be that the mortar was not sufficiently carbonated (or had too high a pH); for this reason it will not be possible to apply silicate effectively with calcium silicate bricks.

The examination of the drilled core makes it clear that the preliminary examination can be

used to ascertain if a particular type of brick can, in principle, be treated successfully. The effectiveness however must be determined ultimately with a masonry test piece.

Examination of walls. The capillary absorption behaviour and the determination of the moisture content

Comparison of the results, as recorded in 3.6, shows that both for series 1 and series 2 there is a good agreement between the suction behaviour of the piers (test walls) and the observed moisture content. The behaviour of silicate was an exception; while, six months after re-injection, the product seemed to be effective, regarding the volume of liquid added, the moisture content recorded was so high that this conclusion had to be regarded as premature. An explanation for this abnormal behaviour is that the moisture content determination in this particular case took place too early; it was indeed found on resampling after a little more than 12 months that the moisture content in the pier treated with silicate had fallen considerably. For the other products, the same agreement existed between both methods after both 12 and 6 months.

As to the difference in moisture content between series 1 and 2, it may be stated that the generally lower moisture content for the series 1 piers can be mainly attributed to environmental conditions (55% RH instead of 70% RH), in relation to the presence of salts in the materials.

Observations

The following observations concern the method of examination of the test walls:

- For some products, particularly those applied under pressure, the dimensions of the piers are probably too small. An increased width up to 0.8 to 1.0 m would be better to evaluate such systems.

- The method of moistening by submersion could no longer be applied with larger test pieces. Spraying of the surface with the salt solution in question is an alternative when it is carried out for a time corresponding to that used for submersion.

- Sealing of the lower part of the test walls by means of a plaster layer, as used for series 2, is considered necessary for products applied under pressure. This means that also in practice a wall should be sealed at the injection zone level during the application.

- Brickwork one full brick thick, as used in the test walls, appear to be the absolute minimum for these products to guarantee a proper (practice) application.

4.2 The effectiveness of the tested products

The conclusions, based on laboratory examination, are given below for each product. They are based on both series of tests. A summary of the results is shown in Table 1. The indication of the effectiveness is based on the preliminary classification as described in section 4.3.

- Acrylic amide gel

The effectiveness with brick test walls was mediocre to poor. While there was some reduction in the movement of damp, the wall was by no means dry. It is possible that a better result could be obtained in structures larger than those tested. In such cases the principle of injection under pressure will be seen to better advantage.

- Gelling silane

The effectiveness on brick test walls was mediocre. The same considerations apply as for acrylic amide gel.

- Siloxane in hydrocarbon

The effectiveness on brick test walls was very good. The product could be applied well on a wet substrate.

- Siloxane in alcohol

The effectiveness on brick test walls was very poor. The product was difficult to apply to a wet substrate.

- Siliconate

The effectiveness on brick test walls was mediocre. The reason for this disappointing result, certainly when compared to the extremely effect on small brick test pieces, is that the mortar had not reached sufficient carbonation. When carbonation is adequate, a good result is to be expected with this product.

- Silicone micro-emulsion

The effectiveness on brick test walls was very good.

Table 1 Summary of laboratory examination

Product	series 1 topping up	series 2 topping up
acrylic amide gel	--	0
gelling silane	-	0
siloxane (HC)	++	n.d.
siloxane (alcoh)	n.d.	--
siliconate	0/+	-
silicone micro-emulsion	++	++

explanation: -- very poor
 - poor
 0 mediocre/reasonable
 + good
 ++ very good
 n.d. not determined

4.3 Evaluation criterion

The question remains as to what the criterion should be for the approval or rejection of a product. Although the determination of the moisture content, related to the hygroscopic behaviour, is simpler: the criterion to be applied is clear, that is a lower moisture content than the blank and at the same time lower than the hygroscopic moisture absorption. This is probably the most reliable way of acting, moreover, it shows the closest relation with what can be expected in practice concerning the drying time. Nonetheless, a proposal is made below for a classification of effectiveness, based on the water absorption (topping up-method).

Preliminary product classification based on the 'topping up'-method

The preliminary classification (given in table 2) is fairly pragmatic and is based on the results from the examination six months after treatment. While the criterion could be regarded as somewhat arbitrary, it is suggested that it should be applied as a preliminary

classification that later, when more experience has been built up, can be further refined.

Table 2 Preliminary classification of products for the treatment of rising damp

Waterabsorption treated pier compared to untreated, after 6 months	Classification
> 60%	poor
40-60%	mediocre / reasonable
25-40%	good
<25%	very good

5 Conclusions

The indicative tests (i.e. the 'in-practice' method) gives a good general understanding of the principle of operation of the chemical products (injection systems): no absolute sealing is achieved, but the movement of water is retarded to a greater or lesser extent. The method has a supportive function in explaining why a product works or does not work in combinations of bricks and mortar.

The indicative method can be used to ascertain if a particular type of brick can, in principle, be treated successfully. The effectiveness however, must be determined ultimately with a masonry test piece.

The topping up-method (capillary absorption) on masonry piers gives, already after a period of 6 months, a clear indication of the effectiveness of the treatment against rising damp. A good understanding can thus be gained within a relatively short period. Waiting until the actual drying has taken place to below the hygroscopic level can be a lengthy matter (1 to 2 years appears realistic). The 'topping up-method' is quite suitable as a laboratory evaluation method and provides a reliable answer quickly.

Preliminary classification criteria have been formulated, that later, when more experience has been built up, can be further refined.

RESEARCH REPORT NO. 100
SERIES OF METEOROLOGICAL PUBLICATIONS
NO. 100

Part Five

WEATHERING

1. Introduction

The weathering of rocks is a process that involves the physical and chemical changes that occur in rocks as a result of their exposure to the atmosphere, hydrosphere, and lithosphere. The weathering process is a complex one, involving a variety of factors such as temperature, moisture, and the presence of living organisms. The weathering of rocks is an important process in the Earth's crust, as it plays a key role in the formation of soil and the release of nutrients into the environment.

Weathering is a process that involves the physical and chemical changes that occur in rocks as a result of their exposure to the atmosphere, hydrosphere, and lithosphere. The weathering process is a complex one, involving a variety of factors such as temperature, moisture, and the presence of living organisms. The weathering of rocks is an important process in the Earth's crust, as it plays a key role in the formation of soil and the release of nutrients into the environment.

EVALUATION OF DEGRADATION AND CONSERVATION OF MARLSTONES BY MEANS OF WATER CAPILLARY ABSORPTION AND FROST TESTS

C. ATZENI, M.G. Cabiddu, L. MASSIDDA, U. SANNA
Dipartimento di Ingegneria Chimica e Materiali, Università
degli Studi di Cagliari, Cagliari, Italy

Abstract

Marlstones are sedimentary rocks composed of layers whose thickness and physical and mineralogical properties may differ significantly, and for this reason the problem of their conservation is not easily tackled. Porosity and size distribution of voids also vary substantially and depend on the nature of the mineral phases present. Weathering processes, which cause delamination and scaling along the sedimentation planes, can therefore be attributed to the capacity of marlstones to absorb water. Some commercial hydrorepellants were studied for protecting these stones. Keywords: Marlstone, Porosity, Weathering, Durability, Hydrorepellants, Capillary absorption, Freeze-thaw cycles.

1 Introduction

The stress induced in porous building materials exposed to repeated freeze-thaw conditions is often one of the chief causes of their deterioration (Addleson and Rice, 1991). Figure 1 shows the dependence upon pore size of some physical properties that influence durability of porous materials. The same figure also gives the freezing ranges observed in research on terracotta, the class of porous materials most widely studied in relation to frost sensitivity, as well as the pore size that most influences the durability of cement pastes (Blachere and Young, 1972; Robinson, 1984; Neville, 1986).

Marlstone is a sedimentary rock that lends itself well to illustrating the relationship between frost sensitivity and pore size. This type of stone originates from the lithification either of layers of sediments with different particle size and maybe also mineral composition, or from sediments of similar type but accumulated at different times, for instance as a result of seasonal deposition. Thus the rock displays an essentially parallel bedding of variable thickness, sometimes as little as a few tens of millimetres.

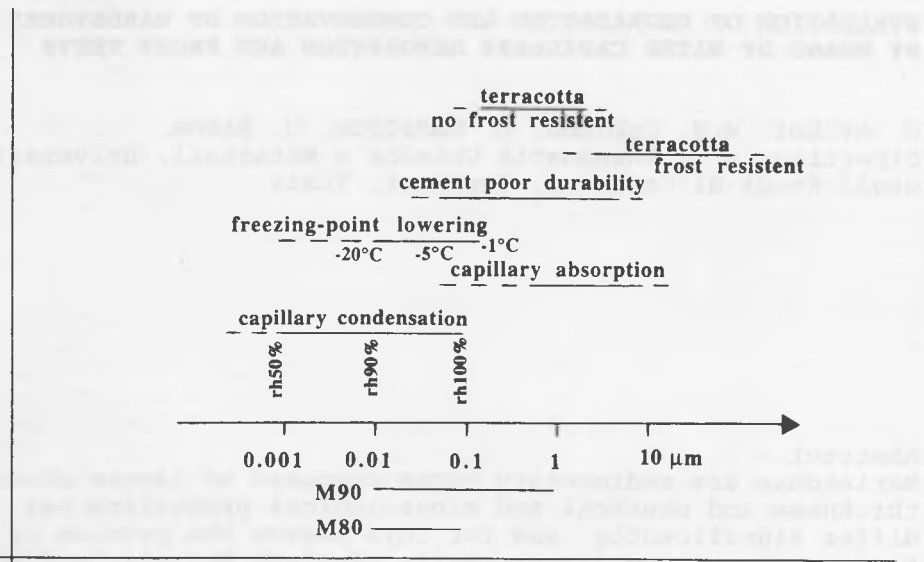

Fig. 1 Physical and durability properties dependent upon pore size.

Consequently cracks produced by frost damage can be observed in very well defined planes and may be attributed to particular microstructural characteristics.

As for the relevance of marlstone in Buildings Heritage, the authors are currently investigating the causes of degradation and techniques for the conservation of prehistoric nuragic constructions in the Marmilla and Trexenta regions in central-southern Sardinia. The most elaborate of these monuments, which date to the Late Bronze Age and are without doubt the most imposing monuments of that age in the central Mediterranean, some being 25 metres high, consist of a series of truncated cone towers with a "false-domed" vault enclosed by turreted outer walls and built of hewn stone (Lilliu, 1988). In the area concerned, which geologically is formed largely of lithified Miocene sediments, marlstone was widely used as building material in the nuraghi which are now in a very poor state of conservation. Deterioration is witnessed by cracks, exfoliation and crumbling that irreversibly alter the original morphology of the stone and their static configuration.

2 Experimental

2.1 Materials

The samples of marlstone used in the tests were taken from the Gennamaria nuragic site in the commune of Villanovaforru (CA). Two different samples were chosen with distinct physical structure and technological features. The layers were sufficiently regular to obtain an adequate number of specimens (measuring 6×7×8 cm) with practically identical microstructure from each specimen. The two samples were

denoted M 80 and M 90.

As water-repellent polymers an oligomeric alkylalcoxysiloxane with low molecular weight (BSd, 20% by weight in ethyl alcohol and BSdd, 10%), a perfluoride polyether partly functionalized with amide groups (BAd, 24% by weight in trichlorotrifluoroethane and BAdd, 12%) and a vinylidene fluoride-hexafluoroprene copolymer (CO, 3% by weight in a mixture of trichlorotrifluoroethane and acetone in the ratio 7:1).

2.2 Methods

Pore size distribution was determined using the forced mercury intrusion technique (MIP) operating up to 4000 bar (equivalent to a radius of about 20 Å), following the NORMAL 4/80 procedure. For M 80 no difficulties were encountered in taking samples but because of the thinness of some layers of M 90 certain samples (indicated in the sequel with I, II, III) actually consist of a number of adjacent layers. The petrographical study was conducted in accordance with NORMAL 3/80, 10/82 and 14/83.

Capillary water absorption tests were carried out in compliance with NORMAL 11/85. In addition isochrones representing absorption profiles were drawn on the samples and these proved useful for differentiating the behaviour in the different layers.

Freeze-thaw tests were conducted on samples immersed in water for 3 and 27 days. In the first case the procedure was repeated for 80 cycles (equivalent to an overall duration of 27 days). Each cycle consisted of two hours to reduce temperature from +20°C to -20°C, two hours at -20°C, two hours to return to +20°C and two hours at 20°C. The samples were placed in polythene bags with some water.

3 Results and discussion

3.1 Microstructure

As can be seen from Fig.2, the sample M 80 has only a small number of layers.

Three phases can be recognized on visual observation, one light and one dark layer with thickness in the order of centimetres and a third layer composed of intercalations, less than a millimetre thick. As for mineral composition, only four major components are present; quartz, calcite, feldspar and glauconite. By contrast M 90 is composed of a much larger number of layers each no more than a few millimetres thick (Fig.2). Pores are present between one layer and another, some even visible to the naked eye (Fig.3). Mineral composition is substantially similar to M 80. Neither contained expandable clays. The photographs of Fig.2 show the sampling position for determining porosity using the MIP technique. Porosity data are given in Table 1. The layers of the sample M 80 exhibit volume fraction

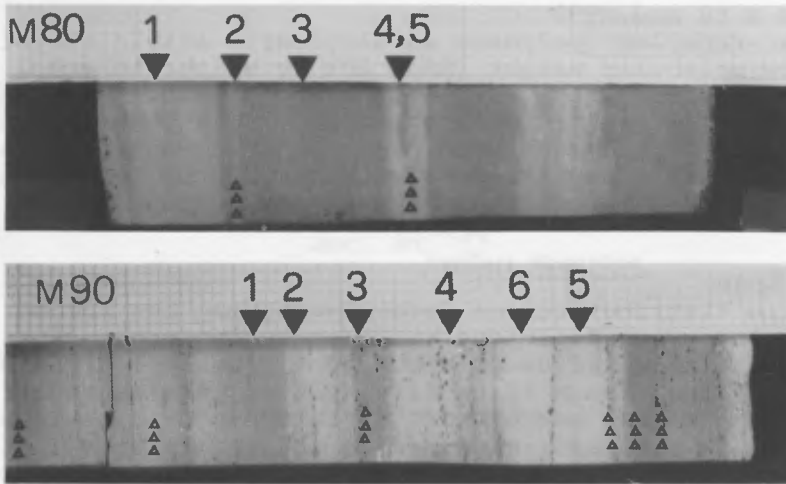

Fig. 2 Bedding in sample M80 and M90. The sampling points where MIP tests were performed and the location of cracks formed after 6 freeze-thaw cycles (specimens prior immersed for 27 days) are indicated.

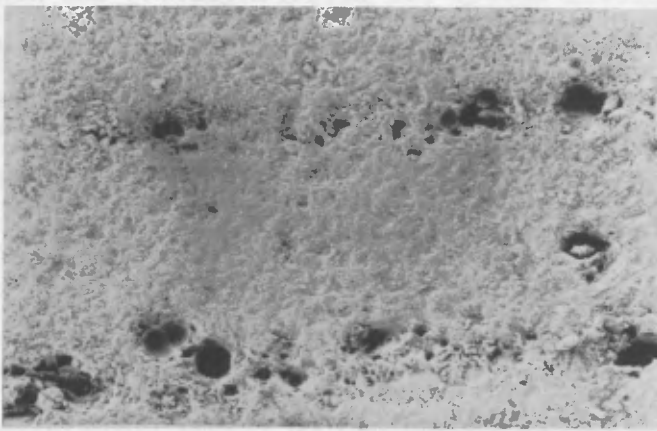

Fig. 3 Macroscopic porosity between adjacent layers of M90 (40x).

porosity of between 9 and 15% against 34-47% for M 90. Pore size distribution for M 80 is generally ranging from 0.01 to 0.1 μm even though in some cases sizes in the range 0.0003-0.03 μm were observed. M 90 is more porous with size generally ranging from 0,01 to 1 μm : pore sizes are larger and vary over a wider range than M 80.

After the data summarized in Fig.1, capillary condensation of vapour in the case at hand is only significant at relative humidity close to 100%. Freezing temperature of water may as expected be as low as -20°C in the lower pore size range even though for the mean radius the temperature should not be

Table 1. Porosimetric characteristics of the different layers of marlstone samples.

	porosity volume (%)	pore size range (μm)	pore size max vol. (μm)	spec. w. (g/cm^3)
M80-1	14	0.01-.1	0.04	2.15
M80-2	9	0.003-0.03	0.02	2.36
M80-3	11	0.003-0.03	0.02	2.17
M80-4	15	0.01-0.1	0.08	2.13
M80-5	13	0.01-0.1	0.05	2.26
M90-1	34	0.01-0.1	0.05	1.77
M90-2	47	0.1-1	0.8	1.47
M90-3	34	0.01-1	0.3	1.68
M90-4	42	0.01-1	0.4	1.53
M90-5	38	0.01-1	0.3	1.63
M90-6	34	0.01-1	0.2	1.73

below -5°C . Pore size distribution falls well within the range defined as frost sensitive for terracotta and for poor durability of cement pastes.

3.2 Capillary absorption

Figure 4 show capillary rise profiles for typical specimens of M 80 and M 90 stone. The most striking feature is that absorptivity varies from one layer to another. Capillary rise is much higher in the light part of M 80, which has volume fraction porosity of 14% and mean radius of $0.04 \mu\text{m}$, than the dark part with porosity of 10% and mean radius of $0.02 \mu\text{m}$. The absorption kinetics of M 90 are much faster and this is consistent with its greater porosity. Of particular significance is the capillary rise observed in layer 2 which is decisively more porous than the adjacent layers 1 and 3 (volume fraction porosity 47% against 34%) and has higher average pore size (see Table 1).

The profound difference in capillary absorption behaviour of the two marlstone samples can also be evaluated from the overall specific absorption. The linearity of absorption (A) with respect to the square root of time (t) (for the whole size range of M 80 about 4 days - up to 8 hours for M 90) indicates that in the specific case the relation $A = St^{1/2}$ essentially holds; absorptivity S is on average $48 \text{ g}/\text{m}^2\text{min}^{1/2}$ for M 80 and $625 \text{ g}/\text{m}^2\text{min}^{1/2}$ for M 90.

3.3 Impregnation with water-repellants

The deposition of a water repellent film on pore surfaces is the most common treatment for protecting porous building materials from deterioration due to weathering. In some cases surfaces have been treated explicitly to protect them from freeze-thaw damage (Nishiura et Alii, 1984; Fratini et Alii, 1988) though not always have the new technological properties thus induced been directly verified (Manganelli Del Fà et Alii, 1992). Specimens were impregnated, using the capillary

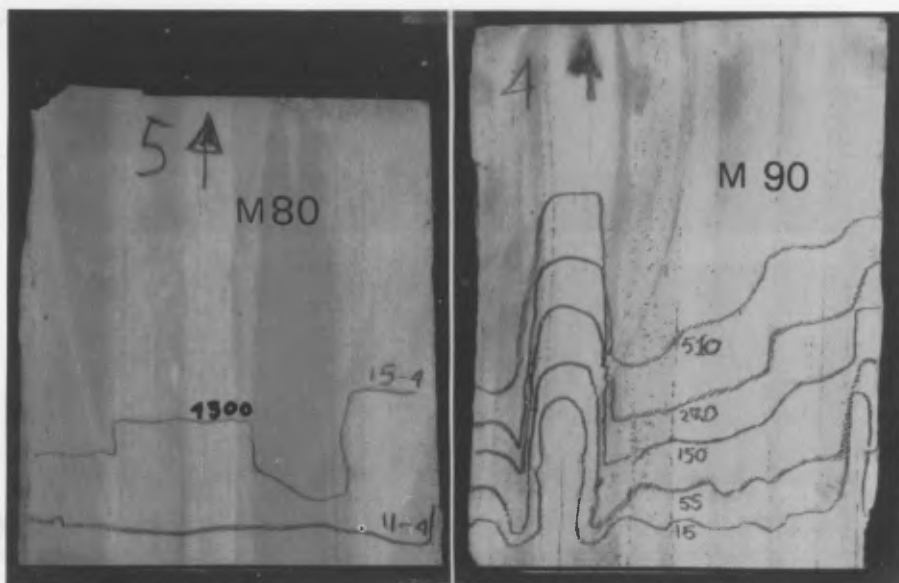

Fig. 4 Isochrones of water absorption on M80 and M90; scale 1:1.2; the number on the curves is the time expressed in minutes.

absorption technique, by treating each face for two hours. The isochrones of the different polymers tested coincided, from a qualitative point of view with the exception of the polymer CO. In this case penetration was practically zero and the polymer simply formed a continuous film that coated the outer geometric surface of the specimen. Quantitatively speaking the specific absorption (in g/m^2) was (M90/M80): Badd=7500/890, BAd=5700/450, BSdd=4800/400 e BSd=2500/390. Table 2 shows percentage reduction after contact with water for 8 hours. As can be seen treatment with the polymers BS was highly effective; even the film of polymer CO acted as a good water repellant; BA performed poorly.

3.4 Freeze-thaw tests

Freeze-thaw tests were conducted on specimens prior immersed

Table 2. Efficiency (%) of water repellant treatment after 8 hours contact.

	M 80	M 90
BSd	85	98
BSdd	75	95
BAd	55	75
BAdd	55	55
CO	85	98

in water for 3 and 27 days. The object of the latter procedure was not only to identify the weak spots in the microstructure but also to evaluate the influence of the initial degree of saturation.

Samples left for 3 days underwent 80 cycles, equal to an overall duration of another 27 days during which they were in any case in contact with water in the liquid state in the cycle at temperatures above 0°C.

Figure 5 gives the data pertaining to specific water absorption during total immersion. Nearly all the samples exhibited a trend represented by an S-shaped curve, i.e. a more or less drastic increase in absorptivity after a certain exposure time and subsequent saturation.

Comparison of specific absorption after four days in untreated M 80 and M 90 samples (on average 3000 and 24000 g/m² respectively) with the values obtained for exposure times increased more than sevenfold indicated that in those cases where the water repellent treatment is not very efficient capillary absorption decreases in any case by 60% for M 80 and as much as 88% for M 90, thus the treatment is, apparently, highly efficacious.

However, just six freeze-thaw cycles were sufficient to cause severe damage in all samples tested after 27 days immersion in water. All of the treated samples suffered damage even those impregnated with BS (initial water absorption was 700 g/m² on M 80, 1600 g/m² on M 90 see Fig.5). Figure 2 shows where the major damage occurred.

Figure 6 show the location of the most severe damage suffered by M 80 and M 90 samples.

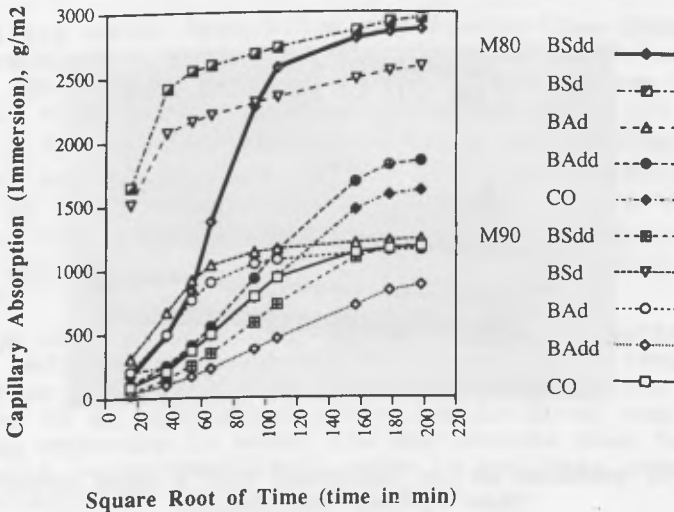

Fig.5. Water absorption in polymer-treated specimens.

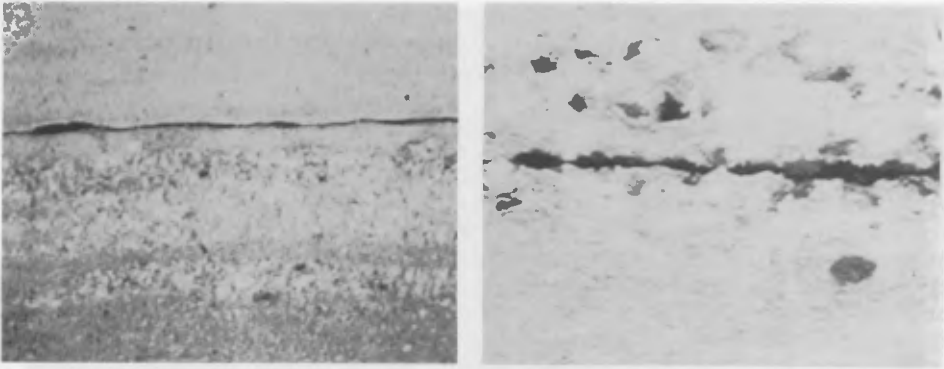

Fig.6. Details on main cracks on M 80 (left, 10x) and M 90 (right, 200x).

The cracks can nearly always be identified in bedding planes. The crack surfaces, particularly on the M 90, sometimes exhibit manganese dioxide dendrites or ferruginous spots, testimony to the fact that water had penetrated into these planes during the geological life of the stone. In the samples immersed in water for 3 days the cracks took much longer to appear. Thus the untreated and BA impregnated samples of M 80 resisted for 30 cycles while the samples treated with BSd resisted up to the 80th cycle (Fig.7). M 90, which has greater volume fraction porosity and on average larger pore size than M 80, suffered no damage practically up to the 80th cycle when it collapsed into a



Fig.7. M 80 samples prior immersed for 3 days after freeze-thaw cycles indicated.



Fig.8. M 90 sample treated with BSd after 80 freeze-thaw cycles after immersion in water for 3 days.

myriad of fracture planes (Fig.8), regardless of type of water-repellant treatment. The microstructure of M 90 displays escape paths for the residual water extruded by partial solidification.

The fracture planes coincide with those observed in the tests conducted on specimens immersed in water for 27 days.

4 Conclusions

- Capillary water absorption and freeze-thaw damage are closely related to pore size distribution and volume fraction porosity. For the marlstones examined here it was found that the sample with volume fraction porosity of 10-15% and size range of 0.01-0.1 μm absorbs less water by capillarity but is more frost sensitive than the one with volume fraction porosity of 35-50% and pore size distribution in the range 0.01-1 μm . This confirms that porous materials where the water extruded during freezing has an escape route, display great resistance.

- In the case at hand the assessment of the performance, in terms of reduced capillary water absorptivity, resulting from impregnation with water-repellant polymers, is not in itself indicative of an equivalent reduction in frost sensitivity. After long exposure to water the marlstones that had been treated with water-repellants were in any case sensitive to damage produced by freeze-thaw cycles.

5 References

Addleson L. and Rice C. (1991): Performance of materials in buildings. A study of the principles and agencies of change, Butterworth-Heinemann, Oxford, 581 pp.

Blachere J.R. and Young J.E. (1972): The freezing point of water in porous glass, *Journal of the American Ceramic Society*, 55, 306-308.

CNR and ICR (1980): Raccomandazioni NORMAL 4/80. Distribuzione del volume dei pori in funzione del loro diametro, Roma, 10 pp.

CNR and ICR (1980): Raccomandazioni NORMAL 3/80. Materiali lapidei. Campionamento, Roma, 6 pp.

CNR and ICR (1982): Raccomandazioni NORMAL 10/82. Descrizione petrografica dei materiali lapidei naturali, Roma, 4 pp.

CNR and ICR (1983): Raccomandazioni NORMAL 14/83. Sezioni sottili e lucide di materiali lapidei: tecnica di allestimento, Roma, 3 pp.

CNR and ICR (1985): Raccomandazioni NORMAL 11/85. Assorbimento d'acqua per capillarità. Coefficiente di assorbimento capillare, Roma, 7 pp.

Fratini F., Manganelli Del Fà C. and Scala A. (1988): Alterazione e conservazione dell'ardesia, *Arkos*, 1, 14-23.

Lilliu G. (1988): La civiltà dei sardi. Dal paleolitico all'età dei nuraghi, Nuova ERI, Torino, 800 pp.

Manganelli Del Fà C., Pecchioni E., Scala A. and Piacenti F. (1992): Sandstone conservation problems: aggregating-protective treatment by fluorinated elastomer, *Science and Technology for Cultural Heritage*, 1, 201-208.

Neville A.M. (1986): Properties of concrete, Longmann Scientific and Technical, Harlow, 779 pp.

Nishiura T., Fukuda M. and Miura A. (1984): Utilisation des résines syntehétiques pour la protection des pierres contre le cycle gel-dégel. In "Adhesifs et Consolidants", Institut International de Conservation des Ouvres Historiques et Artistiques, Paris, 165-168.

Robinson G.C. (1984): The relationship between pore structure and durability of brick, *Ceramic Bulletin*, 63, 295-299.

THE USE OF DIFFUSION DENUDERS FOR STUDYING THE REACTIVITY OF MARBLE SURFACES: AN APPLICATION TO THE EVALUATION OF PROTECTIVES.

F. DE SANTIS, I. ALLEGRIANI AND D. PASELLA
CNR - Istituto Inquinamento Atmosferico, Monterotondo
Scalo, Roma, Italy

Abstract

A particularly desirable property of protectives is their inertness, a characteristic which is frequently overlooked. If these products are to find a really successful use, then the properties of existing products will require better understanding so that new types of protectives can be developed. Two commercially available protectives were investigated from the point of view of their reactivity towards SO_2 by using a diffusional technique. From measurement of SO_2 concentration, a reactivity coefficient and the corresponding deposition velocity have been calculated. Experiments on three types of marble have also been carried out by means of an exposure chamber to highlight the advantages of the diffusional technique used.

Keywords: Protective Agents, Deposition Velocity, Exposure Chamber, Diffusion Denuder.

1 Introduction

A number of test methods have been formulated for studying the deterioration of building materials. Measurement of porosity, bulk density, pore-size distribution, water permeability among others are used to define a marble and the modifications of its surface properties. Much of the characterization of protectives has focused on water repellency, transparency, lack of colour and low superficial tension. The use of these test methods, although effective, do not conveniently lend themselves to a good conceptual and quantitative understanding of the reactivity of a protective. From this point of view, although the concept of deposition velocity has been used to evaluate the reactivity of several materials (Lipfert, 1989), the aspect of the effectiveness of a protective as such, and the change in chemical reactivity offered to a surface when coated, has substantially been overlooked.

Laboratory experiments performed for studying the deposition onto surfaces of marbles have been carried out

on the basis of direct measurements of the deposition on a test specimen when exposed for a selected period of time to a controlled environment containing the pollutant under evaluation. These experiments often refer to concentration levels that are much higher than those characteristic of the ambient atmosphere (Gauri and Gwinn 1983, Gauri et al. 1982, Cobourn et al. 1993, Tambe et al. 1991, Haneef et al. 1992). As a consequence, mechanisms potentially important only in the low concentration region are presumably masked by processes that are higher order in the pollutant under study. Another potential drawback of the majority of the studies reported in the literature, is that they disregard the fact that it is important to study the intrinsic reactivity of a surface independent of mass-transfer limitations. In fact, since the diffusion of pollutants is usually slow at atmospheric pressure, most of the reported corrosion rates for e.g. metals and lithoid materials, both in the field and in the laboratory, are flawed by mass transfer limitations. In this regard, when low pressure is adopted, as it has been done in some studies on various surfaces by Judeikis, 1976, the diffusion is faster but the corrosion rate may be different, because vacuum conditions preclude the formation of a surface H_2O film which is essential for most corrosion processes. The aim of this paper is to describe a simple method based on the use of a diffusion denuder, capable of measuring parameters related to heterogeneous reactivity of pollutants on surfaces in the laboratory at ambient pressure and realistic concentration levels of pollutants and without mass-transfer limitations. As an example of application of this technique we report here on an investigation on the dry deposition of SO_2 on three types of marble surfaces as such and when coated with two commercially available protectives. In order to compare the results obtained with this indirect technique, a series of experiments were also conducted by using an exposure chamber on specimens of the three marbles under evaluation.

In this case, SO_2 deposition was determined directly by measuring the amount of sulfate deposited after exposing the test specimens.

2 Experimental

The flat diffusion denuder used in this study has been described in a previous publication from this laboratory (De Santis et al. 1994). Only a brief summary of salient features will be given here. A flat diffusion denuder consists of an enclosed polyethylene box containing two parallel briquettes of the material under investigation (12 cm long x 5 cm high x 0.8 cm thick). The marble samples, after being polished with 400-grit silicon-carbide powder were washed with distilled water in ultrasonic bath, and

conditioned in a sealed container for > 24 h at the same relative humidity to be used in the test. The briquettes are placed horizontally face to face and spaced 0.3 cm apart. A Viton O-ring which assures the airtightness, constitutes an additional spacer which increases the distance between the plates. The use of a marble surface coated with a 4% NaOH solution allows the estimate of the actual distance. Air is drawn into the box and flows parallel to the plates. The admission of air is carried out through a circular opening that gradually widens in order to insure a uniform distribution of flow at the inlet and outlet. This permits full development of laminar flow (Reynolds number less than 50) before heterogeneous wall removal occurred. The flat denuder is contained in a temperature controlled chamber. Two commonly used protectives (alkyl-alkoxy silanes) were used. The products were Hydrophase and Hydrophase Acqua, both from Phase (Florence, Italy) hereinafter indicated as P1 and P2, respectively. The protective agents were applied by brush following the instruction leaflet released by the supplier.

All determinations have been made after more than one month from the application.

The experiments were carried out as follows: First a flow of air at controlled r.h. was admitted to the flat denuder for conditioning the surface of the marble (as such or coated with the protective), at the chosen r.h. After two hours SO₂ (or SO₂ and NO₂ in selected experiments) was added to the air flow and its outlet concentration monitored by using a SO₂ analyzer.

The chamber experiments performed for studying the effect of mass transfer on the determination of the deposition velocity, were conducted by using an exposure chamber which was built for the simultaneous exposure in the laboratory of up to twelve samples of the marble under evaluation (5 cm x 0.8 cm x 0.8 cm). It consists of a large glass vessel (length = 37.0 cm, internal diameter = 14.6 cm), closed with a removable leak proof cap, in which air flow, humidity, temperature and gas concentration could be controlled. A pump was used to create a steady laminar flow through the vessel up to 10.0 l min⁻¹. A fan placed at the top of the vessel was used for studying the effect of turbulence on the deposition.

To perform the exposure chamber experiments by using the direct method it is necessary to work with specimens at low content in sulfate. Several washing procedures have been tested in the study. It was found that the simple immersion in distilled water for 48 h is suitable for best cleaning the specimens. This procedure has the additional advantage of being "soft" in comparison with treatments which employ heat or ultrasonic waves that could stress the specimens and have an influence on their reactivity.

Permeation tubes were used to generate SO₂ and NO₂ which were diluted at the inlet with clean air at controlled relative humidity (Humicon D.A.S. Palombara Sabina, Italy).

Since the source of NO₂ produces also small concentration levels of HONO and HNO₃, a downstream Na₂CO₃ denuder (coated with a 2.5% solution of aqueous methanol 50/50 v/v) was used as a scrubber. NO₂ and SO₂ were monitored by using a chemiluminescence (Environment Mod. AC 30) and a fluorescence (Monitor Labs Mod. 8850) continuous analyzer, respectively.

2 Theory

Gas exchange rates are often globally given either as an exchange constant (the deposition velocity: V_d = flux of gas/concentration difference), or its reciprocal, which measures the "resistance" of the interface to gas transfer.

To this regard, an analogy exists between flow of heat and flow of matter due to a concentration gradient. In opposition to a single energy effect as it is the case with the heat, diffusion is a physical transfer of matter which occurs at a definite velocity. As a consequence, the mass transfer resistances of a pollutant in the atmosphere can be described in terms of aerodynamic resistance (r_a), the boundary-layer resistance (r_b) and the surface uptake (r_s):

$$V_d = [r_a + r_b + r_s]^{-1} \quad (1)$$

Any one of these mass transfer resistance can be rate determining; i.e. while in the case of transport of air momentum the total deposition is described by only one term (apart from the contribution of sedimentation), in the case of transport of an atmospheric contaminant the aerodynamic resistance is only one part of the process: the boundary layer and surface resistances must also be considered.

The specific interaction gas-surface (i.e. what corresponds to the term r_s) can be represented also by using the concept of reaction probability γ which is defined as the ratio of the number of molecules which are sorbed on a unit surface area per unit time to the total number of molecules which strike per unit surface per unit time.

This coefficient may take values between 0 (no reaction) and 1 (perfect sink surface). The flux of pollutant to the surface (J) is equal to the rate of molecular collision, as predicted by the molecular theory of gases, multiplied by the reaction probability:

$$J = \gamma \left[\frac{kT}{2\pi m} \right]^{1/2} C \quad (2)$$

where C is the pollutant concentration in air near the surface (strictly speaking the concentration at one mean free path away from the surface should be used. This simplification could be unjustified only when γ is high), k is the Boltzmann constant, T is the absolute temperature and m is the mass of an individual pollutant molecule. The above concept of reaction probability can be combined into the mathematical expression [1] in which pollutant flux becomes analogous to electrical flow in circuits, with concentration as driving force.

From the consideration above it is apparent that if γ is sufficiently small then the surface resistance dominates all other terms. Moreover, it is clear that as γ approaches unity, surface resistance becomes negligible, and V_d approaches the transport-limited value.

3 Experiments with the flat denuder

The rationale behind denuder technique applied to the study of surface reactivity has already been presented in a previous paper (De Santis et al. 1994). In short, the use of the diffusion denuder for studying the reactivity of marble results from the basic assumption that the surface reaction is the limiting step for mass transport to the walls, i.e. γ is small (below 10^{-4}). Under this condition uptake rates are independent of diffusion and a surface removal constant, dimensioned as a deposition velocity, can be determined.

The use of the continuity equation gives for a parallel plate denuder (with dimension a corresponding to half depth and b corresponding to the long dimension of the channel), the following equation

$$\frac{C}{C_0} = \exp\left(\frac{-2L(2a+b)K}{Q}\right) \quad (3)$$

with C = outlet concentration
 C_0 = inlet concentration
 K = surface removal constant
 L = length of the channel
 Q = flowrate

On the other hand, when the reaction rate on the surface is fast (as it is the case with the coatings used for environmental sampling) the reaction along the tube is diffusion controlled. In these conditions, the collection efficiency follows the Winiwarter equation (Winiwarter, 1992). In the same units employed above for equation [3], we have:

$$\frac{C}{C_0} = 0.91 \exp \left(-15.08 \frac{DL(2a+b)^2}{4Qab} \right) \quad (4)$$

with D = diffusion coefficient

The two equations [3] and [4] have been utilized to analyze the data obtained with the parallel plate denuder described in the experimental part. The equation [4] which assumes complete retention of the pollutant upon contact with the surface, has been applied to analyze the data obtained with briquettes of Thassos marble coated with a 4% solution of sodium hydroxide. The results obtained at various flowrates show an excellent agreement to the theoretical efficiency curve when $a=0.25$ cm instead than 0.3 cm is adopted as actual half depth of the rectangular channel. This value has been used in the course of the subsequent study and periodically checked in order to monitor possible variation of the distance between the slabs due to ageing of the O-ring spacer.

The equation [3] has been used to investigate the reactivity of Thassos, Penteli and Carrara marbles.

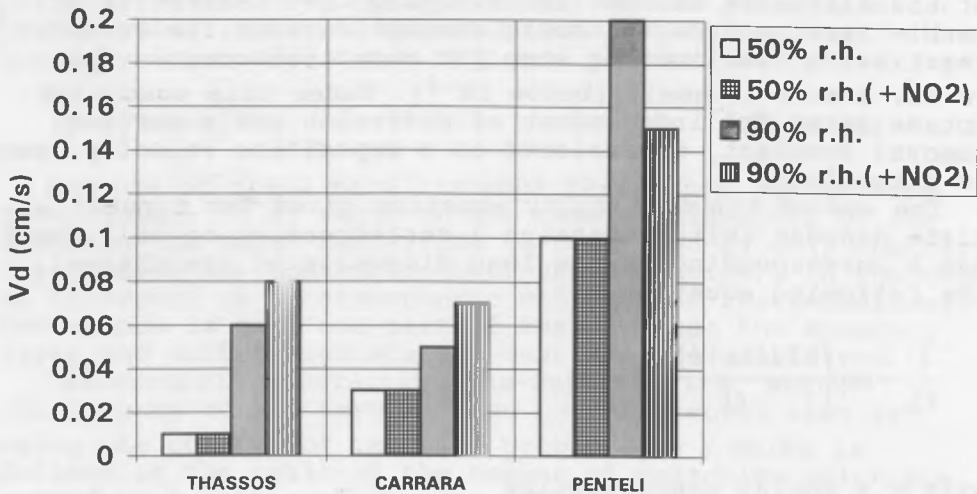

Fig. 1. Determination of V_d by flat denuder.

By measuring the inlet and outlet concentrations of SO_2 at different r.h. conditions and in the presence or not of NO_2 , it has been possible to relate the decrease of concentration with the reactivity expressed as a function of the surface removal constant K , and therefore of the deposition velocity.

The surfaces tested constantly show a pattern of an initially high rate of deposition which decreases sharply during the experiment.

The values reported in Figure 1 refer to the asymptotic conditions reached in about one hour time. The relatively high initial rate of deposition is probably related to SO₂ dissolution in the surface moisture layer of the briquettes. The deposition rate continues to decrease upon prolonged exposure with deposition balancing the reaction with the stone. The addition of NO₂ to the gaseous stream does not cause any effect on the deposition of SO₂ at 50% r.h., whereas at 90% r.h. a sensible increase for Thassos and Carrara marbles can be observed. On Penteli marble the presence of NO₂ surprisingly is able to cause a drop in reactivity.

Figure 2 presents the results obtained at 90% r.h. on marble specimens of the three marbles under study when coated with the two protectives P1 and P2, respectively.

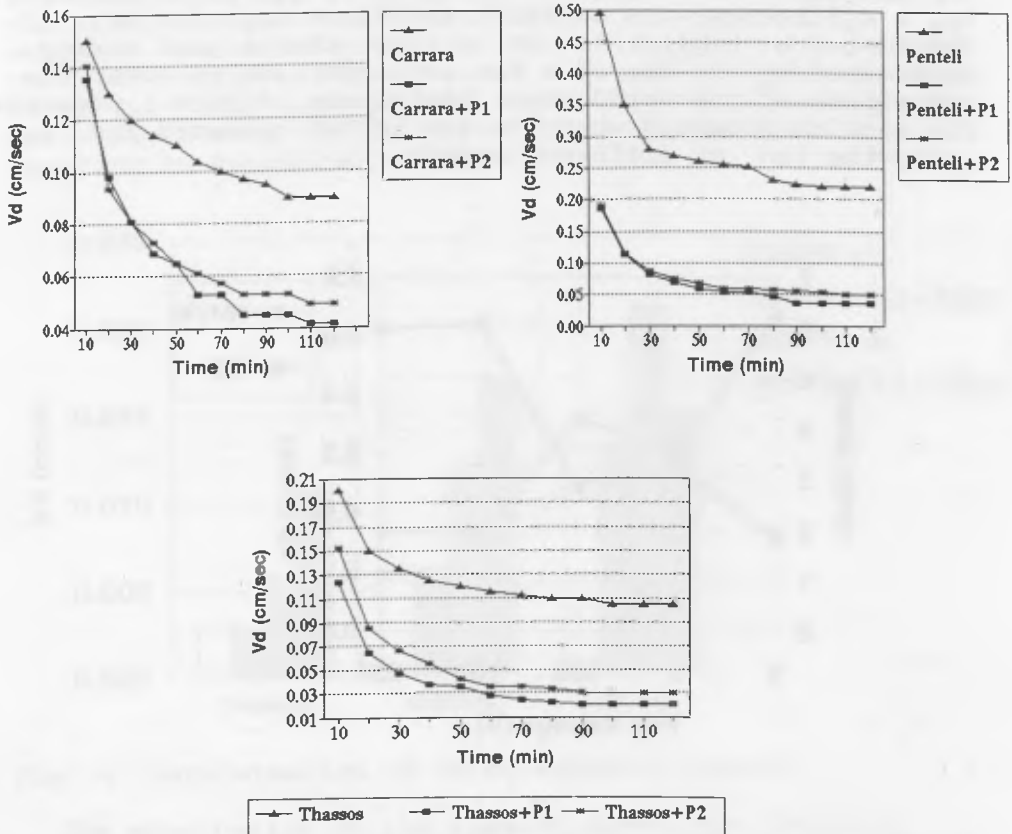

Fig. 2 Deposition of SO₂ at 90% r.h. on protective P1 and P2

The two protective tested show a considerable protective influence on the marbles. It is worth noting that coating of differently reactive surface involves the same degree of protection as a final result. The small differences found can probably be attributed to the different physico-chemical properties of the materials deriving from their porosity and pore size distribution.

4 Experiments with the Exposure Chamber

The deposition of SO_2 and of mixtures of $SO_2 + NO_2$ has been studied by using a direct method (measurement of sulphate on the surface by extraction after the exposure).

Preliminar to the study was an investigation on the influence of the aerodynamic resistance (r_a) on the performance of the exposure chamber. This investigation, has been performed by using specimens coated with sodium hydroxide. In this condition the deposition velocity depends on the aerodynamic and boundary layer resistance ($r_a + r_b$) because the surface resistance (r_s) can be considered as negligible. It is clear that a good mixing determined by the use of a fan is important to lower the contribute of the aerodynamic resistance. Figure 3 presents the results obtained when the fan is not operated and by using the fan at different speeds.

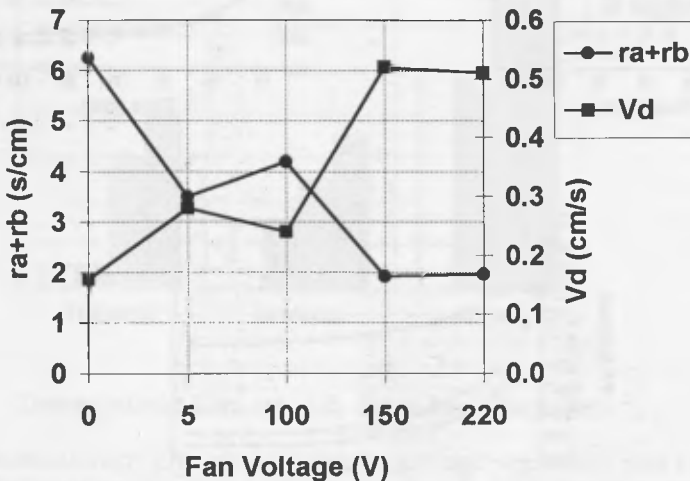

Fig.3 Determination of V_d on Thassos marble coated with NaOH.

As expected the fan causes a noticeable reduction of the total resistance from 6.2 sec/cm to 1.9 sec/cm. It is interesting to note that the result obtained at intermediate and high speed do not differ within the limits of the experimental reproducibility; clearly the system reaches its maximum of turbulence at intermediate speed.

However, the analysis of the sulphate on the samples exposed in three different positions inside the chamber, shows that the deposition is not homogeneous as one could have expected in the presence of total turbulence. From these results we can conclude that even at maximum speed the experiments with the exposure chamber are affected by a residual aerodynamic resistance which should be taken into account in the evaluation of the deposition velocity.

For the sake of comparison with the flat denuder technique, the same three types of marble Thassos, Penteli and Carrara have been investigated. The samples have been exposed in conditions of minimum of aerodynamic resistance (fan at full speed) in the exposure chamber and the effluent monitored for SO₂. At the end of the experiment the specimens have been extracted and analyzed for sulphate. Analogously to the results found in the case of the flat denuder, the specimens constantly show a pattern of an initially high rate of deposition which rapidly decreases during the first two hours of exposure, finally reaching an approximately steady value.

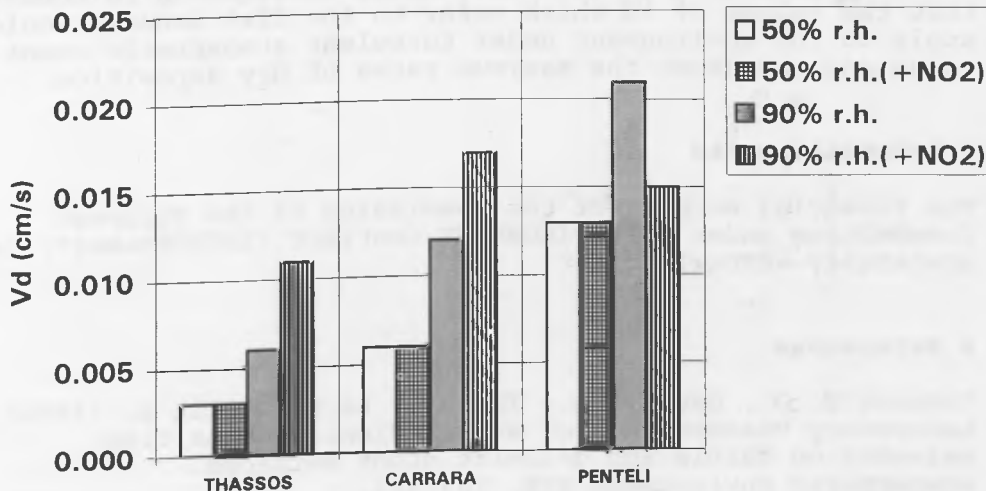

Fig. 4. Determination of Vd by exposure chamber

The examination of the figures shows that Pentelic marble exhibits the highest reactivity, Vd = 0.02 c/sec, followed by the Carrara marble and then the Thassos

characterized by $V_d = 0.012$ c/sec and $V_d = 0.006$ c/sec, respectively. On the basis of the relationship [1] it follows that the total resistance for the three types of marble ranges from 166 s/c for the Thassos to 50 s/c for the Pentelic. To these total resistance contributes an aerodynamic resistance and a resistance of the boundary layer which ranges from about 2 s/cm (in case that the air is well-mixed with the fan) up to about 6 cm/s (when the fan is not operated). This would represent a noticeable fraction of total resistance in the case of higher reactivity (Penteli marble).

Experiments carried out by exposing the marble samples to a mixture of SO_2 and NO_2 , at a relative humidity of 90% have been reported in the same Figure. It is noteworthy that the presence of NO_2 slightly enhances the deposition of SO_2 on Carrara and Thassos marbles ($V_d = 0.017$ cm/s and $V_d = 0.011$ cm/s respectively) while a decrease of deposition velocity occurs on Pentelic marble ($V_d = 0.010$ cm/s). Also in the presence of NO_2 , the quantity of sulfate analyzed by leaching of the samples after the exposure, is in very good agreement with the expected amount calculated on the bases of the SO_2 drop measured at the outlet of the exposure chamber.

As expected, the comparison between data obtained by flat denuder and by exposure chamber shows remarkable differences in the value since mass transport by diffusion has been expressly taken into account in the analysis of the data from the flat denuder. It is interesting to note that the values of V_d which refer to the flat denuder would apply to the environment under turbulent atmospheric conditions and represent the maximum rates of dry deposition.

5 Acknowledgments

The financial support of the Commission of the European Communities under an ENVIRONMENT Contract (EV5VCT940537) is gratefully acknowledged.

6 References

- Cobourn W. G., Gauri K.L., Tambe S. Li S. Saltik E. (1993): Laboratory Measurements of sulfur dioxide deposition velocity on marble and dolomite stone surfaces. Atmospheric Environment 27B, 193-201.
- De Santis F. Pasella D. Allegrini I. (1994): A diffusion technique for the evaluation of surface reactivity: application to the study of SO_2 deposition on marble. Proceedings of the III Int. Symposium on the conservation of monuments in the Mediterranean Basin (Fassina V., Ott H. Zezza F. Eds) Venice, 1994, 213-216.

Gauri K. L. and Gwinn J. A. (1983): Deterioration of marble in air containing 5-10 ppm SO₂ and NO₂. Durability of Building Materials, 1 217-223.

Gauri K. L., Popli R. and Sarma A. C. (1982): Effect of relative humidity and grain size on the reaction rates of marble at high concentrations of SO₂. Durability of Building Materials, 1, 209-216

Haneef S.J., Johnson J.B., Dickinson C., Thompson G.E., Wood G.C. (1992): Effect of dry deposition of NO_x and SO₂ gaseous Pollutants on the degradation of calcareous building stones. Atmospheric Environment 26A, 2963-2974

Judeikis H.J., Stewart T.B. (1976): Laboratory measurement of SO₂ deposition velocities on selected building materials and soils. Atmospheric Environment 10, 769-776

Lipfert F. W. Dry deposition velocity as an indicator for SO₂ damage to materials (1989): JAPCA 39, 446-452

Tambe S., Gauri K.L., Li S. Cobourn W.G. (1991): Kinetic Study of SO₂ reaction with dolomite Environ. Sci. Technol. 25, 2071-2075.

Winiwarter W. (1989): A calculation procedure for the determination of the collection efficiency in annular denuders. Atmospheric Environment 23, 9, 1997-2002.

COMPARISON BETWEEN SEVERAL SPANISH TREATED STONES SUBMITTED TO SALT CRYSTALLIZATION AND FREEZE/THAW ACCELERATED WEATHERING TESTS

J.L. PEREZ* ; M.A. BELLO* ; R. VILLEGAS** ; J.F. VALE** and M. ALCALDE**

* Department of Analytical Chemistry, 41012-Seville, Spain

** Department of Chemical and Environmental Engineering, 41012-Seville, Spain

Abstract

Some of the main stones used in Spanish southern monuments were treated with the main commercial types of conservation products and submitted to salt crystallization and freeze/thaw weathering tests with the aim to compare the behaviour and for demonstrate that the results obtained from both tests are not comparable. For the salt crystallization test, sodium sulphate was employed and the freeze/thaw test was carried out on a climatic chamber. Conservation products tested are siliconic, acrylic and acryl-siliconic types. The results obtained suggest that, in several cases, the application of a protective agent accelerates the deterioration process and this fact demonstrates the need to carry out weathering tests previously the application of the products on the monument.

Keywords: Treated Stones, Accelerated Weathering Test, Salt Crystallization, Freeze/thaw.

1 Introduction

The use of weathering tests on treated stones was shown of capital importance in the evaluation of the behaviour of the conservation products; so, the same product can present different behaviour depending to the stone-type treated and/or the weathering factors. Overcoat, it is necessary to consider the possibility that the application of a conservation product can accelerate the weathering processes.

Logically, the best tests are those realized on the monument, but they are the great disadvantage of their lengthy; in this way it is remarkable the observations of Honeyborne (1965), who was checked that after thirty-four years of freeze/thaw test at the natural environment, several stony materials do not present macroscopical weathering manifestations. This author proposes an accelerated tests which provokes one year of natural weathering in only six days. Nowadays, an European Investigation Project (EUROCARE/EUREKA) is on course with the aim to evaluate the real behaviour of several stony materials submitted at different environmental conditions.

Despite the accelerated weathering tests cannot reproduce in some cases the real weathering mechanisms, for their small duration they are of practical interest overcoat

for the evaluation of the behaviour of conservation products previously their possible application.

The basic types of accelerated weathering tests are four:

- * Freeze/thaw
- * Salt crystallization
- * Thermohygro-metric cycles with or without U.V. radiation
- * Chemical attack with solutions or polluted atmospheres

Exist numerous and extensive studies but in the field of the freeze/thaw test they are remarkable the works of Honeyborne (1965), Daxelhofer (1969), Rossi-Doria and Tabasso (1971), Lautridou and Ozout (1978) and Mamillan and Bouineau (1981). Important works in the salt crystallization process are those of Price (1978) and Rossi-Manaresi (1981).

The most frequent critiques to the freeze/thaw tests in their most usual forms are the no consideration of temperature gradients, which occur in the monument between the internal and external faces of the stones; however, the major number of the tests consists in the saturation with water, then submits the material at temperatures between -15C and -25C and the thaw process completes the cycle.

The most frequently used substance for the salt crystallization tests is the sodium sulphate, which during the hydration process with ten molecules of water increases notably its specific volume (308%).

A similar behaviour for the materials submitted to both accelerated weathering tests was proposed sometimes. However, this work state that despite in both cases the deterioration processes are provoked by internal stress, due the growth of crystals into the pores, the effects are different generally.

2. Experimental

2.1 Stones tested

For this work three stone types very used andalusian monuments were tested: A dolomitic limestones from Almería quarries, located near the city, of white-greyish colour with open porosity between 44.5-48.5 %. Other material is a calcitic sandstone from Puerto de Santa María quarries (Cádiz) of white-yellowish colour and open porosity of 33-37%. The materials from Padul (Granada) are limestones of porosity of 26-31% and yellowish colour.

The materials from Almería constitute the practical totality of the Almería Cathedral and they are profusely distributed in the rest of monuments of the city. The materials from Puerto de Santa María quarries have been widely used in many andalusian monuments; it is remarkable their use in the Seville cathedral, the biggest Gothic monument. The Padul materials constitute the practical totality of the Granada cathedral, which is the biggest renaissance cathedral of Spain, and they also widely were used in other monuments of Granada.

Table 1 shows the typical chemical major composition of the stony materials tested

in this work.

Table 1. Typical major chemical composition (%) of the stony materials

STONE	loss on ignition	SiO ₂	Al ₂ O ₃	Fe ₂ O ₃	CaO	MgO	Na ₂ O	K ₂ O	SO ₃	Total
Almería	43.66	8.55	1.77	1.23	27.58	16.20	0.36	0.03	0.98	100.36
Puerto de Santa María	27.78	36.19	0.28	0.17	35.19	0.22	0.03	0.01	0.43	100.30
Padul	42.17	5.75	0.78	0.74	49.16	0.15	0.30	0.04	1.02	100.11

2.2 Products of conservation

For this study, five known commercial products of conservation were tested. Four products are of silicone type: Stone Strengthener OH (ethylsilicate), Tegovakon V (ethylsilicate), Tegosivin HL100 (monomeric organosilicic); one acrylsiliconic product: ARD 55.050 (acrylsiliconic resin) and one acrylic product: Paraloid B72 (copolymer of methylacrylate and ethylmethacrylate).

Respect to their effect on the stone, they can be classified in:

- * Consolidants: Strengthener OH (OH) and Tegovakon V (TV)
- * Consolidants + water repellents: Paraloid B72 (PA) and ARD 55.050 (ARD)
- * Water repellents: Tegosivin HL100 (TG)

These products cover the main types in composition and effects, and were applied on unaltered stones from the respective quarries.

For the application of the products on the stones, cubic samples of 5 cm edge were used for all the tests carried out. Before applying the products, the samples were cleaned, wetted and left in the air to dry until the water content was 0-2 g; this procedure reproduces the state of the stone in the building and favours the polymerization of organosilicic products (Charola et al. (1984), Lewin and Wheeler (1985), Pauly (1985)). Table 2 shows the solvents and dilutions used for the application of the conservation products.

Table 2. Solvents and dilutions used for the products applied

PRODUCT	DILUTION
Strengthener OH	Ready to use
Tegovakon V	Ready to use
Tegosivin HL100	10% (v/v) with xylene
ARD 55.050	Ready to use
Paraloid B72	5% (w/v) with 1,1,1-trichlorethane

Three samples were treated by ten minutes immersion in order to reach an uniform penetration on all faces. Due to the high stone porosity, this time is enough to achieve a total impregnation of the samples.

2.3 Accelerated weathering tests

2.3.1 Salt crystallization test

The test consists in:

- 24 h total immersion in 10 % (w/v) sodium sulphate solution (room temperature)
- 21 h drying at 65C
- 3 h for cooling and weighing

2.3.2 Freeze/thaw test

The test was carried out in a CCI climatic chamber with home-made automation and consists in:

- 8 h 25C / 80% RH
- 1 h 25C / 100% RH with rain
- 7 h 25C / 80% RH
- 8 h -15C

3. Results

Though the tests are nowadays in progress, the results obtained now permit to realize several considerations about the behaviour of the treatments and stones, and the comparisson between both accelerated weathering tests. For the salt crystallization test one, a total of 75 cycles were carried out; freeze/thaw test was completed the 220th cycle.

First, it is remarkable that for the untreated stones submitted to the freeze/thaw test, only the Puerto de Santa María one was presented macroscopical weathering manifestations and several treated stony materials were presented very important deterioration. This fact says that the use of some conservation products can accelerate the stone weathering and therefore it is necessary to check the behaviour before the application on the monument.

There are different behaviours depending to the stone/product pair, but the worse behaviour correspond, in general, to the products with consolidant characteristics, wich sometimes, as mentioned accelerate the deterioration process in several cases.

Similar considerations can be realized for the salt crystallization tests, though the weathering acceleration is fewer evident. Likewise, it is remarkable that the salt crystallization test is more aggressive that the freeze/thaw one.

Figures 1 and 2 show the comparisson between both accelerated weathering tests for the Puerto de Santa María and Almeria stones, respectively, when they are evident the previously exposed considerations.

The macroscopical weathering manifestations for the salt crystallization test consist

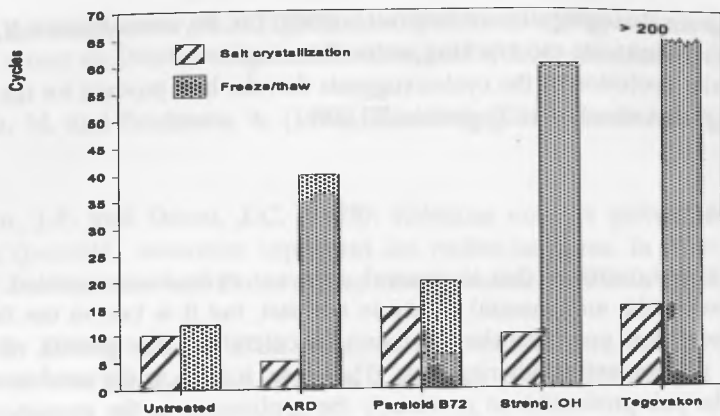

Fig.1. Number of cycles for macroscopical weathering manifestation in Puerto de Santa María stone.

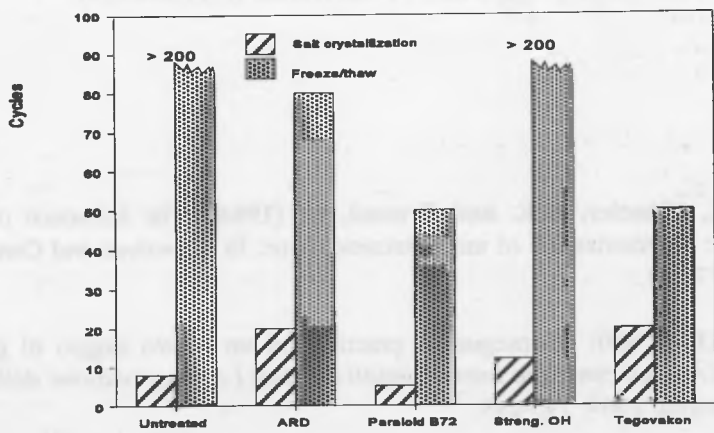

Fig.2. Number of cycles for macroscopical weathering manifestation in Almería stone.

essentially in grain disaggregation or contour scaling; for the freeze/thaw test, the most frequent manifestations are the cracking or the fissuring.

Nowadays, the evolution of the cycles suggests that the best product for the materials and weathering tests checked is Tegosivin HL100.

4. Conclusions

The experience demonstrates that in general does not exist documentation about the products applied to the monumental stones in the past, but it is known the fact that in many cases, they were provoked the weathering acceleration. The present work shows this fact using accelerated weathering tests. Therefore, it is clear the need to check the behaviour of the pair product/stone previously the application on the monument; in this way, for their short duration, the accelerated weathering tests were demonstrated their practical applicability, despite to their very know limitations.

Moreover, the results obtained indicate that both accelerated tests are not comparable, in general, as was occasionally proposed. Likewise, the salt crystallization test is more aggressive than the freeze/thaw one and we consider that in several cases, it not allows to differentiate between the behaviour of certain pairs.

Now, the tests are still in progress, and a correlation between the behaviour and porosimetric data, water-related properties and microscopical observations are trying.

Acknowledgement

This work has been realized with a DICYT subvention (PAT90-0929).

5. References

Charola, A.E., Wheeler, G.E. and Freund, G. (1984): The influence of relative humidity in the polymerization of methyltrimetoxilane. In *Adhesives and Consolidants*, Paris, 1984, 177-181.

Daxelhofer, J.P. (1969): Conseguenze pratiche di un nuovo saggio di gelività in laboratorio. In *Atti del convegno internazionali di studi La conservazione delle sculture all'aperto. Bologna, 1969, 143-149.*

Gerard, R. (1978): L' etat de surface d' un matériau poreux caractérisé pour une mesure d'absorption d' eau. In *Proceedings of Int. Symp. on Deterioration and Protection of stone monuments. Paris, 1978, 3.11.*

Honeyborne, D.B.(1965): A laboratory freezing test for natural building stone. *Building Research Station Miscellaneous Papers.*

Lewin, S.Z. and Wheeler, G.E. (1985): Alkoxysilane chemistry and stone conservation. In *5th Int. Cong. on Deterioration and Conservation of Stone, Lausanne, 1985*, 831-844.

Mamillan, M. and Bouineau, A. (1981): Essais de gel. *Document du RILEM 58 VTP*, 81/17.

Lautridou, J.P. and Ozout, J.C. (1978): Relations entre la gelivité et les propriétés physiques (porosité, ascension capillaire) des roches calcaires. In *Proceedings of Int. Symp. on Deterioration and Protection of stone monuments. Paris, 1978*, 3.3.

Pauly, J.P. (1985): Qualité d'un traitement et teneur en eau. In *5th Int. Cong. on Deterioration and Conservation of Stone, Lausanne, 1985*, 817-829.

Price, C.A. (1978): The use of the sodium sulphate crystallisation test for determining the weathering resistance of untreated stone. In *Proceedings of Int. Symp. on Deterioration and Protection of stone monuments. Paris, 1978*, 3.6.

Rossi-Doria, P. and Tabasso, M. (1971): Artificial ageing tests on stones, marbles and bricks. *L'Ingegnere*, 45(6), 483-502.

Rossi-Manaresi, R. (1981): Salt crystallisation test. *Document of RILEM 58 VTP*, 81/16.

LABORATORY SIMULATION OF AGGRESSIVE CLIMATIC CONDITIONS -THEORETICAL BACKGROUND AND EXPERIMENTAL RESULTS-

B. RIECKEN, B. SCHWAMBORN
University of Technology, Aachen, Germany

Abstract

New polymer-based impregnation agents have been developed as experimental products for the preservation of natural stonemonuments. The assessment of the effectiveness of these materials is carried out by comparison of macroscopic physical test results before and after accelerated aging test results. A new experimental apparatus called "VENUS" (Versuchsanlage zur Entwicklung naturnaher Umweltsimulationskonzepte) is used for accelerated, reproducible, complex weathering. The theoretical background and the technical realisation of the simulation device is demonstrated.

Specimens of different sandstones and one limestone have been weathered for 6, 12 and 18 months in the described experimental system. Outdoor weathered specimens pass the same comprehensive tests as the specimens weathered in the VENUS system.

After exposure, series of comprehensive tests were carried out to determine the rate of deterioration. Experimental results of colour change, ultrasound velocity, capillary water absorption, and mechanical properties after different weathering periods show, that differences in durability are observed according to the different protection materials and different stones. The rate of deterioration after artificial and natural weathering is compared.

Keywords: Natural Stones, Weathering Simulation, Aging Test, Effectiveness of Preservation Materials

1 INTRODUCTION

New polymer-based products for the protection of weathered natural stones have to prove the durability of there effectiveness in accelerated aging tests. The products are related to a new concept for the preservation of natural stones, which has been developed at Aachen University. A detailed description of this concept and exemplary experimental test results are given by H.R. Sasse at al in /1/. The main ideas may be summarized as follows:

The dissolved protection material in a fluid state is sucked into the critical surface volume of the stones by capillary forces. The penetration depth varies between 10 and 60 mm for different stones. The solvent evaporates and the polymer hardens and forms an elastic, hydrophobic layer on the inner surfaces of the stone, without closing the capillary pores. The



hydrophobicity of the polymer surface prevents rainwater penetration, but the open pores allow water vapour diffusion. The elastic polymer film protects the natural binder material from air pollution and strengthens the weak matrix.

During the last years some most promising experimental products passed various tests in the laboratory which demonstrated their suitability. Before they can be applied on buildings of historical value, the products have to prove their durability in accelerated aging tests. A new experimental system for such tests called VENUS (Versuchsanlage zur Entwicklung naturnaher Umweltsimulationskonzepte) was developed. The control unit allows independent variation of IR/UV radiation, humidity, temperature, rain, wind, and air pollution. The aim of the tests is the distinction of the effectiveness and durability of the protection materials under complex without any unnatural increase of weather components.

2 THEORETICAL BACKGROUND - THE CONCEPT OF SIMULATION

The mechanisms responsible for the deterioration of natural stone are very complex. It is assumed that interactions between physical, chemical, and biological attacks do not follow the principle of superposition and differ from stone to stone. Two main ideas for the VENUS concept follow from these facts:

- a) A laboratory simulation for different types of natural stones must be a complex simulation with all the natural elements like sun, rain, freeze-thaw cycles, changes in temperature, humidity, and air pollution. (Limestones, for example, show a very good resistance in uniparametric freeze-thaw cycles, but are sensitive to SO₂ atmosphere. In contrast some common sandstones are sensitive to freeze-thaw cycles, only)
- b) To make sure that no unnatural process of deterioration is involved, all maximum and minimum temperatures and temperature gradients were adapted to the data from different central European meteorological stations. Acceleration is achieved by selecting those parameters which are most important for the deterioration. These parameters are combined in a special way and form a cycle of one week. This week presents all the extreme, but real weather elements of one medium Central European year.

The specimens have been weathered in the experimental device for 0.5, 1 and 1.5 years up till nom. Comprehensive tests of

- hydrophobic properties (capillary water absorption, contact angle and water vapour permeability),
- mechanical properties (tensile strength and ultrasound velocity),
- optical properties (colour, texture in scanning electron microscope)

are carried out to quantify the deterioration status after exposure. To estimate the rate of acceleration in the VENUS concept, additional outdoor weathering is necessary. Specimens with the new protection materials are weathered in four different central European climates, which are continuously registered by neighbouring meteorological stations. The outdoor-

weathered specimens are exposed up for 1 and 3 years. After exposure they pass the same comprehensive tests as the specimens weathered in the VENUS system. In the long term, it is expected that a comparison of VENUS specimens and outdoor-weathered specimens will allow to estimate the durability of the protection materials by accelerated aging tests.

3 THE EXPERIMENTAL DEVICE VENUS

Fig. 1 shows a schematic plan of the experimental device. The test chamber is into two chambers divided into two sections by a horizontal layer of specimens: climate 1 (C1) and climate 2 (C2). The upper climate presents the conditions outside a building, the lower climate presents indoor conditions. Sun (S) and rain (R) are placed in climate 1. The spectral distribution of the sun radiation is according to the international standard D65. The gases SO_2 , CO_2 and NO_x are mixed and injected. They are added in well-defined times of the weathering cycle. The concentration corresponds to the German conditions of „smog, alarm I“. Both climates are independently regulated concerning humidity and temperature. The specimens (SP) sized $5 \times 5 \times 30 \text{ cm}^3$ or $5 \times 5 \times 10 \text{ cm}^3$ are placed in a way, that humidity and temperature transport can only take place vertically. The weathered surface is $5 \times 5 \text{ cm}^2$. The temperature of the chamber walls (W) can be regulated. This allows definite condensation on the inner surfaces of the stones.

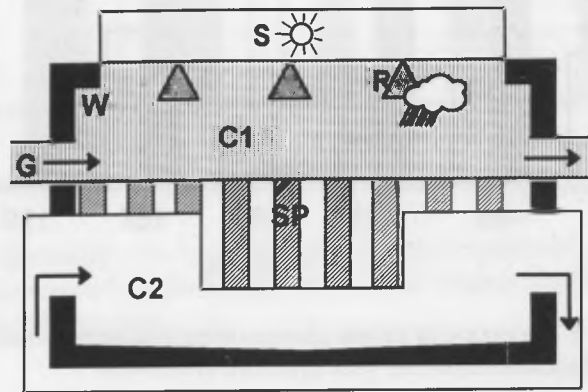

Fig. 1. Schematic plan of the experimental system VENUS

SP	specimens, separating section 1 and 2
C1,C2	section 1, 2 (Climate 1,2)
G	polluted air input, wind input
S	sun (IR, visible light, UV)
R	water nozzles
W	wall temperature independently controlled from temperature in chamber 1,2

4 EXPERIMENTAL RESULTS

4.1 Colour Changes

The impregnation of a natural stone with a polymer-based protection material causes a change in colour. The colour is intensified similar as if the stone is wetted by rain. The change of colour is measured according to DIN 6174. Fig. 2 shows the differences for the sandstone Ebenheider Sandstein with six different film-forming products and one non film-forming hydrophobic product (H) related to the untreated stone. The greater the value of dE^* , the more the change in colour. A variation of brightness is included. After exposure in VENUS the initial change of colour is generally reduced, as demanded by the heritage philosophy ($dE=5$ is generally accepted).

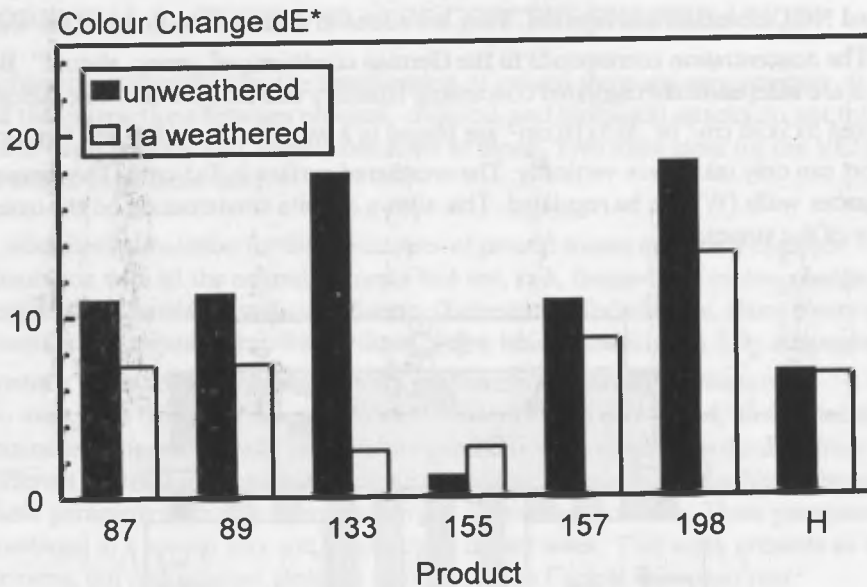

Fig. 2. Reduction of colour change of the sandstone Ebenheider Sandstein after one year exposure in VENUS

4.2 Ultrasound Velocity

The velocity of an ultrasound signal near the surface is a sensitive indicator for matrix deteriorations of a solid two-phase system, even before damage can be seen. A system "Type UVM-3b" was used, which was specially produced for testing natural stones. The piezoelectric transducers are shaped with an extremely small contact area which provides close contact to the surface and precise fixation of measuring distance. Fig. 3 shows the ultrasound velocity of impregnated specimens of the sandstone Sander Schilfsandstein in % related to the velocity in untreated, unweathered specimens. The specimens for VENUS weathering and outdoor

weathering could not be taken from one block of sandstone. Therefore the unweathered reference specimens for both exposures differ from each other and the values measured after treatment have to be compared with the values from untreated stones of the same block. The velocities after three years of outdoor exposure in industrial atmosphere (Duisburg) and after half a year exposure in VENUS are presented. Generally the sound velocity increases by impregnation of the stone. Outdoor exposure in industrial atmosphere as well as artificial weathering in VENUS causes reduction of sound velocity. In two of three cases -product code 87 (polyurethane) and 133 (epoxy)- the degree of reduction was higher after half a year VENUS than after 3 years Duisburg. This trend has to be correlated with mechanical values.

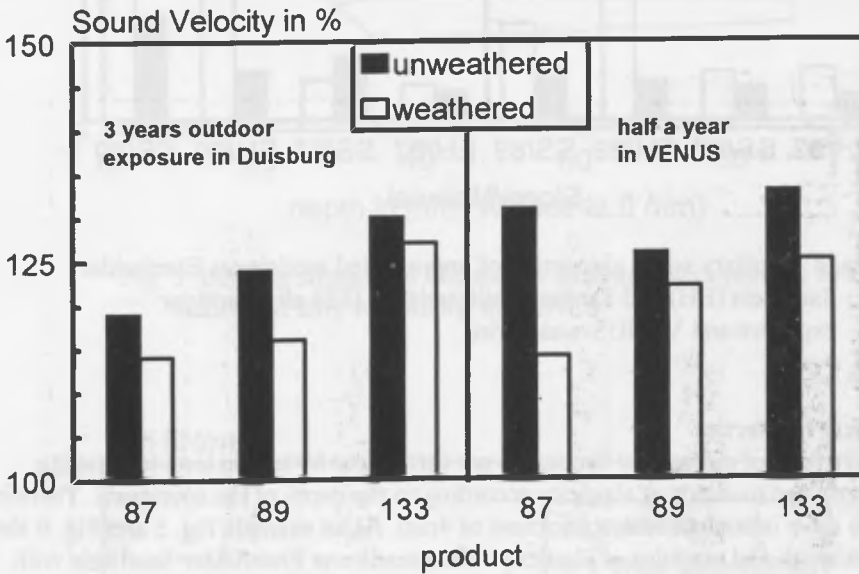

Fig. 3. Ultrasound velocity (in % of the velocity in untreated, unweathered specimens) of Sander Schilfsandstein after outdoor exposure and VENUS weathering

4.3 Capillary Water Absorption

The hydrophobicity of the impregnated stones after exposure is quantified by capillary water absorption and contact angle measurement. Fig. 4 shows the free capillary water absorption (during one day) of the impregnated specimens after exposure. The wetted side was the weathered surface. The hydrophobicity is reduced due to exposure. The degree varies extremely between the different stone/protection material combinations. The trend is more clear in the case of shorter VENUS-weathering with material 89. As described in the last paragraph, the different reference values for Duisburg- and VENUS specimens are caused by different blocks of sandstone.

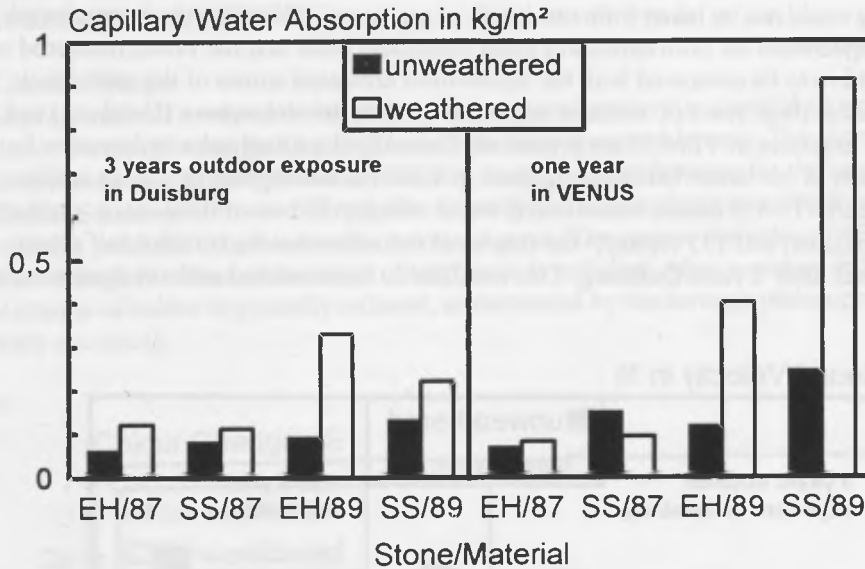

Fig. 4. Capillary water absorption of impregnated sandstones Ebenheider Sandstein (EH) and Sander Schilfsandstein (SS) after outdoor exposure and VENUS-weathering.

4.4 Mechanical Properties

Comprehensive tests of mechanical properties are carried out by tensile tests to estimate bending strength and modulus of elasticity according to the depth of the specimens. Therefore the stones are sawn into slices with a thickness of 4mm. As an example Fig. 5 and Fig. 6 show the bending strength and modulus of elasticity of the sandstone Ebenheider Sandstein with product 87 before and after weathering in VENUS. The mechanical properties did not change significantly during the exposure.

Contrary to these results, the bending strength of Sander Schilfsandstein with product No.87 decreases during the specimens outdoor exposition. Fig. 7 shows the bending strength after outdoor exposure in comparison to the data after VENUS-exposure. The bending strength of the specimens with natural weathering gets lower step by step. After half a year VENUS-weathering no effect could be seen. But one year VENUS-weathering causes a clear decrease of bending strength.

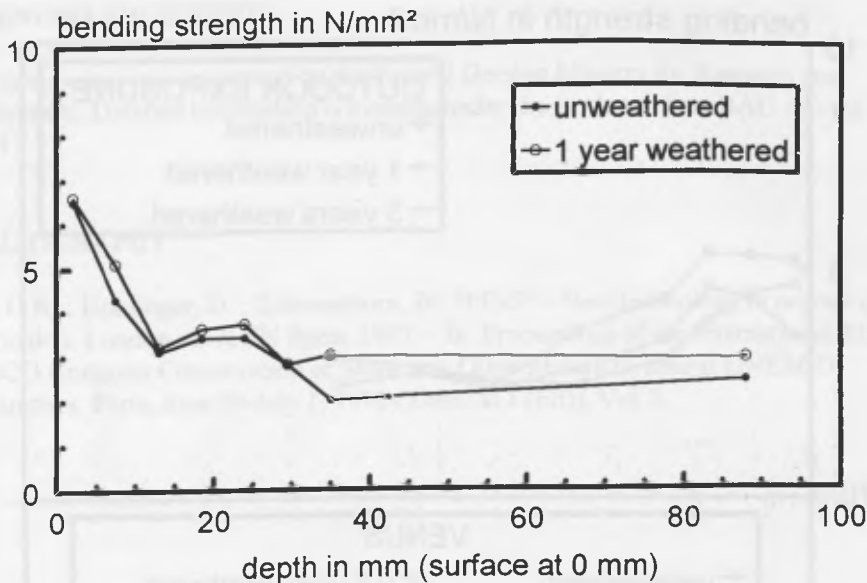

Fig. 5. Bending strength of Ebenheider Sandstein with product 87 before and after weathering in VENUS

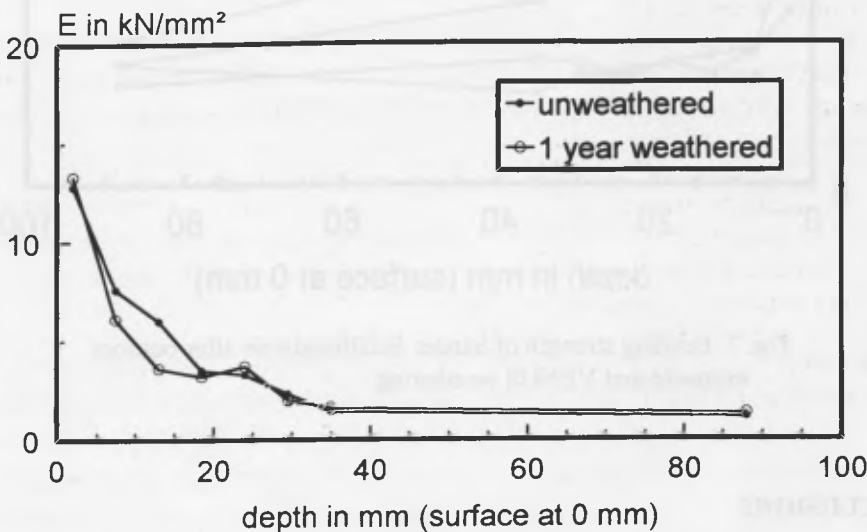

Fig. 6. Modulus of elasticity of Ebenheider Sandstein with product 87 before and after weathering in VENUS

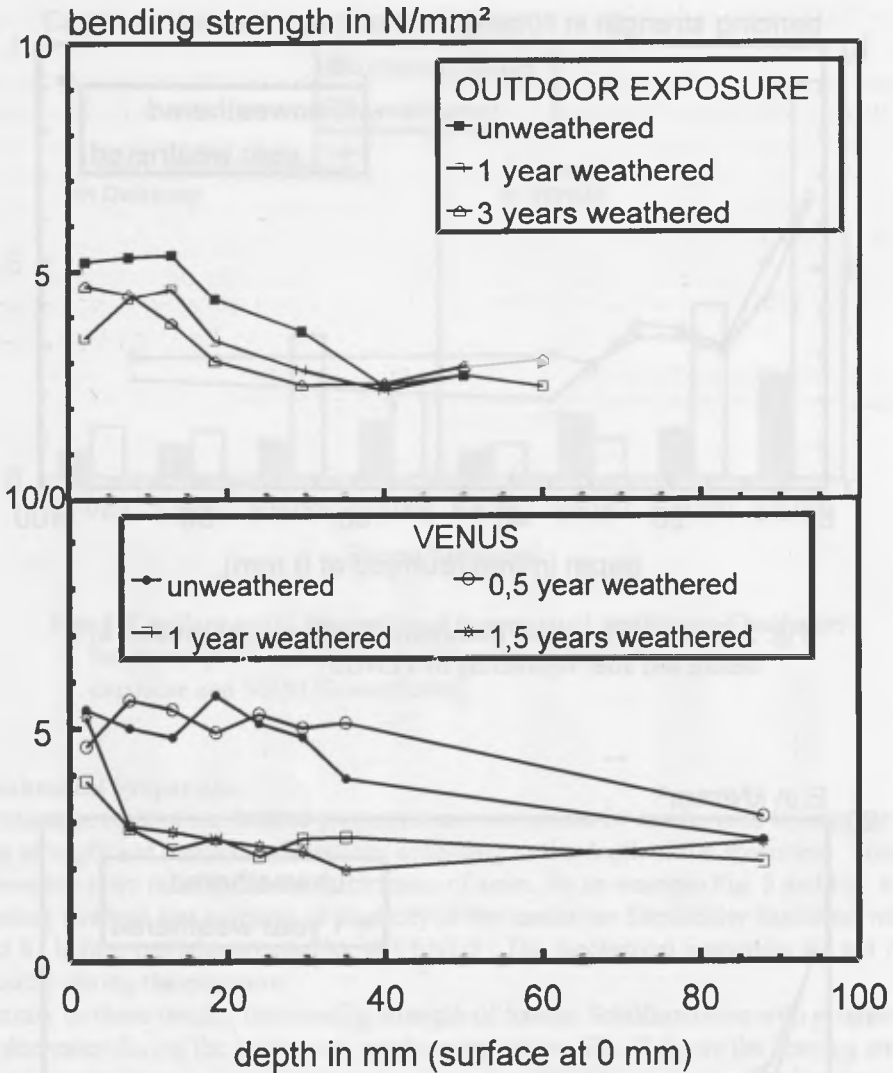

Fig. 7. Bending strength of Sander Schilfsandstein after outdoor exposure and VENUS weathering.

5 CONCLUSIONS

The experimental device for artificial weathering, VENUS, allows accelerated, reproducible testing of the effectiveness and durability of stone preservation materials. The stones show deterioration of hydrophobic and mechanical properties similar to deterioration in nature. The tests have to be continued for further verification.

6 ACKNOWLEDGEMENT

The experiments were sponsored by the Federal German Ministry for Research and Development. Detailed information is available under the work numbers BAU 5014M and BAU 7014M.

7 BIBLIOGRAPHY

Sasse, H.R. ; Honsinger, D. ; Schwamborn, B.: "PINS" - New technology in porous stone conservation. London : E & FN Spon, 1993. - In: Proceedings of the International RILEM/ UNESCO Congress Conservation of Stone and Other Materials, held at UNESCO Headquarters, Paris, June 29-July 1, 1993 (Thiel, M.J.(Ed)), Vol 2

THE APPLICATION AND THE LIMITS OF THE INTENSIFICATION OF THE CONDITIONS BY ARTIFICIAL WEATHERING OF STONES

THEODORE SKOULIKIDIS, Department of Materials Science and Engineering, Faculty of Chemical Engineering, National Technical University of Athens, Athens 157 80, Greece

Abstract

To acquire accurate, reproducible and comparative results by artificial weathering of stones, direct measurements methods must also be applied. To compare the predisposition in decay of several stones and the effectiveness of protective coatings, all specimens (more than three of each type) must be in the same weathering chamber. Irrespectively of the object of treatment, direct tests of specimens resistance in decay must be realised before and after treatment. The intensification conditions must not change the mechanisms of decay phenomena, the reaction types and the products as they are valid under natural conditions and they must not equalize the results on differently treated specimens. Simulation and in situ measurements are indispensable. Application to sulfation and protection of marbles.

Keywords: Weathering Acceleration, Direct Methods, Reproducibility, Unchanged Mechanisms (activation energy) and Products, Not Equalisation, Simulation, In Situ Measurements.

1 Introduction

By slow physical or (and) chemical reactions taking place spontaneously in nature such as corrosion of metals and stone decay it is essential to accelerate them in the laboratory in order to reveal the mechanism (rate determining step) of each of these reactions. The revelation of the real mechanism and the physical meaning of the rate constant make possible the application of adequate methods of protection.

The same must be done in order to evaluate the conservation (consolidation, hydrophobation, cleaning and protection) methods of stone and of the used substances.

In the present work the conditions of artificial weathering of stones in order to acquire accurate, reproducible and comparative results close to reality are discussed, suggested and applied as an example to marble sulfation.

1.1 Application of direct methods to reveal the mechanisms of decay and the effectiveness of treatments of stones. All specimens in the same weathering chamber. Reproducibility

To reveal the mechanism of corrosion and the effectiveness of protection of metals Wagner (1,2) used the weight loss of the specimens a direct method in order to measure the corrosion rate. If Wagner applied only the indirect electrochemical methods, such as potential-time, current-time, potentiostatic curves, or electrochemical weight loss (used in that time), or impedance measurements, the contemporary method, without using the weight loss, he would not find this mechanism because electrochemical methods are indirect and additionally they disturb the mechanisms (3,4). They are useful more or less in some cases for comparison of the corrosion intensity between several metals and the effectiveness of several coatings, but not for revealing mechanisms by absolute measurements.

We used this example because, as it was proved (5-13), the mechanism of sulfation is similar to the one of the uniform corrosion of metals: activation energy $75.3\text{KJ/mol} = 18\text{Kcal/mol}$, galvanic cell model, rate determining step the solid state diffusion of calcium ions, similar physical meaning of the rate constant. Another reason is that the experience regarding the corrosion and protection of metals is older and larger than the one regarding the conservation of stone and because of the mentioned total similarity of corrosion phenomena of metals and the ones of stone decay (5-13) it was possible to transfer this experience from metals to stone (14-23) and this is relevant to the present work.

Thus to reveal the sulfation mechanism (quartz spiral balance) and to test the effectiveness of the protective systems for stones (regular balance) the weight gain method was employed, i.e. a direct method (5-13). By using other indirect methods such as e.g. by decreasing the SO_2 concentration during the reaction it could not be found the real mechanism as it was not achieved so far by others (e.g. 24).

Concerning the mechanism of acid rain attack, direct methods of weight loss must be performed.

Concerning consolidation, it is not adequate to test only the effectiveness of the method and the consolidant by heating-freezing cycles. Because the methods of consolidation (even positive in this test), can be proved inadequate concerning the total increase of the mechanical resistance. Measurements of the mechanical resistance of the specimens before and after treatment are also required, as it is indeed done.

Concerning the hydrophobation treatment, it is not enough to measure the contact angle (indirect method) but the water absorption (direct method) before and after the treatment with hydrophobic materials.

Concerning the surface consolidation treatments, it is also necessary to take measurements of the mechanical resistance and the hardness.

Concerning protection we must also use direct methods (weight gain for sulfation, weight loss for acid rain) for the evaluation of the substances and methods.

It is also not enough for the evaluation of a protective substance for its resistance against UV to be based on the absence of colour change (indirect method), IR and UV spectroscopy must be performed (direct methods). Because, as it is the case for acrylic polymers, they do not change colour in UV, but changes can be detected (25) in IR and UV spectroscopy in its molecular structure; this results in changes of its mechanical and protective properties. [The protective systems acrylic + n-semiconductor pigments (14-23) are also anti-UV (25) due to the anti-UV action of Al_2O_3 , Fe_2O_3 , TiO_2 e.t.c.].

Because the stones are inhomogeneous (see also 1.5) and the imposed conditions of artificial weathering (temperature, concentration of SO_2 , salt spray e.t.c.) can not be exactly the same in every test, it is important::

- in order to compare and to conclude on the quantitative sensibility of the several stones against the parameters of decay and

- on the quantitative effectiveness of several types of protective coatings

to test all specimens (uncoated included) in the same chamber of artificial weathering and, for reproducibility reasons, more than three specimens of each type must be used.

From the above mentioned it follows: To reveal the mechanisms of decay and the effectiveness of treatments, direct methods must also be used, with which we observe the phenomena themselves. The quantitative comparison tests of uncoated or coated specimens must be realized in the same chamber of artificial weathering on more than three specimens of each type.

1.2 Irrespectively of the object of the treatment (consolidation, hydrophobation, cleaning, protection) direct test of the resistance of the specimens against acid rain and sulfation before and after treatment must be performed

Because the method of consolidation and (or) protection can accelerate the decay by acid rain or sulfation as it was found by several authors (e.g. 26-28 and 5-17, 29), it is also essential to test the resistance of the specimens before and after consolidation, as after protection, against acid rain (by weight loss) and sulfation (by weight gain) because the decay of protected stone depends on the pretreatment that can accelerate the Ca^{2+} diffusion (5-13).

After hydrophobation it is also essential to test the resistance against acid rain (weight loss) and sulfation (weight gain) because the change in pore size distribution of stones can accelerate decay. It also must be noticed that the sulfation can also take place without humidity due to the solid state diffusion of Ca^{2+} (5-13) and that the formation of $CaSO_4$ (anydrite) is also possible (24). Also the use for porous stones of a not special cement, accelerates the decay (30), in spite of the decrease of the pore volume.

Concerning cleaning treatments, it is also necessary to obtain measurements (weight loss for acid rain, weight gain for sulfation) before and after treatment, because the elimination of the precipitated suspended particles and of the black crust accelerates the decay (31) and the surface must immediately be protected.

From the above mentioned it follows: Irrespectively of the object of the treatment direct measurements of the acid rain attack and sulfation must be performed before and after treatment.

1.3 Acceleration. Intensification of conditions

1.3.1 Limit: The change of the mechanism (activation energy)

First of all, as an author correctly expressed (32) it must be distinguished between acceleration and simulation. Both have as object to accelerate the rate of the phenomena that occur spontaneously in nature with a very low rate and make possible their study in the laboratory on untreated and treated specimens of stones.

By acceleration, one parameter actually influencing the rate of one reaction is intensified.

By simulation, all parameters influencing the rate of all reactions are intensified.

The question is: how much the conditions can be intensified, i.e. what are the limits of the intensification.

The answer that the limits of the intensification must be near the natural conditions seems to be logical but not scientific, i.e. in the frame of Thermodynamics (the right thought in natural sciences) and the Chemical Kinetics (the extreme causes of the phenomena).

The author adopted the presumption that by intensifying the conditions the mechanism of each reaction must not be disturbed and changed.

If the mechanisms remain the same as those under natural conditions, the artificial weathering conditions can be intensified very much and it is possible to realise the measurements very far from the natural ones (see also 1.3.2, 1.3.3).

We are interested in testing the specimens under very intensive conditions because thus we can find the mechanisms of the very slow decay phenomena, predict the effectiveness of treatments for a very long time and be sure about their effectiveness in natural conditions.

To be in position to know that the mechanism has not changed, we must know the mechanism of each reaction under natural conditions. Studying the mechanisms of reactions we must calculate the real activation energy (5-8), the value of which can result in the first hypothesis for the rate determining step because it is directly related to it. In the case of heterogeneous reactions such as the corrosion of metals and the sulfation of stones the activation energy is indeed "real" and not "apparent" as it is in most of the cases for homogeneous reactions.

The calculation of the activation energy of sulfation was achieved by measuring in an environment of $100\mu\text{g}/\text{m}^3$ SO_2^* , saturated in water vapour in each temperature and at several constant temperatures between 15° and 40°C^* . The measurements (weight gain) were realised by the aid of a quartz spiral balance at a sensitivity (10^{-8} gr) enough to determine very low weight differences, using CaCO_3 , Pentelic marble powder or thin sections of marble. By these measurements and the Arrhenius diagram (Fig.1) the activation energy of sulfation was calculated and it was found $75.3\text{KJ}/\text{mol}$, $\cong 18\text{Kcal}/\text{mol}$ (7).

Under the same conditions of sulfation of the specimens, measurements in cross section with E.P.M.A. were performed (direct method) and the thickness gain of the sulfated film was measured instead of the weight gain; the same value of the activation energy was found. With the aid of this value we put forward the first hypothesis for the mechanism and we also proved it and found a method of protection (5-13,16,17,19,20,22,23). But in the present case of acceleration of an heterogeneous reaction we do not need to work with the mechanism, the value of its real activation energy is enough, due to the fact, which is already mentioned, that the real activation energy of a reaction, i.e. its measure: the slope of

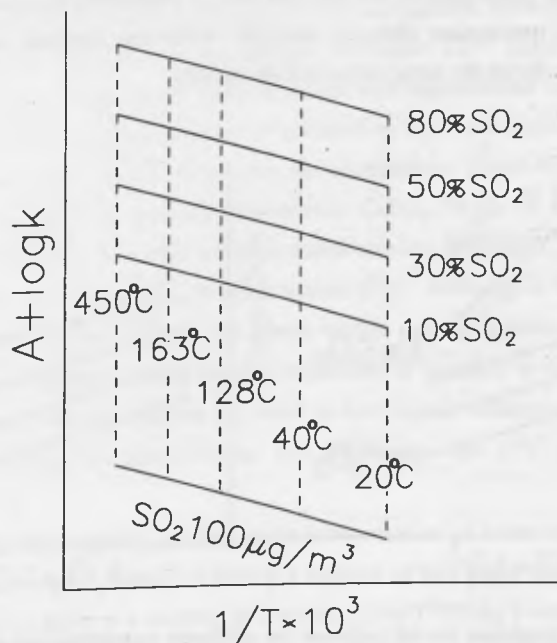

Fig.1. Arrhenius diagram for the sulfation of marbles for several concentrations of SO_2 (K: rate constant, A: constant, T: absolute temperature). The slope of the rectilinear presentation of the function of the Fig. 1 (q^*/R) does not change. Consequently the value of the activation energy (q^*): $\log K = -q^*/RT + C$ (R: gas constant, C: frequency factor) does not change, as well as the mechanism (rate determining step).

* Very near to the natural condition in the Athens region.

the Arrhenius line, concerns the rate determining step and if it did not change, the mechanism would not change either.

First of all we see in Fig. 1 that by increasing the concentration of SO_2 the Arrhenius lines shift parallel to each other and to the line for $100\mu\text{g}/\text{m}^3$. Thus, the slope up to 80% SO_2 , i.e. the activation energy and the mechanism remain the same as in natural conditions. If by increasing the concentration the mechanism changed, the diagram of Fig. 2 were valid.

Indeed after 80% SO_2 the slope changes. Thus, concentrations between 50 and 80% (50% see §1.3.3) were adopted (5-17, 19, 20, 22, 23) to make tests on stone specimens treated for consolidation, hydrophobation, cleaning and protection and for selection of the best material.

As we see in diagram (Fig.1) concerning the temperature rise the slope of the line for SO_2 $100\mu\text{g}/\text{m}^3$ remains the same up to 450°C . The same is true for all other lines for higher concentrations of SO_2 . According to the above mentioned, this means that the mechanism does not change. For reasons that are mentioned in §1.3.2 the temperature of 25°C was adopted to make tests of the effectiveness of protection materials. If by rising the temperature the mechanism changed, then the Arrhenius diagram would have the following form (Fig. 3) for the same concentration of SO_2 .

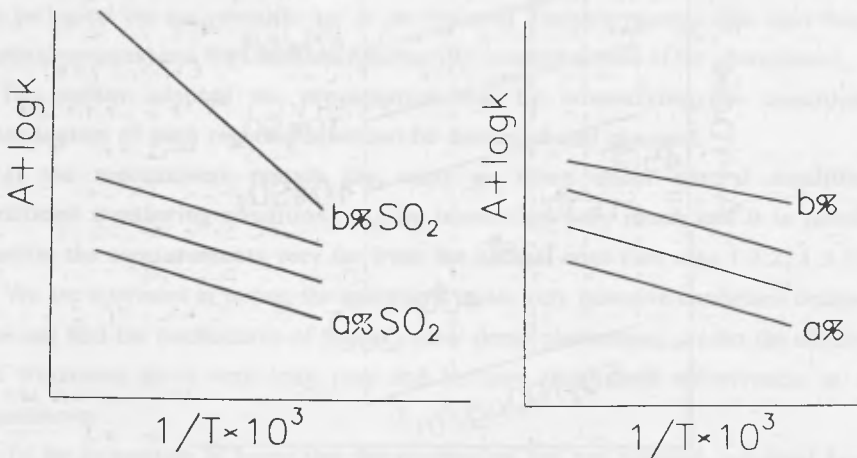

Fig. 2. Arrhenius diagrams for the sulfation for different concentrations of SO_2 . For a concentration b% of SO_2 the slope changes and consequently the value of the activation energy and the mechanism.

The combination of Fig.2 and 3 can also be valid.

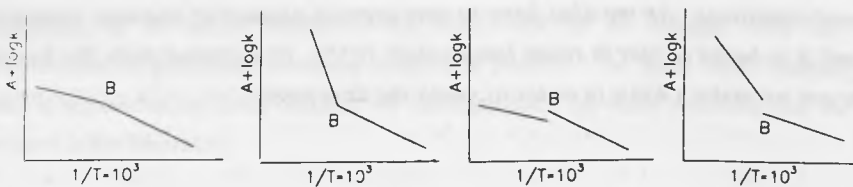

Fig.3. Change of the mechanism in B for the same concentration of SO_2 after a temperature increase.

From the above mentioned we conclude that: we can intensify the conditions (the concentration of the pollutant SO_2 , an increase of temperature) up to the limits where the activation energy of the studied reaction, i.e. the mechanism, remain the same.

1.3.2 Limit: The change of reaction products by rising temperature. Change of reaction types by rising humidity

Although the activation energy of sulfation, i.e. the mechanism, between 20° and 450°C is the same and the rate determining step remains the same: Ca^{2+} solid state diffusion, the reaction products are not the same. Both in natural and experimental conditions near room temperature (25°C) the reaction product of sulfation is 95-100% $\text{CaSO}_4 \cdot 2\text{H}_2\text{O}$ (gypsum), the 0-5% can be $\text{CaSO}_3 \cdot 2\text{H}_2\text{O}$. Increasing the temperature above 40°C and up to 115 - 128°C the $\text{CaSO}_4 \cdot 2\text{H}_2\text{O}$ is partially dehydrated: $\text{CaSO}_4 \cdot 2\text{H}_2\text{O} \rightarrow \text{CaSO}_4 \cdot 0.5\text{H}_2\text{O}$ and above 140 - 190°C CaSO_4 is formed which remains between 400 - 600°C with the possibility to reabsorb water and after 600°C is dead burned (33). Although a mixture of different products is formed we can attribute the whole weight gain to gypsum. The form of the curves and the comparison among several treatments is possible to be realised, but it is better (in addition to the fact that we also have to test organic substances pigmented or not for protection) to adopt low temperatures. For this reason the 25°C was adopted as it is mentioned in § 1.3.

If by increasing the humidity, the dew point (condensation of water vapors) appears, then the reaction type changes. Instead of having a reaction of two gases (SO_2 and water vapor) with solid (CaCO_3), there is a reaction of a solution ($\text{H}_3\text{O}^+ \text{HSO}_4^-$) with solid. But this, if it could not visually understood, it could be revealed because the activation energy from 75.3KJ/mol (18Kcal/mol) for the sulfation (1.3) becomes 25.1KJ/mol (6Kcal/mol) for the dissolution.

From the above mentioned we conclude that we can increase the temperature up to a limit where we have the same activation energy and the same products as in

natural conditions. As we also have to test organic protective coatings (pigmented or not) it is better to test in room temperature (25°). In sulfation tests the humidity must not overtake a limit in order to avoid the dew point.

1.3.3 Limit : The equalization of the differences

As it is known regarding all heterogeneous reactions in which a solid takes part, as in the cases of sulfation, acid rain attack and corrosion of metals, local reactions take place preferably in active centers (geometrical or structural) of the surface (even when protected) or in the pores or in the grain boundaries. The different stones, even different specimens of the same stone have different number and intensity of active centers and a different microstructure and contamination; for this reason they have a different rate of sulfation. This is evident from many tests. Different rates of sulfation also appear to commercial CaCO_3 powder, Pentelic marble powder and marble pieces, all for the same real specific surface or total surface (11). But when the conditions are intensified above a limit, although the mechanism may remain the same (e.g. between 50 and 80% SO_2) above 50% the rate of sulfation is so rapid that the above differences are equalized and the rate of sulfation is approximately the same for all three substances (CaCO_3 and marble powder, marble pieces). Equal rate of sulfation also acquires different types of stones. The same happens by increasing the temperature.

Equalization can also occur by a too high intensification of conditions for the same stone treated with different consolidation, or protective materials. Thus to realise the above tests for sulfation we adopted a 50% concentration of SO_2 , though the 1.1, 1.3.1, 1.3.2. conclusions are also accomplished between 50 and 80%.

From the above mentioned we conclude that although the conditions of the conclusions 1.1, 1.3.1, 1.3.2 can be accomplished we can not work at very intensive conditions because this equalizes the results (rate of sulfation and of acid rain attack) even if a great difference in the behaviour of several types of stones or of several treatments (different substances) exists.

1.4 Simulation

By acceleration, as it is mentioned above, we intensify one condition of the studied reaction. In natural conditions a synergistic action of the several parameters and reactions that produce decay on stones take place. We know (34,35) that no synergistic action of NO_x exists by sulfation: the rate of sulfation does not change in the presence of NO_x . But we know the synergistic effect of nitric and sulfuric acid by acid rain attack. Thus, it is essential too to make tests in the laboratory under simulation conditions: the same mean

temperature as in natural reactions, the same flow of air charged with the mean concentration of pollutants including suspended particles, the same mean humidity etc. Thus, it is possible to check whether we can reproduce the same reactions and the same products in the laboratory.

1.5 Measurements in situ

To be in position to make accelerated tests and simulation measurements in the laboratory it is necessary to measure the temperature in situ, the humidity and the concentration of pollutants, as well as the wind intensity and direction of the monument surroundings, the UV intensity etc (for at least a period of one year). It is also necessary to check the reaction products and the evolution of decay by measurements with specimens of the same stone exposed in situ (either protected from acid rain or not). Also not destructive methods can be used to measure the extension and depth of sulfation [e.g. liquid crystals (36), Pin probe method (7)]. It is also essential to make observations in situ on the effectiveness of old treatment methods.

2 Conclusions

From the above mentioned on the study of the mechanisms of decay reactions, on the testing of the effectiveness of consolidation, hydrophobation, cleaning and protection treatments of stones it is essential:

1. To make measurements also with direct methods with which the phenomena themselves are observed and measured on more than three specimens of the same type for reproducibility reasons. All types of specimens must be tested in the same weathering chamber in order to have for all exactly the same conditions .
2. To make additional tests regarding the resistance of specimens against acid rain and sulfation, irrespectively of the object of the treatment (consolidation, hydrophobation, cleaning, protection).
3. That the intensification of the conditions in order to accelerate the reactions (temperature, pressure, concentration of pollutants, humidity, alternative conditions) must have as a limit the change of the mechanism of reaction, of the reaction type and of reaction products. If the real activation energy (a measure in heterogeneous reactions of the rate determining step) remains the same, the conditions can be intensified far from natural conditions.

We suggest to work at room temperature (at 25°C) because the reaction products can be different from those in situ and because we make tests with organic coatings.

4. That even if all these conditions are accomplished we must not exaggerate by intensification because under extreme conditions the different rate of decay of different stones with different properties are equalized. The same is valid for the evaluation of the different substances used for treatment.

For these reasons we suggest 25°C and 50% SO₂ to test the effectiveness of protective substances against sulfation.

5. That, besides the conditions of acceleration, simulation conditions are also required.

6. That also measurements in situ must be obtained.

5. To exclude or rearrange some of the used methods of artificially weathering for which the above conditions are not valid.

3 References

1. WAGNER,C., 1952, "The electrochemistry of ionic crystals", *J. Electr. Soc.*, **99**, 346.
2. WAGNER,C., 1952: "Theoretical analysis of the diffusion processes determining the oxidation rate of alloys", *J. Electr. Soc.*, **99**, 368.
3. SKOULIKIDIS,TH., VASSILIOU,P. & SYMNIOTIS,E., 1979: "Critique on corrosion potential-time and on potentiostatic polatisation curves as a method of predicting the general corrosion of metals and alloys (Fe,Al)", *Br. Corros. J.*, **14**, 149.
4. SKOULIKIDIS,TH. & VASSILIOU,P., 1982: "Further problems in predicting corrosion rates from electrochemical measurements", *Br. Corros. J.*, **17**, 142.
5. SKOULIKIDIS,TH., CHARALAMBOUS,D., PAPAKONSTANTINOY,E. & BELOYANNIS,N., 1979: "The mechanism of marble sulfation by SO₂ action", *3rd Intern. Congress on the Deterioration and Preservation of Building Stones, Venice*, Proc. pp. 439-452.
6. SKOULIKIDIS,TH., 1980: "Atmospheric corrosion of the reinforcements of reinforced concrete and of marbles of ancient monuments and statues". *Intern. Symposium on Atmospheric Corrosion, Electrochemical Society, Hollywood, Miami, Florida*, Proc. pp. 807-825.
7. SKOULIKIDIS,TH. & PAPAKONSTANTINOY-ZIOTIS,P., 1981: "The mechanism of sulfation by atmospheric SO₂ of limestones and marbles of the ancient monuments and statues. I. Observations in situ and measurements in the laboratory; activation energy", *Br. Corros. J.*, **16**, 63.
8. SKOULIKIDIS,TH. & CHARALAMBOUS,D., 1981: "The mechanism of sulfation by atmospheric SO₂ of limestones and marbles of the ancient monuments and statues. II. Hypothesis and proofs on the rate determining step; galvanic cell model", *Br. Corros. J.*, **16**, 70.

9. SKOULIKIDIS, TH., 1981: "Presentation of protection methods for marbles against atmospheric pollution", *Troisiemes Journees de l' Industrie Minerale, Universite Libre de Bruxelles, Bruxelles*, Proc. pp. 839-856.
10. SKOULIKIDIS, TH., CHARALAMBOUS, D. & PAPAKONSTANTINOY-ZIOTIS, P., 1982: "Additional proofs for the galvanic cell model, valid for the marble sulfation", *4th Intern. Congress on the Deterioration and Protection of Building Stones, Louisville*, Proc. pp. 307-310.
11. SKOULIKIDIS, TH., CHARALAMBOUS, D. & PAPAKONSTANTINOY-ZIOTIS, P., 1983: "Mechanism of sulfation by atmospheric SO₂ of the limestones and marbles on ancient monuments and statues. III. Further proofs for the galvanic cell model", *Br. Corros. J.*, 18, 200.
12. SKOULIKIDIS, TH. & CHARALAMBOUS, D., 1985: "Proofs for the galvanic cell model of the mechanism of marble sulfation", *Vth Intern. Congress on the Deterioration and Preservation of Stone, Lausanne*, Proc. pp. 547-551.
13. SKOULIKIDIS, TH., CHARALAMBOUS, D. & KYRKOS, M., 1987: "Further proofs for the mechanism of sulfation (Galvanic cell model) of marbles and orientation for their protection", *Conference on the Recent Advances in the Conservation and Analysis of Artifacts, London*, Proc. pp. 383-385.
14. SKOULIKIDIS, TH. & VASSILIOU, P., 1984: "New anticorrosive paints", *3rd Intern. Congress on Marine Technology*, Proc. pp. 535-539.
15. SKOULIKIDIS, TH. & VASSILIOU, P., 1984: "New anticorrosive paints", *6th Intern. Congress on Marine Corrosion and Fouling, Athens*, Proc. pp. 335-346.
16. SKOULIKIDIS, TH., CHARALAMBOUS, D. & PAPAKONSTANTINOY, P., 1988: "New protective coatings for marble against pollution", *Intern. Symposium on Engineering Geology as Related to the Study, Preservation and Protection of Ancient Works, Monuments and Historical Sites, Athens*, Proc. pp. 871-875.
17. SKOULIKIDIS, TH., CHARALAMBOUS, D. & KALIFATIDOU, E., 1988: "New protective coatings for marble against pollution", *VIth Intern. Congress on Deterioration and Conservation of Stone, Torun, Poland*, Proc. pp. 534-544.
18. SKOULIKIDIS, TH., VASSILIOU, P. & DIAMANTIS, N., 1990: "Red mud can be used as pigment for steel anticorrosive paints combined with cathodic protection", *5th Intern. Congress on Marine Technology, Athens*, Proc. pp. 155-157.
19. SKOULIKIDIS, TH. & KRITIKOU, E., 1991: "Protection of marbles of ancient monuments; method of doped semiconductors", *2nd Intern. Symposium for the Conservation of Monuments in the Mediterranean Basin, Geneva*, Proc. pp. 389-396.
20. SKOULIKIDIS, TH. & KRITIKOU, E., 1992: "Protective coatings for marbles and stones using polymers pigmented with doped n-semiconductors", *7th Intern. Congress on Deterioration and Conservation of Stones, Lisbon*, Proc. pp. 1137-1145, Vol. III.

- 21.SKOULIKIDIS,TH. & VLACHOS,S., 1992: "New pigments to intensify known anticorrosive paints", *12th Scandinavian Corrosion Congress & EUROCORR' 92, ESPOO, Finland*, Proc. pp. 453-460.
- 22.SKOULIKIDIS,TH., VASSILIOU,P., CHARALAMBOUS,D., PAPAKONSTANTINO, P., KALIFATIDOU,E., VLACHOS,S. & KRITIKOU,E., 1993: "Protection of steel and marbles from pollution based on their similar mechanism of decay", *1st Intern. Exhibition and Conference of Environmental Technology for the Mediterranean Region, Athens*, Proc. pp. 106-115.
- 23.SKOULIKIDIS,TH. & KRITIKOU,E., 1993: "Protective coating for marbles and stones using n-semiconductors as pigments", *3rd Intern. Conference STREMA 93, Bath, U.K.*, Proc. pp. 241-249.
- 24.SPRUNG,F., 1964: "Das Verhalten des Schwefels beim brennen von Zementklinker", *Schriftenreihe der Zementindustrie*, p. 31.
- 25.SKOULIKIDIS,TH., 1994: "Decrease of UV influence on 'protective polymers' for stones and marbles by n-semiconductor pigments", *3rd Intern. Symposium on the Conservation of Monuments in the Mediterranean Basin, Venice*, Proc. pp.903-909.
- 26.BELL,F. & COULTHARD,I., 1988: *Intern. Symposium on Engineering Geology as Related to the Study, Preservation and Protection of Ancient Works, Monuments and Historical Sites, Athens*, Proc. p. 883.
- 27.FASSINA,V. & BORSELLA,S., 1993: "The effects of past treatments on the acceleration of weathering processes in the statues of Prato Della Vale", *Intern. UNESCO-RILEM Congress on the Conservation of Stone and Other Materials, Paris*, Proc. pp. 129-136.
- 28.FASSINA,V., ROSSETTI,M., FUMO,G., ZEZZA,F. & MACRI,F., 1993: "The marble decay of Pilastrini Acritani and problems of conservation", *Intern. UNESCO-RILEM Congress on the Conservation of Stone and Other Materials, Paris*, Proc. pp. 75-82.
- 29.SKOULIKIDIS,TH., VASSILIOU,P., TSAKONA,K. & KRITIKOU,E., 1993: "Stress corrosion cracking of untreated Pentelic marble or artificially weathered or treated with pigmented or unpigmented polymer", *3rd Intern. Conference STREMA 93, Bath, U.K.*, Proc. pp. 251-258.
- 30.BOSC,J., CHABANNET,M., PERA,J., & AUGET,F., 1993: " Alteration of cement mortars placed in a saline air environment-Importance of the addition of metacaoline", *Intern. UNESCO-RILEM Congress on the Conservation of Stone and Other Materials, Paris*, Proc. pp. 67-74.
- 31.KOUZELI,K., 1992: "Black crust removal methods in use. Their effects on Pentelic marble surfaces", *7th Intern. Congress on Deterioration and Protection of Stones, Lisbon*, Proc. p. 1147.

- 32.FURLAN,V. & GIRARDET,F., 1993: "Consideration of the role of atmospheric pollution in the alteration of stone", *Intern. UNESCO-RILEM Congress on the Conservation of Stone and Other Materials, Paris*, Proc. pp. 27-34.
33. Handbook of Chemistry and Physics, 1989.
- 34.VASSILAKOS,C. & SALTA,.A.: 1993: "Synergistic effect of SO₂ and NO₂ in the action on marble studied by reversed flow gas chromatography", *Intern.UNESCO-RILEM Congress on the Conservation of Stone and Other Materials, Paris*, Proc. pp. 99-106.
- 35.HANEEF,S., DICKINSON,C., JOHNSON,C., THOMSON,J. & WOOD,G., 1990: "Effects of air pollution on historic buildings and monuments and the scientific basis for conservation", *European Culture Heritage, Newsletter on Research*, **4**, No 3, 9.
- 36.SKOULIKIDIS,TH., KOUJ,M. & KOSTOUDI,A., 1991: "A new non destructive method to differentiate in situ marble from gypsum and CaCO₃ from inversion of gypsum; use of liquid crystals", *Mol. Cryst. Liq. Cryst.*, **206**, 117.





