



T25 PARTS CATALOGUE 2018

OVER
550
NEW
PRODUCTS*





Owned by Andy, Trade Sales Advisor. Photographed in JK's own Product Test Workshop at JK HQ

 **FREE UK delivery**
on all orders over £35

 **No UK oversized**
delivery charges

10% **Save 10%**
on Bundle Deals

 **Sign Up** to our email
news for the latest offers

 **Save £'s** on your
Classic VW Insurance

10% **Insure with Jk &**
save 10% on JK Parts

JUSTKAMPERS.COM | 0800 9156 618

Welcome

Welcome to the latest JK catalogue for VW T25 parts and accessories!

We're really proud of our T25 range, which includes over 1,700 products and is constantly growing. We know these vehicles inside and out, and always on the look out for the next great part or accessory to bring into the range. We've used this expertise to bring you hundreds of top quality products at excellent prices. Throughout this catalogue, and our range as a whole, you'll see that we've raised the quality and reduced the price.

There are seven VW T25s in the JK Fleet, used by different members of the JK Team. These include a converted fire engine, a synchro pick-up at two Gypsies! This has given us a great understanding of which areas or parts on the T25 are most prone to problems, and helped us source fantastic quality parts. When these haven't been available, we've created them from scratch in our on-site workshop here at JK HQ to the exact original specifications. You can find these parts and accessories listed under Preservation Parts.

Best regards



Mark Reynolds MD

Technical Information

Engine numbers

This can be found stamped on the top of the crankcase, centrally above the crankshaft pulley/fan on all petrol engines. And stamped on the engine block between the injection pump and vacuum pump on all diesels.

CODE	CC	BHP	NOTES
1600cc aircooled			
CT	1600cc	50 bhp	Flat 4
2000cc aircooled			
CU	2000cc	70 bhp	Flat 4
CV	2000cc	70 bhp	Flat 4
1900>2100cc watercooled			
EY	1900cc	55 bhp	Flat 4
DF	1900cc	60 bhp	Flat 4
SP	1900cc	73 bhp	Flat 4
DG	1900cc	78 bhp	Flat 4
DH	1900cc	83 bhp	Flat 4
GW	1900cc	90 bhp	Flat 4
SR	2100cc	87 bhp	Flat 4
SS	2100cc	92 bhp	Flat 4
MV	2100cc	95 bhp	Flat 4
DJ	2100cc	112 bhp	Flat 4

Engine types

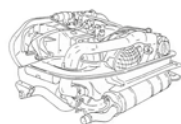

1600cc aircooled



2000cc aircooled

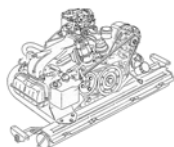

1900>2100cc water-cooled



1600>1700cc diesel and turbo diesel

CODE	CC	BHP	NOTES
1600>1700cc diesel & turbo diesel			
CS	1600cc	50 bhp	Inline 4
KY	1700cc	57 bhp	Inline 4
JX	1600cc	70 bhp	Inline 4

Contents

- Introduction & Technical Info
- Engine
- Exhaust
- Fuel Tanks, Filters & Hoses
- Heating
- Gearbox & CV Joints
- Front Suspension, Steering & Bearings
- Braking System
- Body Panels
- Bumpers & Fitting Kits
- Seals, Trims & Accessories
- Interiors: Camping, Carpets & Storage
- Pedals, Cables & Levers
- Electrical
- Wheels, Alloys & Tyres
- Accessories, Gifts & Tools
- Dynamat
- Fiamma
- Protect Your T25
- 0% Finance Deal
- JK Insurance

Handy Hint



What is nearside and offside?

Many parts are described as being nearside or offside, this simply indicates which side of the vehicle the part fits.

For the UK, an easy way to remember is nearside means near the kerb. this applies, regardless of whether the car is left or right hand drive.



Nearside Offside



SIMPLE RETURNS POLICY

14 Days to Return Unused Goods



TRADE ENQUIRES WELCOME

Call to Register +44 01256 863216

Dedicated Trade Team



WE GUARANTEE

Original Quality, OEM and Branded Parts

12 Months Warranty on all parts we sell



GROUP BUYING

Bulk Purchase Discounts

Ideal for Clubs & Forums



See What our Customers Say About Us



FREE delivery
on all orders over £35



NO oversized
delivery charges

10%

Save 10%
on Bundle Deals

A brief model history

May 1979

Hanover built the first models of the 'third' generation Volkswagen Transporter. It was a total redesign of the old Bay window, being wider with larger windows and tailgate, and a new front style. Very little was carried over from the previous model. There was new suspension, which moved away from the torsion bar system. powered by either a 1600cc 50bhp (37kw) or 2000cc 70bhp (51kw) aircooled engine.



Late water cooled model

February 1981

Saw the introduction of a watercooled 1600cc diesel engine with 50bhp (37kw). This engine originally came from the Golf.

September 1981

Introduction of the Caravelle, offering a more luxurious interior.

October 1981

Saw the first watercooled flat four petrol engines in two versions: DF 1900cc 60bhp (44kw) and DG 1900cc 78bhp (57kw). Rear air intakes became plastic inserts.

1982

Was the end of production of aircooled engined models in Germany.



'Caravelle'

August 1983

Saw the introduction of a higher spec 'Caravelle' with the option of a 4 lamp square grill.

1985

The year of a full 'revamp' of the model. Changes included new exhaust systems, front suspension, sliding door locks, fuel injection systems, to name a few. It is said they made over 1000 changes in this year. It also saw the introduction of the Syncro, a four wheel drive vehicle,

which was built with Steyr/Daimler/Puch in Austria. Capable of climbing a 54% gradient and utilizes a centre viscous coupling.

1986

Onwards vehicles did not suffer so badly with rust due to a new rust treatment in the production process.

September 1990

Saw the last T25 leave the Hanover factory, however production carried on in South Africa until the end of 2002. The last Syncro was built in 1992.



4x4 Syncro 'crewcab' pickup

Chassis Number

This can be found stamped inside, on the offside door pillar.

Find the 10th digit of the VIN (Vehicle Identification Number)

Using the table below, this digit will give you the model year.

Bare in mind that the build dates run from August to July not January to December, so for example a 1981 model could have been built in late 1980. The last 6 digits are the serial no.

10th digit of chassis number

10th digit	Model year	
	Year	Build dates
A	1980	1st Aug 79 > 31st Jul 80
B	1981	1st Aug 80 > 31st Jul 81
C	1982	1st Aug 81 > 31st Jul 82
D	1983	1st Aug 82 > 31st Jul 83
E	1984	1st Aug 83 > 31st Jul 84
F	1985	1st Aug 84 > 31st Jul 85
G	1986	1st Aug 85 > 31st Jul 86
H	1987	1st Aug 86 > 31st Jul 87
J	1988	1st Aug 87 > 31st Jul 88
K	1989	1st Aug 88 > 31st Jul 89
L	1990	1st Aug 89 > 31st Jul 90
M	1991	1st Aug 90 > 31st Jul 91
N	1992	1st Aug 91 > 31st Jul 92

Type 25 paint codes

LH8B.....	Assuan Brown
L86Z.....	Agate Brown
LA8A.....	Marian Brown
LH8B.....	Mocca Brown
L90D.....	Pastel White
LH9D.....	Damuso White
L567.....	Ivory
LP7Y.....	Flash Silver Metallic
LH7V.....	Wolfram Grey Metallic
LB7Y.....	Vesuve Grey Metallic
L20B.....	Black
LH1N.....	Samos Beige
LH8T.....	Timor Beige
LH8U.....	Bronze Beige Metallic
LH1V.....	Savannah Beige Metallic
LL1M.....	Beige

LA1N.....	Nevada Beige
LT6A.....	Escorial Green
LH5H.....	Cornat Blue
LY5B.....	Copenhagen Blue
LH5K.....	Guinea Blue
LH5G.....	Medium Blue
LA5D.....	Monaco Blue
LH5T.....	Kuril Blue
LH5U.....	Dove Blue Metallic
LA5B.....	Marine Blue
LK5E.....	Capri Blue
LP5Z.....	Orly Blue Metallic
LH1B.....	Bamboo Yellow
L20B.....	Brilliant Orange
LH3D.....	Marsala Red
LB3V.....	Titan Red Metallic
LC3Y.....	Bordeaux Red Metallic
LY3D.....	Tornado Red

Information is correct to the best of our knowledge, and we accept no responsibility for erroneous information

SHOP ONLINE TO SEE OUR FULL RANGE
www.justkampers.com



WE STOCK TOP QUALITY BRANDS



For all our terms and conditions please go to www.justkampers.com

Just Kampers Limited. Unit 1 Stapely Manor, Long Lane, Odiham, Hants. RG29 1JE Company Registration Number 302 4961

Prices and specifications are subject to change. For up to date prices visit www.justkampers.com

































Sign Up to our email news for the latest offers



Save £'s on your Classic VW Insurance

10%

Insure with Jk & save 10% on JK Parts

-  **Timing Belt for Diesel and Turbo Diesel 1981 to 1990**
Specification is 1285.9mm long by 25.4mm wide with 135 teeth.
J10443A 068109119E..... **£16.00**
-  **Pierburg 2E Carburetor Rebuild Kit 1900cc 1984-1992**
This carb rebuild kit contains the gaskets for re building your Pierburg 2E carburettor.
J39653 049198571S..... **£38.50**
-  **Cylinder Head Stud Kit 1900,2100cc Watercooled 1983-1992**
Consists of 8 x 222mm studs 4 x 191mm studs 4 x 175mm studs 16 x Head nuts
J39683 **£378.75**
-  **Carb To Manifold Gasket VW T25 1900cc 1984-1992**
This Genuine Volkswagen paper carb to manifold gasket as fitted to all 1900cc watercooled VW T25s from 1984 to 1992.
J39723 25126621..... **£3.50**
-  **Throttle Valve to Body Gasket 2100cc 1985 to 1992**
Valve to body gasket fits in-between the intake air distributor and the throttle body.
J39724 25133073..... **£5.75**
- Carb Base Flange VW T25 1900cc 1983-1992 34mm Single Choke**
Often the cause of poor running and engine hunting this reproduction carb base flange fits the VW T25 with the 1900cc Watercooled engine fitted with the single choke 34mm Solex carb from 1983 to 1992
J39768 25129761..... **£21.75**
- Clutch Master Cylinder 1980 to 1992**
Problems engaging gears? It may be a faulty or leaking master cylinder. This replacement cylinder fits all VW T25s from 1980 to 1992.
J10710A 251721401A..... **£37.50**
-  **M 7 X 18 Clutch to Flywheel Bolt 1979-1985**
6 per clutch
J11262 022141197C..... **£3.20**
- Clutch Slave Cylinder Hose, Rear 615mm T25 8/1985-7/1992**
J31154 251721477J..... **£35.75**
-  **Water Pump 1900cc Watercooled 1983 to 1985**
Supplied with gaskets and an O ring.
J10413 025121010..... **£43.75**
-  **Water Pump Pulley (Front Half) 1900 - 2100cc 1983 to 1992**
This OEM part is the outer half furthest from the pump.
J10416 025121031A..... **£12.75**
-  **Water Pump All Diesel Engines 1985 to 1987**
A leaky or noisy pump is not only annoying – over time it will lead to overheating and potential engine problems. This quality pump fits all diesel T25s (1985-1987).
J10485A 037121005C..... **£15.00**
-  **Temperature Sender 1600, 1700cc Diesel 1900, 2100cc Petrol**
The sensor works between 0° and 125°.
J10726A 49919501..... **£5.00**
-  **Metal Waterpipe (L-Shaped) 1900, 2100CC 1985 To 1992**
located at the front on the 1900, 2100cc engine
J10912 025121081G..... **£64.50**
-  **Lower Radiator Hose**
This radiator hose fits between the actual radiator and main front to rear return pipe . This hose fits all VW T25 1900 cc watercooled petrol engines and the 1600cc Diesel from 1985 to 1992.
J11604 251121083H..... **£17.75**
-  **Water Pump Diesel 1600, 1700cc 1986 to 1992**
Fits vehicles with engine codes CS and JX
J13449A 037121010C..... **Call For Availability**
-  **Turbo Charger T25 1979 - 1992 1600 Diesel**
This reproduction Turbo Charger fits all 1600cc Diesel VW T25s with the JX engine code as fitted to VW T25s from 1984-1992
J27786 068145701Q..... **£493.25**
-  **Thermostat Seal Ring VW T25 1900cc 1983-1985 VW T4 1900, 2000cc Petrol 1990-2003 VW T5 1900 Diesel 2000cc Petrol**
This 60 x 3.5 mm thermostat seal ring fits VW T25 1900cc water-cooled engines from 1983 to 1985
J13703 038121119B..... **£0.40**
-  **Jubilee Clip 13-20mm**
General Purpose Use
J29451 **£1.00**
-  **Jubilee Clip 18-25mm**
General Purpose Use
J29452 **£1.75**
-  **Jubilee Clip 35-50mm**
General Purpose Use
J29453 **£2.00**
-  **Coolant Hose O/S/Right Head To Coolant Manifold**
1987 on 1900 and 2100cc
J29535 251121130B..... **£9.25**
-  **Hose -O/S/Right Head to Coolant Distribution Manifold**
1900/2100cc 1985-1987
J29537 251121130A..... **£7.25**
-  **Coolant Hose Left Cylinder Head 1986-1992 1.9 2.1**
1900 and 2100cc (with air con)
J29539 025121058M..... **£16.75**
-  **Coolant Hose to Expansion Tank (Pickup Models)**
Fits 1900/2100cc 1985 on pickup models only
J29544 025121108E..... **£12.00**
-  **Coolant Hose To Thermostat 1900cc (DF,EY) 1985 on**
This radiator hose fits to the thermostat housing on T25 1900 engine DF and EY codes
J29545 025121058K..... **£47.00**
-  **Coolant Hose - Oil Cooler To Auxiliary Water Pump**
1600 Diesel models
J29546 68121105..... **£21.00**
-  **4 Way Coolant Hose -1600/1700c D and TD**
fits between the oil cooler, water flange, main feed pipe and expansion bottle on T25 1600/1700cc
J29547 068121101H..... **£38.75**
-  **Coolant Hose 7mm x 2.5mm (Sold per metre)**
Sold per meter and cut to length required
J29548 443121107A..... **£21.50**
-  **Coolant Hose From Expansion Bottle To Water Pump**
1900cc - 1986 on
J29549 025121108J..... **£35.00**
-  **Coolant Hose From Cooler To Distribution Manifold**
1900 -2100cc 1985-1992 (Auto)
J29550 251121104..... **£43.50**
- Coolant Distribution Manifold 1900, 2100cc 1986-1987**
Coolant distribution manifold located next to cylinder 1. Excluding automatic and Syncro models.
J33460 251121438..... **£58.00**
- Heat Exchanger for Rear Heater 1982 - 1992**
This is a replacement heat exchanger or heater matrix for the auxiliary rear heater
J39085 867819121A..... **£25.75**
-  **Under Tin Nearside (Left) 1900,2100cc Watercooled 1984-1992**
This engine under tin sits on the Nearside (Left) and protects the pushrod tubes.
J39713 25109655..... **£68.25**
-  **Under Tin Offside (Right) 1900,2100cc Watercooled 1984-1992**
This engine under tin sits on the Offside (Right) and protects the pushrod tubes.
J39714 25109656..... **£68.25**



Water Elbow 1900 2100cc Water cooled
This Metal water pipe elbow fits on the right hand side on the block
J39232 25121171 **£27.25**



Coolant pipe O Ring 1900-2100 1985-1992
This O ring fits between the water Pump and the metal coolant pipe
J39260 30121119 **£0.80**



Gasket for Water Elbow 1900-2100cc Watercooled 1983 - 1992
This Genuine Volkswagen gasket is used for fitting the water elbow J39232.
J39541 N90128802 **£3.50**



Oil Pressure Switch Boot 2000cc Aircooled 1979 to 1983
This oil pressure rubber boot fits between the oil pressure switch and the tin wear.
J39656 21119957 **£10.25**



Water Pump Gasket VW T25, Diesel 1985-1987 VW T4 1800cc-2000cc Petrol 1995-2003 All Diesel Engines 1990-2003
J39682 026121041P **£4.00**



Coolant Manifold Syncro 1900,2100cc Watercooled 1986-1992
This coolant manifold features a extra outlet for use with a auxiliary heater.
J39715 **£50.50**

VW T25 Radiator cooling fan motor 1984 to 1992
450w, 305mm Radiator cooling fan motor for the Type 25 between 1984 and 1992 Engines DJ, DG Petrol and KY diesel
J39905 251959455M **£104.75**



Water Pipe Flange Bolt (Pair) 1900,2100cc 1985-1992
Sold as a pair these water pipe flange bolts are used in conjunction with the metal water pipe J10912
J40130 N0903151 **£1.50**

Thermostat and Housing Bundle Kit VW T25 1985-1992
This thermostat housing bundle kit fits 1900 and 2100cc VW T 25s from 1985 to 1992. This kit consists of J11160 Thermostat Housing J10911 Thermostat Top Housing J10398 Thermostat J10793 Thermostat Seal J64607 4 x Housing Bolts J64598 4 x Spring Washers
J40281 **£74.25**



M6x18 Bolt for T25 Thermostat housing
M6x18 Bolt for T25 Thermostat housing.
J64607 N0147035 **£0.90**



Pushrod Tube 2000cc Aircooled 1979 to 1983
Can be fitted in situ, 8 required per engine.
J10122 021109335C **£5.25**



Hydraulic Follower 1600, 2000 Aircooled 1900, 2100 WC
This hydraulic cam follower fits engines from 1979 to 1992
J10445 22109309 **£10.50**



Cylinder Head 2000cc Aircooled 1979 to 1994
Head comes fully built up and ready to fit
J10593A 071101061X **£449.50**



Type 25 1.9 & 2.1 Cylinder Head Liner Top Seal
Type 25 1.9 & 2.1 Cylinder Head Liner Top Seal
J21188 25101177 **£6.25**



Rocker Cover Clip Type 2 and Type 25 1700 - 2000cc Aircooled
J21226 21101487 **£7.25**



Rocket Arm
9mm Screw CT, DG, DF
J21287 025109405C **Call For Availability**



End Float Shim 1900,2100cc Watercooled 1986-1992
A genuine Volkswagen Crank shaft shim measuring 0.40mm This fits the 1900 and 2100cc
J39725 25105281 **£6.00**



Oil Breather Kit (Cast Aluminium) All Petrol Models
Reduce Crank case pressure, eliminate blow by and oil loss.
J16927 115552 **£39.75**

Sump Plug Seal (16mm) VW T25
Sump Plug Seal (16mm) VW T25
J40241 N0138481 **£1.15**



Exhaust Valve VW T25 1900,2100cc 1984-1992
Sold as singles this genuine Volkswagen exhaust valve has a 34mm diameter head and fits all 1900 and 2100cc VW T25 engines from 1984 to 1992.
J39718 025109612A **£33.25**



Head Gasket (3-Groove) VW T25 1600cc Diesel 1985-1992
This 1.6mm thick, cylinder head gasket fits the 1600cc diesel VW T25, from 1985 to 1992, and is identified by the three grooves along its side per van artwork. Handy the camper, home or give as a gift.
J40137 068103383FG **£24.75**



Camshaft End Cap
Replacement cam plug for the 2000cc Type 4 aircooled engine.
J16764 113101157C **£2.75**



Intake Manifold Gasket T4 1.8ltr (PD Engine Code)
This inlet manifold gasket fits all T4 1800cc petrol engines with the engine code PD and T25 1.6 Diesel CS engine code
J19774 026129717D **Call For Availability**



Cylinder Base Gasket 2000cc Aircooled 1979 to 1983
Sold as singles this Genuine Volkswagen cylinder base gasket measuring 100 x 109 mm x 0.14 thick
J39719 021101341A **£3.00**



Water Pump to Thermostat Gasket 1900cc 1983-1985
This gasket fits between the water pump and thermostat.
J39821 **£3.70**



Lead Substitute (500ml)
Will treat up to 150ltr of unleaded petrol.
J11412 **£10.00**



Fuel Filter 1600, 1700cc Diesel 1985 to 1992
Fits all diesel and turbo diesel models
J29279 191127401C **£25.00**



Fuel Tank Sending Unit VW T25 Syncro
This lever-arm unit fits all T25s Syncro models from 1985 to 1992
J29395 251919051H **£99.50**



Diesel Filter Valve Seal Type 25 & T4 February 1981 to August 2003
This Febi quality seal is for diesel filters, fits all diesel T25, 1981-1991
J29716 N90426402 **£2.00**



Fuel Pump Push Rod 2000cc Aircooled Engines 1979 to 1983
139.8mm in length
J31081 021127307A **£25.50**



Fuel Pressure Regulator 2100cc 1985-1992
This Genuine Volkswagen fuel injection regulator fits all VW T25s with the 2100cc injection engines
J39726 25133035 **£131.75**



Small End Bush 1700-2000cc (Set of 4)
Con rod small end bearing
J29040 021105431A **£13.50**



Gland Nut Washer
Fits 1600cc aircooled engine 1979 to 1981
J21054 111105297 **£3.70**



Nut For Oil Pump Cover VW Aircooled 1967 on VW T25 1600cc & Watercooled
Sold as singles these oil pump nuts fit all 1200-1300-1500 & 1600cc aircooled engines from 1967 on These also fit the VW T25 1600cc CT 1900 and 2100cc watercooled engines. You will require four per engine.
J21239 111115161 **£2.40**



Stainless steel tinware screw & washer set
Pack of 25 screws & washers for the engine tinware.
J21328 N0107108 **£4.95**



Oil Pump Gasket
Fits all air cooled engines.
J21241 111115131B **£1.45**



Air Hose 1.6 Turbo Diesel
This Genuine Volkswagen air hose fits between the air inlet on the vehicle body and the Turbo.
J39716 251959179 **£43.00**

**1600cc Air Cooled
Cylinder Head**

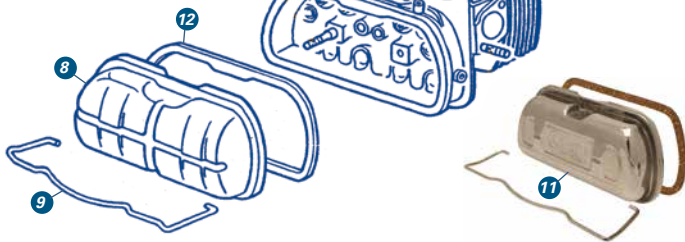

**2000cc Air Cooled
Cylinder Head**

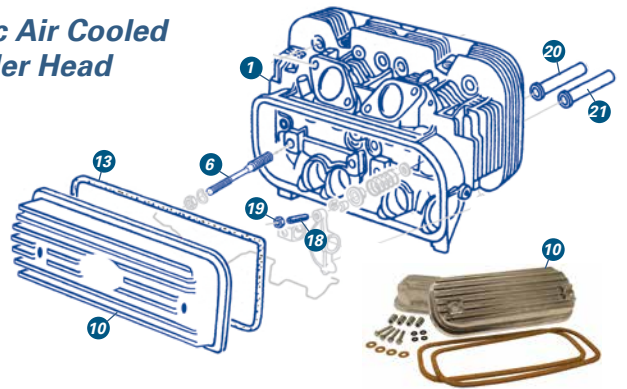

Reconditioned Water Cooled Engines

**2100cc Watercooled Petrol
Engine 1985 to 1992**

Fits vehicles with engine codes: DJ, MV, SR and SSTA.

J11756 £1900.00



**2100cc Watercooled
Engine MV 1985 to 1992**

Vege reconditioned engine for 2100cc MV codes

J19870 £1900.99



**1900cc Watercooled
1900cc DG/DF 1985 to 1992**

Vege 1900cc, watercooled, DG or DF coded engines.

J10917 £1900.00



**1900cc Watercooled Engine
DG / DF 1983 to 1985**

A reconditioned exchange 1900cc Vege engine

J14087 £1900.00



**1.6 Turbo Diesel JX
Engine 1984 to 1992**

1.6 TD Vege engine excluding injection equipment.

J16963

Call For Availability

Vege Engine (With Injection Equipment)

Reconditioned 1600cc Diesel engine for the T25 built between 1984 and 1991 with JX engine code. These are fully reconditioned engines.

J14181

Call For Availability



**Reconditioned Air Cooled
Engines**



**2000cc Engine (Short)
1980 to 1983**

Vege reconditioned engine for 2000cc aircooled

J10477 £2299.00



**CT 1600cc Aircooled Engine
1979 to 1982**

Reconditioned 1600 CT code Vege engine.

J17075 £1950.99



Reconditioned Engines



Flywheel Locking Tool for all Engines 1979 to 1992

locks the flywheel in place to allow removal of the gland nut.

J10551 00-5003-0 £9.75



Clutch Aligning Tool

Ensure that the drive plate is in the correct place.

J11208 00-5335-K £4.95



Piston Ring Compressor Tool (83mm-87mm)

Fits all rings from 83mm-87mm on 1500cc to 1641cc petrol

J11304 00-5764-7 £6.00



Piston Ring Compressor Tool (88mm-94mm)

Can be used on all rings from 88mm-94mm on all 1700cc-2000cc

J11349 00-5765-7 £6.00

Prices include VAT

'Hylomar Blue' Gasket Sealant (100g)

A tough waterproof and pressure resistant seal.

J11667 £8.00



Carburettor balancer (With 2 adaptors)

Used for balancing twin carburettors for optimum performance

J19476 £55.25

Cylinder Heads & Parts



Cylinder Head 2000cc Aircooled 1979 to 1994

Head comes fully built up and ready to fit

J10593A 071101061X £449.50



2 New Cylinder Head 1900, 2100 Watercooled 1985 to 1992

Supplied with lapped-in valves and springs

J10455 025101065CX £577.25

Call For Availability



3 Complete Cylinder Head 1600cc Diesel 1981 to 1992

Supplied with lapped-in valves and springs in place

J10780 068103265CD £577.25



Cylinder Head Temperature Sensor 2000cc 1979-1983

Fits all 2000cc injection engines.

J15344 £577.25

Call For Availability



4 Cylinder Head Stud (222mm) 1900, 2100cc Watercooled

Eight required per engine

J10479 025101143 £20.75

GENUINE



4 Cylinder Head Stud (191mm) 1900, 2100cc Watercooled

Sold as singles you will require 4 per engine

J10938 025101143A £24.50

GENUINE



4 Cylinder Head Stud (175mm) 1900, 2100cc 1983 to 1992

Sold as singles you will require 4 per engine

J10939 025101143B £17.25



5 Cylinder Head Bolt (12mm x 115mm) 1600, 1700cc Diesel

Sold as singles 10 required per engine.

J10781 068103384A £1.90



6 Rocker Shaft Stud 2000cc Aircooled 1979 to 1984

OEM rocker shaft stud.

J10980 021101397 £4.45

GENUINE



7 Exhaust Manifold Stud 1900, 2100cc Watercooled 1984 to 1992

8mm exhaust manifold stud sold singly

J10560 N01444312 £0.90

GENUINE



Exhaust Lock Nuts

Copper Locking nuts. 8mm - 1.25 x 12mm O.D

J14857 175129650 £0.55



Exhaust Lock Nuts 11mm O.D

Copper Locking nuts. 8mm - 1.25 x 11mm O.D

J14858 N0221464 £1.20



Rocker Cover 1600cc Aircooled 1900, 2100 cc Watercooled

These rocker cover will fit either side.

J10460 113101475B £5.50

Shop online at justkampers.com

- 8** **Rocker Cover Clip 1600 Aircooled 1900, 2100 Watercooled**
This rocker cover clip fits either side.
J10462 043101487..... **£3.05**
- 9** **Bolt On Aluminium Rocker Covers 1600cc Aircooled**
Supplied with all fittings and gaskets.
J12175 00-9152-0..... **£26.75**
- 10** **Scat Bolt on Rocker Covers 2000cc Aircooled**
Sold as a pair, supplied with all fixings required.
J14335 **£119.75**
- 11** **Scat Rocker Covers 1600, Aircooled 1900, 2100 Watercooled**
Rust resistant Stainless-Highly polished for lasting looks.
J14337 **£39.75**
- Rocker Cover 2000cc 1979 to 1984**
Rocker cover for all Type 4 engines.
J17028 021101471..... **£19.75**
- 12** **Rocker Gasket 1600 Aircooled 1900, 2100 Watercooled**
Made by SCAT in the USA from a Neoprene cork mix.
J14338 113101481F..... **£0.75**
- 12** **Neoprene Rubber Rocker Cover Gasket 1600CT, 1900 & 2100cc**
Sold in pairs
J20274 **£9.25**
- 13** **Rocker Cover Gasket for 2000cc Aircooled 1979 to 1983**
This cork rocker cover gasket fits 2000cc Aircooled
J10425 021101481..... **£1.80**
- 14** **Cylinder Head Gasket 1900, 2100CC Watercooled 1983 to 1992**
Sold singly, we also stock a engine gasket set (J10361)
J10907 025101345..... **£22.25**
- 15** **Rocker Cover Gasket Set All Diesel Engines 1981 to 1992**
Supplied complete with end seals.
J10595 026198025A..... **£3.00**
- Rocker Cover Vents Petrol Engined Models**
Helps decrease crankcase pressure and eliminate blow by
J18151 **£8.25**
- Oil Deflector Plate 1600, 1700cc Diesel 1981 to 1992**
Prevents oil spraying into the engine breather and air filter.
J10786 026103547..... **£6.00**
- 16** **Cylinder Head Gasket 1700cc Diesel 1984 to 1992**
3 Groove head gasket for all 1700cc with the KY engine code.
J10453 033103383M..... **£31.25**
- 16** **Head Gasket (3-Groove) 1600cc Diesel 1979 to 1992**
1.6mm thick, 3 groove cylinder head gasket.
J10783 068103383FN..... **£22.50**
- 17** **Barrel Liner Gasket 1900, 2100cc 1983 to 1992**
Fits between the top of the cylinder barrel and head.
J10908 025101343B..... **£5.50**

Bundle kit

Push Rod Tube & Seal Set 2000cc Aircooled 1979 to 1984

Consisting of 8 push rod tubes and 8 small and 8 large seals

J20299..... **£46.00**



SAVE 10%

- 18** **Hydraulic Tappet Screw 1600, 2000cc Aircooled 1979 to 1984**
Fits 1600, 2000cc aircooled engines.
J11202 025109451..... **£1.80**
- 18** **Tappet Adjust Screw 2000cc Aircooled**
10mm tappet screws sold as singles.
J11119 022109451..... **£3.95**
- 19** **Tappet Adjusting Nut 2000cc 1979 to 1984**
OEM tappet adjusting nut
J11120 N0111525..... **£1.60**
- Inlet Valve (35.5mm Head) 1600cc Aircooled 1979 to 1982**
Sold singly.
J11682 311109601..... **£6.75**
- Exhaust Valve (32mm Head) 1600cc Aircooled 1979 to 1980**
Sold singly.
J11683 311109601..... **£8.00**
- 20** **Valve Guide (9mm) Inlet 2000cc Aircooled 1979 to 1984**
This inlet valve guide (9mm) fits all Type 4 engines
J10458 021101403A..... **£5.25**
- 21** **Valve Guide (9mm) for Exhaust 2000cc Aircooled 1979 to 1984**
This exhaust valve guide (9mm) fits all Type 4 engines
J10459 021101417A..... **£6.25**
- Valve Collet Fits All Petrol Engines**
Sold as singles 16 required per engine.
J19846 113109651A..... **£1.50**
- Rocker Cover Breather Seal VW T25 Diesel**
This is the Seal for the breather valve which is on top of the rocker cover fitted to T25 1.6 Turbo Diesels and VW T4's
J21106 028103500..... **£2.50**
- Thermostat Housing T25 Syncro 1980-1992 1900 - 2100cc**
This aluminium thermostat housing is specific for the VW T25 Syncro with either the 1900 or 2100cc engine as built from 1985 to 1992. Please Note this thermostat housing uses screw in switches not the clip in style
J29389 025121117E..... **£95.00**

1900 & 2100cc Water Cooled Cylinder Head

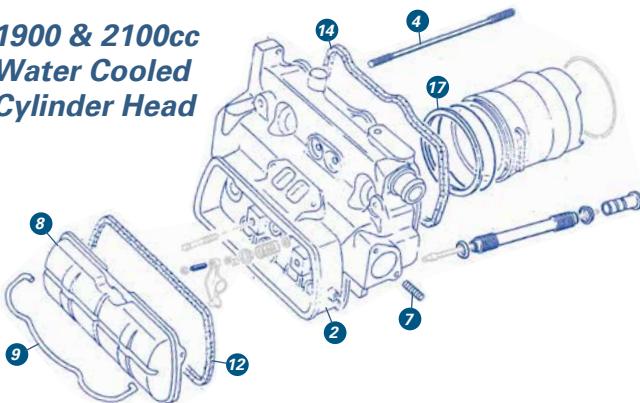

1600 & 1700cc Diesel & Turbo Diesel Cylinder Head

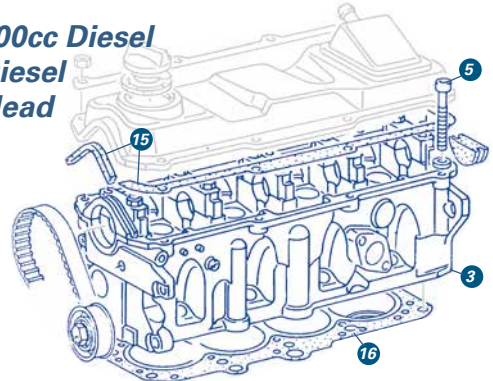

Product Key:



Exclusive to Just Kaspers



Made in the UK







Genuine VW part



Oversized charges apply to non-mainland UK deliveries



-  **Valve Stem Oil Seal 1600 & 1700cc Diesel**
Sold as singles these fit all T25 Diesel engines.
J19714 026109675..... **£0.80**
-  **Hydraulic Follower 1600, 2000 Aircooled 1900, 2100 WC**
This hydraulic cam follower fits engines from 1979 to 1992
J10445 022109309..... **£10.50**
-  **Pushrod Tube 1600cc Aircooled 1900, 2100cc Watercooled**
The tubes are sold singly, you will need eight per engine.
J10432 025109335..... **£8.50**
-  **Stainless Steel Push Rod Tube 2000cc Aircooled**
Sold as singles, you will require 8 per engine.
J19231 021109335C..... **£8.75**
-  **Pushrod Tube Retaining Spring 2000cc 1979 to 1984**
Used to align and hold the pushrod tubes in place.
J10696 021109339..... **£8.75**
-  **Pushrod Tube Seal 2000cc Aircooled 1979 to 1983**
These fit on the engine block end of the pushrod tube
J10433 021109345A..... **£0.45**
-  **Pushrod Tube Seal (Large) 1600cc Aircooled 1900, 2100cc**
This is the larger seal and fits on the cylinder head.
J10434 070109345..... **£0.60**
-  **Pushrod Tube Seal 1600cc Aircooled 1900, 2100 Watercooled**
Sold as singles 16 required per engine.
J10435 113109345A..... **£0.35**
-  **Push Rod Tube Seal (Large) 2000cc Aircooled 1979 to 1984**
Eight per engine they fit the cylinder head ends of the tube.
J10436 021109349B..... **£0.70**
-  **Gasket (Exhaust Cylinder Head to Manifold)**
1600cc to 1983 1900 & 2100 to 1992
J10331 111251261B..... **£0.70**
-  **Gasket (Preheat Inlet Manifold) 1600 cc 1979 to 1983**
Links the preheat pipe on the inlet manifold
J10332 113251263..... **£0.80**
-  **Engine Decoke Set 1600cc Turbo Diesel 1982 to 1990**
All gaskets except head gasket for 1600cc JX turbo diesel
J10349 068198012H..... **£20.75**
-  **Cylinder Head Set for One Side 1900 - 2100cc 1983 to 1992**
Set contains all the gaskets to remove and replace one head
J10364 025198012AB..... **£57.75**
-  **Inlet Manifold Gasket 1600cc Diesel 1984 to 1992**
Fits all diesel and turbo diesel engines from 1984.
J12306 068129717AE..... **£2.25**

Barrel & Pistons

-  **Barrel and Piston Set (94mm) 2000cc 1979 to 1983**
A set of four, supplied with piston rings and gudgeon pins
J10357 029198075..... **£323.75**
-  **Piston Ring Set (94mm) 2000cc Aircooled 1900cc Watercooled**
Supplied as a complete set to fit the four barrels and pistons
J10345 029198175..... **£34.75**
-  **94mm Piston Ring Set 2100cc Watercooled 1985 to 1992**
Sold as a complete set for four pistons.
J10708 025198151A..... **£49.75**
-  **Barrel Liner Gasket 1900, 2100cc 1983 to 1992**
Fits between the top of the cylinder barrel and head.
J10908 025101343B..... **£5.50**
-  **Piston Ring Compressor Tool (83mm-87mm)**
Fits all rings from 83mm-87mm on 1500cc to 1641cc petrol
J11304 00-5764-7..... **£6.00**

-  **Piston Ring Compressor Tool (88mm-94mm)**
Can be used on all rings from 88mm-94mm on all 1700cc-2000cc
J11349 00-5765-7..... **£6.00**

Cam Belts & Tensioners

-  **Timing Belt for Diesel and Turbo Diesel 1981 to 1992**
Specification is 1285.9mm long by 25.4mm wide with 135 teeth.
J10443 068109119E..... **£16.75**
-  **Cam Belt Tensioner for All Diesel Models 1979 to 1992**
When replacing a belt, we recommend you check the tensioner
J10483 068109243F..... **£14.75**
-  **Crankshaft Timing Gear 1600cc Diesel**
Lower crankshaft timing gear.
J19708 028105263E..... **£24.25**

Bundle kit

Cambelt Kit 1600, 1700 cc Diesel 1981 to 1990

This kit consists of 1 x cam belt and 1 x cam belt tensioner

J18544..... **£28.25**

SAVE 10%



General Engine Parts

-  **1 Flywheel Gland Nut 1600cc Aircooled 1979 to 1982**
This gland nut comes complete with spigot bearing.
J10426 111105305E..... **£9.75**
-  **2 Flywheel Shim (0.34mm) 1600cc Aircooled**
J13007 113105287A..... **£1.90**
-  **3 Flywheel Dowel Pin 1600 Aircooled 190, 2100cc Watercooled**
8mm flywheel dowel pin is sold singly, You will need four
J10662 113105277..... **£1.90**
-  **Main Bearing Set (Standard) 2000cc Aircooled 1979 to 1984**
A complete set of standard size main bearings
J19354 039105701..... **£40.00**
-  **4 Standard Main Bearing Set 1600cc Aircooled 1979 to 1982**
This set of standard size bearings fits 1600cc aircooled
J11100 070198461..... **£38.75**
-  **5 Big End Bearing Set 2000cc Aircooled 1979 to 1983**
Standard size big end bearings to fit 2000cc engines
J18071..... **£69.25**
-  **6 Small End Bush 1600cc Aircooled 1979 to 1983**
Sold singly four required per engine.
J11034 311105431A..... **£6.50**
-  **7 Camshaft Bearing Set | All Aircooled 1979 to 1994**
Standard-sized camshaft bearings are sold as a set.
J10594 021198541..... **£19.75**
-  **8 Crankshaft Woodruff Key 2000cc Aircooled 1979 to 1984**
located at the small pulley end of the crankshaft.
J11256 N0127082..... **£5.75**
-  **9 Timing Scale 2000cc Aircooled 1979 to 1984**
Provides the timing reference point for your engine.
J13415 021119249E..... **£11.25**

Product Key:



Exclusive to Just Kampers



Made in the UK

GENUINE PARTS & ACCESSORIES

Genuine VW part





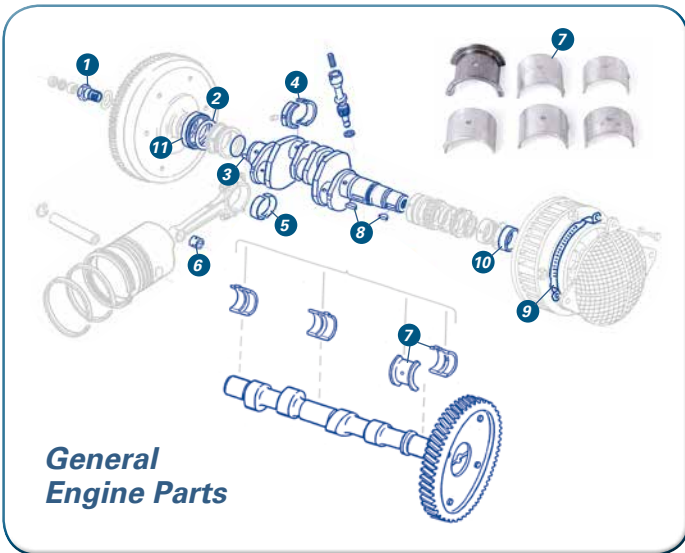



Oversized charges apply to non-mainland UK deliveries













General Engine Parts

-  **Gasket (Preheat Inlet Manifold) 1600 cc 1979 to 1983**
Links the preheat pipe on the inlet manifold
J10332 113251263..... **£0.80**
-  **Oil Cooler Seal 2000cc Aircooled 1979 to 1983**
Standard oil cooler seal which fits 2000cc aircooled engines
J10411 021117151A..... **£0.55**
-  **Crank Shaft Oil Seal (Small) 2000CC Aircooled 1979 to 1984**
Fits at the pulley end of the engine (nearest the rear bumper).
J10451 021105247A..... **£1.80**
-  **Crank Shaft Oil Seal (Front) 1900, 2100cc 1983 to 1992**
Front refers to the pulley end of the engine.
J10600 025105247A..... **£5.50**
-  **Crankshaft Oil Seal (Large) Flywheel End**
Fits 2000cc aircooled, 1900, 2100cc watercooled
J11419 029103245B..... **£7.25**
-  **Camshaft Oil Seal All Diesel 1981 to 1992**
Fits at the front of the engine, behind the pulley.
J12714 026103085F..... **£2.65**
-  **Rear Main Oil Seal 1600, 1700cc Diesel 1981 to 1992**
This is the oil seal next to the flywheel.
J11041 068103051G..... **£7.75**
-  **Flywheel' O' Ring 1600cc Aircooled 1979 to 1982**
Fitted to the inside lip on the flywheel
J10570 311105295A..... **£1.45**
-  **Water Pump O' Ring 1900 & 2100cc 1983 to 1992**
4mm O ring fits the water pump on all T25 1900, 2100cc
J19760 035121043..... **£1.10**

Engine Gasket Sets & Seals

-  **Engine Gasket Set 2000cc 1979 to 1983**
This comprehensive set includes all the gaskets you'll need
J10362 071198009A..... **£69.50**
-  **Engine Gasket Set 1900 - 2100cc 1983 to 1992**
This comprehensive set includes all the gaskets you'll need
J10361 025198009A..... **£122.25**
-  **Engine Decoke Set 1600cc Turbo Diesel 1982 to 1990**
All gaskets except head gasket for 1600cc JX turbo diesel
J10349 068198012H..... **£20.75**
-  **Cylinder Head Set for One Side 1900 - 2100cc 1983 to 1992**
Set contains all the gaskets to remove and replace one head
J10364 025198012AB..... **£57.75**
-  **Valve Cover Sealing Strip 1600 & 1700cc Diesel**
This sealing strip fits to the front of the valve cover
J19862 056103489A..... **£0.80**
-  **Head Gasket (3-Groove) 1600cc Diesel 1979 to 1992**
1.6mm thick, 3 groove cylinder head gasket.
J10783 068103383FN..... **£22.50**
-  **Sump Gasket 1600, 1700 cc Diesel 1981 to 1992**
Fits all 1600 & 1700cc Diesel engines.
J13692 044103609D..... **£7.00**
-  **Inlet Manifold Gaskets (Pair) 2000cc Aircooled**
J12186 00-3227-0..... **£1.75**
-  **Inlet Manifold Gasket 1600cc Diesel 1984 to 1992**
Fits all diesel and turbo diesel engines from 1984.
J12306 068129717AE..... **£2.25**
-  **Pushrod Tube Retaining Spring 2000cc 1979 to 1984**
Used to align and hold the pushrod tubes in place.
J10696 021109339..... **£8.75**
-  **Pushrod Tube Seal 2000cc Aircooled 1979 to 1983**
These fit on the engine block end of the pushrod tube
J10433 021109345A..... **£0.45**
-  **Pushrod Tube Seal (Large) 1600cc Aircooled 1900, 2100cc**
This is the larger seal and fits on the cylinder head.
J10434 070109345..... **£0.60**
-  **Pushrod Tube Seal 1600cc Aircooled 1900, 2100 Watercooled**
Sold as singles 16 required per engine.
J10435 113109345A..... **£0.35**
-  **Rocker Gasket 1600 Aircooled 1900, 2100 Watercooled**
Made by SCAT in the USA from a Neoprene cork mix.
J14338 113101481F..... **£0.75**

Fuel System & Filters

-  **Locking Petrol Cap 1979 to 1992**
Supplied with two keys. Fits all except syncros
J10335 251201551C..... **£21.75**
-  **Fuel Filler Neck 1979 to 1992**
Used on all models except Syncros
J11024 251201119D..... **£14.50**
-  **Fuel Filler Neck Surround 1979 to 1992**
located on the front arch all except Syncro models
J11027 251201117 01C..... **£9.75**
-  **Gasket Ring (Behind Fuel Filler Neck) 1979 to 1992**
Holds the fuel filler neck in place (except Syncro models)
J11513 251201197..... **£4.65**
-  **Sealing Pipe 1985 to 1992**
OEM sealing pipe fuel filler pipe to the breather pipe.
J10760 211611833D..... **£2.45**
-  **Fuel Tank Breather Pipe 1979 to 1992**
Fits all models except Syncros.
J19245 251201147B..... **£29.75**
-  **Fuel Tank Grommet 1979 to 1992**
Sold as singles three required per tank.
J10945 N90100401..... **£3.45**
-  **Metal Filler Neck Seal 1979 to 1985**
Tank seal 70mm OD to 50mm ID
J19234 251201139B..... **£10.25**
-  **40mm Fuel Neck Seal 1985 to 1992**
Fuel neck seal which seals the filler neck to the fuel tank.
J10758 251201139A..... **£10.10**
-  **Metal Filler Neck Seal (70mm) 1979 to 1985**
Fitted to vans with a metal filler neck.
J11055 251201139..... **£6.25**
-  **Fuel Tank (68mm Filler) 1985 to 1992**
This tank fits all diesel and carburetor petrol models.
J19275 251201075AD..... **£85.25**

-  **Fuel Tank (48mm Filler) 1985 to 1992**
Fits all models except petrol injection.
J10756 251201075AE £86.25
-  **Fuel Tank (48mm Neck Size) Petrol Injection Models Only**
Fits injection models from 1985 to 1992 except syncro.
J12744 251201075AH £123.50
-  **Fuel Tank Sending Unit 1979 to 1992**
lever-arm unit, from world-class manufacturer VDO
J10192 251919051E £42.75
-  **Fuel Tank Sending Unit 1987 to 1992**
lever-arm unit, from world-class manufacturer VDO
J10193 251919051K £32.75
-  **Fuel Tank Sender Seal 1979 to 1992**
Fits all models.
J11046 113919131A  £3.95
-  **Fuel Filter for Diesel and Turbo Diesel 1981 to 1987**
Fuel filter for all diesel and turbo diesel T25 models.
J10392 068127177B £7.25
-  **Fuel Filter 1600, 1700cc Diesel 1979 to 1992**
Fits all diesel and turbo diesel models
J10792 1H0127401C £13.75
-  **Fuel Filter 1900 & 2100cc 1985 to 1992**
Filter removes impurities which would cause premature wear
J10333 1H0201511A £6.75
-  **Fuel Filter All Petrol Models Except Injection**
J10791 251201511G £1.70
-  **Fuel Pump Pushrod 1900cc 1983 to 1992**
Fits all 1900cc Carburettor engines.
J10395 113127307A £2.95
-  **Fuel Pump Gasket 2000cc Aircooled 1979 to 1984**
Located between the engine case and the fuel pump base.
J11339 021127311A  £2.25
-  **Fuel Pump Gasket (Lower Base) 1979 to 1992**
Fits the fuel pump 1600cc aircooled & 1900cc watercooled
J10396 025127311A £0.55
-  **Fuel Pump Flange 1900cc 1983 to 1992**
Fits all 1900cc petrol engines
J10393 113127303 £2.75
-  **Fuel Pump for 1600cc and 1900cc Petrol 1979 to 1992**
May require slight modification to fuel lines on the 1900cc.
J10391 025127025A £11.75
-  **Fuel Pump Repair Kit 1600cc Aircooled, 1900cc Watercooled.**
Contains the diaphragm and all the gaskets required.
J13079 111198555 £33.25
-  **Electric Fuel Pump (12V) Petrol**
Flow rate 114 Ltr/Ph, 0.42 Bar (6.1psi)
J13083 £47.75
-  **5mm Fuel Hose 1979 to 1992**
5mm inner diameter sold by the metre
J10583 N0203551 £3.75
-  **7mm Fuel Hose**
7mm x 2.5mm Sold by the metre,
J11668 N203571 £2.90
-  **Fuel Hose Clip 10mm (For 5mm Hose) Pack of 6**
J12965 N0245223 £5.00
-  **Fuel Pump Flange Vw T25 1979-1983 1700-1800 and 2000cc aircooled engines**
J29506 021127303A £16.00

-  **Servo T-Piece 2000cc Aircooled 1979 to 1984**
located on the balance bar between the carburettors.
J10772 071129755A  £9.00
-  **Inlet Manifold Rubber Elbow 2000cc Aircooled 1979 to 1984**
J10848 021129637F  £2.95
-  **Breather Hose to Air Filter 1900 & 2100cc 1983 to 1992**
This fits from the oil breather tower to the air box
J11048 025129493A £29.25
-  **Inlet Manifold Gasket 2000cc 1979 to 1984**
You will need two for each side.
J10773 021129707E  £3.70
-  **Paper Air Filter Petrol Engines 1979 to 1985**
This square-shaped part fits in to the plastic air box
J10129 021129620 £6.25
-  **Air filter 1900 - 2100cc 1985 to 1992**
A blocked or dirty filter can cause your engine to run rich
J10378 025129620A £8.75
-  **Air filter 1600cc, Turbo Diesel 1981 to 1990**
A blocked or dirty filter can cause your engine to run rich
J10379 060129620 £12.75
-  **Air Filter Element 1600 - 1700cc Diesel 1981 to 1990**
A blocked or dirty filter can cause your engine to run rich
J10380 069129620 £5.25
-  **Injector Diesel CS and KY Engines**
Bosch injector. Fits all (non Turbo) Diesel T25 models.
J12837 068130201E £57.00
-  **Injector Turbo Diesel JK Engines**
Bosch injector. Fits all Turbo Diesel T25 models.
J12838 068130201BX £53.75
-  **Sealing Washer for Injector All Diesel Engines.**
Sold as singles.
J18270 068130219  £0.85

Carburetor, Manifolds & Rebuild Kits

-  **Carburettor Gasket Kit 2000cc 1979 to 1984**
Gaskets, seals etc to rebuild a pair of PDSIT 34 2/3 carbs
J11084 £41.25
-  **Accelerator Linkage Spring 2000cc Aircooled 1979 to 1984**
This spring helps keep the carb linkage tight.
J10545 021129959  £2.45

Bundle kit

Fuel Pressure Regulator Kit Petrol Carburetor Engines

kit allows you to set your fuel flow to the correct pressure.

J13370.....





Bundle kit

Dual Brosol Carbs 44mm 2000cc Aircooled 1979 to 1984

Complete kit with manifolds and fittings.

J14186.....

£828.75



Bundle kit

Empi Dual Weber 34 ICT Carb Kit 2000cc Aircooled

Please note, this kit does not come with a cold start system.

J12145.....£499.00



Bundle kit

Weber Single Carb 2000cc Aircooled 1979 to 1984

Kit contains manifolds, gaskets, choke and vacuum take off

J11144.....£385.95



Inlet Manifold Gasket 2000cc 1979 to 1984

You will need two for each side.

J10773 021129707E.....£3.70



Inlet Manifold Gasket 1900cc 1984 to 1992

Fits large port 1900cc engines.

J19762 025129717D.....£2.75



Vacuum Hose (3.5mm Diameter) All Petrol Engines

Sold by the half metre, this vacuum hose (3.5mm diameter)

J10558 N203535.....£1.40



Accelerator Cable Bolt

Can also be used to fit heater cables to heat exchangers.

J11439 111129859.....£2.75



Fuel Pressure Regulator (1-4 psi)

Supplied with kit J13370

J13371 9102.....£5.75

Call For Availability



Mount For Fuel Pressure Regulator

Mounting Bracket For Fuel Pressure Regulator (J13371)

J13372 9090.....£5.75



Barbed Fuel Fittings (5/16" (Pair)

Supplied with kit J13370

J13373 9097.....£5.00



Fuel Fittings (1/4" (Pair)

Supplied with kit J13370

J13374 00-9103-0.....£5.75



Brass Fuel T Fitting 5/16"

This 5/16" Barbed brass fuel tee

J19355.....£10.25

Handy Hint



Jacking up your Volkswagen

If you are using the standard VW jack and jacking points, always check the condition of jacking points and surrounding metalwork.

If you are using a bottle, scissor or trolley jack, they must be placed under the front axle beam or under the rear torsion bar crossmember (ahead of the gearbox).

Always 'chock' the wheels to prevent the vehicle rolling and if you are going to be under the

vehicle, ALWAYS USE AXLE STANDS. Wherever possible, always jack your vehicle on a level solid surface, never on gravel or grass. You may not have a choice in the case of a break down, so carry a flat (strong!) piece of wood or similar to put under the jack if you have to change a wheel on the 'not so hard' shoulder.



World

News, Tech, How To's and more...



Tech Guides



Competitions

JK Projects



You'll find handy tips, reviews, tech guides and competitions all on the JK blog

JK Projects



Product Reviews



Events

Trips & Tricks



www.justkampers.com

Oil System & Lubricants

- 1 Oil Filler Cap 1600, 2000 Aircooled 1900, 2100 watercooled**
Oil filler cap for the filler tube.
J19757 070115311..... £4.45
- Oil Deflector Plate 1600, 1700cc Diesel 1981 to 1992**
Prevents oil spraying into the engine breather and air filter.
J10786 026103547..... £6.00
- Rocker Cover Breather Pipe Diesel 1984 to 1992**
This breather hose is located on the top of the rocker cover.
J19653 068103493AE..... £39.75
- Oil Breather Kit (Cast Aluminium) All Petrol Models**
Reduce Crank case pressure, eliminate blow by and oil loss.
J16927..... £39.75
- Rocker Cover Vents Petrol Engined Models**
Helps decrease crankcase pressure and eliminate blow by
J18151..... £8.25
- 2 Boot (For Dipstick Tube) 2000cc Aircooled 1979 to 1983**
J10961 021119245..... 4.95
- Oil Pressure Pipe 1600cc Turbo Diesel 1984 to 1992**
This is the oil pressure feed pipe on the side of the block.
J18538 068145771F..... £26.50
- 3 Oil Pump for Diesel and Turbo Diesel 1981 to 1992**
This oil pump fits all diesel and turbo diesel engines
J10431 068115105BP..... £33.75
- 4 Oil Cooler 2000cc 1979 to 1984**
Fits the 2000cc Type 4 engine.
J16683 021117021B..... £56.75
- 5 Oil Cooler Seal 2000cc Aircooled 1979 to 1983**
Standard oil cooler seal which fits 2000cc aircooled engines
J10411 021117151A..... £0.55
- Oil Cooler 1600 & 1700cc Diesel 1979 to 1992**
Mounted between the oil filter and the filter housing.
J19716 068117021B..... £25.00
- Oil cooler Seal 1600 7 1700cc Diesel**
Used in conjunction with J19716
J20016 038117070A..... £2.40
- 6 Oil Filter 2000cc 1979 to 1983**
Bosch filter provides superior oil filtration.
J10123 021115351A..... £10.00
- 7 Oil filter 1600, 1900 and 2100cc Petrol 1979 to 1992**
Fits 1600cc aircooled engines and 1900cc-2100cc watercooled
J10347 070115561..... £6.25
- 8 Oil Filter All Diesel Engines 1979 to 1992**
An anti-drain back valve ensures a supply of oil on start-up.
J10484 068115561B..... £10.00
- 9 Sump Gasket 1600, 1700 cc Diesel 1981 to 1992**
Fits all 1600 & 1700cc Diesel engines.
J13692 044103609D..... £7.00
- 10 Oil Strainer Gasket Set 2000cc Aircooled 1979 to 1983**
Used between the oil strainer and sump plate
J10351 021198031..... £2.15
- 11 Oil Strainer 1600cc Aircooled 1979 to 1983**
Oil strainer fits all engines with a 14.5mm oil pick-up
J10403 311115175A..... £5.00
- 12 Oil Strainer 2000cc Aircooled 1979 to 1984**
This gauze filter fits in the sump
J10856 021115175..... £7.25
- Sump Drain Plate 1600cc Aircooled 1979 to 1984**
A simple solution to make oil changes less messy.
J10664 043115181..... £8.00

- 13 Oil Drain Plug 2000cc Aircooled 1979 to 1993**
This genuine VW sump plug fits 2000cc aircooled engines
J10405 N0297014..... £6.50
- 14 Sump Plug Seal 1600cc Aircooled**
Used on engines fitted with a sump drain plug.
J11047 N0138492..... £1.25
- 15 Domed Sump 1600cc Aircooled 1979 to 1984**
A open-ended nut can allow oil to run down the threads.
J10588 N0110624..... £0.065
- 16 Deep Sump (Aluminium) 2000cc Aircooled**
Simply bolts on the bottom of your engine
J14336..... £116.75
- 17 Oil Pressure Switch 1600, 2000cc Aircooled 1979 to 1984**
1.15-0.45 Bar fits all aircooled models.
J10513 021919081B..... £3.05
- 18 Oil Pressure Switch (Black) All Watercooled 1985 to 1992**
1.2-1.4bar please check colour before ordering.
J10724 068919081..... £3.35
- Oil Pressure Switch 1900, 2100cc Watercooled 1983 to 1992**
Rated at 0.15 to 0.35bar colour blue
J11045 028919081H..... £3.70
- Oil Pressure Switch (Grey) 1900, 2100cc 1983 to 1994**
0.75 and 1.05bar Please check requirement before ordering.
J11054 068919081A..... £3.95
- Oil Pressure Switch (White 1.6-2.0 Bar) 1983 to 1992**
Fits all Petrol watercooled T25 models.
J12011 056919081E..... £3.85
- Morris Semi Synthetic 10w/40 Engine Oil (5Litres)**
5 litres of Morris quality 10w/40 engine oil.
J14585..... £30.25
- Morris Performance Plus 15/40 Multigrade Oil (5Litre)**
High quality multigrade suitable for all engines.
J10553..... £24.25
- Morris SAE30 Oil (5litre) for all Aircooled Engines**
This oil is recommended by VW for all air cooled engines.
J10650 ML001..... £22.75
- Flexi-Neck Oil Jug**
Marked in 1/4litre increments.
J10859..... £8.00
- CV Joint and Rack Grease (90g)**
High temperature molybdenum grease
J10651 G052133A2..... £2.45
- Multi Purpose Grease (500g)**
J11331..... £6.00
- Grease Gun**
Side lever operation with flexi neck.
J11390..... £35.00
- Oil Return Pipe From Turbo T25 1.6 TD JX Engine 1984-1992**
J31237 068145735B..... £80.25

Morris Brake Fluid 1 Litre

Morris Brake Fluid 1 Litre
J10646..... £9.25



Cooling System

1600cc Air Cooled Oil System

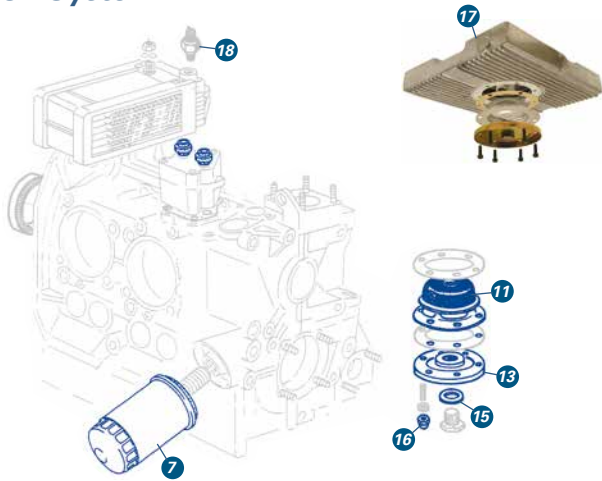

2000cc Air Cooled Oil System

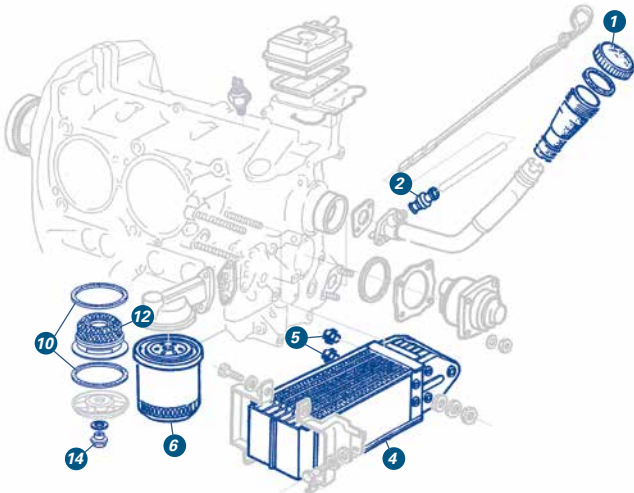

1600 & 1700cc Diesel & Turbo Diesel Oil System

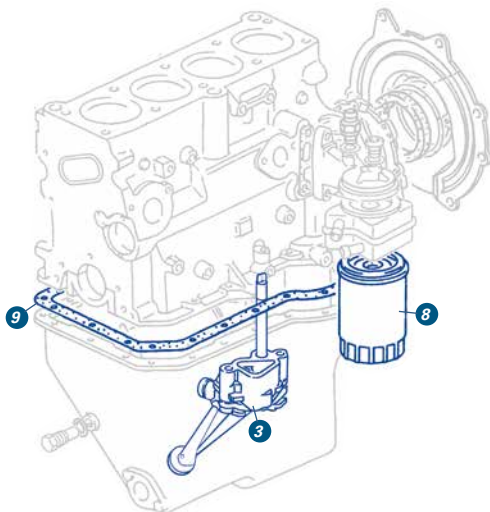

Stainless Steel Water Pipe Sets

No More Rusty Coolant Pipes!

Stainless Water Pipe (Feed & Return) 1900, 2100

38mm pipe 1985 on 1900, 2100cc Except Syncro

J15345 £174.25



Stainless Water Pipe (Feed & Return) Diesel 1985 to 1992

38mm pipe fits all Diesel and Turbo Diesel 1985 to 1992

J15346 £196.50



Stainless Water Pipe (Feed & Return) Syncro 1985 to 1992

38mm pipe fits all Syncro models

J15347 £135.00





Stainless Water Pipe (Feed & Return) 1979 to 1985

32mm pipe fits all models up to 1985

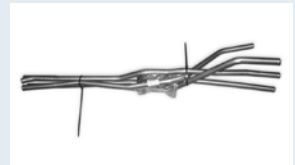
J15348 £174.25





- 

Thermostat Cable 1600, 2000cc Aircooled 1979 to 1984
Requires shortening to 350mm if fitting to the 1600cc
J10861 021119751 £5.75
- 

Fan Guard Mesh 2000cc Aircooled 1979 to 1983
Fan Guard Mesh. Fits the Type 4 aircooled Engine.
J10983 021119207 01C £24.75
- 

Tinware Screws 1600, 2000cc Aircooled 1979 to 1984
M6 thread sold in packs of 25.
J10663 N0107108 £4.50
- 

Engine Bay Seal for Aircooled 1979 to 1984
OEM quality part which fits 1600cc and 2000cc aircooled engines
J10740 251813226A £64.75
- 

Oil Cooler 2000cc 1979 to 1984
Fits the 2000cc Type 4 engine.
J16683 021117021B £56.75
- 

Coolant Distribution Manifold 1900, 2100cc Watercooled
Mounted on the left hand side of the engine bay fits from 1984
J19229 251121438A £36.75
- 

Coolant Pipe Connector 1983 to 1992 1900cc Watercooled
Connector pipe from expansion tank to the engine block.
J19230 025121438 £16.75
- 

Coolant Bleeder Valve 1900cc Watercooled 1983 to 1985
The 4 way junction and bleeder valve for 1900cc
J19246 025121082 £32.75
- 

Water Flange Distribution Block Diesel 1988 to 1992
Mounted to the side of the head, with hole for sender.
J13705 068121132 £5.75
- 

Coolant Distribution Manifold 1900, 2100cc 1986 to 1992
Distribution manifold sited next to number 1 cylinder.
J18080 251121438B £42.00

1900cc Water Cooled 1983 to 1985

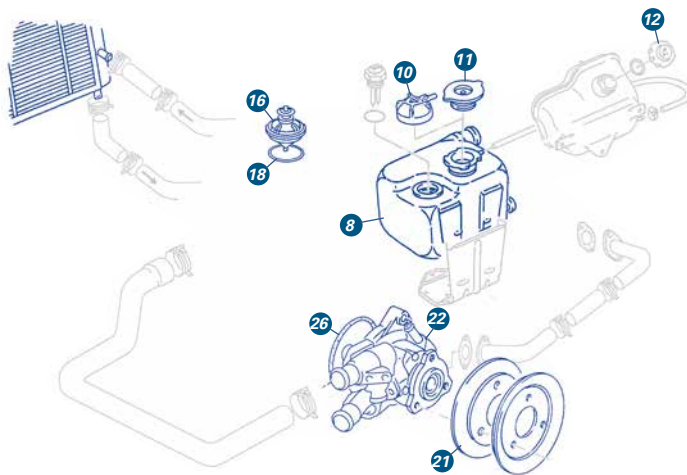

1900cc Water Cooled 1985 to 1992

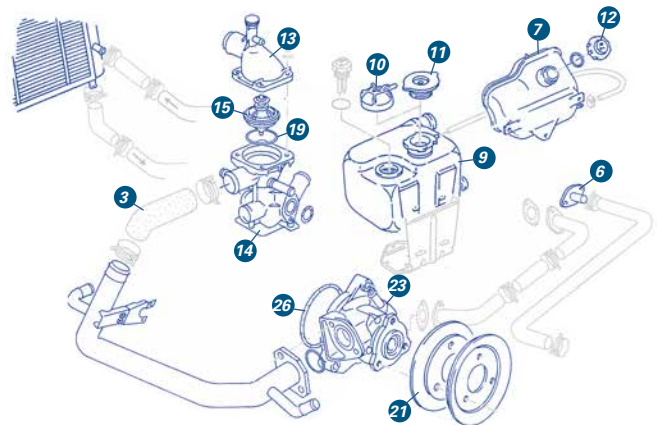

1 Water Hose 2100cc 1984 to 1992

This radiator hose fits between the thermostat and oil cooler.

J19766 025121058E..... £4.95

Inlet To Cooler Hose 2100cc 1984 to 1992

Fits between the water inlet and oil cooler housing

J19767 025121058G..... £2.95

2 Water Pump To Cooler Hose 2100cc 1984 to 1992

Fits between the water pump and oil cooler

J19768 025121058J..... £4.95

3 Water Hose Pump to Thermostat 1900 & 2100cc

This hose fits between the water pump and thermostat.

J20119 025121073H..... £7.25

4 Water Hose Block to Water Pump All Diesel Engines

J11595 068121053M..... £6.50

5 Water Hose to Oil Cooler 2100CC 1985 TO 1992

Original Equipment quality water hose to oil cooler

J11598 025121058D..... £3.70

6 Waterpipe Flange 1900, 2100cc 1985 to 1992

Fitted to the righthand / offside of the cylinder head.

J11215 025121160D..... £24.75

Water Flange Diesel

fits diesel engines with the engine code JX, KY and CS

J19771 068121133M..... £5.25

Water Flange Sender Seal 1983 to 1992

Sealing O ring that is on most clip-in cooling senders.

J19891 N90316802..... £0.75

Heater Control Valve 1979 to 1992

Fits all watercooled vehicles.

J19901 171819809E..... £9.50

Coolant Switch Retaining Clip Watercooled Models

This horseshoe clip holds the coolant switch in place.

J19955 032121142..... £0.50

Water Flange Blanking Plug Watercooled Models

Coolant Switch Blanking Plug for use on Coolant Water Flanges.

J20017 357121140..... £3.85

7 Coolant Reservoir 1900, 2100cc Watercooled

Overflow tank located directly behind the numberplate

J11177 025121403..... £42.25

8 Coolant Reservoir All Diesel & 1900cc Petrol 1983 to 1985

Top pipe is approximately 30mm, and the bottom pipe is 23mm.

J10794 025121403A..... £13.00

9 Coolant Reservoir 1900 - 2100cc 1983 to 1992

Coolant reservoir fits most 1900 & 2100cc petrol engines

J10389 025121403B..... £12.00

10 Reservoir Cap 1600cc-2100cc 1983 to 1992

This expansion tank cap fits all T25s form 1983-1992.

J10399 025121321B..... £6.75

11 Reservoir Pressure Cap 1900, 2100 Watercooled 1983 to 1992

Fits to the header tank

J11245 025121321..... £5.75

12 Replacement Cap For The header Tank

This cap fits the header tank, not the expansion bottle.

J19773 025121482..... £4.15

13 Thermostat Housing 1900, 2100CC 1985 to 1992

This OEM component is the top part of the thermostat housing

J10911 025121114..... £15.75

14 Thermostat Housing 1900cc 1985 to 1992

Not suitable for Syncro models.

J11160 025121115A..... £49.25

15 Thermostat Housing 2100cc 1985 to 1992

Requires use of a T piece on some 2100cc engines

J12835 025121115..... £48.25

16 Thermostat 1900 - 2100cc Petrol & 1600 - 1700 Diesel

This thermostat opens at 87deg C

J10398 02512113F..... £10.75

17 Thermostat All Diesel Engines 1981 to 1992

This thermostat opens at 87deg C

J10486 068121113H..... £8.75

Original VW Formula Anti-Freeze All Engines

Don't use anything else with your T25 engine - universal anti-freeze may not contain the necessary anti-corrosive elements. To help avoid corrosion on the head studs of your Type 25 water boxer engine, we strongly recommend you use this.

4 bottles are required for a Type 25 engine.

Anti-corrosion, blue anti-freeze comes in 1.5litre containers.

J10916..... £10.75



- 17 Thermostat 1600cc Diesel 1987 to 1992**
 This thermostat is supplied with seal
J19770 056121113AS..... **£4.70**
- 18 Thermostat Seal 1900, 2100cc watercooled 1983 to 1994**
 The seal is 3.5mm thick and has an Internal diameter of 60mm.
J10793 N90136802..... **£0.65**
- 19 Thermostat Housing' O' Ring 1900, 2100cc 1985 to 1992.**
 This 26mmx3mm thermostat housing 'O' ring.
J11291 N90278101..... **£1.15**
- 20 Thermostat Seal 1600, 1700cc Diesel 1979 to 1992**
 This 4mm wide thermostat seal has an internal diameter of 50mm.
J11292 N90560801..... **£1.50**
- 21 Water Pump Pulley (Front Half) 1900 - 2100cc 1983 to 1992**
 This OEM part is the outer half furthest from the pump.
J10416 025121031A..... **£12.75**
- 22 Water Pump 1900cc Watercooled 1983 to 1985**
 Supplied with gaskets and an 'O' ring
J10413 025121010A..... **£43.75**
- 23 Water Pump 1900 - 2100cc Watercooled 1985 to 1990**
 Fits late, petrol-engined 1900cc T25s, 1985-1990.
J10414 025121010B..... **£61.75**
- 24 Water Pump All Diesel Engines 1985 to 1987**
J10485 026121005H..... **£19.75**
- 25 Water Pump Diesel 1600, 1700cc 1986 to 1992**
 Fits vehicles with engine codes CS and JX
J13449 037121010C..... **£37.25**
- Water Pump (Complete) 1600cc Diesel 1981 to 1985**
 Fits 1600cc diesel and turbodiesel models
J10730 026121010D..... **£44.75**
- 26 Water Pump O ring 1900 & 2100cc 1983 to 1992**
 5 mm thick offering a better seal than the standard 4mm O ring.
J19761 069121043..... **£5.50**
- Radiator All Petrol And Diesel Models 1983 to 1992**
 Core size 570 440 30MM
J13629 068121068B/C..... **£138.75**

Metal Waterpipe (L-Shaped) 1900, 2100CC 1985 to 1992

located at the front of all petrol watercooled engines.

J10912 **£64.50**



Exclusive to JK!

- Radiator Mount 1980 to 1985**
 Sold as singles fits all watercooled upto 1985.
J19847 803121273..... **£2.30**
- Replacement Heater Core 1983 to 1992**
 Fits all watercooled models.
J18572 251265303C..... **£110.00**
- Dual Thermo Switch 1984 to 1992**
 This is the cooling fan switch
J10178 251959481K..... **£11.75**
- Coolant Level Switch 1981 to 1992**
 Length 68mm, it attaches to the top of the expansion tank.
J10725 251919372..... **£7.25**
- Temperature Sender 1900, 2100cc Watercooled 1985 to 1992**
 Temperature sender for the coolant temperature gauge.
J10568 251919501..... **£7.25**
- Temperature Sender 1600, 1700cc Diesel 1900, 2100cc Petrol**
 The sensor works between 0° and 125°.
J10726 049919501..... **£4.65**
- Temperature Sensor (2-Pin) 1983 to 1992**
 This two-pin temperature sensor fits all engines, 1983-1992
J13717 251919501D..... **£5.25**

Handy Hint

Which cap fits your model?

There are two styles of cap. Please check before ordering.



J10399
£6.75



J11245
£5.75

2100cc Water Cooled

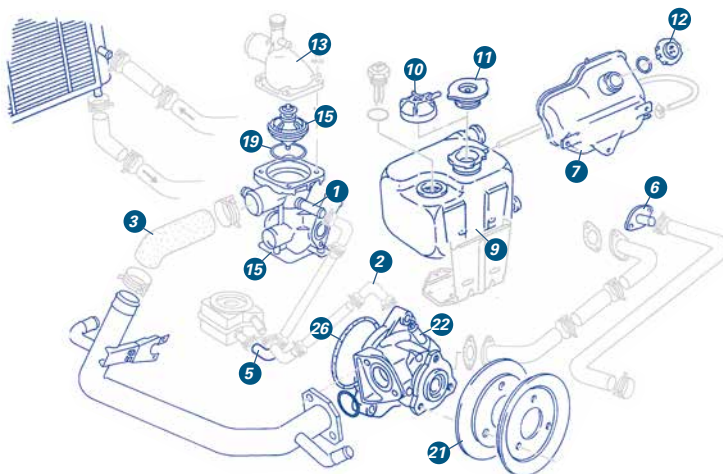

All Diesel Models

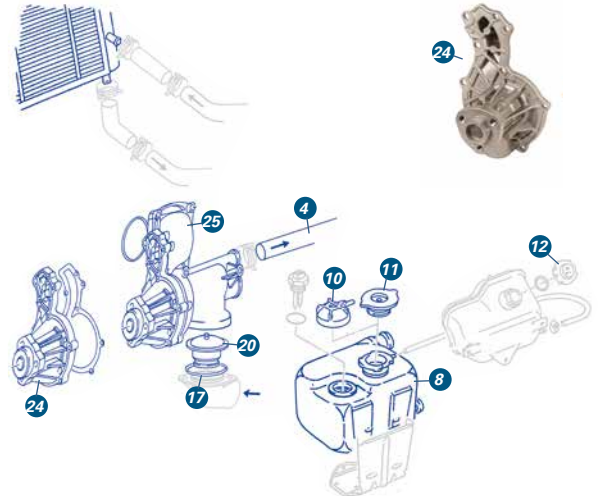

Product Key:



Exclusive to Just Kaspers



Made in the UK



Genuine VW part



Oversized charges apply to non-mainland UK deliveries

Cooling System

	Water Hose Bleed Valve to Lower Thermostat Housing 1900cc 1983-1985 J11600 025121073E..... £30.00
	Coolant Hose For Left Cylinder Head 1986-1992 J27780 025121058C..... £38.00
	Thermostat Housing T25 Syncro 1980-1992 1900 - 2100cc J29389 025121117E..... £95.00
	Coolant Hose Water Pump To Header Tank T25 Diesel Engines (3 Way) J29496 068121081C..... £7.25
	Coolant Hose to expansion tank 1900/2100cc 1985 on J29531 025121058H..... £6.25
	Coolant Distribution Manifold 1900, 2100cc Watercooled J29532 251121058A..... £10.00
	Coolant Pipe Connector 1983 to 1992 1900cc Watercooled J29533 251121082..... £21.25

	Coolant Hose Expansion Tank to Water pump 1900/2100cc J29534 025121108D..... £12.75
	Coolant Hose Thermostat Housing to Plastic Water Pipe 2100cc J29538 025121058B..... £13.50
	Water Hose return pipe to thermostat Housing 1900, 2100 1985 on J31077 025121062E..... £34.00
	Metal Coolant Pipe (Oil cooler to thermostat) 1986 - 1992; 2100cc, DJ, MV and SR Engine codes J31506 025121065a..... £24.50
	Metal Coolant Pipe (Oil cooler to thermostat) 1986 - 1992; 2100cc, DJ, MV and SR Engine codes J31507 025121065..... £28.25
	Coolant Joining Hose (58x32mm) 1980 - 1992 J39230 N90128703..... £3.80



EMPI Alloy Wheels

EMPI 911 5 Spoke Alloy Wheel (15" / 5x112 - Set of 4 Inc Wheel Bolts)

Empi 5 Spoke 911 Alloy Wheels in Matt Black with Matt Silver.

This classic wheel is now available with a 5 x 112 stud pattern. This wheel comes with silver cap with logo and chrome valve stem.

15 x 5", Max Weight 675 kgs Per Wheel, ET 40

J19146

Call For Availability

EMPI 911 Alloy Wheel (17" / 5x112)

Empi 5 Spoke 911 Alloy Wheel in Matt Black with Matt Silver.

This classic wheel is now available with a 5 x 112 stud pattern. This wheel comes with silver cap with logo and chrome valve stem.

17 x 7", Max Weight 675 kgs Per Wheel, ET 40

J18876

£172.75



Clutch Components

- Clutch Kit (215mm) 1600, 1700 Diesel 1981 to 1992**
Comprises of a pressure plate, centre plate, release bearing.
J10796 068198141H..... **£131.75**
- Clutch Kit 228mm (Three Parts) 2000cc 1900cc 1979 to 1989**
Contains pressure plate, centre plate and release bearing
J10135 029198141..... **£118.25**
- Clutch Kit 215mm 1979 to 1983**
Contains pressure plate, centre plate and release bearing.
J10348 043198141..... **£112.75**
- Clutch Kit (228mm) 2100cc 1989 to 1992**
Contains pressure plate, centre plate and release bearing.
J10358 029198141B..... **£156.50**
- Flywheel Gland Nut 1600cc Aircooled 1979 to 1982**
This gland nut comes complete with spigot bearing.
J10426 111105305E..... **£9.75**
- Spigot Bearing 1979 to 1992**
Spigot bearing. Fits all T25 fly wheels.
J17025 056105313C..... **£6.75**
- Clutch Operating Shaft 1979 to 1992**
This clutch operating shaft fits all T25s 1979 to 1992
J10666 091141701..... **£22.75**
- Clutch Master Cylinder 1980 to 1992**
J10710 251721401A..... **£32.25**
- Clutch Slave Cylinder 1982 to 1992**
Since 1982, all T25s have been fitted with hydraulic clutches.
J10290 251721263A..... **£22.25**
- Clutch Slave Cylinder Repair Kit 1980 to 1979**
Kit contains piston seal, dust boot and bleed nipple cover.
J10797 251798041..... **£10.25**
- Clutch Cable With Front Conduit 1979 to 1992**
It comes supplied as a complete cable with the front conduit.
J10235 252721335..... **£18.75**
- Clutch Cable Conduit 1979 to 1982**
Fits all righthand drive models.
J10811 251721361B..... **£4.75**
- Clutch Flexi-Hose 1981 to 1982**
Mounted between the metal pipes at the gearbox end.
J10815 251721477D..... **£6.50**
- Clutch Slave Cylinder Hose, 1035mm T25 8/1985-7/1992**
J31146 251721478F..... **£27.75**

Handy Hint

Adjusting the clutch pedal free-play (1979-1982)

Clutch adjustment is carried out by means of the adjusting nut on the cable end. Release the locknut, and turn the adjusting nut to give a pedal free-play of 10–25mm (0.4–1.0 in) which corresponds to the correct clearance of approx. 2 mm (0.08 in) on the clutch release bearing. Tighten the locknut.

To avoid cable snatch, the clutch cable guide should sag 25–45mm (1.0–1.8 in) as seen in the diagram

below. The sag at point 'B' is achieved by inserting or removing shims at point 'A', between the end of the cable guide, and the retaining bracket.

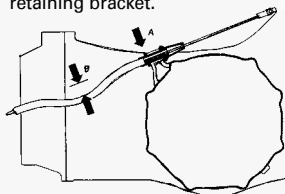

Engine Mounts

- Engine Mount (Inner) All Petrol Engines 1979 to 1992**
Fits either side two required per vehicle.
J10341 070199231..... **£8.00**
- Engine Mount (Outer) All Petrol Engines 1979 to 1992**
Fits either side two required per vehicle.
J10342 070199231A..... **£8.75**
- Diesel Engine Mount 1981 to 1992**
Sold singly, you will require 2 per vehicle.
J10885 251199201G..... **£28.00**
- Powerflex Gearbox Mounting All Petrol Manual Box.**
Powerflex gearbox mount for petrol with manual gearbox
J19273 **Call For Availability**
- Powerflex Gearbox Mounting Auto, 2100cc and Diesel**
Powerflex mount for Automatic, 2100cc and all Diesel models
J19274 **Call For Availability**

Tools

- Engine or Gearbox Stand**
450kg Maximum Capacity
J11238 53092..... **£109.75**
- Piston Ring Compressor Tool (83mm–87mm)**
Fits all rings from 83mm–87mm on 1500cc to 1641cc petrol
J11304 00-5764-7..... **£6.00**
- Oil Drain Can 9 Litre Capacity**
Doubles as a container with a pouring neck.
J11718 **£12.00**

1600cc, Petrol, Air-Cooled

- 1 Exhaust Tailpipe for 1600cc Aircooled 1979 to 1983**
This tailpipe fits the 1600cc aircooled T25, 1979–1983.
J10327 070251187A..... **£30.25**
- 2 Transfer Pipe for 1600cc Aircooled 1979 to 1983**
Offside heat exchanger to the exhaust silencer
J10338 070251108A..... **£100.75**
- 3 Heat Exchanger (Nearside) for 1600cc 1979 to 1983**
Fits to the nearside on the 1600cc petrol engine code CT
J10112 070256105..... **£194.50**
- 4 Heat Exchanger (Offside) for 1600cc 1979 to 1983**
Fits to the offside on the 1600cc petrol engine code CT
J10113 070256106..... **£194.50**
- 5 Silencer and Tailpipe Fit Kit 1600cc Aircooled**
Not suitable for use with a double flange box.
J11197 070298052A..... **£17.00**
- Gasket (Exhaust Cylinder Head to Manifold)**
1600cc to 1983 1900 & 2100 to 1992
J10331 111251261B..... **£0.70**

Handy Hint

Clutch cable conduit

When you replace the clutch cable on your 1979-82 model, check the condition of the clutch cable conduit. An aging conduit can often break inside, leaving a sharp edge which will eventually cut your new cable.

Product Key:



Exclusive to Just Kampers



Made in the UK

GENUINE PARTS & ACCESSORIES

Genuine VW part



Oversized charges apply to non-mainland UK deliveries

Exhaust

Exhaust Silencer for 1700cc Diesel 1986 to 1992

This fits non-turbo diesel T25s supplied with tailpipe.

J10100 033251051D..... **£147.25**



Exhaust Down Pipe for 1600cc Diesel 1980 to 1987

links the manifold to the silencer 1600cc, non-turbo

J10103 068251171D..... **£52.75**

Silencer 1600cc Turbo Diesel 1989 to 1992

For JX engine

J13429 068251053J **£161.75**



Exhaust Elbow Pipe Type 25 June 1979 to July 1983 1600cc (CT)

Exhaust Elbow Pipe Type 25 June 1979 to July 1983 1600cc (CT)

J21388 70251108 **£82.00**



Joining Pipe Sealing Ring 1600cc Diesel & TD 1989-1992

This exhaust sealing ring fits between the down pipe and back box on the 1600cc Diesel and Turbo Diesel engined VW T25s from 1989 to 1992.

J39466 447253137..... **£3.70**



Exhaust Kit 1600 Turbo Diesel JX 1989-1992

Back Box with a pair of new mounts, down pipe and gasket along with the tail pipe

J39643 **£231.75**



Exhaust Kit 1600cc Diesel 1981-1987

Back Box with a pair of new mounts, down pipe and gasket along with the tail pipe and gasket.

J39644 **£166.50**



Exhaust Kit Turbo Diesel 1984-1989

Back Box with a pair of new mounts, down pipegasket and sealing ring with the tail pipe and gasket.

J39645 **£168.50**



Exhaust Kit 1700cc Diesel 1986-1992

Back Box with a pair of new mounts, down pipe the gasket and sealing ring

J39646 **£212.50**



Exhaust Clamp 45.5mm VW T25 Diesel

This quality Exhaust clamp fits exhausts on all VW T25 diesel models from 1980 to 1986

J40232 191253139H..... **£3.00**



Exhaust Gasket (Head to Manifold) 1900,2100cc 1983-1992

Sold as singles these exhaust gaskets fit between the cylinder head and exhaust manifold

J39618 N90131602 **£2.25**

Stainless Steel Exhaust VW T25 1900cc Watercooled 1983-1985

Exclusive to Just Kampers this stainless steel replacement exhaust is a direct replacement for your old and rusty system. Sold with a lifetime warranty against faulty workmanship or rust these offer outstanding value for money. Please note the exhaust fittings bolts and clamps etc are made from mild steel and are not covered by the warranty. This system fits the early style 1900cc VW T25 Built from 1983 to 1985.

J40266 **£399.00**



Stainless Exhaust Silencer 2000 Aircooled 1900 Watercooled

Made from 304 Stainless steel

J31189 021251053D..... **£385.00**



Stainless Steel Quiet Pack Exhaust 2000cc Aircooled

Made from 304 stainless steel this quiet pack exhaust supplied complete with header and fit kit.

J31194 **£269.95**

Silencer US Spec 2000cc Aircooled 1900cc Watercooled

Made to the original VW spec this heavy gauge steel exhaust silencer fits the American Specification 1700 to 2000cc VW T2 Bay and the 2000cc Aircooled and 1900 watercooled VW T25. Please Note this silencer will only fit US market vehicles, if your van is a import please check the suitability before ordering.

J39428 071251053D..... **£130.00**



Exhaust Manifold Stud Cylinder Head To Heat Exchanger

2000cc Aircooled M8-M9

J27877 N0146841..... **£4.40**

Intermediate Exhaust Pipe 1900cc 1983-1985

This intermediate exhaust pipe fits the US spec 1900cc with the DH code

J39233 025251172G..... **Call For Availability**



VW T25 Catalyst

Catalytic converter for the 2100cc watercooled engine. (engine code MV and SS)

J27924 025131701AX..... **£259.50**



Stainless Steel Exhaust Tailpipe VW T2 Bay 1700, 1800, 2000cc 1971-1979 VW T25 2000cc Aircooled 1900cc Watercooled 1979-1985

Give your 1700,1800 or 2000cc T2 Bay or 2000cc Aircooled and 1900cc Watercooled T25 up to 1985 a quality resto with this excellent JK Exclusive tailpipe. In stainless steel, it comes with a lifetime warranty and adds a touch of class to the rear of your bus.

J39118 021251185F **£24.95**

Stainless Steel Full Exhaust Kit 1900, 2100cc Watercooled



Fits 1985 to 1992 sold with a lifetime warranty

J41207..... **£503.00**

lifetime warranty!

1600cc Air Cooled Heat Exchangers

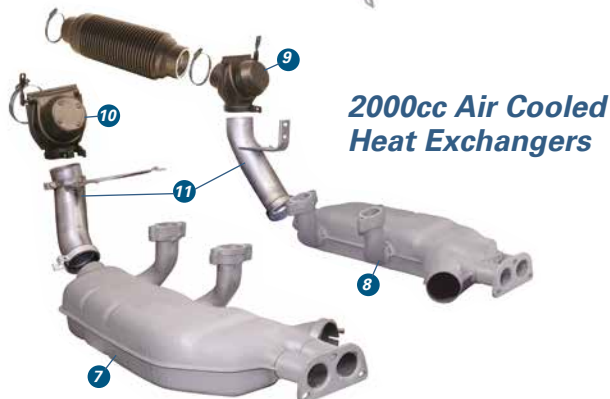

2000cc Air Cooled Heat Exchangers

Gasket (Preheat Inlet Manifold) 1600 cc 1979 to 1983
Links the preheat pipe on the inlet manifold
J10332 113251263..... **£0.80**

2000cc, Petrol, Air-Cooled

Exhaust Silencer 1979 to 1985
Fits 2000cc aircooled and 1900cc watercooled
J10079 025251053P..... **£126.75**

Exhaust Tailpipe 2000 cc Aircooled 1900cc Watercooled
Don't forget to order a gasket (J10577).
J10078 021251185F..... **£16.75**

2-Tip GT Exhaust System 2000cc Aircooled
Empi 2-tip GT exhaust system whose twin chromed tips.
J12149 **£161.75**

Quiet Pack Exhaust 2000cc Aircooled 1979 to 1984
A tuned system that can increase horsepower and performance
J14893 **£125.50**

Heat Exchanger (Nearside) for 2000cc
'flat-top' mounting to cylinder head fits all 2.0l aircooled
J10311 070256091..... **£217.75=**

Heat Exchanger (Offside) for 2000cc
'flat-top' mounting to cylinder head fits all 2.0l aircooled
J10312 070256092..... **£217.75**

12 Heat Riser Elbows (Pair) 2000cc Aircooled

Exclusive to JK!

These fit between the heat exchanges and heater control pods.

J13379..... **£35.25**



Heat Exchanger Kit. Type 25 June 1979 to July 1983 2000cc Air Cooled

SAVE 10%

Keep your T25 nice and warm and take advantage of our heat exchanger bundle kit.

This kit consists of a pair of heat exchangers, a pair of heat risers, a pair of heater pods and the required gaskets.

This bundle deal is suitable for all T25s fitted with the Type 4 2000cc engines built from 1979 to 1983.



J20108..... **£554.50**

9 Heater Control Pod (Offside) 2000cc 1979 to 1983
Offside control pod directs the hot air forward to the cab
J10111 071256206A..... **£61.75**

10 Heater Control Pod (Nearside) for 2000cc 1979 to 1983
Nearside control pod directs the hot air forward to the cab
J10110 071256205A..... **£61.75**

Gasket (Cylinder 1 or 4) 2000cc 1979 to 1983
Fits between the cylinder head and the heat exchanger
J10313 029256251..... **£4.20**

Gasket (Cylinder 2 or 3) 2000cc 1978 to 1979
Fits between the cylinder head and the heat exchanger
J10315 029256252A..... **£4.20**

Silencer and Tailpipe Fit Kit 1900cc and 2000cc
Fits 2000cc aircooled to 1983 and 1900cc watercooled to 1985
J10317 021298001..... **£12.25**

Gasket (Silencer to Heat Exchanger) 1979 to 1985
2000cc aircooled to 1983 1900cc watercooled to 1985
J10330 021251261..... **£1.40**

Tailpipe Gasket 2000 Aircooled 1900, 2100 Watercooled
J10577 025251235..... **£1.00**

Holts Firegum Exhaust Assembly Paste
Acts as a lubricant for a fast and easy assembly.
J11329 **£5.00**

Silencer 1600cc Air Cooled



Silencer 2000cc Air Cooled



Silencer 2000cc Air Cooled

Exhaust Bundle Kit 1900cc Watercooled 1983 to 1985

Silencer, tailpipe, front and rear manifolds & fitting, kit.

J11610 £369.25



SAVE 10%

Exhaust Bundle Kit 1900cc Watercooled 1985 to 1992

silencer, tailpipe, jointing pipe, knuckle, manifolds, gaskets.

J11611 £432.25



SAVE 10%

Exhaust Bundle Kit 2100cc Watercooled 1985 to 1992

silencer, tailpipe, jointing pipe, knuckle, manifolds, gaskets.

J11612 £365.25



SAVE 10%

1900 & 2100cc Petrol Water-Cooled

- 
Exhaust Silencer 1979 to 1985
 Fits 2000cc aircooled and 1900cc watercooled
 J10079 025251053P £126.75
- 
Exhaust Silencer for 1900cc and 2100cc 1985 TO 1992
 Fits 1900cc and 2100cc watercooled (codes DG, DF and DJ)
 J10104 025251053M £98.25
- 
Exhaust Mount (Nearside/Left) 1900, 2100cc 1985 to 1992
 The exhaust mount which holds the back box to the engine block.
 J19650 025251519F £23.00
- 
Exhaust Mount (Offside/Right) 1900, 2100cc 1985 to 1992
 The exhaust mount which holds the back box to the engine block.
 J19651 025251520F £25.00
- 
Silencer Straps 1900, 2100cc Watercooled 1985 to 1992
 Sold in pairs.
 J11272 025251521C £8.00

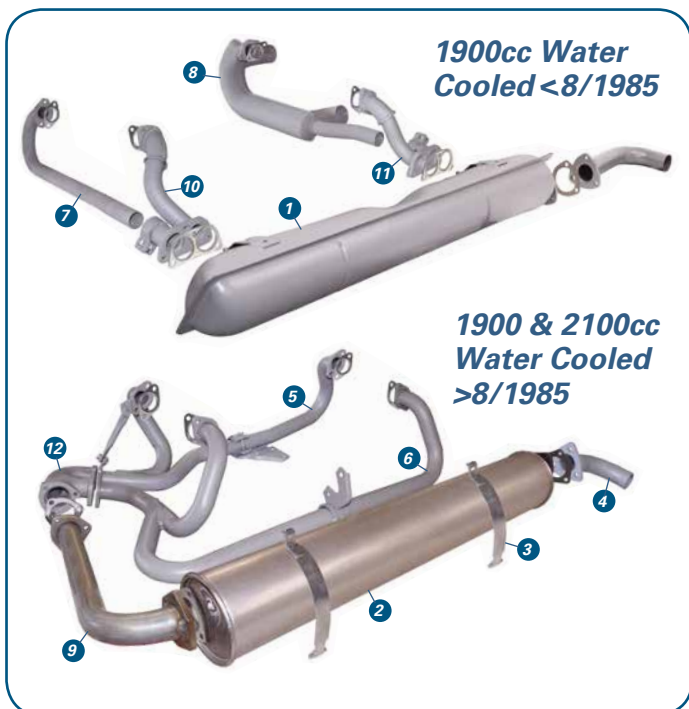

1900cc Water Cooled <8/1985

1900 & 2100cc Water Cooled >8/1985

- 
Exhaust Tailpipe 2000 cc Aircooled 1900cc Watercooled
 Don't forget to order a gasket (J10577).
 J10078 021251185F £16.75
- 
Exhaust Tailpipe 1600 Diesel, 1900, 2100cc Watercooled.
 Exhaust tailpipe diesel and petrol 1983 to 1992.
 J11141 025251185F £20.75
- 
2-Tip GT Exhaust System 2000cc Aircooled
 Empi 2-tip GT exhaust system whose twin chromed tips.
 J12149 £161.75
- 
Quiet Pack Exhaust 2000cc Aircooled 1979 to 1984
 A tuned system that can increase horsepower and performance
 J14893 £125.50
- 
Exhaust Intermediate Pipe 2100cc Syncro 1985 to 1992
 Closest to the gearbox all models except catalytic equipped.
 J14031 025251172AB £154.25
- 
Exhaust Pipework (Front) for 2100cc 1985 to 1992
 This is the exhaust header pipe from cylinders one and three
 J10106 025251171AD £100.75
- 
Exhaust Pipework (Front) 1900cc 1985 to 1992
 This is the exhaust header pipe from cylinders one and three
 J10107 025251169N £175.25
- 
Exhaust Intermediate Pipe 2100cc Syncro 1985 to 1992
 Next to the rear valance all models except catalytic equipped.
 J14028 025251172P £100.00
- 
Exhaust Pipework (Rear) 1985 to 1992
 This is the exhaust header pipe from cylinders two and four
 J10105 025251172R £87.75
- 
Manifold Pipe (Nearside) for 1900cc 1983 to 1985
 This manifold pipe fits the nearside 1900cc watercooled
 J10324 025251171F £45.25
- 
Exhaust Manifold Pipe (Offside/Right) 1900cc Watercooled
 Fits 1900cc watercooled 1983 to 1985
 J12019 025251170D £87.50
- 
Exhaust Intermediate Pipe 2100cc Syncro 1985 to 1992
 All models except catalytic equipped.
 J14030 025251147BM £54.50
- 
Exhaust Down Pipe for 1900cc and 2100cc 1985 to 1992
 Down pipe from the cast iron elbow to the silencer
 J10108 025251147BC £24.75
- 
Manifold Pipe (Nearside) 1900cc 1983 to 1985
 This manifold pipe fits the nearside
 J10328 025251251E £59.50
- 
Manifold Pipe (Offside) 1900cc 1983 to 1985
 This manifold pipe fits the offside
 J10329 025251252E £59.50
- 
Cast Exhaust Elbow 1900cc and 2100cc 1985 to 1992
 links the front and rear manifold pipes to the jointing pipe.
 J10109 025251217 £43.00
- 
Silencer and Tailpipe Fit Kit 1900cc and 2000cc
 Fits 2000cc aircooled to 1983 and 1900cc watercooled to 1985
 J10317 021298001 £12.25
- 
Gasket (Silencer to Heat Exchanger) 1979 to 1985
 2000cc aircooled to 1983 1900cc watercooled to 1985
 J10330 021251261 £1.40
- 
Tailpipe Gasket 2000 Aircooled 1900, 2100 Watercooled
 J10577 025251235 £1.00
- 
Exhaust Gasket 1900, 2100cc Watercooled 1985 to 1992
 Used between the cast knuckle and the jointing pipe.
 J11413 025251509B £4.25
- 
Exhaust Sealing Ring 1900, 2100cc 1984 to 1992
 J15079 855253137A £3.25

1600 & 1700cc Diesel Water-Cooled

- 13 Silencer for 1600cc Diesel 1981 to 1987**
Exhaust silencer fits all non-turbo 1600cc diesel T25s.
J10336 068251053D..... £99.50
- 14 Exhaust Silencer for 1600cc Turbo Diesel 1984 to 1989**
This silencer fits 1600cc turbo diesel JX engine.
J10102 068251053H..... £93.75
- 15 Silencer 1600cc Turbo Diesel 1989 to 1992**
For JX engine
J13429 068251053J..... £161.75
- 16 Exhaust Silencer for 1700cc Diesel 1986 to 1992**
This fits non-turbo diesel T25s supplied with tailpipe.
J10100 033251051D..... £147.25
- 17 Exhaust Tailpipe 1600 Diesel, 1900, 2100cc Watercooled.**
Exhaust tailpipe diesel and petrol 1983 to 1992.
J11141 025251185F..... £20.75
- 18 Exhaust Tailpipe for 1600cc Turbo Diesel 1982 to 1992**
We recommend changing the gaskets when fitting this part.
J10326 068251185B..... £24.75
- 19 Exhaust Down Pipe for 1600cc Diesel 1980 to 1987**
links the manifold to the silencer 1600cc, non-turbo
J10103 068251171D..... £52.75
- 20 Exhaust Downpipe 1600cc Turbo Diesel 1982 to 1989**
Uses gasket (J10331) at the manifold, sleeves on the silencer
J10325 068251171E..... £50.25
- 21 Jointing Pipe 1600cc Turbo Diesel 1989 to 1992**
Jointing pipe manifold to back box.
J13430 068251171..... £52.75
- 22 Exhaust Down Pipe for 1700cc Diesel 1986 to 1992**
Exhaust jointing pipe links the manifold to the back box
J10101 033251171C..... £73.25
- 23 Exhaust Mount Rubber All Diesel 1981 to 1992**
Sold as singles two required per vehicle.
J10887 033251393..... £4.90
- 24 Down Pipe to Manifold Gasket 1600cc Diesel 1982 to 1992**
Not suitable for turbo diesel.
J10812 811253115A..... £1.45
- 25 Manifold Gasket All Turbo Diesel 1982 to 1992**
J10813 893253115..... £3.50
- Exhaust Manifold Gasket 1600, 1700cc Diesel**
Fits all diesel engines 1981 to 1992
J12308 028129589B..... £0.95
- 26 Tail Pipe Gasket 1600cc Turbo Diesel 1981 to 1992**
This fits turbo diesel vans only.
J13464 068251235A..... £1.30
- Sealing Ring For Joining Pipe 1700cc Diesel 1979 to 1992**
J18350 253415002..... £4.50

Bundle kit

Exhaust Fitting Kit 1900, 2100cc Watercooled 1985 to 1992

Kit of gaskets, exhaust rings nuts and bolts to fit exhaust.

J11749..... £29.75



Stainless Steel Full Exhaust Kit 1900, 2100cc Watercooled

Fits 1985 to 1992 sold with a lifetime warranty

J41207..... £503.00

lifetime warranty!*



*See website for details.

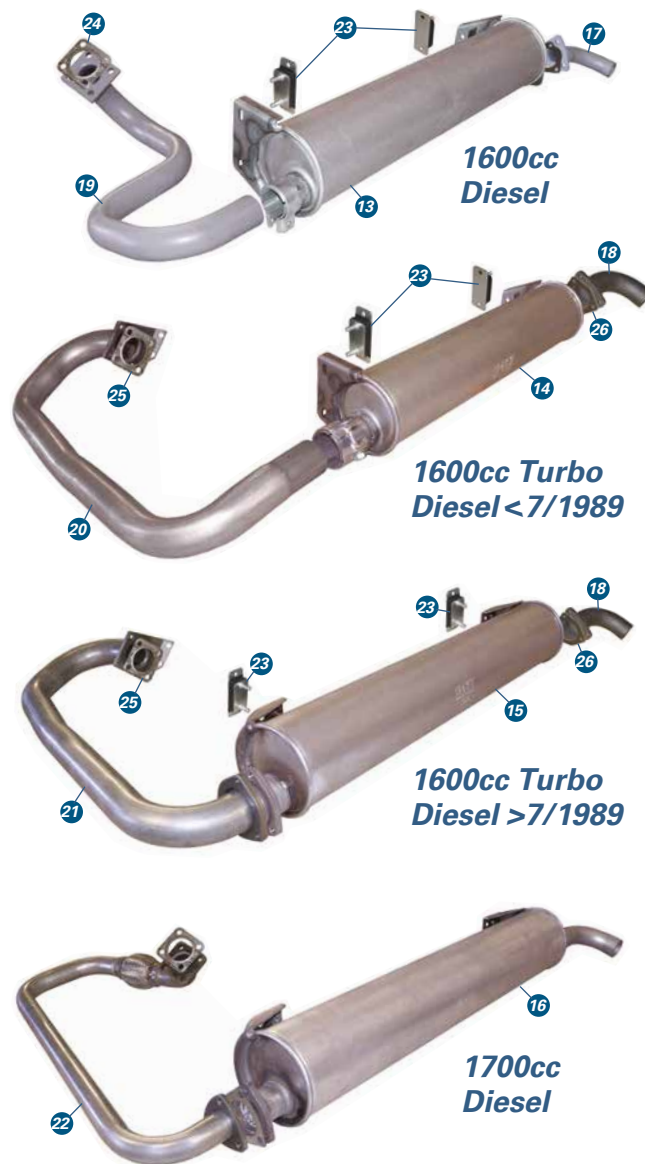

Product Key:



Exclusive to Just Kampers



Made in the UK

GENUINE
PARTS & ACCESSORIES

Genuine VW part



Oversized charges apply to non-mainland UK deliveries















Heater Tubes & Ducting

- 
Heater Control Pod (Offside) 2000cc 1979 to 1983
 Offside control pod directs the hot air forward to the cab
 J10111 071256206A..... £61.75
- 
Heater Control Pod (Nearside) for 2000cc 1979 to 1983
 Nearside control pod directs the hot air forward to the cab
 J10110 071256205A..... £61.75
- 
Heat Transfer Pod (Offside) 1600cc Aircooled 1979 to 1983
 Fits to the offside and connects to the exhaust transfer pipes.
 J10340 070251152..... £90.50

Heater Cables & Controls

- 
Heater Cable (Offside/Right) Left Hand Drive 1979 to 1983
 4205mm in length fits the righthand (offside) on 2000cc
 J11086 251711630A..... £27.00
- 
Heater Cable (Nearside) 2000cc 1979 to 1983
 Fits nearside all righthand drive 2000cc from 1979 to 1983.
 J10239 252711629..... **GENUINE** £32.00
- 
Heater Cable (Offside) 2000cc Aircooled 1979 to 1983
 Fits offside all 2000cc aircooled, righthand drive
 J10246 252711630..... £26.75
- 
Heater Cable (Offside) 1600cc 1979 to 1982
 Fits all 1600cc aircooled, righthand drive offside
 J10247 252711630A..... £27.00
- 
Heater Cable Boot Aircooled Models
 Helps prevent dirt and dust getting into the heater tubes
 J10970 211711633..... **JK** £4.45
- 
Heater Control Lever 1979 to 1992
 Sold as singles you will need 4 in total.
 J11163 251259371C..... **GENUINE** £4.50

Fuel Tanks, Filters & Hoses

- 
Filler Cap Retaining Ring VW T25 1979-1992
 3 hole fixing plate that holds the fuel filler neck at the cap end
 J20291 251201131..... **Call For Availability**
- 
VW Type 25 Fuel Injection Pipe Set for Turbo Diesel JX
 A complete set of Fuel injection pipes with ends to fit VW T25s with the 1600cc Turbo Diesel 1600cc JX engine built from 1984 to 1992.
 J31543 068198300A..... £61.25
- 5mm Fuel Hose (Per metre) and Clips**
 This product is a flexible, black hose suitable for leaded and unleaded petrol.
 J39806 £7.75
- 
Heater Cable VW T25 Left Hand Drive Diesel 1981-1984 1900, 2100cc Petrol 1983-1992
 This heater control cable fits all Left Hand Drive VW T25 Diesel engines from 1981 to 1984. This cable also fits the 1900 and 2100cc including Syncro models from 1983 to 1992.
 J39082 251265473A..... £6.25
- 
1 Locking Petrol Cap 1979 to 1992
 Supplied with two keys. Fits all except syncros
 J10335 251201551C..... £21.75
- 
2 Fuel Filler Neck Surround 1979 to 1992
 located on the front arch all except Syncro models
 J11027 251201117 01C..... **GENUINE** £9.75
- 
3 Fuel Filler Neck 1979 to 1992
 Used on all models except Syncros
 J11024 251201119D..... **JK** £14.50
- 
4 Gasket Ring (Behind Fuel Filler Neck) 1979 to 1992
 Holds the fuel filler neck in place (except Syncro models)
 J11513 251201197..... £4.65
- 
5 Sealing Pipe 1985 to 1992
 OEM sealing pipe fuel filler pipe to the breather pipe.
 J10760 211611833D..... **GENUINE** £2.45
- Fuel Tank Breather Pipe 1979 to 1992**
 Fits all models except Syncros.
 J19245 251201147B..... £29.75
- 
6 Fuel Tank Sending Unit 1979 to 1987
 lever-arm unit, from world-class manufacturer VDO
 J10192 251919051E..... £42.75
- 
6 Fuel Tank Sending Unit 1987 to 1992
 lever-arm unit, from world-class manufacturer VDO
 J10193 251919051K..... £32.75
- 
7 Fuel Tank Sender Seal 1979 to 1992
 Fits all models.
 J11046 113919131A..... **GENUINE** £3.95
- 
8 40mm Fuel Neck Seal 1985 to 1992
 Fuel neck seal which seals the filler neck to the fuel tank.
 J10758 251201139A..... **GENUINE** £10.00
- 
5mm Fuel Hose 1979 to 1992
 5mm inner diameter sold by the metre
 J10583 N0203551..... £3.75
- 
7mm Fuel Hose
 7mm x 2.5mm Sold by the metre,
 J11668 N203571..... £2.90
- 
Fuel Hose Clip 10mm (For 5mm Hose) Pack of 6)
 J12965 N0245223..... £5.00



Fuel Tank And Filler Neck

Product Key:



Exclusive to Just Kampers



Made in the UK



Genuine VW part



Oversized charges apply to non-mainland UK deliveries

Fuel Tanks, Filters & Hoses

-  Fuel Hose Clip 13mm (For 7mm Fuel Hose) Pack of 6
 J12966 311133343A.....£7.00
-  Fuel Hose Clips
 1/4" & 5/16" Pack of 4
 J13375 9224.....£2.15
-  Brass Fuel T Fitting 5/16"
 This 5/16" Barbed brass fuel tee
 J19355£10.25

Brand New Fuel Tanks

Fuel Tank (48mm Filler) 1985 to 1992

Fits all models except petrol injection.

J10756.....£86.25



Fuel Tank (48mm Neck Size) Petrol Injection Models Only

Fits injection models from 1985 to 1992 except syncro.

J12744.....£123.50



Fuel Tank (68mm Filler) 1985 to 1992

This tank fits all diesel and carburetor petrol models.

J19275.....£85.25



Type 25

1979-92

Inner Sill 1979-1992



EXCLUSIVE

Made in the UK exclusively for Just Kampers these inner sills fits all VW T25 transporters from 1979 to 1992. Available for nearside (left) and offside (right)

Right - J11408 **£193.75**

Right - J11407

Lower Front Panel 1983-1992

Lower section of the front panel. Fits VW T25s from 1983 to 1992. Made in the UK exclusively for JK. 13 cms tall.

J14622 **£79.75**



EXCLUSIVE

B Post Repair 1979 to 1992

Hand made in the UK exclusively for JK using the correct gauge mild steel. Fits all VW T25s from 1979 to 1992. 11" (28 cms) tall.

Right - J18789 **£36.75**

Left - J18790



EXCLUSIVE

Over 400 product lines in stock
FREE Mainland Delivery
 on orders over £35

Call us on 0845 1204711

Interiors - Gas Heating



Propex Heatsource Bundle Kit

Features and benefits

- ✓ Easy to install.
- ✓ Solid state electronic thermostat.
- ✓ Quiet in operation.
- ✓ Choice of propane, butane or LPG power.
- ✓ Room sealed for safety.
- ✓ Minimal drain on battery.
- ✓ Reduces interior condensation.
- ✓ Extremely low maintenance.



Adjustable thermostat



Adjustable air vents



J19842

£495.00



FREE

SAVE 15%

With the JK Propex kit Part No. J19842

- ✓ Gas hose (2m length)
- ✓ Gas bottle holder (7kg gas bottle)
- ✓ Butane regulator
- ✓ Magnetic gas level indicator



For over 20 years the Propex name has been synonymous with quality air heating and water heating products. From the early days of heaters designed for the leisure market and with their new Heatsource range, they now supply some of the most advanced gas heaters available today for a variety of applications from motor-homes and caravans to marine craft and horseboxes.

Propex heaters run on clean burning Propane gas or Butane gas so are entirely independent from the engine fuel supply, they produce less pollutants and are cheaper to run than diesel heaters.

All heatsource blown air heaters conform to the latest European Standards for gas fired heaters where focus is very much on safety. All Propex blown air heaters and water heaters incorporate leading edge electronics that are constantly monitoring all operations of the water or air heaters to ensure maximum efficiency.

Propex Gas Heatsource HS 2000E 240 Volt



The HS2800 heaters are automatic thermostatically controlled blown air heating systems fuelled by propane or butane gas. The HS2800 with its greater heat output of 2.8kW and twin outlet is the big brother to the smaller output, single outlet HS2000.

J27697..... £589.00

Propex Gas Heatsource HS 2000E 240 Volt



The Propex HS 2000E heater gives you the option of using mains hook-up to provide selectable 500W, 1kW or 2kW of heat output.

Dimensions : Length: 320 mm, Width: 172 mm, Height: 100 mm
Fuel: Propane or Butane gas

J20285 £715.00

Control Unit for the Propex Heatsource



These units are for the Heatsource range post February 2010 and NOT the older Heatsource, Compact 1600 or X1 heaters.
INCLUDED FREE IN KIT: J19842

J20028 £45.00

Propex Gas Heatsource HS 2000 12 Volt



The Propex HeatSource HS2000 is a highly efficient, compact, interior heating system that is specifically engineered for touring vehicles and motor homes.

Box dimensions 31.5cm x 16.5cm x 9.5cm (excluding outlets)

Fuel: Butane, Propane Gas or LPG

J18073 £480.00

Diesel Heating

How an Eberspächer AIRTRONIC Air Heater Works:

As soon as the heater receives its starting pulse, the following processes are triggered by the central control unit:

- Automatic safety check.
- The burner motor starts, the combustion space is pre-ventilated, the glow plug is warmed up, the metering pump conveys fuel.
- The glow plug ignites the fuel-air mixture, the flame is formed.
- The hot combustion gases flow through the heat exchanger.
- The hot air fan draws in room air or fresh air.
- The heat of the combustion gases is transferred by the heat exchanger to this hot air.

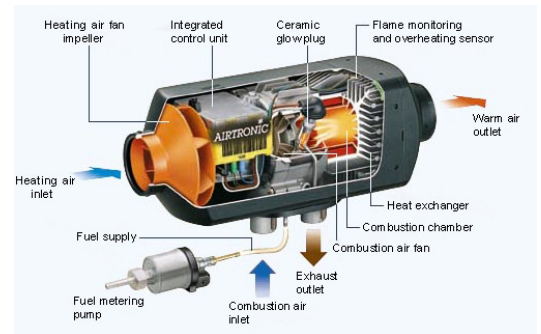

Eberspächer Standard D2/801 Manual Airtronic 2 12V Diesel Universal Kit

Airtronic D2 Diesel Heater Kit with 801 Modulator comes complete with everything needed to fit the unit into a T25. The Eberspächer Airtronic D2 is a compact and economical diesel powered heater offering optimised fuel efficiency, a range of operation modes and unsurpassed safety standards.

This unit features a 801 Series modulator and is perfect for all diesel T25 Transporters. (Diesel models)



J31241.....£749.00

Eberspächer Standard D2/701 Programmable Airtronic 2 12V Diesel Universal Kit

Airtronic D2 12v Externally Mounted Diesel Heater Kit for the T25. Complete with 801 Series Modulator. The compact and economical Airtronic D2 Diesel powered heater offers optimised fuel efficiency, a range of operation modes and unsurpassed safety standards.

This unit features a 801 Series modulator and is perfect for all T25s. Transporters with Diesel engines.



J39816£849.00

Eberspächer Airtronic D2/801 internal heater kit for VW T25 Diesel

Eberspächer Airtronic D2 12v internally mounted Diesel Heater Kit for the T25.

This unit features a 7 day programmable 701 Series timer and is perfect for all T25 Transporters with Diesel engines.



J39817 [Call For Availability](#)

Eberspächer Airtronic D2/701 Internal Programmable Heater kit VW T25 Diesel

Eberspächer Airtronic D2 12v internally mounted Diesel Heater Kit for the VW T25. Complete with 7 Day programmable 701 series timer.

This unit features a 7 day programmable 701 Series timer and is perfect for all Type 25 Transporters with Diesel engines.



J39818£895.00

Eberspächer Airtronic Diesel Heater Fuel Pick Up Kit VW T25

Fuel Pick Up Kit for Airtronic Diesel Heater Kits



J27630.....£38.00



Lobro CV Joint 1979 to 1992

OE Quality CV Joint manufactured by LOBRO. Sold as singles this fit inner or outer either side

J39684 211501331B.....

Call For Availability

CV Joint Bolt (Pack of 6) VW Beetle 1968 VW T2 Bay 1967-1979 VW T25 1979-1992

CV Joint Bolt, pack of 6.

J40138

Call For Availability



Set of 4 CV Boots with Fitting Kits VW T2 Bay 1967-1979 VW T25 1979-1992

Split or perished boots? You'll find everything you need to replace them in our best quality, German-made CV boot kit.

J40229 251598201.....

£24.50



Gear Stick Refurbishment Kit 1982 to 1992

This Kit contains all the components to refurb your gear stick. Fits all 4 and 5 speed models.

J16965 251798116A.....

£41.00

Gear Linkage Cap VW 5 Speed 1984-1992

This cap retains the gear pivot pin in place.

J39572 251711242A.....

£3.25

Gear Linkage Boot 5 Speed 1983-1992

This Genuine Volkswagen gear linkage boot fits at the base of the gear stick

J39573 251711248A.....

£16.75

Morris Lodexol EP90 Gearbox Oil (1ltr)

Morris Lodexol EP90 Gearbox Oil (1ltr)

J40227

£8.50



Selector Lever (Petrol Models Only) 1979 to 1992

Selector lever. Fits all Petrol models with manual gearboxes.

J10902 251711973.....

£31.25



Selector Lever 1979 to 1992

Genuine Volkswagen selector lever for diesel with manual gearbox

J10903 251711973A.....

£40.50



Drive Flange Seal for Manual Gearbox

Sold as singles you will require two of these per gearbox.

J31217 91301189.....

£3.15

**SAVE
10%**

Bundle kit

Gear Linkage Bush Repair Kit VW T25 Diesel 1979-1992

This gear linkage repair kit contains the majority of parts you will need to refurb the linkage on T25 Diesel vans and pick ups from 1979 to 1992. This kit consists of the following:

2 x Gear linkage bush

A sloppy gear change on your VW T25, 1979-1992, could be due to worn gear linkage bushes.

J10893

1 x Selector shaft

Genuine Volkswagen quality selector shaft joint is used on all 4-speed VW T25 gear linkages with manual gearboxes.

J10894

2 x Circlips

This Genuine Volkswagen circlip performs 2 different functions on 2 different vehicles.

J10897

1 x Universal joint

The universal joint on the gear linkage of your T25, from 1979 to 1992, may be worn and cause play in the gear linkage

J10896

2 x Jubilee clips

This Genuine Volkswagen jubilee clip for the gear linkage fits all VW T25 models with a manual gearbox and holds the shift rod bellows in place.

J10898

1 x Support plate

This Genuine Volkswagen quality support plate for the gear linkage fits all VW T25 models with manual gearboxes, from 1979 to 1992

J10905

1 x Gearshift joint

This gearshift joint fits all VW T25 models with manual gearboxes, from 1979 to 1992

J10904

2 x Bellows

This Genuine Volkswagen bellows for the shift rod fit all VW T25 vans with manual gearboxes, from 1979 to 1992.

J10899

1 x Shift rod boot

This JK Exclusive shift rod boot fits onto the rear gear linkage and helps prevent dirt and dust contaminating the gear rods.

J10890

1 x Bellows

These Genuine Volkswagen shiftrod bellows fit all VW T25s with manual gearboxes from 1982 to 1992.

J10901

1 x Selector lever

This Genuine Volkswagen selector lever fits all VW T25 diesels with manual gearbox from 1979 to 1992,

J10903



J90063

Call For Availability

Recon'd Gearboxes & Rebuild Parts

- 

4 Speed Gearbox 1600cc Aircooled 1979 to 1982
J19299   **Call For Availability**
- 

Vege 4 Speed Gearbox 2000cc 1979 to 1983
 A exchange reconditioned gearbox.
J16947   **Call For Availability**
- 

4 Speed Gearbox 2000cc Aircooled 1979 to 1984
 An exchange reconditioned gearbox.
J15162 091300043GX   **Call For Availability**
- 

4 Speed Gearbox 1600cc Diesel 1979 to 1992
 An exchange reconditioned gearbox.
J15149 091300044KX   **Call For Availability**
- 

Vege 4 Speed Gearbox 1600 & 1700cc Diesel
 Exchange reconditioned gearbox for diesel models.
J16950   **Call For Availability**
- 

Vege 5 Speed Gearbox 1600 & 1700cc Diesel
 Exchange reconditioned gearbox for diesel models.
J16951 094300043FX   **Call For Availability**
- 

4 Speed Gearbox 1700cc Diesel 1979 to 1992
 A exchange reconditioned gearbox.
J19296 091300047JX   **Call For Availability**
- 



5 Speed Gearbox 1600cc Turbo Diesel 1979 to 1992
 We require your existing gearbox for rebuilding.
J15336   **Call For Availability**
- 

4 Speed Gearbox 1600cc Turbo Diesel 1979 to 1992
 A exchange reconditioned gearbox.
J19297 091300044NX   **Call For Availability**
- 

4 Speed Gearbox 1900cc 1984 to 1992
 An exchange reconditioned gearbox.
J15146 091300044CX   **Call For Availability**
- 

5 Speed Gearbox 1900cc 1984 to 1992
 We require your existing gearbox for rebuilding.
J15147 094300043KX   **Call For Availability**

- 

Vege 4 Speed Gearbox 1900 & 2100cc
 Exchange reconditioned gearbox for watercooled models.
J16948   **Call For Availability**
- 



Autobox Sump Gasket 1979 to 1992
 OEM quality part.
J11193 010321371B **GENUINE** **£21.75**
- 

Gearbox Gasket 4 Speed
 This is the intermediate gasket for all 4 speed gearboxes.
J19778 091301191 **£1.45**
- 

Gearbox O' Ring 1979 to 1992
 A OE quality manual gearbox 'O' Ring
J11257 010409549B **GENUINE** **£5.75**
- 

Main Shaft Seal for Gearbox 1979 to 1992
J10300 113311133A **£2.25**
- 

Selector Shaft Seal for Manual Gearbox 1979 to 1992
 OEM quality product.
J10841 020301227F **GENUINE** **£9.25**
- 

Shift Rod Boot 1979 to 1982
 Helps prevent dirt and dust contaminating the gear rods.
J10890 251711167A  **£5.25**
- 

Shift Rod Boot 1979 to 1992
 keeps dirt and grit from contaminating your gear linkage.
J11228 020301261A **GENUINE** **£3.70**
- 

Bellows for Selector 1982 to 1992
 OEM quality shiftrod located on the side of the gearbox
J10901 251711167E **GENUINE** **£5.00**
- 

Gearstick Bush
 OEM bushes sold singly you will need two to complete the job.
J10891 171711166 **GENUINE** **£1.65**

Staff Vehicles Q&A...

Alex,
Technical Sales Advisor
 1987 T25 Ex German Feuerwehr

Ex German Feuerwehr (Fire vehicle) From Weinheim. Sirens and blue light still work.

Interior replaced with a Westfalia multivan interior (Full width bed)

2100cc DJ petrol engine and 5 speed gearbox

Stainless steel exhaust Lowered 60mm and running 17 inch Brm wheels

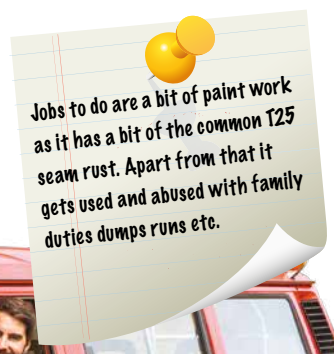

 Alex's VW T25 'Firebus'!

Drive Shaft & CV Joint

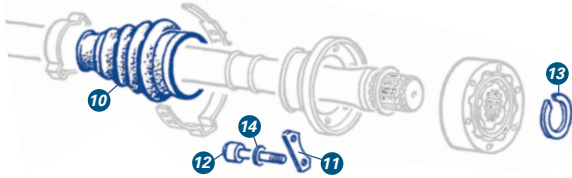

- 1 Support Plate for Gear Linkage 1979 TO 1992**
OEM quality support plate for the gear linkage
J10905 251711187B..... **GENUINE** £10.50
- 2 Shift Bracket 1979 to 1982**
OEM shift bracket is located on the lefhand of the gearbox.
J11701 251711219..... **Call For Availability**
- 3 Gearshift Joint 1979 TO 1992**
OEM quality gearshift joint.
J10904 251711221F..... **GENUINE** £9.75
- 4 Gear Linkage Bush 1979 to 1992**
Sold singly, 2 are required per vehicle.
J10893 251711207D..... **GENUINE** £3.35
- 5 Selector Shaft 1979 to 1992**
OEM quality selector shaft joint is used on all 4-speed
J10894 251711575B..... **GENUINE** **Call For Availability**
- 6 Universal Joint (on Gear Linkage) 1979 to 1992**
OEM quality. You may also need J10895 and J10897 when fitting.
J10896 251711551..... **GENUINE** £3.10
- 7 Circlip for Gear Linkage Pin 1979 to 1992**
OEM circlip for the gear linkage to secure the link pin
J10897 N0124362..... **GENUINE** £0.45
- 8 Jubilee Clip (for Gear Linkage) 1979 to 1992**
OEM quality jubilee clip holds the shift rod bellows in place.
J10898 N90561801..... **GENUINE** £1.95
- Gear Selector Bush 1985 to 1992**
OEM gear selector bush
J10900 251711207E..... £3.10
- Guide Ring For Shift Rod 1979 to 1985**
Mounted onto the shift rod guide pin on the side of the gearbox
J10971 251711227..... **GENUINE** £1.50
- Reverse Light Switch 1988 to 1992**
Reverse Light switch. Fits all T25 vans from 1988 onwards.
J11065 085941521..... **GENUINE** £7.75
- Gearbox Starter Motor Bush 1979 to 1992**
Should always be replaced when changing your starter motor.
J11137 113301155..... £0.70
- Reverse Light Switch 1981 to 1987**
Fits to the side of the gearbox.
J11234 020941521A..... £6.25

CV Joints & Boot Kits

- Constant Velocity Joint Kit 1979 to 1992**
kit comprises of CV joint, boot, 6 bolts, grease and clips.
J10276 211598101..... £49.75
- Outer Front CV Joint Syncro Models**
This CV kit is supplied with grease, boot, clips and nut.
J19806 251498099A..... £45.00
- 9 CV Boot and Fitting Kit 1979 to 1992**
German-made CV boot kit 2 required per shaft
J10069 251598201..... £6.25

Bundle kit

CV Joints Bundle Kit

Kit contains 4 joints, 4 boots, 24 bolts, grease and clips.

J11223..... £179.00

SAVE 10%



- 10 CV Boot (Inner or Outer) 1979 to 1992**
Fits either inner or outer joints
J10278 211501149..... **Call For Availability**
- 11 CV Boot Flange Plate 1979 to 1992**
Sold singly, but you will require 3 per joint.
J10988 1J0407357A..... £1.15
- 12 CV Joint Bolt 1979 to 1992**
You'll need six bolts per CV joint.
J10592 113501229D..... £1.15
- 13 CV Circlip 1979 to 1992**
Prevents the CV moving beyond its specified range of travel.
J10667 113517279..... **GENUINE** £1.95
- 14 CV Bolt Washer 1979 to 1992**
Helps prevent the CV bolt working loose, sold as singles.
J11247 N0153711..... **GENUINE** £1.45
- Cover For Final Drive Flange**
These covers fit either side on the gearbox output flange.
J19813 002517289A..... £3.05

Gear Levers & Linkage Parts

- 15 Billet Aluminium Gear Knob**
A OE style gearknob in billet aluminium.
J17002..... **GENUINE** £23.00
- 16 Gear Shift Lever LHD 1979 to 1992**
Fits all LHD 4 speed gearboxes.
J19830 251711121E..... £15.00
- Gearstick Bush**
OEM bushes sold singly you will need two to complete the job.
J10891 171711166..... **GENUINE** £1.65
- Plastic Frame For Gear Stick Boot**
Fits all T25 models with manual gear box.
J13903 253711120..... £5.50
- 5 Selector Shaft 1979 to 1992**
OEM quality selector shaft joint is used on all 4-speed
J10894 251711575B..... **GENUINE** **Call For Availability**
- 3 Gearshift Joint 1979 TO 1992**
OEM quality gearshift joint.
J10904 251711221F..... **GENUINE** £9.75

Morris Gearbox Oil

Lodexol Semi Synthetic 1 Litre

J12807..... £8.50

Morris Liquimatic Automatic Transmission Fluid

Sold in 1 litre bottles

J20009..... £10.75



Gear Stick Extensions

Gear Stick Extension (M12 Threads)

Brings the gearknob approx 12cm (4.5in.) closer to hand.

J13457 **£15.00**

Gear Stick Extension (M14 Threads) 1985 to 1992

Brings the gearknob approx 12cms (4.5in.) closer to hand.

J13458 **£12.50**

Exclusive to JK!



- Shift Rod Boot 1979 to 1992**
keeps dirt and grit from contaminating your gear linkage.
J11228 020301261A..... **£3.70**
- 17 Bellows for Selector 1982 to 1992**
OEM quality shiftrod located on the side of the gearbox
J10901 251711167E..... **£5.00**
- 18 Shift Rod Boot 1979 to 1982**
Helps prevent dirt and dust contaminating the gear rods.
J10890 251711167A..... **£5.25**
- 19 Bellows For Shift Rod 1979 to 1992**
OEM bellows for the shift rod
J10899 251711167F..... **£8.25**

Gearbox Oils & Tools

- Gearbox Sump Plug Socket (17mm)**
This 17mm sump plug socket uses a 3/8in square drive.
J11205 38323..... **£5.25**
- Driveshaft Bolt Splined Hex Tool**
Features an 8mm spline with 3/8 drive
J11237 **£10.25**
- Automatic Gearbox Fluid Filter**
this transmission filter fits all Automatic T25s
J19848 010325421A..... **£4.65**

- 2 Shift Bracket 1979 to 1982**
OEM shift bracket is located on the lefhand of the gearbox.
J11701 251711219..... **Call For Availability**
- 1 Support Plate for Gear Linkage 1979 TO 1992**
OEM quality support plate for the gear linkage
J10905 251711187B..... **£10.50**
- 4 Gear Linkage Bush 1979 to 1992**
Sold singly, 2 are required per vehicle.
J10893 251711207D..... **£3.35**
- 6 Universal Joint (on Gear Linkage) 1979 to 1992**
OEM quality. You may also need J10895 and J10897 when fitting.
J10896 251711551..... **£3.10**
- 7 Circlip for Gear Linkage Pin 1979 to 1992**
OEM circlip for the gear linkage to secure the link pin
J10897 N0124362..... **£0.45**
- 8 Jubilee Clip (for Gear Linkage) 1979 to 1992**
OEM quality jubilee clip holds the shift rod bellows in place.
J10898 N90561801..... **£1.95**
- Gear Selector Bush 1985 to 1992**
OEM gear selector bush
J10900 251711207E..... **£3.10**
- Guide Ring For Shift Rod 1979 to 1985**
Mounted onto the shift rod guide pin on the side of the gearbox
J10971 251711227..... **£1.50**
- Plastic Ball For Shift Bracket 1979 to 1992**
Ball for rear shift bracket. Fits all manual gearbox models
J17024 251711221F..... **£27.50**
- Socket Bearing For Gearstick 1979 to 1992**
The lower pivot point for the gearstick.
J19780 823711255..... **£3.50**
- Gearstick Ball Socket 1979 to 1992**
This is the ball socket as used on the base of the gearstick
J19782 823711643A..... **£5.50**
- Hemisphere For Gearstick 1979 to 1992**
Hemispherical shaped pivot found at the base of the gearstick.
J19783 251711645..... **£5.50**

Gear Lever And Linkage Parts

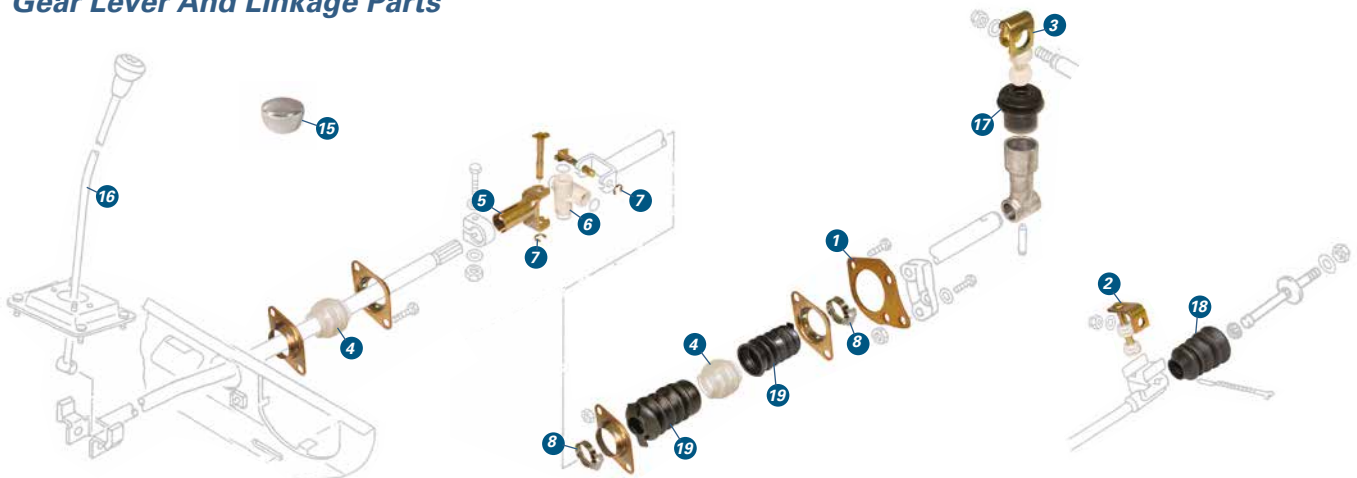

Product Key:



Exclusive to Just Kammers



Made in the UK





GENUINE
PARTS & ACCESSORIES

Genuine VW part





Oversized charges apply to non-mainland UK deliveries

Springs & Lowering Kits

- 
1 45 / 50 mm Sports Lowering Springs 1979 to 1992
 Complete set of 4 springs Made in Germany by H&R.
J19315 **£360.00**
- 
Rear Coil Spring 1979 to 1992 (Except syncro)
 Heavy duty, standard height, rear coil spring
J11099 251511105A..... **£53.25**
- 
T25 Syncro Front Coil Spring 1984 to 1992
 Front coil spring for VW T25 Syncro
J18092 251411105F 952..... **£49.75**
- 
Syncro Rear Coil Spring
 Rear spring for Syncro 4 x 4 only
J18093 251511105E 952..... **£89.00**

Rear Shock Absorbers

- 
Rear Shock Absorber Best Quality Sachs/Boge 1979 to 1990
 Not suitable for Syncro
J12902 251513031G..... **£50.00**
- 
Rear Shock Absorber Sachs Boge For Syncro Models
 Not suitable for 16" Wheel models.
J12938 251513031D..... **£54.75**

Steering Components, Rack & Boots

- 
2 LHD Steering Rack 1979 to 1992
 This manual steering rack fits all left hand drive T25s
J19792 251419061..... **£60.50**
- 
3 Steering Rack Mount 1979 to 1992
 Sold as singles, you will require four per rack.
J10764 251419081..... **£3.90**
- 
Powerflex Steering Rack Mount Bush
 A set of four Powerflex steering rack mounts.
J19264 **Call For Availability**
- 
4 Steering Rack Boot 1979 to 1992
 Fits left or righthand side
J10284 251419831A..... **£7.00**
- 
5 Track Rod for T25 1979 to 1992
 Includes ball joint and nylock nut. Fits nearside or offside.
J10283 251419803..... **£31.00**
- 
6 Track Rod End 1979 to 1992
 Fits either side on all models
J10289 251419811..... **£9.75**
- 
7 Upper Ball Joint (Front Wishbone) 1979 to 1992
 supplied with Nylock nut.
J10297 251407361..... **£15.75**

Front Suspension

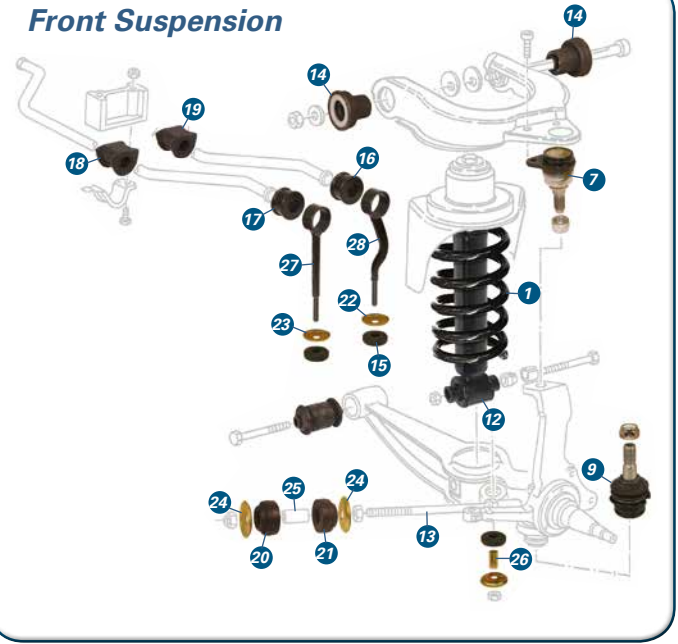

- 
8 Trackrod Nylock Nut (M12x1.5) 1979 to 1992
 These M12x1.5mm nylocks fit all trackrod ends.
J10669 211405389..... **£2.75**
- 
9 Replacement Boot For Lower Ball Joint
 Fits lower ball joints only.
J14211 211405375..... **£6.00**
- 
Steering Column Bush 1979 to 1992
 Please note, you will need two of these to fit your vehicle.
J10271 803419775B..... **GENUINE** **£2.75**
- 
Steering Column Bush 1979 to 1992
 OEM part, It mounts at the base of the steering column
J10763 251419579B..... **GENUINE** **£7.25**
- 
Top Support Ring for Steering Tube 1979 to 1992
J19793 171419341..... **£3.80**
- 
10 Steering Column Coupling 1979 to 1992
 Sold as singles there is three couplings in total.
J10803 251419417B..... **£9.75**
- 
11 Steering Column Clamp for 1979 to 1992
 Secures the steering shaft on the rack.
J10833 291415539..... **GENUINE** **£7.00**
- 
Power Steering Pump Diesel 1980 to 1992
 Fits all Diesel and Turbo Diesel models with power steering.
J19795 251422155A..... **£105.50**

Steering Components

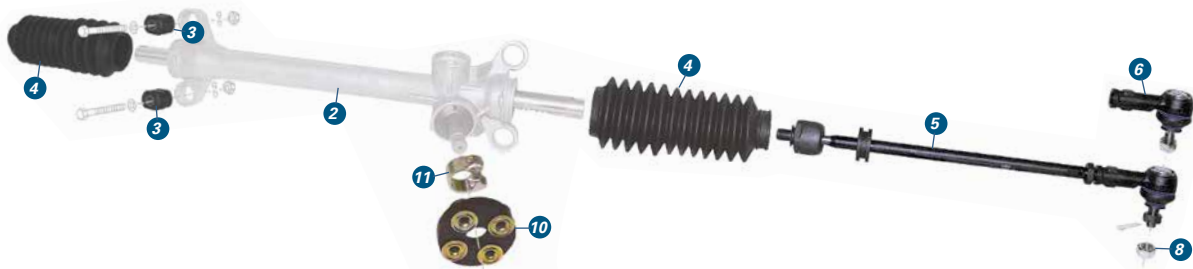

Product Key:



Exclusive to Just Kampers



Made in the UK

GENUINE
PARTS & ACCESSORIES

Genuine VW part



Oversized charges apply to non-mainland UK deliveries



Power Steering Pump Belt 1900, 2100cc 1983 to 1992
J15134 023903137A..... **£3.85**



Track Control Arm Eccentric Washer 1979 to 1992
 located on the top arm and is used to adjust the camber.
J19789 251407133A..... **£4.10**



Damping Ring For Anti Roll Bar June 1979 to July 1985
 JK exclusive and fits the base of the cranked anti-roll bar link
 two per side.
J20281 251411039..... **£3.90**

Front Shock Absorbers



Front Shock Absorber 1979 to 1992
 Fits all models (except 4x4 Syncro).
J10286 251413031J..... **Call For Availability**



Heavy Duty Front Gas Shock Absorber Diesel 1979 to 1992
 Sachs Boge heavy duty shock absorbers for diesel T25
J16687 251413031G..... **Call For Availability**



Heavy Duty Front Oil Shock 1979 to 1990
 Not suitable for Syncro
J11574 251413031G..... **Call For Availability**



Front Shock Absorber Best Quality Sachs / Boge 1979 to 1990
 Not suitable for Syncro
J12901 251413031J..... **£64.75**



Front Sports Shock Absorber
 All models excluding Syncro.
J14715 **Call For Availability**

Anti Roll Bars, Links & Bushes



13 Radius Rod
J18072 251407059A..... **£82.25**



14 Wishbone Bush (Upper) 1979 to 1992
 Two required per side. Held in place with a simple spot weld
J10306 251407077..... **£14.25**



15 Damping Ring 1979 to 1985
 Fits the base of the cranked anti-roll bar link, two per side.
J10765 411513121..... **£2.45**



16 Anti-Roll Bar Bush (21mm) 1979 to 1985
 This 21mm top bush fits the cranked anti-roll bar link.
J10766 251411045..... **£2.95**



17 Anti-Roll Bar Bush (23mm) 1985 to 1992
 23mm top bush fits to the straight link on the anti-roll bar.
J10767 251411045A..... **£5.00**



18 Anti-Roll Bar Mounts (20mm) 1985 to 1992
 20mm anti-roll bar mounting Sold singly, two required.
J10936 251411041C..... **£6.75**



19 Anti Roll Bar Mounts (20mm) 1979 to 1985
 These mounts are for the Anti roll bar with cranked links.
J14172 251411041..... **£6.50**



20 Inner Tie-Rod Mount 1979 to 1992
 Sold individually, you will need two per van.
J10770 251407175..... **£5.75**



21 Outer Tie-Rod Mount Bush 1979 to 1992
 Sold individually, you will require two per van.
J10846 251407179..... **£4.70**



22 Washer Plate for Cranked Link 1979 to 1985
 Sold individually, you will need two for each side of your Van.
J10768 251411043..... **£4.50**



23 Anti-Roll Bar Washer Plate 1985 to 1992
 OEM quality sold singly, you will require 4 per vehicle.
J10922 171512337..... **£4.65**



24 Tie-Road Mounting Seat 1979 to 1992
 You will need two of these tie-rod mounting seats per side
J10769 251407069..... **£4.95**



25 Track Control Arm Spacer Sleeve 1979 to 1992
 Used between the two bushes on the lower track control arm.
J19788 251407097..... **£4.05**



26 Spacer Sleeve for Anti-Roll Bar Link 1979 TO 1992
 Sold as singles, 2 required per vehicle.
J10935 251411047..... **£2.95**



27 Straight Anti-Roll Bar Link 1985 to 1992
 All models except Syncro.
J10802 251411051A..... **£23.00**



28 Cranked Anti-Roll Bar Link 1979 to 1985
 Fits either side.
J11420 251411051..... **£32.75**

New Braking System Products



Front Brake Disc Backing Plate Syncro 16" 1985-1992
 Fits 16" Syncros Nearside (Left)
J31156 251407343D..... **Call For Availability**



Front Brake Disc Backing Plate Syncro 16" 1985-1992
 Fits 16" Syncros Offside (Right)
J31157 251407344A..... **Call For Availability**



Front Brake kit VW T25 1979-1986
 2 brake discs with bearing kits, a pair of flexi hoses with clips, a set
 of pads with fitting kit.
J39638 **£144.00**



Front Brake Kit 1986-1992
 Two brake discs with the bearing kits to fit, a pair of flexi hoses &
 clips and a set of pads.
J39639 **£161.25**



T25 Syncro 16" Rear Brake Wheel Cylinder
 23.81mm rear wheel cylinder for 16" T25 Syncro Brakes
J31068 251611047..... **£18.50**



T25 Syncro 16" Rear Brake Shoe Kit
 270x65x7 Brake Shoe set for 16" T25 Syncro
J31095 291698527GX..... **£55.00**



Rear Brake Kit 1979-1992
 Consisting of, rear shoes, rear drums, wheel cylinders, brake flexi
 hoses and rear shoe fit kit.
J39640 **£151.25**



ATE Front Brake Caliper Nearside (Left) 1986-1992
 These are the late style single piston callipers that use the crescent
 shape brake pads.
J39417 251615123C..... **£103.25**



ATE Front Brake Caliper Offside (Right) 1986-1992
 These are the late style single piston callipers that use the crescent
 shape brake pads.
J39418 251615124C..... **£103.25**

Caliper Rebuild Kit VW T25 1986 On
 Includes all the seals for rebuilding 1 single piston caliper

J40247 **£19.50**



Wheels Balance Bar to Rear Brakes
 Hand Brake Cable Type 25 Syncro (Right) 14" Wheels Balance Bar
 to Rear Brakes
J21409 251609702..... **£26.00**

Front Wheel Bearing Kit 1979 to 1984 Except Syncro

Comprises the inner and outer bearings, hubseal and lock nut.

J11501 £22.25



Powerflex 21mm Anti Roll Bar Link Bush

A pair of Powerflex 21mm anti roll bar link bushes.

J19270 251411045

Call For Availability

Powerflex 23mm Anti Roll Bar Link Bush

A pair of Powerflex 23mm anti roll bar link bushes.

J19271 251411045

Call For Availability

Ball Joints

Upper Ball Joint (Front Wishbone) 1979 to 1992

supplied with Nylock nut.

J10297 251407361 £15.75

Lower Ball Joint Wishbone 1979 to 1992

Lower ball joint fits either side.

J10299 251407187 £18.75

Trackrod Nylock Nut (M12x1.5) 1979 to 1992

These M12x1.5mm nylocks fit all trackrod ends.

J10669 211405389 £2.75

Replacement Boot For Lower Ball Joint

Fits lower ball joints only.

J14211 211405375 £6.00

Wheel Bearings & Seals

Front Hub Seal 1979 to 1992

Fits all T25s 1979 to 1992 except Syncro 4x4 models.

J10293 281407641C £2.25

Front Hub Nut 1979 to 1992

Fits all T25s 1972 to 1992 except Syncro 4x4 models.

J10294 251407671 £1.90

Front Wheel Bearing Kit 1984 to 1992 Except Syncro

Comprises of inner and outer bearings, hubseal and lock nut.

J11502 £25.25

Front Wheel Bearing Kit Syncro 1985 to 1992

Kit comprises a bearing, hubseal, circlip and locknut.

J11571 251407625

Call For Availability

Brake Discs, Backing Plates & Fittings

1 Brake Disc 1979 to 1992

These fit early T25s up to June 1986 (except 4x4 Syncros).

J10291 251407617A £38.75

2 Brake Disc 1986 to 1992

These fit all T25s from 1986 (except 4x4 Syncros).

J10292 251407617K £37.50

Front Brake Disc Syncro (14" Wheel)

Fits T25 Syncro models with 14 inch wheels from 1986 onwards.

J11249 251407615Q £28.50

Front Brake Disc Dust Shield 1979 to 1985

Sold as singles, fits either side.

J13460 291407343 £11.25

Front Brake Disc Dust Shield (Nearside/Left) 1985 to 1990

Fits all vehicles with late style callipers.

J13461 251407339A £9.75

Front Brake Disc Dust Shield (Offside/Right) 1985 to 1992

Fits all vehicles with late style callipers.

J13462 251407340A £9.75

Prices include VAT



Brake Caliper Nearside (Left) 1979 to 1985

Sold on an exchange basis.

J11715 251615107X £101.75



3 Brake Caliper Offside (Right) 1979 to 1985

Sold on an exchange basis.

J11716 251615108X £101.75



Front Brake Caliper (Nearside) 1986 to 1992

Takes crescent shape pads.

J10255 251615123D £107.75



4 Front Brake Caliper (Offside) 1986 to 1992

Takes crescent shape pads.

J10256 251615124D £107.75



5 Caliper Rebuild Kit 1979 TO 1985

Comprises: 2 piston seals, 2 dust seals and retaining springs.

J10810 251698471 £21.25



6 Caliper Rebuild Bridge Seal Large

13 x 8 x 2 mm

J13094 251698471 £2.00



7 Upper Caliper Bolt (M14x1.5x34) 1979 to 1986

OEMt quality upper caliper bolt (M14x1.5x34)

J11269 211615141A GENUINE £5.75



8 Lower Caliper Bolt (M14x1.5x37) 1979 to 1986

OEM quality, lower caliper bolt (M14x1.5x37)

J11270 211615143A GENUINE £3.95



9 Bleed Nipple (For Caliper)

Bleed nipple for hydraulic brakes, uses 7mm spanner.

J10853 311615273 £1.90



10 Dust Cap for Bleed Nipple

Fits front or rear bleed nipples.

J10854 211611483 GENUINE £0.90



11 Brake Pads (Set of 4) 1979 to 1986

Square-shaped brake pad sets fits 1979-1986

J10066 251698151D £16.75

Disc Brake 1979 to 1986

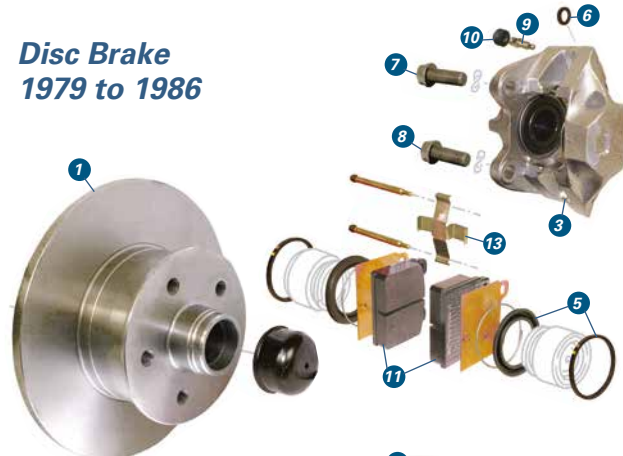

Disc Brake 1986 onwards

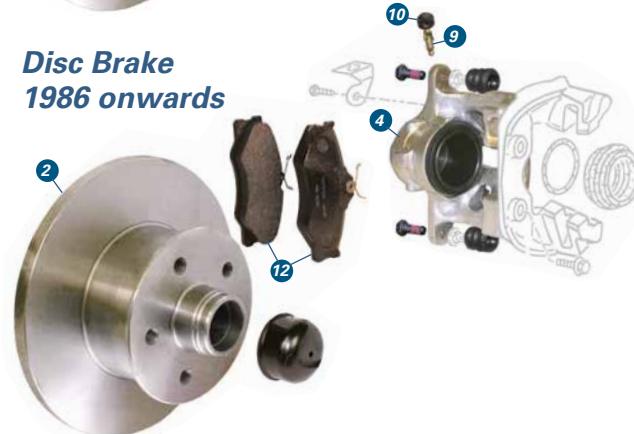

- 12 Brake Pads (Set of Four) 1986 to 1992**
These crescent-shaped brake pads are sold in sets of four
J10249 251698151F..... **£27.75**
- 13 Brake Pad Fitting Kit All Vehicles 1979 to 1985**
All T25s from 1979–1985 which have square-shaped brake pads.
J10493 211698455B..... **£8.25**
- Brake Pad Fitting Kit & Anti Rattle Plates 1979 to 1985**
Complete Brake pad fitting kit
J16974 211698911B..... **£17.75**
- Front Brake Hose 1979 to 1986**
This flexible brake hose has female fittings at both ends,
J10253 251611775A..... **£3.85**
- Front Hub Nut 1979 to 1992**
Fits all T25s 1972 to 1992 except Syncro 4x4 models.
J10294 251407671..... **£1.90**

Drums, Cylinders & Backing Plates

- 14 Rear Brake Drum 1979 to 1992**
These Febi drums are made in Europe by the original supplier
J10264 251609615..... **£40.75**
- 15 Rear Brake Backplate (Nearside/Left) 1975 to 1992**
OEM quality, rear brake backplate
J10822 251609425D..... **£49.75**
- Rear Brake Backplate (Offside/Right) 1979 to 1992**
OEM quality, rear brake backplate
J10823 251609426D..... **£49.75**
- 16 Brake Back-Plate Bung 1979 to 1992**
Fits rear brake backing plates
J10528 211609163..... **£1.15**
- 17 Rear wheel Cylinder 1979 to 1992**
Febi, wheel cylinder. Supplied with bleed nipple and dustcap.
J10148 211611047F..... **£10.25**
- 18 Rear Brake Shoes (Set of 4) 1979 to 1992**
Specifically made for the T25 and sold as a set of four
J10572 251698531LX..... **£32.75**
- 19 Rear Brake Shoes Fitting Kit 1979 to 1992**
The retaining pins with this kit are 41mm long.
J11132 251698545..... **£12.00**
- 20 Rear Brake Adjuster (Nearside/Left) 1979 to 1992**
OEM quality rear brake adjuster
J10820 281609801B..... **£19.75**
- Rear Brake Adjuster (Offside/Right) 1979 to 1992**
OEM quality rear brake adjuster
J10931 281609802B..... **£19.75**
- Brake Shoe Mount 1979 to 1992**
Sold as singles two parts are required for each side.
J10821 251609209..... **£11.25**

- 21 Rear Brake Shoe Retaining Pin 1979 to 1992**
45mm rear brake shoe retaining pin.
J10828 251609279..... **£1.45**
- 22 Retaining Pin For Handbrake Lever 1979 to 1992**
Used to retain the handbrake arm in place.
J10530 211609601B..... **£1.45**
- 23 Handbrake Cable 1979 to 1992**
Connects the balance bar to the rear brakes
J10268 251609701C..... **£8.50**
- 24 Bleed Nipple (Rear) 1979 to 1992**
These 6mm x 28mm nipples fit all rear drum brakes.
J10529 211611477A..... **£0.65**
- 25 Dust Cap for Bleed Nipple**
Fits front or rear bleed nipples.
J10854 211611483..... **£0.90**
- 26 Rear Hub Nut (46mm) 1979 to 1992**
Don't forget to replace the split pin (J12288)
J10559 N90149601..... **£5.25**
- Split Pin (For Rear Hub Nut)**
Rear hub split pin, 5.0 X 63mm.
J12288 N0125481..... **£0.55**
- 27 46mm Socket 3/4 in Drive**
Fits all rear hub nuts from 1979 to 1992.
J11235 00-5769-0..... **£15.25**

Brake Shoes & Fitting Kits

- 18 Rear Brake Shoes (Set of 4) 1979 to 1992**
Specifically made for the T25 and sold as a set of four
J10572 251698531LX..... **£32.75**
- 19 Rear Brake Shoes Fitting Kit 1979 to 1992**
The retaining pins with this kit are 41mm long.
J11132 251698545..... **£12.00**
- 20 Rear Brake Adjuster (Nearside/Left) 1979 to 1992**
OEM quality rear brake adjuster
J10820 281609801B..... **£19.75**
- Rear Brake Adjuster (Offside/Right) 1979 to 1992**
OEM quality rear brake adjuster
J10931 281609802B..... **£19.75**
- Brake Shoe Mount 1979 to 1992**
Sold as singles two parts are required for each side.
J10821 251609209..... **£11.25**
- Brake Shoe Mount 1979 to 1992**
This is the rear brake shoe retaining pin concave clip for VW T25s from 1979 to 1992.
J31287 251609289..... **£2.25**

Rear Drum Brakes

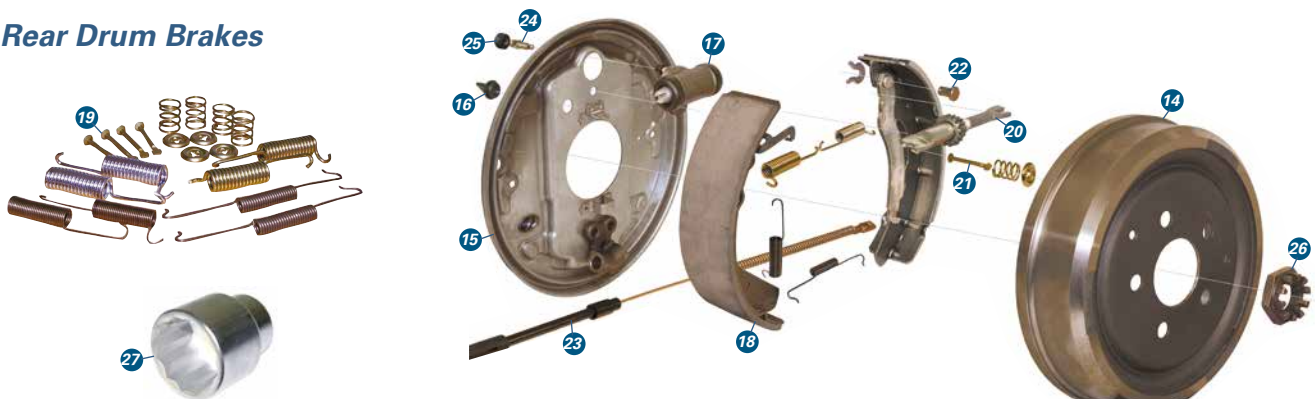

Front Wheel Bearing Kit 1979 to 1984 Except Syncro

Comprises the inner and outer bearings, hubseal and lock nut.

J11501 £22.25



Brake Master & Wheel Cylinders

Brake Master Cylinder Servo Unit 1979 to 1992
Fits all vehicles with servo assist brakes.
J10258 251611021C £59.75

Brake Light Switch (2 Pin) 1979 to 1992
Please check your requirement before ordering.
J10534 113945515H £3.95

Brake Pressure Regulator 1983 to 1992
J19818 251612501 £252.25

Brake Servos & Non Return Valves

Brake Vacuum Non-Return Valve 1979 to 1992
This OEM valve fits all vans with servo-assisted brakes.
J11061 191611933 £19.00

Brake Servo Unit
New not reconditioned, fits all models with servo brakes.
J16624 252612101 £302.75

Brake Pipes & Hoses

Copper Brake Pipe Set (Right Hand Drive) 1979 to 1982
A full set of copper brake pipes for single circuit systems.
J16899 £129.00

Brake Pipe Set (Right Hand Drive) 1982 to 1992
A full set of copper brake pipes.
J16900 £159.25

Goodridge Front & Rear Brake Hose Kit 1979 to 1985
Fitting these stainless steel hoses can help improve braking.
J16845 **Call For Availability**

Goodridge Front & Rear Brake Hose Kit 1985 to 1992
Fitting these stainless steel hoses can help improve braking.
J16847 **Call For Availability**

Brake Hose (Rear) 1979 to 1992
With female fittings at both ends hose fits either side
J10250 171611775 £10.75

Front Brake Hose 1979 to 1986
This flexible brake hose has female fittings at both ends,
J10253 251611775A £3.85

Front Brake Hose 1986 to 1992
This flexible brake hose has female fittings at both ends
J10254 291611775 £10.25

Brakepipe Grommet
Protects solid brakelines where they pass through metal work.
J10967 211611751 £1.95

Brake Bleeding Kit

Designed for one-person brake or clutch fluid bleeding

J11350 £13.00



Brake Pipe T-Piece Connector
3-way brake pipe T-piece connector
J11807 803611755 £5.75

Servo Hose (1/2 inch / 13mm) Sold Per Metre
13 mm servo hose
J18127 £13.75

Handbrake & Cables

Handbrake Cable 1979 to 1992
Connects the balance bar to the rear brakes
J10268 251609701C £8.50

Retaining Pin For Handbrake Lever 1979 to 1992
Used to retain the handbrake arm in place.
J10530 211609601B £1.45

Plastic Cover for Handbrake 1979 to 1992
Simple to fit, clips straight over Hand brake lever.
J90025 251711461B £8.25

Brake Pedal Parts

Pedal Pad Rubber
Fits either the brake or clutch pedal.
J12044 311721173A £2.95

Rear Hub Seal 1967 to 1979
Two required per side
J10275 211501317 £3.20

Wheel Bearings & Seal

Front Wheel Bearing Kit 1984 to 1992 Except Syncro
Comprises of inner and outer bearings, hubseal and lock nut.
J11502 £25.25

Rear Wheel Bearing Kit 1979 to 1992 Except Syncro
Comprises of inner and outer bearings, and 2 hubseals.
J11503 251598287 £38.75

Front Wheel Bearing Kit Syncro 1985 to 1992
Kit comprises a bearing, hubseal, circlip and loknut.
J11571 251407625 **Call For Availability**

Front Hub Seal 1979 to 1992
Fits all T25s 1979 to 1992 except Syncro 4x4 models.
J10293 281407641C £2.25

Wheel Studs, Nuts & Bolts

Front Hub Nut 1979 to 1992
Fits all T25s 1972 to 1992 except Syncro 4x4 models.
J10294 251407671 £1.90

Rear Wheel Stud 1979 to 1992
This M14x40mm stud is sold singly.
J10877 211501627A £2.25

Rear Wheel Hub
These reconditioned rear hubs fit either side on all T2s and T25s with 5 x 112 stud pattern.
J19811 211501619 £164.00

Fluid, Cleaner, Tools, Reservoir & Caps

Brake Reservoir Seal 1979 to 1992
Sold as singles you will need two of these grommets per vehicle
J11266 357611817 £3.55

Holts Brake Cleaner (600ml)
Cleans and degreases removing residue, scaling and dust.
J15239 £5.00



At Just Kampers

- Side Awnings
- Bike Racks
- Storage solutions
- Draught excluders
- Skylights
- Table Bases



1 T25 bike rack
J11470 £179.50



1 T25 bike rack
Fiamma bike rack (with FREE bike cover) for T25 models. Carries 2 bikes with the option of carrying 4 bikes using the Fiamma 3rd bike kit J11508 (available separately)
J11470 £178.75

Fiamma Bike Racks

These quality Fiamma anodized aluminium light weight bike racks are TUV approved and designed for the full VW Transporter range.

For Type 25 vans the bike rack carries 2 bikes as standard, but you have the option of carrying up to 3 bikes using the Fiamma 3rd bike extension kit J11508 (available separately)

All bike racks are quick and easy to install without drilling the vehicle.

3rd bike extension kit

This kit can be added to the T25 bike rack J18366 to increase carrying capacity to 3 bikes.

J11508 £32.00



3 Bike cover (up to 4 bikes)

Protective cycle cover. Large enough to cover up to 4 bikes. Ideal for use on bike racks. Made from lightweight polyester/vinyl material with adjustable straps. Comes with its own carry bag for storage.

J13304 £40.00

Bike Rack Accessories

2 Reflective warning sign

It is a legal requirement to use one of these in many European countries if you have a bike rack.

J13052 £8.00



Exclusive to Just Kampers

3 4 bike protective cover
J13304 £39.95

or call our sales team on 0800 9156601

Prices include VAT

Body Panels

Front Panel (Upper Part) LHD

This is the panel between the wind screen and the head light grille. Fits LHD models only

J12402 251805035.....£119.75

Upper Front Nose Panel 1979 to 1992

J18194 252805035.....£122.75

Retaining Clip For Grille Pin T25

This grill pin retaining clip is used on the upper grill of VW T25s built from 1979 to 1992. Sold as singles you will require five of these per vehicle. When ordering you may also require the corresponding grill pin J11173

J40242 251853696.....£2.50

Front Spoiler VW T25 1979-1992

J40273 255070920ABC.....£183.25

Lower Rear Panel VW T25 1979-1992

This lower rear valance panel fits from the base of the tailgate to the bottom of the van, These fit VW T25s from 1979 to 1992 excluding pickups.

J40187 251813191G.....£313.25

Sliding Door Handle Offside (Right) VW T25 August 1985-1992

J14403 251843704E.....£16.00

Sliding Door hinge Support Offside (Right)

This Genuine Volkswagen sliding door hinge upper support fits all Offside (Right) doors.

J39538 251843342A.....

Call For Availability

'V' Channel Section (for Side Cover) VW T2 Bay 1967-1979 VW T25 1979-1992

Made in the UK exclusively for JK, channel section is used to affix the side covers below the window. It fits either side of your VW T2 Bay 1967 to 1979. These can also be used on VW T25 models but will require trimming to fit.

J11019 211843818.....£23.50

Hobbyweld Mix 5 Gas Cylinder Deposit

J19629.....£110.00

Mild Steel Sheet 2mm

Supplied in sheets of 1000mm x 450mm x 2mm,

J29552.....£20.00

Rear Wheelarch Lower Panel Nearside (Left) VW T25 1979-1992

J39536 251809161.....£31.00

Rear Wheelarch Lower Panel Offside (Right) VW T25 1979-1992

A lower rear arch over panel this fits the Offside (Right) VW T25 1979 to 1992.

J39537 251809162.....£31.00

VW Type 25 Left Hand Sliding Door Lock 1979 to 1992

Type 25 Left Hand Sliding Door centre rear lock. Will fit all years from 1979 to 1992

J39359 252843603A.....

Call For Availability

JK Exclusive UK Made Repair Panels



Just Kampers originally started as a workshop so we understand the frustrations of poor quality parts, or worse still, being unable to source the parts at all.

As the supply of many parts dried up we realised the only way to guarantee a good supply was to invest in remanufacturing these obsolete or difficult to find parts ourselves.

We are continually expanding our range and reinvesting in more tooling and wherever possible, bringing manufacturing back to the UK. As a result, many of the panels shown in this catalogue are produced here at JK in Hampshire.



Front Panels

1 Lower Centre Nose Panel All Watercooled Models

J18195 251805037A.....GENUINE.....£126.50

Front Panel Lower Centre 1979 to 1983

Fits all air cooled models.

J19655 251805037.....£149.25

2 Front Panel (Lower Repair) 1979 TO 1992

J14622£79.75

3 Front Grille 1979 to 1985 95mm Badge Hole

You will need 5 x pins (J11173) to fit.

J11116 251853652D.....£57.75

4 Twin Headlamp Grille Kit 1979 to 1992

J11284 £272.75

5 Lower Grille Vent 1981 to 1982

lower vent grille that fits all watercooled models.

J10734 251853663.....£34.75

Grille Pin 1979 to 1992

J11173 2RD853731.....GENUINE.....£5.25

Lower Radiator Grille Securing Clip 1985 to 1992

Sold as singles, 5 required for the lower grille.

J13048 171853695A.....GENUINE.....£0.60

'A' Pillar Moulding (Offside / Right) 1979 to 1992

Moulding strip that fits over the seam by the windscreen.

J10643 251853706 1BG.....GENUINE.....£19.00

'A' Pillar Moulding (Nearside Left) 1979 to 1992

Moulding strip that fits over the seam by the windscreen.

J16752 251853705 1BG.....GENUINE.....£19.00

Black Front Bumper for 1979 to 1992

This standard steel bumper comes in black primer,

J10059 251807111C.....£84.50

Bundle kit

T25 Black Front Bumper Kit 1979 to 1992

The kit comprises bumper blade, end caps and two fitting kits.

J11601.....£94.25

SAVE 10%



Front Wheel Arches

Complete Front Arch Offside (Right) 1979 - 1992

J29367 251809244B.....£65.75

Front Wheelarch Outer Skin 1979 to 1992

you may also need a new wheelarch step (J10052)

J10053 251809501.....£35.75

7 Complete Front Arch Nearside (Left) 1979 - 1992

Complete with the lower front step outer skin.

J29368 251809243B.....£65.75

Front Arch Skin (Offside/Right) 1979 to 1992

You may also require the step J10629.

J10630 251809502.....£35.75

8 Front Wheelarch Step (Nearside) 1979 to 1992

This step includes the outer edge of the front wheelarch

J10052 251809503.....£26.75

Front Wheelarch Step (Offside/Right) 1979 to 1992

Includes the outer edge of the front wheelarch

J10629 251809504.....£26.75

Complete Front Arch Offside (Right) 1979 - 1992

J29367 251809244B.....£65.75

Complete Front Arch Nearside (Left) 1979 - 1992

Genuine VW front arches are complete with the lower front step outer skin.

J29368 251809243B.....£65.75

Front Seat Belt Mount Repair Panel T25 Nearside (Left)

J31150£24.50

Front Panels And Grilles



Body Panels

Rear Wheel Arches

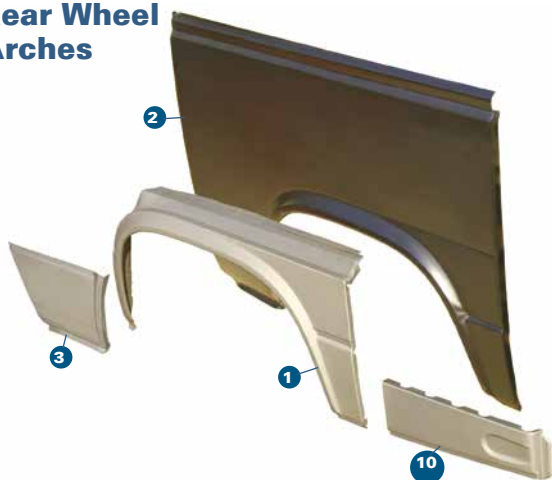

Rear Wheel Arches

- 
1 Rear Wheelarch Lower Panel (Nearside) 1979 to 1992
 We also stock a 'tall' rear-arch panel (J10054)
J10055 251809161..... **£45.50**
- 
Rear Arch (Offside/Right) 1979 to 1992
 We also stock a tall rear arch panel (J10631)
J10632 251809162..... **£45.50**
- 
2 Rear Wheelarch 'Tall' Panel (Nearside) 1979 to 1992
 70cm 'tall', rear-arch and quarter panel
J10054 251809171..... **£39.75**
- 
Rear Arch (Offside/Right) 1979 to 1992
 70cm deep, they go from base up to the centre swage line.
J10631 251809172..... **£39.75**

Handy Hint

Removing old body panels

The panels that make up a classic VW are often spot welded together, so to replace them, the neatest way is to unpick the original spot welds.

How to find the spot welds. As long as the panels has not been repaired before and the original spot welds lost, try the following. Rub a 40 grit piece of sand paper along the edge that has the spot welds (for example along the bottom edge of the outer sill). As the paint comes off you will see dimples



with the original paint still showing in them. These are the spot welds. You will not easily remove them with a normal drill bit. So use a spot weld drill bit (Just Beetles Part No. J11399) and going at a slow speed drill through the top layer of metal (the panel you want to remove). Continue this on all the visible spot welds. To break the last bit of each spot weld, carefully split the two panels apart using a thin metal chisel.

Any areas that need cutting (because you cannot get to the original spot welds) use as thin a cutting disc as possible in an angle grinder. If you have access to air tools such as air chisels and air saws, it is important that you practice on some scrap metal, as they can cause a lot of damage quickly if you are not sure how to use them.









Think before you cut!



Always think about what you are doing. Offer up the new panel, mark it with a sharp scribe, make sure you are happy with the size and fit. If you cut too much away, you are just making more work for yourself. Panels such as rear corners and rear wheel arches are worth spending extra time offering them up and rechecking before you cut. A badly fitted panel can ruin the look of a restored camper.

- 
3 Rear Wheelarch Front Section (Nearside) 1979 to 1992
 We also stock a 'tall' rear-arch and quarter panel (J10054)
J10056 251809159B..... **£12.25**
- 
Rear Arch, Front Section, (Offside/Right) 1979 to 1992
 Fits the lower front edge of the righthand (offside) rear arch
J10633 251809160..... **£12.25**
- 
Rear Seat Belt Mount Repair Panel T25 Offside (Right)
J31151 **£24.50**

Cab Door Parts

- 
Lower Front Doorskin (Nearside) for 1979 to 1992
 save your door with this lower repair skin.
J10048 251831107..... **£15.75**
- 
Lower Front Doorskin (Offside/Right) 1979 to 1992
 The lower front section measuring 20cm
J10627 251831108..... **£15.75**
- 
Door Check Strap 1979 to 1992
 OEM quality door check strap.
J10683 251837249..... **£62.00**
- 
Pin for Door Check Strap 1979 to 1992
 These pins retain the check strap into the door pillar.
J17019 211837257B..... **£2.75**
- 
Cab Door Seal (Nearside/Left or Offside/Right) 1979 to 1992
 This OEM cab door seal fits either side cab door.
J10691 251837911B..... **£31.00**
- 
Opening Quarter Light Rubber (Nearside/Left) 1979 to 1992
 These are for the opening quarter light only on T25 vans.
J17017 251837625A..... **£35.75**
- 
Opening Quarter Light Rubber (Offside/Right) 1979 to 1992
 These are for the opening quarter light only on T25 vans.
J17018 251837626A..... **£35.75**
- 
Quarterlight Bar (Offside/Right) 1979 to 1992
 For vans with fixed quarterlights.
J10637 251837410..... **£40.75**

Handy Hint

Stop the rust coming back

Once you have finished welding the following simple steps can help keep the rust out.

1) If you have replaced a panel like the rear side panel, you have a long welded edge, but are unable to get to the inside to seam seal it.

So using finely chopped fibre glass fill along the outside edge squeezing as much as possible into the joint. This will help to stop moisture getting in from the back and rusting the panel out. Sand back the fibre glass filler on the outside and fill as normal.

2) Where ever possible use seam sealer to make sure the damp can not get back in. Seam sealer is available in tubes (that you use in a grouting gun) from most car paint shops etc. It is also available in tins, so that you can brush it on.

3) Panels come in a protective primer. It is advisable to remove this primer before you fill and paint. On the inside it needs to be either sprayed with a waxoyl (or similar) covering which will stop rust starting and dispels water, or it should be painted in a water tight paint or under sealed.

4) Avoid cheap under seal. It goes hard with time, cracks and allows water to be trapped between the under seal and the metal. Use flexible products such as Waxoyl under seal or Hammerite paints.

5) Make sure you clean mud from under the vehicle regularly (a pressure washer at your

local petrol station, is great for this) touch up any stone chips and scratches as soon as possible. Make sure rubber seals are still supple and do not leak.

Product Key:



Exclusive to Just Kampers



Made in the UK

GENUINE PARTS & ACCESSORIES











Oversized charges apply to non-mainland UK deliveries

Prices include VAT

Shop online at justkampers.com

-  **Quarterlight Bar Felt 1979 to 1992**
This OEM quality, felt channel fits either side.
J10745 171837433A..... GENUINE **£14.75**
-  **Rubber for Window Lift Channel 1979 to 1992**
locates and holds the door drop glass into the lift channel.
J10731 831837565..... UK **£4.25**
-  **Felt Channel for Door Glass 1979 to 1992**
OEM felt channel fits either side.
J10746 281837709..... GENUINE **£29.75**
-  **Window Scraper 1979 to 1992**
Fits righthand door outer or on the lefthand door inner.
J10747 251837704..... GENUINE **£11.00**
-  **Window Scraper 1979 to 1992**
Fits righthand door inner on the lefthand door outer.
J10748 251837703..... GENUINE **£11.00**
-  **Cab Door Handle and Keys 1979 to 1992**
Supplied with two keys fits either side.
J11032 251837205..... **£39.50**
-  **Window Winder Handle 1979 to 1992**
This standard specification window winder handle fits all
J10152 111837581J..... **£2.95**

Side Panels & Sills

-  **4 Sill & Lower Side Panel (Offside/Right) 1979 to 1992**
Fits right hand drive models.
J13898 252809560..... UK UK **£43.00**
-  **B Post (Offside / Right) 1979 to 1992**
These measure 28 cms tall from the base.
J18789 UK **£36.75**
-  **B Post (Nearside/ Left) 1979 to 1992**
These measure 28 cms tall from the base.
J18790 UK **£36.75**
-  **Inner Sill (Offside/Right) 1979 to 1992**
OEM inner sill replacement fits the offside / right
J11408 253801252..... GENUINE **£193.75**
-  **5 Outer Sill (Offside/Right) 1979 to 1992**
Outer sill fits the lower section of the centre panel.
J11425 251809586..... UK UK **£29.75**
-  **6 Outer sill Sliding Door Guide (Nearside/ Left) 1979 to 1992**
The outer sill and door track
J13498 UK UK **£54.75**
-  **7 Sliding Door Seal 'U' Channel Repair 1979 to 1992**
This sliding door U channel repair will fit either side.
J13499 UK UK **£19.00**
-  **8 Sill Section (Nearside/Left) For Nearside Load Doors**
Fits all from 1979 with U channel for the door rubber.
J14617 UK UK **£38.25**
-  **9 Outer Sill 1979 to 1992**
11.5 cms tall Fits non sliding door side.
J16913 UK UK **£40.00**
-  **3 Rear Wheelarch Front Section (Nearside) 1979 to 1992**
We also stock a 'tall' rear-arch and quarter panel (J10054)
J10056 251809159B..... **£12.25**
-  **Rear Arch, Front Section, (Offside/Right) 1979 to 1992**
Fits the lower front edge of the righthand (offside) rear arch
J10633 251809160..... **£12.25**
-  **10 Lower Rear Corner (Nearside) 1979 to 1992**
Replaces the small panel on the lower edge of the rear quarter
J10057 251813357..... **£9.75**
-  **Lower Rear Corner Panel (Offside/Right) 1979 TO 1992**
Lower corner where the bumper end cap bolts on.
J10634 251813358..... **£9.75**













Side Panels And Sills



Rear Panels

-  **B Post Bung 1979 to 1992**
Fits either side B post at the base.
J11213 211611849..... GENUINE **£2.25**

Sliding Door Parts

-  **Outer Sliding Door Skin Repair 1979 to 1992**
This panel will fit nearside (left) or offside (right)
J10050 251843107..... **£24.25**
-  **Sliding Door Inner Repair 1979 to 1992**
Measuring 18cm high, this fits left or right hand doors
J10051 251843109..... **£25.75**
-  **Sliding Door Seal (Nearside Left) 1979 to 1992**
OEM quality sliding door seal is a one-piece construction
J10735 252843791A..... GENUINE **£69.25**
-  **Sliding Door Seal (Offside/Right) 1979 to 1992**
OEM quality a one-piece construction with moulded corners.
J10814 251843792B..... GENUINE **£64.75**
-  **Trim For Side Covers 1979 to 1992**
Flexible side cover trim fits either side.
J11121 281843799..... UK UK **£4.55**
-  **Cap for Sliding Door Inner Handle 1979 to 1992**
OEM cap for the sliding door inner handle.
J11028 211843645 466..... GENUINE **£2.90**
-  **Sliding Door Inner Handle 1979 TO 1992**
Fits both left and righthand sliding doors.
J11060 211843642A..... **£19.75**
-  **Top Nylon Guide For Sliding Door 1979 to 1985**
Fits either side sliding door.
J11136 251843423..... UK **£6.75**
-  **Nylon Guide Block for Sliding Door 1979 to 1985**
Fits to the centre hinge to provide a smoother slide.
J11271 251843368..... UK **£6.75**
-  **Sliding Door Buffer 1979 to 1984**
This buffer fits the front edge of the sliding door lock.
J18826 211843471..... GENUINE **£9.25**
-  **Sliding Door Handle 1979 to 1985**
Will fit either side.
J11444 251843704 / 252843703..... GENUINE **£56.00**
-  **Sliding Door Lock Cylinder 1979 to 1992**
J16992 251843709..... **£29.75**

Call For Availability

Tools & Welding



Waxoyl Kit (2.5litre) With Pump
Rust-prevention formula to help protect your vehicle.
J11333 **Call For Availability**



Waxoyl Rustproofing Refill (2.5Ltr)
Rust-prevention formula to help protect your vehicle.
J11361 **£30.00**



Waxoyl Spray Can (400MI Clear)
Rust-prevention formula extends the life of vehicle bodywork.
J12732 **Call For Availability**



Non-Structural Seam Sealer (310ml)
Formulated to flex with the vehicle.
J11330 **£10.00**



Morris Ankor Wax (5 litres)
Protects your van against rust and corrosion.
J18158 **£41.75**



Mild Steel Sheet
Supplied in sheets of 1000mm x 450mm x 1.2mm,
J16917 **£16.75**



Welding Gauntlets (Large)
Protect your hands with these fully lined leather gauntlets
J19284 **Call For Availability**

Hobbyweld Acetylene Cylinder (5litre) (Collection only)

J20114 **£78.50**



MIG Welding Gas Refill (Collection only)
J19236 **£45.50**



MIG Welding Gas Refill (Collection only)
J19237 **£43.00**



Hobbyweld Argon Refill (Collection only)
J19238 **£52.50**



Oxygen Gas Refill (Collection only)
J19239 **£36.00**



Spotweld Drill (8mm)
High speed, cobalt steel, spotweld drill (8mm)
J11399 **£9.75**



Franklin Hand Wire Brush
J19034 **£2.50**

Handy Hint

Rustproofing your VW

WAXOYL.....rust proofing system

Kills old rust and prevents new rust. A thick waxy fluid, saturated with a powerful rust killer that stays active indefinitely. WAXOYL can be used on the chassis, inside door panels, under wheel arches, in the engine



compartment and underneath the vehicle. JK no. J11333

Hammerite underseal

this is designed not to go hard and crack. It is the ideal finish for the underside of your vehicle after you have finished any welding. JK no. J11332

Seam Sealer

This comes in tubes that you can use with a grouting gun. you should seam seal all welding joints that are exposed to moisture.



Bundle kit

Bumper End Cap Kit

Take advantage of our bumper cap bundle kit.

J13563 **£36.50**

SAVE 10%



Bundle kit

Bumper Bolt Cap Bundle 1979 to 1992

A bundle kit of 8 white bumper caps.

White J16959 **£10.25**

Black J33456 **£8.50**

SAVE 10%



Front Bumpers & Fittings



Black Front Bumper for 1979 to 1992

This standard steel bumper comes in black primer,

J10059 251807111C **£84.50**



Chrome Bumper Front 1979 to 1992

Please note these bumpers are finished in show chrome.

J18037 251807111B **£130.50**

Chrome Front Bumper (Extra thick quality-Without holes)

Does not take deluxe trim

J29103 255 807 111B **£180.00**

Chrome Front Bumper with holes (Extra thick quality)

Comes With holes for deluxe trim

J29105 255807111B **£180.00**



Bumper End Cap (Front Offside Rear Nearside) 1979 to 1992

Fits both front (offside) and rear (nearside) steel bumpers

J10060 251807124A 1BG **£5.75**



Bumper End Cap (Front Nearside or Rear Offside) 1979 to 1992

A fitting kit (J10701) is also available.

J10606 251807123A **£5.75**



Front Bumper Impact Rubber Strip 1979 to 1992

Impact rubber strip. For T25 Chrome Bumper.

J18039 251807221A **£24.25**



Bolt Cap (White) 1979 to 1992

Can be used on bumper and sliding door bolts.

J10695 211707192 90D **£1.45**



Bumper Bolt Cap (Black) 1979 to 1992

Sold singly, they fit the front or rear.

J11069 211707192B **£1.20**



M8X16 Bolt General Purpose

Sold in packs of four

J12953 **£0.95**



Clip For Bumper Mouldings Deluxe Models

Sold as singles you will require 8 front and 10 for the rear

J14165 251807249 **£0.55**

Rear Bumpers & Fittings

- 

Rear Bumper (Black) 1979 to 1992
Supplied in black we recommend that it is painted.
J10591 251807311D..... **£82.50**
- 

T25 Black Rear Bumper Kit 1979 to 1992
The kit comprises bumper blade, end caps and two fitting kits.
J11603 **£92.50**
- 

Chrome Bumper Rear 1979 to 1992
Please note these bumpers are finished in show chrome.
J18038 255807311H..... **£130.50**
- 

Bumper End Cap (Front Offside Rear Nearside) 1979 to 1992
Fits both front (offside) and rear (nearside) steel bumpers
J10060 251807124A 1BG..... **£5.75**
- 

Bumper End Cap (Front Nearside or Rear Offside) 1979 to 1992
A fitting kit (J10701) is also available.
J10606 251807123A..... **£5.75**
- 

Bolt Cap (White) 1979 to 1992
Can be used on bumper and sliding door bolts.
J10695 211707192 90D..... **ik** **£1.45**
- 

Bumper Bolt Cap (Black) 1979 to 1992
Sold singly, they fit the front or rear.
J11069 211707192B..... **ik** **£1.20**
- Chrome Rear Bumper (Extra thick quality-Without holes)**
This is the best quality rear bumper. T25 1979-1992
J29104 **£180.00**
- 

M8X16 Bolt General Purpose
Sold in packs of four
J12953 **£0.95**
- 

Clip For Bumper Mouldings Deluxe Models
Sold as singles you will require 8 front and 10 for the rear
J14165 251807249..... **GENUINE** **£0.55**

Bumper Trims

- Chrome Rear Bumper with holes (Extra thick quality)**
This is the best quality rear bumper. T25 1979-1992
J29106 255807311H..... **£180.00**
- 

Bumper End Cap (Front Offside Rear Nearside) 1979 to 1992
Fits both front (offside) and rear (nearside) steel bumpers
J10060 251807124A 1BG..... **£5.75**
- 

Bumper End Cap (Front Nearside or Rear Offside) 1979 to 1992
A fitting kit (J10701) is also available.
J10606 251807123A..... **£5.75**
- 

Bolt Cap (White) 1979 to 1992
Can be used on bumper and sliding door bolts.
J10695 211707192 90D..... **ik** **£1.45**
- 

Rear Impact Rubber Strip 1979 to 1992
Impact rubber strip. For T25 Chrome Bumper.
J18040 251807421A..... **£39.50**
- 

Bumper Bolt Cap (Black) 1979 to 1992
Sold singly, they fit the front or rear.
J11069 211707192B..... **ik** **£1.20**
- 

Clip For Bumper Mouldings Deluxe Models
Sold as singles you will require 8 front and 10 for the rear
J14165 251807249..... **GENUINE** **£0.55**
- 

Front Bumper Impact Rubber Strip 1979 to 1992
Impact rubber strip. For T25 Chrome Bumper.
J18039 251807221A..... **GENUINE** **£24.25**

Bundle kit

T25 Black Bumper Kit Front and Rear 1979 to 1992

The kit comprises bumper blade, end caps and two fitting kits.

- J11601** **£94.25 Front**
- J11603** **£92.50 Rear**

SAVE 10%



Bumper Endcap Fitting Kit 1979 to 1992

Exclusive to JK!

You'll need one kit to fit each bumper endcap.

- J10701** **£4.45**



Window Seals

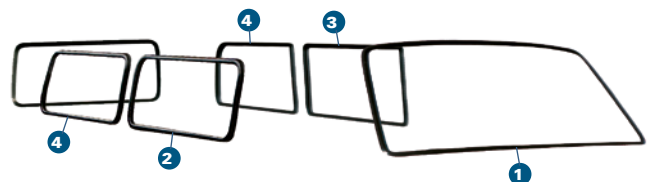

Window Seals

- 

1 Windscreen Seal 1979 to 1992
The seal is plain, without chrome trim.
J10743 251845121..... **ik** **£41.75**
- 















2 Middle Side Window 1979 to 1992
This seal fits middle, side window plain no trim.
J10742 253845322..... **ik** **£19.25**
- 

3 Sliding Door Window Seal 1979 to 1984
fits either side sliding door plain no trim.
J10741 253845321..... **ik** **£29.75**
- 

4 Rear Side Window Seal 1979 to 1992
Fits either side plain no trim.
J10739 253845341..... **ik** **£25.50**
- Side Window Seal Converted Panel Vans 1979 to 1992**
Sold in 310cm lengths with black insert.
J10686 211845321..... **ik** **£25.25**
- Side Window Seal for Converted Panel Vans 1979 to 1992**
Comes as a 310 cms length with a chrome insert.
J11106 **ik** **£25.25**
- Rear Side Window Seal 1979-1992 (With Groove) Best Quality**
J29520 **ik** **£25.50**
- 

Window Conversion Seal (5m Length)
Supplied in 5m lengths You will need insert (J11379) to fit.
J11378 **ik** **£52.50**

Seals, Trims & Accessories

-  **Quarterlight Rubber 1979 to 1992**
OEM quality, cab door fixed quarterlight seal fits either side
J10744 251837625..... **£29.75**
-  **Cab Door Seal Kit (Both Doors) 1979 to 1992**
Complete cab door seal kit for doors with fixed 1/4 lights.
J19566 **£229.00**
-  **Door Seal Retaining Clip VW T25 1979-1992**
Sold as singles these plastic clips are used to hold the front cab door seals in place on all VW T25s from 1979 to 1992. Six clips are required in total.
J21636 251823717..... **£0.30**
-  **Pair of Billet Aluminium Window Winder Handles**
Come with screws and gaskets
J31090 **£112.50**
-  **Door Striker Wedge**
Rubber wedge for door striker plate. LHS or RHS. Type 25 Years 79-91.
J63521 251837177..... **£8.00**
- Door window Glass (Left)**
J90039 251845201..... **£36.00**
- Door window Glass (Right)**
J90040 251845202..... **£36.00**
-  **Fitting Kit for Rock and Roll Beds to Fit All VW T2 Bays and T25s**
This is the full fitting kit for rock and roll beds on all VW T25s.
J12987 **£12.00**
-  **Brown Front Door Cards**
T25 Cab door cards. Fits all models from 1980 onwards. Sold as a pair.
J27870 **£90.00**
-  **Early Sliding Door Inner Handle T25**
Early Sliding Door Inner Handle T25
J21567 253843642 1BG..... **£42.00**
-  **Interior Door Lock Pull Knob T25**
Type 25 Interior Door Lock Pull Knob T25
J21638 251837187A..... **£5.50**
-  **Sliding Door Inner Handle (black)**
Fits both left and righthand sliding doors.
J39227 211843642A..... **£9.00**
-  **Tailgate Lock Gasket VW T25 1983 - 1992**
This tailgate lock gasket fits all VW T25s from 1983 to 1992. This gasket not only holds the lock in place but also helps prevent moisture getting into your van.
J39272 251829233..... **£5.00**
-  **Roof Toggle (Westfalia / beige)**
Supplied with metal clip.
J13144A 231068013A **£10.00**
-  **End Piece Gutter Trim (Front / Left) (Rear / Right) for Type 25 June 1979 to November 1990 (Black)**
J31285 251853709..... **£8.25**
-  **Westfalia Joker Club Joker Skylight**
Made to original specification this will require drilling to match your brackets.
J39470 255070741C..... **£79.00**
-  **Chrome Front Badge (125mm) 1985 to 1992**
This OEM part, fits all from 1985 onwards
J10272 251853601..... **£37.75**

Bundle kit

Westfalia Roof Canvas (Grey) And Seal Kit

This fantastic kit contains:
Westfalia Roof Canvas 3 Window
Westfalia elevating roof pop top seal
Westy / Devon Edge trim
Westfalia Pop Top Seal Between Roof and Rack. 1.8M Lengths
Westy Roof Toggle Cream / Yellow
J15049..... **£248.25**



SAVE 10%

End Piece Gutter Trim (Front / Right) (Rear / Left) for Type 25 June 1979 to November 1990 (Black)

J31284 251853710..... **£8.25**

B Post Bung

This is the external rear valance bung that fits to all fixed rear valances on the lower right hand side for VW T2 Bays from 1971 to 1979. Also used on the B post on all VW T25s 1979-1992 and rear corners on VW T25 Pickups 1979-1992
J39270 211813395..... **£2.65**

Pickup Bed Drop Side Stop Buffer (28mm) VW T25 1979-1992

Sold as singles these Genuine Volkswagen rubber buffers measure 28mm high and fit to the drop sides and tailgates on VW T25 pickups and crew cabs from 1979 to 1992.
J40291 245829577..... **£6.50**

Door Lock Pull Collar

Pair of collar pieces for the door locking knob. Genuine VW. Suitable for all models.
J63524 25183735501C..... **£2.40**

Vanagon Tailgate Script Vw T25

For the rear hatch on Type 25 models. More suited for the USA spec vans.
J63559 255853689A..... **Call For Availability**

Middle Sliding Window Nearside (Left) VW T25 1985 to 1992

This nearside left middle sliding window fits the left hand sliding door from 1985 to 1992. Before ordering please check dimensions these windows measure 1043.5 x 419
J20295 **£149.50**

Middle Sliding Window Offside (Right) VW T25 1985 to 1992

This offside right middle sliding window fits the right hand sliding door from 1985 to 1992. Before ordering please check dimensions these windows measure 1043.5 x 419
J20296 **£149.50**

Middle Sliding Window Offside (Right) VW T25 1979 to 1985

This offside right middle sliding window fits sliding doors upto 1985 and fixed panel all years 1979 to 1992 Before ordering please check dimensions these windows measure 1073.5 x 419
J20297 **£149.50**

Middle Sliding Window Nearside (Left) VW T25 1979 to 1992

This nearside Left middle sliding window fits sliding doors upto 1985 and fixed panel all years 1979 to 1992 Before ordering please check dimensions these windows measure 1073.5 x 419
J20298 **£149.50**

T25 Pick-Up Rear Window Seal 79-92

J21600 245845521..... **£52.50**

Sliding Door Glass

This clear flat door glass fits the sliding door on either side.
J31517 **£69.50**

Rear Side Window Glass

A laminated side window glass fits either side rear on all vans with factory fit windows.

J31527

Call For Availability

Middle Sliding Window (Left) RHD WITH SEAL (Sliding door)

Comes with seal

J40248 **£157.00**

Middle Sliding Window Offside (Right) LHD (Sliding door)

Comes with seal

J40249 **£157.00**

Middle Sliding Window (Right) RHD (opposite sliding door)

Comes with seal

J40250 **£157.00**

Middle Sliding Window (Left) (opposite the sliding door)

Comes with seal

J40251 **£157.00**

Pop Top Seal 50M Roll

J14146 **£270.00**

Westfalia Sticker 1979-1992

Sold as singles these reproduction stickers are fitted to either side of the elevating roof

J29121

£1.50

Tailgate Window Seal (No Groove) Best Quality

Rear Tailgate Window Seal No Trim Moulded Corners Type 25 June 1979 to November 1992 5/79>7/91 Best Quality

J21111 251845521..... **£34.00**

Windscreen Seal (With Groove) Best Quality

Windscreen Seal (For Chrome Trim) Type 25 June 1979 to November 1992 Factory fitted windows only.

J21601 255845121..... **£37.75**

Middle Window Seal Non Sliding Door side (German Q)

With Groove for Factory fitted window models only (German Quality)

J21602 255845322..... **£25.50**

Sliding Door Window Seal (With Groove) Best Quality

With Groove for Factory fitted window models only (German Quality)

J27700 255845321..... **£25.50**

Middle Side Window Seal (No groove) Best Quality

This seal fits the middle, side window on the fixed panel (i.e. the non-sliding door side) on T25, 1979-1992. This is a standard style rubber, without chrome insert.

J27701 253845322..... **£38.00**

Sliding Door Window Seal (No Groove) Best Quality

This window seal fits the sliding door on all T25s 1979-1992 without chrome insert.

J27703 253845321..... **£38.00**

Rear Side Window Seal No groove (Best Quality)

factory-fitted windows, this rear, side window seal fits either side on 1979-1992 models.

J27785 **£38.00**

Window Seal Kit (With Groove) Best Quality

complete set of Deluxe window seal rubbers for factory fitted window vans

J29517 **£155.25**

VW T25 Sliding Window Seal - for JK Window (Sliding Door Side)

VW T25 Sliding Window Seal - for JK Window (Sliding Door Side)

J40244 **£157.00**

Call For Availability

Six-piece Window Seal Kit Best Quality (factory-fitted windows) VW T25

Best Quality 6 piece seal kit for VW T25 Buses with windows originally factory-fitted by Volkswagen from 1979 to 1992. (Unsuitable for Deluxe Buses with chrome trimmed windows.)

J40261 **£206.75**

Rear Window Seal for Type 25 (Pick Up)

Rear window seal for pick-up vans. Genuine VW. Years 79-92.

J62552 245845521.....

Call For Availability

Windscreen Seal (Best Quality)

Plain seal - no groove for trim.

J63529 251845121.....

£43.75

Window Scraper For Models With Chrome Moldings Nearside (left) 1979-1992

J11445 255837703.....

£18.25

Window Scraper For Models With Chrome Moldings Offside (Right) 1979-1992

J39129 255837704.....

£20.00

Front Door Opening 1/4 Glass Nearside (Left) 1979-1992

This front door Opening 1/4 glass fits the Nearside (Left) on all VW T25 transporters from 1979 to 1992

J31515

£19.50

Front Door Opening 1/4 Glass Offside (Right) 1979-1992

This front door Opening 1/4 glass fits the Offside (Right) on all VW T25 transporters from 1979 to 1992

J31516

£19.50

Bundle kits

Six-Piece Window Rubber Kit Van Conversion 1979 to 1992

A six piece bundle deal for van chrome trim conversion rubbers.

J14042 **£159.00**



SAVE 10%

Six-piece Window Seal Kit 1979 to 1992

6-part kit for Buses with windows originally factory-fitted.

J12698.....

Call For Availability

SAVE 10%

Six-piece Window Seal Kit (for Van conversions)

6-part kit for panel van conversions.

J12699.....

Call For Availability

SAVE 10%

Conversion Window and Pop Top Rubber Seal (10m)

Requires the seal J18707 to fit.

J18706

£89.50

Insert Seal (5m length)

For use with J11378

J11379



£5.00

Rubber Seal Black Insert (10m for J11378)

Insert trim to go with our J11378 seal.

J18707

£10.00

Joining Sleeve (For plastic Trim On Window Seals)

Joining sleeve for deluxe window seals.

J13893 311853309b.....



£2.80

Glass

Fixed 1/4 Light Glass Nearside (Left)

Fits all vehicles with non opening 1/4 lights.

J90037 251845251..... **£23.50**

Fixed 1/4 Light Glass Right (Offside)

Fits all vehicles with non opening 1/4 lights.

J90038 251845252..... **£23.50**

Heated Rear Window 1979 to 1992

Fits all T25s **Please note this is a collect only item**

J90036 251845501A..... **£79.50**

Side Middle Window Glass Collection only

Middle window Glass & Sliding Door Window Glass up to 08/84

J90028 253845301..... **£39.50**

Rear Side Window Glass

Sold as singles, fits either side.

J90029 253845331..... **£40.50**

Diamond Lacing Tool

For Inserting window seal trim.

J11400 **£11.75**

Mirrors

Door Mirror (Offside/Right) 1979 to 1992

Complete mirror housing, glass, gasket and mounting screws.

J10941 251857514..... **£18.75**

Door Mirror (Nearside/Left) 1979 to 1992

Complete mirror housing, glass, gasket and mounting screws.

J10942 251857513..... **£18.75**

Convex Door Mirror (Nearside/Left) 1979 to 1992

A convex mirror offers a greater view.

J11710 251857513A..... **£20.00**

Convex Door Mirror (Offside/Right) 1979 to 1992

A convex mirror offers a greater view.

J11711 251857514A..... **£20.00**

Blind Spot Mirror (50mm)

50mm, self-adhesive mirror is easily attached to your mirror.

J12095 **£5.00**

Cab Door Seals, Trims & Winder Mech

Cab Door Seal (Nearside/Left or Offside/Right) 1979 to 1992

This OEM cab door seal fits either side cab door.

J10691 251837911B..... **£31.00**

5 Opening Quarter Light Rubber (Nearside/Left) 1979 to 1992

These are for the opening quarter light only on T25 vans.

J17017 251837625A..... **£35.75**

6 Opening Quarter Light Rubber (Offside/Right) 1979 to 1992

These are for the opening quarter light only on T25 vans.

J17018 251837626A..... **£35.75**

7 Window Scraper 1979 to 1992

Fits righthand door outer or on the lefthand door inner.

J10747 251837704..... **£11.00**

8 Window Scraper 1979 to 1992

Fits righthand door inner on the lefthand door outer.

J10748 251837703..... **£11.00**

Handy Hint

Ordering window seals

It's a common misconception, that VW Built campers. VW never actually produced a camper. All VW vans were built with either factory fitted glass such as the 'Microbus' or 'Kombi' models, or built as 'Panel Vans' with no side glass. These were then converted into campers by private companies like Danbury, Devon, Dormobile and Westfalia.

Most were built from Microbuses and Kombi's, but some companies used panel vans which were converted by adding side windows.

If you are ordering new side window seals, it's important to know whether your van started life with factory fitted glass or whether the glass was added later on.

3 ways to tell if your van has factory fitted glass

Microbus-Kombi with factory fitted glass



Recessed FLAT glass.
Second digit of the Chassis No. starts with a 2, 3 or 4
Van comes with rear seat belt mounts.

Panel van with window conversion



Flush mounted CURVED glass.
Second digit of the Chassis No. starts with a 1
Van has no rear seat belt mounts.

9 Quarterlight Bar (Offside/Right) 1979 to 1992

For vans with fixed quarterlights.

J10637 251837410..... **£40.75**

10 Quarterlight Bar Felt 1979 to 1992

This OEM quality, felt channel fits either side.

J10745 171837433A..... **£14.75**

11 Felt Channel for Door Glass 1979 to 1992

OEM felt channel fits either side.

J10746 281837709..... **£29.75**

Seal For Interior Light Switch (On Door Pillar)

Fits under the switch on the door pillar, fits either side.

J12733 113947565A..... **£2.75**

Seal for Cab Door Check Rod

Sold as singles, fits either side.

J19828 867837267..... **£6.00**

Window Winder Mechanism for Nearside/Left 1979 to 1992

OEM quality. You may also need the lift channel (J10835).

J10837 251837501A..... **£71.50**

12 Window Winder Mechanism for Offside/Right 1979 to 1992

OEM quality. You may also need the lift channel (J10835).

J10838 251837502A..... **£71.50**

Window Winder Handle 1979 to 1992

This standard specification window winder handle fits all

J10152 111837581J..... **£2.95**

Heavy Duty Winder Handle 1979 to 1992

More robust than the standard winder handle.

J11385 321837581..... **£2.35**

Chrome Window Winder Handle

Sold as singles

J13524 113837581D..... **£15.25**

Gasket for Window Winder Handle 1979 to 1992

Fits between the winder handle and the interior trim.

J10834 111837595A..... **£3.40**

Screws For Winder Handle 1979 to 1992

Sold as a pack of two.

J12949 **£1.15**

Door Seals, Handles, Hinge & Rollers

Sliding Door Seal (Nearside Left) 1979 to 1992
 OEM quality sliding door seal is a one-piece construction
J10735 252843791A..... GENUINE **£69.25**

Sliding Door Seal (Offside/Right) 1979 to 1992
 OEM quality a one-piece construction with moulded corners.
J10814 251843792B..... GENUINE **£64.75**

Cup Holder

Made from robust steel with a easy clean powder coat finish
J20278 **£29.00**



Cab Door Seals, Trims & Winder Mechanism

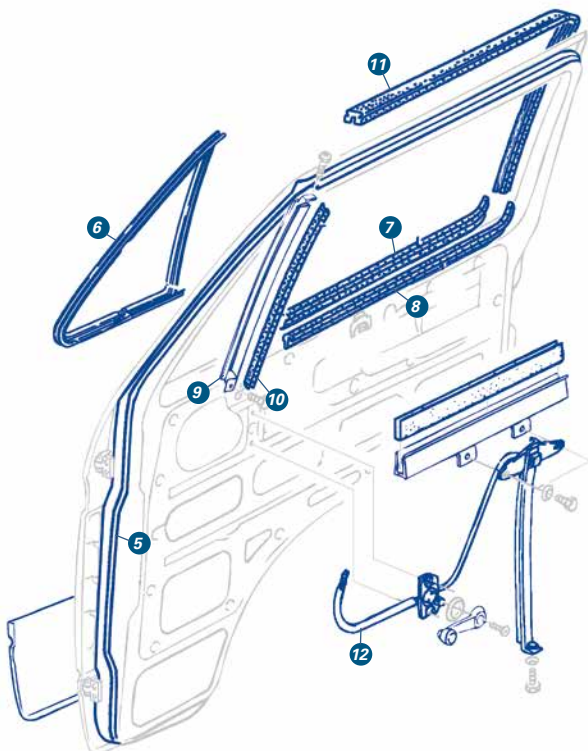

Bundle kits



Cab Door Seal Kit (Both Doors) 1979 to 1992
 Complete cab door seal kit for doors with opening 1/4 lights.
J19567 **£239.75**



Cab Door Seal Kit (Offside/Right) 1979 to 1992
 Complete cab door seal kit for doors with opening 1/4 lights.
J19570 **£119.75**



Cab Door Seal Kit (Nearside/Left) 1979 to 1992
 Complete cab door seal kit for doors with opening 1/4 lights.
J19569 **£119.75**

A Pair Of Custom Window Winder Handles

Custom handles add to that custom interior look.

J14840 £10.75



Bundle kit

Winder Handle Bundle Kit 1979 to 1992

Contains 2 handles, 2 winder handle gaskets, 2 screws.

J14391 £34.50





SAVE 10%

- 

Trim For Side Covers 1979 to 1992
Flexible side cover trim fits either side.
J11121 281843799 **£4.55**
- 

Sliding Door Roller Wheel 1979 to 1985
Made exclusively for JK this wheel fits the centre hinge.
J10093 211843359B **£24.75**
- 

Top Nylon Guide For Sliding Door 1979 to 1985
Fits either side sliding door.
J11136 251843423 **£4.55**
- 

Nylon Guide Block for Sliding Door 1979 to 1985
Fits to the centre hinge to provide a smoother slide.
J11271 251843368 **£6.75**
- 

Circlip for Roller Wheel 1979 to 1992
Used to retain the lower roller on the sliding door bracket
J11029 N0124071 **£0.40**
- 

Sliding Door Inner Handle 1979 TO 1992
Fits both left and righthand sliding doors.
J11060 211843642A **£19.75**
- 

Cap for Sliding Door Inner Handle 1979 to 1992
OEM cap for the sliding door inner handle.
J11028 211843645 466 **£2.90**
- 

Billet Aluminium Sliding Door Inner Handle 1979 to 1992
Fits either side sliding door.
J19248 **£48.00**
- 

Slam Handle Grommet 1979 to 1985
Fits between the sliding door handle and the door skin.
J20011 251843711 **£3.60**
- 

Sliding Door Handle Grommet 1985 to 1992
OEM quality part, it fits either side.
J11184 251843711A **£3.75**
- 

Sliding Door Handle 1979 to 1985
Will fit either side.
J11444 251843704 / 252843703 **£56.00**
- 

Sliding Door Lock Cylinder 1979 to 1992
Sliding door lock barrel with keys. Fits all T25 vans.
J16992 251843709 **£29.75**

Door Handles & Locks

- 

Cab Door Handle Gasket (Large) 1979 to 1992.
Sold singly, this large gasket fits either side.
J10749 251837211 **£1.15**
- 

Cab Door Handle Gasket (Small) 1979 to 1992
Sold singly, this small gasket fits either side.
J10750 251837209 **£1.75**

- 

Sliding Door Handle Grommet 1985 to 1992
OEM quality part, it fits either side.
J11184 251843711A **£3.75**
- 

Tailgate Lock With 2 Keys 1985 to 1992
Fits only those vehicles without central locking.
J12063 251829231B 251829231b **£39.75**
- 

Tail Gate Lock (Non Central Locking) 1979 to 1983
Fits all from 1979-1983 excluding central locking systems.
J16848 251829231 **£39.75**
- 

Sliding Door Lock Cylinder 1979 to 1992
Sliding door lock barrel with keys. Fits all T25 vans.
J16992 251843709 **£29.75**
- 

Billet Aluminium Sliding Door Inner Handle 1979 to 1992
Fits either side sliding door.
J19248 **£48.00**
- 

Empi Universal Door Puller
A stylish replacement for original door pulls.
J19352 **£38.75**
- 

Slam Handle Grommet 1979 to 1985
Fits between the sliding door handle and the door skin.
J20011 251843711 **£3.60**

Tailgate Seals, Gas Rams & Jail Bars

- 

Tailgate Gas Strut 1979 to 1992
We recommend that you change these in pairs.
J10076 251829331A **£7.25**
- 

Tailgate Seal 1979 to 1992
OEM quality tailgate seal fits all models.
J10736 255829193 **£55.25**
- 

Engine Hatch Seal 1979 to 1992
Helps keep noise and fumes out of your van's interior.
J10737 251813133B **£16.75**
- 

Tailgate Window Seal 1979 to 1992
Plain no trim.
J10738 251845521 **£22.00**
- 

Engine Bay Seal for Aircooled 1979 to 1984
OEM quality part which fits 1600cc and 2000cc aircooled engines
J10740 251813226A **£64.75**
- 

Rear Window Jail Bars Set 1979 to 1992
Supplied with all brackets and fittings.
J12123 **£33.50**
- 

Rear Tailgate Window Seal with Groove for Trim 1979 to 1992
OEM quality window seal for the T25 deluxe with chrome trim
J19597 255845521 **£30.25**
- 

Bolt for Engine Lid Support Spring
Holds the support spring to the vehicle body
J19477 211827409A **£6.75**

Exterior Trim, Accessories, Badges & Grilles

- 

Front Grille 1979 to 1985 95mm Badge Hole
You will need 5 x pins (J11173) to fit.
J11116 251853652D **£57.75**
- 

Twin Headlamp Grille Kit 1979 to 1992
OEM quality includes inner lamps, grille and badge.
J11284 **£272.75**
- 

Grille for Kit J11284 1979 to 1992
OEM twin headlamp grille for kit J11284
J11376 22S853641A **£160.75**
- 

Lower Grille Vent 1981 to 1982
lower vent grille that fits all watercooled models.
J10734 251853663 **£34.75**

Bundle kit

T25 Mud Flap Set 1979 to 1992

OEM quality all models except Syncros

J11981 £107.50



SAVE 10%

Cab Wind and Rain Deflectors 1979 to 1992

Exclusive to JK!

Sold as a pair and made from UV-stable perspex,

J11739 £30.00



Westfalia Roof, Window & Interior Parts



Westfalia Roof Canvas 3 Window Grey 1986 to 1992

With side window vents and zipped access to the roof rack

J13465 £179.00



Grille Pin 1979 to 1992

Sold in singles, five required for the upper grille.

J11173 2RD853731 £5.25



Lower Radiator Grille Securing Clip 1985 to 1992

Sold as singles 5 required for the lower grille.

J13048 171853695A £0.60



Oval Head Panel Screw (Lower Grille)

Sold 5s. These are used with the grille clips (J13048).

J13049 N 0139741 £0.85



VW Chrome Badge (Rear) 1979 to 1992

OEM chrome badge fits the tailgate on all T25s.

J11058 251853601B £39.75



Front Badge for Grille Kit J11284 1979 to 1992

OEM front badge for grille kit J11284

J11377 3A0853600 EPG £37.00



Clip For Volkswagen & Transporter Emblems

Sold in packs of three.

J13682 191853615A £6.00



Chromed GB Letters (Self-Adhesive)

Self-adhesive 80mm, chromed GB letters.

J12027 £10.00



Front Mudflap Set 1979 to 1992

OEM front mudflaps supplied with fixings

J10883 251898010 £59.75



Rear Mudflap Set 1979 to 1992

OEM rear mudflaps supplied with fixings

J10884 251898011 £59.75



Gutter Trim 1979 to 1992

Black gutter trim, one piece does one side.

J11544 251853707D 1BG £16.75



'A' Pillar Moulding (Offside / Right) 1979 to 1992

Moulding strip that fits over the seam by the windscreen.

J10643 251853706 1BG £19.00



'A' Pillar Moulding (Nearside Left) 1979 to 1992

Moulding strip that fits over the seam by the windscreen.

J16752 251853705 1BG £19.00



Twin-Mount Aerial

Twin-mount aerial gives a vintage look to your Bus

J10955 111999900A £20.75



Cab Door Window Air Vent (Pair) 1979 to 1992

Quick and easy to fit, they can only be removed from inside

J11738 £29.00



Spoiler Bolt (For Front Spoiler / Pack of 16)

Used for fitting original VW front spoilers

J12962 N0141444 £8.50



Window Tint Film (Grey/Black 20%)

76cm x 400cm

J14461 **Call For Availability**

Bundle kit

SAVE 10%



Westfalia Roof Seal Kit (Rear-hinged)

7.5m of top seal, 4.5m roofrack trim & 1 x flap seal.

J12506 £69.75

Insure your Type 25 with Just Kampers Insurance

Go online for a 60 second quote or call us on 0845 1256257



justkampersinsurance.com

Elevating Roof Parts

 **Westfalia Roof Canvas Tan 1979 to 1985**
A German quality canvas 3 windows with mosquito nets
J18857 £464.75

 **Westfalia Roof Canvas 3 Window Grey 1986 to 1992**
With side window vents and zipped access to the roof rack
J13465 £179.00

 **Westfalia Roof Canvas Beige 1986 to 1992**
A German quality canvas 3 windows with mosquito nets
J18858 £454.25

 **Westfalia Elevating Roof-to-Rack 1979 to 1992**
This 1.8m long roof-to-rack seal fits all Westfalia roofs.
J10865 £11.75

 **Window Conversion Seal (5m Length)**
Supplied in 5m lengths You will need insert (J11379) to fit.
J11378 £52.50

 **Insert Seal (5m length)**
For use with J11378
J11379 £5.00

 **Conversion Window and Pop Top Rubber Seal (10m)**
Requires the seal J18707 to fit.
J18706 £89.50

 **Rubber Seal Black Insert (10m for J11378)**
Insert trim to go with our J11378 seal.
J18707 £10.00

 **Roof Toggle (Pair) for T2, T25, T4 and T5**
Sold in pairs, 13cm long toggles are supplied with fittings
J10950 £17.25

 **Roof Toggle (Westfalia / Yellow)**
Supplied with metal clip.
J13144 £9.75

 **Bunk Bed Mount**
This bunk bed mount is designed to take a 32mm diameter pole.
J11495 £2.75

 **Fixed Mushroom Roof Vent**
19cm in diameter and requires an aperture size of 11cm to fit.
J11955 [Call For Availability](#)

 **Handle Extension (Up to 85mm for Fiamma Skylight)**
Use with J13404
J13035 [Call For Availability](#)

 **White Fiamma Roof Skylight**
Dimensions 45.5 x 45.5 x 8.5cm. Hole size 39 x 39 cms
J13404 £49.50

 **Fiamma Thermo 40 Mat Kit**
A 40 x 40 cms thermo mat for your Fiamma skylight.
J13185 £10.00

Elevating Roof Seals

 **Pop Top Seal 8.5m (for Dormobiles & Devon Moonrakers)**
General purpose elevating roof seal. Pre cut to 8.5 meters.
J13095 £46.00

 **Pop Top Seal**
General purpose elevating roof seal. Pre cut to 10.5 meters.
J13096 £57.00

 **Elevating Roof Seal (7.5m)**
Self-gripping, roof seal is generally used on Westfalia roofs.
J13098 £45.75

 **Elevating Roof Trim for Devon Tops (4.5m)**
Self-gripping edge trim for Devon and Westfalia roofs.
J13099 £20.00

 **Devon and Westfalia Edge Trim**
Pre cut to 8.5 meters
J13100 £33.00

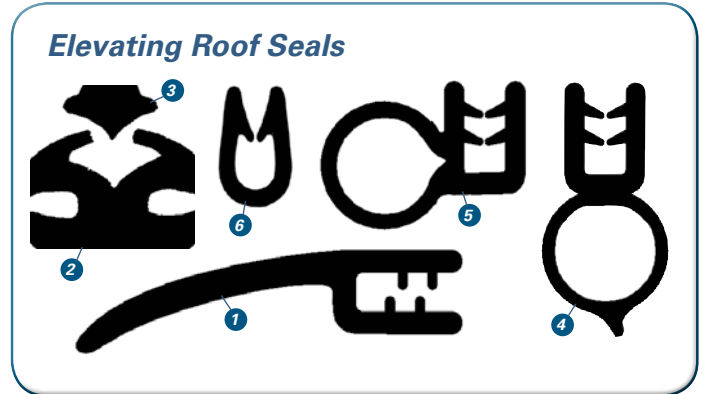

Door Cards & Door Trim

 **Trim Clips (Pack of 25) 1979 to 1992**
Trim clips are used for mounting original-style door panels
J10934 £5.00

 **Spire Clip**
This universal spire clip has many possible uses
J11172 £1.40

 **Black Front Door Cards**
Made exclusively for JK fits all years.
J18598 £100.00

 **Pair Of Door Cards In 3mm Plain MDF**
Ready for you to cover in the material of your choice.
J12428 £34.00

 **Sliding Door Panel In 3mm Plain MDF**
Ready for you to cover in the material of your choice.
J12429 £17.00

 **Sliding Door Panel Plain MDF 1979 to 1985**
Early style panel with no cut out to the rear.
J12828 £17.00

 **Panel Opposite Sliding Door In 3mm Plain MDF**
Ready for you to cover in the material of your choice.
J12430 £17.00

 **Tailgate Panel In 3mm Plain MDF**
Ready for you to cover in the material of your choice.
J12431 £17.00

 **Pair of Rear Side Panels In 3mm Plain MDF**
Ready for you to cover in the material of your choice.
J12432 £27.00

 **Rear Boot Side Panels 1979 to 1992**
Sold as a pair, with cutout for the rear washer bottle.
J12622 £29.00

Product Key:



Exclusive to Just Kampers



Made in the UK

GENUINE PARTS & ACCESSORIES

Genuine VW part



Oversized charges apply to non-mainland UK deliveries

Bundle kit

Interior Panel Kit (9 Panels) 1984 to 1992

A bundle deal kit of plain MDF panels ready for trimming

J18353.....£153.75



SAVE 10%

Bundle kit

Interior Panel Kit (9 Panels) 1979 to 1984

A bundle deal kit of plain MDF panels ready for trimming

J18352.....£153.75



SAVE 10%

MDF Interior Panels

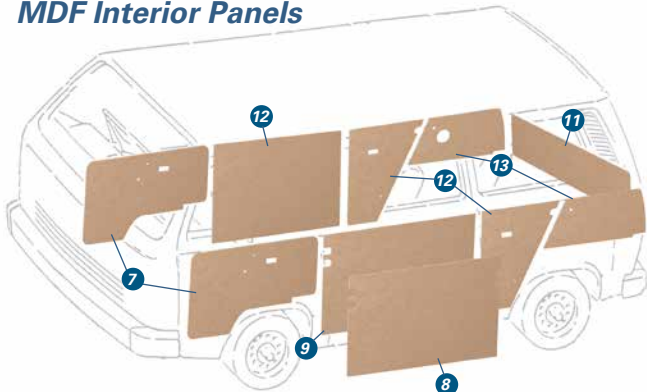

Door Step Rubber Nearside (Left) 1979 to 1992

J10703 251863735.....**ik**.....£9.75

Door Step Rubber Offside (Right) 1979 to 1992

J10704 251863736.....**ik**.....£9.75

Cab Overmat Right Hand Drive 1979 to 1992 (Except Autos)
Black with waterproof backing and sewn in rubber pad.

J13299.....**ik**.....£37.25

Plastic Frame For Gear Stick Boot

Fits all T25 models with manual gear box.

J13903 253711120.....£5.50

Grab Handle for Cab Door or 'A' Pillar 1979 to 1992

To fit you may require 2 x J11159 and 2 x J11176.

J10836 251857607 01C.....**GENUINE**.....£29.50

Door Grabhandle Packing 1979 to 1992

OEM quality door grabhandle packing 2 required per door.

J11159 255867195 01C.....**GENUINE**.....£3.90

Heater Control Lever 1979 to 1992

Sold as singles you will need 4 in total.

J11163 251259371C.....**GENUINE**.....£4.50

Elasticated Storage Net

Exclusive to JK!

This useful pocket measures 320mmx215mm

J12155.....£11.00



Bundle kit

Elasticated Storage Nets (Pair)

A bundle deal for two J12155 storage nets.

J13775.....£19.75



SAVE 10%

Grabhandle Screw (Pair) 1979 to 1992

Sold in pairs.

J11176 N0139351.....£0.75

Black Trim Clips 1979 to 1992

Sold in packs of five.

J11303 801867299 01C.....**ik**.....£2.50

JK Plastic Curtain Rail C Profile 2.25 mtr

4x grey 2.25 meter rail, 80 hooks and glides 6 end stops.

J18860.....£56.50

Curtain Rail

For full kit – with hooks and gliders – please order J18860.

J15038.....**ik**.....£30.00

JK Curtain Runners For J15038 Curtain Rail

Combined hook and glide sold in packs of 20

J11900.....**ik**.....£7.00

JK Curtain Rail End Stop

For use with j15038 curtain rail Sold in packs of 6.

J11901.....**ik**.....£2.00

Silent Glis Sold in packs of 25

Sold in packs of 25 you may require the hooks J11484.

J11483.....**ik**.....£4.00

Silent Gliss Hooks

Sold in packs of 25 you may require the glides J11483.

J11484.....**ik**.....£4.00

Silent Gliss Curtain End Stops

Sold as a pack of 2, these fit Silent Gliss curtain track.

J11485.....£2.00

Rock and Roll Seat Brackets (Pair)

Cad plated, heavy duty steel, supplied with support legs.

J11561.....**ik**.....£74.75

Spare Spring (Rock & Roll Bed Bracket)

Sold as singles.

J14249.....**ik**.....£2.00

Bundle kit

A Pair Of Cab Step Rubbers

A bundle kit of J10703 and J10704

J19641.....£16.00



SAVE 10%

Storage Pockets

Exclusive to JK!

Door Storage Pockets

Sold as a pair 530mm long with can holder.

J12373.....£24.00

Door Storage Pockets



Sold as a pair 350mm long with can holder.

J12374.....£23





ACCESSORIES, GIFTS & TOOLS









BIKE RACKS

-  **Fiamma VW T25 Bike Rack with FREE COVER**
Quality Fiamma product. Designed for carrying 2 bikes with a VW T25. Includes free bike cover.
J18366 £196.75
-  **Westfalia BC70 Tow Ball Mounted Two Bike Carrier**
Quality Westfalia product. Two bike universal tow ball mounted cycle carrier. Can be used on any vehicle fitted with a tow bar.
J41139 £429.00
-  **Westfalia BC60 3rd Bike Expansion**
Genuine Westfalia product. Add a third bike the BC 60 Cycle Carrier.
J40173 £133.50











BOOKS & WORKSHOP MANUALS

-  **The Rolling Home Book**
The Rolling Home book is a cross between a coffee table stunner and an inspirational guide for life! A great gift for those with a touch of wanderlust or even as a treat for yourself.
J40938 £24.00
-  **Official VW Service Manual. Type 3 1968-73 By Robert Bentley**
For 1968-73 Squareback, Fastback And Notchback
J35061 11-100-6-0 £48.00



ELECTRICAL

-  **Tachometer 6000 RPM 52mm**
Ideal for any 12 volt system. 6000 RPM rev counter - set for 4 cylinder engines but can also be switched for 6 and 8 cylinders.
J41627 £90.50
-  **Heavy Duty Split Charge Relay 4 Pin (100A) With Connectors**
Heavy duty, 100 amp split charge relay with automatic off default. Supplied with connectors. Suitable for 12 volt applications.
J41601 £14.00
-  **Mains Hook Up Extension Lead (25m)**
Heavy duty 25m mains hook up extension lead.
J11648 £34.50
-  **Hella Classic 6 1/2" Chrome Fog Lamp**
Quality Hella product. Sold individually. Supplied with mounting bracket and protective cover.
J41002 £87.25
-  **Amber Spot Light With Mesh Grille 1979 to 1992**
Sold individually. 160mms x 80mms. Retro style amber spot light. Supplied with a 12 volt bulb.
J41050 £66.00
-  **Hella Comet 550 Fog Lamp Set**
This kit is supplied with a pair of lights, bulbs, relay wiring and switch for easy installation.
J41003 £79.50
-  **Red Spot Light With Mesh Grill 1979 to 1992**
Sold individually. 160mm x 80mm. Retro style red spot light. Supplied with a 12 volt bulb.
J41051 £66.25
-  **LED Recessed Light (12v)**
Alternative quality product. A non-intrusive, swivel-head, LED, recess light.
J18609A £11.50
-  **4W Solar Battery Maintainer**
Quick and easy to instal this 4 Watt solar battery maintainer features a folding stand allowing it to be placed in a convenient place to allow charging and maintenance of your battery. With a battery charge LED indicator and a set of leads allowing either direct battery connection or through an in car 12 volt socket in a self contained folding case.
J41699 £25.00

GIFTS

-  **JK Gift Card / Voucher (Minimum value £10)**
Give someone the gift of choice with a Just Kampers Gift Card. The credit card sized gift cards are handy and much more convenient than gift vouchers and can be spent on our web-site and when placing orders over the phone. When purchasing a gift card, you specify the amount from £10 - £5000 a physical gift card will be sent out with a personalised receipt (If a message has been entered). The card is valid for 1 year from the date of purchase and can be used incrementally across many orders giving the owner recipient the flexibility to use it when they want and on what they want.
The gift card comes with a card which has your personalised message printed it on ready to give to the recipient.
J31283 £10.00
-  **Just Kampers Polycarbonate Tumblers (2 Pack)**
Size 9cm top diameter x 10cm high
J19542 £7.00
-  **Campershop Childs Melamine Set**
Campershop Campervan print childs melamine set is sure to make your little one happy and mealtimes easy. Designed and manufactured exclusively for Just Kampers. This set contains 1 plate, 1 bowl, 1 beaker, and 1 Spoon and Fork
J40778 £9.50
-  **Campershop Melamine Tray**
Campershop Melamine Tray
J39675 £5.50
-  **Campershop Melamine 4pk Mugs**
Campershop Melamine 4pk Mugs
J39674 £10.00
-  **Campershop Melamine 4pk Side Plates**
Campershop Melamine 4pk Side Plates
J39672 £10.00
-  **Small Dog Bowl**
The ultimate pet accessory for your VW loving dog ! This 16.3 x 6.5 cm bowl with a fun Dog inspired design to match in with our ever popular melamine dining set.
J40780 £4.50
-  **GB Sign with Universal Bracket**
Supplied with a universal mounting bracket that can be adapted to fit most vehicles.
J40495 £25.50
-  **Illuminated Stop Sign**
A replica of the illuminated Stop sign sold by SWF in the '60s.
J40582 £66.00
-  **Just Kampers Overall - Childs (11 to 12 yrs)**
Just Kampers Overall - Childs (11 to 12 yrs)
J40152 £15.00
-  **8 Ball Gear Knob 1979 to 1985**
They've got a 12mm thread, and screw on to your gear stick
J14706 £9.75

SAFETY & SECURITY

-  **Fire Extinguisher ABF Multifoam 600ml**
600ml ABF multi-foam fire extinguisher. Suitable for use on flammable solids and liquids. Forms a flame-smothering seal. Suitable for use on petrol and volatile liquid fires.
J41835 £12.00
-  **Fire Extinguisher ABC Dry Powder 1kg**
1kg dry powder ABC fire extinguisher. Supplied with a powder coated mounting bracket. Multi purpose fire extinguisher, suitable for use on ABC fires and is suitable for electrical fires.
J41836 £15.00
-  **Fire Extinguisher ABC Dry Powder 2kg**
2kg ABC dry powder fire extinguisher. Supplied with a powder coated mounting bracket. Multi purpose fire extinguisher, suitable for use on ABC fires and is suitable for electrical fires.
J41837 £22.00



Van Safe T Pedal VW T25 RHD 1979-1992

A simple, effective way to secure your pride and joy and deter the opportunist thief.

J40404 **£134.00**



Aluminium Reflective Warning Sign

Made of lightweight aluminium with four mounting holes and four red reflector panels.

J41342 **£22.75**



Locking Wheel Nuts for Standard Wheels

Size M14 x 1.5, with 60° taper seat. Fits VW T25s with standard wheels from 1979 to 1992.

J14415 **£15.00**



Extra Housing For Mini Traveller Safe

Allows Mini Traveller Safe J14120 to be used in another point.

J14121 **£5.50**

TOOLS



Waxoyl Kit (2.5litre) With Pump

Quality Waxoyl product. 2.5 litres of Clear Waxoyl and a spray pump for easy application.

J40788 **£63.50**



Ankor Wax Kit (2.5litre) With Pump

Quality Morris product. Sold in 5 litre cans supplied with a pump / sprayer.

J40928 **£74.25**



Waxoyl High Pressure Sprayer / Applicator

The new and improved Waxoyl applicator. This spray tool allows you to easily apply waxoyl to protect your vehicle. Save money by buying our waxoyl kit (J40788) which contains both the applicator and a 2.5 litre can of waxoyl.

J40787 **£40.75**



13mm Angled Spanner

Ideal for the rear nut on a 34 pict carb, the top nuts on heat exchangers and other awkward places.

J40129 **£9.25**



Spot Weld Drill (6mm)

A High speed cobalt steel spot weld drill (6mm)

J40851 **£10.50**



Tool Roll All Aircooled Vehicles

A reproduction canvas tool roll containing a useful selection of tools for road side break downs along with being a authentic accessory. This Kit includes:

1 x brace Bar, Hubcap Removal Tool, Brake Adjusting Tool, 14 mm Box Spanner, 10-13 mm Spanner, 21-19 mm Spanner, A Flat Blade Screwdriver, A Set of Pliers

J41683 111-898-025/GN **£55.50**



Battery Mat

The Original Battery Mat

J21659 **£7.75**



Compact / Extending Snow Shovel

Lightweight but sturdy.

J19249 **£12.00**



Soudal Contact Adhesive (1 Litre)

Toluene free, designed for the use on rubber and synthetics making it ideal for use on your VW.

J19549 **£10.00**



Self Locking Nut M8 VW Beetle 1975 on, T2 Bay 1967-1979, T25 1979-1982, T4 1991-2003

An original style self locking M8 nut

J41255 N 0-11 - 184/ 9 **£2.05**



M8 Single Coil Spring Washer Bzp

Good quality reproduction product. M8 coil spring washer. Ideal for a number of uses on your VW

J40798 N01-203-87 **£0.85**



M6 x 30mm (1.00 Pitch / 8.8 Strength) Bolt. Various uses

This M6 X 30 bolt has various uses such as the distributor clamp on aircooled engines.

J39888 **£0.70**



M8x40mm Bolt for General Purpose Use

Used in many applications such as:

Beetle steering column to clamp, steering UJ clamp (1302/03), T2 brake pedal rod clamp, T2 battery clamp to battery tray, T25 Front gear shift rod Clamp to universal joint

J64581 N0103404 **£3.70**



M12 x 100mm (1.75 Pitch / 10.9 Strength) Bolt. Various uses

High tensile bolt with various uses.

J20802 N101921 **£6.50**

VEHICLE COVERS & WINDOW THERMO MATS



DIY Thermo mat kit

If your vehicle is not listed or has odd-sized windows, if you have a caravan, or if you just enjoy making things yourself, DIY thermo-mat kit is just the thing. So if you want to be warm in your vehicle in winter, cool in the summer and enjoy privacy and security, this is kit is for you.

Please Note: Supplied with two packs of eyelets J12931 to go with this kit.

J20809 **£71.00**

BODY PANELS

CAB DOOR PARTS



Deluxe Quarter Light Rubber Nearside VW T25 1979-1992

Fits offside (right) on VW T25 Deluxe Models. Has moulded groves to accept chrome trim.

J40164 255-837-625 **£54.75**



Window Lift Channel 1979 to 1992

We also stock the glass cushion: J10731.

J10835 281-837-571/ **£16.00**



Clips For Window Scraper

You will require 4 per scraper or 8 per door.

J19829 171-837-485 **£1.50**



Billet Aluminium Window Winder Handles

Quality EMPI product. Pair of EMPI billet alloy window winder handles. Fits T25s from 1979 to 1992.

J64121 00-851-0-0 **£41.00**

CHASSIS



Rear Inner Trailing Arm Mount Bracket Nearside (Left) 1980-1992

Quality VW product. Rear inner trailing arm mount bracket. Fits nearside (left) on VW T25s from 1980 to 1992.

J41641 251-803-191 **£48.00**



Rear Inner Trailing Arm Mount Bracket Offside (Right) 1980-1992

Genuine VW product. Inner trailing arm mount bracket. Fits offside (right) on VW T25s from 1980 to 1992.

J41642 251-803-192 **£48.00**



Rear Inner Trailing Arm Repair Panel Nearside 1980-1992

Genuine VW product. Rear inner trailing arm repair panel. Fits nearside (left) on T25s from 1980 to 1992.

J41643 251-803-193 **£6.50**



Front Jacking Point Nearside (Left) VW T25 1979-1992

Genuine VW product. Jacking point. Fits the front nearside (left) on VW T25s from 1979 to 1992.

J41199 251-803-229 **£19.75**



Front Jacking Point Offside (Right) VW T25 1979-1992

Quality Preservation Parts product. Made in the UK exclusively for Just Kampers.

Replacement front jacking point. Fits the front offside (right) on VW T25s from 1979 to 1992.

J41200 251-803-230 **£17.75**



Rear Inner Trailing Arm Repair Panel Offside (Right) 1980-1992

Genuine VW product. Rear inner trailing arm repair panel. Fits offside (right) on VW T25s from 1980 to 1992.

J41644 251-803-194 **£6.50**



Rear Swing Arm Mount Jacking Point Nearside (Left) VW T25 1979-1992

Jacking point for the rear swing arm mount. Made from the correct gauge steel. Fits the nearside on T25s from 1979 to 1992.

J41774 251-803-197..... **£29.75**



Rear Swing Arm Mount Jacking Point Offside (Right) VW T25 1979-1992

Made from the correct gauge steel. Fits the offside (right) on T25s from 1979 to 1992.

J41775 251-803-198..... **£29.75**

FRONT PANELS

Screen Repair, VW T25 1979-1992

Preservation Parts product. Made in the UK, exclusively for JK. Fits VW T25s from 1979 to 1992.

J40972 **£35.00**



"A" Pillar Outer Panel (Nearside)

Genuine Volkswagen product. Fits nearside (left) on all T25 vans from 1979 to 1990.

J13068 251-805-053/..... **£336.50**



Outer A Pillar Panel (Offside / Right / Shipping Restrictions Apply)

*** Shipping restrictions apply to this product please ask before ordering

J12468 251-805-054/..... **£346.00**



Outer B Pillar Nearside (Left) 1979-1992

Genuine VW product. Outer B pillar. Fits the nearside on VW T25s from 1979 to 1992, excluding pick up models.

J14141 251-809-253/..... **£346.00**



B Post (Offside Right)

Complete B post Offside. Fits all T25 vans.

J14143 251-809-254/..... **£262.00**



Lower Radiator Grille (Wraparound) 1979 to 1992

OEM quality It fits all air and watercooled T25s

J11283 225-853-663/C..... **£188.00**

FRONT WHEEL ARCHES



Inner Front Wheel Arch Step VW T25 1979-1992 Nearside (Left)

Inner front wheel arch step. Fits nearside (left) on VW T25s from 1979 to 1992.

J41197 251-801-173..... **£99.00**



Inner Front Wheel Arch Step VW T25 1979-1992 Offside (Right)

Inner front wheel arch step. Fits offside (right) on VW T25s from 1979 to 1992.

J41198 251-801-174..... **£99.00**

REAR PANELS



Complete Rear Corner Section, Offside (Right) VW T25

Good quality reproduction panel. Fits offside (right) on all T25s, 1979 - 1992.

J40970 251-813-368/A..... **£349.00**



Complete Rear Corner Section, Nearside (Left) VW T25

Good quality reproduction panel. Fits nearside (left) on all T25s, 1979 - 1992.

J40971 251-813-367/A..... **£349.00**



Inner Rear Corner VW T25 Nearside (Left) VW T25 1979-1992

Genuine VW product. Also known as the air deflector. Fits in the rear corner behind the rear lights.

J40326 251-801-559/A..... **£102.75**

SIDE PANELS & SILLS



Inner Sill (Nearside/Left) 1979 to 1992

JK inner sill replacement fits the nearside / left

J11407 253-801-251/..... **£193.75**



Front Jacking Point Nearside (Left) VW T25 1979-1992

Genuine VW product. Jacking point. Fits the front nearside (left) on VW T25s from 1979 to 1992.

J41199 251-803-229..... **£19.75**



Front Jacking Point Offside (Right) VW T25 1979-1992

Quality Preservation Parts product. Made in the UK exclusively for Just Kampers.

Replacement front jacking point. Fits the front offside (right) on VW T25s from 1979 to 1992.

J41200 251-803-230..... **£17.75**



Rear Swing Arm Mount Jacking Point Nearside (Left) VW T25 1979-1992

Jacking point for the rear swing arm mount. Made from the correct gauge steel. Fits the nearside on T25s from 1979 to 1992.

J41774 251-803-197..... **£29.75**



Rear Swing Arm Mount Jacking Point Offside (Right) VW T25 1979-1992

Made from the correct gauge steel. Fits the offside (right) on T25s from 1979 to 1992.

J41775 251-803-198..... **£29.75**

SLIDING DOOR PARTS



Sliding Door Lower Roller Bearing Guide VW T25 1979-1992

Genuine VW product. Lower vertical roller wheel, as fitted to either side sliding door on all VW T25s from 1979 to 1992.

J41277 251-843-419..... **£43.25**



Roller & Bearing For Sliding Door VW T25 1979-1992

Guide roller and bearing, located on the centre hinge on either side sliding door on VW T25s from 1979 to 1992.

J41278 251-843-361/B..... **£28.75**



Guide Roller Lower For Sliding Door VW T25 1979-1985

Genuine VW product. Sliding door lower guide roller. Fits VW T25s from 1979 to 1985.

J41279 251-843-423/B..... **£12.50**



Guide Roller For Sliding Door VW T25 1985-1992

Quality VW product. Guide roller for the horizontal sliding door locator. Located on the upper front edge of the sliding door. Fits VW T25s from 1985 to 1992.

J41276 251-843-425/A..... **£17.50**

TOOLS & WELDING



Dinitrol Rustproofing Kit

A comprehensive Dinitrol rustproofing kit consisting of: 1 x RC900 400ml Spray, 2 x 4941 Under body wax 1 litre, 2 x ML Brown cavity wax, 10 x 10 mm cavity plugs, 2 x HS 3125 Cavity wax 1 litre, 1 x Extension straw

J41398 **£111.50**



Anchor Wax Kit (2.5litre) With Pump

Quality Morris product. Sold in 5 litre cans supplied with a pump / sprayer.

J40928 **£74.25**



Dinitrol RC900 400ml Spray

Dinitrol RC 900 is an Epoxy Primer with a built in rust converter that actively converts rust to a stable organic Iron complex. Free of Lead chromium and Zinc RC 900 penetrates 7 to 10 times deeper than standard rust converters.

Overpaintable this product is ideal for prepping the underside of your vehicle before coating in Dinitrol 4941

J41223 **£26.50**



Dinitrol ML Brown Cavity Wax Rust Proofing 500ml Aerosol

Supplied in 500ml Aerosol Dinitrol ML is a oil based corrosion and protection product specially designed for applying in cavities such as inner sill sections, front valance, door bottoms etc.

Once applied ML forms a soft and wear resistant film that effectively eliminates dampness and helps prevent corrosion.

J41225 **£10.50**



Dinitrol 4941 Under Body Wax 500ml Aerosol

Supplied in 500ml Aerosol tins Dinitrol 4941 offers long term resistance against corrosion and abrasion even under extreme conditions.

Once applied the solvents disperse leaving a tough black elastic protective film that is heat resistant with the added bonus of offering a degree of sound deadening.

J41232 **£11.25**



Dinitrol 445 Black Stone Chip 500ml Aerosol

Dinitrol 445 Black is a black polymer based anti drone effect elastic stone chip. Over paintable this also offers protection against corrosion. After drying, the materials are resistant to carbon hydride-based cold cleaning agents, surfactant-based acid and alkaline high pressure cleaners, salt water and road salt.

J41238 £10.50



Dinitrol Aerosol Extension Straw

This 60cm extension straw is for use with Dinitrol Aerosol rust-proofing products. Adding this extension piece allows access to difficult to reach areas.

J41241 £2.50



Dinitrol 4941 Under Body Wax 1Ltr

Dinitrol 4941 offers long term resistance against corrosion and abrasion even under extreme conditions. Once applied the solvents disperse leaving a tough black elastic protective film that is heat resistant with the added bonus of offering a degree of sound deadening.

To apply you will require a schutz gun and a compressor with 6 Bar / 90 psi pressure and 4 Cubic feet per minute output. Please Note This product is not over paintable

J41231 £13.75



Dinitrol ML Brown Cavity Wax Rust Proofing 1 Litre

Supplied in 1 Litre tins Dinitrol ML is a oil based corrosion and protection product specially designed for applying in cavities such as inner sill sections, front valance, door bottoms etc.

Sprayed using a Schutz gun once applied ML forms a soft and wear resistant film that effectively eliminates dampness and helps prevent corrosion.

J41224 £14.75



Dinitrol 445 Black Stone Chip 1 litre

Dinitrol 445 Black is a black polymer based anti drone effect elastic stone chip. Over paintable this also offers protection against corrosion. After drying, the materials are resistant to carbon hydride-based cold cleaning agents, surfactant-based acid and alkaline high pressure cleaners, salt water and road salt.

To apply you will require a schutz gun and a compressor with 6 Bar / 90 psi pressure and 4 Cubic feet per minute output.

J41237 £12.50



Dinitrol HS 3125 Cavity Wax 1ltr

Dinitrol HS 3125 is a oil based corrosion and protection product specially designed for applying in cavities such as inner sill sections, front valance, door bottoms etc.

With its rust fighting properties this product is ideal for use in older vehicles.

J41367 £15.50



Dinitrol 4941 Under Body Wax 5 Litre

Dinitrol 4941 offers long term resistance against corrosion and abrasion even under extreme conditions. Once applied the solvents disperse leaving a tough black elastic protective film that is heat resistant with the added bonus of offering a degree of sound deadening.

Sold in 5 litre tins to apply you will require either a manual pump J40787 or a air fed wax injection gun.

Please Note: This product is not over paintable

J41236 £66.50



Dinitrol ML Brown Cavity Wax Rust Proofing 5 Litre

Supplied in 5 Litre tins Dinitrol ML is a oil based corrosion and protection product specially designed for applying in cavities such as inner sill sections, front valance, door bottoms etc.

Sprayed using a wax cavity gun once applied ML forms a soft and wear resistant film that effectively eliminates dampness and helps prevent corrosion.

J41448 £65.00



10mm Cavity Plugs For Rustproofing (Pk of 12)

Sold in bags of 12 these tapered 10mm plastic plugs are used to blank of new holes required when rustproofing box sections on your vehicle such as inner sills valances etc.

J41226 £0.70



Dinitrol RC800 Rust Treatment 1ltr

Sold in 1 litre bottles Dinitrol RC800 is a polymer based rust treatment that when applied it converts rust in to a stable organic iron complex. As it dries it forms an impregnable barrier to oxygen and moisture thus sealing out any further corrosion.

Free from solvent, acid and lead RC800 can be over painted as long as its pre treated with a primer.

J41233 £35.50



Dinitrol MS40 Rust Protection / Lubricant Spray 400ml Aerosol

Dinitrol MS40 is a multipurpose lubricant and rust preventative, non greasy water repellent. Silicone free MS40 will not effect most plastics, rubber or lacquers.

MS40 protects metal from corrosion, dirt and water whilst penetrating rust to release seized nuts bolts and screws used as a lubricant it stops screeching immediately It dissolves adhesives and easily removes labels and adhesives tapes.

J41234 £7.25

BRAKING SYSTEM

BRAKE MASTER & WHEEL CYLINDERS



Brake Fluid Reservoir VW T25 1980-1992

Genuine VW product. Supplied complete with cap. Fits T25s with servo brakes from 1979 to 1992.

J40292 251-611-301/S £44.75



Master Cylinder Blanking Plug M10x1 VW T25 1979-1992

M10x1 master cylinder blanking plug. Fits VW T25s from 1979 to 1992.

J40742 214-611-225 £1.45

BRAKE PIPES & HOSES



Brake Hose (Rear) 1979 to 1992

Alternative quality product. 183mm rear brake hose, with female fittings at both ends.

J10250A 171-611-775 £6.50



Front Brake Pipe 110mm VW T25 1979-1984

Cupro Nickel front brake pipe. Supplied complete with the required ends. 110mm long. Located from the front brake flexi to the front calliper.

J40673 £6.00



Front Brake Pipe 120mm VW T25 1979-1992

Made in the UK exclusively for JK. Supplied with the required ends. Located from the front brake flexi to the front calliper.

J40672 £6.00



Front Brake Pipe 305mm VW T25 1984-1992

Made in the UK for JK. 305mm Cupro Nickel front brake pipe. Supplied complete with the required ends.

J40689 £7.50



Front Brake Pipe 500mm VW T25 1979-1984

Made in the UK for Just Kampers this Cupro Nickel front brake pipe is supplied complete with the required ends. Measuring 500mm long this pipe goes from the front T piece to the front brake flexi

Please check length before ordering.

J40674 £7.50



Front Brake Pipe 950mm VW T25 1979-1984

Made in the UK for JK. Cupro Nickel front brake pipe. Supplied complete with the required ends.

J40677 £9.00



Front Brake Pipe 950mm VW T25 1984-1992

Quality Just Kampers product. Made in the UK. 950mm. Cupro Nickel front brake pipe. Supplied complete with the required ends. Located from the rear T piece to the rear flexi pipe. Can also be used from the first joiner after the master cylinder running back to the rear of the vehicle.

Please check length before ordering.

J40688 £9.00



Front Brake Pipe 1100mm VW T25 1979-1984

Made in the UK for JK. Supplied complete with the required ends. Located from the master cylinder to the first joiner.

J40682 £9.00



Front Brake Pipe 1200mm VW T25 1979-1984

Made in the UK for Just Kampers this Cupro Nickel front brake pipe is supplied complete with the required ends. Measuring 1200mm long this pipe goes from the master cylinder to the first joiner. Please check length before ordering.

J40676 £9.00



Front Brake Pipe 1200mm VW T25 1984-1992

Quality JK product. Made in UK. 1200mm cupro nickel brake pipe. Supplied with required ends.

J40700 £9.00

SWITCHES, IGNITION SWITCHES & KEYS



Coolant Level Switch VW T25 1985-1992
Quality Febi product. Fits all petrol injection VW T25 models from 1985 to 1992.

J19814 251-919-372/A **£8.00**

WIPER BLADES, MOTORS & SWITCHES



Non Return Valve For Washer Jet All Vehicles with Electric, Manual Washer Pumps
Good quality reproduction product. Non-return valve for washer jets. Prevents water from the water jets draining back into the tank. Ideal for all vehicles with electric, manually operated washer pumps.

J41977 113-955-975/C **£3.20**

ENGINE



Air Intake Boot T25 1980-1985 1900cc Injection
Air intake boot. Fits 1900cc VW T25s from 1980 to 1985 with fuel injection systems.

J40782 025-129-967/A **£24.75**

BARREL & PISTON



94mm Kolbenschmidt Piston Rings VW T25 2100cc Watercooled 1985-1992
Complete set of Kolbenschmidt 94mm piston rings for one piston. Fits VW T25s with 2100cc engines from 1985 and 1992.

J41567 **£22.75**

CAM BELTS & TENSIONERS



Timing Belt for Diesel and Turbo Diesel 1981 to 1992
Alternative quality product. 1285.9mm long by 25.4mm wide with 135 teeth. We also stock a best quality Febi belt: J10443.

J10443A 068-109-119/E **£16.00**



Woodruff Key Crankshaft Pulley VW T25 Petrol 1.6 CT 1.9 DG, 2.1 DJ 1980-1992
Woodruff key for the crankshaft pulley on petrol T25s. Ideal for 1.6 CT, 1.9 DG and 2.1 DJ engines from 1980 to 1992.

J41740 113-105-249 **£2.35**

CARBURETOR, MANIFOLDS & REBUILD KITS



Carb To Manifold Gasket 2000cc Aircooled VW T25 1979-1983
Thick heat insulation gasket as used between the carburettor and inlet manifold.

J41397 071-129-795 **£10.25**



CSP Fuel Pump Block Off Plate Type 4, T25 1979-1983
Quality CSP product. Fits 1700cc, 1800cc and 2000cc Type 4 engine crankcase from 1979 to 1983.

J32074 127-30-3 4/00 **£11.25**



Air Hose 1Meter 1900 Diesel 1990 to 1996
Cardboard air hose. 50mm diameter. Ducts air from the fan housing down to your heat exchangers.

J10487 028-129-087/A **£4.45**



Idling Stabiliser Unit (GH/CT/CU)
Genuine Volkswagen product. Fits VW T25s from 1979 to 1983.

J11115 251-906-083/ **£165.00**



Vacuum Unit Pierburg 2E3 / 2E4 VW T25 1900cc 1983-1992
Operates 2nd choke on Pierburg 2E3 and 2E4 carburettors, on 1900cc DG VW T25s from 1983 to 1992.

J40331 025-129-061 **£54.50**



Fuel Fittings (1/4" (Pair)
Quality EMPI product. Pair of 6mm 1/4" barbed fuel fittings.

J13374 00-910-3-0/ **£5.75**



Barbed Fuel Fittings (5/16" (Pair)
Quality EMPI product. Pair of 8mm 5/16" barbed fuel fittings.

J13373 9097 **£5.00**



Mount For Fuel Pressure Regulator
Quality EMPI product. Mounting bracket for fuel pressure regulator (J13371).

J13372 9090 **£5.75**

CLUTCH COMPONENTS



Clutch Slave Cylinder VW T25 Bosch OE Quality
OE quality Bosch clutch slave cylinder, fits all VW T25s built from 1980 to 1992.

J41985 251-721-263/A **£59.00**



Clutch Master Cylinder 1980 to 1992
Alternative quality clutch master cylinder. Fits all VW T25s from 1980 to 1992. Best Quality: J10710

J10710A 251-721-401/A **£37.50**



Flywheel VW T25 1600cc Diesel And Turbo Diesel 1981-1992
A brand new fly wheel. Fits 1600cc Diesel and Turbo Diesel VW T25s from 1981 to 1992.

J41888 068-105-269/A **£176.00**



Flywheel VW T25 1900cc - 2100cc 1984-1992
Brand new, reconditioned flywheel. Fits 1900cc and 2100cc VW T25s from 1984 to 1992.

J41887 105-025-271/A **£498.25**



Bolt On Clutch Cable Bowden Tube Bracket 1979-1982
This bracket bolts to the side of the gearbox and holds the conduit in place.

J35712 16-990-7-0 **£9.25**



Clutch Operating Shaft Bush VW T25 1979-1982
Genuine VW product. Located to the right side of the gearbox bellhousing (starter motor side).

J40802 113-141-711/A **£6.50**



Clutch Shaft Rubber Bush VW T25 1979-1992
Genuine Volkswagen product. Clutch operating shaft bush / seal.

J40803 113-141-721/A **£2.50**

COOLING SYSTEM



Coolant Hose Clamp T25 32mm
Good quality reproduction product. 32mm. Fits watercooled VW T25s from 1983 to 1992.

J40943 N0164041 **£1.90**



Coolant Hose Clamp T25 40mm
Good quality reproduction product. 40mm. Fits watercooled VW T25s from 1983 to 1992.

J40944 N0164041 **£2.90**



Coolant Hose Clamp T25 19mm
Good quality reproduction product. 19mm. Fits watercooled VW T25s from 1983 to 1992.

J40945 N0164011 **£2.10**



Coolant Hose Clamp VW T25 18mm
Good quality reproduction product. 18mm. Fits watercooled VW T25s from 1983 to 1992.

J40946 N10-098-001 **£1.45**



Coolant Hose Clamp T25 47mm
Good quality reproduction product. 47mm. Fits watercooled VW T25s from 1983 to 1992.

J40947 N0164091 **£2.45**



Coolant Hose Pipe T25
Good quality reproduction product. Fits watercooled VW T25s from 1983 to 1992.

J40948 251-121-102 **£8.25**



Coolant hose clamp T25 23mm
23mm clamp for the coolant hose. Fits watercooled VW T25s from 1983 to 1992.

J40949 N0164021 **£1.45**



Coolant Hose Clamp T25 27mm
27mm clamp for the coolant hose. Fits watercooled VW T25s from 1983 to 1992.

J40951 N0164031 **£1.90**



Stainless Steel Metal Waterpipe 1900,2100cc 1985-1992
Made exclusively for Just Kampers this Stainless Steel water pipe fits from the water pump
J39119 025-121-081/G..... **£96.25**



Metal Waterpipe (L-Shaped) 1900, 2100cc 1985 To 1992
Quality Just Kampers product. JK exclusive.
We recommend you change the O ring at the same time.
J10912 025-121-081/G..... **£64.50**



Stainless Steel Metal Water Pipe 1983 to 1992 1900cc-2100cc
SSupplied complete with fittings. Located to the water pump, just below the pulley.
J40950 025-121-151..... **£67.75**



Water Pipe Thermostat to Cylinder Head 1900cc 1983-1985
This stainless steel water pipe located from the right hand cylinder head to the thermostat housing
J40154 025-121-180/A..... **£70.00**



Manifold Hose 1900cc 1983-1985
This water hose goes from the flange on the left cylinder head to the the inlet manifold.
J41097 025-121-058/A..... **£3.50**



Expansion Bottle Hose 1900, 2100cc 1985-1992
This hose goes from the top of the header tank to the T piece on the plastic bleed rail
J41099 025-121-058/H..... **£10.25**



Water Hose (Right Manifold To Carburettor) VW T25 1900cc DG 1982-1992
Replacement water hose. Fits the right-hand side manifold to the carburettor on 1900cc DG engined VW T25s from 1982 to 1992.
J41913 025-121-060..... **£20.75**



Water Hose Return Pipe To Thermostat Housing VW T25 1900cc 1983-1985
This replacement water hose runs from the return pipe to the bleed valve on 1900cc VW T25s built from 1983 to 1985.
J41915 025-121-062..... **£45.00**



Water Pump Hose VW T25 1600cc Turbo Diesel & 1700cc Diesel 1980-1992
Located from the water pump to the radiator and includes a T off to go to the electric water pump.
J41098 068-121-073/H..... **£26.50**



Water Hose 1600cc Turbo Diesel 1700cc Diesel 1979-1992
This water hose goes from the water pump to the radiator with the take off for the oil cooler
J41101 068-121-073/G..... **£18.25**



Coolant Hose From Water Pump To Lower Valve 1983-1985
Coolant hose that joins the water pump to the 4 way junction / lower valve.
J42085 025-121-108/A..... **£7.50**



O Ring Water pipe Thermostat Housing 1900cc 1983-1985
O ring measures 25 x 3.55mm fits the solid water pipe from the thermostat housing to the water pump.
J41075 N0282252..... **£1.25**



Water pipe Gasket Thermostat Housing 1900,2100cc 1984-1992
This gasket fits between the thermostat housing and the right hand cylinder head
J41076 N90-168-502..... **£1.25**



Water Pump All Diesel Engines 1985 to 1987
Quality Febi product. Fits diesel T25s from 1985 to 1992.
J10485 037-121-005/C..... **£19.75**



Water Pump All Diesel Engines 1985 to 1987
Alternative quality product.
We also stock a best quality water pump: J10485
J10485A 037-121-005/C..... **£15.00**



Waterpump Pulley (Rear Half) 1900 - 2100cc 1983 to 1992
This OEM part is the outer half closest to the pump.
J10417 025-121-031/B..... **£9.75**



Type 25 Diesel Water Expansion Tank (NOS)
Type 25 Diesel Water Expansion Tank
J21335 068-121-405/B..... **£91.50**



Coolant Level Switch VW T25 1985-1992
Quality Febi product. Fits all petrol injection VW T25 models from 1985 to 1992.
J19814 251-919-372/A..... **£8.00**

CYLINDER HEADS & PARTS



Adjustable Spring Loaded Push Rod Tubes (Set of 8)
Fits 1900cc - 2100cc Watercooled Set of 8
J27882 **£64.25**



CSP Adjustable Push Rod Tubes 1600,1900,2100cc Watercooled.
CNC-machined seal faces help guarantee a perfect fit stainless steel spring & Viton inner seals.
J31998 109-337-111MT..... **£169.50**



Adjustable Spring Loaded Push Rod Tube VW T25 1983-1992
Quality Scat product. Finished in gold, supplied individually and with all the seals to fit.
J27886 **£10.00**



Stainless Steel Push Rod Tube 2000cc Aircooled
Quality Preservation Parts product. Sold individually. Fits all 2000cc VW T25s from 1979 to 1983.
J19231 021-109-335/C..... **£8.75**



Cylinder Head Nut 10mm VW T25 2000cc 1979-1983
10mm cylinder head nuts. Suitable for 1700cc, 1800cc and 2000cc Type 4 engines
J40121 021-101-457..... **£1.45**



Domed Head Nut for Cylinder Head Studs 1900-2100cc
Genuine VW product. Fits T25 cylinder head studs. 16 required per vehicle.
J29190 N90-184-101..... **£5.50**



Rocker Shaft Thrust Washer VW T25 Petrol 1979-1992
Flat washer for the rocker shaft. Sold individually. Sixteen of these per engine.
J39974 025-109-435..... **£1.15**



Exhaust Valve 33mm VW T25 2000cc 1979-1983
33mm Exhaust valve. Fits 2000cc Aircooled VW T25s from 1979 to 1983.
J40107 022-109-612/D..... **£10.75**



Valve Spring Retainer VW T25 1600 1979-1983
Good quality reproduction product. Sold individually. Valve spring retainers.
J39976 113-109-641/B..... **£2.50**



Cam Follower Shim 3.5mm Diesel VW T25 1980-1992
3.5mm cam follower shim. Allows you to adjust your valve clearances to eliminate noisy tappets.
J42109 **£2.50**



Cam Follower Shim 3.3mm Diesel VW T25 1980-1992
Allows you to adjust your valve clearances to eliminate noisy tappets.
J42105 056-109-561..... **£2.50**



Cam Follower Shim 3.35mm Diesel VW T25 1980-1992
Allows you to adjust your valve clearances to eliminate noisy tappets.
J42106 056-109-562..... **£2.55**



Cam Follower Shim 3.4mm Diesel VW T25 1980-1992
3.4mm cam follower shim. Allows you to adjust your valve clearances to eliminate noisy tappets.
J42107 056-109-563..... **£2.50**



Cam Follower Shim 3.45mm Diesel VW T25 1980-1992
3.45mm cam follower shim. Allows you to adjust your valve clearances to eliminate noisy tappets.
J42108 056-109-564..... **£2.20**



Cam Follower Shim 3.55mm Diesel VW T25 1980-1992
3.55mm cam follower shim. Allows you to adjust your valve clearances to eliminate noisy tappets.
J42110 056-109-566..... **£2.50**

SWITCHES, IGNITION SWITCHES & KEYS



Coolant Level Switch VW T25 1985-1992
Quality Febi product. Fits all petrol injection VW T25 models from 1985 to 1992.
J19814 251-919-372/A **£8.00**

WIPER BLADES, MOTORS & SWITCHES



Non Return Valve For Washer Jet All Vehicles with Electric, Manual Washer Pumps
Good quality reproduction product. Non-return valve for washer jets. Prevents water from the water jets draining back into the tank. Ideal for all vehicles with electric, manually operated washer pumps.
J41977 113-955-975/C **£3.20**

ENGINE



Air Intake Boot T25 1980-1985 1900cc Injection
Air intake boot. Fits 1900cc VW T25s from 1980 to 1985 with fuel injection systems.
J40782 025-129-967/A **£24.75**

BARREL & PISTON



94mm Kolbenschmidt Piston Rings VW T25 2100cc Watercooled 1985-1992
Complete set of Kolbenschmidt 94mm piston rings for one piston. Fits VW T25s with 2100cc engines from 1985 and 1992.
J41567 **£22.75**

CAM BELTS & TENSIONERS



Timing Belt for Diesel and Turbo Diesel 1981 to 1992
Alternative quality product. 1285.9mm long by 25.4mm wide with 135 teeth. We also stock a best quality Febi belt: J10443.
J10443A 068-109-119/E **£16.00**



Woodruff Key Crankshaft Pulley VW T25 Petrol 1.6 CT 1.9 DG, 2.1 DJ 1980-1992
Woodruff key for the crankshaft pulley on petrol T25s. Ideal for 1.6 CT, 1.9 DG and 2.1 DJ engines from 1980 to 1992.
J41740 113-105-249 **£2.35**

CARBURETOR, MANIFOLDS & REBUILD KITS



Carb To Manifold Gasket 2000cc Aircooled VW T25 1979-1983
Thick heat insulation gasket as used between the carburettor and inlet manifold.
J41397 071-129-795 **£10.25**



CSP Fuel Pump Block Off Plate Type 4, T25 1979-1983
Quality CSP product. Fits 1700cc, 1800cc and 2000cc Type 4 engine crankcase from 1979 to 1983.
J32074 127-30-3 4/00 **£11.25**



Air Hose 1Meter 1900 Diesel 1990 to 1996
Cardboard air hose. 50mm diameter. Ducts air from the fan housing down to your heat exchangers.
J10487 028-129-087/A **£4.45**



Idling Stabiliser Unit (GH/CT/CU)
Genuine Volkswagen product. Fits VW T25s from 1979 to 1983.
J11115 251-906-083/ **£165.00**



Vacuum Unit Pierburg 2E3 / 2E4 VW T25 1900cc 1983-1992
Operates 2nd choke on Pierburg 2E3 and 2E4 carburettors, on 1900cc DG VW T25s from 1983 to 1992.
J40331 025-129-061 **£54.50**



Fuel Fittings (1/4" (Pair)
Quality EMPI product. Pair of 6mm 1/4" barbed fuel fittings.
J13374 00-910-3-0/ **£5.75**



Barbed Fuel Fittings (5/16" (Pair)
Quality EMPI product. Pair of 8mm 5/16" barbed fuel fittings.
J13373 9097 **£5.00**



Mount For Fuel Pressure Regulator
Quality EMPI product. Mounting bracket for fuel pressure regulator (J13371).
J13372 9090 **£5.75**

CLUTCH COMPONENTS



Clutch Slave Cylinder VW T25 Bosch OE Quality
OE quality Bosch clutch slave cylinder, fits all VW T25s built from 1980 to 1992.
J41985 251-721-263/A **£59.00**



Clutch Master Cylinder 1980 to 1992
Alternative quality clutch master cylinder. Fits all VW T25s from 1980 to 1992. Best Quality: J10710
J10710A 251-721-401/A **£37.50**



Flywheel VW T25 1600cc Diesel And Turbo Diesel 1981-1992
A brand new fly wheel. Fits 1600cc Diesel and Turbo Diesel VW T25s from 1981 to 1992.
J41888 068-105-269/A **£176.00**



Flywheel VW T25 1900cc - 2100cc 1984-1992
Brand new, reconditioned flywheel. Fits 1900cc and 2100cc VW T25s from 1984 to 1992.
J41887 105-025-271/A **£498.25**



Bolt On Clutch Cable Bowden Tube Bracket 1979-1982
This bracket bolts to the side of the gearbox and holds the conduit in place.
J35712 16-990-7-0 **£9.25**



Clutch Operating Shaft Bush VW T25 1979-1982
Genuine VW product. Located to the right side of the gearbox bellhousing (starter motor side).
J40802 113-141-711/A **£6.50**



Clutch Shaft Rubber Bush VW T25 1979-1992
Genuine Volkswagen product. Clutch operating shaft bush / seal.
J40803 113-141-721/A **£2.50**

COOLING SYSTEM



Coolant Hose Clamp T25 32mm
Good quality reproduction product. 32mm. Fits watercooled VW T25s from 1983 to 1992.
J40943 N0164041 **£1.90**



Coolant Hose Clamp T25 40mm
Good quality reproduction product. 40mm. Fits watercooled VW T25s from 1983 to 1992.
J40944 N0164041 **£2.90**



Coolant Hose Clamp T25 19mm
Good quality reproduction product. 19mm. Fits watercooled VW T25s from 1983 to 1992.
J40945 N0164011 **£2.10**



Coolant Hose Clamp VW T25 18mm
Good quality reproduction product. 18mm. Fits watercooled VW T25s from 1983 to 1992.
J40946 N10-098-001 **£1.45**



Coolant Hose Clamp T25 47mm
Good quality reproduction product. 47mm. Fits watercooled VW T25s from 1983 to 1992.
J40947 N0164091 **£2.45**



Coolant Hose Pipe T25
Good quality reproduction product. Fits watercooled VW T25s from 1983 to 1992.
J40948 251-121-102 **£8.25**



Coolant hose clamp T25 23mm
23mm clamp for the coolant hose. Fits watercooled VW T25s from 1983 to 1992.
J40949 N0164021 **£1.45**



Coolant Hose Clamp T25 27mm
27mm clamp for the coolant hose. Fits watercooled VW T25s from 1983 to 1992.
J40951 N0164031 **£1.90**



Stainless Steel Metal Waterpipe 1900,2100cc 1985-1992
Made exclusively for Just Kampers this Stainless Steel water pipe fits from the water pump
J39119 025-121-081/G..... **£96.25**



Metal Waterpipe (L-Shaped) 1900, 2100cc 1985 To 1992
Quality Just Kampers product. JK exclusive.
We recommend you change the O ring at the same time.
J10912 025-121-081/G..... **£64.50**



Stainless Steel Metal Water Pipe 1983 to 1992 1900cc-2100cc
SSupplied complete with fittings. Located to the water pump, just below the pulley.
J40950 025-121-151..... **£67.75**



Water Pipe Thermostat to Cylinder Head 1900cc 1983-1985
This stainless steel water pipe located from the right hand cylinder head to the thermostat housing
J40154 025-121-180/A..... **£70.00**



Manifold Hose 1900cc 1983-1985
This water hose goes from the flange on the left cylinder head to the the inlet manifold.
J41097 025-121-058/A..... **£3.50**



Expansion Bottle Hose 1900, 2100cc 1985-1992
This hose goes from the top of the header tank to the T piece on the plastic bleed rail
J41099 025-121-058/H..... **£10.25**



Water Hose (Right Manifold To Carburettor) VW T25 1900cc DG 1982-1992
Replacement water hose. Fits the right-hand side manifold to the carburettor on 1900cc DG engined VW T25s from 1982 to 1992.
J41913 025-121-060..... **£20.75**



Water Hose Return Pipe To Thermostat Housing VW T25 1900cc 1983-1985
This replacement water hose runs from the return pipe to the bleed valve on 1900cc VW T25s built from 1983 to 1985.
J41915 025-121-062..... **£45.00**



Water Pump Hose VW T25 1600cc Turbo Diesel & 1700cc Diesel 1980-1992
Located from the water pump to the radiator and includes a T off to go to the electric water pump.
J41098 068-121-073/H..... **£26.50**



Water Hose 1600cc Turbo Diesel 1700cc Diesel 1979-1992
This water hose goes from the water pump to the radiator with the take off for the oil cooler
J41101 068-121-073/G..... **£18.25**



Coolant Hose From Water Pump To Lower Valve 1983-1985
Coolant hose that joins the water pump to the 4 way junction / lower valve.
J42085 025-121-108/A..... **£7.50**



O Ring Water pipe Thermostat Housing 1900cc 1983-1985
O ring measures 25 x 3.55mm fits the solid water pipe from the thermostat housing to the water pump.
J41075 N0282252..... **£1.25**



Water pipe Gasket Thermostat Housing 1900,2100cc 1984-1992
This gasket fits between the thermostat housing and the right hand cylinder head
J41076 N90-168-502..... **£1.25**



Water Pump All Diesel Engines 1985 to 1987
Quality Febi product. Fits diesel T25s from 1985 to 1992.
J10485 037-121-005/C..... **£19.75**



Water Pump All Diesel Engines 1985 to 1987
Alternative quality product.
We also stock a best quality water pump: J10485
J10485A 037-121-005/C..... **£15.00**



Waterpump Pulley (Rear Half) 1900 - 2100cc 1983 to 1992
This OEM part is the outer half closest to the pump.
J10417 025-121-031/B..... **£9.75**



Type 25 Diesel Water Expansion Tank (NOS)
Type 25 Diesel Water Expansion Tank
J21335 068-121-405/B..... **£91.50**



Coolant Level Switch VW T25 1985-1992
Quality Febi product. Fits all petrol injection VW T25 models from 1985 to 1992.
J19814 251-919-372/A..... **£8.00**

CYLINDER HEADS & PARTS



Adjustable Spring Loaded Push Rod Tubes (Set of 8)
Fits 1900cc - 2100cc Watercooled Set of 8
J27882 **£64.25**



CSP Adjustable Push Rod Tubes 1600,1900,2100cc Watercooled.
CNC-machined seal faces help guarantee a perfect fit stainless steel spring & Viton inner seals.
J31998 109-337-111MT..... **£169.50**



Adjustable Spring Loaded Push Rod Tube VW T25 1983-1992
Quality Scat product. Finished in gold, supplied individually and with all the seals to fit.
J27886 **£10.00**



Stainless Steel Push Rod Tube 2000cc Aircooled
Quality Preservation Parts product. Sold individually. Fits all 2000cc VW T25s from 1979 to 1983.
J19231 021-109-335/C..... **£8.75**



Cylinder Head Nut 10mm VW T25 2000cc 1979-1983
10mm cylinder head nuts. Suitable for 1700cc, 1800cc and 2000cc Type 4 engines
J40121 021-101-457..... **£1.45**



Domed Head Nut for Cylinder Head Studs 1900-2100cc
Genuine VW product. Fits T25 cylinder head studs. 16 required per vehicle.
J29190 N90-184-101..... **£5.50**



Rocker Shaft Thrust Washer VW T25 Petrol 1979-1992
Flat washer for the rocker shaft. Sold individually. Sixteen of these per engine.
J39974 025-109-435..... **£1.15**



Exhaust Valve 33mm VW T25 2000cc 1979-1983
33mm Exhaust valve. Fits 2000cc Aircooled VW T25s from 1979 to 1983.
J40107 022-109-612/D..... **£10.75**



Valve Spring Retainer VW T25 1600 1979-1983
Good quality reproduction product. Sold individually. Valve spring retainers.
J39976 113-109-641/B..... **£2.50**



Cam Follower Shim 3.5mm Diesel VW T25 1980-1992
3.5mm cam follower shim. Allows you to adjust your valve clearances to eliminate noisy tappets.
J42109 **£2.50**



Cam Follower Shim 3.3mm Diesel VW T25 1980-1992
Allows you to adjust your valve clearances to eliminate noisy tappets.
J42105 056-109-561..... **£2.50**



Cam Follower Shim 3.35mm Diesel VW T25 1980-1992
Allows you to adjust your valve clearances to eliminate noisy tappets.
J42106 056-109-562..... **£2.55**



Cam Follower Shim 3.4mm Diesel VW T25 1980-1992
3.4mm cam follower shim. Allows you to adjust your valve clearances to eliminate noisy tappets.
J42107 056-109-563..... **£2.50**



Cam Follower Shim 3.45mm Diesel VW T25 1980-1992
3.45mm cam follower shim. Allows you to adjust your valve clearances to eliminate noisy tappets.
J42108 056-109-564..... **£2.20**



Cam Follower Shim 3.55mm Diesel VW T25 1980-1992
3.55mm cam follower shim. Allows you to adjust your valve clearances to eliminate noisy tappets.
J42110 056-109-566..... **£2.50**

K JK Conversions



We stock a range of products for campervans, motorhome, caravans, trailer conversions, horse boxes, catering vans and a whole host of other vehicles that will help you to quickly and affordably transform these into your ideal home-away-from-home.

This is a new venture for us, which focusses on combining our 28 years of experience in sourcing and creating top quality products, with a sales and aftercare service that has earned us high praise on both Trust Pilot and Google Reviews.



EBI SHOW

We sent Gemma from the JK Purchasing Team, and Duncan from the Export Department over to European Bug-In in the summer, for their first ever show across the Channel! They went in Jack the Giant Slayer, and the pair had an amazing time at the show (despite the weather). It's always one of our favourite events!

★ **NEW PARTS ADDED** ★

We've added **over 1,000 new parts & accessories** to our range here at JK, and have had to expand our warehouse yet again to fit them in. This is becoming something of a yearly tradition here at JK HQ as we need more and more space to hold our stock!

**COME AND SEE OUR
NEW SHOP
& AWNING DISPLAY
OPENS DECEMBER 2017**

Unit 1, Stapeley Manor, Long Lane, Odiham, Hampshire. RG29 1JE

HESSISCH OLDENDORF

After JK made such a place at the Mille Miglia, they were invited to bring the Beetle 'Jack the Giant Slayer' to the famous *Hessisch Oldendorf* show in Germany. The show was a lot of fun, and we're already looking forward to the next one in four year's time.



PRESERVATION PARTS

Over 470 parts in the range

We've scoured the globe to bring together the very best parts and accessories to create our **exclusive** Preservation Parts range. These are a showcase of the highest quality parts available anywhere in the world.

To become a Preservation Parts product, it must:

- Be as good as the original part
- Be manufactured by a reputable company
- Fit an Aircooled VW
- Be great value for money
- Pass our stringent quality control



K Insurance

**WIN THIS
Year**



**DECEMBER
2017**

★ **WIN** ★
**A 1977 WESTFALIA
CAMPER IN 2018**

IT'S BEEN A BUSY YEAR AT JUST KAMPERS.

Here's some of the things we were
doing in 2017.

WHERE WILL YOU GO IN YOUR VW IN 2018?



MILLE MIGLIA

Earlier this year, the JK Team took part in the 90th Mille Miglia, a gruelling 1,000mile classic car rally around Italy. The vehicle they raced in was Jack the Giant Slayer, JK's 1956 Oval Beetle that really lived up to it's name. JK started out as car 429, but finished in 223 place, well within the top 50%.

The Mille Miglia was also a fantastic opportunity for JK to test out their ever-expanding range of parts and accessories, as they needed to get Jack ready for the event. Many of these new products are now on the shelves at JK.



This summer Mark Reynolds, who set up JK back in 1989, took some time off for his 50th birthday to travel around Italy with his wife, Kerry. They took a relaxed route through the countryside, enjoying the weather in Mark's 1967 Beetle Cabriolet, built just two weeks before he was born!



Join us for the weekend and enjoy an outdoor cinema, great food, music and good times in the beautiful Hampshire countryside. All proceeds go directly to Cancer Research UK.

8-10TH JUNE 2018

Look for event details on our facebook page

BEACH CLEAN

As Surfers Against Sewage 250 Club Members we are keen to support SAS in any way we can. Most recently we've been attending their Beach Clean series.

During the 2017 series 475 beach cleans took place, removing an amazing 55 tonnes of plastic from our beaches.

In October, 18 of the JK team headed down to Bracklesham Bay. Our most disturbing find: a bottle top from 1972. Plastic is a real problem for the environment and we're happy to support SAS in their work to tackle it.



For more info: www.sas.org.uk

THE JK WAREHOUSE

We've just added another 3,000 square feet to our existing warehouse space, allowing us to store the hundreds of new products that we'll be adding into our range over the next few months. This brings our total warehouse space to nearly 40,000 square feet!

When we first arrived at JK HQ in 1999 we occupied a tiny space and wondered how we'd ever fill our little corner. Now, the space we originally took on only just fits in our Dispatch Department! We send out over 100,000 orders each year, and our warehouse is now open from 7am to 7pm, seven days a week. We've come a long way since 1999, and continue to grow all the time!



Cam Follower Shim 3.6mm Diesel VW T25 1980-1992

3.6mm cam follower shim. Allows you to adjust your valve clearances to eliminate noisy tappets.

J42111 056-109-567..... **£2.50**

Cam Follower Shim 3.65mm Diesel VW T25 1980-1992

3.65mm cam follower shim. Allows you to adjust your valve clearances to eliminate noisy tappets.

J42112 056-109-568..... **£2.50**

Cam Follower Shim 3.7mm Diesel VW T25 1980-1992

3.7mm cam follower shim. Allows you to adjust your valve clearances to eliminate noisy tappets.

J42113 056-109-569..... **£2.50**

Cam Follower Shim 3.75mm Diesel VW T25 1980-1992

3.75mm cam follower shim. Allows you to adjust your valve clearances to eliminate noisy tappets.

J42114 056-109-570..... **£2.50**

Cam Follower Shim 3.8mm Diesel VW T25 1980-1992

3.8mm cam follower shim. Allows you to adjust your valve clearances to eliminate noisy tappets.

J42115 056-109-571..... **£2.50**

Cam Follower Shim 3.85mm Diesel VW T25 1980-1992

3.85mm cam follower shim. Allows you to adjust your valve clearances to eliminate noisy tappets.

J42116 056-109-572..... **£2.50**

Cam Follower Shim 3.9mm Diesel VW T25 1980-1992

3.85mm cam follower shim. Allows you to adjust your valve clearances to eliminate noisy tappets.

J42117 056-109-573..... **£2.50**

Cam Follower Shim 3.95mm Diesel VW T25 1980-1992

3.95mm cam follower shim. Allows you to adjust your valve clearances to eliminate noisy tappets.

J42118 056-109-574..... **£2.50**

Cam Follower Shim 4mm Diesel VW T25 1980-1992

4mm cam follower shim. Allows you to adjust your valve clearances to eliminate noisy tappets.

J42119 056-109-575..... **£2.50**

Cam Follower Shim 4.05mm Diesel VW T25 1980-1992

4.05mm cam follower shim. Allows you to adjust your valve clearances to eliminate noisy tappets.

J42120 056-109-576..... **£2.50**

Cam Follower Shim 4.1mm Diesel VW T25 1980-1992

4.1mm cam follower shim. Allows you to adjust your valve clearances to eliminate noisy tappets.

J42121 056-109-577..... **£2.50**

Cam Follower Shim 4.15mm Diesel VW T25 1980-1992

4.15mm cam follower shim. Allows you to adjust your valve clearances to eliminate noisy tappets.

J42122 056-109-578..... **£2.50**

Cam Follower Shim 4.2mm Diesel VW T25 1980-1992

4.2mm cam follower shim. Allows you to adjust your valve clearances to eliminate noisy tappets.

J42123 056-109-579..... **£2.50**

Cam Follower Shim 4.25mm Diesel VW T25 1980-1992

4.25mm cam follower shim. Allows you to adjust your valve clearances to eliminate noisy tappets.

J42124 056-109-580..... **£2.50**

ENGINE GASKET SETS & SEALS

Flywheel O-ring 2000cc Aircooled 1979 to 1983

O ring that fits between the flywheel and the crank.

J60651 021-105-279..... **£0.95**

Needle Bearing Seal VW T25 2000cc Aircooled 1979-1983

This is the felt seal between the needle bearing and fly wheel as used on VW T25 with the 2000cc aircooled engines.

J40089 021-105-311..... **£0.80**

ENGINE MOUNTS

Starter Motor D Bolt 1979-1983

Genuine VW product. Fits VW T25s with 1600cc and 2000cc air-cooled engines from 1979 to 1983.

J40329 001-199-103..... **£9.25**

FUEL SYSTEM & FILTERS

Service Kit T25 1979-1985 1900cc

Money saving bundle kit. Complete service kit for 1900cc VW T25s built from 1979 to 1985.

J41202 **£90.00**

Service Kit VW T25 2000cc Aircooled 1979-1983

Money saving bundle kit. A service kit for 2000cc Aircooled VW T25s built from 1979 to 1983.

J41201 **£98.00**

Service kit VW T25 1600cc Turbo Diesel 1981-1987

Money saving bundle kit. Complete service kit for VW T25s from 1981 to 1987 with 1600cc Turbo Diesel engines.

J41206 **£48.75**

Service Kit VW T25 1600cc, 1700cc Diesel 1981-1987

Money saving bundle kit. Complete service kit for VW T25s with 1600cc and 1700cc Non-Turbo Diesel engines.

J41205 **£42.00**

Service Kit VW T25 2100cc 1985-1992

Money saving bundle kit. Complete service kit for VW T25s fitted with the 2100cc petrol injection engines from 1985 to 1992.

J41204 **£78.25**

Service Kit VW T25 1900cc 1985-1992

Money saving bundle kit. Complete service kit for VW T25s fitted with the 1900cc petrol engine from 1985 to 1992.

J41203 **£78.25**

Breather Pipe

This is an OEM part

J10759 251-201-166/..... **£21.25**

Fuel Pump 2000cc Aircooled 1979 to 1984

Comes with gaskets. Advisable to change push rod J31081

J20006 021-127-025/A..... **£64.25**

Injection Fuel Pump VW T25 1983-1992

Good quality reproduction product. Fuel pump for use with fuel injection engines

J41665 251-906-091..... **£49.75**

CSP Fuel Pump Block Off Plate Type 4, T25 1979-1983

Quality CSP product. Fits 1700cc, 1800cc and 2000cc Type 4 engine crankcase from 1979 to 1983.

J32074 127-30-3-4/00..... **£11.25**

Diesel Filter Valve 1981 to 1992

Quality Febi product. Fits all diesel VW T25s from 1981 to 1992.

J12723 191-127-247/A..... **£5.75**

Fuel Injection Pipe Set VW T25 1600cc Diesel 1981-1987 & 1700cc Diesel 1986-1992

Good quality reproduction product. Complete set of fuel injection pipes with ends.

J41986 068-198-300..... **£61.25**

GENERAL ENGINE PARTS

Service Kit VW T25 2000cc Aircooled 1979-1983

Money saving bundle kit. A service kit for 2000cc Aircooled VW T25s built from 1979 to 1983.

J41201 **£98.00**

Service Kit T25 1979-1985 1900cc

Money saving bundle kit. Complete service kit for 1900cc VW T25s built from 1979 to 1985.

J41202 **£90.00**

Service Kit VW T25 1900cc 1985-1992

Money saving bundle kit. Complete service kit for VW T25s fitted with the 1900cc petrol engine from 1985 to 1992.

J41203 **£78.25**



Con Rod Bearing Set 0.50 VW T25 1600cc 1900cc-2100cc 1979-1992
A complete set of 0.50 mm Undersize con rod big end bearings
J39969 113-105-713..... **£11.50**



End Float Shim .30 VW T25 2000cc Aircooled 1900cc, 2100cc Watercooled 1979-1992
Genuine VW product. Sold individually. 0.30 end float shim. Fits 1900cc to 2100cc watercooled engines in VW T25s from 1983 to 1992.
J40092 021-105-281..... **£5.25**



End Float Shim .32
Genuine VW product. Sold individually. Fits 1900cc - 2100cc water-cooled engines in the VW T25s from 1983 to 1992.
J40093 021-105-283..... **£5.75**



End Float Shim .36 VW T25 2000cc Aircooled 1900cc, 2100cc Watercooled 1979-1992
Genuine VW product. Sold individually. .36 end float shim.
J40094 021-105-287..... **£5.25**



End Float Shim .38
Genuine VW product. Sold individually. Fits 1900cc - 2100cc water-cooled engines in VW T25s from 1983 to 1992.
J40095 021-105-289..... **£5.75**



Fly Wheel Locating Pin VW T2 Bay 1700,1800,2000cc 1971-1979 VW T25 2000cc Aircooled 1900,2100cc Watercooled 1979-1983
Sold as singles this 4.5 x 16 flywheel pin is used to locate the flywheel on the 1700, 1800, 2000cc Aircooled t4 engine from 1971 to 1983 and the 1900-2100cc Watercooled petrol engine from 1983 to 1992.
J40082 N01-330-91..... **£0.50**



Woodruff Key Crankshaft Pulley VW T25 Petrol 1.6 CT 1.9 DG, 2.1 DJ 1980-1992
Woodruff key for the crankshaft pulley on petrol T25s. Ideal for 1.6 CT, 1.9 DG and 2.1 DJ engines from 1980 to 1992.
J41740 113-105-249..... **£2.35**



Crankshaft Woodruff Key Large Aircooled Engines 1200cc-1600cc & Watercooled 1900cc-2100cc
Genuine VW product. Large crankshaft woodruff key. Locates the timing gear.
J39965 111-105-213..... **£4.45**



Distributor Drive Lockring
This distributor drive lock ring retains the distributor drive on to the crank shaft.
J39966 111-105-227..... **£4.25**



Needle Bearing VW T25 1900 to 2100cc
Good quality reproduction product. Replacement needle bearing.
J40090 111-105-313/A..... **£5.00**



CSP Valve Covers - Orange
Quality CSP product. Second generation Custom and Speed Parts' aluminium valve covers. Fits all Type 1 and WBX engines. Second generation Custom and Speed Parts' aluminium valve covers.
Please note: Also available in black or raw finish
J31974 101 475 113CO..... **£131.00**



Con Rod Bolt 1099,2100cc 1984-1992
These con rod bolts are the press in type with a M9 thread
J39968 113-105-425/B..... **£5.50**



CSP Fuel Pump Block Off Plate 2000cc Aircooled 1979 to 1983
Used when replacing the original mechanical fuel pump with an electric fuel pump.
J31917 127-30-3 4/00A..... **£22.00**



Turbo Charger Pressure Hose VW T25 1.6 TD JX 1984-1992
Fits between the turbo charger and the inlet manifold on VW T25s with the 1600cc turbo diesel JK engines built from 1984 to 1992.
J41482 068-129-628/E..... **£27.75**



Turbo Hose VW T4 2.5 TDI 1996-2003
This high pressure turbo to inter cooler hose fits VW T4s with the 2.5 TDI engine codes ACV, AUF, AYC, AXL
J41100 701-145-832/A..... **£39.75**

OIL SYSTEM & LUBRICANTS



Oil Drain Plug (M16 x 1.5) VW T25 1980-1992 1900cc, 2100cc
M16 x 1.5. Fits 1900cc and 2000cc VW T25s from 1980 to 1992.
J40841 N0161563..... **£10.75**



Oil Return Pipe From Turbo T25 1.6 TD JX Engine 1984-1992
Fits 1600cc Turbo Diesel VW T25s with JX engine codes from 1984 to 1992.
J31237A 068-145-735/B..... **£35.00**



Service Kit T25 1979-1985 1900cc
Money saving bundle kit. Complete service kit for 1900cc VW T25s built from 1979 to 1985.
J41202 **£90.00**



Service Kit VW T25 2000cc Aircooled 1979-1983
Money saving bundle kit. A service kit for 2000cc Aircooled VW T25s built from 1979 to 1983.
J41201 **£98.00**



Service kit VW T25 1600cc Turbo Diesel 1981-1987
Money saving bundle kit. Complete service kit for VW T25s from 1981 to 1987 with 1600cc Turbo Diesel engines.
J41206 **£48.75**



Service Kit VW T25 1600cc, 1700cc Diesel 1981-1987
Money saving bundle kit. Complete service kit for VW T25s with 1600cc and 1700cc Non-Turbo Diesel engines.
J41205 **£42.00**



Service Kit VW T25 2100cc 1985-1992
Money saving bundle kit. Complete service kit for VW T25s fitted with the 2100cc petrol injection engines from 1985 to 1992.
J41204 **£78.25**



Service Kit VW T25 1900cc 1985-1992
Money saving bundle kit. Complete service kit for VW T25s fitted with the 1900cc petrol engine from 1985 to 1992.
J41203 **£78.25**



Service Kit VW T25 1600cc Turbo Diesel 1988-1992
Money saving bundle kit. Complete service kit for VW T25s from 1988 to 1992 with 1600cc Turbo Diesel engines.
J41842 **£54.50**



Morris Golden Film Flushing Oil
Removes all traces of old oil, oil sludge and contaminating particles from your engine
J42144 **£30.00**



Oil Sump, 1600 Diesel And Turbo Diesel VW T25 1981-1992
Good quality reproduction product. Fits 1600cc diesel and turbo diesel VW T25s from 1981 to 1992.
J41010 068-103-601/AB..... **£220.25**



Breather Tower 1900, 2100cc
This plastic breather tower is mounted to the top of the engine block supplied complete with cap
J39390 025-115-451..... **£79.50**



Oil Filler Pipe VW T25 1900cc, 2100cc 1983-1992
Supplied with the plastic filler tube but will require the reuse of your old filler cap or the purchase of a new one (J19757).
J41993 025-115-302..... **£94.25**



Oil Pressure Relief Spring VW T25 1600cc, 2000cc Aircooled 1900cc, 2100cc Watercooled 1979-1992
Good quality reproduction product. Oil pressure relief valve. Fits 1600cc, 2000cc aircooled and 1900cc & 2100cc watercooled engines in VW T25s from 1979 to 1992.
J40097 021-115-421/B..... **£8.50**



Oil Pressure Relief Washer 1600,2000cc 1900,2100cc
A crush washer for use on the oil pressure relief valve
J40099 N0138293..... **£0.75**



Oil Pressure Spring Dual Relief 1600,2000cc Aircooled
This Genuine Volkswagen oil pressure relief spring measures 15 x 32.3
J40055 111-115-425/A..... **£2.25**

TOOLS



CSP Flywheel Seal Installer

Quality CSP product. Specialist tool designed for fitting the flywheel seal.

J32224 012-18-2 1/05..... **£15.75**

EXHAUST

1600 - 1700cc DIESEL WATER-COOLED



7 Piece CT Exhaust Bundle Kit (CT Engine Code)

Kit contains: T25 heat exchanger (nearside and offside), T25 heat transfer pods and pipes n/s and o/s, silencer, tailpipe and all required gaskets.

J11371 **£782.25**



Stainless Steel Exhaust 1600cc Turbo Diesel 1984-1989

lifetime guarantee against faulty workmanship or rust

J40319 **£250.00**



Stainless Steel Exhaust 1600cc Diesel 1981-1987

lifetime guarantee against faulty workmanship or rust

J40321 **£299.00**



Stainless Steel Exhaust 1600cc Turbo Diesel 1989-1992

lifetime guarantee against faulty workmanship or rust

J40322 **£299.00**



Stainless Steel Exhaust 1700cc Diesel 1986-1992

lifetime guarantee against faulty workmanship or rust

J40320 **£299.00**



Exhaust Elbow Pipe Type 25 June 1979 to July 1983 1600cc (CT)

Exhaust Elbow Pipe Type 25 June 1979 to July 1983 1600cc (CT)

J21388 070-251-108..... **£82.00**



CSP Stainless Steel Tail Pipe 2000cc Aircooled 1979 to 1983

Fits all VW T25s from 1979 to 1985 fitted with a 1700cc to 2000cc Type 4 engine.

J31821 251 185 021FE..... **£39.75**



Exhaust Manifold Washer VW T25 Diesel 1984-1992 VW T4 & VW T5 All Models

These expansion washers are used on the exhaust manifold to head studs, these are designed to expand and contract as the exhaust heats up without coming undone. Sold as singles these are used on the VW T25 Diesel from 1984 to 1992 and all VW T4 and VW T5 models.

J40341 n90-095-501..... **£3.05**

1600cc, PETROL, AIR-COOLED



Exhaust Silencer 1600cc Aircooled 1980 to 1983

Fits 1600cc aircooled engines with a CT engine code.

J12328 070-251-053/C..... **£107.00**



Heat Transfer Pod (Nearside / Left)

This is an OEM part.

J10339 070-251-151/B..... **£125.00**



CSP Stainless Steel Tail Pipe 2000cc Aircooled 1979 to 1983

Fits all VW T25s from 1979 to 1985 fitted with a 1700cc to 2000cc Type 4 engine.

J31821 251 185 021FE..... **£39.75**



Exhaust Gasket VW T25 1600CC CT 1979-1983

Located between the header and the back box. Fits 1600cc CT VW T25s from 1979 to 1983.

J40826 070-251-235/A..... **£5.00**

1900 & 2100cc PETROL WATER-COOLED



Exhaust Kit 2000cc Aircooled and 1900 Watercooled to 1985

Exhaust silencer supplied complete with tail pipe and the required gaskets and fittings.

J33449 **£140.00**



Stainless Steel Full Exhaust Kit 1900, 2100cc Watercooled

Quality Preservation Parts product, exclusive to JK. Sold with a lifetime warranty!

J41207 **£503.00**



Manifold Pipe (1 & 3) VW T25 1980-1985

Replacement manifold pipe for 1 & 3. Fits VW T25s from 1980 to 1985.

J39790 025-251-171/G..... **£100.00**



Manifold Pipe for Outlets 2 & 4 VW T25 1980-1985

Exhaust manifold pipe, for outlets 2 and 4. Fits VW T25s from 1980 to 1985.

J39791 025-251-172/G..... **£100.00**



CSP Stainless Steel Tail Pipe 2000cc Aircooled 1979 to 1983

Fits all VW T25s from 1979 to 1985 fitted with a 1700cc to 2000cc Type 4 engine.

J31821 251 185 021FE..... **£39.75**



Exhaust Mount Nearside (Left) VW T25 Syncro 1900-2100cc 1985-1992

When fitting a new back box you may also require the right hand mount sold separately as J40361.

J40360 025-251-519/H..... **£23.75**



Exhaust Mount Offside (Right) VW T25 Syncro 1900-2100cc 1985-1992

When fitting a new back box you may also require the left hand mount sold separately as J40360.

J40361 025-251-520/K..... **£21.50**

2000cc, PETROL, AIR-COOLED



CSP Stainless Steel Tail Pipe 2000cc Aircooled 1979 to 1983

Fits all VW T25s from 1979 to 1985 fitted with a 1700cc to 2000cc Type 4 engine.

J31821 251 185 021FE..... **£39.75**



Clamp (70mm) For Airhose 1700, 1800, 2000cc 1972 to 1979

Retains the airhoses from the fan to the heat exchangers. 1700cc, 1800cc and 2000cc.

J11049 N0245044..... **£1.45**

PROPEX AUXILIARY HEATING SYSTEMS



Propex Heatsource Kit

Money-saving bundle kit from JK. Kit contains all the components you need to fit the Propex HS2000.

J19842 **£495.00**



VIM (Vehicle In Motion) Bracket for Propex Heater

Quality Propex product. Designed for use with Propex Space Heaters to allow the heater to be safely operated whilst the vehicle to which it is fitted is moving.

J19550 **£30.00**

FRONT SUSPENSION, STEERING & BEARINGS

ANTI ROLL BARS, LINKS & BUSHES



Radius Rod Bush Kit VW T25 1979-1992

Contains: 2x tie rod mounting seat, 1x spacer sleeves, 1x inner tie rod mount, 1x outer Tie rod mount.

J40260 **£21.75**



Straight Anti-Roll Bar Link Bush Kit VW T25 1985-1992

Money saving bundle kit. Straight anti-roll bar link bush kit. Suitable for one side on VW T25s from 1985 to 1992.

J40259 **£19.75**



Cranked Anti-Roll Bar Link Bush Kit T25 1979-1985

Money saving bundle kit. Cranked anti-roll bar link bush kit. Suitable for one side on VW T25s from 1979 to 1985.

J40258 **£18.00**



Cranked Anti Roll Bar Link Type 25 1979-1985 Pair

Made exclusively for JK to the original specification. Pair of cranked anti-roll bar links.

J21109 **£76.75**





Powerflex 19mm Anti Roll Bar Link Bush

A pair of Powerflex 19mm anti roll bar link bushes.

J19269 251-411-045/B..... **£7.75**

 **Anti-Roll Bar VW T25 1985–1992**
19mm anti-roll bar. Complete with bushes and drop links.
J41951 251-411-025/C **£128.50**

 **Bracket For Anti Roll Bar VW T25 1979-1984**
Sold as singles this anti roll bar clamp can be used on either side on VW T25s built from 1979 to 1984
J41895 251-411-063 **£13.25**

 **Bracket For Anti Roll Bar VW T25 1984–1992**
Anti-roll bar bracket. Sold individually. Fits nearside or offside on VW T25s from 1984 to 1992.
J41890 251-411-063/A **£13.25**

 **Wishbone Bush (Upper) 1979 to 1992**
Two required per side. Held in place with a simple spot weld
J10306A 251-407-077 **£12.50**

 **Wishbone Bush (Lower) 1979–1992**
Quality Febi product. Sold individually.
Fits either side on all VW T25s from 1979 to 1992.
J10298 251-407-183 **£8.75**

 **Top Wishbone Bolt 12 x 1.5 x 105 VW T25 1979–1992**
Good quality reproduction product. Sold individually. 12 x 1.5 pitch x 105 long. Fits nearside or offside.
J41351 251-407-053/A **£23.75**

 **M12 x 1.5 Pitch Nyloc Nut For Top Wishbone Bolt VW T25 1979–1992**
M12 x 1.5 pitch Nyloc nut. Grade 10 BZP.
Fits the top wishbone bolt on VW T25s from 1979 to 1992.
J41352 N0221414 **£1.45**

 **Inner Tie-Rod Mount 1979 to 1992**
Sold individually, you will need two per van.
J10770A 251-407-175 **£6.50**

BALL JOINTS

 **Ball Joint bolt (M10 x 16) VW T25 1979–1992**
M10 x 16 ball joint bolt. Fits the upper ball joint on VW T25s from 1979 to 1992. Two required per upper joint.
J41389 N0447273 **£0.95**

FRONT SHOCK ABSORBERS

 **Front Shock Absorber Best Quality Sachs / Boge 1979 to 1990**
Quality Sachs Boge product.
Fits VW T25s from 1979 to 1990, excluding Syncros.
J12901 251-413-031/J **£64.75**

 **Front Shock Absorber Syncro Models**
Sold individually. Fits 14" Syncro VW T25s from 1985 to 1992.
Not suitable for 16" Syncros.
J12937 251-413-031/C **£111.25**

 **Strut / Damper Cover VW T25 1979–1992**
Sold individually. Fits on the front shock absorber on VW T25s built from 1979 to 1992.
J40910 113-412-305 **£4.05**

 **M14 Nut Front Lower Shock Nut VW T25 1979–1992**
Sold individually. M14 nut, used on the front lower shock mount on VW T25s from 1979 to 1992.
J41345 N0110212 **£1.05**

 **Front Upper Wishbone (Excluding Syncro Models)**
Supplied as a bare unit requiring the bushes and ball joint to be fitted
J41211 251-407-047/B **£39.50**

SPRINGS & LOWERING KITS

 **Front Coil Spring for T25 1979–1992**
Standard height. Not suitable for Syncros.
We always recommend fitting springs as matched pairs.
J10295 251-411-105/A **£42.00**

STEERING COMPONENTS, RACK & BOOTS

 **Right Hand Nut For Track Rod VW T25 1979–1992**
Genuine VW product. Right hand thread locking nut for track rod end. Fits T25s from 1979 to 1992.
J40884 N10-218-704/ **£1.90**

 **Steering Rack (Right Hand Drive)**
You may also require new mounts (J10764) and boots (J10284).
J10804 252-419-061 **£79.50**

 **Spacer Sleeve on Steering Column VW T25 1979–1992**
Good quality reproduction product. Replacement steering column sleeve spacer
J61924 171-419-549 **£5.75**

 **Rear Trailing Arm Front Wishbone Bolt VW T25 1979-1992**
Sold individually. Fits front lower wishbone & rear trailing arm on T25s from 1979 to 1992.
J21091 N0101675 **£2.70**

 **Power Steering Pump Rebuild Kit VW T25 1979–1992**
Genuine VW product. All gaskets and main pump seal. Fits all VW T25s fitted with power steering.
J39720 026-198-049/A **£15.75**

 **Rear Feed Power Steering Pipe (Petrol Engines)**
Genuine VW product. Power steering feed pipe from front to rear on VW T25s with petrol engines from 1979 to 1992.
J29033 251-422-897 **£225.00**

 **Power Steering Front Return Pipe for RHD VW T25**
Power Steering return pipe for a RHD T25 within the years of 1980 - 1992.
J63550 252-422-851 **£112.25**

 **Power Steering Front Feed Pipe RHD**
Power Steering Feed pipe for a RHD T25 within the years of 1980 - 1992.
J63551 252-422-867 **£192.50**

 **Power Steering Front Return Pipe LHD**
Power Steering return pipe for a LHD T25 within the years of 1980 - 1992.
J63505 251-422-851 **£165.50**

 **Power Steering Front Feed Pipe LHD**
Power Steering Feed pipe for a LHD T25 within the years of 1980 - 1992.
J63506 251-422-867 **£210.00**

 **Power Steering Pump Belt 1600 & 1700 Diesel (CS/JX)**
Quality Optibelt product.
Fits 1600cc and 1700cc VW T25s from 1980 to 1992.
J29498 068-145-271/C **£3.90**

 **G4 Power Steering Hydraulic Oil - 1Ltr**
Quality Febi product. 1 Litre bottle.
G4 synthetic oil for hydraulic power steering systems.
J27919 G00-400-0M2 **£10.75**

STEERING WHEELS & BOSSES

 **Billet Aluminium Steering Wheel Boss VW T25 1979–1992**
Quality HJS product. Made in the UK. Required when fitting our luxury Rosewood steering wheel (J16698).
J40254 **£142.25**

FUEL TANKS, FILTERS & HOSES

FUEL TANKS, FILTERS & HOSES

 **Fuel Tank Sender Seal VW T25 Syncro 1985 - 1992**
Specially designed fuel tank sender seal for the VW T25 Syncro. Fits Syncros from 1985 to 1992.
J40839 251-919-133 **£13.00**

 **Fuel Tank Rubber Pad VW T25 1979–1990**
Good quality reproduction product. Sold individually, four required per vehicle.
J41243 251-201-525 **£4.95**

 **Fuel Tank Rubber Pad VW T25 1979-1990**
Good quality reproduction product. Sold individually, four required per vehicle.
J41243 251-201-525..... **£4.95**

 **Filler Cap Retaining Ring VW T25 Diesel Models**
Fixing ring that holds the fuel filler neck at the cap end. Fits all diesel VW T25s, except Syncros.
J40369 251-201-131/A..... **£10.00**

 **Fuel Tank Breather Pipe VW T25 1980-1992**
Genuine VW product. Located from the metal breather pipe located on either side of the petrol tank.
J41250 251-201-167/B..... **£10.50**

 **Fuel Tank Breather Valve VW T25 1979-1992**
Genuine VW product. Located on the front wheel arch breather tanks, and T25 Syncro fuel tank.
J40330 251-201-311/B..... **£22.25**

 **Fuel Tank Grommet VW T25 1979-1992 (Breather Tanks)**
Fits the float valve under arch breather tanks on VW T25 Syncros from 1979 to 1992.
J40743 N90-100-501..... **£3.50**

 **Fuel Tank Breather Pipe VW T25 1980-1992**
Genuine VW product. Sold individually. Located from the rubber pipe on the top breather to the rubber on the expansion tanks.
J41254 251-201-169/B..... **£10.50**

GEARBOX & CV JOINTS

CV JOINTS & BOOT KITS

 **Complete Driveshaft VW T25 1980-1983**
Supplied complete with both joint and boots. Sold individually. Fits nearside or offside on all four speed T25s. 548mm.
J40368 251-501-203..... **£100.75**

 **GKN CV Joint Kit VW T25 1979-1992**
Quality GKN product. Best quality CV joint replacement kit. Includes CV joint, CV boot, 6 CV bolts, grease and clips.
J41302 211-598-101..... **£67.50**

 **CV Boot and Fitting Kit 1979 to 1992**
Quality Febi product. Sold individually, two kits required per drive shaft. Kit contains: the boot, bolts, grease and clips.
J10069A 251-598-201..... **£3.50**

 **CV Boot Kit VW T25 Syncro 16" 1985-1992**
Fits inner or outer rear CV joints on 16" VW T25 syncros from 1985 to 1992. Sold individually.
J40367 443 498 201 B..... **£16.00**

GEAR LEVERS & LINKAGE PARTS

 **5 Speed Gear Lever VW T25 RHD 1983-1992**
Genuine VW solid gear lever. Fits right hand drive VW T25s from 1983 to 1992.
J40719 252-711-117/C..... **£183.00**

 **CSP Quick Shift Kit Bus 1979-1992 12mm**
Fits T25s with 14mm shifter rods. Reduces the gearstick shift travel by about 25%.
J31858 711-14-9 2/12..... **£40.00**

 **CSP Quick Shift Kit Bus 1979-1992 14mm**
Fits T25s with 14mm shifter rods. Reduces the gearstick shift travel by about 25%.
J31859 711-14-9 2/14..... **£37.75**

 **Gear Stick Extension (M14 Threads) 1985 to 1992**
Quality JK product. Fits VW T25s from 1985-1992. Brings the gearknob approx 12cm closer to hand.
J13458 **£12.50**

 **CSP Shift Knob with logo**
Quality CSP product. Ball-shaped shift knob for CSP gear shifters, complete with CSP logo.
J31714 711 141 000CSP..... **£18.00**

 **Pin For Gearstick (5 Speed) VW T25 1983-1992**
Often worn and the cause of missed gears, this is the pivot pin that the gearstick moves on.
J40488 251-711-246/A..... **£11.50**

 **Gearstick Spring (5 Speed) VW T25 1983-1992**
Genuine Volkswagen product. Located at the base of the 5 speed gearstick.
J40489 251-711-247/A..... **£1.15**

 **O Ring For Gear Joint VW T25 1979-1992**
These O rings fit the plastic universal joint on the front to rear gear linkage. Four required per total. Fits VW T25s from 1979 to 1992 excluding some early 4 speed syncro models
J40720 N90-089-901/..... **£1.45**

GEARBOX OILS & TOOLS

 **Morris Lodexol SAE 80w-90 Gearbox Oil API GL 4 (1 Litre)**
Morris Lodexol SAE 80-90 API GL 4 gear oil. Features extreme pressure additives that offers extra protection to gear assemblies along with corrosion and foam prevention.
J41701 **£8.50**

RECONDITIONED GEARBOXES & REBUILD PARTS

 **Gearbox Pinion Bearing VW T25 1979-1992**
Good quality reproduction product. Rear gearbox pinion bearing.
J40606 091-311-219..... **£123.75**

 **2nd Gear Synchro Ring 1983-1992**
A Genuine Volkswagen 2nd gear synchro ring for 094 5 speed gearboxes
J40596 091-311-247/D..... **£45.00**

 **Reverse Synchronizer Ring 1984-1992**
This low / reverse synchronizer assembly fits 094 4 wheel drive and 5 speed gearboxes
J40620 094-311-283/B..... **£260.75**

 **Weddle Racing 15 Tooth Reverse Gear 1979-1983**
A 15 tooth reverse gear that mates to the 40 tooth slider for use in the 091 gearbox.
J40630 091-311-531..... **£45.00**

 **094 3-4 Slider Hub 1979-1983**
A heavy duty replacement for the factory 3 to 4 hub that is prone to cracking.
J40616 **£110.00**

 **1st to 2nd Gear Slider 1984-1992**
A Genuine Volkswagen gear slider as used on 1st and 2nd gear in the 094 gearbox
J40623 091-311-255/A..... **£78.00**

 **3rd to 4th Gear Slider 1984-1992**
A Genuine Volkswagen gear slider as used on 3rd and 4th gear in the 094 gearbox
J40624 091-311-315/B..... **£77.75**

 **091 Front Mainshaft Bearing VW T25 1979-1983**
Good quality reproduction product. Front mainshaft bearing for 091 gearboxes.
J40580 091-311-123..... **£32.75**

 **Gearbox Front Mainshaft Bearing VW T25 1984-1992**
Gearbox mainshaft bearing. Fits VW T25s with 094 transmissions from 1984 to 1992.
J40592 091-31-1-1/23C..... **£75.00**

 **Gearbox Rear Mainshaft Bearing 1979-1992**
Good quality reproduction product. Rear main shaft bearing. Fits petrol VW T25s from 1979 to 1992.
J40581 002-31-1-1/25A..... **£10.75**

 **Needle Bearing, Forward End Of Mainshaft 1984-1992**
This needle roller bearing fits the forward end of the mainshaft on 094 gearboxes
J40617 094-311-373..... **£27.50**



Low Gear Thrust Bearing 1984-1992

This low gear thrust bearing is used for the four wheel drive and 5 speed gearboxes

J40618 094-31-1-3/75..... **£44.75**



Selector Shaft Bushing 1984-1992

Selector shaft bushing also used on the 020 front wheel drive transmission

J40594 020-141-711/A..... **£3.15**



Gear Selector Shaft Seal

094 gearbox Selector shaft oil seal, with external garter spring

J40595 020-141-733/D..... **£5.75**



Nosecone Seal 1980-1983

Good quality reproduction product. Nose cone seal. Fits 4 speed VW T25s from 1980 to 1983.

J40542 001-301-227..... **£9.75**



Manual Gearbox Rebuild Kit 1983-1992

All the gaskets, seals, bearings etc. you'll need to help re-build your 4 speed manual gear box.

J40410 **£850.00**



Gearbox Gasket Set VW T25 1979-1983

Complete set of gearbox gaskets, as required for rebuilding your gearbox.

J40584 091-398-005..... **£13.50**



Complete Gearbox Gasket Set VW T25 1984-1992

Good quality reproduction product. Complete gearbox gasket rebuild kit. Ideal for VW T25s from 1984 to 1992.

J40631 **£16.50**



Bronze Clutch Shaft Bush Heavy Duty 20mm

This 20mm Bronze self lubricating heavy duty clutch shaft bearing is made by Weddle industries

J40599 091-141-701/K.6..... **£7.50**



Mainshaft Circlip, Prong Style

This 5mm prong style circlip is used on the input shaft on 094 gearboxes

J40601 091-311-381/A..... **£2.90**



Circlip For 3rd Gear VW T25 1984-1992

Good quality reproduction product. 2.2mm thick circlip used on 3rd gear.

J40554 113-31-1-3/86..... **£5.00**



Circlip For 3rd Gear VW T25 1984-1992

Good quality reproduction product. 2.3mm thick circlip, used on 3rd gear.

J40558 113-31-1-3/87..... **£2.50**



3rd Gear Circlip VW

This 2.5mm thick 3rd gear circlip is also used on the 002 and 091 mainshaft.

J40587 113-311-388/F..... **£26.25**



Final Drive Flange Circlip

A Genuine Volkswagen circlip this fits the final drive flange on 002 and 091 gearboxes

J40588 014-311-317..... **£3.30**



Gearbox C-Style Circlip 1984-1992

A "C" style securing ring for use in 094 4 and 5 speed gearboxes

J40600 091-311-187/B..... **£2.05**



Slider Hub Circlip

This Circlip is used for 1st 2nd and 3rd 4th slider hubs in 091 gearboxes Also for 1st and 2nd slider hub in 094 gearboxes

J40602 091-311-321..... **£9.25**



3-4 Slider Hub Circlip 1984-1992

This circlip is used on the 3rd and 4th gear slider hub

J40603 091-31-1-3/21A..... **£9.25**



Circlip 091 4th (Pinion) or End of 113 Mainshaft 1979-1983

A Genuine VW part

J40564 020-311-187..... **£4.15**



Reverse Idler Gear Circlip

This 6 x 1 circlip is used on the reverse idler gear

J40591 N0124171..... **£0.25**



Reverse Idler Clip 1979-1983

This circlip is used on the reverse idler shaft to retain the late style bearing in the gearbox

J40590 113-311-527..... **£0.60**

HEATING SYSTEM

HEATER MOTOR, MATRIX & SWITCHES



Knob For Blower Motor Switch for All T25

Genuine VW product. Knob For Blower Motor Switch. Fits all VW T25s from 1979 to 1992.

J20293 321-959-513/B..... **£7.25**

PROPEX HEATING SYSTEMS



Replacement Water Heater Vent / Flue Terminal

For all versions of the Propex and Belling Malaga

J27765 **£35.00**



Call-Start GSM Switch - Eberspacher Heaters

Call-Start is a GSM switch which can be used to remotely operate Eberspacher air and water heaters.

J42057 **£160.25**

INTERIORS

ACCESSORIES



Dynamat Dynaliner (12mm)

Quality Dynamat product. 81x173cm. Ultra light weight insulator, ideal for use on top of Dynamat.

J27791 **£79.50**



Dynamat Hoodliner (19mm)

Quality Dynamat product. Get better sound, protect your VW's paint finish and get that show car look! 81cm x 137cm.

J27792 **£69.50**



Dynamat DynaDeck

Quality Dynamat product. DynaDeck is the ultimate floor liner and excellent for the rear load area. 137cm wide x 365cm.

J27794 **£499.00**



Dynamat DynaDeck

Quality Dynamat product. DynaDeck is the ultimate floor liner and excellent for the rear load area. 137cm wide x 183cm.

J27793 **£289.00**



Dynamat Professional Rubber Roller 2 Inches

Quality Dynamat product. Ideal for more complicated or fiddly Dynamat installations. 50mm wide.

J27797 **£20.00**



8 Ball Gear Knob 1985 to 1992

Good quality reproduction product. Super cool '8 ball' gear knob. 14mm thread.

J19946 **£14.50**



Trim Fix Adhesive 500ml (High Temperature Resistant)

Trim Fix flexible adhesive is ideal for use in vehicle trimming applications such as headlinings, door and panel trims, carpets etc.. with a high temperature resistance to 120 degree.

J29551 **£5.75**



Vital Statistics Label

Neat way of logging height / length / weight and other useful measurements related to vehicle.

J29813 **£1.50**



Empi Speed Warning Sticker

Quality EMPI product. Silver & black 200mph caution sticker. Raise a smile and add some nostalgia.

J15045 00-980-2-0..... **£1.65**



Empi Sticker 'Power Rules'

Quality EMPI product. Add a bit of that that old skool style with the original Empi power sticker!

J15046 00-981-6-0 **£1.50**



Oval Empi Logo Sticker

Quality EMPI product. 80mm x 55mm. Give your VW bug or bus a strong hint of old-skool street cred!

J11337 00-981-5-0/ **£2.00**



8 Ball Gear Knob 1979 to 1985

They've got a 12mm thread, and screw on to your gear stick

J14706 **£9.75**

CARPETS, MATS & FLOOR TRIM



Cab Overmat Black VW T25 Left-Hand Drive 1979-1992

This Black cab overmat. Made from high quality rubber backed automotive carpet with bound edges and a sewn in heel pad.

J41721 **£37.25**

DOOR TRIM & DIY TRIMMING PANELS



Brown Front Door Cards

Quality Just Kampers product. Brown vinyl covered door cards, sold in pairs. Fits all VW T25s.

J27870 **£90.00**

GENERAL CAMPING INTERIOR PARTS



Table Sliding Rail Set

Reimo sliding table rail with height adjustable folding leg

J27698 **£42.75**



Fiamma Tube Pro Table Leg (70cm)

Sturdy anodized aluminium with a maximum height of 70cm

J27699 06375-01 **£25.00**



Aluminium Floor Mount And Table Top Fitting Kit

Kit contains: 6 x screws for mounting our table top (J12010), 6 x bolts with washers and nuts for mounting the floor base.

J40220 **£2.95**



Flush Cupboard Knob

A compact push lock for cupboard doors, finished in silver.

J12755 **£5.50**



12mm Red Water Hose Sold Per Metre

This 12mm x 8.5mm hot water hose is sold in metre lengths. Approved for use with water for human consumption. Ideal for use in camper conversions

J41478 **£21.50**



13mm Blue Reinforced Water Hose (Sold Per Metre)

13mm Blue Reinforced Water Hose Sold Per Metre Approved for use with portable water for humane consumption Ideal for use in campervan conversions.

J42031 **£2.50**



12mm Equal Tee For Fresh Water Hose

Sold as singles these 12mm equal Tees feature push fit connections for quick and easy installation of water hoses.

J41479 **£2.95**



12mm Non Return Valve For Fresh Water Hose

Sold as singles this 12mm non return valve features push fit connections for quick and easy installation of water hoses.

J41501 **£14.50**



12mm Equal Elbow For Fresh Water Hose

Sold as singles these 12mm equal elbow feature push fit connections for quick and easy installation of water hoses.

J41480 **£2.95**



12mm Stem Shut Off Valve For Fresh Water Hose

Sold as singles this 12mm stem shut off valve features push fit connections for quick and easy installation of water hoses.

J41500 **£9.50**



12mm Straight Adaptor 1/2" Flexible For Fresh Water Hose

Sold as singles this 12mm straight adaptor with a 1/2" flexible end this features push fit connections for quick and easy installation of water hoses.

J41498 **£5.75**



3/8" x 1/2" Hose Connector For Fresh Water Hose

Sold as singles this 3/8" x 1/2" hose connector / reducer

J41508 **£1.50**



12mm Female Adaptor For Fresh Water Hose

Sold as singles this 12mm female adaptor features push fit connections for quick and easy installation of water hoses.

J41496 **£3.00**



12mm Shut Off Valve For Fresh Water Hose

Sold as singles this 12mm shut off valve features push fit connections for quick and easy installation of water hoses.

J41499 **£7.00**



12mm Stem Elbow For Fresh Water Hose

Sold as singles this 12mm stem elbow features push fit connections for quick and easy installation of water hoses.

J41495 **£3.50**



12mm Equal Straight For Fresh Water Hose

Sold as singles this 12mm equal straight feature push fit connections for quick and easy installation of water hoses.

J41493 **£2.25**



12mm - 10mm Elbow Reducer For Fresh Water Hose

Sold as singles this 12mm to 10mm elbow reducer features push fit connections for quick and easy installation of water hoses.

J41494 **£4.50**



12mm Female Adaptor 3/8" For Fresh Water Hose

Sold as singles this 12mm female adaptor features push fit connections for quick and easy installation of water hoses.

J41497 **£3.50**



12mm Two Way Adapter For Fresh Water Hose

Sold as singles this 12mm two way adapter features push fit connections for quick and easy installation of water hoses.

J41502 **£3.50**

HEADLINING KITS & SUNVISORS



Sunvisors (Pair) VW T25 1979-1992

Supplied as a pair. You may also require sun visor clips J12554 (Sold separately)

J41773 251-898-550 **£67.25**



Perforated Off-White Vinyl Headliner VW T25 1979-1992

Good quality reproduction product. Complete, off-white perforated vinyl headliner. Fits VW T25s from 1979 to 1992.

J41212 **£236.00**

SEATS, SEAT COVERS & SWIVEL BASE KITS



Seat Adjustment Knob Front VW T25 1979-1992

Sold individually. Fits nearside or offside front seats. Also for rear seats in crew cab pickups.

J40310 251-881-251 **£6.75**

WESTFALIA PARTS



Gasket For Westfalia Mains Socket VW T25 1979-1992

Rubber gasket or seal, used on the mains hook up socket on Westfalia conversions.

J40342 **£2.65**



Gasket for Westfalia Water Inlet VW T25 1979-1992

Used on the water inlet on Westfalia conversions. Fits all VW T25s from 1979 to 1992.

J40343 255-333-331 **£2.50**

PEDALS CABLES & LEVERS

ACCELERATOR CABLES & FITTINGS



Accelerator Cable

T25 accelerator cable fits all 1600 cc vans from June 1979 to July 1983.

J12276 251-721-555/..... **£9.00**



Throttle Cable Extender Kit

This throttle cable extender kit is ideal for use when fitting twin or progressive carbs.

J33563 00-317-1-0..... **£3.50**



Accelerator Cable Retaining Clip Diesel Engines 1982-1992

This Genuine Volkswagen accelerator cable retaining clip fits all Diesel models

J41192 171-721-570/A..... **£2.50**

CLUTCH CABLES & FITTINGS



Clutch Cable Sleeve / Seal VW T25 1979-1982

Good quality reproduction product. Clutch cable centring guide / seal, as fitted where the clutch cable conduit enters the vehicle floor pan.

J41474 311-721-363..... **£2.90**

HANDBRAKE CABLES & FITTINGS



Hand Brake Cable

Genuine Volkswagen product. This is the front cable from the hand brake to the centre balance bar.

J10543 251-711-471/D..... **£81.25**

HEATER CABLES & FITTINGS



Heater Cable Left Hand Drive Nearside (Left)

Quality GEMO product. Nearside heater cable. Fits all lefthand drive 2000cc VW T25s 1979-1983.

J12284 251-711-629..... **£38.75**

HYDRAULIC CLUTCH COMPONENTS



Clutch Slave Cylinder VW T25 Bosch OE Quality

OE quality Bosch clutch slave cylinder, fits all VW T25s built from 1982 to 1992.

J41985 251-721-263/A..... **£59.00**

SPEEDO CABLES & FITTINGS



Speedo Cable Hub Seal VW Beetle 1950 on VW T2 Split 1950-1967 VW T2 Bay 1967-1979 VW T25 1979-1992

Seal between the speedo cable and the front hub. Seals the gap where the speedo cable passes into the hub. Fits all VWs from 1950 to 1992

J60792 111-957-855/B..... **£1.45**

REAR SUSPENSION & WHEEL BEARINGS

BUSHES



Rear Trailing Arm Front Wishbone Bolt VW T25 1979-1992

Sold individually. Fits front lower wishbone & rear trailing arm on T25s from 1979 to 1992.

J21091 N0101675..... **£2.70**

CHASSIS



Rear Inner Trailing Arm Mount Bracket Nearside (Left) 1980-1992

Quality VW product. Rear inner trailing arm mount bracket. Fits nearside (left) on VW T25s from 1980 to 1992.

J41641 251-803-191..... **£48.00**



Rear Inner Trailing Arm Mount Bracket Offside (Right) 1980-1992

Genuine VW product. Inner trailing arm mount bracket. Fits offside (right) on VW T25s from 1980 to 1992.

J41642 251-803-192..... **£48.00**

REAR SHOCK ABSORBERS



Rear Wishbone Nearside (Left) T25 1979-1992

Fits offside (right) rear on all VW T25s from 1979 to 1992.

J40941 251-501-401/E..... **£332.75**



Rear Wishbone Offside (Right) VW T25 1979-1992

Fits offside (right) rear on all VW T25s from 1979 to 1992.

J40942 251-501-402/E..... **£332.75**

SPRINGS & LOWERING KITS



Rear Trailing Arm Repair Plate VW T25 1979-1992

Preservation Parts product. Made in the UK. Sold individually. Fits either side on all VW T25s.

J40439 **£30.25**

SEALS, TRIMS & ACCESSORIES

CAB DOOR SEALS, TRIMS & WINDER MECH



Cab Door Seal Kit (Both Doors) 1979 to 1992

Complete cab door seal kit for doors with fixed 1/4 lights.

J19568 **£114.50**



Deluxe Quarter Light Rubber Nearside VW T25 1979-1992

Fits offside (right) on VW T25 Deluxe Models. Has moulded grooves to accept chrome trim.

J40164 255-837-625..... **£54.75**



Clips For Window Scraper

You will require 4 per scraper or 8 per door.

J19829 171-837-485..... **£1.50**



Quarterlight Bar Fixed Nearside (Left) VW T25 1979-1992

Quarter light bar for fixed windows. Fits the nearside (left) on VW T25s from 1979 to 1992.

J41317 251-837-409..... **£36.25**

CARPETS, CURTAIN RAILS, STORAGE & TRIM



Rock & Roll Bed Fitting Kit T25 1979 to 1992

Quality JK product. Full fitting kit for rock & roll beds in all T25s from 1979 to 1992.

J12987 **£12.00**



Silent Gliss Curtain End Stops

Sold as a pack of 2, these fit Silent Gliss curtain track.

J11485 **£2.00**



Brown Front Door Cards

Quality Just Kampers product. Brown vinyl covered door cards, sold in pairs. Fits all VW T25s.

J27870 **£90.00**

DOOR HANDLES & LOCKS



Blank Key N 1979 to 1992

Blank key that needs to be cut to your original key.

J19432 251-837-219/A..... **£7.25**

DOOR SEALS, HANDLES, HINGE & ROLLERS



Sliding Door Lower Roller Bearing Guide VW T25 1979-1992

Genuine VW product. Lower vertical roller wheel, as fitted to either side sliding door on all VW T25s from 1979 to 1992.

J41277 251-843-419..... **£43.25**



Roller & Bearing For Sliding Door VW T25 1979-1992

Guide roller and bearing, located on the centre hinge on either side sliding door on VW T25s from 1979 to 1992.

J41278 251-843-361/B..... **£28.75**



Guide Roller Lower For Sliding Door VW T25 1979-1985

Genuine VW product. Sliding door lower guide roller. Fits VW T25s from 1979 to 1985.

J41279 251-843-423/B..... **£12.50**



Guide Roller For Sliding Door VW T25 1985-1992
Quality VW product. Guide roller for the horizontal sliding door locator. Located on the upper front edge of the sliding door. Fits VW T25s from 1985 to 1992.

J41276 251-843-425/A..... **£17.50**

ELEVATING ROOF PARTS



Westfalia Roof Canvas 3 Window Grey 1986 to 1992
Quality JK product. Fits Westfalia T25s from 1986 on. Durable, weatherproof fabric, with 3 windows.

J13465 **£179.00**



Reimo Roof Bead/Seal (1.0 - 4mm) Sold per Metre
Sold by the meter this seal is used on The Reimo roof conversions.

J40111 **£9.25**

EXTERIOR TRIM, ACCESSORIES, BADGES & GRILLES



Lower Radiator Grille (Wraparound) 1979 to 1992
OEM quality It fits all air and watercooled T25s

J11283 22S-853-663/C..... **£188.00**



Spoiler Bolt (For Front Spoiler / Pack of 16)
16 per pack. Self-tapping bolts for the front spoiler. Used for fitting original VW front spoilers.

J12962 **£8.50**



Syncro Style Rear Left Mud Flap VW T25 1979-1992
Genuine VW product. Syncro rear mud flap. Fits nearside (left) on all VW T25 Syncros from 1979 to 1992.

J40327 251-821-811/B..... **£81.75**



VW Badge (Chrome 95mm) for T25 1979-1985
Whether it's the finishing touch or the first stab at restoring your T25, this iconic, chrome VW badge (95mm) is essential. It fits T25 front grills from 1979-1985. Please check that your badge aperture is 95mm before ordering.

J10502 321-853-601..... **£20.75**



VW Transporter Script VW T25 1979-1992
Genuine VW product. 'Transporter' script for the tailgate on VW T25s from 1979 to 1992.

J13681 251-853-689/D..... **£31.25**



Deluxe Square Chrome Front or Rear Window Trim VW T25 1979-1992
Sold in a length to fit either the front or rear screen rubber. Fits all deluxe T25s.

J40161 255-853-305..... **£13.75**



Deluxe Chrome Side Window Trim VW T25 1979-1992
Sold in three meter lengths, enough to fit one side window rubber. Fits all deluxe VW T25s.

J40163 255-853-345/A..... **£15.00**



T25 Deluxe Chrome Window Trim Joiner
T25 Deluxe Square Chrome Window Trim Joiner for the Front Windsreen and Tailgate window trims

J40162 171-853-339/A..... **£5.25**

SEAT BELTS & MOUNTINGS



Rear 3 Point Static Seat Belt
Quality Securon product, made in the UK. Three-point static seat belt. Fits T25s from 1979 to 1992.

J21034 **£23.50**

TAILGATE SEALS, GAS RAMS & JAIL BARS



Tail Gate Gas Strut Washer VW T25 1979-1992
Good quality reproduction product. Washer for the tailgate gas strut on VW T25s from 1979 to 1992.

J41244 N0116961..... **£1.20**

WESTFALIA ROOF, WINDOW & INTERIOR PARTS



Westfalia Roof Canvas 3 Window Grey 1986 to 1992
Quality JK product. Fits Westfalia T25s from 1986 on. Durable, weatherproof fabric, with 3 windows.

J13465 **£179.00**



Gasket For Westfalia Mains Socket VW T25 1979-1992
Rubber gasket or seal, used on the mains hook up socket on Westfalia conversions.

J40342 **£2.65**



Gasket for Westfalia Water Inlet VW T25 1979-1992
Used on the water inlet on Westfalia conversions. Fits all VW T25s from 1979 to 1992.

J40343 255-333-331..... **£2.50**

WINDOW SEALS

Best Quality Window Seal Bundle Kit VW T25 1979-1984 With Chrome Trim

Best quality window seal bundle kit for VW T25s from 1979 to 1984 with Deluxe Chrome Trim.

J40767 **£251.25**



Best Quality Window Seal Bundle Kit VW T25 1984-1992 With Chrome Trim

Best quality window seal bundle kit for VW T25s from 1984 to 1992 with Deluxe Chrome Trim.

J40768 **£253.50**



VW T25 Sliding Window Seal for JK Window (Sliding Door Side)

Quality JK product. Good quality rubber seal for our JK sliding window kit (J40250).

J40063 **£25.00**



Middle Side Window 1979 to 1992

Quality Preservation Parts product. Standard style rubber, without chrome insert.

J10742 253-845-322..... **£19.25**



Side Window Seal Converted Panel Vans 1979 to 1992

Quality Preservation Parts product. Length 310cm. Supplied with black insert.

J10686 261-845-321..... **£25.25**



VW T25 Sliding Window Seal for JK Window (Non Sliding Door Side)

Excellent quality rubber seal for our JK sliding window kit (J40251).

J40062 **£25.00**



Deluxe Chrome Side Window Trim VW T25 1979-1992

Sold in three meter lengths, enough to fit one side window rubber. Fits all deluxe VW T25s.

J40163 255-853-345/A..... **£15.00**



Deluxe Square Chrome Front or Rear Window Trim VW T25 1979-1992

Sold in a length to fit either the front or rear screen rubber. Fits all deluxe T25s.

J40161 255-853-305..... **£13.75**



Plastic Chrome Insert Trim

Good quality reproduction product. Plastic chrome window insert trim. Supplied in a 3.1 meter length.

J61076 113-853-355/F..... **£3.75**

WHEELS, ALLOY WHEELS, TYRES & HUBCAPS

ALLOY & STEEL WHEELS



Standard 14in. Steel Roadwheel (Black) 1979-1992
Standard 14inch steel wheel. Sold individually.
5 x 112 pcd 5.5J x 14".

J11804 211-601-027/H..... **£114.75**

HUBCAPS & TRIMS



Set of Four Chrome Plated Hub Cap (Genuine Volkswagen) VW T25 1979-1992
Genuine VW product. Sold as a set of four. Made for Classic Parts using the original tooling to the original spec with best quality chrome.

J41878 **£283.50**



Set of Four Stainless Steel Baby Moon Hubcaps T25 1979-1992
Quality Preservation Parts product. Complete set of four 304 Stainless Steel 'Baby Moon' hub caps.

J41877 **£87.25**

WHEEL STUDS, NUTS & BOLTS



Locking Wheel Nuts for Standard Wheels
Size M14 x 1.5, with 60° taper seat.
Fits VW T25s with standard wheels from 1979 to 1992.

J14415 **£15.00**



Aluminium Wheel Spacers, Pair, 3/8" Thick for 5/112 Late Bus Lug Bolts/
Quality EMPI product. 9.5mm (3/8 inch) thick. For use with 5/112 lug bolts/studs.

J35721 16-991-5-0..... **£46.00**



**SIGN UP
TO OUR EMAILS
FOR ALL THE LATEST
NEWS & OFFERS**

VISIT JUSTKAMPERS.COM



JK JK Conversions



**A NEW
COMPANY IN
CONVERSION
PARTS
WITH A 28 YEAR
HISTORY**

**jkconversions.com
0800 240 4229**



VDO Single Pod Gauge Holder
52mm pod provides the perfect mounting point for VDO gauges.
J11566 £18.00



VDO Time Clock Kit
52mm diameter, backlit, black face, 12-hour quartz clock
J11689 £69.50

Call For Availability



Hand Pump Tap
Pumps 8 litres of water per minute uses 1/2in hose, J11680.
J11691 £69.50



Folding Cup Holder
Holds an average coffee cup or regular 330ml drink can.
J11799 £7.00



Suction-Mounted Bud Vase
Can be used to hold a flower – or as a pen/pencil pot!
J11837 £5.00



Fiamma Tripod Pro Table Base
Designed for use with our table kit J18622
J18622 £39.50



Cover For Recessed Table Leg Base (J11869)
Stop dirt and debris clogging up your table base.
J13506 £3.00



Table Mounting Kit
4-piece table mounting kit simply attached by screws
J12161 £6.50



Anti-Slip Cupboard Mat in Assorted Colours
150cm x 30cm and can be easily cut to size.
J12153 £5.00



Sunvisor (Pair) 1979 to 1992
Made exclusively for JK this pair of sunvisors fit all T25s
J19912 £3.75

Call For Availability



Sun Visor Clip 1979 to 1992
Sold as singles fits all models.
J12554 £3.75



Billet Aluminium Sliding Door Inner Handle 1979 to 1992
Fits either side sliding door.
J19248 £48.00



Plastic Cover for Handbrake 1979 to 1992
Simple to fit, clips straight over Hand brake lever.
J90025 £8.25



Moisture Trap (Including 1 Bag of Crystals)
This refillable moisture trap, complete with crystals, helps prevent condensation and musty odours in your vehicle, awning, tent – or even on your window sill at home. Crystals last for 2 to 3 months.
J11866 £10.00



Moisture Trap Refill 500g
For refilling J11866 Moisture Trap.
J11867 £6.00



Bundle pack of 5 stickers
12v, tyre pressure, valve setting and 2 EMPI stickers
J16854 £10.75

Handy Hint



Seat belt extender kits

Seat design and the thickness of seat foam varies, so we sell extender kits for lengthening the seatbelts. Just Kampers part no. J11679.



Seat belt mountings

If your camper started life as a panel van, the van will have no rear seat belt mounts. Just Kampers stocks seat belt mounting plates which can be welded to the vans floor and side panels. Just Kampers part no. J11582.

Seat foam must be fixed

When covering your rear seat foam, fix the seat cover SECURELY to the seat base, otherwise in an accident your passengers will slide under and probably hang themselves on your new seatbelts.....Be warned!

Seat Belts & Mountings



Front Seat Belt 123" Ideal For Bench Seats
These are a specialist belt and are not std fit for the T25
J12743 £35.25



Rear Lap Seatbelt 1979 to 1992
Belt length 120cm and stalk 45cm. Supplied with mounting bolts
J10557 £28.75



Front Seat Belt Kit 1979 TO 1992
Made in the UK, Belt length is 290cm while the stalk is 45cm.
J10116 £40.75



Automatic Front Seat Belt
Standard style seat belt. Black webbing and buckle.
J14693 £47.75



Seatbelt Mounting Plates (Pair)
Measuring 55mmx55mm, supplied with lock nuts.
J11582 £12.00



Seat Belt (Rear) Extender
Provides an extra 16in (40 cm) of flexibility.
J11679 £14.50



Seatbelt Mounting Nut
Seatbelt mounting nut is to industry standard 7/16 UNF
J11996 £0.50



Seatbelt Mounting Bolt
2in long bolt is to industry standard 7/16 UNF.
J11997 £0.85



Blue Front Seatbelt Kit
Belt length is 314cm with 45cm stalk length includes fittings.
J12008 £59.25



Rear Seat Belt With Adjustable Buckle Strap Stalk
Webbing length, retractor to end bkt 376cm + stalk.
J13005 £50.00

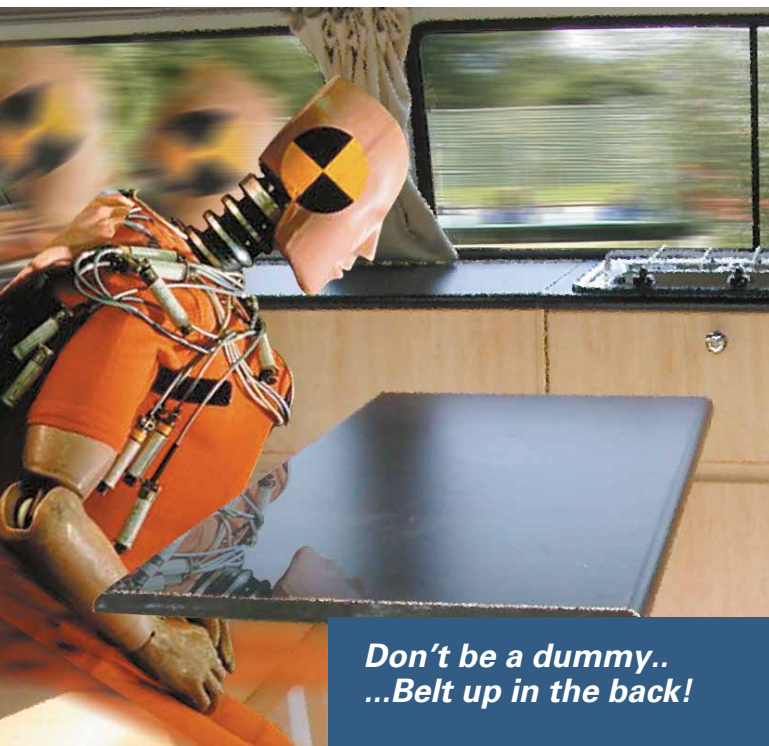

**Don't be a dummy..
...Belt up in the back!**

Seat Belt Positions

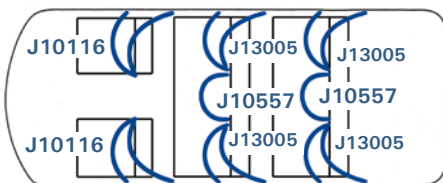
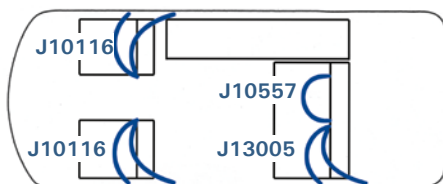

Rear Lap Seat Belt (Retractable) For Bench Seats.
Made in the UK Belt length is 110cm while the stalk is 22cm
J13538 £30.00

Seats, Seat Covers & Swivel Base Kits



Seat Swivel Plate
Simple to fit can be used on either passenger or drivers seat
J18046 £180.00

Door Trims & DIY Trimming Panels



Trim Clips (Pack of 25) 1979 to 1992
Trim clips are used for mounting original-style door panels
J10934 823867299 £5.00



Black Trim Clips 1979 to 1992
Sold in packs of five.
J11303 801867299 01C £2.50



Black Front Door Cards
Made exclusively for JK fits all years.
J18598 £100.00



Pair Of Door Cards In 3mm Plain MDF
Ready for you to cover in the material of your choice.
J12428 £34.00



Sliding Door Panel In 3mm Plain MDF
Ready for you to cover in the material of your choice.
J12429 £17.00



Panel Opposite Sliding Door In 3mm Plain MDF
Ready for you to cover in the material of your choice.
J12430 £17.00



Tailgate Panel In 3mm Plain MDF
Ready for you to cover in the material of your choice.
J12431 £17.00



Pair of Rear Side Panels In 3mm Plain MDF
Ready for you to cover in the material of your choice.
J12432 £27.00



Rear Boot Side Panels 1979 to 1992
Sold as a pair, with cutout for the rear washer bottle.
J12622 £29.00



Sliding Door Panel Plain MDF 1979 to 1985
Early style panel with no cut out to the rear.
J12828 £17.00

Bundle kit

Interior Panel Kit (9 Panels) 1979 to 1984

A bundle deal kit of plain MDF panels ready for trimming
J18352 £153.75



SAVE 10%

Bundle kit

Interior Panel Kit (9 Panels) 1984 to 1992

A bundle deal kit of plain MDF panels ready for trimming
J18353 £153.75



SAVE 10%



Door Trim Removal Tool
Avoid damaging your door cards when removing them
J11401 £8.00

Carpets, mats & floor trim



Door Step Rubber Nearside (Left) 1979 to 1992
J10703 251863735 £9.75



Door Step Rubber Offside (Right) 1979 to 1992
J10704 251863736 £9.75



Cab Overmat Right Hand Drive 1979 to 1992 (Except Autos)
Black with waterproof backing and sewn in rubber pad.
J13299 £37.25

Headlining Kits & Sunvisors



Sunvisor (Pair) 1979 to 1992
Made exclusively for JK this pair of sunvisors fit all T25s
J19912 251857551A **Call For Availability**



Sun Visor Clip 1979 to 1992
Sold as singles fits all models.
J12554 251857561A 581 £3.75

Window Thermo Mats

For more details on thermo mats see page 79



Eight Piece Thermo Mat Kit
Comprises eight mats (windscreen, side and rear windows)
J12747 £99.50



External Thermo Screen Cover 1979 to 1992
Quick and easy to fit insulated cab thermo mat.
J10703 £49.50



Brass Grommet Kit (Eyelets)
Kit consists of 20 eyelets in brass-coated steel.
J12931 £4.50



Thermo Mat Suckers (Pack of 10)
Please note, thermo mat sets are sold complete with suckers
J90020 £8.50

Product Key.



Exclusive to Just Kampers



Made in the UK













GENUINE PARTS & ACCESSORIES

Genuine VW part



Oversized charges apply to non-mainland UK deliveries

General Camping Interior Parts

- Slimfit Interior light**
16w 12v light measures 37cm x 6cm x 4cm.
J11480 £19.25
- Silent GlisSold in packs of 25**
Sold in packs of 25 you may require the hooks J11484.
J11483  £4.00
- Silent Gliss Hooks**
Sold in packs of 25 you may require the glides J11483.
J11484  £4.00
- Bunk Bed**
Canvas size is 57cm x 176cm and poles are 32mm x 200mm.
J11494  Call For Availability
- Bunk Bed Mount**
This bunk bed mount is designed to take a 32mm diameter pole.
J11495 £2.75
- 3 Part Foam Set For 3/4 Width Bed 1979 to 1992**
Made from flame retardant foam, ready cut to match most beds.
J12654   Call For Availability
- 3 Part Foam Set For Full Width Bed 1979 to 1992**
Made from flame retardant foam, ready cut to match most beds.
J12655   £153.75
- Luxury (Double) Memory Foam Mattress Pad**
Dimensions: 184cm x 129cm x 4cm
J13302   £114.00
- Just Kampers Sleeping Bag (Single Grey/Green/Van Motifs)**
Quality and value rolled into one - literally!
J19150  Call For Availability
- Beech Effect Table Top**
MDF material and measures 76cm x 42cm (30in. x 17in.).
J12010   £37.00
- Fiamma Tripod Pro Table Base**
Designed for use with our table kit J18622
J18622 £39.50
- Height Adjustable Table Leg**
Adjusts from 56cm to a maximum 78cm in length
J12162 £22.50
- Reimo Adjustable Sliding Table Rail Kit**
Overall Length is 104.5cm useable length of the rail 95cm.
J12164 £25.00
- Table Mounting Kit**
4-piece table mounting kit simply attached by screws
J12161 £6.50
- Terry Clips (Pair)**
Specifically for securing our island table leg (J11868)
J12472 £5.00

Bundle kit

Table Kit

75cm x 43cm, with a 2cm deep top, and a sturdy 70cm leg.

J11993 £63.75



SAVE 10%

Bundle kit

A Pair Of Bunk Beds Complete (Includes Poles & Mounts)



A bundle deal on two J11494 bunk beds.

J18733.....

Call For Availability

SAVE 10%



- Table Base Fitting**
Used under the table with our table leg (J11868).
J11870 £8.00
- Island Table Leg (Chrome)**
5.5cm in diameter and 70cm in height.
J11868 £15.00
- Floor-Mounted Table Base**
Used with the 5.5cm diameter table leg (J11868) .
J11869 £8.00
- Cover For Recessed Table Leg Base (J11869)**
Stop dirt and debris clogging up your table base.
J13506  £3.00
- Stainless Steel Insert Sink**
Measures 32cm x 32cm x 13cm, with waste outlet.
J11791 Call For Availability
- Adjustable Sink Tap**
Built-in 12v switch and wiring to plumb into your sink.
J11793 £25.00
- Water Hose (13mm/0.5in. diameter) per metre**
Approved for use with portable water for human consumption
J11680 £2.50
- Water Hose 9mm (3/8in) Diameter, per metre**
Approved for use with portable water for human consumption.
J12057 £2.00
- Submersible Water Pump (12v)**
Pumps 10ltr per minute and is 3.3cm wide by 10.5cm long.
J11693 £14.00
- Water Pump Foot Switch (12v)**
Ideal for use with JK's submersible pump (J11693).
J11694 £7.00
- Butane Gas Regulator (28mbar/8mm Nozzle)**
Use with Calor 4.5kg bottles that have screw-on fittings.
J11843 £6.00
- Butane Gaz Regulator (9kw rating)**
Suitable for use with Campingaz 907 cylinders.
J11845 £6.00
- Cigar Lighter Socket**
Features a rubber cap to keep out moisture and dust.
J11849  £5.00

Seat Swivel Plate

Simple to fit can be used on either passenger or drivers seat

J18046 £180.00



Pull Tested!

Product Key:



Exclusive to Just Kampers



Made in the UK

GENUINE
PARTS & ACCESSORIES

Genuine VW part



Oversized charges apply to non-mainland UK deliveries

- Curtain Rail**
For full kit – with hooks and gliders – please order J18860.
J15038 **£30.00**
- JK Curtain Runners For J15038 Curtain Rail**
Combined hook and glide sold in packs of 20
J11900 **£7.00**
- JK Curtain Rail End Stop**
For use with j15038 curtain rail Sold in packs of 6.
J11901 **£2.00**
- Gas Bottle Holder**
7kg gas bottle holder ideal for keeping gas bottles upright
J11935 **£10.95**
- Adjustable Mushroom Roof Vent**
14cm in diameter and requires an aperture size of 10cm to fit.
J11954 **£32.50**
- Anti-Slip Cupboard Mat in Assorted Colours**
150cm x 30cm and can be easily cut to size.
J12153 **£5.00**
- Snap Fastener Kit (Studs and Poppers)**
Contains 8 screw-in fixings plus 8 popper caps.
J12498 **Call For Availability**
- Flush Cupboard Knob**
A compact push lock for cupboard doors, finished in silver.
J12755 **£5.50**
- 12v Multi-Socket**
A 0° to 90° adjustable head with twin 10amp sockets.
J13600 **£7.00**
- Triple Multi Socket (8 Amp 12V DC)**
3 guide light rings, mounting arms and coiled cable.
J13606 **£10.25**
- Cigar Lighter Plug**
For wiring 12v appliances to run from a cigar lighter socket.
J13617 **£4.00**
- Ring 12v Defroster & Fan**
Fitted with fused 12v cigarette lighter plug.
J18579 **Call For Availability**
- HG Moisture Trap 450g**
Helps prevent condensation and musty odours in your van
J19135 **Call For Availability**
- HG Moisture Trap Refill 450g**
Used in conjunction with J19135
J19136 **Call For Availability**

Westfalia Parts

- Westfalia Roof Canvas Tack Strip 1979 to 1985**
Sold in 10 meter roll
J18571 253070707 **£30.00**
- Westfalia Sticker**
As fitted to the front or rear of Westfalia pop tops.
J19837 701070914 **£3.80**

Dash Tidies & Storage Solutions

- 2 Piece Dash Tidy (Right Hand Drive) 1979 to 1992**
A sturdy 2 piece construction Made from 3mm ABS plastic
J13122 **£44.25**
- 2 Piece Dash Tidy Type (Left Hand Drive) 1979 to 1992**
A sturdy 2 piece construction Made from 3mm ABS plastic
J13123 **£44.25**
- Dash Tidy (Only Fits Right Hand Drive) 1979 to 1992**
Made from strong black 3mm ABS plastic. For RHD models.
J10919 **£29.00**

Camper Fridge with 12v/240 capability

35ltr fridge runs on 12 or 240 volt mains power.

J19648 **Call For Availability**

Exclusive to JK!



- Cup Holder**
Made from robust steel with a easy clean powder coat finish
J20278 **£29.00**
- Folding Cup Holder**
Holds an average coffee cup or regular 330ml drink can.
J11799 **£7.00**
- Backseat Organiser Tidy (Black)**
Has deep pockets for useful storage. Easy fitting.
J39413 **£13.00**

Storage Pockets

Exclusive to JK!



- Door Storage Pockets**
Sold as a pair 530mm long with can holder.
J12373 **£24.00**
- Door Storage Pockets**
Sold as a pair 350mm long with can holder.
J12374 **£23.00**



Accessories

- 2 Piece Dash Tidy (Right Hand Drive) 1979 to 1992**
A sturdy 2 piece construction Made from 3mm ABS plastic
J13122 **£44.25**
- 2 Piece Dash Tidy Type (Left Hand Drive) 1979 to 1992**
A sturdy 2 piece construction Made from 3mm ABS plastic
J13123 **£44.25**
- Dash Tidy (Only Fits Right Hand Drive) 1979 to 1992**
Made from strong black 3mm ABS plastic. For RHD models.
J10919 **£29.00**
- Cup Holder**
Made from robust steel with a easy clean powder coat finish
J20278 **£29.00**
- Backseat Organiser Tidy (Black)**
Has deep pockets for useful storage. Easy fitting.
J34913 **£13.00**
- Rear Window Jail Bars Set 1979 to 1992**
Supplied with all brackets and fittings.
J12123 **£33.50**
- Jail Bar Set (Side Window)**
Supplied with end pieces and screws.
J13855 **£42.50**

Pedals, Cables & Levers

- 
'Backsee' Lens
 Magnifying lens reversing aid size 25cm x 20cm.
J11473 £10.00
- 
Billet Aluminium Sliding Door Inner Handle 1979 to 1992
 Fits either side sliding door.
J19248 £48.00
- 
Billet Aluminium Gear Knob
 A OE style gearknob in billet aluminium.
J17002 £23.00

Accelerator Cables & Fittings

- 
Accelerator Cable
 T25 accelerator cable fits all 1600 cc vans from June 1979 to July 1983.
J12276 251721555 £9.00
- 
T25 Accelerator Cable LHD, Diesel 1980-87
 This 3945 mm accelerator cable fits Left Hand Drive Diesel T25s 1980 to 1987 with engine code CS.
J12286 251721555C £28.75
- 
Accelerator Cable T25 Right Hand Drive Automatic 1980-1992
 This 3700 mm accelerator cable fits all Right Hand Drive VW T25s with a automatic gearbox from 1980 to 1992.
J33461 252723655F £31.25
- 
Accelerator Cable Righthand Drive 1600cc Aircooled
 Fits all righthand drive, 1600cc aircooled except automatics.
J10227 252721555 £9.50
- 
Accelerator Cable Righthand Drive 2000cc Aircooled
 Fits all righthand drive, 2000cc aircooled except automatics
J10229 252721555B £6.50
- 
Accelerator Cable RHD 1900cc 78 BHP 1983 to 1992
 Fits all RHD 78 BHP 1900cc watercooled except automatics
J10231 252721555Q £14.50
- 
Accelerator Cable RHD 1900cc 60BHP 1982 to 1990
 Fits all RHD 78 BHP 1900cc watercooled except automatics
J10232 252721555R £14.50
- 
Accelerator Cable RHD Diesel 1982 to 1992
 Fits all righthand drive diesel and turbo diesel,
J10233 252721555T £12.75
- 
Accelerator Cable (Left Hand Drive) 1900cc Watercooled
 Accelerator cable fits all 1900cc petrol left hand drive vans
J12275 251721555R £12.75
- 
Accelerator Cable (Left Hand Drive) 2000cc Aircooled
 Fits all 2000cc left hand drive vans from 1980 to 1984
J12279 251721555B £10.25
- 
Accelerator Cable (Left Hand Drive) 2100 Watercooled
 Fits all 2100cc LHD from August 1985 to October 1990.
J12287 251721555Q £9.75
- 
Accelerator Cable Left Hand Drive Automatic 1984-1992
 Fits all Left Hand Drive VW T25 Transporters
J33463 251723655D/EQ £22.75
- 
Accelerator Cable Left Hand Drive Automatic 1980-1983
 Fits all Left Hand Drive VW T25 Transporters
J33464 251723655 £25.00
- 
Accelerator Cable Right Hand Drive Diesel 1980-1985 and 1988-1992
 Fits Diesel VW T25 from 1980 to 1985 and 1988 to 1992
J33473 252721555T £21.75
- 
Accelerator Cable Right Hand Drive Diesel 1981-1982
 Fits all Right Hand Drive VW T25 Diesel models from 1981 to 1982.
J33474 252721555C £29.00
- 
Accelerator Cable Left Hand Drive 1900cc Watercooled 1983-1992
 Fits all Left Hand drive 1900cc watercooled VW T25s from 1983 to 1992
J33475 251721555R Call For Availability

Cup Holder





Made from robust steel with a easy clean powder coat finish

J20278 £29.00



Exclusive to JK!





NEW!

- 
Accelerator Cable Left Hand Drive 1900cc Watercooled 1983-1992
 Fits all Left Hand Drive VW T25s from 1980 to 1992
J33476 251721555G £14.50
- 
Accelerator Cable 2000cc Aircooled Injection 1979-1983
 Fits all VW T25s with the 2000cc aircooled injected engine
J33482 211721555AA £6.00
- 
Clutch Cable Left Hand Drive 1979-1982
 Fits all Left hand drive VW T25s from 1979 to 1982
J33485 251721335 £12.00
- 
Bolt for Accelerator Cable Barrel (J11439) Petrol Models
 This bolt fits our accelerator barrel J11439
J20003 N01020506 £0.35





Clutch Cables & Fittings

- 
Clutch Cable With Front Conduit 1979 to 1992
 It comes supplied as a complete cable with the front conduit.
J10235 252721335 £18.75
- 
Clutch Cable Conduit 1979 to 1982
 Fits all righthand drive models.
J10811 251721361B £4.75









Hydraulic Clutch Components

- 
Clutch Slave Cylinder 1982 to 1992
 Since 1982, all T25s have been fitted with hydraulic clutches.
J10290 251721263A £22.25
- 
Clutch Slave Cylinder Repair Kit 1980 to 1979
 Kit contains piston seal, dust boot and bleed nipple cover.
J10797 251798041 £10.25
- 
Clutch Flexi-Hose 1981 to 1982
 Mounted between the metal pipes at the gearbox end.
J10815 251721477D £6.50





Handbrake Cables & Fittings

- 
Handbrake Cable 1979 to 1992
 Connects the balance bar to the rear brakes
J10268 251609701C £8.50
- 
Hand Brake Cable Type 25 Syncro (Right) 16" Wheels
 Hand Brake Cable Type 25 Syncro (Right) 16" Wheels Balance Bar to Rear Brakes
J21406 251609701F £26.00
- 
Hand Brake Cable Type 25 Syncro (Left) 16" Wheels
 Hand Brake Cable Type 25 Syncro (Left) 16" Wheels Balance Bar to Rear Brakes
J21407 251609701E £26.00
- 
Hand Brake Cable Type 25 Syncro (Left) 14" Wheels
 Hand Brake Cable Type 25 Syncro (Left) 14" Wheels Balance Bar to Rear Brakes
J21408 251609701D £26.00











Heater Cables & Fittings

-  **Heater Cable (Nearside) 2000cc 1979 to 1983**
Fits nearside all righthand drive 2000cc from 1979 to 1983.
J10239 252711629.....  **£32.00**
-  **Heater Cable (Offside) 2000cc Aircooled 1979 to 1983**
Fits offside all 2000cc aircooled, righthand drive
J10246 252711630..... **£26.75**
-  **Heater Cable (Offside) 1600cc 1979 to 1982**
Fits all 1600cc aircooled, righthand drive offside
J10247 252711630A..... **£27.00**
-  **Heater Cable (Offside/Right) Left Hand Drive 1979 to 1983**
4205mm in length fits the righthand (offside) on 2000cc
J11086 251711630A..... **£27.00**
-  **Heater Cable Clamp Kit 1600 & 2000cc Aircooled**
This heater clamp kit mounts the cable to the heater flap arm.
J10323 111298101A..... **£3.95**
-  **Heater Cable Boot Aircooled Models**
Helps prevent dirt and dust getting into the heater tubes
J10970 211711633.....  **£4.45**

Speedo Cables & Fittings

-  **Speedo Cable (Righthand Drive) 1979 to 1981**
This GEMO speedometer cable is in the 'screw-in' style
J10175 252957803..... **£16.00**
-  **Speedo Cable (Righthand Drive) 1981 to 1992**
This GEMO speedometer cable is in the 'push-in' style
J10176 252957803F..... **£19.75**
-  **Speedo Cap**
This is the grease cap that takes the speedo drive.
J10816 251407691A..... **£25.25**
-  **Speedo Cable Circlip 1979 to 1992**
This circlip retains the speedo cable to the drive cap
J10584 N0124342..... **£0.15**
-  **Speedo Cable (Left Hand Drive) 1981 to 1992**
Push-in style, speedo cable
J12274 251957803E..... **£18.75**

Accelerator Pedal & Linkage

-  **Accelerator Pedal 1979 to 1992**
OEM quality plastic accelerator pedal fits all T25s
J10761 251721511D 01C.....  **£9.50**
-  **Accelerator Pedal Pin for T25 1979-1992**
OEM quality pin secures the accelerator lever in the mounting
J10762 251721639.....  **£3.90**
-  **Accelerator Push Rod 1979 to 1992**
Fits under the accelerator pedal on manual gearbox models.
J10818 251721609C.....  **£4.00**
-  **Accelerator Pedal Locking Washer 1979 to 1992**
Holds the accelerator pedal pin (J10762) in place.
J10819 N90095603.....  **£1.45**
-  **Accelerator Pedal Lever 1979 to 1992**
This OEM accelerator pedal lever fits below the pedal
J10831 251721507A.....  **£28.75**

Bundle kit

Leisure Battery Wiring Kit

A complete kit for wiring a leisure battery.

J15328 **£65.50**



SAVE 10%

Bundle kit

12v Dual-Charging Bundle Kit

This kit allows you to charge a 12v auxiliary battery

J14388 **£30.00**























SAVE 10%

Pedal Rubbers

-  **Pedal Pad Rubber**
Fits either the brake or clutch pedal.
J12044 311721173A..... **£2.95**

Batteries, Leads & Leisure Batteries

-  **Vehicle Battery 12 Volt (50 Amp Hours)**
Dimension 242mm Length x 175mm Width x 175mm Height
J16856 
-  **Vehicle Battery 12v (60Amp Hours)**
Dimension 242mm Length x 175mm Width x 175mm Height
J16857 000915105DE..... 
-  **Leisure Battery (85Amp Hours)**
Specifically designed for use as a leisure battery.
J16858 JZW915105B..... 
-  **Leisure Battery (110Amp Hours)**
Specifically designed for use as a leisure battery.
J16859 000915105DL..... 
-  **Leisure Battery (75 Amp Hours)**
Specifically designed for use as a leisure battery.
J16860 000915105DG..... 
-  **Battery Cover for T25 1979 to 1992**
Will stop any electrical short out on the seat base.
J10705 281915411G.....  
-  **Dual Charging Kit for All models**
Kit consists of relay, wiring and easy-to-follow instructions.
J10520 092VAG227..... **£25.00**
-  **Battery Earth Strap (41cm)**
Has an eye at one end and a clamp at the other.
J11178  **£12.25**
-  **Battery Positive Lead (103cm)**
Features an eye at on end and a clamp at the other.
J11179  **£15.00**
-  **Chassis Earth Strap**
Braided earth strap 28 cms long
J14187 111971237A..... **£8.75**
-  **Heavy Duty Split Charge Relay**
Heavy duty 10 bit microprocessor controlled split charger.
J16918 

Handy Hint

Remember to carry spare cables with you

It's worth while carrying a spare accelerator and clutch cable with you in the van. Due to the unusual length of the cables, Mr AA or RAC may not carry the right cables and it may not be possible to repair your broken one at the roadside.

- Illuminated Cigar Lighter**
Can be used to power satnavs, mobile phone chargers etc.
J10920 171998250..... **£12.25**
- Illuminated Accessory Switch**
Switch has interchangeable red, amber or green lenses.
J11630 **£15.00**
- Phoenix 12V / 180W Inverter**
All Victron Energy Inverters utilise innovative hybrid high/line frequency switching technology to benefit from the advantages of efficiency, compact dimensions and lighter weight without compromising output performance.
J29068 **Call For Availability**
- Motor Horn 1979 to 1992**
Fits any 12v VW and, as it's a quality Hella product,
J10154 191951113A..... **£16.925**
- Horn wire rubber boot**
Protects your wires. 2 required per vehicle. Sold individually
J20757 111951195A..... **£2.25**
- CTEK 12v Multi Battery Charger MXS5.0**
With function to restore deeply discharged batteries.
J29060 **£94.00**
- CTEK 12v Multi Battery Charger MXS7.0**
With function to restore deeply discharged batteries.
J29061 **Call For Availability**
- CTEK 12v Smartpass Battery Charger**
Obtains energy from DC sources such as solar or wind power
J29062 **Call For Availability**
- CTEK D250S 12v Dual Battery Charger**
Obtains energy from DC sources such as solar or wind power
J29063 **Call For Availability**
- Battery Isolator Switch Key**
For use with the battery isolation switch.
J29443 **£2.00**
- Ignition Leads and Sparkplugs Set for 1900cc VW T25 1983-1984**
Use J16915 for kit with Free spark plugs
Use J16915 for kit with Free spark plugs
J10913 905QHT018..... **£34.25**
- Fuel Gauge**
A Genuine Volkswagen fuel gauge that fits all models.
J10857 251919031A..... **£60.00**
- Single Blade Fuse Holder**
Protection from movement and weather - single blade holder.
J27768 **£1.50**
- Headlight Adjusting Screw (Horizontal) VW T25 1980 - 1992**
Adjusting screw for horizontal adjustment of square main headlight
J31153 255941141C..... **£4.50**
- Headlight Adjusting Screw (Vertical) VW T25 1980 - 1992**
J31155 191941297..... **£3.20**
- H2 12 Volt 12v 55w Halogen Bulb**
12v 55w H2 X511 Halogen Headlamp
Product Dimensions (mm): H 31 x W 21 x D 21 Voltage: 12v
Watts: 55w ECE Type: H2 Cap Type: X511
J40230 **Call For Availability**
- Rotor Arm 1979 to 1985**
Bosch rotor arm features a 4500rpm cut-out.
J10195 211905225B..... **£17.25**
- Wiper Spindle Seal Type 25 up to July 1991**
2 required per vehicle. Sold each
J21217 133955261..... **£1.80**
- Pertronix Flame Thrower Chrome Ignition Coil**
Pertronix Coil 3.0 Ohm Chrome (Oil Filled/ 12 volt)
The ideal coil to use with the Pertronix Ignitor 1, and suitable for all inductive ignition systems. These oil filled coils offer greater cooling and with 45,000 volts you can run larger plug gaps giving added power and fuel economy. Chrome finish this fits all 12volt ignition system
J19685 **£44.50**
- Pertronix Black 8mm Universal HT Leads (for Pertronix Billet Distributors only) VW 1700-2000cc Aircooled Models**
World renowned Pertronix plug wires feature twin current paths, primary spiral wound stainless steel and a secondary carbon impregnated centre core. Sold as a set of 5 leads with straight plug and distributor boots.
J39406 **£59.00**
- Pertronix Blue 8mm Universal HT Leads (for Pertronix Billet Distributors only) VW 1700-2000cc Aircooled Models**
World renowned Pertronix plug wires feature twin current paths, primary spiral wound stainless steel and a secondary carbon impregnated centre core. Sold as a set of 5 leads with straight plug and distributor boots.
J39407 **£59.00**
- Pertronix Red 8mm Universal HT Leads (for Pertronix Billet Distributors only) VW 1700-2000cc Aircooled Models**
World renowned Pertronix plug wires feature twin current paths, primary spiral wound stainless steel and a secondary carbon impregnated centre core. Sold as a set of 5 leads with straight plug and distributor boots.
J39408 **Call For Availability**
- Pertronix Yellow 8mm Universal HT Leads (for Pertronix Billet Distributors only) VW 1700-2000cc Aircooled Models**
World renowned Pertronix plug wires feature twin current paths, primary spiral wound stainless steel and a secondary carbon impregnated centre core. Sold as a set of 5 leads with straight plug and distributor boots.
J39409 **Call For Availability**
- Front Indicator Bulb Holder**
Sold as singles this indicator bulb holder will fit either side
J39271 171953053A..... **£10.50**
- Satellite Point - Surface Mounted (White)**
J27690 **£4.80**
- Slim waterproof linear LED 12 volt strip light**
Contains 72 LEDs. Length 500mm
J27736 **Call For Availability**
- Slim waterproof linear LED 12 volt strip light**
Contains 144 LEDs. Length 1000mm.
J27737 **£49.50**
- Linear LED light joiner**
Enables you to join two lights together. Use with J27732.
J27739 **£1.95**
- 12 V Cigarette Lighter Vintage Style**
J29320 **£5.00**
- 12v LED Switched Spot Lamp**
Finished in brushed aluminium this attractive single spot light features a built in on off switch with its swivel base offering all round versatility.
J40238 **£17.95**
- Surface Mounted Aluminium Light Kit (Low Profile)**
A set of six Surface Mounted Low Profile 12 volt Aluminium Lights for the interior of your van. Easy installation this kit includes 6 Led Lights with a splitter and cable.
J40270 **Call For Availability**
- Ignition Switch 1979 to 1992**
Made from nylon, this ignition switch has push-on connectors
J10171A 111905865L..... **Call For Availability**
- T-Piece for T2 Washer Pipe**
J21215 211955975..... **£2.00**
- Screenwash Fluid 1Ltr bottle**
1 Ltr Concentrated Lemon scented cleaner for the washer system, with anti-freeze for year round use.
J29393 G052164M2..... **£6.75**

Prices include VAT

Shop online at justkampers.com



Noise reduction kits for Type 25 Camper or Panel Vans

Just Kampers have teamed-up with Dynamat, the leading automotive noise and heat reduction specialists, to provide a range of products for your VW.

To make things easier and take the guess work out how much Dynamat you need, we've measured the inside of a Type 25 Camper and put together a range of kits that have all the sound deadening you'll require.

The benefits of installing Dynamat from Just Kampers are:

- *Less road noise*
- *Less engine/transmission noise*
- *Less resonance & rattles*
- *Improved sound quality from your music system*
- *Less heat from engine/exhaust*

Camper With Windows



Complete Coverage

For maximum results apply our Full Coverage kit. With enough Dynamat to cover all accessible areas of your Camper this really is the best way to make you Bus feel more like a modern car.

Kit includes;

- Door and side panels
- Floors
- Roof

J42353 - £599

All bar the roof

If you've already fitted your headliner or you don't want to remove your existing headliner, this is the kit for you. There's enough Dynamat to cover the entire floor and all doors and side panels.

Kit includes;

- Door and side panels
- Floors

J42354 - £449

Doors & Side Panels

We recommend this kit as the bare minimum. You'll get a 60% improvement by applying Dynamat to the doors and side panels. And you'll get the added bonus of your doors shutting with a modern car thud.

Kit includes;

- Door and side panels

J42361 - £149.50

Panel Van Without Windows



Complete Coverage

For maximum results apply our Full Coverage kit. With enough Dynamat to cover all accessible areas of your Panel Van this really is the best way to make you Bus feel more like a modern car.

Kit includes;

- Door and side panels
- Floors
- Roof

J42355 - £748.50

All bar the roof

If you've already fitted your headliner or you don't want to remove your existing headliner, this is the kit for you. There's enough Dynamat to cover the entire floor and all doors and side panels.

Kit includes;

- Door and side panels
- Floors

J42356 - £599

Doors & Side Panels

We recommend this kit as the bare minimum. You'll get a 60% improvement by applying Dynamat to the doors and side panels. And you'll get the added bonus of your doors shutting with a modern car thud.

Kit includes;

- Door and side panels

J42362 - £299.50

**For our full Dynamat range call 0845 1252125
or visit justkampers.com**

Bundle kit

12v Dual-Charging Bundle Kit

This kit allows you to charge a 12v auxiliary battery

J14388 £30.00







SAVE 10%

Fuses & Boxes, Relays & Fuel Senders

	Torpedo Type Fuse Pack 1 Each of 2.5A & 5A & 25A Plus 4 x 8A Plus 3 x 16A J13120 £4.00
	Blade Fuse Pack A selection of blade fuses J13121 £3.00
	5amp Glass Fuse For use with J10933. J11662 N0171211 £0.80
	Versatile In-line Fuse Holder Ideal for wiring-in accessories J10933 £1.95
	50amp Fuse For Glowplugs All Diesel Engines 1979 to 1992 J10940 N0171251 £0.30
	Headlamp Relay 1979 to 1992 12v, five-pin, headlamp relay J10161 111941583 £21.75
	Indicator Relay 1979 to 1992 12v, three-pin indicator relay J10162 111953227D £5.50
	Relay (For Glowplugs) All Diesel Models 1981 to 1995 J10720 443911261 £19.00
	Hot Start Relay (12V) Helps starting problems on older vehicles. J12928 141951253B £8.25
	Glowplug Relay All Diesel 1981 to 1995 J13723 171911261E Call For Availability
	Dual Thermo Switch 1984 to 1992 This is the cooling fan switch J10178 251959481K £11.75
	Dual Thermo Switch (3-Pin) 1982 to 1984 located on the radiator and operates the cooling fan on. J10721 191959481C £12.75
	Thermo Switch 1981 to 1982 located on the radiator and operates the cooling fan. J10722 191959481B £9.75
	Coolant Level Switch 1981 to 1992 Length 68mm, it attaches to the top of the expansion tank. J10725 251919372 £7.25
	Temperature Sensor (2-Pin) 1983 to 1992 This two-pin temperature sensor fits all engines, 1983-1992 J13717 251919501D £5.25

	Temperature Sender 1900, 2100cc Watercooled 1985 to 1992 Temperature sender for the coolant temperature gauge. J10568 251919501 £7.25
	Temperature Sender 1600, 1700cc Diesel 1900, 2100cc Petrol The sensor works between 0° and 125°. J10726 049919501 £4.65
	Oil Pressure Switch 1600, 2000cc Aircooled 1979 to 1984 0.15-0.45 Bar fits all aircooled models. J10513 021919081B £3.05
	Oil Pressure Switch (Black) All Watercooled 1985 to 1992 1.2-1.4bar please check colour before ordering. J10724 068919081 £3.35
	Oil Pressure Switch 1900, 2100cc Watercooled 1983 to 1992 Rated at 0.15 to 0.35bar colour blue J11045 028919081H £3.70
	Oil Pressure Switch (Grey) 1900, 2100cc 1983 to 1994 0.75 and 1.05bar Please check requirement before ordering. J11054 068919081A £3.95
	Oil Pressure Switch (White 1.6-2.0 Bar) 1983 to 1992 Fits all Petrol watercooled T25 models. J12011 056919081E £3.85
	Fuel Tank Sending Unit 1979 to 1987 lever-arm unit, from world-class manufacturer VDO J10192 251919051E £42.75
	Fuel Tank Sending Unit 1987 to 1992 lever-arm unit, from world-class manufacturer VDO J10193 251919051K £32.75

Switches, Ignition Switches & Keys

	Hazard Switch (On Dash) 1979 to 1992 This is a Febi quality dashboard hazard switch J15164 161953235B £7.25
	Headlamp Switch with Dimmer 1979 to 1992 Complete with dimmer. J11191 251941531M £6.00
	Temperature Sensor (2 Pin Blue) 1985 - 1992 2.1 only Foglight switch with warning light J31089 025906041A £4.85
	Push Button Switch for General Use Waterproof switch with a 101 uses. J11465 00-9367-0 £9.00
	Ignition Barrel Lock & Key 1979 to 1992 Supplied with 2 keys. J12404 251905855B Call For Availability
	Ignition Switch 1979 to 1992 Made from nylon, this ignition switch has push-on connectors J10171 111905865L £13.75
	Steering Column Lock Housing 1979 to 1992 Top bearing mount complete with ignition lock housing J10937 155905851 £14.75
	Indicator Switch 1979 to 1992 Fits all T25s, except those fitted with cruise control. J10185 251953513 01C £9.75
	Wash Wiper Switch 1979 to 1992 Fits all models. J10723 251953519C £13.75
	Interior Light or Handbrake Warning Switch 1979 to 1992 Sold as singles, fits either side. J10536 113947561H GENUINE £1.75

Product Key:



Exclusive to Just Kampers



Made in the UK

GENUINE
PARTS & ACCESSORIES

Genuine VW part



Oversized charges apply to non-mainland UK deliveries

	Oil Pressure Switch 1600, 2000cc Aircooled 1979 to 1984 0.15-0.45 Bar fits all aircooled models.	J10513 021919081B.....	£3.05
	Oil Pressure Switch (Black) All Watercooled 1985 to 1992 1.2-1.4bar please check colour before ordering.	J10724 068919081.....	£3.35
	Oil Pressure Switch 1900, 2100cc Watercooled 1983 to 1992 Rated at 0.15 to 0.35bar colour blue	J11045 028919081H.....	£3.70
	Oil Pressure Switch (Grey) 1900, 2100cc 1983 to 1994 0.75 and 1.05bar Please check requirement before ordering.	J11054 068919081A.....	£3.95
	Oil Pressure Switch (White 1.6-2.0 Bar) 1983 to 1992 Fits all Petrol watercooled T25 models.	J12011 056919081E.....	£3.85
	Brake Light Switch (3-Pin) 1979 to 1992 Fitted to models which have a brake fluid warning light.	J10535 113945515G.....	£5.75
	Reverse Light Switch 1988 to 1992 Reverse Light switch. Fits all T25 vans from 1988 onwards.	J11065 085941521..... <small>GENUINE</small>	£7.75
	Reverse Light Switch 1981 to 1987 Fits to the side of the gearbox.	J11234 020941521A.....	£6.25
	Dual Thermo Switch (3-Pin) 1982 to 1984 located on the radiator and operates the cooling fan on.	J10721 191959481C.....	£12.75
	Thermo Switch 1981 to 1982 located on the radiator and operates the cooling fan.	J10722 191959481B.....	£9.75
	Coolant Level Switch 1981 to 1992 Length 68mm, it attaches to the top of the expansion tank.	J10725 251919372.....	£7.25
	Temperature Sender 1600, 1700cc Diesel 1900, 2100cc Petrol The sensor works between 0° and 125°.	J10726 049919501.....	£4.65

Engine ECU's, Switches & Senders

	Ignition Control Unit All Petrol Models 1979 to 1992 Ignition switch amplifier module with aluminium heat sink	J11373 191905351B.....	£35.50
	Ignition Coil Petrol Engines 1979 to 1984 For vehicles with electronic ignition	J10538 211905115B.....	£50.75
	Ignition Coil 1900, 2100cc 1984 to 1992 This coil is designed specifically for electronic ignition	J10539 211905115D.....	£27.75
	Vacuum Advance Distributor 1900 cc Watercooled Supplied as a complete unit with cap and rotor arm.	J19596 043905205M.....	£120.00
	Distributor Cap 1900, 2100cc 1984 to 1992 Bosch cap used with pin-type leads	J10205 027905207.....	£9.75
	Distributor Cap 1900, 2100cc 1985 to 1992 This insulated distributor fits engine codes SS and MV	J13701 027905207A.....	£4.95
	Governed Rotor Arm 1900, 2100cc 1983 to 1992 Governed rotor arm which features a cut-out at 4500rpm.	J10514 071905225A.....	£11.00
	Rotor Arm for T25 1985 to 1992 Fits the later, 10mm, small-shaft distributor	J10728 052905225C.....	£7.25

Bundle kit

009 Ignition Kit 2000cc Aircooled 1979 to 1984

Kit contains 4 x W7CC plugs; 009 distributor, seal; and coil.

J11221 **£109.75**



SAVE 10%

Bundle kit















Vacuum Advance Distributor Bundle Kit 2000cc Aircooled

A ignition kit bundle deal

J18814 **£115.00**



SAVE 10%

	Hall Sender for T25 1979 to 1992 Located inside the distributor unit, it fits all petrol T25s	J10729 035998065.....	£43.25
	Hall Sender 2100cc 1985 to 1992 Bosch quality hall sender unit.	J15125 035998065.....	£82.00
	Plug Cap 2000cc Aircooled 1979 to 1984 The longer of the two plug caps used on cylinders two and four.	J10590 021035255G.....	Call For Availability
	Metal Sparkplug Cap 1900 and 2100cc 1983 to 1992 Simply screws on to your existing copper core plug lead.	J10715 036035255J.....	£4.25
	Bosch W7AC 1600cc Aircooled 1979 to 1983 This 'short reach' plug has a 12mm-long thread.	J10712 W7AC.....	£2.50
	Bosch W8CC Long Reach Sparkplug 1600cc 1979 to 1983 This 'long reach' plug has a 19mm-long thread.	J10713 W8CC.....	£2.75
	Spark Plug WR7DC+ 1900, 2100cc Watercooled 1983 to 1992 Bosch WR7DC single electrode spark plugs.	J10910 101000005AB.....	£2.25
	VDO Oil Pressure Sender VDO oil pressure sender twin terminal for gauge and light.	J11554 360081030001.....	£58.25
	Coolant Temperature Gauge Watercooled Models 52mm diameter, Range is 40-100deg Centigrade.	J11558 310 010 002.....	£47.25
	VDO Fuel Sender For custom tanks or retro fit with fabrication.	J11553 226801015001.....	£55.75
	Cylinder Head Temperature Sensor 2000cc 1979-1983 Fits all 2000cc injection engines.	J15344	Call For Availability
	Lambda Sensor 2100cc 1985 to 1992 Sold as a complete unit with wiring and plug.	J19652 025906265B.....	£52.25
	Fuel Cut Off Valve 1.6 & 1.7 Diesel Fits to the side of the injection pump.	J19721 028130135B.....	£13.00
	Water Temperature Sender 1900 & 2100cc The sender is Blue and has a M22x1.5 thread with 2 pins.	J19859 025906041.....	£6.00

Ignition, HT Leads, Spark & Glow Plugs

- 1 Ignition Coil Petrol Engines 1979 to 1984**
For vehicles with electronic ignition
J10538 211905115B..... £50.75
- 2 Alternative Quality 009 Distributor**
Supplied complete with points condenser cap and rotor.
J13331 126903205..... £53.00
- Distributor 1900cc DJ 1985 to 1992**
supplied complete with cap and rotor ready to instal.
J19786 025905205AF..... £150.00
- Distributor 2100cc MV 1986 to 1991**
Supplied complete with cap and rotor ready to instal.
J19787 025905237..... £150.00
- 3 Distributor Shaft Seal 1979 to 1992**
A OEM quality seal.
J10614 111905261..... £0.55
- 4 Distributor Cap 1900, 2100cc 1984 to 1992**
Bosch cap used with pin-type leads
J10205 027905207..... £9.75
- 4 Distributor Cap All Petrol Engines 1979 to 1984**
For standard and 009 distributors.
J10645 113905207C..... £14.25
- Distributor Cap 1900, 2100cc 1985 to 1992**
This insulated distributor fits engine codes SS and MV
J13701 027905207A..... £4.95
- Bosch W7CC Spark Plug (Single) 2000cc 1979 to 1983**
W7CC is the original fitment to all 2000cc aircooled engines
J10118 101000012AA..... £2.50
- Ignition Switch 1979 to 1992**
Made from nylon, this ignition switch has push-on connectors
J10171 111905865L..... £13.75
- 5 Spark Plug Air Seal 1600, 2000cc 1979 to 1983**
Fits the plug leads and seals the air flow over the engine.
J10200 111905449A..... £1.30
- 6 Ignition Lead Set 1600, 2000cc Aircooled 1979 to 1983**
.Set of five leads is supplied with ends and air seals.
J10204 905QHT016..... £30.75
- Rotor Arm for T25 1985 to 1992**
Fits the later, 10mm, small-shaft distributor
J10728 052905225C..... £7.25
- Rotor Arm All Petrol Engines 1979 to 1985**
This Bosch rotor arm fits standard and 009 distributors
J10420 055905225B..... £5.75

Bundle kit

009 Ignition Kit 2000cc Aircooled 1979 to 1984

Kit contains 4 x W7CC plugs; 009 distributor, seal; and coil.

J11221..... £109.75

SAVE 10%



Bundle kit

Vacuum Advance Distributor Bundle Kit 2000cc Aircooled

A ignition kit bundle deal

J18814..... £115.00

SAVE 10%



Ignition System



- 7 Governed Rotor Arm 1900, 2100cc 1983 to 1992**
Governed rotor arm which features a cut-out at 4500rpm.
J10514 071905225A..... £11.00
- Hall Sender for T25 1979 to 1992**
Located inside the distributor unit, it fits all petrol T25s
J10729 035998065..... £43.00
- Hall Sender 2100cc 1985 to 1992**
Bosch quality hall sender unit.
J15125 035998065..... £82.00
- Plug Cap 2000cc Aircooled 1979 to 1984**
The longer of the two plug caps used on cylinders two and four.
J10590 021035255G..... Call For Availability
- Metal Sparkplug Cap 1900 and 2100cc 1983 to 1992**
Simply screws on to your existing copper core plug lead.
J10715 036035255J..... £4.25
- 6 Bosch W7AC 1600cc Aircooled 1979 to 1983**
This 'short reach' plug has a 12mm-long thread.
J10712 W7AC..... £2.50
- Bosch W8CC Long Reach Sparkplug 1600cc 1979 to 1983**
This 'long reach' plug has a 19mm-long thread.
J10713 W8CC..... £1.75
- Spark Plug WR7DC+ 1900, 2100cc Watercooled 1983 to 1992**
Bosch WR7DC single electrode spark plugs.
J10910 101000005AB..... £2.25
- Glowplug All Diesel Models 1979 to 1992**
Fits all diesel and turbo diesel.
J10714 N10213002..... £8.00
- Relay (For Glowplugs) All Diesel Models 1981 to 1995**
J10720 443911261..... £19.00

Bundle kits

Ignition Lead Kit & Plugs 1900cc Watercooled 1983 to 1985

Lead set with with four free spark plugs.

J16915 £38.75

SAVE 10%



Hella Ignition Lead Set 1900, 2100cc 1983 to 1992

A set of 5 ignition leads with 4 free Bosch WR7DC plugs.

J10914 £31.75

SAVE 10%



Ignition Lead Set 2000cc Aircooled 1979 to 1984

A ignition bundle kit with free spark plugs

J18056 £36.50

SAVE 10%



Ignition Lead Set 2100cc Watercooled

Use J10914 for kit with Free spark plugs

J14133 £26.50



Bundle kit

W7AC Short Reach Spark Plug 1600cc Aircooled

A set of 4 W7AC short reach plugs for 1600 CT 1979 to 1983

J13149 £9.00



SAVE 10%

Bosch W8CC Long Reach Spark Plug 1600cc Aircooled

A set of 4 W8CC long reach plugs for 1600 CT 1979 to 1983

J13148 £6.25



SAVE 10%

Bosch W7CC Spark Plugs 2000cc Aircooled 1979 to 1979

A set of four W7cc spark plugs.

J13139 £9.00



SAVE 10%

Handy Hint



Starter motor fault finding



Gearbox Starter Motor Bush 1979 to 1992
Should always be replaced when changing your starter motor.
J11137 113301155 £0.70

- Glowplug Relay All Diesel 1981 to 1995**
J13723 171911261E **Call For Availability**
- 50amp Fuse For Glowplugs All Diesel Engines 1979 to 1992**
J10940 N0171251 £0.30
- Ignition Barrel Lock & Key 1979 to 1992**
Supplied with 2 keys.
J12404 251905855B **Call For Availability**
- Timing Scale 2000cc Aircooled 1979 to 1984**
Provides the timing reference point for your engine.
J13415 021119249E **Call For Availability** £11.25

Starter Motors

- Starter Motor (Petrol) 1980 to 1986**
This starter motor fits all petrol-engined, manual transmission
J10194 091911023BX £110.00
- Starter Motor All Diesel Models 1981 to 1984**
Supplied complete with a solenoid,
J10541 068911023JX **Call For Availability**
- Starter Motor Diesel 1984 to 1992**
Supplied complete with a solenoid
J10542 068911023MX £112.75
- Starter Motor 1900, 2100 cc Watercooled 1986 to 1992**
Supplied complete with solenoid.
J11674 025911023AX £141.75
- Starter Motor (Automatics Only) 1982 to 1992**
Fits from 1982 onwards Automatic gearboxes only.
J12172 003911023DX £264.75
- Starter Motor For Automatics 1979 to 1992**
Hella starter motor fits all automatic transmissions
J10202 003911023BX **Call For Availability**

Product Key:



Exclusive to Just Kaspers



Made in the UK

GENUINE PARTS & ACCESSORIES





Genuine VW part













Oversized charges apply to non-mainland UK deliveries

Alternators & V Belts

-  **Alternator (45amp) 1600, 2000cc Aircooled 1979 to 1983**
The Hella 45amp alternator fits all 1600 & 2000cc
J10217 070903023CX..... **£166.75**
-  **45amp Alternator 1900cc Watercooled 1983 to 1985**
Sold on a exchange basis
J10805 068903017AX..... **£134.75**
-  **65amp Alternator 1900, 2100cc Watercooled 1983 to 1985**
Sold on a exchange basis.
J10806 068903017X..... **£134.75**
-  **65amp Alternator 1900, 2100cc Watercooled 1985 to 1992**
Sold on a exchange basis.
J10807 026903017AX..... **£106.75**
-  **Alternator (65Amp) 1600, 1700cc Diesel 1981 to 1985**
Sold on a exchange basis.
J10808 036903017X..... **£161.75**
-  **90amp Alternator 1900, 2100cc Watercooled 1983 to 1992**
A Hella exchange reconditioned unit.
J12851 025903023E..... **£159.00**
-  **Alternator (65amp) Diesel and Turbo Diesel, 1986 to 1992**
Hella 65amp alternator fits diesel and turbo diesel models
J10214 068903017MX..... **£151.75**
-  **Alternator (90amp) Turbo and turbo Diesel 1981 to 1992**
Hella 45amp alternator fits diesel and turbo diesel models
J10215 068903017PX..... **£165.75**
-  **Alternator Woodruff Key 1600, 2000cc Aircooled 1979 to 1984**
J10888 N0127051..... **£1.95**
-  **Voltage Regulator 1900, 2100cc 1983 to 1992 Diesel to 1991**
Voltage regulator for Bosch alternators.
J12786 068903803D..... **£4.15**
-  **Adjusting screw for alternator**
Voltage regulator for Bosch alternators.
J29494 034903555B..... **£4.25**
-  **V-Belt (10mm x 1175mm) 1600, 2000cc Aircooled 1979 to 1983**
10mm x 1175mm V-belt for all aircooled 1600cc and 2000cc
J10207 070903137..... **£5.25**
-  **Alternator V-Belt (10mm x 1075mm) 1900cc 1984 to 1986**
Fits 1900cc engines with 45 and 65amp alternators.
J10692 025903137..... **£4.70**
-  **Alternator V-Belt 1900, 2100 cc 1986 to 1992**
10mm x 1100mm belt fits 45amp, 65amp and 90amp Alternators
J10693 025903137G..... **£5.75**

-  **Alternator V-Belt (10mm x 617mm) 1985 to 1992**
10mm x 617mm for 90amp alternators.
J10694 068121039G..... **£5.25**
-  **V-Belt (10mm x 600mm) 1600, 1700 Diesel 1979 to 1988**
10mm x 600mm V-belt for use with all diesel T25s, up to 1988,
J10206 068903137AF..... **£5.25**
-  **Water Pump V-Belt (10mm x 650mm) All Diesel 1981 to 1988**
Water pump V-belt on all T25 diesel engines 1981-1988.
J10418 068121039B..... **£3.80**
-  **Alternator (V Belt 9.5 x 875) All Diesel Models**
Fits all diesel engines from 1988 to 1990.
J12299 068903137B..... **£4.05**
-  **Power Steering Pump Belt 1900, 2100cc 1983 to 1992**
J15134 023903137A..... **£3.85**

Wiper Blades, Motors & Switches

-  **Front Wiper Blade 18in 1979 to 1992**
This Bosch quality wiper blade, 18in. long, fits all models,
J10172 191955427B..... **£3.85**
-  **Wiper Blade (16in) 1979 to 1992**
Suitable for front or rear.
J10567 161955425..... **£3.75**
-  **Front Wiper Arm for Righthand Drive 1979 to 1992**
OEM part and fits either side on all righthand drive models.
J10718 252955409..... **£23.25**
-  **Front Wiper Arm Left Hand Drive Models Only.**
Fits either side on all Left Hand Drive T25s
J19824 251955409..... **£27.00**
-  **Wiper Arm Cap 1979 to 1992**
Small, black plastic cap fits snugly over the retaining nut
J10084 133955435..... **£0.70**
-  **Plastic Cap For Wiper Spindle 1979 to 1992**
Please check suitability before ordering.
J13391 171955275..... **£1.75**
-  **Wiper Motor (Front) All Models**
You will need to reuse the crank from your old unit.
J19833 251955119..... **£58.25**
-  **Washer Jet 1979 to 1992**
This OEM quality part comes complete with base gasket
J10013 211955993..... **£5.75**
-  **Windscreen Washer Hose**
Sold by the metre.
J10677 N0203011..... **£4.45**
-  **Electric Washer Pump 1979 to 1992**
The existing plug may need to be replaced with terminals
J10181 251955651..... **£17.00**

Smoked Front Indicator (Nearside/Left) 1979 to 1992

You will need to use your old bulb holder

J11884..... **£13.50**



Smoked Front Indicator (Offside/Right) 1979 to 1992

You will need to use your old bulb holder

J11885..... **£13.50**



Clear Front Indicator Lens Nearside (Left)

Comprises the lens and backing and reuses your old bulbholder.

J19831..... **£23.25**



Clear Front Indicator Lens Offside (Right)

Comprises the lens and backing and reuses your old bulbholder.

J19832..... **£23.25**



- 

Universal Washer Pump (12v)
Can be used in line in any system.
J11314 £13.75
- 

Rear Screen Washer Pump 1979 to 1992
Single outlet, 12v, rear screen washer pump.
J11974 43195651..... £7.75
- 

Washer Bottle Cap Cover 1979 to 1992
Fits on the rear washer bottle.
J13061 211863127 01C..... GENUINE £10.50
- 

Wash Wipe Relay 1979 to 1992
J10575 321955531A..... £7.00
- 

Wash Wiper Switch 1979 to 1992
Fits all models.
J10723 251953519C..... £13.75

Headlights & Switches

- 

H4 Halogen Headlight 1979 to 1992
Fits either side, the bulb is sold separately.
J11165 252941105A..... £42.50
- Left Hand Drive Headlamp 1979 to 1992**
These standard round headlights fit all Left Hand Drive vans
J20120 251941105A..... £40.00
- 

Head Light Pigtail (Heavy Duty 3 Prong)
J13011 16-2102-0..... £4.95
- 

Headlamp Relay 1979 to 1992
12v, five-pin, headlamp relay
J10161 111941583..... £21.75
- 

Headlamp Switch with Dimmer 1979 to 1992
Complete with dimmer.
J11191 251941531M..... £6.00

Rear, Side & Number Plate Lights

- 

Rear Tail Lamp Lens (Nearside) 1979 to 1992
Hella rear lamp is the Original Equipment as fitted by VW.
J10063 251945111D..... £37.25
- 

Tail Lamp Lens (Offside/Right) 1979 to 1992
Please check before ordering to see if you have a Hella unit.
J10719 251945112D..... £37.25

Indicators & Switches

- 

Front Indicator Lens (Nearside) 1979 to 1992
Comprises the lens and backing and reuses your old bulbholder.
J10061 251953141..... £12.25
- 

Front Indicator Lens (Offside/Right) 1979 to 1992
Reuses your old bulbholder.
J10635 251953142..... £12.25
- 

Smoked Front Indicator (Nearside/Left) 1979 to 1992
You will need to use your old bulb holder
J11884 GENUINE £13.50
- 

Smoked Front Indicator (Offside/Right) 1979 to 1992
You will need to use your old bulb holder
J11885 GENUINE £13.50
- 

Clear Front Indicator Lens Nearside (Left)
Comprises the lens and backing and reuses your old bulbholder.
J19831 251953141WHI..... £23.25
- 

Clear Front Indicator Lens Offside (Right)
Comprises the lens and backing and reuses your old bulbholder.
J19832 251953142WHI..... £23.25

Crystal Black Tail Lights Set 1979 to 1992

Smoked tail light lenses only fits models with Hella lights.



J15005..... £93.25

- 

Indicator Bulb Orange (12v 21w)
A single filament 12volt orange bulb.
J11358 £0.80
- 

Indicator Relay 1979 to 1992
12v, three-pin indicator relay
J10162 111953227D..... £5.50
- 

Indicator Switch 1979 to 1992
Fits all T25s, except those fitted with cruise control.
J10185 251953513 01C..... £9.75
- 

Brake Light Switch (2 Pin) 1979 to 1992
Please check your requirement before ordering.
J10534 113945515H..... £3.95

Interior Lights & Switches

- 

Slimfit Interior light
16w 12v light measures 37cm x 6cm x 4cm.
J11480 £19.25
- 

Interior Light
20.5cm x 7cm x 3cm, it requires 2 x J10658 10w bulbs
J11827 £24.25
- 

Interior Light or Handbrake Warning Switch 1979 to 1992
Sold as singles, fits either side.
J10536 113947561H..... GENUINE £1.75
- 

Seal For Interior Light Switch (On Door Pillar)
Fits under the switch on the door pillar, fits either side.
J12733 113947565A..... GENUINE £2.75
- 

Dash Panel Bulb 1979 to 1992
A 12V 1.2 W bulb with base.
J13376 431919040..... £1.00

Bulbs

- 

Halogen Spare Bulb Kit 1979 to 1992
Contains one of each bulb plus common (blade style) fuses.
J11565 000998204A..... £8.25
- 





Halogen Bulb 472 H4 1979 to 1992
12v 60/55w H4 halogen headlight bulb
J11030 N0177632..... £5.75
- 

Stop Tail Bulb (12v 21/5w) 1979 to 1992
This dual filament, 12v, 21/5w 380 bulb.
J10660 N0177382..... £0.65
- 



Stop Tail Bulb
12v, 21/5w, stop tail light with parallel mounting pins.
J13818 N0177382..... £1.15
- 

Side Light Bulb 1979 to 1992
12volt, 4watt used in side lights
J10655 N0177172..... £0.50
- 

Indicator Bulb (12v, 21w) 1979 to 1992
This single filament, 12v, 21w 382 bulb
J10659 N0177322..... £0.50

-  **Indicator Bulb Orange (12v 21w)**
A single filament 12volt orange bulb.
J11358 **£0.80**
-  **Number Plate Lightbulb 1979 to 1992**
12v, 10w, Number plate light bulb
J10656 N0177192..... **£0.90**
-  **Interior Lightbulb (12v, 10w) 1979 to 1992**
12v, 10w, 261, festoon bulb
J10658 N0177232..... **£1.15**
-  **Dash or Switch Bulb (12v) 1979 to 1992**
12v, 1.2w, capless bulb
J11037 N0177512..... **£0.25**

Heater Motors, Switches, Matrix

-  **Blower Motor Switch 1979 to 1992**
When fitting you will need to retain and re-use your old knob.
J10727 171959511..... **£8.75**
-  **Blower Motor 1979 to 1992**
OEM Quality blower motor. Fits all T25 models.
J17026 251819015..... **£31.25**

Handy Hint

Wheel fitting guide

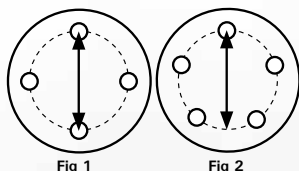

Bolt pattern

Type 25 vans used wheels with a PCD (Pitch Circle Diameter) of 5/112.

The PCD (measured in millimetres) is the distance between the center of two diametrically opposite bolts. In the 4-bolt wheel (Fig 1), this would be the distance between the top and bottom holes. Some basic geometry is needed to find the center of the 5-bolt pattern (Fig 2): But the simplest way is to multiply the center distance between any two adjacent holes by 1.701 (for example bolt holes 3 and 4 in Fig 3).

It's possible for 4 and 5 bolt wheels to share the same PCD, so if the wheels in Fig 1 and Fig 2 both had a PCD of 130mm the 4 bolt wheel on the left would be described as having a PCD of 4/130 and the wheel on the right would be a 5/130.

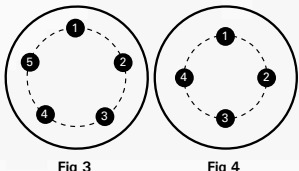

Offset

The offset (measured in millimeters) can be negative or positive, and is the distance from the hub-mounting surface (i.e the brake drum surface) to the wheels true centerline. A positive offset means the hub-mounting surface is closer to the outside edge of the wheel; a negative offset means the hub-mounting surface is closer to the inside edge of the wheel. When selecting aftermarket wheels, a wheel with too

little positive offset will be closer to the fender, and one with too much positive offset will be closer to the suspension components.

Before ordering any wheels, the choice of wheel width, offset, wheel diameter and tyre size should be considered very carefully to avoid tyre contact with the inner and outer wheel arches or steering and suspension components, especially if your Type 25 is lowered or has non standard brakes. Fitting non standard brakes can widen or narrow the track of the vehicle (The track is the distance between two wheels on the same axle).

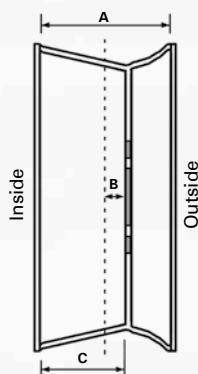

Fig 5 A = Wheel width
-- = Wheel centre
B = Offset
C = Backspace

Another thing to consider when fitting new wheels is using the correct wheel nuts or bolts. Steel wheels and alloy wheels require different fittings, so make sure you use the correct bolts or nuts for your choice of wheel. If you are using steel wheels these are held in place by the standard wheel bolt, but if you are fitting alloy wheels you will need to use bolts or nuts designed for use with alloys, which have a different seat. Using the wrong type could result in your wheels coming loose or losing a wheel altogether.

Klaxon Horn for a Vintage Sound



Retro-style 12 volt Klaxon horn.

J11281 **£29.75**

Aerials & Horns

Twin-Mount Aerial

Twin-mount aerial gives a vintage look to your Bus

J10955 111999900A..... **£20.75**

Twin-Mount Pillar Aerial

Fixes to the A-post and fits all T25s 1979-1992.

J11059 035VAG503..... **£22.50**

Motor Horn 1979 to 1992

Fits any 12v VW and, as it's a quality Hella product,

J10154 191951113A..... **£16.25**

Twin-Tone Air Horn Kit

A powerful, compact harmonised twin-tone car horn

J13321 **£13.00**

High Tone Dual Horn 1985 to 1992

This is a OE style dual tone horn

J20000 191951223..... **£9.00**

12 Volt Dual Type Horn (Low Tone) VW T25 1985-1992

This is an original style dual tone horn

J31083 **£6.50**

Accessories

Chrome Reversing Lamp

Hella quality chrome reversing lamp

J11631 **£40.75**

Rear Foglamp

Hella quality chrome fog lamp

J11632 111999222A..... **£40.75**

Fog Lamps (110mm Pair / Clear Glass Chrome Body)

A pair of 110mm chrome with clear glass fog lamps.

J13527 **£32.00**

Fog Lamps

A pair of 110mm chrome lamps with amber glass

J13917 **£32.00**

Bundle kit

Empi 911 5 Spoke Alloy Wheel 15" 1979 to 1992

A set of four 15" Empi 911 alloys with fitting kit.

J18927 £465.25



SAVE 10%

Bundle kit

Empi 911 5 Spoke Alloy Wheel 17" 1979 to 1992

A set of four 17" Empi 911 alloys with fitting kit.

J18925 *Call For Availability*



SAVE 10%

Empi Dish Wheels (Set of 4 / 5.5" / 5x112 Inc Lug Nuts & Wheel Studs) T25 1979 to 1992

These classic wheels have been created with all new tooling and are finished to the highest quality. The look of the 70s meets new technology. These wheels come with chrome cap with logo and chrome valve stems. This kit is sold with front studs and slim nuts to fit the T25

J18923 £437.25

Radial White Walled Tyre (185 R14) 1979-1992

These are a 8 ply commercial rated tyre designed to carry a maximum load of 800kg per wheel.

J39831 £97.75

Empi Dish Wheels (5.5" / 5x112)

All new wheels made by EMPI are just like the original EMPI wheels made in the 70s. These classic wheels have been created with all new tooling and are finished to the highest quality. The look of the 70s meets new technology. These wheels come with chrome cap with logo and chrome valve stems. These wheels require special lug nuts J18785.

J18872 £106.50

Chrome Plated Hub Cap Genuine Volkswagen VW Beetle 1968 on VW T2 Bay 1971-1979 VW T25 1979-1992

Sold as singles these Genuine Volkswagen hubcaps have been made for Classic Parts using the original tooling to the original spec with best quality chrome.

J39928 £78.75

Empi 911 Alloy Wheel (17" / 5x112) 1979 to 1992

Empi 5 Spoke 911 Alloy Wheels in Matt Black with Matt Silver.

J18876 £172.75

Road Wheel

OEM quality standard 14" steel wheel.

J11804 211601027H  £114.75

Wheel Studs, Nuts & Bolts

Locking Wheel Nuts for Standard Wheels 1979 to 1992

A set of 4 Size M15 x 150, with 60° taper seat.

J14415 7M0698137 £15.00

Empi Alloy Wheel Lug Nuts (Set of 5 inc Key)

Used with J18754 Empi 911 alloy

J18785 £12.50

Empi Wheel Nut Set of 5 / 14mm x 1.5 x 1.25

To be used with J18874 studs for fitting alloy wheels.

J18920 £28.25

M14 Wheel Bolt Front 1979 to 1992

Fits front only all T25s 1979 to 1992

J10260 251601139 £0.90

Wheel Nut Rear Only 1979 to 1992

This M14 wheel nut fits standard steel wheels

J10569 N0201121 £1.25

Rear Wheel Stud 1979 to 1992

This M14x40mm stud is sold singly.

J10877 211501627A £2.25

Rear Stud Pack Of 10 1979 to 1992

Pack of 10, M14 X 50mm for alloy wheels.

J14038 211501627A *Call For Availability*

Empi Wheel Studs (Set of 5 / 14mm - 1.5 / Zinc)

Sold in fives these replace standard 14 mm x 1.5 bolts.

J18874 £5.00

Wheels, Tyres, Hubcaps & Trims



Hubcaps & Trims

2 Stainless steel smooth Baby Moon Hub Cap (No Logo)

A smooth domed hubcap that replaces the flat style cap.

J11351 £24.25

14" Wheel Trim Rings (Stainless Steel) 1979 to 1992

Sold as a set of Four

J13010 10-1068-0 £85.25

Alloy Wheel Centre Cap 1986 to 1992

Silver coloured plastic centre caps for VW alloy wheels

J19654 251601171 £12.75

4 Hub Cap Puller

Helps to remove hubcap, without damaging the wheel or hubcap

J10868 4D0012243  £2.90

Tyres & Whitewalls

5 White Walled Tyre (195 X 75 X R14 17mm White Band 4 Ply)

Load rating 635 kg per wheel

J12028 *Call For Availability*

6 Whitewall Trims Set for Standard 14in

Sold in sets of four.

J12029 £47.75



Carasafe Venus Wheel Clamp

Carasafe Venus Wheel Clamp designed to fit a caravan, car, trailer and Motorhome with 10 to 13" Wheels. Easy to install, supplied with two keys.

J39517 £25.00



Carasafe Jupiter Wheel Clamp

Full Face Wheel Clamp. Universal design to fit most 13" To 15" wheels. Comes Complete with high quality lock and two keys.

J39518 £32.75



Hycote Super Stick Multi-Purpose Adhesive

Ideal for fixing door rubbers and interior trim.

J11335 £7.90



Compact / Extending Snow Shovel

Lightweight but sturdy.

J19249 £12.00



Universal Wheel Brace

Fits 17mm, 19mm, 21mm and 23mm wheel bolts/nuts.

J21598 £13.00



Draper 2 Piece Strap Wrench Set

Draper 2 Piece Strap Wrench Set (43863)

J21637 £10.50



Diesel Camshaft Locking Tool 1990-2003 VW T25 1600cc Diesel 1981-1992

This locks the Bosch diesel injection pump sprocket in position, which allows the drive belt to be removed without the injector losing its general timing position. This tool is used on VW T25s with the 1600cc Diesel engine with the CS engine code.

J29102 VW2065A £20.00

Call For Availability

Quick connector for Hobbyweld Ultra Gas Bottle



The Hobbyweld Ultra cylinder features a built in gas regulator / valve with flow adjustment, pressure gauge and flow gauge. This has a drop tested reinforced shroud or valve guard to ensure maximum safety when using the Ultra Gas bottle. These require a Quick Action Coupling to connect to all welders this connector is supplied FOC when you pay your deposit on your first gas bottle. These can be purchased separately if you damage or lose your connector.

J39610 £20.00

M10 x 40mm (1.5 pitch / 10.9 strength) Bolt . Various Uses



J39866 £0.75

M10 x 40mm (1.5 pitch / 8.8 Strength) Bolt Various uses



For mounting VW T2 Bay engine bay to Crankcase.

J39869 £0.75

M10 x 48mm (1.5 Pitch / 8.8) Strength Bolt. Various Uses



Steering box clamp to Axle. Plus other uses

J39870 £0.85

M10 x 50mm (1.5 Pitch / 10.9 Strength) Bolt. Various uses



J39871 £0.95

M10 x 55mm (1.5 Pitch / 10.9 Strength) Bolt. Various Uses



Steering box bolt VW T2 1968-1972 (4 required) Anti roll bar mount Vw T2 1968-1979 (2 required) Various uses.

J39872 £0.95

M10 x 60mm (1.5 Pitch / 10.9 Strength) Bolt Various Uses



Steering box to chassis bolts Vw T2 1973-1979 (4 required) Vw T25 waterboxer engine bay. Various other uses

J39873 £1.50

M10 x 70mm (1.5 pitch / 10.9 Strength) Bolt. Various uses (Upper left engine bolt pre 1975)



J39874 £1.50

M10 x 75mm (1.5 Pitch / 10.9 Strength) Bolt. Various uses



For Rear gearbox mount hanger Vw T2 bay 1972-1979 (2 required) Plus various other uses.

J39875 £1.50

M10 x 90mm (1.5 Pitch / 10.9) Bolt. Various uses (Upper left engine bolt VW T2 and T25 1975-1983)



Plus various other uses.

J39876 £1.50

M12 x 20mm (1.5 Pitch / 8.8 Strength) Bolt. Various Uses (VW T25 rear bumper iron to Body)



Plus other various uses

J39877 £2.50

M12 x 35mm (1.5 Pitch / 10.9 Strength) Bolt. Various uses



J39878 £1.50

M12 x 45mm (1.75 Pitch / 8.8 Strength) Bolt. Various uses (T2 bay Steering Pitman arm)



J39879 £0.95

M12 x 65mm (1.5 Pitch/ 10.9 Strength) Bolt. Various Uses VW T25 rear shock bolt



T25 rear shock bolt (Upper and lower) Various other uses.

J39880 £2.50

M12 x 70mm (1.5 Pitch / 8.8 Strength) Bolt. Various uses including VW Beetle 1302 and 1303 lower rear shock bolt



Various uses

J39881 £7.25

M12 x 90mm (1.75 pitch / 10.9 strength) Socket Head bolt. Various Uses



J39882 £2.50

M12 x 100mm (1.5 Pitch / 10.9 Strength) Bolt. Various Uses Including Vw T25 Front Lower Wishbone & Rear Wishbone to Chassis



Various uses

J39883 £3.50

M14 x 100mm (1.5 Pitch / 10.9 Strength) Bolt. Various Uses Including Vw T2 Bay A Arm To Spring Plate & Rear Hub Assembly



Various other uses

J39884 £3.50

M14 x 110mm (1.5 Pitch/ 10.9 Strength) Bolt. Various Uses Including VW T25 Front Lower Shock Bolt



Various other uses

J39885 £3.50

M5 x 25mm (8.8 Strength) Bolt. Various uses including Fuel Sender to Tank



Various other uses

J39887 £0.60

M6 x 12mm (1.00 Pitch / 8.8 Strength) Bolt. Various uses



J39888 £0.70

 **M8 x 35mm (1.00 pitch / 8.8 strength) Bolt. Various uses including Track rod clamp bolt**
Plus various other uses

J39889 **£0.95**

 **M8 x 35mm (1.25 pitch / 8.8 strength) Hex Bolt. Various uses including Steering coupling bolt**
Various uses

J39890 **£0.75**

 **M8 x 40mm (1.25 pitch / 10.9 strength) Bolt. Various uses**
T25 front gear shift rod to universal joint clamp bolt

J39891 **£0.95**

 **M8 x 45mm (1.25 pitch / 10.9 strength) Bolt. Various uses including T2 bay steering box flange to steering column**
Plus various other uses

J39892 **£0.60**

 **M8 x 55mm (1.25 pitch / 8.8 strength) Bolt. Various uses**

J39894 **£0.95**

 **M8 x 60mm (1.25 pitch / 10.9 strength) Bolt. Various uses**
1302 and 1303 master cylinder bolt
T25 centre fixing for thermostat housing (diesel)
T25 1985-92 silencer pipe and cross pipe cast elbow (Waterboxer)

J39895 **£0.50**

 **M8 x 65mm (1.25 pitch / 8.8 strength) Bolt. Various uses**

Plus other uses

J39896 **£0.85**

 **M8 x 70mm (1.25 pitch / 10.9 strength) Bolt. Various uses**

Various uses

J39897 **£0.85**

 **M10 x 30mm (1.5 pitch / 8.8 strength) Bolt. Various uses**

Beetle rear chassis bolt (above torsion tube)

J39898 **£0.85**

 **Auxiliary 4 way fuse box**
Protect your electrical accessories with this 4 way fuse box.

J11328 111937205 **Call For Availability**

 **9-12mm Capacity Nut Splitter**
Safe removal of damaged nuts without damaging the thread.

J60284 10913 **£9.75**

 **Westfalia BC60 Load Carrier Transport Box**
Quickly-mounted, additional, dirt-resistant storage space on the following bicycle carrier Westfalia BC 60; 45 kg max. weight and 200 litres volume
Easy to mount without tools; energy and CO2 efficient thanks to attachment in slipstream; folding mechanism lets you access the boot easily; anti-theft device

J40253 **£295.50**

 **Westfalia BC60 Tow Ball Mounted 2 Bike Carrier**
This carrier is made for any vehicle with a Towbar, Cycle carrier for 2 cycles and folds down when not in use for easy storage. The maximum payload of 60kg makes it ideal for heavy electric cycles, with a wheelbase of up to 1300mm. Adjustable wheel holders for cycle tyres with a maximum 50mm width and thick rubber pads on the wheel holders protect the frame of the cycle, frames up to 80mm. Fold down mechanism facilitates free access to the boot even when loaded. Cycle carrier and all cycles can be locked individually with just one key, offering protection against theft.

Fitted with a 13pin socket (7-13pin adaptor maybe required for older vehicles - J40245)

Expansion rail available increasing the BC 60's capacity to 3 cycles
J40172 **Call For Availability**

 **Just Kampers Overall - Medium (42" Chest)**
Just Kampers overalls are a functional yet robust garment, designed to be worn daily and offer comfort and rugged durability. These Navy Blue overalls with an embroidered JK logo are the perfect choice when working on your Volkswagen.

J39907 **Call For Availability**

 **Just Kampers Overall - Large (46" Chest)**

J39908 **Call For Availability**

 **Just Kampers Overall - Extra Large (50" Chest)**

J39909 **Call For Availability**

 **Just Kampers Overall - Childs (1-2 Yrs)**

J40067 **Call For Availability**

 **Just Kampers Overall - Childs (2-3 Yrs)**

J40068 **Call For Availability**

 **Just Kampers Overall - Childs (3-4 Yrs)**

J40069 **Call For Availability**

 **Just Kampers Overall - Childs (5-6Yrs)**

J40070 **Call For Availability**

 **Just Kampers Overall - Childs (9 to 10 yrs)**

J40151 **Call For Availability**

 **Just Kampers Overall - Childs (11 to 12 yrs)**
Just Kampers Overall - Childs (11 to 12 yrs)

J40152 **£15.00**

 **Just Kampers Overall - Childs (13yrs)**
Just Kampers Overall - Childs (13yrs)

J40153 **Call For Availability**

 **Large Magnetic Parts Tray (230 X 140mm)**
For storage of nuts, bolts, screws, etc. whilst working.

J63976 56332 **£11.25**

 **Westfalia Branded Tow Ball Cover**
Westfalia Branded Black Plastic Tow Ball Cover fits all standard tow balls.

J40174 **£1.95**

 **Coil Spring Compressor Tool**
Coil spring compressors - for working on 1302/03, T25, T4, T5 front strut assemblies or anything with macpherson struts. Used to compress springs when fitting or removing. Supplied as a pair!

J60061 127 **£22.00**

 **DIY Thermo mat kit**
3.5 m Isoflex material 155cm wide, 30 suckers, 30m edging

J12382 **£70.00**

 **Carbon Monoxide Alarm SF350EN ,EEC Approved ENS0291**
Detector with loud alarm. Keep your family safe while camping.

J12648 **£39.50**

 **Jump Leads (2 Metre)**
Battery Booster Jump Leads 2 Metre

J15236 **£13.00**

 **or call our sales team on 0800 9156601**

Bundle kit

Winter Care Pack (Van Cover & Waxoyl Kit)

Contains a 2.5ltr can of Waxoyl rust prevention.

J31142 £180.50

SAVE 10%



- 

Grease Gun
Side lever operation with flexi neck.
J11390 £35.00
- 

Ball Joint Breaker
19mm jaw with scissor action.
J11393 13914 £28.00
- 

Spotweld Drill (8mm)
High speed, cobalt steel, spotweld drill (8mm)
J11399 £9.75
- 

Brake Spring Pliers
Simple but effective brake spring pliers
J11402 £15.00
- 

Anti Squeal Brake Lube 75ml
Operates to 1000° c Copper & Acid Free Non Conductive
J13082 111999319 £3.15

Vehicle Covers & Window Thermo Mats

- 

Eight Piece Thermo Mat Kit
Comprises eight mats (windscreen, side and rear windows)
J12747 £99.50
- 

External Thermo Screen Cover 1979 to 1992
Quick and easy to fit insulated cab thermo mat.
J17073 £49.50
- 

Luxury Breathable Van cover VW T25 1979-1992
Made with 3 layers of highly water resistant (not waterproof) and breathable polypropylene non woven fabric.
J39910 £107.75
- 

Luxury Breathable Van Cover VW T25 VW T2 High Top Models
Made with 3 layers of highly water resistant (not waterproof) and breathable polypropylene non woven fabric.
J29561 £140.00
- 

Fiamma Thermo 40 Mat Kit
A 40 x 40 cms thermo mat for your Fiamma skylight.
J13185 £10.00
- 

Thermo Mat Suckers (Pack of 10)
Please note, thermo mat sets are sold complete with suckers
J90020 £8.50
- 

Brass Grommet Kit (Eyelets)
Kit consists of 20 eyelets in brass-coated steel.
J12931 £10.00

Call For Availability

Rock & Roll Beds, Bed Hinges & Bunks

- 

Adjustable Rock 'n' Roll Bed
With a minimum width of 1m, and a maximum of 1.5m,
J14576 £392.00
- 

Rock and Roll Seat Brackets (Pair)
Anodised, heavy duty steel, supplied with support legs.
J11561 £74.75
- 

Spare Spring (Rock & Roll Bed Bracket)
Sold as singles.
J14249 £2.00
- 

3 Part Foam Set For 3/4 Width Bed 1979 to 1992
Made from flame retardant foam, ready cut to match most beds.
J12654 £153.75
- 

3 Part Foam Set For Full Width Bed 1979 to 1992
Made from flame retardant foam, ready cut to match most beds.
J12655 £153.75
- 

Bunk Bed Mount
This bunk bed mount is designed to take a 32mm diameter pole.
J11495 £2.75
- 

Mounting Brackets For J11825 Childs Bunk
A set of four brackets for J11825 Childs bunk
J12578 £15.00

Call For Availability

Fiamma Awnings & Roof Racks

- 

Fiamma F35 Pro 250cm Awning (Titanium / Blue Ocean)
Please contact us or go on line for further details.
J19522 £290.00
- 

Fiamma F35 Pro 180cm Awning (Titanium / Blue Ocean)
Please contact us for further information.
J19571 £249.00
- 

Fiamma F35 Pro Sun Visor/Shade (Deluxe Grey)
A convenient top valance shade to slide into the roller guide.
J19573 £27.00
- 

Fiamma F35 Pro Sun Visor/Shade (Blue Ocean)
A convenient top valance shade to slide into the roller guide.
J19574 £25.00
- 

Fiamma F35 Pro 220cm Awning (Titanium / Blue Ocean)
Please go on line or call for details.
J19575 £279.00
- 

Fiamma F35 Pro 220cm Awning (Titanium / Deluxe Grey)
Please go on line or call for details.
J19576 £279.00
- 

Fiamma F35 Pro 180cm Awning (Titanium / Deluxe Grey)
Please contact us for further information.
J15621 £77.25
- 

Fiamma F45s, L or Zip Awning Adapter Kit
Contains two 8cm brackets and the fittings required.
J15628 £77.25
- 

Fiamma F35 Pro Awning Adapter Kit
Please contact us for details before ordering.
J15630 £67.00

Call For Availability

Call For Availability

Bundle kit

A Pair Of Bunk Beds Complete (Includes Poles & Mounts)

A bundle deal on two J11494 bunk beds.











J18733 £180.00

Call For Availability







SAVE 10%



Bike Racks

-  **Cycle Cover for 4 Bikes**
lightweight polyester/vinyl cycle cover
J13304 £40.00
-  **Fiamma Carry-Bike Rack 1979 to 1992 (2 Bike)**
Comes with: 2 quick rails; 2 bike blocks; 2 Security Straps.
J11470 £178.75
-  **Fiamma Supplementary Bike Rail Quick Red**
A supplementary 128cm rail with a reinforced base.
J12255 £26.75
-  **Fiamma Supplementary Bike Rail Strip Red (128cm)**
128cm Bike Rail Strip Red with reinforced base.
J12256 £21.50
-  **Fiamma Bike Block Pro 1**
Sold as a replacement or for use as a extra arm.
J15719 £11.75
-  **Fiamma Bike-Block Pro 2**
Suitable for use with all Fiamma Carry-Bike models.
J12252 £14.25
-  **Fiamma Bike-Block Pro 3**
Sold as a replacement or for use as a extra arm.
J12253 £15.50
-  **Fiamma Bike-Block Pro 4 (Min 54cm - Max 57cm)**
Suitable for use with all Fiamma Carry-Bike models.
J12254 £17.50
-  **Rail End Cap for Fiamma Bike Rack/Red**
Replacement end cap for Fiamma bike rack rail end.
J13568 £3.90
-  **Fiamma Carry Bike Security Strip (2m)**
Original style replacement strip with stainless steel buckle.
J15571 £7.00

Dash Tidies and Storage Solutions

-  **Dash Tidy (Only Fits Right Hand Drive) 1979 to 1992**
Made from strong black 3mm ABS plastic. For RHD models.
J10919 £29.50
-  **2 Piece Dash Tidy (Right Hand Drive) 1979 to 1992**
A sturdy 2 piece construction Made from 3mm ABS plastic
J13122 £44.25
-  **2 Piece Dash Tidy Type (Left Hand Drive) 1979 to 1992**
A sturdy 2 piece construction Made from 3mm ABS plastic
J13123 £44.25
-  **Folding Cup Holder**
Holds an average coffee cup or regular 330ml drink can.
J11799 £7.00
-  **Elasticated Luggage Safety Net 140cm x 180cm**
Can be used on roof racks or in the rear of your van.
J12229 £15.00
-  **Bungy Spider Cord For Securing Luggage On Roof Rack**
Can be used with 4 or 8 flexible but strong bungy 'legs'
J12932 [Call For Availability](#)

Bundle kit

Elasticated Storage Nets (Pair)

A bundle deal for two J12155 storage nets.

J13775 £19.75

SAVE 10%



Cup Holder

Made from robust steel with a easy clean powder coat finish

J20278 £29.00

Exclusive to JK!



NEW!

Bundle kit

Third-bike Extension Kit for Fiamma Bike Rack













Our kit allows you to add a third bike to your Fiamma Rack.

J11508 £32.00



SAVE 10%

Tools

-  **Engine or Gearbox Stand**
450kg Maximum Capacity
J11238 53092 £109.75
-  **Franklin 42pce Combination Bit Set**
J19029 [Call For Availability](#)
-  **Franklin 110pc Socket Rail**
J19030 [Call For Availability](#)
-  **Franklin 39pce Alloy Steel Tap & Die Set**
Metric Coarse & Fine M3-M12
J19037 [Call For Availability](#)
-  **Franklin 10pce HSS-Co Cobalt Drill Set**
1.0 - 10.0 mm drill set.
J19031 [Call For Availability](#)
-  **Irwin 5pce Bolt Grip Set**
Grips and removes damaged nuts & bolts.
J19032 [Call For Availability](#)
-  **Irwin 5pce Bolt Grip Expansion Set**
Grips and removes damaged nuts & bolts.
J19033 [Call For Availability](#)
-  **Franklin 21pce Punch & Chisel Set**
Drop forged, chrome vanadium steel, hardened and tempered.
J19035 [Call For Availability](#)
-  **Gearbox Sump Plug Socket (17mm)**
This 17mm sump plug socket uses a 3/8in square drive.
J11205 38323 £5.25
-  **46mm Socket 3/4 in Drive**
Fits all rear hub nuts from 1979 to 1992.
J11235 00-5769-0 £15.25
-  **Breaker Bar**
3/4 drive, 24in. long, heavy duty breaker bar.
J11391 £46.50
-  **Driveshaft Bolt Splined Hex Tool**
Features an 8mm spline with 3/8 drive
J11237 £10.25
-  **Tyre Pressure Gauge**
Dual pressure readout covering 6-50psi & 0.4-2.4bar.
J11389 26443 [Call For Availability](#)

NEW Product

Ring European Travel Kit

A comprehensive European break down travel kit.
 Kit contents: 1 x Warning triangle. 2 x high visibility jackets. 1 x Universal bulb kit. 1 x Set of beam converters. 1 x GB sticker. 1 x First aid kit. 1 x Foil blanket. 1 x Twin pack of NF approved breathalyzers. 1 x carry Bag.



J31239 £35.00

Bundle kit

Tow Bar 1979 to 1992 (Models With Steel Bumpers)

A complete bundle kit for tow bar and electrics.

J16656 £189.75



SAVE 10%

Bundle kit

Tow Bar 1989 to 1992 (Plastic Bumper Models)

A complete bundle kit for tow bar and electrics.

J16657 £202.75



SAVE 10%

Safety & Security

Alco Breathalyser (Twin Pack)
 Some EEC countries require you to carry a breathalyser.
 J20111 £7.00

GTP Automatic ABC Powder Fire Extinguisher 2.0kg
 Functions on its own with no help from an operator.
 J15335 £60.00

GTP Automatic ABC Powder Fire Extinguisher 1.0kg
 Functions on its own with no help from an operator.
 J18362 £50.00

Fire Blanket (1m Square)
 BS-approved fire blanket packs down to just 460mmx120mm.
 J11859 £15.00

Warning Triangle (Folding / Reflective)
 A legal requirement in many European countries.
 J12631 £6.00

Reflective Warning Sign (Fiamma)
 A legal requirement to use in many European countries.
 J13052 £8.00

Reflective Vest (High Visibility)
 Make roadside breakdowns less dangerous.
 J13310 £5.00

Fiamma Cable Lock (2.5mtr)
 Anti-theft cable made of black plastic-coated steel.
 J15565 £19.00

Fiamma Carry Bike Security Strip (2m)
 Original style replacement strip with stainless steel buckle.
 J15571 £7.00

Extra Housing For Mini Traveller Safe
 Allows Mini Traveller Safe J14120 to be used in another point.
 J14121 £5.50

Locking Wheel Nuts for Standard Wheels 1979 to 1992
 A set of 4 Size M15 x 150, with 60° taper seat.
 J14415 7M0698137 £15.00

Halogen Spare Bulb Kit 1979 to 1992
 Contains one of each bulb plus common (blade style) fuses.
 J11565 000998204A £8.25

Headlamp Beam Converters (For Continental Motoring)
 Convert your headlights for driving on the right hand side.
 J13206 £9.00

Cab Door Window Air Vent (Pair) 1979 to 1992
 Quick and easy to fit, they can only be removed from inside
 J11738 £29.00

Van Levelling Chocks (Pair)
 9cm maximum lift, maximum capacity of 5.0t per axle.
 J11861 £18.00

Anti-Slip Grip Mats
 A pair of grip mats with ties.
 J11863 £12.50

'Backsee' Lens
 Magnifying lens reversing aid size 25cm x 20cm.
 J11473 £10.00

Gas Bottle Holder
 7kg gas bottle holder ideal for keeping gas bottles upright
 J11935 £10.95

Elasticated Luggage Safety Net 140cm x 180cm
 Can be used on roof racks or in the rear of your van.
 J12229 £15.00

Bungy Spider Cord For Securing Luggage On Roof Rack
 Can be used with 4 or 8 flexible but strong bungy 'legs'
 J12932 **Call For Availability**

Fire extinguisher 900g with mounting bracket, Protect your pride and joy

For use on BC class and electrical fires.

J13931 £20.00



Tow Bars & Electrics

Towball (50mm) Fits All Just Kampers Tow Bars
 Made in the UK and fits all towbars.
 J10869 £13.75







Towbar Electrics Pack
 Complete with wiring and mounting plate.
 J10871 £23.50

Towball Bolts (Pair)
 M16 x 65mm high-tensile steel bolts suitable for all towballs.
 J10870 £4.00

Tow Bar VW T25 (Steel Bumper Models)
 Fits all 1979>1990 models with steel bumpers
 J11225 £169.75

Tow Bar VW T25 (Plastic Bumper) 1989 to 1990
 This tow bar is designed for T25s with plastic bumpers.
 J13405 £184.25

Electrical



- Leisure Battery (85Amp Hours)**
Specifically designed for use as a leisure battery.
J16858 JZW915105B 
- Leisure Battery (110Amp Hours)**
Specifically designed for use as a leisure battery.
J16859 000915105DL 
- Leisure Battery (75 Amp Hours)**
Specifically designed for use as a leisure battery.
J16860 000915105DG 
- Leisure Battery Box 280mm x 190mm x 225mm**
Made from heavy duty plastic.
J16909 **£21.50**
- Leisure Battery Box 400mm x 185mm x 230mm**
Made from heavy duty plastic.
J16910 **£36.00**
- Dashboard Solar Panel (1.5w)**
keeps a battery topped up when your van or bus is not in use.
J13058 SOL10 111161..... **£23.00**
- 6-Way Auxiliary Fusebox**
Don't forget to order your fuses (J13120) at the same time.
J11327 **£9.00**
- Fuse Box Link (8 Way)**
8 way link. Cut to length required.  **J13714** **£2.00**
- Versatile In-line Fuse Holder**
Ideal for wiring-in accessories
J10933 **£1.95**
- Quick Release Battery Terminals**
Isolate your battery for storage or security.
J11476  **£8.50**
- Battery Earth Strap (41cm)**
Has an eye at one end and a clamp at the other.
J11178  **£12.25**
- Battery Positive Lead (103cm)**
Features an eye at on end and a clamp at the other.
J11179  **£15.00**

Bundle kit

Leisure Battery Wiring Kit **SAVE 10%**

A complete kit for wiring a leisure battery.
J15328 **£65.50**



- Dual Charging Kit for All models**
Kit consists of relay, wiring and easy-to-follow instructions.
J10520 092VAG227 **£25.00**
- Heavy Duty Split Charge Relay**
Heavy duty 10 bit microprocessor controlled split charger.
J16918 
- Battery Isolation Switch**
Switch is rated at 100amp.
J11858 **£9.95**
- Voltage Gauge With Switch**
Monitor two batteries with a flick of the switch.
J11477 **£59.50**
- Custom Voltage Gauge**
The easy read display covers 8v-15v
J11478 
- 12v Multi-Socket**
A 0° to 90° adjustable head with twin 10amp sockets.
J13600 **£7.00**

Handy Hint

Wiring up twin batteries with a dual charging kit

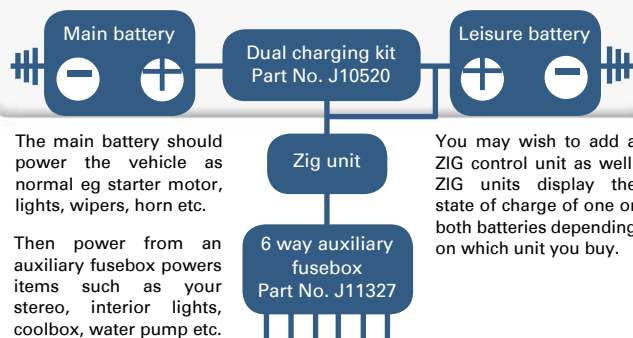

Handy Hint

How long will my battery last if I use an inverter

Here is a handy hint to remember, if you wish to know how quickly a power item will flatten your battery, for example a 12v interior light or if you are going to run household 240v items off your 12v car battery by using one of our power inverters.

Firstly check what Amp battery you have, (written on the side of the battery) then take the wattage of the item and divide it by the volts, the answer is the amps per hour it will use. (12 volt, 16 watt interior light (16 divided by 12) will draw 1.33 amps per hour)



Current draw guide for 12v to 240v inverters

- Laptop computer 75w
- Laptop printer 10w
- Satellite receiver and dish... 40w
- TV set..... 60w
- Household hairdryer draws a lot of power..... 1,000w
- Coffee maker..... 750w

Product Key:

jk Exclusive to Just Kamper's

 Made in the UK

GENUINE Genuine VW part
PARTS & ACCESSORIES

kg Oversized charges apply to non-mainland UK deliveries

VDO Gauges



Bundle kit

VDO Voltage Gauge Kit for T2, T25 and T4

52mm, backlit, black-faced voltmeter.

J11688 £46.25

SAVE 10%



Bundle kit







VDO TaVDO 0-7000rpm rev counter.

VDO 0-7000rpm rev counter. 80mm diameter, backlit black face.

J11552 £86.00

SAVE 10%



-  **Triple Multi Socket (8 Amp 12V DC)**
3 guide light rings, mounting arms and coiled cable.
J13606 £10.25
-  **Cigar Lighter Plug**
For wiring 12v appliances to run from a cigar lighter socket.
J13617 £4.00
-  **Single-Mount Aerial**
Classic single-mount aerial.
J10954 11199901A £13.75
-  **Twin-Tone Air Horn Kit**
A powerful, compact harmonised twin-tone car horn
J13321 £13.00
-  **Universal Washer Pump (12v)**
Can be used in line in any system.
J11314 £13.75
-  **Lamp for Grille Kit J11284 (Offside/Right) 1979 to 1992**
As fitted to the righthand/offside of our twin lamp kit J11284.
J11374 BCW941782 £52.75
-  **Lamp for Grille Kit J11284 (Nearside/Left) 1979 to 1992**
As fitted to the nearside/left of our twin lamp kit J11284.
J11375 BCW941781 £52.75

Vdo Oil Pressure Gauge

52mm diameter gauge 0 - 10 bar

J11699 £37.00





-  **Smoked Front Indicator (Nearside/Left) 1979 to 1992**
You will need to use your old bulb holder
J11884 £13.50
-  **Smoked Front Indicator (Offside/Right) 1979 to 1992**
You will need to use your old bulb holder
J11885 £13.50
-  **Crystal Black Tail Lights Set 1979 to 1992**
Smoked tail light lenses only fits models with Hella lights.
J15005 £93.25
-  **Fog Lamps (110mm Pair / Clear Glass Chrome Body)**
A pair of 110mm chrome with clear glass fog lamps.
J13527 £32.00
-  **Fog Lamps**
A pair of 110mm chrome lamps with amber glass
J13917 £32.00
-  **Chrome Reversing Lamp**
Hella quality chrome reversing lamp
J11631 £42.75
-  **Rear Foglamp**
Hella quality chrome fog lamp
J11632 111999222A £40.75
-  **Halogen Spare Bulb Kit 1979 to 1992**
Contains one of each bulb plus common (blade style) fuses.
J11565 000998204A £8.25
-  **Cool Blue Halogen Bulb**
12V 60/55W these H4 bulbs fit all T25s
J12110 £10.75
-  **Reverse Light Switch 1979 to 1982**
Fits to the nosecone on the gearbox.
J19908 251941521 £6.50
-  **1 VDO Tachometer (12 volt 80mm 0-7000 Rpm)**
A 80mm tachometer can be used on petrol and diesel engines.
J14134 333 015 001K £89.75
-  **2 VDO Ammeter (Range -30amp to +30amp)**
52mm diameter, VDO ammeter (range -30amp to +30amp).
J11545 190 077 001 £49.50
-  **3 VDO Voltmeter (12v)**
52mm diameter, VDO voltmeter (12v) covers the range 8v-16v.
J11546 321919531A £45.50
-  **4 VDO Fuel Gauge**
Please note this is calibrated to work with sender unit J11553
J11547 301 010 002 £40.75
-  **5 VDO Oil Temperature Gauge (50C-150C Range)**
Used in our temperature gauge kits J11684, J11685 and J11686.
J11548 321919541A £31.50
-  **6 VDO Oil Pressure Gauge (0-5 Bar Range)**
This 52mm diameter VDO gauge measures in a 0-5 Bar range.
J11549 155919551 £31.50

- 

VDO Mounting Bracket Black 1 Hole (Diameter 2")
Under dash mounting bracket for VDO 52 mm gauges.
J19357 £11.25
- 

VDO Mounting Bracket Black 2 Hole (Diameter 2")
Under dash mounting bracket for two VDO 52 mm gauges.
J19358 £14.25
- 

VDO Single Pod Gauge Holder
52mm pod provides the perfect mounting point for VDO gauges.
J11566 £18.00
- 

Accessory Wiring Kit
6m wire, 10 flat, 2 piggyback terminals, fuse holder & 5amp fuse
J11703 £6.00
- 

VDO Water Temperature Fitting Kit
For use with VDO gauge J11558
J13064 X11323003011 £70.00
- 

Mains Hook-Up Inlet Socket (Flush-Fitting)
Requires an aperture of 78mm x 78mm x 91mm.
J12806 £19.95
- 

MPK Mains Hook-Up Inlet Socket (Flush-Fitting)
All you need to fit 240v power into your camper
J13291 Call For Availability
- 

Continental Mains Hook-up Adaptor (2-pin)
Allows you to plug your 240v mains cable into you camper.
J11850 £6.00
- 

UK Mains Hook-Up Adaptor (3-Pin)
UK 3-pin plug allows you to use your mains hook-up at home.
J12471 £6.00
- 

Mains Hook-up Extension Lead (10m)
10m long and made in UK and conforms to BS4343 standards.
J11851 £19.50
- 

Cable Tidy
lightweight and practical cable tidy
J11912 £7.00
- 

12v Hanging Striplight
Complete with cigar socket plugs and clips.
J12054 65314 Call For Availability
- 

Ring 12v Defroster & Fan
Fitted with fused 12v cigarette lighter plug.
J18579 Call For Availability

Bundle kit

Mains Hook-Up Kit (Flush-Mounted, 240v)
All you need to install 240v power in your camper.
J11916 £83.50





Bundle kit

Mains Hook-Up Kit (Surface-Mounted, 240v)
All you need to install 240v power in your camper.
J11915 £83.50



- 

LED Aluminium Swivel Light (12v)
LED swivel strip with mini rocker switch (12v).
J18605 £20.00
- 

LED Map/Reading Light (12v)
Plugs directly into a cigarette lighter socket.
J18606 £16.25
- 

LED Spotlight (12v)
Features a swivel base and mini slide-switch.
J18607 Call For Availability
- 

LED Recessed Light (12v)
A non-intrusive, swivel-head, LED, recess light.
J18609 £9.95

Tools

- 

Contact Adhesive (1ltr)
Toluene free, designed for the use on rubber and synthetics
J19549 £10.00
- 

Waxoyl Kit (2.5litre) With Pump
Rust-prevention formula to help[protect your vehicle.
J11333 Call For Availability
- 

Waxoyl Rustproofing Refill (2.5Ltr)
Rust-prevention formula to help[protect your vehicle.
J11361 £30.00
- 

Waxoyl Spray Can (200MI Clear)
Rust-prevention formula extends the life of vehicle bodywork.
J12732 Call For Availability
- 

Morris Ankor Wax (5 litres)
Protects your van against rust and corrosion.
J18158 £41.75
- 

Underbody Seal (2.5ltr)
Sold in 2.5ltr tins with added Waxoyl
J11332 £20.00
- 



Carburettor and Choke Cleaner (400ml)
Formulated to remove dirt, grease and gum deposits
J11312 £4.00
- 

Gunk Engine Degreasant Foam (500ml)
A powerful and effective cleaner that rinses off with water.
J15231 £7.00







































Handy Hint

Rustproofing wax

Wax is an essential rust preventative for long term corrosion protection. Produced by Morris (Ankor Wax) and Hammerite (Waxoyl) both brands have low viscosity and surface tension thereby enabling them to spread rapidly, penetrating all inaccessible areas like sills, chassis members and inner body panels, covering the surface however irregular. The wax dries to leave a continuous protective coating that imparts excellent corrosion protection. Wax also has de-watering properties, therefore it can be used where the metal parts to be treated are wet. Effective in damp and humid climates, all traces of water are displaced before the protective film is applied giving excellent protection against salt spray. The ideal for rustproofing measure for your van.

Product Key:  Exclusive to Just Kamper's  Made in the UK  Genuine VW part  Oversized charges apply to non-mainland UK deliveries

	Holts Firegum Exhaust Assembly Paste Acts as a lubricant for a fast and easy assembly.	
J11329	£5.00	
	Sealant Bonding Agent (Black) Multi-purpose, non-sag, polyurethane sealant and bonding agent.	
J18126	£17.00	
	Sealant Bonding Agent (White) Multi-purpose, non-sag, polyurethane sealant and bonding agent.	
J18185	£12.00	
	Caulking Gun Used for applying seam sealer and bonding agents.	
J18186	£4.00	
	Oil Drain Can 9 Litre Capacity Doubles as a container with a pouring neck.	
J11718	£12.00	
	Flexi-Neck Oil Jug Marked in 1/4litre increments.	
J10859	£8.00	
	Engine or Gearbox Stand 450kg Maximum Capacity	
J11238 53092	£109.75	
	Hub Cap Puller Helps to remove hubcap, without damaging the wheel or hubcap	
J10868 4D0012243	£2.90	<small>GENUINE</small>
	Gearbox Sump Plug Socket (17mm) This 17mm sump plug socket uses a 3/8in square drive.	
J11205 38323	£5.25	
	46mm Socket 3/4 in Drive Fits all rear hub nuts from 1979 to 1992.	
J11235 00-5769-0	£15.25	
	Breaker Bar 3/4 drive, 24in. long, heavy duty breaker bar.	
J11391	£46.50	
	Driveshaft Bolt Splined Hex Tool Features an 8mm spline with 3/8 drive	
J11237	£10.25	
	Piston Ring Compressor Tool (83mm-87mm) Fits all rings from 83mm-87mm on 1500cc to 1641cc petrol	
J11304 00-5764-7	£6.00	
	Piston Ring Compressor Tool (88mm-94mm) Can be used on all rings from 88mm-94mm on all 1700cc-2000cc	
J11349 00-5765-7	£6.00	
	Tyre Pressure Gauge Dual pressure readout covering 6-50psi & 0.4-2.4bar.	
J11389 26443	£35.00	Call For Availability
	Grease Gun Side lever operation with flexi neck.	
J11390	£35.00	
	Flexi Brake Hose Clamp Great for clamping of brake or clutch flexihoses.	
J11392 11634	£7.00	
	Ball Joint Breaker 19mm jaw with scissor action.	
J11393 13914	£28.00	
	Scissor Action Ball Joint Separator (Jaw Gap 19mm - 22mm)	
J13422 63770	£32.50	
	Metric Feeler Gauges Metric feeler gauges with a range from 0.04mm - 0.80mm.	
J11396 73988	£10.25	
	Diamond Lacing Tool For Inserting window seal trim.	
J11400	£11.75	<small>GENUINE</small>
	Door Trim Removal Tool Avoid damaging your door cards when removing them	
J11401	£8.00	
	Spirit Level Helps level your van for a good nights sleep.	
J13258	£3.50	
	Battery Charger Ctek Multi XS3600 4 stage battery charger.	
J16958	£12.00	Call For Availability
	M8 Nuts (Pkd 5) Bag of general purpose M8 nuts. 13mm spanner or socket size	
J12948	£0.95	
	M6 Nut (Pack of 5 / General Purpose Or Wiper Arm Nut)	
J12955	£0.95	
	M6 Nut (Single)	
J16999 N01100624	£1.45	
	Trackrod Nylock Nut (M12x1.5) 1979 to 1992 These M12x1.5mm nylocks fit all trackrod ends.	
J10669 211405389	£2.75	
	M8 Washer Pack of 5	
J12952	£1.15	
	M6 X 20 Bolt General Purpose	
J16973	£0.50	
	Bolt M8X30 (Pack of 5 / General Purpose)	
J12956	£3.00	
	General purpose self tapping screw	
J12957	£0.25	
	Spoiler Bolt (For Front Spoiler / Pack of 16) Used for fitting original VW front spoilers	
J12962 N0141444	£8.50	
	Oval Head Panel Screw (Lower Grille) Sold 5s. These are used with the grille clips (J13048).	
J13049 N 0139741	£0.85	<small>GENUINE</small>
	M8x50 Bolt, General purpose	
J15189	£0.85	
	Front Spoiler Fixing Bolt This is the fixing bolt for the original VW front spoiler.	
J13493 N 0141444	£0.75	<small>GENUINE</small>
	Fixing Washer 6.4 x 18 x 1.6 For front bumper spoiler	
J13494 N 01166620	£0.85	<small>GENUINE</small>
	Fixing Nut M6 Rivnut for fitting the VW factory spoiler.	
J13495 N 0304001	£2.00	<small>GENUINE</small>

Brake Bleeding Kit

Designed for one-person brake or clutch fluid bleeding

J11350 £13.00









Morris Brake Fluid 1 Litre

Morris Brake Fluid 1 Litre

J10646 £9.25



Books & Workshop Manuals

-  **Kamper Manual for VW Diesel and Turbo Diesel 1982 to 1992**
Suitable for 1600cc diesel and 1700cc turbo diesel
J10839  **£10.00**
-  **Haynes Workshop Manual 1600 and 2000cc Aircooled**
Owner's Workshop Manual for 1600c and 2000cc models
J10842 0638  **£27.75**
-  **Robert Bentley Official Service Manual 1979 to 1992**
Volkswagen Official Service Manual as used by VW main agents
J11239 **£117.00**
-  **Haynes Transporter 1900, 2100cc Watercooled**
Covers rear-mounted water-cooled, petrol engines
J11287 3452  **£24.00**

Gifts

This Campervan print melamine dining set is sure to make you stand out from the crowd. Designed and manufactured exclusively for Just Kampers. This set contains 4 plates, 4 bowls, 4 cups, and 4 side plates. Why not complete the collection and take a look at the matching cutlery set (J39676)

Campervan Print 16 Piece Dining Set



J39670
£39.00



Our 4-person cutlery set is with new solid colour orange handles and comes with bread board, salt and pepper set, napkins and corkscrew/bottle opener.

All cutlery items are stainless steel and wrapped in a handy folding Light Grey & Orange trim wallet. The set contains: 4 knives, 4 forks, 4 tablespoons, 4 teaspoons and a cheese knife, plus those items already mentioned.

An ideal gift for picnics and those who like to eat outdoors.

Campershop Cutlery Set 2015

(4 Person)



J39676
£25.00



NEW Retro CoolBoxes

Retro Coolbox 17 litre Black Edition

Powder coated steel cooler with and insulated aluminium internals. Features an external bottle opener. Height: 43 cm (including handle)
J31509

Call For Availability



Retro Coolbox 13 litre Blue

Powder coated steel cooler with and insulated aluminium internals. Features an external bottle opener. Height: 36cm (including Handle)
J19195

Call For Availability



Retro Coolbox 17 litre Blue

Powder coated steel cooler with and insulated aluminium internals. Features an external bottle opener.
J29314

Call For Availability



Retro Coolbox 17 litre White

Powder coated steel cooler with and insulated aluminium internals. Features an external bottle opener.
J29316

Call For Availability



Retro Coolbox Retro 17 litre Red

Powder coated steel cooler with and insulated aluminium internals. Features an external bottle opener.
J17032 **£49.00**



Retro Coolbox Retro 17 litre Light Blue

Powder coated steel cooler with and insulated aluminium internals. Features an external bottle opener.
J17033

Call For Availability

Bundle kit

Campershop Melamine Dining & Cutlery Collection

SAVE 10%



J39793
£57.50



Luxury Breathable Van Covers

- Improved using the latest materials available on the market
- Rain flaps on door access zips
- Adjustable under body straps
- All round elasticated hem
- 3 layers of highly water resistant and breathable polypropylene non woven fabric
- Fit left and right hand drive vans
- Now available for high top roof models 1950-1992



3 under body elasticated straps which hold the cover on tight in all weathers.



Rain protected zipped openings for cab and cargo doors to allow access without removing the whole cover.

Thermo Mats

- Helps keep you warm in winter and cool in the summer
- Provide security by making sure your valuables are not on show when you leave the vehicle
- Snug fitting, offering greater privacy than curtains
- 3 piece design with velcro adjustment for a tight fit
- Simple fitting (no tools required)
- Carefully edged to prevent fraying
- Storage bag



Internal thermo mats

Quick and easy to fit, these can be used in conjunction with your existing curtains or can replace your curtains completely.

T25 Internal 8 piece thermo mat set (covers all windows)

Part No. J12747 **£99.50**



External thermo mat

All the features of the internal mats with the added benefit that they can be used in the winter to keep your cab windows frost free.

T25 External thermo mat (cab windows only)

Part No. J17073 **£49.50**

Exclusive to JK

Also available for other models. Go online to view the full range



Spend over £399 and spread the costs over 12 months **INTEREST FREE** with Just Kampers

Interest free credit is available on all purchases of £399 or more. You can apply online or over the phone– it's quick, easy and you'll get an instant decision. Our online retail finance partner is Pay4Later. Credit is provided subject to status.

Finance Options Available

- Spend £399 or more and spread the cost over 12 months.
- Spend £1399 or more and spread the cost over either 12 or 18 months.
- Spend £1999 or more and spread the cost over either 12, 18, or 24 months.

How To Apply

You can apply for credit in two ways;

- Visit our web-site and select the items you wish to purchase. At the check out screen select "Finance" as your payment option.
- Or call our sales team on 0345 121 56 56 who will complete an application with you and email you an agreement to sign.

However you apply, it only takes a couple of minutes and you get an instant decision.

12 months
0%
Finance*

Example Finance Options

Cash Price: £676.00

Deposit: £70.00

Credit Amount: £606.00

12 Monthly Instalments of £50.50

Typical APR: 0%

With nothing to lose, why wait?

Go online at www.justkampers.com
or call our sales team on **0800 9156601**



JustKampers

Restore it, Insure it, Enjoy it



Enjoy a **10% Discount**

on parts from Just Kampers when you insure your vehicle with **JK Insurance***

Parts & Accessories

Engine | Gearbox | Heating | Bodywork | Seals
Steering | Suspension | Brakes | Interior
Electrical | Accessories | Camping

*Ts&Cs apply.

Freephone for Insurance:

0808 2781 099

justkampersinsurance.com

Authorised and regulated by the Financial Conduct Authority

Parts & Customer Service:

0800 9156 618

justkampers.com