

Latitude 38

Latitude 38

VOLUME 366 December 2007

WE GO WHERE THE WIND BLOWS



DECEMBER 2007

VOLUME 366



Many thanks and warm holiday wishes from all of us here at Grand Marina!

- Over 400 concrete berths 30 to 60 feet
- Secured Gatehouses (electronic key system)
- Dockside Electrical (up to 50A - 220V)
- Cable TV & Telephone Service
- Heated & tiled restrooms with individual showers
- Beautifully Landscaped
- Ample Parking available
- Sailboat & Powerboat Brokers on site
- Excellent customer service
- Monthly informative newsletter

DIRECTORY of GRAND MARINA TENANTS	
Bay Island Yachts	7
Bay Marine Diesel.....	217
The Boat Yard at Grand Marina..	18
Lee Sails	206
New Era Yachts.....	224
Pacific Coast Canvas.....	95
Pacific Yacht Imports	9



GRAND MARINA
 ANDERSON-ENCINAL

510-865-1200

Leasing Office Open Daily
 2099 Grand Street, Alameda, CA 94501
www.grandmarina.com

Our wait list for liveaboard status is now closed.

Best of the Best

★
Happy
Holidays
from all of us
at Pineapple Sails.
We'll be closed from
noon on Saturday, Dec.
22, through Wednesday,
Jan. 2.

PHOTO: PETER LYONS WWW.LYONSIMAGING.COM



*Ditzy**

The One Design division of this year's Champion of Champions Regatta was won by Michael Land in his strikingly handsome Alerion Express 28, *Lizbeth*. The story of how he got there is a long, complex one. First, you have to be invited, which means you had to win your Class Championship for the season. The boat that actually won the Alerion Class had a conflict and couldn't make it. The invitation was passed to Michael, who had placed second. But his boat was not equipped to fly a spinnaker. The Alerion Class rules specify only a main and self-tacking jib. Since the regatta was to be sailed using PHRF rules, which do allow spinnakers, Michael called his friends Ralf Morgan and Debbie Clark to ask to borrow their Alerion, *Ditzy*. Ralf and Deb would only agree to the loan of their boat if they were allowed to crew for the regatta. It was a tough negotiation, but a deal was eventually struck.

Now *Ditzy* is set up with some serious go-fast toys. Like a carbon mainsail and a carbon roller furling (!) self-tacking jib... and of course, a spinnaker - all from Pineapple Sails.

This story has a happy ending: The Alerion is this year's Champion of Champions. Fully powered by Pineapples.

YOUR DEALER FOR: Musto foul weather gear, Dubarry footwear and Headfoil 2

Sails in need of repair may be dropped off at:
West Marine in Oakland, Alameda, or Richmond;
or Svendsen's in Alameda.

*Powered by Pineapples



PINEAPPLE SAILS

Phone (510) 522-2200

Fax (510) 522-7700

www.pineapplesails.com

2526 Blanding Ave., Alameda, California 94501

Let Passage Yachts elevate the quality of your life

Ultimate Bluewater Cruisers

SPECIAL OFFER:
No payments till June 2008 on any new boat purchased from Passage Yachts

At our docks



ISLAND PACKET 485



WAUQUIEZ 47 PS

At our docks



ISLAND PACKET SP 41



ISLAND PACKET 440



At our docks

WAUQUIEZ 41 PS

Island Packet 370 ~ 440 ~ 465 ~ 485 ~ SPC

Wauquiez 41 PS ~ 47 PS ~ 55 PS ~ 40 C ~ 45 C

Life in the Fast Lane – One Design Racing



BENETEAU FIRST 36.7



BENETEAU FIRST 10R



ALERION EXPRESS 28

Beneteau First 50 ~ 45 ~ 44.7 ~ 40.7 ~ 36.7 ~ 10R

Alerion 20 ~ 28 ~ 33 ~ 38

Year-End Closeout Sale
Rock Bottom Prices!

- First 44.7** **\$298,000**
Great sail inventory
- First 10R**..... **\$199,000**
Full race, loaded, save \$24,000
- Beneteau 343** **\$139,000**
New boat – used boat price
- Swift Trawler 42**..... **\$419,000**
Loaded – save \$100,000
- Wauquiez 41 PS** **\$299,000**
Elegant – low, low price

3 Ways to Own a New Boat

1. Take advantage of low interest rates, 20-year terms, and no payments until June 2008.
2. Place a boat in a local charter company and let the boat pay for itself.
3. With Beneteau Fractional Yachting, own a boat at 25% of the cost.

...with great boat and ownership options

Beneteau 2008 – A New Level of Luxury

BENETEAU 37



NEW!

BENETEAU 40



At our docks

Over the past 14 months, Beneteau has revamped its entire line of sailing yachts. Not only is Beneteau the most popular yacht in the world, our Marion (S.C.) facility is now producing the best-selling boat made in the United States.

From the performance and reliability of Farr, Berret and Finot's naval architecture, to the elegance and style of Nauta Design's interiors... from a voyage of a lifetime to rounding the buoys on the Bay, Beneteau genuinely offers a model for anyone who appreciates innovation and sophistication. Act now – don't settle for less! We're now accepting orders for Spring 2008 delivery.



At our docks



BENETEAU 43

At our docks



BENETEAU 46

At our docks



BENETEAU 49

Beneteau Cruising 57 ~ 523 ~ 49 ~ 46 ~ 43 ~ 40 ~ 37 ~ 343 ~ 31

Featured Brokerage Boat



ISLAND PACKET 380, 2001
Was \$243,500.
Reduced to \$235,000!

See our complete list on page 221.

**SERIOUS
ABOUT
SELLING?**

**We are, and
we get results!**

December Special
**Three months free
berthing for new,
qualified listings.**



Pt. Richmond Office

1220 Brickyard Cove Road

p: 510-236-2633 f: 510-234-0118

Alameda Office ■ Marina Village

1070 Marina Village Pkwy, Ste 101

p: 510-864-3000 f: 510-337-0565

www.passageyachts.com

sales@passageyachts.com

Award-winning Sales & Service since 1981

PUSSER'S®

*"The single malt of rum™
and the father of grog"*



Forbes writes, "Pusser's is still made in the same way it was at the time of Trafalgar - in wooden pot-stills as opposed to modern industrial column-stills. This results in the most full-flavored rum available anywhere".



The original Navy Rum and the father of grog as the rum of the Royal Navy and Royal Marines for more than two centuries.



*Gold Medals, London, 2001
San Francisco, 2003 & 2005*



Pusser's isn't for everyone. Some people prefer rums that are almost flavorless when compared to the intensely rich flavor of Pusser's. But if you want a rum that you can enjoy sipping, or still taste through the mix of your favorite cocktail, then Pusser's is for you. Try a Pusser's and Cola sometime and taste the difference.

Pusser's is not always easy to find but your local retailer can order it for you. Or take a look at HOW TO FIND IT on our web site at

www.pussers.com

Charles Tobias

Charles Tobias, Chairman

IMPORTED BY SHAW-ROSS INT'L IMPORTERS, MIAMI, FL. PUSSEY'S RUM 42% ALC/VOL.

CONTENTS

subscriptions	8
calendar	32
letters	40
loose lips	98
sightings	102
baja ha-ha 14	122
oil spill	136
caribbean circuit preview	140
year in review	144
diesel troubleshooting, pt. II	150
dinghy disaster	154
winners, pt. II	158
max ebb: picture perfect	164
the racing sheet	170
world of chartering	176
changes in latitudes	184
classy classifieds	204
advertisers' index	213
brokerage	218

Cover: Two Boats, 3rd Leg
14th Annual Baja Ha-Ha

Photo by: *Latitude 38*/Richard

Copyright 2007 Latitude 38 Publishing Co., Inc.

Latitude 38 welcomes editorial contributions in the form of stories, anecdotes, photographs—anything but poems, please; we gotta draw the line somewhere. Articles with the best chance at publication must 1) pertain to a West Coast or universal sailing audience, 2) be accompanied by a variety of pertinent, in-focus digital images (preferable) or color or black and white prints with identification of all boats, situations and people therein; and 3) be legible. These days, we prefer to receive both text and photos electronically, but if you send by mail, anything you want back must be accompanied by a self-addressed, stamped envelope. **Submissions not accompanied by an SASE will not be returned.** We also advise that you not send original photographs or negatives unless we specifically request them; copies will work just fine. Notification time varies with our workload, but generally runs four to six weeks. Please don't contact us before then by phone or mail. Send all submissions to editorial@latitude38.com, or mail to Latitude 38 editorial department, 15 Locust Ave., Mill Valley, CA 94941. For more specific information, request writers' guidelines from the above address or see www.latitude38.com/writers.html.



Bay Island YACHTS

(510) 814-0400

yachtsales@bayislandyachts.com

www.bayislandyachts.com

PACIFIC SEACRAFT 34



PRICE REDUCED

1989. Ready to go cruising!!
\$99,500

48' AMEL MARAMU



NEW LISTING

1979. New engine + much more.
Fully reconditioned. \$189,000

ISLANDER BAHAMA 30



NEW LISTING

1979. Fresh from Lake Tahoe.
\$22,500

WAUQUIEZ HOOD 38



1979. Truly a performance cruiser.
\$85,500

47' BENETEAU 47.7



SOLD

Gone to Australia for
America's Cup Campaign.

HUNTER LEGEND 40



NEW LISTING

1989.
The Legend...\$69,500

CONTESSA 32



"Old world" quality. Excellent sailing.
\$39,500

36' CATALINA, 1983



PRICE REDUCED

Great condition for her age.
Good gear. \$45,000

BABA 30, 1983



NEW LISTING

Nicely kept.
\$65,500

35' SCHOCK, 1994



PRICE REDUCED

Ex-class champion. "Full race."
\$45,500

36' SOLARIS SUNSTAR, 1993



SISTERSHIP

New Listing at Grand Marina
\$145,000

YOUR MULTIHULL BROKERAGE SPECIALIST

SAILING CATS

82' CNB.....	\$1,700,000
56' MARQUISES, 1997.....	€390,000
50' TROPIC, 1993.....	€253,000
48' PRIVILEGE, 1991.....	\$400,000
48' PRIVILEGE, 1990.....	\$400,000
44' KOHLER, 1993.....	\$249,000
43' BELIZE, 2003.....	\$416,000

43' LAGOON POWER CAT, 2003	\$550,000
42' VENEZIA, 1995.....	\$195,000
38' ATHENA, 1998.....	\$185,000
33' SEAWIND, 2000.....	\$182,000

POWER CATS

40' EUPHORIE, 1991.....	€145,000
37' MARYLAND, 2002.....	315,000

MONOHULLS FOR SALE IN THE CARIBBEAN

52' NAUTICAT.....	\$390,000
51' BENETEAU 510.....	\$189,000
50' JEANNEAU.....	\$290,000
47' WAUQUIEZ.....	\$219,000
47' JEANNEAU.....	\$155,000
47' BENETEAU.....	\$275,000
47' SWAN.....	\$199,000
43' SAGA.....	\$272,000
43' SLOCUM.....	\$160,000

NONSUCH 36, 1987



'FAST LUCY'

Lovable, simple, elegant!
\$102,500

SOLD

ALEUTIAN 51 BENETEAU 39
ERICSON 35 (2)
MORGAN 41 HUNTER 29.5
ISLANDER 32 CATALINA 34
BENETEAU 405
HUNTER 430 SPINDRIFT 43
ERICSON 30+ IRWIN 46
ISLANDER 37 COMPAC 25
NONSUCH 30 (2)
HUNTER 29.5 ERICSON 28
O'DAY 30 HUNTER 45 (2)
CATALINA 27 PEARSON 32
BENETEAU 42s7
FORMOSA 51 HUNTER 33
BENETEAU 390 CHB 34
HUNTER 37.5 NEWPORT 33
HUNTER 40 ISLANDER 30
HUNTER 37 NEWPORT 30
CATALINA 36 SANTANA 30
BENETEAU 47 NONSUCH 33
MULL 82

SPINDRIFT 43, 1981



NEW LISTING

Ready for liveaboard cruising.
\$129,000

HUNTER 31, 1984



NEW LISTING

...around
\$30,000

32' CUST. GAFF RIGGED



Full keel cruising boat, baggy wrinkle.
\$55,500

YACHTWORLD.com



In Grand Marina • 2099 Grand St., Alameda, CA 94501 • Fax (510) 814-8765

BOAT LOANS

from



Trident Funding

*"a fresh approach from
people you can trust"*

*In Northern California call
JOAN BURLEIGH
(800) 690-7770*

*In Southern California call
JEFF LONG
MARGE BROOKSHIRE
(888) 883-8634*

*In San Diego
MIKE LOCKARD
(619) 255-5666*

www.tridentfunding.com

SUBSCRIPTIONS

Please read form carefully before submitting.

We regret that we cannot accept foreign subscriptions. Check, money order, or credit card information must accompany request. Please allow 4-6 wks to process changes/additions, plus delivery time.

Enclosed is \$18 for one year on eBook

PDF eBooks Check out www.latitude38.com and click on eBooks to see what we're talking about. Our eBooks are now in PDF format, easy to use with Adobe Reader

Enclosed is \$36 for one year Third Class Postage

(Delivery time 2-3 weeks; Postal Service will not forward third class, so you must make address change with us in writing.)

Enclosed is \$55 for one year First Class Postage (Delivery time 2-3 days; FPO/APO (military), Canada & Mexico subscriptions are first class only)

Third Class Renewal First Class Renewal (*current subs. only!*)

Gift Subscription – Card to read from: _____

Name _____

Address _____

City _____

State _____

Zip _____

Phone: () _____ Email: _____

CREDIT CARD INFORMATION
Min. Charge \$20

MASTERCARD

VISA

AMERICAN EXPRESS

Number: _____ Exp. Date: _____

INDIVIDUAL ISSUE ORDERS

Current issue = \$6.00 • With classy ad placed = \$5.00

Back Issues = \$7.00 (must indicate exact issue by month or vol. #)

DISTRIBUTION

We have a marine-oriented business/yacht club in California which will distribute copies of *Latitude 38*. (Please fill out your name and address and mail it to the address below. Distribution will be supplied upon approval.)

Please send me further information for distribution outside California

Business Name _____

Type of Business _____

Address _____

City _____

State _____

Zip _____

County _____

Phone Number _____

Latitude 38

"we go where the wind blows"

Publisher/Exec. Editor.....Richard Spindler.....richard@latitude38.com.....ext. 111
Associate Publisher.....John Arndt.....john@latitude38.com.....ext. 108
Managing Editor.....John Riise.....johnr@latitude38.com.....ext. 110
Senior Editor.....Andy Turpin.....andy@latitude38.com.....ext. 112
Staff Writer.....LaDonna Bubak.....ladonna@latitude38.com.....ext. 109
Advertising Sales.....John Arndt.....john@latitude38.com.....ext. 108
Advertising Sales.....Shawn Grassman.....shawn@latitude38.com.....ext. 107
Classified Sales.....Mary Briggs.....class@latitude38.com.....ext. 104
General Manager.....Colleen Levine.....colleen@latitude38.com.....ext. 102
Production/Web.....Christine Weaver.....chris@latitude38.com.....ext. 103
Production/Photos.....Annie Bates-Winship.....annie@latitude38.com.....ext. 106
Bookkeeping.....Helen Nichols.....helen@latitude38.com.....ext. 101

Directions to our office.....press 4
Subscriptions.....press 1,4
Classified.....class@latitude38.com.....press 1,1
Distribution.....distribution@latitude38.com.....press 1,5
Editorial.....editorial@latitude38.com.....press 1,6
Calendar.....calendar@latitude38.com
Other email.....general@latitude38.com.....Website: www.latitude38.com

15 Locust Avenue, Mill Valley, CA 94941 • (415) 383-8200 Fax: (415) 383-5816

Please address all correspondence by person or department name



Tayana 54 Deck Saloon

NEW TAYANA 54 DECK SALOON

Performance cruiser by Bill Dixon. Custom built to your specifications by Tayana. Two, three and four stateroom options available.

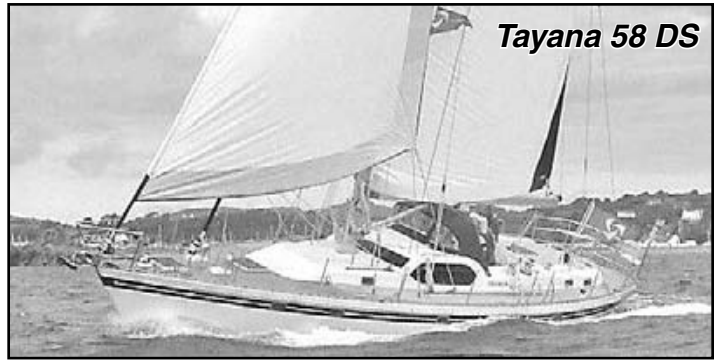

Tayana 58 DS

TAYANA 58 DECK SALOON

World famous Tayana 58 Deck Saloon. Fast and stable, custom interior. More than 100 hulls built!



Tayana 64 Deck Saloon

TAYANA 64 DECK SALOON

Robb Ladd design. Center or twin cockpit. 18-ft beam and long waterline. Modern looking bluewater cruiser.

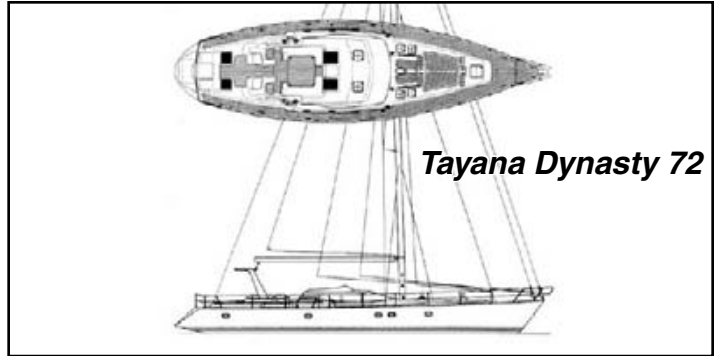

Tayana Dynasty 72

TAYANA DYNASTY 72

Designed by Bill Dixon/Andrew Winch. Cruise in luxury on this 72-footer with 20-ft beam. Many interior plans to choose from. Fast and spacious.



NEW LISTING

2005 TAYANA 48 CC

Like new and loaded. 500 hours on Yanmar 75 turbo. LeisureFurl, electric winches, KVH 33 Imarsat phone. **\$489,000**



SOLD

2002 TAYANA 48 DECK SALOON

Well-equipped, hard-to-find, rare Deck Saloon 48. Just back from Mexico. Watermaker, LeisureFurl, electric winches. Pristine! **SOLD**



AT OUR DOCKS

NEW TAYANA 460 PILOTHOUSE

Three-stateroom model with inside steering and all the quality craftsmanship you have come to expect from Tayana Yachts. **\$375,000**



REDUCED

1988 HANS CHRISTIAN 41 Molokai

In as fine a condition as one will hope to find in a yacht of this caliber. Fully equipped. **\$225,000**



SISTERSHIP

2000 BENETEAU FIRST 40.7. Race ready with many upgrades like larger motor, oversize primary winches, carbon spin pole, professionally faired. **\$189,000**



REDUCED

1987 MORGAN 41 CLASSIC. Modernized version of Charlie Morgan's very popular Out-Island 41. Updated inter. design; improved underbody w/fin keel. **\$99,900**



1984 TAYANA V-42 aft cockpit cutter. Mast has new LPU paint, rigging & wiring. Raymarine pkg. incl. AP, radar, GPS plotter AGM batteries. Full cockpit enclosure, 3 genoas, spinn w/sock, extensive equip. list **\$149,500**



READY TO SHIP

2007 TAYANA 48 DECK SALOON Our most popular 2-stateroom 2-head model. You can still add any factory options. Many extras at a discounted price. Ready to ship. **\$430,000**

Pacific Yacht Imports

2051 Grand Street, Alameda, CA 94501

We're at Grand Marina

Dave Wolfe, Neil Weinberg, Keith Rarick

Tel (510) 865-2541 Fax (510) 865-2369

www.pacificyachtimports.net • tayana@mindspring.com

**INCOME TAXES HAVE YOU SEEING RED?
TAKE DELIVERY OF THE JEANNEAU
OF YOUR DREAMS BY 12/31/07 &
TAKE \$50,000+ OFF YOUR 2007 TAX BILL!***



New Jeanneau Sun Odyssey 36i



Jeanneau Sun Odyssey 45



Jeanneau Sun Odyssey 42DS



New Jeanneau Sun Odyssey 39i

**IT'S NOT TOO LATE TO SLASH YOUR 2007 TAXES. THESE IN-STOCK
BOATS CAN BE DELIVERED THIS YEAR! CALL TODAY!**



Cruising Yachts, Inc.

www.cruisingyachts.net

Monterey Bay
32 Cannery Row, Suite D,
Monterey, CA 93940
831-333-1597

San Francisco Bay
1120 Ballena Blvd.
Alameda, CA 94501
888-78-YACHT

* Charter boat program only. Income tax savings will vary with model purchased & purchaser's tax bracket. See dealer for details. © 2007 Cruising Yachts, Inc.

TAKE DELIVERY OF A NEW HUNTER BY 12/31/07 & LOWER YOUR 2007 TAX BILL BY UP TO \$50,000!*



New Hunter 45DS Now In Stock!



Hunter 45DS Saloon



Hunter 45CC Master Stateroom

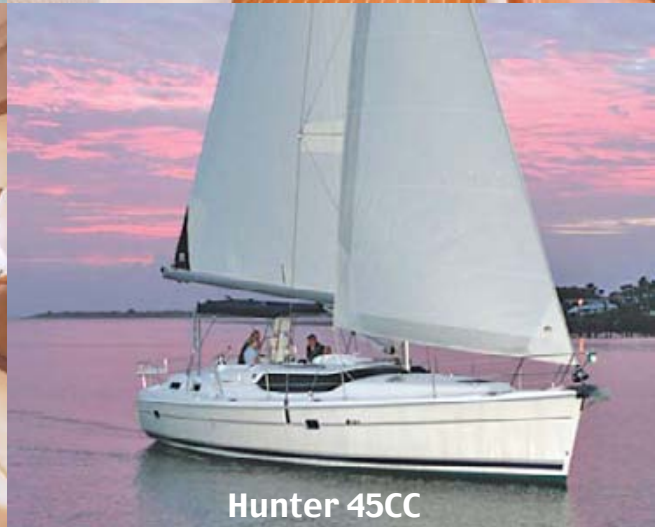

Hunter 45CC

**Hunter plays Santa Claus & makes the payments until 2009
on new Hunters purchased from stock before 12/31/07!**

Monterey Bay
32 Cannery Row, Suite D,
Monterey, CA 93940
831-333-1597

Cruising Yachts, Inc.
www.cruisingyachts.net

San Francisco Bay
1120 Ballena Blvd.
Alameda, CA 94501
888-78-YACHT

* Charter boat program only. Income tax savings will vary with model purchased & purchaser's tax bracket. See dealer for details. © 2007 Cruising Yachts, Inc.

Randall Burg YACHT AND SHIP, INC.

Marina del Rey
Newport Beach
San Diego
Alameda

(310) 574-9449
(949) 675-5940
(619) 222-1907
(510) 865-1934



Open at the Ballena Isle Marina!!!
info@rbyachts.com • www.rbyachts.com

Brokerage Slips Available in Long Beach, Marina del Rey & Newport Beach.
Stated Income Loans to \$350,000 starting at 6.5%. Broker Co-Ops encouraged.



50' PIVER
Just returned from cruising Mexico and loaded with gear!! The boat sleeps 8 in 4 cabins and sails like a dream. New rigging and Yanmar diesel, Autohelm, watermaker, has solar power -5 amps. New roller furler and rigging, re-glassed & LP's in 2005. Has Cross Mini-Keel for better up-wind sailing. Main Stack Pak, huge interior, new bluewater hatches, etc. \$169,000.



51' MASON OFFSHORE YAWL, 1958
New wiring, plumbing & paint in/out, hydraulic windlass, Volvo 71 hp dsl. \$129,990



46' HUNTER 46, 2000
Lots of light below. Excellent condition. \$217,000



35' CATALINA, 2004
\$139,000



40' MARINE TRADER, 1978
\$79,000



459 MERIDIAN, 2005
\$449,000



37' RAFIKI, 1978
\$71,000



32' RADON DIVE BOAT, 1992
\$104,000



REDUCED
47' KETTENBURG SLOOP, 1958
Fully restored. \$99,000



50' COLUMBIA, 1974
Custom interior. \$199,000



50' DELTA, 1976
\$482,000



60' CAPE ISLAND TRAWLER, 1994
\$299,990



38' HANS CHRISTIAN MkII CUTTER, 1983
Very well equipped. \$135,000



36' HUNTER, 2003
\$128,500



43' PETERSON
\$76,500



40' BLUEWATER TRAWLER, 1979
Pristine long range pilothouse. \$175,000



47' MCKINNA, 1997
Aft cabin. \$347,500



52' DEFEVER
Located in La Paz. \$135,000



52' CALIFORNIAN, 1988
\$289,000



34' CHB TRAWLER, 1978
\$60,000



REDUCED
42' GRAND BANKS CLASSIC, 1973
Well maintained. \$89,000



REDUCED
50' SEA RANGER, 1986
\$239,000



42' GRAND BANKS TRAWLER, 1974
\$139,990

LIST YOUR BOAT WITH US AND WE'LL PUBLISH A FREE FULL PAGE AD IN YACHT BUYERS GUIDE UNTIL IT SELLS!

Happy Holidays from

F A R A L L O N E & *Catalina* Yachts



CATALINA 309



CATALINA 34 Mk II



CATALINA 350 MkII



CATALINA 42 Mk II – 3 stateroom



CATALINA 440



CATALINA 470



ALAMEDA OPEN BOAT WEEKEND • DECEMBER 8-9



Catalina 42, MkII, 2000



Mikelson 50, 1988



Valiant 37, 1978



Hunter 29.5, 1996



Catalina 30, 1990



Jeanneau 36, 1997



Jeanneau 37, 2000



Hunter 36, 2004



Franz Maas 42, 1972

NEW CATALINA YACHTS

In Stock

- Catalina 470
- Catalina 350 Mkl
- Catalina 309

PREOWNED CATALINA YACHTS

Catalina 42 MkII	2000	169,000
Catalina 400*	2000	185,000
Catalina 380	2000	167,000
Catalina 36	2001	125,000
Catalina 36 MkII*	2001	122,500
Catalina 36	1999	89,900
Catalina 36 MkII	1995	103,000
Catalina 36	1987	55,000
Catalina 34	1987	47,000

Catalina 30 1990 38,500

PREOWNED SAILING YACHTS

Mikelson 50	1988	319,000
Franz Maas 42	1972	149,950
S&S 40	1982	139,000
Morgan 38	1979	57,500
Jeanneau 37	2000	122,000
Valiant 37	1978	79,500
Jeanneau 36	1997	109,000
Hunter 36	2004	122,000

Islander 36	1975	34,500
C&C 36	1981	43,000
Hunter 29.5	1996	40,000
PREOWNED POWER YACHTS		
Apex Pangs Offshore 2600*		29,900

**In San Diego*

HIGHLY visible sales docks.

1070 Marina Village Pkwy., # 104
Alameda, CA 94501
T: 510.523.6730
F: 510.523.3041

Exclusive San Diego and San Francisco Bay Area Catalina Dealer

yacht sales
F A R A L L O N E
www.faralloneyachts.com

***2302 Shelter Island Drive**
San Diego, CA 92106
New Location! **T: 619.523.6730**
F: 619.523.3041



5 Convenient Southern California Locations

Open 7 Days a Week • We take trades

CALL TOLL-FREE

888.325.4353

www.HSyacht.com

YOUR SOUTHERN CALIFORNIA DEALER FOR:



HUNTER®
MARINE CORPORATION



JEANNEAU

TRADE-IN CLEARANCE SALE!



1993 Columbia 50 - A/P Radar, Diesel - \$130K



2000 Catalina 36 - Very popular model! \$82K



1984 Newport 28MKII - A steal at only \$17,900



2006 Jeanneau 49 DS - Owner moved up. \$479K



2000 Beneteau 461 - 2 cabin/2hd. \$199K



1975 Swan 44 - Sleek & FAST! \$135,000



2006 Beneteau 343 - Save \$\$ over new. \$132K



1997 Catalina 42 - 3 cabin version \$118K



1998 Catalina 36 - Sleeps 7. \$80,000



2007 Catalina 309 - BRAND NEW! \$95,000

2005 Catalina 320	\$139,000
1990 Hunter 32	\$44,000
2002 Hunter 326	\$82,500
2003 Hunter 326	\$77,900
2005 Hunter 33	\$119,500
2004 Hunter 33	\$114,900
2002 Beneteau 331	\$94,500
1989 Hunter 33.5	\$42,500
2001 Hunter 340	\$89,900
1995 Catalina 34	\$78,000
1988 Schock 35	\$55,000
1992 Hunter Legend 35.5	\$59,900
1987 Hunter 35.5	\$65,000
1990 Hunter Legend 35.5	\$64,900
1988 J Boats 35	\$55,000
2004 Hunter 36	\$138,000
2000 Catalina 36 MKII	\$95,000
2004 Hunter 36	\$148,000

2002 Catalina MK II	\$134,950
1986 Catalina 36	\$57,500
1998 Catalina 36	\$89,000
1996 Beneteau 36s7	\$97,000
1987 Catalina 36	\$60,000
1999 C&C 110	\$139,995
2003 Hunter 356	\$132,500
2005 Hunter 36	\$149,999
1993 Hunter Legend 37.5	\$86,500
2005 Hunter 38	\$199,500
2006 Hunter 38	\$192,246
1999 Hunter 380	\$120,000
1985 Catalina 38	\$53,000
1984 Catalina 38	\$54,900
2005 Beneteau 393	\$175,000
2007 Jeanneau 391	\$213,000
1997 Catalina 400	\$149,000
1996 Hunter 40.5	\$128,500

2004 Hunter 41 AC	\$229,900
1999 Hunter 410	\$159,000
2000 Hunter 410	\$165,000
1984 C&C 41	\$89,000
1999 Hunter 410	\$149,500
2005 Hunter 41AC	\$209,000
1987 Morgan 41	\$99,000
1998 Hunter 410	\$145,500
2002 Hunter 410	\$149,900
1997 Catalina 42 MK II	\$118,000
1994 Hunter Passage 42	\$139,000
1993 Catalina 42	\$134,900
1991 Hunter 42	\$139,000
1989 Irwin 43 Mark III	\$145,000
2001 Dufour Gib Sea 43	\$160,000
1990 St. Francis 43	\$199,500
2003 Jeanneau 43DS	\$229,500
1975 Nautor Swan 44	\$155,000

2006 Hunter 44DS	\$298,000
2007 Hunter 44DS	\$272,000
1999 Hunter 45	\$199,000
2000 Hunter 450	\$209,000
2004 Hunter 466	\$279,000
2000 Jeanneau 45.2	\$259,000
2005 Hunter 46 LE	\$290,000
1980 Island Trader 46	\$225,000
2000 Hunter 460	\$220,000
2000 Beneteau 461	\$199,000
2001 Catalina 470	\$269,000
1999 Catalina 470	\$259,000
1993 Columbia 50	\$130,000
1999 Beneteau 50	\$280,000
2000 Jeanneau 52.2	\$429,900
1981 Pearson 530	\$289,000
2004 Jeanneau 54DS	\$650,000
2005 Jeanneau 54DS	\$750,000

SELL YOUR BOAT FASTER WITH H&S

- WE SELL MORE 30'- 60' SAILBOATS THAN ANYONE!
- You'll have over 25 salesmen marketing your boat from 5 offices across Southern California.
- Your boat will appear on the leading boating websites, printed boating publications and at boat shows.



SAN DIEGO | NEWPORT BEACH | MARINA DEL REY | CHANNEL ISLANDS

TARTAN
YACHTS



TARTAN
4100
View at our
Sales Dock

Call for
Appt.

TARTAN NEW 5300 • NEW 5100 • 4400
NEW 4300 • 4100 • 3700 • NEW 3400

C&C
YACHTS



C&C 121 • C&C 115 • C&C 110
C&C 99 • ONE DESIGN SPECS

NOW STANDARD ON ALL TARTANS AND C&Cs
Carbon Spar, Epoxy Hull, 15-Year Hull Warranty



GULFSTAR 50, 1978
Mexico ready. \$125,000



BENETEAU FIRST 305, 1986
Diesel, race equipped. \$36,000



WESTSAIL 32, 1976
Perkins 4-108, new interior. \$58,000



PASSPORT 40, 1982
Diesel, dodger, nice. \$128,000



SOLD

30' S-2 CC, 1977
SOLD

OPEN BOAT WEEKEND
DECEMBER 8-9

We need listings now!!



Klaus Kutz
Broker

Don Wilson
Broker



TAYANA VANCOUVER 42, 1979
Cruise ready. Call for appt. \$99,500



REDUCED

WHITBY 42, 1981. Cruising classic,
clean, roller furling. \$74,500



CASCADE 41, 1971
Center cockpit. \$59,500



EXPLORER 45 KETCH, 1979
\$130,000



SOLD

TARTAN 3400, 2006
SOLD

ISLANDER 40 SOLD SPARKMAN & STEPHENS 47 SOLD
PACIFIC SEACRAFT 44 SOLD CAPE DORY 36 SOLD

Tartan C&C Yachts of San Francisco
1070 Marina Village Parkway, Suite 102, Alameda, CA 94501
(510) 769-9400 • www.tccsf.com



PASSPORT 40, 1986. Cruise ready,
well equipped. \$149,500



Discover

Brisbane Marina

**SEALED BID
LIEN SALE**
Now in Progress
Call for Info

GREAT LOCATION!

Just ten minutes from downtown San Francisco and close to Central Bay sailing.

GREAT RATES!

\$5.90/foot!

GREAT FACILITIES!

All concrete docks.
Newly constructed boater restrooms and laundry room.

KAYAK STORAGE!

\$25 per month.



DRIVING NORTH OR SOUTH ON HWY 101,
TAKE THE SIERRA POINT PARKWAY EXIT AND
FOLLOW THE SIGNS TO THE MARINA



400 Sierra Point Parkway, Brisbane, CA 94005

(650) 583-6975

www.ci.brisbane.ca.us · harbormaster@ci.brisbane.ca.us

Open 7 days a week: Monday - Saturday 8am-5pm, Sunday 8am-4:30pm

Cityyachts

San Francisco's yacht broker
since 1969

YACHTS AND THE CITY



Morgan 41 Out Island
2 from \$54,900



Passport 40, 1985
\$150,000



Harbormaster 37
Ideal City location. \$80,000



Ohlsson 41
\$34,950



Newport 41 Mk II
\$34,500



Bayliner 28, 2000
\$57,000/Offer



Californian Aft Cabin 36, '83
\$74,900

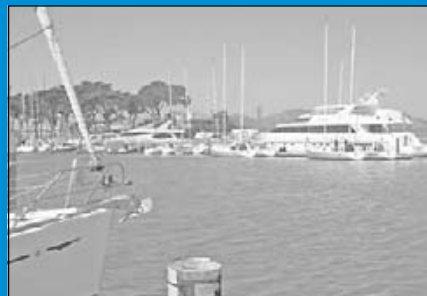

Classic Coronado 26, \$55,000
40' SF berth, perfect location



Islander 30 Mark II
\$9,000

10 MARINA BL. • SAN FRANCISCO, CA 94123 • Toll Free: 877-444-5091 • 415-567-8880
FAX (415) 567-6725 • email sales@citysf.com • website <http://yachtworld.com/cityyachts>



PLEASE VISIT OUR FUEL DOCK AT GASHOUSE COVE MARINA • OPEN 7 DAYS A WEEK • 9AM TO 5PM

THE BOAT YARD AT GRAND MARINA

Formerly Mariner Boat Yard

"Where Service Has Meaning"

**60-TON
TRAVELIFT**

DECEMBER SPECIAL

FREE Hull wax

with bottom job*



FEATURING
TRINIDAD
ANTI-FOULING PAINT BY
PETTIT
marine paint
RATED "SUPERIOR" by
Practical Sailor

The only yard to brush on your bottom paint!

Dealers for:

MAX-PROP
AUTOMATIC FEATHERING PROPELLERS

GORI
marine

Webasto

PACKLESS SEALING SYSTEM
SHAFT SEAL

LECTRA/san

SIDE-POWER
Thruster systems

PROFURL

facnor
FURLING SYSTEMS INC.

AQUAMARINE
FINE REVERSE OSMOSIS EQUIPMENT

IT'S SIMPLE!

Call The Boat Yard at Grand Marina for the Lowest Bottom Prices!

~ COMPARE US WITH THE COMPETITION ~

- Prop and Shaft Work
- Mast & Rigging Repair
- Fiberglass & Blister Repair
- Gelcoat Repair
- Gas & Diesel Engine Service
- LPU Hull & Topside
- Electrical Repair & Installation

CALL FOR A RESERVATION

(510) 521-6100 • Fax (510) 521-3684

Located at Grand Marina • 2021 Alaska Packer Place, Alameda

www.boatyardgm.com

*weather permitting

OUR STAR ATTRACTIONS



37' 1985 AMAZON



33' 1985 NAUTICAT



37' 1999 PAC SEACRAFT



48' 1989 HANS CHRISTIAN

- 2006 57' Beneteau \$795,000
- 1987 50' Santa Cruz \$215,000
- 1977 50' Gulfstar \$115,000
- 1989 48' Hans Christian \$339,500
- 1985 44' Sirena \$148,000
- 1999 43' Shannon \$499,000
- 2000 40' Pacific Seacraft \$299,500
- 1987 39' FairWeather Mariner \$139,900
- 1982 38' Morgan \$70,000
- 1985 37' Amazon \$157,500
- 1999 37' Pacific Seacraft \$219,500
- 1981 35' Hinterhoeller \$64,900
- 1985 33' Nauticat \$134,000



50' 1987 SANTA CRUZ

PRESENTING
Miss
December



57' 2006 BENETEAU

EVERYTHING LIKE NEW EXCEPT THE PRICE!

*Our All-Star
Power Boats*

- 1988 73' Philbrook
- 2004 53' Barge
- 1984 49' Kha Shing
- 1998 48' Navigator
- 1996 46' Viking
- 1989 45' Californian
- 2006 44' Sea Ray
- 1979 44' Marine Trader
- 1984 43' Bestway
- 1987 43' Kha Shing
- 1984 40' Kha Shing
- 1987 38' Riviera
- 1980 36' Albin
- 2005 36' Meridian
- 2000 36' Heritage
- 2006 34' Meridian
- 2006 34' Meridian
- 1972 34' CHB
- 1980 34' Mainship
- 1984 32' Island Gypsy
- 1990 31' Tiara
- 1997 31' Albin
- 1982 31' Sea Horse
- 2000 30' Pursuit
- 2000 28' Albin
- 1987 28' Fairline
- 2000 27' Sea Sport
- 2000 27' Sea Ray
- 1999 27' Sea Sport

Yachts
McGrath



McGrath Yachts, Inc 41 Liberty Ship Way Sausalito CA 94965 415.331.5020 www.McGrathYachts.com

COME VISIT COYOTE POINT MARINA:

The Peninsula's Complete Recreational Destination!



**RECENT
DREDGE
COMPLETE!!**



BERTHING

- Slips to 40' available
- 22' inside ties for \$85 per mo.
- Multihull side ties available
- Check out our rates!

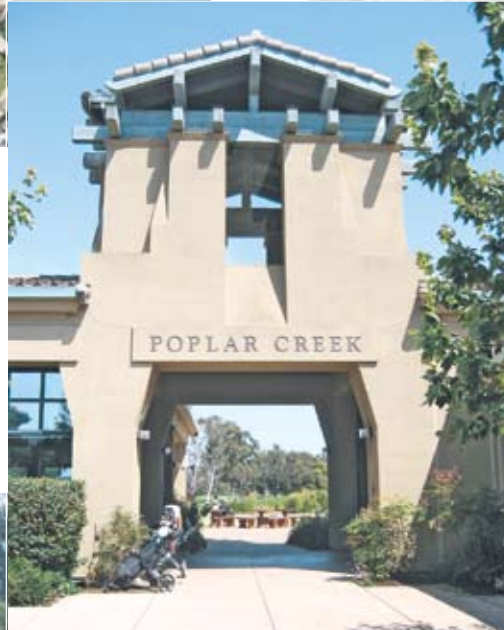

FUEL DOCK & PUMP OUT

- Open 7 days per week
- Gas and diesel available
- Check our prices
- Free pump outs



**GREAT
WEATHER!**



COYOTE POINT RECREATIONAL AREA – HOME TO:

- Coyote Point Marina
- Poplar Creek Golf Course
- Coyote Point Park
- Captain's House Conference Center
- Beach, Picnic & BBQ Areas
- Coyote Point Yacht Club
- Dominic's Restaurant
- Magic Mountain Playground
- Coyote Point Museum
- Shoreline Trail

COME FOR A VISIT – WE THINK YOU'LL STAY

Call us and mention this ad for a FREE One Night Guest Berth

COYOTE POINT MARINA ~ 1900 Coyote Point Drive • San Mateo

650.573.2594



Flying Cloud Yachts



Hans Christian

GEMINI

Sail • BROKERS • Power

MEMBER
BoatWizard
M.S.
YachtWorld.com



6400 Marina Dr., Long Beach, CA 90803

Phone (562) 594-9716 Fax (562) 594-0710



NEW 105Mc - GEMINI, 2008
Best selling cruising catamaran in the U.S.!
\$154,500



57' BOWMAN KETCH, 1978
Five hours on rebuilt 110hp Perkins. New electronics. Top-quality bluewater cruiser. \$249,000



36' CATALINA SLOOP, 2001
Better than new! Extensive upgrades include Avon RIB with 15hp OB. \$119,500



45' HUNTER SLOOP, 1999
Very clean and sharp, shows little use. Just reduced, serious seller. \$199,500



42' CATALINA(s), 1992 & 1997
New diesel, fresh sails, 2 & 3-stateroom layouts. Very nice! From \$119,500



37' C&C, 1984
Pristine condition! Low hours on Yanmar diesel. Loads of upgrades! \$74,500



35' CHARTER CATS WILDCAT, 2001
Space & performance in ready to cruise cat. 4 strms, hard bottom dinghy, good electronics. \$209,000



47' GIL'S CHOY CATAMARAN, 2002
Ready to cruise the South Pacific today! Everything as new, fully equipped. \$400,000



42' WESTSAIL CUTTER, 1974
\$113,000

Web site: www.yachtworld.com/fcyachts • email: flyingcloud@verizon.net



43' CONESSA SLOOP, 1978
Performance designed by Doug Peterson. Quality construction. Must see! \$139,000



41' YORKTOWN, 1985, \$44,500
39' YORKTOWN, 1976, \$39,500



42' PEARSON KETCH, 1978
Aft cockpit, aft stateroom cruising ketch, excellent construction. \$79,950



41' NAUTOR'S SWAN, 1973
Clean and ready to sail. New LP and new bottom paint in 5/07. 120,000



40' CARROL MARINE TRIPP 40, 1991
\$64,900



40' ISLANDER PETERSON, 1982
Well maintained by original owner. \$69,000



38' HANS CHRISTIANS
1980-1986
From \$99,000



36' CATALINA SLOOP, 1984
Very clean. Owners moved out of country - need offers! \$53,500



36' C&C SLOOP, 1981
Clean, good sails and equipment, FAST. \$45,900



36' ISLANDER SLOOP, 1981
Meticulously maintained! New Universal diesel, new upholstery. Many upgrades. \$74,500



35' CAL CRUISING SLOOP, 1974. Hard to find cruiser w/big interior. 90 hours on rebuilt Perkins. 2 fuel tanks hold 170 gals. \$39,000



32' DOWNEAST, 1976
Clean pocket cruiser. Low hours on new Volvo diesel! \$45,000



35' ALLIED SEABREEZE, 1964
\$29,500



33' RANGER SLOOP, 1974
\$13,500



30' DIDHAM / PETERSON SLOOP, 1979
Cold-molded performance cruiser in excellent condition. \$23,000



30' BABA CUTTER, 1983
Low hours on Yanmar diesel. Serious seller, priced right! \$55,000

Some boats shown may be sisterships.

Photo: David Gartland



- **Engine sales and installation**
- *Sprayed racing bottoms*
- *Custom topside paint*
- *Fiberglass and gel coat repairs*
- *Electrical and mechanical systems*
- *Rigging repairs and refit*
- *Wood repairs*

SAN FRANCISCO BOAT WORKS

835 Terry A. François St., San Francisco, CA 94158

(415) 626-3275 Fax (415) 626-9172

www.sfboatworks.com sfboatworks@yahoo.com

*Be our guest for lunch at the historic Ramp Restaurant**

** Some restrictions apply*





CLIPPER YACHT HARBOR
Sausalito's Only Full Service Marina
 www.clipperyacht.com
 310 Harbor Dr., Sausalito, CA 94965
 (415) 332-3500
800 Slips 20-60 ft • Dry Storage Available



"Your Destination for a Full Service Marina"

- Fuel Dock
- Bait & Tackle Shop
- Sport Fishing
- Restaurants
- West Marine
- Launch Ramp
- Pump Out
- Laundry Facility
- Private Restrooms/Showers
- Anderson's Boat Yard
- Guest Slips Available

BayRisk Classic 



"I'll get the BayRisk policy."

BayRisk Insurance Brokers, Inc.
 800-647-2025
 Visit our Website www.bayrisk.com
 1920 Minturn Street • Alameda, CA 94501

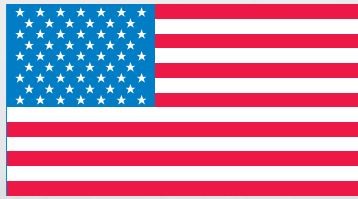

Along with a great place to berth your boat, San Leandro Marina offers you a wealth of recreational opportunities...

- **27 holes of championship golf**
- **A waterfront hotel**
- **Fine dining at 2 restaurants overlooking the water**
- **40 acres of shoreline park and picnic sites**
- **300 acres of tidal wetlands on the Bay Trail**
- **2 active yacht clubs**



(510) 357-7447

www.ci.san-leandro.ca.us/slmarina.html

YACHTFINDERS**WINDSEAKERS****(619) 224-2349 • Toll Free (866) 341-6189**2330 Shelter Island Dr. # 207
San Diego, CA 92106
info@yachtfinders.biz
www.yachtfinders.biz**74' CUSTOM KETCH, '41** \$374,900
Sundancer is a handsome yacht with comfortable living areas. She is capable of extensive world cruising or comfortably lying at anchor. Her exceptionally reasonable asking price is a fraction of the replacement costs.**43' GULFSTAR CC SLOOP, '79** \$84,900
Want to get away? *Leonore* has been in Florida, St. Lucia and Hawaii as well as many places here in California, and her pedigree as a proven cruiser provides the cure for those in need of visiting those far-away places.**42' BAVARIA, '05** \$219,500
Indonesian Grace is a 'near new' offering available at a very affordable price. She has been well maintained and lightly used by her owner. Anyone searching for an upscale vessel of this size and quality should not miss this chance.**42' CATALINA, '97** \$149,500
This Catalina 42 is a veteran cruiser. Her layout offers wide decks, a large cockpit, and ample accommodations below. She is outfitted with all the desirable cruising equipment for safe and comfortable passages.**42' CAMPER-NICHOLSONS, '74** \$59,000
Gigi is fully equipped for bluewater cruising. The interior is well suited for extended voyages with abundant storage space and easy access to essential systems. She's a great opportunity to acquire a quality sailing yacht.**42' PRIVATEER CC KETCH, '89** \$89,000
Ebb Tide is truly a go-anywhere design, professionally built by the current owner for his own use. She is a Mexico veteran and has proven herself to the owner and his wife to be a safe and durable vessel in all conditions.**40' CATALINA, '96** \$137,500
Ideal vessel for cruising or comfortable overnighters and a must-see! *Bearoffers* upgraded 62-hp Yanmar diesel, transmission and electronics. She is ready for any adventure, family outing or entertaining in style and comfort.**38' HANS CHRISTIAN, '86** \$137,000
Soul Mates is a proper yacht that is meticulously maintained and continuously upgraded. Her varnish is beautiful and she's clean, safe, dry and odor-free. She has the Telstar keel which aids in docking and close maneuvering.**38' ROBERTS, '82** \$39,000
A veteran of the Sea of Cortez with only 100 hours on her rebuilt diesel engine, *Sunbar* offers a nice opportunity for a budget to acquire a reasonably well-equipped, mid-size cruiser that is ready to go.**34' CAL 3-34 MKIII, '78** \$26,000
This yacht is shy on added equipment but outgoing in beauty. She is a beautifully maintained one-owner vessel. Add goodies if you wish, but in the interim enjoy her beauty and grace on the water.**32' ERICSON, '76** \$24,500
Want a 32' Ericson equipped for cruising but also with the ability to perform in light or moderate breezes? This well-equipped, well-cared for boat needs a new owner. You need *Po'oino!* Come appreciate her.**27' CHEOY LEE, '70** \$17,500
A tidy little pocket cruiser from the great Cheoy Lee lineage. Easy to singlehand and in great condition with an elegant interior, this classic must be seen to be fully appreciated. Come see *Marieta* at our dock.**B A L L E N A B A Y**
YACHT BROKERS

1150 Ballena Blvd. #121, Alameda, CA 94501 ♦ (510) 865-8600 ♦ Fax (510) 865-5560

2736 Shelter Island Drive, San Diego, CA 92106 ♦ (619) 523-1151

♦ www.ballenabayyachts.com ♦ www.trawlers.com ♦ www.yachtworld.com/ballenabay ♦

California dealer for
Valiant Yachts
New 42' Valiant
Coming in January 2008**33' MASON CUTTER, 1987**
Bristol condition. Professionally maintained. A must see boat! **\$114,500****39' FAIRWEATHER, 1989.** Proven ocean cruiser and great liveaboard. **\$140,500****41' COOPER PILOTHOUSE, 1981**
Comfortable, bluewater-capable boat. **\$95,000****Check our Web sites for other fine listings!**

FULL SERVICE BOATYARD

WINTER Haulouts for Bottom Painting

Interlux yachtpaint.com Small yard offers specialized service.

NEW MARINE DIESELS



Perkins DIESELS

SALES
SERVICE
PARTS

10% OFF

GENUINE PERKINS PARTS

Mention this ad ~ Good until 12/31/07

Perkins Authorized Master Service Dealer

We ship worldwide!

BRITISH MARINE



& INDUSTRIAL

#11 Embarcadero Cove
Oakland, CA 94606

(800) 400-2757
(510) 534-2757

Two blocks from West Marine

www.britishmarine-usa.com

BETA MARINE

SMOOTHER... QUIETER!

Our engines idle smoother and quieter because of our high inertia flywheel. This is one of the many Beta Marine exclusive features that make our diesel engines easier to live with.



What a Concept! It is engineered to be easily serviced.

Beta Marine superb propulsion engines, using Kubota diesel 10-90hp including our famous Atomic 4 replacements.

Also available: Marine Generators up to 30 kw.

Regional Dealer:

BETA MARINE US, LTD. **HIRSCHFELD YACHT LLC**

P.O. Box 5, Arapahoe, NC 28510
www.betamarine.net

265 Gate 5 Rd, Sausalito, CA 94965
www.engineerite.com

877-227-2473 • 252-249-2473

415-332-3507

info@betamarinenc.com

Best Buys for Your Eyes

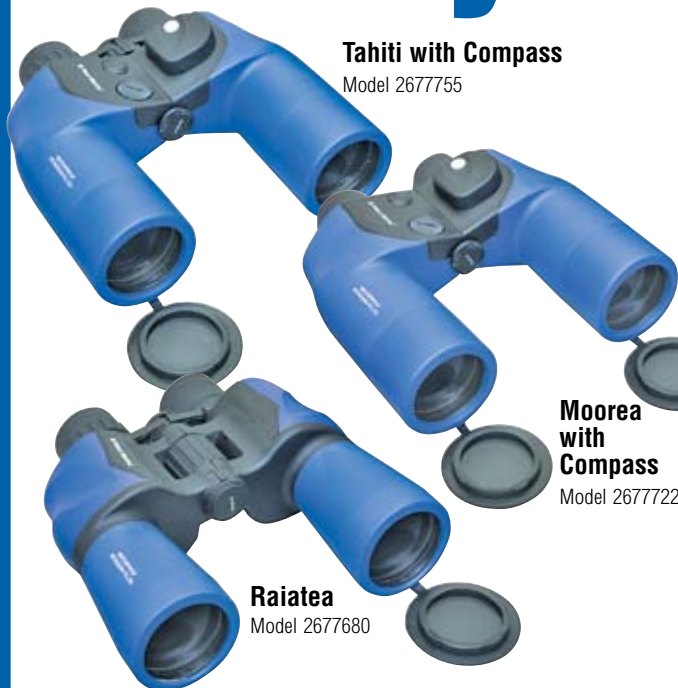

Tahiti with Compass

Model 2677755

Moorea with Compass

Model 2677722

Raiatea

Model 2677680

Waterproof 7 x 50 Binoculars

When it comes to choosing a pair of binoculars for marine use, it's easy to be overwhelmed by the jillions of available options. But if superb performance at an affordable price is what you want, you can comfortably narrow your focus to one binocular brand—West Marine's Island Series binoculars.

Our complete line of marine binoculars combines truly superb optical performance with rugged, waterproof and fog-proof construction at prices that make them exceptional values. But you don't have to take our word for it. *Practical Sailor* magazine's August 2006 issue rated our Tahiti "Excellent" and a "Best Buy." Better yet, prove it to yourself by stopping by one of our convenient store locations and seeing (and we mean that literally) the difference for yourself!

West Marine
We make boating more fun!

Visit our **Alameda Sailing Superstore!**

730 Buena Vista Ave. • 510-521-4865

We have 22 stores in Northern California.

Log onto westmarine.com or call **1-800-BOATING** to find the store nearest you.

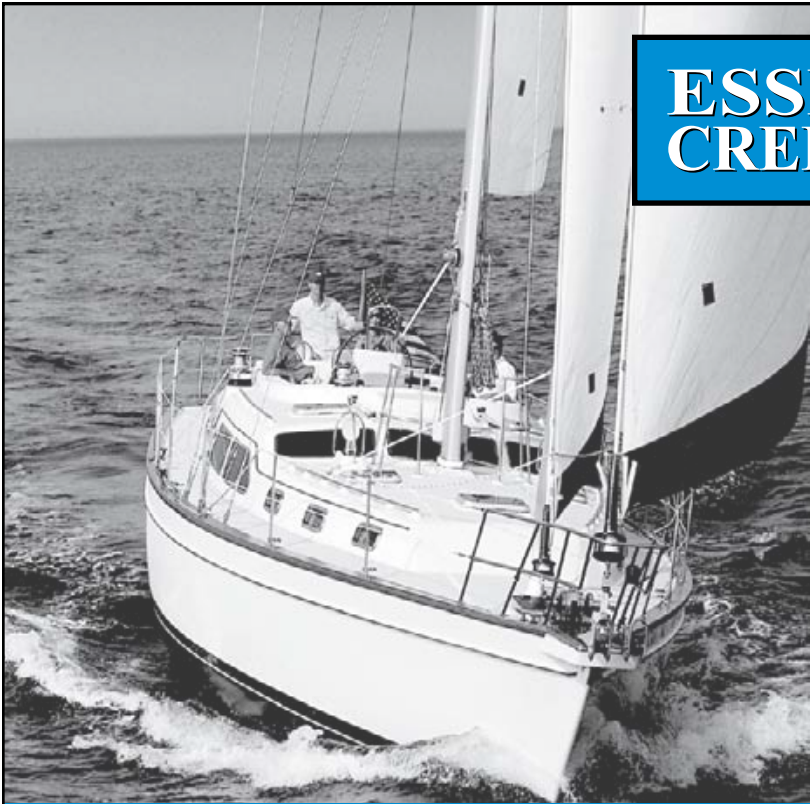

**ESSEX
CREDIT**

NEW - USED - REFINANCE

Boat Loans Made Easy®



Let our 26 years of experience go to work for you!

Linda Carroll

866-377-3948 ext. 7215

www.essexcredit.com

EQUAL CREDIT OPPORTUNITY LENDER

Loan Amounts from \$15,000 Instant Loan Approvals*
Zero Down Program* 90 Days to First Payment*

*(Subject to Loan Program Guidelines and Credit Approval)

Reference Code =MAR931

Take Our Boat Test. Please.



1. See a boat on MazMarine.com.
2. Add cost of plane ticket to Mazatlan.

3. Add up all costs in this column.

total: \$?



1. Find a comparable boat near you.
2. Add in all sales taxes. All of 'em.
3. Add in all requisite gear needed for off-shore cruising. All of 'em.
4. Add in your time, energy and costs to install and test both gear and boat.
5. Add in your time, energy and costs to sail her down to Mazatlan.
6. Add up all costs in this column.

total: \$?

Interesting comparison, isn't it? Try it. Do the math on any comparable yacht up in your neck of the woods, with one of our well-equipped and maintained off-shore yachts listed on MazMarine.com. Compare the specs. Add it up. The reality is that selecting a blue-water vessel from Mazatlan Yachts, Mexico's biggest and best, and now a new office in La Paz, is often ultimately safer and less expensive. And you're cruising Baja now...not a year or two from now. Our yachts were sailed here by experienced owners. Each boat's gear has been selected, installed and ocean proven. Each awaits your inspection at our docks in Marina Mazatlan or La Paz. Do it. Please. Crunch the numbers and call us.



Ray Watson & Jeannette Sarrasin
Toll free: 1 (888) 716-7430
Phone & FAX: 011-52-(669)-913-3165
E-mail: MazMarine@aol.com
Compare our listings at: MazMarine.com



Mike Rickman
VHF Ch. 22 "Amazing Grace"
Cell: 011 521 (612) 105-6459
Toll Free US/CAN: 1 (877) 245-9689



BAY PROPELLER

FULL SERVICE PROPELLER
AND SHAFT REPAIR

Bay Propeller is the largest and most experienced
propeller shop in Northern California

**SAIL MORE
SAIL FASTER
SAVE FUEL**



Folding or feathering props simply
make your sailing life better.

**Call NOW to SAVE
up to 15% on:**

**Gori • Flex-O-Fold • Martec
and more!**

BAY PROPELLER • 2900 MAIN STREET #2100 • ALAMEDA, CA 94501

510-337-9122

FAX: 510-263-9827 • www.bay-ship.com

Relieves Gas Pains

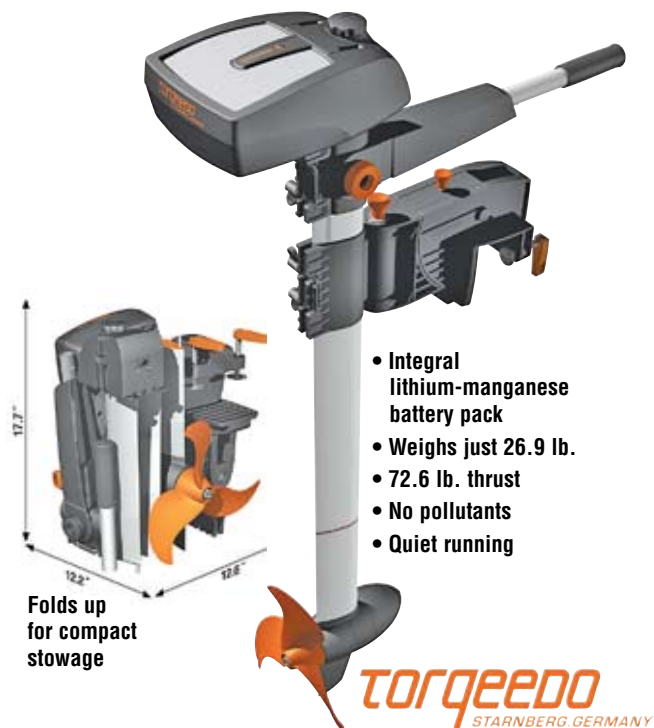

- Integral lithium-manganese battery pack
- Weighs just 26.9 lb.
- 72.6 lb. thrust
- No pollutants
- Quiet running

Folds up
for compact
storage

torqeedo
STARNBERG, GERMANY

Travel 801 Electric Motor

Finally! A practical alternative to gas-powered outboards that's ideal for tenders, small keelboats and sportboats. The Torqeedo Travel 801 eliminates the mess and potential hazards of gas tanks along with oil changes, tune-ups, fumes and that infernal racket.

The Torqeedo combines an advanced lithium-manganese battery, highly efficient synchronous permanent magnet motor and variable pitch prop to produce thrust equivalent to a 2 hp combustion motor. It weighs a mere 26.9 lb. (with battery) and can be folded for easy storage and transport.

If you're ready to say good-bye to gas pains, say hello to a better propulsion solution—the Torqeedo Travel 801 Electric Motor.

Long & Short Shaft versions available.

West Marine®
We make boating more fun!®

Visit our **Alameda Sailing Superstore!**
730 Buena Vista Ave. • 510-521-4865

We have 22 stores in Northern California.
Log onto westmarine.com or call **1-800-BOATING**
to find the store nearest you.



Season's Greetings!
from all of us at Staa Sails

A Full Service Sail Loft

Providing Quality Customer Service
and Competitive Pricing

*It's the right time of year to give your
loved one a gift they will really enjoy:*

**15% OFF NEW SAILS
20% OFF FURLING HARDWARE
15% OFF GILL CLOTHING**

801 Harris Ave., Bellingham, WA 98225

(360) 734-8559 or (800) 234-6157

email: drew@sailoft.com

Used sails listed on our website: www.sailoft.com

SPECIALIZING IN BLUEWATER CRUISING YACHTS



63' Dynamique, 1983... \$325,000



53' Amel, 1981...\$175,000



48' Offshore, 1981...\$350,000



46' Hatteras, 1977...\$199,000



46' Beneteau, 2001...\$260,000



44' Kelly Peterson, 1976...\$123,000



40' Fortuna, 2006...\$469,000



30' Proline, 2003...\$79,000

SAIL		40' Passport, '81	\$99,000	46' Lien Hwa motoryacht, '87	\$159,000	36' Blackfin sportfisher, '88	\$155,000
65' Swan, '75	\$695,000	40' Passport cutter, '86	\$149,900	46' Hatteras convertible SF, '77	\$199,000	30' Albemarle Express 305, '02	\$179,000
63' Dynamique Elite cutter, '83	\$325,000	40' Baba/Tashing cutter, '83	\$139,000	43' Albin Marine trawler, '79	\$128,000	30' Pro Line Express, '03	\$79,000
60' Maple Leaf pilothouse, '87	\$290,000	40' Beneteau, '95	\$126,500	41' President Sundeck Twlr, '87	\$109,000	29' Back Cove, '07	Inquire
53' Amel Mango cutter ketch, '81	\$175,000	40' Fortuna Island Spirit 401, '06	\$469,000	38' Californian aft cabin trawler, '75	\$84,500	28' Bertram Flybridge, '79	\$79,000
52' Tayana aft cockpit, '91	\$325,000	39' Cavalier, '80	\$75,000	38' Bayliner, '92	\$110,000	27' Skipjack cuddly sportfisher, '85	\$34,000
50' Force Venice ketch, '87	\$219,000	38' Ingrid cutter sloop, '81	\$79,000			18' Striper Sea Swirl, '03	\$26,000
47' Beneteau 473, 2003, 3-cabin	\$260,000	38' Downeast, '77	\$59,000				
46' Catamaran Choy Seaman, '91	\$174,900	38' Pearson cutter, '84	\$89,500				
46' Jensen Marine Cal 2-46, '72	\$79,000	38' Catalina sloop, '84	\$59,900				
46' Beneteau 461, 2001	\$224,000	37' Irwin, '79	\$59,900				
45' Liberty 458 CC cutter, '83	\$175,000	37' Pacific Seacraft/Crealock, '81	\$115,000				
45' Jeanneau Sunkiss, '84	\$150,000	36' CS Yachts LTD Canadian, '84	\$69,000				
44' Formosa cutter, '87	\$149,000	36' Custom C-Crest ketch, '88	\$59,000				
44' Kelly Peterson cutter, '76	\$123,000	34' Columbia sloop, '70	\$27,000				
43' Beneteau 432 sloop, '87	\$89,000	34' Coronado sloop, '74	\$36,000				
42' Beneteau First, '82	\$74,000	34' Ericson, '79	\$17,500				
42' Catalina sloop, '90	\$120,000	32' Brandmayer/Spencer, '71	\$14,500				
42' Catalina sloop, '89	\$115,000	26' McGregor, '98	\$22,000				
42' Westsail, '74	\$60,000	POWER					
41' Hunter, '98	\$159,900	61' Princess, '06	Inquire				
41' Dufour Gib Sea, '85	\$65,000	58' Princess, '06	Inquire				
41' Jeanneau Sun Legend, '86	\$79,000	57' McKinna pilothouse, '00	\$599,000				
41' Master Mariner Neptune, '85	\$99,000	52' Hatteras convertible SF, '84	\$349,999				
40' Jeanneau Sun Fast sloop, '02	\$189,000	48' Offshore Camargue yacht, '91	\$350,000				



VALLARTA YACHTS S.A. DE C.V.

Nick and Carol Rau
Paradise Village Marina

Ph/Fax: 011-52-322-297-2249
Local Cell: 044-322-227-2944
US: 314-667-4111 (rings in MX)

www.vallartayachts.net
nick@vallartayachts.net

Exclusive Mexico Dealer for Sabre and Back Cove Yachts

GLEN COVE MARINA



Located on the Carquinez Straits

- 135-ft. Guest Dock
- Yacht Clubs Welcome
- Café & General Store
- Picnic & Event Areas
- Great Fishing Spots Nearby
- Free Wireless Internet
- Pump Out
- Security
- Showers & Laundry

Now Available:

24-36 ft. Covered Berths • Up to 55 ft. Uncovered Berths

GLEN COVE MARINA 707-552-3236

2000 Glen Cove Road, Vallejo, CA 94591

www.glencovemarina.net • glencovemarina@gmail.com

less fuel
less noise
less pollution
more power



OSSA Powerlite diesel-electric systems by Glacier Bay are up to 95% quieter.
www.ossapowerlite.com

Glacier Bay, Inc. 2930 Faber Street Union City, CA 94587
(510) 437-9100 (510) 437-9200 fax www.glacierbay.com

RICHMOND YACHT HARBOR, LTD.

320 West Cutting Blvd. • Richmond, California



Looking for space at Pt. Richmond?

On the Santa Fe Channel, there is flexible marine & light industrial multi-use zoning. Approx. 9,000 sq. ft. building, land – storage, parking and docks. Also, 1,000 sq. ft. free-standing drive-in shop. (Between Bay Marine and KKMI).

(510) 235-1176 • Fax (510) 235-1178

A Flare For The Dramatic



ORION

Orion SOLAS-Approved Flares

You don't want to think about it. We don't want to think about it. But good seamanship demands that each of us be prepared for on the water emergencies in order to prevent avoidable dramas.

When the unthinkable happens, you want to attract as much attention as possible from potential rescuers. Which is why you want the brightest, longest burning, highest flying flares you can get your hands on. And SOLAS-approved flares are the best you can buy.

Waterproof, easy to fire and extremely bright, SOLAS flares significantly exceed US Coast Guard requirements. The dramatic difference has to be seen to be appreciated. And, after all, being seen is what it's all about.

West Marine has Orion SOLAS-approved flares in several styles for your boating safety: Red Parachute Flare, Red Handheld Flare and Orange Smoke Canister.

West Marine[®]
We make boating more fun![®]

Visit our **Alameda Sailing Superstore!**
730 Buena Vista Ave. • 510-521-4865

We have 22 stores in Northern California.
Log onto westmarine.com or call **1-800-BOATING**
to find the store nearest you.

HONDA
MARINE
IT'S ALL ABOUT POWER.

caribe
INFLATABLES

Aquapro
INFLATABLES



TOHATSU
outboards

Achilles

We've been **THE Bay Area authority for inflatables and outboards for more than 35 years.**

Call us today for quotes.

Voyager Marine

1296 State St.
P.O. Box 246, Alviso, CA 95002-0246
(408) 263-7633 • (800) 700-7633
Open Tuesday thru Saturday





OWL HARBOR MARINA

THE FRIENDLY MARINA

**HOME OF
ANDREAS COVE
YACHT CLUB**
Limited Time Only-
\$100 Memberships
Call for details

- 30'-50' deep draft berths @\$5.00 per foot
- Dry and open storage
- Extra wide berths for multihulls
- Home of Club Rio Sailing School
- Robert A. Viel, Certified Marine Surveyor

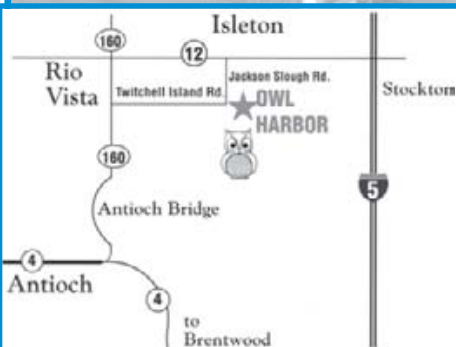

'CANVAS BY THE LOOP' On-site canvas & repair shop

- SAIL - Alterations & Repair
- CANVAS - New & Repairs
- SAILBOAT RIGGING
- HARDWARE INSTALLATIONS
- 12-VOLT REPAIR & INSTALLATION
- FAST TURNAROUND ON REPAIRS

LOCATED ON SEVEN MILE SLOUGH
OFF THE SAN JOAQUIN RIVER

HARBORMASTER: SHAWN PASSERI

(916) 777-6055

email: shawn@owlharbor.com
www.owlharbormarina.com

1550 W. TWITCHELL ISLAND RD.
ISLETON, CA 95641

Margaret W Fago

Yacht Portraits ~ now in Oil

visit my
Open Studio
Dec 1 & 2
10am to 5pm

Great Holiday Gift
originals, prints & cards



Margaret's Studio-1524 Mozart St, Alameda, CA
www.margaretfago.com
510 522-1309 mwfago@earthlink.net



COAST MARINE

& INDUSTRIAL SUPPLY INC.

398 Jefferson St. San Francisco - On the Wharf.

Call Bruce Becker or Clark Atkinson
(415) 673-1923 (415) 516-4860

800-433-8050

Fax (415) 673-1927

LIFE RAFT Sales & Service



U.S.C.G. Approved Testing Facility

- ★ U.S.C.G. life raft facility for Solas commercial yacht and fisherman rafts
- ★ COMAR DEBARKATION LADDERS
- ★ COMAR PILOT LADDERS
- ★ COMAR WORK LADDERS
- ★ All U.S.C.G. approved

GUINNESS "World's longest tested ladder 320ft."
WORLD RECORD



Major Distributor for:



Pains Wessex
Safety Systems



STEARNS



IN SAN DIEGO CALL OCEANS WEST 619 544-1900



McGinnis Insurance

Since 1972

**Knowledge ♯ Commitment
Reliability ♯ Service**

Happy Holidays!



Large and small, we do them all!

Call us at: **800-486-4008**

mcginnisins@aol.com

License #0570469

Alameda Prop & Machine

Stainless Steel Fabrication

(510) 522-7899 (800) 774-7899



***Season's
Greetings***

*to all our valued
customers
and friends*

Located at the Grand Marina Marine Center
www.marinepropellers.com

Optimize Your Spring Lineup



Get Set for Spring Training

Savvy managers in every sport know that laying the foundation for success begins in the off-season. That's why now is the ideal time for you to scrutinize the sail handling systems aboard your boat.

If you're looking for ways to make your systems run quicker, smoother and stronger, look to West Marine's huge selection of sailboat running rigging.

We've got everything from the latest super-fiber synthetics to affordable standbys in every combination of sizes, colors and constructions. And we've got rigging experts who can help you choose precisely the right lines for every rigging system aboard. We can even splice, taper and strip the lines to ensure they're perfectly tailored to your needs at our Alameda Sailing Superstore.

Get set for a great season now by optimizing your lineup at your nearby West Marine.

 **West Marine**[®]
We make boating more fun![®]

Visit our **Alameda Sailing Superstore!**
730 Buena Vista Ave. • 510-521-4865

We have 22 stores in Northern California.
Log onto **westmarine.com** or call **1-800-BOATING**
to find the store nearest you.

Downwind Marine's

NEW WWW WEBSITE!

Expanded Worldwide Service
Reduced Market Beating Prices
Rapidly Growing Inventory



West Coast sailors have long known of
Downwind Marine's
extensive experience and great value.

- Save with every 'click'.
- We specialize in special orders.
- Expert help when you need it.
- TRY IT, it won't cost you, it will save you!



Open: M-F 8-5 • Sat. 9-5

(619) 224-2733 • TOLL FREE (866) 289-0242

www.downwindmarine.com

2804 Cañon St., San Diego, CA • email: info@downwindmarine.com
CRUISERS' NET, Ch. 68, from 8:30 am weekdays: WHX369

Boating is
already Fun –
We make it more
Affordable®

CALENDAR

Non-Race

Dec. 1 — 31st Annual Lighted Yacht Parade on the Oakland/Alameda Estuary, starts at 5 p.m. Presented by Encinal YC, Oakland YC and Marina Village Yacht Harbor, this year's theme is 'A Child's Christmas'. Find out more and enter your boat at www.lightedyachtparade.com.

Dec. 1 — South Beach YC Lighted Boat Parade from McCovey Cove to the Ferry Building, Chili and hot buttered rum at the YC after. Info, www.southbeachyc.org.



What better way to kick off the holiday season than by watching a lighted boat parade near you? There are several to choose from on the Bay.

Dec. 1 — Petaluma River Lighted Boat Parade, begins at the marina at 6 p.m. Info, (707) 762-4697.

Dec. 1 — San Leandro Marina's "Christmas Through the Eyes of a Child" Lighted Boat Parade. Goodies and Santa at 5 p.m., parade starts at 6 p.m. Info, (510) 577-SHIP.

Dec. 1 — Oakland West Marine's 30th Anniversary Celebration, 8 a.m.-7 p.m. Refreshments and prizes. Call (510) 532-5230 for directions.

Dec. 2-30 — Free sailing at Pier 40 every Sunday courtesy of BAADS. Info, (415) 281-0212 or www.baads.org.

Dec. 4 — The first day of Hanukkah.

Dec. 5-26 — Wednesday Yachting Luncheon Series at St. Francis YC, 12-2 p.m., \$13.50. Enjoy lunch and a dynamic speaker every Weds. All YC's members welcome. More info under the 'Events' tab at www.stfyc.com.

Dec. 5, 19 — Pt. Fermin Singles Sailing YC invites singles to two monthly meetings. 6 p.m. at Acapulco Restaurant in San Pedro. Info, (310) 427-4817 or www.pfsyc.com.

Dec. 8 — Sausalito YC Lighted Boat Parade, starts at 6 p.m. with viewing along the waterfront. Info, (415) 332-6609.

Dec. 8 — Vallejo YC Harbor Lighting Parade. Info, www.vyc.org or (707) 643-1254.

Dec. 8 — Celebrate "Christmas at Sea" aboard *Balclutha* at Hyde St. Pier. Enjoy sea chanteys with a holiday twist then stay for ornament-making and refreshments before the Big Guy arrives by boat. Admission is \$5 (free for kids 15 and under) for the event, starting at 3 p.m. Info, (415) 447-5000.

Dec. 12 — Free Rope Splicing Seminar at Sausalito West Marine, 5:30 p.m. Info, (415) 332-0202.

Dec. 13 — Gulf of the Farallones National Marine Sanctuary advisory council meeting, Bodega Marine Lab, 9 a.m.-4:15 p.m. Info, (415) 561-6622 ext. 205.

Dec. 13 — If you want to meet other single sailors, learn to sail or need crew, Single Sailors Association's monthly meeting is at Oakland YC, 6:30 p.m. Info, www.singlesailors.org.

Better Sail Control



now requires less effort...

Garhauer's adjustable genoa car system is the answer to leaving the cockpit and going forward to move the genoa car with every wind shift and sail adjustment.

Experience better sail control with less effort. With four to one purchase, you can now easily control the travel of a block on any track from a single line led aft.

This is a four piece system consisting of two control cars and two end controls (port & starboard). A single line threads thru the two horizontal blocks on the easily-installed track cars for each track. Your genoa sheet slides thru the pivoting vertical block and back to the winch.

Available in track widths of 1 and 1-1/4", built with rock solid durability that all Garhauer hardware is known for.

Now tack better and spend less:

E-Z G-1UB 1 in. track \$242.00

E-Z G-2UB 1-1/4 in. track \$302.50

E-Z G-3 1-1/4 in. track \$363.00

optional swivel cams

available: \$96.80 per pair

**for sailboats
25-30' LOA**



E-Z G-1UB

*Optional
swivel cam on slide*

**for sailboats
30-36' LOA**



E-Z G-2UB

*Optional
swivel cam on slide*

**for sailboats
37-47' LOA**



E-Z G-3

*Optional
swivel cam on slide*



1082 West Ninth Street,
Upland, California 91786

Phone: (909) 985-9993
FAX: (909) 946-3913

email: garhauer@garhauermarine.com
<http://www.garhauermarine.com>

Nothing Beats a J/Boat!

Make your holiday dreams come true.
Order now for spring delivery.



Now at our sales docks.



Now at our sales dock.



Newest One Design Fleet on the Bay • www.j109.org



What's different about a J/Boat? You have to sail it to believe it. Call us to find out about the J/Boat experience.

SAIL California

Web page: www.sailcal.com
Email: info@sailcal.com

SAIL CALIFORNIA
NEWPORT BEACH
251 Shipyard Way
Cabin A
(949) 675-8053
FAX (949) 675-0584

SAIL CALIFORNIA
SAN FRANCISCO BAY
1070 Marina Village Pkwy,
#108, Alameda
(510) 523-8500
FAX (510) 522-0641

SAIL NORTHWEST
SEATTLE
7001 Seaview Ave., NW
Suite 140
(206) 286-1004
FAX (206) 286-1353

CALENDAR

Dec. 15 — San Rafael Canal Holiday Parade of Lights. Info, Russ Hamel at (415) 485-1489.

Dec. 15 — 20th Annual Holiday Boat Lighting Contest at Pillar Point, beginning at 6 p.m., with a party following at Half Moon Bay YC. Info, www.hmbyc.org or (650) 725-2120.

Dec. 16 — Monterey Peninsula YC Lighted Boat Parade, starting around 5:30 p.m. Info, (831) 372-9686.

Dec. 16 — Cal Sailing Club will give free sailboat rides at Berkeley Marina, 1-4 p.m. Info, www.cal-sailing.org.

Dec. 19 — Sausalito West Marine's annual holiday event, 8 a.m.-8 p.m. Info, (415) 332-0202.

Dec. 21 — Winter Solstice, the shortest sailing day of the year. They only get longer from here!

Dec. 23 — Full moon on Sunday night.

Dec. 25 — Give your favorite sailor a subscription to *Latitude 38* for Christmas. See page 8 for the form.

Jan. 4-13 — Northern California Boat Show at the Alameda County Fairgrounds in Pleasanton. Adults \$10; Kids under 15 free. Info, www.ncma.com.

Jan. 8, 10, 17, 19, 22, 24 — Boat Smart course by Marin Power & Sail Squadron at Kell Education Center in Novato, 7-9 p.m. For info or to register, call (415) 924-2712.

Jan. 9-Feb. 13 — Basic Coastal Navigation by Flotilla 12-2 at Oakland YC, 6:30-8:30 p.m. Followed by six-week Advanced course. Info, (510) 601-6239 or nancy@windwave.com.

Feb. 5-Apr. 29 — Boating Skills and Seamanship course taught by USCGA Flotilla 12 at Sausalito Cruising Club, Tuesdays 7:30-9:30 p.m. \$75 fee. For info, contact Margrit at (415) 924-3739 or margritkeyes@sbcglobal.net.

Racing

Dec. 12-15 — Superyacht Cup Antigua, a beautiful venue to watch beautiful boats. Info, www.thesuperyachtcup.com.

Dec. 17 — Offshore Communications Seminar (plus navigation, weather and sailing software) for the Singlehanded TransPac at Ballena Bay YC. Info, www.sfbaysss.org.

Jan. 1 — Master Mariners' New Year's Day Race & Chili Potluck at Pt. San Pablo YC in Pt. Richmond. Info, (415) 364-1656 or www.mastermariners.org.

Jan. 19 — Richmond YC Little Daddy Regatta. Big Daddy isn't until March 8-9. Info, www.richmondyc.org.

Jan. 21-28 — Acura Key West Race Week, the best regatta in the country. Info, www.premiere-racing.com.

Jan. 26 — Three Bridge Fiasco, one of the oddest and most entertaining races ever invented, the first SSS event of the season. Info, www.sfbaysss.org.

Jan. 27-Feb. 2 — US Sailing's Rolex Miami Olympic Classes Regatta (OCR), a Grade 1 ISAF event with competition in seven Olympic and Paralympic classes. Info, www.ussailing.org.

July 12 — 30th anniversary of the Singlehanded Transpac from SF to Hanalei. If you've been wanting to prove your mettle, this could be your year. Info, www.sfbaysss.org.

July 14-19 — 15th Biennial Fun Race to Hawaii, a.k.a. the Pacific Cup. For details on the race and seminars, visit www.pacificcup.org.

Midwinter Regattas

ALAMEDA YC & ISLAND YC — Estuary Midwinters: 12/9, 1/13, 2/10, 3/16. Joanne McFee, (510) 521-7442.

BERKELEY YC — Midwinters: 12/8-9, 1/12-13, 2/9-10, 2/24. Bobbi, (925) 939-9885.

WE WANT TO SELL YOUR BOAT! CALL TODAY – DOCK SPACE AVAILABLE!

SAIL *California*

SANTA NEEDS A NEW SLED!

Don't wait another day to have the J/Boat Experience, visit our sales dock and choose from pre-owned J/105s, J/109, J/120, J/42 and J/44



Santa Cruz 52, 2000 Natazak

This SC 52 is pristine. Major refit in summer '06: full inshore/offshore racing and cruising equipment. There is no finer SC 52 on the planet. Now on our sales dock for you to view.

Asking **\$629,000**



Andrews 56, 1992 Cipango

Looking to win the Pacific Cup? This is your ride!

Asking **\$389,000**

**J/120, 1998
Hot Tamale**

This boat is 40' of fun, the J/120 can do it all: race and cruise. *Hot Tamale* is turn key to race in Winter Series. On our sales dock!

Asking **\$219,000**



**Elan 40, 2004
Tupelo Honey**

This boat offers speed and comfort. She has a proven record on the race course and all the interior amenities needed for cruising. On our sales docks!

Asking **\$239,000**



Hunter 450, 2000, Fall Asea

Priced to sell, ultimate cruiser and/or liveboard. Palatial interior (standing hdrm over 6.5'), large cockpit, great swim platform, spacious decks. Ready for year-around fun. Asking **\$229,000**



Andrews 56, 1994, Charisma

This performance cruising boat offers speed and comfort with the allure for adventure. Call today to fulfill your cruising dreams. Asking **\$395,000**



Back Cove 29, 2005, Diamond Lil

Style, grace and performance, what more could you want? Asking **\$199,000**



J/44, 1990, Phoenix

The perfect sailboat – liveboard comfort, easily managed by two, offshore durability and speed to win Fastnet and Sydney-Hobart. Asking **\$239,000**

56' Andrews 56, '92, <i>Cipango</i>	389,000
56' Andrews 56, '94, <i>Charisma</i>	\$395,000
53' HC-50, <i>Break n' Wind</i> , '01.....	Reduced \$498,000
53' Andrews, '90, <i>Artemis</i> **.....	Reduced \$349,000
52' Santa Cruz, '00, <i>Natazak</i>	\$629,000
45' Hunter 450, '00, <i>Fall Asea</i>	\$229,000
44' J/44, '90, <i>Phoenix</i>	\$239,000
40' J/120, '98, <i>Hot Tamale</i>	Reduced \$219,000
40' J/120, '95, <i>Attitude</i> **.....	\$199,000
40' Tripp, '92, <i>Snake Oil</i> **.....	\$89,900
40' Elan, '04, <i>Tupelo Honey</i>	Reduced \$239,000
38' Ericson 38-200, '87, <i>Yankee Rose</i> **.....	\$95,000
36' J/109, '03, Hull #43, <i>Doc Holiday</i> **.....	Reduced \$207,500

36' 362 Sabre, '95, <i>Soledad</i> **.....	New Listing \$169,950
36' J/109, '05, Hull #204, <i>Commotion</i>	New Listing \$239,900
35' J/35, '84, <i>Courageous</i> **.....	\$42,000
35' J/105, '99, Hull #255, <i>Rodster</i> **.....	\$119,000
35' J/105, '99, Hull #235, <i>Life Is Good</i> **.....	\$105,000
35' J/105, '98, <i>Wianno</i>	Reduced \$87,000
35' J/105, '02, Hull #523, <i>Streaker</i>	New Listing \$139,000
35' One Design, '98, <i>Double Trouble</i>	New Listing \$94,900
34' J/34, '85, <i>The Zoo</i> **.....	Reduced \$29,900
33' J/100, '04, Hull #9, <i>Brilliant</i> **.....	\$134,900
33' J/100, '05, Hull #14, <i>Crewcut</i>	SOLD
33' J/100, '05, Hull #17**.....	\$125,000
32' Melges, <i>Emotional Rescue</i>	Reduced \$74,500

30' J/92, '93, <i>Zippy</i> , Waukesha, WI.....	\$54,500
30' Sea Ray 300 Sundar, '06, <i>Sophie Ann</i> **.....	New Listing \$149,950
29' J/29, '81, <i>Macs</i> *.....	\$26,900
29' J/29, '84, <i>Jolly J</i> *.....	\$25,000
29' Back Cove, '05, <i>Diamond Lil</i>	\$199,000
29' Back Cove, '06, <i>Desiderata</i> *.....	New Listing \$197,500
27' Choate, '79, <i>Allegro Con Brio</i> **.....	New Listing \$17,500
26' J/80, '00, <i>Risky Business</i> **.....	Reduced \$32,000
26' J/80, '01, <i>Flying J</i>	SOLD
22' Aquapro Raider 665, '04.....	New Listing \$44,900
20' Harbor 20, '04**.....	\$26,500
19' Alerion Cat, '98, <i>Whiskers</i> **.....	Reduced \$19,000

* Indicates So. California Boats
** Indicates Seattle Boats

YACHTWORLD.com

**OPEN BOAT WEEKEND
DECEMBER 8-9**

**J
Net**

SAIL *California*

Web Site: www.sailcal.com
Email: info@sailcal.com

NEWPORT BEACH
251 Shipyard Way
Cabin A
Newport Beach, CA 92663
(949) 675-8053
FAX (949) 675-0584

ALAMEDA
1070 Marina Village Pkwy
#108
Alameda, CA 94501
(510) 523-8500
FAX (510) 522-0641

**SEATTLE
SAIL NORTHWEST**
2130 Westlake Ave. N.
#3
Seattle, WA 98109
(206) 286-1004

Introducing the SABRE Spirit

Now at Sail California



*Sail California is proud to offer the new Sabre Spirit.
She's all about simplicity, style and sailing!*

For 35 years, Sabre Yachts has handcrafted sailing yachts with a performance pedigree, all built for people who love sailing and who treasure the exhilarating feeling that a great sailboat design can offer her crew. Sabre asked Jim Taylor to design a daysailer with the style and elegance of sailing yachts of a bygone era, and added to the design mandate blending the performance of a youthful sport boat with "grown-up" ease of handling available with today's modern sailing hardware. With her comfortable and deep cockpit, efficient weekend accommodations and quality Maine craftsmanship, the Sabre Spirit is ideal for San Francisco Bay.

*Call now to own the first boat now
at our docks in Newport Beach.*

Also available ~ the Sabre 386 and 426.

SAIL
California

Web page: www.sailcal.com
Email: info@sailcal.com

SAIL CALIFORNIA
NEWPORT BEACH
251 Shipyard Way
Cabin A
(949) 675-8053
FAX (949) 675-0584

SAIL CALIFORNIA
SAN FRANCISCO BAY
1070 Marina Village Pkwy,
#108, Alameda
(510) 523-8500
FAX (510) 522-0641

CALENDAR

BERKELEY YC — Chowder Races: Sundays through March except when it conflicts with above. Paul, (510) 540-7968.

CAL SAILING CLUB — Year-round Sunday morning Lido 14 races, intraclub only. Ed, racing_chair@cal-sailing.com.

CORINTHIAN YC — Midwinters: 1/19-20 & 2/16-17. Allyn Schafer, (415) 435-4812 or racing@cyc.org.

ENCINAL YC — Jack Frost Series: 12/15, 1/12, 2/9, 3/8. Charles Hodgkins, rearcommandore@encinal.org.

GOLDEN GATE YC — Seaweed Soup Series: 12/1, 1/5, 2/2, 3/1. Gary Salvo, (916) 363-4566.

OAKLAND YC — Sunday Brunch Series: 1/6, 1/20, 2/17, 2/24, 3/2. Steve, (510) 373-3280.

REGATTAPRO — Winter One Design: 12/8, 1/12, 2/9. Winter Keelboat: 12/1, 1/5, 2/2. Jeff Zarwell, (415) 595-8364 or jzarwell@regattapro.com.

RICHMOND YC — Small Boat Midwinters: 12/2, 1/6, 2/3, 3/2. Sue Hubbard, (510) 235-0184 or www.richmondyc.org.

SANTA CRUZ YC — Midwinters: 12/15, 1/19, 2/16, 3/16. Info, (831) 425-0690.

SAUSALITO YC — Sunday Midwinters: 12/2, 1/6, 2/3, 3/2. J. Rigler, (415) 332-6367 or race@syconline.org.

SEQUOIA YC — Winter Series: 12/1, 2/9, 3/1. J. Draeger, (650) 244-6529. Redwood Cup: 12/16, 1/6, 2/24, 3/9. R. Brown, (650) 430-5567.

SOUTH BAY YRA — Midwinters: 12/1, 1/5, 2/2, 3/1. Larry Westland, (510) 459-5566.

SOUTH BEACH YC — Island Fever Midwinters: 12/15, 1/19, 2/16, 3/15, 3/24 (makeup). Info, www.southbeachyc.org.

VALLEJO YC — Tiny Robbins Midwinters: 12/1, 1/6, 2/3. Info, (707) 643-1254.

Mexico, The Season Ahead

Dec. 2 — Subasta at Marina de La Paz. This annual auction is held by Cub Cruceros as a fundraiser for local charities and *colonias*, the poorest communities in the area. Anyone heading to La Paz is encouraged to bring marine and household items, as well as clothing, as a donation to the Subasta. Info, www.clubcruceros.org.

Dec. 7-9 — Banderas Bay Blast, nothing-serious series of fun cruiser races on the warm and smooth waters of the bay between members of the Vallarta YC and Punta Mita Yacht & Surf Club — and anyone else who wants to participate — culminating in the Pirates for Pupils Spinnaker Run for Charity on Sunday. *Latitude* and others host this 12-mile spinnaker run — one of the most pleasant in the world — to Paradise Marina to raise money for the schools in the village of Emiliano Zapata in Punta Mita as well as other schools around Banderas Bay. Sail your own boat or make a donation to sail on someone else's. But watch out for the whales! For info, email richard@latitude38.com.

Jan 29-Feb. 3 — 7th Annual Zihua Sail Fest in Zihuatanejo, Mexico. Five days of parties, contests, potlucks, races, BBQs, auctions and chili cook-offs are what attracted over 100 boats to last year's event, but the real payoff was raising money for the Nueva Creaciones School for indigenous children. These kids, many of whom are orphaned, can't attend Mexican schools until they learn to speak Spanish. Last year nearly \$95,000 U.S. was raised — thanks in large part to matching funds raised by the Bellack and Underwood Foundations. To join in the fun and help some needy kids — even if you can't make it to the parties — go to www.zihuasailfest.com.

Late February — Pacific Puddle Jump Kick-Off Party. *Latitude 38*, Paradise Marina and the Vallarta YC team up to host a final get-together for South Pacific-bound cruisers. It

Think Green

Order now and help
save the Bay

Quantum Sails San Francisco will **donate 1%** of
all proceeds from the month of December to
savesfbay.org to help with the clean up
and preservation of the Bay
after the disastrous
oil spill.*



TM

*Sails and Service must be ordered through the Quantum Pacific office and within the month of December.

Winter Discounts Still Apply

Quantum Pacific
1230 Brickyard Cove Road
Point Richmond, CA 94801
sanfrancisco@quantumsails.com
510.234.4334

Los Angeles
222 West 'D' St.
Wilmington, CA 90744
mtaylor@quantumsails.com
310.518.2842

San Diego
2832 Canon St.
San Diego, CA 92106
reynolds@quantumsails.com
619.226.2422



OYSTER POINT MARINA/PARK

MARINA SERVICES

BERTHING: 600 berths from 26-60 ft.

GUEST DOCK & BERTHING: Available at 60¢/ft./night

RESTROOMS & HOT SHOWERS: Public restrooms and private restrooms with showers

LAUNCH RAMP: Two-lane concrete ramp with parking for 70 boat trailers and cars

PUMP-OUT FACILITY: Located on the fuel dock

PARK/OPEN SPACE: Approximately 33 acres of park and open space with trails, promenades and swimming beach

FISHING PIER: A 300' concrete fishing pier

24-HOUR SECURITY

DRY STORAGE

CABLE TV: Available

OFFICE HOURS: Weekdays 8:30 to 4:30

Saturdays and Sundays by Appointment
Closed holidays

BOAT & MOTOR MART

New Boat Sales (Parker, Osprey)

Yacht Broker

(650) 246-1660

OYSTER POINT BAIT, TACKLE & DELI

(650) 589-3474

MARINE CENTER

Dry Storage, Fuel (Both Regular & Diesel)

(650) 872-0795

DOMINIC'S RESTAURANT

Weekday Lunch • Banquet Facilities

Dinner Nightly

(650) 589-1641

INN AT OYSTER POINT

Bed & Breakfast with Restaurant

(650) 737-7633

ANCHOR DETAILING

Complete Yacht Detailing Services

(650) 579-2776

OYSTER POINT YACHT CLUB

(650) 873-5166

Located in

SOUTH SAN FRANCISCO

Take Hwy. 101 to South San Francisco/Oyster Point Blvd. exit.

Then one mile EAST on Oyster Point Blvd.

By Water: 8.2 Nautical Miles SOUTH of Bay Bridge.

FOR INFORMATION CALL
(650) 952-0808
www.smharbor.com

CALENDAR

gives everyone a chance to compare notes and finalize radio skeds one last time, and also gives *Latitude's* Andy Turpin a chance to interview you and take your photo for the magazine. Open only to people who are Puddle Jumping this year. For details, email andy@latitude38.com.

Mar. 1-8 — The 16th Annual Banderas Bay Regatta has expanded to a week of 'friendly racing for cruising boats'. The sailing conditions and the Paradise Marina venue couldn't be better. Everybody plays it safe because they're sailing their homes, and the entry is free. It's the perfect time and place to have family and friends fly down and join you in the tropics. In fact, you'd have to be nuts to miss this one. The Regatta is part of the month-long Festival Náutico Vallarta. For details, visit www.banderasbayregatta.com.

April 11-13 — La Paz Bay Fest. This will be the fourth year for this descendant of the (in)famous La Paz Race Week. After Race Week died, Club Cruceros created a new event for area cruisers that includes races, potlucks, cruising seminars and lots of other fun activities for the whole family. More info on Bay Fest 2007 will soon be found at www.clubcruceros.org.

May 1-4 — Loreto Fest and Cruisers' Music Festival. This classic Baja event, started to clean up Puerto Escondido, draws a very large crowd of cruisers and Baja land-travellers for a chili cook-off, dinghy races and other water activities, the Candeleros Classic race, and lots of participant-created music. The goals are to have fun and raise lots of money for Mexican charities in Puerto Escondido and Loreto. Visit www.hiddenpartyachtclub.com.

Please send your calendar items by the 10th of the month to calendar@latitude38.com. If you're totally old-school, mail them to *Latitude 38* (Attn: Calendar), 15 Locust Avenue, Mill Valley, CA, 94941 or fax them to us at (415) 383-5816. But please, no phone-ins! Calendar listings are for marine-related events that are either free or don't cost much to attend. The Calendar is not meant to support commercial enterprises.

December Weekend Currents

date/day	slack	max	slack	max
12/01 Sat	0050	0405/4.0F	0716	1000/2.3E
	1336	1616/1.9F	1851	2151/3.0E
12/02 Sun	0142	0456/3.0F	0759	1059/2.6E
	1440	1728/2.0F	2003	2252/2.5E
12/08 Sat	0053	0259/1.6E	0608	0854/2.1F
	1136	1501/4.4E	1909	2217/3.3F
12/09 Sun	0138	0338/1.6E	0643	0931/2.1F
	1211	1541/4.5E	1948	2254/3.3F
12/15 Sat	0216	032F	0551	0809/2.2E
	1134 2349	1411/1.7F	1643	2013/3.7E
12/16 Sun		0302/3.2F	0630	0902/2.6E
	1242	1516/1.8F	1757	2108/3.3E
12/22 Sat	0003	0209/2.1E	0505	0803/2.9F
	1049	1421/5.8E	1823	2131/4.4F
12/23 Sun	0059	0304/2.1E	0558	0855/3.0F
	1139	1513/5.9E	1914	2223/4.5F
12/24 Mon	0151	0357/2.1E	0651	0947/3.0F
	1231	1603/5.9E	2005	2314/4.4F
12/25 Tue	0241	0448/2.1E	0745	1039/2.9F
	1323	1653/5.6E	2054	
12/29 Sat		0224/3.3F	0541	0812/2.5E
	1154	1429/2.0F	1714	2013/3.2E
12/30 Sun	0004	0311/2.9F	0623	0905/2.6E
	1301	1539/1.9F	1825	2107/2.5E
12/31 Mon	0052	0358/2.6F	0704	0958/2.9E
	1404	1654/2.0F	1940	2205/1.9E

THE FINEST SAILS BEGIN WITH THE BEST SAILCLOTH

Our patented woven Vectran® sailcloth performs like the laminates with the durability of Dacron®, especially in roller furling applications. In fact, Vectran® is lighter, lower stretch, and retains its shape over a longer life than any sailcloth we've ever offered to cruising sailors. That's because Hood Vectran® is woven, not laminated to Mylar® film.

And you can be sure that each sail we roll out is built by hand, with the same care and craftsmanship that has been the Hood hallmark for 50 years. To discuss your sailcloth needs – whether our state-of-the-art Vectran® or our soft, tight-weave Dacron® – give us a call today.



SAILMAKERS

Call Robin Sodaro
(800) 883-7245
(415) 332-4104
Fax (415) 332-0943
email: hoodsails@aol.com

 Sails & Service

 New Sails

 Sail Repairs

 Furling Conversions

 Pickup & Delivery

 Winter Discounts
Now in Effect

*Jim Fair's
Outbound 46,
'Chesapeake'
Photo Courtesy
of Swiftsure Yachts*

Visit our website for Special Online Discount Pricing...
www.hoodsailmakers.com

HOOD SAILMAKERS
466 Coloma Street, Sausalito, CA 94965



passionate about sailing

SAILING VACATIONS



Discover your passion with Sunsail

At Sunsail we share your passion for sailing, and have spent over 30 years working to ensure our charters are the best value available. No matter if you're a group on our largest yacht, or a couple on our smallest, you'll get the same Sunsail quality and service that make us the best value in sailing vacations today.

Trust your vacation to Sunsail –
The company that loves sailing as much as you do...

Call 800 734 8682
or visit www.sunsail.com



Caribbean • Mediterranean • South East Asia

LETTERS

↑↓ **RESPONSE TO THE WHINE ABOUT THE HA-HA**

Thanks for the fine publication. *Latitude 38* — and the Baja Ha-Ha — get a lot of people out cruising, and that's the whole point.

My wife and I dropped our high-paying jobs in the Bay Area in '03 for the full-time sailing life aboard our Peterson 46, the name of which we'd prefer to withhold because of what we're going to say. We were in our early 30s, and decided it was better to go while we were young than later. It was a fantastic decision that taught us more about ourselves and each other than anything else life has brought our way before or since. We didn't do the Ha-Ha but, while in Mexico, we did hang out with a lot of people who had participated in that event. They had nothing but praise for it.

That being said, we were just having dinner the other night with another young couple who actually made it all the way around the world, getting back to Ft. Lauderdale last spring. During our conversation, we agreed on a couple things that we really hated about cruising. The first was boats, the second was 'cruisers'. By cruisers (pronounced kroo-serrrs) we were talking about Mr. and Mrs. Master Mariner — MMMM, or 4M from now on — that you responded to in the November issue.

What a breed! How can you quickly and easily identify a 4M? There are seven primary characteristics: 1) They've always 'been there and done that' a few years ago; 2) They love to talk equipment and gear; 3) They are full of do's and don'ts; 4) They are legally drunk by 3 p.m. each day; 5) They are passed out down below by 6 p.m.; 6) They complain about the locals, other boats, the weather, and everything else; 7) They are one-sided conversationalists, so you better be ready to listen. 4Ms are stickier than 3M!

It's so ironic that some 4Ms should ridicule members of the Ha-Ha by saying they should really be in an RV park, because these are the very same people who, if not found in a marina or a mooring ball at Puerto Escondido, prefer the most protected anchorages and sit in the most protected corners for weeks at a time. And don't get too close, for they'll let you know that they own the place by staring blankly at you from the cockpit while you're setting your anchor. Thankfully you don't actually encounter 4Ms that often, especially in places that require more than a daysail or overnight to get to.

It was also our experience that the more sea miles folks had, the more humble they were about their knowledge. It was like the more they knew, the more they knew they didn't know. After all, if you get your butt kicked and get really scared a few times, you'll be much less prone to criticizing people with 'less' experience. Fortunately, 95% of the folks we encountered out there doing it were really cool people. They had adventurous spirits, were easy-going, enthusiastic and optimistic, generous to a fault, and emotionally open.

As we mentioned before, the other thing we four young, fit, able-bodied cruisers agreed that we hated about cruising was boats. We had all done well with our short careers, and had left with some really nice machinery that allowed us to have very comfortable boats . . . for about a month or so. Then things started needing attention. And fixing all that stuff — and it breaks whether you paid a lot or a little for it — gets old in a hurry. So unless you're going to bring along your own engineer, keep that cruising boat simple.

The bottom line is, yes, you should go now rather than later, and you should know how to fix your own boat and how to operate her safely. And yes, keep your boat as simple and easy to use as possible. The other point is that 4M is a rare species. At any real destination, you are going to find like-

From top to bottom, Svendsen's delivers quality craftsmanship.



3M



3M Superior Products

- Abrasives & Masking
- Sealants and Fillers
- Compounds
- Buffing Pads
- Finishing Materials

Svendsen's is a full-service boat yard, performing all aspects of marine repair using the finest **3M** materials. Boasting some of the most experienced craftsmen in the bay area, our experts will handle your boat bottom with care. From thorough sanding and preparation to fine detail painting and finishing. Treat your boat like it's one of the family, because we will.



SVENDSEN'S BOAT WORKS

Call today to schedule your haulout : **510.522.2886**
Or schedule your work online at **svendsens.com**

FREE

Polish and Wax with Bottom Job

Offer Expires
1/31/08

Giving Sailing has never been easier

For yourself or that someone special -
Learning to Sail is affordable, safe and fun!

Basic Keelboat Certification



only
\$695!

if classes taken before 3/31/2008

\$795 take classes any time in 2008

Retail value \$895

Offer expires -
12/23/2007

Club Nautique

Winner Prosser Award
For Excellence in Sailing Education

Alameda: 800 343-7245 Richmond: 866 606-7245 Sausalito: 800 559-2582



www.clubnautique.net

Call today for your free brochure with CD-rom

LETTERS

minded people with the same spirit as you. So go out there and join them, as soon as possible. If that means a Ha-Ha, all the better.

My wife and I (name withheld)
Boat Name Withheld
Portland, Oregon

M.W.A.I. — *Having just done another Ha-Ha, this time with 601 participants, we were reminded of how much fun it is to sail the coast of Baja with some folks who are relatively*



ELECTRONIC / RICHARD

new to cruising. They are jazzed instead of jaded, and their enthusiasm about making their first landfall, seeing their first whale, catching their first fish, and dropping the hook in their first remote anchorage, is infectious. And when they arrive in Cabo, they are so proud of what they've accomplished. We feel privileged to get to be part of it.

Angelika had so much fun on the Ha-Ha that she vowed go every year.

What kind of new cruisers are we talking about? Take Angelika Sullivan of Sacramento. She showed up at the Ha-Ha Crew List Party at the Encinal YC in early October, got a ride on Jim Steven's Cross

53 trimaran Blind Luck, and had a fabulous time. How fabulous? As the accompanying photo of her was being taken, she said, "I'm never going to miss another Ha-Ha for the rest of my life!" Only time will tell if that proves to be true, but we're pretty sure she enjoyed herself.

We also subscribe to your philosophy of simple boats. Although Profligate is a very large cat, she's also very simple, which means there is very little on her to break. We love that, because we're primarily interested in sailing our boat, not working on her. But how could you ever hate your boat? We've been indifferent about one or two of ours, but have been passionate about all the others.

↑↓ AND PUSH ALL THE LAWYERS OVERBOARD

I'm completely disgusted with the America's Cup. Alinghi's Ernesto Bertarelli comes to the St. Francis YC to defend his vision of the future of the Cup, and says he hopes that the club or someone in Northern California will see fit to put up the \$150 million U.S. it would take to be competitive. One hundred and fifty million!!! The only thing more ridiculous is all the squabbling between *BMW Oracle* and *Alinghi* over the nature of the next America's Cup — if there even will be one. At this point, who cares?

And what's with the stupid IACC boats they've been sailing? Sure they can point extremely high, but even Bertarelli admitted they were slow and boring. I like *Latitude's* idea of competing for the Cup in ORMA 60 trimarans, boats that would sail circles around the IACC leadmines. But I've got an even better idea — make the Cup a G Class multihull race across an ocean.

“I’ve always been happy with my North sails, but never happier than I am now.”

Tom Coates, owner of J/105 *Masquerade*, 2007 N.A. Champion

FAST

...the power to perform



FOR THE RECORD

J-105 RESULTS

- N.A. Championships '07... 1st*
- Rolex Big Boat Series '07... 1st
- Annapolis NOOD '07... 1st
- St. Petersburg NOOD '07... 1st
- Toronto NOOD '07... 1st
- Texas NOOD '07... 1st
- Acura Key West Race Week '07... 1st

▶ 3 of 4 past J-105 N.A. Championships were won by North Sails-equipped boats

*majority North inventory



1957 NORTH SAILS 2007

Faster by Design

Sausalito 415-339-3000

San Diego 619-224-2424

Long Beach 562-795-5488

Channel Islands 805-984-8100

Marina Del Rey 310-827-8888

www.northsails.com

Tom Coates & crew of St. Francis YC sailed *Masquerade* to 1st place in the J-105 '07 North American Championship, hosted by Annapolis YC. *Masquerade* carried North 3DL AP jib and a North AP crosscut mainsail. Tim Wilkes photo

When was the last time you gave your loved one (boat or spouse?) a windvane for Christmas?

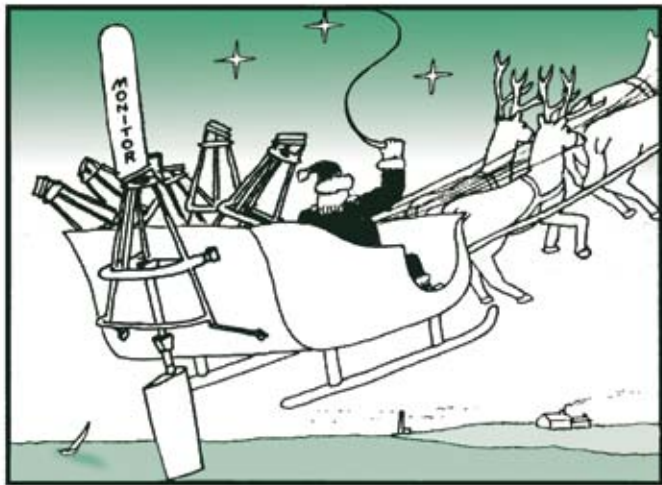

A \$600 deposit will lock in our **Christmas Special**. Mounting details for your 'sled' and delivery can wait till after New Year's. We will put a gift package together so you have something fun to put under the tree. This gift is guaranteed to put a smile on your mate's face.



- **ALL STAINLESS STEEL**
- **NO ELECTRICITY**
- **NO IMPOSSIBLE-TO-FIX ELECTRONICS**
- **QUIET**
- **CAN BE CONVERTED TO EMERGENCY RUDDER**



GO TO

www.selfsteer.com

LOTS OF INFO AND 5,000 INSTALLATION PHOTOS

FACTORY DIRECT

SCANMAR
INTERNATIONAL

432 South 1st St. • Pt. Richmond, CA 94804

Tel: 510 215-2010 • Fax: 510 215-5005

Toll Free: 888 946-3826

email: scanmar@selfsteer.com

LETTERS

I'd like to remind everyone that in July of this year, Frenchman Frank Cammas and his crew weren't in some courtroom arguing, but rather setting two remarkable new sailing speed records with his 106-ft G Class trimaran *Groupama*: 1) 794 nautical miles in 24 hours, an average — average! — of over 33



YVAN ZEDDA / GROUPAMA

'Groupama 3' covered 794 miles in 24 hours — about 500 more than an IACC boat could do.

knots; and 2) A new record on the 2,925-mile New York to Lizard, England, Transatlantic course, averaging 29.26 knots for over four days. Records like that not only

impress me, they make me hot! Hell, you could drop an IACC boat out of an airplane and I don't think it would hit 33 knots on its way to the ground.

So yeah, if I had my druthers, the America's Cup would be a Transatlantic Race from New York to England in G Class multihulls — and they'd push all the sailing lawyers and lawyer-like people overboard halfway across. Wait a minute — what about a San Francisco to Hawaii course? Can you imagine boats sailing from here to Hawaii in under three days? And with the half a billion dollars they saved, they could make the Ala Wai Yacht Harbor into something Hawaii could be proud of.

Jim Stenson, Jr.
Sacramento

Jim — Groupama's new records really impress us, too. In fact, they make us wish that Steve Fossett, the only American who ever gave a hoot about sailing speed records, would reappear from wherever he is, build a Playstation or Cheyenne II, and restore honor to American sailors. To be honest, we're tired of being shown up by the French.

↑↓ THE PEOPLE ON THE SAILBOAT SCREWED UP

With regard to the incident on Clear Lake in which the sailboat *Beats Workin' II* was hit at high speed by Deputy Russell Perdock's powerboat, I see that you are supporting the idea that the sailboat had her running lights on. However, the news video that night showed the instrument panel switches. It showed that the only one that was on was the one for the cabin lights.

It's also worth noting that the crew of the sailboat didn't shine a light on their sails, so it really was their fault they were hit by Perdock's boat.

Furthermore, because the sailboat's cabin lights had been on, they had no night vision, and therefore couldn't see the powerboat approaching. And when a powerboat comes straight at you, it's not that easy to hear.

From the perspective of Perdock, the sailboat would have looked like a house or something on shore with white lights on. The people on the sailboat just screwed up.

It's too bad, but having the right navigation lights on and having good night vision is important. I've seen lots of people also trying to use gadgets at night that ruin night vision and then everyone gets upset when the skipper needs COMPLETE

WE  BOATS

SEATTLE
BOAT SHOW 
INDOORS + AFLOAT

JAN 24 - FEB 2, 2008

QWEST FIELD EVENT CENTER
AND SOUTH LAKE UNION

WEST COAST'S LARGEST BOAT SHOW!

More than 1,000 Recreational Watercraft,
Hundreds of Seminars and the
Latest Innovations in Accessories.

SEATTLEBOATSHOW.COM

PRESENTED BY



OFFICIAL SPONSOR



PRODUCED BY



❖ Season's Greetings ❖



Celebrate the Holidays and the Whole Year at Fortman Marina

- Sheltered Alameda Location
- Competitive Rates
- Home of the Alameda Yacht Club

1535 Buena Vista Avenue
Alameda, California
(510) 522-9080



For directions and rates go to:
www.fortman.com

LETTERS

light control at night. Always use a red light ONLY for charts and for looking at lines, and compass lights. People don't know and it gets them killed.

Darrell 'Carey' Caraway
Lake County

Carey — If Deputy Perdock had been patrolling Highway 20 through Lake County some night and seen a car driving without headlights, he'd have pulled the car over, right? That's because the driver couldn't see where he was going in the dark — just the way Perdock couldn't see where he was going that dark night on Clear Lake when he drove his boat into the side of the sailboat at such high speed that it resulted in the death of Lynn Thornton.

We don't know whether the sailboat's running lights were on at the time she was hit by Perdock's boat, but we do know that a marina owner and a former law enforcement officer both testified that they were on — and that the Lake County District Attorney didn't want to take that testimony. Given the fact that the Lake County Sheriff's Department has a reputation for being a 'boy's club' and for all the officers to watch each others' backs, how hard would it have been for one of Perdock's buddies to flick that running light switch to the 'off' position before starting the video recording? We're not big on conspiracy theories, but this case stinks so bad that you can't help but be suspicious.

According to the testimony of a member of the sailboat's crew, Perdock came at them so fast — his speed was estimated at between 40 and 55 mph — that they were hit before they even knew a boat was coming at them. In other words, they never had a chance. The accident was no more their fault because they didn't shine a light on the sails than is an innocent person getting shot because they didn't duck to avoid a bullet they didn't know was coming their way.

You're correct about one thing: from Perdock's perspective the sailboat must have looked like a house on shore. That's precisely why, if you check the Coast Guard's rules for navigation, a boat operator is not supposed to head for background lights. On the other hand, can you find anything in the Rules of the Road that says a powerboat operator is absolved of the responsibility of mowing everyone down in his/her path just because he/she is confused by background lights?

It appears that Deputy Perdock will never face criminal charges for the death of Lynn Thornton — but only because the Lake County District Attorney, in what appears to us to be a clear case of cover-up, steadfastly refuses to charge him, preventing an impartial jury from getting the chance to ever render a verdict. The D.A.'s pathetic excuse? He claims that he can't prove beyond a reasonable doubt that Perdock was operating his boat at an unsafe speed — despite the fact that Perdock admitted he was travelling 40 to 45 mph at the time of the impact, and that others estimated his speed to be 55 mph. As such, this will just be like the O.J. case, where the public will have to look to the civil case against Russell Perdock and/or the insurance company negotiations to get a real verdict on his guilt or innocence. And you can take it from us, Perdock is going to be the big loser.

A few months ago, there was a young soldier back from Iraq, who, in a fit of whimsy, threw a big rock off a cliff somewhere in Wyoming. Unbeknownst to him, some people were rock climbing below. Tragically, the rock hit and killed one of the climbers. As soon as the soldier learned what happened, he was grief stricken, but nonetheless ran down below to confess his responsibility. Despite the horrible tragedy, and the foolish thing the soldier had done, you have to at least respect the soldier for taking responsibility for his actions. Indeed, the brother of



Yacht Sales & Service - San Diego



65' J 65 "Brand New Day"
Call For Pricing



42' Hinckley SW, 1987
\$329,000



2002 C&C 121 Xpress 'Anasazi'
\$215,000

FEATURED LISTINGS



34' J/109, 2004 ~ \$225,000



40' Delphia, 2007 ~ \$203,206

2006	65'	J/65, <i>Brand New Day</i>	Call for pricing
1990	46'	Wylie, <i>Stardust</i>	\$349,000
1983	46'	Swan Hull #1, <i>Equity</i>	\$280,000
1987	42'	Hinckley SW, <i>Alcyone</i>	\$329,000
2005	42'	Renzo PT Runner 4.0.....	Call for pricing
2006	42'	Renzo Express 4.0.....	Call for pricing
2006	42'	Renzo Coupe 4.5.....	Call for pricing
2006	42'	Renzo Coupe 4.0.....	Call for pricing
2007	40'	Delphia.....	Base price \$203,206
1998	40'	J/120, <i>Scamp</i>	\$220,000
1999	40'	J/120, <i>Blew Bayou</i>	\$195,000

2002	40'	C&C 121 Xpress, <i>Anasazi</i>	\$215,000
2006	37'	Delphia.....	Base price \$152,127
2004	34'	J/109, <i>Zephyr</i>	Sale pending \$225,000
1980	34'	Peterson, <i>Yellowbird</i>	\$34,500
2007	33'	Cross Current, <i>Electra</i>	Call for pricing
2005	33'	J/100, <i>Faster Horses</i>	Sale pending \$119,000
2007	33'	Delphia.....	Base price \$130,823
1984	29'	J/29, <i>Zulu</i>	\$25,000
2007	25'	Hunt Harrier.....	\$175,000
2004	26'	J/80, <i>Jim</i>	SOLD \$32,000
2001	26'	J/80, <i>Whiplash</i>	\$31,000

Sell your boat with us we are always looking for quality listings.



Yacht Sales & Service
- San Diego

2330 Shelter Island Dr. #106
San Diego, CA 92106
SD office: (619) 224-6200
SF office: (408) 218-2828
Jeff Brown John Bohne Barry Demak
www.jk3yachts.com



Dealers for
San Diego
and Hawaii

Clean Boat Bottoms Today... Cleaner Bays and Waters Tomorrow.



Help keep our bays and waters clean for the boaters of tomorrow.

Introducing Sea Hawk's
New Copper-Free
"GREEN" Antifouling:
Mission Bay



Available at your local boatyard or contact us:



Family Owned &
Operated since 1978

PREMIUM YACHT FINISHES

NEW NAUTICAL COATINGS, INC.

800.528.0997 U.S.A. Only • 727.523.8053 International
contactus@seahawkpaints.com • www.SeaHawkPaints.com

LETTERS

the dead climber immediately forgave him. Does anybody see any similarity between Perdock and that young soldier? We don't.

LOOK AT THAT WORK, AS THEY SAY

I have a little item to report on that's somewhat lighter



JEAN VAURY

Using his head — and the balcony of his waterfront apartment — Jean replaced his spinnaker halyard.

than the very sad and shocking oil spill story that has been dominating the local waterfront news. The spinnaker halyard of my faithful Santana 22 *Smooth* parted during a gust on leg one of the Vallejo 1-2. It left me with trying to figure out the easiest way to replace it — preferably without having to go up the mast. So what I did was get the boat to settle solidly in the mud at the dock behind The Cove Apartments in Tiburon. I then secured the top of the mast to the balcony, which has a very wide top plank. From there I was able to replace the halyard and even install a Windex — "Et voilà le travail." It was a fun project for a Sunday afternoon.

Jean Vaury
Smooth, Santana 22
Tiburon

LIVING ABOARD AND CHILD CUSTODY

Every mariner and marina resident has seen them, no matter if they are newborns, toddlers or teenagers. I'm speaking of kids who live aboard boats with their parents. And I don't think anybody would argue against the lifetime benefits of growing up on a boat within a boating community. After all, for how many of us has an early introduction to sailing started a lifelong passion? And how many of us wish that our relationship with sailing had started earlier?

But what happens when a child's lifetime home comes under fire because one parent chooses to make it an issue in a custody case? I'm left to ponder what a social worker is going to say about the liveaboard environment for a child. How will I argue that the liveaboard environment is both nurturing and safe? I would appreciate any legal or other advice from *Latitude* and fellow mariners.

And thanks for the 'child friendly' November issue cover.

Michael Wasilewski
Maluhia
South San Francisco

Michael — We're naturally inclined to be sympathetic to your case, but find it difficult to be helpful without you providing even the most basic information. For starters, what kind of boat do you live on and what marina do you keep her in? Even more important, what's the age and sex of your child? Does he/she know how to swim and/or sail? Are there other kids around? How far is it to the child's school? What kind of work do you



ULLMAN SAILS

The Sailmaker to Champions!

**THE FASTEST SAILORS CHOOSE
THE FASTEST SAILS ON THE PLANET**

**R/P 50 *Staghound*
Alec Oberschmidt
Carbon GPL Main
and
Carbon Fiberpath Lt#1 Genoa**

PHOTO: DAVE McBRIDE



PHOTO: BRUCE COOPER US



**Farr 46 *Wasabi*
Jorge Ripstein
Carbon GPL "Fat Head" Main
and Carbon GPL Lt#1 Genoa**

**J/105 *Masquerade*
Thomas Coates
Airx 700 and
Superkote 75
AP Spinnakers**

PHOTO: STACY McLEAN



CONTACT AN ULLMAN LOFT OR REP FOR SERVICE AND SALES

LOFTS:

Newport Beach
(714) 432-1860
2710 S. Crodody Way
Santa Ana, CA 92704
Dave Ullman
Bruce Cooper
Steve Beck
Erik Champain

San Diego
(619) 226-1133
2805 Canon
San Diego, CA 92106
Jim Clinton
Tom Niebergall
Chuck Skewes

Long Beach
(562) 598-9441
6400 Marina Drive #9
Long Beach, CA
90803
Bryan Dair
Sam Heck

**Marina del Rey /
King Harbor**
Mike George
(310) 645-0196
Sam Heck
(310) 418-9179

Ventura
(805) 644-9579
3639 E. Harbor Blvd.
#111
Ventura, CA 93001
Gary Swenson
Deke Klatt

Santa Barbara
Ken Kieding
(805) 965-4538
Gary Swenson
(805) 644-9579

Santa Cruz
Brent Ruhne
Rhune Racing
(831) 295-8290 mobile

One Design
Charlie Ogletree



Visit our website: www.ullmansails.com

Pre-Cruised Best Buys



'01 Hunter HC50/53 • \$498,000



Monterey Slip!

'06 Hunter 45CC • \$330,000



New Listing
3 Staterooms!

'07 Hunter 44DS • \$299,950



Like New!

'05 Hunter 41DS • \$219,950



Fast Cruiser

'83 C&C Landfall 43 • \$129,999



'04 Hunter 386 • \$169,995



'05 Hunter 38 • \$199,000



Warranty!

'05 Hunter 27 • \$59,995

**We're Selling Boats & We
Can Sell Yours! Call Today!**



Cruising Yachts, Inc.

1-888-78-YACHT • www.cruisingyachts.net

Alameda • Monterey

Sisterships may be shown. Subject to prior sale, change or withdrawal without notice.

LETTERS

do, and who takes care of the child when you're away or at work? Those are all legitimate questions.

We don't think living aboard a boat in a marina is inherently any better or worse than living in a more traditional home. Each could be excellent or terrible; it all depends on the details. Hopefully a social worker will think the same way, and that your liveaboard situation is conducive to the health, safety and welfare of your child. But above all, let's hope that neither you nor the mother are using the child as an artillery piece in a battle between the two of you.

SMALL KIDS, BIG BOAT RACING

If the three proud owners — Russell Houlston, Bill Woodruff, and Jeff Klausner — of the Catalina 30 *Huge*, had been told that within seven months of the purchase of their boat, their children, ages 6 to 10, would participate in sailboat racing against adults in a recognized beer can series, they would have disbelieved it on several different levels. That's because:

— The wives/mothers had given them the "over my dead body" speech.

— The kids knew it would be dangerous, and would have said, "Yeah, dad, what were you thinking?"

As such, none of the owners thought about it when they looked at an ad for a boat on the other side of the continent and said to themselves, "Let's get that one." But as it turned out, they bought the Catalina MK 3 *Huge*, had her trucked to the West Coast from Georgia, and immediately entered her in the Friday Night Series at the South Beach YC. South Beach has a one-design class for Catalina 30s because there are so many of them.

We battled it out with nine other Catalina 30s, coming in second in the second half of the season, and third for the entire season, having finally overcome a string of East Coast lightweight gear failures. By the end of the season we'd replaced most of the on-deck hardware.

When Bill Woodruff woke up on most Saturday mornings during the racing season, he'd be pestered for detailed reports on the previous night's race, the finish times, the boat names,



COURTESY HUGE

Despite having the typical short attention span of youngsters, these kids sailed to big boat victory.

and boat standings, by his six-year-old son David, who would also frisk him for trophies. Eventually, David talked his father into letting him come

on board during a race. Despite some serious racing drama and close-quarter duels, he enjoyed himself immensely.

But due to the competitive nature of the division, it was a less than optimal situation for the other partners to be distracted by watching out for a six-year-old while dueling it out with other large boats. So the partners decided to introduce all their offspring to racing in a separate series, where they could focus on safety first, winning second, and in which the kids could participate as real crew. The venue chosen was the Monday Night Madness Series at the Bay View Boat Club.

To keep it safe, several onboard rules were established: Adults would handle the starts or any maneuvers close to other boats. Adults would handle the mainsail. Adults would

Best wishes for the holidays...



We're thankful to count among our many blessings the wonderful people who touch our lives. Best wishes for the holiday season and for a great new year!

For up-to-date oil spill information, please check our web site.

**Chandlery &
Fuel Dock
Open 7 Days**

Mon – Fri
8 am to 5 pm

Sat & Sun
9 am to 5 pm



Lift capacity 35 tons

Sprayed Racing Bottoms

Full Painting Service

Fiberglass & Gelcoat Repairs

Rigging Repairs & Installation

Electrical Repairs & Installation

Engine Service & Repowering

Propeller Installation & Tuning

Wood Hull Repairs & Caulking

Teak & Non-Skid Deck Repairs



In Berkeley Marina • 510-843-8195 • www.berkeleymarine.com

LOCATION!
LOCATION!
LOCATION!

**ENJOY THOSE SUNSETS!
RENT YOUR VERY OWN SLIP –
60 SECONDS FROM THE BEST
SAILING ON THE WEST COAST!**

- EASY ACCESS FROM DOWNTOWN
- CONVENIENT DISCOUNTED PARKING
- 24-HOUR ON-SITE SECURITY
- FULL SERVICE FACILITIES

VISIT OUR NEW WEBSITE
FOR DETAILS
WWW.PIER39MARINA.COM



PIER 39
MARINA

NOW AVAILABLE
SLIPS FROM 36' TO 60',
90'x48' SLIP & 80' SIDE-TIE
(415) 705-5558

LETTERS

handle the buoy roundings. Adults would take over when winds were over 18-20 knots. The rest of the racing — including sheeting in the jib during tacks, grinding in the jib, and driving — would be handled by the kids.

The kids learned how to drive quickly, despite not being as tall or as strong as would be ideal. In a couple of incidents the adults only became aware that the helm was too heavy when the helmsperson was pitched across the cockpit! Fortunately, this was accompanied by much laughter and very little blood.

We adults expected to have to help grind in the jib, but the determined kids weren't interested in giving up their positions. They managed — sometimes eventually — to achieve good upwind sail shape on most of the upwind legs. Of course, the pace with which the sheet was brought in was almost tortuously slow for us adults to watch. But other things made up for it. For example, while the jib was still barely beyond luffing and we were almost halfway to the next mark, one young grinder asked, "When we win the trophy, who gets to take it home?"

In any event, the result was three first place finishes and a second — and an overall series victory! It should be noted that the Bay View's Monday Night racing isn't as competitive as the South Beach's on Friday nights. When the kids went into the Bay View Boat Club they were treated as celebrated champions by all. Sportsmanship flows even faster than the beer in that hallowed place.

Stunned by the success of the 'little people', the big owners plan to return to the Bay View Boat Club with their now-seasoned kids for the Spring Series.

Participants included: Foster Houlston (9), David Woodruff (6), Henry Klausner (9), Teddy Klausner (6), Jack Lugliani (6), Gretchen Mendel (10), Shae Kober (6), Cameron Burns (6), John Safipour (8), Harrold Pigman (7) and Sophie Pigman (10).

By the way, we've made a few notes for next time:

- 1) No Oreos — for the kids — before the racing is over.
- 2) No chips or chocolate until the kid is on the dock.
- 3) The kids will be trained to open the (beer) bottles and hand them to the adults.
- 4) Adults get one beer each before the race to steady their nerves.
- 5) Kids will not use the head. It's a long story, so don't ask.

Russell Houlston
Huge, Catalina 30
South Beach YC

↕ **BLIND LUCK HAD EIGHT BEAUTIFUL CREWMEN**

Some guys have all the luck. Jim Stevens, who has been totally blind since age 19, not only owns the Cross 53 trimaran *Blind Luck*, but had his 'luck' further confirmed during the Ha-Ha by putting together, with the help of skipper Michael Fanfa, a crew of eight beautiful women. Hmm, could this be another first for the Ha-Ha?

Stevens told me that he'd always wanted to do the Ha-Ha, and signed up because he also thought it would be a good way to prepare his boat for the Pacific Cup race from San Francisco to Hawaii. When his skipper volunteered to assemble a crew, and told Stevens that he'd like it to consist entirely of women, Stevens told him to "go for it!"

Three of the Ha-Ha crew met up with the San Leandro-based tri in San Francisco for the trip down to San Diego. But it wasn't until arriving at the fuel dock in San Diego on October 28 that all the women crew met each other for the first time. All but a token Canadian were from California. Excited at the prospect of an adventure the likes of which none of them had

KKMI  **Maritime**
Racing & Rigging

"I took on several projects myself which gave me the chance to work alongside the KKMI Team. Everyone was competent, friendly, helpful and showed real interest in my project."



Bottom Painting Packages
where the price we quote
is the price you pay!

"The quality of the hull and bottom painting exceeded my expectations."



KKMI  **Maritime**
Full Service Yard

"Your team of professionals treat people with respect"

"Hats off to everyone; I couldn't be more satisfied"



KKMI  **Maritime**
Electronics

"Your team of professionals treat people with respect"

"Hats off to everyone; I couldn't be more satisfied"



KKMI  **Maritime**
Engine Sales & Service

"Each time the end result exceeds our expectations."

"Thanks for the thorough 101 tutorial about my engine."

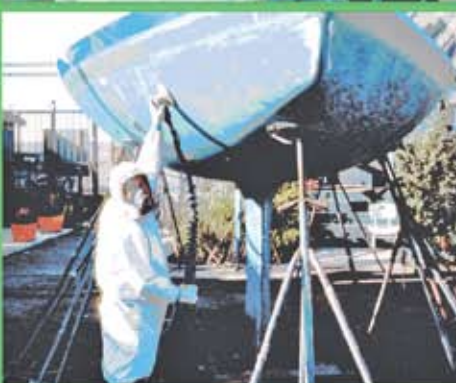

Ask us about discounted Bottom Painting Packages.

Keefe Kaplan Maritime, Inc
530 West Cutting Blvd.
Office Ph (510) 235-KKMI
kkmi.com * yard@kkmi.com



LETTERS

Harken Self-Tailing and Powered Winches

Why Upgrade?



Marten 49, Francolini / Azzura Marine Photo

WINCHES



SELF-TAILING WINCHES

Upgrading from a standard to a self-tailing winch frees your tailing hand and **allows a single person to trim or raise the sails.** Either manage light loads with one hand, or use both hands to deliver more power to a Speedgrip handle.

POWERED WINCHES

The **touch of a button** allows you to sit back while a powered Harken winch does all the work. Upgrading to powered winches lets you **perform high-load jobs effortlessly** and **sail larger boats shorthanded.** In marginal conditions a single electric winch can make the difference between sailing and motoring.

ELECTRIC WINCH CONVERSION

Harken winches made after 1999 can be converted to electric power (size 44 and up).



HARKEN
CELEBRATING 40 YEARS

1251 E. Wisconsin Ave., Pewaukee, WI 53072, Tel: 262-691-3320
Fax: 262-691-3008, Email: harken@harken.com, Web: www.harken.com

seen before, the combination of experienced sailors and novices got to know each other over a few drinks, while Stevens and Fanfa observed in amazement at the camaraderie that was building among this randomly selected group of women. How random? Half of them were recruited from the *Latitude 38* Crew List, the others came from various meetings in and around San Francisco.

Stevens is a quiet and thoughtful man, gentle and kind to the core. Despite his lack of sight, he lives aboard during the week in San Leandro with his guide dog Cayenne. For obvious



LATITUDE / ANDY

Owner Jim Stevens was just one of two men among a 10-person crew.

reasons, his boat has to be orderly. He's not only employed, he's an IT Director for Kaiser Permanente. On weekends, he returns home to his family in Davis.

Behind the person the world sees, Stevens is a man whose passion for life has not been dampened by his inability to see by conventional means. He has never allowed his lack of sight to stop him from doing the things he loves, and one of those passions is sailing. Stevens knows *Blind Luck* as well as any sighted man, and can sense the wind speed

and direction as well as any instrument. Listening to the wind in the sails, you'll hear him say things like, "Let's trim in the genny a bit and really make this boat fly."

As orderly as *Blind Luck* was before the start of the Ha-Ha, I leave it to your imagination the metamorphosis that took place once all the crew arrived. Stevens' orderly world was suddenly thrown into a bit of chaos, but he loved it!

From San Diego to Turtle Bay to Bahia Santa Maria to Cabo, the crew of *Blind Luck* truly had the adventure of a lifetime. Despite being 48 years old, and having both sailing and life experience, I confess that I cried like a baby when it came time to say goodbye to Jim. The theme song from the movie *To Sir With Love* kept running through my mind the day I left *Blind Luck*. Jim's kindness, generosity and, most of all, courage to overcome adversity and live his dreams — no matter what! — was heartwarming. I'm eternally grateful for the opportunity to have known and sailed with such an extraordinary man, and have been inspired by him to live my own dreams.

Lee 'the token Canadian' Wolff
Crew, *Blind Luck*
Baja Ha-Ha '07

Lee — When you asked if the *Blind Luck's* voyage in the Ha-Ha was "another first," you needed to be more specific. Was it the first time that a legally blind skipper sailed in the event? No, as you'll learn from the next letter. Was it the first time that a legally blind person — or for that matter, any skipper — had done the Ha-Ha with eight women crew? To the best of our knowledge, yes. In any event, we're glad that you and the others enjoyed yourselves.

ANOTHER YEAR IN THE BLIND CIRCUMNAVIGATION

Wow, what a year of cruising it's been for the two of us and our 'Blind Circumnavigation'. In some ways it feels as though we've been running to stand still because we haven't gotten

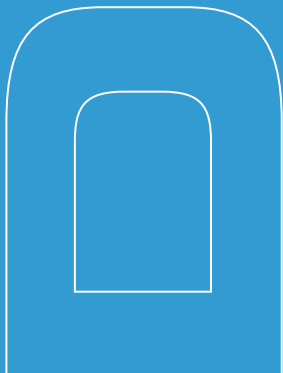
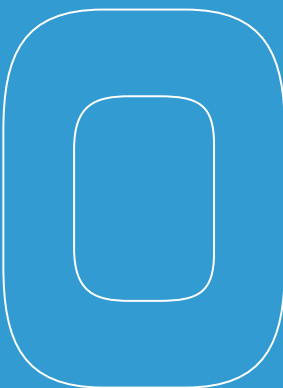
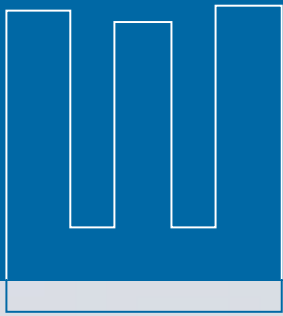

Photo courtesy of Sailing World

Four NOODs. Four Victories.

Doyle powered Beneteau 36.7's have won their class in the 2007 San Diego, Annapolis, Detroit, and Chicago NOODs. The secret? Doyle offshore one-design clients are finding that not only are their sails faster than the competition but that the Doyle Set Up and Tuning Guides help them go faster across a wide range of conditions. You can go faster in 2008, too—take the first step by contacting your local Doyle loft.

Doyle San Francisco

Bill Colombo & Rusty Canada
2035 Clement Avenue
Alameda, CA 94501
Tel: 510-523-9411
E-mail: sanfrancisco@doylesails.com

www.doylesails.com



1-800-94-DOYLE

BETTER ENGINEERED SAILS

Sailing Away?

Call Today
for Winter
Pricing

We build custom
sails to suit your
needs, your boat,
your plans.



Keep cruising with
HOGIN SAILS



- New racing or cruising sails
- Roller furling conversions
- Boom and canvas covers
- Repair and service

In the Alameda Marina at
1801-D Clement Ave., Alameda, CA 94501

510.523.4388

Mon-Fri 8:30am to 5pm
Saturday by appointment only

sales@hoginsails.com
service@hoginsails.com
www.hoginsails.com

LETTERS

very far. But even though we've put fewer miles under our keel than we planned, we've met so many wonderful people and have had a fantastic experience in Australia.

As those who have been following our website already know, the engine on our Pearson 390 *Starship* died a sudden death outside of Sydney just prior to our arrival in Australia. Once we cleared in and got settled, we had a rebuilt, rather than new, engine installed in an attempt to save money. Every-



ABNER KINGMAN

Sometimes the smartest decision is choosing not to go — as Scott and Pam did.

thing seemed fine as we sailed out between Sydney Heads, but various problems began to arise with the engine on our way to Pittwater. We kept thinking we got the engine problems licked, but the gremlins just kept at it. Once we arrived in Newcastle, we'd lost all faith in the engine. Fortunately, Bob, who was both our mechanic and friend, kindly agreed to take the engine back and give us a full refund.

At that point, we decided to invest in a new Volvo Penta diesel rather than a rebuilt engine. Our Volvo not only purrs like a kitten, but has a three-year warranty.

By the time we got our engine problems behind us, it was very late in the cruising season, and tropical cyclone season was looming. As such, we've decided to keep *Starship* in Australia for the duration of the cyclone season, which means until April of next year. To fill the time until then, we have set our focus on working in order to feed the ever-hungry cruising kitty. As such, Scott has returned to the States and is consulting in chilly Virginia, while Pam is beating the pavement looking for work in Newcastle. Scott will be returning to Australia for the holidays, so we hope to get in some coastal cruising in Australia's beautiful cruising grounds.

Our plans for the next cruising season are similar to what our plans had been for this one before the demise of our engine. We will depart Australia to the northeast, make a quick stop in Kumac, New Caledonia, and head off to Vanuatu and the Solomon Islands. We will then turn west, stopping in Papua New Guinea, Indonesia, Malaysia, and finally Thailand for the '08/'09 cyclone season.

As always, check out our website at www.blindsailing.com to share our adventures when we depart Australia to continue our Blind Circumnavigation.

Scott Duncan and Pam Habek
Starship, Pearson 390
San Francisco

Readers — Why would anyone sail around the world if they were legally blind? Scott responds by writing, "First and foremost, I would probably have undertaken this challenge if I were fully sighted. I grew up near the beach in Santa Monica and I have always loved the water. I was a swimmer in school, became a certified diver, and have always dreamed about sailing around the world. I'm also a person who believes deeply that we should all pursue our dreams. I would also like my

SEND YOUR BOAT TO COLLEGE!

Donate your boat to:

STANFORD SAILING

Stanford University's Sailing Program exists to support the varsity team through outreach to all types of community members. This is achieved through physical education classes, special seminars, summer camps, recreational sailing, and racing.

Your boat will provide on-the-water opportunities!

TEACH LIFE LESSONS TO AT-RISK YOUTH

We are proud that the Stanford Sailing Summer Camp is recognized by the California Department of Boating and Waterways. From grade-schoolers to Special Olympians, more than 450 kids per year are exposed to sailing and boating safety through Stanford's programs. Boat donations make it possible to get these kids on the water.

TEACH SAILING TO MEMBERS OF THE COMMUNITY

Our Physical Education classes are filled to capacity: undergrads, grad students, faculty, staff and the community need keelboats to learn to sail. Many have graduated from our program and are currently boat owners sailing in the SF Bay Area and around the world!

TEACH RACING SKILLS TO THE STANFORD SAILING TEAM

Our nationally-ranked team needs big boats to hone their racing skills outside the normal FJs and 420s.

Your donation is tax deductible!

Stanford Sailing makes
donating your boat SEAMLESS!

Contact: Jay Kehoe, Head Coach, Sailing
(650) 723-2811 • jkehoe@stanford.edu
Stanford Athletics - Arrillaga Family Sports Center
641 East Campus Dr., Stanford, CA 94305

LETTERS

challenge to encourage anyone living with vision loss. The world has a way of placing limitations on anyone who does not fit the 'normal' mold. Since my birth, doctors told my parents that I would never be 'normal'. "Don't expect much from him, and you may want to consider sending him to a residential school or institution," they were told. Unfortunately, this has been a constant theme throughout my life. To sail around the world will be one more accomplishment in a long line of accomplishments made by visually impaired people, one that will send a signal to everyone that the capabilities bar has been raised another notch higher."

Pamela's response is, "Sailing has always been in my blood. I grew up in Maine on Mount Desert Island, and my father worked as a sailboat rigger for Hinckley Yachts. Growing up in rural New England, I never had the chance to interact with other blind children, and sighted people always told me what I could and could not accomplish. It took me until the age of 23, when I moved to San Francisco, to challenge my family's perceptions of my capabilities. I met many blind people in San Francisco who served as role models, so I pushed my own boundaries to achieve independence. I am participating in this voyage to reach out to blind children everywhere who feel all alone and live by the limitations set by others."

By the way, if you're a sailor looking for a worthy cause to contribute to over the holidays, check out Scott and Pamela's dream at www.blindsailing.com/Sponsors.htm.

NO POSITIVE PORTRAYALS OF THE COASTIES?

I'm the wife of a U.S. Coast Guard helicopter pilot, and am writing to you in protest of the preponderance of negative portrayals of the Coast Guard's interactions with members of the local sailing community. Those negative portrayals also bother me as a recreational sailor and pilot of a small aircraft.

My husband — and all Coast Guard personnel — have and will continue to search for members of the Bay Area sailing community who find themselves in distress, and they will even do so in conditions that would be considered unsafe and unflyable by civilian pilots. In many bad weather conditions, it's only members of the U.S. Coast Guard who will risk their lives to save you.

And by the way, if you're a sailor in distress and a Coast Guard helicopter has come to rescue you, do not, as a sailor recently did off Sausalito, train your high-powered light at the helicopter. You'll temporarily blind them, making it impossible for them to help.

Despite the fact that it seems no positive portrayals of the Coast Guard will appear in *Latitude*, mariners shouldn't be afraid, as nobody in the Coast Guard will hold it against you. If you find yourself in danger, please call for help. But please, try to call before it has reached the point where the lives of the rescuers will be put in danger as well. They expect no thanks, for they are just doing their job.

Evelyn Greene
Hawaii

Evelyn — What do you mean there have been no positive portrayals of the Coast Guard in *Latitude*? Countless times over the years we've editorialized that when mariners need help, there is nobody who will try harder — including by putting their lives on the line — than members of the U.S. Coast Guard. We've reported many stories that detailed Coastie heroism, and pointed out how it was often made necessary by the incompetence or inexperience of recreational mariners. We have nothing but the highest respect — and repeatedly have stated it



MARINERS
GENERAL INSURANCE GROUP

Now with six offices offering you local insurance service and global insurance coverage.

SEATTLE
Joe Cable
(800) 823-2798
(206) 281-8144
Fax (206) 281-8036

NO. CALIFORNIA
(800) 853-6504
(650) 373-0595
Fax (650) 548-1585
email: boomeins@aol.com
Lic. # OA99058

L.A./ORANGE COUNTY
Craig Chamberlain
(800) 992-4443 • (949) 642-5174
Fax (949) 642-0252
Lic. # OD36887

SAN DIEGO
Henry Medina
(800) 639-0002
Fax (619) 226-6410
Lic. # OA96346

BRADENTON, FLORIDA
Jerry Norman
(800) 914-9928
Lic. # EO51940

New! PUERTO VALLARTA
(949) 642-5174

We insure racers and cruisers all over the world with prompt, reliable service.
www.marinersinsurance.com

- **Sail & Power**
- **Fishing Boats**
- **Charter Boats**
- **Liveaboards**
- **Marine Businesses**
- **Tugboats**
- **Cargo**
- **Offshore Cruising**

Official Sponsor
2007 BAJA HA-HA

ATTENTION CRUISERS! MEXICAN LIABILITY INSURANCE ONLINE

It's A Mariner's Fact:
When a halo rings the moon or sun,
rain is approaching on the run.



HAULOUTS 20' to 80'

HAULOUTS ON SHORT NOTICE...CALL US!



NORTHERN LIGHTS

GENERATOR SALES & SERVICE

WUGGER

MARINE ENGINES SALES & SERVICE

YOUR NEW FULL SERVICE VOLVO PENTA DEALER IN THE BAY AREA

PETTIT marine paint

FULL SERVICE BOATYARD:

- ✓ COMPLETE PROPELLER SHOP
- ✓ ELECTRICAL REPAIR & INSTALLATION
- ✓ FIBERGLASS BLISTER WORK
- ✓ LPU PAINTING
- ✓ COMPLETE MACHINE SHOP
- ✓ SHIPWRIGHTS - CAULKING & CARPENTRY
- ✓ GAS & DIESEL ENGINE SERVICE
- ✓ MAST & RIGGING REPAIR
- ✓ SANDBLASTING & EPOXY COATINGS
- ✓ FIBERGLASS & GELCOAT REPAIRS
- ✓ USCG CERT. WELDERS - STEEL/ALUMINUM
- ✓ INSURANCE WORK WELCOME

88-TON TRAVELIFT HANDLES UP TO 23' BEAM!

Online reservations now available at www.baymarineboatworks.com



1-800-900-6646
(510) 237-0140 • Fax: (510) 237-2253

STEVE TAFT, MANAGER

310 WEST CUTTING BLVD. • POINT RICHMOND, CA 94804



**FINANCE
YOUR DREAM
THROUGH OUR
WELL-CHARTED
WATERS**



Seacoast Marine Finance offers more than the best rates, extraordinary expertise and a streamlined loan process. You can rest assured that your application is being handled by professionals who value your privacy and confidentiality. Don't drift into uncharted waters for assistance. Navigate to Seacoast Marine Finance, the premier haven for yacht buyers, dealers and brokers.

Call for your complimentary quote today.

Florida toll-free | 877-916-2326

California toll-free | 800-233-6542

Seattle | 206-784-7773



www.seacoastmarinefinance.net



A division of Seacoast National Bank

LETTERS

in writing — for members of the Coast Guard Search & Rescue, and are hardly unique among the boating community.

Where the Coast Guard has come in for lots of criticism by recreational mariners is in regard to safety inspections and similar issues. We go to pains to point out that, in these instances, the Coasties are merely following orders from above, and that it's the higher-ups and members of the Executive branch of the government who need to be taken to task.

↑↓**MY BOARDING WAS HANDLED PROFESSIONALLY**

I've been sailing and racing 20 to 30 days a year for over 30 years, the first 10 in Chicago, the last 20 on San Francisco Bay. In all that time I'd never been boarded by the Coast Guard. I'd heard many horror stories from others about such boardings, so I'd always dreaded having to endure one. Well, I finally got boarded about a month ago while I was motoring singlehanded from Richmond through Raccoon Strait. And I must say that my trepidations were totally dispelled.

The boarding launch had six Coasties on it, of which three actually came aboard my boat. All were extremely courteous at all times. The lead officer came below with me and performed the primary steps in the safety inspection. He was at every turn fair in his application of the requirements, if not sometimes even generous. In the end, I didn't meet all the requirements, but he explained to me exactly what the process would be for enforcement of future compliance. When the inspection was complete, one of the crew printed out a detailed record of the event for me from a handheld computer/printer.

All in all, it had been a very constructive event, handled professionally, and I actually felt that the future safety of my boat, passengers, and crew would be enhanced by it.

I don't know if the contrast between my expectations and the reality was due to real improvements in Coast Guard procedures, or if the actions and directions of the new commander played a role, but in any case, the whole process could not have been done in a better manner.

Bartz Schneider
Expeditious, Express 37
San Francisco

Bartz — While the Coast Guard is not perfect with regard to safety inspections and issuing citations — something Capt. W.J. Uberti admitted in a letter to Latitude last month — we've never had what we consider to be a bad boarding either. But then we've always gone out of our way to be as cooperative as possible. We think some people would be surprised by the results of being nice to law enforcement. A few years ago there was a period in which we were stopped by law enforcement five times in a row — for things like no proof of insurance, missing registration, doing 59 mph in a 45 mph zone on Tiburon Blvd, not wearing a seat belt, and something else — without being issued a citation. Our success drove Doña de Mallorca and our kids crazy. Our 'secret' was always being cooperative, and in the cases where we were guilty, fessing up to it right away. When we were caught driving 15 mph over the speed limit on Tiburon Blvd, the officer was so shocked at our admitting guilt that he simply said, "OK, just don't do it again," and walked off.

↑↓**WHEN DID EL SALVADOR INVADE GUATEMALA?**

I don't know if you were testing your readers' geographic knowledge in last month's *Cruise Notes*, but the last time I was anchored off the navy base in Puerto Quetzal, it was in Guatemala, not, as you reported, El Salvador. And I don't think El Salvador has invaded Guatemala and conquered it



ALAMEDA MARINA

1815 Clement Ave., Alameda ~ (510) 521-1133
www.alamedamarina.net



A MARINA TO SUIT ALL YOUR NEEDS

- 530 Wet Berths 22-40 ft
- End Ties 40-70 ft
- Dry Storage – Trailer Boats
- RV & Camper Storage
- **Easy Access by Car or Boat**



Our tenants include some of the most respected names in the sailing industry, representing a full spectrum of services. Visit us today.

<p>Doyle Sailmakers 2035 Clement, Bldg. 32C (510) 523-9411 <i>Better Engineered Sails</i></p>	<p>L.T.D. Marine Electrical 2035-B Clement, Bldg. 32B (510) 523-2521 www.ltdmarine.com</p>
<p>Eskelund Marine Volvo Service 1913 Clement, Bldg. 13 at Pier 2 (510) 523-7670 <i>Volvo Penta specialist since 1980</i></p>	<p>Reliable Marine Electronics 1925 Lafayette (510) 864-7141 www.reliablemarine.com</p>
<p>Hogin Sails 1801-D Clement, Bldg. 28A (510) 523-4388 www.hoginsails.com</p>	<p>Sal's Inflatable Services, Inc. 1914 Stanford (510) 522-1824 <i>Your Survival is Our Business</i></p>
<p>The Japan Woodworker 1731 Clement (510) 521-1810 www.japanwoodworker.com</p>	<p>Svendsen's Boat Works/Chandlery/Metal Works 1851 Clement (510) 522-2886 www.svendsens.com</p>
<p>HF Radio On Board 1813 Clement, Bldg. 24 (510) 814-8888 www.hfradio.com</p>	<p>Waypoint 1813 Clement, Bldg. 24 (510) 769-1547 www.waypoints.com</p>

MUSTO[®]

PERFORMANCE

Performance Foul Weather Gear
In Stock at
Pineapple Sails

Free Gift
with Musto orders of \$295 or more.
expires 12/22/07

select either...



**Musto
Knee Pads**



**Musto
Toiletry Kit**



**Musto
Neck Scarf**



visit our online Musto catalog at
www.pineapplesails.com/musto



PINEAPPLE SAILS

Phone (510) 522-2200

Fax (510) 522-7700

www.pineapplesails.com

2526 Blanding Ave., Alameda, CA 94501

LETTERS

in the meantime. For more on Puerto Quetzal, see page 29 of Capt. Pat Rains excellent new guidebook, *Cruising Ports, the Central American Route*.

Sven Querner
Reliance, Brewer 50
Sausalito

Sven — We apologize for the error. Our minds tend to disengage near the end of an issue.

↑↓THE JURY IS MOST DEFINITELY IN

In the November *Latitude*, Larry Brown claims that "the jury is still out" on global warming. No, Larry, the jury has actually decided. Maybe you just don't want to inform yourself of the facts of the case, and therefore simply don't accept the jury's verdict.

In criminal law, a preponderance of even circumstantial evidence is enough for a conviction. So let's consider the circumstantial evidence:

Polar Ice Caps — According to the website www.nrdc.org/globalwarming, the average temperatures in the Arctic region are rising twice as fast as they are elsewhere in the world. The Arctic ice is getting thinner, melting and rupturing. For example, the largest single block of ice in the Arctic, the Ward Hunt Ice Shelf, had been around for 3,000 years before it started cracking in 2000. Within two years it had split all the way through and is now breaking into pieces. And the polar ice cap as a whole is shrinking. Images from NASA satellites show that the area of permanent ice cover is contracting at a rate of 9% each decade. If this trend continues, summers in the Arctic could become ice-free by the end of the century. A similar process is underway in the Antarctic. These developments are threatening animal species ranging from polar bears in the Arctic to penguins in the Antarctic. They also directly threaten Inuit people in the North, especially those living on some of the islands around Alaska.

Tropical Glaciers — According to Raymond Pierrehumbert, a climate dynamicist at the University of Chicago, "Throughout the tropics, glaciers are in retreat. Well-documented examples include Quelccaya, Huascarán, Zongo and Chacaltaya in South America, and the Lewis, Rwenzori and Kilimanjaro (more properly, Kibo) glaciers in the East." The steady decrease in the size of these glaciers is shown to be unprecedented in the last 1,500 or more years.

Sea Levels — According to Joseph Romm of the Center for Energy and Climatic Solutions, "The planet is warming — especially the oceans. Since 1955 the oceans have absorbed roughly twenty times more heat than the atmosphere. Even at a depth of 600 feet, the North Atlantic has warmed .2°C [about 32°F] thanks to human emissions." According to the IPCC report, global average sea level rose at an average rate of 1.8 (1.3 to 2.3) mm per year from 1961 to 2003. The rate was faster from 1993 to 2003, about 3.1 (2.4 to 3.8) mm per year. This is caused both by the fact that water expands as it gets warmer by and the melting of Arctic ice.

According to one researcher, 10% of the world's population — 634 million people — live on low-lying (meaning under 30-ft elevation) coastal areas. Two thirds of the world's cities with five million or more people are at least partially in such regions, and in most parts of the world, countries' populations are increasingly shifting to such cities. In addition, a rise in sea level will not only directly affect coastal areas, such rises could also flood further inland.

Rising sea levels are already having an affect on some parts of the world's human population. According to Ross Gelb-

NELSON *Yachts*

SELL WITH US!

www.nelsonyachts.net
(510) 337-2870

Chad Freitas Justin Scott
Ruth Scott



**HUDSON
FORCE 50,
1974**

Spacious, multi-level,
inside steering,
large open decks.

**Just
\$189,000**



**DEFIANCE
41' SHOCK,
1984**

Ready to race
singlehanded.

\$68,000



**47' CHEOY LEE
OFFSHORE,
1974**

Just back from Baja
adventures and ready
to go again.

\$95,000



**FARR 40,
1984**

Clean, well built
custom racer.

\$59,000



**34' PETERSON,
1980**

New bottom,
Andrews designed
keel, tall rig.

\$39,000



**SILVERTON 34
1985**

Ready for fishing.
Great liveaboard.

\$56,000



**34' CHINOOK,
1967**

Gracious Lady

\$18,000

SAIL

50' Hudson Force, '81.....	189,000
41' CT Formosa Yankee Clipper, '74..	47,000
34' Chinook, '67.....	18,000
34' Peterson cruiser, '80.....	39,000
32' Columbia 5.5 Sabre, '67.....	7,000
30' Carter, '76.....	19,950
29' Cal 2-29, '72.....	13,900
28' Albin sloop, '82.....	14,900
28' Wylie Hawkfarm, '78.....	Make Offer
27' Catalina, '79.....	7,500
27' Nor'Sea, '79.....	39,000

POWER

35' U.S. Military Amphibious, '63..	90,000
32' Uniflite.....	24,400

NEW HUNTERS

21.5' Hunter 216, demo '04.....	13,499
17' Hunter 170, new '06.....	7,599
14.5' Hunter 146, new '06.....	4,999
14' Hunter 140, new '06.....	4,499
10' Hunter Xcite, new '05.....	2,599

LETTERS

Don't Let This Happen To You!



Marine AIS Receivers

Give your navigation software or chartplotter
the power to see shipping traffic.

Prices start
from only
\$189!



**Why Leave Your –
And Your Family And Crew's –
Safety to Chance?**

Commercial ships now use AIS transponders.
Map nearby ships with supported
navigation software and chartplotters
connected to one of our low cost AIS Receivers.

For more information visit:

www.MiltechMarine.com

Or call us at:

**Milltech Marine
425-818-5246**

span, some 40,000 inhabitants of the Duke of York Islands near Papua, New Guinea, began evacuating in the year 2000. This was due to global warming threatening the inhabitants of these low-lying — 12 feet above sea level — islands. Some 10,000 people in the island nation of Tuvalu are in the process of resettlement for the same reason.

Gelbspan writes: "According to scientific estimates, a rise of one meter — which has been predicted by the IPCC — would submerge 17.5% of Bangladesh, 6% of the Netherlands, and 80% of Majuro Atoll in the Marshall Islands." In Alaska, some villages are considering moving their entire populations inland because the higher water levels are destroying their homes.

Sea Water pH Balance — Some scientists had previously thought that all or almost all CO₂ produced by human activity would be absorbed by the world's oceans. This has proven to be incorrect. However, the oceans have absorbed massive amounts of CO₂, but not without a problem developing. As the oceans absorb more carbon, the pH balance changes. This is the balance that makes water either alkaline or acid. The lower pH balance in the oceans has meant increased acidity due to the formation of carbonic acid (H₂CO₃). This acid tends to dissolve shells of microscopic shellfish, whose shells are made of calcium carbonate (CaCO₃), as well as bleach coral. These microscopic sea animals are some of the basic building blocks for the oceans' food chains. This, along with the warming of the oceans, is causing the coral reefs to bleach and die.

Hurricanes and Typhoons — Hurricanes and typhoons receive their strength by the difference in temperature between the air and the surface sea water. As the temperature of this sea water increases, one would expect these storms to increase in strength. And this is what's happening. As the IPCC reports: "Specifically, the number of Category 4 and 5 hurricanes increased by about 75% since 1970. The largest increases were in the North Pacific, Indian and Southwest Pacific Oceans. However, numbers of hurricanes in the North Atlantic have also been above normal in nine of the last 11 years, culminating in the record-breaking 2005 season."

Drought — Residents of the Southeast United States are presently caught up in a record-breaking drought. Boaters are complaining that they can't take their boats out on Lake Lanier in Georgia, and homeowners are complaining that they can't water their lawns or wash their cars. But these are minor inconveniences compared to what people are going through in other parts of the world. Istanbul is described as "a dry, desolate, dusty city without even a hint of green anywhere, and precipitation is way down elsewhere in Turkey." While precipitation rates have varied throughout history in the region, there has not been a multi-year trend like this. The same is happening throughout the Mediterranean, which is related to the disastrous fires that swept Greece in the summer of '07. The IPCC reports that, "Drying has been observed in the Sahel, the Mediterranean, southern Africa and parts of southern Asia." There is also the record-breaking multi-year drought in Australia. Due to the warmer weather, rain patterns have shifted south, so the rain has missed Australia.

Forest Fires — On October 21, CBS's *60 Minutes* did a portion of their show on the increased forest fires in the western United States. They interviewed a fire chief in charge of teams that fight such fires. According to him, ten years ago a 100,000-acre forest fire was considered huge. Today, he said, a 200,000-acre fire is "just another day at the office." Seven out of 10 of the busiest fire seasons since the '60s, when records started being kept, are from 1999 to the present, with 2006 being the worst year in U.S. history for forest fires.

Happy Holidays



from

ANDERSON'S BOAT YARD

*The #1 Boatyard on the Bay Wants to Wish
All of Our Customers a Safe and Happy Holiday Season.*

Call Now to Reserve Space For:

- Sprayed Racing Bottoms
- Complete Rigging & Wood Shops
- Electrical Installation & Repairs
- Custom Topside Paint Jobs
- Custom Metal Fabrication
- Engine Service and Repower

400 HARBOR DRIVE • SAUSALITO, CA 94965

(415) 332-5432 • (800) 310-5432

Fax: (415) 332-8136

andersonsboat@pacbell.net • www.andersonsboatyard.net

 **Interlux.**
yachtpaint.com



YOUR BOAT DESERVES IT!

Clean-Up SPECIALS*

Bunker fuel, airborne pollutants, winter mold and mildew can degrade your boat. Call Seashine for Winter Protection and a fresher spring!

Ask your Harbormaster?! Fully Insured & Marina Approved

"Seashine does an incredible job on our new Hunters, Jeanneaus and brokerage sailboats – they have impeccable service and reliable quality."
– Don Durant, Cruising Yachts

***Call now for a
Free Estimate**

510 428-2522 or 415 457-6300
www.seashine.net

LETTERS

It's true that, to an extent, the Forest Service's success in fighting fires has allowed an increase in undergrowth that helps fuel these fires. However, this is not the total reason. According to the Forest Service, global warming has meant that spring comes earlier in the year and summer ends later. This has meant that the fire season has been extended by 78 days. Coupled with persistent low precipitation, this means that the forests are drier for longer than ever. They are also more vulnerable to attacks of such pests as the pine beetle, which leave even more dead and dry trees. It should be noted that large scale, and extremely hot forest fires do immensely more damage, including destroying the soil, thus preventing these forests from growing back.

Incidentally, a huge mistake some people make is to say that if it's not possible to accurately predict the weather in the next week, then we can't for the coming years either. This is like saying that if we can't predict whether a coin will land on heads or tails the next time we flip it, then we can't make any prediction for the next 100 times. In fact, the general pattern is far easier to predict than any single event.

I find it incredible that sailors, of all people, would close their eyes to the facts surrounding global warming. For one thing, our 'footprint' is far smaller than those of many others. In addition, far more than most, we base our sport and get our pleasure from the wonders of nature. I know this letter is pretty long, but people had better wake up and listen to the jury! And I accept that sometimes the jury makes mistakes. I wish they had this time, but they sure have the preponderance of evidence behind their verdict. I know that some people feel that the conclusions regarding human-caused global warming don't fit with their general social attitudes. If they want to blind themselves, that's their right, but facts are stubborn things; they just won't go away.

John Reimann
Y-Knot, Catalina 36
Oakland

John — We're very sympathetic to your point of view, but just because you and others say that the jury is no longer out on global warming doesn't make it true. There are some — not a lot — of respected scientists who still disagree with some or all of the conventional thought. So to follow your analogy, if you were the D.A. and you were trying to get a conviction on global warming, there are several reasons that we wouldn't be so sanguine about your being successful. First, your medical examiners — i.e. politically driven scientists — have been wrong a few too many times before for at least one member of a jury not to have 'reasonable doubt'. Second, arguments such as the one comparing the long term certainty of the results of flipping a coin, in which there are only two possible outcomes, versus long-term predictions of what the climate will be like 50 years from now, in which there are an infinite number of outcomes, seem silly. Finally, the fact that scientists have such radically different forecasts for global warming only underscores what would seem to be their real lack of knowledge of the situation.

But as we wrote in the November issue, despite our inherent skepticism of just about everything, we're willing to go along with the argument that says that global warming is real and that it's primarily being caused by additional CO₂ created by man. And we're also willing to modify our behavior in a number of ways that many scientists believe might help lessen or prevent the problem. As we also reported last month, it's not hard to take this position because the behavior it calls for is both in our personal financial best interest and the country's

SEAWIND



FIVE SOLD IN ANNAPOLIS!*

In Northern California



YACHT SALES INC.

314 Tideway Dr., Alameda, CA 94501
www.helmsyacht.com
(510) 865-2511

**In Southern California
West Coast Multihulls**

P.O. Box 6338, San Diego, CA 92166
www.westcoastmultihulls.com
kurt@seawindcats.com
(619) 571-3513



SEAWIND 1160

The new Seawind 1160 is turning heads everywhere. This new 38-ft catamaran has just been launched and is proving to be an immediate success. The 1160 combines some of the best features of the Seawind 1000 and 1200 sailing cats. The winner of 2007 *Cruising World* Boat of the Year, the 1160 features an innovative interior layout for easier living arrangements and stunning sailing performance.



This rare West Coast find needs a new owner that's ready to cruise. Low engine hours and lots of great stuff make this a hot deal! Won't last long so call for more information today.

Call Kurt at (619) 571-3513 or email: kurt@seawindcats.com

* One of the best boat shows in Seawind's 25-year history saw FIVE boats sold at the Annapolis Boat Show! The new 1000 XL and 1160 are proving exceedingly popular with bright, open interiors and outstanding performance. Production is busy so be sure to schedule your build now.



CORSAIR 28, 2002
Like new boat.
Very well equipped.
\$79,000



CORSAIR 24 MKII, 2001
Lightly used, very clean.
\$39,900.



41' DEHLER DECK SALOON
Performance cruiser. German engineering built to an exceptionally high standard. This Dehler is in new condition, electric winches, fly-by-wire inside controls. Full weather and sun enclosures. A rare find and a great buy. \$230,000.



HC-50-4
The next step in the evolution of sailing design and technology brings you the most advanced long distance express cruiser. Born of singlehanded around-the-world experiences, the HC-50 is built to provide a fast, stable, and comfortable passage.



THE NEW CORSAIR 750
Arriving this month - call for demo.
Corsair 24s from \$31,000 • F-27s from \$46,500
Corsair 28s from \$72,000



CORSAIR 36
Fast on the water and on the road!
\$206,000.

BROKERAGE

Contact Gary Helms at
(510) 865-2511

We Still Offer More!



Making boating easier – and more fun! is what a marina should be all about.

That's why Oyster Cove Marina rates number one with many Bay Area boaters. It's an exclusive yet reasonable facility of 219 berths, accommodating pleasurecraft in slips up to 60-ft long.

Oyster Cove is the private Peninsula marina closest to Blue Water boating.

Want to cruise to Sausalito, lunch at Tiburon, or sail to Angel Island? How about a day's fishing outside the Gate, or a weekend at the Delta? No other private Peninsula marina is better situated or offers nicer, fresher surroundings.

- Berths 30 feet to 60 feet
- Double Finger Concrete Slips
- Telephone Available
- Five Minutes from SFO
- Heated Dressing Rooms & Showers
- Laundry Room
- Nightly Security Patrol
- Complimentary Ice
- Cable TV/High Speed Internet
- Recently Dredged
- End Ties Available at \$5.75/Ft!



OYSTER COVE MARINA

385 OYSTER POINT BOULEVARD #8A
SOUTH SAN FRANCISCO

(650) 952-5540

LETTERS

security interests.

But to paraphrase Mark Twain, everybody talks about climate change, but not many people are doing anything — or at least enough — about it. We think it's an absolute no-brainer that private enterprise and government should work toward developing solar, wind, and all other forms of alternative energy. And naturally, we should be using traditional energy — such as oil — as efficiently as possible. What's with people buying cars that only get 25 mpg when 50 mpg cars are available? Unfortunately, even a combination of all these isn't going to be anywhere near enough to meet the upcoming clean energy needs of the world, not with hundreds of millions of people coming out of poverty and dying to emulate the highly consumptive lifestyles that even middle-class Americans have enjoyed for all these decades. It seems pretty certain there are going to be some big changes ahead, it's just not clear what kind of changes they are going to be.

↑↓ THE SEA OF CORTEZ IS STILL FABULOUS

I did the 'Lucky Number 13 Ha-Ha' in '06 aboard my Cal 34 *Gypsy Soul*, and have been keeping her at Marina Costa Baja in La Paz ever since. I get down once every couple of months to do



JAY SOUSA

There are few places in the world with sunrises and sunsets as spectacular as the Sea of Cortez.

some 'commuter cruising'. I just returned from another great week, in which we enjoyed both La Paz and a couple of nights at nearby Islas Espiritu Santo and Partida. What an

awesome time we had! The water and air temperatures were still 80 degrees. The accompanying photo was taken on November 7 at the El Candelero anchorage at Espiritu Santo at sunset, with *Gypsy Soul* resting at anchor.

Jay Sousa
Gypsy Soul, Cal 34
Merced

Jay — You don't have to convince us of the pleasures — visual and otherwise — of La Paz, the nearby islands, and the Sea of Cortez. And as you probably know by now, March through June, and October through early December, are the prime times. For folks who haven't been there before, it's not until late spring that the water has finally gotten warm enough for swimming again, while in fall the air temperatures are bearable and the water is still warm.

In fact, we remember anchoring our Freya 39 Contrary to Ordinary at Isla Partida on Thanksgiving Day in '82, and then lying in the 87° shallows with our then-wife and Latitude co-founder Kathy McCarthy. It was at that moment we came up with the idea for Sea of Cortez Sailing Week — an Antigua Sailing Week-type end-of-season chance for everyone to see each other and have some sailing fun before heading off in all directions. That event had about five really terrific years — with as many as 200 boats participating — before descending into mediocrity and finally death because of poor organization.

The only downside to La Paz, of course, is that it's become so popular with mariners. Despite the fact that just two years

☎(510) 236-6633 • fax: (510) 231-2355
 yachtsales@kkmi.com • www.kkmi.com
 530 W. Cutting Blvd., Pt. Richmond, CA 94804

Ask us about our Maritime Protection Program to find out what a warranty can do for the purchase or sale of your yacht.



Swan 601 Moneypenny (2005).

This yacht exceeds the pedigree of her design, construction and the Nautor brand. Truly an extraordinary vessel whether your passion is to sail in world-class regattas or cruise in a high performance yacht.

\$2,975,000



Nelson Marek Custom

A 92-ft aluminum world cruiser. Recently repowered. Immaculate throughout and in perfect condition.

\$2,850,000



Santa Cruz 52 (1993)

Beautiful, fast cruiser, set up for short-handed sailing. Maintained to very high standards, the hull has been repainted in stunning red with new bottom paint.

\$490,000



Fox 44 (2006) Ocelot

Tom Wylie/Kernan Yacht Design sloop rigged offshore racer. Carbon hull and spars, rod rigging, POB back stay with full complement of sails, and includes trailer.

Asking **\$395,000**



Oyster 53 (1999)

A semi-custom yacht which includes numerous detailed appointments. Designed to be modern and coordinated, while remaining practical and durable at sea.

Now **\$849,000**



Nick Potter/Wilmington Boat Works 62' classic sloop (1938).

Designed by renowned Nick Potter for Jascha Heifetz, *Serenade* has been completely restored and is in pristine condition.

Asking **\$1,200,000**



Nordic 46 Raised Salon (1992) Blue Point

Robert Perry designed 2-cabin offshore cruiser set up for shorthanded sailing in comfort in all conditions. Built to the same high quality standards as all Nordic yachts, this is a one of a kind yacht perfect for the serious cruiser. Asking **\$209,000**



Swan 112 Song of the Sea (2002)

One of the finest yachts produced by Nautor's Swan standing in a league with the super yachts. The vessel has been maintained to a very high standard and shows as new.



Nordlund 65 (1995)

Custom motor yacht designed for easy operation and comfortable living. Understated and tasteful accommodations in excellent condition.

Asking **\$895,000**



Dubois Custom 50' (1989)

Custom two cabin cruising yacht designed by Dubois Naval Architects. Exceptionally well thought out cruiser with many details, *Norther* is robustly built, very comfortable and easily sailed short-handed.

Asking **\$650,000**

CRUISING OR RACING ...OR BOTH? YOU DECIDE. BUT ALL YOU NEED IS A SINGLE SET OF SAILS IF THEY HAVE UK-HALSEY IN THE CORNER.



Ljubo Gamulin photo: www.ljubogamulin.com

Tape-Drive cruising sails save you a lot of bother and expense. Light, strong and able to hold their aerodynamic shape through miles of storms and seasons. Race or cruise – without changing inventories. Notice the tapes we've added to carry the loads when this genoa gets roller-furled: smart.

There are big advantages to using a sailmaker who enjoys cruising as much as racing.



NORTHERN CALIFORNIA

451 W. Atlantic, Suite 115, Alameda, CA 94501

(510) 523-3966

Sylvain Barrielle · Synthia Petroka · Jason Crowson · John Herne

www.ukhalsey.com • sanfrancisco@ukhalsey.com

LETTERS

ago the number of berths in La Paz was doubled, it's now difficult to find a berth there in the winter. What's driving the huge demand for berths in the Sea of Cortez and the rest of Mexico? Boomers like you and us, who have come to realize that 'commuter cruising' to our boats in Mexico is not only relatively inexpensive and convenient, it's fabulous.

↑↓DON'T FORGET OUR MEXICO RACE

I was pleased to read your comprehensive article on long-distance Southern California to Mexico races in the November *Sightings*. Unfortunately, you failed to mention the oldest continuous race to the Mexican mainland. The Del Rey YC's Marina del Rey to Puerto Vallarta International Yacht Race began in '71, and has been held biennially ever since! Some of the most illustrious yachts in the world — *Windward Passage*, *Ragtime*, *Pyewacket* and so forth — have participated, and earlier this year Doug Baker's Andrews 80 *Magnitude 80* broke the elapsed time record.

Incidentally, the San Diego YC's very well-run race, which was featured in your article, actually finishes at Punta Mita at the tip of Banderas Bay, and the fleet ends up staying at Paradise Marina, which is in Nuevo Vallarta. So technically, the DRYC Race is the only Puerto Vallarta race that actually terminates in Puerto Vallarta!

Plans are now in progress to make the DRYC 2009 Puerto Vallarta experience the most unique and enjoyable ever. Our PV '09 Series will feature stops in the beautiful anchorages down the coast of Baja and separately scored races. Additional details will be forthcoming as they become available.

Tom Redler
PV'09 Race Committee Chairman
Del Rey YC, Marina del Rey

Tom — We didn't mention the Del Rey YC's race because we were limiting the scope of our article to races to Mexico this winter. After all, we don't want to steal the thunder of this season's events. When the time comes, we'll be more than happy to alert our readers to your race.

Although you didn't spell out the details, it seems that you're going to be trying a different concept next year, with a race that features several legs, each one of them scored separately, rather than a nonstop run. It's an interesting idea, as it will certainly give a greater number of folks a better chance to be a 'winner' in at least some part of the event. But if we can offer some constructive input, we see two things you might want to consider. The first is that it would make the event longer, and people just don't seem to have too much free time these days. Secondly, while the weather was almost perfect at Turtle Bay and Bahia Santa Maria during the Ha-Ha, it's because we stop in those places in early November, prime time for good weather. Come February, the water will be cold in both places, and the wind often howls. In any event, good luck with your race.

↑↓THOSE WERE THE GOOD OLD DAYS

How jolly that you remembered the original painted fish and ribbon trophies that we gave out at the first Melaque to Tenacatita Regatta more than a dozen years ago, the ones the Ha-Ha 'trophies' have been modeled after. The fact that you mentioned those *Scallywag* days in the November issue resulted in my getting many emails and phone calls from friends from those wonderful days.

I happened through a box of photos last month, and saw many shots of the trophy presentation brunch the morning after that first race. I think there was one of your delivery crew accepting a fish and ribbon trophy for your Ocean 71

Seawear™

Nautical and Celtic Jewelry



A



B



G



H

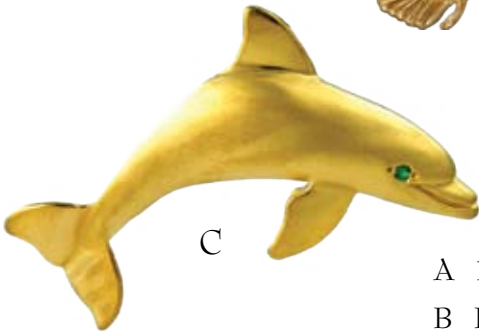

C



I

A 14kt shells, simple and nature perfect

B Hand made mallard in flight

C Hand made dolphin slide in 14kt with emerald eye in 14kt satin finish

D 14kt sea turtle slide with emerald eyes

E 14kt Thomas Point Lighthouse

F 14kt propeller cufflinks and studs, with or without diamonds

G 14kt pelican hook bracelet, for men or women

H 14kt hand made lifeline rigging bracelet.

I 14kt anchor shackle bracelet

J 14kt sailor's ring

K Two-tone turks head ring

L Captain & first mate rings 18kt & platinum

M Tri-tone turks head ring



D



J



K



E



L



F



M

Canvaswork and Sailmaking are Sailrite's specialties and we're here to help you with your projects. Build it new, repair it, retro fit it— You can do it! Sailrite can help!

Matthew Hunt

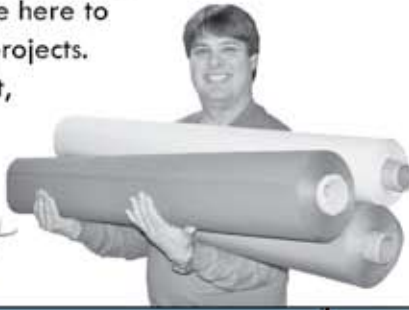

Fabric



Kits



Thread



Tools



Sailrite

For a free supplies catalog call 1-800-348-2769 or visit us online at www.sailrite.com



Churubusco, IN
Annapolis, MD

LETTERS

Big O's superb performance in the 'non-entrant' class.

You may also recall that was the season that *Big O* pulled in right behind *Scallywag*, and spent a month or more anchored off La Ropa Beach in Zihuatanejo. I was an early adaptor of the stand-up *panga* style of dinghy driving because my outboard turned with great difficulty. Having been the auxiliary engine for my last sailboat, it'd had little opportunity to turn, so it didn't do it particularly well. Many others soon imitated that stand-up style.

I also remember the Grand Poobah's spectacular stand-up crash when he hit a mooring float line at full speed one evening, ripping the handle off the outboard in the process. Thereafter it was easy to spot *Big O's* dinghy, for the driver was always in a tight embrace, with one arm around the engine and the other pulling the throttle cable.

You mentioned many of the Mexico races in that issue, but you left out one of the oldest — the Del Rey YC's semi-annual Marina del Rey to Puerto Vallarta race in February. They plan many wondrous innovations for '09, including lots more classes and lots more fun. They have been reviewing the history of the stuff like Sea of Cortez Sailing Week, and all the laid-back cruiser races we had in the various parts of friendly Mexico, in order to try to bring more good times to the prestigious P.V. race.

Tim (aka Padre Timo) Tunks
Scallywag, Islander 37
Marina del Rey

Tim — We're always happy to give credit where it is due, and you deserve all the credit for those simple but cool trophies that the Ha-Ha adopted — as well as much of the 'nothing serious' attitude for many of the casual 'races' in Mexico. "Superb performance in the 'non-entrant' class" indeed!

Speaking of giving credit, we regularly note that it was Hugh Lamson of the Long Beach YC who came up with the basic concept of the Baja Ha-Ha. He was instrumental in the Long Beach YC having a cruising division in their '93 race to Cabo, which featured stops at Turtle Bay and Bahia Santa Maria. We were part of that small fleet. Since the club wasn't going to do another until at least '95, if at all, we decided to create the Ha-Ha for '94. Because the Ha-Ha wasn't going to be a yacht club event, Latitude, which started it, was able to charge a much lower entry fee and run a significantly less structured and more casual event than a yacht club is used to doing.

↑↓ I DIDN'T KNOW WE COULD RESERVE A SLIP THERE

We left Vancouver Island on August 28 and arrived in Port Angeles, Washington, where we were cleared through Customs in less than an hour by two very courteous and professional Customs officers. In the process, we got our six-month U.S. cruising permit. All was well.

The next day we cleared Cape Flattery and prepared for the downwind sleighride to San Francisco. Unfortunately, the sleighride turned into 36 hours of motoring due to a lack of wind. Nonetheless, we had a great time in San Francisco playing tourist, seeing a ball game and staying at South Beach Marina. The staff at South Beach were a big help with sending faxes to Mexico and telling us places that we should see. All was well in San Francisco, too.

We then arrived in San Diego on October 1, at which point we were required to phone Customs for clearance. No problem. We stayed at Chula Vista Marina for a month and had a great time, meeting some wonderful people. The trolley system from Chula Vista to downtown San Diego proved to be exceptional, and we found the shopping and restaurants

SLAM

ADVANCED TECHNOLOGY SPORTSWEAR

866-488-4060



WWW.SLAM-SHOPS.COM

FAR-OUT GENNAKER SAILING...

Now available
in carbon!



...with an extendable
Seldén gennaker bowsprit

- Gives the gennaker more clear air
- Facilitates rapid gybing
- Always ready for quick extension
- Makes for fast and efficient gennaker handling
- Can be fitted to most yachts
- Complete kit for deck mounting

www.seldenmast.com

 **SELDÉN**
for sailing

Rig solutions for dinghies, keelboats and yachts. Aluminium and carbon spars. More than 750 authorised dealers worldwide.

Seldén Mast Inc. Tel 843-760-6278, info@seldenus.com

LETTERS

to be superb. With our Canadian dollar at a record 1.07 to the U.S. dollar, the exchange rate certainly didn't hurt. The people we did business with at West Marine and Downwind Marine were very helpful, so that was all good, too. Up until that point, all was well in San Diego, too.

On November 4, we cleared through Customs in half an hour to head for Mexico. It was after that when we had our problem. As it was already 4 p.m. on a Sunday afternoon, I noticed that there were slips available at the Police Dock. So I went to the Harbor Police office and inquired about a slip for the night. The man at the desk said they were filled up. When I mentioned that there were empty slips, he said that they were reserved for the rally to Cabo San Lucas. I thought the slips at the Police Dock were first-come, first-served. I guess I was wrong.

When I asked if I could anchor at La Playa Cove for the night and leave in the morning, the man behind the desk said that we'd be towed away if we anchored there because we didn't have a permit. I asked if we could get a permit. He said we couldn't because they needed 24 hours advance notice to give us a permit. Furthermore, he said it was 'people like me' who ruined it for everyone else. When I inquired if there was anywhere else we could go for the night, his response was, "I couldn't care less where you go," at which point he returned to his desk and sat down.

In my opinion, it's people like us who keep the boating business going in California. After all, we spent money on moorage and a new radar in San Francisco, and on moorage, a satellite modem and new refrigeration in San Diego, and general tourism dollars in both places.

Anyway, I hope the Harbor Police officer who waited on us gets promoted, because that way maybe they'll be able to fill the position with someone who is better at dealing with the public. We talked to several other cruisers who reported they also had problems with this particular fellow.

Otherwise, we had a great time. We've enjoyed reading *Latitude* for several years and will continue to do so.

Jim and Dianne Currah
Ladysmith, Prairie Oyster 1
British Columbia, Canada

Jim and Dianne — We hope you got the officer's name and reported the incident to his superiors, because they care about stuff like that. We had one bad experience with the San Diego Harbor Police during the first Ha-Ha and lodged a rather unorthodox protest that involved members of the Ha-Ha and others sending ladies panties — it's a long story — to the San Diego Convention and Tourism Bureau. Much to our surprise, the then-Chief of the Harbor Police took our complaint seriously and made changes in the department policy. The Ha-Ha has had excellent relations with the San Diego Harbor Police ever since.

SAN DIEGO HARBOR PARTOL



"San Diego Harbor Police? I'd like to make a reservation at the Police Dock."

As for the slips at the Police Dock, we've always been told they were first-come, first-served, and have never known the policy to be any different. But we're confused by the officer saying that the Police Dock slips were reserved for the "rally

CALL FOR
**COUNTER-
 SEASON SPECIALS!**

Yacht at Rest, Mind at Ease

WWW.YACHT-TRANSPORT.COM



SAFEST WAY TO SHIP • PREMIER SERVICE FOR ANY YACHT • RELIABLE FREQUENT SCHEDULES • UNIQUE DESTINATIONS • COMPETITIVE RATES

UNIQUE DESTINATIONS • COMPETITIVE RATES

PHOTOS BY ONNE VAN DER WAL

RELIABLE FREQUENT SCHEDULES • SAFEST WAY TO SHIP • UNIQUE DESTINATIONS • COMPETITIVE RATES • PREMIER SERVICE FOR ANY YACHT



WORLD CLASS YACHT LOGISTICS

Dockwise Yacht Transport USA

Telephone +1 954 525 8707

E-mail: dyt.usa@dockwise-yt.com

Dockwise Yacht Transport Europe

Telephone +39 [0]10 278 9411

E-mail: dyt.europe@dockwise-yt.com

Dockwise Yacht Transport France

Telephone +33 493 931 856

E-mail: dyt.france@dockwise-yt.com



Hardware and lighting
engineered for the marine environment.

FACTORY DIRECT!!!

**NOW OFFERING OUR
SAVINGS DIRECTLY TO
THE PUBLIC –
Visit Our Showroom Today!**

Precision Lighting Showroom

3635 Standish Avenue, Santa Rosa
Just two blocks off Hwy. 101 – Todd Rd. Exit

- **Holiday gift items: Desktop/bar globes, knives, porthole clocks, barometers, mirrors, ship bells**
- 12-volt light fixtures
- Cabinet hardware, plumbing hardware, restoration hardware
- Portholes and ventilation
- Anchoring, docking and deck hardware
- Tools and accessories
- Sailboat hardware
- Bulb bases and adapters

**Let us help you with
energy savers and lighting ideas**

WWW.ABIMARINE.COM

800•422•1301

707•585•6210

LETTERS

to Cabo San Lucas," because as you're probably aware, the Ha-Ha fleet departed San Diego on October 29, six days before you made your inquiry. So either the officer was giving you bad information or the slips were being saved for the FUBAR powerboat rally to Cabo San Lucas. Those powerboat guys have so much money there is no way of telling who they might be able to influence.

In any event, we encourage you to write a letter of complaint to Chief Kirk Sanfilippo, Chief of the Harbor Police. According to the Port of San Diego, which is in charge of the Harbor Police, complaints are welcome and will be thoroughly investigated by an officer who is a sergeant or above. You can complain in person, by telephone or by mail, but since you've already sailed south, it would be best to download a PDF complaint form from the Port's website. Although you can file complaints anonymously, it would obviously be best to sign your name so you could be contacted. According to the website, within 30 days of the conclusion of the investigation of your complaint, you'll be sent a letter informing you of the conclusion of the investigation and provided with a report on the general disposition of your complaint. We think it's in everyone's best interest if you take a few minutes to fill out such a form — after all, lots of sailors would like to know what it takes to reserve one of those desirable Police Dock slips.

↑↓ A CHINESE TWIST ON A FOOTBALL TRADITION

My Polish friend Marchin Grzeslo, who lives in Qingdao, China, where he races the Flying Tiger 10 Meters that



MARCHIN GRZESLO

"Sis, boom, bah, jibe on their wind" ... or something like that.

you featured in *Sightings* last month, sent me some photos from the Shangri-la Cup, which was held in Qingdao at the end of September. He skipped for Team Emerson Challenger to a third place finish in the 14

boat fleet, earning him the Bronze Medal. The teams from Maersk and Asahi Beer finished one and two. After viewing his photos, I realized that what's really missing from our races here in Northern California are cheerleaders. As such, I couldn't resist sending you the photos of cheerleaders for sailing, who will be in action at the Olympic Village Sailing site next year.

Larry Weinhoff
Synergizer, Ericson 28
Daly City

Larry — There is so much new and dynamic stuff happening in China that we in the somewhat stodgy-seeming U.S. can't help but be a little jealous. Cheerleaders — why not?

↑↓ CONSUMED WITH VISCERAL HATRED

I'm sending you a commentary from Seaflow, a nonprofit organization working internationally to protect whales, dolphins and all marine life, about the 902-ft container ship Cosco Busan colliding with the base of a Bay Bridge Tower. They contend that international trade is very destructive from an ecological standpoint.



MARINA RIVIERA NAYARIT
AT LA CRUZ



Marina Coordinates: Lat. 20°45'N • Long. 105°42'W

La Cruz de Huanacaxtle, Bahía de Banderas, Nayarit, México
(322) 293 4064 • info@marinarivieranayarit.com

GRAND OPENING
December 2007



marinarivieranayarit.com



RESERVE NOW!

- UP TO 400 vessel capacity (30-350 ft.)
- Fuel station • Dry dock 150 ton travel lift • Yacht club
- Hotel Site • Condominiums • Restaurants & Bars
- First-class services and much more!

WHALE POINT

MARINE & HARDWARE CO.



**A FAMILY OWNED & OPERATED BUSINESS
FOR THREE GENERATIONS**

ACE Hardware
MARINE PARTS & ACCESSORIES, PLUS A COMPLETE HARDWARE STORE

CHRISTMAS GIFT IDEAS

ECO & COASTLINE Clock, Barometer & Thermometer



3.75" face. Coastline has opening fronts.
Eco **NOW \$44⁹⁹ each**
Coastline **NOW \$49⁹⁹ each**

2008 CALENDARS



Many styles available: Woodenboat, Sail, Art, Cruising, Bay Area Tide, Cruising, Bay Area Tide Calendar...
10% OFF
*Qty. ltd.

GILL Deckhand Gloves



FREE
with purchase of
Gill Foulweather
Gear Suite

Gill—present quality in sailing gear. Sizes: S, L & X.
List \$19.95 • **Whale Pt. \$16⁹⁵**

15 LED FLASHLIGHT



NOW \$19⁹⁹

3 AAA batteries included.
5 green LED for night vision
and lazer pointer.
Compass on opposite end.

PORTABLE HEATER

Indoor safe
propane
heater.



Mr Heater
4,000-9,000 BTU: **NOW \$99⁹⁹**

MAGMA BBQ

Perfect BBQ for a
Sunday night
dinner on your
boat. Stainless steel.
Mounts easily with
optional mount to your
boats rails.



Charcoal: West \$109 • Whale Pt. **\$99⁹⁹**
Propane: West \$139 • Whale Pt. **\$129⁹⁹**
Rail Mount: West \$49 • Whale Pt. **\$39⁹⁹**

STEARNS Float-Coats



USCG approved.
Long Jacket **NOW \$179⁹⁵**
Short (bomber) Jacket **NOW \$159⁹⁵**

SILVER MARINE Inflatables



Length..Width.....Max.....Floor.....**NOW**
7'8" ... 4'1" .. 2.7hp .. Roll-up **\$699**
8'2" ... 4'3" 4hp .. Roll-up **\$799**
9'8" 5' .. 9.9hp ... Wood .. **\$1199**

205 Cutting Blvd, Corner of 2nd, Richmond
510-233-1988 • FAX 233-1989
Mon-Sat: 8:30am - 5pm • Sun: 10am - 4pm
Email: whalepoint@acehardware.com

LETTERS

I realize that *Latitude* supports international trade because it's good for the economy. Aside from my strong disagreement with that assertion, if you prioritize the economy above the environment, not only will you immorally pollute and destroy much of life on earth, you will not have a planet to live on.

Since we're all sailors, we should appreciate and respect the sea and waterways like the San Francisco Bay, and we should prioritize their protection above economic concerns. I have long viscerally hated hideous monstrosities in the water like large freighters, tankers, and military ships. The only reasons I give them right-of-way are that it's legally required — and because they are so much bigger than any sailboat that I've ever been on that I assume the boat along with all her crew would be crushed if we were in a collision. I'd like to see a small maximum limit be imposed on the size of these ships and a drastic curtailment of international trade, which is so ecologically destructive. Stopping all dredging, which causes more environmental harm, would be another good place to start.

Jeff Hoffman
San Francisco

Jeff — Why settle for half measures? If you really want to help the environment, why not support a Jim Jones-style extinction of the human race?

You're correct, we are big supporters of world trade for the simple reason that it's been the engine that's pulled more humans out of poverty than anything else in history. We think that's a good thing. In fact, whenever we hear somebody say they are against world trade, we also hear the corollary, which is that they're also in favor of global poverty. Idiots! Even St. Bono of U2 argues that what the world really needs is more, not less, globalization.

It's childlike to think that you can do anything as simple as "prioritize" the environment over economic concerns, as they are totally interdependent. If you think the world's got environmental problems now, just throw six billion people back into poverty and see what an orb of misery and war you'll have. And if you think poverty doesn't breed inefficiency, stupidity, violence and waste, you haven't been spending enough time in the Third World.

We're not arguing that improvements shouldn't be made to World Trade. For example, the mindless consumption of crap ought to be curtailed — but that's a personal decision that has to be made by each one of the four billion of us who can afford to buy such rubbish. And the massive pollution caused by the burning of bunker oil — as well as archaic union work rules in places such as Southern California — should have been remedied years ago. But still, let's not cut off our noses to spite our faces.

As fun as it might be to allow yourself to be consumed by "visceral hatred," the downside is that it blinds you, and leads you to crazy ideas such as thinking it would be better to have more smaller ships. Aren't you the least bit familiar with economies of scale as they apply to both economics and the environment? What's next, are you going to call for people to abandon buses because they are big and go back to using single-passenger vehicles?

⚠️ LATITUDE WAS NEARLY, BUT NOT QUITE, ACCURATE

I always enjoy reading *Latitude*, but every once in a while something inaccurate slips by your watchful eye. For example, in the article *Captain's Licensing* there were a few items in the 'Licenses for Operation' section that were less than your typical perfection. To give credit where it's due, the licensing

Season's Greetings



MARINA VILLAGE

Much More Than Just a Marina

www.marinavillageharbor.com

(510) 521-0905



Not Using Your Boat?



**STORE
IT**

Want To Sell Your Boat?



**STORE
IT**

Want to Dry Out Your Boat?



**STORE
IT**

Leaving the Country?



**STORE
IT**

Want to Save Money?



**STORE
IT**

DRY STORAGE
\$3.75/ft
Power & Sail



CELEBRATING OUR 50TH ANNIVERSARY

NAPA VALLEY MARINA

1200 Milton Road • Napa, CA 94559

(707) 252-8011 • Fax (707) 252-0851

www.napavalleymarina.com

Marina • Boatyard • Chandlery • Brokerage

Dealers for
YANMAR

Interlux
yachtpaint.com

Distributors for *Brownell*
Boat Stands

LETTERS

requirements and the Code of Federal Regulations are difficult to read and understand, so this sort of thing crops up from time to time.

1) Uninspected passenger vessel (OUPV or 'Six-Pack') licenses are, in fact, not issued at various levels of tonnage. They are issued for inspected vessels, e.g., 25 GT, 50 GT, 100 GT, etc. (FYI, I have a 50 GT, and had an OUPV, which I had to relinquish when I was issued my Inland Master license. I still have my OUPV for Near Coastal.) In addition, the tests are not "the same," but they are similar. You have to get a higher percentage of the questions correct and, if my recollection serves me, there are more questions in the tests for the Master-level licenses.

Even less well understood is the maximum number of paying passengers allowed on an uninspected vessel when the skipper has a Master's license. That number is six, the same number as for an OUPV license. The number allowed only increases when it is an inspected vessel.

2) A valid day on the water can be as little as four hours, depending upon the appropriateness of the situation. Most OUPV license holders don't document eight-hour days.

I quote from the CFR: "On vessels of less than 100 gross tons, a day is considered eight hours unless the Officer in Charge, Marine Inspection, determines that the vessel's operating schedule makes this criteria inappropriate. In no case will this period be less than four hours."

3) Just prior to this section, there was a mention of a conical, inverted shape "required" by vessels propelled by sails and engine. This is only somewhat accurate, as this applies to vessels upon international waters, or if inland, 12 meters or longer. (Rule 25). The implication from the article was, from my read, all vessels.

Jonathan (No Last Name, Please)

Excalibur
Planet Earth

Jonathan — Despite trying our best, we still make plenty of mistakes in every issue. We want to thank everyone who takes the time to correct any substantive errors.

Since you seem to be up on the regulations, we've got a couple of questions for you. In the old days, if someone gave the owner of a boat a sandwich, a gallon of gas, or something else of value to help offset a day's boating expenses, he/she technically became a 'paying passenger'. Given these litigious times, that would never do, so a number of years ago the Coast Guard changed the rules. As best we understand them now, a person can now contribute as much cash, sandwiches, booze and whatever he/she wants, provided that it doesn't exceed the expenses of the trip, and still not be considered a paying passenger. We have two questions. First, do we understand the regulations correctly? Second, by "not exceeding the expenses of a trip," does the law mean that the owner can include the pro rata costs for things like boat payments, insurance, haulouts, maintenance and so forth? We'll take our answer on the air.

↑↓ **LIKE OUT OF A GUY AFTER PROSTATE SURGERY**

Several years ago I wrote about sailors needing to check their PSA (prostatic specific antigen), a blood marker for early prostate cancer, as well as the need to check their boat's bilge. I am a sailor, as well as senior cancer specialist M.D. who chose proton beam radiation therapy at Loma Linda Medical Center in the spring of '02 for curative treatment. All my flow systems work, and my own tabernacle mast and the one on my Catalina 34 *Dazzler* still go up and down as needed.

Keeping saltwater out of my boat has been another

Perpetual Peace of Mind™

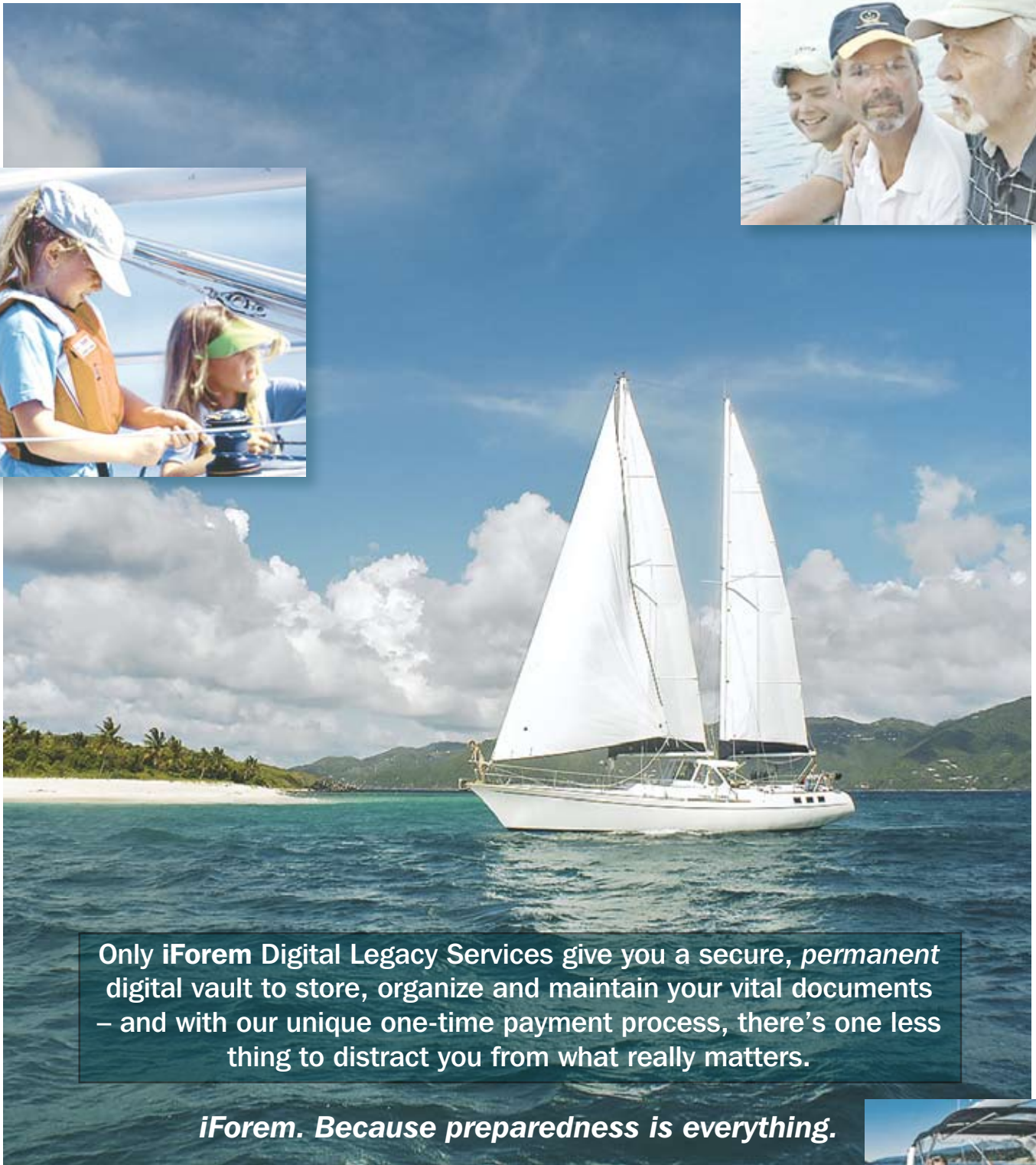

Only iForem Digital Legacy Services give you a secure, *permanent* digital vault to store, organize and maintain your vital documents – and with our unique one-time payment process, there's one less thing to distract you from what really matters.

iForem. Because preparedness is everything.

iForem, Inc.
(877) 543-6736
info@iForem.com
350 Marine Parkway, Ste 200
Redwood Shores, CA 94065

www.iforem.com

Enter promotion code Lat38 for our Special Holiday Offer



SHAFT SHARK

**The best rope,
line and debris
cutter there is!**

Two piece unit

For both
power and sail



AB Marine, Inc.

747 Aquidneck Ave.
Middletown, RI 02842

401-847-7960

Fax: 401-849-0631

sales@ab-marine.com

www.ab-marine.com



Gori® propeller



3-Blade



2-Blade



Racing

AB Marine, Inc.
747 Aquidneck Avenue
Middletown, RI 02842

Phone: 401 847 7960

Fax: 401 849 0631

sales@ab-marine.com

www.ab-marine.com

LETTERS

issue. First, there was the time I lost the rubber gasket on the screen filtering the water intake for the heat exchanger. Dumb mistake. There was also the time when the packing gland lost its packing and the bilge pump was on manual. Another dumb mistake. By far the most interesting bilge filling occurred when we were out for an afternoon sail. As I was raising *Dazzler's* tabernacle rigged mast and attaching fittings, my wonderful wife and first mate said, "There sure is a lot of water coming out the back of the boat." Since I had just changed out the impeller, I wasn't too concerned. But she insisted that I check things out, and boy was I wrong! The water was being pumped out of the bilge like a guy after prostate surgery!

I went below, and what to my wondering eyes should appear but smoke and a lot of fumes from Bertha, my trusty 1986 vintage M-25 Universal diesel. I shut things down, let the bilge pump empty the bilge, and sailed into Alamitos Bay, Long Beach, to tie up and assess the situation. I restarted the engine, and no water was exiting the boat from the salt-water pump. After investigation with a more knowledgeable friend, we (he) discovered that I had a major leak in the exhaust system. My wonderful water pump was pumping water backwards through the exhaust leak instead of through the muffler box, as the former was the path of least resistance. I was pumping saltwater into my boat, and maybe into my engine. Unfortunately, Bertha doesn't like saltwater in her orifices. Well, we (he) fixed it with a new elbow, new hose, new wrapping and so forth, and we were soon both happy, as Bertha was purring, and water was exiting the boat rather than entering it.

I gave my friend a generous 'thank you', and asked what I could do for him. "I'm happy to help you fix the boat," he said, "but you should just keep talking to people about prostate cancer and effective proton curative treatment. It all comes around."

I am writing this letter from Molokai and looking at beautiful Maui. I greatly enjoy *Latitude* each month, and give many thanks to the staff for the many lessons learned by me and others through the *Letters* section. Hopefully this letter will help other sailors who find themselves pumping saltwater into their boat, and/or sailors who are diagnosed with prostate cancer and need to choose a lifesaving therapy that has minimal side effects. If you have a leaky boat, call a friend like my buddy, Ed. If you have questions about prostate cancer, contact me at Captiv@aol.com or check out www.protonbob.com.

The other lesson is that we all need to check out our personal and boat exhaust systems. To check out your personal exhaust system, have a colonoscopy after age 55 or so to prevent and defeat colon cancer. For your boat, you need to unwrap the exhaust system insulation tape after 10-15 years of service and check the integrity of the system. Let's keep the fumes flowing out of the right holes to keep sailing in fair winds as long as possible. Saving boats and sailors one at a time seems to be my calling.

H. Terry Wepsic, M.D.
Dazzler, Catalina 34
Huntington Beach

H. Terry — An ounce of prevention works for both boats and bodies, right?

HA HA REPORT FROM AN EXPERIENCED SAILOR

People have asked me what the sailing conditions were like in the Ha-Ha.

On the morning of the start from San Diego, there was ab-

Why settle?



Ballena Isle Marina

Alameda 510.523.5528

Jack London Marina

Oakland 510.834.4591

Treasure Island Marina

San Francisco 415.981.2416

Martinez Marina

Martinez 925.313.0942

You don't settle for less, why do it with your marina? Join one Almar marina and gain access to seven Bay Area marinas. Almar's reciprocal program takes the hassle out of your boating weekend. A simple call to the marina office and you can spend the weekend at Jack London Square or Treasure Island. Maybe a trip to a few of Almar's seven Southern California marinas. We make it so easy you may find yourself using your boat.

Almar boaters receive a 10% discount on any fuel purchase at Jack London Square and Ballena Isle Marina. Jack London Square Marina has just upgraded it's fuel dock with high speed fuel dispensers and now has the fastest pumps in the Bay Area. You don't have to settle anymore.

Almar is the largest operator of saltwater marinas in the country. Almar Marinas provide a wide range of services and programs that few marinas or yacht clubs offer. Some of these programs include: monthly boating seminars, boat handling classes, navigation courses and organized outings to local anchorages. Each marina offers wireless high speed internet access, which can be used with your reciprocal privileges at any Almar Marina. To see the difference, visit one of our marinas this weekend.



almar.com



- Super efficient
- High reliability
- Worldwide sales and support



We have a watermaker to fit any need, from 150 to 1000 gallons a day.

WEST COAST DEALERS

Emerald Harbor Marine, Inc.
Seattle, WA 98199
Tel: 206-285-3632
www.emeraldharbormarine.com

Svendsen's Boat Works
Alameda, CA 94501
Tel: 510-521-8454
www.svendsens.com

Channel Coast Marine
Oxnard, CA 93030
Tel: 805-985-0220
www.channelcoastmarine.com

Outbound Yacht Services, Inc.
Dana Point, CA 92629
Tel: 949-488-0652
www.outboundyachtservices.com

Daily Marine
San Diego, CA 92106
Tel: 619-222-9613
dailymar@aol.com

Your Dream, Realized.

Spectra Watermakers • Tel: 415-526-2780
www.spectrawatermakers.com



LETTERS

solutely no wind 10 minutes before the start. Then it filled in, as if on cue, with 10 knots from the northwest, providing for a beautiful spinnaker start. We ended up leaving the Coronado Islands to starboard, which resulted in light wind in the lee, but it picked up again. That first afternoon my crew asked about my procedures for taking the spinnaker down. I thought I was joking when I told them that we wouldn't take it down, that God would. It really was my plan to keep it up the entire way, but at 5 a.m. on the second morning it literally blew to bits. During the roll call that morning, a few boats reported 30 knots of wind. It was a bit breezy, but I don't know about 30 knots. Anyway, that spinnaker had been my favorite. It was 24 years old and had come with my boat when I bought her. It had been repaired many times, but there's not much to fix this time. Oh well, it's a good thing we had three more onboard. We had good wind for the entire first leg, but my wife reminds me that the seas were a little "yucky."

The second leg started just like the first, and we had a headstay reach with the kite up. By midday the wind had clocked and we were running deep. As I recall, the seas were flat. By the next morning the wind had shut down entirely, and *Profligate*, the 63-ft catamaran mothership, started motoring for the first time. But we decided to cook breakfast and wait it out. By midday the wind was back, and we were glad we waited.

The start of the third leg, Bahia Santa Maria to Cabo, was delayed an hour. Santa Maria is a very large bay that's protected from the northwest, but not the south. There is nothing there but a fish camp and a few recently built small buildings. There was nothing there in '99. Anyway, there was a large swell coming through the anchorage that was generated by storms at 40°S, which made crossing the bar in a dinghy to get to the beach very dangerous. I made it in and out once while alone in my 15-hp powered dinghy. But I saw another dinghy with four people get flipped on their way in. When I told the rest of my crew that taking our dinghy meant we might end up swimming in, they decided to take a *panga*.

As many people know, *pangas* are open high-speed fishing boats about 20 feet long. The *pangañeros* are really good at driving them over the bar because they do it for a living every day. Almost everyone took a *panga* in the afternoon of the beach party. There was no moon, so when the sun set, it got dark very quickly. When it got dark, Richard, the owner of *Latitude* and the Grand Poobah of the Ha-Ha, announced that those still on shore should stay on shore rather than risk a *panga* ride back out through the surf. We'd gotten a *panga* ride back to our boat just before dark, but heard that the last one to make it out had gotten totally airborne. Mind you, this was a heavy *panga* full of passengers. After that, even the fearless *pangañeros* called it a night, resulting in 72 Ha-Ha folks — including two of the three folks who manage the event, Banjo Andy Turpin and Doña de Mallorca — having to spend the night on the beach. What a story they have.

Because of the time it took to get the folks on the beach back to their boats the next morning, the start was postponed from 7 a.m. to 8 a.m. Nonetheless, it was yet another spinnaker start, with light to moderate winds and a somewhat moderate sea. By the afternoon, it was blowing pretty good, maybe 20 knots. By the next morning, it had shut down again. We were wing-on-wing with 20 miles to the finish. The wind never really came up, but we stuck it out nonetheless. We figured we could turn on the motor at any time and be in Cabo in just a few hours, so we decided to see what would happen. At times the only progress we made was due to the shore current going our way. At other times the swell, which

Make Your First Ocean Passage a Great One!



L EARN WHAT IT TAKES...

to make a major cruise under sail during our 23rd offshore sail training voyage. Our 2008 schedule offers you a choice of shorter excursions in prime cruising areas, exotic land-falls and classic ocean passages.

Our emphasis is on helping you build skills in an environment of fun and great sailing. Many who sail with us are planning voyages of their own—there is no better way to prepare. Underway, we provide in-depth experience in vessel management, safety, provisioning, electrical and plumbing systems, celestial navigating, anchoring, sail handling, weather routing, and heavy weather.

Along with eight other crewmembers, you'll sail in all conditions, standing watches and steering as *Alaska Eagle* sails 180 to 240 miles a day. Delicious meals are prepared by the ship's cook. Everyone has a comfortable berth, and double cabins are available for couples and single women.

Alaska Eagle is owned by one of the nation's premier non-profit sailing schools. Designed by Sparkman & Stephens and strongly built of aluminum by the Royal Huisman Shipyard, *Alaska Eagle* (ex Whitbread winner *Flyer*) has logged more than 350,000 offshore miles. She has a comfortable four stateroom interior and all the latest electronics and cruising gear. She is Coast Guard certified for All Oceans.

2007/2008 SKIPPERS – Sail and Learn with the Best



Since Rich and Sheri first sailed aboard *Alaska Eagle* from England to California in 1982, they have been aboard as skipper and mate for the majority of her voyages. Combined, they have sailed more than 550,000 miles, including three Atlantic crossings, more than 30 crossings between Hawaii and the West Coast, 13 equator crossings, and many miles through the South Pacific between Tahiti and Australia. In between, Rich and Sheri have built three boats, virtually by themselves. In their first boat, a Farr 44, they circumnavigated South America. Their next boat was a 54 foot aluminum sloop in which they voyaged to Antarctica. Their third boat, the Farr 44 *Tabu* has just been launched and is ready for adventure.

Licenses held: USCG Master Upon Oceans • STCW International Yacht Master (RYA/DOT) • US Sailing Instructor: Keelboat, Cruising, Coastal Navigation

ALASKA EAGLE VOYAGE SCHEDULE

Auckland – Bay of Islands – Auckland

Feb 2 – 11 or Feb 14 – 23, 2008

Starting and ending in Auckland, these coastal trips will explore the Coromandel Peninsula and the beautiful Bay of Islands.

Auckland – Raivavae – Tahiti

May 15 – Jun 5, 2008

Predominately an upwind passage, heavy weather and an exotic landfall combine to make this a challenging voyage.

Tahiti – Raiatea

Jun 9 – Jun 18, 2008

Starting from the rollicking Papeete waterfront, you'll sail to the exotic islands of Moorea, Huahine and Bora Bora before finishing in lovely Raiatea.

To learn more: occsailing.com

To request a color catalog or

specific info: 949-645-9412

Or write: Alaska Eagle Voyages, 1801 W. Coast Hwy, Newport Beach, CA 92663

Raiatea – Fanning – Hawaii

Jun 22 – Jul 12, 2008

Leaving the legendary island of Raiatea, this passage includes a stop at Fanning Island and an equator crossing officiated by King Neptune.

Hawaii – San Francisco

Jul 15 – Aug 1, 2008

Conditions range from upwind sailing and squalls to exquisite reaching conditions. Sailing under the Golden Gate Bridge brings a picture perfect ending to this trip.

San Francisco – Newport Beach

Aug 4 – Aug 8, 2008

For those wanting a taste of the voyaging life, this short coastal passage will include stops in San Miguel, Morro Bay or Catalina (conditions permitting).

The School of
SAILING & SEAMANSHIP
Orange Coast College



*one design
offshore spec
multihulls*

classic sails

NEIL PRYDE SAILS

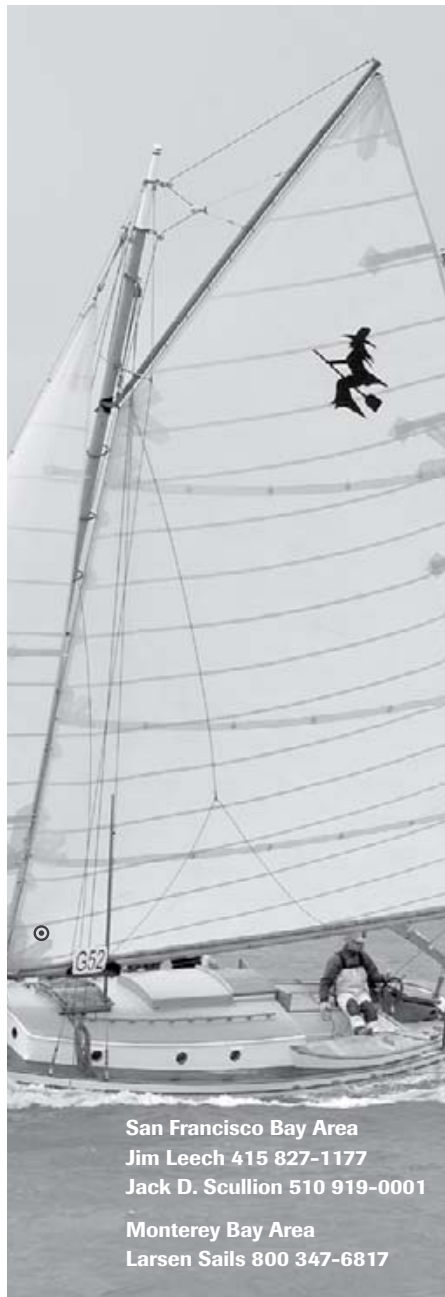

San Francisco Bay Area
Jim Leech 415 827-1177
Jack D. Scullion 510 919-0001

Monterey Bay Area
Larsen Sails 800 347-6817

Sail outside the box
www.neilprydesails.com

LETTERS

was about six feet, got us up to two knots. I think our top speed for the day was three knots, but we crossed the finished line at 5:30 p.m., having sailed the entire Ha-Ha course. We're all glad we stuck it out.

I love doing the Ha-Ha and recommend it to everyone. In fact, I'd do it every year if I could.

Phil MacFarlane
Sail A Vie, Ericson 35
San Mateo

Phil — That you and Mark Deppe, who was part of the Profligate crew, both enjoyed the Ha-Ha meant a lot to us. After all, the two of you have seven Singlehanded TransPacs to your credit, and you've both won the event, so we have great respect for your sailing skills and your opinions.

The Ha-Ha boats get spread out over quite a distance, some inshore and some offshore, so boats reporting considerably dif-



ELECTRONIC / RICHARD

MacFarlane's favorite — and ancient — spinnaker met its demise in the Ha-Ha.

ferent wind strengths doesn't surprise us. Like you, we never saw 30 knots on the first leg, but we sure didn't see 20 on the afternoon of the third leg either. We would have loved that! Our best sailing was just after crossing the finish line of the first leg, when Carol Cort, wife of the Los Angeles YC Commodore Dave Cort, used the warm winds to repeatedly rip off extended bursts of 17 to 18 knots in flat water. It was idyllic. Having done the Ha-Ha course at the same time of year for 14 out of the last 15 years, we can report that it was a typical weather year. The wind was a little stronger than normal the first night out of San Diego and maybe a little lighter on the afternoon of the second leg, and the air was a few degrees warmer at night, but all in all, it was typical Ha-Ha weather.

By the way, the decision to make the announcement that nobody should go back out across the bar at Bahia Santa Maria after it got dark was a no-brainer. A longtime surfer, we understand the damage those kinds of waves could have done to a panga full of people, both on impact and once 10 or so folks not used to swimming in big waves — let alone big waves in the pitch black — found themselves in the drink. After all, why risk the very real possibility of somebody being injured or killed when the other option was to stay ashore, where it was warm enough that there weren't going to be exposure issues and where there was food and water? We'd make the same decision any time.

⚡ THE PUERTO ESCONDIDO COMMUNITY IS DEAD

Twelve years ago, we sailed from Berkeley to Baja and left our Valiant 40 at Puerto Escondido. Each year since, we've returned for two to three month's worth of cruising. Up until just a few years ago, we were used to seeing 50 to 60 boats in the Inner Harbor, and even more during Loreto Fest.

Puerto Escondido was arguably the safest hurricane hole in the Sea of Cortez until '05, at which time Singlar kicked out all the anchored boats and put in more than 100 unsafe moorings, making it one of the least safe places in the Sea. It bothers us that word the moorings aren't safe hasn't been getting around, and that Americans there who know better aren't telling people.



SeaPortal Ltd.
INTERNATIONAL
Marine Group

www.seaportal.com

HOME

NEW BUILDS

SAILING YACHTS

POWER YACHTS

CHARTER

BROKERAGE

NEW BUILDS:

Building the boat of your dreams is a rewarding yet demanding endeavor. Seaportal can make the experience fun while providing knowledgeable guidance in the process. For more information go to www.seaportal.com

(415) 999-6144

☆☆☆
HYDROVANE

SINCE 1968

Survive Your Dream

Courtesy Jimmy Cornell



'Great Atlantic Gear Test'
Again rated #1!

YACHTING
MAGAZINE

100
best bits of gear - ever!
HYDROVANE Included twice!

Hydrovane is both:
★ Self Steering
★ BEST Emergency Steering

Announcing New Product!

ECHO Tec Watermakers

It Just Works - ALWAYS!

www.hydrovane-watermakers.com

604-925-2660 info@hydrovane.com www.hydrovane.com



INNOVATIVE MARINE LIGHTING

- The ultimate LED nav. light
- Full range for ALL vessel sizes
- Approved for ALL vessel types
- High quality construction
- Low power consumption
- Submersible to 100+ meters
- Vibration safe
- 50,000 hours lifetime
- 5 years warranty



TYPE APPROVAL FOR ALL VESSEL SIZES AND TYPES

For more information please visit www.lopolight.com

|||| LOPOLIGHT ||||

U.S. Representatives • Euro Marine Trading, Inc. • 62 Halsey Street, M
Newport, R.I. 02840 • www.euromarinetrading.com • Tel. (800) 222-7712

SALE INTO HOLIDAY SAVINGS

GET AN ADDITIONAL

10% OFF

ALREADY REDUCED
MERCHANDISE*

BRING THIS COUPON IN TO REDEEM.

*EXCLUDES OUTBOARD MOTORS AND SMALL BOATS

OFFER EXPIRES 12/31/07



SVENDSEN'S MARINE

510-521-8454
1851 Clement Ave.
Alameda, CA 94501
svendsensmarine.com

LETTERS

What's wrong with the moorings? They were built 'upside down', with line from the block up to the chain at the top instead of vice versa. In addition, the line is not spliced, but rather attached with a galvanized clamp. They are so bad that buoys have broken loose in strong weather — even with no boats attached. The latest failure took place during Hurricane *Henriette* in October, when the mooring the sloop *Erikazona* was on broke loose, causing her to sink on the rocks. You can see the photo of the result on page 201 of the October *Latitude*. The mooring did not drag, as *Latitude* had been told, it broke.

Adding credence to the fact that the moorings are bad, Singlar tells us that money would be available to repair them "sometime in 2008."

Speaking of money, one of the reasons there have been so many problems at Puerto Escondido is that Singlar's rates for moorings are so high that nobody has wanted to pay them. As a result, most moorings that have been put in have never had a boat on them, and the once-thriving cruiser community, which tended to watch over the boats of folks who had gone back to the States, has disappeared. Most boats and their owners have left.

Call us naïve, but since there had never been any significant number of thefts in Puerto Escondido prior to Singlar putting in the moorings, we still thought it was safe to leave our boat in Escondido after the cruising community had left. But starting this fall, unoccupied boats were broken into. Our boat, which was on an improved Singlar mooring, was hit on or before October 11. Even though a Singlar employee noted that our companionway was open, they failed to notify us for another 11 days, by which time \$16,000 of equipment and personal items — all the radios, the little dinghy motor, solar cells, dive gear, sail sheets, tools, etc. — had been stolen.

After we were notified of the theft, we arranged for our boat to be moved and we flew down. We were devastated. We also learned that our boat was the fourth one to be broken into. The next shock we got was what we consider to be the total lack of support from members of the local American community,



ELECTRONIC / RICHARD

The arrival of Singlar — and their very high prices for moorings — seems to have had a devastating effect on Puerto Escondido's cruiser community.

most of whom live ashore in neighboring Juncalito. The police told us that the prime burglary suspects lived in Juncalito, and that palapas there had been broken into. When we inquired about this on the net, it was met with silence. When we asked acquaintances of many years about it, we got more silence. Finally, one person told us that we should leave! Only our real friends offered assistance.

We then spent a week working with the police, district attorney, and Singlar attorney, and discovered what we believe is the real reason for the silence. The police investigations of criminal activity in the area include Federal officials, and many Juncalito Americans have 'dirty laundry' to hide. We only met one Juncalito resident who refuses to live in fear and

PREMIER SLIPS FOR SALE

Yacht in the Heart of San Francisco Bay

EMERY COVE
YACHT HARBOR

BUY A SLIP: Save money & earn equity! Save 1/3 of your rental cost. Enjoy big tax savings as a slip owner. Emery Cove Yacht Harbor is the only marina on the Bay with FEE SIMPLE dockminium ownership.

OR RENT A SLIP: 35-60' slips! Rates from \$8.00 to \$9.20.

Season's Greetings



CALL FOR A MARKETING PACKAGE • 510-428-0505

3300 Powell Street, Emeryville, CA 94608 • www.emerycove.com • Email: info@emerycove.com

Ballenger Spar Systems, Inc.

Custom Racing and Cruising Spars
Expert Design and Consultation

- Carbon and Aluminum spars
- Rod and wire rigging
- Hi-tech and conventional halyards
- Spar kits, extrusion
- Repair and modification
- Custom fabrication, waterjet and CNC
- Hardware, sheaves, spreaders
- Bay Area pick-up and delivery
- **Discounts** on halyards, standing rigging, deck hardware, furlers, Navtec integral cylinders
- 30 years experience!

Call about Carbon Spars.
Masts • Booms • Poles

ballengerspars.com

831/763-1196

831/763-1198 (fax)

CRUISING CATS USA

Your West Coast Dealer for



BEARCAT 46

Special intro savings: \$100K
LESS than the \$749K price.
(46' x 18' x 3' - 16-24kts.)
2,3, or 4 suites. Fully
equipped/turn-key ready.



LAGOON 500

38' to 62'
\$350,000 to \$1.5M
Also L-420 'hybrid', dsl-elec



MAHÉ 36

36' to 65'
\$300,000 to \$1.3M



GEMINI 105MC

34' x 14'
Fully equipped for cruising
\$169,000

California

Don Margraf

(510) 469-3330

Pacific Northwest

Rod Gibbons

(877) 937-2287

www.CruisingCatsUSA.com

The Largest Boat Show in Northern California!



new Fearless from John Beery Yachts



JANUARY 4-13

Alameda Cty. Fairgrounds
Pleasanton

MAJOR SAILBOAT DISPLAY
Boats & Yachts from 7' to 70'!
Lots of Marine Accessories!

Wkdays: Noon-8p, Sat: 10a-8p, Sun: 10a-6p
Adults: \$10, Kids: 15 and under FREE w/adult
More info @ www.ncma.com

Northern California
BOAT-SHOW

\$2.00 DISCOUNT!
Weekdays only
Adult admissions-Kids FREE! L-38

LETTERS

who takes action when threatened. The others prefer to bury their heads in the sand and distance themselves from victims. Some refuse to speak out against Singlar, and because they hope to get future employment from Singlar remain silent about the condition of the moorings.

We shall continue pursuing action to recover our stolen goods and compensation for our losses. Nonetheless, as we were leaving for La Paz, we heard angry remarks directed at us by cruisers who didn't know the details of the crime against us and hadn't even been in Escondido at the time. It was a sad commentary on human nature.

As for the Hidden Port YC, it's really just a 'palapa club', meaning people who live ashore. There is no active boating community in Puerto Escondido like there used to be before Singlar came in.

We are sad and angry — but will not let other cruisers be fooled. All the Singlar moorings are bad, and the Inner Harbor and Juncalito are no longer safe anchorages.

Jane Pitts and Frank Hubach
Shore Loser, Valiant 40
La Paz / Northern California

↑↓ HORSESHOE COVE IS NOT A GOOD MWR FACILITY

The November *Sightings* article titled "Horseshoe Cove Marina Faces Closure" leaves out some important facts.

First, the Presidio YC is a social organization under the sponsorship of 60th Services Squadron, Travis Air Force Base. Membership is available to all active duty and reserve military forces, retired military, federal employees, National Park employees and auxiliary members of the Coast Guard. The docks do not belong to the club; the buildings do not belong to the club; the rental/training boats do not belong to the club; and the bar and grill does not belong to the club.

As the Presidio YC continues to bring in members who are not associated with the military, they continue to forget the prime mission of the marina. It is not for the PYC members, it is for use by the military members — active duty, reservist, guardsman, and retired military — who have earned that privilege through honorable service. Those participants who are government employees or who work for Homeland Security — to include the USCG Auxiliary — or work for the National Park Service are invited to participate with the Presidio YC and can then, through that door, use the marina services.

Presidio YC members work at the marina attempting to maintain the docks and the buildings, assist with maintenance of the boats at times, and promote seamanship and nautical activities. They are also allowed to use the facilities for club functions. But contrary to what many people think, the marina is not part of the Presidio YC. By doing this work, the members provide a symbiotic relationship with the Air Force, since they provide the free labor to maintain the facilities at no cost to the military. If not for that fact, the marina would probably have closed in '96. When the Presidio was turned over to the civilian population, Travis Marina could have taken possession of the docks and parking areas, but the military was not interested in gaining additional property during the time when military installations around the world were being closed. It was an opportunity missed, Travis Services Squadron and the National Park Service established a rental agreement. You can say that the nails were being driven into the marina coffin at that moment.

That said, let's discuss why the marina is being closed. All MWR facilities must meet some basic requirements to survive in today's military: They must meet the mission of providing recreation opportunities for all military members, they must

EXPAND

Your Cruising Possibilities

Telstar 28 Trimaran

EASILY CONVERTS FROM 8'6" TO 18' IN SECONDS



One unique boat that has it all with thrilling performance, cruising-friendly accommodations, ingenious folding and mast-raising systems... all in a trailerable package that's ready to go.

Performance  Cruising

410.626.2720 17364 Edgewood Road, Annapolis, MD 21403

www.PerformanceCruising.com

wallas®

SAFEFLAME

85DU/270

Marine Diesel
Stove with Heater Lid

UNIQUE
EFFICIENT
DESIGN

- Safe no-open flame operation.
- Exhaust vented outside, helps keep cabin dry.
- Lid up: cooking. Lid down: cabin heating
- Superb marine grade construction, great looking.
- Easy to install, either flush or surface mounted.
- Super clean, variable output combustion process.

Importer & Distributor for North America:

ScanMarine
EQUIPMENT

2144 Westlake Ave N, Suite D
Seattle, WA 98109
Ph: 206-286-3675
Fax: 206-286-9532
info@scanmarineusa.com
www.scanmarineusa.com

DO YOU SEE WHAT I SEE?



*We have a workshop full of elves
But it's too late to call
The Christmas presents on our shelves
Were ordered in the Fall!*

Happy Holidays!

The 'Re-berth' of Paradise Cay!



Luxury townhomes with gated access and private elevators from \$1,575,000.

Single-family residences from \$2,500,000.

Elevate your style of living at Tiburon's newest waterfront enclave, at San Francisco Bay's newest marina. Our large and luxurious townhomes have private elevator access available, so you can live on all three levels overlooking San Francisco Bay without ever climbing the stairs.

Or choose one of our splendid single-family homes (seven with private, 60-foot boat docks) that redefine the concept of waterfront living. Open daily 10 a.m. to 5 p.m.

Broker Cooperation
tiburonmist.com (415) 435-1342



TIBURON MIST
240 Trinidad Drive At Paradise Cay



LETTERS

be cost effective, and they must reflect a positive image for the military. How does the Travis Marina measure up to these standards?

Mission: The Travis Marina, the bar and grill, and the Travis Sailing Academy exist for the sole purpose of providing recreational services to the members of the Armed Forces. The biggest attraction for the location of the Travis Marina is also its biggest detriment — it's 55 miles from the base and is not served by public transportation. For many young airmen, it would be too expensive to make the trip, even if they did own a car. And once they have participated in sailing activities, they face a long drive back to the base. The distance also keeps the facility out of the day-to-day thoughts of leadership. Many commanders and first sergeants aren't aware that the marina exists and, if they are, they haven't taken time to visit the facility. In any event, the primary purpose of having an MWR site at Horseshoe Cove is not being fulfilled.

Cost Effectiveness: There is a lack of funds designated to the marina, so the docks are literally falling apart. Pilings are rotting and breaking with those being replaced by concrete pours mixed at the dock and poured down a tube that surrounds the rotten timber; the dock fingers lack cleats and are unstable; and the utilities — both water and power — are unreliable, with the power boxes lacking individual circuit breakers. The cost to bring these up to the standards as set forth by Army Corps of Engineers or even the California Department of Boating and Waterways would be in the many millions of dollars, especially given the location and the need to meet all of the restrictions established in the San Francisco Bay Area. The Marina is not cost effective.

Image: As mentioned before, the docks are in disrepair. To add to this problem, red tape and lack of support from base leadership has led to the marina being occupied by a number of dilapidated vessels. Some are absentee owners who may or may not be current with their dock fees. If those owners are not absent, their boats are often covered in mold, dirt, and pollution; the bottoms are covered in marine growth; dock boxes and various boat parts crowd the small walkways; and the lines, often supplied by the marina, are tied together sections of various sizes. The cove is slowly silting in, and is also the dumping ground of the Bay, with dunnage and flotsam, dead animals, and of course, oil spills, all finding their way into the marina. In addition, the Cove has problems with high levels of feces in the water. And although there have been major strides taken to clean up the buildings, the Presidio YC and boatowners have been using the marina buildings for their private storage facility. As a result, the marina is not in 'Spit and Polish Fashion' as should be expected of a military facility, and therefore does not present a positive image.

I support the Air Force having a marina. I support the need for members of the military being able to learn to sail at prices they can afford. Having learned to sail at the Travis Sailing Academy, I support the need for the military members to have a recreational outlet. Until recently, my wife and I ran, on a voluntary basis, the Travis Sailing Academy, making it the most profitable MWR facility at Travis. We had people come from as far as Omaha, to take sail training at our facility, and one of the students became an instructor. As an American Sailing Association facility, we graduated students with an average score of greater than 90%. We'd love to continue to teach sailing — with compensation — for the Air Force.

Having said all that, I don't believe it's in the best interest of the military to maintain the current Travis Marina site. More suitable locations, such as Mare Island, would be better suited for the younger airman if the Air Force wanted to have

**Novice, ancient mariner or olympic rower...
the fun exercise machine you've been waiting for
has arrived.**



The New Whitehall Spirit™ Solo 14

**Comes fully equipped
We sell direct and ship worldwide
Dealer inquiries welcome**

**Watch the video at
www.whitehallsolo.com 1-800-663-7481
See us at the San Diego and the Seattle Boat Shows!**



Carbon Sculls



Slide Seat

**REPAIR
REPAIR
REPAIR**

**ROOSTER SAILS
A REPAIR
LOFT**

- CRUISERS' REPAIRS
- FAST TURNAROUND
- RACING REPAIRS

**YOUR ROLLER
FURLER UV COVER
SPECIALIST**

ROOSTER SAILS

451 West Atlantic Ave., Alameda Pt. (Alameda Naval Air Strn.)
(510) 523-1977

www.roostersails.com • rui@roostersails.com

Open M-Th 9-6 • Fri 9-5 • Sat by appt.

Owned and Operated by Rui Luis • Experienced Sail Repair and Fabrication

NOW OFFERING NEW CRUISING SAILS!

SAIL REPAIR SPECIALISTS • COMPETITIVE RATES • RECUTS • CONVERSIONS

Design and Upholstery

**Happy Holidays
from your friends
at
North Beach
Marine Canvas**

**YACHT:
CARPE DIEM**

**NORTH
BEACH
MARINE
CANVAS**

415.543.1887; nbmc@earthlink.net
www.northbeachmarinecanvas.com
Pier 40, South Beach Harbor, San Francisco

Outboard Motor Shop

Where the professionals shop!

(formerly Seapower Marine)

Season's Greetings and Best Wishes for 2008!



from our family to yours!

BOSTON
WHALER

2007 Model
CLEARANCE SALE

More Fun. Less Fuel.



- Quiet, 4-stroke technology
- Unsurpassed fuel economy
- Transistorized pointless ignition
- Ideal for sailboats, small tenders

IDEAL FOR
SAILBOATS
AND
SMALL
TENDERS



POWERED BY

**HONDA
MARINE**

Meets EPA
2006 & CARB
2008
Emissions
Standards!

© 2007 American Honda Motor Co., Inc.

Always wear a personal flotation device while boating and read your owner's manual.
5-Year Warranty Offer good on all new Honda outboard engines purchased through 3/31/08.
Check with participating dealers for complete details.



BRISTOL FINISH

VARNISH TODAY...

Don't repeat for two to four years!

We use it and swear by it!

RANGER TUGS

R-25

110 hp Yanmar, 3 GPH, cabin heater, diesel generator, air conditioning, fresh water, marine head, 1 burner stove, holding tank.

Call for viewing!



At the
Boat Show

www.outboardmotorshop.com

(510) 533-9290

333 Kennedy St., Oakland, CA 94606 • Fax 510-533-3374

LETTERS

a marina. Public transportation is available, it's only about 20 minutes from the base, and you can add fishing boats to the mix for a full-service MWR facility.

I'd also like to address anchoring at Horseshoe Cove. It's necessary to use a fluted anchor, as plow anchors won't hold in the soft mud. Those who do anchor there will be affected by the tides, currents, gusty winds, and noise from the 24-hour flow of traffic across the Golden Gate Bridge. While an overhead view of Horseshoe Cove might make it appear similar to the Ayala Cove at Angel Island, Mr. Kasiersk has never spent a night on the hook or even tied up to a dock in Horseshoe Cove. It's not the most comfortable place. But one thing is sure, you can't beat the view! So if somebody could dredge the entire cove and did a good job of putting in some mooring balls, you could have a nice view while being bounced around all night.

Jeffrey Keeton, USAF (Ret)
ASA Instructor — CONI
P B & J, Hunter 31
Vallejo

Jeffrey — Thanks to your portrayal, which is as gloomy as a foggy and windy February afternoon in the Cove, it would seem that the marina isn't a good fit with the military. Indeed, we have to wonder how it ever could have been, and are curious what kind of Treasury-draining boondoggle ever created it. Nonetheless, it's a rare and unique marina site, so we think it ought to be made available to folks or organizations with greater vision and resources. Wouldn't you agree?

THE TIME WAS RIGHT BUT THE PLACE WASN'T

On November 12, I visited the Greenwich Observatory in England, GPS in hand, and stood on the prime meridian. My GPS read 51° 28' 677"N, 00° 00' 088"W. I had to walk a couple of hundred feet west in order to get all zeros.

I couldn't get an explanation from the Observatory.

John Hill,
Ariel, Columbia 29
Belmont

John — That's hilarious! We presume, although aren't certain, that there's a very simple explanation, and that it's the same one that results in GPS charts not corresponding with reality in various places in Mexico. The problem is that the charts, which were based on less-accurate pre-GPS navigation methods, are simply wrong. If this is true, we think the folks at Greenwich should create a new, accurate line, and then use both the old and new to show how navigation accuracy has improved over the years.

Speaking of Greenwich, isn't that one of the most bitchin' places in the world for a sailor to visit? For those who haven't been there, the Royal Naval Observatory was established, on beautiful grounds, by King Charles II in 1675 to figure out a



Wanna go back in time 400 years? Visit the Old Royal Observatory at Greenwich, England.

accurate line, and then use both the old and new to show how navigation accuracy has improved over the years.

Speaking of Greenwich, isn't that one of the most bitchin' places in the world for a sailor to visit? For those who haven't been there, the Royal Naval Observatory was established, on beautiful grounds, by King Charles II in 1675 to figure out a

ELECTRONIC / RICHARD

For more than 20 years, yacht owners have been able to trust **PACIFIC COAST CANVAS** for the best in design, service and quality.

• Offshore Dodger™

Welded aft handrail
Bolt-on side handrails
Lexan windshields

• Baja Awning™

Lightweight and waterproof
Durable and easy to launch
Multiple side screen configurations



Ocean sailing veteran Don Durant insisted on a Pacific Coast Dodger for his new Jeanneau 49DS.

• Coastal Dodger™

Affordable designs
Same high quality materials
Same superior workmanship

• Cruiser's Awning™

Easy setup off your dodger
Flies with no bulky frame
Comes with shade screens

Open Monday-Friday 8:00-4:00
Saturday by appointment
(510) 521-1829



**2021 Alaska Packer Place
Alameda, CA 94501
Grand Marina**

South Beach Riggers

**Winning
Technology for
the Hot Race or
the Casual Cruise**

- Expert advice, sales and splicing of Vectran, Spectra, Technora, and Dacron by our certified splicer
- Professional survey and tune for your rig
- Standing and running rigging replacement
- Fabrication and hydraulics
- More than 100,000 miles racing and cruising experience



TWO LOCATIONS

**399 Harbor Dr. • Clipper Marina • Sausalito • 415.331.3400
Pier 40 • South Beach Harbor • San Francisco • 415.974.6063**

SEE THE FUTURE: Forward Looking Sonar

SE-200

Now plugs into your multi-function system or VGA display



The SE-200 does below the waterline what radar does above. Take a look ahead.

www.interphase-tech.com
888.777.6627

**ALWAYS
THINK
AHEAD™**



INTERPHASE
Forward Looking Technology

SOUTH BEACH

H·A·R·B·O·R

South Beach Harbor is a great way to experience San Francisco. Boats of all sizes are welcome in our protected deep water harbor. Bring your boat to South Beach and enjoy all the attractions of the city.



Two guest docks for boats up to 125'

20 guest berths up to 50'

Casual and fine dining nearby

Adjacent to AT&T Park

Easy access to transportation

24 hour security

Free pump-out stations

For Reservations:

415.495.4911
fax: 415.512.1351
sb.harbor@sfgov.com
www.southbeachharbor.com

LETTERS

way to accurately determine longitude, as the inability to do so was causing the loss of many British ships around the world. The Observatory soon became the acknowledged experts in determining longitude. We've been lucky enough to visit a number of times, and have always enjoyed the walk from the park-like grounds of the Observatory to the town of Greenwich,



ELECTRONIC / RICHARD

with the Cutty Sark in the background. While still in the park and just before Greenwich, you see few signs of modern life, but do see the tall masts and broad yards of the Cutty Sark in the distance, so it's easy to imagine yourself in London hundreds of years ago, on your way to your ship, about to set sail for the West Indies.

It turns out de Mallorca wasn't really on the Prime Meridian, so how could it have tickled?

By the way, to show you how cooperative the French can be with the international community, in 1884 delegates from around the world gathered at the International Meridian Conference in Washington to come up with a single prime meridian. At the time, 72% of the world's shipping was using Greenwich as the prime meridian, while the other 28% of the world's shipping were using 10 other prime meridians. The French said they would only accept the prime meridian at Greenwich if Great Britain adopted the metric system. While virtually all of the world accepted Greenwich as the prime meridian, and Great Britain did adopt the metric system, the French went back on their word and kept their own prime meridian for many years.

Greenwich Time is mean solar time, with midday defined as the time at which the sun crosses the Greenwich Meridian, which, by definition, is 0 degrees longitude. Originally, a second was defined as 1/86400th of a mean solar day. But because scientists later determined that the earth wobbles in its planetary orbit, in the '60s a second began being defined by relation to the speed of which radiation was emitted from an atom of caesium 133. No, we don't understand it either. In any event, it was then that Universal Coordinated Time, or UTC, despite the abbreviation being wrong, replaced Greenwich Mean Time, although almost everybody still refers to it as Greenwich Mean Time or GMT. While UTC is based on Greenwich time, it's coordinated from Paris because, you know, the rest of the world had to throw the French a bone to get them to come along and play with everyone else.

By the way, the last time we were at Greenwich, Doña de Mallorca straddled the prime meridian — and said that it "tickled." Since it apparently wasn't the prime meridian after all, do you suppose that she was just putting us on or was the tickling self-induced?

In a typical month, we receive a tremendous volume of letters. So if yours hasn't appeared, don't give up hope.

We welcome all letters that are of interest to sailors. Please include your name, your boat's name, hailing port, and, if possible, a way to contact you for clarifications.

By far the best way to send letters is to email them to richard@latitude38.com. You can also mail them to 15 Locust, Mill Valley, CA, 94941, or fax them to (415) 383-5816.



MODERN SAILING ACADEMY

SAUSALITO, CA

PREPARE TO TAKE THE HELM



www.modernsailing.com

800-995-1668

415-331-8250

GIVE THE GIFT OF SAILING

Gift certificates are available for sailing lessons, skippered or bareboat charters, club membership, day trips, classroom courses, and more!

This holiday season, give someone the skills and confidence to enjoy a lifelong activity - sailing!



Call us now to order your personalized gift certificate. 415-331-8250

Considering a Club Membership?

Become a member! Enjoy club events, BBQs, club sails, discounts on courses and great deals on chartering - up to 40% off!

Monthly Dues Only \$35!

ADVENTURE SAILING with JOHN CONNOLLY

Check our website for future trips.

Caribbean 2007



\$1975 person, \$3555 cabin

Leg 1: Dec 11 - Dec 21 **St. Lucia to Grenada *SOLD OUT!***

Leg 2: Dec 24 - Jan 3 **Grenada to St. Lucia**

Captain's License Course - U.S. Coast Guard Approved



We offer these courses with **On Site Testing** and **On-The-Water Practical**. Our pass rate is **100%**. We **Guarantee** it. Convenient night and weekend classes make this course ideal. **Feb. 2 - March 2**

OUPV (6 pack) - \$995 100 Ton Master - \$1195

COVER CRAFT

An Ode to Dodgers



Order now for summer!

Because Comfort Counts!
Custom designed to work with you and with your boat – and with clear windows!

1230 Brickyard Cove Road, #106
Pt. Richmond, CA 94801
In Brickyard Cove Marina

(510) 234-4400

Quality
Yacht
Canvas

Sail Mexico Aboard the Schooner Seaward Winter 2008



Be part of the adventure!

San Francisco to Channel Islands & LA Dec. 27-Jan 2
Ages 15-19 • \$750/student (limited scholarships available)

Los Angeles to Cabo San Lucas Jan 6-17
All ages, experience levels • \$1,350/participant

Puerto Vallarta & Banderas Bay area
Feb 19-24, \$1,000 & March 2-8, \$1,200/participant
All ages, experience levels

Puerto Vallarta to San Francisco March 12-March 28/31
All experience levels, in good health • \$1,200/participant

www.seawardadventures.org

Seaward, an 82-ft USCG inspected vessel, is owned by Call of the Sea, a non-profit educational organization connecting people to the sea • (415) 331-3214

www.callofthesea.org • info@callofthesea.org



West Marine
Rigging Service

Custom RIGGING by the Experts!

From outfitting traditional cruisers to fine-tuning cutting-edge racers, let West Marine's experienced staff design the ultimate package to optimize the performance and look of your boat. Custom rigging is available through any West Marine store location.



- PowerLite PBO
- Running Rigging
- Standing Rigging
- Dock & Anchor Lines
- Lifelines

Contact us at 888-447-RIGG, or visit our
Onsite Rigging Locations Inc.

Atlanta	San Diego	Seattle
730 Powers Ferry Ave.	1250 Romanow St.	1000 Mercer St.
Ph 518-521-4855	Ph 618-255-8844	Ph 206-292-9653

LOOSE LIPS

Return of Santa Cruz Yachts.

The Santa Cruz 37? Ain't no such animal, you say? Think again. Not only is the 37 on the drawing board, the company that started the whole 'fast is fun' movement in the late '70s is itself on a 'comeback tour'.

"It's a great next boat for Santa Cruz Yachts," said the Wizard himself, Bill Lee. Bill started the business with the SC 27 and put it forever on the map with a 67-ft ultralight missile called *Merlin*. That boat — still thrilling owners and crew all these years later — spawned a whole fleet of Santa Cruz 70s, all of which were 'hatched' in a converted chicken coop in Soquel.

In later years, Santa Cruz Yachts moved to more modern digs in La Selva Beach, producing most recently the line of lovely SC 52s and the cruising-oriented 53C.

The SC 37, the first of which is due to splash next spring, kicks off the next chapter for this storied firm. Designed by California naval architect Tim Kiernan, who penned the lines for Mike Campbell and Doug Williams' 68-ft Cabo Race winner *Peligroso* among others, designed the 37. The boat will feature a carbon deck, hull and mast — but, true to the SC bloodline, will be balanced with comfortable accommodations below.

Also true to the lineage, performance will take precedence over any racing rule. "Santa Cruz yachts has always been a bit of a maverick in that regard," says Kiernan. "The new team at Santa Cruz Yachts said, 'Let's just build fast boats' and that's essentially what we're going to do." They're also ratcheting up another hallmark of the marque: craftsmanship. "We're working with the next generation of materials and construction technology using automotive tolerances with extremely tight specs," says Kiernan.

The only major difference between the 37 and its forerunners: the new boat will be built in Florida.

Missing camera.

Christian Buhl, of the Hughes 45 catamaran *Capricorn Cat*, lost a camera at Bahia Santa Maria during the recent Baja Ha-Ha Rally. It was an older Nikon waterproof camera, of the kind that uses film (remember that?), and had a bright orange 'floatie' strap on it. So it would float. He was in a kayak, traversing the big surf you will read about later in the Ha-Ha article in this issue, and when he got to the boat, the camera was gone.

We know the odds are slim that it will be found by anyone, much less anyone who reads this. But on the off chance that it is, you can reach Christian at christianbuhl4@gmail.com.

"Over my dead body."

You've all heard that one, right? Well, several years ago, one older gentleman fell in love with a certain type of boat and got all the information on price and so on from a broker in Sausalito. But when he told his wife he wanted to order one, she said, "Over my dead body." That was the last the broker saw of the guy until about a month ago, when he walked in and placed the order. In making conversation, the broker offhandedly said, "So you finally convinced your wife to let you get the boat, eh?"

"No," said the man. "She died."

Adventure of a lifetime.

That's what the brochures said, and that's what the 100 passengers aboard the 250-ft 'eco-cruise ship' *Explorer* got. In a scenario way too close for comfort to the *Titanic*, the 2,400-ton Canadian *Explorer* hit ice and began sinking. The incident happened in the wee hours of November 23 during one of the ship's regular runs to Antarctica — an increasingly popular cruise destination. Unlike on the *Titanic*, the crew maintained order and got all 100 passengers and 45 crew into lifeboats.

Featured Trade-In
SWEDEN YACHTS



Move up to the beauty of a Sweden Yachts classic 1984 Sweden 36

Superb sailing characteristics, comfortable teak interior and quality construction combine to make this an exceptional find for the discerning West Coast sailor.

- Teak Decks
- Beautiful Interior
- Comfortable Cockpit
- Lots of Storage
- Lines Lead Aft
- Private Sleeping

Call for appointment
Asking \$75,000

Available for Demonstration
NEW HANSE 350



Hanse 350

After unprecedented success with her introduction in Europe, the stunning, new Hanse 350 is ready to impress sailors on American shores.

See it at our San Rafael sales dock

LRM

Larry Mayne Yacht & Ship
 Northern California Hanse Dealer
 General Manager, New Boat Sales, ABC Yachts

(650) 888-2324 • www.hanseyachts.net

DIMEN

Marine Financial Services

"A better way to get a boat loan."

Boat Loans



Loans Starting
 at \$25,000

Fixed Rates

New and Used

Liveaboard

Northern California

Bill Kinstler

866-486-2628

dimenmarine@pacbell.net

Port Townsend Shipwright's Co-op



Celebrating our **25th**
Anniversary!

The oldest boat yard in Port Townsend!

360-385-6138 800-567-8780

www.ptshipwrights.com



*Happy
Holidays,
from Easom Rigging*

2007 was our best year ever...
Thank You!

We look forward to
winning with you in 2008!



1150 Brickyard Cove Rd. Suite B1
Point Richmond, CA 95801
(510) 232-SAIL (7245)
www.easomrigging.com

LOOSE LIPS

They were later picked up by larger Norwegian cruise ship *Nord-norge*. Although everyone had a good chill in the 20-degree air, no injuries whatsoever were reported in the incident. *Explorer's* captain and mate stayed aboard for a time in a last-ditch effort to save the ship, but they, too, were eventually evacuated. The 40-year-old ship sank in 2,000 feet of water about 25 miles from King George Island in the South Shetlands. The irony was not lost on anyone that the unspoiled, pristine beauty they had paid \$7,000 to \$16,000 apiece to see is what did the ship in.

Top 10 boat babes.

If you look really closely through some of those old Hobie Cat ads, the ones with the pretty 'California girl' hiking out, you may recognize her. Young Mary Collins grew up to become Bo Derek. Her father, Paul Collins, was a sailor, boat broker and ad guy who worked for Hobie for a while.

Boating brew.

Last month, a small employee-owned brewery in Oregon took top honors in the extremely competitive 'Premium Lager' category of the World Beer Awards. Its name? Full Sail. We just want to mention that we would be glad to, um, test any of their labels any time there's a need for . . . you know . . . professional courtesies.

London calling.

I was born so long ago that I grew up before the era of gasoline. As a result, I am old-fashioned. I prefer a sailboat to a motorboat, and it is my belief that sailing is a finer, more difficult, and sturdier art that running a motor. Gasoline engines are becoming foolproof, and while it is unfair to say that any fool can run an engine, it is fair to say that almost anyone can. Not so when it comes to sailing a boat. More skill, more intelligence, and a vast deal more training are necessary. It is the finest training in the world for boy and youth and man. If the boy is very small, equip him with a small, comfortable skiff. He will do the rest. He won't need to be taught. Shortly, he will be setting a tiny leg-of-mutton and steering with an oar. Then he will begin to talk keels and centerboards and want to take his blankets out and stop aboard all night.

But don't be afraid for him. He is bound to run risks and encounter accidents. Remember, there are accidents in the nursery as well as out on the water. More boys have died from hothouse culture than have died on boats large and small; and more boys have been made into strong and reliant men by boat-sailing than by lawn-croquet and dancing school.

And once a sailor, always a sailor. The savor of the salt never stales. The sailor never grows so old that he does not care to go back for one more wrestling bout with wind and wave. I know of it myself. I have turned rancher, and live beyond sight of the sea. Yet I can stay away from it only so long. After several months have passed, I begin to grow restless. I find myself daydreaming over incidents of the last cruise, or wondering if the striped bass are running on Wingo Slough, or eagerly reading the newspapers for reports of the first northern flights of ducks. And then, suddenly, there is a hurried packing of suitcases and overhauling of gear, and we are off for Vallejo where the little Roamer lies, waiting, always waiting, for the skiff to come alongside, for the lighting of the fire in the galley stove, for the pulling off of gaskets, the singing up of the mainsail, and the rat-tat-tat of the reef-points, for the heaving short and the breaking out, and for the twirling of the wheel as she fills away and heads up Bay or down.

— jack london

(from an article entitled 'The Joy of Small Boat Sailing' in *Country Life in America* magazine, August, 1912.)

ELLIOTT / PATTISON SAILMAKERS

Load Path Membranes now available

Great Sails, Great Service, and Great Prices... Made in our loft in Newport Beach

As Load Path Membrane sail technology continues to develop we are committed to providing the proper solution for your application, whether it is a Load Path, D4, D3, or tri-radial paneled sail.

*Call us now for a quote
and see how competitive
these sails are: both on
the race course, and the
budget!*

**For information:
949 645-6697**

LA Harbor Area:
Steve Dair 310 619-7245

Marina Del Rey:
Doug Johnstone
310 528-2146

Oceanside: Lee Pryor
760 529-0062



Antrim 40 "XL"

**The Only Sailloft
in Newport Beach**

870 Production Place

(949) 645-6697

Newport Beach, CA 92663



FISHING FOR SAVINGS...THIS IS THE BIG ONE!!!

FREE 15-Point Engine Check with Bottom Painting Package

--- DECEMBER ONLY ---



Ask us about our FREE shuttle back to your car or marina & courtesy boat wash before delivery.

Keefe Kaplan Maritime, Inc.

www.kkmi.com * Ph. (510) 235-KKMI (5564)
530 W. Cutting Blvd. * Pt. Richmond, CA 94804

Cool stuff!



Great holiday gifts for sailors...

NORTH gear

800-sail-123 ext. 653

www.northsails.com

The difference between a boat and a yacht



- Mobile Service: We Deliver!
- Washing
- Waxing
- Varnishing
- Interior Cleaning



Westwind

Complete Yacht Care

Serving the entire Bay Area for more than 20 years



(415) 661-2205

Pier 40, South Beach on the Embarcadero • San Francisco

Call Toll Free **888-828-6789**



westwinddetailing@sonic.net
www.boatdetailing.com



the accidental house guests

"Someday this will be funny," someone muttered in the darkness, the obvious implication being that the situation was not terribly funny at that moment. The unseen speaker was one of 72 Baja Ha-Ha participants who'd become stranded ashore overnight at Bahia Santa Maria without any means of returning to their boats.

The abnormally large swells — said to be remnants of huge South Pacific storms more than 1,500 miles away — that had been rolling through the anchorage all day and piling up sets of 4- to 6-ft breakers on the beach, forced Ha-Ha'ers to flag rides ashore with *pangañeros*. But as the party wound down, the surf only got worse, resulting in the Grand Poobah imploring everyone to stay put for their own safety, and sleep on the beach rather than attempting the surf crossing in darkness. That was an extremely unpopular idea as many were dressed only in swim trunks and T-shirts, and some were still soaking wet and shivering from romping in the tidepools.

Within minutes, however, debate became irrelevant when the last working *pangañero* announced that he would make no more runs. "*Es muy peligroso*," he reported in earnest — this from a guy who is accustomed to sea travel at night and for whom the tenets of machismo are innate. It was then that the grim reality hit: We would all have to find shelter for the night in or around the fish camp.

In their humble way, however, the fisherfolk couldn't have been more hospitable. Back at the 20- x 30-ft cookhouse, the fishermen's wives fired up their stove and cooked all their remaining seafood. When that was gone, those who were hungry were offered rice and beans.

Victor, the head honcho, arranged for a family with kids, as well as several other groups, to use his four plywood cabins, then rustled up a few cots and blankets for several sailors. A few spirited folks decided the best course of action was simply to party all night with the few remaining fishermen. But the vast majority congregated in the shelter of the cookhouse, feeling lucky if they could claim one of the many randomly arranged plastic chairs as accommodations for the night. With its four walls, peaked roof and slab floor, it was, at least, shelter from the wind and warm enough due to ample body heat.

By 10 p.m. it was clear that most of the cookhouse refugees were ready to sleep — or at least try to. So we shut off the lone lamp and everyone did their best to find a tolerable position. Within minutes, though, the first snorer sounded from somewhere on the south side of the room. Followed by a second, on the north side. A chair squeaked on the cement floor as someone squirmed to get comfortable. Then another and another. Then yet another snorer bellowed, deeper than the others, garnering a few muted giggles plus a few muffled curses. On the rooftop, the drone of a wind generator accentuated the sound of the night wind. At least one refugee made a pact with himself never to go anywhere again — even to the beach — without earplugs.

About 20 minutes into what was obviously going to be a very long night, a new element was added to this darkly comic chaos: The first of many would-be sleepers decided he had to pee, and did his best to shuffle toward the door in the blackness past outstretched legs, chairs and whole bodies lying prone on the cement floor. The power of suggestion soon had others rising and inching toward the exits, each failing miserably in his or her attempt to tiptoe out unnoticed.

When the first hint of dawn loomed over the eastern horizon, a band of stiff-necked survivors shuffled outside toward the firepit, where a jovial fisherman tossed a cupful of gasoline, then a match onto an empty beer box. The bleary-eyed sailors huddled around it, staring toward the creeping sunrise in silent celebration, each waiting for the dull roar of the first outboard. When one did, the cookhouse doors burst open and out poured a squinting mass of survivors, quickly saying their goodbyes to the fisherfolk and stumbling toward the beach.

For most, it had been a long, lousy night. Yet all, no doubt, realized that it was all part of the great adventure called cruising.

— andy

the new

In an effort to step up national security, Secretary of Homeland Security Michael Chertoff announced plans recently for a new anti-terrorism initiative that would screen and inspect small recreational boats for nuclear threats. "I haven't heard anybody talk about small boats," Chertoff said, "and a nuclear bomb on a small boat can do just as much damage

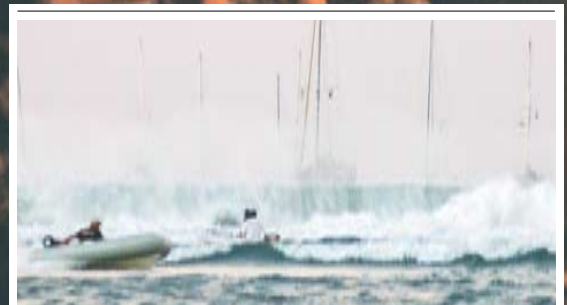

Spread, 'The Castaways' greet dawn's early light at Bahia Santa Maria. "Here's an idea, let's vote everyone off the island today!" Inset, the rollers that left everyone stranded in the first place.

terrorist threat

as one in a container.” Of the country’s 17 million small rec boats, it wasn’t clear exactly which — or how — boats would be inspected. We’re certain we won’t be the only ones closely watching the pilot programs in San Diego and Puget Sound.

The Coast Guard is also looking for a new federal requirement that all boat

continued in middle column of next sightings page

sorcery’s new home

If you’ve always wanted to race on a maxi, your ship — literally — may have come in. She’s *Sorcery*, the 1983 Mull 84 built for Southern California’s legendary Jake Wood, and she’s always been berthed at Marina del Rey. During the great Clipper Cup years in Hawaii, the big red boat was arguably the fastest maxi in the world. And while no longer the fastest of her size boat-for-boat, earlier this year, Wood won the MEXORC for the sixth time, reportedly correcting out first in all eight races. She’s that race-ready.

continued on outside column of next sightings page



PHOTOS: LATITUDE / ANDY

SIGHTINGS

***sorcery* — cont'd**

Sorcery was recently purchased from Wood's estate at a bargain price by Brit John Walker, who recently relocated to Northern California. Walker is one of the few big boat owners who knows what the bow of a big boat looks like. A lifelong sailor who started in dinghies, Walker raced his Excalibur 36 *Astelot* out of Sydney to destinations in Australia and around the South Pacific. He was also the bowman on various big boats, including the 83-ft *Anaconda*, the 83-ft *Batavia*, the 75-ft *Buccaneer*, and others.

Improbably, *Sorcery's* regular berth will be next to Walker's cruising boat, the Hunter 48 *Artemis*, at Glen Cove Marina, just past the Carquinez Bridge on the way up the Delta. And she'll race for the newly formed Glen Cove YC. Walker believes that Glen Cove is ide-

continued on outside column of next sightings page

threat

operators — and we now know from the Clear Lake case, that means anyone on board who might ever have the tiller in their hand — carry ID so they can keep track of who enters restricted zones. They're also pushing for mandatory boater education — not a big issue since 46 states already require it. Even the Boat Owners Association (aka BoatU.S.) isn't opposed to the plan, as long as operators don't have to carry separate ID or install expensive tracking devices.



SPREAD: ELECTRONIC / RICHARD; INSETS: JOHN WHITE

— cont'd

We asked *Lectronic Latitude* readers if they thought the plans were Big Brother run amok or a necessary precaution. Here's what they said:

"The concept of Big Brother boarding my boat for no reason except that I might be a terrorist is absurd and frightening."

— Steve Morrow

"This administration is doing everything it can to create a police state, using the pretext of protecting us from terror-

continued in middle column of next sightings page



'Sorcery's new owner, John Walker, is looking for a few good men and women to crew aboard this legendary yacht.

sorcery — cont'd

ally situated for *Sorcery* as, within minutes, the big boat can be out sailing in the open and uncluttered waters of San Pablo Bay for crew training, yet quickly return to sunny and sheltered Glen Cove. Not to put a damper on things, but we can't help but wonder if there's enough water in mostly-shallow San Pablo Bay for a boat that draws nearly 14 feet to really stretch her legs.

Even more improbable is the fact that Walker, who will manage the boat himself, is looking for crew — 48 to be exact — to become part of the *Sorcery* team. He's looking for amateur men and women for all positions, from helmsmen on down, to race the legendary boat. He intends to race her locally as much as possible starting this month, but plans to do the revitalized Los Angeles to Tahiti Race in June of next year, then continue on to Australia for the Sydney Hobart. After the South Pacific, the boat will be brought back to California.

Not originally from California, or even the States, Walker knew of *Sorcery* by worldwide reputation, but has only a sketchy understanding of her 24-year history. As such, he'd love to hear from folks who have raced on her. No matter if you're interested in becoming part of the crew, or have info and stories to share, you can contact Walker by going to www.sorceryoceanracing.com. We're making you go to the website to get the phone number just to encourage you to check out Walker's hotel in Bath, England. An obviously proud Walker also encourages the curious to drive to the Glen Cove Marina to check *Sorcery* out from shore, saying she's much more impressive in person than in photos.

We at *Latitude* think Walker is doing a grand thing by taking over the reins of *Sorcery*, and wish him the best of racing luck and sailing pleasure.

— richard

hot case files — good timin'

Sometime during the evening of Saturday, November 10, Chris Perkins' J/105 *Good Timin'* was stolen from its slip at San Francisco Marina. So began one of the most emotional roller coaster rides of Perkins' long sailing career, and one of the weirdest 'true crime' stories we've ever reported on.

Even as we were finalizing details of the theft Monday morning for that day's *Lectronic Latitude*, Perkins called back to report that he'd been contacted by the Coast Guard — who had found the boat off Pillar Point.

Here's the story as we understand it:

Late Saturday night, in pouring rain, a fellow named Dan climbed aboard *Good Timin'* and got into the boat through the forward hatch. (For reasons you will understand in a minute, we are withholding Dan's last name.) After that, it was a relatively easy matter to open the companionway, start the engine, and motor out. It's unclear whether he did that late Saturday night or sometime Sunday, but *Good Timin'* was gone by the time Perkins' partner Dave Wilson went by the marina in the early evening.

Dave called Chris and asked "Where's *GT*?" Neither had authorized anyone else to take the boat out, but it wasn't until each had made a few more phone calls and met up at the marina that they realized the boat truly had been stolen. Perkins' attempts to make a police report met limited success.

"Monday morning I went to the police station with all my documents and pictures. They were closed for Veterans Day," said Chris. "The harbor master also wasn't working. I called the Coast Guard, but they said they didn't take stolen boat reports and would wait to hear from the police"

Accepting the logic that the boat could be halfway to Mexico by the

continued on outside column of next sightings page

SIGHTINGS

good timin' — cont'd

time that happened, a nice person at the Coast Guard finally took his faxed information and walked it around the office.

Fast forwarding to mid-day, the Pillar Point assistant harbormaster got a cell phone call from a guy claiming distress offshore. He called the Coast Guard, and they went out to assist. What do you know — the boat in trouble was none other than *Good Timin'*.

When the wetsuit-clad man aboard saw that his saviors were the Coast Guard, he jumped in the water and tried to swim away.

Once hauled back aboard, Dan — a local sailor in his mid-30s — claimed he had “fallen in love with the boat and just wanted to go for a sail.” Turns out Dan has done a lot of local sailing and racing, and Perkins said that he had rigged the boat fairly well, even the asymmetrical spinnaker and sprit pole. But it was obvious to everyone concerned that Dan was not thinking correctly. As if to underscore the fact, when Perkins went below he found numerous items missing, including the cupboard doors, companionway ladder, engine cover, engine belts and so on. Even the engine mounts had been partially unbolted. Dan was apparently throwing almost anything and everything he could get loose over the side as he headed down the coast. When asked why, he reportedly replied, “The boat surfs faster down the waves.”

There was no food on board. And the only gear that Dan had was a bag of clothing, but no foulies. Officials speculated that he might have been planning to return to the Bay, since he mentioned his car was still parked in the StFYC's parking lot.

Dan was arrested, held for a few days and released. For his part, Perkins says he went through “all the stages of grief” over the brief loss of the boat, and was fully prepared to throw the book at Dan. Upon seeing the situation firsthand, however, most of the anger went away and he says he ended up just feeling sorry for the guy. “I'd like him to have a chance at putting this behind him quickly, and the best way to help him is to not publish his last name,” Chris said. We honor that request here, and give Perkins a tip of the hat for being such a stand-up guy.

Except for the missing gear and a few scuffs and scrapes from departing the dock, *Good Timin'* appeared to be none the worse for wear. Chris and his brother towed the boat home behind a Protector the next day and, by the time you read this, she will have been pulled for an insurance survey.

— lc & jr

more boat thefts

Good Timin' wasn't the only boat stolen last month. In Florida, 35-year-old Daniel Johns thought it would be a good idea to steal Robert Caco's Morgan Out Islander 41 *Segue* from its slip near Naples. On November 1, Caco dropped by the marina to check *Segue's* lines before Tropical Storm *Noel* hit — the lines were in great shape, but there was no boat attached to them.

Caco immediately called the police and began searching for his “little home on the water” from his daughter's small plane. He'd just returned from a 10-day cruise a few days before, so he knew the thief couldn't have made it far traveling at six knots. On Sunday he got the call that the Coasties had found *Segue* 30 miles north of Cuba.

Johns was alone on the boat, and authorities found no evidence

continued on outside column of next sightings page

threat

ism. The terrorists who are the most likely to cause us harm are in D.C., mainly in the White House.” — Jeff Hoffman

“We do not need this becoming another ‘airport security sieve’ wherein the huge effort at inspection and control becomes clearly futile, judging from the tests that have been run. It provides another deterrent where none exists, but is clearly not a failsafe answer.” — John McNeill

“Before people get bent out of shape about having a ‘police state’, they should



'Good Timin', four time Big Boat Series winner, was stolen last month — and found in just two days. Take this as a reminder to beef up your own boat's security system.



LATITUDE / JR

— cont'd

ask themselves how big the vessel was that nearly sank the *USS Cole*. I rest my case.” — Ramos

“Another way for someone in a uniform to harass and terrorize the recreational boater. A big waste of taxpayer money. How are they going to control small radio-controlled model boats (like drones) from doing harm?” — Klaus Kutz

“Security measures do need to be adopted, but so as not to supplant our free-
continued in middle column of next sightings page

boat thefts — cont'd

of contraband. Drug and human trafficking are common activities in Florida, but police have not been able to determine Johns' motive for the theft. He's been charged with grand theft.

Then on November 6, 26-year-old transient Giovanni Stoll was running from cops after carjacking an SUV in Panama City. Instead of trying to outrun the police, Stoll drove the commandeered Silverado into a bayou and swam out to a moored sailboat. The cops watched with amusement from shore as Stoll struggled to raise sail while the sheriff's 27-ft Boston Whaler, equipped with two 225-hp engines, bore down on the thief. He surrendered without a struggle.

These three thefts should bring it home to readers that our boats
continued on outside column of next sightings page



CHRIS PERKINS

SIGHTINGS

boat thefts — cont'd

are sitting ducks for thieves. The locks on most boats we see are wimpy at best, if they're even locked at all, and many boat owners we know keep their engine keys close at hand and easy to find. As winter closes in and your trips to the marina grow more infrequent, take a good, hard look at your boat's security and figure out ways to beef it up. Move anything that could easily 'walk away' (snatch blocks, outboards, BBQs) into the boat or your garage, talk with your neighbors about a 'marina watch', take the engine keys home, install an engine kill switch and upgrade your locks.

— *ladonna*

threat

dom. The terrorists have won yet one more time, not by attacking our shores, but by breaching our civil liberties, the real fabric of America." — Marc Longwood

"Homeland Security can't even carry out its present mission, let alone check my Potter 15 for nukes! Secretary Chertoff should be more concerned with all the cargo coming into our ports everyday . . . unchecked." — Dan Phy

KKMI's Julio Chincilla expertly applied three different paints to our hull. Will the experimental paints, below right, be as effective as the tried-and-true-but-not-very-eco-friendly copper paint? Only time will tell.



— cont'd

"When a Coast Guard ship comes by to check me out, my response is 'Go ahead guys and THANK YOU!' I'd rather put up with a little inconvenience and live to see another day than stubbornly parrot a tired, anti-establishment mantra about 'civil liberties'." — John Barreiro

"Thank God I live in a free country, not the USA." — David Howie, New Zealand
— *ladonna*



nice bottom

Anti-fouling paint is a necessary evil for boaters. No one really wants to add more toxins to our waters but, so far, eco-friendly bottom paints have proven to be less than effective, especially when compared to copper paints. The fervor over the environment in the last few decades has spawned a number of 'green' anti-fouling solutions — everything from copper-flecked epoxy coatings to cayenne pepper-based paint — but none has held a candle to good old cuprous oxide.

Except that cuprous oxide isn't good at all, at least where the environment is concerned. It's the main ingredient in many of the most effective — and popular — paints on the market, with content as high as 70%. As soon as the paint comes in contact with water, copper starts leaching out, preventing crusty little critters from attaching to your hull. Unfortunately, it doesn't just target barnacles. Several studies have shown that other filter feeders, such as mussels, oysters and scallops, are negatively affected by copper as well.

The stuff also tends to accumulate, rather than dissipate. The EPA allows a Total Maximum Daily Load (TMDL) of 3.1 micrograms per liter (ug/L) of dissolved copper in U.S. waters. In well-protected, and consequently slow-flushing, harbors like San Diego, Newport Bay and Marina del Rey, the level of copper in the water is closer to 13 ug/L or higher, the great majority of which can be directly attributed to anti-fouling paint. As a matter of fact, the 2,000 boats in the back basin of Marina del Rey leach nearly 3,700 lbs. of dissolved copper every year.

A plan implemented by the San Diego Water Board in 2005 calls for a 76% reduction of dissolved copper in San Diego Bay over the next 15 years (a similar plan has been set up for Marina del Rey). Since the highest concentrations of copper are in marinas, it seems clear boaters will be hit hardest by any new rules or restrictions on copper-based products. Several European countries have already banned copper bottom paint on rec boats, and some think the U.S. isn't far behind.

The good news is that companies are constantly working on effective replacements for cuprous oxide. One such company is Janssen Pharmaceutica, a division of Johnson & Johnson. Over the last 10 years, they've spent millions developing the biocide Ecomea, a compound that appears to work as well as copper but is significantly less toxic and biodegradable. Janssen has already registered Ecomea with the federal EPA and now is working on California registration, but the state requires efficacy data in the form of studies.

In late September, Janssen partnered with KKMI in Richmond to haul and paint Bay Area boats with copper-free Ecomea paint. In the September 21 edition of *Lectronic Latitude*, we put out a call for volunteer bottoms to join in the study, and the response was overwhelming. KKMI's Bob Hennessey reports he had more than 25 qualified candidates but could only accommodate four boats. In desperate need of a bottom job ourselves — and, of course, always up for doing our part for the environment — we volunteered our own very dirty bottom and were among the four selected.

Of course we, along with the other test boats, had to meet several requirements before being considered for the study: 1) We have to keep our boats in the area for the next year

so they can be hauled every six months for inspection; 2) We had to have a hard/non-ablative paint on our bottoms already (unlike many 'green' paints, Ecomea is chemically compatible with cuprous oxide);

continued on outside column of next sightings page



bj — cont'd

3) We absolutely, positively, no matter what cannot scrub our bottoms during the testing period — doing so would skew the results; 4) The first haulout and application of the paint was on our tab, while the paint and follow-up haulouts are free; and 5) We had to like black, as that was the only color available.

Several different paint companies developed formulas incorporating Ecomea into copper-free anti-fouling paint for the study. "This is the first generation of these paints," said Dave Helmer, Director of Janssen PMP, "so after these tests, the paint companies will start getting really creative. If the old copper paints consist of 70% copper, and then you take all that copper out and replace it with the recommended 3-6% Ecomea, you have a lot of room to play." Somewhere in the world, a scientist's heart just started beating faster.

Each boat's bottom was divided into three sections and painted with two test paints and one control paint with 67% copper content. Every six months, the boats will be hauled and the paints evaluated. Preliminary testing by the paint companies, who had to show positive efficacy data to even participate in this study, gives every reason to be optimistic. We'll report on the results throughout the study.

Incidentally, Jack Hickey, who is coordinating Janssen's countrywide studies, is looking for volunteer boats in Marina del Rey and San Diego to participate by the end of the year. Remember that you have to keep your boat in those areas for the next year and, while the paint itself is free, you'll still have to foot the bill for the initial haulout and application. If you'd like to volunteer your own bottom, contact Jack Hickey at (732) 319-1435 or harborengineer@aol.com.

— ladonna

anchoring 101

When it comes to sailing, 'A' is for anchoring. Unfortunately, from Paradise Cay in Tiburon to Pillar Point in Half Moon Bay, and from Takatz Bay in Alaska to Turtle Bay in Mexico, lots of sailors deserve an 'F' for their technique. To a certain extent, this general incompetence is understandable, as the average sailor seldom has to anchor and rarely in adverse conditions. Active cruisers tend to be the best at anchoring because they do it often, but they've also learned it's the key to getting a good night's sleep and not losing their boats on lee shores.

At the risk of sounding like a schoolmarm, can we review the basics?

1. Have a big enough anchor and plenty of adequate size rode. If you just sail locally and normally only anchor for the afternoon or overnight in fair weather, you can use the normal guidelines for boats your size. If you're going cruising, you want to up the recommended sizes. Sailing expert Steve Dashew's rule of thumb is that your anchor and rode should be so big that people laugh when they see them. We're not sure we'd go to that extreme, but when it comes to anchors, as well as some other things in life, bigger and longer is better.

2. Technique is critical. In fact, a sailor with great anchoring technique but marginal gear is going to do better than a sailor with the best gear but bad technique.

The technique is simple. Once you find the best place to anchor — an art in itself — you stop your boat. Then, while moving very slowly in reverse, gently lower your anchor to the bottom and pay out more rode at the same rate your boat is moving backward. Depending on the expected conditions, quality of holding and how much room you have, you might put out anywhere from 3:1 to 10:1 scope. No matter how much you put out, gently pull it tight in reverse. Once you've got a good bite, you slowly increase the revs to put some real strain on it. The important thing to realize is that if you can drag your anchor

continued on outside column of next sightings page

this is

Singlehander Jeanne Socrates, who is well into a "fast circumnavigation" aboard her Najad 36 *Nereida*, arrived safely in Richards Bay, South Africa, on November 17, having made the 4,300-mile passage from Cocos Keeling across the Indian Ocean in just 11 days.

Though the trip started out a little bumpy, Socrates reported that the seas calmed, winds died and temps rose just a few days out. Besides some issues with



Spread, Jeanne Socrates hung 'Nereida's nameboard in the beach shack where 'yachties' congregate for sundowners and BBQs on Direction Island. Inset, forget Dungeness, let's have coconut crab!



africa

her communication system, the only trouble she had was a broken shackle on her roller-furling genoa — and the subsequent dunked sail. Just as she was steeling herself to climb the mast to retrieve the halyard, it miraculously slid down within reach.

When her electronics are cooperating, Jeanne posts updates on her website at www.svneraida.com.

— *ladonna*

anchoring 101 — cont'd

with your boat in reverse, you're not really anchored securely.

As you can see, the technique for anchoring well isn't difficult. So where do people go wrong? Not putting out adequate scope is the classic. The next time you charter a boat in a warm weather area, dive on your anchor with different amounts of scope. You'll quickly see how critical it is to have adequate scope. Of course, you don't want to go crazy, thereby reducing 10-boat anchorages to only having enough room for one boat.

The second big anchoring blunder is the so-called 'French method',

continued on outside column of next sightings page



PHOTOS COURTESY NEREIDA

SIGHTINGS

anchoring 101 — cont'd

which is dropping the hook while the boat is still moving forward. It's just as bad to drop the hook when the boat is merely standing still. Both are the classic ways to foul an anchor, and a fouled anchor means dramatically reduced scope and prevents an anchor from working as it should.

The last mistake is not backing down hard to make sure the anchor is well set. If you back down at half speed in reverse and your boat moves, you're not really anchored. A lot of times you can solve the problem by backing down very slowly, which gives your anchor the opportunity to really dig in. Once it's hooked up, back down hard to make sure you're really set. Once you've done that, you've got nothing more to do — but enjoy a good night's sleep.

— *richard*

from here

It's well known that adventure is the world's most powerful aphrodisiac, so it's no surprise that there were enthusiastic entrants for this year's Baja Ha-Ha From Here To Eternity Kiss contest, held in the warm waters on the sandy shore of Bahia Cabo San Lucas. That the contest drew a record number of entrants was probably due to sentimental reasons. Deborah Kerr, the recipient of "the most famous kiss in film history" from Burt Lancaster,



to eternity

had passed on just a month before.

To say that the event was hotly contested would be an understatement. From the moment it started it was a crowd-pleaser. Various strategies were employed — longest kiss, most time underwater, greatest rolling around, limbs most askew, woman on top — but in the end the audience chose Chris and Vicky Nugier of *Wingstar* as the victors.

— richard

having a whale of a time

Recreational sailing got a backhanded boost at the start of World War II. That's when the U.S. Navy decided it needed motorized whale-boats on its ships rather than sailing ones. With the stroke of a pen, hundreds, if not thousands, of the utilitarian double-enders (some of which sported small auxiliary engines) ended up ashore at auctions or surplus stores. Many of them wound up doing civilian duty with the Sea Scouts or other programs. They would be instrumental in introducing legions of kids to sailing, including a particularly large segment who would later be known as baby boomers.

Sixty-some years later, there are only a handful of these craft left,

continued on outside column of next sightings page

Winners Chris and Vicky (not pictured) did the Ha-Ha with their three kids. Their passion for each other was so evident, even through the spray and sand, that we almost thought they were going to start kid #4 right there on the beach.



SIGHTINGS

whaleboat — cont'd

two of which reside in the Bay. One of them, *Viking*, got T-boned by another boat in the summer of 2006 (and is currently undergoing repairs at North Bay Boat Works). The other is the 30-ft *Corsair*, which was designed and built as a ketch at Puget Sound Naval Shipyard in 1938.

"When I joined the Sea Scouts in 1968, there were about 10 whaleboats at the San Francisco Sea Scout Base," says Michael O'Callaghan, a long-time Moore 24 racer and one of *Corsair's* volunteer captains. "The Scout base was built around boats like this, either 30-ft sailing and pulling boats, or 26-ft pulling boats." To haul them out, the Scouts installed Navy surplus battleship davits.

Just as some people stand out in a crowd, there was something special about *Corsair* from the time the Scouts got her in 1950 — something that excited the spirit of adventure in young sailors. Perhaps that was what drove a group of them into the misty streets of San Francisco one dark night in search of a new mainmast. Imagine the look on the face of the fellow who went to raise the flag in front of the Sunset District Scout Meeting Hall the next morning — only to find a sawed off stump where the flagpole had stood. *Corsair* carried that spar for the next 40-odd years. Like the boat, the mast itself gained infamy over the years — for how many times it broke. If the stories are correct, it may well be the most-repaired mast in maritime history.

Corsair herself is looking quite new. The fact is, she was hauled for refurbishment in 1996 and just got relaunched last June. Working around endless funding famines, Al Blair at Marin Boatworks did a splendid job of refastening and reframing the old girl. Last January, the Scouts delivered the bare hull to North Bay Boat Works in Sausalito, who fitted her with a new interior, poured-in-place flotation and new mahogany wash rails, new oak rub rails and lots more. The refurbishment was faithful to her reconfiguration from military duty to civilian. She differs from the original Navy design in several ways: the main and mizzen are a little taller, the rails have been widened for comfort, she has a fin keel rather than a centerboard, and she sports full styrofoam flotation in place of the original copper air tanks.

After her June launch and an initial sail in Aquatic Park on the Fourth of July, *Corsair* ventured into the Bay for a sail . . . and promptly broke her mainmast again. Rather than scarf the old flagpole one more time (the original mast section has gotten progressively shorter over the years as new sections were scarfed above), the Scouts once again turned to North Bay Boat Works to build the splendid new hollow fir spar she sports today. The new mast was stepped just in time for the Scouts' annual two-week cruise up the Delta in early August.

Most recently, *Corsair* took part in the Jessica Cup, a competition for classic craft in October. Look for her to take part in next spring's Master Mariners Regatta, in which she has participated several times. Other than that, you may see her out and about by herself on any given day, introducing yet another crew of smiling youngsters to the wonders and fun of sailing.

The Sea Scouts — a branch of the Boy Scouts — started in America in 1912. It is open to both boys and girls of high school age. There are still Councils and boating programs all over the U.S. The Sea Scout

continued on outside column of next sightings page



LATTUDE / JR

whaleboat — cont'd

Base in San Francisco is located at 3500 Van Ness, on the west side of Aquatic Park.

Sea Scouting has had its ups and downs over the years. These days, there are more diversions than ever for youngsters — including many other fine junior sailing programs at yacht clubs and sailing centers around the Bay. But Sea Scouting is not only hanging in there, it's been undergoing something of a resurgence in the last few years — even reincarnating a national championship for Sea Scout sailors, which had fallen by the wayside sometime in the '80s.

It was brought back into being by none other than America's Cup winner — and former Sea Scout — Bill Koch. The next William I. Koch International Sea Scout Cup (aka the Koch Cup) is scheduled for July, 2008 in New York. It will be sailed in 420s.

For more on the Sea Scouts, log onto www.seascout.org. For more information about the San Francisco Sea Scout program, contact Michael O'Callaghan at mojc@pacbell.net, or log onto <http://wregion3.seascout.org/corsair>.

— jr



NANCY BUSH

Learning the ropes the Sea Scout way. Above, intentional capsizes and rightings are part of regular Sea Scout training. Left, 'Corsair' at the Jessica Cup. Below, happy faces on another new crop of converts. The sails on the boat are all ancient — Hank Jotz made the mizzen, Peter Sutter built the main, and the headsails are all hand-me-downs.



SIGHTINGS

mystery solved

In the August 10 edition of *Lectronic Latitude* we wondered about the origins of a 'Mystery Boat' washed up on an outer island of the Marshalls. We received several colorful theories which we ran in November's *Loose Lips*. They were all wrong.

Unofficial Sausalito historian Derek Van Loan strolled into our Mill Valley headquarters last month with the facts. Van Loan, who's lived and worked in Sausalito since 1967, literally wrote the book on Sausalito's waterfront stories and recalls Larry 'The Wizard' Greetz vividly.

"The Wizard may have been crazy, but he wasn't stupid," Van Loan wrote in his book *Sausalito Waterfront Stories*. "He traded [his 36-ft lifeboat] straight across for *Disko*, a 25-ft dory sailboat built by Herb Manley." The Wizard, it seems, had it in his head that he was going to sail to the Marquesas. Unfortunately, he didn't know how to sail so he asked Van Loan to teach him aboard *Disko*. "To my surprise, the little vessel tacked perfectly the first time," Van Loan recalled of the 1979 lesson. "From that time, The Wizard and *Disko* could be seen sailing along the waterfront every day."

"Then there came a day when everyone noticed they hadn't seen The Wizard in awhile." The commonly held theory was that he had been

sent back to the "funny farm." For months, no one knew what became of the wharf rat, then "The Wizard reappeared as suddenly as he had departed. I noticed the white coral scars that covered his body, and his missing



COURTESY MOANA

Larry 'The Wizard' Greetz sailed 'Disko' to the Marquesas.

ear." Though Greetz was more interested in discussing his new goal of becoming the "champion weightlifter of the world," Van Loan managed to get the story out of him.

Apparently Greetz believed "they" were after him so he left Sausalito under the cover of darkness, headed for the Marquesas. "I sailed and I sailed," he told Van Loan. "I ran out of food, so I caught fish. My hooks rusted away and I had no more food. Then a seabird landed on my bow. I ate him, feathers and all. I sailed on. I was a dead man in my coffin. Then one day my boat stopped. I was on a coral reef!"

It seems he'd drifted for five months until he reached the islands he so desperately sought. He was badly cut swimming to shore from the reef and, once there, lived on cockroaches until he was discovered. "The Wizard was then airmailed to Los Angeles, and the psych ward became home. It was there that a fellow inmate chewed his ear off."

You just can't make this stuff up.

— ladonna

bismarck dinius defense fund

A number of *Latitude* readers have — like us — been outraged by the legal developments following the tragic boating accident on Clear Lake a year ago June that claimed the life of Lynn Thornton.

continued on outside column of next sightings page

call of

For the second summer in a row, Mountain View resident Jerry Borucki sailed his Freya 39 *Arctic Alpha Wulf* north to the Arctic Circle. Borucki left his homeport of Pillar Point on July 7, skirted the North Pacific High and turned right.



Spread, Jerry Borucki spent four and a half months singlehandedly his Freya 39 from Pillar Point to the Arctic Ocean and back again. Above, in the land of the midnight sun.

the wild

But instead of being satisfied by reaching the Aleutians, an amazing feat in itself, the 70-something Borucki kicked it up a notch by sailing through the Bering Strait in search of a viable lead through the pack

continued in middle column of next sightings page

dinius — cont'd

You'll recall that Thornton, along with several others, was aboard her fiancé's O'Day 28 sailboat *Beats Workin' II*, drifting in zephyrs on a very dark Clear Lake following an afternoon of racing. A short time later, off-duty Deputy Sheriff Russell Perdock, with two others, took his high-powered speedboat on the lake for a speed run through the

continued on outside column of next sightings page

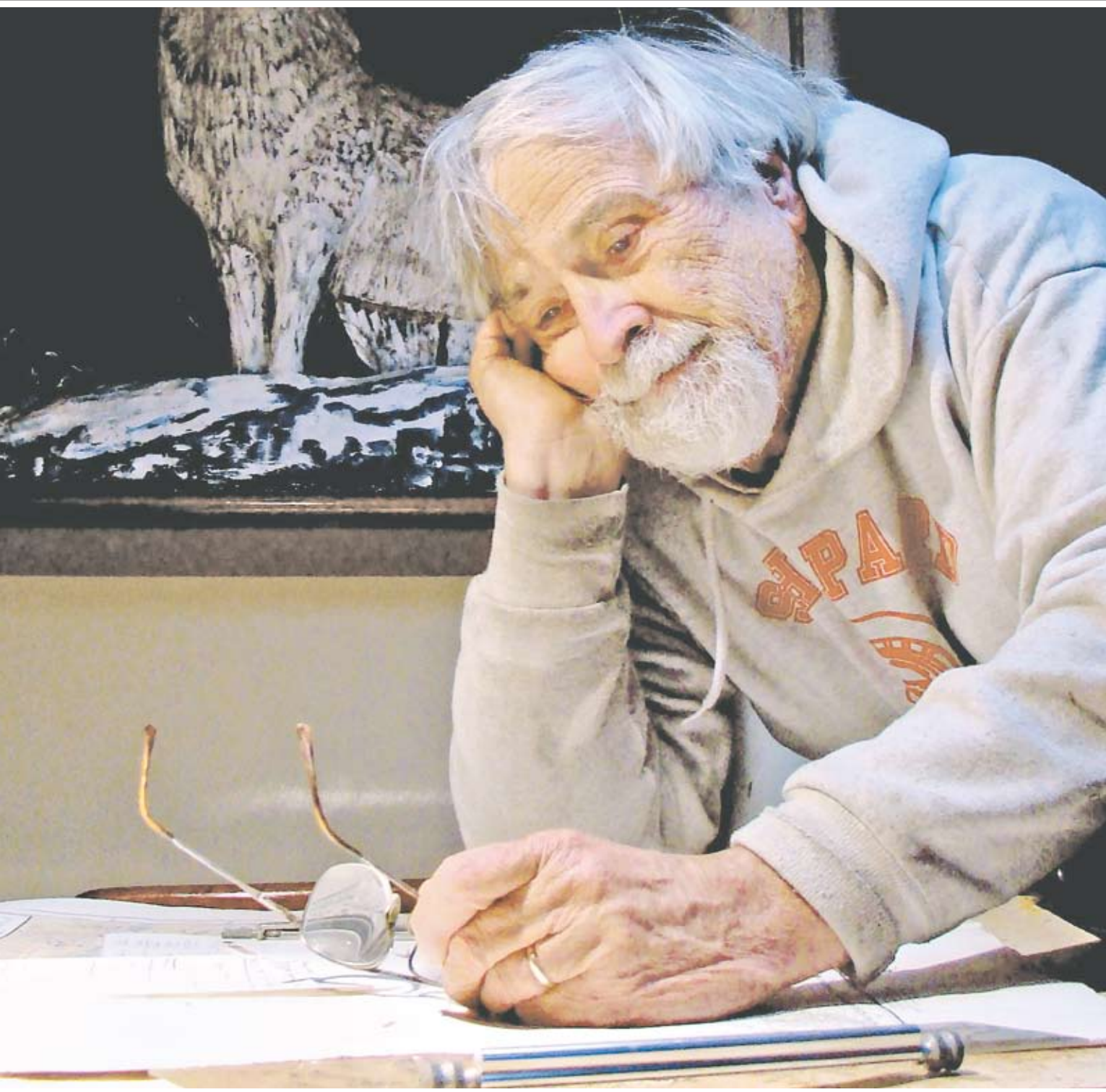

JERRY BORUCKI

SIGHTINGS

dinius — cont'd

blackness. Based on the boat's rpm, Perdock estimates he was doing 40 to 45 mph. Witnesses guessed his speed at 55 mph. Perdock had to be all but blind, not only because there was no moon, but because he deliberately headed toward background lights — exactly what a boat operator is taught not to do.

Whatever speed Perdock's boat was traveling, he never eased off the throttle prior to slamming into the aft quarter of the sailboat.

continued on outside column of next sightings page

wild

ice to the geographic North Pole.

While the pack ice ultimately defeated him, Borucki still managed to make it as far north as 76° 20' 51" N — just 840 miles short of his goal. Deciding discretion was the better part of valor, he wisely chose to head home before the ice trapped him.

Unfortunately, the ride south wasn't



LATITUDE / RICHARD

— cont'd

all downhill from there — he suffered a knockdown, shredded a sail, nearly ran out of diesel and had to take refuge for 16 days along the way. Then he got into some *really* bad weather.

We hope to share Borucki's full story with you next month.

— *ladonna*



dinius — cont'd

Those on the sailboat weren't aware of the presence of the powerboat until a fraction of a second before impact. Thornton would die of her injuries a short time later.

Inexplicably, Perdock told an investigating officer that it wasn't the first time he'd made such a speed run in the dark — despite knowing that it wasn't unusual for people to be on the lake in unlit boats. Further, he foolishly volunteered that he headed for the background lights on purpose so that he might be able to see a silhouette of any boats in his path.

Even more bizarrely, Jon Hopkins, the Lake County District Attorney, who is part of the same Lake County law enforcement system as Perdock, refused to press charges against the deputy. His explanation to *Latitude* was that he would be unable "to prove beyond a reasonable doubt" that Perdock had been operating his boat at an unsafe speed. He really said that, ignoring all the obvious forensic evidence, and ignoring Perdock admitting that he'd been traveling at 40 to 45 mph. We presume Perdock would have had to be traveling at, oh, about twice the speed of sound for Hopkins to think he could convince a jury that it was an unsafe speed.

There are some possibly mitigating circumstances. First, there is a dispute over whether or not the boat's running lights were on. There has been testimony from those on the boat, as well as a marina owner and a retired law enforcement officer, that the sailboat did have her running lights on. An investigator for the Lake County Sheriff's Department — in other words a colleague of Perdock's — said the switch at the instrument panel for the running lights was off.

In addition, Mark Weber, the boat's owner, was well over the limit for being under the influence of alcohol at the time of the accident. He was standing in the companionway at the moment of contact. Furthermore, Bismarck Dinius, who happened to be sitting at the helm position, was also over the limit, although not so much so that he couldn't have legally driven on California highways before the DUI standards were lowered.

California Boating Regulations are ambiguous as to who is actually in command of a vessel. In one part, it says it's the person who makes the normal decisions of the boat. That's what most sailors would agree with. But in another section, it says it's whoever happens to be sitting at the helm position — apparently even if that person were a toddler or had no knowledge of sailing whatsoever. Few, if any, sailors would agree with that.

By using that unusual latter definition, D.A. Hopkins decided not to charge Perdock, who had blindly slammed into the sailboat at high speed. Nor did he charge Weber, the experienced sailor and owner of the boat who was but a few feet from the helm. No, in his infinite wisdom, Hopkins only charged Dinius, whose crime was to be sitting at the helm of an all-but-stationary sailboat when it was hit by a missile coming up from behind on a black night. And Hopkins has charged Dinius with manslaughter and operating a vessel under the influence.

We've relentlessly pointed out the absurdity of the D.A.'s handling of the case, but to no avail. Dan Noyes of Channel 7 News picked up on our story and did a three-part series of his own, also critical of the D.A., but also to no avail. So as it stands now, Dinius, who is a data tech for a cell phone company, is facing a pretrial hearing. If the D.A. is successful there, he will face a criminal trial. No matter what happens, he's had to come up with lots of money to defend himself.

Many *Latitude* readers have asked if they could contribute to a defense fund for Dinius. Now they can. You can send checks made out to Bismarck Dinius, writing 'Bismarck Dinius Defense Fund' in the memo section, and mailing them to Sierra Central Credit Union, Attn: Brian Foxworthy, Branch Manager, 306 N. Sunrise Avenue, Roseville, CA 95661.

We hope you find it in your heart to make some kind of contribution, because from the bottom of our hearts, we believe that Dinius — a man we don't know and haven't met — is getting the total shaft by the the Lake County D.A., and he's getting it so that Deputy Perdock, the one we're convinced should be charged, can get away with manslaughter. Did we mention that the last we heard from Lake County, Perdock wanted to be the Sheriff?

— *richard*

BAJA HA-HA XIV

BROUGHT TO YOU BY THESE OFFICIAL SPONSORS

Grand Opening
2007



MARINA RIVIERA NAYARIT
AT LA CRUZ

• Now accepting reservations • 150-Ton Travel Lift
Call 011-52-322-779-9191 or 011-52-322-293-4064
www.marinalacruz.net or info@marinalacruz.net

GERRY

CORTEZ CHARTS

NAVIGATION CHARTS - CRUISING GUIDES
TIDE TABLES - LIGHT LISTS
GPS POINTS

www.gerrycruise.com

Summer
is safe at
Paradise..



Enjoy
your stay
with us!

011-52-322-22-66728 • www.paradisevillage.com
marina@paradisevillagegroup.com

Making Fresh Water, Worldwide.™



Most energy efficient • Push button operation
Quick & easy installation • Low maintenance

(415) 526-2780

www.spectrawatermakers.com

RIGGING ONLY

Standing and running rigging, lifelines, furlers,
winches, main slider systems, windlasses,
travelers, wire terminals, blocks and more...
Expert advice for selection and installation

Our 22nd Year

www.riggingonly.com



El Cid
RESORTS
marathon coastal concave

Let Marina El Cid
Welcome You to Mexico

A Cruiser's Paradise!

www.elcid.com
qcevallos@elcid.com.mx

011-52 (669) 916-3468

HYDROVANE

SINCE 1968

Survive Your Dream

ECH,O Tec Watermakers

604-925-2660 www.hydrovane.com



The Rally Committee encourages you to patronize

A GRAND SUCCESS!

As you'll read elsewhere in this issue, the 2007 Baja Ha-Ha cruisers rally was a huge success.

Of the 179 boats which signed up, 154 completed the rally — with 601 sailors aboard.

Although the Baja Ha-Ha Rally Committee has officially gone into hibernation until May 1 — when the 2008 event will be officially announced — we can tell you that the rally will begin Monday, October 27, following a kickoff party the day before. The fleet will begin arriving at Cabo on Thursday, November 6.

It's too early to sign up, of course, but it's certainly not too early to start making boat preparations and recruiting crew.

For general info on this, and next year's event, go to:

WWW.BAJA-HAHA.COM

MONITOR
WINDVANE™
and other windvanes

SOS Emergency
Rudder

SCANMAR
INTERNATIONAL

Factory
Direct

432 South 1st Street • Pt. Richmond, CA 94804
Tel: (510) 215-2010 • Fax: (510) 215-5005
email: scanmar@selfsteer.com • www.selfsteer.com

Boat Electronics. Done right ... priced right.

CAL MARINE
ELECTRONICS

Sales - Installation - Service - Integration

415-391-7550
www.calmarineelectronics.com

marina mazatlan

Not just a marina — a cruiser's community
Your best destination across the Sea...

www.marina-mazatlan.com

011-52 (669) 916-7799

elizarraga@marinamazatlan.com

Satellite Phone

Rentals • Sales • Accessories



High Speed Satellite Internet Access

888-884-7623

www.allroadsat.com

San Diego, CA

OPEQUIMAR
MARINE CENTER CENTRO MARINO

A Full Service Boat Yard in Puerto Vallarta
88 ton Travellift • Parts • Service • Repairs

011-52 (322) 221-1800 www.opequimar.com
info@opequimar.com

Almar
Marinas The West's Finest

The West's finest marinas, with locations at
Alameda, Treasure Island, Oakland, Ventura,
Oxnard, San Diego and Hawaii.

800-307-ISLE (nationwide) • www.almar.com



the advertisers who make this event possible.

Mexico Cruising Insurance
Blue Water Insurance
 (800) 655-9224 • (619) 226-6702
 Fax: (619) 226-8513
 Mexico full or part-time • Crew of two
www.bluewaterins.com

COSTABAJA RESORT & MARINA
 Located in La Paz, we are the newest, best and most secure marina in all of Mexico.
 Contact us at: CostaBajainfo@BellPortGroup.com
 Tel. from U.S.: 011 52 612 121 6225
www.costabajaresort.com

DOWNWIND MARINE
 THE CRUISER'S CHANDLERY
 www.downwindmarine.com
 info@downwindmarine.com
 (619) 224-2733 • Fax (619) 224-7683

The southbound cruiser's source for EVERYTHING!
Can't Wait to Outfit?
 Use our website to order early!

The Watermaker Store 619-226-2622
 A DIV. OF PACIFIC CONSOLIDATED INDUSTRIES, LLC
 CALL US about Watermakers, Generators, Combos or Diesel Re-power, we will design and install a system to meet your needs in time for the BAJA HA HA.
sales@watermakerstore.com • www.watermakerstore.com

YACHTFINDERS/ WINDSEAKERS
 Professional yacht brokers located in the heart of San Diego's boating community. Specialists in cruising sailboats for 26 years
 info@yachtfinders.biz • www.yachtfinders.biz
 866-341-6189 • 619-224-2349
 Fax (619) 224-4692

www.MexicoBoating.com

- ✓ **Baja Bash II** Capt. Jim Eifers
- ✓ **The Baja & Sea of Cortez Anchorage Map (fold out)** Hemingway-Douglass
- ✓ **Mexico Boating Guide**
- ✓ **Cruising Ports: the Central American Route** Capt. Pat Rains

West Marine
 We make boating more fun!
 Call 1-800-BOATING
 (1-800-262-8464)
 for a catalog or the store nearest you.

Ventura Harbor Boatyard
 Full & Self Service Facility • Up to 165 Tons On-Site Chandlery
 (805) 654-1433 • www.vhby.com
 1415 Spinnaker Drive, Ventura, CA

The perfect solution for long line storage on your vessel!
 Marine Products from the World to the USA
QuicklineUSA
 15561 Computer Ln, #A, Huntington Beach, CA 92649
 714-843-6964 714-843-6906 fax
www.quickline.us or info@quickline.us

TOTAL YACHT WORKS
 Your Authorized Yanmar Dealer is now in the new harbor boat yard facility next to Marina Mazatlan. E-mail: TotalYachtWorks@hotmail.com
 See: www.TotalYachtWorks.com
 Phone: 011-521-669-117-0911
 Call: VHF channel 22
YANMAR marine
 "We Fix What Won't Work"

MARINA DE LA PAZ
FULL SERVICE MARINA
 New breakwater • New docks
 New U.S. #: (619) 618-0615
 Tel: 011-52 (612) 122-1646
 email: marinalapaz@prodigy.net.mx
www.marinadelapaz.com

KATADYN
 MAKING WATER DRINKING WATER
 Watermakers that improve the cruising lifestyle.
 (800) 755-6701
marine@katadyn.com

MARINER'S GENERAL INSURANCE GROUP
 OD36887
 Cruise with Confidence
 (800) 992-4443
www.marinersinsurance.com
 See Our Half-Page Ad In This Issue
 Newport Beach, CA • Burlingame, CA • San Diego, CA • Seattle, WA • Bradenton, FL

San Diego
 Turtle Bay
 Bahia Santa Maria
 Cabo San Lucas

NOV. 1
 NOV. 5
 NOV. 8

They're on their way to the Cape!

If you're sorry to have 'missed the boat' this year, there's always next year. Baja Ha-Ha XV will begin on October 27, 2008. Look for the official announcement in *Latitude 38's May Sightings* section.

Baja Ha-Ha Inc.
 401-F Miller Ave., PMB 140
 Mill Valley, CA 94941
www.baja-haha.com
 There is no phone number for the Baja Ha-Ha. And please don't phone Latitude 38 with questions, as the Ha-Ha is a completely separate operation.

BAJA HA-HA '07

"The big thing is the date," agreed Wayne Hendryx and Carol Baggerly of the 45-ft *Capricorn Cat*. They were the umpteenth owner/skippers over the years to pick that as the #1 best thing about the Baja Ha-Ha, the 750-mile cruiser's rally that departs San Diego in late October and arrives in Cabo San Lucas about 10 days later after stops in Turtle Bay and Bahia Santa Maria.

"To have that date — that deadline when you *have* to be ready to go — is absolutely at the top of my list," said Wayne. "If I didn't have that, I'd still be back home working on this boat."

"And the worst thing?" said Carol — "Having that date!"

The Date' this year was October 29. That's when 156 boats assembled off Coronado Roads for the start of Baja Ha-Ha 14 — 154 boats and 601 sailors officially made it across the finish line. They ranged in size from the Rawson 30 *Del Norte* to the Farr 58 *Tribute*. As in previous Ha-Has, there was even a motorboat contingent, although this year the *No Comprendo* Division had only one entry, Mark and Lynn Acosta's Bertram 35 *Wahoo*, out of Dana Point.

The rules of the Ha-Ha are simple

Sometimes, when you least expect it, visitors will drop by to say hello. En route to Cabo, Ha-Ha'ers saw dozens of dolphin.

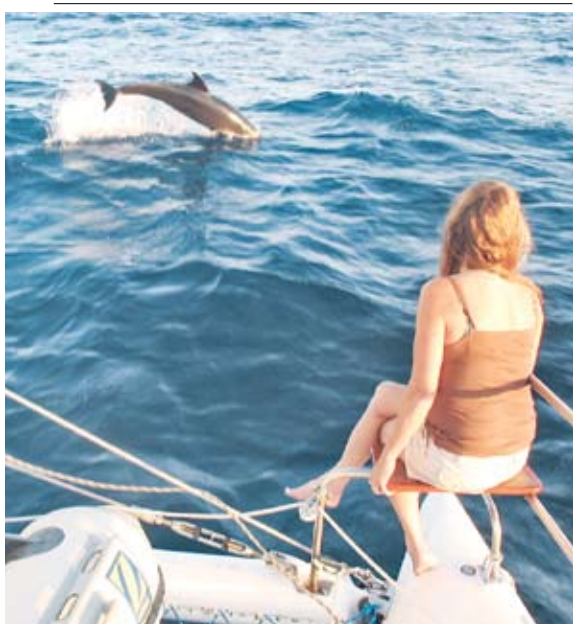

Some adventurous souls run off and join the circus. Others go cruising. Lou and Laura of 'Cirque' sort of did both.

and few: have fun, be safe and check in at the roll call every morning. Past that, skippers and crews are responsible for sailing their own boats. That's what Ha-Ha organizers mean by not being an 'offshore hand-holding service'.

However, participants also soon learn that many helping hands are offered when it comes to advice and repairs — which, by the way, is usually the second 'best liked' facet of the event.

As it has since the first Ha-Ha back in 1994, the route features three

distinctly different legs. Leg 1, 360 rhumbline miles from San Diego

to Turtle Bay, is the longest, coldest and usually scariest. For most boats, it means at least two days and nights at sea and is almost always the leg where the most damage to sails, boats and occasionally people occurs. For ocean sailors it's usually no big deal, but for newbie cruisers, some of whom are on their first long offshore passage, it can be a hardship. All of which makes arrival in Turtle Bay that much sweeter. And the aspect of a shared ordeal provides the first spark of *esprit de corps* felt by Ha-Ha'ers. This, in keeping with the theme, happens to be the third thing that Ha-Ha'ers

like best about the event — the friendships, many of which last well beyond the rally.

Leg 2 goes 240 miles farther south to lovely and desolate Bahia Santa Maria, located just north of Mag Bay. Santa Maria is typically flat and serene, with offshore breezes at night bringing the scents of the mangroves and the desert beyond wafting over the fleet. On moonless nights, as happened this year, the anchor lights of the fleet blend with the stars and the milky way to form a breathtaking sea-level

'constellation'.

The third, shortest and final leg heads 175 miles to the finish line off Cabo San Lucas. These are usually the easiest and warmest miles, with the water also getting warmer and bluer with every change of watch. It is also the yang to Santa Maria's yin — a bustling tourist mecca whose harbor is chock-a-block with million-dollar sportfishers, and whose once-pristine bay and famous Lands End are now roaring from dawn to dusk with glass-bottomed tourist boats, dive boats, jet skis, paragliders, cruise ships and pangas. Ashore, boutiques and duty-free shops rub shoulders with throbbing nightclubs and open-air restaurants that charge \$15 for hamburgers. The biggest shock of Cabo is not to those who arrive for the first time, but to older sailors who remember days long past, when you could anchor anywhere and spend a week on Lover's Beach without ever seeing another soul.

All three Ha-Ha stops are punctuated by parties, potlucks and other events,



— THE MAÑANA ARMADA

ALL PHOTOS LATITUDE 38
EXCEPT AS NOTED

starting with the pre-race costume party in San Diego the day before the start.

The big fires of October forced a last-minute change of venue for the October 28 kickoff party. So instead of assembling at the Cabrillo Isle Marina, the cave-men, leprechauns, padres and pirates descended on the parking lot of the new host — the big West Marine store on Rosecrans.

Highlights of the Halloween-themed bash included awards for best costumes in various categories, a sumptuous lunch of barbecued chicken or roast beef prepared on site, another great MC job by former West Marine staffer Missy Welch and the piece d' resistance — a terrific rendition of *Mack the Knife* by everybody's favorite harbormaster, Alan Weaver of Marina Village, who was celebrating his 60th birthday with his fourth trip south on the Ha-Ha.

"We sailed as low as we could on starboard jibe for 300 miles, then reached into the finish."

Leg 1

This year's Leg 1 was one of the windiest in Ha-Ha history. Breeze built from 10-12 at the start into the low 20s the first evening, and built further through the second day to the high 20s, with a few

As if on cue, a light breeze filled in literally minutes before the start. Before nightfall it built into the 20s.

boats reporting over 30. It was accompanied by enough of a swell to put old gear and new cruisers to the test. Not to mention a few sailors' stomachs. Many crews shortened down to manageable sail combos to give boats and people a

more comfortable motion, while sailors with racing in their blood reveled in the conditions, setting kites and sailing hot angles for splendid surfs into the mid or high teens.

Among the latter was Garland Bell's *Sooner Magic*, the first boat into Turtle Bay on November 1. Her log showed Bell and his crew, Jim Taylor, Mike Herlihy and Judy Bullimore had sailed 372 miles in 39 hours, 10 minutes — an average of better than 9 knots. It probably won't surprise you that everyone aboard was an experienced racer. What did come as a surprise was that *Sooner Magic* was not one of the 12 multihulls in the race, nor is it a slippery SC 50, 52 or J/160. It's a six-year-old Beneteau 47.7, which boasts such exotic go-fast gear as air conditioning and two flat-screen TVs.

"We sailed as low as we could on starboard jibe for 300 miles, then reached into the finish," said Jim 'JT' Taylor. "With Mike and Judy aboard we had some really good driving, so we never used the autopilot." They flew spinnakers as long as they lasted (the first got a rip,



"See my sand dollar?" More than a dozen young kids joined the fun this year — and they especially loved the beach days.

the head blew off the second one), at night employing the old 'drive by whap' technique — too low, one big whap, too high: two whap-whaps. "We never crashed, but there was a lot of whapping," said JT. It didn't help that their fluxgate compass somehow developed a 30-second 'lag' before settling on the correct course. Through it all, they never got a drop of water on the deck — gotta love that downwind sailing.

Notable among the stories that started making the rounds in Turtle Bay was that of Mary Forrest's unscheduled swim. On the second morning out, she was rinsing off the back step of *Capricorn Cat* after a fish cleaning when the bucket jerked full and pulled her right off the boat. A potentially serious situation was handled quickly and well by the *Cap*



BAJA HA-HA '07

Cat crew, who luckily were motorsailing under double-reefed main at the time. They had Mary back aboard in about 30 seconds, none the worse for wear. The off watch didn't even know it had happened until they woke up!

While many people might have panicked, "I really wasn't worried," said Mary, who had come to the Ha-Ha after two years of trekking through Central and South America. "Plenty of people saw me go off. I knew they'd come back for me."

Once everyone was anchored in Turtle Bay, the Ha-Ha continued its long friendship with the great people there. Several boats donated supplies to the local school. In return, they were invited to classrooms to learn about *El Dia de Los Muertos*, Mexico's famous 'Day of the Dead' celebration, which was taking place during the fleet's visit there on November 1-2.

In the following days, several boats — notably *Grace* and *Volcano* — arranged activities which included both cruiser kids and local kids. One was a game of soccer between the visitors and the home team. The local kids took that one. The Mexican kids were also included in various kid activities at the following day's beach party. More on that in a minute.

There were also several donations of supplies to the local medical clinic — including a large first-aid kit supplied by West Marine and sailed down on their well-traveled Olson 40 *ProMotion*. As in the past, these kindnesses were repaid several times over as banged-up members of the fleet were hauled into the clinic for repairs. Among these were Steve 'Esteban' Shugart off *Mañana*, who dislocated a shoulder; Bob Maher of *Dis-*

"Hang loose!" Baba Muller of the SC 52 'Isis' shows off her 'skurfing' technique to the cheers of onlookers.



tant Drum, who cracked a couple of ribs; and David Eakin of *Narnie O'Shea*, who collapsed suddenly at the beach party.

In the latter instance, Eakin was lucky that Steve Coleman of the Swan 42 *Bluzzz* was nearby. Not only is Coleman a cardiologist (it was initially thought that David might be having a heart attack), but his shipmate, Mary Ferro, is a nurse. Eakin was rushed to the clinic, where he was hooked up to an EKG machine "of a type so old I barely remember it as an intern," said Coleman. But it worked, and it showed David's heart was fine. The final diagnosis: dehydration. Turns out the crew of *Narnie O'Shea* had spent the day resewing a ripped clew in their mainsail in the hot sun and, as David puts it, "I was just a couple quarts low." After receiving a saline drip and whopping bill of \$50, and he was good to go.

Narnie O'Shea's main wasn't the only sail that suffered from Leg 1 breeze. Numerous other boats — *Moontide*, *At Last*, *Carpe Diem*, *Blarney*⁴ and *Jim 'N I* among them — related similar tales of dacron woe. Even Phil MacFarlane's favorite pink kite that had powered his Ericson 35 *Sail A Vie* to Hawaii in two

The well-sailed Beneteau First 47.7 'Sooner Magic' blasts along on an easy spinnaker run during the ideal conditions of Leg 1.

Singlehanded TransPacs blew to confetti. Luckily, there were a few sailmakers in attendance, and before long, TJ and Julie Edwards of the Tacoma-based Hunter 37 *Itchen* had set up a genset and sewing machine ashore beside Enrique's Restaurant and were doing a brisk business at the makeshift 'loft'.

The first day after arrival is always reserved for rest onboard and/or exploration ashore. At Turtle Bay, this might mean hiking, limited shopping, enjoying the impromptu party at the Veracruz Restaurant and — this year — witnessing some unusual local customs at decidedly opposite ends of the cultural spectrum. The first was a special Day of the Dead observance at the local church. The second was '*Lucha Libre*', a troupe of traveling wrestlers who hit town for a Sunday show. Cruisers who attended the event called it either "interesting" or "hilarious." Apparently these opinions had a lot to do with how much beer you'd had before or during the matches.

November 2 was the date for the Ha-Ha's first beach party. Organizers were pleased early on to meet 13-year-old Emily Applewhite of *Volcano*, who readily volunteered to organize kid activities. Turns out Emily, daughter of *Volcano* crew Leah Applewhite and Bob Schoon-

— THE MAÑANA ARMADA



maker, had been planning to take on this responsibility for quite some time, as it would fulfill an assignment that was part of her home-schooling curriculum for the month she'd be in Mexico. (After the Ha-Ha, she was going to do some overland travel with her parents, ending up building houses for Homes Of Hope in Tijuana. She headed back to Woodward Middle School in Bainbridge Island, Washington at the end of last month).

There were about 12 to 15 kids spread over seven or eight boats in this year's fleet, ranging in age from about a year and a half to 15 years. Emily had plans in place for all of them except 16-month-old Tobylee, daughter of Jeff and Misty Sparrow's Bay-based Morgan 382 *Pepe*. Turns out Toby preferred to stay close to Mom, anyway. But that didn't prevent the little 'California girl' from becoming the sweetheart of the fleet. Of the dozen or so boats that contributed photos for use in this article, probably 3/4 of them included pictures of Toby. We took a bunch ourselves, too.

Unfortunately, some of Emily's kid plans for Turtle Bay were cut short when the crew from the Committee Boat, *Profligate*, inflated and launched two 'Nuclear Balls' — those big, clear round things that you're supposed to be able to climb into and 'roll' across the water. Nobody could quite get the hang of controlling them in any manner, much less getting

one to move — but they sure kept the kids busy and laughing.

The only thing better than large beach balls that you could climb into were small rubber ones you could fill with water and throw at people. The Water Balloon Toss always starts innocently enough: the Grand Poobah lobbs water-filled 'bombs' to groups of boys and girls, with two out of three bursting all over the recipients. But after awhile, once the kids get the hang of catching the balloons, they start returning fire — and the Balloon Toss quickly degrades into the traditional 'Blast the Poobah' event. After awhile it's a total firefight between the Poobah, who at 6'4" makes a large and excellent target, and the kids, who are numerous, small and fast moving. Kodak moments for sure.

Of course, by this time the beach party had been in full swing for a couple of hours, with cruisers full of potluck delights, and the local beer concession doing a brisk trade. Before it was over, there was a big group photo from the

There are several seamounds on Leg 2 where the fish are so plentiful you can practically stick a toe in and get one.

cliff, a tug of war between women and men (the women won again) and some heated games of beach volleyball. There were also a few embarrassing dinghy dumps by inexperienced people coming and going, but nothing like what was in store for the fleet at the next stop.

Leg 2

A gentler ocean swell and lighter breeze than the first leg ushered the fleet southward, this time against the backdrop of the rugged 'Baja Sierras'. Once again, Com-



Big boats, small boats, old boats, new boats — as in years past, this year's fleet was made up of a wide variety of boat types.

manders' Weather proved accurate with their forecast of 10- to 15-knot winds for the run to Bahia Santa Maria. Winds dropped a bit during the night but held most of the way, again allowing many more boats than usual to sail the entire second leg comfortably.

Also improved was the fishing. There are several seamounds on Leg 2 where the fish are so plentiful you can practically stick a toe in and get one. People who had rarely fished before were reporting catches of yellowfin and dorado. And the people who knew what they were doing were doing really well. The biggest one that didn't get away (or that was purposely released) was a wahoo caught by Lynn Acosta of, well, *Wahoo*. It was almost as tall as she was. Lynn and hubby Marc gained instant popularity by giving away filets from this and other

"Hola amigos!" The Turtle Bay kids love it when the Ha-Ha fleet comes to town. And not just because of the Halloween candy they get.



BAJA HA-HA '07

fish all the way to Cabo.

Volume-wise, Bob Mathews' Formosa 51 *Pegasus* probably had the most success, catching about 30 fish total, including an 8-foot marlin (released) and a keeper 35-pound dorado taken right off the lighthouse at Cabo Falso. "We actually set our waypoints for the seamounds," says Bob, who notes that Pinnacle Rock off Mag Bay was the most bountiful spot of the trip. He and his crew — several of whom fished commercially out of Alaska for several years — were so into fishing

that they even have a smoker aboard, and it was chuffing away all the way to Santa Maria. They also gained many friends by giving pounds and pounds of freshly smoked fish away.

Contigo's problem wasn't how much they could take out of the sea — it was how to keep the sea out of the boat. Suffering from a chronic case of leaky keelbolts, Bill Crysler's Victoria-based Islander 36 kept the fleet on pins and needles with daily reports of the inflow — at one point estimated at a gallon a

minute. As a precaution, Bill also called the Coast Guard in San Diego. They advised the Mexican Navy of the situation, and also — *Contigo* being homeported in Victoria, BC — contacted the Canadian Coast Guard.

The boat leaked less at anchor, so Bill was feeling pretty good about life in Turtle Bay — until he found out from another boat that two Mexican Navy ships had been out looking for him. . . for two days! Turns out he had advised Coast Guard San Diego that everything



PURA VIDA



— THE MAÑANA ARMADA

was under control, but they hadn't told the Mexican Navy. With no cell phone reception in Turtle Bay, and unable to reach Mexican, American or Canadian authorities by radio, Bill finally got an email through to a friend in Canada, who then phoned the Coasties, who called off the Mexican Navy. International incident

avoided. "We couldn't wait to get going again and 'lose ourselves' in the fleet for fear the Mexicans would find us and shoot us," said Bill, who hoped to haul out and fix the problem before he got too much farther down the coast.

Bernard Slabeck of *Simple Pleasures* had an underwater encounter of yet an-

other kind: the second night out, the San Francisco-based Freedom 36 bumped into a whale. "The bow went down like we'd gone aground, but there was no ground out there to hit," said Bernard. "We knew right away what it was." As the whale surfaced behind the boat, Bernard and his crew rushed below to see if there was any damage or leakage. Luckily, they found none. Slabeck said the whale and his pod escorted the boat for about an hour following the bump. "There was no moon, so we couldn't see them, but we

Clockwise from upper left: "Hey! Look at all the shells we found!"; going for the spike; the Nuclear Globes were a big hit at the Turtle Bay beach party; no keys on the key ring = freedom; an award-winning boat bite; three generations worked nonstop at the Vera Cruz restaurant; valet parking at the beach party; Mary surveys the desert moonscape; sushi sampling; a plentiful potluck; sailmaker Karl Dierdorf of 'Pangea' spent hours practicing his trade on the Turtle Bay pier.



CHRISTIAN BUHL

BAJA HA-HA '07



"Wait for me! I want off of this Committee Boat!" Just kidding. When the wind went light, the 'Profligate' crew and others took a dip.

could hear them all around us".

When the fleet turned the corner under Cabo San Lazaro and anchored in Bahia Santa Maria, the Grand Poobah got on the radio and noted the stark beauty of the place, the miles of deserted beach and the notably warmer weather. "Welcome to the first *real* Mexico," he said. Little did he know how prophetic that statement would turn out to be.

The first thing everyone noticed was the southerly swell. It wasn't huge but, at 4 to 6 feet, it made for a roly anchorage. It also threw big breakers on the beach. Dinghy landings through surf are dicey enough for experienced hands, but the not-so-distant thunder of these waves hitting the sand made some new cruisers wonder if they should even lower their inflatables off the davits. Some of

It's officially a rally not a race. But that fact doesn't prevent most skippers from doing their darnedest to avoid being passed.

them might even have recalled that the dramatic photo of the upended dinghy from last year's Ha-Ha was taken at this beach — in about 2-foot surf.

In addition, between concerns about anchors dragging and the roller coaster motion, not everyone got a lot of sleep that first night — or the second.

Saturday dawned clear and bright, with the swell still throbbing against the shore. Only a few Ha-Ha'ers felt confident enough to brave the surf in their dinghies. Most opted for the Poobah's suggestion to take *pangas* ashore — despite the rate hike: \$2 per person in, and as much as \$3 or \$4 per person for a ride back out.

But even the *panga* drivers admitted they'd never seen surf so big in the normally tranquil bay. For safety's sake, they recommended the party be delayed from 1 p.m. until 2, when the tide went out and the bar got a bit safer.

No problem . . . let's have a rum tasting!

Pusser's Rum was once again gracious enough to supply the Ha-Ha fleet with enough of that former British Navy beverage for the skipper of every boat to have a 'tot'. Unlike last year, *Profligate* ended up with boxes full of mixer — but no rum — there was plenty of rum this year . . . but none of the brand's famous 'Pain Killer' mixer. So the crew of the mothership set up a makeshift bar and, as visiting skippers motored up in their dinghies, they were offered rum and coke, rum and juice, shots of rum — or bottled water for 'dry' skippers. Plus, every skipper got a nice Pussers 'Good to the Last Drop' cap.

The *pangas* started running promptly at 2 p.m. By about 2:30, everyone was ashore who was going there, and the party was in full swing.

One who did not go ashore that afternoon was Chris Maher of the Beneteau



The start of Leg 2 saw light but steady winds. Scott Culver, center, skippered 'Alaska Eagle' in '06. This year he was back on his in-law's boat, 'Volare', with three generations aboard. Inset: Keeping a bow watch.

*Blarney*⁴. He had had his fill of 'the real Mexico' the day before and needed to recover. It had all started with a VHF call the first day from an American ex-pat by the name of "Baja Bob" Hoyt, founder and operator of Mag Bay Outfitters, which runs fishing charters afloat and ATV expeditions ashore. To the surprise of the fleet — and for the first time in Ha-Ha history — Bob advised that he could take a few orders for provisions and spare parts. He was immediately flooded, mostly with requests for beer, but a few other odds and ends, too. Chris needed metric bolts to replace ones that had broken off his alternator mount. So the next day, he and Joe Stern of *ProMotion* piled into Bob's old Suburban and headed out.

After traversing a small road that wound around the mountain and came out near the lighthouse at San Lazaro, Bob put the pedal to the metal, and the big Chevy launched northward up the beach at 60 mph on the hardpacked sand. Bob explained that it wouldn't be so easy on the way back, after the tide had come up.

"I originally thought we were going to San Carlos" (at the north end of Mag Bay) said Chris. "But we were go-



— THE MAÑANA ARMADA

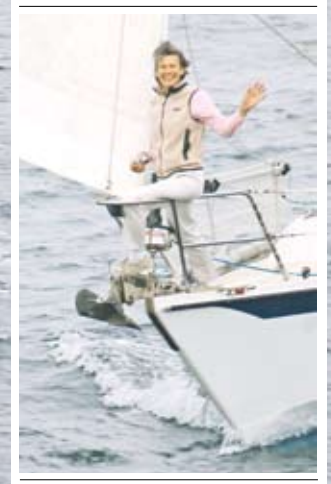

ing the wrong way. After awhile, I didn't know where in the hell I was or where we were going."

The truck finally pulled to a stop beside a dilapidated platform boat — it had once done service for the Boy Scouts in the Channel Islands, but now served as the 'ferry' across 3/4 of a mile of estuary at the far upper end of Magdalena Bay. But the motor on the platform boat wouldn't start, so Bob jumped in an equally dilapidated *panga* and took off for the opposite shore. The boat was so beat up that Joe had to keep his foot on the flimsy bottom so it wouldn't open up and sink.

They finally arrived, not at San Carlos, but at tiny Lopez Mateo, a town so small "it made Turtle Bay look like San Rafael," said Chris. His hopes of finding a NAPA auto parts store quickly evaporated, but he was able to scrounge the fasteners he needed out of vehicles that had been abandoned by the side of the road. Meanwhile, Joe went off to look for provisions. An hour or so later, when they met up, Chris had his bolts and Bob had secured numerous cases of beer. They schlepped everything down to the Estuary, where by now the owner of the platform boat had gotten the engine started. They loaded her up, turned west, the driver hit the throttle and the boat promptly nose-dived, submerging the platform. The cases of beer all floated off

and started downstream. Chris, Joe, Bob and the driver all dove in and managed to rescue all the *cervesa*. Once the boat was reloaded, the driver took it slow and easy the second time, and they made it back to the waiting Suburban.

By this time, it was early afternoon and the tide had come in. "For 20 miles, 30 miles — I don't know — Bob drove back down the beach at 60 miles an hour, dodging waves," said Chris, who admits to being physically drained by the time they made it back to Santa Maria. "Bob told us earlier that his trucks only last a couple of years down here. Now I know why."

But that was just the start of the craziness at Santa Maria this year.

Next were 'the dinghy guys', Alan and Carl of the Amel 53 *Charisma*. They were both flipped out of their dinghy, which then took off on a 15-minute, full-throttle joyride with no one at the controls. We hadn't seen anything like it in any previous Ha-Ha — or in 30 years of covering sailing for that matter. For the complete story, see *Dinghies Gone Wild* elsewhere in this issue.

About the only ones to miss all that excitement were the Nugier family of Sonoma. Their dinghy had parted company with their Fraser 51 *Wingstar* the previous night, and they hadn't noticed until morning. Since no one else had found it, they had motored offshore to look for it. In an amazing happy ending, they actually found it — 9 miles out!

As the sun sank in the west, a big line of tired cruisers formed for the *panga* express. The darker it got, the longer the line — and the fewer the *pangas*. One by one, the returning *pangas* would

West Marine's 'Promotion' smokes along under spinnaker. Each of her crew had won a staff lottery to secure his or her berth.





WAHOO



MARCO ACOSTA



skim past the waiting *gringos* and head back to the fish camp in the mangroves. The first few times, those in line thought they were just going back for fuel. It soon dawned on people that those guys weren't coming back. At least not that night. (Several of the drivers later told us that even they had never seen such big surf in the bay.) One or two boats kept running, though they took smaller and smaller loads of folks out every trip.

The implications of the situation finally began to dawn on everyone still ashore, perhaps best voiced by Marc Acosta of *Wahoo*: "I never felt there was any danger until I saw the *panga* guys putting lifejackets on."

Indeed, when it started to get really

dark, there was only one *panga* running and, in their last trip, those brave fishermen took only five people. Then they, too, were done. And there were still 72 Ha-Ha'ers ashore.

The castaways included the Ha-Ha's own Doña de Mallorca and 'Banjo Andy' Turpin. And if you haven't detected a bit of surrealism in this whole scenario yet, imagine being caught ashore with no bed, no jacket, limited shelter, frightened kids and even a scorpion or two. Still not *Twilight Zone* enough? How about keeping warm by starting campfires? But since there hasn't been a tree here since the last ice age, the only fuel available for the fire was beer boxes — fortunately, there were *lots* of those.

The 'Survivor Baja' folks were returned to their boats early the next morning — most soon collapsed in their bunks to catch up on missed sleep, and all will go down in Ha-Ha lore as 'The Survivors.' By the time the fleet got together for one last hurrah in Cabo, The Survivors were bona fide celebrities.

(For a firsthand account of the night on the beach, see this month's *Sightings*).

Leg 3

The homestretch to Cabo began November 7 at 8 a.m. in light air under misty skies. Winds held through most of the day at 10-12 knots, which was once again great for fishing. It was also great



Top row, left to right: Ridin' the rail on 'NovaKane'; Lynn Acosta finally caught a wahoo (to match her boat's name); exiting the Santa Maria beach was a challenge even in daylight; hamming it up; the die-hard Baja band. Middle row: Catchin' a sweet ride; the J/World dream team; frisbee flyoff; refugees exit at dawn. Bottom row: "Cheers!"; a surreal sunset; skim boarding on the flats.

for several boats whose engines were kaput. They were particularly grateful when it built to about 20 in the late afternoon.

One fellow whose boat really enjoyed the bigger breeze was Glenn Burch of Petaluma. He was sailing this year's oldest boat, the only woodie, and one of only a handful of gaffers ever to have done the event. His 42 Chapelle schooner *La Sirena* — built a quarter century ago in Costa Mesa — also made one of the prettiest 'postcard' pictures as she made her regal way down the coast. It was obvi-

ous Glenn himself also put the event in proper perspective. When we asked how he was enjoying things so far, he reached in his pocket and held up a shiny metal ring. Then he asked us what it was.

"Um, a key ring — with no keys?"

"Freedom, my friend," he said, a smile forming under his thick mustache. "What you see here is freedom."

Patsy Verhoeven was also enjoying the 'freedom' aspect of the Ha-Ha on her Gulfstar 50 *Talion*. One of four or five female skippers on this year's rally, Patsy has lived aboard various boats

for almost 20 years in her homeport of Portland, Oregon, the last 10 of which have been aboard *Talion*.

Patsy grew up in a powerboat family (her father was a commercial fisherman) but gravitated to sailing after crewing for a friend on a J/24 years ago. When the cruising bug bit, she started racing a lot on different boats and working in boat-yards (mainly Steve Rander's Schooner Creek Boat Works) "just to learn how to fix things that break." This year, with her kids grown and a relationship ending, the time was ripe for heading south. With plans to permanently relocate to La Paz, Patsy was using the Ha-Ha as just the first stepping stone in a new life adventure.

BAJA HA-HA '07

Although the female skippers had to share the limelight with one another, there was only one 'senior discount' boat, Lloyd Clauss' Catalina C400 out of L.A. Yacht Club. Lloyd had the same crew aboard this time as when he did the 2003 and 2005 Ha-Ha's: Rob Snyders and Ron Wood. None of the three longtime amigos were under 67.

"This is a great way to get down here and we've always felt an extra measure of safety," said Clauss, who first learned about the Ha-Ha when he picked up an old *Latitude* in Salinas Marina in Puerto Rico. He became so enamored of the event that he says he sold his old Catalina 36 and chose *Tranquillo* specifically to do the Ha-Ha in comfort with his friends. He admits they're only up for so much 'roughing it', though — in the larger marinas, the boat stays at the dock and the crew adjourns to the nearest Marriott.

For the record, *Tranquillo* boasted the highest average age, but not the oldest participants. That honor went to *Jim 'N' I* owners Doris and Jim Maxwell, 81 and 82, respectively!

To turn the corner at the Land's End arch and go from sublime serenity to the tourist Gomorrah that Cabo has become is a bit like emerging from a wilderness retreat into the middle of Disneyland.

Adding to the confusion was Adam Sandler. Or at least a movie he was making that required 'uninhabited' water in the east end of the anchorage. (Can't have a bunch of *gringo* yachts bobbing around in what's supposed to be the Dead Sea.) That meant that half the anchorage was unavailable for the better part of two days.

Because dock space at Cabo is *mucho* expensive (\$134 per night for a 40-footer this year!), most Ha-Ha'ers opted to anchor off the beach. But that first night, the anchorage was so crowded that several boats reported bumping into their neighbors, resulting in lots of frayed nerves and little sleep. Fortunately, Sandler called it a wrap early Saturday, and the whole anchorage opened up again at noon.

For the boats that did want to tie up inside, the Marina Cabo San Lucas staff once again pulled out all the stops

to accommodate the Ha-Ha fleet, even down to having several of the big boats of the recently completed Long Beach to Cabo Race move or vacate the premises. Despite the price of admission, 42 boats opted to tie up — many rafting three deep — to take advantage of the proximity of laundry, showers, restaurants and other signs of civilization.

Many first-time Ha-Ha'ers have told us over the years that they were initially reluctant to take part in the event



2007 Baja Ha-Ha XIV Finishers

Timekeeper's Note: Amazingly, there were ties for third in every division! (A + beside a finishing rank indicates special accomplishment)

AGAVE Division				Beyond Reason				Hans Christian 43	Bill Novak	Alameda
1) <i>Alaya</i>	Westisail 32	Robert Anderson	Kalispell, MT	3) <i>Footloose</i>	Gulfstar 43	Diane Brown	Emery Cove			
2) <i>Surf Scooter</i>	Island Packet 35	Poul Kjaer	Discovery Bay	ENCHILADA Division						
3) <i>La Bonbonniere</i>	Rawson 30	Keith P. Davis	Vallejo	1) <i>Deliverance</i>	Hunter 41	Dan Swett	Bonita			
3) <i>Mirage</i>	Ganley Steel 34	Mike Wirth	San Francisco	2+) <i>Full Quiver</i>	Beneteau First 405	Steve Lannen	San Francisco			
3) <i>Pacific Star</i>	Island Packet 35	Horst Wolff	Paradise	3+) <i>Cok Cabuk</i>	Wauquiez Hood 38 Mk I	Gary Johnson	Charleston, OR			
3) <i>Carpe Diem</i>	Fantasia 35	David Moore	Alameda	3+) <i>Talaria</i>	Ericson 38	Bill Martin	Sausalito			
3) <i>Third Day</i>	Pearson 365	Richard Boren	Port San Luis	3) <i>Somerset</i>	Catalina 38	Ronald Burkard	Alamitos Bay			
3) <i>Isis</i>	Islander Freeport 36	Neil Wehrle	Half Moon Bay	3) <i>Pepe</i>	Morgan 382	Jeff Sparrow	San Francisco			
3) <i>Colleen O'Neill</i>	Pearson 365	George R. Paterson	Channel Islands	3) <i>Serendipity</i>	Cal 39	David Pedersen	Moss Landing			
BURRITO Division				3) <i>Tranquillo</i>	Catalina 400	Lloyd Clauss	San Pedro			
1) <i>Sail a Vie</i>	Ericson 35 Mk II	Phil MacFarlane	San Mateo	3) <i>Pura Vida</i>	Catalina 400	Dennis Cannon	Scottsdale, AZ			
2) <i>Voyager</i>	Beneteau 345	Dean Hocking	Sausalito	3) <i>Volare</i>	Beneteau Oceanis 400	Henry Salerno	Long Beach			
3+) <i>Pangea</i>	J/30	Mike Leary	Ventura	3) <i>Loomings</i>	Hunter 40	James Rummmonds	La Selva Beach			
3+) <i>Lorien</i>	Islander 30	Guy Carlson	Redwood City	3) <i>New Moon</i>	Hunter 410	Gerald Elder	Albuquerque			
3) <i>Capt Geo Thomas</i>	C&C 30	Bill Thomas	Vallejo	FRIJOLE Division						
3) <i>Befana</i>	Catalina 30 BS	Randy Hough	Port Moody, BC	1) <i>Surfride</i>	Valiant 42	Richard Bernard	Cardiff			
3) <i>Setting Sun</i>	Pearson 323	George Johnstone	San Rafael	2) <i>Scot Free IV</i>	Hylas 42	Bill Hall	Vancouver, BC			
3) <i>Jim 'N' I</i>	Freedom 32	James Maxwell	Albuquerque	3+) <i>Destiny</i>	Catalina 42	John Foy	Alameda			
3) <i>Vinmar</i>	Ranger 33	Scott Haselton	San Diego	3) <i>Dreamseeker</i>	Beneteau Oceanis 411	Tom Lilienthal	Richmond			
3) <i>Second Wind</i>	Beneteau 331	Cory Reinking	San Diego	3) <i>A Cappella</i>	Valiant 42	Ed Gould	Half Moon Bay			
3) <i>Ciao</i>	Catalina 34	Juan Spampinato	Point Richmond	3) <i>Aurora</i>	Valiant 42	Jim Goetsch	San Francisco			
3) <i>Kismet</i>	Irwin 34	Miguel Cardonas	Richmond	3) <i>Both/And World</i>	Catalina 42	Kevin Collins	San Diego			
3) <i>Krissy</i>	Ericson 35	Allen Cooper	San Francisco	3) <i>Cool Breeze</i>	Catalina 42	John Beane	Winchester Bay, OR			
CEVICHE Division				3) <i>Final Final</i>	Catalina 42 Mk II	Marvin Zietzke	San Francisco			
1) <i>Delight</i>	Hunter 36	Albert Miller	Sacramento	3) <i>Serenity</i>	Catalina 42 Mk II	David Albert	Oceanside			
2) <i>Pipe Dream</i>	CF 37	John Davis	Long Beach	3) <i>Dolfino</i>	Catalina 42 Mk II	Rick Lino	Marina del Rey			
3) <i>Infinity</i>	Catalina 36 Mk II	Craig Adams	Channel Islands	3) <i>Jammin</i>	Catalina 42 Mk II	David Peoples	Portland, OR			
3) <i>Lady Jane</i>	Catalina 36 Mk II	Raymond Oleson	San Francisco	3) <i>Sea Angel</i>	Catalina 42 MkII	Mel Hamp	4 Winds & 7 Seas			
3) <i>Simple Pleasures</i>	Freedom 36	Bernard Slabeck	San Francisco	3) <i>Liberty</i>	Hunter 430	Monty VanderMay	Newport, OR			
3) <i>Contigo 1</i>	Islander 36	Bill Crysler	Powell River, BC	GUACAMOLE Division						
3) <i>Water Spirit</i>	Pearson 36	Richard Mogford	San Francisco	1) <i>Sans Cles</i>	Royal Passport 43	Lyman Potts	Portland, OR			
3) <i>Itchen</i>	Hunter 37	TJ Edwards	Tacoma	2) <i>Solace</i>	Hylas 44	Paul Rae	Lyttelton, NZ			
3) <i>Someday Isle</i>	Passport 37	Tom Mishler	San Diego	3+) <i>Cirque</i>	Beneteau First 42s7	Louis Kruk	San Francisco			
3) <i>Wild Rose</i>	Tartan 37C	Lori Warner	Stockton	3+) <i>Bluzzz</i>	Swan 42	Stephen Coleman	Sausalito			
DESPERADO Division				3) <i>Blarney4</i>	Beneteau First 42	Chris Maher	Alameda			
1) <i>Emerald Star</i>	Cabo Rico 38	Ray Horowitz	Santa Cruz	3) <i>Mystical Traveler</i>	Beneteau 423	Lewis H. Guthrie	San Diego			
2) <i>Harrier</i>	Spencer 42	Ted Brittsan	St. Helens, OR	3) <i>Sabbatical</i>	Ron Holland 43	Michael Jones	Oxnard			
3) <i>Creme Brulee</i>	Island Packet 380	William M. Noonan	Bainbridge Island	3) <i>Windward Bound</i>	Columbia 43	Jim Graham	Redondo Beach			
3) <i>Gypsea's Palace</i>	Irwin 38	Steve Garvin	Redondo Beach	3) <i>Windswept</i>	Irwin 43	Scott Karlin	Newport Beach			
3) <i>Brendon</i>	Shannon 38 PH	Stephen Pepper	San Diego	3) <i>Jake</i>	Hunter Legend 45	Jake Howard	Seattle			
3) <i>Triple Stars</i>	Island Packet 380	Robert Anderson	Sausalito	3) <i>Entropy</i>	Hunter 456	Robert Forbes	Newport Beach			
3) <i>Symphony*</i>	Hans Christian 38 MkII	Michael Bagwell	Vancouver	3) <i>No Worries</i>	Jeanneau 45.2	Mike Scheck	Alameda			
(*name changed to <i>Easily Amused</i>)				3) <i>Merry Rowe's</i>	Hallberg Rassy 46	David Rowe	San Diego			
3) <i>Zephyra</i>	Morgan O/I 41	Russ Noorda	Lake Tahoe	HUEVOS RANCHEROS Division						
3) <i>Welcome Passage</i>	Sceptre 41	Don Rosenthal	Tiburon	1) <i>QuickStar</i>	Beneteau 46	Peter Bruckmann	Kamloops, BC			
3) <i>Solstice</i>	Sceptre 41	John Forbes	San Francisco	2) <i>Second Wind</i>	LaFitte 44	Jim Barbee	Alameda			
3) <i>Off Piste</i>	Cabo Rico 42 PH	Stephen Cavanagh	Steamboat Springs	3) <i>Psyche</i>	Taswell 43	Steven Truax	Placerville			
3) <i>Pacific Wind</i>	Sceptre 43	Steve Dana	Friday Harbor							
3) <i>Avalon</i>	Mason 43	Jim Jennett	Lake Tahoe							

— THE MAÑANA ARMADA



"Raise your hand if you don't want to go home."

because they thought it was just a big drunken party the whole way to Cabo. This always surprises us, as the Ha-Ha could hardly be a more 'PG' event. But we're pretty sure we know where the 'drunken party' myth started. Two words: Squid Roe.

Ha-Ha organizers encourage everyone to save up their latent maniacal tendencies for the Squid Roe nightclub in Cabo, where 'R'-rated fun is not only tolerated, but encouraged. Like the days of old when sailormen returned to land after long voyages, when the Ha-Ha fleet 'invades' Cabo and hits Squid Roe that first night, anything can happen. The place has a sound system that rivals

anything Led Zepplin ever plugged into, and you can get your alcohol of choice in mixed drinks, shots, bottles, test tubes or Jello cubes. Early in the evening is the time to go with the family; after about 10 or 11 p.m., let's just say things happen that you probably wouldn't want young kids to see.

The awards ceremony was held on Saturday evening, at the Cabo Marina which generously provided a PA system, 550 chairs and 1,600 beers and soft drinks.

In what must be a jillion-to-one odds, once the results were tabulated, it turned out there were so many ties for third place that no one finished out of the money! So everyone got prizes. Boats which sailed one or more legs (without no motor) got special mention, and division winners were usually those who had sailed the most miles overall. The dozen skippers whose boats sailed the whole way received special acknowledgement as 'soul sailors' — a long-time Ha-Ha tradition.

The awards party — indeed the whole

3) Maya	LaFitte 44	Rick Meyerhoff	Sausalito
3) Mocakyki	LaFitte 44	Frank Hagar	Dana Point
3) Wand'r'n Star	Hans Christian 44 PH	Gary Engelman	St. Clair Shores, MI
3) Ketching Up	Morgan 452	Noel DesMarteau	Astoria, OR
3) Fidelitas	Tayana 460 Pilothouse	Gernot Winkler	Chula Vista
3) Grace	Peterson 46	Geoffrey Lane	Bainbridge Is, WA
3) Air Ops	Amel Maramu 46	Dave Wallace	Portland, OR
3) Perfect	Beneteau 461	Rob Woltring	San Francisco
3) Narnie O'Shea	Hunter 46	Tom Pinkerton	San Diego

IGUANA Division

1) Sooner Magic	Beneteau 47.7	Garland Bell	Norman, OK
2) At Last	Skye 50	Scott Neal	San Diego
3+) Tin Soldier	Waterline 50	Glen Middleton	Vancouver, BC
3) Imagine	Fastwater 47	Leon Tad Davis	Blaine, WA
3) Jambo Duex	Beneteau 473	Jon Riksford	San Diego
3) SoCal SoGood	Beneteau 473	Richard Merrall	San Diego
3) Ticket	Beneteau 473	Rick Niello	Sausalito
3) In Cahoots	Beneteau 49	Tom Van Loo	Phoenix
3) Indigo	Bristol 49	Rob Ritchie	Victoria, BC
3) Moody Blues	Catalina 50	Gene Gearhart	Friday Harbor, WA
3) Seabird	Swan 51	Lou Freeman	San Diego
3) Wingstar	Fraser 51	Chris Nugier	Sonora
3) Rhapsody	Beneteau Oceanis 510	Patrick Horton	San Diego
3) Distant Drum	Beneteau Idylle 51	Harry Hazzard	San Diego

JALAPEÑO Division

1) Theleme	C&C Landfall 48	Dennis Buschman	Brownsville, WA
2) Hiatus	CT 47	Kent Sisk	Portland, OR
3) Sagittaire	Brewer 47 PH	Michael Quiriconi	Seattle
3) Airwego	McIntosh 47	Mike Miller	Tacoma, WA
3) Paradise Bound	Vagabond 47	Joel R. Stern	San Diego
3) Meridian	Tayana 48 CC	John Powers	Napa
3) Oasis	Mariner 48	Richard Farmer	San Diego
3) Tamara Lee Ann	Celestial 48	Doug Thome	Alameda
3) La Sirena	Chapelle 42 Schooner	Glenn Burch	Petaluma
3) Farah Anne	Island Packet 485	Alistair Barron	Las Vegas
3) Solstice	Island Packet 485	Bruce Bock	Coronado

KILO Division

1) Talion	Gulfstar 50	Patsy Verhoeven	Portland
2) Snow Goose	Maple Leaf 50	Michael McIntyre	Las Vegas
3) Tropical Dance	Gulfstar 50	Daniel Yarusso	San Clemente
3) Pegasus	Formosa 51	Bob Mathews	San Diego
3) Charisma	Amel 53	Alan Spence	Napa
3) Nefertiti	Tayana 55	Adam Cohen	San Francisco
3) Mandalay	Ta Chou 55	Anthony Diliberti	Seattle
3) Volcano	Frers 65	The Phantom	Bainbridge Island

LANGOSTINA Division

1) J / World	J/120 (40)	Wayne Zittel	San Francisco
2) Tribute	Farr 58	Neil Kaminer	Mermad, DE
3+) Another Girl	Santa Cruz 50	James Bewley	Richmond
3) Gala	J/109 (35)	Robert Riggle	Seattle
3) ProMotion	Santa Cruz 40	West Marine staff	Santa Cruz

3) Isis	Santa Cruz 52	Brendan Busch	Kailua, HI
3) Novakane	J/160 (52)	Michael Kane	San Francisco

MARGARITA Division

1) Flying Fox	Corsair 31 Ultimate tri	Duncan Hincks	Incline Village
2) Boomerang	Corsair 31 UC tri	Chuck VanderBoom	Lake Havasu, AZ
3+) Mañana	Seawind 1000 (33)	Tom McCarthy	Aptos
3) Heavenly Star	Hay Gemini 3000 (30)	Monte Cottrell	San Diego
3) Pitufa	Piver 30 Nimble tri	Walter S. Ludlow	San Diego
3) Wind Trekker	Corsair 31 UC tri	Tom Brown	Oxnard
3) Sea Ya	Seawind 1000 (33)	Joe Weathers	San Diego
3) Windchaser II	Piver Victrus 40 tri	Charles Holt	Newport Beach
3) Duetto	Voyage Norseman 430	Stuart Kaplan	Scottsdale, AZ
3) Capricorn Cat	Kurt-Hughes 45 cat	Wayne Hendryx	Brisbane
3) Blind Luck	Cross 50 tri	Jim Stevens	Kihei, HI
3) Profligate	Surfin' 63 cat	Rally Committee	Tiburon

NO COMPRENDE Division

1) Wahoo	Bertram 35 M/Y	Marc Acosta	Dana Point
-----------------	----------------	-------------	------------

Ha-Ha 2007 Sponsors:

(without them, there would be no Ha-Ha)

Almar Marinas (800) 307-ISLE; www.almar.com • **All Road Communications** (888) 884-7623; www.allroadsat.com • **Blue Water Insurance** (800) 655-9224; (619) 226-6702; www.bluewaterins.com • **Cal-Marine Electronics** (415) 391-7550; www.calmarineelectronics.com • **Commanders' Weather** (603) 882-6789; www.commandersweather.com • **Downwind Marine** (619) 224-2733; www.downwindmarine.com • **Gerry Sea of Cortez Charts** (520) 394-2393; www.gerryrcruise.com • **Grupo Naval Mar de Cortez** 011-52 (669) 913-3871; www.gruponavalmardecortez.com • **Hydrovane** (604) 240-4021; www.hydrovane.com • **Katadyn Watermakers** (800) 755-6701 or (763) 746-3500; www.katadyn.com • **Latitude 38 magazine & 'Lectronic Latitude** (415) 383-8200; www.latitude38.com • **Marina Costa Baja** 011-52 (612) 121-6225; www.costabajaresort.com • **Marina de la Paz** 011-52 (612) 125-2112; www.marinadelapaz.com • **Marina El Cid** 011-52 (669) 916-3468; www.elcid.com • **Marina Mazatlan** 011-52 (669) 916-7799; www.marina-mazatlan.com • **Marina Riviera Nayarit** 011-52 (322) 779-9191; www.marinarivieranayarit.net • **Mariner's General Insurance Group** (800) 992-4443 or (949) 642-5174; www.marinersinsurance.com • **Mexico Boating Guide / Point Loma Publishing** (888) 302-BOAT (2628); www.mexicoboating.com • **Opequimar Marine Center** 011-52 (322) 221-1800; www.opequimar.com • **Paradise Village Marina** 011-52 (322) 226-6728; www.paradisevillagegroup.com • **Quickline USA** (714) 843-6964; www.quickline.us • **Rigging Only** (508) 992-0434; www.riggingonly.com • **Scanmar International** (888) 946-3826 or (510) 215-2010; www.selfsteer.com • **Seven Seas Cruising Association** (954) 771-5660; <http://ssca.org> • **Spectra Watermakers** (415) 526-2780; www.spectrawatermakers.com • **Total Yacht Works** 011-521 (669) 117-0911 • **Ventura Harbor Boatyard** (805) 654-1433; www.vhby.com • **The Watermaker Store** (619) 226-2622; www.watermakerstore.com • **West Marine** (800) 538-0775; www.westmarine.com • **Yachtfinders/Windseekers** (619) 224-2349; www.yachtfinders.biz

BAJA HA-HA '07

Ha-Ha — was capped off by one of the few 'serious' facets of the event, the Steven Swenson Spirit of the Ha-Ha Award. This special prize is named for 2004 Ha-Ha participant Steven Swenson, whose good cheer and 'can-do' attitude went far toward making that event a big success. Sadly, Steve died in a tragic diving accident the following year, leaving a wife and two small children. So although the award is still given to a participant who goes above and beyond the call of duty, it has taken on a special significance to everyone who knew Steve, including Ha-Ha organizers.

This year, the Steven Swenson Award — an ornate flagon of Pusser's Rum on a carved hardwood base — was given to Lyman and Terry Potts of the Oregon-based Royal Passport 43 *San Clés*. They were among many cruisers who were quick to offer help, parts and advice to others, but what really sealed the deal was their final run into Cabo. They were literally within a few miles of having sailed the entire 750-mile course when they started the motor and headed back out to help another boat, *Itchen*, whose



A tot of rum for what ails you. Sporting her new Pusser's cap, Tammy raises a toast to a splendid cruise.

engine had quit back in Santa Maria.

A quick show of hands revealed what was next on people's agendas. It looked like a dozen or so boats were headed straight back to California on the infamous Baja Bash. Most others were

continuing around the corner to La Paz, or across to Mazatlan or Puerto Vallarta. Many cruisers will be in PV or Z-Town for the holidays, and a decent slice indicated they will continue on through the Canal and east, way south to destinations below the Equator, or west into the Pacific in springtime.

The end of a Ha-Ha is a bit like graduation day — the pressure is finally off, the student body is happily celebrating what they've accomplished, and the alumni are bidding them fair winds and good luck in the days and months to come. Ha-Ha'ers were expressing sometimes tearful good-byes to new friends, or happily planning to buddy up with them at some future port or date. The many who came up expressly to shake the Poobah's hand talked of the exciting time they'd had, or how thankful they were or how cool it felt to be part of such a great adventure.

And then it was over. The folding chairs got stacked up, the lights went out, and the Baja Ha-Ha class of 2007 melted into the night.

— latitude/jr

**service &
quality
at the best
price**

75 ton travel lift
Paint, carpentry & blister repair
S.S. & aluminum mig & tig welding
Mechanical & structural work
Full service marina
Short & long term rentals

bajanaval.com

Ensenada, México
Ph 011-52-646-174-0020
Fx 011-52-646-174-0028



**Boatyard
& Marina**

Palm Princess
Destination Services
Huatulco, Mexico

- * Marine Services
- * Concierge Service
- * Provisioning & Catering
- * Real Estate Consulting
- * Travel Arrangements

Marina Chahue:
15°45'61" N; 96°07'21" W • Radio Channel VHF # 16
86 slips, up to 200 feet. All services.

Plaza Chahue, Local 9, Blvd. Benito Juárez s/n,
Bahías de Huatulco, Oaxaca, Mexico, 70989
52 958 587 25 27 / valerie@palmprincessmexico.com
www.palmprincessmexico.com



Paradise Village™
MARINA & YACHT CLUB

Paradise Village Marina *...Treasure of the Gold Coast*



Share with us our Successful combination:

• *Service* • *Security* • *Location*

Services:

- Electrical service, 110/30amps, 220/50 amps and 3 phase 100amps
- Potable water
- Cable TV
- Garbage collection
- Pump-out Station
- Fire fighting boat protection
- 24 hrs. Security.
- Computerized gate access

Additional services:

- Vallarta Yacht Club
- Special area for marina guests
- Restrooms
- Showers
- Lockers
- Pool and Jacuzzi
- Free access to all the facilities of our 5 star hotel
- White sand beach
- Dive tank refilled
- Propane refill
- Launch ramp



CONTACT US:
marina@paradisevillagegroup.com
Phone & fax from U.S. 01 1-52-322-22-66728
www.paradisevillage.com



GPS Coordinates 105 17.9 W 20 41.2 N CHANNEL 16

COSCO BUSAN

"We just touched the Delta span." Those words were spoken by veteran San Francisco bar pilot Capt. John Cota at 8:32 a.m. on November 7 after the *Cosco Busan*, the 902-ft container ship he was piloting out of the Estuary, sideswiped the base of the Bay Bridge's

helmsperson, but the captain of the ship holds ultimate responsibility for the safety of the vessel.

The already dark waters only get murkier when you add Cota's claim

that language barriers and electronics issues were to blame. Cota told NTSB investigators that the *Cosco Busan's* two radars weren't functioning properly before leaving Oakland and then "conked out" halfway out of the Estuary. From that point, Cota and the ship's Chinese captain, Mao Cai Sun, navigated with

the ship's electronic charting system.

Cota claims he wasn't familiar with the symbols on the chart, so he asked Sun to point out the center of the 2,210-ft wide Delta-Echo span. If Cota's account is accurate, Sun either didn't understand or also had trouble reading the electronic chart — this was his first voyage on the *Cosco Busan* — because he pointed to the Delta support

itself. At 8:29, Vessel Traffic Service notified Cota that the ship was traveling nearly parallel to the bridge. "AIS [Automatic Identification System] shows you on 235 heading. What are your intentions?" they asked. "I'm coming around. I'm steering 280 right now," he responded. It was that fateful 45° turn to starboard

that brought the ship's port side into contact with the support's wood fendering system and, ultimately, the concrete support itself.

A Bay Area boating website that features nearly-live ship tracking via AIS transmissions posted the *Cosco Busan's* alleged track that day at www.boatingsf.com/busan.php. It clearly shows the odd heading the ship was on and the sharp turn into the bridge. It also shows the ship continuing on to the west end of Al-

catraz — about one mile — before coming to a full stop. While that may seem to be a long distance, you have to remember that a 65,000-ton ship doesn't exactly stop on a dime.

The Coast Guard has also come under fire for their slow response to the spill. Indeed, it almost seemed as if they were purposely trying to keep information from the public, allegations they deny.

Immediately after the accident, a second bar pilot relieved Cota, who then went to the Bar Pilots Association for drug and alcohol testing. He passed, showing no evidence of alcohol or drugs. Once aboard, the second pilot was told that only 140 of the ship's 1.8 million gallons of heavy fuel oil had spilled, a number he relayed to the Coast Guard.

By the time the first Coast Guard vessel arrived on-scene nearly an hour later, it didn't take long for crews to realize they were dealing with a lot more oil than just 140 gallons. But the ship's fuel



Thick ribbons of oil spread through the Bay — one of the hardest-hit spots was Berkeley.

Delta tower (the one nearest the large central span west of Treasure Island) in dense fog. It now seems like the year's biggest understatement.

That "touch", while it didn't damage the bridge, ripped a 100-ft gash into the side of the ship, rupturing two fuel tanks which then spewed 58,000 gallons of bunker oil into the Bay. It also set off a firestorm of fingerpointing, scapegoating and grandstanding by everyone from the pilot to the Coast Guard to State politicians.

While everyone wants to know what really happened that morning, it seems those answers will likely be a long time coming. The National Transportation Safety Board, the federal agency entrusted with the investigation of the spill, has made it clear their full report may take a year to complete.

Some feel the bar pilot is ultimately responsible for the 'allision' (when a ship hits a stationary object). After all, he's the one who's supposed to be in control of the ship until it's out of the Bay, right? Well, not exactly. It's true that the pilot gives navigational instructions to the



LATITUDE/LADONNA

Tarballs and a thin oily scum can still be seen.

COURTESY NOAA



tank sounding tubes had been smashed, so they had no sure way to determine an accurate estimate.

While Capt. William Uberti initially had no way of knowing exactly how much oil was involved, his decision to use the 140 gallon estimate in response to the first press inquiries was probably not the best one — when the real number came out, it caused sharp and immediate criticism of the Coast Guard.

When the damaged fuel tanks were finally drained around 5 p.m., the Coast Guard knew the exact figure — 58,000 gallons. Waiting until 9 p.m. to reveal that number only added fuel to the fire and, within days, Uberti was replaced as the lead by Capt. Paul Gugg, an oil disaster specialist.

Many believe this unexplained delay in communication translated into a delay in the response, an allegation the Coast Guard vehemently denies. In fact, Rear Adm. Craig Bone, the 11th District

Commander, testified at a congressional hearing that the National Response Corporation and Marine Spill Response Corporation had begun mobilizing just minutes after the *Cosco Busan* hit the bridge, with the first two skimmers arriving on-scene within an hour. Another two skimmers were at work by the four-hour mark, and eight were working the Bay by 2:30 that afternoon. Within 12 hours, nearly 8,000 gallons of the tar-like gunk had been retrieved, an impressive number if you take into account that, in the following



LATITUDE / JOHN A.

Marinas all over the Bay Area set up containment booms to protect boats and shoreline.

13 days and using 11 skimmers, only 11,000 more gallons were collected.

But for the 2,000 oil-covered birds that have died so far, it was too little too late. Every fall the Bay is visited by hundreds of thousands of migratory seabirds — surf scoters, Western grebes and Pacific loons, for example. Wildlife conservationists fear hundreds, if not thousands, more birds will die from the effects of the spill.

What isn't as quantifiable are the long-term effects on the Bay's already-fragile ecosystem. Bunker oil that's not skimmed, or that doesn't dissolve, has the disturbing tendency to sink, which means globs could continue turning up for years. One way or another, the nearly 35,000 gallons of unrecovered goo will undoubtedly make its way into the food chain, starting at the lowest levels and working its way up.

While sailors were way down the 'priority food chain', the oil spill also had a long-term effect on our boats and the local marine industry. The pristine *Morris 36 Annie*, for example, went out for a daysail on November 7, as oblivious as everyone else about the spill. Until she sailed right through it, splashing the thick oil all over her bow, teak decks and sails.

KKMI's Paul Kaplan reported that the removal process went smoothly, once they determined the safest solvent to use on the boat's Awlgrip paint job.

Kaplan advises other sailors who find oil on their boats to not clean it off in the slip. Doing so could easily compound the



LATITUDE / LADONNA

Spread, the 'Cosco Busan' displays her wounds. Above, the Bay Bridge's concrete abutment acted like a giant can opener on the ship. Note the oily 'arterial spray' from the accident.



JEFF BERMAN

COSCO BUSAN

pollution by dripping solvent or dissolved oil into the water. Baykeeper, a Bay Area environmental watchdog group, seconds that opinion, and further suggests that,

UC DAVIS



The messy business of cleaning boats and birds requires special training.

be eligible to file a claim for your oiled property by calling (866) 442-9650.

Bill Kinney was also sailing the day of the spill. When he returned to his slip in Sausalito, his Northstar 80/20 *Fetchin' Ketch* had

brown splotches everywhere. He removed a few of the globs that could spread, called the claim line and waited for a surveyor to assess the damage. While the

surveyor showed up within three days, Kinney was, at press time, still waiting to hear about getting his hull cleaned. A plan is reportedly in place to clean boats, but owners must call the claim line to make arrangements.

In the bigger picture, oil booms were installed around many marinas to keep them free of contamination. Of course, these also prevented boats from leaving. Most weren't anyway — either because they didn't want to risk getting 'oiled', or because several agencies specifically requested boaters not to go out until the worst of the oil had been cleaned from the water and beaches. Several yacht clubs cancelled races that first weekend, and again the following weekend.

As we were wrapping up this issue, most of the booms were gone, only one skimmer was still out, and presidential politics once more led the evening news.

The bird flocks were back, the seals were on buoys and sailboats were again venturing out on the Bay. But, in a way, it seems like it will be a long time before life on the Bay gets back to normal.

— **latitude 38/ladonna**

PAUL KAPLAN / KKMII



if you feel you must clean the boat yourself, wear gloves and use oil absorbent pads. Then contact your marina for proper disposal guidelines. You may



greenboatstuff.com
Environmentally Friendly Boating Supplies

- Anti-Fouling Paint
- Fueling Systems
- Sunscreen
- Galley Gear
- Clothing & Linens
- Personal Care Items
- Bags & Buckets
- And Much, Much More!
- Cleaning Supplies

VISIT OUR WEBSITE TODAY!!

www.greenboatstuff.com

or call us toll free at
(866) 535-1610



MARINE INSURANCE

Global Coverage • Personal Service
Unbeatable experience to match your needs to the right product.



Insurance made simple, affordable and effective.

TWIN RIVERS MARINE

INSURANCE AGENCY, INC.

7 Marina Plaza, Antioch, CA 94509 LIC # OE32738

www.boatinsuranceonly.com **800-259-5701**

It's Time to "Fuel-Proof" Your Boat!

FilterBOSS

"It's like having an onboard fuel mechanic"

A dual filter controller with a built in vacuum pressure gauge for monitoring the online filter, a built in fuel pump for easy engine bleeding and onboard fuel polishing, along with an early warning panel to let you know when the filter is clogging.



The All New FuelBOSS Onboard Fuel Cleaning/Transfer System

Designed to be installed into the existing engine fuel feed and return lines. An easy way to deal with the continuous problem of contaminated fuel. Available in two models operating at 60 or 90 GPH.



FUEL BOOST PUMP

Supplies sufficient fuel pressure and flow for servicing and bleeding. Acts as a back up if your engine lift pump fails and is not leaking.

FUEL MANIFOLD SYSTEMS

Aluminum and brass housing available.

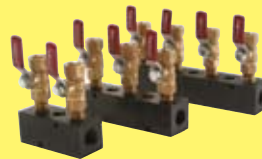

FilterBOSS
"Don't Leave Shore Without It."

Visit our website
or call us for
more details!

www.KTISYSTEMS.com (800) 336-0315 / Fax (413) 569-6911 / Filterboss@ktisystems.com

NEW COAST FABRICS
EST. 1972



Distributor to the automotive
and marine aftermarket.

New Coast Fabrics is a distributor for



Polish and Plastic, Canvas and Vinyl Cleaners

Inflatable Boat Cleaner is an easy-to-use biodegradable cleaner. Dissolves dirt, oil, creosote, diesel soot and scuff marks on inflatable boats, fenders, rub rails, etc.

Super Swabby Bilge Cleaner dissolves oil, grease, gasoline, scum and sludge, leaving a clean fresh scent. Biodegradable.

Boat Wash with Carnauba Wax cleans and maintains waxed finishes on boats, cars, planes and recreational vehicles.

We also carry complete lines of marine vinyls,
carpets and WeatherMax outdoor fabric.

NEW COAST FABRICS

1955 Davis Street, San Leandro, CA

800.772.3449

KISSINGER CANVAS

Marine Canvas & Interiors
STEVEN KISSINGER

(925) 825-6734

Covering the Entire Bay Area



- Biminis
- Boat Covers
- Cushions
- Sail Covers
- Headliners
- Awnings

DODGERS

Side handrails and window covers
included

OPTIONS

Aft handrail, dodger cover,
sailing bimini.

Free Estimates and Delivery

THE CALL OF THE CARIBBEAN

When Old Man Winter blows chilly winds across the Bay Area, sending die-hard sailors in search of a cozy fire, we are reminded that the coming of winter has distinctly different connotations in different latitudes. In fact, in places like the Eastern Caribbean, winter and early spring are synonymous with the height of the sailing season, when the easterly trades blow steadily and both 'glam yachts' and top-tier racing machines arrive from Europe and the U.S. mainland.

With all this in mind, we were inspired

to peruse photographer Tim Wright's sensational archives of photos from last year's top Caribbean regattas. We hope the resulting 'eye candy' will motivate you to think seriously about getting down to the ol' Caribe this season and joining in the fun.

Not only will the tropical sun and warm, turquoise water sooth your soul, but trading tacks and swapping tales with the Caribbean's finest local sailors will give you a refreshing new perspective

on the joys of sailing — and perhaps even a renewed appreciation for life outside the rat race.

Oh, and did we mention the epic post-race parties? Mix together the toned-up feeling you get from physical exertion in the tropical sun, with a few cold libations

Spread: The 138-ft Nat Herreshoff schooner 'Mariette' smokes along the course of the '07 Antigua Classic Regatta. Inset: Shirts-off sailing conditions at Tobago Race Week. Right: The big guns blast at Antigua Sailing Week.



— "WE BE RACIN', MON"

and the infectious beat of reggae and calypso, and, well, "You be feelin' good, mon. Real good!"

Yeah, we know, not everybody can afford to campaign a half-million-dollar racing machine to venues that are thousands of miles



from home. But don't let that stop you. The actual boat owners never seem to be the ones having the most fun anyway. There are plenty of ways to get in on the action.

First, if you and your buddies are serious racers, it is often possible to rent and campaign a well-equipped race boat from one of the big Caribbean agencies like Nicholson Yacht Charters. But, of course, that's a serious undertaking.

Another idea is to contact the sponsoring YCs and get on their eager-to-crew lists. Or, if you're particularly adventurous — and are feeling lucky — consider just showing up a few days in advance of a regatta and chatting up every sailor that comes into the YC bar for a ride. Worst case, you'll end up sleeping under a palm tree on a 75° night. (We've done it — wasn't that bad, actually, but bring bug spray.)

The most popular way to get in on the action is to rent a bareboat from a nearby charter base and either enter to race in the bareboat classes, or simply follow the courses to observe the action and join in the revelry.

True, most bareboats certainly were not designed to race, but in the huge bareboat-only classes found at events like the St. Maarten Heineken Regatta, the BVI Spring Regatta and Antigua Sailing Week there's always plenty of hard-fought, boat-for-boat competition. With

crews flying in from all over Europe, the Caribbean and elsewhere, such events breed a refreshingly international sort of camaraderie.

Accommodations aboard a bareboat will also give you at least visual access to two of the most amazing events in the Caribbean, the Classic Yacht Regattas

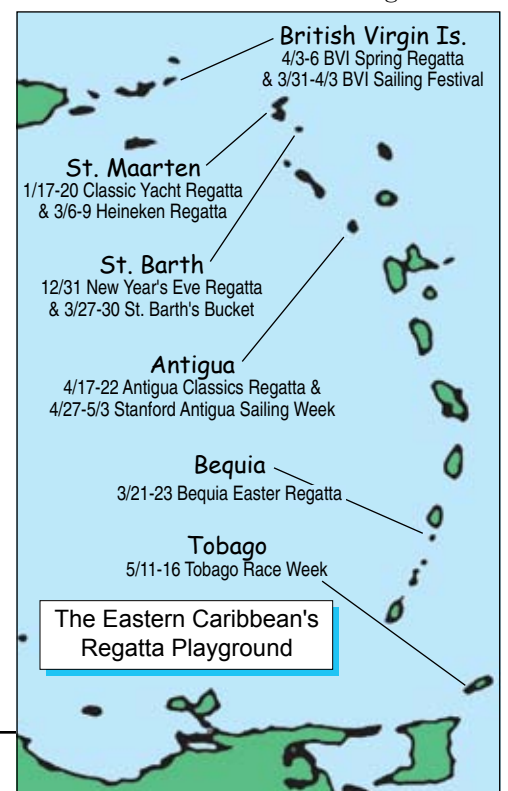

THE CALL OF THE CARIBBEAN



held at Antigua and St. Maarten. While Antigua's draws a substantially larger and more prestigious fleet, both can boast gatherings of vintage, traditionally rigged schooners, ketches and sloops which have been lovingly maintained — often to museum-quality standards — yet are raced hell-bent-for-leather

Although not as long-established as 'The Heinie' or ASW, the popularity of Tobago Race Week is rapidly increasing.

as if the purse was 10 million bucks. Similarly, it's great fun simply to be in St. Barth when top-flight luxury charter yachts, gold-platers owned by the rich and famous and meticulous classics race

together around the island on New Year's Eve day, or later, during the three-day St. Barth Bucket.

Smaller gatherings, such as Bequia's Easter Regatta, can be loads of fun too, especially if big crowds are not your thing. In fact, we can't think of a major Caribbean regatta we wouldn't love to attend this year. As the locals would say, whenever you're sailing in those sunny latitudes, "Life is sweet!"

— **latitude/at**

A virtual warehouse of Tim Wright's action-packed photos can be found at www.photoaction.com.

THE MEXICO CIRCUIT

While we're on the subject of sunny winter racing, we'll also remind you of Mexico's regatta schedule. While none of the following approach the scope of the major Caribbean regattas, all are great fun, and well worth attending.

- 1/29- 2/3 Zihua Sailfest (Zihuatanejo)
- 2/19-3/1 Vallarta Race (San Diego to Nuevo Vallarta)
- 3/1-8 Banderas Bay International Regatta* (Nuevo Vallarta)
- 3/1-8 MEXORC* (Nuevo Vallarta; *both events coincide this year as part of Nautical Week.)

Catalina // Yachts

Introducing fractional sailing from WindPath.

Sail a new Catalina luxury yacht in your local waterways without maintenance hassles — for less than you ever imagined. Evening sails, day sails, even week-long sailing trips — just choose when you want to sail: We do the rest. WindPath offers Fractional Member and Member Owner programs, (including sail training!) in a marina near you.

Get out on the water.
(Not in over your head.)

Business Opportunities Available in Bay Area

Always leave the dock happy.

Visit us at www.WindPath.com or call **888.2.WindPath**

©2006 WindPath Sailing, Inc. L38906

SUNNY ✨ WARM ✨ FRIENDLY
 LOCH LOMOND MARINA
 IN SAN RAFAEL

**Completely Rebuilt Marina • Gas & Diesel Fuel Dock
 Free Pump Out Station • Modern Launch Ramp
 Guest Slips Available • Marine Mechanical Boat Repair
 Arena Marine Supply Store • Bobby's Fo'c's'le Cafe • Loch Lomond Market**

110 Loch Lomond Drive, San Rafael, CA 94901
 Phone: (415) 454-7228 • Fax: (415) 454-6154
 www.lochlomondmarina.com
 Harbor Master – Pat Lopez • pat@lochlomondmarina.com



YACHT INSURANCE

Commercial Operations

- COMMERCIAL POLICIES
 Marinas, Yards,
 Yacht Clubs,
 Brokers,
 Shipwrights

Pleasure Yachting

- YACHT & BOAT POLICIES
 Offshore, Coastal, Inland
 and Liveboards



Lic. #OB21939

Bill Fowler
McDERMOTT COSTA INSURANCE
 (925) 606-6606 Fax (510) 357-3230
 bfowler@mcdermottcosta.com



CORAL HOTEL & MARINA
 Ensenada, Mexico

INCREDIBLE SAVINGS ON FUEL AT MARINA CORAL!
 Call for a quote ~ 866•302•0066



- The only fuel dock & best launch ramp in Ensenada
- Concrete docks from 30' to 65' with 110v/220v elect., water, cable TV, phone service and wireless internet, laundry, marine chandlery.
- Enjoy the amenities of the 147 ocean view suite resort which will make your stay the most enjoyable.

www.hotelcoral.com

Reservations toll free 1-866-302-0066

E-mail: marina@hotelcoral.com Fax-011526461750058 VHF 71
 Carretera Tijuana-Ensenada Km. 103, No 3421 Zona Playitas, Ensenada, B.C. C.P 22860

2007 — THE YEAR



Howard actually hooked Sheira long ago. This year they'll Puddle Jump to New Zealand.



It's a bird, it's a plane... Actually, what the heck is it anyway?



COURTESY CHILLEN NAVY

Ken Barnes' circumnavigating dreams were dashed by a Southern Ocean storm.



SAM PETERSON

Sally and Sam were able to trade tins of Spam for fresh fruit in the Marquesas.



During Zihua SailFest, cruisers worked alongside locals to build new schools.



Down in sunny St. Barth, the 135-ft J-Class yacht 'Ranger' leads the Swan 82 'Opus V' to the finish of the Around-The-Island Race.

The arrival of 2007 had huge significance for this humble publication, as it was 30 years ago that Publisher and Executive Editor Richard Spindler cranked out the first issue while living aboard his fiberglass sloop in Sausalito. Having successfully reached such an impressive milestone, he vowed in a **January Sightings** note to take more time away from the office to pursue his passion — sailing! Elsewhere in the issue we were introduced to the twentysomething crew of *Sary*, which made a pit stop in the Bay after completing a one-month transit of the fabled Northwest Passage. There was sad news too, as a delivery crew was lost without a trace when their 44-ft catamaran flipped in stormy weather off the Oregon coast. Meanwhile, in Mexico and Honduras, two cruising boats were lost, yielding lessons we can all learn from. All crewmen got ashore safely.

In **February** we were introduced to a truly bizarre, spider-like watercraft dubbed a WAM-V (Water Adaptive Modular Vessel), which was designed specifically to do, ahh, whatever. The *Latitude* staff aired their New Year's resolutions, in which they vowed mostly to do a whole lot more sailing. Luckily, they didn't fulfill them all or there would have been a lot of blank pages in the magazine. Publisher Spindler, however, did fulfill his fantasy of spending 45 days in the Caribbean, which yielded a wealth of anecdotes, photos and friendships — all chronicled in an eight-page spread. An in-depth profile of international racer Ashley Perrin gave us insights into her fast-paced world, and we shared the heartbreak of solo sailor Ken Barnes, whose dreams of circumnavigating nonstop were dashed by a rogue wave on the approach to Cape Horn.



LARRY/BAILEY
Maxine Bailey made a lot of new friends on South Georgia Island.



Columbia 5.5s smoke across the Bay during their Nationals.



Going down! Doug Chew and his 'Challenger' crew auger in at the BYC Midwinters.



AQUARELLE

Terry and Evelyn of 'Aquarelle' raced with local Bequia boats en route to Trinidad carnival.



In Hawaii, young 'Morning Light' crew practiced rescues as well as offshore sailing.



Drummond and Teddi strike a pose at Bloody Mary's during a Tahiti charter.

In **March** we puzzled over the mysterious disappearance of sailor/scientist Jim Gray, whose unannounced exit triggered the most highly sophisticated satellite search ever seen — yet sadly produced not a single clue. By contrast, getting to know circumnavigators Larry and Maxine Bailey was uplifting, as they shared tales of exploring some of the world's most remote regions under sail. Back here on the Bay, cold, foggy weather seemed to inspire, rather than deter, local single- and double-handers, who turned out in droves — 279 boats in all — to compete in the 21-mile Three Bridge Fiasco. At the same time, south of the border, Zihua SailFest drew more than a hundred boatloads of cruisers who raced and reveled, but also spent time building new schools for needy children and raising funds to keep them supplied.

April gave us our biggest issue of the year, which brought us sailing news from all over the world, and introduced us to all sorts of sailors. Among them was the Bay Area's own rock star, Paul Cayard, who gave us his insights on the A-Cup, the Volvo 'Round the World Race, the new World Sailing League — and his kids. We celebrated the success of French singlehander Maud Fontenoy, 29, who completed a solo circumnavigation aboard her 85-ft sloop *L'Oreal Paris* after her carbon-fiber mast snapped 2,000 miles from the finish. Her credo: "Make your life a dream and turn that dream into reality." We also introduced readers to lower-profile adventurers: the year's Pacific Puddle Jumpers, who were poised for departure from Mexico to the Marquesas. Back on Bay waters warm sun and strong breeze combined to make the 25th Big Daddy Regatta a huge success.

2007 — THE YEAR



MCKENZIE/SWELL

Out in the South Pacific Liz Clark demonstrates cruiser self-sufficiency.



A salty contingent of West Coast circumnavigators gathered on the schooner 'Lynx'.



PETER LYONS

Wet woodies during WBRA racing on the Cityfront.



WWW.PGREY.SMIUGMUG.COM

Good clean fun at the RYC's Big Dinghy Regatta.



'Lynx' (in the background) and 'Yankee' sprint down the homestretch of the Master Mariners Regatta.

Little did we know that our **May** cover, depicting a bikini-clad woman perched on a catamaran's bow, would stir up controversy. But letters of both protest and praise were penned shortly after the issue hit the streets. In world news we reported that a replica of the 185-ft schooner *Atlantic* — whose transatlantic record was unbeaten for 75 years — would soon be launched in the Netherlands. Here at home, we paid tribute to an elite, yet decidedly unpretentious group of sailors: those who've circumnavigated from the West Coast. And, although not a West Coaster, we saluted 46-year-old 'grandma' Donna Lange, who completed a solo lap aboard a 28-ft sloop. Down in Brazil, another circumnavigator, the 1936 Alden schooner *Lord Jim* was resurrected after being holed by an uncharted rock and sinking.

In **June**, we reported on the slow build-up of the Melges 24 Worlds in Santa Cruz, where competition grew in intensity along with the wind speeds, which reached into the 30s — with 10-foot seas — on the final day. SoCal sailmaker Dave Ullman, the eventual winner, graced us with a wide-ranging interview afterwards. But for A-Cup enthusiasts there was pain in Spain, as the last American contender, Larry Ellison's *BMW Oracle Racing* was eliminated by Italy's *Luna Rossa* in the Louis Vuitton Semis. Elsewhere in the issue we met the bumbling 'Bumfuzzers', a young couple who successfully circumnavigated on a late-model cat despite their apparent nautical cluelessness. At the other end of the spectrum, Sam and Sally Peterson took us on a cultural tour of Kiribati, and Medea Bern prepped us for summer cruising in the Delta.

COURTESY STAGHOUND



'Staghound', stuck in the mud en route to Ensenada.

HOLGER KREUZTHAGE



Good old fashioned Brazilian ingenuity led to 'Lord Jim's resurrection' after sinking in coastal waters.

LANCE EKHART



Paul and Susan Mitchell have fond memories of their early cruising years.



This group of sailors was obviously enjoying their mid-summer daysail.



PETER LYONS



Riding the rails down at the windy Melges 24 Worlds.

July brought us expansive coverage of the annual Master Mariner's Regatta, which fielded 80 meticulously cared-for schooners, cutters, gaffers and sloops for a glorious romp around the Bay in ideal — 20-knot — conditions. Sending the magazine to press that month was sort of a Truman-vs-Dewey moment, as the America's Cup was a cliff-hanger with the ultimate winner yet to be decided. (*Alinghi*, of course, eventually triumphed over *Emirates Team NZ*.) We shared the joy of voyaging shown by Paul and Susan Mitchell, who've been cruising since '82, and were also introduced to Polish supermodel-turned-solo-circumnavigator Natasza Caban. There was ugly news too, though. We felt it our duty to rail at the injustice in a Lake County court case where an off-duty sheriff's speedboat rammed a sailboat, taking the life of sailor Lynn Thornton.

In August we set our sails for Hawaii with the 74-boat fleet of the 44th TransPac, from L.A. to Honolulu. It was a fast trip for some and a bit of a slog for others, essentially dependent on which day (and weather window) they started in. Line honors went to a greatly modified *Pyewacket*, whose 77-year-old owner, Roy Disney, came out of racing retirement to run the 2,200-mile course one more time. The other big racing story, of course, was that *Alinghi* did, in fact, beat *Emirates* in the seventh race by one second, meaning that the Auld Mug will remain in Europe until the next go-round. At the other end of the sailboat spectrum, we meandered up the Bay and Delta with a bevy of antique open boats in the Gunkhole Rally, then helped this year's Pacific Puddle Jumpers celebrate their Polynesian arrival at the Tahiti Tourisme Cup.

2007 — THE YEAR



NICOLE FRIEND

Gar Duke takes a sun sight from the deck of 'Dreamkeeper' on a perfect day in mid-ocean.



Spinnaker bonding at the BBS.



NATASZA POLSKA

Polish super-model Natasza takes a dip at Vanuatu after soloing from Hawaii.



Nancy and Commodore take a spin in 'Flashgirl's Tom Wylie-designed sailing dink.



ROLEX/DAN FORSTER

'Samba Pa Ti' boogies down the course of the Big Boat Series.

In our **September** edition, we got better acquainted with two truly salty characters with similar yet different last names: Merl Petersen and Will Peterson. Also similar is the fact that they've both had many adventures while cruising all over the world. But, as readers learned, their styles of travel were vastly different. With the prime summer weather upon us, we made the case for low-pressure, high-pleasure beer can racing — which is at its best in the late summer and early fall. In international racing, the Rolex Fastnet Race this year was, as we wrote, "one for the record books." The enormous 271-boat fleet took such a battering by a low pressure front, that only 60 eventually finished. Weather was much more benign during this year's Pacific Puddle Jump, as noted in our recap.

The big news in **October** was the Rolex Big Boat Series which attracted 112 entries. Rather than the usual blasting winds and choppy seas, however, this year's contest saw 10 to 17 knots, flat seas and sunny skies. In fact, conditions were so un-San Francisco-like that some sailors were inspired to strip off their clothes and take a dip in the chilly Bay water during a postponement! Elsewhere in the mag, we finally conquered the seemingly-complex workings of SSB radio transmissions and shared them with our readership. We met local tech entrepreneur Kevin Alston, whose diesel-electric power plants are all the rage among yacht designers, and were introduced to *Cangarda*, a classic beauty from the 'golden age of yachting', now being painstakingly restored by local woodmeister Jeff Rutherford.



Low-pressure mid-week fun during a beer can race.



At Catalina's Buccaneer Bash, the pirates look much better than in the old days.



'Grace Quan's sail was finished by boiling it with the bark of oak trees.



PETER LYONS

Big breeze batters the IKCs in the Central Bay.

Within the wide assortment of news that filled *Sightings* in **November** was word that sailing icon Ken-Ichi Horie — who made headlines 45 years ago when he crossed the Pacific in a 19-ft plywood sloop — will soon attempt another crossing in a catamaran powered by wave action. Elsewhere in the issue we were introduced to the Season's Champions of the local racing scene, dozens of folks slated to do the Baja Ha-Ha rally, and a fascinating fellow named Evan Dill. Having been smitten by the cruising bug in his mid-50s, he has become the embodiment of the phrase 'less is more', as he claims to be healthier and happier than ever while living a spartan cruising lifestyle, sometimes on as little as \$150 a month. Also, for the mechanically challenged, we offered a layman's guide to diesels.

And that brings us to **December**. All in all, it's been a pretty great year in the realm of sailing — a place where we and our readers take solace from the not-so-great headlines of the wider world. As you've seen, we've dedicated a great deal of this issue's real estate to coverage of the recently completed Baja Ha-Ha cruisers' rally which was a huge success, despite a few blips along the way. If you missed out on the southbound migration this year, don't fret — there's always next year. As 2007 draws to a close we'll make our usual resolutions: to work smarter and make more time for healthy endeavors like sailing on the ocean with family and friends. And as always, we'll do our best to bring our readers a thoughtful distillation of news from around the Bay and around the world.

— **latitude/at**

DIESEL DIAGNOSIS

Last month, we acquainted you with the many worthwhile aspects of diesel engines in sailboats; the benefits to giving one proper care and feeding; and how to determine when it was time to call your friendly diesel mechanic.

We address this second installment to everyone who missed the first because they're now anchored in Bongo Bongo with an engine that won't start and the nearest mechanic is about 200 miles away . . . to windward.

Obviously, an engine is a complex machine, and we can't address everything that can go wrong with one. And reading this article is not going to get you any closer to being a diesel mechanic. What we hope it will accomplish is to give you a fleeting chance of fixing the beast before it smells your fear.

As you read about these five major diesel issues that boat owners deal with, keep one premise in mind: most trouble with most engines is *not* caused by the failure of major parts or systems. It's caused by simple, dumb stuff like loose wires or clogged filters. So when something — anything — goes wrong, look first for the obvious: leaks (of any kind), split or busted hoses, broken or rusted hose clamps, loose belts, loose wires, or any signs of 'constipation' in filters or hoses (sometimes evident as either swelled or collapsed hoses).

Be forewarned: you're going to get dirty. And smelly. So wear old clothes. You're going to need a decent set of tools, with wrenches that fit your engine (some foreign brands use metric fasteners). You should have the factory 'shop manual' that came with your engine. You don't really need to know exactly how an engine works, nor do you necessarily need to possess a lot of mechanical aptitude, although both will help quite a bit. Moral support from a spouse is always good. And luck. You will need lots of that.

(Although the following information is aimed specifically at diesel engines, most of the basics also apply to gas engines — which we hasten to remind you are much more dangerous to work on as gasoline explodes and diesel doesn't. Please, please be careful no matter what machinery you are working on, and specifically, *never EVER* work on an engine while it's running.)

Here's what to look for and what to do if . . .

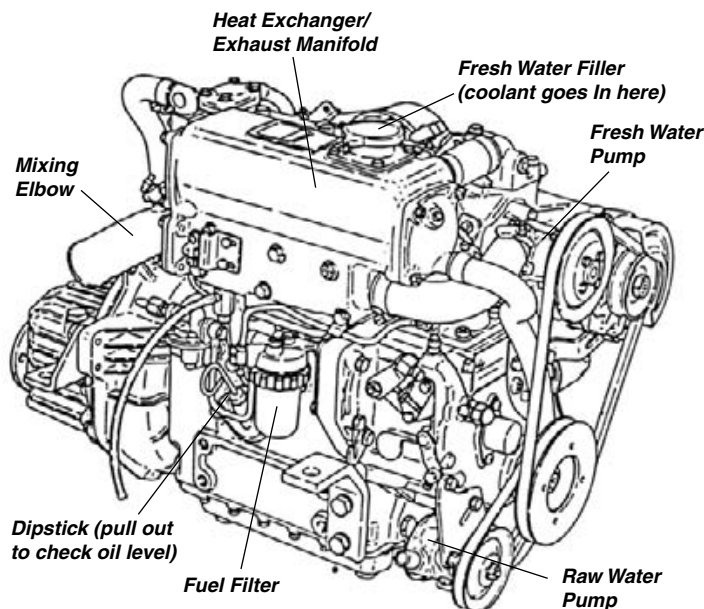

1. The engine doesn't turn over.

- Is the battery switched on? Duh!
- Could something be wrapped in the prop?

• Is the battery discharged or dead? (Check battery condition at your electrical panel or with a voltmeter. Readings should be at, near or slightly above 12 volts for most boats.) You don't need as much juice to crank an engine in warm climates as cold, but diesels still need a lot more power to start than gas engines.

• If the battery(s) are good, check the path of juice from the battery to the starter motor, looking for loose wires and bad connections. Do this on *both* the positive (red wire) and negative (black) wires. (Negative is also referred to as the "ground" side.)

If the battery checks out good, but the engine still won't turn over, here are some quick and easy things to try:

• Take off the battery terminals, clean both the post and connector (inside and out) and reattach. Try it now.

• Give the starter solenoid a sharp whack with a small hammer, crescent wrench or anything else you can fit in the engine compartment. We're not talking a John Henry railroad-building blow, but a decidedly sharp rap. What it does: The solenoid (the small cylinder on top of a starter motor) makes the starter gear temporarily engage the engine and turn it. As solenoids age they tend to 'stick'. Sometimes a sharp rap will free it. If this works, know that your starter solenoid is living on borrowed time and you will need to replace it soon.

• Jump the solenoid with a screwdriver. In other words, touch the metal shaft of a screwdriver to the two big electrical terminals on the back of the solenoid. This good ol' boy trick bypasses the

starting circuit of the boat, and applies 12 volts directly to the starter. If it works (the engine starts), it indicates that there's something wrong between the ignition key (or button) and the starter. Be warned that it's normal with this method to see a big, fat, scary spark when you make contact. **IMPORTANT NOTE: Do NOT try this with a gasoline engine.**

• The issue may be water in the cylinders. This would qualify as a serious problem. Engines are basically big air pumps that compress air,

mix it with fuel and ignite the mixture. Water, however, does not compress. The engine will not start until it's removed. If you try to start an engine with water in it, you could easily cripple the motor or ruin it completely.

Testing for water in a diesel engine is beyond the scope of this article. If there are procedures in your engine manual, and you feel confident in your abilities, by all means proceed. If you are less than confident, now might be a good time to get on the radio and see if you can find a more experienced mechanic among the cruising community — or up anchor and sail those 200 miles to the mechanic.

How does water get into an engine? Glad you asked . . .

2. Engine turns over but won't start.

By far the most common way for water engine to get into an engine is to keep cranking if it won't start. So, after two or three *short* cranking periods, if the engine won't 'catch', stop and consider the following.

- Is the fuel turned on?
- Is there fuel in the tank?
- Is the battery charged?
- Is the battery good? (Older batteries can show a full 12 volts but still not have enough 'oomph' to turn over a motor.) If you have another battery, try switching to that one to start the motor.
- Is the fuel filter clear?
- Is the forward-reverse lever in neutral? (Some engines will not start if they are in gear.)
- Was the 'stop' knob or lever returned to the 'running' position after the engine was last shut down?
- Is there anything blocking the air intake (including a really crudded-up air filter)? Is there anything blocking

— FOR THE MECHANICALLY INEPT

the exhaust (such as a shut-off thruhull)?

Low fuel pressure could also cause a non-start problem. But again, that's a larger problem than can be dealt with here.

3. Running engine suddenly stops.

- Are you out of fuel?
- Are the fuel filter(s) clogged?
- Is the air filter clogged?
- Does the temperature gauge read hotter than normal? (If so, check for leaks or low cooling water and fix or refill as necessary. Let the engine cool for several hours before trying to restart.)

- Is there a line or lobster pot fouling the propeller?

More serious possibilities include:

- Air in the fuel lines.
- Broken or leaking fuel lines.
- Water in fuel, algae in fuel, or just bad fuel.
- Loss of oil pressure.

Again, you will have to assess (with your trusty engine manual) whether you can adequately troubleshoot these problems, much less fix them.

If, in your visual inspection, you see a large hole in the side of the motor and the remains of a piston melted into the quarter berth, that could indicate internal problems. At that point, stop checking the engine and go check your bank account. You may have to sell the dinghy, too.

4. Engine runs poorly or boat doesn't seem to have as much power.

- When was the last time you cleaned the bottom?

- Dirty fuel. This is common in Mexico and some other countries, both because of bad fuel and because boats haven't been used in a long time and their tanks are full of algae. Change the filter and hope for the best.

- Air in fuel. Check and tighten everything you can reach that's part of the fuel system. If you see any leaks anywhere, fix them.

- Water in fuel. This is why most boat fuel systems have clear watertraps (and drains) in the bottom of fuel filters — so you can see if there's any water there. Engines with water mixed in the fuel may also burn white smoke.

Water most often gets in fuel past old, leaky O-rings in fuel filler caps, which are

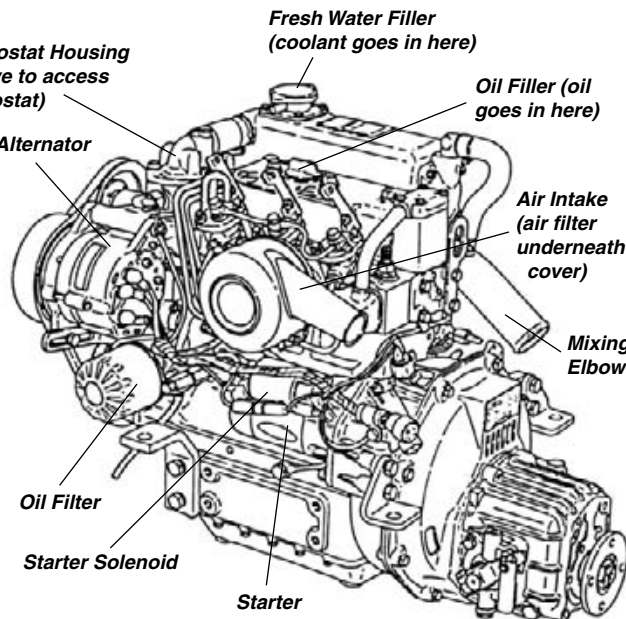

easy to fix. Removing it from tanks is not so easy. Time to call someone wiser.

- Clogged or leaking injectors. This is borderline 'dark side' for the amateur mechanic. Onboard injector testing is messy and potentially dangerous. (Diesel injectors operate under high pressure.) If you have a spare set of new injectors aboard, and you have exhausted every other possibility, go ahead and try replacing them. But know in advance that you will not only have to get each one in and hooked up correctly, you will also have to bleed the air out of the fuel system. Again, the manual is your best friend here. It is possible to do this at anchor far from civilization, but it's not easy or fun.

5. Engine overheats.

An engine running over 220 degrees is living on borrowed time. If you see this temperature on the gauge, or your temp alarm goes off, or you see white smoke or what appears to be steam coming out of the exhaust (or anywhere else) — shut the engine off immediately. Don't attempt to restart it until it cools completely — which usually takes several hours.

Possible causes of overheating include:

- Low coolant in heat exchanger (if fresh-water cooled).
- Clogged raw water filter.
- Raw water thruhull closed. (D'oh!)
- Loose or missing belt.
- Loose or leaking hose.
- Blocked or nearly-blocked exhaust mixing elbow.

All except the last should be easy for the layman to find and remedy. As for the last, the mixing elbow is the place where the raw water mixes with the engine exhaust before it's spit out the exhaust

pipe. Four-cylinder engines have one of these; larger motors may have two. They are located at the rear of the exhaust manifolds.

The interplay between cold water and hot exhaust causes exhaust elbows to corrode internally and eventually clog with rust like bad arteries. Depending on how and how much you use the engine, elbows can clog to unacceptable levels within a year or two. (Most last longer.) There's nothing you can do to prevent it and the only fix is to replace the elbows with new ones, a dirty, messy, horrible job, even when you *do* have elbow room to do it. Symptoms of blocked exhaust include reduced exhaust water out the back of the boat, decreased engine performance and the swelling of water hoses going into the elbows.

Although those are the major issues, there are a plethora of lesser ones. Many will not be apparent until an alarm goes off that you've never heard before, and you finally trace that blinking light to, for example, low oil pressure.

Here's a quick look at some other issues, the resolutions of which are — once again — for the most part beyond the scope of this article. In other words, just hope to the heavens you never run across . . .

Loss of Oil Pressure — Oil pressure is critical for your engine. If you lose it, it's a matter of seconds before you lose lubrication, and without lubrication, it's a matter of a few more seconds before the engine dies a hideous, shrieking death.

Coolant in Oil — After too many tequilas the night before, you mistakenly poured coolant (either water or antifreeze) into the wrong hole. Now there's coolant inside the engine. First off, *don't panic*. Second, *do NOT start the engine*. The fix here is simple, if not exactly quick or cheap. You have to drain or pump all that oil and water out of the engine's crankcase. Then refill with oil and do it again. Then start the engine, run it for about a minute or two, shut it off and drain/replace the oil again. Then start/stop/replace one more time. If that doesn't cure you of ever making that mistake again, nothing will.

If you *didn't* pour coolant in the wrong hole and still have water in the oil (indicated by water droplets on the dipstick or — worse — what looks like a chocolate shake), ooooh. Bummer. Bad. Possible blown head gasket. There goes the kids' inheritance.

Smoke Signals — Generally speak-

DIESEL DIAGNOSIS

ing, white smoke indicates either water in the fuel or misfiring injectors. Black smoke is caused by a rich air-fuel mixture. Possible causes: clogged air filter, dirty prop or bottom, wrong size prop (makes the engine bog down or work too hard), or — again — worn, plugged or misfiring injectors.

Note that some old diesels are so worn they pretty much smoke all the time.

Low or erratic temperature readings indicate a stuck thermostat. This is usually a quick and worthwhile fix. All engines are made to run most efficiently in a certain temperature range and the thermostat controls that.

Weird noise and/or vibration can be hard to diagnose. Again, inspect the engine and its attendant plumbing as diligently as you can. You can often pinpoint an unusual internal knock by using a screwdriver as a stethoscope — put the blade against various parts of the engine and the handle in your ear. (Be very careful you don't stick the blade in any moving parts or you'll have the screwdriver in your ear permanently.) Internal clunks can indicate bad injectors,

stuck valves or other 'varsity' issues.

Squealing or shrieking usually indicates a loose belt.

A new vibration 'out of the blue' can indicate a bent prop or shaft, or even a prop that's thrown a blade — indicative of hitting something in the water.

When you're trying to assess vibrations, don't overlook the engine mounts themselves. Some wear out, some break, some just unscrew themselves, in extreme cases, allowing the engine to jump off its beds and clunk into the bilge. Don't wish that one on your worst enemy.

We've only scratched the surface here. But we hope we've encouraged rather than terrified you. There is nothing quite like fixing a problematic engine yourself to make you feel like you are truly on your way to becoming self-reliant. And once you gain some confidence and experience, you could well come to appreciate the logic, wonder and genius of generations of engineers who brought us these marvelous machines.

In addition to your factory manual (if you don't have one, get one) we recommend Don Compton's *Troubleshooting Marine Diesels* (International Marine, 1998). We also recommend attending one of the many diesel seminars held around the Bay. Two of the local best are run by Tom List of List Marine in Sausalito (listmarine@yahoo.com; (415) 332-5478) and Mike Haley at KKMI (yard@KKMI.com; (510) 235-KKMI).

Two final notes. First, the best offense is a good defense. Keep your engine filters and fluids changed regularly. Keep your engine and engine room clean. Follow the maintenance schedule for periodic lubrication, belt changes and so on. And have spares of the important stuff on board.

Second, while you still may not think you can handle this engine stuff — and we hope you never have to if you don't want to — we have to tell you that relative novices have accomplished some amazing things halfway to the Marquesas, being talked through even difficult procedures by radio.

So never say never.

*since 1989**

D
F
F

DIESEL FUEL FILTERING

*Superior equipment and years of experience
guarantee results - Don't settle for less.*

Purify Diesel Fuel & Flush Tanks.
Process scrubs; polishes; removes algae, dirt,
rust and water from diesel fuel.
Includes internal tank washdown.
Save your injectors, costly engine repair and down time.
*We are in compliance with State and Federal
Specifications & pollution control.*

- "All Pleasure Yachts & Commercial Craft."
- Your berth or boat yard.
- Fully Insured

(510) 521-6797

Fax: (510) 521-3309



*Owned and operated by Bob Sherman since 1989

SAUSALITO

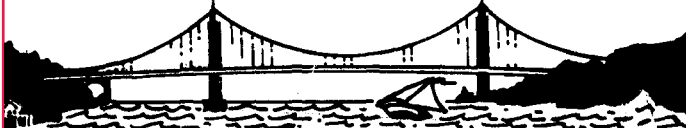

LIST MARINE INC.

- Full service engine shop
- We service all makes
- Dockside facilities
- Mobile service trucks



YANMAR

marine 

P.O. BOX 2008 / 69 LIBERTY SHIP WAY
SAUSALITO, CA 94966
Adjacent to Schoonmaker Pt. Marina

415•332•5478



Increase Your Solar Output With Solar Boost™ MPPT Solar Charge Regulators

Get All The Power You Need To Weather Any Storm

The Solar Boost™ 3024i & 2000E are two of the most reliable Solar Charge Controllers on the market & our patented technology extracts all the power your solar panels can deliver, up to 30% more !

Blue Sky Energy Inc. gets rave reviews in Practical Sailor. Read the article at www.blueskyenergyinc.com

800-493-7877 or 760-597-1642
2598 Fortune Way, Suite K, Vista, CA 92081 USA
E-mail: sales@blueskyenergyinc.com
Web: blueskyenergyinc.com

QUALITY....RELIABILITY....BLUE SKY ENERGY, CHANGING THE WAY SOLAR IS USED EVERYDAY



ULTRA SMALL CABIN AND WATER HEATER

NEW HEATER BREAKTHROUGH

Be comfortable all year round with a quiet, reliable Webasto hot water heating system. Can be linked to pre-heat an engine and provide all the hot water you'll need in the galley or for showers.

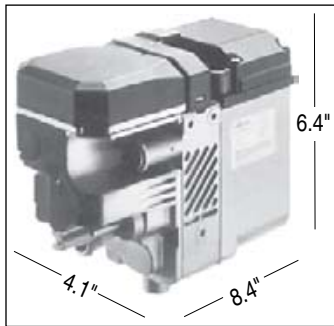

Webasto

CERAMIC IGNITION SYSTEM

- Heat output 17,200 btu/hr (5kw)
- Fuel Consumption .18 gal/hr
- Power Consumption 32 w
- Weight 6.4 lbs

**CALL FOR
MORE
INFORMATION**



SWEDISH MARINE

1150 BRICKYARD COVE RD., SUITE B6
PT. RICHMOND, CA 94801 (510) 234-9566

Peaceful Southern San Diego Bay

**Slips Available
Various Sites**

**Southbound
Cruisers Welcome**

HOME OF CHULA VISTA MARINA

552 slips with complete amenities from private dock boxes to pool and jacuzzi to ample free parking.

Come feel the South Bay difference.

Permanent or temporary berths available.

(619) 691-1860

Dockmaster's office open 7 days a week



boatslips@cvmarina.com
www.chulavistamarina.com

DINGHIES

Outboard-powered dinghies can kill you. They are often the most dangerous when being taken in or out through the surf. While nobody has been seriously hurt as a result of dinghy dumpings

set after set of them. It was pretty epic.

As an indication of how big and dangerous the waves were, the hardcore *pangañeros*, who cross the bar every day for a living, and who regularly bring many of the Ha-Ha participants ashore for the beach party, insisted that the party be delayed for an hour until the tide was higher. The higher tide meant their outboards wouldn't

run aground and that they'd be able to maneuver — a necessity in such conditions.

If a member of the Ha-Ha fleet had a planing dinghy and a surfer's background in understanding waves, it wasn't impossible to get in and out. We did it in the morning alone with our 11' 10" hard-bottom Carib powered with a 15 hp Yamaha. We weren't as successful later on with two passengers. The extra weight limited our speed and ability to maneuver. We made it in, but with a dinghy full of water.

Scott Culver, a professional mariner aboard *Volare*, was another who made several trips in and out with his 9 hp dinghy. But he was careful about the weight. For example, he made two separate runs in with his young kids, knowing he needed to limit the weight for speed. And when it came time to take the kids back to *Volare*, he made sure they went in a *panga*, knowing it would have been too dangerous in his dinghy.

Although only a handful of people took their dinghies in through the big surf to the beach, a relatively high percentage of them got into trouble. Take the crew of the Amel 53 *Charisma*. Owners Alan and Kristen Spence, along with friends Carl and Tia Butz, had taken a *panga* ashore and were enjoying the festivities. At some point, someone pointed out a dinghy adrift in the anchorage, and Alan soon realized it was *Charisma's*.

No problem. Carl got a *panga* ride out to the adrift dinghy and motored it back to the beach. Later on, he and Alan decided to head back out to *Charisma*. As is often the case, going in with the waves

is much easier than going out through them. With several hundred Ha-Ha'ers on the bluff watching — and later ooohing and ahhhhing — the pair ended up getting into a very dangerous situation.

It was not impossible to get out through the surf safely. In fact, Scott of *Volare* and the Grand Poobah did it on separate dinghies about a half-hour after Alan and Carl had their troubles.

The key elements to success were hovering in what was, in effect, a staging area between the just broken waves and the shallow water close to shore. For an impressive succession of 14 large, close-out waves, Scott and the Poobah hovered in the staging area, sometimes taking the soup head on, sometimes briefly running with it toward shore to let the power dissipate. At no time were either of us — or Robert Sutherland, who was a passenger in the Poobah's dinghy — concerned. We would simply hover in the staging area until there was a significant lull, then we'd make a break for it. As all surfers know, lulls happen on even the biggest days, particularly if you're patient. When we got ours, we were in the perfect position to make a dash, and had no trouble reaching deeper water.

What got Alan and Carl into trouble is that, in what appeared to be an attempt to outrun the breaking crests of a series



LATITUDE / JF

during a Ha-Ha, Lauren Spindler, Honcho of the Ha-Ha, nonetheless insisted that every skipper in this year's event be given a special attachment to the Rally Rules to warn of the dangers of dinghies in the surf, and how to avoid them.

Not everyone paid heed. Even though the surf was unusually small for the beach party at Turtle Bay, we're told the first dinghy to go ashore through the one-foot surf either got dumped or dumped her passengers.

To the Grand Poobah's dismay, many of the basic 'rules' of dinghying through the surf were either not understood or ignored. Dillydallying around, for example, when getting everybody into the dinghy and heading out through the surf. Too many people think they can take their own sweet-ass time but, in reality, they have less than 10 seconds after one wave to hop into the dinghy and get out over the next wave. The surf was so small at Turtle Bay that the worst that happened was a few people got splashed. It was an entirely different story at Bahia Santa Maria, the second stop on the Ha-Ha.

We've sailed from San Diego to Cabo at the end of October and early November for 14 of the last 15 years and six other times. In all those years we'd never seen anything close to the swells rolling into the anchorage. Generated by a series of storms in the far-distant South Pacific, the swells were long, gentle, and harmless — in the deep water of the anchorage. But when they reached the shallow bar entrance, particularly at low tide or along the shoreline, it was an entirely different story. There were relentless sets of six-foot waves, and we're talking about close-out waves, not mushy crumblers. And they weren't isolated big waves, but

After this wave ejected the crew of 'Charisma', their dinghy went on a wild rampage, nearly mowing them down in the process.



of waves that peeled very rapidly down the beach, they got out of the staging area at the bar entrance. This left them with a much shorter distance between the breaking waves and shore. On several occasions, Alan and his crew almost made it over a wave, but at the last minute had to turn back and run toward shore with the whitewater. Finally, they got caught in the worst possible position, running parallel to the whitewater of a just-broken wave, and getting hit by it. Both were immediately thrown into the water — which fortunately wasn't cold.

The first rule of operating an outboard-powered dinghy — and the first 'rule' of the Ha-Ha's guide to taking dinghies in through surf — is to always wear the kill switch line on your wrist. As Alan later admitted — and he was a great sport about being an object lesson in how not to do things — he'd put the bitter end of the kill switch cord in his pocket as opposed to around his wrist or clipped to something. As a result, when he and his crew were thrown overboard, the kill switch line went with the outboard instead of killing the motor.

For all intents and purposes, the outboard-powered dinghy was a killer on the loose.

Adding tremendously to the danger was the fact that there was something wrong with the tensioning screw on the



LATITUDE / JR

outboard's throttle, so it wouldn't easily and automatically go back to the idle setting. As a result, the killer dinghy on the loose wasn't just idling, it was going like a bat out of hell.

But what happened next was one of the more bizarre and inexplicable things that we've seen in 30 years of covering sailing. After a brief run at the beach, it made a 180° turn and headed right back

at its two former occupants, who were struggling to come to grips with having been rag-dolled by the big wave. Whizzing past them at what appeared to be a relatively close distance, the dinghy seemed to be headed for the Galapagos. But then, only 100 or so feet past the duo, it took another 180° turn, and headed back toward them — and shore — once again. As it closed in on the beach, it miraculously did yet another 180°, and headed back out in the general direction of the victims again.

If someone had told us this story — and we hadn't seen it — we wouldn't have believed it, for it was as though some demon had taken control and was intent on terrorizing the two. What that dinghy was doing — going straight, then suddenly making 180° turns — just isn't possible. The crowd watching from up on the bluff couldn't believe their eyes.

The Poobah grabbed the microphone from the band and put out a call for assistance. To give you an idea of how long this demonic dinghy continued carrying on, rescuers Banjo Andy Turpin, the Assistant Poobah, and Bill Lilly had to run all the way down from the bluff



COURTESY TALION

DINGHIES

to the beach, drag Lilly's inflatable into the water, then motor several hundred yards down the beach to the site of the mayhem. The runaway dinghy was on its impossible path for at least 10 minutes. Fortunately, Turpin and Lilly, with the help of Scott from *Volare*, were able to bump the dinghy and corral her toward the beach, where the hard sand stopped her prop and finally put an end to her wild ride. Fortunately, Alan and Carl weren't injured.

We know reading about this near-death dinghy experience is not going to be as powerful as it was for the hundreds who watched it unfold, but we beg all of you to follow safety precautions for using your outboard-powered dinghy. It's important to follow them all the time, and it's absolutely critical when coming in or going out through surf. The 'rules' can be found in November 26's edition of *Electronic Latitude* at www.latitude38.com.

Based on what we've seen over the years, taking a dinghy through big surf

is not for novices. It's best left to folks who have a lot of experience with breaking waves and a lot of experience with dinghies. For anyone else, the risk of injury or worse seems pretty high — even if you are wearing your kill switch properly. So please, folks, be very careful out there, and make sure your kids follow all the rules and always wear PFDs.

Lest anyone think we're presenting ourselves as know-it-alls, we've had to learn our dinghy-in-the-surf lessons the hard way. At Bahia Santa Maria several years ago, we were out in our dinghy checking the surf at the point with the Surf Queen Angela de Vargas. A little too smart for our own good, we decided that we'd try to surf some of the bigger waves with our dinghy. The takeoff turned out to be a little steeper than we'd planned, and we found ourselves with a dinghy



LATITUDE / JR

You really have to understand wave dynamics and how to handle your dinghy before attempting big surf landings.

full of water on the rocks inside the surf line. At least we'd had the kill switch on, so neither of us were at risk of being chopped up. After weathering the soup of several more waves, we were able to make our way back to deep water. And we were extremely lucky not to have been pin-cushioned by urchin spines.

So yes, dinghies can injure or kill even when being driven by an experienced operator — or an experienced operator not thinking very clearly.

— **latitude 38**/richard

MARITIME INSTITUTE



Commitment

Offer the best and most practical instruction for mariners!

We assist our students at every step to see that, not only are they prepared to pass the USCG test, but, more importantly that they're more likely to retain and use what we've covered. A well prepared mariner will be a safer mariner.

Some schools are offering a barebones course to get a student through the exam; a number of students won't pass the test and there won't be anyone there to tutor them to understand and to retest and pass what was missed. Even though 98% of our students pass the exam on their first try, as a matter of principle, we provide the additional where it's needed and at no additional cost.

For over 30 years we have built a reputation for offering the very best mariner's instruction available, anywhere. Give us a try and find out why.

CALL TOLL FREE 888-262-8020

Visit our website for more information.

www.MaritimeInstitute.com

CAPTAIN'S LICENSE • RADAR • RADIO • NAVIGATION • SAFETY





Tradewinds Sailing School and Club

1230 Brickyard Cove Rd #100, Point Richmond, CA 94801

Phone: (510) 232 - 7999

Email: staff@tradewindssailing.com

“The Best Sailing and Training Value on the San Francisco Bay!”

American Sailing Association School

Basic Keelboat (101) - \$525

January 12th
January 14th
January 19th
January 23rd
January 26th
February 2nd
February 6th

Basic Coastal Cruising (103) - \$675

January 19th
January 28th
February 2nd
February 16th
February 25th
March 8th
March 12th

Bareboat Charter (104) - \$895

March 8th
March 22nd
March 26th

***Dates listed are class start dates. 101 and 103: Weekend classes are 4 days. Weekday classes are 3 days. 104: Class is 3 days with overnight.*

Our club members enjoy unlimited sailing for one low monthly rate!

Winter Special!
Take \$200 off any of the above courses!

*Expires 2/29/08

www.TradewindsSailing.com

Season's Greetings

and

Thank You

for a wonderful 2007



We couldn't continue without your support and patronage.

Best wishes for 2008!

SAL'S

INFLATABLE SERVICES, INC.



PHONE (510) 522-1824 FAX (510) 522-1064

1914 Stanford Street, Alameda, CA 94501

salsinflatables@sbcglobal.net • www.salsinflatableservices.com

Blue Water Yacht Insurance

Blue Water Yacht Insurance covers more active cruising boats than any other marine agency in the Western Hemisphere and is the leading innovator of insurance products for the offshore sailor.

Our Insurance Programs Provide

- Crew of two anywhere
- Hawaii
- South Pacific
- Multihulls
- Racing Boats
- Worldwide Navigation
- Caribbean
- Charter Boats
- Liveaboards

Quality Rated Insurance Companies

Boats aged 1 to 40 years • "Agreed Value"
"All Risks" • "New for Old" replacement partial losses
Hulls valued \$50,000 to \$2,500,000

Worldwide Health Insurance

International and USA health insurance plans at affordable prices.

Call Toll Free (800) 866-8906

Fax: (866) 795-3707

email: sales@bluewaterinsurance.com

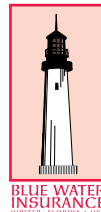

BLUE WATER INSURANCE

Quotes requests/Visit our website:
www.bluewaterinsurance.com



SEASON CHAMPIONS, PART II



Welcome to the second installment of our annual Season Championship series. This month, we profile winners of 11 of the Bay's larger one-design classes.

These fleets are as eclectic as the people who sail in them. They range in size from the 40-year-old Santana 22 class to the 40-ft J/120s, and in intensity from the gentlemanly Alerion Express 28s to the wild and crazy Melges 24s. The Islander 36 fleet sails 14 non-spinnaker races, while the Etchells maniacs cover a 52-race program. The Moore 24 fleet enjoys the unique Roadmaster series, which takes the fleet to such diverse

venues as Huntington Lake and the Hood River, while the SF 180 finds their variety in combining three similar-size classes (Cal 29, Catalina 30 and Newport 30) into a single 'one-design' class. Whatever type of racing you like to do, you can find it in one design.

Whatever the fleet, whatever the format, the big appeal of one design is that all the boats in each fleet are the same. So — theoretically anyway — crew skill and tactics are what win races. Of course, there's a *bit* more to it than that, and some boats are 'more equal' than others. But one design is a good place to

be if you want to test your skills, learn some new ones, and just generally become a better sailor.

Twenty years ago, almost all one design fleets raced under ODCA — the One Design Classes Association — which was, and is, part of the Yacht Racing Association of San Francisco Bay. YRA acts as an advocate for sailing in the Bay, maintaining buoys, coordinating race management, and processing PHRF certificates, to name a few. Other fleets under the YRA umbrella include HDA (handicap racing), OYRA (Ocean racing), and WBRA (Wooden boat racing).

—ONE-DESIGN



Most YRA fleets have remained relatively stable over the last few years, ODCA numbers have dwindled. Try as they did (and still do), it was impossible for YRA to find a format that pleased everyone, so one by one, many fleets have dropped out of YRA to run their own seasons. The month's champions represent half ODCA boats (pages 160-161) and half independents (162-163).

Seventy-six boats in 9 classes signed up for the 2007 ODCA season, with only 48 boats in seven classes

2007 one design fleet action. Top row (l to r) J/105, Express 27, J/24, Etchells. Bottom, Melges 24 and J/120.

qualifying. To qualify, a boat must race at least 50% of the scheduled events. That's down slightly from the 2006 season, once again reflecting a decline in overall YRA participation.

"Next year we plan to combine HDA and ODCA race days, which will give both fleets the option to choose longer or shorter courses and one or two races each race day," says ODCA President Bill Murphy.

One of YRA's own creations drew some one-design boats away from their 'core' fleet races. The new Party Circuit, which consists of three full-weekend events (Vallejo Race, Summer Sailstice and Second Half Opener), attracted a number of boats from all fleets. In particular, a handful of Express 27 guys returned to the YRA fold to enjoy the more laid back Party Circuit instead of compete in that independent fleet's 46 possible races. (Interestingly, the 27 also ran its own variation of the Party Circuit, a seven-event program called the Long Distance/Mellow Series.)

SEASON CHAMPIONS, PART II

A number of incentives are in the works to draw more boats back into YRA.

For one, the success of the SF180 'one design' fleet has spawned an SF198+ fleet for 2008. Designed to attract smaller, older boats back into racing with YRA, any sailboat with a rating of 198+ may enter and sail — such boats as the Catalina 27, Ranger 23 and 26, Pearson 28, Cal 2-27, Santana 20 and, who knows, even a Thunderbird or two. Like the SF180 boats, the new class will sail ODCA 'around the buoys' races rather than the much longer HDA courses. Like other ODCA Fleets, there will be two races each race day, each about 3 to 5 miles in length.

The Party Circuit will also be expanded in 2008 to include non-spinnaker and shorthanded divisions. They'll join the traditional spinnaker and multihull divisions. The Party Circuit for 2008 once again includes three race weekends, each with a Saturday night dinner/party at the host yacht club: the great Vallejo Season Opener hosted by the Vallejo YC; the Second Half Opener hosted by the Encinal YC, and the expanded YRA Season Closer hosted by Corinthian YC.

Anyone interested in ODCA racing or in establishing a new one-design fleet should contact Bill Murphy at (510) 525-3161 or email to capnbill@lmi.net.

In the end, what fleet people sailed in doesn't matter half so much as that they just went sailing in the first place. We hope many more local sailors will try racing in the coming year. Whether you're a Type A, AA+, or even a laid-back Type B, there's something out there for everyone.

— **latitude/lc & jr**

Our apologies, but we didn't have enough room to profile all one-design winners. Congratulations and most honorable mentions go to these additional ODCA classes:

BENETEAU 36.7 — 1) **Mistral**, Ed Durbin, 40 points; 2) **Ay Caliente**, Aaron Kennedy, 49; 3) **Bufflehead**, Stuart Scott, 50. (5 boats)

ANTRIM 27 — 1) **Cascade**, Steven Rienhart, 10 points; 2) **Always Friday**, John Liebenberg, 13; 3) **Max**, Ryan Richard, 14. (4 boats)

ISLANDER 36 — 1) **Windwalker**, Richard Schoenhair and Greg Gilliom, 16 points; 2) **Captain Hooke**, Tom & David Newton, 25; 3) **Pacific High**, Harry Farrell, 31. (10 boats)

OLSON 30 — 1) **Hoot**, Andy Macfie, 25 points; 2) **Voodoo Child**, Charles Barry, 34; 3) **Naked Lady**, Jeff Blowers, 44. (5 boats)

Alerion Express 28 Eagle



Chuck Eaton St. Francis YC

Some season championships aren't decided until the last leg of the last race. Others are settled way earlier. *Eagle's* Chuck Eaton (with "my stalwart crew of two years," Adrienne Mally, above) were among the latter. In fact, we haven't seen a victory this lopsided since Little Big Horn. *Eagle* scored — count 'em — eight bullets in the fleet's 11-race, 2-throwout series, ending up with 10 points *total* for the season. The second-place boat had 20. Chuck could literally have sat out the last four races and still won.

But when you like sailing as much as he does — particularly 'gentleman' sailing aboard a lovely boat like the AE28 — who wants to sit home?

"This is a low-key class compared to some I've sailed in," said Eaton, an investment banker who has sailed in lots of classes (including lots of dinghies) in the last 38 years. As such, he feels the Alerion fleet is a great haven for other racers who, like himself, might have tired of the yelling and intensity of some fleets. By contrast, the Carl Schumacher-designed AE28s race under main and 95% jib only (no spinnakers or genoas), and the rules require everyone to stay in the cockpit. There are no bruising rail rides for this class.

"I'd like to see more Alerion Express owners try racing next year — and more sailors take a look at this class," says Chuck. "It would be great to see the fleet grow."

2) **Lizbeth**, Michael Land; 3) **Scrimshaw**, Michael Maurier. (6 boats)

Express 37 Elan



Bill Riess Richmond & Encinal YC

Express 37 fleet members are among the friendliest you will ever meet — ashore. But once they get out on the water, the gloves come off and no quarter is given. This has long been one of the Bay's most intense racing fleets.

Bill carried on that fine tradition this summer, going mano-a-mano with the Kame Richards/Bill Bridges *Golden Moon* team the whole nine-race, no-throwout series. Both boats chalked up three wins, with *Elan* taking four seconds to *Moon's* three. When the spray had finally settled, *Elan* scored an 18 to the *Goldies'* 20. And *Expeditious* was only a few points away in third. Now that's good racing.

Bill has owned *Elan* for 11 years now, and crewman John Kernot has been with him since the beginning. (Kernot actually drove a number of their races this year when Bill was busy with his work as a psychologist.) Other crew coming and going this year included Carla Thorlson, Steve Hutchinson, Shannon Kelley, Jeff Angermann, Maria Flores, Chris Chapman, Dave McMurtry, Richard Beauregard, Guy Rittger and Steve Sorosz.

As well as being one of the nice guys of the sport (ashore, anyway), Bill also enjoys a reputation as a 'clean' sailor. "I'm sensitive to the state of the planet and the amount of pollution we sailors create," he says. "I'm happy to say it isn't much, but it's important to be mindful."

2) **Golden Moon**, Bridges/Richards; 3) **Expeditious**, Bartz Schneider. (7 boats)

**Olson 25
Vivace**



**Nelson/Van Kirk
Richmond YC**

This is Larry Nelson and Frank Van Kirk's fifth season with *Vivace*, and they have yet to finish worse than third. This year's season championship marks their third in the class (the others were in 2004 and 2006) and, with an 18-point lead over the second place boat, it was their most convincing one yet.

Which is not to say it was easy.

"It never felt like we had a strong lead, the racing was much tighter than the results indicate," said Larry, who runs a flooring business in Sonoma. (Frank runs a painting shop.) Both partners credit their "tried and true" crew for making it happen: Mike Quinn, Terry Bennett, Harry Weiner and Baird Lloyd-Knuckles.

While it's hard to argue with 9 bullets in the 19-race, 5-throwout series, the partners are wondering if their sails are going to make it one more year. The main is four years old and the jib five, which in racerspeak equates to the late Pleistocene period.

"They're not all that bad," says Larry. "It just means we'll have to try a little harder next time. I think our guys are up to the challenge."

For *Vivace*, September doesn't mean the end of racing — it just means trading drivers. Larry steers the boat in the summer and Frank drives during the winter, when the boat sails in the Berkeley Mid-winters. They win pretty routinely there, too.

2) **Clean Sweep**, Tom Nemeth; 3) **Synchronicity**, Steve Smith. (10 boats)

**Santana 22
Tackful**



**Lawler/Stierhoff
Sausalito YC**

You know all that wedding vow stuff about 'love, honor and obey'? Frank and Kathy live it both on and off the water. As equal partners in *Tackful*, they trade off steering (and skipping) duties. And when it's Kathy's turn, Frank does a lot of 'obeying'! The arrangement has worked well for the couple ever since they got the boat almost 20 years ago. *Tackful* herself dates back to 1972, with the Tuna 22 design going back even further than that — to the mid-60s when a young naval architect graduate named Gary Mull made some doodles on a napkin during lunch with Bill Schock.

Kathy and Frank — a CPA and retired sheet metal worker, respectively — heaped praise on their crew for the '07 win: Ted Miller, Kari Ving and Mark Miglio. They also thank the owners of *Carlos* and *Tchoupitoulas* "for missing a few key regattas."

Like any racer who's been out there a few years, Frank has developed a good local knowledge of San Francisco's complex winds and currents. Kathy says he's also cultivated a sixth sense of what and whom to watch out there on race day, and it's not just the other Tuna 22s.

"I keep an eye on other starts and other fleets as they pass by to get a better idea of what the conditions are prior to our start," he says. "That's one good thing about being the last class to get going — you get to see what a lot of other boats are doing before it's your turn."

2) **Carlos**, Jan Grygier; 3) **Tchoupitoulas**, Buckingham/Giovacchini. (12 boats)

**SF 180
Goose — Catalina 30**



**Michael Kastrop
South Beach YC**

Michael began sailing at 12 years of age and started racing a year later. Originally from Southern California, he's lived in many places, including Texas, Utah and Arizona, but now calls the Bay home. Despite more than 40 years of sailing under his belt, Michael has yet to tire of going out. Or learning something every time he does. "No one ever really truly knows the Bay," he says, noting that's what keeps him and his crew always challenged. "The Bay really tests your knowledge."

Among those being 'tested' on *Goose* this year were Michael's family — wife and 'spinnaker goddess' Lorianna, and teenage sons Jack and Clint. Rounding out the crew were Alex Kononoff, Mark Hensley, Tom Hawkins, Ramelle Ruff and Urs Willimann.

Michael attributes this year's win to two things: "Great crew work and practice nailing the starts." Even then, the competition was tough, especially one of the newest SF180 boats, Dick Aronoff's veteran Newport 30 *Harry*, which finished only 4 points behind *Goose*.

Michael says the SF180 class is an ideal venue for older boats of around 30 feet and PHRF 180 to keep racing together, and invites more old vets to come back out next year.

Michael makes his living as an architect. Among his many projects was the interior design of the new South Beach YC building.

2) **Harry**, Newport 30, Richard Aronoff; 3) **Achates**, Newport 30, Bob Schock. (8 boats)

SEASON CHAMPIONS, PART II

Etchells JR



Bill Melbostad
SFYC

Bill Melbostad first started racing Etchells way back in 1980, crewing then for Jeff Madrigali and Chuck Findley. These days, he sails his own boat *JR* (named for his late father, James Richard Melbostad) with co-owner Bryan Moore, who is also the primary helmsman. Rounding out the three-man complement is Steve Fentress. *JR* herself is an Australian-built 1984 Ian Bashford boat, one of three or four sailing locally.

In addition to his regular crew — "who really gelled this year; I'm so appreciative of these guys" — Melbo says plenty of credit for the '07 win goes to his old "Jedi master", Jeff Madrigali. "We got a new mast and sails, but Jeff is the one who really dialed us in. We had superior boatspeed the whole season."

The proof in the pudding — as well as the most memorable moment — which came during the PCCs in June when *JR* was over early in the last race and had to make up a lot of ground. They managed to claw back to eighth at the finish, which tied them for first with Ben Wells. By virtue of two earlier first places, *JR* won the tiebreaker.

As good as winning this tough class might be, Bill, who makes his living as a marine surveyor, made sure to say that he's even more excited about his recent engagement to Frances Barbour, "and her great support of my racing."

Now *there's* a guy who has his priorities straight!

2) **Ginna Fe**, Mike Lapport; 3) **Catalunya**, Nate Ballard. (10 boats)

J/24 Small Flying Patio Furniture



Edward Walker
OCSC

2007 marked the first time Ned Walker and his crew have made it to the J/24 winner's circle. They've achieved numerous second and third-place seasons since Walker first started in the fleet in 1998, but this year it finally came together for them — big time. Out of 38 counting races, they took 18 firsts and never finished worse than third the whole season.

Ned credits crew work as the main reason for their stellar summer. "I have a very good, experienced crew who are also a ton of fun to sail with," he says. The main people rotating through the boat this year were Jim Pascucci, Jack Ehlers, Annelise Moore, Lea Prince, Rich Clymer, Max Starnitsky and Isaac Miller.

Walker, who teaches political science at U.C. Berkeley, also 'rotated' boats. Although he started the season racing *Casual Contact*, he got a deal on *SFPF* (previously owned by former fleet captain Steve Hartman) and finished out the season dry-sailing that boat while *Casual Contact* did some 'teaching duty' of her own as part of Olympic Circle Sailing Club's program.

Ned also gives due credit for his success to competitor Michael Whitfield and his *TMC Racing* crew. "They're very good, and it was a real measure of success to us when we could beat them," says Ned. "Of course, that usually only happened when Michael was sick and someone else was steering."

2) **TMC Racing**, Michael Whitfield; 3) **On Belay**, Don Taylor (14 boats)

J/105 Aquavit



Timothy Russell
SFYC

With more than 20 boats turning out on any given weekend (and more than 40 total participants over the year) the J/105 class is the biggest one-design fleet currently racing on the Bay. And certainly one of the toughest to win, which makes Tim Russell's first season victory all the sweeter — especially since he's finished second in '04, '05 and '06.

"First I'm grateful to my crew, Bill Tiesman, Scott Parker, Brent Draney, John Claude and tactician Ted Wilson," says Russell, a financial planner. "We've had a great time together, we're laughing all the time, and we like each other so much we even camp together as a group."

"Secondly, I'd like to thank Chris Perkins for not sailing the entire season."

Aquavit has been moving steadily up the ranks since Tim acquired the boat in 2003. Before that, he had crewed for a couple of years on other 105s, and had a few more years in the Express 27 ranks. Although he grew up sailing dinghies, *Aquavit* is the first big boat he's owned.

The turning point for the *Aquavit* crew was the Albert T. Simpson Regatta, raced out of StFYC in July. Sailing with old sails and Brent substituting for Ted on tactics, *Aquavit's* stellar 1-1-2-2-1 performance showed they had 'arrived'.

(*Aquavit's* win was in the longer and more intense J/105 'A' series. The 'B' series, with half the number of events and a smaller fleet, was won this year by Tom Kassberg's *Walloping Swede*.)

2) **Donkey Jack**, Scott Sellers; 3) **Brick House**, Kristen Lane. (35 boats)

**J/120
Chance**



Barry Lewis
StFYC

2007 marks the third time that *Chance* has occupied the J/120 winner's circle. And no one has a bigger appreciation of what it took to get her there than owner Barry Lewis.

When Lewis came west about 20 years ago, he was a dedicated dinghy sailor — born and raised sailing little boats on the East Coast (including during his stint at the Naval Academy). But he found the Bay a bit unforgiving for centerboard sailing. He took a few keelboat classes at OCSC, and in 2001 took the plunge with his first and so far only big boat: *Chance*. At first he didn't intend to race, but class sparkplug Steve Madeira convinced him to at least give it a try when the class got one design status in 2002. Lewis found he liked racing the big 40-footer. He liked it a lot — not only the boat itself, but the people and especially the competition.

"Every year on the Bay raises the game another notch," says Lewis, a wireless industry entrepreneur. "There are no runaway winners in this fleet. Most regattas are won by a point or two and at the end of the season, the top four or five boats are all within a 10-point range. That means if you're not fully on your game every race, you're going to fall back. And that means you're constantly improving."

Lewis credit's *Chance's* consistency and constant improvement to her long-time crew: Doug Nugent, Scott Kozinchik, Matt Gingo, Mark Ruppert, Aaron Elder, Sean Ross and David Krausz.

2) **Mr. Magoo**, Steve Madeira; 3) **Dayenu**, Jermaine/Payan. (9 boats)

**Melges 24
Matilda**



Richard Leslie
Encinal YC

It might seem to the casual eye that Richard Leslie is a bit overextended in the sailing department — the *Melges* sailing department. After all, he owns two *Melges* 24s and their new big sister, a *Melges* 32.

But the results speak for themselves. Leslie sailed *Matilda* hard and consistently, edging out nemesis *Smokin'* in the 9-race, 4-throwout *Melges* 24 season by just one point. Richard says he owes the win to "a variety of lucky circumstances, starting with my great crew" — Bill Odgers and Mahalynn Lu, with Steve Lovegrove occasionally filling in.

On the weekends he wasn't sailing *Matilda* (hull #19) or *Southern Cross* (#676), he was learning the new 32, which is also named *Southern Cross*. (He sailed the latter to a third in the new M-32 Division at this year's Big Boat Series.) He says he will once again sail both the big and little *Southern Crosses* in local events next year, while *Matilda* has been shipped to Australia, so he can keep sharp when he's home visiting.

Richard, who runs a mergers and acquisitions firm, says his love affair with *Melges* designs began almost a decade ago when he was at the St. Francis YC and saw a fleet of them planing by. "I was in awe of the speed and the skill," he says — "and the fact that no one was crashing." Once he saw up close how well built and well balanced the boats (and fleet members) were, he was hooked.

2) **Smokin**, Kevin Clark; 3) **Nothing Ventured**, Tom Klenke. (12 boats)

**Moore 24
Morphine**



Brad Butler
Port Madison YC

The *Moore* 24 fleet is unique in that their Roadmaster series takes participants into the ocean, the Delta, Huntington Lake and even the Hood River for this year's Nationals (which count in the season totals). Next year, they'll add Whidbey Island Race Week to the circuit, a tip of the hat to the ultimate Road Warrior, Brad Butler. Brad lives and works (as a phone company manager) in Bainbridge Island, Washington. But on the Thursdays before a race weekend, he and his crew — Steven Trunkey, Ian Beswick and Andy Schwenk — hitch *Morphine's* trailer up to the 'Team Black and Blue' diesel SUV and hit the road on a 16-hour trip that puts them at the race venue by about noon on Friday.

So when Brad says his 2007 win "is due to my phenomenal crew," he doesn't just mean on the water. "When you're trapped in a Suburban for 32 hours, you have to get along," he notes.

On the water, 'steady' is Butler's goal — specifically, to stay with the half-dozen top boats in any race. This year, that strategy landed him a second at the PCCs and another second at the NAs.

Going into the final weekend of the '07 season — the Great Pumpkin — *Morphine* was once again second (tied with *Paramour*), but six full points behind Bill Erkelens' *Tortuga* (which didn't race). After posting a 2-5-1 on Saturday, Butler was astounded to learn that he had slid by both *Paramour* and *Tortuga* to clinch the season — by two points!

2) **Paramour**, Rowan Fennell; 3) **Tortuga**, Erkelens/Canada. (26 boats)

MAX EBB

"Max, you be line spotter," said the Principal PRO as he handed me a pocket-sized VHF radio.

We seemed to have more people than jobs to do on the committee boat, but the easy job was fine with me. Whatever the assignment, a day on the water is better than a shift in the kitchen — my club asks all its members to do one or the other at regular intervals. And, as line spotter, I would have my hands free to take pictures.

The RC boat was a great vantage point for photos. As the time for the first warning gun approached, boats began making close passes to check for signals and make sure they were checked in. I was imagining some of my pictures finding their way into the club newsletter, framed on the wall behind the bar or, who knows, maybe even in a local sailing magazine . . .

"Why do they all have to come so close?" asked the owner of the big new powerboat we had requisitioned for RC duty.

"It's this wacky starting system," said the woman in charge of timing. "We go by the book, ISAF Rule 26, and under that system you never know who starts next until you see the class flag go up with only five minutes to go."

"Isn't the starting order published in advance?"

"Yes, but the RC can change the order or, more commonly in YRA racing, leave out a class that doesn't show up. So you don't really know for sure. If they 'delete' a class, your start might happen five or ten minutes earlier than what's in the

in the sequence."

"That's nuts," said the owner, as one of the Division C boats luffed up toward us to narrowly thread its way between our transom and a Division A boat crossing our stern in the opposite direction. "If my insurance broker only knew . . ."

The Division C boat was too close for a good picture, and their jib was still down anyway. But I did get a nice group portrait of the cockpit crew.

"We should at least publish the starting sequence with 'earliest possible start times' for each division," added the timer. "The way we do it now, we make everyone count by fives or sixes from the first warning just to figure out what time they might start, and then they still don't really know."

"It's better to run the starts exactly the way they are prescribed by the rules," said our Principal PRO, who was fresh from a race management seminar.

Then things started to happen fast. There was a flag and gun for the warning, another flag and another gun a minute later at the preparatory, a flag down and horn at one minute, and a gun and more flag changes at the start.

No over-earlies, so I got a great shot down the line as the big boats started.

But the next signal was a postponement. The wind had shifted a little and it was decided a new mark would be dropped to keep the course axis exactly upwind. While the PRO was busy



Only shoot into the sun if backlighting can be used to advantage.

sailing instructions. Or you might start later if there was a postponement earlier

setting up the code flags to indicate the magnetic bearing to the new windward mark, I explained what was going on over the VHF. But it didn't stop the rest of

the fleet from making more close passes to see the signals and ask or complain about the delay. Though it gave me some more great photo ops, I could tell from the owner's expression that it would probably be a long time before we could use his boat for RC again.

While we waited for the mark boat to confirm the location of the new windward mark, I noticed a woman in a sea kayak paddling toward us along the starting line.

"Please clear the area," announced the PRO over the hailer, "we are starting a sailboat race."

"Parlez!" responded the paddler, whom I now recognized as Lee Helm.

"It's okay, she's with me," I said to the PRO before he could repeat his warning to stay clear.

He was going to warn her off again anyway, but when one of the flag han-



MAX EBB

A low shooting position keeps the horizon below deck level for better composition, and getting in close adds perspective for a more dramatic portrait.

dlers shrugged "Navigable waterway, you know," the PRO sighed and put the microphone down.

"Yo, Max!" Lee hailed again as she came closer. "I heard your voice on the radio." She had a camera around her neck, too.

"Getting some good shots out here?" I said.

"Totally awesome!" she exclaimed as she pulled her kayak alongside the big powerboat. "Too bad you're on this end of the line, though."

"The view's pretty good from up here," I boasted.

"Lighting's all wrong," she said. "And like, except for boats coming up the barging line off your starboard quarter, you'll just get shots of boats sailing away from you."

I had managed a few shots over the starboard stern, but from where I was stationed on the boat I couldn't really get a clear shot in that direction.

"Also," she continued, "you're, like, way too high up. You'll have the horizon running right through the rigs on every frame.

"Uh, what's wrong with that?" I asked innocently.

"Poor composition. I'll show you after the starting sequence. Gotta get back on station at the other end of the line as soon as your postponement ends. There are some boats in the next start on my shopping list, and this is, like, my last chance to get good pix of them before the holidays."

"So that's what you're up to," I said. "Digital photos as Christmas presents."

"For sure. I'm a starving grad student. And if I use the printer in the department office on campus I don't even have to pay for toner. All I have to buy is photo

paper and frames, and I know where to get those cheap."

Lee paddled back to the pin end of the line as we prepared to end the postponement.

"Wait a minute! The leeward gate isn't square anymore," said the PRO.

"No time to change it before the first division gets there," advised one of the flag handlers.

"Wish we had a second mark boat," fretted the PRO. "Maybe we can adjust it after the first group is around."

The postponement ended, the wind direction held, and we got the rest of the fleet off to our leader's satisfaction, even though the wind favored the pin end despite our adjustment to our anchor line. All the close action was down where Lee was stationed.

We had time to kill between the last start and the first finish, so we broke out

MAX EBB

the sandwiches and our one-beer-only ration of grog.

"Getting any good shots?" the timer asked me.

"Yes, I think so. And since my friend in the kayak gave me the idea, I can use a few of them for Christmas presents."

"That's a wonderful idea," agreed the owner's wife, known for her attention to protocol and etiquette around the yacht club. "Perfect for people you don't normally exchange gifts with, because it's not expensive enough to make them feel awkward for not having a gift ready for you."

"Might turn out to be kind of labor-intensive, though," said the timer. "A lot of work goes into making good prints, even digital prints. I just give Amazon gift cards to all the nieces and nephews on my list. The parents still think they're for books, but the kids can buy virtually anything."

"Gifts for sailors can be hard," complained the flag handler. He had crewed for me on my boat, and I suspected he was probing for a clue. "You never know which toys they already have or which

ones they need."

"Winch handles always work," I said. "Especially if you dropped one overboard during the season . . . ahem."

"Personally, I've dropped more VHF's over the side than winch handles," admitted the timer, who usually sails as tactician on a big boat. "I felt pretty aw-

"Never give a photo as a gift unless it's in a frame."

ful the first time, but then I realized that they actually cost less than good winch handles these days, so no big deal."

"Gotta snap your lifejacket buckle through a loop in the VHF's lanyard," said the flag handler. "And use a PFD made for fishing, with lots of pockets."

"Sailing simulators also make great presents," added the timer. "My favorite is from the Dutch company Stentec."

"Great idea," said the owner's wife.

"Was it you who got me that powerboat simulator last year?" asked her husband. "I never did figure out where it came from, but I imagine it had something to with that time the wind blew us into the sailboat at the guest dock. I think that program was also from Stentec. It would be a great teaching aid for beginners — the simulation even includes the effects of prop walk and current."

Mrs. Owner changed the subject by talking about hats, scarves, sweaters and golf shirts with club logos.

I hadn't even finished my sandwich when Lee's kayak bumped alongside the big powerboat's swim step.

"What's for lunch?" she said as she invited herself into the main cabin with her camera.

"Plenty of extra hardtack," I said, noting that some of our crew had diminished appetites.

"For sure," said Lee as she grabbed a

The North Bay's complete marine service facility:

- Complete chandlery
- 40-ton haulout service
- Engine & drive service
- Trailer boat/outdrive service & repair
- Bottom paint
- Finish paint
- Fiberglass repair
- Marine electrical



Factory
Authorized
Dealer

Don't Pass Us By...

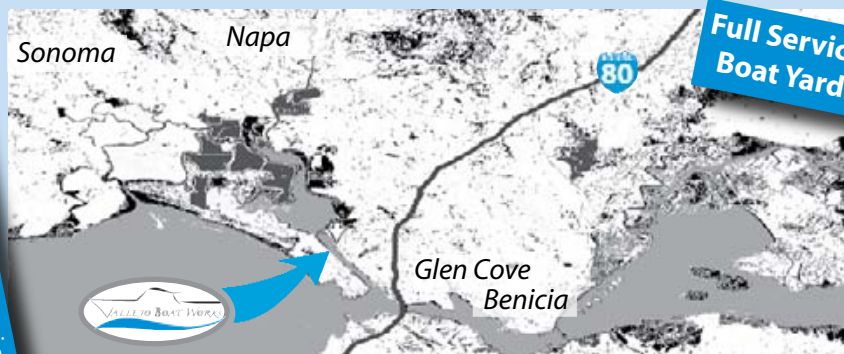

*"If it's broken,
we fix it."*

Onan

AWLGRIP

**Attention !!!
Herring Boat
Fishermen:
I will match \$\$
on long-term
storage fees!
Limited Space Available.
First Come, First Served.**

Why Haul Your Boat Down to the Central Bay?

1 Harbor Way, Vallejo
(adjacent to the Vallejo Marina)

(707) 554-2813

www.vallejoboatworks.com

sandwich. "The motion of a powerboat anchored in the middle of the Bay can be, like, a little rough. Anyway, I got some great shots from the up-sun end of the starting line."

She switched on her camera and passed it to me, and I immediately saw what she meant about shooting from low enough to put the horizon below deck level. Her kayak was perfect for the task. The boats in her photos, even on the two-inch screen, were practically jumping out at me.

"Perspective," she said through a mouthful of crab salad. "I like to be close enough to use a wide angle, so the bow is bigger than the stern. No telephoto compression, unless you want the effect of making a lot of boats look like they're closer together than they really are."

"You have some crooked horizons here," I said, having trouble finding anything else to criticize in her work.

"The 'yak bounces around a lot," she admitted. "But I'll never let a photo go out of my control until it's been straightened,



LATITUDE / LADONNA

cropped, and adjusted for sharpness, contrast and color.

"I know exactly what you mean," said the timer. "Last regatta, there was a professional shooting the event, and his web

The 'Latitude 38' helicopter, aka the Golden Gate Bridge — A high horizon works great if the horizon is out of the frame.

page must have had a thousand photos up on it. Most of them were so bad I



VALLEJO MARINA

Gateway to the Bay & Delta



*Join us!
We love making new friends
and spoiling them!*

- **Competitive Rates!**
- **Ample Guest Dock**
- **Full Service Boat Yard and Chandlery**
- **2 Restaurants for Breakfast, Lunch, Cocktails and Dinner**
- **Covered and Open Berths**

**48-ft.
BERTHS
NOW
AVAILABLE**

**(707)
648-4370**



**Winter Berthing
~ Close to Home ~**

- **One hour from Sacramento**
- **Only Three hours from Reno**
- **Easy access to San Francisco Bay and the Delta**

Fax 707-648-4660
42 Harbor Way
Vallejo, CA 94590
www.ci.vallejo.ca.us

MAX EBB

would have been ashamed to show them at my old high school photo club."

"Maybe that's what separates professionals from amateurs," I offered. "I've seen some websites that are great. The best ones usually classify photos by the name of the event, so you don't have to sift through *that* many photos to find one of your boat. Plus the pros do weed out the bad or out-of-focus shots.

"But they should sort by sail number or boat name," said the owner's wife. "Anything else is just terribly bad manners."

"That makes sense if you're shooting single boats," said Lee. "But if you're trying to make a living at sailing photography, you have to have an eye for action. That usually means two or more boats in every frame and focusing on composition, not sail numbers. You also have to remember that these folks are shooting two or three events a weekend.

Each race has several divisions and many of those divisions have identical white boats with white sails. So it's not always as easy as you might think to

stern, to help ID the boat later. Same with sail numbers."

"Well, that may be true for some photographers, but most of them remind me of an unmoderated internet chat group," commented the flag handler, "but without any of the fun."

That stopped the conversation for a few seconds, because no one else seemed to agree that unmoderated groups were fun.

"A moderated photo gallery site would be an interesting experiment," proposed Lee. "Especially if it, like, supported keyword searches by sail number, event date, spinnaker color . . ."

"We'd end up with a two-tier system if all the active photographers on the Bay had access to this moderated gallery," said the timer. "The best images could be put up for display in the moderated gallery, with links to

TIPS FOR TAKING GOOD SHOTS

- Keep the horizon straight or fix it later in Photoshop.
- Shoot from below deck level or above masthead height.
- Get in close for perspective and to minimize telephoto compression.
- Compose with boat moving toward the camera.
- Wait for a bow splash.
- Keep the sun behind the camera, or use backlighting effectively.
- Add some foreground interest.

TIPS FOR GETTING YOUR SHOT TAKEN

- Sail trim perfect, especially spinnaker pole trim.
- Steer a little low and fast if upwind, high and fast if downwind.
- Stow your fenders.
- Look ahead or up at sails, not at the camera.
- Don't wave (unless the *Latitude 38* photoboat is waving madly at you).

identify individual boats. Not that they don't try — a few pros I know get the bow shots they want, then swing around and zoom in for a close 'name' shot of the

photographers on the Bay had access to this moderated gallery," said the timer. "The best images could be put up for display in the moderated gallery, with links to

Buy Quality Sails Direct at 25-40% Savings!



It's the easy way to measure and order your own sails and SAVE!

www.cruisingdirect.com

FREE 2006 BUYER'S GUIDE call toll free:

1-888-424-7328, or fax: 1-888-237-2457

MANUFACTURED AND SERVICED BY NORTH SAILS

CD
CRUISING DIRECT
SAILS

Wright Way designs

Custom Yacht Interiors

PROFESSIONAL DESIGN

SERVICES INCLUDE

CUSTOM

carpeting

cushions

designer fabrics

draperies

linens

upholstery



Deborah Wright

510.908.3939

8000 Main Street #67, Alameda, CA 94501

wrightwaydesigns@hotmail.com

Check out our new web site:

www.wrightwaydesigns.com

the raw footage if anyone wants to wade through it all."

"It would be a perfect place to look for gift photos," added the owner's wife as she served another large tin of cookies.

I passed my camera over to Lee so she could see what I had come up with from the starts that morning.

"A few of these are okay," she conceded, "especially the ones of several boats approaching off the starboard stern, where being high up helps get more boats in the picture, the telephoto compression works in your favor, and the lighting is right. But your down-the-starting-line shots have problems. Shooting toward the light only works if the sun is low and you can use the backlighting effect to advantage on semi-transparent sails, which is not very often. Most boats are too far away for a fill-in flash to work. And like, you have some crooked horizons too."

"Don't worry, I'll rotate and crop before I give them as gifts."

"You do know the trick for straightening a horizon in Photoshop, don't you?" Lee asked.

I shook my head.

"Right-click the eyedropper tool, se-



LATITUDE / LADONNA

Get close — but not too close — for the most exciting shots.

lect the measure tool. Use it to draw a line along the crooked horizon. Then go into the 'Image' menu, click on 'Rotate Canvas', and select 'Arbitrary'. It will automatically make the line horizontal. I do that for, like, every picture I take on

the water."

"And don't forget the frames," said the owner's wife. "Never give a photo as a gift unless it's in a frame. Would anyone like some tea?"

It turned out there was no time for tea or any other dessert, with the Division A boats rapidly approaching the finish line. Lee jumped back in her kayak, I resumed my position as line spotter, and the timer and flag handlers were ready with the gun and the paperwork. The PRO put an air horn in my hands.

"We'll want to square up the line after the A boats finish," he announced, "then adjust the windward mark and the gate for the next race."

As Lee paddled around the RC boat and into position to get the finishers on camera, I snapped a couple of her in her kayak. The sun angle was right, composition looked good, horizon was high but would be well out of the frame. One more sailor I could check off my Christmas gift list.

— max ebb



MARINA BAY YACHT HARBOR

A Certified Clean Marina

(510) 236-1013

www.MarinaBayYachtHarbor.com

1340 Marina Way South
Richmond, CA 94804



- Berth to Bay 15 Minutes
- Single Load Concrete Docks
- Deep Draft Harbor
- Nearby Boatyards, Marine Stores and Fuel Dock
- Wireless Internet
- **Check Out Our Fall Specials**

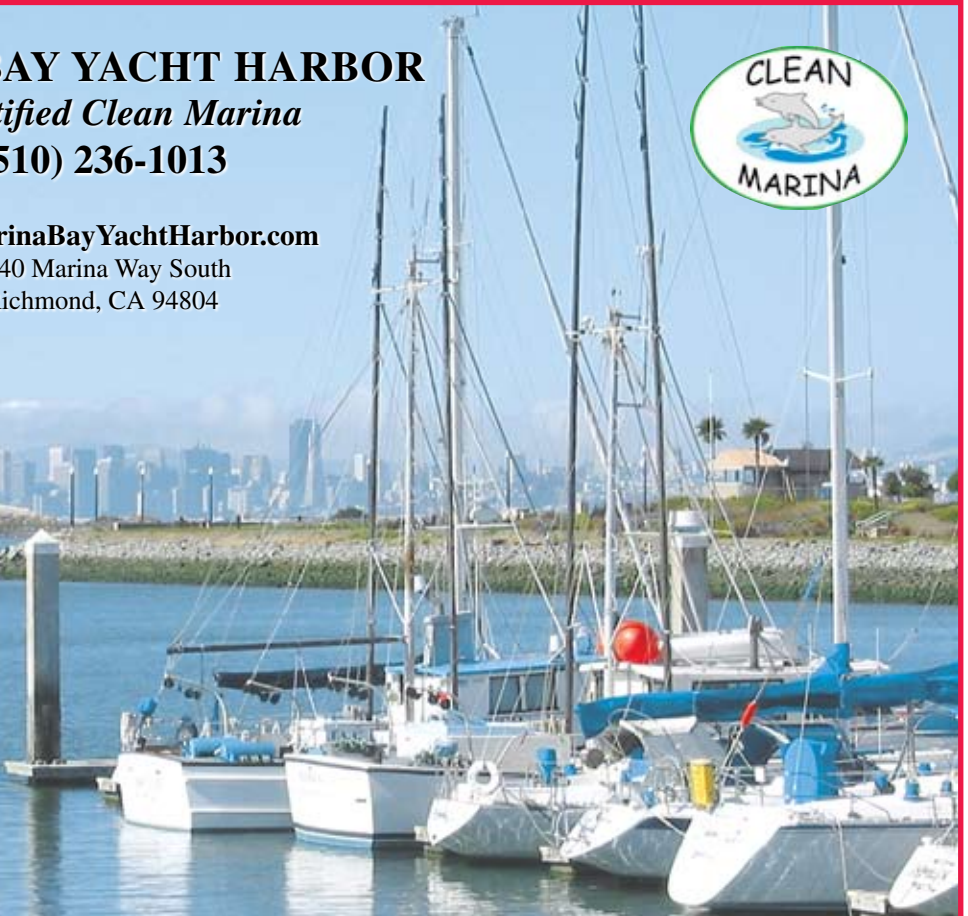

THE RACING

Remember that old bumper sticker — "What if they gave a war and nobody came?" The nautical version of that question got answered last month. Between no-air midwinters and an oil spill that closed out marinas and events all over the Bay, there was a dearth of racing the Bay Area hasn't seen since the original 49ers jumped ship here to go look for gold. So let's just say this month's Racing Sheet will make up in quality what it lacks in quantity. In addition to coverage of the **Great Pumpkin Regatta**, you'll read about the past, present and future of the **Berkeley Circle**, the winner of our **Women's Challenge** and a few odds and ends in **race notes**. We hope to return to our regular programming next month.

Great Pumpkin

Light breeze, a honkin' 5 knots of afternoon ebb, and competitors dressed in Hawaiian muu-muus — all the ingredients but one were there for another Great Pumpkin Regatta at Richmond YC the weekend of October 27-28. The one conspicuous absence was wind on Sunday, which resulted in the cancellation of the 'just for fun' pursuit race — although the retrieval of floating pumpkins (strategically planted near the non-starting line) proceeded per usual.

That and the rest of the festivities were once again a perfect way to bid a final *adieu* to summer and hello to fall. Some 256 boats turned out for the three-race, one-party event. Except for the costumes, Saturday is the 'serious' day for racing. Boats started in light breeze, which turned to pretty decent 10-15 knots as the afternoon wore on — ideal fall conditions for the 15 one-design and 6 handicap classes, including the 25 boats in the Moore 24 fleet who

courses and management on three different East Bay venues: Southampton, the Olympic Circle and the 'deepwater' course off Treasure Island.

But then there was that current.

"We were in the pre-start for the second race, moving the kite around and not paying too much attention," said Jason Crowson, whose *Sea Bear* had won the first race of the Santana 20 division. "But with the ebb building, we found ourselves over the line with a minute to go. We tried to work our way back before the gun, but by the time we started, the rest of the fleet was way gone up the course. On the next race, we went into ultra conservative mode and stayed a length or two below the line — and watched another boat drift over early." Despite her fourth in Race 2, *Sea Bear* came back to win.

Per tradition, one of the better parties of the year kicked off Saturday night, with good food, good music and some really good costumes. And the

awards ceremony was as much about the best costumes and 'golden pumpkin' search winners (the crew of the AE 28 *Mil Besos*) as it was for who won on the water. All in all good way to say goodbye to summer, 2007.

"After a highly competitive racing season, it's refreshing to just have fun and not worry about results," says 1D35 racer Kevin Moon.

ALERION EXPRESS 28 —
1) **Ditzy**, Ralf Morgan, 4 points; 2) **Eagle**, Chuck Eaton, 5; 3) **Encore**, Dean Dietrich, 10. (6 boats)

BENETAU 36.7 — 1) **Bufflehead**, Stuart Scott, 5; 2) **Mistral**, Ed Durbin, 8; 3) **Serendipity 2**, Thomas Bruce, 8. (6 boats)

CAL 20 — 1) **Recluse**, Howard Martin, 4; 2) **Invader**, Byron Jonk, 5; 3) **Andalucia**, Luther Greulich, 12. (3 boats)

EXPRESS 27 — 1) **Strega**, Larry Levit, 7;



Left to right — Cher, Don Ho (*isn't he dead?*), Michael DeBakey and Wayne Gretzky made guest appearances at the Great Pumpkin.

were using the Pumpkin as the final 'counter' in their overall season scores. Richmond YC once again provided fine

2) **Motorcycle Irene**, Will Paxton, 8; 3) **Witchy Woman**, Thomas Jenkins, 9. (17 boats)

EXPRESS 37 — 1) **Bullet**, Michael Maloney, 4; 2) **Golden Moon**, Kame Richards, 5; 3) **Stewball**, Bob Harford, 10. (4 boats)

J/24 — 1) **TMC Racing**, Michael Whitfield, 3; 2) **On Belay**, Don Taylor, 7; 3) **Break Through**, Darren Cumming, 9. (5 boats)

J/105 — 1) **Wonder**, Tom Kennelly, 5; 2) **Tiburón**, Steve Stroub, 7; 3) **One Trick Pony**, Robin Driscoll, 9. (9 boats)

J/109 — 1) **Crazy Diamond**, Liga Hoy, 3; 2) **Knots**, John Notman, 7; 3) **Joyride**, Jim Vickers, 8. (4 boats)

MOORE 24 — 1) **Morphine**, Brad Butler, 8; 2) **Gruntled**, Bart Hackworth, 10; 3) **More Cowbell**, Kathryn Meyer, 13. (25 boats)

OLSON 25 — 1) **74**, Daniel Coleman, 4; 2) **Hamburger Haus**, Jens Jensen, 9 (2 boats)

OLSON 30 — 1) **Naked Lady**, Jeff Blowers, 5; 2) **Junkyard Dog**, Ross Groelz, 9; 3) **Utopia**, David Lee, 11. (5 boats)

SANTANA 22 — 1) **Betty Boop**, Betty Lessley, 6; 2) **Bonito**, Michael Andrews, 11; 3) **Usquebaugh**, Bill Murphy, 15. (7 boats)

SANTANA 20 — 1) **Sea Bear**, Jason Crowson, 7; 2) **Fusion**, Mark Erdrich, 7; 3) **In N Out**, Nick Genovese, 7. (4 boats)

ULTIMATE 20 — 1) **Ricochet**, Geoffrey Gardner, 4; 2) **Cloud Nine**, Jim Carlsen, 9; 3)



Outtakes from the Great Pumpkin, which enjoyed the last decent wind of the fall.

Layla, Burden/Sudell, 10. (8 boats)

WYLIE WABBIT — 1) **Mr. McGregor**, Kim Desenberg, 6; 2) **Weckless**, Tim Russell, 6; 3) **Hare Today Gone Tomowow**, Erik Urias Menzel, 10. (8 boats)

99ERS — 1) **Razzberries**, Olson 34, Bruce Nesbit, 5; 2) **Two Scoops**, Express 34, Christopher Longaker, 6; 3) **Baleineau**, Olson 34, Charlie Brochard, 7. (4 boats)

SF 30 — 1) **Shameless**, Schumacher 30, George Ellison, 7; 2) **Wishful Thinking**, Tartan 10, Lester Gee, 9; 3) **Elusive**, Olson 911S, Charles Pick, 11. (9 boats)

DEEPWATER A (2 races) — 1) **Howl**, Sydney 38, Peter Krueger, 2; 2) **Tivoli**, Beneteau 42S7, Torben Bentsen, 6; 3) **Jarlen**, J/35, Robert Bloom, 6. (8 boats)

DEEPWATER B — 1) **Sea Saw**, Henderson 30, Tim Cordrey, 3; 2) **Yeofy**, 1D35, Eliel Redstone, 11; 3) **Great Sensation**, 1D35, JB Louvet, 12. (9 boats)

DEEPWATER C — 1) **Arch Angel**, Antrim 27, Bryce Griffith, 5; 2) **Flashpoint**, Melges 24, Pat Brown, 6; 3) **Always Friday**, Antrim 27, John Liebenberg, 7. (4 boats)

DEEPWATER D — 1) **Uno**, WylieCat 30, Steve Wonner, 6; 2) **Arcadia**, Santana 27, Gordie

Nash, 6; 3) **Sheeba**, C&C 99, Michael Quinn, 9. (7 boats)

Circular Logic — The Berkeley Circle

It seemed like a good idea at the time. The standard Olympic course used three marks: One was a mile to windward of the starting line, one was a mile to leeward, and the jibe mark was a mile to one side. The course was a one-mile beat, two 45-degree reaches, then a two-mile beat, a two-mile run, and a one-mile beat back to the finish.

Now, the interesting thing about this course is that, if you rotate the whole deal 90 degrees, two of the three marks are still in the right place for the new course axis.

We don't know who came up with the idea — it was probably a member of the U.C. Yacht Club (later to become Cal Sailing Club), because that was the name on the Coast Guard buoy permits when YRA took them over. But it was evident to that sailor that all you needed was eight buoys in a circle around

the starting mark, and you could run a true Olympic course in any wind direction without setting any more marks. And so was born the Berkeley Olympic Circle, in time for the 1968 Star North Americans and the 1972 U.S. Olympic Trials.

They chose the daymark near the old pier for one of the marks, and that anchored the location of the circle in space. Go exactly one mile at 315 magnetic to get to 'X', the starting mark. Then go one mile mag north to buoy A, or one mile at 45 degrees to B, or one mile at 90 to C, and so on around the circle. The daymark became mark D, and the A-E axis is north-south. On a normal summer afternoon southwesterly seabreeze, F is the usual windward mark. "Fast Dogs Bite Fast Boys" is the mnemonic for the typical course, although there are many variations.

Back in those days it was okay if the wind was 22.5 degrees off the course axis, and this happens fairly often, especially early in the day when the wind is coming from right between E and F. For most boats racing in the YRA one design or handicap fleets it's still okay if one side of the windward legs are 22.5 degrees closer to the wind.

What the racers get in return for dealing with short tacks and long tacks is that it's 'easy' to calculate the compass course between any two of the Oly Circle marks in your head. If you can count by 45s and know the alphabet up to H, you can come up with the heading to the first mark. Then subtract 135 to get the first reach, subtract another 90 for the second reach (add 360 if it goes negative) and then it's back to the windward course axis for the beat, and the reciprocal for the long run. Well, it's easier if you have the diagram in front of you. (Exercise for the reader: What's a quick way to determine the course between two adjacent marks?)

But the world changed around the Olympic Circle. The average race boat got bigger and the average keel got deeper. But the water, if anything, got thinner. More to the point, the Olympics stopped using the Olympic course configuration, and everyone else suddenly realized that reaches, at least in buoy races for non-planing keelboats, can be pretty boring.

Just about the only event still using the original Olympic course is the Berkeley Yacht Club Midwinters. Lots of other races use the buoys: YRA in the summer, BYC for the Friday Night and Chowder series, and the occasional one design fleet that needs a venue but

THE RACING

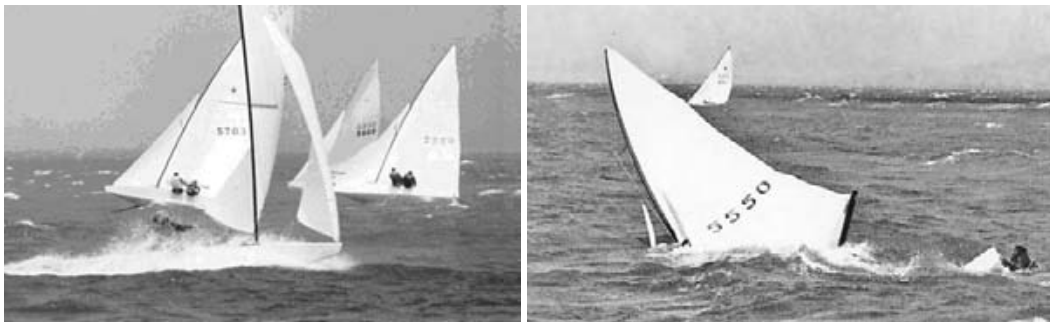

Days of old and knights so bold — left, Lowell North shreds the Circle during the 1972 Olympic trials. Right, Tom Blackaller didn't fare so well.

doesn't have the resources to set their own marks.

In fact, this has always been the main value of the Circle, and even one of the main arguments for a YRA: They maintain the marks, making entry-level race management possible for organizations that don't have the fleet of mark boats and the volunteers to run them. And these entry-level races have become a major pipeline for new YRA members.

That's the theory. The reality is that the current batch of buoys is wearing out. Costs are up, and the YRA buoy budget is mostly directed to the Central Bay marks like Yellow Bluff and Fort Mason that are more heavily used by YRA events. The bad news is that Circle marks A, C and H are gone, and since none of these are needed for the summer YRA races, they might not be back on station.

This hits Berkeley YC the hardest, because BYC has enjoyed the ability to

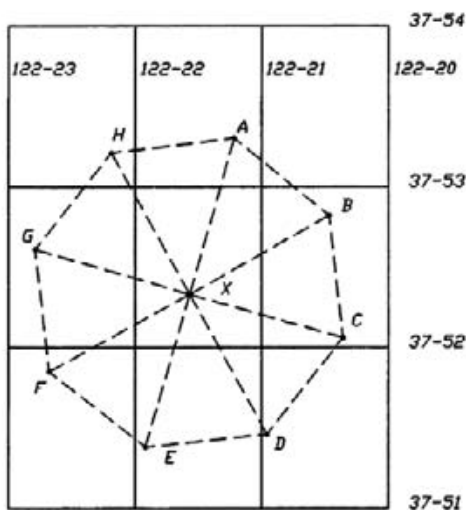

The design of the Olympic Circle. If you're good, you can figure out the course between any two marks without looking at a chart. Marks A, C and H are currently off station, making it more of the Berkeley polygon.

run fairly large-scale races for some 40 years without ever having to set a temporary mark — at least, not when the Circle was intact.

But now that the Circle is an irreg-

ular polygon, some new opportunities have come up. Forget the classic Olympic course. All the racers and the race committees really need is a bunch of marks with known positions. The Coast Guard is not in the mood to issue new permits for new marks, but reassigning an existing permit is not a problem. So we have an opportunity to tweak the map to make the buoys more useful to the local clubs and racing organizations.

The hope is that clubs, sailing schools and class associations will take an interest in maintaining one or more of the old marks. The attraction here is that the positions can change a little. X, for example, could be further north to make F (or YRA #8) a better windward leg. Buoys A and B could be moved out into deeper water. Richmond Yacht Club might want to maintain a permanent mark at the location it usually uses to start races on their Southampton course. Berkeley YC has plans to do the same for their Friday Night and Chowder entry-level races.

Is this really going to be better? For race committees it will be, because if the marks are placed carefully they will have fewer temps to drag out and set. For racers, no more calculating courses in your head, because the geometry of the circle will be gone. But the Olympic Circle is not dead yet. This winter the BYC Midwinters are still using the classic Olympic course, and it might be your last chance to sail it.

— paul kamen

RegattaPRO Midwinters

The second annual RegattaPRO midwinters caught a lucky break on November 3 — it actually had wind. The word is definitely out on this series, created last year by PRO Jeff Zarwell and run through his race management program. From 5 one design fleets in 2006, the dance program now lists — count 'em — 13 fleets: J/24, Moore 24, Etchells, Express 27, Alerion Express 28, Beneteau 36.6 and 40.7, J/120, J/105, Melges 32, 1D35, Express 37 and Syd-

ney 38. Half are scheduled to race the first Saturday of the month from November through February, half on the second weekend.

As mentioned, the first group had enough breeze on November 3 to actually get in three races instead of the planned two. The second weekend was cancelled due to the oil spill.

Lucie Mewes

— Life on the Circuit

Early this year, *Latitude* issued our first-ever Women's Challenge. The idea was to offer a special award to whichever woman completed the most women-specific events over the course of the summer. You didn't have to win anything (the sponsoring yacht club gave awards for that), you just had to be a bona fide participant.

Turns out only one 'iron woman' took up the challenge. (If there were others, we never heard from them.) But she did it with such style and gusto that she probably would have triumphed in any kind of tie-breaker anyway. 'She' is Lucie Mewes. Here's what her 'Women's Circuit' resume looked like:

Sadie Hawkins

Race (Island YC, 2/24) — The ink on the Master Race Calendar was barely dry when the longest-running women-skipper's race was sailed on the Estuary. There was great competition among the 20 boats in 3 classes. I began the Women's Challenge circuit with a first place finish, beating some of the Estuary royalty, such as Laraine Salmon of the Merit 25 *Bewitched* and Dawn Chesney on *Dire Straits*, a J/24. This was a thrilling finish for my husband, Ben Mewes, and me, wailing our Black Soo *Mirage*.

Rites of Spring

(Oakland YC, 3/17) — According to the old timers, this is the second in the short-handed spring series (Doublehanded Light-

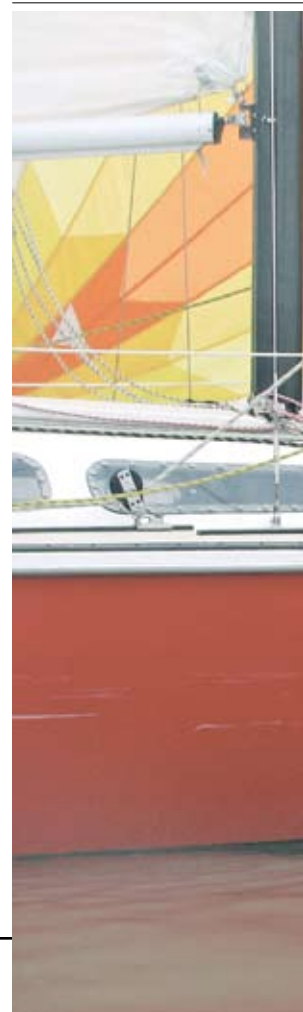

ship is first; the Double Farallones and Singlehanded Farallones are third and fourth). Ben has trophied numerous times in these events in each of our two boats.

This year the ROS was windy, so we took 'the house' — our custom Van de Stadt 40 *Georgia*. We won a flashlight.

Women's Sailing Seminar (Corinthian YC, 5/19-20 and 6/9) — I was honored to participate on the Race Day of this series (June 9), providing a few words of guidance to a great group of sailors. We had a bit of everything: light air, nice reaching, close corners. Came away with a great sense of 'community' — and a nice pair of gloves.

Gracie and George Regatta (Encinal YC, 8/11) — I usually 'place' in this event and have some beautiful trophies to show for my efforts. This year's watercolors by race organizer Margaret Fago are a special treasure.

Ruth Gordon Schnapp Regatta (Golden Gate YC, 10/13) — Ben's surprise angioplasty left me unwilling to take our little boat out as planned, so

Insult to injury — of the few midwinters that did take place post-oil spill (like this Berkeley Chowder Race), none had appreciable wind.

I hitched a ride on my pal's boat *Stink Eye*. First time on a Laser 28, and I was thrilled to be invited to drive for one race. A beautiful day for the classic Cityfront course: Blackaller, Harding, Mason, gibe and everything. We finished just short of the podium, but at least the two skippers were within seconds of each other. More importantly, we helped raise \$2,500 for the Susan G. Komen Breast Cancer Research Fund.

Women Skipper's Regatta (Sausalito YC, 10/14) — *Stink Eye* again, this time in the tricky Richardson Bay-Knox area. Flood, ebb, drifting, honking — all our favorite racing conditions. Again, the gracious offer (and acceptance) to drive. Jonathan and Christine are terrific sailors, and it was an honor to sail with them. A little confusion on the starting line and scoring system once again denied us the podium. But this time we had the satisfaction of helping the Tall Ship Semester for Girls.

Jack & Jill +1 (Island YC, 11/4)



'Queen Lucie' Mewes with her proof of participation, and her awards.

— Phew! It's been a long year. I finished the circuit on Steve Wonner's WylieCat 30 *Uno*. Steve graciously offered the boat, and my pal Joy Brahmst crewed while Ben (good as new after his medical procedure) served on the race deck. Another new boat, another new experience, and a lot of fun. Again, no other competitors felt the least bit threatened by my performance.

I can't wait for next year.

Race Notes

— Coates of many talents. Congratulations to Tom Coates and his *Masquerade* Team for winning the **J/105 North Americans**, a seven-race, no-throwout series held in Annapolis November 1-4. Among his crew was Chris Perkins, whose own J/105 *Good Timin'* was recently stolen and recovered (see this month's *Sightings*). The only other local boat to attend was Bruce Stone's *Arbitrage*, which finished 25th in the 36-boat fleet.

— Deck the halls. The International Sailing Federation (ISAF) has launched the **Sailing Hall of Fame** as part of their centennial celebration. The ISAF evolved from the need for racing sailors to have a uniform set of rules and measurement standards, and to set up an international ranking system. The inaugural inductees into the Sailing Hall of Fame include: Olin Stephens, Dame Ellen MacArthur, Paul Elvström, Barbara Kendall, Eric Tabarly and Sir Robin Knox-Johnston. Also part of the 100th anniversary event: ISAF Rolex World Sailors of the Year Claire LeRoy and Ed Baird were also presented with their awards.

— Tornado alley. In other ISAF news, the Tornado catamaran is — for the moment — excluded from the sailing roster at the **2012 Summer Olympics** in London. What actually happened is that the



THE RACING

ISAF had 10 Olympic slots to fill (down from 11 in previous years) and last month they decided what *classes* would be included (men's keelboat, women's singlehanded, etc.). Those decisions did not include a multihull team, male or female, so everyone assumed the worst. Technically, the ISAF would not choose the actual boats for the Olympics until next November. But that didn't stop a firestorm of criticism over the perceived slight. The Tornado has been the only Olympic-class multihull since 1976.

— Does anybody really know what time it is? Does anybody really care? Behind the scenes machinations at the **America's Cup** lurched further sideways last month. Here, in more or less chronological order, is the shorthand:

- Semi-civil talks between *Alinghi* and *BMW Oracle Racing* broke off at mid-month. *BOR* charged that *Alinghi* was purposely stalling. *Alinghi* said *BOR* had come up with five additional demands overnight.

- *Alinghi* demanded that *BOR* withdraw their suit (which contends that

the Spanish Challenge of Record is not legitimate) and enter America's Cup 33 immediately.

- *BOR* rejected this ultimatum, which means the court case will likely go ahead in the New York Supreme Court.

- ACM (America's Cup Management) announced that if legal proceedings progress much farther, the next America's Cup will be delayed until at least 2010. Maybe later.

- *Alinghi* lamented the fact that *BOR* was ruining the event.

- *BOR* lamented the fact that *Alinghi* was ruining the event.

The way we understand it, if the New York judge rules in favor of *Alinghi*, then *BOR* is back to square one. They can either accept the ruling and enter, or appeal it. If the judgment is made in favor of *BOR*, then it's likely that an 'interim' America's Cup may be raced in 90-foot multihulls.

— Joyon to the world. There were numerous ocean racing events starting, ending or in progress last month, including the Transat Jacques Vabré,

Mini-Transat and Barcelona World Race. But the one most intriguing to us was a solo round-the-world record attempt by 57-year-old French ironman **Francis Joyon**, who departed France on November 23 in a race against time. Specifically, the singlehanded round-the-world record of 71 days, 14 hours and 18 minutes set by Dame Ellen MacArthur in 2005 aboard the 75-ft trimaran *B&Q/Castorama*.

Joyon is on a much bigger horse — the brand new, 100-ft Irens/Cabaret trimaran *IDEC II*. If this boat holds together, and her skipper's past performance is any indication, Joyon will obliterate Dame Ellen's record. You may recall that the record *she* broke belonged to Joyon, who set it in 2004 in a hand-me-down, 92-ft trimaran with no weather router, and 10-year-old sails. If you read French, you can follow Joyon's progress at www.trimaran-idec.com. (No English version is offered.) Look for Joyon and his big red giant to reappear off Brest, France, sometime in mid to late January.





"The Raceware Specialists"

KNOWLEDGE

- Shop Where Fellow Racers Work

CONVENIENCE

- Online Orders Save on Shipping
- Same Day Shipping
- Speedy Custom Rigging

SELECTION

- Largest Selection of Racing Hardware,
Apparel, & Cordage In the World...Online
and In Stock!



www.APSLTD.com ~ 800.729.9767

RICHARDSON BAY MARINA
formerly Kappas Marina

MODERN FACILITIES IN A WELL-PROTECTED HARBOR

Concrete Dock System

Well Maintained Facilities

Beautiful Surroundings

- DEEP WATER BERTHS: BASIN AND CHANNEL DREDGED
- CARD KEY SECURITY SYSTEM
- DOCK CARTS
- PUMP OUT STATION
- AMPLE PARKING
- CLEAN SHOWER AND TOILET FACILITIES
- WITHIN WALKING DISTANCE: MARKET/DELI, LAUNDROMAT, RESTAURANT
- AT EACH BERTH: LARGE STORAGE BOX, METERED ELECTRICITY, PHONE HOOKUPS, WATER

BERTH YOUR BOAT IN SAUSALITO

Phone 415 • 332 • 5510

100 Gate Six Road, Sausalito • Fax (415) 332-5812

JOIN US FOR OUR MIDWINTER SERIES

★ ALL BOATS WELCOME ★

January 19-20 & February 16-17

Post-Race Festivities – Drink, Dine and Dance to a Fabulous Band

Information & Sign-Up at: www.cyc.org

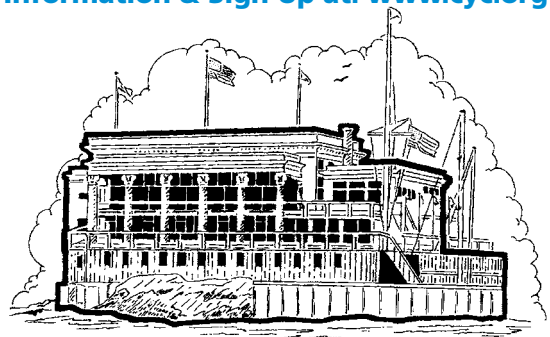

Corinthian Yacht Club

OF SAN FRANCISCO

43 MAIN, TIBURON, CA 94920 • (415) 435-4771

Visit our website: www.cyc.org

With reports this month on **Charter Planning Strategies For Costly Times**, a long-time cruising couple's **Cat Charter in Tahiti's Leeward Isles** and miscellaneous **Charter Notes**.

Savvy Travel Tips That Will Save You Time and Money

Like many of our readers, we absolutely looooooovee visiting far-flung destinations, especially under sail. In fact, we can honestly say that the annual sailing vacations we take make the rest of the year — slaving away at our computer terminals and clawing our way through mind-numbing traffic jams — tolerable.

Trouble is, these days the process of actually getting to your desired vacation destination is becoming increasingly more challenging and potentially more expensive. What to do? Give up traveling entirely? Heck no. The answer is to travel smarter by doing your homework well in advance of leaving town and employing the strategies and insights of travel industry experts. We'll share some of their tips here, as well as some of our own.

Before we get to the tricky stuff — like flight and route planning — let us reiterate what we consider to be the essential first steps toward organizing a charter vacation as painlessly as possible. As we've often written in these pages, beginning the booking process far in advance — like six months out or more — has many advantages, including getting the best choice of boats, dates and flight schedules. By locking in your plans far in advance you'll also avoid the substantial stress that results from last-minute bookings.

"Land ho!" What sailor worth his salt wouldn't love to spend a week or more in the sunny Caribbean this winter.

Once you've got a potential destination or two in mind and a general or specific timetable penciled in, think about who you'd ideally like to have along as shipmates. Holiday gatherings, by the way, often prove to be great opportunities for mapping out future charter trips with family or friends. Once you've introduced your game plan, however, we suggest giving your would-be shipmates a firm deadline by which to get back to you, not only with a verbal commitment, but also with a deposit check toward the boat's booking fees. In our experience, nothing cements a travel pact like putting down cash on the barrelhead. Once that's done people tend to seriously plan their lives around the travel dates, rather than being wishy-washy right up to the 11th hour — as often happens when they *haven't* put money down. With deposits in hand, book the boat ASAP in order to get the widest choice of boats for your given sailing dates. This becomes especially important in places where fleet sizes are small, such as the Sea of Cortez, Tahiti and Tonga. You can usually make slight adjustments to your rental dates later if flight possibilities don't mesh.

Of all the elements in a travel plan, securing air tickets with ideal dates and times for a reasonable price is by far the greatest challenge. Ever since deregulation, air ticket pricing structures have been both mysterious and frustrating to the average consumer. But travel experts have some tips which may help you navigate these treacherous waters.

First, a word about frequent flyer miles. Wouldn't it be nice if you could use those hard-earned mileage awards for your next sailing vacation? Sadly, however, there are so many people earning miles these days through so many different means that it's become nearly impossible to redeem them unless you make your book-



ing 9 to 12 months in advance, are content to fly in the dead of winter or are willing to pay double to upgrade to

OTHER USEFUL TRAVEL SITES

- www.oag.com is the site of the Official Airline Guides, which include info on every airline which flies between given airports
- www.airlinetollfree.info has toll-free phone numbers of all major carriers
- www.gethuman.com gives listings of 'direct to a human' travel numbers
- www.alternateairports.com gives listings of airports near major gateways
- www.seatguru.com gives info on the best and worst seats on all aircraft by carrier, plus additional airline info
- www.airlinequality.com gives actual seat measurements and space between seats in each class of service
- www.flightarrivals.com gives real-time info on flight arrivals and delays
- www.avoiddelays.com lists the most-often delayed flights and worst airports for delays based on Department of Transportation stats
- www.babelfish.altavista.com translates passages of foreign text or entire web pages



OF CHARTERING



to supply and demand — there are things you can do to insure that you're getting the best deal possible when you do book flights.

Because more than half of all travel booking is now done online, there are now a number of amazing websites out there in cyberspace which can make you a more highly informed traveler, while saving you big bucks. In addition to well-known online ticket sellers like Orbitz and Travelocity, check out www.kayak.com and www.sidestep.com. Both will simultaneously search dozens of other booking sites, giving you an easily comparable overview. Similarly, www.bookingbuddy.com allows you to search a vast number of sites, yet you only have to enter your route info once. The downloadable application TripStalker also comes highly recommended by some savvy travelers (sadly, it's for Windows only). It continuously searches for the best prices on airfares as well as hotels and car rentals, and informs you via email or an on-screen pop-up when a particular price drops.

Once you've found a fare and routing that you like, check out the same itinerary on the actual carrier's site. We're told that in some cases it may actually be cheaper. As easy as it is to search and compare online, some travel pros, including Greenberg, still like to call a real live airline reservationist to be sure there isn't some creative pricing structure or alternate routing which could save money, but may be too complex for the computer models. He points out that human reservationists can hold a reservation for you at a specific fare

The idyllic Iles des Saintes are among the treasures of the Eastern Caribbean. To access them, search for flights to Guadeloupe.

Instead of staying home all winter shivering, picture yourself relaxing at some sunny spot like Soper's Hole, BVI. If you're clever and diligent in your planning, the cost of air travel doesn't have to be a deal-breaker.

a higher class of service. In the insightful tome *The Complete Travel Detective Bible*, travel guru Peter Greenberg writes that over 2.5 million award tickets were redeemed in 2005 on American Airlines alone. However, that airline estimated that nearly 1.5 billion miles had been earned, but not yet redeemed. Bottom line, if you want to fly to any popular tourism venue during the prime season on an award ticket, you'll need a near miracle or an enormous lead time.

So, assuming you'll be purchasing air tickets, how far out should you lock them in? This is a toughie. While the standard reply from many travel experts would probably be "four to six weeks out," others point out that the best fares can often be found less than 21 days out — but certainly not always. However, we'd be quick to caution you that it re-

ally depends on where you're going and how flexible your dates are. Air corridors which are serviced by a wide variety of carriers (i.e. S.F. to London) will naturally give you the greatest opportunities for finessing a great fare. But if you're headed for, say, Belize or Tonga, gambling on finding a cheap last-minute fare would be a bad bet. Note also that with low-fare airlines such as Southwest and JetBlue, buying far in advance is definitely the way to go.

Despite the inherently frustrating nature of air pricing these days — rates on some corridors change almost constantly due

ALL PHOTOS LATITUDE / ANDY

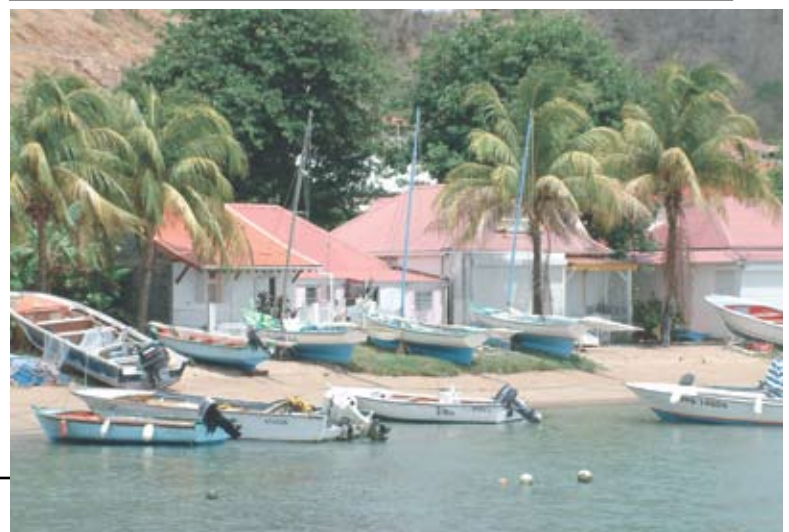

WORLD

for at least 24 hours before payment is required, while web 'agencies' can't. This interval of limbo gives you time to double-check the timing with your travel partners and/or do more cost comparisons on the net. Greenberg also highly recommends comparing fares and availability to alternate, nearby airports when possible, as well as comparing alternate dates if you are at all flexible. Generally, Fridays, Sundays and Mondays are the most expensive days to fly.

Much like obsessing about stock market fluctuations, you could drive yourself crazy fretting about whether or not you got the best possible fare. One useful tool which might help preserve your sanity in this regard is www.farecast.com, which predicts when fares will rise and fall based on historical data. Note also that we've heard a theory from several travel junkies that you tend to find the lowest fares on Wednesdays, very early in the morning. The idea is that prices are lowest when the fewest people are shopping.

At some point, of course, you'll have to bite the bullet and complete the transac-



LATITUDE / ANDY

These days, part of doing your homework in preparation for an overseas trip is getting a passport — or making sure yours is still valid.

tion. So if you've done your homework and think you've found a pretty fair price, go ahead and book it. Trust us, there will always be someone who got a slightly better fare anyway!

That said, in this ultracompetitive

age, some airlines now offer 'lowest price' guarantees, meaning, in theory, that if you are holding tickets for a given route and the price drops, the airline will refund the difference. After registering your flights with the website www.yapta.com you'll be alerted if and when the price drops and how to claim vouchers or refunds.

We don't claim to be air travel experts, but we do travel enough to know that using these proven strategies can make a big difference to your travel budget's bottom line — and perhaps also to the success or failure of your efforts to recruit crew. We know from experience that unreasonable air prices can often be a deal-breaker, especially for first-timers. With fuel prices rising and the value of the dollar dropping, it's important to ferret out the best pricing you can. So we encourage you to use all the tricks in the book to turn your sailing vacation fantasies into reality. After all, what's the alternative? Staying home? *Fugget-aboutit!*

— latitude/at

HAVE WE GOT A CAT FOR YOU...

GO CATS
Catamaran Charters Worldwide

In North America
Call for a Brochure
1.800.592.1254
WWW.GOCATS1.COM

SOUTH PACIFIC • MEDITERRANEAN • CARIBBEAN • INDIAN OCEAN

Tahiti,
is calling you

The...
magical seduction! spectacular beauty!
dazzling sunshine! turquoise lagoons!

Charter a new catamaran for a week or more
and cruise around the best palm trees in the world

TAHITI YACHT CHARTER CO.
P.O. Box 5162 • Newport Beach CA 92662
949-675-3519 • Fax: 949-723-8512
marimktg@ix.netcom.com

For reservations Call toll free:
1-800-404-1010
anywhere in USA or Canada

www.tahitiyachtcharter.com

photographers: B. Picard, P. Lefebvre

Continuing the Cruising Life Via Bareboat Chartering

After nearly seven years of cruising in the Caribbean aboard *Serendipity*, Renee and I had only been back in Southern California for a month before flying out to the Society Islands for a cat we'd arranged long before.

We explored Raiatea, Tahaa and Bora Bora aboard a Moorings 42 catamaran which was the perfect party platform for the eight of us. Our only complaint was that the trades were way down during the 10 days we were aboard, so we had to motor almost everywhere.

We spent three days in Papeete prior to picking up the boat in Raiatea and three days in Moorea after returning the boat to The Moorings. We would recommend this timetable to anyone who might be going that direction. It kind of allows one to wind up to the cruise and then wind down too before the flight home.

The islands are still absolutely beautiful, the water crystal clear and we enjoyed just superb weather — it rained only part of one day. Our group,



BARRITT & RENEE NEAL

Having just returned from extensive Caribbean cruising, Barritt and Renee, left, did a splendid 10-day charter with friends in Tahiti.

who were all good friends and mostly experienced sailors, had planned the trip almost a year and a half prior to flight

time. Chip and Katie Prather, Jack and Diane McFadden and Mark and Hillary Radovich rounded out our crew — and a super crew it was! Everyone had a great time.

Our favorite anchorage was Nao Nao

NORTH AMERICA • CARIBBEAN • MEDITERRANEAN • SOUTH PACIFIC • INDIAN OCEAN

OUR EXPERIENCE, MAKES
YOURS A BETTER ONE.

J

The Moorings has been providing "The Best Sailing Vacations In The World" since 1969. Our reputation for meticulously maintained yachts, unmatched customer service and the best selection of exotic destinations to choose from, guarantees an unforgettable, personalized sailing adventure. Plus, choose from the largest catamaran charter fleet in the world. So set sail and enjoy the vacation of a lifetime.

The Moorings

The Best Sailing Vacations In The World

www.moorings.com • 800-521-1198

BAREBOAT • CREWED • SKIPPED



LATITUDE / ANDY

at the southern end of Raiatea. It has very clear water, lots of fish, and a spectacular reef with really healthy coral formations. The little island also has an old WWII air strip that made for good exploration. Tahaa and Raiatea provide for great flat-water sailing as they are both inside the same reef and one can circumnavigate both islands easily. We took full advantage of several great anchorages on the northwest side of the

If you decide to spend a few days in Papeete, it's fun to visit the downtown market, where you'll find everything from pareos to pineapples.

Tahaa lagoon, behind the reef.

Bora Bora is where we spent the most time, partly because we had chosen the dates of our trip to coincide with Heiva or Fete, which is the big annual celebration held throughout the islands. Nights were incredibly festive, with torches gleaming, colorful dance

contests, and lots of very happy folks taking it all in.

On Bora Bora, we found the most enjoyable anchorage to be just south of Bloody Mary's restaurant. There was very good snorkeling there as tour folks fed the fish regularly, and it was close to shopping for the girls (who made the obligatory black pearl purchases). The Bora Bora Yacht Club is still in full swing. They still cater to charterers and cruisers by providing moorings, free water and garbage dropoff.

No matter which island we visited, our most enjoyable times were after a good meal, with a drink in hand and lying on the trampoline of our catamaran looking up at the stars — Priceless!

The Moorings Company treated us just fine, and we had no problems with the boat at all. If there was a complaint at all it would have been about the extraordinary prices of everything in French Polynesia. But we all knew what to expect going into the trip. For our three-day wind-down, we all stayed at the Club Bali Hai in Cooks Bay, Moorea. I had anchored in front of this hotel in

PACIFIC OFFSHORE PASSAGES AND PRIVATE CHARTERS

57' Steel Cutter. Custom Built 2002 in BC, Canada.



- PRIVATE CHARTERS: Mexico • BC Canada • Alaska • \$5,000 - \$11,000/week
- La Paz to Puerto Vallarta, every other Dec. 2-15, \$1,600 - \$3,400/week + 18% tax
- Puerto Vallarta to Zihuatanejo, Jan. 14-25, \$2,400 - \$4,000/week + 18% tax
- Alaska to Hawaii March 31 - April 22, \$2,900 - \$4,000/week
- Hawaii to Florida, Dec. April 26 - May 21, \$2,400 - \$4,000/week
- Around Vancouver Island, June 7-21 & Sept. 6-20, \$2,900 - \$4,000/week
- Victoria BC to San Francisco, Oct. 29th, \$1,600 - \$3,000/week
- San Francisco to Cabo San Lucas Oct. 18 - Nov. 7, \$2,900 - \$4,000/week

Sailing Yacht Western Grace
www.WesternGrace.ca
 800.664.6049 / 808.271.3540

BRITISH VIRGIN ISLANDS "BEST DEALS ON KEELS"



Conch
 Charters

Est. 1986

- Most selection of sailboats 32'-52'
- "Purr" with cats 37'-45'
- Bare boat or skippered
- Best yacht management program

NEW
 YACHTS IN
 FLEET!

www.conchcharters.com

Email: sailing@conchcharters.com

Call our 'Sails' Office

(USA) (800) 521-8939

Tel (284) 494-4868 • Fax (284) 494-5793

Sail paradise with Conch Charters

CALIFORNIA'S CARIBBEAN CONNECTION

OF CHARTERING

1993 for a month. Moorea has changed very little — it's just as enchanting today as it was back then. We all really enjoyed our stay.

One item to mention regarding airport arrangements with a large group: We treated ourselves and hired a stretch limo to take us to the airport and to pick us up when we returned from the trip. What made that especially cool was the fact that for a large group it is a lot less expensive than taking the normal shuttle — and it feels good!

— barritt & renee neal
san diego

Barritt and Renee — We wholeheartedly agree with your assessment. Despite the fact that the Society Islands are very expensive — especially when you're spending U.S. dollars — they are spectacularly beautiful and blessed by a splendid climate during the prime (April to October) sailing season. It's refreshing to discover that many aspects of ancient Polynesian culture are still actively practiced, such as traditional music, dance and outrigger canoe racing.

We should note also that although restaurants and hotels are pricey, most local Polynesians don't have loads of money to spend, but they still manage to get by. Bareboaters on a budget can follow their lead

and 'dine in' (aboard) rather than out. Fresh fruits and veggies are reasonable and abundant, and you'll find plenty of French products in the supermarkets.

If you plan to lay over at Papeete before island-hopping to the charter bases at Raiatea, consider going to the open market downtown and also to a big 'supermarche' to stock up on staples and imported goods, including French wines. Provisioning is limited in the main cruising area, the Leeward Islands. A final tip: if you enjoy an evening cocktail or two,

INTERLUDE



Probably the most distinctive feature of French Polynesia is its stunningly beautiful geography — formed by ancient volcanoes.

consider bringing your own booze, as it's very 'spensive in the islands.

— ed.

Charter Notes

If you've spent a few winters in the Bay Area, you know that in addition to periods of truly nasty weather, we also typically get occasional interludes with **clear, sunny days** — like stints of Indian

Real People. Real Sailing. Real Fun.



Sail Cats, Power Cats,
Monohulls, Trawlers,
Arenas, Skiing.

Real Choices.

Choose CYOA and become part of the family. We've been providing beautifully maintained yachts, personal service and reasonable prices to sailors since 1960.



1-800-944-2962
info@cyoacharters.com
www.cyoacharters.com
St. Thomas, USVI 01601

CYOA
YACHT CHARTERS



Tortola BVI
Belize
The Grenadines

UNIQUELY
TMM



Marisa
TMM Belize

Most charter companies offer blue water & palm trees but it takes the personalized care of people like Marisa to make your vacation a success.

Like Marisa, everyone at TMM is committed to your complete satisfaction. Our specialized three-location operation offers large company quality with small company service. A combination that is uniquely TMM.

TMM
Yacht Charters
Since 1979

catamarans • monohulls
motor yachts
ownership programs

WORLD OF CHARTERING

Summer, right in the middle of December, January or February.

Marc Kraft of Pacific Sailing and Yachting in Santa Cruz likes to remind us that those precious weather windows are ideal for coastal daysails with the express purpose of observing several **varieties of whales** which head south during our winter months to their spawning grounds in the sunny latitudes of Mexico.

During December and January, Marc notes, "You have a 50/50 chance of observing whales" not far off the coast.

A write-up in Pacific Sailing's recent newsletter reminded us of some of the whale facts we learned long ago (and, sadly, have long since forgotten):

"The **gray whale** grows between 45 and 49 feet in length, has a mottled gray appearance and 9-13 bumps along the dorsal ridge rather than a true dorsal fin. Gray whales carry whale lice and barnacles that create yellow and white patches on the skin. The gray whale migrates southward from **November to**



TERRY GLASCO

Who's watching whom? 'Tis the season for whale watching along the California coast, especially in Monterey Bay.

early February along the entire West Coast of the U.S., Canada and Mexico, ending a **10,000-mile journey** stretching from the Bering Sea and Arctic Ocean to Mexico. Their northward migration spans from **February to June**. Some whales do not complete the migrations and instead remain off the coasts

of British Columbia, Washington, Oregon or California.

"The endangered **humpback whale**, known for its spectacular breaching, lobtailing, flipper slapping, singing and bubble net feeding, is one of the most energetic whales that passes along the coast of California. The humpback whale grows to 52 to 56 feet in length, generally has a black or dark gray back with white flippers and a low dorsal fin. Widely distributed in all oceans, humpback whales migrate seasonally, spending their winters in the warmer waters of Mexico and their summers in colder waters along the California coast."

Naturally, Marc would love it if you'd make a jaunt down to Santa Cruz and rent a boat from him for a **whale-watch daysail**. But, of course, similar opportunities can be found outside the Golden Gate also — and, assuming you are qualified, any of the Bay's sailing schools (clubs) would be happy to rent you a nice, big, stable boat that's comfortable in near-shore conditions.

Maine Cat 30 & 41 Hope Town, Abaco, Bahamas Bareboat Charters

Enjoy well protected Sea of Abaco waters with their beautiful islands and beaches aboard an open bridgedeck cruising catamaran. A breeze to handle and fully equipped.



www.mecat.com or www.maineatcharters.com

New email: info@mecat.com

Phone: 1-888-832-CATS

ANACORTES YACHT CHARTERS PACIFIC NORTHWEST ADVENTURES

Enjoy Yachting
for a Lifetime
with the
World's Best!
Rated #1 by Cruising World



Largest Selection in
the Pacific Northwest
Bareboat & Skipped
Power and Sail 28'-66'
Charter Yacht Ownership
Yachting & ASA Sailing
Schools

www.ayc.com

800.233.3004

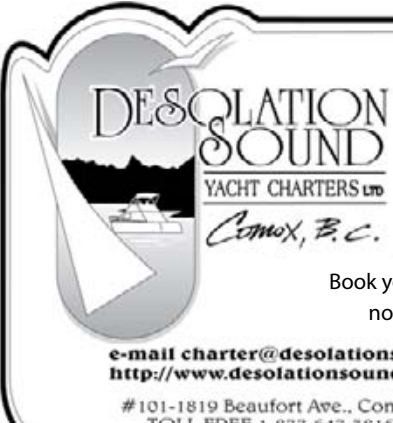

Closest full-service charter base to Desolation Sound & Princess Louisa Inlet
Visit our Web site for a preview of our 25' to 54' Power & Sail fleet

Book your 2008 charter now and SAVE!

e-mail charter@desolationoundyachtcharters.com
<http://www.desolationoundyachtcharters.com>

#101-1819 Beaufort Ave., Comox, BC, Canada V9M 1R9
TOLL FREE 1-877-647-3815 FAX (250) 339-2217

YACHT CHARTERS IN GREECE, TURKEY, ITALY & CARIBBEAN

Best Rates For Reliable Charters
Full services: Low airfares, hotels, tours, transfers

Visit our website for yacht photos and details, destinations and itineraries:
www.albatrosscharters.com

PLAN WINTER CARIBBEAN CHARTERS NOW!

Sailboats • 30'-60'
Bareboat/Crewed
Monohulls & Catamarans
Luxury Sail & Motor
5 to 60 Guests

Albatross
An American owned and operated company

(800) 377-8877
(856) 778-5656
Box 250, Moorestown, NJ 08057

JUST YOU AND THE SEA...



Punta Mita Beachfront Condos

Call now for reservations!

1.415.599.5012

www.puntamitabeachfrontcondos.com

HOLIDAY SHOPPING FOR SAILORS

DISCOUNT MARINE HARDWARE



New & Used

Online, ready to ship worldwide

- Line
- Hardware
- Winches
- Outboard Engines
- Carbon Poles
- Spectra Loops
- Pre-made One Design Rigging
- Electronics

• Constant savings •
Constantly changing inventory

<http://stores.ebay.com/Discount-Marine-Hardware>



Save money and save the planet!
Reuse & recycle.

Custom Canvas & Interiors



The Gianola Family has been designing and fabricating custom canvas and interiors since 1969. Gianola & Sons offers you the best in quality, more choices, and personal service.



360 Gate 5 Road
Sausalito, CA 94965
(415) 332-3339
www.gianolacanvas.com

RACE A LEGEND!



TWO-TIME B.O.C. AROUND THE WORLD RACER!
MIGHTY TONGAROA
SANTA CRUZ 50

6 CREW SPACES AVAILABLE FOR THE FOLLOWING RACES!

- February 2008 **PV Mexico Race** \$3,000+SE
Fast is Fun
- March 2008 **Cabo Mexico Race** \$2,500+SE
Potential Class Winner
- June 2008 **Tahiti Transpac Race** \$5,500+SE
- June 2008 **Pacific Cup Race** \$5,000+SE
Set a Class Record
- November 2008 **Sydney/Hobart (tuneup) Race** \$1,500+SE
Lord Howe Island/easily handled by 6-18
- December 2008 **Sydney/Hobart Race** \$5,000+SE
Boat Speeds 24+ knots
- February 2009 **Great Barrier Reef/WB Race** \$2,500+SE
- June 2009 **TransPacific Race** \$5,500+SE

CHOOSE YOUR RACE AND CALL!

- Hassle Free • Fly In/Fly Out After
- Bare Boat with your Crew or Crew with us (Syndicate)
- Delivery Space Available to Learn Seamanship from the Following Passages: Mexico, Tahiti, Cook Islands, Australia, New Zealand, Hawaii – \$1,500+SE

HIGH PERFORMANCE SAILING HAWAII

Contact Bill Boyd

(562) 714-2455 or (808) 230-5551

CHANGES

With reports this month from **Moontide** on Singlar's marina in La Paz; **Pythagoras** on the Winson family's 10-month cruise in Mexico; **Finalmente** on cruising in France and Italy; Steve Sidell of **Reba** on the pleasure of Spain and Morocco; **Far Niente** on the end of a trip across the Pacific; **Daimana** on the Rio Dulce; **Narwahl** on the new Singlar Boatyard in Mazatlan; **Espiritu** on what's new in San Carlos; and a holiday sized portion of **Cruise Notes**.

Moontide — Lagoon 470

Bill Lilly

Singlar's Fidepaz Marina, La Paz (Newport Beach)

Having taken a berth at the new Singlar Fidepaz Marina on the north side of La Paz in mid-November, I'd like to pass along the following information to other cruisers — especially those who are looking for a slip in the La Paz area. The marina has the capacity for about 40 boats — plus or minus a few depending on how they use the end-ties. The good news is that as of mid-November they still had about 22 slips open, so it might still be possible to get a slip in the La Paz area for the winter after all.

One downside of the brand new marina is its location, which is a bit outside of the main part of town — in much the same way that Marina Costa Baja, and to a lesser extent Marina Palmira, are a bit out of town on the other side of La Paz. However, a six peso or 60-cent bus ride solves that problem.

Getting to the marina involved a straight shot along the north shore of the bay, a leg for which there were no channel markers. Then there was another straight shot down a well-marked and dredged private channel along the west shore of La Paz. The GPS positions we were given matched perfectly with those that showed up on my chart plotter. As for depths, I never saw less than 12.5 feet in the main bay, or less than 13 feet in the private channel. Nonetheless, the marina happily sends a *panga* out to guide all boats in.

I found the Fidepaz staff to be very

One of the fun features of most of the new Singlar marinas and boatyards is a small pool and Jacuzzi on the roof.

professional, although not quite as folksy as the ones at Marina de La Paz. Both are great, they just have different operating styles. The Fidepaz facilities are extensive — including a lap pool with a Jacuzzi on the upper deck of the administration building! There's also a community room, which was locked while I was there, and free Wi-Fi service, although the latter curiously gets turned off when the staff goes home for the night. I meant to talk to them about it. Showers are \$1, and there is a laundry on site. They also have a boatyard with a new Travel-Lift.

When I got to the marina, most of the boats seemed to be in storage, so it was pretty quiet. But then the season was just getting started. There's a fellow from San Diego supervising the construction of a 100-ft powercat that is being built next door and will be used for booze cruises when it's done. That should liven things up.

I also attended the Governor's Cup festivities for the Ha-Ha boats and other cruisers at Marina Costa Baja in La Paz, and can report that about 100 or so folks showed up for the fun. The beer truck got lost or broke down, so they only had water and soft drinks! But what a great spread of food — beef, chicken, shrimp and pork — and none of it overcooked, as is often the case in Mexico. They even had clams on the shell.

At the end of dinner, the Costa Baja folks showed the film *Ocean Oasis*, which is about the Sea of Cortez and its sealife. It was both interesting and educational, with lots of great underwater footage. *Ocean Oasis* was filmed for IMAX theaters, so the production values and sound were terrific. All in all, it was

a great cruiser welcome by the Costa Baja folks and local officials.

As for La Paz in general, the local ex-pats are still pretty much the same as when I was here two years ago with my boat, with most being helpful, but a few radio nazis and snobs making their presence known. I think it's pretty sad when a station is trying to help another boat figure out the entrance buoys and someone starts clicking their mic because they think



it's inappropriate to use the the hailing channel for stuff like that. To my thinking, the hailing channel is appropriate for immediate safe navigation advice. The boats in question weren't abusing the hailing channel, but I suppose some of the people with '15,000 miles of experience in 100 years' — ha-ha — might disagree.

Anyway, it's been great to be back in La Paz, where the weather has been great.

— bill 11/18/07

Pythagoras — Olson 40

The Winson Family

A Life-Changing Cruise

(Alamitos Bay, Long Beach)

Our family's 10-month, 4,000-mile cruise to and around Mexico, which started with the '06 Ha-Ha, was a truly life-altering experience. Since *Latitude* had a big role in making our dream come true, our family would like to thank the Grand Poobah and the entire *Latitude* staff for the inspiration.

I'm a longtime sailor, having pur-



IN LATITUDES



BOTH PHOTOS COURTESY PYTHAGORAS

Spread; Dawn, in a warm embrace with daughters Danielle and Darbie. Inset; 'Pythagoras', the Olson 40 racer turned cruiser, on the hook.

chased the Olson 40 *Pythagoras* with my father in '84. We'd done a lot of racing with the boat, but not much cruising other than to Catalina and Santa Cruz Island. A few years after buying *Pythagoras*, I married my wife Dawn. Although she's never really been a sailor, she's always had a great sense of adventure. So when she began reading the *Latitudes* that I left around the house, she was immediately attracted to the reports people had sent in about their cruising adventures. As with many couples, our plans for a sailing adventure of our own were delayed by my business responsibilities and then the birth of our daughters Danielle and Darbie. Nonetheless, my wife continued to dream about our family doing the Ha-Ha and cruising Mexico one day. We were further inspired by Dean and Gay Prophet, good friends who had done the Ha-Ha back in '97 with *See World*, their Ventura-based Sea Wolf ketch.

"It's time," Dawn told me in August of '06 — just two months before the start of last year's Ha-Ha! She explained that our girls, then 12 and 11, were growing older and soon wouldn't be interested in making such a trip with us. I accepted the challenge, so we began the task of converting our 22-year-old racing boat to a cruising boat in just two months. We had dozens of projects to complete — and were still working on them on the morning of the start of the Ha-Ha, which is why we crossed the starting line five hours late!

Here are some of the lessons we learned during our 10-month cruise:

1) A small living space — such as an Olson 40 — wasn't a bad thing for a family of four, and actually brought us closer together. We found that we had all the space we needed to do schoolwork, prepare meals, eat, sleep — and

even use the head. It helped that we had a really big 'backyard'. Since there was nowhere to hide on the boat, we had to communicate with one another and work out our problems — which turned out to be a good thing. For as soon as any of us started to act out bad attitudes, we had to deal with them.

Despite having been the only sailor in the family, I have to confess that I had the biggest problem with the small living space. Before we left, I'd tried to convince Dawn that we needed a bigger boat, pointing out that the Olson 40 had been designed specifically for racing, not cruising. But Dawn and the girls never complained about how small and crowded the boat could sometimes seem. I was amazed at how well they adapted to the small space. The kids set up their little personal living spaces — and thrived in them. Once the cruise was over, they actually missed them! It took me, on the other hand, six months to get used to living on the boat. Prior to the start of our trip, I was worried that my family would want to bail and head home early. It turned out that I was the only one who entertained such thoughts.

2) Relationships are what really count. In modern life it's easy for us to be busy doing things instead of really being with others. And it was a trap I fell into on the boat, too. There was an almost endless list of things to do on the boat, both before we left and once we took off. Eventually, I had to force myself to slow down and focus on the people I was with rather than the projects that I needed to get done. As I look back over the 10 months, it's not the projects that I remember, but my family and the people who helped me complete those projects. As much fun as it was to see all the beautiful sites, my best and most

Good and lasting memories are made of times such as this — adventures with family and close friends. Preferably in warm water, of course.



PYTHAGORAS

CHANGES

fulfilling memories are of the times we spent working and playing with other cruisers.

3) That there are a lot of modern things that we could do without — and still be happy. For 10 months we went without a telephone/cell phone, television, cars, dishwasher, clothes washer and dryer, microwave, air-conditioning, running hot and cold water, any more than seven gallons of water a day, the news and newspapers, more than one 60-watt bulb's worth of electricity at a time, fashionable clothing, haircuts and beauty treatments, and access to just about anything anybody could need or want 24 hours a day, seven days a week.

OK, we did have a computer on board, which was our primary navigation tool, and a radar display. We also used the computer to send and receive basic text emails via our ham radio, watch the occasional DVD, and store the music we listened to. And when we stopped at a place that had wireless internet, we'd use SKYPE to call family back home. But that was pretty much it for technology.

But we did just great without all the other stuff. Sure, some jobs — like shopping for groceries and doing the laundry — were harder and took longer than back home. For example, shopping would involve going ashore in the dinghy while trying to keep from getting dunked by a wave, hauling the dinghy up on the sand, walking to where we needed to shop, carrying everything back to the dinghy, dragging it back into the water, trying not to get wet while going through the surf, and loading everything onto the boat. Yes, cruising is a very physical lifestyle — but did I mention that I dropped 15

Not all of the friends that the Winson family made were of the human species. They enjoyed being able to live out in nature.



PYTHAGORAS

pounds in 10 months without going on a diet? Despite the extra effort required, we still had a good time doing these jobs and tasks. For example, our family would go to the laundromat and wash and dry our clothes as a team.

4) Living in a community is the way God intended us to live. Back home in 'real life', we don't really need neighbors, because if we have problems we just hire an expert and have them solve it. But when you're on a boat in a strange place without easy access to parts and services, you really need your neighbors. No matter what problem we came across, there was always someone in the cruising community with a suggestion for solving it. In many cases, we were flat out given the parts or items we needed for repairs. On other occasions, cruisers would come to our boat and spend hours helping us. As a result, we got to know our cruising friends and acquaintances on a deeper level than we know most of our friends back home. For New Year's, just a short time into our cruise, we made a list of everyone who had helped us — and it turned out to be two typewritten pages long. It felt good to get that help. So good, in fact, it kept us on the lookout for people we could help. The 'pay it forward' program really works!

5) A family adventure is easily worth the sacrifice and expense. Will your kids remember how much money you made or how many toys, games, clothes and things they were given — and ultimately threw away? Not as much as the time spent together as a family shaping their values and lives. It seems as though many parents today think their job is to make their kids' lives as easy as possible so the kids don't have the 'burdens' they did as kids. This is wrong. Kids need to experience burdens so they can learn to bear them. It may make them cry and feel frustrated in the beginning, but it's those kinds of challenges that teach patience and perseverance, and build character and self-confidence.

And when you're on a boat at sea, opportunities to bear burdens and overcome challenges abound. Our challenge as parents was to sit back and let our girls struggle with them. It took time, but we learned to just wait and let them figure out ways to deal with them on their own. We would offer support and encouragement, but we would not solve the problems for them.

6) If you're willing to persevere, a cruising adventure such as ours can transform a good marriage into a great one. (I don't, however, recommend a



cruise as a means to try to fix a bad marriage.) Although Dawn and I had a good marriage before we took off, our adventure forced us to deal with issues that we'd been ignoring. And when you're cruising, you don't have all the normal distractions of modern life to keep you from evaluating your own behavior. In my case, I wasn't happy with my evaluation. I was forced to dig deep and start making some real changes in how I acted. But we all had a chance to look at ourselves and take the time to set goals for developing our characters. We challenged each other to be nicer and more caring toward one another. What we found was that we'd often been programmed to respond to each other with irritation and frustration. It wasn't easy, but we worked on responding with kindness and patience.

7) It's not that hard to afford a family cruise. You can start by making choices right now that will give you the freedom to do it later. For example, the total cost of our trip was about the same as two average new cars. Most people own their

IN LATITUDES



ELECTRONIC/RICHARD

And not a moment too soon! Much to the relief of everyone — including Harbormaster Dick Markie at nearby and jammed Paradise Marina — Marina Riviera Nayarit was opened a month early. While obviously still a work in progress, it's meeting the demands of cruisers needing slips.

cars for three or four years, but if you keep yours for six to eight years instead, you'll have paid for your cruise. We were also able to cover the expenses on our home by finding renters. And even if you were to come back a little poorer financially, you'd be richer for the experiences you had with those you love most. I know it's not easy, because it wasn't for us. We'd been talking about it for 10 years, but, once we made the decision, things fell in place and we just made it happen.

8) A cruising adventure is not a vacation. I know friends pictured us at anchor day after day in beautiful coves with clear water and white sand beaches, lying in hammocks and sipping margaritas. In fact, before we left this was what I pictured us doing. But I think I got 30 minutes of hammock time in 10 months. Yes, we did anchor in some beautiful places, but with home-schooling and boat maintenance, the times to relax

were few and far between. When you go on vacation for a week or two, you can put everything in your life on hold. But when you go for an extended period of time, life goes on, and you have to keep up. We still had to do our taxes, balance the checkbook, pay bills, follow up on problems with our house, and closely watch our budget. Plus, our boat required constant work. Stuff was frequently breaking or in need of maintenance. And a boat is not like a house, where you can just ignore many of the problems. Still, we found that being busy was just another habit, and somehow we found ways to stay busy even when we had very little to do. After about three months, I remember saying to Dawn, "I'm so busy that I haven't read a single book!" And taking time to read books had been one of my goals for the trip. Even 'out there', everything

still came down to the choices we made in how we prioritized and conducted our lives.

9) It's important to slow down! For me, part of slowing down was learning to become a better captain — and husband and father. In the beginning, I felt that I had to do all the sailing stuff myself, as it was faster and easier that way. But two months into the trip, I was completely exhausted, hating the trip, and even wanting to return home. Instead of doing everything myself, I decided that I had to try to become a teacher and coach, and not just a person who did it all. Teaching Dawn and the girls how to do the stuff I had been doing had multiple benefits. First, putting the girls to work made life for Dawn and me easier. And, as the girls developed their skills and gained confidence, I was able to relax more. Second, Dawn and the girls became much more confident in the boat and in themselves, the latter being something that will serve them well for the rest of their lives. Finally, I became more fun because I stopped being a stress biscuit, running around the boat with my hair on fire and complaining about everything.

Wow, how time flew! As I write this, it's been 10 months almost to the day since we left San Diego on the start of our 4,000-mile voyage. The unfortunate thing about all great adventures is that they have to come to an end. While it's great to be back home in the United States, we have so many wonderful memories. Among them:

1) The sail from Bahia Santa Maria to Cabo San Lucas on the last leg of the Ha-Ha. For that part of the trip we'd been

All jobs — even troubleshooting electrical problems — were a lot more fun when they became family projects.



PYTHAGORAS

CHANGES

joined by my dad, Bob, Dawn's step-dad, Ken, and Tim Celek, a family friend. After months of work preparing the boat and our home, we'd really had to scramble to make the start, and were still hours late. After making two stops on the 11-day trip to Cabo, our last night of sailing was one of those that made all the effort seem worthwhile. We were sailing with the spinnaker up in about 15 knots of wind, the night sky was full of bright stars, it was warm enough that we only needed shorts and T-shirts, and Dawn had just made a fresh batch of chocolate chip cookies. Our entire seven-person crew sat in the cockpit together, gazing at the sky, talking, relaxing and eating the warm cookies as the boat gently glided through the clear and warm water. Sailing just doesn't get any better than it was that night!

2) The time a 30-foot humpback whale surfaced within an arm's length of our overcrowded small dinghy at Isla Isabella is something none of us will soon forget! The island is known as 'the Galapagos of Mexico' because of all the amazing wildlife that lives there. It's also a mating ground for humpback whales, and there were whales everywhere. Anchored in a small bay, we decided to go ashore, we being the four in our family and our five friends from *Hakuna Matata* — or a total of nine in our little 11-ft dinghy. While still about 200 yards offshore, this huge whale — they look much bigger when they are right next to you in real life — surfaced next to us. Part of his body was under our dinghy and part of

After a year of cruising, Danielle, like her sister Darbie, got all A's on her report card. She says the trip has also made her "a happier person".



PYTHAGORAS

him was right next to us. We all assumed that he'd flip his tail and we'd all be going for a swim. But instead he just gently pushed his tail in the water, moving on without disturbing our little dinghy. We remained dry — and breathless.

3) The time in La Paz when Danielle bravely swam a line to shore to rescue our disabled boat. We'd just left the dock when our engine died, leaving us adrift in the channel and unable to maneuver. I decided that I would grab a line and swim it to the dock, then pull our boat back in. Dawn thought it would be a better idea if I stayed on the boat while she swam the line in. "No," our daughter Danielle quickly interrupted, "I'm a better swimmer, so I'll do it!" And she did! It was awesome to see our young daughter act so selflessly to assist her family and rescue the boat. It was a chance for her to be a young 'hero' that she won't forget.

4) The dinner conversation on a \$15 million, 115-ft megayacht. The dinner was delicious and the \$15 million yacht was incredible, but what made the memory was our dinner conversation with the woman who owned the yacht. She inquired about what we were doing, and, after hearing about it, looked at us intently and asked, "How can I do what you guys are doing?" I was stunned. How could it be that someone who obviously had many millions, wanted to do what we were doing, but didn't think she could? It was a great lesson in life that money doesn't necessarily bring happiness or freedom. In fact, the woman seemed to be a slave to her business and lifestyle. Her life looked so attractive from the outside, but she just really wanted to have a simple adventure like ours — but couldn't figure out how to do it.

5) The way we handled the dreaded Baja Bash, the 750-mile upwind and up-current slog back to California. It turned out to be an incredible culmination of our voyage in more ways than one. During our time in Mexico, I'd always planned for Dawn and the girls to fly home, while some friends and I would do the Bash. But as I thought about it, I realized that a Bash would be an important finale to our family adventure, bringing everything full circle. I also knew that it would be a lasting memory precisely because it would be difficult. For if you think about it, the great stories we tell about ourselves are the ones in which we endured hardship yet prevailed. Anyone can look good during the easy times; it's when it's tough that character shows.



It was good that the Bash was at the end of our adventure, because if it had been at the beginning, it still would have been the end — if you know what I mean. Frankly, we wouldn't have been up to the challenge if it had been at the beginning of our cruise. We barely made it going downwind to Cabo, and that was many times easier. We needed the lessons we'd learned during 9.5 months on the boat to do the Bash. Indeed, the Bash tested us in everything we'd learned in the previous months, and we worked better as a team than I ever could have imagined — despite enduring great discomfort. Our family hung together without complaint for those final rough eight days and seven nights — an excellent character builder.

The bottom line is that we had an awesome and life-altering trip. We hope our story can help your dreams of cruising adventures become a reality.

— dale 10/10/07

Finalmente — Dolphin 460 Cat Ni and Krissy Orsi



ALL PHOTOS COURTESY FINALMENTE



Spread; 'Finalmente' on the hook at Corsica. Inset left; Krissy at the helm. Inset right; Portovenare, near the cat's winter home.

Cruising France and Italy (Stockton Sailing Club)

Since arriving in Santa Margherita, Ligure, Italy, on May 26 from Aracaju, Brazil, having sailing 5,900 miles on our new cat with my delivery crew, my wife Krissy and I have added another 2,440 miles this summer sailing in French and Italian waters. We have now visited most of Corsica and Elba, great islands with lots of sand beaches and little bays in which to anchor. Later, we sailed from Santa Margherita to St. Tropez, France, and back. Then we were off again to Corsica, before ending up at the Cannes Boat Show — where *Finalmente* was the first Dolphin 460 to be shown to the European market. She was a hit!

Two weeks ago, we sailed south down the Italian coast once again, but this time to put *Finalmente* away for the winter at La Spezia. However, before putting her away, we sailed around the Portovenere area, and found several very good an-

chorages with excellent restaurants. Now that our cat has been put away for the winter, we are heading back to Stockton to visit friends we have missed. But we will return to our boat next February 23, with the intention of sailing south to revisit Elba and Corsica, then continue on down to Sardinia, Capri and Sicily.

— ni 11/10/07

Reba — Celestial 48 Steve and Jamie Sidells Spain, Morocco, Canary Islands (Incline Village, Nevada)

Before Steve joined Dudley Nigg's circumnavigating Island Packet 45 *Happy Now*, the two of us enjoyed a grand land tour of southern Spain. We mention this because Madrid, Toledo, Cordoba, Granada and Malaga all have world-class cultural and historic sights. We particularly recommend the art galleries and Royal Palace in Madrid, the Mesquita in Cordoba, and the Alhambra in Granada. So if you're cruising the Mediterranean coast of Spain, be sure to get off your boat and take the tour! Spain's RENFE trains provide a

convenient way to travel to these places from the coast. It's most enjoyable if you do this kind of sightseeing in the cooler months. Now here's Steve's report from being on *Happy Now*:

The often light and variable winds of the Med made our travels along the southern coast of Spain mostly motor-sails. However, Spain's Sierra Nevada mountains added majestic and interesting scenery. The small coastal towns have marinas full of small pleasure craft, yet we've found that the harbormasters worked hard to find berthing for visiting cruisers. The ambience at these places is wonderful, and the basic supplies are always at hand.

After leaving the large tourist center of Torremolinos, we crossed to the small Spanish enclave of Ceuta (Thay-U-ta) on the coast of North Africa. Since it's a duty-free island and less frequently visited, diesel was about 75% of the price on peninsular Spain. There was also more economical berthing and less congestion than in the busy port of Gibraltar, which was in view across the strait of the same name.

The month-long observance of Ramadan was well underway in Morocco when we arrived. Since Morocco's Atlantic ports aren't known for having lots of accommodations for cruising boats, we had low expectations, but decided to give them a try anyway. So we kept close to shore on our overnight passage to Mohammedia, just north of Casablanca. We encountered many strange quick-flashing red and yellow lights during our night passage, and at first thought that they were offshore oil wells. But

As majestic as Spain's Sierra Nevada mountains were, they couldn't compare with the volcanic activity found on the Canary Islands.



STEVE SIDELLS

CHANGES

then we noticed that they slowly moved around. We later learned that Moroccan fishermen hold to a different standard of navigation lights, as during the holidays they think nothing of decorating their boats with little flashing lights.

It turned out that Mohammedia has a small marina with room for up to 12 cruising boats. This marina provided a place to keep our boat while we took off on what turned out to be a wonderful Moroccan adventure. In the course of eight days, Dudley and I spent about 20 hours on trains to the north and south, visiting places such as Casablanca, Marrakech, Rabat and Fez — and all at low cost. The latter three cities have millennium-old sections still enclosed by medieval fortress walls, as well as more modern French-built sections laid out along grand boulevards.

Marrakech was my favorite. It has beautifully decorated minarets, intriguing *souks* — which are the twisting, cloth-covered alleys with seemingly endless stalls full of exotic goods — snake charmers, monkey trainers, brightly dressed water men, and even storks nesting atop the ancient walls. As night fell during Ramadan, chants could be heard from the minarets, and the day-long fast without food and water ended. Because special meals are served during Ramadan, all the tables in the restaurants were set with that meal, just waiting for the customers. I tried this at McDonalds, but added the special McAfrique sandwich. It was spicy and delicious.

Morocco is a land of beautiful mosques, some of which are gigantic, such as the Hassan II mosque in Casablanca. Most

If you're looking for something different in a cruising destination, Morocco should fit the bill. And the people are very friendly, too.

Moroccans speak either Arabic or Berber as well as French, but English is not uncommon among the more educated. You can bargain on most items and services in Morocco and get 20-35% off. The exception are rides in the ubiquitous 'petite taxis', which always seem to cost \$1.25 U.S.

All the Moroccans were very friendly, and the port and Immigration officials weren't a problem at all. As soon as Ramadan ended, there were suddenly people everywhere. And once it was over, a local told us people weren't "grumpy" anymore.

A 72-hour light air sail brought us to the volcanic wonderland that is the Canary Islands. In case you're wondering, the islands aren't named after the birds of the same name, but rather the birds were named after the islands. The Island's name comes from the Latin *canis*, as early Romans discovered large dogs when they first arrived.

Our first stop was at the main fishing village on the northernmost island of La Graciosa. I marveled to find that all the buildings in the village were seemingly new or at least newly painted white, with all doors and window frames painted the same shade of blue. The buildings were bordered with narrow tile sidewalks, while the roads were smooth packed sand. All the fishing boats were carefully painted. There was not a speck of trash anywhere. It reminded me of the beautiful island of Santorini in Greece, except without the blue cupolas and the crowds of tourists. A new Travel-Lift at the boatyard allows do-it-yourselfers the opportunity for a low-cost haulout.

We then sailed to Puerto Calero on neighboring Lanzarote, where we found that all villages on this much larger island had the same uniform color scheme and care as on Graciosa. Amazing! I asked why this was so, and was told that the people of Lanzarote realize they are living in a privileged place, a place where they should work closely with their environment. Puerto Calero is home to a first-rate marina with great docks, hospitality, restaurants and services — a place we would recommend to any sailor. A major regatta was underway while we were there, featuring a boat that belongs to King Juan Carlos of Spain.

A UNESCO biosphere reserve site, Lanzarote is a must-see destination with remarkably unique features. With my interest in geology and planetary history, I found our trip to Timanfaya National Volcanic Park to be an astonishing journey through a display of the volcanic power



that has shaped our earth. Many large stratovolcano calderas show evidence of mighty prehistoric explosions, probably greater than the 1883 explosion at Krakatoa. Before leaving, we saw the artificial geyser and watched food being grilled by subterranean volcanic heat. Then, in the volcanic ash covering most of the island, we found semicircular stone-ringed 10' diameter circular pits, each of which held an individual grape vine. This is the unique viticulture of Lanzarote. Try the wine and the island — both are great.

We next called on the port of Gran Tarajal on Fuerteventura, another arid island. We found an interesting local cultural program in progress, all free, on a comfortable fall evening. Next was Las Palmas on the more tropically lush Gran Canary Island, which was then preparing to host several hundred boats gathering for the Atlantic Rally for Cruisers. There wasn't enough room for those of us not entered in the ARC.

We continued on to Tenerife, the island of mountains and bananas. It's home to Pico de Teide, which, at 12,200 feet, is the tallest mountain in Spain.



STEVE SIDELLS

ALL PHOTOS COURTESY STEVE SIDELLS

and came from the east rather than the south. Fortunately, this allowed us to rip on down the rhumbline, averaging 8+ knots. In 24 hours we logged a personal best of 205 miles, cutting our expected passage time by a full day.

How sweet that very fast day was, considering that we had to wait — patiently and otherwise — in Nuku'alofa for 19 days — the same amount of time it took us to do our Puddle Jump — to get a favorable weather forecast for the long and sometimes dangerous passage to New Zealand. We guess the weather wizards knew what they were talking about when they told us to stay put.

Although seemingly never-ending, our days in Nuku'alofa were spent hanging around with the crews of 30 other boats. We went in and around town, eating, provisioning — again and again — and reading *Time* magazines from the previous months. We also enjoyed play days at Big Mama's YC, just off our anchorage on Pangaimotu Island. Ping-pong, bocce ball, hula hoops, volleyball, a Halloween pirate party, and lots of beers and fish & chip dinners kept everyone happy — including Big Mama. In fact, the day we left the anchorage, Big Mama got on the VHF to wish us all a safe passage and thank us for bringing them so much business. For not wanting to be there, in retrospect we certainly had a great time.

Forecasts call for light winds again today, tomorrow, and possibly Wednesday. But an intense high over Australia may push a trough over New Zealand and then right into us on Wednesday and Thursday. That would bring very cold air and strong southerlies — which would mean we'd have to head west a bit, then south again before making landfall

Dreaming of a South Pacific cruise while dining at Punta Mita in February of '06 seems like just yesterday to Eric and Gisela.



The sights and sounds of Morocco, from the walled fortresses to the souk to the birds on the minarets — so unMexico.

Using a combination of a car, tram, and foot, we almost made it to the top. But from far above the scattered clouds, we could see clear evidence of an even mightier volcanic explosion than on Lanzarote. The caldera was formed some 170,000 years ago, and the high peak we climbed had been formed after that. The panoramic view was superb.

Whether you go by air or by boat, Spain, Morocco, and the Canaries have sights that are well worth the visit.

— jaime and steve 11/05/07

**Far Niente — Island Packet 42
Eric & Gisela Gosch
The End Is Almost Near
(Hemet)**

Today is the third day of our passage from Tonga to New Zealand, and we've been making great time. The sun is shining in a mostly cloudless sky, but we're moving out of the tropics, so there's already a bite in the air.

A light rain bade us farewell as we weighed anchor Saturday morning, ex-

ited Egeria Channel, and finally rounded Tongatapu's western point into the open ocean. Ours was but one of about 20 boats beginning our passage to "the land of the long white cloud". As we motor-sailed the first 24 hours in light winds, the number of boats around us slowly dwindled from six to three, and finally to none at all. Although we can't see any of the others now, we are within 15 to 30 miles of them, and are keeping in contact via VHF radio and email. Normally we'd also use our SSB radio, but it's on the fritz.

Most of us have decided to skip the Minerva Reefs because of our late starting date and our need to get south fast ahead of developing weather. The light winds at the start weren't much help getting us on our way down to New Zealand, but they were perfect for landing a nice yellowtail tuna on the first evening. A short time later, the winds kicked up to beyond the 20-25 knots that were forecast,



CHANGES

in Whangarei. We hope to get as many miles under us now in calm weather to minimize our exposure to the later system, but we should arrive on Friday nonetheless.

We're now quietly biding our final days on *Far Niente*, settling once again into three-hour watches, reading, sleeping, doing small boat chores, figuring out Kakuro, and playing Up-Words. Our fridge and freezer are full, so we're also aiming to finish off all our fresh food before landfall. In order to avoid the introduction of foreign pests and diseases, New Zealand has very strict laws about what can and cannot be brought into the country. Although actual practice varies, most boats are boarded and thoroughly inspected for a laundry list of prohibited goods — including fresh foods, honey, feathers, seeds (including those in jewelry), pesticides, and so forth. Boat and dinghy hulls are also inspected for barnacles and algae, tennis shoes for grasses and soil. We have done our due diligence in preparation, and hope to pass muster.

Sadly, the end of our fantastic South Pacific adventure is near, and we're soon to be landlubbers again. It's only four or five days until landfall, and then just four another until we fly home. Where has the time gone!? It seems like only yesterday that we were itching to leave Puerto Vallarta. Since then we've sailed over 6,000 miles, visited seven countries and 35 islands, gathered a lifetime's worth of memories — and finally experienced the art of *Far Niente!*

— eric & gisela 11/10/07

Damiana — Manta 42 Cat Roy & Marlene Verderey The Rio Dulce, Guatemala (Sausalito)

With our catamaran having survived the summer well at her berth at Monkey

Rumble in the thick jungle. This is a typical cruisers' workshop, with electrical power, at a marina on the Rio Dulce.



Bay Marina on Guatemala's Rio Dulce, we had her taken out on rails at Astillero Magdalena for a new bottom. Astillero has been in business for 25 years and does all the work on TMM charter boats based in Belize, so they have extensive experience. They've also hauled a lot of bigger charter cats, so our boat's 20-ft beam was no problem for them. Abel, the yard's manager, is the son of the original owner, so everyone has come to refer to the yard as Abel's instead of Astillero.

Ram Marine, another yard nearby, recently opened their doors for business. They have a Travel-Lift and jack stands as opposed to rails. We've been told that they can handle boats with beams as great as 22.5 feet. They also provide dry storage. With over 200 cruising boats on the Rio Dulce, it would seem that there's more than enough work to keep two yards busy.

Mar Marine, a combo marina/hotel/chandlery just across the way from Ram Marine, has marine gear and gets supplies shipped in from West Marine and Port Supply. In addition, they carry a small supply of everyday items. There is also a *ferreteria* in town that sells some boat items such as chain, and Tienda Reed, located at the foot of the bridge, carries a variety of hardware, goods, propane and other supplies.

We've visited several of the other marinas besides ours, and discovered that most of them have restaurants that welcome diners from the outside. Bruno's, which is actually a marina/hotel/restaurant, is located at the foot of the bridge in Fronteras, and has a long dinghy dock that they allow everyone to use while shopping in town.

The main street in Fronteras is part of the main north-south highway, and is therefore busy all day and well into the night with truck, bus and vehicular traffic. The street is lined with food stalls and *tiendas* selling everything from candy to appliances. There is one small supermarket where we purchase our staples and even BBQ'd chickens. I usually purchase all our produce on the street, then stow my bags in a locker inside the supermarket while I pick up meats and other items that need refrigeration. There's also a small *tienda* in Bruno's that stocks gourmet cheeses, olives and other hard-to-find treats. Similarly, Miriam's, another *tienda* at the water's edge, stocks jars and cans of just about anything you'd ever want, as well as wines and liquors.



Across the street from her *tienda* is a pizza restaurant that bakes fresh whole wheat bread every day. In other words, there's no need to go anywhere else for staples or treats, as they're all right here in the Rio.

There's also no need to go anywhere to meet Ha-Ha vets. Yesterday some folks returned to their boat in Monkey Bay Marina for the season, and they turned out to be Ron and Bette Vallerga of the Mountain Ranch-based Pearson 390 *Frances V*, vets of the '02 Ha-Ha. And next week we expect Ron Olson and Yen Trinh of the Oxnard-based Hunter 42 *Moonlight*, veterans of the '04 Ha-Ha, to return to their boat in a marina close to ours.

Tomorrow I'll get on the local net and ask if there are others boats here in the Rio that participated in Ha-Ha's so we can have a get-together.

— roy and marlene 10/18/07

Narwhal — Falmouth Cutter Michael Latta New Singlar Boatyard In Mazatlan (Mazatlan)

IN LATITUDES



SPREAD, LATITUDE/RICHARD; INSET, MICHAEL LATTA



The changing face of marina services in Mexico. The spread shows how the Singlar site looked in the fall of '05. The inset photos show that the yard is up and running, with spanking new fuel tanks. Jared Martinez, in the inset to the left, is in charge.

Last week I hauled my 22-ft Falmouth Channel Cutter Narwhal at Singlar's big new boatyard facility next door to Marina Mazatlan, as I needed to complete an engine installation and take care of the usual maintenance items. The yard had been open and hauling boats for about two months, and they were running smoothly, having apparently worked all the kinks out. The physical plant and associated equipment are absolutely first-class, and I've found the workers to be professional, open, and always ready to help.

The Supervisor of both Operations and Administration is Jared Martinez, who, along with Administrations head Alma Magro, run a well-oiled ship. For example, the paperwork for my haul and launch was minimal. By the way, it cost me just under \$180 for both ways, which I think is reasonable. The only way I could have done it cheaper was to careen on a tidal flat. For boats from 31 to over 51 feet, the price is between \$7.14 and

\$8.82 a foot, but doesn't include tax.

The old 'build it and they will come' adage seems to be true here, as several major marine repair and general maintenance organizations have leased workshop space in the Singlar facility, and more will be arriving soon. Bob Buchanan's Total Yacht Services was selected by Singlar to move in as a kind of 'anchor tenant'. As the biggest Yanmar dealer on the Pacific coast of Mexico, Canadian Buchanan — who is well-known to many cruisers — and his business have become a magnet for engine repair and services. His installation of my new Yanmar two-cylinder is almost complete, and I hope to start giving waterskiing lessons as soon as I'm back in the water.

C&C Marine Services is another company that is very busy and doing good work. They just completed a tough blister job on *Narwhal*, and will be doing all the barrier coats and bottom paint, too. The folks at Grupo Naval are available for fiberglass and bottom jobs, as

well as other maintenance work. So the resources are here for just about any fix-it problem a sailor might have. Also coming to the boatyard are a chandlery, stainless steel fabrication business, sail loft, grocery store, and a cafe and restaurant. Singlar also has inside storage space rentals, wet and dry outside boat storage, a token-operated laundromat, and free Wi-Fi.

In addition, the Pemex fuel dock is now open from 8 a.m. to 5 p.m., Monday through Saturday. You just need to call Claudia, the manager, for an appointment. The fuel dock is an easy in and out, and has 10 feet of water at low tide.

My favorite Singlar feature? Whenever I get tired of working in the hot sun — which is most of the time — I can simply climb the steps to the rooftop swimming pool and Jacuzzi, and hop in. There's nothing like looking over the edge of a pool to supervise work on your boat.

Jared tells me that Fonatur, the Mexican tourist development agency that is also their parent company, has been in contact with the government to widen and deepen the main harbor entrance that leads to Marina El Cid, Marina Mazatlan and Singlar. I don't know if that's good or bad. Sure, it would make it much safer in bad weather, but it would also mean that the richy-rich folks with their 100 and 200-ft boats could get in, and there would go the neighborhood — not to mention the berth rates.

— michael 11/10/07

Espiritu — Hunter 430 Pat & Carole McIntosh The New Captain's Club (Sacramento)

Our boat has just been splashed after our first experience of putting our boat back together after a summer on the *The new Captain's Club, founded by former cruiser Mike Napolitani of the Trintella 29 'Yoli', is a big hit with cruisers around San Carlos.*



COURTESY NARWHAL

CHANGES

hard at Marina Seca in San Carlos. The folks here do a first-class job of running a marina, storage yard, and work yard, and a cruiser can do as much or as little of the work as they want. It's nice to have the opportunity to save money by doing your own work.

Espiritu wasn't as dirty as we had feared she might be, but thanks to so many cruising friends from last year showing up in November, we found it hard to stick to our work schedule. It was just so much fun getting reacquainted with all those friends while getting ready to relaunch. Among them were Doug and Marci Sanford of the Lacey-based Island Packet 380 *Charm*, Les Sutton and Diane Grant of the Alameda-based Albin-Nimbus 42 *Gemini*, Vic and Roberta Kelley of the Sonora-based F/P 45 cat *Apollo II* — all from last year's Ha-Ha — and Canadians Barry and Ann from *Cat's Paw IV*.

The following is what we believe would be some worthwhile information for members of the Ha-Ha fleet — as well as anyone else who has sailed down — about the San Carlos area: Marina



LATTITUDE/ANDY

The McIntoshes made it as far south as Zihua for SailFest last year, but will stick to the Sea of Cortez this season.

Seca is putting the final touches on a large addition to the storage yard so they will be able to accommodate even more boats. They already have over 500 boats in storage. The new Singlar Marina is

now open in Guaymas, giving cruisers even more options. But some of the best news is that there's a great new cruisers' hangout, called the Captain's Club, across the street from the Marinaterra Hotel, which means it's an easy walk from San Carlos Marina. The Captain's Club was opened by Mike Napolitani, the young sailor who owns the Trintella 29 *Yoli*. Although Mike has crewed to Hawaii, since '02 he's spent most of his time cruising in the Sea of Cortez. His place offers good drinks at happy hour prices all day, but you gotta try the fish soup! The Captain's Club has all the information cruisers need, does LP gas pickups, offers free wi-fi, has many other services, and is staffed by some wonderful locals.

Last year we got as far south as Zihua for SailFest, but this year we'll stay mostly in the Sea of Cortez. Thanks once again for being the catalyst that got us to head south in the Ha-Ha last year, as we're lovin' it down here. We're looking forward to visiting new places and seeing old friends as we continue with our

Puerto Lucia, the gate to the South Pacific
www.puertolucia.com.ec

2900 miles to Marquesas Island
 Galapagos At only 500 miles from Puerto Lucia
 2 10 S 80 23 W

PUERTO LUCIA YACHT CLUB
 ECUADOR

50-ton Travelift
 Long and short term dry storage. Maintenance and provisioning.

Excellent climate year round, floating docks, fuel, laundry, Mediterranean-style moorings, Wi-Fi, Cruiser's Lounge electric and water hook-ups.

Ecuador has the Best Climate in the World
 (Source: International Living, January 2005)

South Pacific Ocean

For Further information: 593-4-2783190 / 593-4-2206154 or email us: marina@puertolucia.com.ec, www.puertolucia.com.ec

cruising life. Incidentally, your response to the "annual whiner's letter about the Ha-Ha" was much more reserved than many of ours would have been.

— pat & carole 11/07/07

Cruise Notes:

We know that the **slip situation** in the Cabo, La Paz, Banderas Bay, and Navidad areas is tight this winter, but don't give up all hope. There are always people whose cruising dreams fall through for a year or so, opening up some berths. For example, 29 of the 179 paid entries in the Ha-Ha didn't show — a typical percentage — and a few of the boats that did start returned to San Diego. As a result, a number of boats that had reservations at marinas in Mexico couldn't use them. So while you can't count on anything, if you're near a marina and don't have a reservation, there's no harm in calling them and saying, "I understand that you're probably full, but do you have any last-minute cancellations?" And here's a big tip — being nice counts.

It will also be interesting to see

what effect the addition of the new berths at the soon-to-officially-be-open **Puerto Los Cabos Marina** in San Jose del Cabo and **Marina Riviera Nayarit** in La Cruz will have on slip supply and demand in Mexico's prime cruiser grounds. Los Cabos is opening up 70 slips this month, with another 100 to follow by next winter. Riviera Nayarit is expected to have 260 available by the end of February. The good news is that the majority of slips in both marinas are 50 feet or longer. The less good news is that both marinas cost a fortune to build and are in areas where real estate has been appreciating at an explosive rate, so don't be expecting any bargains. If you're looking for greater certainty in getting a berth, or lower cost berths, it's best to go further north into the Sea of Cortez or further south to Ixtapa.



A couple of boats enjoying the uncrowded —and free — anchorage, not a winch handle's throw from the new marina at La Paz.

Before anyone gets too bummed about the situation in Mexico, we want to remind everyone that **Mexico is full of great places to anchor** — for free. And that the low-cost way to leave your boat if you have to return to the States is leave it on the hook with some responsible buddyboats watching over her. This is commonly done in places such Punta Mita, La Cruz, Tenacatita Bay and Zihua.

YOUR SECRET PARADISE...

Located in a beautiful sheltered lagoon on the north Pacific coast of Nicaragua, **Marina Puerta del Sol** is your premier cruising destination in Central America.

- * Onsite Immigration & Customs
- * Full service restaurant and bar
- * 24 hour security patrol
- * Internet & Fax/UPS service
- * Yacht club with showers and laundry

- * 140 foot fuel dock - diesel/gasoline
- * Well marked channel
- * 40 slips with water, power and cable TV
- * Two pools, ocean side and marina
- * Tennis, surfing, fishing, horseback riding
- * Luxurious hotel with 12 executive suites



Marina Puerta del Sol

Marina Puerta del Sol • 21110 Puerto del Sol, Nicaragua, 505-888-1616 • info@puertadelsole.com • www.marina-puertadelsole.com • USA 800-444-4017

...IN BEAUTIFUL NICARAGUA

CHANGES

"Instead of returning to Marmaris, Turkey, we had our Beneteau 37.5 **Limerance** shipped back to the U.S.," report Doug and Judy Decker, who were from San Diego when they started their cruise with the '00 Ha-Ha. "In September our boat was loaded onto a Dockwise Yacht Transport ship, and a few weeks later arrived in Fort Lauderdale. The ship was packed with large motoryachts and just two sailboats. Everything onboard our boat was in perfect condition. After a couple of days, we moved *Limerance* up the Intracoastal Waterway to Soverel Marina in Palm Beach Gardens. We were impressed with the marina facilities and the shopping in that area. From now on, we'll be landlubbers at Pawley's Island, South Carolina, and will vacation on our boat and cruise Florida and the Bahamas at our leisure.

"It's been quite an adventure to live aboard *Limerance* since April of '98 and sail with her through so many countries," the couple continue. "We don't have a favorite place because each had something unique to offer. Nonetheless, we think it would be hard to beat Panama's San Blas Islands, both for beautiful water and



LECTRONIC/RICHARD

What's not to like about Capri? Except, perhaps, that it can be hard to find a place to anchor or moor, and you have to pay in euros.

exotic culture. We spent three months anchoring among the San Blas Islands, enjoying true island life — which means going without things we normally take for granted, such as grocery stores and

laundromats. Once we got to Europe, our highlights were spending seven months in Barcelona, and an even longer time in Rome. We eventually passed through the Messina Straits past Sicily, around the 'boot' of Italy, and north through the Adriatic. After cruising Croatia and Montenegro, we stopped in Albania for a few days on our way to Greece. While Albania is not quite ready for tourists, it was interesting to see a country that has been completely isolated from the western world for so many years. We eventually sailed through the Greek Islands to Bodrum, Turkey. The countries we saw were so rich in culture and history! But to our thinking, it's hard to imagine a more beautiful place than St. Jean Cap Ferrat in France, or the island of Capri off the coast of Naples. The final conclusion to our trip, after Greece and Turkey, was exploring the city of Istanbul on the way back to the States. What a great time we've had!"

If you've already read this month's *Letters*, you know that Jim and Dianne Currah of the Nanaimo, British Columbia-based Beneteau Idylle 11.5 **Praire**

SCHOONMAKER POINT MARINA

• IN SAUSALITO •



Call the Marina Office
for more information

415-331-5550

FAX 415-331-8523

or check our web site at
www.schoonmakermarina.com

85 LIBERTY SHIP WAY, #205
SAUSALITO, CA 94965



160 Berth Marina in one of the most
beautiful spots on the Bay

- Visitor berths • Guest moorage able to handle yachts up to 200 ft.
- Dry storage • Waterfront Offices • Three-ton Hoist • Windsurfing
- Deli • Beach • Rowing • Kayaking • Yacht clubs always welcome

Oyster 1, had a less than satisfactory experience with an officer at the San Diego Harbor Police Station. But just before we went to press, they wanted to let everyone know that they had an experience on their way to Cabo that renewed their faith in human nature.

"After departing San Diego, we spent five days in Ensenada, which was great except when the two cruise ships in port made everything too crowded. After a nice sail for an overnight at the north end of Cedros Islands, we took off the next morning — only to have our diesel start banging and die. So I strapped our 6 hp Suzuki on the boarding ladder, and by 3 p.m. managed to limp into Cedros Harbor and tie up at the dock. The next morning, Port Captain Issac Vargas stamped our papers and then, during his time off, came down to our boat to troubleshoot and help repair our diesel! He found that our primary problems were a broken keyway on the primary gear, which put the timing out, and three bent push rods and two broken rocker arms. He took the bad parts to the salt processing plant, where he had

the rods straightened and the rocker arms welded. Then, over a three-day period, he helped us put the motor back together. What's more, he invited us to join his family and friends for a lobster barbecue at the island's North Point! We tried to pay Vargas for his services, but he refused! What incredible kindness! The last time I paid a mechanic, it was about \$50/hour. Vargas said that we should replace the rods and rocker arms with new ones, something we plan to do upon arrival in La Paz. But there you have it, the yin and yang of our experiences with port officials. The one at Isla Cedros more than made up for the one in San Diego."

Where, every reader will want to know, did Jim and Dianne find a diesel mechanic north of the border who will



"We were first!" Yes, Spokane-based Hunter 42 'Aimless' was the first boat in at Marina Riviera Nayarit. The yacht club is in the background.

work for \$50/hour?

"For the record, **Aimless**, Jim Olson's Hunter 42 from Spokane, with Paul Mathews and Ryan Goodman, both of Whidbey Island, as crew, was the first boat to take a berth at the new Marina Riviera Nayarit," reports Mathews. "We arrived on November 12, having sailed from Cabo two days earlier. The other boats didn't arrive until three or four days later."

Toll Free
1 866 365 25 62
01 52 646 153 41 06

info@marinapuertosalina.com



New Slips Available 30 to 60 ft.
\$.55cts daily \$11.55 monthly \$9.35 & \$8.50 long term per ft per month.



Marina Services
Power 220/110 volts
Fresh water
Security 24 hrs.
Cleaning
Dock master
Showers
Dressing room
Laundry
Interguar

Swimming
Furnished & US boats
Pump out
Restaurant & Bar
Walk Club
Dry Dock
14 E. digital live tide
(remote access)

Lat. N 17° 32' 25"
Long. W 115° 53' 20"
Ensenada 27 NM south
Tijuana 59 NM north

CHANGES

It's been duly noted.

If you're reading this issue of *Latitude* in early December, it will be while a fleet of up to 240 boats — an all-time record — in the 22nd annual **Atlantic Rally for Cruisers** are making their 2,900-mile way across the Atlantic from the Canary Islands to St. Lucia in the West Indies. The only West Coast entry in this granddaddy of all cruising rallies, which started on November 22, is Jerry and Karen Eaton's Belvedere-based Hallberg-Rassy 43 **Blue Heron**. Having already cruised 14,000 miles in Europe, Karen is leaving the ARC to her husband and his friends. *Latitude* hopes that *Blue Heron* — as well as everybody else in the ARC — has as wonderful an ARC as we did with our Ocean 71 *Big O* back in '94.

"If anyone has considered heading to the South Pacific, but isn't quite sure if it would be worth it, rest easy, because it's truly wonderful," report Rod and Elisabeth Lambert of Alameda. While they are the owners of the Swan 41 **Proximity**, they cruised 2,200 miles across the South Pacific aboard Orange Coast College's S&S 65 **Alaska Eagle**,



LATITUDE/ANDY

No matter if you're just cruising, or enjoying a little racing between the cruising, it's hard to beat sailing in French Polynesia.

a former Whitbread Around the World Race winner.

"For the most part we had warm weather, and we enjoyed classic tradewind sailing and sunbathing on

deck with the spinnaker up. Of course, we also did some close-hauled sailing in winds to 32 knots, too, but *Eagle* was made for conditions such as that. It was all pretty great sailing. The real special part, however, was visiting the islands. Fiji wasn't the best of all places, however. Suva was a bit of a downer, so as soon as you can provision, you want to get to Fiji's outer islands. In addition, there are political and cultural problems in that country, as the native-born Fijians are laid-back islanders, while the ethnic Indians, brought to Fiji by the Brits, are wound-up business folks. So it's turned out that the Indians own all the businesses and the Fijians do all the work for them. And the Indians have nice houses while the Fijians live in squalor. Vanuatu, on the other hand, was a treasure. We visited both Tanna and Efate. The former was rural and primitive — no shoes, grass houses, and dugout canoes — and nothing but dugout canoes. It's real *National Geographic* stuff. On top of that, the people were the most friendly and unspoiled that we've ever met. We



We help make El Salvador worth the trip!



Visit our Web site www.barillasmarina.com to learn more about our many amenities including high speed Internet, on-site customs and 24-hour security.

Barillas Marina Club is the premier cruising destination in El Salvador.

We are Located in Jiquilisco Bay, the largest Bay in El Salvador.

Make Barillas Marina Club your headquarters in Central America and experience the difference that makes us a preferred destination.

www.barillasmarina.com
(503) 2632-1802 • info@barillasmarina.com

**LET MARINA EL CID
WELCOME YOU TO MAZATLAN!**

**Cruisers -
FIRST
NIGHT
FREE***



**Official
Sponsor
2007
BAJA
HA-HA**

A CRUISER'S PARADISE IN THE HEART OF MEXICO'S LUSH TROPICAL COASTLINE AND BEAUTIFUL ISLANDS

A Full Service Marina Offers...

- ★ 90 slips from 25' to 120'
- ★ Electrical and water hookups
- ★ Telephone connections
- ★ Restrooms and shower facilities
- ★ Dock Boxes
- ★ Dock Carts
- ★ 24-hour security
- ★ 24-hour laundromat
- ★ Supermarket
- ★ Dry dock
- ★ Gasoline – Diesel
- ★ Pump-out station

NEW Marina-Wide High Speed Wireless Internet Connections!

www.elcid.com

011-52 (669) 916-3468 • gcevallos@elcid.com.mx

***Reserve for any multi-day stay and your first day is FREE!**

had many wonderful experiences with them. Sydney was another surprise, as it was so clean, totally cosmopolitan, and the people were so friendly. In fact, for our money it was cleaner, more friendly, and more cosmopolitan than San Francisco. We'd live there in a heartbeat! We left *Eagle* at the Cruising Yacht Club of Australia, the club that puts on the Sydney Hobart Race."

The Lamberts further noted the critical importance of taking immediate and thorough care of all cuts in the tropics. "One crewmember cut his leg on coral in Vanuatu. He didn't take care of it properly, so it became infected. He had to be emergency evacuated off the boat some 200 miles off the coast of Australia. It was pretty dramatic."

Speaking of Ocean 71s, as we were on the last page, Antioch's Max Young, who is doing a long circumnavigation aboard his Perry 47/50 **Reflections**, had this to report from Turkey:

"A sistership to *Big O*, which like my Perry 47/50 had a stern extensive, moored next to us in Turkey. The owner

said she was built in '76, but she was in bristol condition. As for us, we left Thailand last January, and arrived in Turkey in April. The Red Sea is one nasty place to sail, so I can understand why so many boats are lost there. For if you're not faced with a northerly wind and sea, you have the red sand blowing off the Sahara Desert and into your face. I've washed my boat about 20 times after leaving the Red Sea, and am still getting red sand draining from the lines as well as cracks and crevices. And forget about going into marinas, as there just aren't many there. The best place to wait out high winds is in the marshes. We worked the east side of the Red Sea, which is the old tall ship route, and we encountered a lot less wind and headseas than did the flotilla that went



Max Young took this photo of an Ocean 71 moored next to him in Turkey. The 30-year-old boats are in demand as family cruisers.

up the west side. The problem with going up the east side is you can't stop in Saudi Arabia, so you need to fuel up in Yemen, not forgetting to fill your jerry cans, too. We stayed close to the freighter lanes, found errors in the charts, islands that weren't marked, abandoned oil rigs that were cut off about a meter above water level, and other hazards. And you don't want to anchor on the Egyptian side unless it is marked that you can do so,

Life Line

by

WAGNER INSURANCE

Since 1978

Life Insurance Rates That Will Keep You Afloat

- Compare our rates with anyone.
- More than 50 companies to choose from.
- Many other Life and Health products.

TERM LIFE INSURANCE RATES:

\$250,000 COVERAGE, SUPER PREFERRED NON-TOBACCO, MONTHLY PREMIUMS							
FOCUS TERM PREMIUM RATES:	ISSUE AGE	10-YEAR POLICY		20-YEAR POLICY		30-YEAR POLICY	
		MALE	FEMALE	MALE	FEMALE	MALE	FEMALE
	30	9.84	9.19	13.78	12.47	22.09	18.38
	40	11.81	10.94	18.16	15.53	33.25	25.38
	50	25.16	21.66	47.25	33.03	71.97	51.41
60	67.17	43.97	117.69	79.84	N/A	N/A	
\$500,000 COVERAGE, SUPER PREFERRED NON-TOBACCO, MONTHLY PREMIUMS							
30	15.31	14.00	23.19	20.56	39.81	32.38	
40	19.25	17.50	31.94	26.69	62.13	46.68	
50	45.94	38.94	90.13	61.69	139.56	98.44	
60	129.94	83.56	231.00	155.31	N/A	N/A	
\$1,000,000 COVERAGE, SUPER PREFERRED NON-TOBACCO, MONTHLY PREMIUMS							
30	25.38	22.75	40.25	34.13	72.63	56.00	
40	32.38	29.75	56.88	49.00	117.25	84.00	
50	86.63	70.00	175.00	115.50	266.00	186.38	
60	246.75	158.38	456.75	305.38	N/A	N/A	

Rates are monthly. 15- and 25-year policies are also available.

Lic. #0F22446

Protect Your Assets. Protect Your Family.

It's Easy!

CALL US TODAY FOR A QUOTE: **(888) 788-8855**

WEST COAST LIFE
INSURANCE COMPANY
Sample Ad

CHANGES

or else you'll have to pay a heavy fine if caught. They are very protective of their coral — and rightly so, as it's the most brilliantly colored coral that I've ever seen."

"Having not seen anything in the last *Latitude*, we want to report that **Mi Baru**, a large Mexican-owned motor-yacht, burned in a spectacular fire at Marina Palmira in La Paz on October 20," reports Robin Aitken Hardy of the San Pedro-based wood trawler, **The Cat's Meow**. "Although our boat was 150 feet away, the flames were so big that it became rather hot on our aft deck, and was purrrty scary for quite a while. We monitored the huge fire carefully, and were prepared to take action if our boat was threatened. We're told that after the fire started, the crew was unable to put the flames out with their fire extinguishers. The burning boat was pushed/towed to a small dock next to the breakwater to get her away from all the other boats. Unfortunately, this put her right next to **Sunbreak**, a sailboat with a non-functioning engine that had a woman, her two children, a dog, a cat and a turtle aboard.



THE CAT'S MEOW

'Mi Baru' burned like crazy, but thanks to the efforts of all the firemen and others, no other boats were damaged.

Fortunately, a young Mexican man with a dinghy took a man off the burning boat, then assisted Marina Palmira workers and their panga in towing *Sunbreak* to another dock. In less than 30 minutes,

every bit of fire-fighting equipment in La Paz, from all the fire trucks to the Pemex fire boat, were on hand battling the fire. And battle the fireman did, often putting themselves in harm's way. While *Mi Baru* was a lost cause, they did manage to contain the fire. After several hours, two pangas towed the still-burning boat out of the harbor — which was risky in itself. Left at the edge of the channel with the Pemex fireboat on standby, *Mi Baru* continued to burn for another day or two. Any boat fire is sad, but a big boat fire in a marina is very scary. I hope to never see another."

"We're on our way from Isla Providencia, Colombia, to Guatemala's Rio Ducle — with a few stops in between — reports Jerry Blakeslee, formerly of the East Bay, but more recently of St. Martin in the West Indies. "Our next stop with my NAB 38 **Islomania** will be Roatan, Honduras, where hopefully there will be an internet that's not quite so slow as the one that I'm using now. We had a decent sail from Bocas del Toro, Panama, where we spent the hurricane season, to Isla San



Society of Accredited Marine Surveyors®

Serving Northern California

Al Blair, SA

415.456.3154

blairsurvey@msn.com

Jesse Brody, SA

415.342.0757

jesse@baymarinesurvey.com

Alan Huguenot, AMS®

415.531.6172

huguenot@comcast.net

Tom List, AMS®

415.332.5478

listmarine@yahoo.com

Jack Mackinnon,

AMS®/SMS

510.276.4351

surveyjack@aol.com

Francoise Ramsay, SA

415.497.7409

framsay@comcast.net

Randell Sharpe, AMS®

877.337.0706

rsharpe@alamedanet.net

Terry Tucker, SA

510.381.1925

ttucker100@sbcglobal.net

Terry Tupper, SA

415.722.7695

bluwater@juno.com

Rick Whiting, SA

415.740.2924

captain_rick@sbcglobal.net

R.J. Whitfield & Assoc, AMS®

800.344.1838

rjwsurvey.com

Andreas, Colombia — except for a couple of medium squalls. Then it was a long and slow 55 miles to Providencia. The problem was that we had light northeast winds on the nose, and *Islomania's* not at her best in that stuff."

"After four great seasons in Mexico, it's time to broaden our horizons a bit," report Chris and Heather Stockard of the Juneau-based Saga 43 **Legacy**. "Our current plans call for us to be in Huatulco for New Year's, spend the spring in Central America, and get the boat to Ecuador for summer. Heather will be researching food for a Central America version of her recently published *Cruising Cook's Guide to Mexico*, while Chris will be sampling Heather's creations and doing dishes. Ira and Minnow, our Portuguese water dogs, will be on guard."

"We've just arrived in New Zealand after our third Puddle Jump," reports Bob Bechler of the Portland-based Gulfstar 44 ketch **Sisiutl**. "But this is the furthest west that I've gone, as the other two ended in Hawaii. I haven't been here long, but so far I love New Zealand! As soon

as we sailed into the Bay of Islands, I was reminded of the Pacific Northwest — rain included! We're now in Opuia and hoping to see more of the country."

"I just finished delivering Chris Maher's Alameda-based Beneteau First 42 **Blarney 4** from the new Puerto Los Cabos Marina at San Jose del Cabo to San Diego," reports Wayne Maretsky. "We made it in just 5 days and 18 hours, having only stopped for 55 minutes in Turtle Bay for fuel, during which time we didn't even anchor. Thanks to VHF contact with **Welcome Passage**, another northbound Ha-Ha boat, we had arranged for 70 gallons of diesel to be ready for us. We paid just \$2.40/gallon, and, for the first time ever, felt as though



Not wanting to waste good weather, Maretsky didn't even take the time to anchor when taking on fuel at Turtle Bay.

each gallon was indeed a gallon. We had consistently light northwest winds for the delivery. We did manage to motorsail a bit, but mostly just motored on the rhumbline. The highest true winds we saw were 14 knots for a few hours just south of Mag Bay, while the more typical conditions were 5 to 8 knots, allowing us to average a hair under 5.5 knots."

When it comes to doing a Baja Bash, you can't hope for much better condi-

Your Boatyard in the Heart of Paradise



Large, fenced, secure dry storage area

Tahiti Customs policy has changed!
Foreign Flag vessels can stay on dry storage in our yard for up to 12 months out of 24.

Our Services |

HAULOUT

- Marine Travelift 25 tons
- Marine railway 120 tons
- Storage in adjustable steel cradles
- Fenced Yard

PAINTING

- Topsides, hull, bottom, varnish
- Brush, roller, spray

MECHANICAL WORK

- Inboard, outboard, diesel, gas
- All brands

REPAIRS

- Electrical repairs
- Refrigeration installation & repair
- Fiberglass & woodwork
- Welding, steel, stainless, aluminum

SAIL LOFT

- Sail repairs, biminis, dodgers, covers

STORE

- International, Pettit, Epiglass, Devoe
- Spares
- Fill U.S. gas cylinders

DO-IT-YOURSELFERS WELCOME!

BoatUS Cooperating Marina



Professional boatyard in the heart of Paradise



A Subsidiary of
The Moorings Yacht Charter, Ltd.

Raiatea Carenage will make sure paradise is everything you expected. Call, write, or sail in . . . we're here to serve you.

B.P. 1111 Uturoa Raiatea 98 735 Polynésie Française

Tel: (689) 600-545 ~ Fax: (689) 600-546 ~ VHF 68

Web site: <http://www.raiatea.com/carenage> ~ email: raiataecarenage@mail.pf

CHANGES

tions than that.

Is it easier to get from the East Coast of the United States to the tropics, as in the **Caribbean 1500**, or from the West Coast to the tropics, as in the **Baja Ha-Ha**? Just ask Ci Ci Saylor, the popular summer shoreboat driver at Two Harbors, Catalina. As crew aboard Jeff Edwards' Brewer 52 **Night Heron**, one of 70 boats in the 1500, they had three lovely days of sailing in the first week of November to start the event. On the fourth day, they got pummeled by 35-ft winds, gusting to 40, with 15-ft seas. Then, in the middle of the night, of course, they were hit by a 50-knot gust that shredded their reefed genoa, and a huge wave that smacked the hull so hard that the boat's big genset was ripped right off its mounts and slammed into the Cummins diesel. Although that was just the beginning of their many troubles, they eventually did make it to the finish in the British Virgins, although in their crippled state they averaged less than 100 miles a day. We'll have a more detailed report in the next issue, but can tell you that, having done the trip, Ci Ci



NIGHT HERON

'Night Heron' had to make most of the trip from Virginia to the British Virgins with a stuck main-sail and a tattered genoa.

is no longer as afraid of heavy weather as she was. "Hand-steering in 50 knots of wind is still scary," she writes, "but after what I've been through, hand-steering in 40 knots is doable."

"I finally made it to Durban, South Africa, by way of Richard's Bay," reports Mike Harker, who is attempting an 11-month, mostly singlehanded circumnavigation aboard his Hunter Mariner 49 **Wanderlust 3**. "I'd tried to make it to Durban without stopping, but the headwinds and headseas were so strong on the nose that I had to take shelter 80 miles to the north. After waiting two days for the weather to improve, I covered the 80 miles in just eight hours. I was only sailing through the water at 8.5 knots, but I had another 3.5 knots of current to help, so I was doing 12 to 12.5 knots over the bottom for eight hours! When I got to Durban, I found myself in port with all the boats in the English-based Clipper Race, so there's been a lot of excitement. Unfortunately, delays have put me behind schedule so that I won't be able to ring in New Year's Eve in St. Barth, but I'll try to get there as soon as possible."

While crossing the Indian Ocean, Mike got some bad news — the cabin he calls home at Lake Arrowhead was one

in Southern California...



*A First Class Full Service Facility Serving the Entire Pacific Coast
150 Ton & 30 Ton Travelifts*

VENTURA HARBOR BOATYARD

**Open 6 Days a Week!
Competitive Rates ~ Professional Staff**

*For quality and attention to detail you can count
on our commitment to your satisfaction.*

(805) 654-1433

**1415 Spinnaker Drive, Ventura, CA 93001
www.vhby.com**

marina real

San carlos, sonora, mexico

IN THE SEA OF CORTEZ

Located on the Mexican mainland near
Guaymas and San Carlos, 265 miles south of
Nogales, Arizona.

- 350 slip marina • 20 & 30 amps electrical service
- 24-hour security patrol
- Fuel dock with gasoline/diesel
- Restrooms & showers
- Web email • Fax/copy service
- Port entry clearance
- Book exchange • Video loan library
- Ice & bottled water
- Wet storage for summer months (low prices)

**Now Offering:
Haulouts, Dry Storage & Service Yard**



Phone/fax 011-52-622-2270011
Call on VHF #16 when in area
email: marinareal@prodigy.net.mx

Visit our website:
www.marinareal.bravehost.com

of the many structures consumed by the Southern California wildfires in late October. What's worse, the 1948 Indian Chief classic motorcycle he was restoring at the cabin has vanished.

Max De Rham, a Swiss with a home in Maui, is another who is going to have to delay his trip from South Africa to the Caribbean. De Rham had gone to South Africa for the launch of his new Gunboat 66 cat **Kanaloa**, and expected to set sail for Antigua via Fernando de Naranja on November 19. Alas, there was so much more that needed to be done to the boat that the start of the passage has been delayed until at least February 1. A boat not being completed on time — imagine that!

Headed for **La Paz**? Make sure you check out the new buoys and route into the bay, as otherwise it could be confusing and/or dangerous. Google 'Baja Insider', then once on that site, visit 'La Paz Navigation'. There is an excellent graphic to explain the situation.

"We said our final goodbyes on November 8 to **Annapurna**, the Hans Christian



LECTRONIC/RICHARD

If you're cruising this winter, we'd love to hear from you — and get some compositionally interesting hi-res photos such as this one.

48 that had been our home for the last 13 years," report Buddy and Ruth Ellison, the Sausalito couple who did an 11.6-year circumnavigation starting with the '96 Ha-Ha. "Having 'swallowed

the anchor', we sold her to a nice young couple from Hawaii, who hopefully will take good care of her while having great sailing adventures. We're now living in a turnkey house in Oceanside that requires little or no maintenance. So yes, we've become **CLODS** — Cruisers Living On Dirt. Although there's not much of the world we haven't seen, we still plan to travel and explore, but our circumnavigation will be a tough act to follow, what with all the fantastic people from all walks of life that we met."

"After six years of cruising Mexico, Central America, Panama, South America, the Galapagos Islands, Marquesas, Tuamotus, Tonga, Fiji, New Zealand, Vanuatu, Australia, and Thailand, we sold **Crusader**, our Santa Barbara-based Kelley Peterson 44," report Dick and Pat Wotruba. We completed our trip around the world by air in time to return to Santa Barbara for the holidays with our family and grandchildren."

Out **cruising this winter**? How about sending us an email with a couple of high resolution photos? Send your stories and pictures to richard@latitude38.com.

OPEQUIMAR

MARINE CENTER ~ CENTRO MARINO

**88-ton (max)
Travelift!**
Length to 100'
Width to 23'

Puerto Vallarta, Jalisco, Mexico
Paseo de la Marina Sur #214 • Marina Vallarta, 48354
Tel: 011 52 (322) 221 1800 Fax: 011 52 (322) 221 1978
email: info@opequimar.com

Visit Our
Yacht Club!

Opequimar Yacht Club

First Class • Full Service
On site dining, Internet, socials

BOAT SALES
NEW & USED BROKERAGE
www.opequimar.com

West Marine

We make boating more fun!

SIMRAD

A KONGSBERG Company

PETTIT

marine paint

Come to Mexico,
Enjoy the Mexican Riviera,
Repair your boat at
OPEQUIMAR

Please read before submitting ad

Classy CLASSIFIEDS

- 1. Write your ad.** Describe what you're selling. Indicate category. Don't forget price and contact info. Be neat. We aren't responsible for errors due to illegible writing or unclear meaning. We make final placement determination.
- 2. Count the words.** Anything with a space before and after counts as one word (eg, phone number, email address, price). We'll spell-check, edit and abbreviate, as necessary.
- 3. Mail your ad.** Enclose check or money order, or deliver to our office with cash, or ...

Post your ad safely online with Visa, MasterCard or AmEx at: www.latitude38.com

Personal Ads

1-40 Words: \$40
 41-80 Words: \$65
 81-120 Words: \$90
 Photo: B&W \$20
 Photo: Color \$30
 • Personal Advertising Only •
 No Business/promotional ads except Non-Profit, Job/Biz Op.

Business Ads

\$70 for 40 Words Max
 All promotional advertising
 1 boat per broker per issue
 Camera-ready art OK
 No photos/reversals
 No Extra Bold type
 Not to exceed 12 pt font
 Artwork subject to editor approval.

'Trying to Locate' Ads

Searching for People: \$10 for 20 Words Max
 All ads will be set to fit Latitude 38 standard.
 Re-Run Ads: Same price, Same deadline.

Mail (or bring) to: **Latitude 38**
 Attn: Classified Dept
 15 Locust Ave, Mill Valley, CA 94941
 Questions?: (415) 383-8200, ext 104 • class@latitude38.com

DEADLINE

is always the

18th at 5 pm

of the month prior to publication. Due to our short lead time, deadlines are *very strict* and include weekends & holidays.

- No ads without payments
- No billing arrangements
- No ads accepted by phone or fax
- No verification of receipt
- We reserve the right to refuse poor quality photos or illegible ads.

DINGHIES, LIFERAFTS AND ROWBOATS

YUKON 12, ALASKAN-STYLE commercial-grade inflatable, excellent, hardwood floor, bags, wheels, \$950. Also, Avon rigid hull, good/fair condition, \$750. Trailer for inflatable or to 16', excellent, \$450. Chain, 5/16", 300', \$2/ft. Anchor, 30-lb USN Danforth, stamped "Berkeley 1942", dismantlable, \$175. (916) 777-5510.



24 FEET & UNDER

ETCHELLS 22, US392. Lots of sails, crinkly spinnakers, good running/standing rigging. On heavy-duty tandem-wheeled trailer. Located Stockton Sailing Club, discount if new owner races in Club's 2008 Spring Series. \$3,000/obo. Phil Hendrix (209) 476-1381 or phil.hendrix@excite.com.

PACIFIC SEACRAFT FLICKA 20, 1978. Sturdy pocket cruiser, all lines aft. Beautiful blue hull. Five sails, tanbark. Outboard with remote control. Los Angeles area. Asking \$16,500. Email for pics and more info: bgeklund@gmail.com.

CAL T/4 QUARTER-TON, REDUCED \$500. Now \$2,150. Got a great deal and bought my 34, retirement boat. Somebody (you?) gets a great deal on this one. Jensen Marine 1972, 24' x 8' x 4', 2 mains, 3 jibs, spinnaker. Oldie but goodie. (530) 828-9854.

ETCHELLS, 1974. Good condition, large sail inventory, gin pole. One-of-a-kind road trailer, launch from ramp or unbolt tongue and keel guides, use as yard dolly, with disk brakes, new tires. Needs bottom paint. \$6,995. (559) 645-0559 or t_b_systems@yahoo.com.



10-FT LIGHTWEIGHT WHITEHALL- type rowing boat or traditional and space-age materials in first class condition including oars. \$970. (415) 332-0635.

9-FT APEX RIB, 2004 only used. 8-hp Nissan ob with hose. Oars and oarlock. Salito Yacht Harbor. \$1,200. www.latitude38.com or (415) 461-1111 (5 pm).



25 TO 28 FEET

PEARSON COMMANDER, 1965. LOA 25.8', draft 3.8', displacement 5,000#, ballast 3,000#. Full keel bullproof classic, well maintained. Fresh paint/varnish inside and topsides. 6-hp ob, propane, cold water, Porta-Potti, depth, compass, VHF, new sails 2003. \$4,700/obo. (510) 232-5869.

WANTED: CAL 28 HULL. Must be physically sound, suitable for racing. Santa Barbara. jasrudy@verizon.net or (805) 939-1857.



CORONADO 27, \$6,000/OBO. Richmond Yacht Club. Sails in good condition, 1 main, 2 jibs, 2 Barient winches. Signet wind instruments. 9.9 Honda 2003, hardly used. Sink, stove and head with holding tank. Call (707) 253-2324 or email: hill3252@earthlink.net.

ALBIN VEGA 27. Adapted for ocean voyaging. Fully found, provisioned and ocean tested. All systems new. Presently in San Diego. More details available on Craigslist in San Francisco Bay Area, listed under Boats. \$22,500. Call Larry Bryant (415) 259-7100.

MERRY CHRISTMAS. Quality-built Du-four 27, reduced to \$8,500. Solid coastal/Bay cruiser. Very clean, well appointed, standing headroom, galley, enclosed head, freshwater-cooled Volvo diesel, full sail inventory, VHF. Lying Coyote Point. Call Dick (408) 358-0384.



COLUMBIA 28, 1971. Plastic classic. Proven Creaklock design, fast, safe, and bulletproof. North sails, Navico autopilot, new Plastimo compass, and knotmeter. Strong and reliable rebuilt 22-hp engine, nice layout. Asking \$8,200/obo. In Alameda. Call (510) 754-0455.

LANCER 28, 1981. Nice, clean, dry Bay boat. \$4,800. Sleeps 4. Porta-Potti, 2-burner alcohol stove, 9.9 Honda outboard, anchor and rode, jib and main. Sailed mostly in fresh water. Berthed in Alameda. Call for more info. (559) 260-6671.

PEARSON TRITON 28.5, 1962. A gem. 1st place Classic winner So-Bay OP-Day, 2006. 18-hp Yanmar, freshwater cooled. 7 sails including spinnaker. Barians, autopilot, standing headroom. Haulout 4/05. Located Redwood City, CA. (650) 327-0190. Will email photos: cdroth2@sbcglobal.net. Asking \$12,000. Certified check only.



NOR-CAL COMPASS ADJUSTING

Magneuto™ System Exclusively
 Boat Remains in Berth • Eliminates Deviation
 Authorized Compass Repair • All Major Brands
 Hal McCormack • Phone/Fax: (415) 892-7177

WOODRUM MARINE

Specializing in custom interior cabinetry, tables, cabinets, countertops, cabinsoles. For power or sail.

CARPENTRY
 Mobile cabinet shop
 Contact Lon Woodrum at:
415-420-5970
www.woodrummarine.com

BOAT • LETTERING

alphaboatsue@aol.com • (510) 599-1197 • www.alphaboatgraphics.com

Creative and durable lettering and artwork for your boat

MERCY IS FOR SALE. This wooden 28-ft gaff tops'l cutter is a two-time Master Mariners champion. Fife design, built by legend Dean Stephens. New Hogin main and staysail. Sutter jib that has never been set. Volvo inboard diesel has just had a \$1,500 service by Bay Marine and runs as new. Lots of ground tackle. \$2,500. (310) 721-2101. The boat needs some work but is fundamentally sound. For pictures see: <www.havealittlemercy.com>

BALBOA 26, 1974. Good condition, good bottom paint, nice sail inventory with spinnaker and mast stepping system. Lots of extras including ob motor, excellent tandem trailer with brakes, new tires, wheels and tongue-actuator. \$5,995. Call (559) 645-0559 or t_b_systems@yahoo.com.

PEARSON ARIEL 25.7, 1964. New bottom paint, rigging and knotmeter. 5-hp Mercury ob, all lines led aft. Perfect boat for couple seeking fun. Berthed in South Beach, SF. Asking \$4,995. Call Scott (415) 865-0323 or scottwall@earthlink.net.

29 TO 31 FEET

30-FT ONE DESIGN BIRD. Excellent condition. Recent Season Champion, 1998-2004, plus Master Mariner Champ. Must see to appreciate. Nothing sails like a bird. \$15,000. (415) 302-7490.

OLSON 30. Clean. 2006 Ballenger single-spreader rig, main and 95% jib. 2005 double-axle trailer, extended cockpit. Nissan outboard. Not raced in San Francisco. Fun boat to sail. Dry stored, Alameda Marina. \$16,500. Call Frank (321) 662-4340.

ERICSON 29, 1973. Ready to sail: New sails 2004, great running Atomic 4, overhaul plus new exhaust 2005. Very clean interior. Berkeley slip available. Low tech. Price \$9,000. Call (510) 289-0355 or jdeboersf@yahoo.com.



NONSUCH 30, 1982 CLASSIC. Hard dodger, autopilot, anchor windlass, all chain rode. 4-cyl Westerbeke with V-drive, 2,000 hours. Force 10 propane cabin heater, Paloma demand water heater. New aluminum propane tanks with crossover. Electric main halyard windlass. Propane stove with oven. New Sunbrella cabin cushions, vinyl cockpit cushions, interior refinished. Lee cloths, all berths and jacklines, new sail cover. Located Richmond, CA. \$49,000. (925) 934-1580 or dwheweler9458@hotmail.com.

PACIFIC SEACRAFT MARIAH 31, 1979. Factory-finished liveaboard cruiser, double Pullman berth, no sleeping in the forepeak. Major refit in 2000, extremely well found, lovingly maintained. Lying Mazatlan. \$65,000/obo. For specs and photos email: jhallorion@netzero.net.

NEWPORT 30, 1985. New mainsail, wheel steering, Universal diesel, Harken furling, new upholstery. Solid bay boat. Needs some TLC. \$14,000. Stephen (775) 782-2584.

30-FT ONE DESIGN BIRD. Restored. Active YRA class. \$30,000. Call (415) 302-7490.

RAWSON 30, 1981. Unbelievable deal. We equipped her, sailed down to Mexico, and now we must sell. She is a spacious, strongly built, bluewater cruiser with GPS, watermaker, fridge, Monitor windvane and much more. Sitting in LaPaz, waiting to go. We have a new baby or we'd still be sailing. Paid \$40,000. Sell for \$20,000/firm. Call Jay (604) 617-1436.

32 TO 35 FEET

1974 ERICSON 32 with good bones. Project boat, needs bottom and hatch repairs, engine, sails, interior refinishing. \$6,000. (909) 981-7217.



EXPRESS 34. *Locomotion* is seriously for sale. Your chance to own one of Carl's best designs. Successful Puget Sound race record. Many upgrades prior to 2006 Pacific Cup. New rod, sails, charging system. Spec sheet available. Asking \$73,500. Call (425) 765-2456 or ebmorgan50@yahoo.com.

1965 CHEOY LEE LION. Fiberglass-hulled sloop/cutter. Roller furling, serviceable main, dodger and full covers. Propane stove and H2O heater. Yanmar diesel with 500 hours. Too much to list. \$35,000/obo. Call or email for more details. (707) 688-2314 or webmaster@deltamarina.com.

ERICSON 35 Mk II, 1980. I'm a two-boat owner and this one needs to go. She's got just about everything on her. Engine has 780 original hours. New upholstery. Sails are in great shape, new roller furling, wheel steering, etc. Sails great and is set up for the Bay and offshore work. \$29,500. (916) 997-4541.

PEARSON 35 CB. Pearson quality. Wheel, roller furling jib, hot and cold water, stove, oven. Westerbeke 30 hp, 900 hours. Great Bay, Delta, coastal boat, shoal draft with centerboard. Sleeps 6. New Raymarine autopilot and wind/depth. Raymarine GPS, VHF radio, stereo CD with great saloon and cockpit speakers. 2 anchors, extra sails and spinnaker. Ready to go. In Sausalito. Roomy cockpit with dodger. Just redone brightwork. \$34,800. Call Curt (415) 559-8883 (cell).



BENETEAU OCEANIS 350, 1991. 34 feet. Well equipped and in excellent condition. Raymarine radar/GPS/autopilot/plotter, windlass, SSB, VHF. New rigging 2006. 28-hp Volvo diesel. New maintenance-free batteries. 4 sails, full cockpit canvas. Beautiful custom interior, new oven, water filter, many extras. Berthed Richmond. \$64,500. Call (530) 272-7157 or email: mike8140@aol.com. Please write for photo description file.

CATALINA 320, 2006. Almost new. 53 hours on Yanmar engine, ultra-leather interior, dodger, cockpit cushions/table. 8" LCD RAY C80 chartplotter, RAY 60 wind/knot/depth/repeater. 2-kw radar, ICOM VHF, autopilot ST4000. 6' fin keel, Martec prop, many extras. \$130,000. (408) 353-3393.

VANDESTADT 34. Fast, safe steel multichine ocean cruiser, launched 1998. 12,000-lb displacement, fin keel, offshore equipped, Monitor windvane, radar, watermaker, liferaft, Volvo 28 hp, oversized rigging, teak/holly interior, custom hard dodger. Loaded. Email for spec sheet: vandestadt34@gmail.com.

WYLIE 34, 1980. Excellent condition. Presently rigged for singlehanding. Rebuilt standing rig by Easom Racing, New Quantum Fusion X sails with Strong Track and battens. New NX2 instruments, new Harken roller furler, new running rigging, new electric panel and new sail cover. 18-hp Yanmar runs great. Bought a bigger Wylie so this one must go. Make an offer, asking \$29,500. See full details plus pictures at <www.tillerduck.com> Call Rick (916) 207-1887.

ERICSON 35 Mk III. Rigged for blue water. VHF, SSB, radar, furler, 1.5kw inverter, refrigeration, new upholstery in and out. Cockpit enclosure. Solar panels and charger. Lots of extra gear. Very fast, comfortable, clean boat. \$45,000/obo. (209) 986-5906 or vwomanpaul@yahoo.com.

36 TO 39 FEET

CATALINA 36, 1985. Meticulously maintained. New dodger, sail cover, lifelines, davits, inflatable with 8 hp. Electric windlass, 200' hi-test chain, CQR, washdown pump. New mainsail, 100 jib, 140 genoa, spinnaker, whisker pole, upgraded rigging. Autopilot, Nexus wind data, radar, GPS, VHF, CD sound system. 40-amp TrueCharge, inverter, Link 10 monitor, Next Step regulator. Five 100ah gel batteries. Microwave, refrigeration, CNG range/oven. 22" LCD television, feathering prop. Much more included. \$58,000. (831) 661-0947.



HANS CHRISTIAN 38 Mk II. Bay, coastal, offshore cruiser. Equipped. Roller furling forestay/jib, extra sails. Chrysler Nissan diesel engine. GPS, radar, VHF, autohelm, depth sounder, knotmeter, helm. Liferaft, PFDs, safety equipped. Beautiful teak and holly interior. Perfect galley, shower/head. Comfortably sleeps 6-7. Full head room for 6'5" tall. Spare parts, tools, dinghy outboard. USCG C.O.D. Hauled, surveyed and bottom paint Aug. 2007. Sturdy, well built. Upwind berth Vallejo. Weekend fun or lifestyle change. \$98,000. (510) 206-2218 or Margaret.Reasoner@crowley.com.

ERICSON 38-200, 1988. Outstanding condition. New standing/running rigging, new autopilot, new instruments, new canvas. Bottom paint/wax 11/07. Beautiful all-teak interior in excellent condition. All replaced since new. Ready to go. \$78,000. (510) 864-3930.

ISLANDER 36, 1979. Must sell now. Price is set for very quick sell. Yanmar 3GM30, 2,000 hours. Sails and all other equipment in good working order. Many extras, cruising equipped. \$35,000. Call (408) 410-2167.



FAST PASSAGE 39. Legendary cruising yacht. Two-time Hawaii, three-time Mexico vet. New engine, prop, dinghy, dodger, gennaker. Much much more. \$140,000. For details, email: DRJY2K@aol.com.

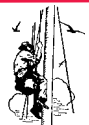

MARINE SURVEYS • Jan Van Sickle

Member: SAMS – AMS, ABYC & IAMI
Ultrasound Thickness Testing of Steel & Aluminum
jtv@s.post.harvard.edu • www.vintageyachts.org
(707) 939-9131 • No travel charge within Bay Area

CATALINA 32, 2004 • Purchased New Dec. 2005

Loaded • Like New • Only 16 Hours! • Sailing Instruments • Autopilot
Raytheon E-80 GPS/radar • Tabernacle Mast • Windlass • Refrigeration
\$119,000 • View Specs & Photos: <www.yachtworld.com/yachtsource>

Bob Sherman • YachtSource • (619) 847-1122

All-Marine Electronics & Electrical

◆ System Design ◆ Troubleshooting / Repair ◆ AC & DC ◆ Quality Installation ◆ Licensed & Insured ◆
◆ Radio & RADAR ◆ Antennas & Mastwork ◆ Integrated Navigation Systems ◆ Auto Pilots ◆
◆ Battery Monitoring Systems ◆ Alternators, Regulators ◆ Solar ◆

Alameda, CA -- (510) 523-6011

Marine Architecture

John Seward
105 Edison Ave.
Corte Madera, CA 94925
(415) 924-0429 • nims65@gmail.com

Brochure Available

Marine Construction

Millerick Bros. Coast Marine
PO Box 357, Cotati, CA 94931
(707) 829-2507
(707) 823-1954 (fax)

QUALITY SAILS FOR LESS!



**MAINSAILS
MIZZENS
STAYSAILS
HEADSAILS
CRUISING SPINNAKERS
MAINSAIL COVERS
ALL CUSTOM FIT**

(510) 769-4858 • leesailsnc@yahoo.com

2021 Alaska Packer Pl. • Grand Marina • Alameda, CA 94501

SAILMAKERS TO THE WORLD!

Monterey Bay Marine

at Santa Cruz Harbor

SeaSport • Scout Boats • Livingston

Pacific & EZ Loader Trailers

Yamaha • Honda • Volvo/Penta

www.montereybaymarine.com 831.479.4595



Enviro Lua
Environmentally friendly products

Nature's Head Composting Toilet



- No harsh chemicals
- Organic composting
- Only \$850 – includes hoses, brackets, fan
- No thru-hulls needed

(530) 383-4217

www.envirolua.com

Wm. E. Vaughan

Maritime Attorney, Arbitrator & Mediator

17 Embarcadero Cove, Oakland, CA 94606

Mail: PMB 232 909 Marina Village Pkwy, Alameda, CA 94501

(510) 532-1786 • Fax 532-3461

evstarmr@sbcglobal.net

Avoid Rocks, Shoals, 'Land Sharks' & Confiscatory Taxes

We have resolved marine insurance coverage, damage claims, warranty and lien disputes. Experienced in drafting and negotiating purchase/sale, charter, builder's contracts and dealing with the IRS, State and local tax agencies.

A life-long, Bay, coastal, Delta racer/cruiser as well as an Officer/Director and/or Counsel of Yacht Clubs and other maritime entities since 1954. Affiliate of the Society of Accredited Marine Surveyors (SAMS).

BENETEAU 36.7, 2002. One design/cruiser. \$135,000. Excellent condition. Raymarine electronics, Neil Pryde cruising sails, North 3DL racing sails. (310) 922-2111.



CATALINA 38, 1982. Freshwater only. New interior, diesel, 3 Head sails, spinnaker. \$48,000. (702) 257-6456.

IRWIN COMPETITION 37, 1973. Performance cruiser/racer. New dodger, autopilot, interior and exterior upholstery, depthsounder, speedlog and much more. Permanent slip in Moss Landing, CA. Equipped with 40-hp diesel, spinnaker, more. \$36,000. (831) 424-5062.



ALLIED PRINCESS 36 KETCH, 1972. Strong, hand-layered hull. For cruising: 60-lb plow, Danforth, 250-ft chain, electric windlass, roller furling, HD sails, Norseman rigging, depth, radar, EPIRB, VHF, stove, 12v fridge, wood stove, liferaft, 75w solar panel, epoxy bottom, 33-hp Westerbeke fresh rebuild, dinghy with outboard, extra equipment. Google 'Allied Boat Company'. Sell now \$36,000. La Paz, Mexico. 011-52 (612) 114-6140.

ISLANDER 36, 1977. Perkins 4-108, new rigging 2002, 2 self-tailing Harken 44s, 2 self-tailing Barlow 25s. Dodger, covers, holding tank, macerator, propane stove/oven, radar, chartplotter, VHF, bowroller, 2 anchors/chain and rode, carpets/curtains, Avon/ob. Alameda Marina #204. \$55,000/obo. Arnie (415) 999-6751 (cell) or (415) 383-9180 (hm) or email: arnoldgallegos@comcast.net.

ERICSON 39-B, 1976. Excellent live-aboard and cruising boat. Just back from Mexico/Hawaii. This very well maintained and equipped boat has too many features to list here. Go to: <www.queserasailing.com/ericson39b.htm> for details and photos. \$65,000. Greg (510) 701-4279.

PEARSON 365 KETCH, #164. One owner, 1977. Outstanding original condition. 1,500 hours Westerbeke 40, well maintained, MaxProp, pss, good sails, self tailing, ProFurl, older good electronics, davits. 150 gals of water, 50 of fuel. Clean. \$58,000. (415) 608-0757 (cell).

CAL 39, 1979. Excellent condition and loaded with new upgrades and extras, list available. Monitor windvane, dodger, bimini. Beautiful clean interior. Great engine and sails. Ready to cruise or sail the Bay. Sausalito slip possible. \$77,000. Call (415) 846-6919 or sailonbaby@gmail.com.



CATALINA 36, 1989. Lying in the beautiful Rio Dulce River, Guatemala. Fully equipped for cruising. Radar, watermaker, bimini and dodger, dinghy/outboard, GPS, auto. Lots more. Asking \$65,000. Email or call for details: (361) 695-5383 or perkins_wayne@yahoo.com.

ISLANDER 36, 1973. Fast, stable and fun. New mainsail, headliner, engine gauges, starter and upgraded lighting fixtures. Roller furled 140% headsail, self-tailing winches, Perkins 40 diesel, 6'8" headroom and shower. Ready to sail for only \$29,500. For details call (530) 582-8235.



ALDEN 38 CUTTER, 1952, #779B. Honduras mahogany on oak. Bronze fastened. Diesel. Modern electrical system. Classic custom woodwork inside and out with specific attention to detail. Very clean and complete. \$75,000. (805) 639-0836. Serious only please.

CATALINA 36, 1986. She'll be good to you. Below deck autopilot, radar, electric windlass with gypsy and capstan, 45# anchor with chain rode, refrigeration, propane oven/stove/BBQ, high-output alternator, two 8D and one Group 27 battery, inverter, more. \$55,000. (510) 219-9116.



MARINE SURVEYS by Captain Alan Hugenot Naval Architect • Yacht Delivery Skipper

Accredited Marine Surveyor (SAMS)

••• Bay or Delta • No Travel Charges •••

All major credit cards accepted • (415) 531-6172

MARINE ENGINE CO.

Complete Engine Services • Gas & Diesel
30 Years Experience • Reasonable Rates
Tune-Ups • Oil Changes • Engine Rebuilding, etc.

(415) 332-0455

VOLVO PENTA

Specialist Dealer Since 1980

ESKELUND MARINE • (510) 523-7670

1913 Clement Ave • Alameda Marina • Bldg 13 at Pier 2

ISLANDER 36, 1975. \$44,000. This boat has it all. 700 hours on a new Yanmar. Lots of sails and spinnakers for racing and cruising. New Maxprop, backstay adjuster, large wheel, mast step, lifelines, riggings and lots more. John (415) 602-8416.



ROBERTS PILOTHOUSE SLOOP motorsailer, 36'9". 4-year-old Harken roller furling, GPS, autopilot (needs wiring), Yanmar 24-hp diesel with low 1,460 hours. Tiller and inside wheel. Sound fiberglass hull. Full standing headroom. Needs cosmetics (paint, new door and window on pilothouse, bottom paint). Great live-aboard with TLC. Best offer over \$8,000. Call (650) 624-9500 or email: lffngcrow@netzero.net.



C&C 37, 1982. Bad Puddy Cat. Proven race winner. Full set of UK tape-drive sails. Four spinnakers. Full set of Raymarine instruments. Garmin chartplotter GPS, Raymarine S1G autopilot, radar, folding prop. Much, much more \$64,900. Call Charlie (650) 851-4160 or cwatt@woodsidentg.com.

BENETEAU FIRST 38, 1985. Great racer/cruiser/liveaboard. 3-cabin, 2-head layout. Completely retrofitted 2002-05. Integrated B&G electronics, autopilots and Furuno radar/plotter. Adler-Barbour fridge/freezer. Complete suit of sails includes spinnaker with sock. Rigged for shorthanding. \$78,000. Email: beneteaufirst38@gmail.com for more info.

40 TO 50 FEET

LANCER 44 PILOTHOUSE motorsailer, 1982. Capable, comfortable cruiser in outstanding condition. Twin Perkins 4-236 diesels. Extensively refit and equipped including new engines, rigging, plumbing, galley, interior, electronics and much more. Ready to go in Newport Beach. \$129,500. (949) 500-6567 or anadebal@yahoo.com.



HARDIN 44 KETCH • ESTATE SALE • MUST SELL

1979 World Cruiser • Fiberglass hull • Wood masts • 5 sails
Roller furling jib • Dinghy • 8-man liferaft • 3 Solar panels • Inverter
Lying La Paz • Complete specs: <www.yachtsus.com> • **Make offer**
Carl (619) 370-8000 • tracomm@tracomm.com

Specialists in Marine SSB
radio and HF E-Mail

ICOM Marine Radios, Furuno,
SCS/Pactor, McMurdo EPIRBs



HF RADIO ON BOARD

Communication is our Business!

www.hfradio.com
(510) 814-8888



BRAVURA WITH TRAILER, 1976. 49-ft aluminum German Frers design. Interior and exterior stripped. Ready to reassemble. Located Benicia, CA. \$30,000 (scrap value), offer. For additional info and photos: boatinfo@bohicabros.com.



BENETEAU 45f5, 1991. Pristine. Never chartered. Elegance, power of Bruce Farr hull lines combined with design beauty of Pininfarina in legendary First Series. Racing around buoys or sailing across oceans, this is your boat. Three cabins, two heads, sloop tall rig, both Kevlar and Dacron sails, deep keel, B&G Network electronics, radar on stern tower, SSB, genset, watermaker, etc. Fully equipped to cruise or race. Located in Santa Barbara. Possible use of 50-ft slip. \$179,000. (805) 692-8856.

BENETEAU 423, 2005. 3-cabin series. *Meredith*. Great multi-family boat, wonderful to sail. All 2005 Boatshow specials, all electronic systems offered. Berthed San Diego, can deliver to Bay Area after sale. Priced at \$204,000. Call (435) 830-4967 or email: JFMConnell@gmail.com.



50-FT DEL REY IN PANAMA. Center cockpit, bimini, roller furling, fiberglass deck/hull, full-keel cruiser. Easy sail for couple. Spacious liveaboard, large aft cabin, big galley, mega storage. Radar, GPS, EPIRB, VHS, SSB, meters, compass. Great ground tackle, chain, windlass. Watermaker, inverter, solar panels, 6500 generator. Dinghy, 15-hp Suzuki outboard. New Cummins Turbo 135-hp engine, 2007. Lots more. Good condition. Photos: <www.usedboats.com> #1343752. Reduced to \$75,000, consider trade? Call (402) 614-1062 or email: emera4sale@hotmail.com.

PETERSON 44 CENTER COCKPIT cutter, 1977. Two staterooms, two heads. New Yanmar, LP, fuel tanks. Robertson autopilot, radar, dinghy, ob. \$119,000. San Carlos, Mexico. Call or email for complete list and photos. (520) 742-2727 or svubetcha@aol.com.



CATALINA 400, 2004. Yanmar engine, 56 horse, 135 hours. Bowthruster, electric winch, windlass, all two-speed winches, two staterooms, two heads, flat screen TV, stereo. Immaculate, absolutely beautiful, everything like new. Located Richmond, CA. \$218,995. (916) 774-1474 or rdsinor@yahoo.com.



48-FT STEEL PILOTHOUSE, 1994. Proven safe and comfortable circumnavigator built by Horizon Steel Yachts. Meticulously maintained, fully equipped, and ready to go around again. On the hard for the winter near Annapolis, MD. Visit <www.svgigolo.com> for full details. \$179,000.



1996 43-FT CENTER COCKPIT KETCH. Morning Star. Mauritius 43. All 4 sails roller furling. Fully equipped for cruising. Building of MS featured in *Lat38* article in 1996. Lying in La Paz, MX. <www.morningstar-rene.blogspot.com> for full details and pictures. \$160,000. Email: ReneDorieMS@cs.com.

FORMOSA 41 KETCH, 1976. 60-hp Isuzu diesel. Stainless fuel tank, aluminum mast. See last issue for more. Cruise ready. San Diego. Photos at <http://picasaweb.google.com/Gilbert.Mackin> \$53,000, gilbert.mackin@gmail.com or (619) 379-7871.

AMEL SHARKI 41, 1980. Center cockpit ketch. Rare chance to acquire a west coast Amel at 2/3rds the outlay of other Sharkis. In Oakland where she has been awaiting refit that is now beyond my time and resources. Fine bluewater vessel which has served me well in all conditions and circumstances. Galley has been augmented with island that doubles counter space and storage. Most of the systems need to be gone through and tuned/serviced or repaired. Recent survey details suggested service items. Some equipment: Simrad AP22 autopilot, water heater, Perkins 4-108, composting head, watermaker. Items that can be negotiated in addition: Windpilot vane steering, Caribe dinghy with outboard, Winslow 6-person liferaft, 6kw Northern Lights generator. See: <http://homepage.mac.com/northp/sharki/sharki.html> \$95,000/firm. (510) 703-8069.

51 FEET & OVER

HARTOG 55 FULL-KEEL SLOOP. Ferro-cement hull recently restored. New keel, quadrant, prop, autopilot, anchors. Lehman 120-hp diesel, low hours but needs work. Otherwise cruise ready. Ideal for Baja. Baby forces sale. \$1,000/obo. will@etfzone.com.



BILL GARDEN-DESIGNED 51-FT ketch, 1977. Totally upgraded for serious cruising. Excellent condition. Must see to appreciate. Slip L132, Berkeley. \$119,000/ obo or will consider trade for 24 to 28-ft powerboat plus cash. Please call (775) 588-5262.



HUNTER 54, 1983. Cruise equipped, EPIRB, raft, dinghy with outboard, windlass, furling jib, watermaker, fridge/freezer, radar, VHF/RAM, SSB. 2006 survey. Much more. Located La Paz, BCS, Mexico. \$105,000. Ron Rowley (801) 870-7110 or fax (801) 924-3400 or email: ronrowley@earthlink.net.

Online and home study
courses in all areas of
marine navigation
and weather

★ ★ ★ ★
STARPATH
School of Navigation

More than 25,000
students since 1977

(800) 955-8328 • **www.starpath.com**

COMPLETE MARINE WOODWORK

Design / Restoration • Expert European Craftsmanship • Interior / Exterior
Repairs / Maintenance • Marine Windows & Frame Replacement
Wood & Dry Rot Repairs • Varnish Work • Marine Painting
References Available • Reasonable Rates • Call (415) 331-6718

ATLANTIC 57 CATAMARAN™



THE ORIGINAL PILOTHOUSE CATAMARAN
 o Designed for easy shorthanded cruising
 o Spectacular windward performance
 o Cored epoxy/glass/carbon construction
CHRIS WHITE DESIGNS
TEL: 508-636-6111
www.chriswhitedesigns.com

Save Your Aft!

Using one of our 1400+ patterns or your own pattern, let our craftsmen create a comfortable, durable, and stylish set of all-weather cushions for your cockpit. Find your custom, closed cell foam cushions at www.bottomsiders.com!

BottomSiders

BottomSiders

2305 Bay Avenue
 Hoquiam, WA 98550

Call Toll Free: (800) 438-0633

Email: cushions@bottomsiders.com

Fax: 360-533-4474

IRON BEAR MARINE CANVAS

Sail Covers ~ Mooring Covers

Bimini Tops ~ Enclosures

Serving Alameda and the East Bay

Custom Fabrication ~ Repair ~ Replication



Call to arrange a quote:

(510) 435-3754

or email:

ironbear_@mac.com

Robert Shashinda, owner

**MARINE
 ENGINE CO.**

PERKINS • YANMAR • ATOMIC 4 • VOLVO
 WESTERBEKE • UNIVERSAL • BETA MARINE

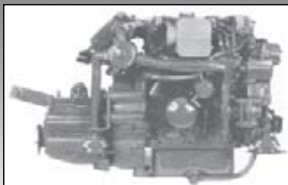

CALL NOW FOR LOW ENGINE QUOTES

- Engine Repowering and Rebuilding
- Engine Sales, Service and Parts
- Complete Marine Engine Service

(415) 332-0455

CLASSICS

1958 JEFFRIES, RESTORED. Current USCG cert. for 49 pass. 45' L, 15' W. Major refit April 2007. GM 6-cyl engine, 509 trans, new wood. Glass over wood. Very unique vessel, includes Furuno radar, 2 VHFS, bow thruster, new 2006. All work done at KKMI. Very well maintained. This is a great Bay boat, turnkey with websites. CA. liq. lic. \$240,000. Must see to appreciate it. (415) 859-7050.

RHODES DOGSTAR, 1984. Beautiful double-ended cutter. LOD-31', LOA-37', bronze fastened, fir on oak, Honduran mahogany house, teak decks, 21-hp Westerbeke, custom bronze hardware. Maintained to a high standard. \$65,000. More details and photos by email: 676687@gmail.com.

MULTIHULLS

OUTRAGEOUS, 1982 31-FT VENTED- wing Searunner tri. 15 hp ob, Autohelm, needs haulout. Located Dock 3, Brisbane Marina, minutes from downtown SF. \$3,500. 45-ft taped mast with one spreader, \$1,100. 16-ft Hobie cat and trailer, \$900. Old Town canoe, \$600. Serious only call 9am to 5 pm only: (650) 207-4044.

1988 CORSAIR F-27. New trailer and full cover. Two mains, two genoas, and two spinnakers. VHF, Loran and handheld GPS. Dry stored in Morro Bay. \$45,000. Call (805) 773-1110 or email: davidprewett@aol.com.



GEMINI 3000, 1987. A proven design and the best-selling cruising catamaran in the U.S. It has the best combination of features and performance: Spacious interior, expansive deck and cockpit, level sailing, fast, and fits in a 35-ft berth. This boat has been owned by the same family since new and continually upgraded. Brand new stainless dinghy davit, stern seat and boarding platform. Autopilot, Garmin 172C, ICOM VHF, stereo, H/C water, 4-stroke Mercury. \$47,000. Email: lmurphy@cox.net or (619) 892-5003.

POWER & HOUSEBOATS

SACRIFICE 60-FT WORK BOAT. Large cabin, 8v71 main, 25kw gen, 2-inch heavily built wood hull, runs. Delivery possible. Good liveaboard, party, cruise. Needs haulout plus cosmetics. No tire kickers or time wasters. \$25,000. Email: juntos94865@mypacks.net.



28-FT ALBIN TOURNAMENT Express 2003, delivered 2004. 315-hp Yanmar turbo diesel, low hours. Full electronics. VacuFlush, bow thruster, windlass, diesel heater, radar, hot shower, autopilot, downrigger, refrigerator, microwave, closed pilothouse. Two-boat owner. A steal at \$127,700. (650) 329-1800 or roxanne28te@gmail.com.



30-FT WILLARD VEGA SEARCHER. Excellent little ship for 2, good for 4. Super condition in/out. All systems in excellent condition. Full electronics. All safety gear, full head, 100 gals fuel, 100 gals water. See to appreciate. \$46,000. Call (650) 207-6898 or (650) 851-3402.



CHRIS CRAFT 28 CATALINA EXPRESS cruiser, 1977. Great family boat. Sleeps 6, VHF, depth, windlass, 6'5" headroom, repowered with 80+ hours. Berthed at Vallejo Marina. Must sell. \$10,000 \$8,000/obo. (707) 486-9647.

GEAR UP TO CRUISE!

Custom Embroidered Boating Gear • Jackets • Shirts • Caps

EMBROIDERY FACTORY • Benicia, CA

(707) 746-7625 • www.embroideryfactory.com

PROFESSIONAL YACHT DELIVERIES

60 years of combined experience, 100,000 miles at sea. Rest assured that

Phil Howe (415) 290-1659 or Greg Snead (415) 846-6919

will get the job done in a safe, professional manner. Call for details.

WISE MARINE SERVICES

Refrigeration • Air Conditioning • Electrical • Engine Services

Experienced in both Power and Sail systems

Roger Wise • (510) 418-7550 • rdwisesr@gmail.com



32-FT CLASSIC MONTEREY. Totally restored Monterey fishing boat, converted to day boat, sportfisher or Bay cruiser. All woodwork has been done. New fuel tanks, hydraulic steering, tinted glass, etc. GMC 2-71 diesel engine. Needs to be finished, such as controls, wiring, exhaust and finishing touches. Must be seen to be appreciated. \$45,000, will consider any reasonable offer. Pics/details: (707) 964-5423 or ancona@mcn.org.



65-FT WOOD CLASSIC, 1939. Heavy built ex-trawler. GMC 12V-71, 21-kw generator. Full electronics. Lots of equipment. Ready to go. Would make great conversion. More pics/details: ancona@mcn.org. Asking \$112,000 or any reasonable offer. Call (707) 964-5423.

TRADE OR SALE OR DONATE: 1974 68-ft x 20-ft working steel trawler/office/home. 1,200 sq.ft. of space. Legal live-aboard. Trade value: 45 to 70-ft sailboat or cash or terms. Be creative. Berkeley slip. See: www.myclassicboats.com Email: GaryKJennings@msn.com or call (510) 665-7716.

PARTNERSHIPS

RANGER 33, 1977. Excellent condition. Sausalito berth. Full electronics, autopilot, furling main and jib, new transmission, dinghy with outboard. Solar panel above dodger. Beautifully finished new interior. 1/3 shared equity. \$8,000. (707) 773-1139 or email: pchristiano@comcast.net.



TIBURON ~ BOATER'S DREAM

Fabulous remodeled 3 br, 3 ba home with 110-ft deep water dock, Bay and bridge views, pool, sauna, and huge decks! This charmer is a must-see! • \$2,795,000 • www.16saintlucia.com

R/E Source • Marcia Sullivan • (415) 819-5852

Charts, Cruising Guides, Software, Nav Tools, Flags, and More!

Electronic Navigation Specialists
OceanGrafix Charts-on-Demand



WAYPOINT
LAT: 37° 46.61' N. LONG: 122° 15.61' W
www.waypoints.com
(510) 769-1547

SMALL AD, SMALL PRICES • RIGGING ONLY

Standing and running rigging, life lines, furling gear, winches, line, windlasses, travelers, wire and terminals, blocks, vang, etc. Problem solving is our specialty.

We are a rigging shop specializing in discount mail order. Free catalog.

www.riggingonly.com • (508) 992-0434 • email: sail@riggingonly.com

1/4 PARTNERSHIP EQUITY SHARE, \$5,000. Monthly fees \$184. Slip in Sausalito. Best sailing boat for Bay. Dependable, economical to operate. Needs some interior cosmetic upgrading of cushions. Sleeps 7. Manual head. Volvo Penta 2-cyl diesel. AJ (415) 378-7817.

BENETEAU 350, 1989. 34-ft sloop berthed in Sausalito. Two cabins, one head, can sleep six. Full galley, spinnaker, folding prop. Fun boat, great Bay sailer. 1/4 non-equity share available. \$350/mo plus deposit. Call Dave (415) 302-7084.



DOWNEASTER-STYLE BASS BOAT. Fortier 26, 2004. Classiest fishing/picnic boat in Santa Cruz Harbor and Monterey Bay. Semi-displacement, powered by Yanmar 260, radar, fishfinder, GPS, etc. Cared for as part of our proud family and want to keep her that way. 10-ft beam provides very stable fishing platform and plenty of room for recreational cruising. Seeking a partner, please. Call (650) 926-9797 or (650) 400-1041.

CATALINA 380, 2001. Berthed at Sausalito Yacht Harbor. Full electronics, chartplotter, autopilot, and radar. Furling main and jib, cruising chute, Yanmar 40 with low hours, new dodger, electric windlass. Equipped for sailing and cruising: 2 cabins, centerline berths, innerspring mattresses, refrigerator, microwave, flat screen HDTV/DVD, electric head, and separate shower. Includes dinghy and outboard. Beautifully finished interior in ultra-leather and Corian. Equity or non-equity shares available, as low as \$300/month, depending on usage. Call (707) 421-0366 or csmsam@aol.com.

TO SHARE: 1969 SANTANA 22 at South Beach. Fully race ready and/or cruisable. Owner out of town too much to compete. \$1,000 for half interest, plus share expenses. Or try 2008 season for \$300/month. Email: PrincessSAT@aol.com.

1/3 INTEREST IN CAL 29 SLOOP at Treasure Island Marina, \$2,500. Very sound, fully equipped boat, great for sailing the Bay, Delta and out the Gate. Gordon (510) 526-5713.



SOUTH OF THE BORDER

RAWSON 30, 1981. Unbelievable deal. We equipped her, sailed down to Mexico, and now we must sell. She is a spacious, strongly built, bluewater cruiser with GPS, watermaker, fridge, Monitor windvane and much more. Sitting in LaPaz, waiting to go. We have a new baby or we'd still be sailing. Paid \$40,000. Sell for \$20,000/firm. Call Jay (604) 617-1436.

MEXICOLDER. Your answer to frosty drinks in Mazatlan and tropical hideaways. Super efficient fridge freezers, lower than U.S. prices. 100% cruiser satisfaction. Visit www.mexicolder.com for helpful advice. Celebrating 30 years of those wonderful tinkling ice cubes. Email: sales@mexicolder.com.

MARINA RESIDENCE: Condo for rent overlooking Paradise Village Marina located on Banderas Bay near Puerto Vallarta. 1 bedroom, 1 bath. Marina view, watch the boats from your patio. Many amenities. For resort information and location call (916) 367-6292 or email: HNDJohn@starstream.net.

LEARN TO SAIL in the Sea of Cortez. San Carlos Sailing School, an ASA school based in San Carlos, Sonora. Specializing in learn-to-sail cruises, vacations. Also offer boat rentals, day trips. See: <http://mexicosailing.com> or please call (800) 874-4830.

CONDO RENTALS NEAR VALLARTA yacht club. Two adjacent condos overlooking Paradise Village Marina. Each 2 br, 2 bath with Jacuzzi, pool and amenities. Access to Sports & Beach Club. Rent one or both. Call (925) 208-1601 or 011-52 (322) 297-7559 or nancywmoore1@aol.com.

ERICSON 38, 1980. \$59,900. Excellent condition, very well maintained. Comfortable cruising boat, perfect for light air conditions in Sea of Cortez. Boat located in LaPaz. Please email us for photos, specs and copy of recent survey: mexicantango@hotmail.com.

BRISTOL 35, 1970. Offshore equipped. 4-person liferaft 2005, EPIRB 2005, newer Yanmar 27 hp, sea anchor, Fleming windvane. 2005 Hasse trysail, storm jib. 2005 upgraded electrical, rigging, storm windows. Clean, comfortable cruiser. \$33,000/obo. La Paz. (360) 774-0918.

PLAN YOUR MEXICAN GETAWAY NOW at the brand-new, gorgeous Cielo Y Mar condos. Located in Punta Mita, 35 minutes from Puerto Vallarta, available to rent from private owner. Right on the beach, 10 feet from the water, they offer spectacular views of ocean and mountains, the biggest infinity pool in the area, an endless beach, great advanced and beginning surf breaks, great fishing, tremendous views of whales, bird life and the islands. While uncrowded and tranquil, it's just a five-minute walk to several waterfront restaurants. Choose from a spacious and beautifully furnished one or three-bedroom unit, or an amazing two-story penthouse with lovely shade trellis on the top floor. See details: www.puntamitabeachfrontcondos.com To reserve, call (415) 599-5012.

TRADE

TRADE OR SALE OR DONATE: 1974 68-ft x 20-ft working steel trawler/office/home. 1,200 sq.ft. of space. Legal live-aboard. Trade value: 45 to 70-ft sailboat or cash or terms. Be creative. Berkeley slip. See: www.myclassicboats.com Email: GaryKJennings@msn.com or call (510) 665-7716.

WANTED

SEND YOUR USED WATERMAKER cruising with us. We are looking for a used 12 vdc watermaker PUR 80 or 160 or similar. We are in Mexico cruising. Will be in SF over Christmas. \$1,500 budgeted. Email: mmcn@jps.net.

GOT AN OCEANGOING 45+ FT multihull, 50+ft monohull you don't use? I have 3 acres on an island in Vava'u? Sold my last boat to buy land. Want yours in paradise? Let's talk. Email: optjay_o@earthlink.net or (808) 896-5054 (wknds).

GEAR

RVG SELF-STEERING WINDVANE for 30 to 50-ft boats, \$750. Honda generator, \$450. SeaPup 8-hp marine engine, make offer. Sytex 12-mile radar, \$450. Call Rod (415) 272-3220.

1800-WATT PROSINE SINE WAVE inverter by Xantrex. 120v, 60hz, AC power output from a 12-volt DC source. 2,900-watt surge capability. Only 16.5 lbs. Sold boat, only used for 3 months. \$750. Call (805) 355-4262 or email: Allwet13@yahoo.com.

Yacht Repair
Design / Consulting

Custom Interiors
Exterior Joinery



STEVE'S MARINE WOODWORK

60 C Libertyship Way, Sausalito
jonessail@aol.com • (415) 332-2500

BLUE PELICAN MARINE

A sailor's consignment store now open at Grand Marina, Alameda
Sails • Winches • Instruments • Brass • Collectibles • Sailing Books
Charts • Small Outboards • Hardware • No large items • No junk
(510) 769-4858 • bluepelicanmarine@sbcglobal.net

VOLPAR, Inc.

(408) 986-0848 • (800) 258-4545
Parts / Service • Penta Only
10am-7pm PST every day including Sat-Sun
email: Volpar@Volpar.com





**BRUNO'S
Island**

**30-50 ft.
Slips Available**

(916) 777-6084

www.BrunosIsland.com

**On the scenic Delta Loop
1200 W. Brannan Island Rd., Isleton, CA**

GOLDEN STATE DIESEL MARINE

PARTS
YANMAR • UNIVERSAL • WESTERBEKE
PERKINS • ISUZU • PATHFINDER • ATOMIC 4

SERVICE
DIESEL ENGINES



Barbara Campbell

**351 EMBARCADERO
OAKLAND, CA 94606** **(510) 465-1093**

Hays Marine Transport

Specializing in oversize boat transport

Servicing 48 States & Mexico

(813) 979-2900



jim@haysmt.net **www.haysmarinetransport.net**



STANDING RIGGING REPLACEMENT

Cruise or Race
One Design Fleet Specials

BUTLER RIGGING

(510) 672-2639
butlerrigging@sbcglobal.net

MAIN AND TWO HEADSAILS off a 1971 Islander 30, all three for \$400. One is a 150 and I believe the other is a 90 or 130, all in good condition. Fred (510) 589-0128 or redfic@aol.com.

58-FT FURLING MAST. Swept double spreaders and boom. Anodized, 2 years old, all in excellent condition, including mainsail and solid vang. Currently on 49-ft sloop, will be available in January. Make any reasonable offer. Call (707) 290-4010.

1895 .450 CUSTOM MARLIN. .44 Ruger, SA, SS mag. 44 and 22# Bruce-type anchors. Heavy-duty California Girl folding bike. New Collins Broadaxe. Main, genoa, jib for 50/60-ft yacht. Hand crank Singer, 81 Alaskan charts. 30-ton press and dies, mandolins, 100-year-old German stein. Danish kero lamp. More. 647 Pacific Ave., Alameda, behind Kelly-Moore Paints. (510) 523-9011 (after 8 a.m.)

MUIR COUGAR ANCHOR WINDLASS. Horizontal electric windlass with wildcat and drum for both chain and rope rode. Immaculate, excellent condition. \$750. Electric air compressor, 110-volt, new, unused, \$250. (415) 596-4884 for info.

VOLVO MD3B FOR SALE. 36-hp, 3-cylinder diesel, very reliable, in boat. 1/2-gal per hr. Rebuilt 2003. Upgrading hp for cruising. \$2,000. (707) 561-7160 or rbrandes@magnoliaah.com.

SAYES RIG WINDVANE. Ready to go, \$600. Classic wood Aeolus 16' dory, \$1,200. Newport Beach, CA. Call Chet (949) 338-1662.

11-HP UNIVERSAL MINUS BELL housing, \$900. 18-hp Westerbeke, complete, \$2,000. 30-hp BMW, \$2,600. All work. Miscellaneous parts and pieces for sale. My cockroach children will install all of the above. Call (415) 272-5776 or email: TheCockroachKing@gmail.com.

74-FT MAST DESIGNED for catamaran. Best offer. (415) 269-5165.

MISCELLANEOUS

CAPTAIN'S LICENSE CLASSES. OUPV (6-pack)/100-ton Masters, plus towing and sailing endorsements. USCG-approved courses. Successful completion satisfies USCG exam requirements. Offered by US Maritime Academy of California. Weeknight classes in San Mateo. Call Mike (650) 298-9489.





SAILBOAT TRANSPORT

Long Haul • Anywhere between San Diego & Blaine
24 to 35 feet • Up to 13,000 lbs. • Experienced • Can rerig

call_norm@shaw.ca • (604) 897-1167

N.E. MARINE TITLE

Coast Guard documentation • Title/lien searches • Transfers • Mortgage filing • Escrow services
Local closing facility for brokers or private transactions
30 years experience of doing it right the first time

1150 Ballena Blvd, Alameda, CA • (510) 521-4925



www.winchmate.com

For Barient & Barlow #27 - #32

(415) 460-5151

CLUBS & MEMBERSHIPS

SINGLE SAILORS ASSOCIATION welcomes all levels of experience. Members enjoy daysailing, cruising, group sails, socials, etc. Monthly meetings 2nd Thursday of month, social 6:30 p.m., meeting 7:30 p.m., Oakland Yacht Club, 1101 Pacific Marina, Alameda. Guests welcome, PICYA member. Call (510) 273-9763. <www.singlesailors.org>

NON-PROFIT

MARIN POWER & SAIL SQUADRON offers members free classes ranging from Seamanship to Celestial Navigation plus cruises and social events. Next Squadron Boating Course in Novato January 8, 10, 17, 19, 22, 24, 2008, all from 7 to 9 pm. Textbook \$35. For details and registration call (415) 924-2712.

SANTA CLARA POWER SQUADRON promotes boating (sail, power and paddle) with high standards in navigation and seamanship, offering members free classes ranging from seamanship to celestial navigation plus cruises and social events. For details call (408) 225-6097 or see: <http://www.usps.org/localusps/santaclara/PE.htm>

BOATING SKILLS AND SEAMANSHIP Course, US Coast Guard Auxiliary Flotilla 12. Covers basics of boating. Meets Tuesdays 7:30-9:30 pm for thirteen weeks beginning February 5, 2008, at Sausalito Cruising Club. Enrollment limited. Course fee \$75, includes textbook. Call Margrit Keyes (415) 924-3739 or margritkeyes@sbcglobal.net.

WANT TO LEARN ABOUT NAVIGATION? Take Basic Coastal Navigation class (6 weeks) followed by Advanced (6 weeks) starting 1/09/2008 at Oakland Yacht Club, 6:30-8:30 pm, \$120. Call Nancy (510) 601-6239 nancy@windwave.com to reserve seat. Coast Guard Auxiliary Flotilla 12-2.

PROPERTY SALE/RENT

BOATER, WATER, WINE-LOVER'S vacation/seasonal rental. New, contemporary home on Napa River near mouth of San Pablo Bay. Deep-water dock. One mile from Napa Marina. Accommodates 6. Monthly rent \$7,800. Details at website: <www.vrbo.com/150787> or call (707) 738-7417.

ATTENTION SAILORS: I have a house and large boat dock at Point Richmond for rent. Exclusive, large 5 br, 3 ba, fireplace, near Richmond Yacht Club. Must see. \$3,500/month or possibly for sale. Call (510) 222-2312.

BERTHS & SLIPS

40-FOOT SLIP FOR SALE AT PIER 39. \$15,000/obo. No liveboards. D Dock, Slip 17. Marina facilities include washer/dryer, toilet, shower, Internet, garbage removal. HOA \$200/mo. Excludes elect/phone. Parking \$3 per 12 hours, Pier 39 Garage. Email: stephaniekrames@aol.com.

50-FT PRIME SLIP, PIER 39. A-Dock, eastside, not by sea lions. 36 years left on lease, not usual 26. Custom dock fenders all around. Great views of City and Bay. Full service marina with 24-hour on-site security, discounted parking pass. Lots of restaurants and entertainment. Easy walk from downtown or North Beach. Handicap accessible. Commercial/pleasure use. This slip appreciates in value. \$39,000. John (415) 602-8416.

CREW



LA PAZ TO PV JAN 19 TO FEB 3, 2008. Learn cruising skills. We all share work aboard a safe, well-equipped 36-ft ketch with a very experienced and mellow skipper. Visit Cabo, Isla Isabella, San Blas, LaCruz. Prefer 1-2 couples. Email: cal20dennis@yahoo.com for details.

EXPERIENCED CIRCUMNAVIGATOR. Schooner returning from high Arctic seeks select crew members on legs: 1) Northern Norway-Scotland-Ireland; 2) Ireland-Spain-Portugal-Gibraltar; 3) Gibraltar-Sardinia-Tunis-Sicily; 4) Sicily-Crete-North Africa-Israel; 5) Israel-Greece-Italy-Croatia. Each leg approximately 4 weeks, June - October. Must participate fully and share expenses. Call Mike (505) 466-6326 or clairehorn@comcast.net.



TRYING TO LOCATE

ERNIE COPP. Please contact Al Lingebach: annandahab@earthlink.net. Thanks.

JOB OPPORTUNITIES

SAUSALITO PERSONAL ASSISTANT and/or boatworker. One or two people, start pt, can become ft career position. Help with business, organization, upgrading boats. Interests in mortgage and real estate brokerage, south of the border real estate, boat remodeling, sales. Lodging possibly included. (415) 331-5251.

CHARTER COMPANY LOOKING for couple to run satellite base in beautiful San Juan Islands during 2008 charter season. Boat handling, basic maintenance and navigation necessary. Send resumes to ABC Yacht Charters, PO Box 129, Anacortes, WA 98221, or email: herve@abcyachtcharters.com.

LARGE RIGGING COMPANY in Annapolis, Maryland, with two locations, is looking for experienced rigger with management skills to run operation in large yacht yard. Run your own operation with the backing of a large company. Call (410) 268-1570.

AN INCREDIBLE OPPORTUNITY to sell today's hottest marine technology: OSSA Powerlite <www.ossapowerlite.com> diesel electric propulsion systems. This is a full-time outside sales position working from Glacier Bay. We are looking for a highly motivated self-starter with solid knowledge of the marine industry and a track record of sales success. Excellent telephone skills, strong mechanical aptitude and knowledge of boats and boat systems will be needed when you talk with our sophisticated customers. Glacier Bay <www.glacierbay.com> is a rapidly growing, internationally known company backed by one of the world's largest venture firms. We offer excellent advancement potential and a very competitive compensation package. Please email your resumé to jobs@glacierbay.com.



ULLMAN SAILS, NEWPORT BEACH is growing and we are looking for an experienced Handworker, Production Manager and Sales Manager. Bring your enthusiasm, commitment and appreciation of teamwork. Salary is commensurate with experience. Contact Erik Shampain at: eshampain@ullmansails.com or (714) 432-1860.

QUANTUM SAILS TORTOLA BVI is looking for a Canvas Manager. Candidate must be experienced, customer-oriented and must be able to manage others. This is an opportunity to come and work in a small island community and join an established team of sailmakers. Great benefits and pay scale and of course a beautiful place to live. If interested please email: kwrigley@quantumsails.com.

YACHT SALESMAN WANTED for growing four-office brokerage. Openings in the Alameda and San Diego offices. Must have track record for listing and selling brokerage boats. Email: randall@rbyachts.com or call Ann (510) 292-8567 or Jack (619) 222-1907.

BUSINESS OPPORTUNITIES

WYLIECAT IS LOOKING FOR a partner with strengths that complement our design and construction skills. Finance - Marketing - Sales. Please visit three websites: <www.wyliecat.com> and <www.sealifeconservation.org> and <www.hybridfishingboat.org> then call Tom Wylie (925) 376-7338.

ASA SAILING SCHOOL, SAILING Club, Charters and Catalina Yachts dealership offered. Fully established with great growth potential. Located in premium resort area of northern California/Nevada area. For details call (877) 542-1691 or captaindeeper@yahoo.com.

ESTABLISHED, PROFITABLE skippered sailing charter company in SE Alaska for sale. Turnkey operation includes boat, permits, and training. Incredible scenery, wildlife, fishing. It's a tough job, but somebody's got to do it. See: <www.soundsailing.com> Email: svbob@soundsailing.com.



TOO LATE TO CLASSIFY



SEA BREEZE 35 SLOOP, 1964. All glass, teak trim, great condition, good liveboard, cruiser or daysailer. New canvas, Yanmar, Harken furler, stainless radar arch, etc. Easy to singlehand. Located in Southern CA. Reduced \$28,000. (562) 706-4334 or sailfast6@verizon.net.



HUNTER 340, 2001. New chartplotter/radar/GPS. Optima batteries. New dodger. 20" flat TV/DVD. Autohelm, roller jib, full-batten main, lazyjack. 27-hp Yanmar, wind/speed/depth instruments, windlass. New bottom paint. \$82,000. (707) 647-2693 or jhsuds@juno.com.



It's Easy

HERE'S HOW

to place or renew a Classified Ad on our Website:

1. Go to <http://www.latitude38.com>
2. Click on 'Place a Classy Ad'
3. Read instructions, click on 'click here'
4. Follow directions, fill in form
5. Preview ad, submit ad
6. Get an emailed confirmation
7. Ad appears in the magazine, then is posted to our website
8. Your ad is read by a highly-targeted audience of boat lovers
9. Sell your boat

Wow, that is easy!

~ Deadline is always the 18th at 5 pm ~

TIBURON ~ WATERFRONT PARADISE

Built in 1999, this amazing 4 br, 3.5 ba home has a 36-ft boat dock! Nothing in Tiburon compares to the value of this fabulous property. Must see! • \$1,995,000 • <www.229martinique.com>

R/E Source • Constance Heldman • (415) 435-1023



ADVENTURE SAILING TRIPS

Baja Ha-Ha • Mexico • Hawaii
(707) 953-0434

www.adventuresailingtrips.com

OFFSHORE PASSAGEMAKING INSTRUCTION IN THE ATLANTIC

John & Amanda Neal are dedicated to providing hands-on, documented instruction aboard their Hallberg-Rassy 46 *Mahina Tiare III*, drawing on their combined 472,000 miles and 63 years of experience.

www.mahina.com • (360) 378-6131

SEGWAY OF OAKLAND

212 International Blvd., Oakland • Rent, buy, or lease
All models in stock • New & Used • Only \$35 for a lesson

(510) 832-2429

BALTIC 38 DP • See: <www.oceanicyachts.com>

Successful design • Excellent craftsmanship • High performance
Easy sail handling • Comfortable 2 staterooms • Very good condition
Local boat • 50 hours on rebuilt Yanmar • New headsail • Many upgrades

Brokers: John Baier • John Callahan • (415) 331-0533



Let Your Boat Make Money • Charter It

NEW and HUGE TAX BENEFITS
www.spinnaker-sailing.com

Spinnaker Sailing • South Beach Harbor, SF • (415) 543-7333



2008 Northern California
SAILING CALENDAR
 AND YRA MASTER SCHEDULE

Complete
 Racing Guide

The 2008
 Racing Season
 is coming into
 focus soon!

Latitude 38
 Publications

FREE! Pick one up

10,9,8,7,6,5,...

It's Countdown Time
 for the 2008
 Racing Season

Look for the new 2008
 YRA Sailing Calendar
 at your favorite Northern California
 Latitude 38 distributor
 on January 2nd.

A Latitude 38 Publication
www.latitude38.com

**VOLVO
 PENTA**

ENGINES • PARTS • SERVICE

We Ship
 Anywhere

1-800-326-5135

(415) 453-1001

FAX: (415) 453-8460

www.helmutsmarine.com

619 Canal Street
 San Rafael, CA 94901

Call us for
 your nearest
 Volvo Penta dealer
 1-800-326-5135

HELMUT'S

MARINE SERVICE INC.

AUTHORIZED POWER CENTER

NEW AND USED SAILS!
 Specializing in production boats and featuring
 the largest selection of stock sails available any-
 where! Save with warehouse volume discounts
 on Stock Sails, Custom Sails, Sail Covers,
 Furlers and Accessories. All top Quality.

FAST SHIPPING!

**All Fully
 Guaranteed!**

- Full Batten Mains
- Furling Genoa's
- Storm Jibs
- Trysails
- Furling Units
- Custom Canvas
- Used Sails

FREE CATALOG!!

THE SAIL WAREHOUSE
 Ph. (831) 646-5346 www.thesailwarehouse.com

PRODUCT DESIGN
 FOR THE MARINE AND
 WATER SPORTS INDUSTRIES
 MECHANICAL & ELECTRICAL
 ENGINEERING

DESIGNS

E-M DESIGNS
 171 Ocean Blvd.
 Box 97
 Half Moon Bay
 CA 94019-0097
 650-728-3406
www.emdesigns.com

PRIME FABRICATION

Marine Hardware and
 Custom Metal Fabrication

- Stainless Anchors - Plow, Fluke, Claw & Ace
- Table Pedestals • Flopper Stoppers
- Helm Seats • Handrails

Ph 949.496.1348
 Fax 949.496.1341
www.primefabrication.com
 33081 Calle Perfecto, Suite B
 San Juan Capistrano CA 92675



deWitt

**DeWitt has gone
to the DOGS!**

**Come to our Gallery to see his
new collection of Dog portraits!**

Commision Jim to paint your Pet! Great gift idea!

DeWitt Art Gallery & Framing
121 Park Place, Point Richmond, CA 94801
(510) 236-1401 • (800) 758-4291
www.jimdewitt.com

Tuesday-Thursday 10:00 a.m. to 5:00 p.m. • Friday 10:00 a.m. to 3:00 p.m. • Saturday Noon to 5:00 p.m.

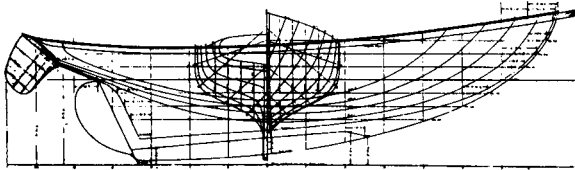

MAKELA BOATWORKS
Family owned since 1948

Wooden Boat Building • Repair and Restoration

19280 South Harbor Drive • Fort Bragg, CA 95437

(707) 964-3963

email: howard@makelaboatworks.com • www.Makelaboatworks.com

RPARTS
 REFRIGERATION PARTS SOLUTION

100% INTERNET BASED We carry a complete line of refrigeration parts for maintenance, repair, and upgrades for all brands including Grunert, Glacier Bay,

Marine Air, Sea Frost, Adler/Barbour and more. We are also



pleased to offer R28+ vacuum insulation panels (independent lab tests) all at Rprices: guaranteed lowest!

www.rparts.com



ADVERTISERS' INDEX

AB Marine82	Annapolis Performance Sailing175	Bay Risk Insurance22	Bruno's Island Resort210	Coyote Point Marina20
ABC Yachts226	Aquatic Protection Agency .219	Berkeley Boat Sales222	Butler Rigging210	Cruising Cats USA89
ABI/Precision Lighting76	Baja Ha-Ha Sponsors .120,121	Berkeley Marine Center51	BVI Yacht Charters219	Cruising Direct Sails168
Admiralty Yacht Sales219	Baja Naval134	Beta Marine Engines25	Cabrillo Yacht Sales224	Cruising World Pacific220
Agape Villages222	Ballena Bay Yacht Brokers24	Blue Sky Energy153	Call Of The Sea97	Cruising Yachts50
Alameda Marina/Pacific Shops Inc.61	Ballenger Spars89	Blue Water Yacht Insurance .157	Chula Vista Marina153	CYOA Yacht Charters181
Alameda Prop & Machine....31	Barillas Marina198	Bluewater Network.....222	City Yachts17	Desolation Sound Charters .182
Albatross Yacht Charters182	Barnett Yacht Insurance214	Bo'sun Supplies.....217	Clipper Yacht Harbor.....22	DeWitt Studio213
Almar Marinas83	Bay Island Yachts7	Boatguys214	Club Nautique42	Diesel Fuel Filtering152
American Battery216	Bay Marine Boatworks.....59	Bottom Siders208	Coast Marine30	Dimen Marine Financing.....99
Anacortes Yacht Charters...182	Bay Marine Diesel.....217	Boy Scouts San Francisco...221	Conch Charters.....180	Discount Marine Hardware .183
Anderson's Boat Yard65	Bay Propeller27	Brisbane Marina16	Corinthian Yacht Club.....175	Dockwise Yacht Transport....75
		British Marine25	Cover Craft97	Downwind Marine32

Circuit breaker tripping? Power problems?

UPGRADE YOUR POWER SERVICE

Call for a consultation with our power specialist.

www.boatguys.us

Complete System Specialists

Inverters & Chargers • AC & DC Electrical • Diesel Generators
Solar • Marine Sanitation • VacuFlush® • Plumbing
Refrigeration • Watermakers • Heating & Air Conditioning

510-393-9168



2007 NISSAN OUTBOARDS

NSF 3.5 AI	3.5 hp 15"	\$962
NSF 8A31	8 hp 15"	\$1,664
NSF 15B21	15 hp 15"	\$2,200

TLDI TWO STROKE ENGINES

NSD 90BEPT02	90 hp 20" fuel injected	\$7,544
NSF 115AEPT02	115 hp 20" fuel injected	\$8,300

Controls & 3-year warranty included. 20% off product and/or labor to veterans.



Now offering 14.5' hand-laid ocean kayaks.

265 Gate 5 Road • Sausalito, CA 94966

(415) 332-8020

weatherguy.com

Defense Applications and Marine Forecast Service

Rick Shema

970 N. Kalaheo Ave • Suite C-109 • Kailua, Hawaii 96734

Toll Free: (866) 882-WXGY (9949)

Mobile: (808) 291-WXGY

email: rick@weatherguy.com

Office: (808) 254-2525

website: www.weatherguy.com

Fax: (808) 254-1525

WIRELESS E-MAIL



ICOM

SCS
the factor creators

SEATECH SYSTEMS™

Computerized Navigation & Communication

800.444.2581 • 281.334.1174

info@sea-tech.com www.sea-tech.com

Call for Info on SeaTech Packages & CAPN Demo Disk



Barnett Yacht Insurance, Inc.

PMB 389 • 2726 Shelter Island Dr.
San Diego, CA 92106

Our Insurance Programs Cover

Crew of Two

Caribbean • Mexico • South Pacific • Worldwide

Call Toll Free: 866-463-0176

Fax: 619-226-8513 • email: sales@barnettyachtinsurance.com

For quotes, visit our website:

www.barnettyachtinsurance.com

HAWAII

LONG TERM DRY STORAGE

Clear Customs at our dock

GENTRY'S
KONA MARINA

HONOKOHAU HARBOR

888-458-7896
TOLL FREE

156°1'30" W

19°40'20" N

The friendliest boatyard in Hawaii

ADVERTISER'S INDEX - cont'd

Doyle Sails.....55	Fortman Marina.....46	Helms Yacht & Ship Brokers/ Seawind Catamarans.....67	Iron Bear Marine Canvas...208	List Marine Enterprises.....152
Easom Rigging.....100	Garhauer Marine.....33	Helmut's Marine Service.....212	Jeanneau America.....10	Loch Lomond Marina.....143
Elliott/Pattison Sailmakers..100	Gentry's Kona Marina.....214	Heritage Yacht Sales.....222	JK3 Nautical Enterprises.....47	Maine Cats.....182
EM Design.....212	Gianola & Sons.....183	High Performance Sailing Hawaii.....183	Kensington Yachts.....221	Makela Boatworks.....213
Emery Cove Yacht Harbor...89	Glacier Bay.....28	Hogin Sails.....56	Kissinger Canvas.....139	Marina Bay Yacht Harbor..169
Emeryville Marina.....215	Glen Cove Marina.....28	Hood Sails.....39	KKMI - Bottom Paint.....101	Marina de la Paz.....217
Enviro Lua.....206	Go Cats.....178	Hotel Coral & Marina.....143	KKMI - Brokerage.....69	Marina El Cid.....198
Essex Credit Corp.....26	Golden State Diesel.....210	Hunter Marine.....11	KKMI - Full Service Yard.....53	Marina Puerto Salina.....197
Euro Marine Trading.....87	Grand Marina.....2	Hydrovane.....87	KTI Systems/Filter Boss.....139	Marina Puesta Del Sol.....195
Fago, Margaret Artist.....30	GreenBoatStuff.com.....138	iForem.....81	Larry R. Mayne Yacht & Ship Broker.....99	Marina Real.....202
Farallone Yacht Sales.....13	H&S Yacht Sales.....14	Interphase Technologies.....95	Larsen Sails/Neil Pryde.....86	Marina Riviera Nayarit.....77
Flying Cloud Yachts.....21	Harken.....54		Lee Sails.....206	Marina Village.....79
Flying Tiger Yachts.....174	Hays Marine Transport.....210			Marine Engine Co.....208

Emeryville Marina



ON THE BAY

NEW SLIPS!

**40-65' Available Now
Call Today...**

*When you call Emeryville Marina Home...
...call this your backyard!*

**Full Amenities
including
Fuel Dock & Pumpout Station**

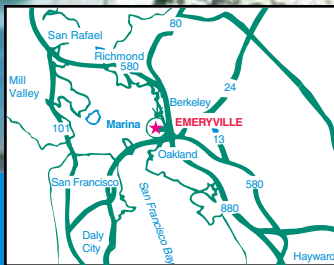

MARINAS
International

(510) 654-3716

www.emeryvillemarina.com

We care about sail care!



San Francisco Service

773 Andersen Drive, San Rafael, CA 94901

T: 415-453-2142 M: 510-333-4644

Hours: 8-5 M-F, Sat. by appointment

SAIL CARE ■ SAIL COVERS ■ YACHT COVERS ■ FLAGS ■ CRUISING PRODUCTS



Faster by Design
www.northsails.com

Ultra Trip Hook



**Hook is
made
of 316L
stainless
steel**

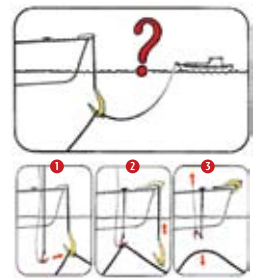

- Untangle fouled anchor lines quickly and easily
- Transfers fouled rode from your anchor for easy clearing
- Simply drop your anchor a few feet, and it's clear of the fouled anchor line



Quickline USA — Marine Products from the World, for the USA
15561 Computer Lane #A, Huntington Beach, CA 92649
Phone: 714-843-6964, Fax: 714-843-6906
www.quickline.us or info@quickline.us

ADVERTISER'S INDEX - cont'd

Marine Lube.....217	Monterey Bay Marina.....206	Northern California Boat Show/NCMA.....90	Palm Princess Mexico.....134	Punta Mita Beachfront Condos.....183
Marine Outboard Co.214	Mr. RPM Mobile Welding...220	NW Marine Trade Assoc./Seattle Boat Show.....45	Paradise Village.....135	Pusher's Rum.....6
Mariner's General Insurance .58	Musto/Pineapple Sails.....62	Opequimar Marine Center .203	Passage Yachts.....4,5	Quantum Pacific.....37
Maritime Institute.....156	Napa Valley Marina.....80	Orange Coast College.....85	Passage Yachts Brokerage..221	Quickline.....215
Marotta Yachts.....225	Napa Valley Marina Yachts .220	Outboard Motor Shop/Star Marine Electronics.....94	Performance Cruising/Telstar .91	R-Parts.....213
Mazatlan Marine Center/ La Paz Yachts.....26	Nelson Yachts.....63	Owl Harbor.....30	Peter Crane Yacht Sales.....223	Raiatea Carenage Svc.....201
McDermot Costa Insurance .143	Nelson's Marine.....228	Oyster Cove Marina.....68	Pier 39 Marina.....52	Randall Burg Yacht & Ship...12
McGinnis Insurance.....31	New Coast Fabrics.....139	Oyster Point Marina.....38	Pineapple Sails.....3	Richardson Bay Marina.....175
McGrath Yachts.....19	New Era Yachts.....224	Pacific Coast Canvas.....95	Point Loma Outfitting.....73	Richmond Yacht Harbor.....29
Milltech Marine Inc.64	Norpac Yachts.....227	Pacific Yacht Imports.....9	Port Townsend Shipwrights Coop.....99	Rooster Sails.....93
Moorings, The.....179	North Beach Marine Canvas .93		Prime Fabrication.....212	Ryan's Marine.....216
Modern Sailing Academy97	North Sails.....101,215		Puerto Lucia.....194	Sail California.....34,35,36
	North Sails - San Francisco ..43			

Latitude 38

Available

Cruisers, racers, and all far-flung sailors can now view the complete magazine online in PDF format with one small annual subscription fee of \$18.



Ryan's Marine

Specializing in Marine Electrical Services for Your Boat

- Electrical system installations from inverters to electronics packages
- Troubleshooting of existing systems
- Dealer for the complete Balmar product line
- Head and holding tank installations



(510) 385-3842

Ryan Schofield
Owner since 1997

email:
rssailor@yahoo.com

HEAVY DUTY DEEP CYCLE MARINE BATTERIES

Available at the following local marine chandleries and service distributors:

<p>ALAMEDA</p> <ul style="list-style-type: none"> • Alameda Prop & Machine • Fortman Marina Store • Mariner Boat Works • Star Marine • Svendsen's Chandlery <p>BENICIA</p> <ul style="list-style-type: none"> • Cruising Seas Services 	<p>MARTINEZ</p> <ul style="list-style-type: none"> • Diablo Marine <p>OAKLAND</p> <ul style="list-style-type: none"> • Golden State Diesel • Outboard Motor Shop <p>OAKLEY</p> <ul style="list-style-type: none"> • Big Break Marina <p>RICHMOND</p> <ul style="list-style-type: none"> • Bay Marine
--	---

AMERICAN BATTERY • Hayward, CA • (510) 259-1150

ADVERTISER'S INDEX - cont'd

Sail Warehouse, The212	Seacoast Marine Finance.....60	Starbuck Canvas.....91	UK-Halsey Sails.....70	Western Grace/Orca Yacht Charters180
Sailrite Kits72	Seaportal.....87	Sunsail Charters.....40	Ullman Sails49	Westwind Precision Details.101
Sal's Inflatable Services.....157	Seashine.....66	Svendsen's Boat Works.....41	Vallarta Yachts28	Whale Point Marine Supply .78
San Carlos Yacht Sales218	Seatech214	Svendsen's Marine88	Vallejo Boat Works.....166	White, Chris Designs.....208
San Francisco Boat Works.....22	Seawear Nautical Jewelry....71	Swedish Marine.....153	Vallejo Marina.....167	Whitehall Rowing & Sail.....93
San Leandro Marina.....23	Selden Mast, Inc. USA.....74	Tartan/C&C Yachts15	Vaughan, William E.206	Windpath Sailing, Inc.....142
Sausalito Dock-n-Sell.....223	Society of Accredited Marine Surveyors/SAMS200	The Boatyard at Grand Marina.....18	Ventura Harbor Boatyard...202	Wright Way Designs168
Scan Marine Equipment.....91	South Beach Harbor.....96	Tiburón Mist at Paradise Cay .92	Voyager Marine.....29	Yacht 'Angel 55'224
Scanmar International.....44	South Beach Riggers.....95	TMM/Tortola Marine Mgmt 181	Wagner Insurance.....199	Yachtfinders/Windseekers ...24
Schmidt, Charlotte Yachts...223	Spectra Watermakers84	Tradewinds Sailing157	weatherguy.com214	
Schoonmaker Point Marina 196	Staaf Sails.....27	Trident Funding8	Wedlock, Ramsay & Whiting Marine Surveyors220	
Sea Hawk/New Nautical Coatings48	Stanford University57	Twin Rivers Marine Insurance.138	West Marine .25,27,29,31,98	

Don't forget to tell 'em that
Latitude sent you!

eBooks

Worldwide



To get a subscription to *Latitude 38* on eBooks, visit our Web site at www.latitude38.com, click on the eBook link, and follow the easy instructions. We think you're going to love it!

No matter where you find yourself, you can still get lost in the pages of *Latitude 38*!

Marine Diesel Specialists AT YOUR SLIP!



30 years experience • Universal/Westerbeke dealers
Repairs/Tune-ups all models • Engine Surveys, Instruction

BAY MARINE DIESEL

510-435-8870

baymarinediesel@comcast.net

STAINLESS STEEL RATCHET BUCKLE & STRAP



*Strength, Quality
& Dependability...
with a Lifetime Warranty!*

Three Widths: 2", 1.5" & 1"
Various Lengths

**Stainless Steel
Hardware, Rigging & Fittings
at Reasonable Prices.**

www.BOSUNSUPPLIES.com

Or call toll-free for catalog and to order

See our complete catalog & order on the Web **1(888) 433-3484**

Bilge Steam Cleaning Oil Changes

From our boat to yours, we bring the SERVICE to YOU



www.MarineLube.biz



Fuel Polishing

Tank Cleaning



**FULL
SERVICE
MARINA**

Friendly, helpful, fully bilingual staff

All new hardwood docks • Wireless Internet
Dinghy landing with potable water
New protective piling & sheetpile breakwaters • And more!

TEL: 01152 612 122 1646

email: marinalapaz@prodigy.net.mx

www.marinadelapaz.com

Apdo. Postal 290, La Paz, 23000, Baja California Sur, Mexico

info@sancarlosyachts.com
 U.S. Toll Free 1-877-694-4568
 U.S. Fax 1-520-232-2032
 Charlie Bloomer, Marisa Velasco,
 and Joanne Preston.
 Empresas Pahinga S. de R.L. de C.V.

**NEW
 NUMBERS!**



San Carlos Yachts

POWER • SAIL

www.sancarlosyachts.com

On Marina San Carlos and
 the Sea of Cortez, your
 Paradise is just a few hours
 south of Arizona!

Mountains and desert on the Sea of Cortez. The fastest growing, largest independent boat brokerage South of the Border! All within a few hours' drive of Tucson. **San Carlos Yachts** has over sixty top-quality cruise equipped sail and power boats available now – and we're adding boats every week.

San Carlos offers easy access WITH NO CAR PERMITS REQUIRED, U.S.-quality boat workers and facilities, certified surveyors, everything you might need. Most everyone here speaks English, too. We can arrange discounted lodging for your stay, dive trips, sportfishing, horseback riding, golf...you name it!

We're only a toll-free phone call away **1-877-694-4568**. Come see why **San Carlos Yachts** is a different kind of brokerage in a different kind of paradise! *¡Se habla ingles tambien!*

SAIL		POWER	
26' HUNTER 260 & trailer, 2000.....	27,000	38' ERICSON sloop, 1982.....	59,500
30' CATALINA Mk III sloop, 1993.....	39,000	40' CATALINA 400 sloop, 1995.....	139,000
30' CATALINA sloop, 1984.....	24,950	40' HANS CHRISTIAN CHRISTINA cutter, 1986.....	149,900
30' HUNTER sloop, 1992.....	37,500	40' HARDIN SEA WOLF ketch, 1978.....	59,000
32' DOWNEAST cutter, 1980.....	35,000	40' HARDIN SEA WOLF ketch, 1978.....	84,900
32' MARINER ketch, 1972.....	35,000	41' C&C sloop, 1989.....	97,500
32' WESTSAIL cutter, 1973.....	49,000	41' CUSTOM CC MOTORSAILER, 1979.....	65,000
33' WAUQUIEZ GLADIATOR sloop, 1982.....	54,900	42' BROWN SEARUNNER cutter, 1976.....	59,500
34' CATALINA sloop, 1986.....	49,900	42' HUNTER PASSAGE CC sloop, 1990.....	118,500
34' COAST CUTTER, 1988.....	Pending	42' SPENCER sloop, 1974.....	84,500
34' GANLEY SHADOW steel sloop, 1986.....	55,000	42' WHITBY CC cutter, 1977.....	89,500
34' TRUE NORTH cutter, 1976.....	49,900	43' WESTSAIL custom tall rig cutter, 1976.....	115,000
35' CAMPER NICHOLSON sloop, 1974.....	39,900	44' KELLY PETERSON CC cutter, 1978.....	109,900
36' UNION POLARIS cutter, 1977.....	67,500	44' KELLY PETERSON CC cutter, 1977.....	119,000
36' UNION POLARIS cutter, 1978.....	69,500	47' HYLAS CC cutter, 1989.....	235,000
37' HUNTER cutter, 1982.....	35,000	54' CUSTOM SOUTH AFRICAN CC ketch, 1983...	169,000
38' C&C LANDFALL sloop, 1980.....	49,900		
38' CUSTOM HORSTMAN trimaran, 1997.....	149,500		
38' DOWNEAST cutter sloop, 1977.....	57,500		
38' DOWNEAST cutter, 1976.....	59,000		

40' BENETEAU OCEANIS CC SLOOP, 2000. This is the one you've been searching for! She's in better than new condition, with central air, genset, and custom Nick Jackson dinghy davits... there's nothing more to add. She's never been chartered and shows beautifully. Cast off now for distant shores with this Oceanis 40CC.

\$199,950



37' NORDIC TUG TRAWLER. A rare opportunity! The Nordic Tug 37 offers it all – classic looks, a modern underbody, extraordinary economy, and build quality you must see to believe. This Pacific Northwest example came south overland and has cruised the Sea of Cortez for several seasons. She's got everything you might want already aboard, is in terrific condition and waiting for you in one of the world's best sportfishing and cruising grounds! **\$299,000**



1990 HUNTER PASSAGE 42 CENTER COCKPIT SLOOP. Fast, roomy, and very seakindly, the Passage 42 was Hunter's breakthrough fast cruising design. Still a great looking boat in any anchorage, this example came south from the Pacific Northwest to stay. She shows well inside and out, is quite well equipped, and a great choice for cruising Mexico and the world. Don't miss it! **\$118,500**



The Following Information Is CLASSIFIED!

Save more than \$1,000 on
 Help Wanted advertising!

John Monroe, owner of Pacific Coast Canvas, spent well over \$1,000 in East Bay papers on Help Wanted ads for a new seamstress.

With a couple of months in *Latitude 38's* Classy Classifieds for less than \$100, he found just the right person.

- Boats for Sale
- Help Wanted
- Used Gear
- Partnerships
- South of the Border
- Business Opportunities
- And Much More!

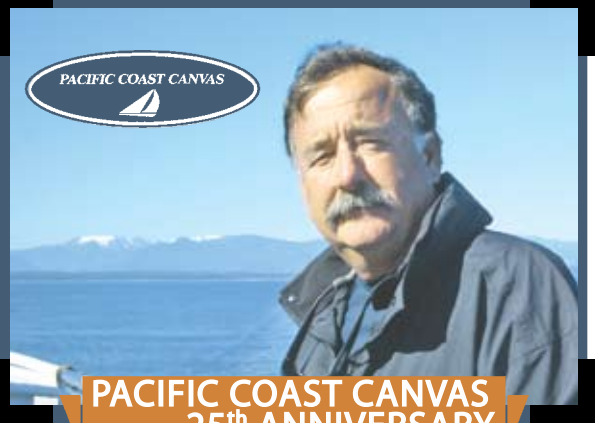

**PACIFIC COAST CANVAS
 25th ANNIVERSARY**

Pacific Coast Canvas is celebrating their 25th anniversary; John has been the owner for the last 15 years. They've been a regular advertiser since the beginning, and we salute their ongoing success.

Targeted and Effective

See page 95 and online at:

www.latitude38.com

DONATE YOUR BOAT

to the Aquatic Protection Agency. We protect our precious coastal waters from illegal toxic pollution. We can use your equipment, so you will get maximum value for your donation.

We are on the water, monitoring cruise ships, performing BlueBoater trainings, and testing outfalls for harmful toxins.

Call (415) 235-0756

or (831) 247-8228

or email

boats@aquaticprotection.org

www.AquaticProtection.org



LOOKING TO BUY A BOAT IN THE BVI?



BENETEAU 50.4, 2007
Brand new boat!
Just Delivered. \$310,000



BENETEAU 473, 2005
Cacafuego. \$239,000



BENETEAU 46, 2007
Jasper. Brand new boat!
AC and genset. \$294,000



BENETEAU 323, 2004
Chablis. \$85,000



BENETEAU 40, 2007
Brand new boat!
December delivery. \$203,000

B.V.I. Yacht Charters
Joma Marina, Tortola, BVI
(284) 494-4289
(888) 615-4006
charters@bviyc.com
www.sailinthebvi.com

yachts in photos may be sisterships



2001 Tayana 58'

Beautiful Cruiser ★ Exceptional Performance
★ Legendary Design, *Only \$695,000*



- ★ Walk-in Engine Room
- ★ In-boom Furling
- ★ Blue Water Ready
- ★ Autopilot
- ★ Complete Galley
- ★ Teak Decks
- ★ Bow Thruster
- ★ North Sails
- ★ Extra Fresh Water Capacity
- ★ Washer & Dryer
- ★ Full Electronics



Admiralty, at your service, since 1981

www.ays.com

Dave Singer 253-272-3700 ★ Dave@ays.com

Tyee Marina 5620 Marine View Dr. NE ★ Tacoma, WA



We'll wrap it with a bow!



Cruising World Pacific

1853 Embarcadero, 2nd Floor, Oakland, CA 94606

(510) 764-1734

On Oakland's Embarcadero just off the 880 Freeway

DESCRIPTION		24/7 ext.	DESCRIPTION		24/7 ext.
52' Tayana CC Cutter	1991	\$295,000	37' Endeavour sloop	1978	\$55,000
50' Hudson Force 50 Ketch	1974	\$109,900	36' Catalina MkII	2000	\$114,900
47' Beneteau 47.7	2001	\$330,000	36' Catalina MkII	1999	\$113,900
44' Peterson cutter	1978	\$114,000	36' Catalina sloop	1984	\$55,000
41' Hunter 410	2004	\$224,900	36' Columbia sloop	1968	\$29,900
40' Cal	1964	\$59,900	34' Cal Pearson	1976	\$29,500
40' Islander Peterson	1981	\$59,900	34' Catalina MkII	2005	\$129,000
39' O'Day sloop	1983	\$69,000	34' Pacific Seacraft	1989	\$119,900
38' Baltic Doug Peterson	1984	\$128,000	33' Nor'West 33.5	1982	\$39,500
38' Ericson sloop	1981	\$46,900	32' Capital Gulf	1985	\$49,995
38' Hans Christian	1976	\$59,900	32' Fuji cutter	1977	\$49,900
38' Tripp Javelin	1961	\$34,500	25' Pacific Seacraft sloop	1976	\$18,900



**You can receive listing data via our 24/7 Automated Fax System
Call (888) 827-1891 then dial extension**

HUNTER 340, 1999

Raymarine, StackPac main, dinghy & more.

Auto Fax Back
(888) 827-1891
ext. 3453



STEVENS 50, 1986

Heat, AC, genset. Completely cruise equipped.

Auto Fax Back
(888) 827-1891
ext. 3213



MAINSHIP 400T, 2006 • \$299,950

Raymarine E-Series Diesel w/Thruster.

Auto Fax Back
(888) 827-1891
ext. 4093



56' FOUNTAINE PAJOT MARQUISES

2001
\$895,000



Most spectacular salon of any yacht in its class. Panoramic views and rich cherry joinery throughout. Large galley complete with bar and built-in seats; wrap-around dinette accommodates 10. Impressive navigation center with all the latest electronics.

Entire starboard hull dedicated to the captain's stateroom. Two large staterooms with their own private heads to port, with additional crew quarters. More than 1,000 sq. ft. of deck space. Low hours on twin Yanmar 75hp direct drive diesel engines.

Never chartered, hardly used. This vessel will take you anywhere in the world and is only limited by your imagination.

NAPA VALLEY MARINA YACHTS

(866) 363-8882 • (707) 252-8011

Mobile Welding & Metal Fabrication

Aluminum • Stainless • Cast Iron • Steel

We Can Fix It or Make It New!



Bonded • Licensed • Insured

www.mrrpmwelding.net

email: mrrpmwelding@yahoo.com

(650) 455-5229

24-hour emergency

CA Lic. # 876283

WEDLOCK, RAMSAY & WHITING
Marine Surveyors



Pre-purchase, insurance: vessel, engine, rig surveys

Serving the Bay Area since 1980

www.wedlockandstone.com

(415) 505-3494



Kensington Yachts

"Everyone needs a bigger boat"

UNIQUE, REDUCED COMMISSIONS!!

Our commission structure is on a sliding scale.

- Have a large note?
- Two boat owner?
- Death or family emergency?
- Want to trade up?

We have seen every situation, and understand.

Call us today. Let us help you sell your boat!



BRISTOL 47.7 CC, 1992...\$399,000



43' MORGAN CENTER COCKPIT, 1985...\$122,500



37' WAUQUIEZ, 1971...\$49,000



34' CANADIAN SAILCRAFT CS, 1990...\$63,000

SAIL	36' S-2 CENTER COCKPIT, 1984.....	SOLD
42' BAVARIA, 2000.....	30' CATALINA, 1980.....	\$23,500
41' COOPER 416, 1980.....	POWER	
37' WAUQUIEZ, 1971, Chance.....	40' BAYLINER 4087, 1996.....	\$169,000
36' FREEDOM YACHTS SLOOP, 1986.....	28' BAYLINER TROPHY 2802, 2001	Santa Cruz Slip

Kensington Yacht & Ship Brokers

email: yachts@kensingtonyachts.com

877.444.5272 • 415.793.9376

www.kensingtonyachts.com

Give A Little...

*Now Accepting
Automobiles!*



Give A Yacht...

Your generosity will give your boat a new home and give you a nice tax break and great satisfaction...

Our growing Scout program needs your support:

- Any serviceable vessel can be used.
- We'll make the transfer quick and easy.
- Tax benefits from donating can meet and sometimes even exceed the amount realized from selling your vessel.
- You can eliminate the bills associated with the cost of owning your boat.

*Donations
Are Tax
Deductible*



Donate Your Boat to the Sea Scouts

**San Francisco Bay Area Council,
Boy Scouts of America**

**For more information contact: Matt Myers
1-800-231-7963 x145 • mattm@sfbac.org**

FREE BERTHING FOR 30 DAYS WITH NEW LISTINGS – CALL



ISLAND PACKET 380, 2001 ~ \$235,500



**BENETEAU 361, 2003
Rare SF Marina berth \$150,000**



**CATALINA 30, 1995
1995 ~ \$54,500**



BENETEAU 473, 2004 ~ \$274,900



**BENETEAU 461, 2000
\$199,000**



**BENETEAU FIRST 36.7, 2002
\$129,000**



**HUNTER 310, 1997
\$52,800**



**BENETEAU IDYLLE 11.5
1985 ~ \$69,000**



**ISLAND PACKET 420, 2000
\$329,000**



**ISLAND PACKET 370, 2004
\$304,000**



NEW ALAMEDA OFFICE
1070 MARINA VILLAGE PKWY, STE 101
ALAMEDA, CA 94501
(510) 864-3000

PT. RICHMOND OFFICE
1220 BRICKYARD COVE RD.
PT. RICHMOND, CA 94801
(510) 236-2633

www.passageyachts.com
sales@passageyachts.com

HERITAGE

Yacht Sales

Live your Dreams



47' PASSPORT AC

2002

\$479,000



43' Kettensburg

1965

\$69,500



43' Westsail

1974

\$149,000



42' Beneteau 423

2005

\$210,000



40' Beneteau Oceanis

1996

\$118,500



36' Islander

1975

\$47,500



Slips available!

Long Beach-Naples	231 North Marina Dr. 866-56-YACHT
Newport Beach	829 Harbor Island Dr. 877-38-YACHT
Wilmington	Berth 202 Peninsula Rd. 877-59-YACHT

Full specs at www.heritageyachts.com

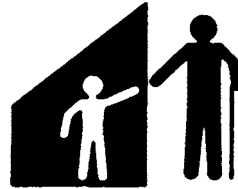

AGAPE VILLAGES

FOSTER CHILDREN NEED YOUR HELP!



Donate your boat to support

AGAPE VILLAGES

Tax Deductible

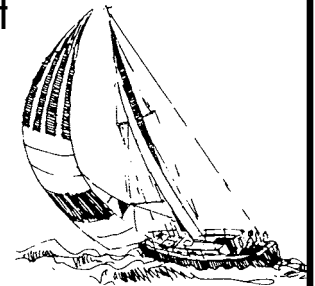

1-800-513-6560

Berkeley-Brisbane Boat Sales +

NEW



24' SOVEREIGN, 1997
Berkeley - \$13,700

Sales Slips
As low as \$120/mo!!

For qualified listings
at only
\$10/ft of Beam!!

51' BILL GARDEN design S-Boat.....\$119,000
44' VINETTI CALIFORNIA.....\$89,900
41' MAINSHIP SEDAN, '89.....\$89,000
27' CAL JENSEN, '73, pop-up top, in Berkeley....\$6,900

Now Brisbane and
Berkeley Boat Sales
(510) 548-1202
cell (415) 515-9215
www.berkeleyboatsales.com

Donate your Boat

Cars, Trucks, RVs, & Real Estate

We handle all DMV & Smog

Running or Not (restrictions apply)

Tax Deduction

BLUEWATER
NETWORK

800-324-7432

"Proceeds help Bluewater Network reduce greenhouse gases, clean up our air and water, and protect marine mammals and wildlife."

Sausalito DOCK-n-SELL

**Dock your yacht where it will be seen
by buyers in downtown Sausalito.
No brokers/salesmen commissions.
Save thousands!**

**Complete Yacht Services
Detailing - Electrical - Heads
Surveys - Title Search
Sea Trials - Financing - Comps**

'For Sale by Owner' is not a new concept, we just made it easier and more cost-effective. Your yacht will be ready to show 24/7 by appointment with pre-qualified buyers. No more wasting time with tire kickers. Space is limited, so call today for details – you will be pleasantly surprised!

Trailerable Boats Welcome!

**"HOLD ON TIGHT TO YOUR DREAMS!"
HAPPY HOLIDAYS from
Sausalito DOCK-n-SELL**

**Sausalito DOCK-n-SELL
41 Liberty Ship Way, Sausalito
behind the Bay Model
415.686.6860**

CHARLOTTE SCHMIDT

YACHT SALES

When Experience Counts

4100A Harbor Blvd.
Oxnard, CA 93035
Fax (805) 382-2374

In SF Bay Area: (415) 613-0712

(805) 382-2375

Csyachtsales@cs.com

www.yachtworld.com/charlotteschmidt



51' CHB PILOTHOUSE LRC, 1978 Twin Ford Lehmans, full flybridge, dual steering, 2 state-rooms, washer/dryer, pilothouse with dinette & berth, strong offshore cruiser, rare offering, great price. Call Listing Agent Gary (415) 613-0712.



46' BENETEAU OCEANIS 461, 1997 Yanmar 78hp diesel, genset, watermaker, dodger, beautiful interior, well maintained, fully equipped for offshore cruising. Must see. Asking **\$193,500**



34' CATALINA, 1988 Universal diesel, autopilot, GPS, dodger, furling jib, Caribe dinghy w/outboard, clean and ready to sail. Asking **\$53,900**



51' COOPER PILOTHOUSE, 1982 Lehman 80hp diesel, chartplotter, GPS, radar, three staterooms, good interior layout, excellent offshore cruiser. Asking **\$174,900**



34' GEMINI 105M CATAMARAN, 1997 Many great features, Westerbeke diesel, autopilot, chartplotter, furling jib, excellent condition! Asking **\$115,000**. Contact owners' listing agent Gary Kaplan at (415) 613-0712.



47' VAGABOND KETCH, 1986 Ford Lehman diesel, genset, chartplotter, radar '06, AP '06, SSB, 12' Avon, dodger. Stunning condition. Top condition. You won't find a better Vagabond. At our docks. Asking **\$239,000**

Peter Crane Yacht Sales and Charters

*In Santa Barbara - experienced, interested, friendly, low pressure
Brokerage without walls*

Peter Crane (805) 963-8000

Mark Scott-Paine (805) 455-7086



1991 Beneteau 45 f 5 Pininfarina pristine, well equipped, cruise ready never chartered, **\$175,000**



1978 Holcomb 38' schooner bronze fastened work of art handcrafted top to bottom **\$75,000**



1958 Bounty II yawl well restored, excl. paint, decks new diesel, good sails **\$45,000**



1992 Gulet 88 motorsailer beautiful condition, new cat engine 6 cabins ea w/ head, shower + crew **\$900,000**



1974 Formosa 51 pilothouse recent major refit for world cruise change in plans forces sale **\$138K**



1981 Herreschoff Nereia 36 traditional good looks in fiberglass well equipped to cruise **\$89,500**

Info and photos: www.petercraneyachts.com
pc@petercraneyachts.com
Santa Barbara Slip Specialists

CABRILLO YACHT SALES

"Discover The Difference"

(619) 523-1745

www.cabrilloyachts.com

Sun Harbor Marina (next to Fisherman's Landing)
5060 N. Harbor Drive, Suite #155, San Diego, CA 92106

tayana yachts sales/service



Custom Construction

64' TAYANA, 2008

- 200 hp diesel
- 650 fuel
- Electric windlass/winch
- 3-4 cabins

All New
72' Deck Salon
Bill Dixon design



2008

72' TAYANA DYNASTY
Bill Dixon/Andrew Winch design.
Design/priced affordably.



2008

48' TAYANA DECK SALON
Center cockpit or pilothouse models.
Also a used 48', 55' & 46' PH



Tayana

ALL NEW BILL DIXON DESIGNED
54' TAYANA
Check it out.



Used Tayanas

TWO 55' TAYANAS
Ready to take on your wildest cruising dreams.
Plus used 42'.



N DOCK

42' BALTIC by CENMARINE
High quality performance cruiser.
Swan-like qualities.



Price Reduced

45' DOWNEASTER KETCH
Location: Hawaii. Slip obtainable with
credit check. Make offer today.



New to Market

55' ISLANDER
Tradwinds Model. She is a famous
circumnavigator ready to go again.



Price Reduced

38' VAGABOND WESTWIND Many
custom features. Super clean, cruise ready.
\$119,900. And 42' Cenmarine/Baltic.



New to Market

51' SPENCER
Canadian built quality.
Has a lot of potential.



2005

MORGAN/CATALINA 440
"No worries" says it all. Under factory warranty.
Also: 42' Catalina, 2002



New to Market

40' BENETEAU
Center cockpit, 2001. Like new condition
with all the whistles and bells.



Recreational

TWO 34' HUNTERS
and a 30' CATALINA.
Great boats for the \$\$.

Worldwide / Mexico / Pacific Coast

Tayana Yachts • Large Selection of Used Yachts

www.cabrilloyachts.com

Mexico Connection Keith Demott (520) 743-7833

NEW ERA yachts

POWER & SAIL



51' BENETEAU, 1986 • \$159,000



47' VAGABOND, 1981 • \$165,000



43' HANS CHRISTIAN, 1999 • \$139,000



36' CATALINA, 1985 • \$55,000



36' CHEOY LEE, 1986 • \$59,000



35' MORGAN, 1970 • \$24,500



32' HUNTER VISION, 1990 • \$37,500



31' HUNTER, 2 to choose from \$28,500

Visit our new office in Grand Marina
2021 Alaska Packer Place, Alameda, CA 94501
sales@newerayachts.com
(510) 523-5988 • www.newerayachts.com

I HAVE ONE OF THESE:



ANGEL 55

Twin Diesel. In a San Diego slip. Real Nice.

\$349,000

I WANT ONE OF THESE:

I'll trade up or down –
or straight across.

- ◆ INDIVIDUALS
- ◆ BROKERS
- ◆ DEALERS



Let me know if you can help.

(Other types of trades considered as well.)

Contact Alan at

(801) 201-2927 • email: orandal@juno.com

w w w . c a b r i l l o y a c h t s . c o m

w w w . c a b r i l l o y a c h t s . c o m



Marotta Yachts of Sausalito

Brokers of Fine Sail and Motor Yachts

415-331-6200 • info@marottayachts.com



See at:
www.marottayachts.com

46' WATERLINE CUTTER, 1999

This beautiful steel cruising cutter is well equipped (almost \$100,000 of electronics, as well as genset, central air, electric winches, watermaker, washer/dryer, etc., etc., etc.), highly customized with a \$225,000 refit in '04-'05, and shows bristol inside and out.

\$499,000



See at:
www.marottayachts.com

47' JEANNEAU SUN ODYSSEY, 1992

Sexy Euro-style performance cruiser with deep draft Kevlar-reinforced hull & nicely laid out, spacious 3-stateroom interior. Well equipped with offshore dodger, full suite of electronics, new Doyle sails, heavy duty ground tackle and 10' Caribe RIB on nicely executed stainless steel davit system.

\$230,000



See at:
www.marottayachts.com

42' CHEOY LEE GOLDEN WAVE, 1984

Designed by Bob Perry to look like a Swan topside and a Valiant 40 below. Never cruised, she shows nicely – sails in fine shape, low time on the trusty Perkins 4-108 diesel, heavy duty stainless steel, dinghy, davits/radar arch, electric windlass, radar, etc.

\$94,000



See at:
www.marottayachts.com

40' SEAWOLF KETCH, 1973

This is THE nicest Seawolf we've seen in years – repowered, new decks and cabin, hull Awlgripp'd, and looks NEW!

Also possible Berkeley liveaboard slip.

\$73,000



See at:
www.marottayachts.com

38' BENEteau, 1990

Moorings 38 model, designed around a modified First 38s5 hull, a sleek, fast two-stateroom two-head racer/cruiser, perennially popular on the brokerage market. Clean, with a new suite of sails and a rebuilt Yanmar engine.

\$69,500



See at:
www.marottayachts.com

40' HUNTER LEGEND, 1987

6'5" headroom throughout, QUEEN berth aft, plus a roomy cockpit and well-designed plan topsides – it's a hard-to-beat package (especially at a price well below \$100,000!). Clean, low engine time and transferable Sausalito slip.

\$69,000



See at:
www.marottayachts.com

36' SWALLOWCRAFT SCYLLA KETCH, 1979

Very nice aft cockpit motorsailer built in Korea to European quality standards. New listing, additional information available soon.

\$54,900



See at:
www.marottayachts.com

35' PEARSON, 1981

Bill Shaw-designed classic in fine shape, just detailed and lying in a transferable Sausalito slip. New listing, full story online at www.marottayachts.com.

\$34,800



See at:
www.marottayachts.com

30' HUNTER, 1979

The Hunter 30s all have attractive lines and a spacious interior, and this particular boat shows nicely inside and out with the topsides looking especially nice for her age. Note Yanmar diesel; most boats in this price range have gas engines.

\$16,500

100 BAY STREET • SAUSALITO • CALIFORNIA 94965



35' HANSE 350, 2008
Available at the San Rafael sales dock.

Anchorage Brokers & Consultants YACHTS



www.yachtworld.com/anchoragebrokers
#1 Gate 5 Road, Sausalito, CA 94965

(415) 332-7245
yachts@abcyachts.net

25 Third Street,
San Rafael, CA 94901
(415) 457-9772

Hanse

CLAY & TERESA PRESCOTT • GEORGE HIGBIE • PHIL HOWE • LARRY MAYNE • DANA PAUL • ARNIE GALLEGOS • PETER BOHN • ED LABARRE • JOHN SAUL



PASSPORT 37, 1986 Robert Perry design, second owner, newer sails in 2003, Pullman berth, beautiful teak interior. **\$109,000**



TWO BENETEAUS

BENETEAU 411, 1999, tri-cabin, **\$139,000**
34' BENETEAU 350, 1988, Bristol, **\$75,000 (pictured)**



35' J/105
One owner, racing and cruising sails. **\$105,000**



36' ISLANDER FREEPORT, 1978
Bob Perry hit the nail on the head when he designed this one! **\$61,900**



PEARSON 37, 1982
Clean, newer rigging and sails. **\$49,000**



FULL KEELS

38' INGRID (2); 35' BABA, 1979
33' MASON, 1987
32' FUJI KETCH, 1976 (pictured)



36' SWEDEN, 1984
Swedish-made, performance plus, beautiful teak joinery below. 2 staterooms. **\$75,000**



NORSEMAN 447 CENTER COCKPIT, 1984
Newer engine, low hours genset, newer rig and sail. **\$230,000**
Also: **NORSEMAN 535, \$549,000**

SAIL	
53' Norseman 535	'88 549,000
52' Hartog schooner	'99 195,000
51' Aleutian	'78 152,900
50' Gulfstar sloop	'78 Inquire
49' Reliant Ketch	'91 135,000
47.7' Bristol CC	'92 399,000
47' Jeanneau Sun Odyssey	'92 230,000
46' Chesapeake	'98 77,000
47' Perry cutter	'80 115,000
45' Bruce Roberts CC	'79 120,000
44' Hylas	'86 185,000
44' Norseman CC	'84 230,000
43' Hans Christian	'82 139,500
42' Baltic DP	'84 189,000
41' CT	'76 79,000
40' Cheoy Lee MS	'75 73,900
40' Olson	'83 69,500
40' O'Day	'86 75,000
40' Hunter 40.5	'95 116,000
40' Challenger	'73 73,000
39' Cal, nice	'79 74,900
39' Freya	'81 109,500
38' Ingrid	'76 & '84 from 61,900
38' Hans Christian	'80 99,000
37' Pearson	'82 49,000
37' Alberg, equipped	'72 90,000
37' Rafiki, new engine '07	'77 67,000
37' Irwin	'79 40,000
36' Pearson 365, Bristol	'81 70,000
36' Islander	'77 & '74 from 42,000
36' Islander Freeport	'78 61,900
36' Catalina	'84 & '93 from 59,500
36' Sweden	'84 75,000
35' Hanse	'08 Inquire
35' Hunter 35.5	'93 69,000
35' Beneteau Oceanis 350	'88 75,000
35' Baba	'79 77,500
35' Ericson, nice	'79 33,000
34' Hanse 341	'03 139,500
34' C&C	'80 37,500
34' Sabre	'83 49,000
34' J/105	'99 105,000
33' Hunter	'04 93,000
33' Hunter	'05 Repo
33' Hunter 33.5	'92 61,000
33' Mason	'87 114,500
33' Newport	'84 34,500
32' Westsail	'77 52,500
32' Fuji ketch	'76 37,500
31' Pacific Seacraft Mariah	'79 69,000
30' Catalina, new engine	'75 16,500
30' Islander	'75 15,000
30' Lancer	'80 36,000
30' Hunter	'90 36,000
29' Hunter 29.5	'94 40,000
28' Newport	'79 9,500
28' Pearson Triton	'61 11,000
27' Pacific Seacraft	'80 59,500
14' Whitehall, sail/row	'02 11,000
12' Beetle Cat, wood	9,975
POWER	
67' Stephens Alum	'80 895,000
65' Pacemaker, cert	'71 299,000
65' Elco Classic MY	'26 450,000
57' Chris Craft	'65 135,000
53' Hatteras MY, new engines	'76 259,000
50' Stephens	'65 135,000
45' Chris Craft	'73 149,000
44' DeFever	'82 245,000
44' Gulfstar	'79 147,000
43' Viking DC	'77 107,000
41' Hatteras	'61 Inquire
41' Hatteras, nice	'65 149,000
40' Sea Ray Sundancer, diesel	'97 197,000
38' Fu Hwa	'84 125,000
38' Bayliner, nice	'90 97,000
35' Cooper Prowler	'86 78,000
34' Mainship	'81 48,000
34' Sea Ray Sundancer	'01 169,000
34' Kevlacat	'97 175,000
32' Uniflite, t/d	'77 37,500
32' Silverton FB, 370 hrs	'98 59,000
30' Sea Ray 305 DB	'88 59,900
27' Pacemaker	'78 15,000
26' Osprey long cabin	'03 85,000
26' Osprey	'02 98,000
25' Farallones	'85 35,000
24' Chaparral, trailer	'94 19,000
24' Orca, inboard	'99 59,950
24' Osprey	'96 69,500
22' Grady White 222 w/trlr	'02 59,000



47' JEANNEAU SUN ODYSSEY, 1992 3 staterooms, master is Pullman, upgraded beautiful interior, RF main, 75hp Yanmar. Worth seeing! **\$230,000**



40' CHALLENGER
Super clean! Complete refit, new paint from mast to keel. **\$73,000**



47' PERRY CUTTER CC, 1980
Anything She Wants. South Beach SF. New tanks, 6 cyl. Ford Lehman. **\$115,000**

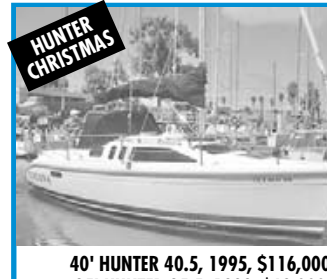

HUNTER CHRISTMAS

40' HUNTER 40.5, 1995, \$116,000
35' HUNTER 35.5, 1993, \$69,000
33' HUNTER, 2005, Bank Repo
33' HUNTER, 2004, \$93,000
33' HUNTER 33.5, 1992, \$61,000
29.5' HUNTER, 1994, \$40,000 (pictured)

Hanse DealerReport

Three new Hanses on the Bay:
350, 370e, 540e

Larry R. Mayne
Yacht & Ship Broker
Dealer & New Boat Sales Manager

Sales dock slip available, \$300/month



Latest arrival, the big 540
with all the trimmings!
Happy Holidays!

NORPAC YACHTS

On
Hwy 101

THERE'S ALWAYS ROOM FOR ANOTHER GOOD BOAT
AT OUR DOCKS - LIST YOUR BOAT NOW!

557 Francisco Blvd., San Rafael, CA 94901

(415) 485-6044 • FAX (415) 485-0335

email: info @ norpacyachts.com

FOR MORE
SEE OUR
norpacyachts.com
WEBSITE

AWESOME

100' MEGA SLOOP Custom Offshore Performance Cruiser. Luxurious, spacious, comfortable, sleeps 25 in 17 bunks. Loaded w/amenities & equipment. Fast, Cummins dsl. Excellent condition. Great private yacht with super charter potential. World class cruising and MORE! **\$1,500,000 Ask**

HIGH ENDURANCE CRUISING YACHT

75' NORTH SEA TRWLR. Awesome Blue Water World Cruiser. Massively built in SCOTLAND to go to sea & stay. CAPE HORN Vet. Impeccable total refit & conversion. Fully found/loaded. Strong, economical & long lasting Gardner dsl. **\$825,000**

ENGLISH ELEGANCE

66' THORNYCROFT CUTTER-RIGGED KETCH Classic 1923 design, well maintained. She's like a beautiful & comfortable private British club down below. Must be seen. Teak decks, diesel, genset, radar and more. Extremely charming and a great performer. **Asking \$199,000**

34' MAINSHIP TRAWLER by Silverton. Flybridge, aux. generator, diesel, dual helms, convertible aft deck enclosure, autopilot, full galley, head & shower. A capable & desirable cruiser & more! **Ask \$49,500**

REDUCED

30' RINKER 300 Fiesta Vee Express, '94 w/near zero hrs on full inside/out remanufacture/refit incl. her twin engines. Aft cabin, quality, comfort, condition & performance. **Ask \$32,988**

REDUCED

40' CHEOY LEE GULF 40 PH Sloop. 56hp Yanmar diesel, varnished teak hull, copper rivet fastened. Good sail inventory including 2 spinnakers, AP, radar, chart/GPS, more! Great yacht in great shape. **Asking \$55,000**

38' INGRID ketch by Wm. Aikin. GREAT cruising double-ender. Extra stout & robust fiberglass construction. Low hrs, dsl, vane, furling, radar, cruise ready & more! Cruise the world in seaworthy comfort. **\$60,950/offers.**

PERFORMANCE CRUISER

37' VILLENAVE Custom Ocean Cruising Cutter designed by JP Villenave & built by Venoco. Super strong cold-molded construction. Dsl (+ spare engine incl), powerful rig, great inventory, inverter, vane, solar, AP, furling, RADAR, dink, WXFax & more! **Ask \$43,950**

30' BRISTOL 29.9. Famous Halsey HERRESCHOFF cruiser/racer. Dsl, extra robust FG construction, roller furling, roomy & comfortable, dodger, pedestal wheel steering & more! This is a great boat. **Ask \$34,950**

42' SPARKMAN & STEPHENS Slp. F/G, dsl engine, spinn., dodger, major refit incl, rig. Beautiful cruiser from world-class architect; she's a very desirable yacht with a great layout, excellent performance & outstanding comfort and cond. Hard to go wrong. **Asking \$49,000**

SAIL

50' CAULKINS Slp. A project, but all there. Dsl, strip plank, ocean racer... Try 15,000

45' COLUMBIA CENTER COCKPIT Sloop, diesel, fiberglass, roomy, comfortable cruiser with good light and visibility down below, 2 heads, shower & more. These are well-respected for cruising & for living aboard. We have two, starting at... Ask 39,750

42' SPARKMAN & STEPHENS steel custom cutter by Olin Stephens. Cent. cockpit, aft cabin, dsl & more... Asking 60,950

41' HINCKLEY Ctr. Trad. beauty and a world-class builder... Ask 69,900

40' BLOCK ISLAND Cutter. Dsl, good wood fixer, 1937 classic... BARGAIN! 6,250

39' FREYA Double-ender, steel, dsl, dink+o/b, new paint, solar, furling, RADAR, AP, cruise equipped + more! ... 62,950

38' KETTENBURG Sloop. Dsl... Ask 43,950

37' GULFSTAR cent. cockpit, aft cabin, dodger, dsl & more... 43,950

36' ISLANDER Sloop. Major upgrades, dsl, dodger, furling & more... Ask 44,950

36' STEEL HARTOG ketch, double-ended cruiser. Great potential and a great value priced at... Offers/16,950

36' NIELSEN classic 1918 Danish aux. sloop. Nice condition... Asking 15,000

35' CHEOY LEE by Robb. Dsl, teak... 17,950

34' COLUMBIA Slp. Dsl, furling ++... 9,450

30' NEWPORT Slp, 1/B, A/P, F/G... 11,950

30' CATALINA Sloop. Furling, dodger, diesel, wheel steering, Avon, EXTRA CLEAN & More! ... Asking 24,950

29' PEARSON TRITON. New diesel. Total refit nearly done... Asking 15,950

28' MORGAN Out-Island Slp, 1/B, shower & more! A Great Boat at a Great Price! ... Ask 8,500

26' INT'L FOLKBOAT, F/G, O/B... Ask 6,950

25' CHEOY LEE FRISCO FLYER, teak... 8,000

23' HERRESHOFF Classic PRUDENCE Slp w/'03 Honda... 7,500

42' GRAND BANKS twl. Aft cabin, FG, Onan, twin dsls, RADAR. Excellent... 121,000

41' CHRIS CRAFT CONSTELLATION. Aft cabin. Great liveaboard, full Delta canvas, good condition... Ask 37,500

40' OWENS, '65 Tahitian. Great for cruise/live, comfort, room & NICE! Newly refinished... Ask 19,988

38' CHRIS CRAFT, aft cabin, twins, convertible aft enclosure. Very nice! And a BARGAIN! ... Asking 24,950

36' UNIFLITE, F/B, aft cabin, twins, radar, GPS and more!... Asking 59,950

36' CHRIS CRAFT Express Cruiser, twins, runs well. BARGAIN!... Offers/6,850

35' CHRIS CRAFT CAVALIER. Aft cabin, flybridge, twin V8s, many recent upgrades. Very nice. Reduced! EXCELLENT BARGAIN... 8,950

32' ROBERTS commercial fish w/'HERRING PERMIT & more!... Asking 58,950

32' CARVER. Glass, twins, Sausalito live-aboard berth. Nice!... Asking 30,950

32' BOWPICKER. aluminum. Commercial (herring) license... 49,000

31' MONTEREY BAY EXPRESS PH utility, F/G, 1991, twin 130 Yanmars, trailer, USCG-documented, commercial quality gem... Reduced! Asking 34,950

30' WILLARD Trawler, dsl ++... Ask 34,950

29' WELLCRAFT 2900 EXPRESS. Twin screw (not outdrives). Super clean & nice! Bright red...REDUCED! Asking 19,950

28' RODMAN WA, F/B, 2004. Twin dsls, high quality & loaded. Looks new!... Asking 189,000

27' FARALLON Pilothouse, F/G, twin 5L V8s, fast & seaworthy. Just detailed & very nice 1986... Ask 51,950

26' PACEMAKER, cab. cruise w/V8, nice!... Ask 8,500

25' FARALLON SF w/trailer. New twin 180 hp Volvos, radar, etc... Asking 22,450

24' SEA RAY V8. Full Delta canvas, trl, o/d, nice!... Asking 12,000

OTHER

60' STEEL BARGE, 20-ton A frame, spuds, deck house, more... Offers/55,000

56' LCM-6 with dive support, steel, W/H, twin 671s, full elect... Try 25,000



57' CHINESE JUNK. Teak const. Huge & very comfortable well lit & well appointed inter. Outstanding liveaboard cruiser w/lug rig & highly desirable Gardner dsl. Charm, character. Gen set, washer/dryer. Pos. liveaboard slip & more! **Asking \$149,000**



65' CLASSIC, '31 MOTORYACHT BY WHEELER. 16' beam, recent 40k hull refurb. Bottom's good & she's ready for you to finish restoration. Pilothouse, twins, 3 heads, huge salon, crew's quarters and more. **Asking \$49,950**



32' FUJI KETCH. Diesel, furling, shower, full galley, full cruising keel with cutaway forefoot. Very nicely maintained ++. We have two starting at **\$31,950 Ask.**



32' GRAND BANKS CLASSIC TRAWLER. 1970 Economical diesel, dual helms, flybridge, TEAK decks, full electronics, swim platform, mast and boom. She's a great cruiser and a very well loved design. **Asking \$39,500**

The OLD KERMIT PARKER BROKERAGE
Serving the Boating Community since 1956.

*Happy Holidays
from
Nelson's Marine.
Hang this one
on your tree!*

**Bring your
ornament in
after January 1
and receive 7%
off a complete
bottom job!***



**Offer good through Feb. 29, 2008.*

NELSON
Yachts

(510) 337-2870 • See ad pg. 63

AWLGRIP

PETTIT
marine paint

Nelson's Marine

1500 FERRY POINT, ALAMEDA, CA 94501
(510) 814-1858 FAX (510) 769-0815