



Metris

Operator's Manual



4475847410

Order no. T447 0423 13 Part no. 447 584 74 10 Edition 2022-01

Metris Operator's Manual

Mercedes-Benz



Front passenger airbag warning

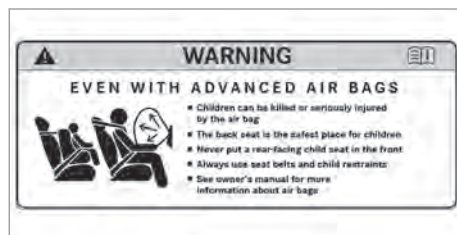

Airbag warning sticker for USA and Canada

⚠ WARNING Risk of injury or death if the co-driver airbag is enabled

If the co-driver airbag is enabled, a child on the co-driver seat may be struck by the co-driver airbag during an accident.

NEVER use a rearward-facing child restraint system on a seat with an ENABLED FRONT AIRBAG; DEATH or SERIOUS INJURY to the CHILD can occur.

Observe the chapter "Children in the vehicle".

Publication details

Internet

Further information about Mercedes-Benz vehicles and about Mercedes-Benz AG can be found on the following websites:

<https://www.mercedes-benz.com>

<https://www.mbusa.com> (USA only)

<https://www.mercedes-benz.ca> (Canada only)

Documentation team

©Daimler VANS USA, LLC

©Mercedes-Benz AG: Not to be reprinted, translated or otherwise reproduced, in whole or in part, without written permission from Mercedes-Benz AG.

Vehicle manufacturer

Mercedes-Benz AG

Mercedesstraße 120

70372 Stuttgart

Germany

Vehicle dealers

Daimler VANS USA, LLC

One Mercedes-Benz Drive

Sandy Springs, GA 30328

<https://www.mbusa.com> (USA only)

<https://www.mbvans.com>

Customer Assistance Center:

1-877-762-8267

Mercedes-Benz Canada, Inc.

98 Vanderhoof Avenue

Toronto, ON M4G 4C9

<https://www.mercedes-benz.ca> (Canada only)

Customer Relations Department:

1-800-387-0100

Daimler VANS USA, LLC and Mercedes-Benz Canada, Inc. are Daimler AG enterprises.

Welcome to the world of Mercedes-Benz

Before you first drive off, read this Operator's Manual carefully and familiarize yourself with your vehicle. For your own safety and a longer operating lifespan, follow the instructions and warning notices in this Operator's Manual. Disregarding them may result in damage to the vehicle or environment or in injuries to people.

Damage to the vehicle caused by failure to observe the instructions is not covered by the Mercedes-Benz limited warranty.

The standard equipment and product description of your vehicle may vary and depends on the following factors:

- Model
- Order
- National version
- availability

Mercedes-Benz reserves the right to introduce changes in:

- Design
- Equipment
- Technical features

Your vehicle may therefore differ, in individual cases, from that shown in the descriptions and illustrations.

The following documents are integral parts of the vehicle:

- Printed Operator's Manual
- Maintenance booklet
- Equipment-dependent supplements

Always keep these documents in the vehicle. If you sell the vehicle, always pass all documents on to the new owner.

Mercedes-Benz USA, LLC

Mercedes-Benz Canada, Inc.

A Daimler Company

4475847410



Symbols	4	Sliding door	47
At a glance	6	Electric sliding door	48
Cockpit	6	Tailgate	51
Indicator and warning lamps (vehicles without steering-wheel buttons)	7	Rear-end doors	54
Indicator and warning lamps (vehicles with steering-wheel buttons)	8	Side window	56
Steering wheel with buttons	9	Anti-theft prevention	58
Center console	10	Seats and stowage	61
Overhead control panel	11	Notes on the correct driver's seat posi- tion	61
Door control panel	12	Seats	61
General notes	13	Steering wheel	73
Environmental protection	13	Stowage areas	73
Genuine Mercedes-Benz parts	13	Information about the bottle holder	74
Information about attachments, add-on equipment, installations and conver- sions	13	Cup holders	74
Operating Instructions	14	Ashtray and cigarette lighter	74
Service and vehicle operation	15	Sockets	75
Operating safety	16	Light and vision	76
Declarations of conformity and notes on driving in different countries	17	Exterior lighting	76
Diagnostics connection	17	Interior lighting	79
Notes on changes to the engine output	18	Changing bulbs	79
Qualified specialist workshop	18	Windshield wipers	84
Vehicle registration	18	Mirrors	87
Correct use of the vehicle	18	Operating sun visors	89
Multi Purpose vehicle	19	Climate control	90
Notes for persons with electronic medi- cal aids	19	Overview of climate control systems	90
Information on problems with your vehi- cle	19	Operating climate control systems	91
"Reporting safety defects"	20	Operating air vents	95
Limited Warranty	20	Driving and parking	97
QR codes for rescue card	20	Driving	97
Data storage	20	Automatic transmission	103
Copyright	24	Refueling	105
Occupant safety	25	Parking	106
Restraint system	25	Driving and driving safety systems	108
Seat belts	26	Trailer operation	128
Airbags	29	Instrument cluster and on-board com- puter	134
Automatic measures after an accident	34	Overview of the instrument cluster	134
Safely transporting children in the vehi- cle	34	Overview and operation of the on-board computer (vehicles without steering- wheel buttons)	135
Notes on pets in the vehicle	42	Overview and operation of the on-board computer (vehicles with steering-wheel buttons)	136
Opening and closing	43	Overview of data shown on the instru- ment cluster display	137
SmartKey	43	Adjusting the instrument lighting	138
Doors	45		

Overview of menus on the on-board computer 138
 Menus and submenus (vehicles without steering wheel buttons) 139
 Menus and submenus (vehicles with steering-wheel buttons) 141

Mercedes me **148**
 Mercedes me calls 148
 Mercedes me connect 149
 Mercedes me and apps 150

Multimedia system **151**
 Notes on operating safety 151
 Overview and operation 151
 System settings 152
 Calling up the tool menu 153
 Navigation 154
 Setting functions for smartphones 159
 Media 160
 Radio 161
 Updating system software and maps 163

Transporting **164**
 Notes on loading guidelines 164
 Notes on distributing the load within the vehicle 165
 Securing loads 166
 Load securing aid 170
 Carrier systems 171

Maintenance and care **173**
 Notes on maintenance 173
 Service interval display 173
 Engine compartment 174
 Cleaning and care 180

Breakdown assistance **185**
 Emergency 185
 Mercedes-Benz emergency call system 185
 Flat tire 187
 Battery 187
 Towing or tow-starting 194
 Electrical fuses 198
 Vehicle tool kit 198

Wheels and tires **202**
 Information on noise or unusual driving characteristics 202
 Notes on regularly inspecting wheels and tires 202

Information on driving with summer tires 202
 Information on M+S tires 203
 Notes on snow chains 203
 Tire pressure 204
 Tire labeling 208
 Information on definitions (tires and loading) 211
 Changing a wheel 213
 Information on wheel and tire combinations 218
 Spare wheel 218

Technical data **222**
 Notes on the technical data 222
 On-board electronics 222
 Regulatory radio identifications and notes 223
 Vehicle identification plate, vehicle identification number (VIN) and engine number 237
 Operating fluids and capacities 238
 Vehicle data 243
 Trailer hitch 244
 Cargo tie-down points and carrier systems 245

Display messages and warning and indicator lamps **246**
 Display messages 246
 Indicator and warning lamps 271

Index **280**

4 Symbols

In these Operating Instructions, you will find the following symbols:

 **WARNING** Danger due to not observing the warning notices

Warning notices draw your attention to hazards that may endanger your health or life, or the health or life of others.

► Observe the warning notices.

 **ENVIRONMENTAL NOTE** Environmental damage due to failure to observe environmental notes

Environmental notes include information on environmentally responsible behavior or environmentally responsible disposal.

► Observe environmental notes.

 **NOTE** Damage to property due to failure to observe notes on material damage

Notes on material damage inform you of risks which may lead to your vehicle being damaged.

► Observe notes on material damage.

 These symbols indicate useful instructions or further information that could be helpful to you.

► Instructions

(→ Further information on a topic page)

Display Messages on the display



 Highest menu level to be selected in the multimedia/audio system

►► Corresponding submenus to be selected in the multimedia/audio system

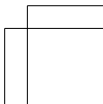
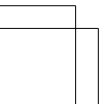
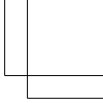
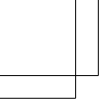
* Indicates a cause

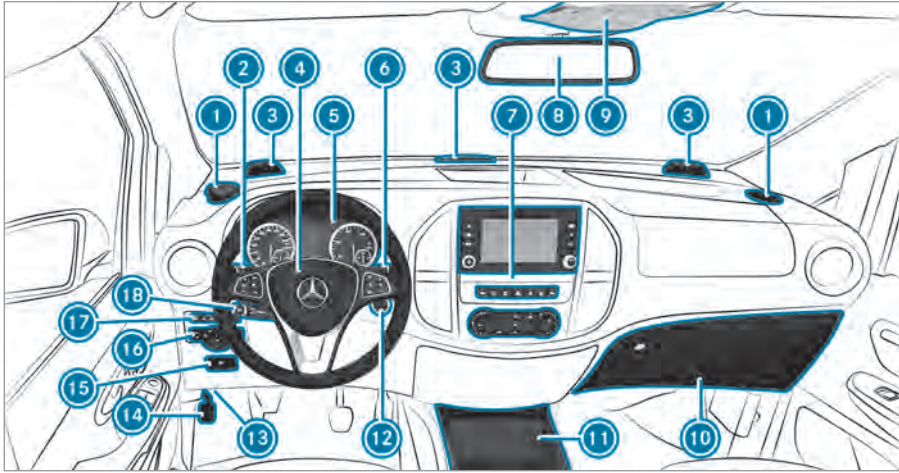



① Cup holders	→	74	⑪ Storage compartment		
Ashtray	→	74	12 V socket	→	75
② Combination switch	→	77	Cigarette lighter	→	75
③ PARKTRONIC warning displays	→	119	⑫ Ignition lock	→	97
④ Adjusts the steering wheel	→	73	⑬ Diagnostics connection	→	17
Steering wheel gearshift paddles	→	104	Opening the hood	→	174
Horn			⑭ Applies the parking brake	→	107
⑤ Instrument cluster			⑮ Releases the parking brake	→	107
⑥ DIRECT SELECT lever	→	103	⑯ Light switch	→	76
⑦ Center console operating unit			⑰ Switch panel for driving systems:		
⑧ Inside rearview mirror			 Lane Keeping Assist	→	127
⑨ Overhead control panel			 Switches PARKTRONIC on/off	→	119
Interior lamp	→	79	⑱ Cruise control lever	→	113
⑩ Glove box	→	73			

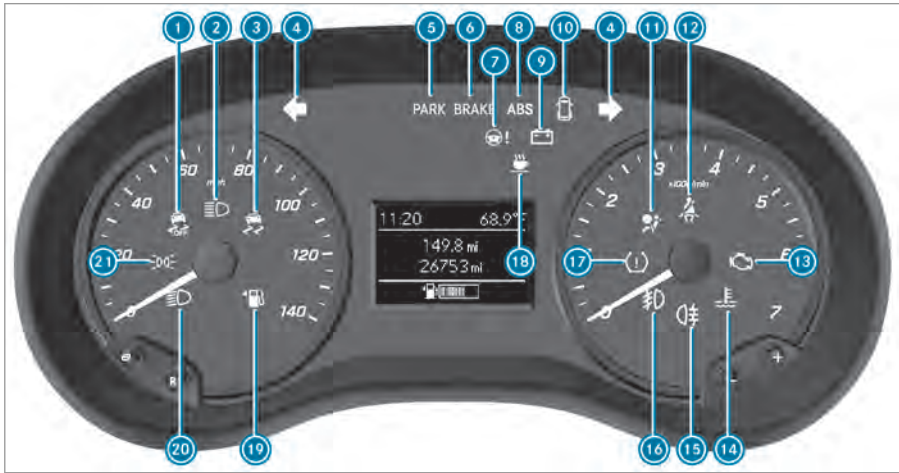

1	ESP® OFF	→	272	12	Seat belt	→	275
2	High beam	→	77	13	Check Engine	→	276
3	ESP®	→	272	14	Coolant	→	276
4	Turn signal lights	→	77	15	Rear fog light	→	76
5	Parking brake (USA only)	→	107	16	Fog light	→	76
	Parking brake (Canada only)	→	107	17	Tire pressure monitoring system	→	279
6	Brakes (USA only)	→	272	18	ATTENTION ASSIST	→	125
	Brakes (Canada only)	→	272	19	Reserve fuel	→	276
7	Power steering	→	276	20	Low beam	→	76
8	ABS	→	272	21	Standing lights and license plate lamp	→	76
9	Power supply	→	263		Corresponding messages may also be shown on the instrument cluster display.	→	246
10	Doors	→	276				
11	Restraint system	→	272				

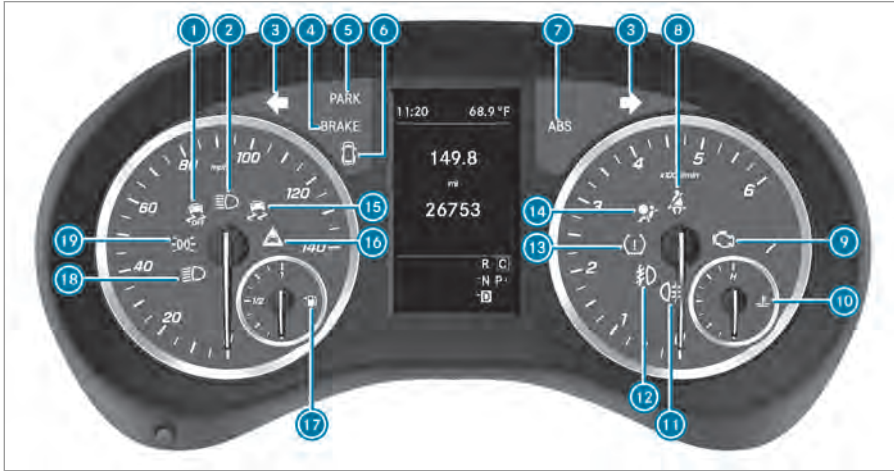

1	ESP® OFF	→	272	11	Rear fog light	→	76
2	High beam	→	77	12	Fog light	→	76
3	Turn signal lights	→	77	13	Tire pressure monitoring system	→	279
4	Brakes (USA only)	→	272	14	Restraint system	→	272
	Brakes (Canada only)	→	272	15	ESP®	→	272
5	Parking brake (USA only)	→	107	16	Distance warning	→	275
	Parking brake (Canada only)	→	107	17	Reserve fuel	→	276
6	Doors	→	276	18	Low beam	→	76
7	ABS	→	272	19	Parking lights and license plate lighting	→	76
8	Seat belt	→	275		Corresponding messages may also be shown on the instrument cluster display.	→	246
9	Check Engine	→	276				
10	Coolant	→	276				

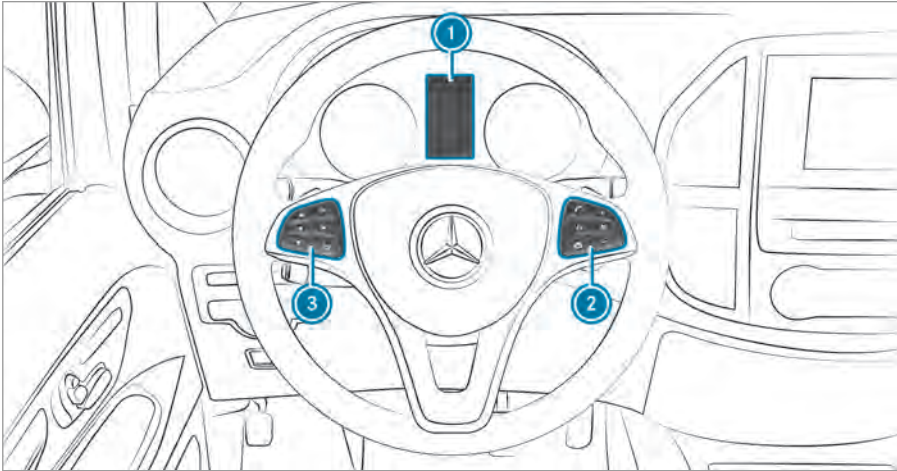

① Display → 137

② Ends or declines calls/ exits the phone book or redial memory → 145

Makes or accepts calls/ switches to the redial memory

Adjusts the volume

Mutes

Vehicles with a navigation system: switches on voice control of the navigation system (see the manufacturer's operating instructions)

③ Calls up the menu bar in the display and selects menus → 136

Selects a submenu or function/scrolls through lists

Confirms a selection/ hides display messages

Back/vehicles with a navigation system: switches off voice control of the navigation system (see the manufacturer's operating instructions)

The multimedia system, telephone, and voice control via the steering wheel buttons in the right control panel only function with a Mercedes-Benz audio or navigation system. If you are using an audio or navigation system from another manufacturer, the described functions may be restricted or may not be available at all.

Operating unit

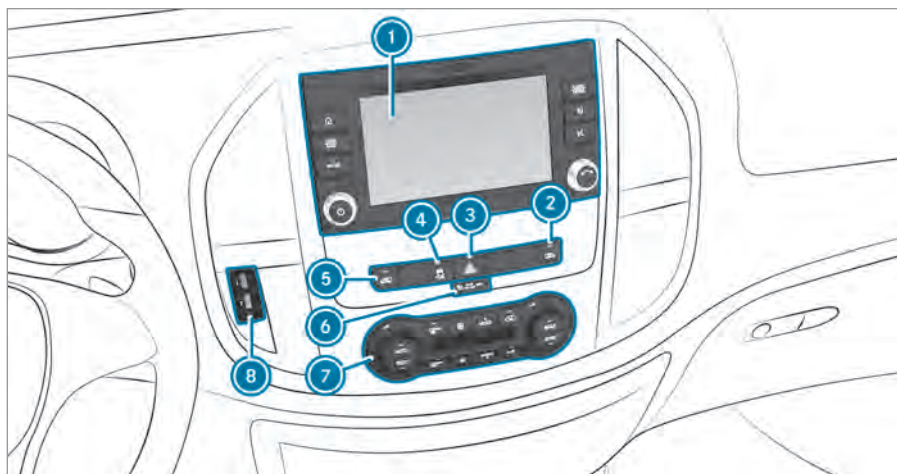

① Multimedia system	→	151	⑥ PASSENGER AIR BAG OFF indicator lamp	→	32
② Opens and closes the electric sliding door on the right side of the vehicle	→	48	⑦ Climate control system operating unit	→	90
③ Switches the hazard warning light system on and off	→	77	⑧ Media interface with AUX connection and USB port		
④ Switches ESP® on and off	→	109	The layout and number of buttons depend on the equipment.		
⑤ Opens and closes the electric sliding door on the left side of the vehicle	→	48			

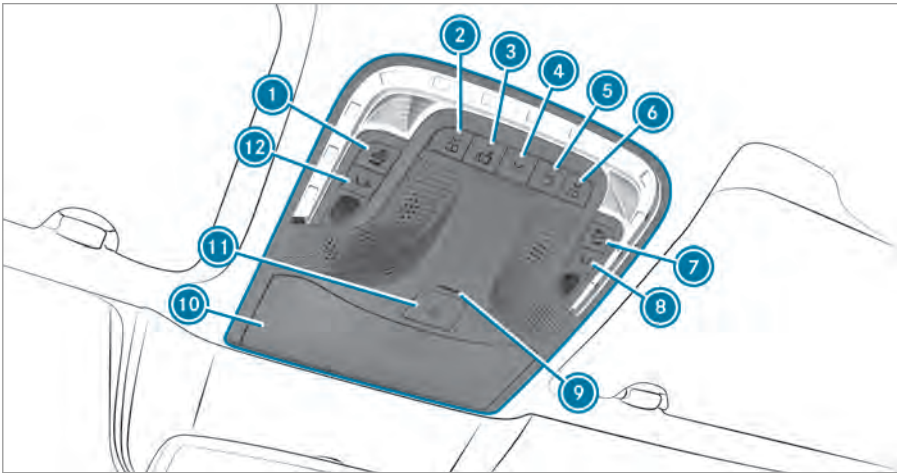

①	Deactivates interior protection	→	60	⑥	Switches the right-hand reading lamp on/off	→	79
②	Switches the left-hand reading lamp on/off	→	79	⑦	Deactivates the tow-away alarm	→	59
③	Switches automatic interior lighting control on/off	→	79	⑧	Button for Info call	→	148
④	Switches the front interior lighting on/off	→	79	⑨	ATA indicator lamp	→	58
⑤	Switches the rear passenger compartment/cargo compartment lamp on/off	→	79	⑩	Eyeglasses compartment	→	74
				⑪	SOS button	→	185
				⑫	Breakdown assistance call button	→	148

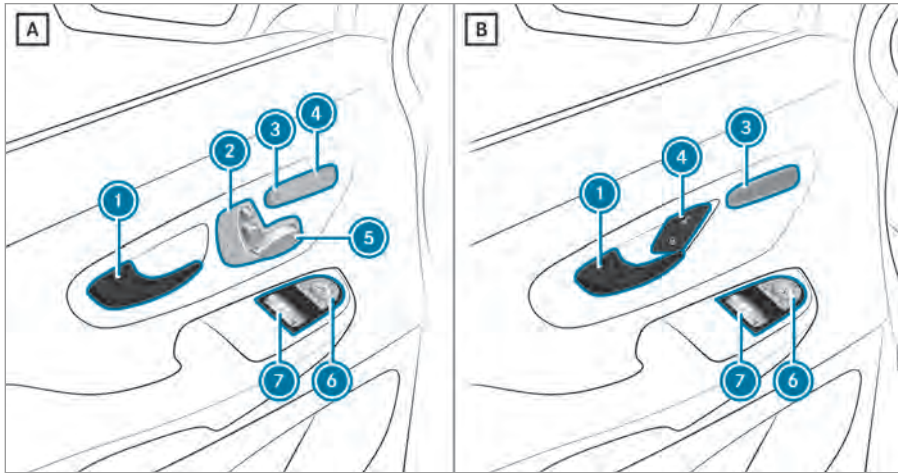

<p>A Vehicles with electrically adjustable front seats</p> <hr/> <p>B Vehicles with manually adjustable front seats</p>	<p>④ Unlocks/locks the vehicle → 45</p> <hr/> <p>⑤ Adjusts the seat electrically → 63</p> <hr/> <p>⑥ Adjusts and folds the outside mirrors in/out electrically → 87</p> <hr/> <p>⑦ Opens/closes the front side windows → 56</p>
<p>① Opens the door → 45</p> <hr/> <p>② Stores seat settings → 65</p> <p>M ① ② ③</p> <hr/> <p>③ Seat heating → 72</p>	

Environmental protection

 **ENVIRONMENTAL NOTE** Environmental damage due to operating conditions and personal driving style

The pollutant emission of the vehicle is directly related to the vehicle's operation.

Operate the vehicle in an environmentally responsible manner to make a contribution to environmental protection. To do this, observe the following recommendations on operating conditions and your personal driving style.

Operating conditions:

- ▶ Make sure that the tire pressures are always correct.
- ▶ Do not carry any unnecessary weight.
- ▶ Observe the service intervals.
A regularly serviced vehicle will contribute to environmental protection.
- ▶ Always have maintenance work carried out at a qualified specialist workshop.

Personal driving style:

- ▶ Do not depress the accelerator pedal when starting the engine.
- ▶ Do not warm up the vehicle while stationary.
- ▶ Drive carefully and maintain a sufficient distance to other vehicles.
- ▶ Avoid frequent, sudden acceleration and braking.
- ▶ Shift gears in good time and use each gear only up to $\frac{2}{3}$ of its maximum engine speed.
- ▶ Switch off the vehicle in stationary traffic.
- ▶ Drive in a fuel-efficient manner.

Environmental issues and recommendations

It is recommended that you re-use or recycle materials instead of just disposing of them.

The relevant environmental guidelines and regulations serve to protect the environment and should be followed carefully.

Genuine Mercedes-Benz parts

 **ENVIRONMENTAL NOTE** Environmental damage due to not using recycled reconditioned components

Mercedes-Benz AG offers recycled reconditioned components and parts with the same quality as new parts. The same entitlement from the Limited Warranty is valid as for new parts.

- ▶ Use recycled reconditioned components and parts from Mercedes-Benz AG.

 **NOTE** Impairment of the operating efficiency of the restraint systems from installing accessory parts or from repairs or welding

Airbags and Emergency Tensioning Devices, as well as control units and sensors for the restraint systems, may be installed in the following areas of your vehicle:

- Doors
- Door pillars
- Door sills
- Seats
- Cockpit
- Instrument cluster
- Center console

- ▶ Do not install accessories such as audio systems in these areas.
- ▶ Do not carry out repairs or welding.
- ▶ Have accessory parts retrofitted at a qualified specialist workshop.

If you use parts, tires, wheels or safety-relevant accessories which have not been approved by Mercedes-Benz, the operating safety of the vehicle may be jeopardized. Safety-relevant systems, e.g. the brake system, may malfunction. Use only genuine Mercedes-Benz parts or parts of equal quality. Use only tires, wheels and accessory parts that are approved for your vehicle model.

Information about attachments, add-on equipment, installations and conversions

Notes on body/equipment mounting directives

Both vehicle manufacturers and body manufacturers must always ensure that the products they

manufacture come into circulation only in a safe state and do not pose any risks to people. Otherwise, there may be consequences under civil, criminal or public law. All manufacturers are responsible for the products that they have manufactured. Manufacturers of attachments, add-on equipment, installations and conversions must guarantee compliance with Directive 2001/95/EC on general product safety.

Mercedes-Benz recommends the following procedure for safety reasons:

- Do not make any other changes to the vehicle.

Acceptance tests performed by public test bodies or official approvals do not rule out safety risks.

- ① You can obtain further information at a qualified specialist workshop.

⚠ WARNING Risk of accident and injury in the event of improper conversions or changes to the vehicle

Conversions or changes to the vehicle can prevent systems or components from functioning properly and/or jeopardize the vehicle's operational safety.

- ▶ Always have conversions or changes to the vehicle carried out at a qualified workshop.

If you intend to make changes to your vehicle, Mercedes-Benz strongly recommends that you contact the dealer. They will give you all the information you need. There may be a charge for this service.

If body manufacturers and dealers make modifications that affect the final inspection of the engine, vehicle or equipment, they must accept sole responsibility for the vehicle. This also applies to marking and documenting the vehicle parts affected by the changes that they make.

You are responsible for ensuring and providing evidence that the following conditions are met:

- The vehicle complies with all relevant standards and regulations that are affected by the modification.
- The modified vehicle still meets the vehicle safety standards and emissions laws and regulations.
- The modification does not impair the safety of the vehicle.

Mercedes-Benz is not responsible for the final inspection, product liability or warranty claims resulting from modification. This applies to the following points:

- The modified components or systems
- The resultant violation of emissions laws and regulations or vehicle safety standards
- All consequences resulting from the modified, less safe or even faulty vehicle

Mercedes-Benz accepts no responsibility as final manufacturer or for the resultant product liability.

Notes on the radiator

Even seemingly minor changes to the vehicle, such as attaching a radiator grille in winter, are not permitted. Do not cover the radiator. Do not use any thermal mats, insect protection covers etc.

Otherwise, the values of the vehicle's diagnostic system will be distorted. Some of these values are prescribed by law and must be correct at all times.

Notes on the partition

Without a partition, vehicles that are registered as commercial vehicles (N1) do not fulfil ISO 27956, which describes the equipment for properly securing loads in delivery vehicles. If the vehicle is used to transport goods, retrofitting the partition is strongly recommended, as properly securing the load in vehicles without a partition will always be a complex operation.

Operating Instructions

These Operating Instructions describe all models, as well as standard and optional equipment of your vehicle that was available at the time of going to press. Country-specific differences are possible. Note that your vehicle may not be equipped with all functions described. This is also the case for systems and functions relevant to safety. Therefore, the equipment on your vehicle may differ from that in the descriptions and illustrations.

The original purchase agreement documentation for your vehicle contains a list of all the systems in your vehicle.

Should you have any questions concerning equipment and operation, consult an authorized Mercedes-Benz Center.

The Operating Instructions and Maintenance Booklet are important documents and should be kept in the vehicle.

Note on vehicles which are equipped by body manufacturers

Always observe the body manufacturer's Operating Instructions. You could otherwise fail to recognize dangers.

Service and vehicle operation**Warranty**

The Limited Warranty for your vehicle is in accordance with the warranty terms and conditions in the Service and Warranty Information booklet.

Your authorized Mercedes-Benz Center will replace and repair all factory-installed parts in accordance with the terms of the following warranty terms and conditions:

- New Vehicle Limited Warranty
- Exhaust System Warranty
- Emission Systems Warranty
- California, Connecticut, Maine, Massachusetts, New York, Pennsylvania, Rhode Island and Vermont Emission Control System Warranty
- State Warranty Enforcement Laws ("Lemon Laws")

Replacement parts and accessories are covered by the Mercedes-Benz Parts and Accessories Warranties.

These are available at any authorized Mercedes-Benz Center.

- i** Should you lose your Service and Warranty Information booklet, have an authorized Mercedes-Benz Center arrange for a replacement. The new Service and Warranty Information booklet will be posted to you.

Vehicle operation outside the USA or Canada

When you are traveling abroad with your vehicle, observe the following points:

- service points or replacement parts may not be available immediately.
- unleaded fuel for vehicles with a catalytic converter may not be available. Leaded fuel can cause damage to the catalytic converter.
- the fuel may have a considerably lower octane number. Unsuitable fuel can cause engine damage.

Certain Mercedes-Benz models are available in Europe through the European Delivery Program.

For more information, please consult an authorized Mercedes-Benz Center, or write to one of the following addresses:

In the USA:

Daimler VANS USA, LLC
European Delivery Department
One Mercedes-Benz Drive
Sandy Springs, GA 30328

In Canada:

Mercedes-Benz Canada, Inc.
European Delivery Department
98 Vanderhoof Avenue
Toronto, Ontario M4G 4C9

Maintenance information

Your customer service advisor will record every service for you in the Service and Warranty Information booklet.

Information on Roadside Assistance

Roadside Assistance offers technical help in the event of a breakdown. Your calls to the toll-free Roadside Assistance Hotline are answered by our agents 24 hours a day, 365 days a year.

1-877-762-8267 (USA)

1-800-387-0100 (Canada)

You can find further information in the Roadside Assistance brochure (USA) or the "Roadside Assistance" section in the Service and Warranty booklet (Canada). You will find both in the vehicle document wallet.

Information on changing address or owner

In the event of a change of address, please send us the "Notification of Address Change" in the Service and Warranty Information booklet or simply call the Customer Assistance Center (USA) at the hotline number 1-877-762-8267 or Customer Service (Canada) at 1-800-387-0100. This way, if necessary, we can reach you in a timely fashion.

If you sell your Mercedes, please leave the entire literature in the vehicle so that it is available to the next owner. If you have purchased a used vehicle, please send us the "Notice of Purchase of Used Car" in the Service and Warranty Information booklet or call the Customer Assistance Center (USA) at the hotline number 1-877-762-8267 or Customer Service (Canada) at 1-800-387-0100.

Possible danger due to substances hazardous to health

In compliance with Proposition 65 ("Prop65"), the following detachable label has been added to each vehicle sold in California:



Operating safety

⚠ WARNING Risk of accident due to malfunctions or system failures

If you do not have the prescribed service/maintenance work or any required repairs carried out, this could result in malfunctions or system failures.

- ▶ Always have the prescribed service and maintenance work as well any required repairs carried out at a qualified specialist workshop.

⚠ WARNING Risk of accident or injury due to incorrect modifications on electronic component parts

Modification of electronic components, their software or wiring could impair their function and/or the function of other networked component parts or safety-relevant systems.

This can endanger the operating safety of the vehicle.

- ▶ Never tamper with the wiring and electronic component parts or their software.
- ▶ You should have all work on electrical and electronic components carried out at a qualified specialist workshop.

Observe the "Vehicle electronics" section in "Technical data".

⚠ WARNING Risk of fire caused by flammable material on hot exhaust system components

Flammable material such as leaves, grass or twigs may ignite if they come into contact with hot parts of the exhaust system.

- ▶ When driving on an unpaved road or off-road, check the vehicle underside regularly.
- ▶ In particular, remove trapped plant parts or other flammable material.
- ▶ If there is damage, consult a qualified specialist workshop immediately.

! NOTE Damage to the vehicle due to driving too fast and due to impacts to the vehicle underbody or suspension components

In the following situations, in particular, there is a risk of damage to the vehicle:

- The vehicle becomes grounded, e.g. on a high curb or an unpaved road
- The vehicle is driven too fast over an obstacle, e.g. a curb, speed bump or pothole
- A heavy object strikes the underbody or suspension components

In situations such as these, damage to the body, underbody, suspension components, wheels or tires may not be visible. Components damaged in this way can unexpectedly fail or, in the case of an accident, may no longer absorb the resulting force as intended.

If the underbody paneling is damaged, flammable materials such as leaves, grass or twigs can collect between the underbody and the underbody paneling. These materials may ignite if they come into contact with hot parts of the exhaust system.

- ▶ Have the vehicle checked and repaired immediately at a qualified specialist workshop.

or

- ▶ If driving safety is impaired while continuing your journey, pull over and stop the vehicle immediately, while paying attention to road and traffic conditions, and contact a qualified specialist workshop.

Declarations of conformity and notes on driving in different countries

Information about the declaration of conformity for wireless vehicle components

USA: "The wireless devices of this vehicle comply with Part 15 of the FCC Rules. Operation is subject to the following two conditions: 1) These devices may not cause harmful interference, and 2) These devices must accept any interference received, including interference that may cause undesired operation. Changes or modifications not expressly approved by the party responsible for compliance could void the user's authority to operate the equipment."

Canada: "The wireless devices of this vehicle comply with Industry Canada license-exempt RSS standard(s). Operation is subject to the following two conditions: (1) These devices may not cause interference, and (2) These devices must accept any interference, including interference that may cause undesired operation of the device."

USA: "Wireless charging system for mobile devices (Model: D-WMI2015A): this device complies with Part 18 of the FCC Rules."

The name and address of the responsible party is:
Continental Automotive Systems US Inc.
2400 Executive Hills Drive
Auburn Hills, MI 48326- 2980

Diagnostics connection

The diagnostics connection is a technical interface in the vehicle. It is used, for example, during repair and maintenance work or for reading out vehicle data in a specialist workshop. Diagnostic devices should therefore be connected only in a qualified specialist workshop.

⚠ WARNING Risk of accident due to connecting devices to the diagnostics connection

If you connect devices to the diagnostics connection of the vehicle, the function of vehicle systems and operating safety may be impaired.

- ▶ For safety reasons, we recommend that you use and connect only products approved by an authorized Mercedes-Benz Service Center.

⚠ WARNING Risk of accident due to objects in the driver's footwell

Objects in the driver's footwell may impede pedal travel or block a depressed pedal.

This jeopardizes the operating and road safety of the vehicle.

- ▶ Stow all objects in the vehicle securely so that they cannot get into the driver's footwell.
- ▶ Always install the floor mats securely and as prescribed in order to ensure that there is always sufficient room for the pedals.
- ▶ Do not use loose floor mats and do not place floor mats on top of one another.

! NOTE Battery discharging from using devices connected to the diagnostics connection

Using devices at the diagnostics connection drains the battery.

- ▶ Check the charge level of the battery.
- ▶ If the charge level is low, charge the battery, e.g. by driving a considerable distance.

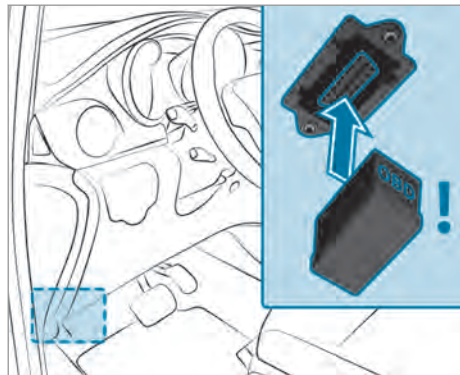

The connection and use of another device on the diagnostics connection can have the following effects:

- Malfunctions in the vehicle system
- Permanent damage to vehicle components

Please refer to the warranty terms and conditions regarding this.

In addition, connecting equipment to the diagnostics connection can lead to emissions monitoring information being reset, for example. This may lead to the vehicle failing to meet the requirements of the next emissions inspection during the main inspection.

Notes on changes to the engine output

Output increases can cause:

- Change the emission values.
- Lead to malfunctions.
- Result in consequential damage.

The operating safety of the vehicle is not guaranteed in all situations.

Any tampering with the engine management in order to increase the engine output will lead to the loss of the New Vehicle Limited Warranty and other warranty entitlements.

If you sell the vehicle, inform the buyer of any alterations to the vehicle's engine output. This may constitute a punishable offense under national legislation.

Qualified specialist workshop

A qualified specialist workshop has the necessary special skills, tools and qualifications to correctly carry out any necessary work on your vehicle. This particularly applies to work relevant to safety.

Always have the following work on the vehicle carried out at a qualified specialist workshop:

- Safety-relevant works
- Service and maintenance work
- Repair work
- Modifications as well as installations and conversions
- Work on electronic components

Mercedes-Benz recommends that you use an authorized Mercedes-Benz Center for this purpose.

Vehicle registration

Mercedes-Benz may ask its service center to carry out technical inspections on certain vehicles. The quality or safety of the vehicle is improved as a result of the inspection.

Mercedes-Benz can only inform you about vehicle checks if it Mercedes-Benz has your registration data.

In the following cases your vehicle may not be registered to you yet:

- you did not purchase your vehicle at an authorized specialist dealer.
- your vehicle has not yet been inspected at an authorized Mercedes-Benz Center.

It is advisable to register your vehicle with an authorized Mercedes-Benz Center.

Inform Mercedes-Benz as soon as possible about any change in address or vehicle ownership.

You can do this, for example, at an authorized Mercedes-Benz Center.

Correct use of the vehicle

If you remove warning stickers, you or others may fail to recognize the dangers. Leave warning stickers in position.

Observe the following information in particular when operating the vehicle:

- Safety notes in these Operating Instructions
- Technical data for the vehicle
- Traffic rules and regulations
- Laws pertaining to motor vehicles and safety standards

⚠ WARNING Risk of fire and accident when transporting substances which are hazardous to health or react aggressively

Gases and fluids can even escape from containers which are fully closed.

This can adversely affect your concentration during the journey and your health. Electronic component parts may also experience malfunctions, short circuits or system failures.

▶ Do not stow or transport any substances which are hazardous to health and/or aggressively reactive in the vehicle interior.

These instructions must also be observed for vehicles with a cargo compartment that is not fully separated from the cab.

Partition with door/window: always keep the door/window in the partition closed while transporting items.

Substances that constitute a health hazard or react aggressively include, for example:

- Solvents
- Fuel
- Oil and grease
- Cleaning agents
- Acid

Multi Purpose vehicle

⚠ WARNING Risk of accident when the center of gravity is too high

The vehicle may start to skid and rollover in the event of sudden steering maneuvers and/or when the vehicle's speed is not adapted to the road conditions.

▶ Always adapt your speed and driving style to the vehicle's driving characteristics and to the prevailing road and weather conditions.

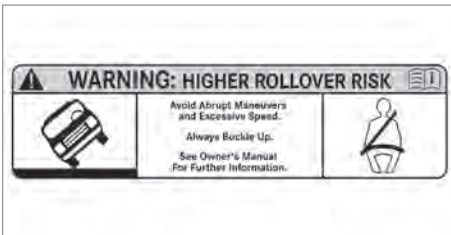

Utility vehicles have a significantly higher rollover rate than other types of vehicles.

Unsafe operation of the vehicle can result in an accident or rollover, as well as serious or even fatal injuries.

In a rollover crash, an unbelted person is significantly more likely to die than a person wearing a seat belt.

You and all vehicle occupants should always wear seat belts.

Notes for persons with electronic medical aids

Mercedes-Benz AG cannot, despite carefully developing vehicle systems, completely rule out the interaction of vehicle systems with electronic medical aids such as cardiac pacemakers.

In addition, there are components built into the vehicle that, regardless of the operating status of

your vehicle, can generate magnetic fields on a par with permanent magnets. These fields can be found, for example, in the area around the multimedia and sound system or also in the seating area, depending on the vehicle equipment.

For this reason, the following can occur in isolated cases, depending on the aids used:

- Medical aids malfunctioning
- Adverse health effects

Observe the notes and warnings of the manufacturer of the medical aids; if in doubt, contact the device manufacturer and/or your doctor. If there is continuing uncertainty concerning the possibility of medical aids malfunctioning, Mercedes-Benz AG recommends using only few electrical vehicle systems and/or maintaining a distance from the components.

Only have repairs and maintenance work in the area of the following components carried out at a qualified specialist workshop:

- Vehicle components carrying live voltage
- Transmission antenna
- Multimedia system and sound system

If you have any queries or suggestions, consult a qualified specialist workshop.

Information on problems with your vehicle

If you should experience a problem with your vehicle, particularly one that you believe may affect its safe operation, we urge you to contact an authorized Mercedes-Benz Center immediately to have the problem diagnosed and rectified.

If the problem is not resolved to your satisfaction, please contact an authorized Mercedes-Benz Center again or write to one of the following addresses.

In the USA:

Daimler VANS USA, LLC
Customer Assistance Center
One Mercedes-Benz Drive
Sandy Springs, GA 30328

In Canada:

Mercedes-Benz Canada, Inc.
Customer Relations Department
98 Vanderhoof Avenue
Toronto, Ontario M4G 4C9

"Reporting safety defects"

USA only:

The following text is published as required of manufacturers under Title 49, Code of U.S. Federal Regulations, Part 575 pursuant to the "National Traffic and Motor Vehicle Safety Act of 1966".

If you believe that your vehicle has a defect which could cause a crash or could cause injury or death, you should immediately inform the National Highway Traffic Safety Administration (NHTSA) in addition to notifying Mercedes-Benz USA, LLC.

If NHTSA receives similar complaints, it may open an investigation, and if it finds that a safety defect exists in a group of vehicles, it may order a recall and remedy campaign. However, NHTSA cannot become involved in individual problems between you, your dealer, or Mercedes-Benz USA, LLC.

Für Übersetzung: To contact NHTSA, you may call the Vehicle Safety Hotline toll-free at 1-888-327-4236 (TTY: 1-800-424-9153); go to <https://www.safercar.gov>; or write to: Administrator, NHTSA, 400 Seventh Street, SW., Washington, DC 20590, USA.

You can find more information on vehicle safety at: <https://www.safercar.gov>

Canada only:

The following text is published as required of manufacturers under subsection 18.4 (4) of the Motor Vehicle Safety Regulations.

If you believe that your vehicle has a defect which could cause a crash or could cause injury or death, you should immediately inform Transport Canada in addition to notifying Mercedes-Benz Canada Inc.

If Transport Canada received similar complaints, it may open an investigation, and if it finds that a safety defect exists in a group of vehicles, it may order a recall and remedy campaign. However, Transport Canada cannot become involved in individual problems between you, your dealer, or Mercedes-Benz Canada Inc.

To contact Transport Canada, you may call the Defect Investigations and Recalls Division toll-free in Canada at 1-800-333-0510 or 819-994-3328 in the Gatineau-Ottawa area or internationally; may also go to the following websites for more information:

- English: www.tc.gc.ca/recalls
- French: www.tc.gc.ca/rappels

Limited Warranty

! **NOTE** Damage to the vehicle arising from violation of these operating instructions.

Damage to the vehicle can arise from violation of these operating instructions.

Such damage is not covered by either the Limited Warranty or the new or used-vehicle warranty.

► Observe the instructions in these operating instructions on proper operation of your vehicle as well as regarding possible vehicle damage.

QR codes for rescue card

The QR code stickers are affixed to the B-pillar on the driver's and front passenger side. In the event of an accident, emergency services can use the QR code to quickly determine the corresponding rescue card for your vehicle. The current rescue card contains the most important information about your vehicle in a compact form, e.g. the routing of the electric lines.

Further information can be obtained at <https://www.mercedes-benz.de/qrcode>

Data storage

Data processing in the vehicle

Electronic control units

Electronic control units are installed in your vehicle. Control units process data which, for example, they receive from vehicle sensors, generate themselves or exchange between themselves. Some control units are required for the safe operation of your vehicle, some assist you when driving, such as driver assistance systems, while others enable convenience or infotainment functions.

The following provides you with general information regarding data processing in the vehicle. Additional information regarding exactly which data in your vehicle are collected, saved and transmitted to third parties, and for what purpose, can be found in the information directly related to the functional characteristics in question in their respective operating instructions. This information is also available online and, depending on the vehicle equipment, digitally.

Personal data

Every vehicle is identified by a unique vehicle identification number. Depending on the country, this vehicle identification number can be used by, for example, governmental authorities to determine the identity of the owner. There are other possibilities for using data collected from the vehicle to identify the owner or driver, such as the license plate number.

Therefore, data generated or processed by control units may be attributable to a person or, under certain conditions, become attributable to a person. Depending on which vehicle data are available, it may be possible to make inferences about, for example, your driving behavior, your location, your route or your use patterns.

Legal requirements regarding the disclosure of data

If legally required to do so, manufacturers are, in individual cases, legally obliged to provide governmental entities, upon request and to the extent required, data stored by the manufacturer. For example, this may be the case during the investigation of a criminal offense.

Governmental entities are themselves, in individual cases and within the applicable legal framework, authorized to read out data from the vehicle. In the case of an accident, information that can help with an investigation can, therefore, be taken from the airbag control unit, for example.

Operational data in the vehicle

This is data regarding the operation of the vehicle, which have been processed by control units.

This includes the following data, for example:

- Vehicle status information such as the speed, longitudinal acceleration, lateral acceleration, number of wheel revolutions or the fastened seat belts display
- Ambient conditions, such as temperature, rain sensor or distance sensor

Generally, these are volatile data and will not be stored beyond the period of operation but will only be processed within the vehicle itself. Control units, vehicle SmartKeys for example, often contain data memories. Their use permits the temporary or permanent documentation of technical information about the vehicle's operating state, component loads, maintenance requirements and technical events or malfunctions.

Depending on the technical equipment, the following data are stored:

- Operating status of system components, such as fill levels, tire pressure or battery status
- Malfunctions or faults in important system components, such as lights or brakes
- System reactions in special driving situations, such as airbag deployment or the intervention of stability control systems
- Information on events in which the vehicle is damaged

In certain cases, it may be required to store data that would have otherwise been temporary. This may be the case if the vehicle has detected a malfunction, for example.

If you use services such as repair services and maintenance work, stored operational data as well as the vehicle identification number can be read out and used. They can be read out by service network employees, such as workshops and manufacturers or third parties, such as breakdown services. The same is true in the case of warranty claims and quality assurance measures.

In general, the readout is performed via the legally prescribed port for the diagnostics connection in the vehicle. The operational data that are read out document technical states of the vehicle or of individual components and assist in the diagnosis of malfunctions, compliance with warranty obligations and quality improvement. To that end, these data, in particular information about component loads, technical events, malfunctions and other faults may be transmitted along with the vehicle identification number to the manufacturer. In addition, the manufacturer is subject to product liability. For this reason, the manufacturer also uses operational data from the vehicle, for example, for recalls. These data can also be used to examine the customer's warranty and guarantee claims.

Fault memories in the vehicle can be reset by a service outlet or at your request as part of repair or maintenance work.

Convenience and infotainment functions

You can store convenience settings and individual settings in the vehicle and change or reset them at any time.

Depending on the vehicle equipment, this includes the following settings, for example:

- Seat and steering wheel positions
- Suspension and climate control settings
- Individual settings, such as interior lighting

Depending on the selected equipment, you can import data into vehicle infotainment functions yourself.

Depending on the vehicle equipment, this includes the following data, for example:

- Multimedia data, such as music, films or photos for playback in an integrated multimedia system
- Address book data for use in an integrated hands-free system or an integrated navigation system
- Entered navigation destinations
- Data on the use of Internet services

These data for convenience and infotainment functions may be saved locally in the vehicle or they may be located on a device which you have connected to the vehicle, such as a smartphone, USB flash drive or MP3 player. If you have entered these data yourself, you can delete them at any time.

These data are transmitted from the vehicle to third parties only at your request. This applies, in particular, when you use online services in accordance with the settings that you have selected.

Smartphone integration (e.g. Android Auto or Apple CarPlay®)

If your vehicle is equipped appropriately, you can connect your smartphone or another mobile end device to the vehicle. You can then control them by means of the control elements integrated in the vehicle. The smartphone's picture and sound can be output via the multimedia system. Simultaneously, specific items of information are transferred to your smartphone. Depending on the type of integration, this includes position data, day/night mode and other general vehicle statuses. For more information, please consult the vehicle/infotainment Operating Instructions.

This integration allows the use of selected smartphone apps, such as navigation or music player apps. There is no additional interaction between the smartphone and the vehicle, particularly active access to vehicle data. The type of additional data processing is determined by the provider of the app being used. Which settings you can make, if

any, depends on the specific app and the operating system of your smartphone.

Online services

Wireless network connection

If your vehicle has a wireless network connection, data can be exchanged between your vehicle and other systems. The wireless network connection is made possible by the vehicle's own transmitter and receiver or by a mobile end device that you have brought into the vehicle, for example, a smartphone. Online functions can be used via this wireless network connection. This includes online services and applications/apps provided to you by the manufacturer or by other providers.

Manufacturer's own services

Regarding the manufacturer's online services, the individual functions are described by the manufacturer in a suitable place, for example, in the Operating Instructions or on the manufacturer's website, where the relevant data protection information is also given. Personal identification data may be used to provide online services. Data is exchanged via a secure connection, e.g. the manufacturer's designated IT systems. Any personal data which are collected, processed and used, other than for the provision of legal services, is done so exclusively on the basis of legal permission. This is the case, for example, for a legally prescribed emergency call system, a contractual agreement or when consent has been given.

You can have services and functions, some of which are subject to a fee, activated or deactivated. This excludes legally prescribed functions and services, such as an emergency call system.

Services of third parties

If you use online services from other providers (third parties), these services are the responsibility of the provider in question and subject to that provider's data protection conditions and terms of use. As a general rule, the manufacturer has no influence on the content exchanged.

For this reason, when services are provided by third parties, please ask the service provider in question for information about the type, extent and purpose of the collection and use of personal data.

Onboard Logic Unit (OLU)

The Onboard Logic Unit (OLU) is available to commercial customers.

It contains control units, including antennas for connection via wireless networks, that permit the

exchange of data between your vehicle and other systems. The control units can be used in conjunction with service provided by a third party. Under certain circumstances, these services may alter the basic configuration of the vehicle and could affect the performance of certain vehicle functions.

For further information about specific services, read the operating instructions of the third-party provider. For further information about the Onboard Logic Unit, consult an authorized Mercedes-Benz Center.

If you, yourself, do not own and are not responsible for the vehicle, you may not know the current status of the Onboard Logic Unit. For further information concerning the services which are currently active, including any data which may be being processed as defined by the GDPR, please contact the person responsible for the vehicle.

Data protection rights

Depending on your country or the equipment and range of functions of your vehicle as well as the services you use and the services on offer, you are entitled to different data protection rights. Further information on data protection and your data protection rights can either be found on the manufacturer's website or you will receive this information as part of the various services and service offers. There, you will also find the contact information for the manufacturer and its data protection officer.

At a workshop, for example, with the support of a specialist and possibly for a fee, you can have data read out which is stored only locally in the vehicle.

Event Data Recorders

USA only:

This vehicle is equipped with an event data recorder (EDR). The main purpose of an EDR is to record, in certain crash or near crash-like situations, such as an air bag deployment or hitting a road obstacle, data that will assist in understanding how a vehicle's systems performed. The EDR is designed to record data related to vehicle dynamics and safety systems for a short period of time, typically 30 seconds or less.

The EDR in this vehicle is designed to record such data as:

- How various systems in your vehicle were operating;
- Whether or not the driver and passenger safety belts were buckled/fastened;
- How far (if at all) the driver was depressing the accelerator and/or brake pedal; and,
- How fast the vehicle was traveling.

These data can help provide a better understanding of the circumstances in which crashes and injuries occur. NOTE: EDR data are recorded by your vehicle only if a non-trivial crash situation occurs; no data are recorded by the EDR under normal driving conditions and no personal data (e.g. name, gender, age and crash location) are recorded. However, other parties such as law enforcement could combine the EDR data with the type of personally identifying data routinely acquired during a crash investigation.

Access to the vehicle and/or the EDR is needed to read data that is recorded by an EDR, and special equipment is required. In addition to the vehicle manufacturer, other parties that have the special equipment, such as law enforcement, can read the information by accessing the vehicle or the EDR.

EDR data may be used in civil and criminal matters as a tool in accident reconstruction, accident claims and vehicle safety. Since the Crash Data Retrieval CDR tool that is used to extract data from the EDR is commercially available, Daimler Vans USA, LLC ("DVUSA") expressly disclaims any and all liability arising from the extraction of this information by unauthorized Mercedes-Benz personnel.

DVUSA will not share EDR data with others without the consent of the vehicle owners or, if the vehicle is leased, without the consent of the lessee.

Exceptions to this representation include responses to subpoenas by law enforcement; by federal, state or local government; in connection with or arising out of litigation involving DVUSA or its subsidiaries and affiliates; or, as required by law.

Warning: The EDR is a component of the Restraint System Module. Tampering with, altering, modifying or removing the EDR component may result in a malfunction of the Restraint System Module and other systems.

State laws or regulations regarding EDRs that conflict with federal regulation are pre-empted. This means that in the event of such conflict, the federal regulation governs. As of December 2016, 17 states have enacted laws relating to EDRs.

Copyright

Information on free and open-source software

Information on license for free and open-source software used in your vehicle can be found on the data storage medium in your vehicle document wallet and with updates on the following website:
<https://www.mercedes-benz.com/opensource>.

Information on registered trademarks

- Bluetooth® is a registered trademark of Bluetooth SIG Inc.
- DTS™ is a registered trademark of DTS, Inc.
- Dolby® and MLP™ are registered trademarks of DOLBY Laboratories.
- ESP® and PRE-SAFE® are registered trademarks of Daimler AG.
- HomeLink® is a registered trademark of Genex Corporation.
- iPod® and iTunes® are registered trademarks of Apple Inc.
- Burmester® is a registered trademark of Burmester Audiosysteme GmbH.
- Microsoft® and Windows Media® are registered trademarks of Microsoft Corporation.
- SIRIUS® is a registered trademark of Sirius XM Radio Inc.
- HD Radio™ is a registered trademark of iBiquity Digital Corporation.
- Gracenote® is a registered trademark of Gracenote, Inc.
- ZAGAT Survey® and related brands are registered trademarks of Zagat Survey, LLC.

Restraint system

Protection provided by the restraint system

The restraint system includes the following components:

- Seat belt system
- Airbags
- Child restraint system
- Child seat securing systems

The restraint system can help prevent the vehicle occupants from coming into contact with parts of the vehicle interior in the event of an accident. In the event of an accident, the restraint system can also reduce the forces to which the vehicle occupants are subjected.

Only a seat belt which is worn correctly can provide the intended level of protection. Depending on the detected accident situation, seat belt tensioners and/or airbags supplement the protection offered by a correctly worn seat belt. Seat belt tensioners and/or airbags are not deployed in every accident.

In order for the restraint system to provide the intended level of protection, each vehicle occupant must observe the following information:

- Fasten seat belts correctly.
- Sit in an almost upright seat position with their back against the seat backrest.
- Sit with their feet resting on the floor, if possible.
- Always secure persons under 5 ft (1.50 m) tall in an additional restraint system suitable for this vehicle.

However, no system available today can completely eliminate injuries and fatalities in every accident situation. In particular, the seat belt and airbag generally do not protect against objects penetrating the vehicle from the outside. It is also not possible to completely rule out the risk of injury caused by the airbag deploying.

Limitations of the protection provided by the restraint system

⚠ WARNING Risk of injury or death due to modifications to the restraint system

Vehicle occupants may no longer be protected as intended if alterations are made to the restraint system.

- ▶ Never alter the parts of the restraint system.
- ▶ Never tamper with the wiring or any electronic component parts or their software.

If it is necessary to adjust the vehicle to accommodate a person with disabilities, contact an authorized Mercedes-Benz Center for details.



USA only: contact our Customer Assistance Center at 1-877-762-8267.

Restraint system functionality

When the vehicle is switched on, a self-test is performed, during which the  restraint system warning lamp lights up. It goes out no later than a few seconds after the vehicle is started. The components of the restraint system are then functional.

Restraint system malfunction

A malfunction has occurred in the restraint system in the following cases:

- The  restraint system warning lamp does not light up when the vehicle is switched on.
- The  restraint system warning lamp lights up continuously or repeatedly during a journey.

⚠ WARNING Risk of injury due to malfunctions in the restraint system

Components in the restraint system may be activated unintentionally or not deploy as planned in an accident.

- ▶ Have the restraint system checked and repaired immediately at a qualified specialist workshop.

Function of the restraint system in an accident

How the restraint system works is determined by the severity of the impact detected and the type of accident anticipated:

- Frontal impact
- Rear impact
- Side impact
- Overturning or rollover

The activation thresholds for the components of the restraint system are determined based on the evaluation of the sensor values measured at vari-

ous points in the vehicle. This process is pre-emptive in nature. The triggering/deployment of the components of the restraint system should take place in good time at the start of the collision.

Factors which can only be seen and measured after a collision has occurred cannot play a decisive role in airbag deployment. Nor do they provide an indication of airbag deployment.

The vehicle may be deformed significantly without an airbag being deployed. This is the case if only parts which are relatively easily deformed are affected and the rate of vehicle deceleration is not high. Conversely, an airbag may be deployed even though the vehicle suffers only minor deformation. If very rigid vehicle parts, such as longitudinal members, are hit, the vehicle deceleration may be high enough for this to happen.

Depending on the detected deployment situation, the components of the restraint system can be activated or deployed independently of each other:

- Emergency Tensioning Device: frontal impact, rear impact, side impact, overturn, rollover
- Driver's airbag, front passenger airbag: frontal impact
- Side airbag: side impact
- Window airbag: side impact, overturn, rollover, frontal impact

The co-driver airbag can only be deployed in the event of an accident if the PASSENGER AIR BAG OFF indicator lamp is off. If the co-driver seat is occupied, make sure, both before and during the journey, that the status of the co-driver airbag is correct (→ page 32).

⚠ WARNING Risk of burns from hot air bag components

The air bag parts are hot after an air bag has been deployed.

- ▶ Do not touch the air bag parts.
- ▶ Have a deployed air bag replaced at a qualified specialist workshop as soon as possible.

Mercedes-Benz recommends that you have the vehicle towed to a qualified specialist workshop after an accident. Take this into account, particularly if an Emergency Tensioning Device is triggered or an airbag deployed.

If the Emergency Tensioning Devices are triggered or an airbag is deployed, you will hear a bang, and a small amount of powder may also be released:

- The bang will not generally affect your hearing.
- In general, the powder released is not hazardous to health but may cause short-term breathing difficulties to persons suffering from asthma or other pulmonary conditions.

Provided it is safe to do so, leave the vehicle immediately or open the window in order to prevent breathing difficulties.

Airbags and pyrotechnic Emergency Tensioning Devices contain perchlorate material, which may require special handling or environmental protection measures. National guidelines regarding waste disposal must be observed. In California see <https://dtsc.ca.gov/>. You can use the search function to find information on perchlorate, for example.

Seat belts

Protection provided by the seat belt

Always fasten your seat belt correctly before starting a journey. Only a seat belt which is worn correctly can provide the intended level of protection.

⚠ WARNING Risk of injury or death due to incorrectly fastened seat belt

If the seat belt is not worn correctly, it cannot perform its intended protective function.

In addition, an incorrectly fastened seat belt can also cause injuries, for example, in the event of an accident or when braking or changing direction suddenly.

- ▶ Always ensure that all vehicle occupants have their seat belts fastened correctly and are sitting properly.

Always observe the instructions about the correct driver's seat position and adjusting the seat (→ page 61).

In order for the correctly worn seat belt to provide the intended level of protection, each vehicle occupant must observe the following information:

- The seat belt must not be twisted and must fit tightly and snugly across the body.
- The seat belt must be routed across the center of the shoulder and as low down across the hips as possible.

- The shoulder section of the seat belt should not touch your neck nor be routed under your arm or behind your back.
- Avoid wearing bulky clothing, e.g. a winter coat.
- Push the lap belt down as far as possible across your hips and pull tight with the shoulder section of the belt. Never route the lap belt across your abdomen.

Pregnant women must also take particular care with this.

- Never route the seat belt across sharp, pointed, abrasive or fragile objects.
- Only one person should use each seat belt at any one time.
- Never secure objects with a seat belt if the seat belt is being used by one of the vehicle's occupants.

Also ensure that no objects, e.g. a cushion, are ever placed between a person and the seat.

The seat belts on the following seats are equipped with a child seat safety feature:

- Co-driver seat
- Rear seats

Activate or deactivate the child seat safety feature of the seat belt (→ page 37).

If children are traveling in the vehicle, always observe the instructions and safety notes on "Children in the vehicle" (→ page 35).

Always observe the instructions for loading the vehicle when securing objects, luggage or loads (→ page 164).

Limitations of the protection provided by the seat belt

▲ WARNING Risk of injury or death due to an incorrect seat position

The seat belt does not offer the intended level of protection if you have not moved the seat backrest to an almost vertical position.

In particular, you could slip beneath the seat-belt and become injured.

- ▶ Adjust the seat properly before beginning your journey.
- ▶ Always ensure that the seat backrest is in an almost vertical position and that

the shoulder belt is routed across the center of your shoulder.

▲ WARNING Risk of injury or death when additional restraint systems are not used for persons with a smaller stature

Persons under 5 ft (1.50 m) tall cannot wear the seat belt correctly without a suitable additional restraint system.

- ▶ Always secure persons under 5 ft (1.50 m) tall in a suitable restraint system.

▲ WARNING Risk of injury or death due to damaged or modified seat belts

Seat belts cannot provide protection in the following situations:

- The seat belt is damaged, has been modified, is extremely dirty, bleached or dyed
- The seat belt buckle is damaged or extremely dirty
- Modifications have been made to the Emergency Tensioning Device, seat belt anchorage or seat belt retractor

Seat belts may sustain non-visible damage in an accident, e.g. due to glass splinters.

Modified or damaged seat belts could tear or fail in the event of an accident, for example.

Modified Emergency Tensioning Devices could accidentally trigger or fail to function as intended.

- ▶ Never modify the seat belt system, for example the seat belt, seat belt buckle, Emergency Tensioning Device, seat belt anchorage and seat belt retractor.
- ▶ Make sure that the seat belts are undamaged, not worn and clean.
- ▶ Always have the seat belts checked immediately after an accident at a qualified specialist workshop.

Mercedes-Benz recommends that you use seat belts which have been approved for your vehicle by Mercedes-Benz.

⚠ WARNING Risk of injury or death from deployed pyrotechnic Emergency Tensioning Devices

Pyrotechnic Emergency Tensioning Devices that have been deployed are no longer operational and are unable to perform their intended protective function.

- ▶ Therefore, have deployed pyrotechnic Emergency Tensioning Devices immediately replaced at a qualified specialist workshop.

Mercedes-Benz recommends that you have the vehicle towed to a qualified specialist workshop after an accident.

! NOTE Damage caused by trapping the seat belt

If an unused seat belt is not fully retracted, it may become trapped in the door or in the seat mechanism.

- ▶ Always ensure that an unused seat belt is fully retracted.

Fastening and adjusting seat belts

If the seat belt is pulled quickly or sharply, the seat belt retractor locks. The seat belt strap cannot be pulled out any further.

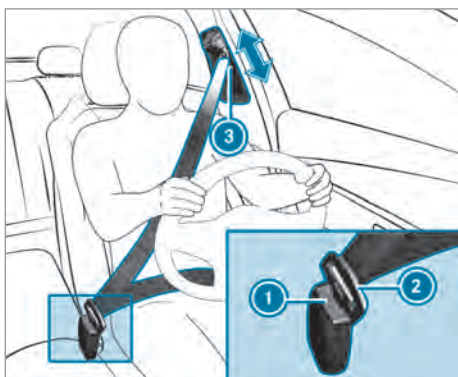

- ▶ Always engage seat belt tongue ② of the seat belt into seat belt buckle ① of the corresponding seat.
- ▶ Press and hold the seat belt outlet release and slide seat belt outlet ③ into the desired position.

- ▶ Let go of the seat belt outlet release and ensure that seat belt outlet ③ locks into position.

① Only a seat belt which is worn correctly can provide the intended level of protection. Observe the notes on fastening the seatbelt (→ page 26).

! NOTE Deployment of components of the restraint system when the front passenger seat is unoccupied and a seat belt is buckled

When the front passenger seat is unoccupied and the seat belt tongue of the seat belt is engaged in the seat belt buckle, components of the restraint system may deploy unnecessarily on the front passenger side, e.g. the Emergency Tensioning Device.

- ▶ Only buckle the seat belts as intended.

① Observe the notes on stowage areas (→ page 164). Information on installing a child restraint system and on children traveling in the vehicle can be found in the "Children in the vehicle" section (→ page 36).

Releasing the seat belt

- ▶ Press the release button in the seat belt buckle and guide the seat belt back with the seat belt tongue.

Function of the seat belt warning system for driver and co-driver

The  seat belt warning lamp in the Instrument Display is a reminder that all vehicle occupants must wear their seat belts correctly.

The  seat belt warning lamp lights up for six seconds each time the vehicle is switched on.

A warning tone may also sound.

After the vehicle is started, the seat belt warning goes out as soon as the driver's and the co-driver's seat belts are fastened.

While driving, the seat belt warning lights up in the following cases:

- If the vehicle's speed is higher than 15 mph (25 km/h) and the driver's or co-driver's seat belt is not fastened
- If the driver or co-driver unfasten their seat belt during the journey

Airbags

Overview of airbags

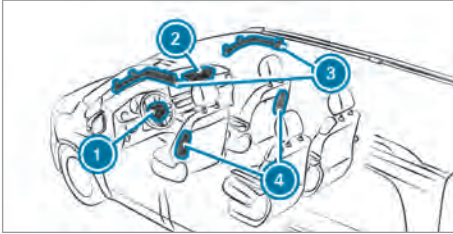

Example: vehicles with window airbag above front door

- ① Driver's airbag
- ② Co-driver's airbag
- ③ Window airbag
- ④ Side airbag

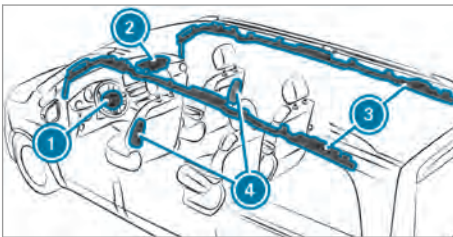

Example: vehicles with window airbag for all rows of seats

- ① Driver's airbag
- ② Co-driver's airbag
- ③ Window airbag
- ④ Side airbag

An airbag's installation location is identified by the label AIRBAG.

When enabled, an airbag can provide additional protection for the respective vehicle occupant.

Possible protection per airbag:

- Driver's airbag, co-driver's airbag: head and ribcage
- Window airbag: head
- Side airbag: ribcage and pelvis

⚠ WARNING Risk of injury or death if the co-driver airbag is enabled

If the co-driver airbag is enabled, a child on the co-driver seat may be struck by the co-driver airbag during an accident.

NEVER use a rearward-facing child restraint system on a seat with an ENABLED FRONT AIRBAG; DEATH or SERIOUS INJURY to the CHILD can occur.

When installing a child restraint system on the co-driver's seat, observe the vehicle-specific information (→ page 39). Also be sure to observe the notes on rearward-facing or forward-facing child restraint systems on the co-driver's seat.

Information on the automatic co-driver's airbag shutoff

The co-driver's airbag can only be deployed in the event of an accident if the PASSENGER AIR BAG OFF indicator lamp is off. If the co-driver's seat is occupied, make sure, both before and during the journey, that the status of the co-driver's airbag is correct (→ page 32).

! **NOTE** Deployment of components of the restraint system when the front passenger seat is unoccupied

In an accident, the components of the restraint system may deploy unnecessarily on the front passenger side if:

- There are heavy objects on the front passenger seat.
- The seat belt tongue is engaged in the seat belt buckle of the front passenger seat and the front passenger seat is unoccupied.

- ▶ Store objects in a suitable place.
- ▶ Only one person should use each seat belt at any one time.

Protection provided by the airbags

Depending on the accident situation, an airbag may supplement the protection offered by a correctly fastened seat belt.

⚠ WARNING Risk of injury or death due to an incorrect seat position

If you deviate from the correct seat position, the airbag cannot perform its intended protective function.

Each vehicle occupant must make sure of the following:

- Fasten seat belts correctly. Pregnant women must take particular care to ensure

that the lap belt never lies across the abdomen.

- Adopt the correct seat position and keep as far away as possible from the airbags.
- Observe the following information.

▶ Always make sure that there are no objects between the airbag and vehicle occupant.

To avoid the risks resulting from the deployment of an airbag, each vehicle occupant must observe the following information in particular:

- Before starting your journey, adjust your seat correctly; both the driver's and co-driver seat should be moved as far back as possible. When doing so, always observe the information on the correct driver's seat position (→ page 61).
- Only hold the steering wheel by the steering wheel rim. This allows the airbag to be fully deployed.
- Always lean against the seat backrest when the vehicle is in motion. Do not lean forwards or against the door or side window. You may otherwise be in the deployment area of the airbags.
- Always keep your feet on the floor. Do not put your feet on the cockpit, for example. Your feet may otherwise be in the deployment area of the airbag.
- If children are traveling in the vehicle, observe the additional notes (→ page 35).
- Always stow and secure objects correctly.

Objects in the vehicle interior may prevent an airbag from functioning correctly. Each vehicle occupant must always make sure of the following in particular:

- There are no people, animals or objects between the vehicle occupants and an airbag.
- There are no objects between the seat, door and door pillar (B-pillar).
- There are no hard objects, e.g. coat hangers, hanging on the grab handles or coat hooks.
- There are no accessories, such as mobile navigation devices, mobile phones or cup holders, within the deployment area of an airbag, e.g. on the cockpit, on the door, on the side window or on the side trim.

In addition, no connecting cables, tensioning straps or retaining straps must be routed or attached to the vehicle within the deployment area of an airbag. Always comply with the accessory manufacturer's installation instructions and, in particular, the notes on suitable places for installation.

- There are no heavy, sharp-edged or fragile objects in the pockets of your clothing. Store such objects in a suitable place.

Limitations of the protection provided by airbags

⚠ WARNING Risk of injury due to modifications to the cover of an airbag

If you change the cover of an airbag or attach objects, e.g. even stickers, to it, the airbag may no longer function as intended.

- ▶ Never modify the cover of an airbag.
- ▶ Do not attach any objects to the cover.

An airbag's installation location is identified by the label AIRBAG (→ page 29).

Objects in the deployment area of an airbag may prevent the airbag from functioning correctly.

⚠ WARNING Risk of injury from objects in the deployment area of an airbag

Objects in the deployment area of an airbag can hinder or prevent the correct deployment of the airbag.

The airbag may then deploy in an uncontrolled manner and may even cause additional injuries to the vehicle occupants by deploying. This may be the case in particular if the airbag is integrated into the seat.

- ▶ Always stow and secure objects correctly.
- ▶ Before commencing your journey, make sure that no objects are stowed in the deployment area of an airbag.

⚠ WARNING Risk of injury or death due to the use of unsuitable seat covers

Due to unsuitable seat covers, the airbags cannot protect vehicle occupants as intended.

In addition, the operation of the automatic front passenger airbag shutoff could be restricted.

- ▶ You should only use seat covers that have been approved for the corresponding seats by Mercedes-Benz.

Vehicles with window airbags in all rows of seats:

⚠ WARNING Risk of injury due to malfunctioning sensors in the door

The function of the airbags can be impaired due to modifications or incorrect work performed on the doors or door trim, or if the doors are damaged.

- ▶ Never modify the doors or parts of the doors.
- ▶ Always have work on the doors or door trim carried out at a qualified specialist workshop.

⚠ WARNING Risk of injury due to deployed airbag

A deployed airbag no longer offers any protection.

- ▶ Have the vehicle towed to a qualified specialist workshop in order to have the deployed airbag replaced.

Have deployed airbags replaced immediately.

Status of the co-driver airbag

Function of the automatic co-driver's airbag shutoff

The automatic co-driver's airbag shutoff is able to detect whether the co-driver's seat is occupied by a person or a child restraint system. The co-driver's airbag is enabled or disabled accordingly.

⚠ WARNING Risk of injury or death due to objects under the co-driver seat

Objects trapped under the co-driver seat can interfere with the function of the automatic co-driver airbag shutoff or damage the system.

- ▶ Do not store any objects under the co-driver seat.
- ▶ When the co-driver seat is occupied, make sure that no objects are trapped under the co-driver seat.

When installing a child restraint system on the co-driver's seat, observe the vehicle-specific information (→ page 40). Also be sure to observe the

notes on rearward-facing or forward-facing child restraint systems on the co-driver's seat (→ page 39).

⚠ WARNING Risk of injury or death due to objects between the seat surface and the child restraint system

Objects between the sitting surface and the child restraint system could affect the function of the automatic co-driver airbag shutoff.

- ▶ Do not place any objects between the sitting surface and the child restraint system.
- ▶ Make sure that the entire base of the child restraint system is resting on the sitting surface of the co-driver seat.
- ▶ Make sure that the backrest of the forward-facing child restraint system is, as far as possible, resting on the seat backrest of the co-driver seat.
- ▶ Always comply with the child restraint system manufacturer's installation instructions.

A person on the co-driver's seat must observe the following information:

- Fasten seat belts correctly (→ page 26).
- Sit in an almost upright seat position with their back against the seat backrest.
- Sit with their feet resting on the floor, if possible.

The co-driver's airbag may otherwise be disabled by mistake, for example, in the following situations:

- The co-driver transfers their weight by supporting themselves on a vehicle armrest.
- The co-driver sits in such a way that their weight is raised from the seat surface.

⚠ WARNING Risk of injury or death due to a disabled front passenger airbag

The front passenger airbag is disabled when the PASSENGER AIR BAG OFF indicator lamp is lit.

A person in the front passenger seat could then, for example, come into contact with the vehicle interior, especially if the person is sitting too close to the cockpit.

If the front passenger seat is occupied, always ensure that:

- The classification of the person in the front passenger seat is correct and the front passenger airbag is enabled or disabled in accordance with the person in the front passenger seat.
 - The front passenger seat has been moved as far back as possible.
 - The person is seated correctly.
- ▶ Both before and during the journey, ensure that the status of the front passenger airbag is correct.

If the co-driver's seat is occupied, the classification of the person or child restraint system on the co-driver's seat takes place after the co-driver's airbag shutoff self-test. The PASSENGER AIR BAG OFF indicator lamp displays the status of the co-driver's airbag.

Always observe the notes on the function of the PASSENGER AIR BAG OFF indicator lamp (→ page 32).

Function of the PASSENGER AIR BAG indicator lamp



Self-test of automatic co-driver airbag shutoff

When the vehicle is switched on, a self-test is performed during which the PASSENGER AIR BAG OFF indicator lamp lights up for approximately six seconds.

The status of the co-driver airbag is displayed after the self-test:

- PASSENGER AIR BAG OFF is not lit: the co-driver airbag may deploy during an accident.
- PASSENGER AIR BAG OFF lights up continuously: the co-driver airbag is disabled. It will not be deployed in the event of an accident.

If the PASSENGER AIR BAG OFF indicator lamp and the  restraint system warning lamp light up simultaneously, the co-driver's seat may not be used. Also in this case, do not install a child restraint system on the co-driver's seat. Have the automatic co-driver airbag shutoff checked and repaired immediately at a qualified specialist workshop.

Status indicator

If the co-driver's seat is occupied, ensure, both before and during the journey, that the status of the co-driver airbag is correct for the current situation.

After installing a rearward-facing child restraint system on the co-driver's seat: PASSENGER AIR BAG OFF must be lit continuously.

⚠ WARNING Risk of injury or fatal injury when using a rearward-facing child restraint system while the co-driver airbag is enabled

If you secure a child in a rearward-facing child restraint system on the co-driver seat and the PASSENGER AIR BAG OFF indicator lamp is off, the co-driver airbag can deploy in the event of an accident.

The child could be struck by the airbag.

- ▶ Always ensure that the co-driver airbag is disabled. The PASSENGER AIR BAG OFF indicator lamp must be lit.
- ▶ NEVER use a rearward-facing child restraint system on a seat with an ENABLED FRONT AIRBAG; DEATH or SERIOUS INJURY to the CHILD can occur.

When installing a child restraint system on the co-driver's seat, observe the vehicle-specific information (→ page 39).

Depending on the child restraint system and the stature of the child, the PASSENGER AIR BAG OFF indicator lamp may be off. In this case, do not install the rearward-facing child restraint system on the co-driver's seat.

Instead, install the rearward-facing child restraint system on a suitable rear seat.

After installing a forward-facing child restraint system on the co-driver's seat: Depending on the child restraint system and the stature of the child, PASSENGER AIR BAG OFF may be lit continuously or be off. Always observe the following information.

▲ WARNING Risk of injury or death due to incorrect positioning of the forward-facing child restraint system

If you secure a child in a forward-facing child restraint system on the front passenger seat that is positioned too close to the cockpit, in the event of an accident, the child could:

- come into contact with the vehicle interior if the PASSENGER AIR BAG OFF indicator lamp is lit, for example
- be struck by the airbag if the PASSENGER AIR BAG OFF indicator lamp is off.

▶ Always move the front passenger seat as far back as possible and fully retract the seat cushion length adjustment. While doing so, always make sure that the shoulder belt strap is correctly routed from the seat belt outlet of the vehicle to the shoulder belt guide on the child restraint system. The shoulder belt strap must be routed forwards and downwards from the seat belt outlet. If necessary, adjust the seat belt outlet and the front passenger seat accordingly.

▶ Always comply with the child restraint system manufacturer's installation instructions.

When installing a child restraint system on the co-driver's seat, observe the vehicle-specific information (→ page 39).

If a person is sitting on the co-driver's seat:

PASSENGER AIR BAG OFF may be lit continuously or be off, depending on the person's stature.

A person on the co-driver's seat must always observe the following information:

- If the co-driver's seat is occupied by an adult or a person with a stature corresponding to that of an adult, the PASSENGER AIR BAG OFF indicator lamp must be off. This indicates that the co-driver airbag is enabled.

If the PASSENGER AIR BAG OFF indicator lamp is lit continuously, an adult or person with a build corresponding to that of an adult should not use the co-driver's seat.

Instead, they should use a rear seat.

- If the co-driver's seat is occupied by a person of smaller stature (e.g. a teenager or small adult), the PASSENGER AIR BAG OFF indicator lamp either lights up continuously or remains off, depending on the result of the classification.
 - If the PASSENGER AIR BAG OFF indicator lamp is off: move the co-driver's seat as far back as possible, or the person of smaller stature should use a rear seat.
 - If the PASSENGER AIR BAG OFF indicator lamp is lit continuously: the person of smaller stature should not use the co-driver's seat.

▲ WARNING Risk of injury or death when the PASSENGER AIR BAG OFF indicator lamp is lit

If the PASSENGER AIR BAG OFF indicator lamp remains lit after the self-test, the front passenger airbag is disabled.

If the front passenger seat is occupied, always ensure that:

- The classification of the person in the front passenger seat is correct and the front passenger airbag is enabled or disabled in accordance with the person in the front passenger seat.
- The person is seated properly with a correctly fastened seat belt.
- The front passenger seat has been moved as far back as possible.

Be sure to also observe the following further related subjects:

- Child restraint system on the co-driver's seat (→ page 39)

Automatic measures after an accident

Depending on the type and severity of the accident, and depending on the vehicle's equipment, the following measures can be implemented, for example:

- activating the hazard warning lights
- triggering an automatic emergency call (→ page 185)
- switching off engine

To start the vehicle again, switch the vehicle off and on once more (→ page 97). Depending on the type and severity of the accident, it may be possible that the vehicle can no longer be started.

- Switching off the fuel supply
- Unlocking the vehicle doors
- Lowering the front side windows
- Switching on the interior lighting

Safely transporting children in the vehicle

Always observe when children are traveling in the vehicle

- ① Always observe the safety notes relevant to the situation. In doing so, you will be able to identify possible risks and avoid dangers when children are traveling in the vehicle (→ page 35).

Be diligent

Bear in mind that negligence when securing a child in the child restraint system may have serious consequences. Always be diligent and secure a child carefully before each journey.

Infants and children must never travel sitting on the lap of a vehicle occupant.

To improve protection for children younger than 12 years old or under 5 ft (1.50 m) in height, Mercedes-Benz recommends you always observe the following notes:

- Always secure a child in a child restraint system suitable for your Mercedes-Benz vehicle.
- The child restraint system must be appropriate to the age, weight and size of the child.
- The vehicle seat must be suitable for the child restraint system to be installed.

Accident statistics show that children secured on the rear seats are generally safer than children secured on the front seats. For this reason, Mercedes-Benz strongly recommends that you install a child restraint system on a rear seat.

The generic term "child restraint system"

The generic term "child restraint system" is used in this Operator's Manual. A child restraint system is, for example:

- a baby car seat
- a rearward-facing child seat
- a forward-facing child seat
- a child booster seat with a backrest and seat belt guides

The child restraint system must be appropriate to the age, weight and size of the child.

Observe laws and regulations

Always observe the legal requirements for using a child restraint system in the vehicle.

Observe standards for child restraint systems

All child restraint systems must meet the following standards:

- U.S. Federal Motor Vehicle Safety Standards 213 and 225
- Canadian Motor Vehicle Safety Standards 213 and 210.2

Confirmation that the child restraint system complies with the standards can be found on an information label on the child restraint system. This confirmation can also be found in the installation instructions that are included with the child restraint system.

Detecting risks, avoiding danger

Securing systems for child restraint systems in the vehicle

Only use the following securing systems for child restraint systems:

- The LATCH-type (ISOFIX) securing rings
- The seat belt system of the vehicle
- The Top Tether anchorages

Installing a LATCH-type (ISOFIX) child restraint system is preferred.

Simply attaching to the securing rings on the vehicle can reduce the risk of installing the child restraint system incorrectly.

When securing a child with the integrated seat belt of the LATCH-type (ISOFIX) child restraint system, always comply with the permissible gross weight for the child and child restraint system (→ page 37).

A booster seat may be necessary to achieve proper seat belt positioning for children over 40 lbs (18 kg) in weight or until they reach a height where a three-point seat belt can be fastened properly without a booster seat.

Mercedes-Benz recommends a child booster seat with a backrest and seat belt guides.

Advantage of a rearward-facing child restraint system

It is preferable to transport a baby or a small child in a suitable rearward-facing child restraint system. In this case, the child sits in the opposite direction to the direction of travel and faces backwards.

Babies and small children have comparatively weak neck muscles in relation to the size and weight of their head. The risk of injury to the cervical spine during an accident can be reduced in a rearward-facing child restraint system.

Always secure a child restraint system correctly

▲ WARNING Risk of injury or death due to incorrect installation of the child restraint system

The child can then not be protected or restrained as intended.

- ▶ Be sure to comply with the manufacturer's installation instructions for the child restraint system and its correct use.

- ▶ Make sure that the entire base of the child restraint system always rests on the sitting surface of the seat.
- ▶ Never place objects (e.g. cushions) under or behind the child restraint system.
- ▶ Use child restraint systems only with the original cover designed for them.
- ▶ Always replace damaged covers with genuine covers.

▲ WARNING Risk of injury or death due to unsecured child restraint systems in the vehicle

If the child restraint system is incorrectly installed or not secured, it can come loose.

The child restraint system could be flung around and hit vehicle occupants.

- ▶ Always install child restraint systems correctly, even when not in use.
 - ▶ Always comply with the child restraint system manufacturer's installation instructions.
- Always observe the child restraint system manufacturer's installation and operating instructions as well as the vehicle-specific information:
 - Installing the LATCH-type (ISOFIX) child restraint system on the rear seat (→ page 37).
 - Securing the child restraint system with the seat belt on the rear seat (→ page 39).
 - Securing the child restraint system with the seat belt on the co-driver's seat (→ page 40). Observe the specific instructions for the rearward-facing and forward-facing child restraint systems (→ page 39).
- If the co-driver's seat is occupied, ensure, both before and during the journey, that the status of the co-driver airbag is correct for the current situation (→ page 32).
- Observe the warning labels in the vehicle interior and on the child restraint system.
 - Also secure Top Tether if present.

Do not modify the child restraint system**⚠ WARNING** Risk of injury due to modifications to the child restraint system

The child restraint system can no longer function properly. This poses an increased risk of injury.

- ▶ Never modify a child restraint system.
- ▶ Only affix accessories which have been specially approved for this child restraint system by the child restraint system's manufacturer.

Only use child restraint systems which are in proper working condition**⚠ WARNING** Risk of injury or death caused by the use of damaged child restraint systems

Child restraint systems or their retaining systems that have been subjected to stress in an accident may not be able to perform their intended protective function.

It may be the case that the child cannot be properly restrained.

- ▶ Always immediately replace child restraint systems that have been damaged or involved in an accident.
- ▶ Have the securing systems for the child restraint systems checked at a qualified specialist workshop before installing a child restraint system again.

Avoid direct sunlight**⚠ WARNING** Risk of burns when the child seat is exposed to direct sunlight

If the child restraint system is exposed to direct sunlight or heat, parts could heat up excessively.

Children could suffer burns from these parts, particularly the metallic parts of the child restraint system.

- ▶ Always make sure that the child restraint system is not exposed to direct sunlight.
- ▶ Cover the child restraint system with a blanket, for example.
- ▶ If the child restraint system has been exposed to direct sunlight, allow it to cool before securing a child into it.

- ▶ Never leave children unattended in the vehicle.

Observe when stopping or parking**⚠ WARNING** Risk of accident and injury due to children left unattended in the vehicle

If children are left unsupervised in the vehicle, they could, in particular:

- open doors, thereby endangering other persons or road users.
- get out and be struck by oncoming traffic.
- operate vehicle equipment and become trapped, for example.



In addition, the children could also set the vehicle in motion, for example by:

- releasing the parking brake.
- changing the transmission position.
- starting the vehicle.

- ▶ Never leave children unattended in the vehicle.
- ▶ When leaving the vehicle, always take the SmartKey with you and lock the vehicle.
- ▶ Keep the vehicle SmartKey out of reach of children.

Overview of suitable seats in the vehicle for installing a child restraint system**Left/right rear seat (second and third seat row)**

Preferred securing system:

-  ISOFIX child seat anchor
-  Also secure Top Tether if present (→ page 38)

Alternative securing system:

-  Seat belt on vehicle seat

Co-driver seat

Securing system:

-  Seat belt on vehicle seat

Always observe the following:

- If the co-driver seat is occupied, ensure, both before and during the journey, that the status

of the co-driver airbag is correct for the current situation (→ page 32).

- Observe the notes on automatic co-driver airbag shutoff (→ page 31).

Center rear seat (second and third seat row)

Securing system:



Seat belt on vehicle seat



Also secure Top Tether if present (→ page 38)

Activating or deactivating the special seatbelt retractor of the seat belt

▲ WARNING Risk of injury or death if a seat belt is unfastened while the vehicle is in motion

If the seat belt is released while the vehicle is in motion, the special seat belt retractor is deactivated and the child restraint system is no longer correctly secured. The seat belt is drawn in slightly by the inertia reel and cannot be immediately closed again.

- ▶ Stop the vehicle immediately in accordance with the traffic conditions.
- ▶ Activate the special seat belt retractor again and correctly secure the child restraint system.

When activated, the special seatbelt retractor ensures that the seat belts of the front passenger seat and rear seats do not slacken once the child restraint system is secured.

The seat belts on the following seats are equipped with a special seatbelt retractor:

- Front passenger seat
- Rear seats

Installing a child restraint system

- ▶ When installing a child restraint system, always observe the manufacturer's installation and operating instructions for the child restraint system used, as well as the notes in this Operator's Manual.
- ▶ Pull the seat belt smoothly from the seat belt outlet.
- ▶ Engage the seat belt tongue in the seat belt buckle.

Activating the special seatbelt retractor

- ▶ Extend the seat belt fully and then allow the inertia reel to retract the belt. When the special seatbelt retractor is activated, you should hear a ratcheting sound.
- ▶ Push the child restraint system down until the seat belt is tight.

Deactivating the special seatbelt retractor

- ▶ Press the release button of the seat belt buckle.
- ▶ Hold the seat belt tongue and guide back to the seat belt outlet.

Installing a LATCH-type (ISOFIX) child restraint system on the rear seat

installing an ISOFIX child restraint system on the rear passenger compartment seat

▲ WARNING Risk of injury or death if the permissible gross mass of the child and child restraint system together is exceeded.

Too much load may be placed on the LATCH-type (ISOFIX) child restraint system and the child may not be restrained correctly in the event of an accident, for example.

- ▶ If the child and the child restraint system together weigh more than the permissible gross mass of 73 lb (33 kg), only use a LATCH-type (ISOFIX) child restraint system with which the child is secured with the vehicle seat belt.
- ▶ Also secure the child restraint system with the Top Tether belt, if available.

Always comply with the information about the mass of the child restraint system:

- in the manufacturer's installation and operating instructions for the child restraint system used
- on a label on the child restraint system, if available

Check regularly that the permissible gross mass of the child plus the child restraint system is not exceeded.

When you install a child restraint system, observe the following:

- ✓ Always observe the correct use and suitability of the seats for attaching a child restraint system.
- ✓ Always observe the manufacturer's installation and operating instructions for the child restraint system used.
- ✓ Make sure that the child's feet do not touch the front seat. If necessary, move the front seat slightly forwards.

 When installing an ISOFIX child restraint system, also observe the following:

- ✓ **When using a Group 0/0+ baby car seat and a Group 1 rearward-facing child restraint system on a rear passenger compartment seat:** adjust the front seat so that the seat does not touch the child restraint system.
- ✓ Move the rear passenger compartment seat backrest to an upright position before you install the child seat. Do not adjust the seat backrest when an ISOFIX child restraint system is installed.
- ✓ For certain child restraint systems in weight category 2 or 3, there may be restrictions on the maximum size setting, e.g. due to possible contact with the roof.
- ✓ Do not put the child restraint system under strain between the roof and the sitting surface and/or install it facing the wrong direction.
- ✓ Do not put the child restraint system under strain by the head restraint. Adjust the head restraints as appropriate.

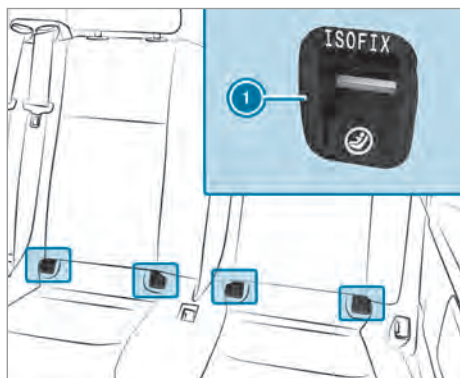



 ISOFIX mounting brackets

Before every journey, make sure that the ISOFIX child restraint system is engaged correctly in both mounting brackets in the vehicle.

 **NOTE** Damage to the seat belt for the center seat during installation of the child restraint system

 Make sure that the seat belt is not trapped.

 Attach the ISOFIX child restraint system to both mounting brackets  in the vehicle.

Securing Top Tether

 If the child restraint system is equipped with a Top Tether belt:

The risk of injury can be reduced by Top Tether. The Top Tether belt enables an additional connection between the child restraint system attached with LATCH-type (ISOFIX) and the vehicle.

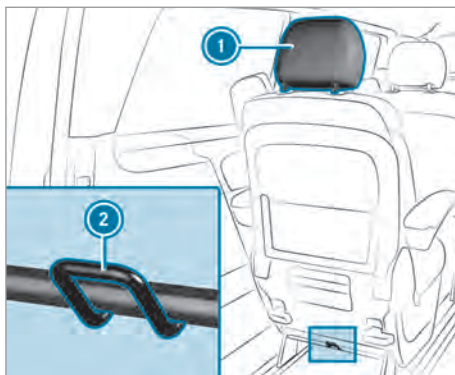

Example

Top Tether anchorage  is on the lower part of the rear seat on the cross strut between the seats or bench seat legs.

 Install the LATCH-type (ISOFIX) child restraint system with Top Tether. Comply with the child restraint system manufacturer's installation instructions.

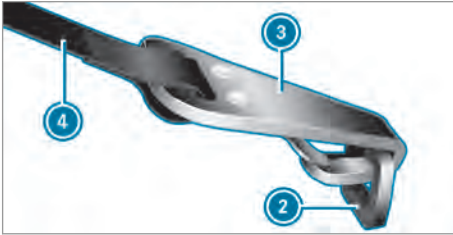

- ▶ Guide Top Tether belt ④ under head restraint ① between the two head restraint bars.
- ▶ Hook Top Tether hook ③ into Top Tether anchorage ② without twisting.
- ▶ Tension Top Tether belt ④. Comply with the child restraint system manufacturer's installation instructions.

Securing the child restraint system with the seat belt

Securing the child restraint system with the seat belt on the rear seat

When installing a belt-secured child restraint system, observe the following:

- ✔ Always observe the manufacturer's installation and operating instructions for the child restraint system used.
- ✔ **When using a baby car seat in weight group 0/0+ and a rearward-facing child restraint system in weight group I on a rear seat:** adjust the front seat so that the seat does not touch the child restraint system.
- ✔ **When using a forward-facing child restraint system in weight group I:** remove the head restraint from the respective seat, if possible.
After the child restraint system has been removed, replace the head restraint immediately and adjust all head restraints correctly.
- ✔ The backrest of the forward-facing child restraint system must, as far as possible, be resting on the seat backrest of the rear seat.
- ✔ For certain child restraint systems in weight category II or III, there may be restrictions on the maximum size setting, e.g. due to possible contact with the roof.
- ✔ The child restraint system must not be put under strain between the roof and the seat cushion and/or be installed facing the wrong direction. Where possible, adjust the seat cushion inclination accordingly.

- ✔ The child restraint system must not be put under strain by the head restraint. Adjust the head restraints as appropriate.
- ✔ Make sure that the child's feet do not touch the front seat. If necessary, move the front seat slightly forwards.

The seat belts on the following seats are equipped with a special seatbelt retractor:

- Front passenger seat
- Rear seats

When activated, the special seatbelt retractor ensures that the seat belts of the front passenger seat and rear seats do not slacken once the child restraint system is secured (→ page 37).

- ▶ Install the child restraint system.
The entire base of the child restraint system must always rest on the sitting surface of the rear seat.
- ▶ Always make sure that the shoulder belt strap is correctly routed from the seat belt outlet of the vehicle to the shoulder belt guide on the child restraint system.
The shoulder belt strap must be routed forwards and downwards from the seat belt outlet.

Notes on rearward-facing and forward-facing child restraint systems on the front passenger seat

⚠ WARNING Risk of injury or death when using a child restraint system while the co-driver airbag is enabled

If you secure a child in a child restraint system on the co-driver seat and the PASSENGER AIR BAG OFF indicator lamp is off, the co-driver airbag can deploy in the event of an accident.

The child could be struck by the airbag.

- ▶ Always ensure that the co-driver airbag is disabled. The PASSENGER AIR BAG OFF indicator lamp must be lit.

NEVER use a rearward facing child restraint on a seat protected by an ENABLED AIRBAG in front of it, DEATH or SERIOUS INJURY to the CHILD may occur.

Observe the specific instructions for the rearward-facing and forward-facing child restraint systems (→ page 40).

Always observe the status of the front passenger air bag on the PASSENGER AIR BAG OFF indicator

- When a rearward-facing child restraint system is used on the front passenger seat, the front passenger air bag must always be disabled. It is only disabled if the PASSENGER AIR BAG OFF indicator lamp is continuously lit up (→ page 32).
- If the PASSENGER AIR BAG OFF indicator lamp is off, the front passenger air bag is enabled. The front passenger air bag may deploy during an accident.

Securing the child restraint system with the seat belt on the co-driver's seat

When installing a belt-secured child restraint system on the co-driver's seat, always observe the following:

- ☑ Observe the notes on rearward-facing and forward-facing child restraint systems on the co-driver's seat (→ page 39).
- ☑ Observe the child restraint system manufacturer's installation and operating instructions.
- ☑ When using a forward-facing child restraint system in category I: remove the head restraint from the respective seat, if possible. After the child restraint system has been removed, replace the head restraint immediately and adjust all head restraints correctly.
- ☑ The backrest of the forward-facing child restraint system must, as far as possible, be resting on the seat backrest of the co-driver's seat.
- ☑ For certain child restraint systems in weight category II or III, there may be restrictions on the maximum size setting, e.g. due to possible contact with the roof.
- ☑ The child restraint system must not be put under strain between the roof and the seat cushion and/or be installed facing the wrong direction.
- ☑ The child restraint system must not be put under strain by the head restraint. Adjust the head restraints as appropriate.
- ☑ Never place objects (e.g. cushions) under or behind the child restraint system.

The seat belt on the co-driver side is equipped with a child seat safety feature.

When enabled, the child seat safety feature ensures that the seat belt does not slacken once the child seat is secured (→ page 37).

⚠ WARNING Risk of injury or death due to objects between the seat surface and the child restraint system

Objects between the seat surface and the child restraint system could affect the function of the automatic front passenger airbag shut-off.

- ▶ Do not place any objects between the seat surface and the child restraint system.
- ▶ Always make sure that the child restraint system is correctly installed.

- ▶ Set the co-driver's seat as far back as possible and move the seat into the highest position possible.
- ▶ Fully retract the seat cushion length adjustment.
- ▶ Set the seat backrest to the most vertical position possible.
- ▶ Install the child restraint system. The entire base of the child restraint system must always rest on the sitting surface of the co-driver's seat.
- ▶ Always make sure that the shoulder belt strap is correctly routed from the seat belt outlet of the vehicle to the shoulder belt guide on the child restraint system. The shoulder belt strap must be routed forwards and downwards from the seat belt outlet.
- ▶ If necessary, adjust the seat belt outlet and the co-driver's seat as appropriate.

Child safety locks

Activating or deactivating child safety locks for the sliding doors

⚠ WARNING Risk of accident and injury due to children left unattended in the vehicle

If children are left unsupervised in the vehicle, they could, in particular:

- open doors, thereby endangering other persons or road users.
- get out and be struck by oncoming traffic.
- operate vehicle equipment and become trapped, for example.

In addition, the children could also set the vehicle in motion, for example by:

- releasing the parking brake.
- changing the transmission position.
- starting the vehicle.

- ▶ Never leave children unattended in the vehicle.
- ▶ When leaving the vehicle, always take the SmartKey with you and lock the vehicle.
- ▶ Keep the vehicle SmartKey out of reach of children.

⚠ WARNING Risk of fatal injury due to exposure to extreme heat or cold in the vehicle

If persons, particularly children, are subjected to prolonged exposure to intense heat or cold, there is a risk of severe injury or even death.

- ▶ Never leave persons, particularly children, unattended in the vehicle.

⚠ WARNING Risk of accident and injury due to children left unattended in the vehicle

If children are traveling in the vehicle, they could, in particular:

- Open doors, thereby endangering other persons or road users
- Get out and be struck by oncoming traffic
- Operate vehicle equipment and become trapped, for example

- ▶ Always activate the child safety locks installed if children are traveling in the vehicle.

- ▶ Never leave children unattended in the vehicle.
- ▶ When leaving the vehicle, always take the SmartKey with you and lock the vehicle.

The following doors have child safety locks:

- Sliding doors
- Pop-out windows

The child safety locks on the doors secure each door separately. The doors can no longer be opened from the inside (exception: electric sliding door). When the vehicle is unlocked, the door can be opened from the outside.

If the electric sliding door is secured, only the sliding door controls in the rear compartment are deactivated. The electric sliding door can be opened at any time using the switch in the center console.

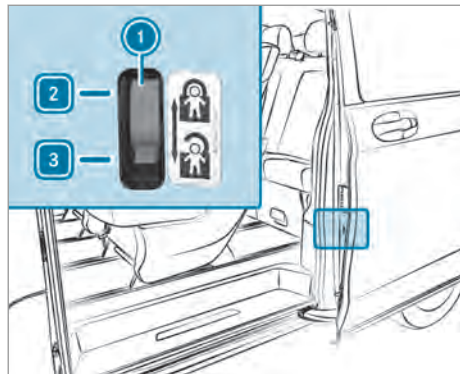

- ▶ Slide the child safety lock latch ① into position ② (secure) or ③ (unlock).
- ▶ Make sure that the child safety locks are working properly.

Activating or deactivating child safety locks for hinged windows

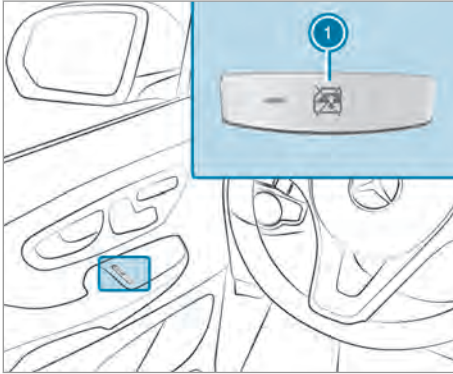

- ▶ **To activate and deactivate:** press button ①.
 If the indicator lamp on button ① is lit, operation of the electrical hinged windows is disabled. Operation is then only possible using the buttons in the driver's door.

Notes on pets in the vehicle

⚠ WARNING Risk of accident and injury due to animals left unsecured or unattended in the vehicle

If you leave animals in the vehicle unattended or unsecured, they could possibly press buttons or switches.

An animal may:

- Activate vehicle equipment and become trapped, for example
- Switch systems on or off and endanger other road users

Unsecured animals may be thrown around in the vehicle in the event of an accident or sudden steering and braking maneuvers and injure vehicle occupants in the process.

- ▶ Never leave animals in the vehicle unattended.
- ▶ Always correctly secure animals while driving, e.g. using a suitable animal carrier.

SmartKey

Overview of key functions

⚠ WARNING Risk of accident and injury due to children left unattended in the vehicle

If children are left unsupervised in the vehicle, they could, in particular:

- open doors, thereby endangering other persons or road users.
- get out and be struck by oncoming traffic.
- operate vehicle equipment and become trapped, for example.

In addition, the children could also set the vehicle in motion, for example by:

- releasing the parking brake.
- changing the transmission position.
- starting the vehicle.

- ▶ Never leave children unattended in the vehicle.
- ▶ When leaving the vehicle, always take the SmartKey with you and lock the vehicle.
- ▶ Keep the vehicle SmartKey out of reach of children.

⚠ WARNING Risk of accident due to the key inadvertently turning in the ignition lock

If heavy or large objects are attached to the key, the key can inadvertently turn in the ignition lock.

- ▶ Do not attach large or heavy objects to the key.
- ▶ Remove the key from a bulky bunch of keys before inserting it into the ignition lock.

! **NOTE** Damage to the SmartKey caused by magnetic fields



- ▶ Keep the SmartKey away from strong magnetic fields.



- ① Indicator lamp
- ② To lock the vehicle centrally
- ③ To unlock the sliding doors and the tailgate or rear-end door, or to unlock and open/close the electric sliding door
- ④ Emergency key
- ⑤ To unlock the vehicle centrally or the front door(s) only

i If you do not open the vehicle within approximately 40 seconds of unlocking, the vehicle will lock again and anti-theft protection will be activated again.

Do not keep the key together with electronic devices or metallic objects. This can affect the key's functionality.



i If the indicator lamp does not light up when you press the  or  button, the battery is discharged.

Replace the key battery (→ page 44).

Changing the unlocking settings

The key has the following adjustable unlocking functions:

- Unlock centrally
- Unlock the driver's and co-driver's door (Cargo Van)
- Unlock the driver's door (Tourer)

▶ **To switch between settings:** press and hold the  and  buttons at the same time for approximately six seconds until the indicator lamp flashes twice.

▶ **To unlock the vehicle centrally when the unlocking function is selected for the driver's door or the driver's and co-driver's door:** press the  button a second time.

Removing and inserting the emergency key



i The anti-theft alarm system (ATA) is triggered when you unlock and open the vehicle using the emergency key (→ page 58).

▶ **To remove:** push release catch **1** in the direction of the arrow and simultaneously pull emergency key **2** completely out of the key.

▶ **To insert:** push emergency key **2** completely into the key until it engages and release catch **1** is back in its initial position.

Replacing the key battery

⚠ DANGER Risk of fatal injuries due to swallowing batteries

Batteries contain toxic and corrosive substances. Swallowing batteries may cause severe internal burns to occur within two hours.

There is a risk of fatal injury.

- ▶ Keep batteries out of the reach of children.
- ▶ If the battery compartment does not close securely, do not use the SmartKey any longer and keep it out of the reach of children.
- ▶ If batteries are swallowed, seek medical attention immediately.

🌿 ENVIRONMENTAL NOTE Environmental damage due to improper disposal of batteries



Batteries contain pollutants. It is illegal to dispose of them with the household rubbish.



Dispose of batteries in an environmentally responsible manner. Take discharged batteries to a qualified specialist workshop or to a collection point for used batteries.

Requirements:

- You require a CR 2025 3 V cell battery.

Replacing the battery

Mercedes-Benz recommends that you have the battery changed at a qualified specialist workshop.

▶ Remove the mechanical key (→ page 44).

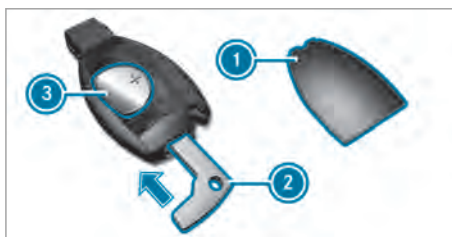

- ▶ Press mechanical key **2** into the opening in the key in the direction of the arrow until battery compartment cover **1** opens. When doing so, do not hold battery compartment cover **1** shut.
- ▶ Tap the key against the palm of your hand so that battery **3** falls out of the battery compartment.
- ▶ Insert the new battery into the battery tray with the positive pole facing upwards. Use a lint-free cloth to do so.
- ▶ Fit battery compartment cover **1** to the key casing with the front lugs first and push it closed.
- ▶ Slide mechanical key **2** back into the key (→ page 44).

Rectifying problems with the key

It is no longer possible to lock the vehicle using the key

Possible causes:

- The doors are not closed properly.

▶ Close the doors properly and lock the vehicle again.



The turn signal lamps do not flash when the vehicle is locked

Possible causes:

- The central locking system has malfunctioned.
- ▶ Lock the vehicle using the emergency key (→ page 44) or press down the locking pins and then close the doors.
- ▶ Have the locking system checked at a qualified specialist workshop.

It is no longer possible to lock or unlock the vehicle using the key

Possible causes:

- The key battery is weak or discharged.
- The key is faulty.
- ▶ Point the tip of the key at the driver's door handle from close range and press the  or  button.

If this does not work:

- ▶ Replace the key battery (→ page 44).
- or
- ▶ Use the emergency key to unlock and lock the vehicle (→ page 44).
- ▶ Have the key checked at a qualified specialist workshop.

The vehicle will not start with the key

Possible causes:

- The on-board electrical system voltage is too low.
- ▶ Switch off all non-essential consumers, such as interior lighting, and try to start the vehicle again.

If this does not work:

- ▶ Check the starter battery and charge it, if necessary (→ page 189).

or

- ▶ Jump-start the vehicle (→ page 189).

or

- ▶ Consult a qualified specialist workshop.

You have lost a key

- ▶ Have the key deactivated at a qualified specialist workshop.
- ▶ If necessary, have the mechanical locks replaced.

You have lost the emergency key

- ▶ Report the loss immediately to the vehicle insurers.
- ▶ If necessary, have the mechanical locks replaced.

Doors

Unlocking and opening the door from inside

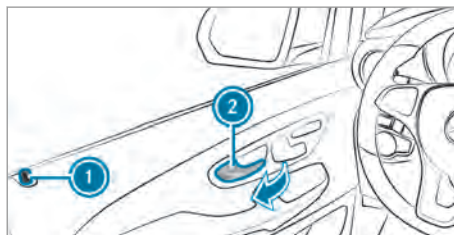

Door handle (example: driver's door)

- ▶ Pull door handle (2).
Safety pin (1) pops up when the door is unlocked.

Centrally locking and unlocking the door from the inside

▲ WARNING Risk of accident and injury due to children left unattended in the vehicle

If children are left unsupervised in the vehicle, they could, in particular:

- open doors, thereby endangering other persons or road users.
- get out and be struck by oncoming traffic.
- operate vehicle equipment and become trapped, for example.

In addition, the children could also set the vehicle in motion, for example by:

- releasing the parking brake.
- changing the transmission position.
- starting the vehicle.

- ▶ Never leave children unattended in the vehicle.
- ▶ When leaving the vehicle, always take the SmartKey with you and lock the vehicle.
- ▶ Keep the vehicle SmartKey out of reach of children.

⚠ WARNING Risk of fatal injury due to exposure to extreme heat or cold in the vehicle

If persons, particularly children, are subjected to prolonged exposure to intense heat or cold, there is a risk of severe injury or even death.

- ▶ Never leave persons, particularly children, unattended in the vehicle.

You can use the central locking buttons to centrally lock and unlock the entire vehicle from the inside.

The central locking buttons are located in the driver's door.

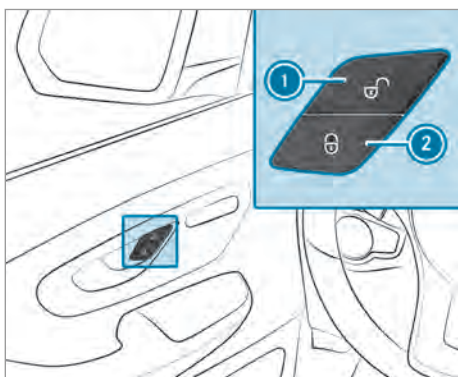

Central locking buttons (vehicles with manually adjustable front seats)

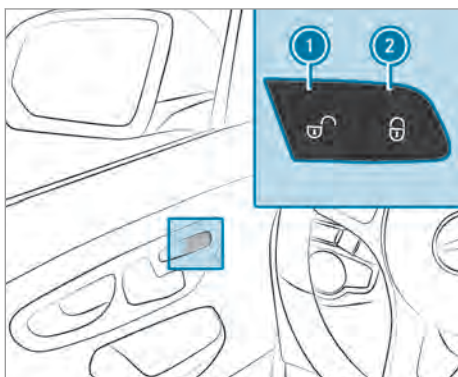

Central locking buttons (vehicles with electrically adjustable front seats)

- ▶ **To lock or unlock the entire vehicle:** press button ① (unlock) or ② (lock) when the doors are closed.

Observe the following settings when locking and unlocking from inside:

- If the driver's or co-driver's door is open, the open door is not locked.
All other doors and the tailgate/rear-end doors are locked.
- If a sliding door or the tailgate/rear-end doors are open, only the driver's and co-driver's door are locked.
- You cannot unlock the vehicle centrally from the inside if the vehicle has been locked with the key.
- If the vehicle has been locked using the central locking button and a door is opened from the inside, only the door that has been opened is unlocked.
- If the vehicle has previously been locked with the key, opening a door from the inside will trigger the anti-theft alarm system. Switch off the alarm (→ page 59).

Activating/deactivating the automatic locking mechanism

Requirements:

- The power supply of the vehicle has been switched on.
- The doors are closed.

When the automatic locking mechanism is activated and the vehicle is traveling at a speed above 9 mph (15 km/h), the vehicle is locked automatically.

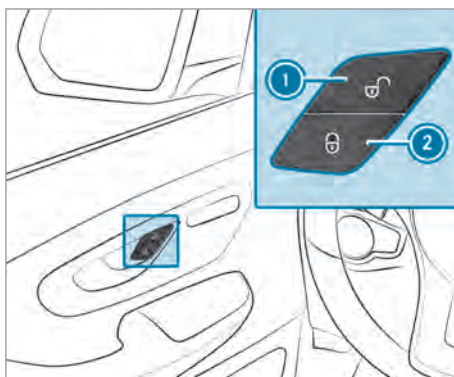

Central locking buttons (vehicles with manually adjustable front seats)

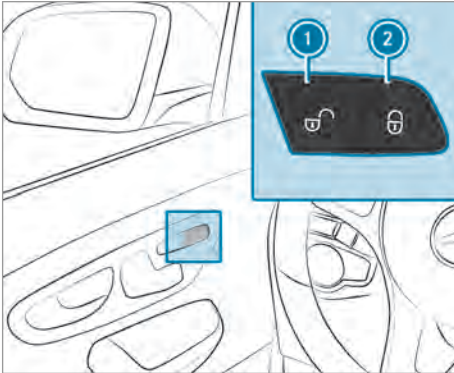

Central locking buttons (vehicles with electrically adjustable front seats)

If the vehicle is being tow-started, push-started or tested on a roller dynamometer, there is a risk of being locked out when the function is activated.

- ▶ **To activate:** press and hold button ② until you hear a tone.
- ▶ **To deactivate:** press and hold button ① until you hear a tone.

Unlocking and locking the driver's door with the emergency key

- ① To lock the vehicle fully with the emergency key, press down the locking pins of the doors. Then lock the driver's door with the emergency key.
- ▶ **To unlock:** insert the emergency key fully into the driver's door lock and turn it counter-clockwise.
- ▶ **To lock:** insert the emergency key fully into the driver's door lock and turn it clockwise.
- ① **Right-hand drive vehicles:** turn the emergency key in the opposite direction for each case.

Sliding door

Opening/closing the sliding door from outside

⚠ WARNING Risk of becoming trapped due to an open sliding door which is not engaged in place

On an incline, the sliding door can move by itself.

This can cause you or other people to become trapped.

- ▶ Always make sure that the open sliding door is engaged. To do so, open the sliding door to the stop.

⚠ NOTE Damage to the sliding door due to incorrect use

Using the lower guide of the sliding door (carriage) as a step can result in damage to the trim and/or mechanical components of the sliding door.

- ▶ Do not use the lower guide of the sliding door (carriage) as a step.

Opening

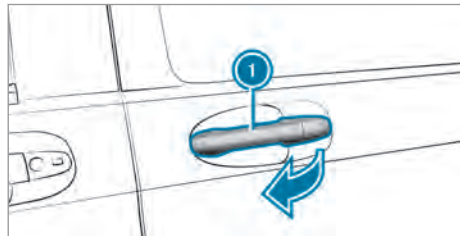

The sliding door is equipped with an active retainer, which engages when the door is opened as far as it will go.

- ▶ Pull door handle ① in the direction of the arrow. The sliding door opens.
- ▶ Push back the sliding door using door handle ① until it engages.
- ▶ Check the sliding door catch.

Closing

- ▶ Pull the sliding door by door handle ①. The sliding door is released from its catch.
- ▶ Push the sliding door firmly forwards using door handle ① and close it.

Opening/closing the sliding door from inside

⚠ WARNING Risk of becoming trapped due to sliding door opening towards the rear

When you open the sliding door, the sliding door could hit other people as it moves towards the rear of the vehicle.

- ▶ Only open the sliding door when traffic conditions permit.

Requirements:

- The child safety lock is deactivated.

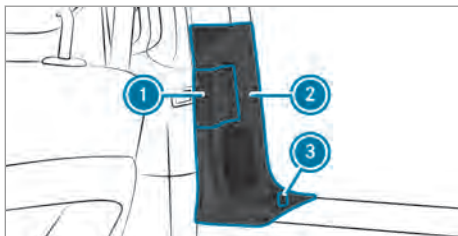
Opening

- ▶ Pull back rocker switch ①.
If the door is locked, locking pin ③ pops up. The sliding door unlocks and opens.
- ▶ Push back the sliding door using door handle ② until it engages.
- ▶ Check the sliding door catch.

Closing

- ▶ Push rocker switch ① forwards. The sliding door is released from its catch.
- ▶ Push the sliding door forwards using door handle ② and close it.

Electric sliding door**Function of the electric sliding door**

⚠ WARNING Risk of becoming trapped due to sliding door opening towards the rear

When you open the sliding door, the sliding door could hit other people as it moves towards the rear of the vehicle.

- ▶ Only open the sliding door when traffic conditions permit.

! NOTE Damage to the sliding door due to incorrect use

Using the lower guide of the sliding door (carriage) as a step can result in damage to the trim and/or mechanical components of the sliding door.

- ▶ Do not use the lower guide of the sliding door (carriage) as a step.

You must reset the electric sliding door if there has been a malfunction or a drop in voltage (→ page 51).

- ⓘ Please note that the sliding door cannot be opened from the inside when the child-proof lock is activated. You can only open the sliding door from the inside if the child safety locks have not been activated. Further information on this can be found in the "Occupant safety" (→ page 41) and "Opening and closing" (→ page 49) sections.

Your vehicle can be equipped with an electric sliding door on the left and/or right-hand side.

You can open and close the sliding door with these controls:

- Sliding door buttons on the center console
- Sliding door button on the door sill (B-pillar)
- Door handle (inside or outside)
- Key

Automatic blockage detection with sliding door reversing function

If a solid object blocks or restricts the sliding door during the automatic closing process, the sliding door opens again automatically. If the sliding door is obstructed during the opening procedure, it moves back a few centimeters in the opposite direction and stops.

The automatic blockage detection with reversing function is only an aid. It is not a substitute for your attentiveness when closing the electrical sliding door.

If an obstacle is detected, the display shows the **Left-hand Electric Sliding Door Obstruction Detected** message, for example, and five warning tones sound.

- ⓘ In unfavorable operating conditions, e.g. frost, ice or heavy soiling, press and hold the appropriate sliding door button. The electric sliding door moves with increased force. Observe that in such circumstances, the blockage detection is less sensitive. To stop the movement, release the sliding door button.

⚠ WARNING Risk of becoming trapped despite reversing function

The reversing feature does not react:

- to soft, light and thin objects, e.g. fingers
- over the last 1/3 in (8 mm) of the closing movement

The reversing feature therefore cannot prevent someone being trapped in these situations.

- ▶ Make sure that no body parts are in the closing area.

If someone becomes trapped, take the following actions:

- press the  button on the key or
- pull the exterior door handle or
- press the appropriate sliding door button in the center console or
- press the button on the door sill or
- pull the rocker switch on the door handle

Opening and closing the electrical sliding door from the inside

- ⚠ **WARNING** Risk of becoming trapped due to sliding door opening towards the rear

When you open the sliding door, the sliding door could hit other people as it moves towards the rear of the vehicle.

- ▶ Only open the sliding door when traffic conditions permit.

Opening

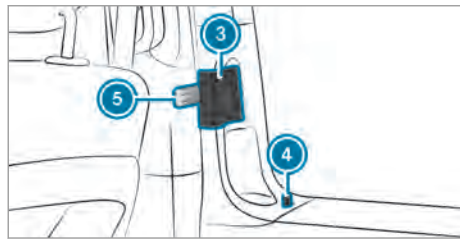
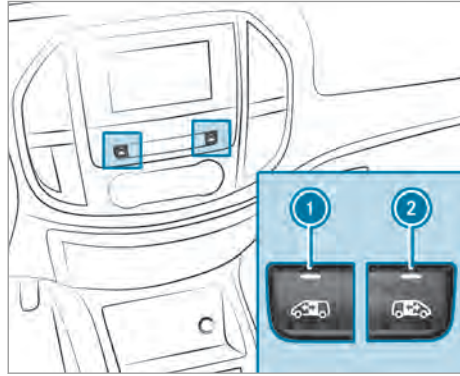

- ① Sliding door button for the sliding door on the left-hand side
- ② Sliding door button for the sliding door on the right-hand side
- ③ Rocker switch
- ④ Safety pin
- ⑤ Sliding door button in the door sill

You can only open a sliding door with sliding door button ⑤ in the door sill or with rocker switch ③ on the door handle if the child-proof lock has not been activated.

The sliding door is equipped with an active retainer, which engages the door at the end stop when opened.

- ▶ Briefly press appropriate sliding door button ① or ② in the center console.

or

- ▶ Press sliding door button ⑤ in the door sill.

or

- ▶ Briefly pull back rocker switch ③.
If the door is locked, locking pin ④ pops up.
The sliding door unlocks, automatic operation is started and the sliding door opens.

If you use sliding door button ① or ② in the center console you will hear two warning signals during the opening procedure.

The indicator lamp in sliding door button ① or ② in the center console flashes for the duration of automatic operation.

The indicator lamp in sliding door button ① or ② in the center console is lit whenever the appropriate sliding door is open. Depending on the vehicle equipment, the display can also show the **Sliding Door Open** message.

Closing

▶ Briefly press appropriate sliding door button ① or ② in the center console.

or

▶ Press sliding door button ⑤ in the door sill.

or

▶ Briefly push rocker switch ③ forwards. The sliding door is released from its lock and automatic operation is started. The sliding door closes.

If you use sliding door button ① or ② in the center console you will hear two warning signals during the closing procedure.

The indicator lamp in sliding door button ① or ② in the center console goes out whenever the corresponding sliding door is closed.

Interrupting automatic operation

▶ Press corresponding sliding door button ① or ② in the center console again.

or

▶ Press sliding door button ⑤ in the door sill again.

or

▶ Briefly pull back rocker switch ③.

Opening/closing the electric sliding door with the SmartKey

① If the vehicle is equipped with two sliding doors, the  button on the SmartKey can only be used to open or close one of the two sliding doors (→ page 50).

▶ **To unlock:** briefly press the  button on the SmartKey.

▶ **To open:** press and hold the  button on the SmartKey for longer than 0.5 seconds. You will hear two acoustic signals and the sliding door will open automatically.

▶ **To close:** press and hold the  button on the SmartKey for longer than 0.5 seconds. You will hear two acoustic signals and the sliding door will close automatically.

▶ **To interrupt automatic operation:** briefly press the  button on the SmartKey. The sliding door stops moving.

Opening/closing the electrical sliding door from the outside

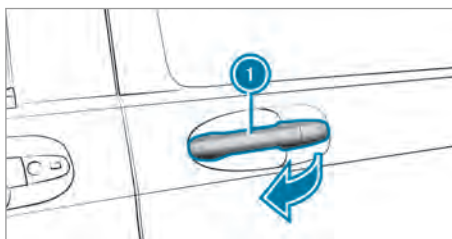

▶ **To open:** pull door handle ①. The sliding door opens. In addition, you will hear two warning signals.



▶ **To close:** pull door handle ①. The sliding door closes.

▶ **To interrupt automatic operation:** pull door handle ① again.

Programming the key button for the sliding door

Requirements:

- The vehicle is equipped with two electric sliding doors.
- The sliding door to be programmed is open.
- The vehicle is switched on.

The  button on the key can be programmed. Program the  button to open the right or left sliding door.

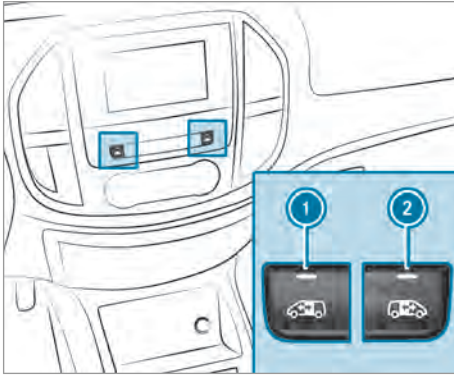





- ❶ Sliding door button for the sliding door on the left-hand side
- ❷ Sliding door button for the sliding door on the right-hand side

- ▶ Press and hold sliding door button ❶ or ❷ in the center console for the appropriate sliding door until the sliding door is closed and four tones have sounded.

The **Left-hand Electric Sliding Door Key Programmed/Right-hand Electric Sliding Door Key Programed** message appears in the display.

Resetting the electric sliding door

You must reset the electric sliding door if there has been a malfunction or a drop in voltage.

- ▶ If the sliding door is open: close it by hand.
- ▶ Using the corresponding  or  sliding door button on the center console, open the sliding door at least 15.8 in (40 cm) and then close the sliding door completely.
- ▶ When the sliding door is closed, open the sliding door fully using the corresponding  or  sliding door button on the center console.

The sliding door is reset.

Rectifying problems with the electric sliding door

The electric sliding door is locked in place.

Unfavorable operating conditions, e.g. frost, ice or heavy soiling, may obstruct the function of the sliding door.

- ▶ Press and hold the sliding door button until the sliding door has opened or closed. The sliding door moves with increased force. Observe that in such circumstances, the blockage detection is less sensitive. To stop the movement, release the sliding door button.
- ▶ Remove the cause of the blockage at the earliest opportunity.

Tailgate

Opening and closing the tailgate

⚠ DANGER Risk of poisoning from exhaust gases

Combustion engines emit poisonous exhaust gases, such as carbon monoxide. Exhaust gases can enter the vehicle interior if the rear window is open when the engine is running, especially if the vehicle is in motion.

- ▶ Always switch off the engine before opening the rear window.
- ▶ Never drive with the rear window open.

! **NOTE** Damage to the tailgate caused by obstacles above the vehicle

The tailgate swings rearwards and upwards when it is opened.

- ▶ Make sure that there is sufficient space behind and above the tailgate.

- ❶ You will find details of the tailgate opening dimensions under "Technical data" (→ page 243).

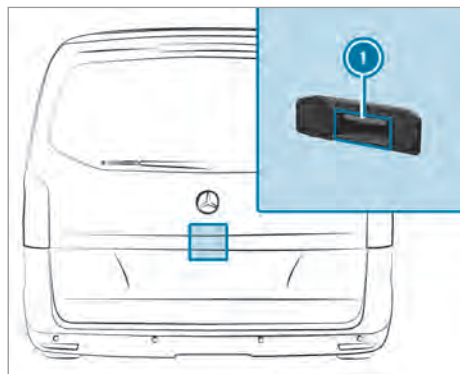

- ▶ **To open:** push button ❶ on the handle and raise the tailgate.

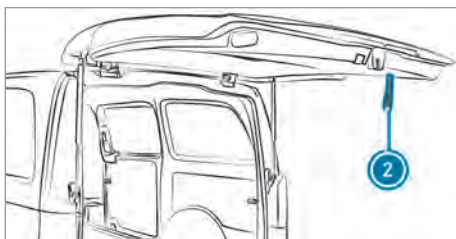

- ▶ **To close:** pull the tailgate firmly downwards by loop ② and close it from outside.

Opening the tailgate in an emergency

If the battery voltage is low or the voltage supply is interrupted, the tailgate cannot be opened.

In an emergency, you can open the tailgate using the release catch for service purposes.

- ▶ Pry off the cover on the lower part of the tailgate with a suitable tool, e.g. the screwdriver from the vehicle tool kit.
- ▶ Insert the screwdriver into the opening and move the release lever until the tailgate unlocks and opens.
- ▶ Lift the tailgate upwards.

EASY-PACK tailgate

Notes on the EASY-PACK tailgate

⚠ DANGER Risk of poisoning from exhaust gases

Combustion engines emit poisonous exhaust gases, such as carbon monoxide. Exhaust gases can enter the vehicle interior if the rear window is open when the engine is running, especially if the vehicle is in motion.

- ▶ Always switch off the engine before opening the rear window.
- ▶ Never drive with the rear window open.

! NOTE Damage to the tailgate caused by obstacles above the vehicle

The tailgate swings rearwards and upwards when it is opened.

- ▶ Make sure that there is sufficient space behind and above the tailgate.

- ① You will find details of the tailgate opening dimensions under "Technical data" (→ page 243).

Obstruction detection with reversing function

The tailgate is equipped with automatic object detection with reversing function. If a solid object blocks or restricts the tailgate during the automatic closing process, the tailgate opens again automatically. The automatic object detection with reversing function is only an aid. It is not a substitute for your attentiveness when closing the tailgate.

⚠ WARNING Risk of becoming trapped despite reversing function

The reversing feature does not react:

- to soft, light and thin objects, e.g. fingers
- over the last 1/3 in (8 mm) of the closing movement

The reversing feature therefore cannot prevent someone being trapped in these situations.

- ▶ Make sure that no body parts are in the closing area.

If someone is trapped:

- press the  button on the key or
- press the closing button on the tailgate or
- pull the handle of the tailgate

Opening and closing the EASY-PACK tailgate

! NOTE Damage to the tailgate caused by obstacles above the vehicle

The tailgate swings rearwards and upwards when it is opened.

- ▶ Make sure that there is sufficient space behind and above the tailgate.

Requirements:

- The rear window is closed.
- The tailgate is unlocked.
- There are no persons within the swinging range of the tailgate.
- The  button on the key is programmed to open and close the tailgate (→ page 54).

Opening

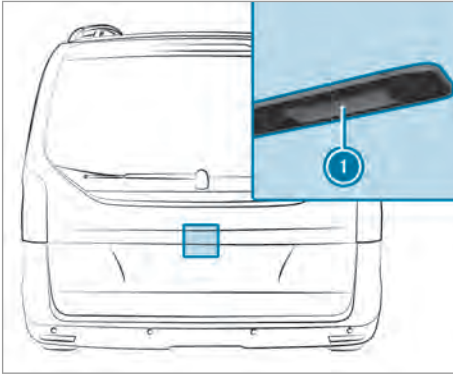

- ▶ Press button ① in the handle and step out of the swinging range of the tailgate.
- or
- ▶ Briefly press and hold the  button on the key. Automatic operation is started. The tailgate opens and swings upwards. In addition, you will hear two warning signals.

Closing

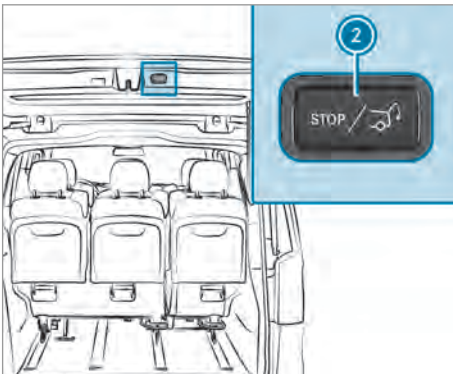

- ▶ Press button ② in the tailgate and step out of the swinging range of the tailgate.
- or
- ▶ Briefly press and hold the  button on the key. Automatic operation is started and the tailgate closes. During closing, closing button ② flashes and two warning tones sound.

Interrupting automatic operation

- ▶ Press button ① in the handle again.
- or
- ▶ Press closing button ② in the tailgate again.
- or
- ▶ Briefly press and hold the  button on the key again.

Adjusting the opening angle of the tailgate

Setting the end position

You can set the opening angle of the tailgate by saving the desired position as the end position.

- ▶ Open the tailgate and stop automatic operation in the desired position.
- or
- ▶ Open the tailgate and manually swing it into the desired position.
 - ▶ Press and hold the  closing button on the tailgate until the acoustic signal sounds once. The current position of the tailgate has been saved as the end position.

Resetting to the maximum opening angle

- ▶ Open the tailgate.
- ▶ Press and hold the  closing button on the tailgate until the acoustic signal sounds twice. The saved end position has been deleted and the tailgate opens again to the maximum extent.

Resetting the tailgate

You must reset the tailgate if there has been a malfunction or an interruption in the voltage supply.

- ▶ If the tailgate is open: close the tailgate by hand.
- ▶ Briefly press the button in the handle of the tailgate, step out of the swinging range of the tailgate and open the tailgate.
- ▶ When the tailgate is fully open, press the  closing button in the tailgate and step out of the swinging range of the tailgate. The tailgate closes. When the tailgate is fully closed, it is reset and operational.

- ① When the  button of the key is programmed for operating the tailgate (→ page 54), you can also use the key to open and close the tailgate.

Opening and closing the rear window

⚠ DANGER Risk of poisoning from exhaust gases

Combustion engines emit poisonous exhaust gases, such as carbon monoxide. Exhaust gases can enter the vehicle interior if the rear window is open when the engine is running, especially if the vehicle is in motion.



- ▶ Always switch off the engine before opening the rear window.
- ▶ Never drive with the rear window open.

Requirements:

- The vehicle or cargo compartment is unlocked and the tailgate closed.
- **To open using the SmartKey:**
 - The vehicle is equipped with an EASY-PACK tailgate and the  button on the SmartKey is programmed to open the rear window (→ page 54) or the vehicle is equipped with the Bunk Package.

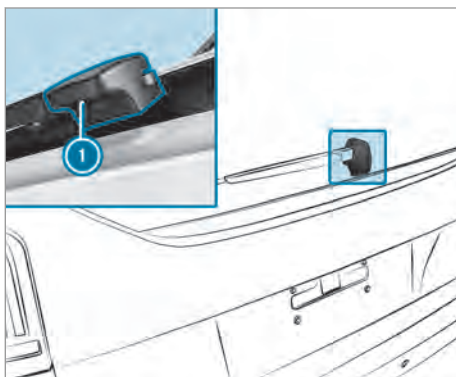
Opening



- ▶ Press the  button on the SmartKey.
- or
- ▶ Press button  on the handle on the rear window.

Closing

- ▶ Swing the rear window down and push it closed.

Programming the key button for the tailgate or rear passenger compartment window

Requirements:

- The tailgate and the rear passenger compartment window are closed.
- The vehicle is switched on.

If your vehicle has an EASY-PACK tailgate, you can program the  button on the key either to open/close the tailgate or to open the rear passenger compartment window.

- ▶ Press the buttons in the handle of the tailgate and in the handle of the rear passenger compartment window simultaneously for approximately five seconds. After successfully changing the function, the vehicle turn signal lamps flash once.
- ▶ Check the function of the  button on the key.

Rear-end doors

Opening and closing the rear-end doors from outside

⚠ DANGER Risk of poisoning from exhaust gases

Combustion engines emit poisonous exhaust gases, such as carbon monoxide. Exhaust gases can enter the vehicle interior if the tailgate or the rear-end door is open when the engine is running, especially if the vehicle is in motion.

- ▶ Always switch off the engine before opening the tailgate or the rear-end door.
- ▶ Never drive with the tailgate or rear-end door open.

⚠ WARNING Risk of accident due to concealed lighting systems

If you open the rear-end doors by 90°, the rear lighting installations will be concealed.

Other road users will then not be able to see the vehicle, or will see it only with difficulty.

Therefore, in these or similar situations, safeguard the vehicle in accordance with national regulations, e.g. with a warning triangle.

! **NOTE** Damage to the rear-end doors due to objects obstructing their range of movement

When the rear-end doors are opened, any objects obstructing the range of movement of the rear-end doors can be damaged as well as the vehicle.

▶ Make sure that there is sufficient clearance when opening the rear-end doors.

Opening the right rear-end door

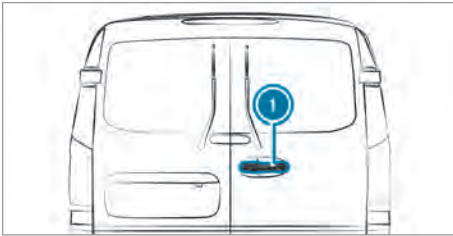

You can stop the rear-end doors at an angle of approximately 90°, and also at 180° or 270°. Make sure that the opened rear-end door is stopped correctly in the catch.

- ▶ Pull handle ①.
- ▶ Swing the rear-end door to the side until it engages.

ⓘ The rear-end doors can also be opened beyond 90° (→ page 55).

Opening the left rear-end door



- ▶ Make sure that the right rear-end door is open and engaged.
- ▶ Pull release handle ① in the direction of the arrow.
- ▶ Swing the rear-end door to the side until it engages.

Closing the rear-end doors from outside

- ▶ If necessary, pull the rear-end doors away from the magnetic door retainer (→ page 55).
- ▶ Close the left rear-end door firmly from outside.
- ▶ Close the right rear-end door firmly from outside.

Opening/closing the rear-end doors from the inside

Opening

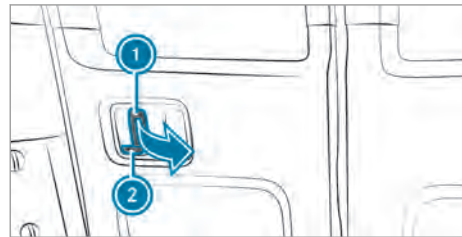

A white area on latch ② indicates that the rear-end door is unlocked.

- ▶ **To unlock:** slide latch ② to the left. A white area is visible.
- ▶ Pull release lever ① and open the rear-end door.
- ▶ Swing the rear-end door to the side until it engages.

ⓘ If you open a locked rear-end door from inside, you only unlock the rear-end door. The other doors remain locked.

Closing

- ▶ Make sure that the left rear-end door is closed.
- ▶ Pull the rear right door firmly to by the door handle.
- ▶ **To lock:** slide latch ② to the right. The white area is no longer visible.

Opening the rear-end doors 180° or 270°

! **NOTE** Damage due to collision between the rear-end door and the sliding door or the pop-out window

If the respective rear-end door is opened 270° while the sliding door is open, the doors will collide.

There will be a collision between the rear window wiper and the pop-out window under the following circumstances:

- The pop-out window is open.
 - The rear-end door is open 270°.
 - The rear window wiper is in operation.
- ▶ Make sure that the sliding door is closed before opening the rear-end door to 270°.
- ▶ Make sure that the rear window wiper is switched off or the pop-out window is closed before opening the rear-end door to 270°.

Requirements:

- The vehicle is designed such that you can open the rear-end doors 180° or 270° (side wall).

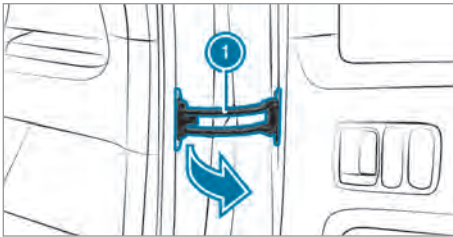

- ▶ Open the rear-end door approximately 45°.
- ▶ Pull and hold door retainer ① in the direction of the arrow.
- ▶ Open the rear-end door at an angle greater than 90° so that the door retainer is no longer locked in place.
- ▶ Release the door retainer and open the rear-end door 180° or 270°.

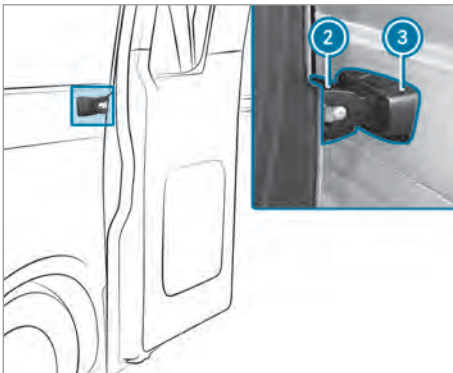

- ▶ With the rear-end door opened 270°, push it against magnetic door retainer ③ on the side wall.

When the magnet on rear-end door ② is in contact with magnetic door retainer ③, the rear-end door is held in position.

Side window

Opening and closing the side windows

- ▲ **WARNING** Risk of entrapment when opening a side window

When opening a side window, parts of the body could be drawn in or become trapped between the side window and window frame.

- ▶ When opening, make sure that nobody is touching the side window.
- ▶ If someone is trapped, release the button immediately or pull it in order to close the side window again.

- ▲ **WARNING** Risk of becoming trapped when closing a side window

When closing a side window, body parts could be trapped in the closing area in the process.

- ▶ When closing, make sure that no body parts are in the closing area.
- ▶ If someone is trapped, release the button immediately or press the button in order to reopen the side window.

- ▲ **WARNING** Risk of becoming trapped when children operate the side windows

Children could become trapped if they operate the side windows, particularly when unattended.

- ▶ Activate the child safety lock for the rear passenger compartment side windows.
- ▶ When leaving the vehicle, always take the SmartKey with you and lock the vehicle.
- ▶ Never leave children unattended in the vehicle.

- ▲ **WARNING** Risk of fatal injury due to exposure to extreme heat or cold in the vehicle

If persons, particularly children, are subjected to prolonged exposure to intense heat or cold, there is a risk of severe injury or even death.

- ▶ Never leave persons, particularly children, unattended in the vehicle.

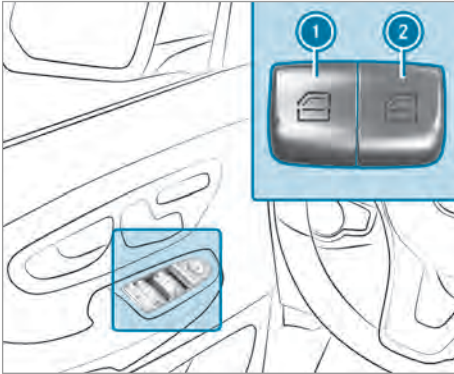

- ▶ **To open manually:** press and hold button ① or ②.
- ▶ **To close manually:** pull and hold button ① or ②.

The windows in the front doors can also be operated automatically.

- ▶ **To open completely:** briefly press button ① or ② beyond the point of resistance. Automatic operation will start.
- ▶ **To close completely:** briefly pull button ① or ② beyond the point of resistance. Automatic operation will start.
- ▶ **To interrupt automatic operation:** briefly press or pull button ① or ② again.

You can still operate the side windows when the vehicle is parked. This function will remain available for around five minutes or until you open a front door.

Automatic reversing function of the side windows

If an object blocks a side window during the closing process, the side window will open again automatically. The automatic reversing function is only an aid and is not a substitute for your attentiveness.

- ▶ During the closing process, make sure that no body parts are in the closing area.

- ▲ **WARNING** Risk of becoming trapped despite there being reversing protection on the side window

The reversing function does not react:

- To soft, light and thin objects, e.g. fingers.
- During resetting.

The reversing function cannot prevent someone from becoming trapped in these situations.

- ▶ During the closing process, make sure that no body parts are in the closing area.
- ▶ If someone becomes trapped, press the  button to open the side window again.



Ventilating the vehicle before starting a journey (convenience opening)

- ▲ **WARNING** Risk of entrapment when opening a side window

When opening a side window, parts of the body could be drawn in or become trapped between the side window and window frame.

- ▶ When opening, make sure that nobody is touching the side window.
- ▶ Release the button immediately if somebody becomes trapped.

The "convenience opening" function can be operated using the key without switching on the vehicle. The key must be in close proximity to the driver's or co-driver door.



- ▶ Press and hold the  button on the key. The following functions are performed:
 - The vehicle is unlocked
 - The side windows are opened
- ▶ **To interrupt convenience opening:** release the  button.

Closing the side windows from the outside (convenience closing)

⚠ WARNING Risk of entrapment due to not paying attention during convenience closing

When the convenience closing feature is operating, parts of the body could become trapped in the closing area of the side windows.

- ▶ When the convenience closing feature is operating, monitor the entire closing process and make sure that no body parts are in the closing area.

- ▶ Press and hold the  button on the key. The following functions are performed:
 - the vehicle is locked
 - the side windows are closed
- ▶ **To interrupt convenience closing:** release the  button.



Adjusting the side windows

The side windows must be readjusted after a malfunction or a voltage supply interruption.

- ▶ Switch on the power supply (→ page 97).
- ▶ Push both buttons on the power window and hold for approximately one second after the side window has closed.
- ▶ If the side windows remain closed when you release the buttons, they have been reset correctly. If this is not the case, repeat the steps described for the open side windows.

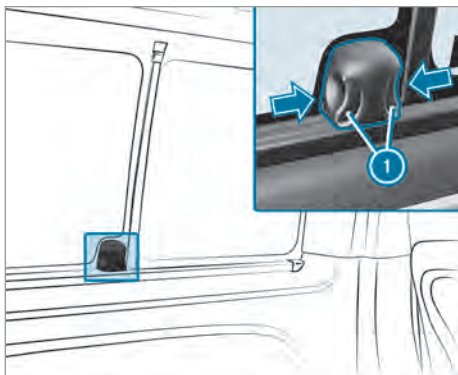
Opening and closing the sliding windows



- ▶ **To open:** press both handle sections  together simultaneously and slide the sliding window to the desired notch.
- ▶ **To close:** slide the sliding window shut until the handle sections  engage audibly and lay flat.

Rectifying problems with the side windows

⚠ WARNING Risk of becoming trapped or fatally injured if reversing protection is not activated

If you close a side window again immediately after it has been blocked, the side window will close with increased or maximum force. The reversing function is then not active and body parts may become trapped.

- ▶ Make sure that no parts of the body are in the closing area.
- ▶ To stop the closing process, release the button or press the button again to reopen the side window.

You cannot open or close a side window all the way.

- ▶ Check to see if there are any objects in the window guide.
- ▶ Reset the side windows (→ page 58).

Anti-theft prevention

Function of the immobilizer

The immobilizer prevents your vehicle from being started without the correct key.

The immobilizer is automatically activated when the vehicle is switched off, and deactivated when the vehicle is switched on.

ATA (Anti-Theft Alarm system)

Function of ATA (Anti-theft Alarm system)

If the ATA system is armed, a visual and audible alarm is triggered in the following situations:

- When opening a door
- When opening the vehicle with the emergency key
- When opening the hood
- When opening the tailgate or rear door

After locking the vehicle with the SmartKey, the ATA system is automatically armed.



When the ATA system is armed, indicator lamp ❶ flashes in the overhead control panel.

ATA is automatically deactivated in the following situations:

- After unlocking the vehicle with the SmartKey
 - When the SmartKey is inserted into the ignition lock
- ❶ The alarm will not be deactivated, even if you immediately close the open door that has triggered it, for example.

Arming/deactivating ATA (Anti-theft Alarm system)

Activating





- ▶ Close all the doors.
- ▶ Lock the vehicle with the key. Indicator lamp ❶ in the overhead control panel flashes.

Deactivating

- ▶ Unlock the vehicle with the key.
- or
- ▶ Insert the key into the ignition lock. Indicator lamp ❶ in the overhead control panel goes out.

Stopping the alarm

- ▶ Press the  or  button on the key.
- or
- ▶ Insert the key into the ignition lock. The alarm stops.

Function of the tow-away alarm

A visual and audible alarm is triggered if the inclination of the vehicle changes, e.g. when lifted on one side, and the tow-away alarm is armed.

Arming/disarming the tow-away alarm

Requirements:

- The doors are closed.
- The tailgate or rear-end doors are closed.

Arming

- ▶ Lock the vehicle with the SmartKey. The tow-away alarm is automatically armed after about 50 seconds.

Deactivating

- ▶ Open the vehicle with the SmartKey.
- or
- ▶ Insert the SmartKey into the ignition lock. The tow-away alarm is deactivated.

Disarming

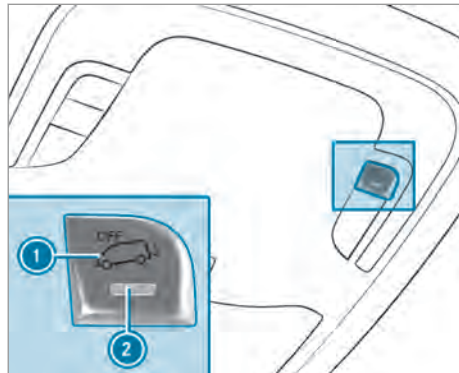

- ▶ Remove the SmartKey from the ignition lock.
- ▶ Press button ❶. When the button is released, indicator lamp ❷ in the button lights up for approximately three seconds.
- ▶ Lock the vehicle with the SmartKey. The tow-away alarm is disarmed.

The tow-away alarm remains disarmed until you lock the vehicle again.

In the following situations, a false alarm can occur:

- When loading and/or transporting the vehicle on a ferry or car transporter, for example
- When parking the vehicle on a movable surface, such as a split-level garage

Disarm the tow-away alarm in these situations.

Function of the interior motion sensor

If the activated interior motion sensor detects motion in the vehicle interior, a visual and acoustic alarm is triggered. This can happen if someone reaches into the vehicle interior, for example.

Activating and deactivating the interior motion sensor

Requirements:

- The side windows are closed.
- The doors are closed.
- The tailgate or rear-end doors are closed.

Activating

- ▶ Make sure that nothing (such as mascots or coat hangers) is hanging on the inside rearview mirror or on the grab handles. This will prevent false alarms.
- ▶ Lock the vehicle with the key. The interior motion sensor is activated after approximately 20 seconds.

Deactivating

- ▶ Unlock the vehicle with the key.
- or
- ▶ Insert the key into the ignition lock. The interior motion sensor automatically switches off.

Deactivating

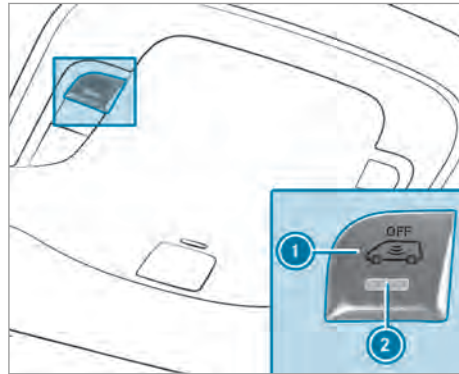

- ▶ Remove the key from the ignition lock.
- ▶ Press button ①. When the button is released, indicator lamp ② in the button lights up for approximately three seconds.
- ▶ Lock the vehicle with the key. The interior motion sensor is deactivated.

The interior motion sensor remains deactivated until you lock the vehicle again.

In the following situations, a false alarm can occur:

- If there are people or animals remaining inside
- When transporting the vehicle on a ferry or car transporter, for example

Deactivate the interior motion sensor in these situations.

Notes on the correct driver's seat position

⚠ WARNING Risk of accident due to adjusting the vehicle settings while the vehicle is in motion

You could lose control of the vehicle in the following situations in particular:

- If you adjust the driver's seat, the head restraint, the steering wheel or the mirror while the vehicle is in motion
- If you fasten your seat belt while the vehicle is in motion

▶ Before starting the vehicle: in particular, adjust the driver's seat, head restraint, steering wheel and mirror, and fasten your seat belt.

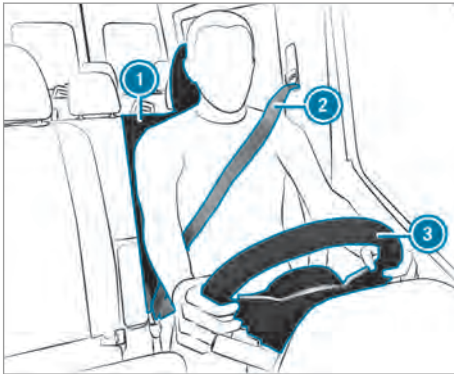

Ensure the following when adjusting steering wheel ③, seat belt ② and driver's seat ①:

- You are sitting as far away from the driver's airbag as possible.
- You are sitting in an upright position.
- Your thighs are gently supported by the seat cushion.
- Your legs are not fully extended and you can reach the pedals easily.
- The back of your head is supported at eye level by the middle part of the head restraint.
- You can hold the steering wheel with your arms slightly bent.
- You can move your legs without any restrictions.
- You can see all of the instrument cluster displays well.

- You have a good overview of the traffic conditions.
- Your seat belt sits snugly against your body and passes across the center of your shoulder and across your hips in the pelvic area.

Seats

Adjusting the front seat mechanically

⚠ WARNING Risk of becoming trapped if the seat is adjusted by children

Children could become trapped if they adjust the seats, particularly if they are unattended.

- ▶ When leaving the vehicle, always take the key with you and lock the vehicle.
- ▶ Never leave children unattended in the vehicle.

⚠ WARNING Risk of accident due to adjusting the vehicle settings while the vehicle is in motion

You could lose control of the vehicle in the following situations in particular:

- If you adjust the driver's seat, the head restraint, the steering wheel or the mirror while the vehicle is in motion
- If you fasten your seat belt while the vehicle is in motion

▶ Before starting the vehicle: in particular, adjust the driver's seat, head restraint, steering wheel and mirror, and fasten your seat belt.

⚠ WARNING Risk of becoming trapped when adjusting the seat

When you adjust a seat, you or other vehicle occupants could become trapped, e.g. on the seat guide rail.

- ▶ When adjusting a seat, make sure that no one has any part of their body within the sweep of the seat.

Observe the safety notes on "Airbags" and "Children in the vehicle".

⚠ WARNING Risk of accident due to the driver's seat not being engaged

The driver's seat may move unexpectedly while driving.

This could cause you to lose control of the vehicle.

- ▶ Always make sure that the driver's seat is engaged before starting the vehicle.

⚠ WARNING Risk of injury or death due to the front seat being positioned too close to the cockpit

The front airbags can also injure the occupants in the front of the vehicle.

- ▶ Always adjust the front seats so they are as far away as possible from the front airbags.
- ▶ In addition, observe the notes on correct seat adjustment.

⚠ WARNING Risk of injury or death due to an incorrect seat position

The seat belt does not offer the intended level of protection if you have not moved the seat backrest to an almost vertical position.

In particular, you could slip beneath the seat-belt and become injured.

- ▶ Adjust the seat properly before beginning your journey.
- ▶ Always ensure that the seat backrest is in an almost vertical position and that the shoulder belt is routed across the center of your shoulder.

⚠ WARNING Risk of injury due to head restraints not being installed or being adjusted incorrectly

If head restraints have not been installed or have not been adjusted correctly, there is an increased risk of injury in the head and neck area, e.g. in the event of an accident or when braking.

- ▶ Always drive with the head restraints installed.
- ▶ Before driving off, make sure for every vehicle occupant that the center of the head restraint supports the back of the head at about eye level.

Do not interchange the head restraints of the front and rear seats. Otherwise, you will not be able to set the height and inclination of the head restraints to the correct position.

Adjust the head restraint fore-and-aft position so that it is as close as possible to the back of your head.

! **NOTE** Damage to the seats and seat heating due to fluids, sharp objects or insulating materials

To prevent damage to the seats and the seat heating, observe the following instructions:

- ▶ Do not spill any fluids onto the seats. If something is spilled onto the seats, dry the seats as quickly as possible.
- ▶ Do not switch on the seat heating if the seat covers are wet or damp. Do not use the seat heating to dry the seats.
- ▶ Clean the seats as recommended; see the "Cleaning and care" section.
- ▶ Do not transport heavy loads on the seats. Do not place any sharp objects, such as knives, nails or tools, on the seats. If possible, use the seats only for people.
- ▶ When using the seat heating, do not cover the seats with insulating materials, such as blankets, coats, bags, protective covers, child seats or booster seats.

! **NOTE** Damage to the seat or partition when adjusting the seat in the Cargo Van

When the seat is adjusted, it may collide with the partition.

The seat or the partition may be damaged in the process.

- ▶ Adjust the seat carefully.

Adjusting the seat fore-and-aft position

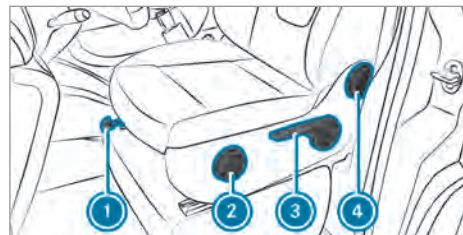

- ▶ Pull lever ① upwards and slide the seat forwards or back until the desired position has been reached.

- ▶ Release lever ❶ and push the seat back or forwards until you hear the seat engage.

Adjusting the seat height

- ▶ Pull or push lever ❸ repeatedly until the desired seat height has been reached.

Adjusting the seat backrest

- ▶ Turn handwheel ❹ forwards.
The seat backrest will move to a vertical position.
- ▶ Turn handwheel ❹ backwards.
The seat backrest will tilt back.

Adjusting the seat cushion inclination

- ▶ Turn handwheel ❷ forwards.
The front of the seat cushion will tilt down.
- ▶ Turn handwheel ❷ backwards.
The front of the seat cushion will tilt up.

Adjusting the front seat electrically

⚠ WARNING Risk of becoming trapped if the seat is adjusted by children

Children could become trapped if they adjust the seats, particularly if they are unattended.

- ▶ When leaving the vehicle, always take the key with you and lock the vehicle.
- ▶ Never leave children unattended in the vehicle.

The seats can be adjusted when the SmartKey is in the ignition lock.

⚠ WARNING Risk of accident due to adjusting the vehicle settings while the vehicle is in motion

You could lose control of the vehicle in the following situations in particular:

- If you adjust the driver's seat, the head restraint, the steering wheel or the mirror while the vehicle is in motion
- If you fasten your seat belt while the vehicle is in motion
- ▶ Before starting the vehicle: in particular, adjust the driver's seat, head restraint, steering wheel and mirror, and fasten your seat belt.

⚠ WARNING Risk of becoming trapped when adjusting the seat

When you adjust a seat, you or other vehicle occupants could become trapped, e.g. on the seat guide rail.

- ▶ When adjusting a seat, make sure that no one has any part of their body within the sweep of the seat.

Observe the safety notes on "air bags" and "children in the vehicle".

⚠ WARNING Risk of injury or death due to the front seat being positioned too close to the cockpit

The front airbags can also injure the occupants in the front of the vehicle.

- ▶ Always adjust the front seats so they are as far away as possible from the front airbags.
- ▶ In addition, observe the notes on correct seat adjustment.

⚠ WARNING Risk of injury or death due to an incorrect seat position

The seat belt does not offer the intended level of protection if you have not moved the seat backrest to an almost vertical position.

In particular, you could slip beneath the seat-belt and become injured.

- ▶ Adjust the seat properly before beginning your journey.
- ▶ Always ensure that the seat backrest is in an almost vertical position and that the shoulder belt is routed across the center of your shoulder.

⚠ WARNING Risk of injury due to head restraints not being installed or being adjusted incorrectly

If head restraints have not been installed or have not been adjusted correctly, there is an increased risk of injury in the head and neck area, e.g. in the event of an accident or when braking.

- ▶ Always drive with the head restraints installed.
- ▶ Before driving off, make sure for every vehicle occupant that the center of the

head restraint supports the back of the head at about eye level.

Do not rotate the head restraints on the front rear seats. Otherwise, you will not be able to set the height and inclination of the head restraints to the correct position.

Adjust the head restraint fore and aft position so that it is as close as possible to the back of your head.

! **NOTE** Damage to the seats and seat heating due to fluids, sharp objects or insulating materials

To prevent damage to the seats and the seat heating, observe the following instructions:

- ▶ Do not spill any fluids onto the seats. If something is spilled onto the seats, dry the seats as quickly as possible.
- ▶ Do not switch on the seat heating if the seat covers are wet or damp. Do not use the seat heating to dry the seats.
- ▶ Clean the seats as recommended; see the "Cleaning and care" section.
- ▶ Do not transport heavy loads on the seats. Do not place any sharp objects, such as knives, nails or tools, on the seats. If possible, use the seats only for people.
- ▶ When using the seat heating, do not cover the seats with insulating materials, such as blankets, coats, bags, protective covers, child seats or booster seats.

Requirements:

- The vehicle is switched on or the door is open.

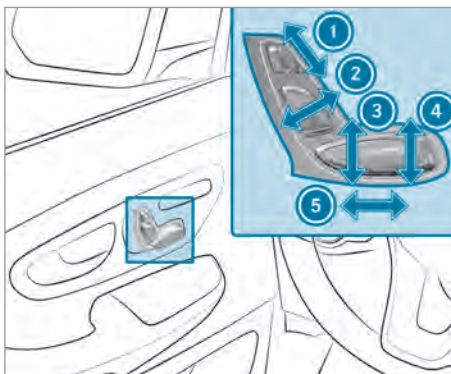

- ① Head restraint height adjustment
- ② Seat backrest inclination adjustment
- ③ Seat height adjustment
- ④ Seat cushion inclination adjustment
- ⑤ Seat fore and aft position adjustment

- ▶ Adjust the seat using buttons ① to ⑤ on the door trim.

If the vehicle is not switched on, you can adjust the seat within 30 seconds of unlocking the vehicle.

- ① You can save the settings for the seat with the memory function (→ page 65).

Setting 4-way lumbar support

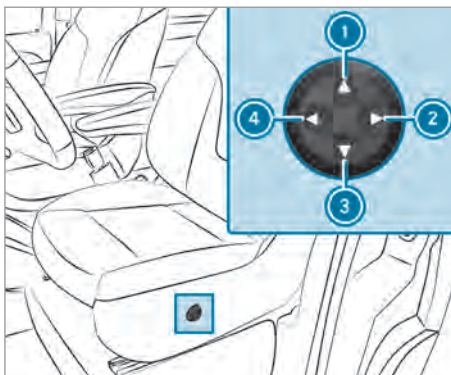

- ① Higher
- ② Weaker

- ③ Lower
- ④ Stronger

▶ Use buttons ① to ④ adjust the backrest contour individually to your spine.

Operating the memory function

⚠ WARNING Risk of an accident if the memory function is used while driving

If you use the memory function on the driver's side while driving, you could lose control of the vehicle as a result of the adjustments being made.

▶ Only use the memory function on the driver's side when the vehicle is stationary.

⚠ WARNING Risk of entrapment when adjusting the seat with the memory function

When the memory function adjusts the seat, you and other vehicle occupants – particularly children – could become trapped.

- ▶ During the adjustment process of the memory function, make sure that no one has any body parts in the sweep of the seat.
- ▶ If somebody becomes trapped, immediately release the memory function position button. The adjustment process is stopped.

⚠ WARNING Risk of entrapment if the memory function is activated by children

Children could become trapped if they activate the memory function, particularly when unattended.

- ▶ Never leave children unattended in the vehicle.
- ▶ When leaving the vehicle, always take the SmartKey with you and lock the vehicle.

The memory function can be used when the vehicle is switched off.

❗ NOTE Damage to the seat when moving into a stored position

If the seat is moved out of the fully reclined position into a stored seat position, it can collide with other vehicle parts.

This can damage the seat.

▶ Before moving the seat into a stored position, move the seat backrest into an upright position.

Storing seat settings

Seat settings for up to three people can be stored and called up using the memory function. The position of the seat, seat backrest and head restraint are stored as a single memory preset.

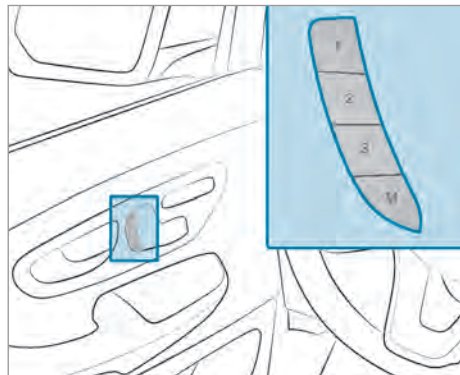

- ▶ Adjust the seat to the desired position.
- ▶ Briefly press memory button **M** and then press preset position button **1**, **2** or **3** within three seconds. An acoustic signal sounds. The settings are stored.
- ▶ **To call up:** press and hold preset position button **1**, **2** or **3** until the seat is in the stored position.

Adjusting armrests

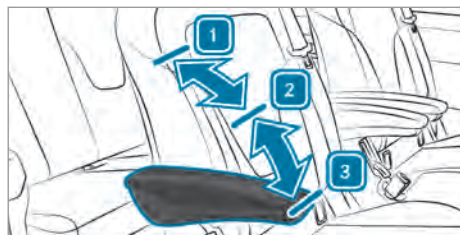

- ▶ Fold the armrest upwards more than 45° in position **2**. The armrest will be unlocked.
- ▶ Fold the armrest forwards **3** as far as it will go.
- ▶ Slowly fold the armrest upwards into the required position.
- ▶ **To fold the armrest upwards:** if necessary, fold the armrest upwards more than 90° in position **1**.

Rear bench seats

Notes on the rear seats

Bench seat anchorage

⚠ WARNING Risk of accident and injury as a result of rear bench seat not being engaged

If the rear bench seat is not engaged, it may be flung around during travel.

- ▶ Always make sure that the rear bench seat is engaged as described.

Keep the seat anchorages in the vehicle floor free of dirt and objects at all times to ensure that the seat engages securely.

If the indicator tab of the seat anchorages is not retracted into the seat leg, the seat is not correctly engaged. Engage the seat again.

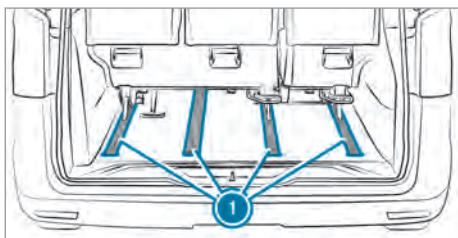

Example: seat rail system with quick-locking mechanism

Guide rails **1** for the seat rail system can be used to mount up to two rear bench seats in two rows.

- i Vehicles with seat rail systems:** When you remove a rear bench seat, the seat slider may slide into a guide rail. The seat sliders will then no longer be parallel in the guide rails. In this case, you will no longer be able to install the rear bench seat. The seat sliders must be moved only using a special tool or at a quali-

fied specialist workshop in order to prevent the risk of damage. The tool is available as a Mercedes-Benz accessory.

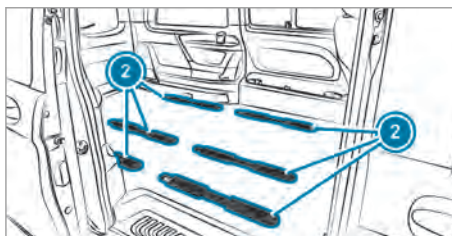

Seat anchorages with quick-locking mechanism (example: three seat anchorages per row of rear seats)

You can secure rear bench seats in seat anchorages **2**. If your vehicle is equipped with four seat anchorages on the first rear seat row, the rear bench seats can be mounted facing one another.

seating variants

⚠ WARNING Risk of injury due to incorrect installation of the rear bench seats

If the rear bench seats are incorrectly installed, the integrated safety precautions in the rear bench seats cannot work as intended.

- ▶ Install the rear bench seats only as described.
- ▶ Only use rear bench seats approved for your vehicle.

Depending on the type of seat anchorage in the vehicle floor, you can install the following seating variants:

- rear bench seats with two or three seats
- Seat/bunk combination with three seats

Depending on the vehicle equipment, you can install the rear bench seats in the first and/or second rear seat row.

The seating variants shown are permitted only if the conditions specified below for safe rear seating are met. Other seating variants are not permitted and may endanger the occupants.

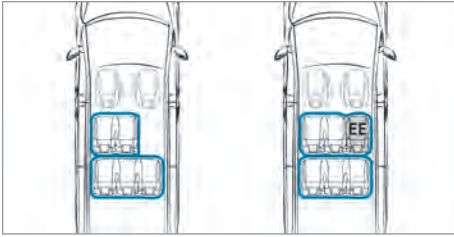

EE Easy entry and exit feature – EASY-ENTRY

If a rear bench seat is marked with EE in the illustrations, a rear bench seat with the EASY-ENTRY and exit feature must be installed in the position indicated.

If a rear bench seat is not marked, a rear bench seat with or without the EASY-ENTRY feature can be installed in the position indicated.

Please observe the following conditions for safe rear seating:

- Use only rear bench seats approved for the vehicle.
- A rear bench seat with three seats without the EASY-ENTRY feature may be installed only if there is no other rear seat row behind it.
- Passengers can use the seats only if the rear bench seat has been correctly engaged (→ page 68).

Using the EASY-ENTRY easy entry and exit feature (rear bench seat)

⚠ WARNING Risk of accident and injury as a result of rear bench seat not being engaged

If the rear bench seat is not engaged, it may be flung around during travel.

- ▶ Always make sure that the rear bench seat is engaged as described.

In order to ensure that the rear bench seat can securely engage, keep the seat guide rails and anchorages in the vehicle floor free of dirt and foreign objects.

If the indicator tab of the seat anchorage is not retracted into the seat leg, the seat is not correctly engaged. Engage the seat again.

⚠ WARNING Risk of becoming trapped when adjusting the rear bench seat

When adjusting a rear bench seat, you or another vehicle occupant could become trapped by the guide rail of the rear bench seat, for example.

- ▶ Make sure that no one has any part of their body within the sweep of the rear bench seat when adjusting the rear bench seat.

⚠ WARNING Risk of becoming trapped due to the rear bench seat not being engaged

The rear bench seat will not engage when folded forward. The rear bench seat may inadvertently fold back while the vehicle is accelerating, braking or changing direction suddenly or in the event of an accident, for example.

People within the sweep of the rear bench seat may become trapped.

- ▶ Always fold back a rear bench seat that has been folded forward before you start driving.
- ▶ Ensure that the rear bench seat is engaged.

Folding the EASY-ENTRY section forwards/back

If you fold the EASY-ENTRY section of the rear bench seat forwards, it is easier for you to get in and out of the vehicle.

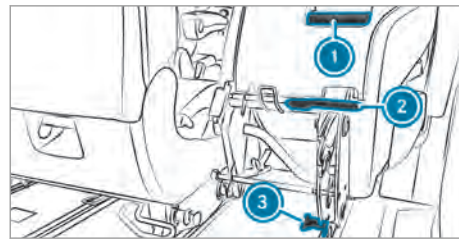

Rear bench seat with EASY-ENTRY feature (example: comfort rear bench seat)

- ① Grab handle
- ② EASY-ENTRY release handle
- ③ Release handle for front seat legs

- ▶ Pull EASY-ENTRY release handle ② upwards.
- ▶ Fold the EASY-ENTRY section forwards with the aid of grab handle ①.
- ▶ **To fold the EASY-ENTRY section back:** fold the EASY-ENTRY section back until it engages in

the seat anchorages. The indicator tab will no longer be visible.

- ① The EASY-ENTRY section is correctly engaged when the seat leg engages audibly and the indicator tab is no longer visible and is fully retracted into the seat leg.

Removing the EASY-ENTRY section

- ▶ **Vehicles with comfort rear bench seat:** Fold the seat backrest forward.
- ▶ Pull EASY-ENTRY release handle ② upwards.
- ▶ Fold the EASY-ENTRY section forwards with the aid of grab handle ①.
- ▶ Pull release handle ③ for the front seat legs upwards.
- ▶ Fold the EASY-ENTRY section further forwards.
- ▶ Lift the EASY-ENTRY section up and out of the anchorage.

Installing the EASY-ENTRY section

- ▶ Place and engage the front seat leg of the EASY-ENTRY section on the seat anchorages.
- ▶ Fold the EASY-ENTRY section back. The rear seat leg of the EASY-ENTRY section will engage audibly. The indicator tab on the seat leg will no longer be visible.

- ① The EASY-ENTRY section is correctly engaged when the seat leg engages audibly and the indicator tab is no longer visible and is fully retracted into the seat leg.

- ▶ **Vehicles with comfort rear bench seat:** Fold the seat backrest back to the seat position.

Moving the rear bench seat

- ⚠ **WARNING** Risk of becoming trapped when adjusting the rear bench seat

When adjusting a rear bench seat, you or another vehicle occupant could become trapped by the guide rail of the rear bench seat, for example.

- ▶ Make sure that no one has any part of their body within the sweep of the rear bench seat when adjusting the rear bench seat.

- ⚠ **WARNING** Risk of injury due to moving the rear bench seat while the vehicle is in motion

If you move the rear bench seat while driving, the seat may move in an unexpected or jerking manner, for instance when braking.

You could become trapped as well as thrown against parts of the vehicle interior or other vehicle occupants.

- ▶ Only move the rear bench seat when the vehicle is stationary.
- ▶ Make sure that the rear bench seat is engaged after it is moved.

- ⚠ **WARNING** Risk of injury due to no protective effect from the window airbag

If you move the seat position outside the marked area, the window airbag can no longer provide optimum protection.

The protective effect of the window airbag is gradually reduced and may in some positions no longer be provided at all.

- ▶ Engage the rear seats or the rear bench seat on the guide rail within the marked area.

- ⚠ **WARNING** Risk of injury from the front seat being positioned too close to vehicle occupants

If you move the rear seats or the rear bench seat outside the markings on the guide rail, this could result in the passenger striking their head on the front seat.

- ▶ Maintain a minimum clearance of 2 in (5 cm) between the knees of the respective vehicle occupants and the seat in front of them.

Requirements:

- The vehicle is equipped with a seat rail system in the vehicle floor.

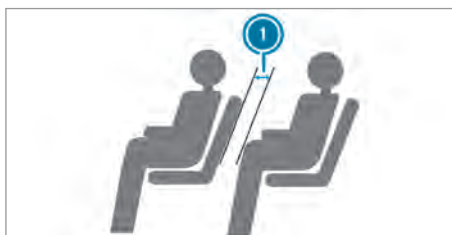

Maintain a minimum clearance of 2 in (5 cm) ❶ between the knees of the vehicle occupants and the seat in front of them.

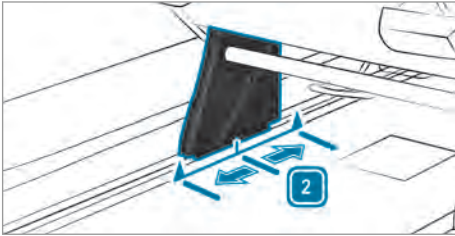

Starting from the basic setting ❷, the rear bench seat for passengers can be moved forwards or backwards by 2 in (5 cm). In doing so, make sure that passengers have sufficient legroom to reduce the risk of injury during braking.

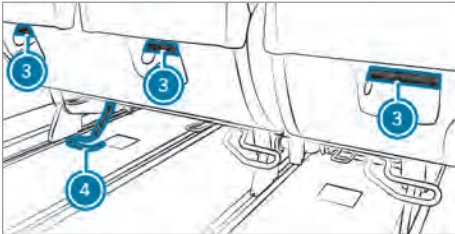

You can slide the rear bench seat only when it is unoccupied. If possible, slide the rear bench seat with the assistance of a second person.

- ▶ Pull up release handle ❹ for seat fore-and-aft adjustment.
- ▶ Move the rear bench seat to the desired position by grab handles ❸.
- ▶ Let go of release handle ❹.
- ▶ Release handle ❹ will fold down to its original position.
- ▶ Make sure that all sliders for fore-and-aft adjustment engage audibly on both sides. It will no longer be possible to move the rear bench seat.

Folding the rear bench seat forwards and backwards

⚠ WARNING Risk of accident and injury as a result of rear bench seat not being engaged

If the rear bench seat is not engaged, it may be flung around during travel.

- ▶ Always make sure that the rear bench seat is engaged as described.

To ensure that the rear bench seat engages securely, keep the seat guide rails and anchorages in the vehicle floor free from dirt and foreign objects.

If the indicator tab of the seat anchorage is not retracted into the seat leg, the seat is not correctly engaged. Engage the seat again.

⚠ WARNING Risk of becoming trapped due to the rear bench seat not being engaged

The rear bench seat will not engage when folded forward. The rear bench seat may inadvertently fold back while the vehicle is accelerating, braking or changing direction suddenly or in the event of an accident, for example.

People within the sweep of the rear bench seat may become trapped.

- ▶ Always fold back a rear bench seat that has been folded forward before you start driving.
- ▶ Ensure that the rear bench seat is engaged.

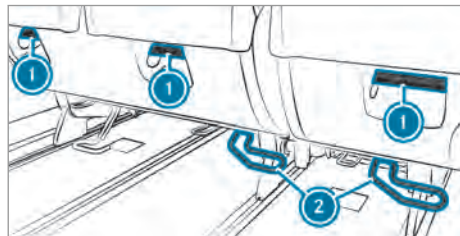

- ▶ Remove the head restraints (→ page 70).
- ▶ Pull the release handles for rear seat anchorage ❷ up and tilt the rear bench seat.
- ▶ Grasp the rear bench seat by grab handles ❶ and fold the seat forwards.

Installing and removing the rear bench seat

⚠ WARNING Risk of accident and injury as a result of rear bench seat not being engaged

If the rear bench seat is not engaged, it may be flung around during travel.

- ▶ Always make sure that the rear bench seat is engaged as described.

Keep the seat anchorages in the vehicle floor free of dirt and objects at all times to ensure that the rear bench seat engages securely.

If the indicator tab of the seat anchorage is not retracted into the seat leg, the seat is not correctly engaged. Engage the seat again.

Removing the rear bench seat

You can install the rear bench seats in the face-to-face position only if the vehicle floor is equipped with four seat anchorages on the first rear seat row or with a seat rail system.

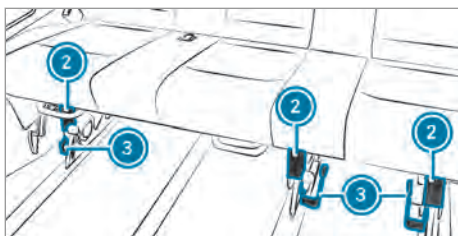
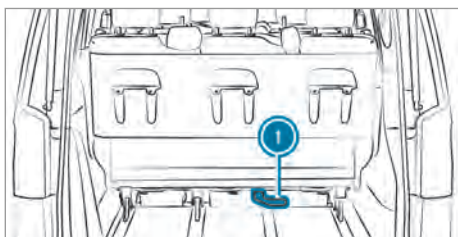

i In vehicles with a seat rail system, carry out the release, removal and subsequent re-installation of a rear bench seat at the marked basic position only (→ page 68).

- ▶ Fold release handle for the rear seat anchorage **1** up.
- ▶ Fold the rear bench seat forwards at the upper edge of the seat backrest.
- ▶ Pull release handle for the front seat legs **3** up.
- ▶ Grasp the rear bench seat by the lower edge of the seat cushion.
- ▶ Fold the rear bench seat forwards and remove it from the seat anchorages **2**.

Installing the rear bench seat

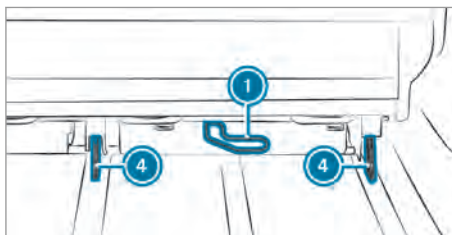

- ▶ Grasp the rear bench seat by the lower edge of the seat cushion.
- ▶ Insert the rear bench seat into the front seat anchorages **2** from above at the front and allow it to engage.
- ▶ Make sure that release handles for front seat legs **3** are folded down in the direction of the floor of the vehicle.
- ▶ Fold the rear bench seat back into the seat position.
- ▶ Press release handle for the rear seat anchorage **1** downwards until indicator tabs **4** have fully retracted into the rear seat legs.

The rear seat legs of the rear bench seat are correctly engaged when the seat legs engage audibly and indicator tabs **4** on the seat legs are no longer visible and have fully retracted into the seat legs.

Head restraints

Adjusting the head restraint manually

⚠ WARNING Risk of accident due to adjusting the vehicle settings while the vehicle is in motion

You could lose control of the vehicle in the following situations in particular:

- If you adjust the driver's seat, the head restraint, the steering wheel or the mirror while the vehicle is in motion
- If you fasten your seat belt while the vehicle is in motion

▶ Before starting the vehicle: in particular, adjust the driver's seat, head restraint, steering wheel and mirror, and fasten your seat belt.

⚠ WARNING Risk of injury due to head restraints not being installed or being adjusted incorrectly

If head restraints have not been installed or have not been adjusted correctly, there is an increased risk of injury in the head and neck area, e.g. in the event of an accident or when braking.

- ▶ Always drive with the head restraints installed.
- ▶ Before driving off, make sure for every vehicle occupant that the center of the head restraint supports the back of the head at about eye level.

Do not rotate the head restraints on the front and rear seats. Otherwise, you will not be able to adjust the height and inclination of the head restraints to the correct position.

Using the head restraint fore and aft adjustment, adjust the head restraint so that it is as close to the back of your head as possible.

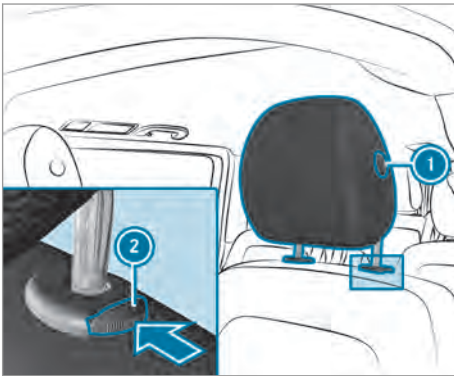

- ▶ **To raise:** pull the head restraint upwards into the desired position and ensure that it engages.
- ① Use the head restraint only when it is engaged.
- ▶ **To lower:** press release button ②, slide the head restraint downwards into the desired position and ensure that it engages.
- ① Use the head restraint only when it is engaged.
- ▶ **To move forwards or backwards:** press release button ① and pull the head restraint forwards

or backwards until it engages in the desired position.

- ▶ **To remove:** press release button ② and pull the head restraint up and out.
- ▶ **To install:** press the head restraint with detent into the holes on the left-hand side when viewed in the direction of travel until it engages.

Adjusting the head restraint electrically

⚠ WARNING Risk of accident due to adjusting the vehicle settings while the vehicle is in motion

You could lose control of the vehicle in the following situations in particular:

- If you adjust the driver's seat, the head restraint, the steering wheel or the mirror while the vehicle is in motion
- If you fasten your seat belt while the vehicle is in motion

- ▶ Before starting the vehicle: in particular, adjust the driver's seat, head restraint, steering wheel and mirror, and fasten your seat belt.

⚠ WARNING Risk of injury due to head restraints not being installed or being adjusted incorrectly

If head restraints have not been installed or have not been adjusted correctly, there is an increased risk of injury in the head and neck area, e.g. in the event of an accident or when braking.

- ▶ Always drive with the head restraints installed.
- ▶ Before driving off, make sure for every vehicle occupant that the center of the head restraint supports the back of the head at about eye level.

Do not rotate the head restraints on the front rear seats. Otherwise, you will not be able to set the height and inclination of the head restraints to the correct position.

Adjust the mechanical head restraint fore and aft position so that it is as close as possible to the back of your head.

! **NOTE** Damage to the electrical head restraint when adjusted manually

If the height of the electrically adjustable head restraint is adjusted manually, this can damage the mechanism of the head restraint.

- ▶ Adjust the height of the electrically adjustable head restraints using the buttons in the door trim.

Requirements:

- The vehicle is switched on or the door is open.

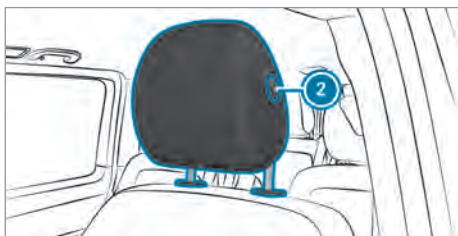
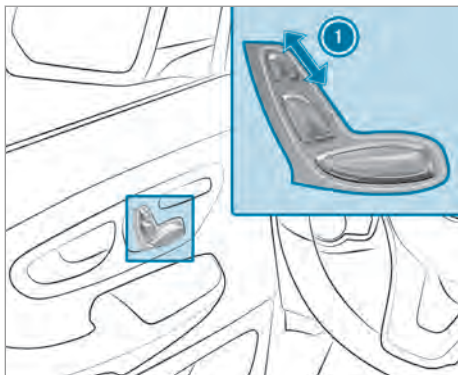

- ▶ **To adjust the height:** push button ① up or down in the direction of the arrow.

Moving forward or back

- ▶ Press and hold release knob ②.
- ▶ Push the head restraint forwards or backwards until it engages in the desired position.
- ① If the vehicle is not switched on, you can adjust the head restraint height within 30 seconds of unlocking the vehicle.

Switching the seat heating on/off

! **WARNING** Risk of burns due to repeatedly switching on the seat heating

Repeatedly switching on the seat heating can cause the seat cushion and seat backrest padding to become very hot.

In particular, the health of persons with limited temperature sensitivity or a limited ability to react to high temperatures may be affected or they may even suffer burn-like injuries.

- ▶ Do not repeatedly switch on the seat heating.

To protect against overheating, the seat heating may be temporarily deactivated after it is switched on repeatedly.

! **NOTE** Damage to the seat heating due to overheating

The seat heating may overheat if the seat is unoccupied when the seat heating is switched on or if objects are placed on the seat.

- ▶ Switch off the seat heating when the seat is unoccupied.
- ▶ Do not place any objects on the seat when the seat is unoccupied.

Requirements:

- The power supply has been switched on.

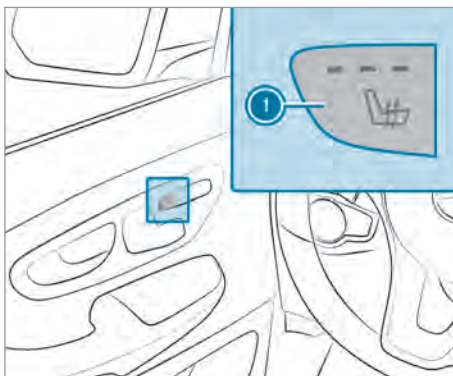

Front seat

- ▶ **To switch on/increase the level:** press button ① repeatedly until the desired heating level is set.
Depending on the heating level, one to three indicator lamps will light up.

- ▶ **To switch off/reduce the level:** press button ① repeatedly until the desired heating level is set.
When all indicator lamps are off, the seat heating is switched off.
- ① The seat heating will automatically switch back out of the three heating levels after 7, 10 and 20 minutes until the seat heating switches off.

Steering wheel

Adjusting the steering wheel

⚠ WARNING Risk of accident due to adjusting the vehicle settings while the vehicle is in motion

You could lose control of the vehicle in the following situations in particular:

- If you adjust the driver's seat, the head restraint, the steering wheel or the mirror while the vehicle is in motion
- If you fasten your seat belt while the vehicle is in motion

▶ Before starting the vehicle: in particular, adjust the driver's seat, head restraint, steering wheel and mirror, and fasten your seat belt.

⚠ WARNING Risk of accident due to unlocked steering wheel

The steering wheel may move unexpectedly if it is unlocked while the vehicle is in motion.

- ▶ Make sure that the steering wheel is locked before driving off.
- ▶ Never unlock the steering wheel when the vehicle is in motion.

⚠ WARNING Risk of entrapment for children when adjusting the steering wheel

Children could injure themselves if they adjust the steering wheel.

- ▶ Never leave children unattended in the vehicle.
- ▶ When leaving the vehicle, always take the SmartKey with you and lock the vehicle.

Adjusting the steering wheel

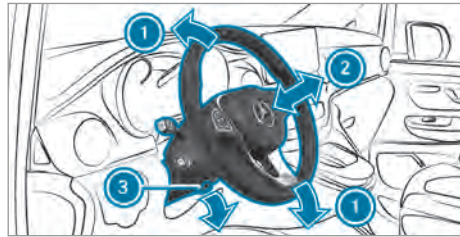

- ▶ **To unlock:** push release lever ③ down as far as it will go.
The steering column is unlocked.
- ▶ Adjust height ① and distance ② to the steering wheel.
- ▶ **To lock:** push release lever ③ up as far as it will go.
The steering column is locked.

Stowage areas

Storage spaces and storage compartments

Opening and closing the glove box

⚠ WARNING Risk of injury due to objects being stowed incorrectly

If objects in the vehicle interior are stowed incorrectly, they can slide or be thrown around and hit vehicle occupants. In addition, cup holders, open storage spaces and mobile phone brackets cannot always retain all objects they contain.

There is a risk of injury, particularly in the event of sudden braking or a sudden change in direction.

- ▶ Always stow objects in such a way that they cannot be thrown around in such situations.
- ▶ Always make sure that objects do not protrude from storage spaces, parcel nets or storage nets.
- ▶ Close the lockable storage spaces before starting a journey.
- ▶ Always stow and secure heavy, hard, pointed, sharp-edged, fragile or bulky objects in the trunk.

Observe the notes on loading the vehicle.

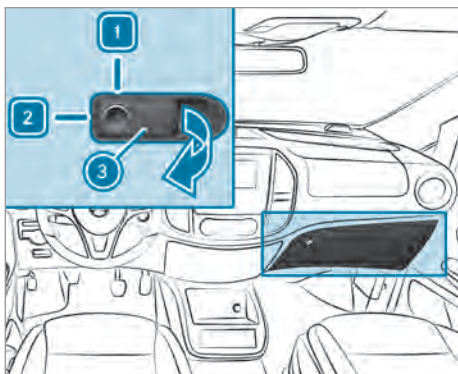

- 1 Unlocked
- 2 Locked
- 3 Glove box handle

▶ **To lock/unlock:** turn the emergency key a quarter turn counter-clockwise 2 (to lock) or clockwise 1 (to unlock).

▶ **To open:** pull glove box handle 3 in the direction of the arrow.

▶ **To close:** fold the glove box handle up and press on it until it engages.

Opening the glasses compartment

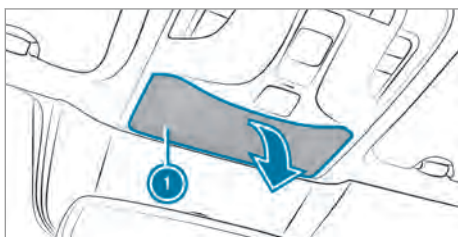

- ▶ Press on glasses compartment 1.

Information about the bottle holder

The bottle holders are in front of the stowage compartments in the front doors.

There are additional bottle holders on the left and right in the rear compartment side trim.

Cup holders

Overview of cup holders in the cockpit

⚠ WARNING Risk of accident or injury if the cup holder is used while the vehicle is in motion

Cup and bottle holders cannot keep containers secure while the vehicle is in motion.

If you use a cup or bottle holder while the vehicle is in motion, the container may be flung around and liquids could be spilled. Vehicle occupants may come into contact with the liquid and if it is hot, they could be scalded. You could be distracted from traffic conditions and you may lose control of the vehicle.

- ▶ Use the cup and bottle holders only when the vehicle is stationary.
- ▶ Place only suitable containers in the cup and bottle holders.
- ▶ Close the containers, particularly if the liquid is hot.

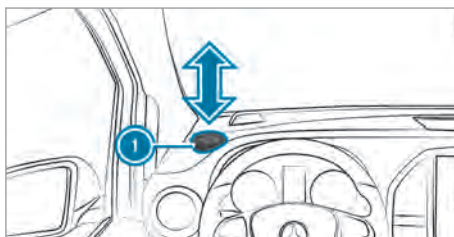

Cup holders 1 are located at the upper left and right of the cockpit.

Ashtray and cigarette lighter

Using ashtrays



- ▶ The ashtray with cap 1 can be inserted into a cup holder in the cockpit or into a cup holder in the rear passenger compartment.

Using the cigarette lighter in the front center console

⚠ WARNING - Risk of fire and injury from hot cigarette lighter

You can burn yourself if you touch the hot heating element or the socket of the cigarette lighter.

In addition, flammable materials may ignite if:

- you drop the hot cigarette lighter
- a child holds the hot cigarette lighter to objects, for example

- ▶ Always hold the cigarette lighter by the knob.
- ▶ Always make sure that the cigarette lighter is out of reach of children.
- ▶ Never leave children unattended in the vehicle.



- ▶ Fold up cover ① of the socket.
- ▶ Insert the plug of the device.

Requirements:

- The power supply has been switched on.

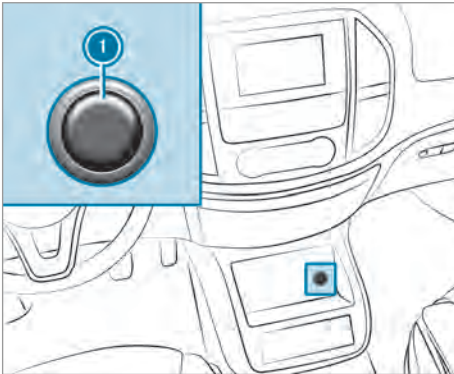

Cigarette lighter (example: vehicle with stowage compartment under the center console)

- ▶ Press in cigarette lighter ①.

Sockets

Using the 12 V socket in the front center console

Requirements:

- The power supply has been switched on.
- Only devices with up to a maximum of 180 watts (15 A) are permissible.

Exterior lighting

Information about lighting systems and your responsibility

The vehicle's various lighting systems are only aids. The vehicle driver is responsible for adjusting the vehicle's lighting to the prevailing light, visibility, statutory conditions and traffic conditions.

Light switch

Operating the light switch

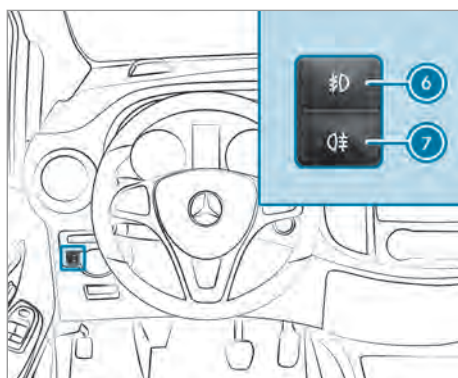
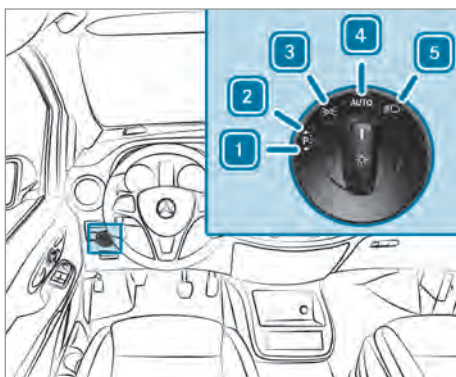

- 1 Left standing lights
- 2 Right standing lights
- 3 Parking lights and license plate and instrument lighting
- 4 Lights off and daytime running lights
- 4 With light sensor: automatic driving lights (preferred light switch position)
- 5 Low beam or high beam

- 6 Fog light
- 7 Rear fog light

If you hear a warning tone when exiting the vehicle, the lights may still be on.

▶ Turn the light switch to or **AUTO**.

The exterior lighting (except standing and parking lights) will automatically switch off in the following cases:

- If you remove the key from the ignition lock.
- If you open the driver's door while the key is in position in the ignition lock.

Switching on the daytime running lights

▶ Turn the light switch to or **AUTO**.

Automatic driving lights function

The parking lights, low beam and daytime running lights will be switched on automatically depending on the vehicle status and the ambient light.

⚠ WARNING Risk of accident when the low beam is switched off in poor visibility

When the light switch is set to **AUTO**, the low beam may not be switched on automatically if there is fog, snow or other causes of poor visibility such as spray.

▶ In such cases, turn the light switch to .

The automatic driving lights are only an aid. Responsibility for vehicle lighting rests with you.

If the parking lights and low beam have been switched on, the green (parking lights) and (low beam) indicator lamps on the instrument cluster will light up.

Activating/deactivating the fog lights

Requirements:

- The light switch is in the or **AUTO** position.
- The power supply or the vehicle has been switched on.
- **To switch on the fog light:** the vehicle is equipped with front fog lamps.

▶ **To switch the fog light on or off:** press the button.

▶ **To switch the rear fog light on or off:** press the button.

Comply with the country-specific regulations for using the rear fog lamp.

Adjusting headlamp range

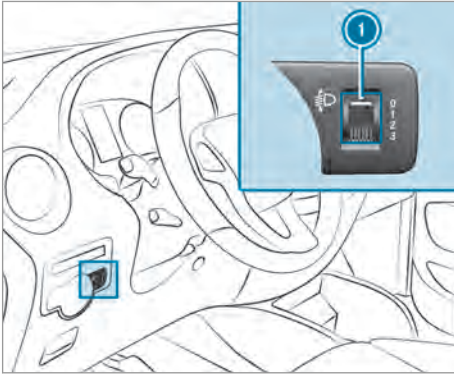

- ▶ Turn headlamp range adjuster ① to the required position.
- ▶ If the vehicle is unladen, select position 0.

The illumination of the road should be 131 ft (40 m) to 328 ft (100 m) and the low beam must not blind oncoming traffic.

You can use the headlamp range adjuster to adjust the light cone of the headlamps to your vehicle's load condition. As the seats are occupied or the cargo compartment is loaded or unloaded, the light cone changes. This may cause visibility conditions to deteriorate and you could blind oncoming traffic.

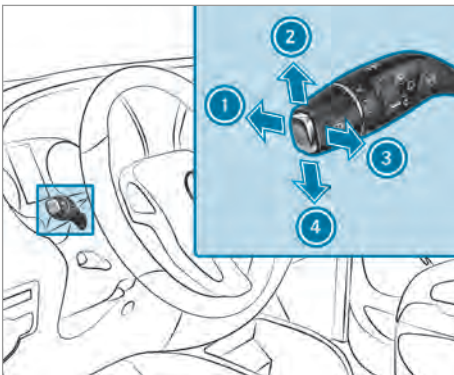

Operating the combination switch for lights



- ① High beam
- ② Right turn signal light
- ③ Headlamp flashing
- ④ Left turn signal light

- ▶ Use the combination switch to select the desired function.

Switching on high beam

- ▶ Switch on the low beam (→ page 76).
- ▶ Push the combination switch forwards ①. The  indicator lamp on the instrument cluster will light up.
- ① In the **Auto** position, the high beam switches on only in darkness and when the vehicle is switched on.
- ▶ **To switch off:** move the combination switch back to its starting position. The  indicator lamp goes out on the instrument cluster.

Headlamp flashing

- ▶ Briefly pull the combination switch in the direction of arrow ③.

Turn signal light

- ▶ **To indicate:** push the combination switch in the required direction ② or ④ until it engages. In the case of larger steering movements, the combination switch will reset itself automatically.
- ▶ **To indicate briefly:** tap the combination switch briefly in the required direction ② or ④. The corresponding turn signal lamp will flash three times.

Switching the hazard warning light system on/off

⚠ WARNING Risk of accident due to concealed lighting systems

If you open the rear-end doors by 90°, the rear lighting installations will be concealed.

Other road users will then not be able to see the vehicle, or will see it only with difficulty.

Therefore, in these or similar situations, safeguard the vehicle in accordance with national regulations, e.g. with a warning triangle.

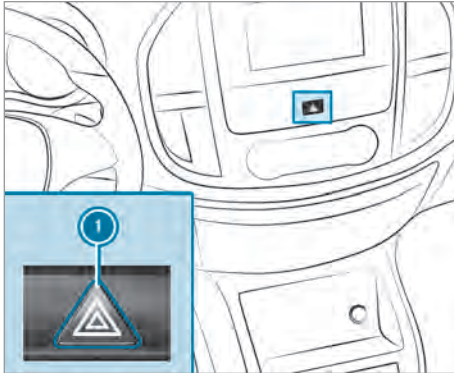

▶ Press button ①.

If you operate a turn signal indicator while the hazard warning light system is switched on, only the turn signal lamps on the relevant side of the vehicle will light up.

The hazard warning light system will switch on automatically in the following situations:

- The airbag is deployed
- The vehicle is heavily braked from a speed of more than 45 mph (70 km/h) to a standstill.

The hazard warning light system will automatically switch off when the vehicle regains a speed of more than 6 mph (10 km/h) after maximum full-stop braking.

Highbeam Assist

Adaptive Highbeam Assist function

▲ WARNING Risk of accident despite Adaptive Highbeam Assist

Adaptive Highbeam Assist does not react to:

- Road users without lights, e.g. pedestrians
- Road users with poor lighting, e.g. cyclists
- Road users whose lighting is obstructed, e.g. by a barrier

On very rare occasions, Adaptive Highbeam Assist may fail to recognize other road users with their own lighting, or may recognize them too late.

In these, or in similar situations, the automatic high beam will not be deactivated or will be activated despite the presence of other road users.

▶ Always observe the road and traffic conditions carefully and switch off the high beam in good time.

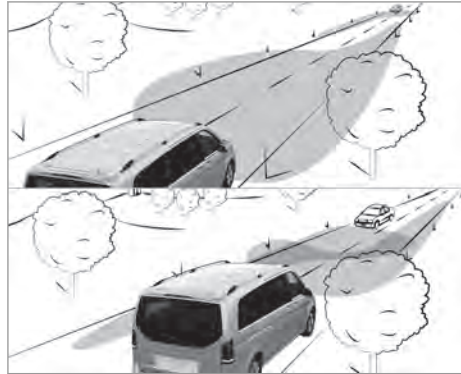

The Adaptive Highbeam Assist automatically switches between the following settings:

- Low beam
- High beam

The system detects that vehicle lights are approaching in the opposite direction or driving ahead of the vehicle.

If your speed is greater than 19 mph (30 km/h) and no other road users are detected, high beam will automatically be switched on.

If your speed is greater than 16 mph (25 km/h), the headlamp range will be controlled automatically depending on the distance from other road users.

High beam will automatically be deactivated in the following cases:

- Your speed is lower than 16 mph (25 km/h).
- Other road users have been detected.
- The road is sufficiently illuminated.

System limits

Adaptive Highbeam Assist cannot take the road, weather or traffic conditions into consideration.

The detection of obstacles may be restricted if:

- visibility is poor, e.g. in fog, heavy rain or snow.
- the sensors are dirty or covered.

Adaptive Highbeam Assist is only an aid. You are responsible for ensuring correct vehicle lighting in accordance with the prevailing light, visibility and traffic conditions.

The system's optical sensor is located behind the windshield near the overhead control panel.

Switching Highbeam Assist on/off

Requirements:

- The light switch is in the **AUTO** position.
- ▶ **To switch on:** switch on high beam using the combination switch. When the high beam is switched on automatically in the dark, the  indicator lamp will light up on the instrument cluster display.
- ▶ **To switch off:** switch off high beam using the combination switch.



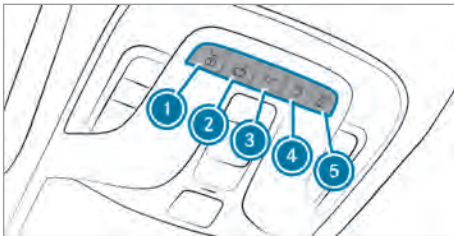

Interior lighting

Adjusting the interior lighting

Front overhead control panel





Interior lighting buttons (example: comfort overhead control panel)

- ①  Front-left reading lamp
 - ②  Automatic interior lighting control
 - ③  Front interior lighting
 - ④  Rear passenger compartment or cargo compartment lamp
 - ⑤  Front-right reading lamp
- ▶ **To switch on/off:** press the corresponding button ① - ⑤.

The layout and number of buttons depend on the equipment.

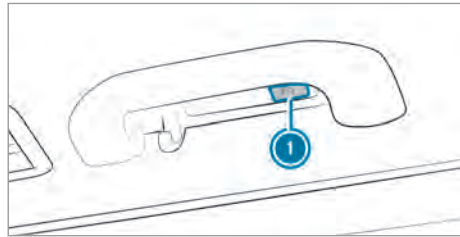
Operating unit in the grab handle



- ①  Rear reading lamp

- ▶ **To switch on/off:** press button ①.

Operating unit in the cargo compartment

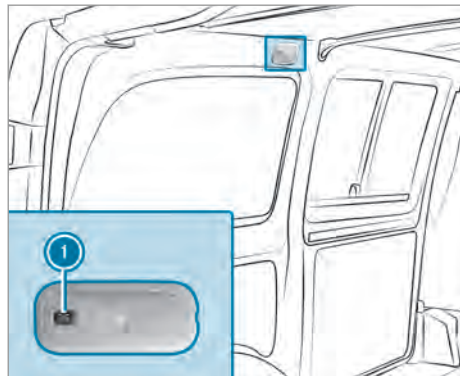

- ①  Cargo compartment lamp

- ▶ **To switch on/off:** press button ①.

If your vehicle is equipped with a cargo compartment lamp with a button, you can switch all cargo compartment lamps on and off by pressing the  button on this cargo compartment lamp.

Regardless of the switch position, you can switch the cargo compartment lamp on and off centrally by pressing the  button on the overhead control panel.

Changing bulbs

Instructions for replacing light sources

⚠ WARNING Risk of burns from hot component parts whilst replacing a bulb

Bulbs, lamps and plug connectors can become very hot during operation.

When replacing a bulb, you could burn yourself on these component parts.

- ▶ Allow the component parts to cool down before replacing the bulbs.

Important safety notes

- Before changing the bulbs, switch off the vehicle's lighting system. This will prevent a short circuit.
- Use only spare bulbs of the same type and with the correct voltage.
- Use bulbs only in enclosed lamps that have been designed for them.
- Do not use any light source that has been dropped or has scratches on its glass tube. Otherwise, the light source may explode.
- The light source may explode under the following conditions:
 - If it is hot and you touch it
 - If you drop it
 - If you scratch it
- Stains on the glass tube will reduce the service life of the light source. Do not touch the glass tube with your bare hands. If necessary, clean the glass tube with alcohol or spirits while it is cold and wipe it down with a lint-free cloth.
- Protect light bulbs from humidity and do not bring them into contact with liquids.

Always ensure the bulbs are firmly secured.

Have the following light sources changed at a qualified specialist workshop only:

- Bulbs in the license plate lamp
- Front fog lamps
- Side marker lamps

Replacing front light bulbs (vehicles with halogen headlamps)

Overview of front light source types



- ① Side additional turn signal lamp: WY 5 W
- ② Turn signal light: PY 21 W
- ③ Low beam: H7 55 W
- ④ Front fog lamp: H11 55 W
- ⑤ High beam/standing/parking lights/daytime running lights: H15 55 W/15 W
- ⑥ Side marker light: LED

Replacing light sources in the headlamp

Requirements:

- The lighting system is switched off.
- The appropriate front wheel is turned inwards.
- **Low beam:** you require a H7 55 W light bulb.
- **Turn signal light:** you require a PY 21 W light bulb.
- **High beam/standing lamps/parking lamps/daytime running lamps:** you require a H15 55 W/15 W light bulb.

Installing/removing the cover in the front wheel arch

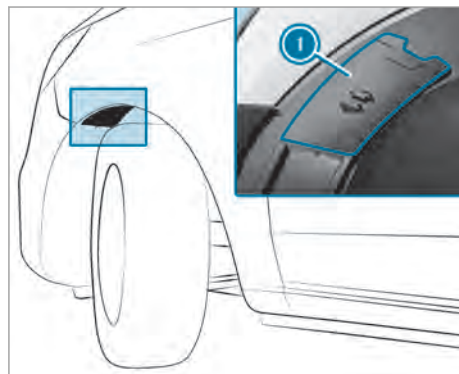

- ▶ **To remove:** grip the center of cover ①, slide it upwards and pull it out. The cover will hang downwards on the strap.
- ▶ **To install:** insert cover ① at the top and slide it downwards until it engages.

Low beam

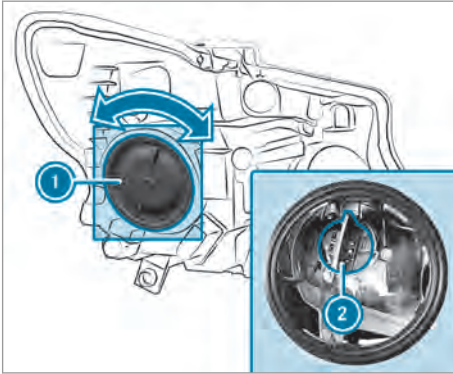

- ▶ Remove the cover in the front wheel arch.
- ▶ Turn housing cover ① counter-clockwise and remove it.
- ▶ Turn socket ② for low beam to the left and pull it out.
- ▶ Pull the bulb out of socket ②.
- ▶ Insert the new bulb into socket ②.
- ▶ Insert socket ② and rotate it to the right to tighten it.
- ▶ Press on housing cover ① and rotate it to the right to tighten it.
- ▶ Replace the cover in the front wheel arch.

High beam, standing/parking lamps and daytime running lamps

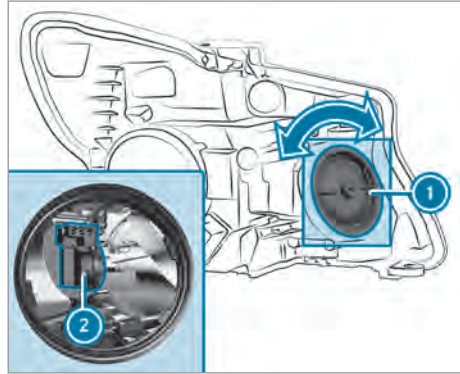

- ▶ Open the hood.
- ▶ Turn housing cover ① counter-clockwise and remove it.
- ▶ Pull out the bulb with socket ②.
- ▶ Insert the new bulb with socket ② and engage it as far as it will go.
- ▶ Press on housing cover ① and rotate it to the right to tighten it.
- ▶ Close the hood.

Turn signal light

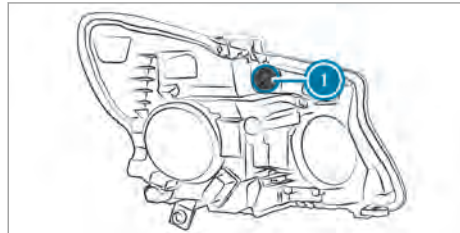

- ▶ Open the hood.
- ▶ Turn socket ① counter-clockwise and pull it out.
- ▶ Pull the bulb out of socket ①.
- ▶ Insert the new bulb into socket ①.
- ▶ Insert socket ① and turn it clockwise until it engages.
- ▶ Close the hood.

Replacing light bulbs in the side additional indicators

Requirements:

- The lighting system is switched off.
- You will need a WY 5 W bulb.

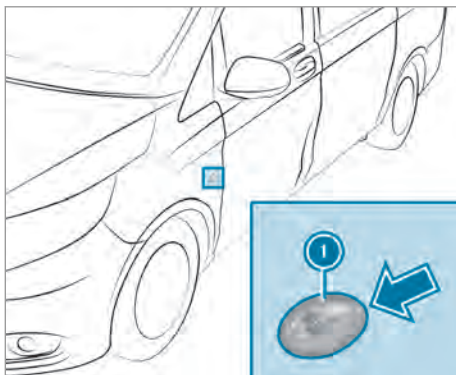

- ▶ Push additional indicator ① forwards and swivel it out.
- ▶ Push the bulb rearwards.
- ▶ Gently turn the bulb counter-clockwise and take it out of the socket.
- ▶ Insert the new bulb into the socket and turn it clockwise to screw it in.
- ▶ Align additional indicator ① at the front and engage it.

Replacing rear bulbs

Overview of rear compartment lamp types

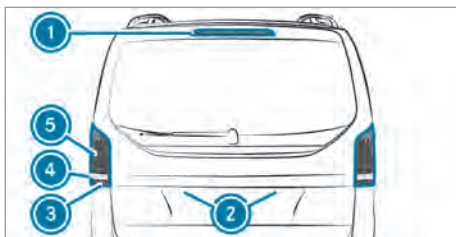

- ① Third brake light: LED
- ② Additional turn signal lamp on the roof: P 21 W
- ③ Rear fog lamp (driver's side): P 21 W
- ④ Backup lamp: P 21 W
- ⑤ Brake light, tail light/standing lamps/turn signal light: P 21 W side marker light: LED

Replacing light sources in the tail lamp

Requirements:

- The lighting system is switched off.
- **Standard tail lamp:** you require a P 21 W light source.
- **LED tail lamp:** you require a W 16 W light source.
- **Additional turn signal lamp on the roof:** you require a P 21 W light source.

Removing the tail lamp

! **NOTE** Damage to the paintwork during tail lamp removal

The paintwork may be damaged when the tail lamps are removed. The tail lamp may, for example, scratch the paintwork when it is removed.

- ▶ Remove the tail lamps carefully.
- ▶ Mercedes-Benz recommends having the tail lamp light sources replaced at a qualified specialist workshop.

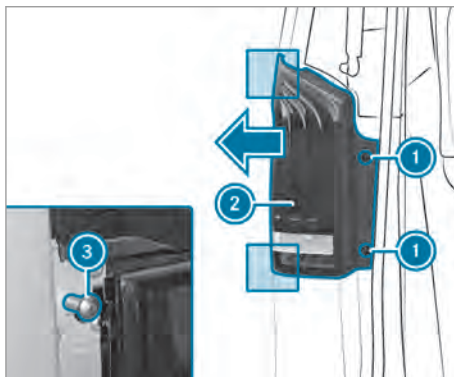

Please note that you can change the bulb of the backing up light only in the case of an LED tail lamp.

- ▶ Open the tailgate/rear-end door.
- ① You will find a screwdriver in the vehicle tool kit (→ page 198).
- ▶ Unscrew two side screws ①.
- ▶ Push tail lamp ② outwards against bolts ③ as far as it will go.
- ▶ Press tail lamp ② off outwards and away from bolts ③.

- ▶ Pull the connector off the bulb mount of tail lamp ②.

Installing the tail lamp

- ▶ Push the connector into the bulb mount of tail lamp ②.
- ▶ Push tail lamp ② onto bolts ③ from the side and press it against the vehicle.
- ▶ Tighten two side screws ①.

Standard tail lamp

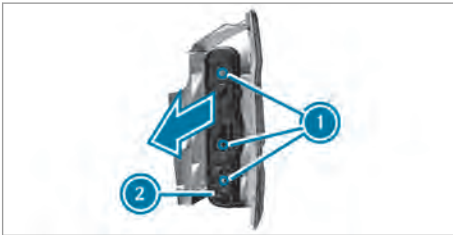

- ▶ Unscrew three screws ① and remove bulb mount ② from the tail lamp.

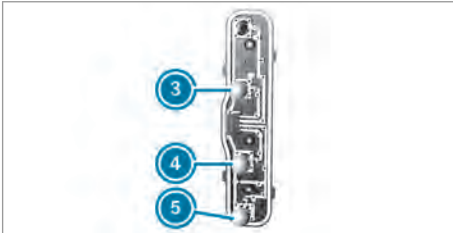

Bulb mount

- ③ Turn signal light, brake light, tail light, standing lamps
- ④ Backing up light
- ⑤ Rear fog lamp (only on the driver's side)
- ▶ Remove the tail lamp.
- ▶ Gently turn the bulb counter-clockwise and take it out of the socket.
- ▶ Push the new bulb into the socket and turn it clockwise to screw it in.
- ▶ Insert bulb mount ② into the tail lamp and tighten all three screws ①.
- ▶ Install the tail lamp.

Replacing interior light bulbs

Replacing illuminants in the interior

Requirements:

- The interior lighting has been switched off.
- **Rear passenger compartment and cargo compartment lamp:** you require a T10 6W xenon illuminant.
- **Interior and surround lighting:** you require a W 5 W illuminant.
- **Signal and ambient lamp in the tailgate:** you require a W 5 W illuminant.

Rear passenger compartment and cargo compartment lamps

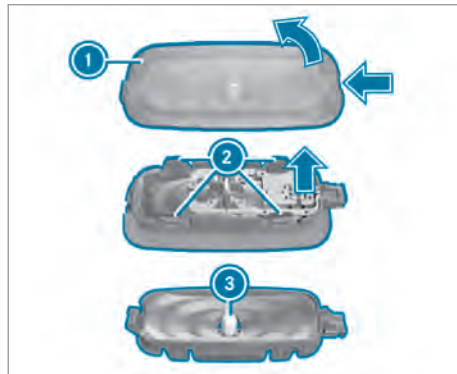

- ▶ Push in the catch spring of lens ① with a suitable object, e.g. a screwdriver, and then pry off the lens with the lamp housing.
- ▶ Push the lugs of socket ② inwards.
- ▶ Remove light source ③ from the lamp housing.
- ▶ Insert the new illuminant.
- ▶ Position the lens on the lamp housing and engage it.
- ▶ Align the lens with the lamp housing and engage it.

Additional interior and surround lighting

Depending on the equipment, replacing the illuminants as described here applies to the following lamps:

- The sun visor mirror lamp
- The ambient lamp at the bottom of the front door
- The ambient lamp on the inside of the tailgate

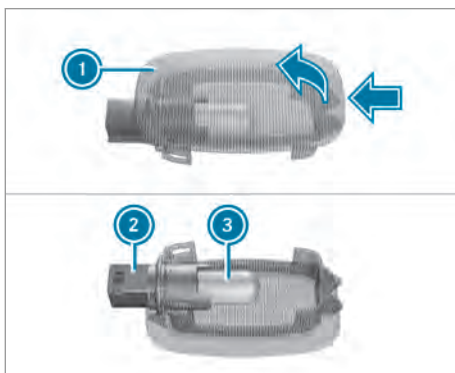

- ▶ Push in the catch spring of lamp housing ① with a suitable object, e.g. a screwdriver, and pry off lamp housing ①.
- ▶ Turn socket ② counter-clockwise and pull it out of lamp housing ①.
- ▶ Pull bulb ③ out of socket ②.
- ▶ Push new bulb ③ into socket ②.
- ▶ Screw socket ② into lamp housing ① by turning it clockwise.
- ▶ Place lamp housing ① in position on the left and engage it.

Signal and ambient lamp in the tailgate

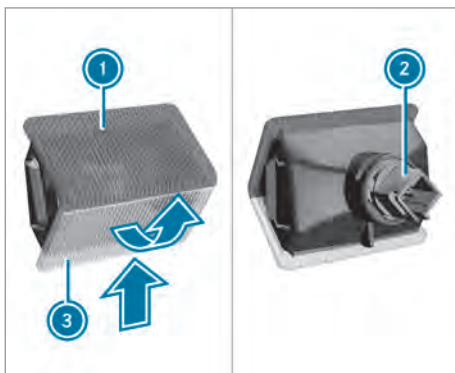

- ▶ Push in the catch spring of the lamp housing on the side of transparent lens ③ with a suitable object, e.g. a screwdriver, and pry off the lamp housing.
- ▶ Turn socket ② counter-clockwise and pull it out of the lamp housing.
- ▶ Pull the bulb out of socket ②.

- ▶ Push the new bulb into socket ②.
- ▶ Screw socket ② into the lamp housing by turning it clockwise.
- ▶ Place the lamp housing in position at the side of red lens ① and engage it.

Windshield wipers

Switching the windshield wipers on and off

Requirements:

- The power supply has been switched on.

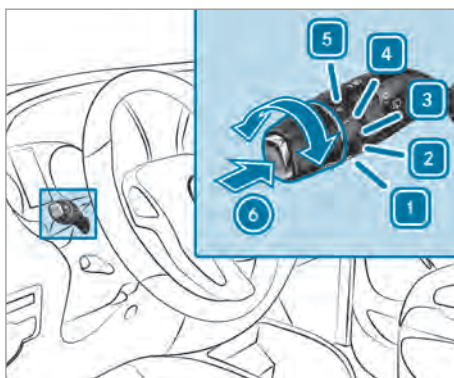

- 1 0 Windshield wipers off
- 2 ... Intermittent wiping, low (low rain sensor sensitivity)
- 3 Intermittent wiping, high (high rain sensor sensitivity)
- 4 — Continuous wiping, slow
- 5 ≡ Continuous wiping, fast

- ▶ Turn the combination switch to the corresponding position 1 - 5.
- ▶ **Single wipe:** push the button on the combination switch in the direction of arrow ⑥.
- ▶ **To wash:** push the button on the combination switch in the direction of arrow ⑥ as far as the second point of resistance.

Switching the rear window wiper on/off

Requirements:

- The power supply has been switched on.

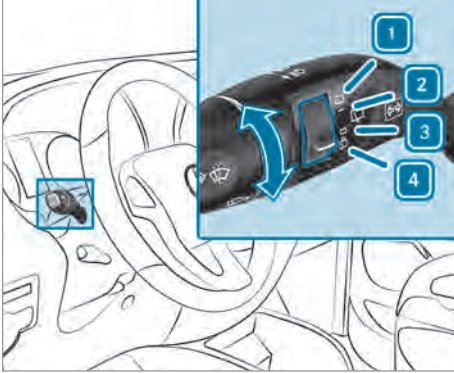

- | | | |
|---|--|--------------------------|
| 1 | | Wiping with washer fluid |
| 2 | | Intermittent wiping |
| 3 | | Rear window wiper off |
| 4 | | Wiping with washer fluid |

- ▶ Move the switch to the corresponding position. When the rear window wiper is switched on, the symbol will appear on the instrument cluster display.
- ▶ **To wipe with washer fluid:** press and hold the switch beyond the current position up to the **1** or **4** limit.

Replacing the windshield wiper blades

- ⚠ **WARNING** Risk of becoming trapped if the windshield wipers are switched on while wiper blades are being replaced

If the windshield wipers begin to move while you are changing the wiper blades, you can be trapped by the wiper arm.

- ▶ Always switch off the windshield wipers and vehicle before changing the wiper blades.

- ⚠ **NOTE** Damage to the windshield or rear window during wiper blade replacement

If the wiper arm on the windshield or rear window is folded back before a wiper blade has been installed, the window may be damaged by the force of the impact.

- ▶ Never fold the wiper arm on the windshield or rear window back until a wiper blade has been installed. Keep hold of the wiper arm when replacing a wiper blade.

- ⚠ **NOTE** Damage to hood or windshield wipers when opening the hood

If the windshield wipers have been folded back from the windshield when the hood is opened, the windshield wipers or the hood may be damaged.

- ▶ Ensure that the windshield wipers have not been folded back from the windshield.

Removing the wiper blades

- ▶ Fold the wiper arms away from the windshield.

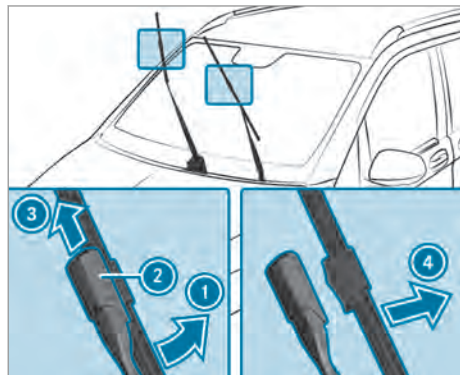

- ▶ Hold the wiper arm with one hand. With the other hand, turn the wiper blade in the direction of arrow **1** away from the wiper arm as far as it will go.
- ▶ Slide catch **2** in the direction of arrow **3** until it engages in the removal position.
- ▶ Remove the wiper blade from the wiper arm in the direction of arrow **4**.

Installing the wiper blades

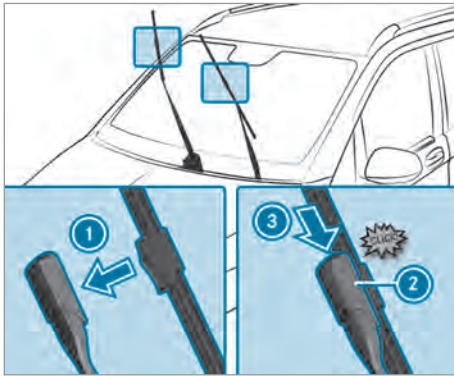

- ▶ Insert the new wiper blade into the wiper arm in the direction of arrow ①.
- ▶ Slide catch ② in the direction of arrow ③ until it engages in the locking position.
- ▶ Make sure that the wiper blade is seated correctly.
- ▶ Fold the wiper arms back onto the windshield.

Maintenance display

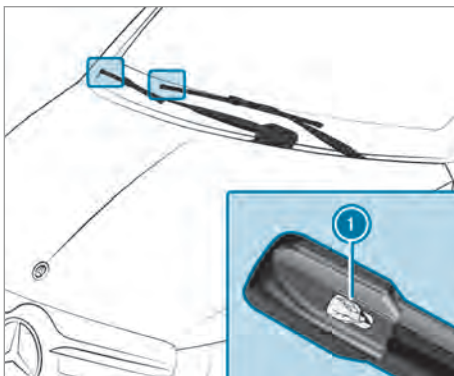

- ▶ Remove protective film ① from the maintenance displays on the tips of the newly installed wiper blades.

If the color of the maintenance display changes from black to yellow, the wiper blades should be replaced.

- ① The time until the color changes varies depending on the usage conditions.

Replacing rear window wiper blades

Tailgate

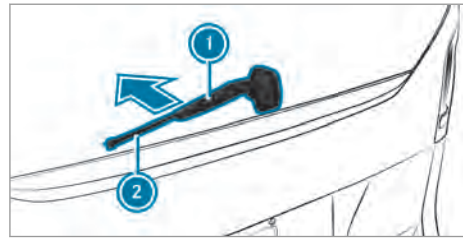

- ▶ Fold wiper arm ① away from the rear window until it engages in the replacement position.
- ▶ Keep hold of wiper arm ① and pull wiper blade ② off the wiper arm in the direction of the arrow.
- ▶ Place new wiper blade ② on wiper arm ①.
- ▶ Keep hold of wiper arm ① and push wiper blade ② in the opposite direction to the arrow until it engages.
- ▶ Make sure that wiper blade ② is seated correctly.
- ▶ Fold wiper arm ① back onto the rear window.

Rear-end doors

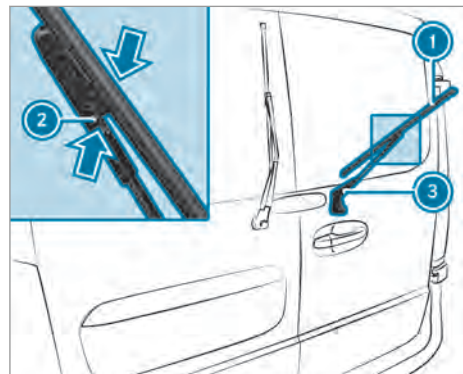

- ▶ Fold wiper arm ③ away from the rear window.
- ▶ Press both retaining clips ② together in the direction of the arrow and swivel the wiper blade away from the wiper arm.
- ▶ Pull wiper blade ① upwards out of the holder on wiper arm ③.
- ▶ Insert new wiper blade ① in the holder on wiper arm ③.

- ▶ Push new wiper blade ① onto wiper arm ③ until the retaining clips engage.
- ▶ Fold wiper arm ③ back onto the rear window.

Mirrors

Operating the outside mirrors

⚠ WARNING Risk of accident due to adjusting the vehicle settings while the vehicle is in motion

You could lose control of the vehicle in the following situations in particular:

- If you adjust the driver's seat, the head restraint, the steering wheel or the mirror while the vehicle is in motion
 - If you fasten your seat belt while the vehicle is in motion
- ▶ Before starting the vehicle: in particular, adjust the driver's seat, head restraint, steering wheel and mirror, and fasten your seat belt.

⚠ WARNING Risk of accident due to misjudgment of distance when using the front-passenger mirror

The outside mirror on the front passenger side reflects objects on a smaller scale. The objects in view are in fact closer than they appear.

- ▶ Therefore, always look over your shoulder to check the actual distance between you and the road users traveling behind you.

Adjusting the outside mirrors manually

- ▶ Adjust the outside mirrors to the correct position manually.

Adjusting the outside mirrors electrically

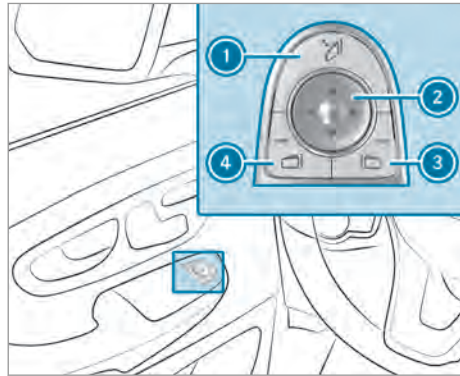

- ▶ Switch on the power supply or the vehicle.
- ▶ Press button ③ or ④ to select the outside mirror to be adjusted.
- ▶ Set the position of the mirror glass using button ②.

Folding the electric outside mirrors in/out

ⓘ NOTE Damage to the electric outside mirrors

If you fold or unfold the electric outside mirrors by hand, you may damage the outside mirrors and the outside mirrors will not engage properly.

If the outside mirrors are not folded in when the vehicle is washed in an automatic car wash, the brushes may forcibly fold in and damage the outside mirrors.

- ▶ Fold the outside mirrors in and out electrically only.
- ▶ Fold in the outside mirrors before washing the vehicle in an automatic car wash.

- ▶ Switch on the power supply or the vehicle.
- ▶ Briefly press button ①.

You will no longer be able to fold in the outside mirrors once you reach a speed greater than 29 mph (47 km/h).

Engaging the outside mirrors

If an outside mirror has been forcibly disengaged forwards or backwards, proceed as follows.



- ▶ Press and hold button ❶ until you hear a click followed by the mirror audibly engaging in position.

The mirror housing will now be engaged and you will be able to adjust the outside mirrors as normal.

Heating the outside mirrors

Vehicles without a rear window heater: At temperatures below 59°F (15°C), the mirror heater will automatically switch on permanently once the vehicle has been started.

Vehicles with a rear window heater: At temperatures below 59°F (15°C), the mirror heater will automatically switch on for ten minutes once the vehicle has been started. The mirror heater can also be switched on together with the rear window heater.

- ▶ Switch on the vehicle.
- ▶ Press the  button on the climate control operating unit. The indicator lamp on the  button will light up and the mirror heater will be switched on together with the rear window heater.

Using the digital rearview mirror

The vehicle may be equipped with a digital inside rearview mirror. This uses a camera in the rear window and a display integrated into the mirror to provide a better view to the rear. The rearview mirror can be used either as a standard rearview mirror or as a display.

To prevent glare from the digital rearview mirror, first set the digital rearview mirror as the standard rearview mirror.

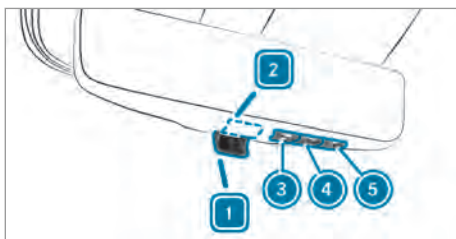

Certain types of sunlight, e.g. sun low on the horizon or light from another intense light source, can reduce the display's contrast and cause it to become too bright. In such situations, objects on the display may be obscured or difficult to see. In these cases, be particularly careful and adapt your driving style accordingly.

Drivers must always wear the necessary personal visual aids required for them to drive a vehicle. Drivers with presbyopia (age-related long-sightedness) should, if necessary, wear visual aids with multifocal lenses to be sufficiently able to see traffic including via the displays.



- ❗ If the camera in the rear window is dirty, operate the rear window wiper with washer fluid (→ page 85) or clean the rear window manually. Observe the notes on cleaning the digital rearview mirror (→ page 183).

- ▶ **To use the standard rearview mirror:** move the switch to position .

- ▶ **To use the display:** move the switch to position .

Adjusting the display brightness



- ❗ The digital rearview mirror is equipped with light sensors on the front and back and automatically adjusts the brightness of the display to the ambient light. Do not cover the light sensors, e.g. with a sticker.

- ▶ Press menu button  once.
- ▶ Press button  to reduce the display brightness.

or

- ▶ Press button  to increase the display brightness.

Adjusting the angle of the camera

- ▶ Press menu button  twice.
- ▶ Press button  to move the angle downwards.

or

- ▶ Press button  to move the angle upwards.

Error mode of the digital rearview mirror

If a system error occurs, e.g. if the camera fails, a crossed-out camera will appear at the top left of the display and no camera image will be visible in the mirror.

- ▶ Switch to the standard rearview mirror if there is a system error.

Automatic anti-glare mirrors function

⚠ WARNING Risk of acid burns and poisoning due to the anti-glare mirror electrolyte

Electrolyte may escape if the glass in an automatic anti-glare mirror breaks.

The electrolyte is hazardous to health and causes irritation. It must not come into contact with your skin, eyes, respiratory organs or clothing or be swallowed.

▶ If you come into contact with electrolyte, observe the following:

- Immediately rinse the electrolyte from your skin with water and seek medical attention.
- If electrolyte comes into contact with your eyes, immediately rinse them thoroughly with clean water and seek medical attention.
- If the electrolyte is swallowed, immediately rinse your mouth out thoroughly. Do not induce vomiting. Seek medical attention immediately.
- Immediately change out of clothing which has been contaminated with electrolyte.
- If an allergic reaction occurs, seek medical attention immediately.

The inside rearview mirror and the outside mirror on the driver's side will automatically go into anti-glare mode if light from a headlamp hits the sensor on the inside rearview mirror.

System limits

The system will not go into anti-glare mode if:

- The vehicle is switched off
- Reverse gear is engaged.
- The interior lighting is switched on.
- The incident light from the headlamps is blocked by objects in the cargo compartment, for example, and does not hit the sensor on the inside rearview mirror.

▶ **Glare from front:** Fold sun visor ❶ downwards.

▶ **Glare from the side:** Swivel sun visor ❶ to the side.



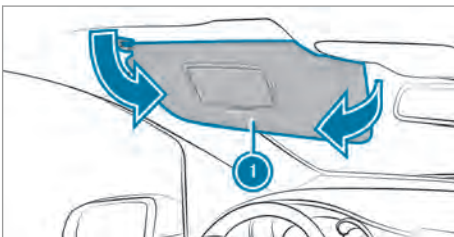



Operating sun visors

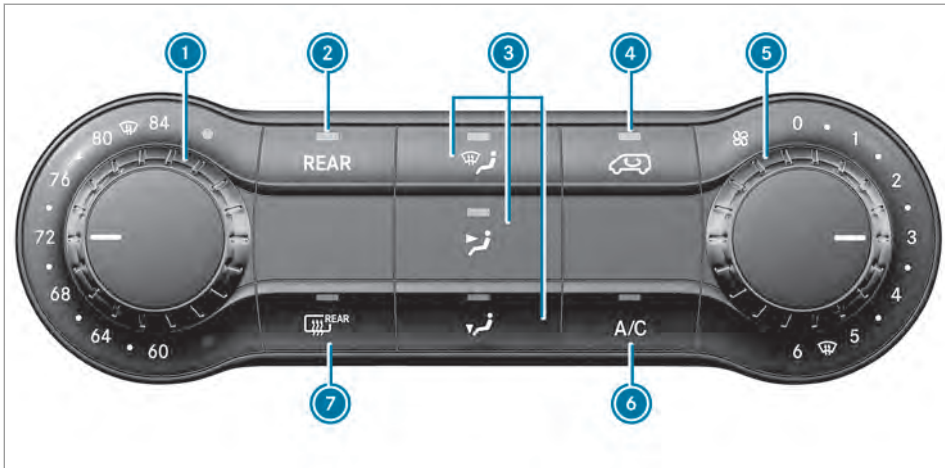

Overview of climate control systems

Overview of automatic climate control



- ① Sets the temperature (→ page 93)
- ②  Switches the rear air conditioning system on/off
- ③  Sets the air distribution (→ page 93)
- ④  Switches air-recirculation mode on/off (→ page 94)
- ⑤  Sets the airflow (→ page 93)
- ⑥  Switches cooling with air dehumidification on/off (→ page 92)
- ⑦  Switches the rear window heater and mirror heater on/off (→ page 95)

Overview of 3-zone automatic climate control

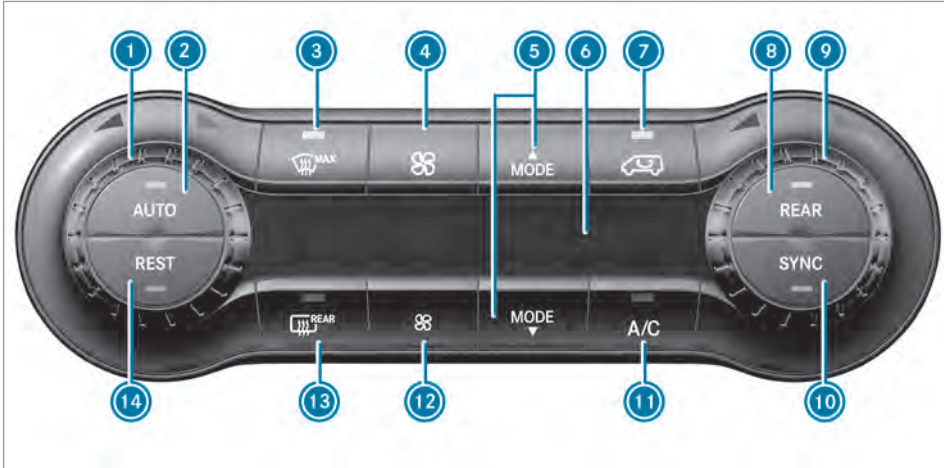

- 1 Sets the temperature on the left and at the rear (for vehicles with rear air conditioning system only) (→ page 93)
- 2 **AUTO** Switches on automatic mode (→ page 92)
- 3 Defrosts the windshield (→ page 94)
- 4 Increases airflow (→ page 93)
- 5 **MODE** Sets the air distribution (→ page 93)
- 6 Display
- 7 Switches air-recirculation mode on/off (→ page 94)
- 8 **REAR** Switches controls to rear air conditioning system (second menu level)
- 9 Sets the temperature on the right and at the rear (for vehicles with rear air conditioning system only) (→ page 93)
- 10 **SYNC** Switches synchronisation on/off (→ page 94)
- 11 **A/C** Switches cooling with air dehumidification on/off (→ page 92)
- 12 Reduces airflow (→ page 93)
- 13 Switches the rear window heater and mirror heater on/off (→ page 95)
- 14 **REST** Switches residual heat utilization on/off (→ page 95)

Operating climate control systems

Switching the climate control system on/off

Heating or automatic climate control, front

If climate control is switched off, the air supply and circulation will also be switched off. Use this setting only for a brief period. Otherwise, the windows could fog up.

- ▶ Switch on the vehicle.
- ▶ **To switch on:** turn the airflow control to level **1** or higher.
- ▶ **To switch off:** turn the airflow control to level **0**.

3-zone automatic climate control, front

- ▶ Switch on the vehicle.
- ▶ **To switch on:** press the **AUTO** button. The indicator lamp on the **AUTO** button will light up. Climate control will automatically be regulated according to the set temperature.

or

- ▶ Press the button and set a blower setting. The blower settings will be shown on the display as a bar graph.
- ▶ **To switch off:** press the button and then press it again once the lowest blower setting has been reached. The operating unit display will go off.

Automatic climate control, rear

- ▶ Switch on the automatic climate control.

- ▶ **To switch on:** press the **REAR** button on the air conditioning operating unit. The indicator lamp on the **REAR** button will light up when the rear climate control is switched on. The settings for temperature, air-flow and, if a rear air conditioning system is installed, air distribution will be adopted for the rear climate control.

3-zone automatic climate control, rear

- ▶ Switch on the 3-zone automatic climate control.

To switch on:

- ▶ Press the **REAR** button on the automatic climate control operating unit. The indicator lamp on the **REAR** button will flash. The operating unit display will show the second menu level for the temperature and air-flow setting of the rear air conditioning system.
- ▶ Press the **⊗** button and set a blower setting for the rear climate control. The blower settings will be shown on the display as a bar graph. The rear air conditioning system will be switched on.
- ▶ If necessary, set the temperature for the rear climate control using the temperature control. The display will show the selected temperature for the rear passenger compartment.

If you do not set a new value within approximately ten seconds, the operating unit display will return to the first menu level for the automatic climate control settings. The indicator lamp on the **REAR** button will light up continuously.

- ⓘ The air distribution setting applies both to the automatic climate control and to the rear air conditioning system and cannot be set separately for the two.
- ▶ **To switch off:** press the **REAR** button on the automatic climate control operating unit. The indicator lamp on the **REAR** button will flash. The operating unit display will show the second menu level for the temperature and air-flow setting of the rear air conditioning system.
- ▶ Press the **⊗** button and then press it again once the lowest blower setting has been reached. The operating unit display will go off and the rear air conditioning system will be switched off.

If you do not set a new value within approximately ten seconds, the operating unit display will return

to the first menu level for the automatic climate control settings. The indicator lamp on the **REAR** button will go out.

- ⓘ When the vehicle is started, the climate control settings most recently selected will be adopted automatically.

Switching the A/C function on/off

Requirements:

- The climate control system has been switched on (→ page 91).
- The vehicle has been started.

When the "Cooling with air dehumidification" function is switched on, the air inside the vehicle will be cooled and dehumidified according to the temperature selected.

For THERMOTRONIC automatic climate control, the function for automatic climate control settings can be activated or deactivated only on the first menu level. If you do not set a new value for the rear passenger compartment climate control on the second menu level within approximately ten seconds, the operating unit display will go back to the first menu level.

- ▶ Press the **A/C** button. The indicator lamp on the **A/C** button will light up when the function is switched on.
- ⓘ Switch off the A/C function only briefly. Otherwise, the windows could fog up more quickly.
- ⓘ Condensation may leak from the underside of the vehicle in cooling mode. This is not a sign of a defect.

Automatically regulating climate control

Requirements:

- The climate control system has been switched on (→ page 91).

3-zone automatic climate control

When 3-zone automatic climate control is in automatic mode, the set temperature will automatically be kept constant. The system automatically regulates the temperature of the dispensed air, the air-flow and the air distribution.

Automatic mode for automatic climate control settings can be activated or deactivated only on the first menu level. If you do not set a new value for the rear compartment climate control on the second menu level within approximately ten seconds,

the control panel display will go back to the first menu level.



- ▶ Set the desired temperature (→ page 93).
- ▶ **To switch automatic mode on/off:** press the **AUTO** button.
When the indicator lamp on the **AUTO** button lights up, automatic mode is switched on. Airflow and air distribution are regulated automatically. The "defrost windshield" function is switched off.

If you deactivate automatic mode, the automatic climate control will save the current settings.







In automatic mode, if you adjust the airflow or air distribution manually, the indicator lamp above the **AUTO** button will go out. The function that has not been changed manually, however, will continue to be regulated automatically.

Information on the air distribution settings

Heating or automatic climate control

-  Directs air to the defroster vent
-  Directs air to the center and side air vents
-  Directs air to the footwell vents

3-zone automatic climate control



-  Directs air to the defroster vent
-  Directs air to the defroster, center and side air vents
-  Directs air to the defroster, center, side and footwell vents
-  Directs air to the defroster and footwell vents
-  Directs air to the center and side air vents
-  Directs air to the center, side and footwell vents
-  Directs air to the footwell vents

Setting the air distribution



Requirements:

- The climate control system is switched on.

Heating or automatic climate control

- ▶ Press the ,  and/or  button.
If the indicator lamp in a button lights up, the air is directed to the corresponding air vents.

3-zone automatic climate control

- ▶ Press the **MODE**  or **MODE**  button to set the air distribution.
The control panel display shows the corresponding air distribution symbol.

Setting the airflow

Requirements:



- The climate control system is switched on.

Heating or automatic climate control

- ▶ **To increase or decrease:** turn the airflow control clockwise or counter-clockwise to the desired level (→ page 90).

Vehicles with rear climate control: the set level will also be adopted for the rear passenger compartment.

3-zone automatic climate control

- ▶ **To increase or decrease:** press the  or  button.
The control panel display will show the airflow control setting as a bar graph.

Vehicles with rear climate control: press the **REAR** button to set the airflow for the rear passenger compartment. When the indicator lamp on the button flashes, you can set the airflow.

Setting the temperature

Requirements:

- The climate control system is switched on.

Heating or automatic climate control

- ▶ **To increase or decrease:** turn the temperature control counter-clockwise or clockwise (→ page 90).

3-zone automatic climate control

You can set the temperature separately for the driver's and front passenger sides. In vehicles with rear climate control, the temperature for the rear passenger compartment can also be set. Each set temperature is automatically maintained at a constant level.

- ▶ **To increase or decrease:** turn the corresponding temperature control counter-clockwise or clockwise (→ page 91).
The control panel display shows the set temperature for the left or right side at the respective edge of the display.

Vehicles with rear climate control: press the  button to set the temperature for the rear passenger compartment. When the indicator lamp on the button flashes, you can set the temperature.



Switching the synchronisation function on/off

Requirements:

- The climate control system has been switched on (→ page 91).

3-zone automatic climate control

The temperature can be set centrally using the synchronisation function. The temperature setting for the driver's side will then be adopted for the front passenger side and, in vehicles with rear climate control, the rear passenger compartment as well.



- ▶ Press the  button. When the indicator lamp on the  button lights up, the function is switched on. The display will then show the temperature set on the driver's side for the front passenger side.

The synchronisation function will switch off if the temperature setting for the front passenger side or for the rear passenger compartment is modified. The indicator lamp on the  button will go out.

Defrosting the windshield

Heating or dual-zone automatic climate control

You can use the following settings to defrost the windshield and remove condensation from the windshield and the front side windows from the inside. Select the following settings only for as long as it takes for the windshield to be clear.

- ▶ Switch on climate control (→ page 91).
- ▶ If necessary, switch on the rear window heater (→ page 95).
- ▶ If the windows are fogged up: switch off air-recirculation mode (→ page 94).
- ▶ Turn the temperature control and airflow control to the  position (→ page 90).
- ▶ Select the  position for air distribution (→ page 93). Only the indicator lamp on the  button will light up.
- ▶ Vehicles with heating: close the center air vent (→ page 95).

- ▶ Vehicles with air conditioning: switch on the "Cooling with air dehumidification" function (→ page 92).

3-zone automatic climate control

You can use the following settings to defrost the windshield and remove condensation from the windshield and the front side windows from the inside. Select the following settings only for as long as it takes for the windshield to be clear.

- ▶ Switch on climate control (→ page 91).
- ▶ If necessary, switch on the rear window heater (→ page 95).
- ▶ Press the  button. The temperature, airflow and air distribution will be regulated automatically. Air-recirculation mode will be deactivated.

When you enable automatic mode, the "Defrost windshield" function will switch off automatically.

When you switch off the "Defrost windshield" function, the previous settings for automatic climate control will be applied again.



Note the following exceptions:

- Air-recirculation mode will remain switched off.
- If the A/C function has been automatically activated, it will remain active.

Switching air-recirculation mode on/off

Automatic climate control or 3-zone automatic climate control

When air-recirculation mode is switched on, the windows may fog up more quickly. Switch on air-recirculation mode only briefly.

- ▶ Press the  button. When the indicator lamp on the  button lights up, air-recirculation mode is switched on.

Air-recirculation mode will automatically switch on in the following cases:

- In high outside temperatures
- While the vehicle is driving through a tunnel (vehicles with 3-zone automatic climate control and navigation only)

After approximately 30 minutes, outside air will automatically be introduced again.

Air-recirculation mode will automatically switch off in the following cases:

- After approximately five minutes at outside temperatures below approximately 44°F (7°C)
- After approximately five minutes when the "Cooling with air dehumidification" function is deactivated
- After approximately 30 minutes at outside temperatures above approximately 44°F (7°C) and when the "Cooling with air dehumidification" function is switched on

Convenience opening/closing

⚠ WARNING Risk of becoming trapped during convenience opening

During convenience opening, body parts could be drawn in or become trapped between the side window and the door frame.

- ▶ When opening, make sure that nobody touches the side window.
- ▶ Release the  button immediately to interrupt the opening procedure if somebody becomes trapped.



▶ **Pre-entry climate control and convenience opening with the SmartKey:** press and hold the  button on the SmartKey.

The side windows will open automatically and the blower of the climate control system will be activated.

▶ **To interrupt convenience opening:** release the  button.

Switching the rear window heater on/off

The rear window heater consumes a lot of electricity. You should therefore switch off the rear window heater as soon as the rear window is clear.





- ▶ Switch on the vehicle.
- ▶ Press the  button on the control panel. If the indicator lamp on the  button lights up, the rear window heater is switched on.

The rear window heater will switch off automatically after a few minutes.

Switching the residual heat utilization on/off

When the vehicle is switched off, it is possible to make use of the residual heat of the engine to heat or ventilate the vehicle interior for approximately

30 minutes. The heating or ventilation time depends on the set vehicle interior temperature.

- ▶ Switch off the vehicle or remove the SmartKey.
- ▶ **To switch on:** press the  button. When residual heat utilization is switched on, the indicator lamp on the  button will light up. The blower will run at a low speed regardless of the airflow setting. If the "Residual heat" function is switched on at high outside temperatures, only the stationary ventilation will be switched on. The blower will then run at medium speed.
- ▶ **To switch off:** press the  button again. The indicator lamp on the  button will go out.

Residual heat utilization will switch off automatically in the following cases:

- After a running time of approximately 30 minutes
- If the starter battery's condition of charge is too low
- If the vehicle is switched on

Operating air vents

Adjusting the air vents

⚠ WARNING Risk of burns or frostbite due to being too close to the air vents

Very hot or very cold air can flow from the air vents.

- ▶ Make sure that all vehicle occupants always maintain a sufficient distance from the air vents.
- ▶ If necessary, direct the airflow to another area of the vehicle interior.

Adjusting the center air vent

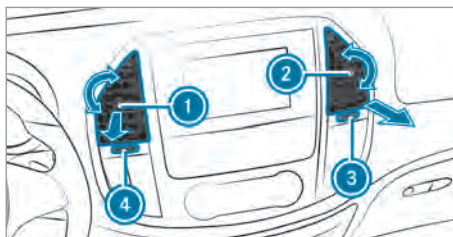

- ▶ **To open/close:** turn controller ① or ② to the left or right as far as it will go.

Adjusting the airflow direction:

- ▶ Hold the center air vent by controller ① or ② and move it up or down.
- ▶ Using adjustment wheel ③ or ④, move the center air vent to the left or right.

Adjusting the side air vents:

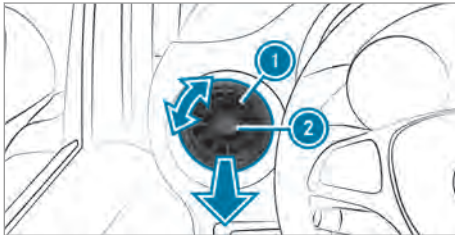

- ▶ **To open/close:** turn controller ② clockwise or counter-clockwise as far as it will go.
- ▶ **To adjust the airflow direction:** hold side air vent ① by controller ② and move it up or down or to the left or right.

Opening/closing the rear air vents:

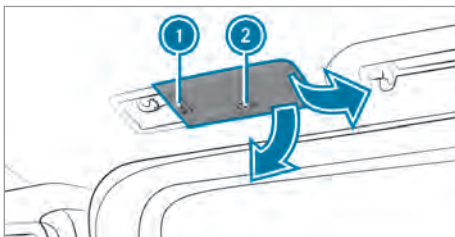

- ① Adjustment wheel for vertically adjusting and regulating airflow
- ② Adjustment wheel for horizontally adjusting airflow

The air vents can be adjusted only on vehicles with rear-compartment air conditioning.

- ▶ **To open:** turn adjustment wheel ① of the rear air vent to the center position.
- ▶ **To close:** turn adjustment wheel ① to the upper or lower end position.

Driving

Key positions

⚠ WARNING Risk of accident and injury due to children left unattended in the vehicle

If children are left unsupervised in the vehicle, they could, in particular:

- open doors, thereby endangering other persons or road users.
- get out and be struck by oncoming traffic.
- operate vehicle equipment and become trapped, for example.

In addition, the children could also set the vehicle in motion, for example by:

- releasing the parking brake.
- changing the transmission position.
- starting the vehicle.

▶ Never leave children unattended in the vehicle.

▶ When leaving the vehicle, always take the SmartKey with you and lock the vehicle.

▶ Keep the vehicle SmartKey out of reach of children.

⚠ DANGER Risk of death caused by exhaust gases

Combustion engines emit poisonous exhaust gases such as carbon monoxide. Inhaling these exhaust gases is hazardous to health and leads to poisoning.

▶ Never leave the engine or, if present, the auxiliary heating running in an enclosed space without sufficient ventilation.

⚠ WARNING Risk of fire due to flammable material in the engine compartment or the exhaust system

Flammable materials may ignite.

▶ Therefore, check regularly that there are no flammable materials in the engine compartment or on the exhaust system.

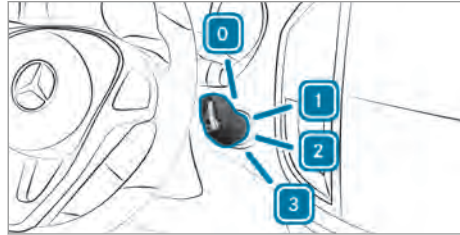

0 To insert/remove the key

1 To switch on the power supply

2 To switch on vehicle

3 To start the vehicle

i If the key does not belong to the vehicle, it can still be turned in the ignition lock. The vehicle is not switched on and cannot be started.

▶ Insert the key into the ignition lock in position **0** and turn it to the desired position.

Breaking-in notes

Protect the engine during the first 1,000 miles (1,500 km) by:

- Driving at varying road and engine speeds.
- Shifting to the next highest gear at the very latest when the needle reaches the last third before the red area in the tachometer.
- Avoiding stress on the vehicle such as driving at full throttle.
- Not shifting manually to a lower gear to brake.
- After 1,000 miles (1,500 km), gradually increasing the engine speed and accelerating the vehicle up to full speed.
- Not depressing the accelerator pedal past the pressure point (kickdown).

This also applies if the engine or parts of the drivetrain have been replaced.

Also observe the following breaking-in notes:

- After the vehicle has been delivered or after repairs, the sensor system of some driving systems and driving safety systems adjusts itself automatically after the vehicle has been driven a certain distance. Full system effectiveness is not reached until the end of this teach-in process.
- New or exchanged brakepads, brake discs and tires only provide optimal braking and bonding after several hundred kilometers. Until then,

compensate for the reduced braking effect by applying greater pressure to the brake pedal.

Driving tips

Notes on driving

⚠ WARNING Risk of accident due to objects in the driver's footwell

Objects in the driver's footwell may impede pedal travel or block a depressed pedal.

This jeopardizes the operating and road safety of the vehicle.

- ▶ Stow all objects securely in the vehicle so that they do not get into the driver's footwell.
- ▶ When using floor mats or carpets, make sure that they are properly secured so that they do not slip or obstruct the pedals.
- ▶ Do not lay multiple floor mats or carpets on top of one another.

⚠ WARNING Risk of accident due to incorrect footwear

Incorrect footwear includes, for example:

- Shoes with platform soles
- Shoes with high heels
- Slippers

There is a risk of an accident.

- ▶ Always wear suitable footwear so that you can operate the pedals safely.

⚠ WARNING Risk of accident if the vehicle is switched off while driving

If you switch off the vehicle while driving, safety functions are restricted or no longer available.

This may affect the power steering system and the brake force boosting, for example.

You will need to use considerably more force to steer and brake, for example.

- ▶ Do not switch off the vehicle while driving.

⚠ DANGER Risk of death caused by exhaust gases

Combustion engines emit poisonous exhaust gases such as carbon monoxide. Inhaling these exhaust gases is hazardous to health and leads to poisoning.

- ▶ Never leave the engine or, if present, the auxiliary heating running in an enclosed space without sufficient ventilation.

⚠ WARNING Risk of skidding and of an accident due to shifting down on slippery road surfaces

If you shift down on slippery road surfaces to increase the engine braking effect, the drive wheels may lose traction.

- ▶ Do not shift down on slippery road surfaces to increase the engine braking effect.

⚠ DANGER Risk of fatal injury due to poisonous exhaust gases

If the tailpipe is blocked or sufficient ventilation is not possible, poisonous exhaust gases such as carbon monoxide may enter the vehicle. This is the case, for example, if the vehicle gets stuck in the snow.

- ▶ Keep the tailpipe and the area around the vehicle free from snow when the engine or the stationary heater is running.
- ▶ Open a window on the side of the vehicle facing away from the wind to ensure an adequate supply of fresh air.

⚠ WARNING Risk of accident and injury due to being under the influence of alcohol and drugs while driving

Drinking and driving and/or taking drugs and driving are very dangerous combinations. Even a small amount of alcohol or drugs can affect your reflexes, perceptions and judgment.

The possibility of a serious or even fatal accident are greatly increased when you drink or take drugs and drive.

- ▶ Do not drink or take drugs and drive or allow anyone to drive who has been drinking or taking drugs.

⚠ WARNING Risk of accident and injury from operating mobile communications equipment

If you operate mobile communication equipment when driving, you will be distracted from the traffic situation. This could also cause you to lose control of the vehicle.

The probability of a serious or even fatal accident increases greatly if you operate mobile communication equipment when driving.

- ▶ Only operate mobile communication equipment when the vehicle is stationary.

For your own safety, observe the following points when operating mobile communications equipment:

- Observe the legal requirements for the country in which you are driving.
- While driving, only operate mobile communications equipment when the traffic conditions permit it. You may otherwise be distracted from the traffic conditions, cause an accident and injure yourself and others.

! NOTE Damage to the drivetrain and engine when pulling away

- ▶ Do not warm up the engine while the vehicle is stationary. Pull away immediately.
- ▶ Avoid high engine speeds and driving at full throttle until the engine has reached its operating temperature.

! NOTE Damage to the vehicle due to not observing the maximum permitted headroom clearance

If the vehicle height is greater than the maximum permitted headroom clearance, the roof and other parts of the vehicle may be damaged.

- ▶ Observe the signposted headroom clearance.
- ▶ If the vehicle height is greater than the permitted headroom clearance, do not enter.
- ▶ Observe the changed vehicle height with add-on roof equipment.

Exhaust emission monitoring

Specific engine systems are designed to keep poisonous components of exhaust gases within legal limits.

These systems only work optimally if they are maintained exactly according to manufacturer's specifications. It is for this reason that all work on the engine should only be performed by qualified and authorized Mercedes-Benz Commercial Van Center technicians.

Under no circumstances should engine settings be changed. In addition, all specific maintenance work must be performed at regular intervals and in compliance with the service regulations of the dealer named in the imprint. Refer to the Maintenance Booklet for details.

Information about transport by rail

Transporting your vehicle by rail may be subject to certain restrictions or require special measures to be taken in some countries due to varying tunnel heights and loading standards.

You can obtain information about this from a Mercedes-Benz Commercial Van Center.

Information on brakes

⚠ WARNING Risk of accident due to the brake system overheating

If you leave your foot on the brake pedal when driving, the brake system may overheat.

This increases the braking distance and the brake system can even fail.

- ▶ Never use the brake pedal as a footrest.
- ▶ Do not depress the brake pedal and the accelerator pedal at the same time while driving.

! NOTE Wearing out the brake linings by continuously depressing the brake pedal

- ▶ Do not depress the brake pedal continuously whilst driving.
- ▶ To use the braking effect of the engine, shift to a lower gear in good time.

Downhill gradients

On long and steep downhill gradients you should observe the following instructions:

- In vehicles with an automatic transmission, shift down to shift ranges **2** or **1** in good time

so that the engine is running at a medium to high engine speed (→ page 104).

- ① Change the shift range in good time when cruise control is activated. Observe the driving tips (→ page 98).

You thereby make use of the braking effect of the engine and do not have to brake as often to maintain the speed. This relieves the load on the service brake and prevents the brakes from overheating and wearing too quickly.

Heavy and light loads

If the brakes have been subjected to a heavy load, do not stop the vehicle immediately. Drive on for a short while. The brakes cool down more quickly in the airflow.

If the brakes have been used only moderately, you should occasionally test their effectiveness. To do this, brake more firmly from a higher speed while paying attention to the traffic conditions. The brakes will grip better as a result.

Wet road surfaces

If you have been driving for a long time in heavy rain without braking, there may be a delayed response when you first apply the brakes. This may also occur after driving through a car wash or deep water. You must depress the brake pedal more firmly. Maintain a greater distance to the vehicle in front.

While paying attention to the traffic conditions, you should brake the vehicle firmly after driving on a wet road surface or through a car wash. This heats the brake discs so that they dry more quickly, which protects them against corrosion.

Limited braking effect on salt-treated roads:

- A layer of salt on the brake discs or brakepads can increase braking distances considerably, or braking may happen on only one side
- Maintain an especially large safe distance to the vehicle in front

To remove the layer of salt:

- Apply the brakes from time to time, paying attention to traffic conditions
- Carefully depress the brake pedal at the end of a journey and after the start of a new journey

Checking the brakepad thickness

In addition to monitoring using the brakepad wear sensor, regularly monitor and check all of the brakepads by performing a visual inspection to look for material wear on the pads.

If you are unable to check the brakepad wear on the inside of the wheels, remove the wheels if you possess the required skills, or visit a qualified specialist workshop.

If the brakepad material thickness is less than 0.12 in (3 mm), have the brakepads checked and replaced at a qualified specialist workshop, if necessary.

Do not solely rely on the brakepad wear sensor.

It is also strongly recommended that you have the brakepads checked at a qualified specialist workshop, not only at every service displayed by the maintenance interval display, but also prior to long journeys and whenever the wheels are removed.

In the following situations, check the brake pads:

- At every service according to maintenance interval
- Before long journeys
- Every time a tire is replaced
- During regular visual inspections for your own safety

New brake discs and brakepads

New brakepads and brake discs only reach their optimal braking effect after a few hundred miles (a few hundred kilometers).

Until then, compensate for the reduced braking effect by applying greater pressure to the brake pedal. For safety reasons, Mercedes-Benz recommends that you only have brakepads and brake discs which are approved by Mercedes-Benz installed on your vehicle.

Other brake discs or brakepads may compromise the safety of your vehicle.

Always replace all brake discs and brakepads on an axle at the same time. Always install new brakepads when replacing brake discs.

Information about driving on wet roads

Notes on hydroplaning

Hydroplaning can take place once a certain amount of water has accumulated on the road surface.

Observe the following notes during heavy precipitation or in conditions in which hydroplaning may occur:

- Reduce your speed
- Avoid tire ruts
- Avoid sudden steering movements
- Brake carefully

Also observe the notes on regularly inspecting wheels and tires (→ page 202).

Notes on driving through water on roads

Water which has entered the vehicle can damage the engine, electrics and transmission.

Water can also enter the air intake installation of the engine and cause engine damage.

Observe the following if you must drive through water:

- The water, when calm, may only reach the lower edge of the vehicle body.
- Drive at walking pace at most; water can otherwise enter the vehicle interior or engine compartment.
- Vehicles traveling in front, or oncoming vehicles, can create waves which may exceed the maximum permissible height of the water

The braking effect of the brakes is reduced after fording. Brake carefully while paying attention to the traffic conditions until braking power has been fully restored.

Information about driving off-road

⚠ WARNING Risk of accident if you do not keep to line of fall on inclines

If you drive at an angle or turn on an incline, the vehicle could slip sideways, tip and rollover.

- ▶ Always drive on inclines in the line of fall (straight up or down) and do not turn.

⚠ WARNING Risk of injury from acceleration forces during off-road driving

You could be thrown from your seat, for example.

- ▶ Always wear your seat belt even when driving off-road.

⚠ WARNING Risk of injury to the hands when driving over obstacles

If you drive over obstacles or in tire ruts, the steering wheel may whip around.

- ▶ The steering wheel must always be held securely with both hands.
- ▶ Always hold the steering wheel so that your thumbs are on the outer rim of the steering wheel.
- ▶ When driving over obstacles, expect increased steering forces at short notice.

⚠ WARNING Risk of fire caused by flammable material on hot exhaust system components

Flammable material such as leaves, grass or twigs may ignite if they come into contact with hot parts of the exhaust system.

- ▶ When driving on an unpaved road or off-road, check the vehicle underside regularly.
- ▶ In particular, remove trapped plant parts or other flammable material.
- ▶ If there is damage, consult a qualified specialist workshop immediately.

ℹ NOTE Damage to the vehicle after driving off-road

Foreign bodies, such as stones and branches, could become trapped on the vehicle underside or on wheels and tires while you are driving and cause damage to the vehicle.

Foreign bodies could cause the following damage:

- Damage the suspension, the fuel tank or the brake system
- Cause imbalances and thus vibrations
- ▶ Regularly remove any trapped foreign bodies, e.g. stones and branches.
- ▶ After driving off-road, check carefully whether there is any damage to the vehicle.
- ▶ If there is damage, have the vehicle checked at a qualified specialist workshop.

When driving off-road and on construction sites, sand, mud and water, for example, also mixed with oil, can get into the brakes. This may lead to a reduction in braking effect or total brake failure, including as a result of increased wear. The braking characteristics will vary depending on the material that has got into the system. Clean the brakes after driving off-road. If you then notice a reduced braking effect or hear scraping noises, have the brake system checked immediately at a qualified specialist workshop. Adjust your driving style to the changed braking characteristics.

Driving off-road or on construction sites increases the possibility of vehicle damage which may in turn lead to the failure of certain major assemblies and systems. Adapt your driving style to the off-road

driving conditions. Drive carefully. Have any vehicle damage rectified at a qualified specialist workshop as soon as possible.

When driving on rough cross-country terrain, do not shift the transmission to neutral and do not disengage the clutch. You could lose control when attempting to brake the vehicle with the service brake. If your vehicle cannot manage an uphill incline, drive back down in reverse gear.

When loading your vehicle for off-road driving or on a construction site, keep the vehicle's center of gravity as low as possible.

Check-list before off-road driving

- Check the fuel supply (→ page 134) and refill if necessary (→ page 105).
- **Engine:** check the oil level and add oil if necessary (→ page 177). Before driving up or down extreme inclines or slopes, fill the oil to the maximum level.
- ⓘ If you drive up or down extreme inclines or slopes, the  symbol may appear in the instrument cluster. The engine operating safety is not put at risk if you have filled the engine oil to the maximum level before the journey.
- **Vehicle tool kit:** check that the jack is working (→ page 198).
- Make sure that a lug wrench, a wooden underlay for the jack, a robust tow rope, a folding spade and a wheel chock (depending on equipment) are carried in the vehicle (→ page 198).
- **Tires and wheels:** check the tire tread depth (→ page 202) and the tire pressure (→ page 207).

Rules for off-road driving

Always be aware of the vehicle's ground clearance, and avoid obstacles such as deep tire ruts.

Obstacles can damage the following parts of the vehicle, for example:

- suspension
- drivetrain
- fuel tank

Therefore, always drive slowly when off-road. If you must drive over obstacles, have the co-driver instruct you.

- ⓘ Mercedes-Benz recommends that you additionally carry a shovel and a recovery rope with a shackle in the vehicle.

- Make sure that loads and items of luggage are securely stored or lashed down (→ page 164).
- Before driving off-road, stop the vehicle and engage a low gear.
- If the surface requires, temporarily deactivate ESP® when pulling away (→ page 109).
- Only drive off-road if the vehicle has been started and a gear is engaged.
- Drive slowly and smoothly. It may often be necessary to drive at walking pace.
- Avoid spinning the drive wheels.
- Always ensure that the wheels remain in contact with the ground.
- Exercise the utmost caution when driving across unfamiliar, unpredictable terrain. As a precaution, get out of the vehicle to take a look at the route to be taken first.
- Look out for obstacles (e.g. rocks, holes, tree stumps and tire ruts).
- Avoid edges where the surface could crumble or break away.

Check-list after driving off-road

Driving over rough terrain places greater demands on your vehicle than normal road operation. Check your vehicle after driving on rough terrain. This allows you to detect damage promptly and reduce the risk of an accident for yourself and other road users. Clean your vehicle thoroughly before driving on public roads.

If you find damage to the vehicle after off-road driving, have the vehicle checked at a qualified specialist workshop immediately.

Observe the following points after driving off-road, on construction sites and before driving on public roads:

- Activate ESP® (→ page 109).
- Clean the exterior lighting, particularly the headlamps and tail lamps, and check them for damage.
- Clean the front and rear license plates.
- Clean the windshield, windows and outside mirrors.
- Clean the steps, entrances and grab handles. This will make your footing safer.
- Clean the wheels, tires, wheel wells and the underbody of the vehicle with a water jet. This increases road adhesion, especially on wet road surfaces.

- Check the wheels, tires and wheel wells for trapped foreign objects and remove them. Trapped foreign objects can damage the wheels and tires or may be flung out from the vehicle when continuing the journey.
- Check the underbody for trapped branches or other parts of plants and remove them.
- Clean the brake disks, brake pads and axle joints, particularly after operation in sand, mud, grit and gravel, water or similarly dirty conditions.
- Check the entire floor assembly, the tires, wheels, bodywork structure, brakes, steering, suspension and exhaust system for any damage.
- Check the service brake for operating safety, e.g. carry out a brake test.
- If you notice strong vibrations after driving off-road, check the wheels and drivetrain for foreign objects again. Remove any foreign objects which can lead to imbalances and thus cause vibrations. In the event of damage to the wheels and the drivetrain, visit a qualified specialist workshop immediately.

Notes on driving in mountainous areas

When driving in mountainous areas, note that engine output – and thus start-off gradeability – will decrease with increasing altitude. Observe the notes on braking on downhill gradients (→ page 99).

The maximum permissible trailer loads are valid for journeys at heights of up to 1100 yds (1000 m) above sea level with gradients up to 12% (→ page 244).

Automatic transmission

DIRECT SELECT lever

Function of the DIRECT SELECT lever

⚠ WARNING Risk of accident and injury due to children left unattended in the vehicle

If children are left unsupervised in the vehicle, they could, in particular:

- open doors, thereby endangering other persons or road users.
- get out and be struck by oncoming traffic.
- operate vehicle equipment and become trapped, for example.

In addition, the children could also set the vehicle in motion, for example by:

- releasing the parking brake.
- changing the transmission position.
- starting the vehicle.

- ▶ Never leave children unattended in the vehicle.
- ▶ When leaving the vehicle, always take the SmartKey with you and lock the vehicle.
- ▶ Keep the vehicle SmartKey out of reach of children.

⚠ WARNING Risk of accident due to incorrect gearshifting

If the engine speed is higher than the idle speed and you engage the transmission position **[D]** or **[R]**, the vehicle may accelerate sharply.

- ▶ If you engage the transmission position **[D]** or **[R]** when the vehicle is at a standstill, always depress the brake pedal firmly and do not accelerate at the same time.

ⓘ NOTE Transmission damage due to shifting at high engine speed or when the vehicle is rolling

You can damage the automatic transmission if you shift from **[D]** to **[R]**, from **[R]** to **[D]** or directly to **[P]** when the engine speed is too high or the vehicle is rolling.

- ▶ Only change the transmission position when the vehicle is stationary.

You use the DIRECT SELECT lever to switch the transmission position. The current transmission position appears in the display of the instrument cluster (→ page 137).

The shifting characteristics of the automatic transmission is designed for comfortable and economical handling. For this reason, the display of the instrument cluster shows, in addition to the transmission position display, the **[C]** for Comfort.

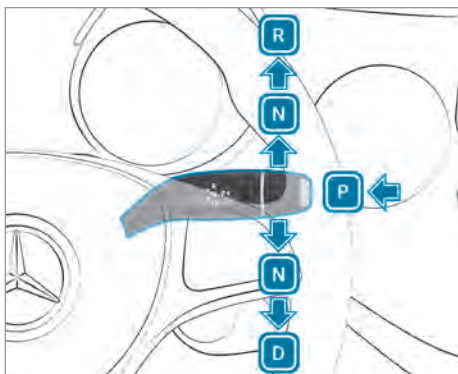

- P** Park position
- R** Reverse gear
- N** Neutral
- D** Drive position

Engaging reverse gear R

- ▶ Depress the brake pedal and push the DIRECT SELECT lever upwards past the first point of resistance.

Selecting neutral N

▲ WARNING Risk of accident and injury when neutral position is engaged

If you park the vehicle with the transmission in neutral position **N** and the parking brake is not engaged, the vehicle may roll away.

There is a risk of accident and injury.

- ▶ Before parking the vehicle, apply the parking brake.

- ▶ Press the brake pedal and the DIRECT SELECT lever upwards or downwards to the first point of resistance.

Subsequently releasing the brake pedal will allow you to move the vehicle freely, e.g. to push it or tow it away.

If the automatic transmission should also stay in neutral **N when the vehicle is switched off, proceed as follows:**

- ▶ Start the vehicle.
- ▶ Depress the brake pedal and engage neutral **N**.
- ▶ Release the brake pedal.
- ▶ Switch off the vehicle and leave the key in the ignition lock.

Engaging park position P

- ▶ Press the **P** button on the DIRECT SELECT lever when the vehicle is stationary.

Park position **P** is engaged automatically when one of the following conditions is met:

- You switch the vehicle off with the transmission in position **D** or **R**.
- You remove the key from the ignition lock.
- You open the driver's door when the vehicle is stationary or moving at a very low speed and with the transmission in position **D** or **R**.

Engaging drive position D

- ▶ Depress the brake pedal and push the DIRECT SELECT lever downwards past the first point of resistance.

The automatic transmission shifts through the individual gears automatically when it is in transmission position **D**. This is determined by the following factors:

- Shift range is limited (→ page 104)
- Position of the accelerator pedal
- Driving speed

Restricting the shift range

Requirements:

- Transmission position **D** is engaged (→ page 104).



- ▶ **To restrict the shift range:** Briefly pull steering wheel paddle shifter **1**. The automatic transmission shifts to the next lower gear, depending on the gear currently engaged. The shift range is also restricted. The selected shift range is shown in the instrument cluster display. The automatic transmission shifts only as far as the selected gear.
- ▶ Pull and hold steering wheel paddle shifter **1**. The automatic transmission will change to a shift range which allows easy acceleration and deceleration. To do this, the automatic trans-

mission shifts down one or more gears and restricts the shift range.

The selected shift range is shown in the instrument cluster display. The automatic transmission shifts only as far as the selected gear.

- i The automatic transmission does not shift down if you pull steering wheel paddle shifter 1 whilst traveling at too high a speed. If the maximum engine speed for the restricted shift range is reached and you continue to depress the accelerator pedal, the automatic transmission will shift up automatically. This protects against engine overrev.

- ▶ **To de-restrict the shift range:** Briefly pull steering wheel paddle shifter 2.

The automatic transmission shifts to the next gear up, depending on the gear currently engaged. This de-restricts the shift range at the same time.

The selected shift range is shown in the instrument cluster display. The automatic transmission shifts only as far as the selected gear.

- ▶ **To de-restrict the shift range:** Pull and hold steering wheel paddle shifter 2.

or

- ▶ engage transmission position D again (→ page 104).

The automatic transmission shifts up one or more gears depending on the gear currently engaged. Simultaneously, the shift range restriction is deactivated and the transmission position appears in the instrument cluster display D.

Recommended shift ranges for the following driving conditions:

- 3 Use the engine's braking effect.
- 2 Use the engine's braking effect on downhill gradients and when driving on steep roads, in mountainous areas as well as under arduous operating conditions.
- 1 Use the engine's braking effect on extremely steep downhill gradients and on long downhill stretches.

Using kickdown

- ▶ **For maximum acceleration:** depress the accelerator pedal beyond the pressure point.

Refueling

Refueling the vehicle

- ▲ **WARNING** Risk of fire or explosion from fuel

Fuels are highly flammable.

- ▶ Fire, open flames, smoking and creating sparks must be avoided.
- ▶ Before refueling, switch off the vehicle and, if installed, the stationary heater, and leave them switched off during refueling.

- ▲ **WARNING** Risk of injury from fuels

Fuels are poisonous and hazardous to your health.

- ▶ Do not swallow fuel or let it come into contact with skin, eyes or clothing.
- ▶ Do not inhale fuel vapor.
- ▶ Keep children away from fuel.
- ▶ Keep doors and windows closed during the refueling process.

If you or other people come into contact with fuel, observe the following:

- ▶ Immediately rinse fuel off your skin with soap and water.
- ▶ If fuel comes into contact with your eyes, immediately rinse them thoroughly with clean water. Seek medical attention immediately.
- ▶ If you swallow fuel, seek medical attention immediately. Do not induce vomiting.
- ▶ Change immediately out of clothing that has come into contact with fuel.

- ▲ **WARNING** Risk of fire and explosion due to electrostatic charge

Electrostatic charge can ignite fuel vapor.

- ▶ Before you open the fuel filler cap or take hold of the pump nozzle, touch the metallic vehicle body.
- ▶ To avoid creating another electrostatic charge, do not get into the vehicle again during the refueling process.

! **NOTE** Do not use diesel to refuel vehicles with a gasoline engine

If you have accidentally refueled with the wrong fuel:

- Do not switch on the vehicle. Otherwise fuel can enter the engine.
- Even small amounts of the wrong fuel could result in damage to the fuel system and the engine. The repair costs are high.

- ▶ Consult a qualified specialist workshop.
- ▶ Have the fuel tank and fuel lines drained completely.

! **NOTE** Damage to the fuel system caused by overfilled fuel tanks

- ▶ Only fill the fuel tank until the pump nozzle switches off.

Requirements:

- The vehicle is unlocked and switched off.
 - The front left-hand door is open.
- i** Do not get back into the vehicle during the refueling process. Otherwise, electrostatic charge could build up again.

Observe the notes on operating fluids
(→ page 238).

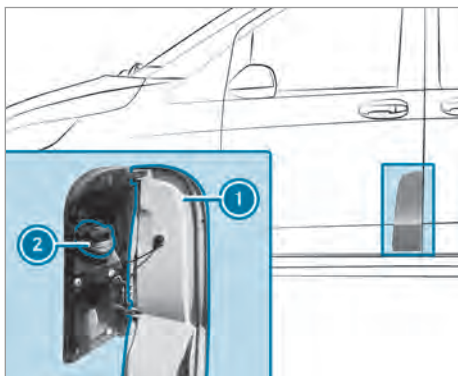

- ▶ Open fuel filler flap **1**.
- ▶ Turn fuel filler cap **2** counter-clockwise and remove it.
- ▶ Close all vehicle doors to prevent fuel vapors from entering the vehicle interior.
- ▶ Completely slide the filler neck of the pump nozzle into the tank, hook in place and refuel.

- ▶ Fill the fuel tank only until the pump nozzle switches off.
 - ▶ Replace fuel filler cap **2** and turn it clockwise. You will hear a click when the fuel filler cap is closed fully.
 - ▶ Open the front left-hand door.
 - ▶ Close fuel filler flap **1**.
- i** If the fuel tank has been run completely dry, add at least 1.3 gal (5 l) of fuel. Switch on the vehicle three to four times before starting the vehicle.
- i** Vehicles that can use a mixture of fuels can be recognized by the sticker "Ethanol up to E85!" on the fuel filler flap.

Parking

Parking the vehicle

! **WARNING** Risk of fire caused by hot exhaust system parts

Flammable materials such as leaves, grass or twigs may ignite.

- ▶ Park the vehicle so that no flammable material can come into contact with hot vehicle components.
- ▶ In particular, do not park on dry grass-land or harvested grain fields.

! **WARNING** Risk of accident and injury due to children left unattended in the vehicle

If children are left unsupervised in the vehicle, they could, in particular:

- open doors, thereby endangering other persons or road users.
- get out and be struck by oncoming traffic.
- operate vehicle equipment and become trapped, for example.

In addition, the children could also set the vehicle in motion, for example by:

- releasing the parking brake.
- changing the transmission position.
- starting the vehicle.

- ▶ Never leave children unattended in the vehicle.
- ▶ When leaving the vehicle, always take the SmartKey with you and lock the vehicle.

- ▶ Keep the vehicle SmartKey out of reach of children.

! **NOTE** Damage to the vehicle or the drivetrain due to rolling away

- ▶ Always park your vehicle safely and according to legal requirements.
- ▶ Always properly secure the vehicle against rolling away.

! **NOTE** Transmission damage due to rollers in neutral position

If the vehicle is switched off and rolling in neutral position (e.g. when towing), this can damage the drivetrain and lead to transmission damage.

- ▶ Only allow the vehicle to roll in neutral position for a short time.

Observe the following points to ensure that the vehicle is properly secured against rolling away unintentionally.

- ▶ Always apply the parking brake.
- ▶ **On uphill or downhill inclines:** Turn the front wheels towards the curb.
- ▶ Shift the transmission to position **P**.
- ▶ Turn the key to position **0**.

Manual parking brake

Applying or releasing the parking brake

! **WARNING** Risk of skidding or an accident by braking with the parking brake

If you have to brake your vehicle with the parking brake, the braking distance is considerably longer and the wheels may lock. There is an increased risk of skidding and/or accident.

- ▶ Only brake the vehicle with the parking brake if the service brake has failed.
- ▶ In this case, do not apply the parking brake with too much force.
- ▶ If the wheels lock, immediately release the parking brake as much as required for the wheels to turn again.

! **WARNING** Risk of fire and an accident if the parking brake is not released

If the parking brake is not fully released when driving, the following situations can occur:

- The parking brake can overheat and cause a fire
- The parking brake can lose its holding function

- ▶ Completely release the parking brake before driving off.

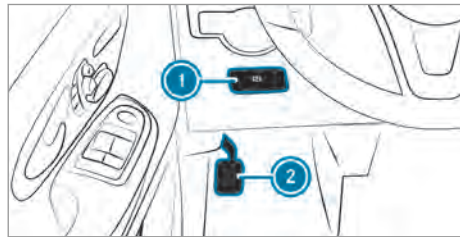

The brake lights do not light up when you brake the vehicle with the parking brake.

- ▶ **To apply the parking brake:** depress parking brake pedal **2** firmly. The red **PARK** (only USA) or **(P)** (only Canada) indicator lamp in the instrument cluster lights up when the vehicle is switched on. If the vehicle is in motion, a warning tone sounds.
- ▶ **To release the parking brake:** depress the brake pedal and keep it depressed.
- ▶ Pull release handle **1**. The parking brake is released abruptly. The red **PARK** (only USA) or **(P)** (only Canada) indicator lamp in the instrument cluster goes out.

Performing emergency braking with the parking brake

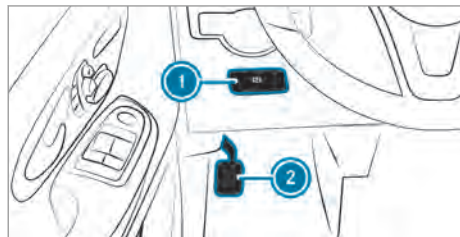

If, in exceptional cases, the service brake fails, you can use the parking brake to perform emergency braking.

- ▶ Pull release handle ① and slowly depress parking brake pedal ②.

Parking the vehicle for an extended period

Parking the vehicle for longer than four weeks

- ▶ Connect the starter battery to a trickle charger via a jump-start connection (→ page 189).

or

- ▶ Disconnect all batteries (→ page 191).

Parking the vehicle for longer than six weeks

- ▶ Contact a qualified specialist workshop and seek advice.
The vehicle can otherwise suffer damage as a result of lack of use.

Driving and driving safety systems

Notes on driving systems and your responsibility

Your vehicle is equipped with driving systems which assist you in driving, parking and maneuvering the vehicle. The driving systems are only aids. These cannot replace your attention to the surroundings and do not release you from your responsibility under road traffic law. The driver is responsible for the distance to the vehicle in front, for vehicle speed, braking in good time and for staying in lane. Always pay attention to the traffic and intervene if necessary. Be aware of the limitations regarding the safe use of these systems.

If you fail to adapt your driving style, the driving systems can neither reduce the risk of accident nor override the laws of physics. The road and weather conditions as well as the traffic situation cannot always be taken into account.

Information on vehicle sensors and cameras

Some driving and driving safety systems use cameras and radar or ultrasonic sensors to monitor the area in front of, behind or next to the vehicle.

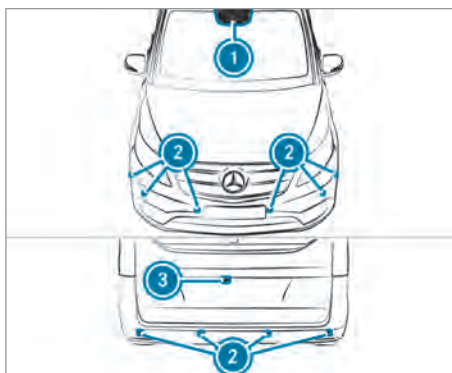

- ① Multifunction camera
- ② Ultrasonic sensors
- ③ Rear view camera

- ⓘ Depending on the vehicle's equipment, the radar sensors are integrated on the side of the rear bumpers and/or behind the Mercedes star in the radiator grille.

⚠ WARNING Risk of accident due to restricted detection performance of vehicle sensors and cameras

If the area around vehicle sensors or cameras is covered, damaged or dirty, certain driving and safety systems cannot function correctly. There is a risk of an accident.

- ▶ Keep the area around vehicle sensors or cameras clear of any obstructions and clean.
- ▶ Have damage to the bumper, radiator grille or stone chipping in the area of the front and rear windows repaired at a qualified specialist workshop.

Keep the areas of the cameras and sensors free of dirt, ice and slush (→ page 182). The sensors and cameras must not be covered and the detection ranges around them must be kept free. Do not attach additional license plate brackets, advertisements, stickers, foils or foils to protect against stone chippings in the detection range of the sensors and cameras. Make sure that there are no overhanging loads protruding into the detection range.

In the event of damage, or following a severe impact, have the function of the sensors checked at a qualified specialist workshop. Have damage or

stone chipping in the area of the cameras repaired at a qualified specialist workshop.

Overview of driving systems and driving safety systems

In this section, you will find information about the following driving systems and driving safety systems:

- ABS (**A**nti-**l**ock **B**raking **S**ystem) (→ page 109)
- BAS (**B**rake **A**ssist **S**ystem) (→ page 109)
- ESP® (**E**lectronic **S**tability **P**rogram) (→ page 109)
- EBD (**E**lectronic **B**rake**f**orce **D**istribution) (→ page 111)
- Active Brake Assist (→ page 111)
- Cruise control (→ page 113)
- Active Distance Assist DISTRONIC (→ page 114)
- Hill start assist (→ page 118)
- HOLD function (→ page 118)
- Parking Assist PARKTRONIC (→ page 119)
- Rear view camera (→ page 121)
- Active Parking Assist (→ page 122)
- ATTENTION ASSIST (→ page 125)
- Blind Spot Assist (→ page 126)
- Lane Keeping Assist (→ page 127)

Function of ABS (Anti-lock Braking System)

ABS controls the brake pressure in critical situations:

- During braking, for instance, at maximum full-stop braking or if there is insufficient tire traction, the wheels are prevented from locking.
- The steerability of the vehicle in terms of physical possibilities is ensured when braking.

If ABS intervenes, you will feel pulsations in the brake pedal. The pulsating brake pedal may be an indication of hazardous road conditions and functions as a reminder to take extra care while driving.

Function of BAS (Brake Assist System)

BAS supports you with additional braking force in an emergency braking situation.

If you depress the brake pedal quickly, BAS is activated:

- BAS automatically boosts the braking force of the brakes
- BAS can shorten the braking distance
- ABS prevents the wheels from locking

When you release the brake pedal, the brakes function as usual again. BAS is deactivated.

Function of ESP® (Electronic Stability Program)

⚠ WARNING Risk of skidding if ESP® is deactivated

If you deactivate ESP®, ESP® cannot carry out vehicle stabilization.

▶ ESP® should only be deactivated in the following situations.

ESP® can, within physical limits, monitor and improve driving stability and traction in the following situations:

- When driving and pulling away on wet or slippery road surfaces
- When braking

If the vehicle is deviating from the direction desired by the driver, ESP® can stabilize the vehicle by performing the following actions:

- One or more wheels are braked
- The engine output is adapted according to the situation

i Only use wheels with the recommended tire sizes. Only then will ESP® function properly.

If the  warning lamp flashes in the instrument cluster, one or more wheels have reached their traction limit:

- Adapt your driving style to suit the prevailing road and weather conditions
- Do not deactivate ESP® under any circumstances
- Only depress the accelerator pedal as far as is necessary when pulling away

Deactivate ESP® in the following situations to improve traction:

- When using snow chains.
- In deep snow.
- On sand or gravel.

- ① Spinning the wheels results in a cutting action, which enhances traction.

If the  warning lamp lights up continuously, ESP® is not available due to a malfunction.

Observe the information on warning lamps and display messages (→ page 271).

When ESP® is deactivated, the  warning lamp in the instrument cluster lights up continuously.

Observe the following points when ESP® is deactivated:

- Vehicle stabilization is delayed and is significantly reduced in the lower speed range
 - The drive wheels may start to spin
 - Traction control is still active
- ① If ESP® is deactivated, ESP® will still support you when braking.

Deactivating or activating ESP® using the button

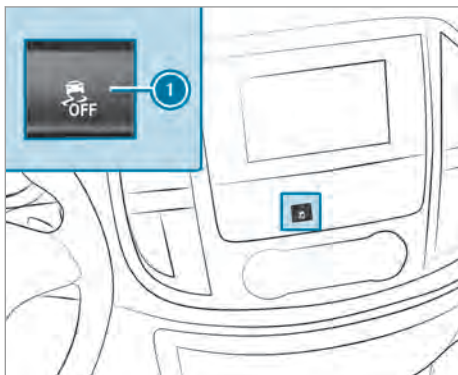





- ▶ Press button ①.
The  warning lamp in the instrument cluster goes on when ESP® is deactivated.
- ① Observe the information on warning lamps and display messages (→ page 271).

Deactivating or activating ESP® using the on-board computer (vehicles without steering wheel buttons)

On-board computer:

↳   Settings  ESP

Adjusting settings using the on-board computer is only available on vehicles without the  button on the center console.

- ▶ **To deactivate/activate:** press the  or  button and confirm with the  button.

If ESP® is deactivated, the  warning lamp in the instrument cluster lights up.



- ① Observe the information on warning lamps and display messages (→ page 271).

Deactivating or activating ESP® using the on-board computer (vehicles with steering wheel buttons)

On-board computer:

↳  DriveAssist  ESP

Adjusting settings using the on-board computer is only available on vehicles without the  button on the center console.

- ▶ **To deactivate/activate:** press the  button.
If ESP® is deactivated, the  warning lamp in the instrument cluster lights up.

- ① Observe the information on warning lamps and display messages (→ page 271).

Function of ESP® Crosswind Assist

ESP® Crosswind Assist detects sudden gusts of side wind and helps the driver to keep the vehicle in the lane:

- ESP® Crosswind Assist is active at vehicle speeds above approx. 50 mph (80 km/h) when driving straight ahead or cornering slightly.
- The vehicle is stabilized by means of individual brake application on one side. The instrument cluster displays a message with the traffic sign for a strong crosswind.

ESP® Crosswind Assist does not react under the following conditions:

- The vehicle is subjected to severe jolts and vibrations, e.g. as a result of uneven surfaces or potholes.
- The vehicle loses traction, e.g. on snow or ice or when hydroplaning.

Function of ESP® trailer stabilization

⚠ WARNING Risk of accident in poor road and weather conditions

In poor road and weather conditions, the trailer stabilization cannot prevent lurching of the vehicle/trailer combination. Trailers with a high

center of gravity may tip over before ESP® detects this.

- ▶ Always adapt your driving style to suit the current road and weather conditions.

When you are driving with a trailer, ESP® trailer stabilization can stabilize your vehicle if it begins to swerve from side to side:

- If the system detects the trailer, ESP® trailer stabilization is active at speeds above approximately 40 mph (65 km/h).
- Minor swerving is reduced by a targeted, individual brake application on one side.
- In the event of severe swerving, the engine output is also reduced and all wheels are braked.

Function of EBD (Electronic Brakeforce Distribution)

EBD has the following characteristics:

- Monitoring and controlling the braking force on the rear wheels
- Improving driving stabilization when braking, especially on curves

Function of Active Brake Assist

Active Brake Assist consists of the following functions:

- Distance warning function
- Autonomous braking function
- Situation-dependent brake force boosting

Active Brake Assist can help you to minimize the risk of a collision with vehicles, cyclists or pedestrians, or reduce the effects of such a collision.

If Active Brake Assist has detected a risk of collision, a warning tone will sound and the  warning lamp will light up on the instrument cluster.

If you do not react to the warning, autonomous braking may be initiated in critical situations. In especially critical situations, Active Brake Assist can initiate autonomous braking directly. In this case, the warning lamp and warning tone will be activated at the same time as the brake application.

If you apply the brake yourself in a situation identified as critical by Active Brake Assist, or apply the brake during autonomous braking, situation-dependent brake force boosting will occur. The

brake pressure will increase up to maximum full-stop braking if necessary.

If autonomous braking or situation-dependent brake force boosting has occurred, the  warning lamp will flash briefly and then go out.

WARNING Risk of an accident caused by limited detection performance of Active Brake Assist

Active Brake Assist cannot always clearly identify objects and complex traffic situations.

In such cases, Active Brake Assist might:

- Give a warning or brake without reason
- Not give a warning or not brake

Active Brake Assist is only an aid. The driver is responsible for maintaining a sufficiently safe distance to the vehicle in front, vehicle speed and for braking in good time.

- ▶ Always pay careful attention to the traffic situation; do not rely on Active Brake Assist alone.
- ▶ Be prepared to brake or swerve if necessary.

Observe the system limitations of Active Brake Assist. Due to the nature of the system, complex but non-critical driving conditions may also cause Active Brake Assist to intervene during braking.

The individual subfunctions are available in the following speed ranges:

Distance warning function

The distance warning function will warn you in the following situations:

- From approximately 4 mph (7 km/h), if your vehicle is critically close to a vehicle or pedestrian, an intermittent warning tone will sound and the  warning lamp will light up on the instrument cluster.

Brake immediately or take evasive action, provided it is safe to do so and the traffic situation allows this.

The distance warning function can aid you in the following situations with an intermittent warning tone and a warning lamp:

- **Vehicles traveling in front:** up to approximately 155 mph (250 km/h)
- **Stationary vehicles:** up to approximately 50 mph (80 km/h)
- **Crossing vehicles:** no reaction

- **Moving pedestrians/cyclists ahead:** up to approximately 50 mph (80 km/h)
- **Crossing cyclists:** up to approximately 37 mph (60 km/h)
- **Stationary pedestrians:** no reaction

Autonomous braking function

The autonomous braking function may intervene at speeds starting from approximately 4 mph (7 km/h) in the following situations:

- **Vehicles traveling in front:** up to approximately 125 mph (200 km/h)
- **Stationary vehicles:** up to approximately 31 mph (50 km/h)
- **Crossing vehicles:** no reaction
- **Cyclists ahead:** up to approximately 50 mph (80 km/h)
- **Moving pedestrians/crossing cyclists:** up to approximately 37 mph (60 km/h)
- **Stationary pedestrians:** no reaction

Situation-dependent brake force boosting

Situation-dependent brake force boosting may intervene at speeds starting from approximately 4 mph (7 km/h) in the following situations:

- **Vehicles traveling in front:** up to approximately 155 mph (250 km/h)
- **Stationary vehicles:** up to approximately 50 mph (80 km/h)
- **Crossing vehicles:** no reaction
- **Cyclists ahead:** up to approximately 50 mph (80 km/h)
- **Moving pedestrians/crossing cyclists:** up to approximately 37 mph (60 km/h)
- **Stationary pedestrians:** no reaction

Canceling a brake application from Active Brake Assist

You can cancel a brake application from Active Brake Assist at any time by:

- Fully depressing the accelerator pedal or with kickdown.
- Releasing the brake pedal.

Active Brake Assist may cancel the brake application when one of the following conditions is fulfilled:

- You maneuver to avoid the obstacle.
- There is no longer a risk of collision.
- An obstacle is no longer detected in front of your vehicle.

System limits

Full system performance will not yet be available for a few seconds after switching on the vehicle or after driving off.

The system may be impaired or may not function in the following situations:

- In snow, rain, fog or heavy spray.
- If the sensors are dirty, fogged up, damaged or covered.
- If the sensors are impaired due to interference from other radar sources, e.g. strong radar reflections in parking garages.
- If a loss of tire pressure or a defective tire has been detected and displayed.
- In complex traffic situations where objects cannot always be clearly identified.
- If pedestrians or vehicles move quickly into the sensor detection range.
- If pedestrians are hidden by other objects.
- If the typical outline of a pedestrian cannot be distinguished from the background.
- If a pedestrian is not recognized as such, e.g. due to special clothing or other objects.
- On bends with a narrow radius.

Setting Active Brake Assist

On-board computer:

➤ DriveAssist ➤ Active Brake Assist:

- ▶ Select the desired setting for the warning/reaction time and press the **OK** button. The setting is retained when the vehicle is next started.

Deactivating Active Brake Assist

- ⓘ It is recommended that Active Brake Assist is always left activated.
- ▶ Select **Off** and press the **OK** button. The distance warning function and the autonomous braking function are deactivated. Also, the status appears in the Status overview of the **DriveAssist** menu.

The next time the vehicle is started, Active Brake Assist is automatically activated with the **Medium** setting.

When Active Brake Assist is activated, the instrument cluster display shows the  symbol.

At speeds up to approximately 20 mph (30 km/h), the instrument cluster display in vehicles with Active Parking Assist first shows the **P** status indicator. Only from a speed of approximately 20 mph (30 km/h) does the display show the  symbol instead of the **P** status indicator.

Cruise control

Function of cruise control

Cruise control accelerates and brakes the vehicle automatically in order to maintain a previously stored speed.

If you accelerate to overtake, for example, the stored speed is not deleted. If you remove your foot from the accelerator pedal after overtaking, cruise control will resume speed regulation back to the stored speed.

You operate cruise control using the cruise control lever. You can store any speed above 20 mph (30 km/h).

Observe the notes on driving systems and your responsibility; you may otherwise fail to recognize dangers (→ page 108).

System limits

Cruise control may be unable to maintain the stored speed on uphill gradients. The stored speed is resumed if the uphill gradient evens out and the vehicle's speed does not fall below 20 mph (30 km/h).

On long and steep downhill gradients, you should change down to a lower gear in good time. Take particular note of this when driving a laden vehicle. By doing so, you will make use of the engine's braking effect. This will take some of the strain off the brake system and prevent the brakes from overheating and wearing too quickly.

If you change wheel size on your vehicle, check it is assigned to the correct wheel size category (→ page 214). If the category is changed without recoding the control units in the vehicle, the functioning of cruise control may be impaired.

Do not use cruise control in the following situations:

- In traffic situations which require frequent changes of speed, e.g. in heavy traffic, on winding roads
- Off-road or on construction sites
- On slippery or slick roads, as the drive wheels can lose traction when accelerating and the vehicle can then skid
- If there is poor visibility

Operating cruise control

Requirements:

- Cruise control is selected.
- The parking brake has been released.
- ESP® is activated, but may not intervene.
- The driving speed is at least 20 mph (30 km/h).
- The brake pedal is not depressed.

Storing and maintaining the current speed

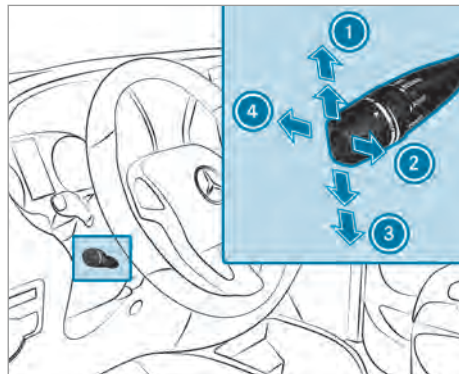

- ▶ Briefly press the cruise control lever up **1** or down **3**.
- ▶ Remove your foot from the accelerator pedal. The current speed is then saved and maintained by the vehicle.

When you activate cruise control, a message with the stored speed is briefly shown in the instrument cluster display's text field. The display also shows the  symbol and the stored speed.

Calling up the stored speed

⚠ WARNING Risk of accident due to stored speed

If you call up the stored speed and this is lower than your current speed, the vehicle decelerates.

▶ Take into account the traffic situation before calling up the stored speed.

▶ Briefly pull the cruise control lever in direction **2**.

The last stored speed is called up and maintained by the vehicle.

If the last stored speed has previously been deleted, the currently driven speed is stored.

i When you switch off the vehicle, the last speed stored is cleared.

Increasing or reducing the speed

▶ Press the cruise control lever up **1** or down **3** as far as the 1st pressure point. The stored speed is increased or reduced by 1 mph (1 km/h).

or

▶ Press the cruise control lever up **1** or down **3** beyond the 1st pressure point. The stored speed is increased or reduced by 5 mph (10 km/h).

Deactivating cruise control

▶ Briefly press the cruise control lever forwards **4**. The  symbol and the stored speed in the instrument cluster display then go out.

i Cruise control is deactivated in the following situations:

- You apply the brakes.
- You drive below a speed of 20 mph (30 km/h).
- You shift the transmission to position **N**.
- ESP[®] intervenes.
- You deactivate ESP[®].
- There is a malfunction with the ABS or ESP[®] system.

If cruise control automatically deactivates, a warning tone sounds and the **CRUISE CONTROL Canceled** message appears briefly in the instrument cluster display.

Active Distance Assist DISTRONIC

Function of Active Distance Assist DISTRONIC

Active Distance Assist DISTRONIC maintains the set speed on free-flowing roads. If vehicles ahead are detected, the set distance is maintained, if necessary until the vehicle comes to a halt. The vehicle accelerates or brakes, depending on the distance to the vehicle in front and the set speed. The speed and distance to the vehicle in front are set and saved using the cruise control lever. The speed can be set in the range between 13 mph (20 km/h) and 125 mph (200 km/h).

Other features of Active Distance Assist DISTRONIC:

- Depending on the preselected distance, DISTRONIC intervenes either dynamically (short distance) or to save fuel (long distance).
- Depending on the vehicle mass detected, the dynamics of the DISTRONIC intervention are reduced.
- Acceleration to the stored speed is initiated if the turn signal indicator is switched on to change to the overtaking lane.

Observe the notes on driving systems and your responsibility; you may otherwise fail to recognize dangers (→ page 108).

System limits

The system may be impaired or may not function in the following situations, for example:

- In snow, rain, fog or heavy spray
- If there is dirt on the radar sensors or they are covered
- If there is interference from radar sources or strong radar reflections, for example in parking garages
- In traffic situations where frequent speed changes are required, e.g. in heavy traffic or on winding roads or off-road
- On roads with steep downhill or uphill gradients
- On winding roads

The system cannot detect stationary objects unless these were previously detected as moving.

In addition, on slippery or slick roads, braking or accelerating can cause one or several of the drive wheels to lose traction and the vehicle can then skid.

Do not use Active Distance Assist DISTRONIC in these situations.

⚠ WARNING Risk of accident from acceleration or braking by Active Distance Assist DISTRONIC

Active Distance Assist DISTRONIC may accelerate or brake in the following cases, for example:

- If the vehicle pulls away using Active Distance Assist DISTRONIC.
- If the stored speed is called up and is considerably faster or slower than the currently driven speed.
- If Active Distance Assist DISTRONIC no longer detects a vehicle in front or does not react to relevant objects.

- ▶ Always carefully observe the traffic conditions and be ready to brake at all times.
- ▶ Take into account the traffic situation before calling up the stored speed.

⚠ WARNING Risk of accident due to insufficient deceleration by Active Distance Assist DISTRONIC

Active Distance Assist DISTRONIC brakes your vehicle with up to 50% of the possible deceleration. If this deceleration is not sufficient, Active Distance Assist DISTRONIC alerts you with a visual and acoustic warning.

- ▶ Adjust your speed and maintain a suitable distance from the vehicle in front.
- ▶ Brake the vehicle yourself and/or take evasive action.

⚠ WARNING Risk of accident if detection function of Active Distance Assist DISTRONIC is impaired

Active Distance Assist DISTRONIC does not react or has a limited reaction:

- when driving on a different lane or when changing lanes
- to pedestrians, animals, bicycles or stationary vehicles, or unexpected obstacles
- to complex traffic conditions
- to oncoming vehicles and crossing traffic

As a result, Active Distance Assist DISTRONIC may neither give warnings nor intervene in such situations.

- ▶ Always observe the traffic conditions carefully and react accordingly.

Active Distance Assist DISTRONIC may not detect narrow vehicles driving in front, e.g. motorcycles or vehicles not traveling in line with your vehicle.

If the following requirements for activation are no longer fulfilled or the system is malfunctioning, Active Distance Assist DISTRONIC is automatically deactivated. If the vehicle is stationary or is moving very slowly during automatic deactivation, the transmission automatically shifts to park position **P**.

Operating Active Distance Assist DISTRONIC

Requirements:

- The vehicle has been started. It may take up to two minutes of driving before Active Distance Assist DISTRONIC is ready for use.
- The parking brake has been released.
- ESP® is activated and is not intervening.
- Active Parking Assist is not active.
- The transmission is in position **D**.
- The doors and tailgate/rear-end doors are closed.
- The driver's seat belt is fastened.

Activating Active Distance Assist DISTRONIC

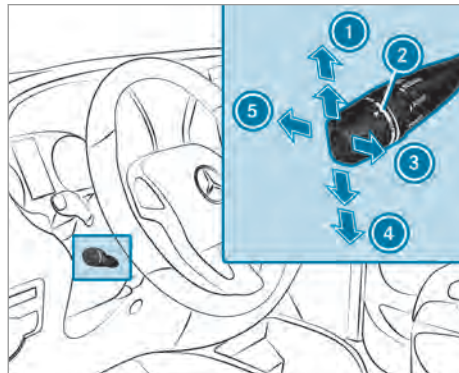

- ▶ **To activate with the current speed:** briefly press the cruise control lever briefly up **1** or

down ④ and take your foot off the accelerator pedal.

The current speed is stored and appears in the speedometer and briefly in the instrument cluster display.

or

- ▶ **To activate with the stored speed:** pull the cruise control lever briefly in direction ③ and take your foot off the accelerator pedal. The speed appears in the speedometer and briefly in the instrument cluster display.

If you do not fully release the accelerator pedal, the **Active Distance Assist Suspended** message appears on the instrument cluster display. The distance to a slower-moving vehicle in front will then not be set. The position of the accelerator pedal will determine the speed.

When you pull the cruise control lever in direction ③ for the first time after starting the vehicle, Active Distance Assist DISTRONIC adopts the current speed. If the current speed is less than 20 mph (30 km/h), Active Distance Assist DISTRONIC adopts the speed of 20 mph (30 km/h).

Pulling away again with Active Distance Assist DISTRONIC

- ▶ Remove your foot from the brake pedal.
- ▶ Briefly pull the cruise control lever in direction ③.

or

- ▶ Depress the accelerator pedal briefly with force. The functions of Active Distance Assist DISTRONIC continue to be carried out.

Deactivating Active Distance Assist DISTRONIC

⚠ WARNING Risk of an accident due to Active Distance Assist DISTRONIC being active when you leave the driver's seat

If you leave the driver's seat while the vehicle is being braked by Active Distance Assist DISTRONIC only, the vehicle can roll away.

- ▶ Always deactivate Active Distance Assist DISTRONIC and secure the vehicle to prevent it from rolling away before you leave the driver's seat.

- ▶ Briefly push the cruise control lever forwards ⑤.

or

- ▶ Brake if the vehicle is moving.

Increasing or reducing the speed

- ▶ Press the cruise control lever up ① or down ④ as far as the first pressure point. The stored speed is increased or reduced by 1 mph (1 km/h).

or

- ▶ Press the cruise control lever up ① or down ④ beyond the first pressure point. The stored speed is increased or reduced by 5 mph (10 km/h).

Increasing or reducing the specified distance from the vehicle in front

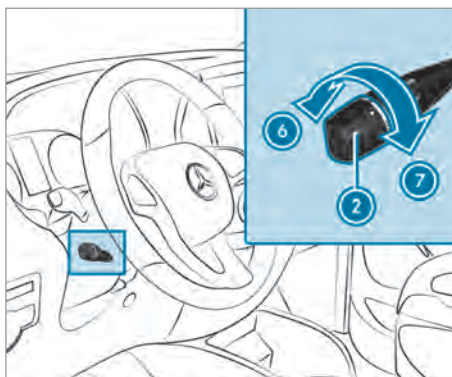

- ▶ Turn controller ② in direction ⑦ to increase the specified minimum distance and in direction ⑥ to reduce the specified minimum distance.

Operating Active Distance Assist DISTRONIC

Requirements:

- The vehicle has been started. It may take up to two minutes of driving before Active Distance Assist DISTRONIC is ready for use.
- The parking brake has been released.
- ESP® is activated and is not intervening.
- Active Parking Assist is not active.
- The transmission is in position **[D]**.
- The doors and tailgate/rear-end doors are closed.
- The driver's seat belt is fastened.

Switching between the limiter and Active Distance Assist DISTRONIC

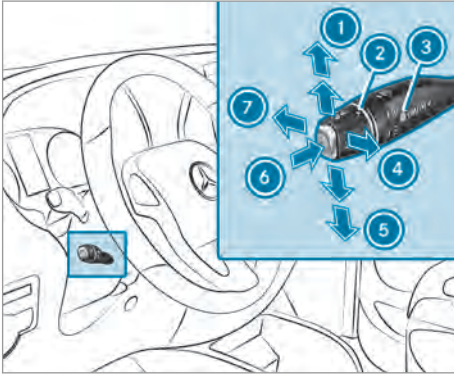

- ▶ Press button ⑥.
 - LIM indicator lamp ③ off: Active Distance Assist DISTRONIC is selected.
 - LIM indicator lamp ③ lit: the variable limiter is selected.

Activating Active Distance Assist DISTRONIC

- ▶ **To activate with the current speed:** briefly press the cruise control lever briefly up ① or down ⑤ and take your foot off the accelerator pedal.

The current speed is stored and shown on the speedometer. The multifunction display briefly shows the set specified distance as well as the stored speed.

or

- ▶ **To activate with the stored speed:** pull the cruise control lever briefly in direction ④ and take your foot off the accelerator pedal. The speed is displayed on the speedometer. The multifunction display briefly shows the set specified distance as well as the stored speed.

- ① Vehicles with Traffic Sign Assist: the speed detected by Traffic Sign Assist can be set by pulling the lever in direction ④.
- ① Information on DISTRONIC displays (→ page 118).

If you do not fully release the accelerator pedal, the **Active Distance Assist Suspended** message appears on the multifunction display. The distance to a slower-moving vehicle in front will then not be set. The position of the accelerator pedal will determine the speed.

When you pull the cruise control lever in direction ④ for the first time after starting the vehicle,

Active Distance Assist DISTRONIC adopts the current speed. If the current speed is less than 13 mph (20 km/h), Active Distance Assist DISTRONIC adopts the speed of 13 mph (20 km/h).

Pulling away again with Active Distance Assist DISTRONIC

- ▶ Remove your foot from the brake pedal.
- ▶ Briefly pull the cruise control lever in direction ④.

or

- ▶ Depress the accelerator pedal briefly with force. The functions of Active Distance Assist DISTRONIC continue to be carried out.

Deactivating Active Distance Assist DISTRONIC

⚠ WARNING Risk of an accident due to Active Distance Assist DISTRONIC being active when you leave the driver's seat

If you leave the driver's seat while the vehicle is being braked by Active Distance Assist DISTRONIC only, the vehicle can roll away.

- ▶ Always deactivate Active Distance Assist DISTRONIC and secure the vehicle to prevent it from rolling away before you leave the driver's seat.

- ▶ Briefly push the cruise control lever forwards ⑦.

or

- ▶ Brake if the vehicle is moving.

or

- ▶ Press button ⑥. The variable limiter is selected. LIM indicator lamp ③ in the cruise control lever lights up.

Increasing or reducing the speed

- ▶ Press the cruise control lever up ① or down ⑤ as far as the first pressure point. The stored speed is increased or reduced by 1 mph (1 km/h).

or

- ▶ Press the cruise control lever up ① or down ⑤ beyond the first pressure point. The stored speed is increased or reduced by 5 mph (10 km/h).

Increasing or reducing the specified distance from the vehicle in front

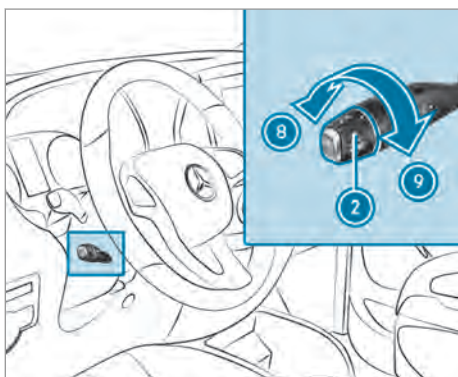

- ▶ Turn controller **2** in direction **9** to increase the specified minimum distance and in direction **8** to reduce the specified minimum distance. The multifunction display briefly shows the set specified distance.

i Information on DISTRONIC displays (→ page 118).

Displays of Active Distance Assist DISTRONIC

Assistance graphic

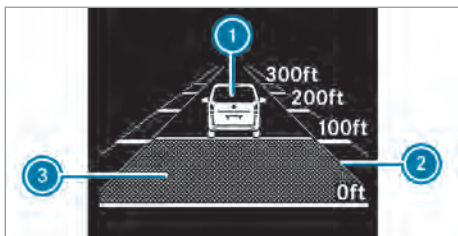

- 1** Vehicle in front, if detected
 - 2** Distance indicator
 - 3** Set specified distance
- i** Information about the assistance graphic menu (→ page 141).

If you set the speed, the assistance graphic briefly appears in the instrument cluster display.

Displays on the speedometer

Vehicles with steering-wheel buttons:

When Active Distance Assist DISTRONIC is activated, one or two indicator segments light up in the stored speed range of the speedometer.

If Active Distance Assist DISTRONIC detects a vehicle in front, the indicator segments, located between the speed of the vehicle in front and the stored speed, light up.

Information on Hill Start Assist

Hill Start Assist holds the vehicle for a short time when pulling away on a hill under the following conditions:

- **Vehicles with automatic transmission:** the transmission is in position **D** or **R**.
- The parking brake has been released.

This gives you enough time to move your foot from the brake pedal to the accelerator pedal and depress it before the vehicle begins to roll.

⚠ WARNING Risk of accident and injury due to the vehicle rolling away

After a short time, Hill Start Assist no longer holds the vehicle.

- ▶ Swiftly move your foot from the brake pedal to the accelerator pedal. Do not leave the vehicle when it is being held by Hill Start Assist.

HOLD function

HOLD function

The HOLD function holds the vehicle at a standstill without requiring you to depress the brake pedal, e.g. when pulling away on steep slopes or when waiting in traffic. When you depress the accelerator pedal to pull away, the braking effect is canceled and the HOLD function is deactivated.

The HOLD function is only an aid. The responsibility for the vehicle safely standing still remains with the driver.

System limits

The HOLD function is only intended to provide assistance when driving and is not a sufficient means of safeguarding the vehicle against rolling away when stationary.

- The incline cannot be greater than 30%.

Activating or deactivating the HOLD function

Requirements:

- The vehicle is stationary and has been started.
- All the doors and the tailgate/rear-end doors are closed and the seatbelt is fastened.

- The parking brake has been released.
- The selector lever is in the **D**, **R** or **N** position.
- Active Distance Assist DISTRONIC is deactivated.

Activating the HOLD function

⚠ WARNING Risk of an accident due to the HOLD function being active when you leave the vehicle

If the vehicle is only braked with the HOLD function it could, in the following situations, roll away:

- If there is a malfunction in the system or in the power supply.
 - If the HOLD function is deactivated by depressing the accelerator pedal or brake pedal, e.g. by a vehicle occupant.
- ▶ Always secure the vehicle against rolling away before you leave it.

▶ Depress the brake pedal until the **HOLD** display appears in the instrument cluster display. The HOLD function is activated. You can release the brake pedal.

ⓘ If depressing the brake pedal the first time does not activate the HOLD function, wait briefly and then try again.

Deactivating the HOLD function

▶ Depress the accelerator pedal to pull away.
or

▶ Depress the brake pedal until the **HOLD** display in the instrument cluster disappears from the driver's display.

The HOLD function is deactivated in the following situations:

- Active Distance Assist DISTRONIC is activated.
- The transmission is shifted to position **P**.

In the following situations, the vehicle is held by transmission position **P**:

- The driver's side seat belt is not fastened, or a door or the tailgate/rear-end door is open.
- The vehicle is switched off.

Information on the reverse warning device

⚠ WARNING Risk of accidents due to persons or objects in the area in which you are maneuvering

Other road users may not hear or may ignore the warning tone of the backing up warning device. There is a risk of an accident.

- ▶ Make sure that there are no persons or objects in the maneuvering area during maneuvering.
- ▶ If necessary, a second person must assist with maneuvering.

The reverse warning device is a system designed to assist you in ensuring the safety of other road users. The reverse warning device cannot guarantee that no persons or objects are situated behind the vehicle.

A warning tone sounds to alert other road users when the reverse gear is engaged. If reverse gear is engaged twice in quick succession, the volume of the warning tone is lowered, for example, for night-time operation. The warning tone sounds at a normal volume by default. The volume of the warning tone has to be lowered again each time you engage reverse gear, if necessary.

When using the reverse warning device described here, observe the legal requirements for the country you are currently in.

PARKTRONIC

Function of PARKTRONIC

PARKTRONIC is an electronic parking assistance system with ultrasonic sensors. The system monitors the area around your vehicle using sensors on the front bumper and on the rear bumper. PARKTRONIC indicates visually and audibly the distance between your vehicle and an object.

The warning ranges in front of and behind the vehicle are indicated by different warning tones.

PARKTRONIC is only an aid. It is not a substitute for you paying attention to the surroundings. You are always responsible for safe maneuvering, parking and exiting a parking space. Make sure that there are no persons, animals or objects etc. in the maneuvering area while maneuvering and parking or exiting parking spaces.

Requirements for automatic activation:

- The vehicle is switched on.
- The parking brake has been released.

The selected transmission position determines whether the front and/or rear area is monitored.

Front area only:

- Transmission position **D**

Front and rear area:

- Transmission position **R**
- Transmission position **N**

Regardless of the transmission position, PARKTRONIC automatically monitors the area behind the vehicle if the vehicle begins to roll backwards, e.g. after stopping on an uphill gradient.

PARKTRONIC is deactivated at speeds above 11 mph (18 km/h). PARKTRONIC is reactivated at speeds below 10 mph (16 km/h).

If your vehicle is equipped with the correct electrical wiring for trailer operation, PARKTRONIC detects a coupled-up trailer. PARKTRONIC is deactivated for the rear area when you establish an electrical connection between your vehicle and a trailer. If you use an adapter for the socket, unplug it from the socket after uncoupling the trailer. Otherwise, PARKTRONIC remains deactivated for the rear area.

Remove a detachable trailer coupling if it is no longer required. PARKTRONIC measures the minimum detection range to an obstacle from the bumper, not the ball neck.

Warning displays

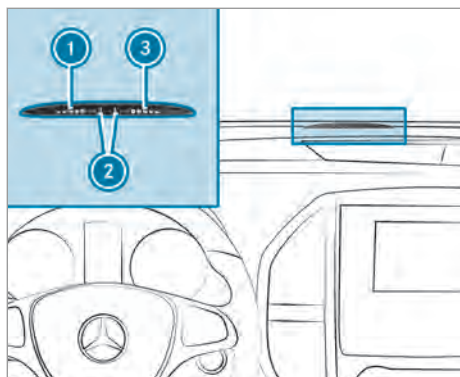

Front area warning display on the center of the cockpit

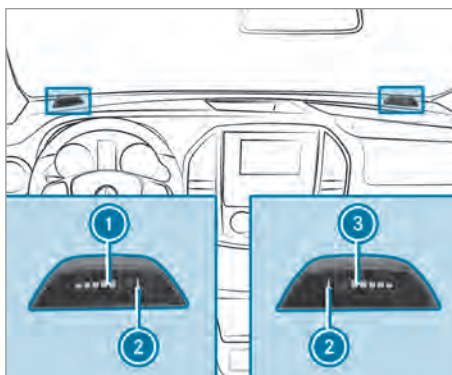

Rear area warning display on the cockpit (example: Cargo Van)

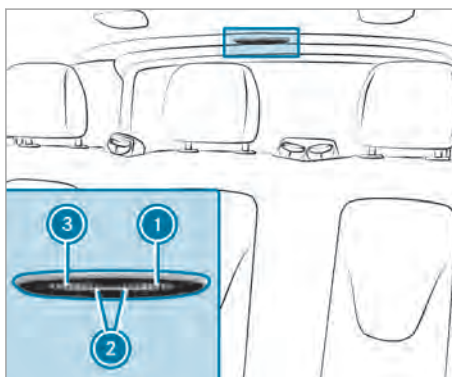

Rear area warning display in the rear at the center of the headliner

- ① Warning segments for the left side of the vehicle
- ② Measurement operational readiness indicator
- ③ Warning segments for the right side of the vehicle

At least one segment will light up as the vehicle approaches an obstacle, depending on the vehicle's distance from the obstacle.

In addition, warning tones are emitted. When the distance to the obstacle is sufficient, you will hear an intermittent warning tone. The shorter the distance to the obstacle, the shorter the frequency of the intermittent warning tones becomes. When the minimum distance is reached, you hear a continuous warning tone.

The warning display for each side of the vehicle is divided into five yellow and two red segments.

PARKTRONIC is active if measurement operational readiness indicator ② lights up.

System limits

PARKTRONIC may not take the following obstacles into account:

- Obstacles below the detection range, e.g. persons, animals or objects
- Obstacles above the detection range, e.g. overhanging loads, overhangs or loading ramps of trucks

The sensors must be free of dirt, ice and slush. They may otherwise not function or their function may be impaired. Clean the sensors regularly, taking care not to scratch or damage them (→ page 182).

Problems with PARKTRONIC

There is a malfunction if only the red segments of the warning display light up. In addition, a warning tone sounds for approximately two seconds. If problems persist, have PARKTRONIC checked at a qualified specialist workshop.

If the warning indicators are displaying implausible distances, it may be due to the following causes:

- **The sensors are dirty:** clean the sensors. Observe the notes on care of vehicle parts (→ page 182).
- **License plate or other detachable parts in the vicinity of the sensors are not correctly fastened:** check the license plate or the detachable parts for correct installation.
- **Interference by another source of radio or ultrasound waves:** check the function of PARKTRONIC at another location.

Deactivating/activating PARKTRONIC

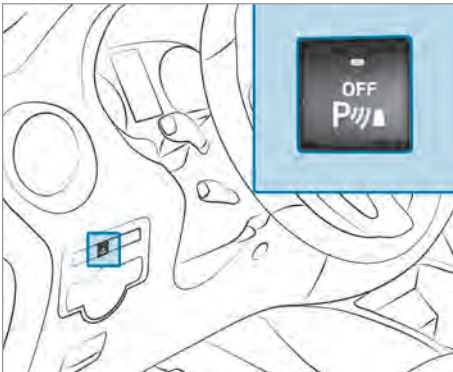

▶ Press the  button.

If PARKTRONIC is deactivated, the indicator lamp of the  button lights up.

Rear view camera

Function of the rear view camera

In vehicles with rear-end doors, the rear view camera is in the upper part of the license plate holder.

The rear view camera is next to the tailgate handle in vehicles with a tailgate.

When you engage reverse gear, the image from the rear view camera is shown automatically in the media display. Dynamic guide lines show the path the vehicle will take for the current steering movement. This helps you to orient yourself and to avoid obstacles when backing up.

The rear view camera is only an aid. It is not a substitute for you paying attention to the surroundings. You are always responsible for safe maneuvering and parking. Make sure that there are no persons, animals or objects etc. in the maneuvering area while maneuvering and parking in parking spaces.

You can use the softkeys located below or to the side to choose between the following views:

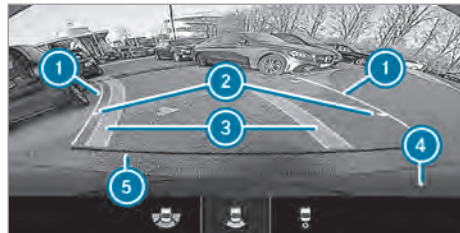

Normal view

- ① Yellow guide line, vehicle width (driven surface) depending on the current steering angle (dynamic)
- ② Yellow guide line at a distance of approximately 3.3 ft (1.0 m) from the rear area
- ③ Yellow path marking the course the tires will take at the current steering position (dynamic)
- ④ Bumper
- ⑤ Red guide line at a distance of approximately 1.0 ft (0.3 m) from the rear area

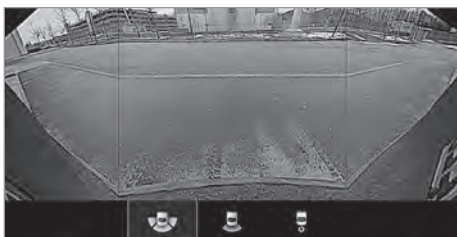

Wide-angle view

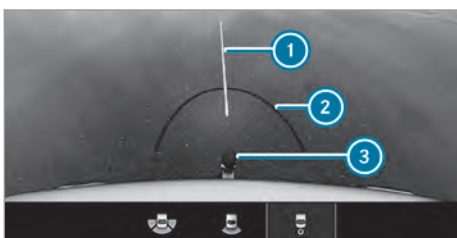

Trailer view (vehicles with a trailer hitch)

- ① Yellow guide line, locating aid
- ② Red guide line at a distance of approximately 1.0 ft (0.3 m) to the ball head of the trailer hitch
- ③ Ball head of the trailer hitch

Observe the notes on cleaning and care of the rear view camera.

The rear view camera may show a distorted view of obstacles, show them incorrectly or not at all. The rear view camera cannot show all objects which are very near to or under the rear bumper. It will not warn you of a collision, people or objects.

The area behind the vehicle is displayed as a mirror image, as in the inside rearview mirror.

When you shift out of reverse gear, the dynamic guide lines are faded out. If, after shifting out of reverse gear, you drive faster than 10 mph (16 km/h), the rear view camera is deactivated.

System limits

The rear view camera will not function or will only partially function in the following situations:

- If the tailgate/rear-end door is open
- If there is heavy rain, snow or fog
- If the ambient light conditions are poor, e.g. at night

- If the camera lens is covered, dirty or fogged up
- If cameras, or vehicle components in which the cameras are installed, are damaged. Have the cameras, their positions and their setting checked at a qualified specialist workshop.

- ① The media display contrast may be impaired due to direct sunlight or other light sources. In this case, pay particular attention.
- ① Have the media display repaired or replaced if, for example, pixel errors considerably restrict its use.
- ① Objects that are not at ground level appear further away than they actually are. This includes, for example:
 - The bumper of a vehicle parked behind
 - The drawbar of a trailer
 - The ball neck of a trailer hitch
 - The tail-end of a truck
 - Slanted posts

Only use the guide lines of the camera image for orientation. Do not travel further than the lowest horizontal guide line when approaching objects. You may otherwise damage your vehicle and/or the object.

Active Parking Assist

Function of Active Parking Assist

Active Parking Assist is an electronic parking assistance system which automatically locates and measures parking spaces on both sides of the vehicle when you are driving forwards up to a speed of approximately 22 mph (35 km/h).

If all requirements are met, the  display appears in the instrument cluster display. The system then independently locates and measures parallel and perpendicular parking spaces on both sides of the vehicle.

When Active Parking Assist has detected parking spaces, the  display appears in the instrument cluster display. The arrows show on which side of the road free parking spaces are located.

Active Parking Assist displays parking spaces on the co-driver side as standard. The parking spaces on the driver's side are only displayed if you operate the turn signal on the driver's side. When parking on the driver's side, you must operate the turn signal until you have started active parking assistance by pressing the  steering-wheel button.

Active Parking Assist can assist you with an active steering intervention and brake application during parking and exiting the parking space.

Active Parking Assist is only an aid. It is not a substitute for your attention to the surroundings. You are always responsible for safe maneuvering, parking and exiting a parking space. Make sure that no persons, animals or objects etc. are in the path of your vehicle.

Active Parking Assist is canceled in the following cases, among others:

- Parking Assist PARKTRONIC is deactivated.
- You steer.
- You apply the parking brake.
- Parking using Active Parking Assist is no longer possible.
- You exceed a speed of 6 mph (10 km/h).
- A wheel spins and ESP® intervenes or fails.
- You engage transmission position **P**.
- You open a door or the tailgate/rear-end door, or unfasten your seat belt, on vehicles with an automatic transmission.

PARKTRONIC is deactivated for the rear area when you have a trailer coupled up and establish an electrical connection between your vehicle and the trailer. Active Parking Assist is then not available.

System limits

Objects located above or below the detection range of Active Parking Assist are not detected when the parking space is being measured. These are also not taken into account when the parking maneuver is calculated, e.g. overhanging loads, overhangs or loading ramps of trucks, or the boundaries of parking spaces. In some circumstances, Active Parking Assist may therefore guide you into the parking space prematurely.

⚠ WARNING Risk of accident due to objects located above or below the detection range of Active Parking Assist

If there are objects above or below the detection range, the following situations may arise:

- Active Parking Assist may steer too early.
- The vehicle may not stop in front of these objects.

There is a danger of collision!

- ▶ In these situations, do not use Active Parking Assist.

Snowfall or heavy rain may lead to a parking space being measured inaccurately. Parking spaces that are partially occupied by trailer drawbars might not be identified as such or be measured incorrectly. Only use Active Parking Assist on level, high-grip ground.

Do not use Active Parking Assist in the following situations, among others:

- In extreme weather conditions such as ice, packed snow or in heavy rain
- On curves
- For parking spaces which are not on the same level as the road, e.g. not on the pavement
- When transporting a load that protrudes beyond the vehicle
- When snow chains are installed

Active Parking Assist may also display parking spaces that are not suitable for parking, for example:

- Parking spaces where parking is prohibited
- Parking spaces on unsuitable surfaces

Active Parking Assist will not assist you with parking spaces perpendicular to the direction of travel in the following situations:

- If two parking spaces are located immediately next to each other
- If the parking space is immediately next to a low obstacle such as a curb
- If you are parking forwards

Active Parking Assist will not assist you with parking spaces parallel or perpendicular to the direction of travel in the following situations:

- If the parking space is on a curb
- If the system deems the parking space to be blocked, such as by foliage or grass paving blocks
- If the area is too small for the vehicle to maneuver into
- If the parking space is bordered by an obstacle, e.g. a tree, a post or a trailer

Parking using Active Parking Assist

⚠ WARNING Risk of accident due to insufficiently securing the vehicle against rolling away when exiting the vehicle

If you leave the driver's seat when the vehicle is being braked by Active Parking Assist only, it could roll away in the following situations:

- if there is a malfunction in the system or in the power supply.
- if the electrical system in the engine compartment, the battery or the fuses are tampered with.
- if the battery is disconnected.
- if the vehicle is accelerated, e.g. by a vehicle occupant.

▶ Before leaving the driver's seat, always secure the vehicle against rolling away.

▶ Bring the vehicle safely to a stop when the parking symbol with an arrow shows the desired parking space.

⚠ WARNING Risk of accident due to vehicle swinging out while parking or pulling out of a parking space

While parking or pulling out of a parking space, the vehicle swings out and can drive onto areas of the oncoming lane.

This could cause you to collide with objects or other road users.

▶ Pay attention to objects and other road users.

▶ Where necessary, stop the vehicle or cancel the parking procedure with Parking Pilot.

▶ Shift the transmission to position **R**. The instrument cluster display shows the **Start Parking Assist? Yes: OK No:**  message and the location of the parking space.

▶ **To cancel the process:** press the  steering-wheel button or drive off.

or

▶ **To park using active parking assistance:** press the **OK** steering-wheel button. The **Parking Assist Active Accelerate and Brake Observe Surroundings** message is shown in the instrument cluster display.

▶ Release the steering wheel.

▶ Reverse the vehicle, being ready to brake at all times. Reverse slowly, and do not drive faster than 6 mph (10 km/h). Parking assistance is otherwise canceled and Active Parking Assist is stopped.

When the vehicle approaches the rear border of the parking space, Active Parking Assist can brake it to a standstill.

▶ Stop at the rear border of the parking space. Stop when PARKTRONIC sounds the continuous warning tone, if not before.

Maneuvering may be required in tight parking spaces. Observe the messages in the instrument cluster display.

On completion of the parking procedure, the **Active Parking Assist Finished** message appears and an acoustic signal sounds. Active Parking Assist no longer supports you with steering interventions and brake applications.

Exiting a parking space with Active Parking Assist

Requirements:

- The vehicle has been parked parallel to the direction of travel using Active Parking Assist.
- The border of the parking space must be high enough at the front and the rear; a curb, for instance, is not sufficient.
- The border of the parking space must not be too wide. Your vehicle can be maneuvered into a position at a maximum angle of 45° to the starting position in the parking space.
- A maneuvering distance of at least 40 in (1 m) must be available.

Please note that you are responsible for the vehicle and surroundings during the entire parking procedure.

▶ Start the vehicle.



▶ Switch on the turn signal on the side you intend to exit the parking space.

⚠ WARNING Risk of accident due to vehicle swinging out while parking or pulling out of a parking space

While parking or exiting a parking space, the vehicle swings out and can drive onto areas of the oncoming lane.

This could cause you to collide with objects or other road users.

- ▶ Pay attention to objects and other road users.
- ▶ Where necessary, stop the vehicle or cancel the parking procedure with Active Parking Assist.

- ▶ Shift the transmission to position **D** or **R**. The instrument cluster display shows the **Start Parking Assist? Yes: OK No:**  message and the location of the parking space.
- ▶ **To cancel the process:** press the  steering-wheel button or drive off.

or

- ▶ **To exit the parking space using active parking assistance:** press the **OK** steering-wheel button. The **Parking Assist Active Accelerate and Brake Observe Surroundings** message is shown in the instrument cluster display.
- ▶ Release the steering wheel.
- ▶ Pull away and be ready to brake at all times. Reverse slowly, and do not drive faster than 6 mph (10 km/h). Parking assistance is otherwise canceled and Active Parking Assist is stopped. When the vehicle approaches the rear border of the parking space, Active Parking Assist can brake it to a standstill.

Maneuvering may be required in tight parking spaces. Observe the messages in the instrument cluster display.

On completion of the parking procedure, the **Active Parking Assist Finished** message appears and an acoustic signal sounds. Active Parking Assist no longer supports you with steering interventions and brake applications.

The parking assistance function of Active Parking Assist is stopped. You will then have to steer and merge into traffic on your own. PARKTRONIC is still available.

ATTENTION ASSIST

Function of ATTENTION ASSIST

ATTENTION ASSIST can assist you on long, monotonous journeys, e.g. on highways and trunk roads. If ATTENTION ASSIST detects indicators of fatigue or increased lapses in concentration on the part of the driver, it suggests taking a break.

ATTENTION ASSIST is only an aid. It cannot always detect drowsiness or increased lapses in concen-

tration in good time. The system is not a substitute for a well-rested and attentive driver. On long journeys, take regular and timely breaks that allow you to rest properly.

If fatigue or increased lapses in concentration are detected, the **ATTENTION ASSIST: Take a Break!** or **Attent. Asst Take Break!** warning appears in the instrument cluster.

You can acknowledge the message and take a break if necessary. If you do not take a break and ATTENTION ASSIST continues to detect increasing lapses in concentration, you will be warned again after a minimum of 15 minutes.

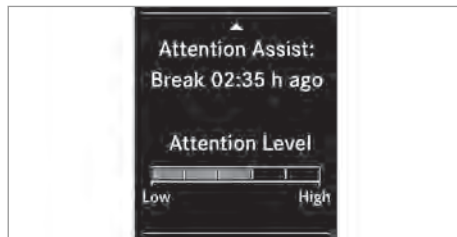

For vehicles with steering wheel buttons you can have the current ATTENTION ASSIST (Attention Level) assessment displayed.

The following information is displayed:

- The journey length since the last break
- The attention level determined by ATTENTION ASSIST:
 - The fuller the bar is, the higher the detected attention level is
 - The bar empties as attentiveness decreases

If ATTENTION ASSIST cannot calculate the attention level and cannot issue a warning, the **System Suspended** message appears.

The bar display is then dimmed. This is the case, for example, if you are predominantly driving at a speed below 40 mph (60 km/h) or above 125 mph (200 km/h).

System limits

ATTENTION ASSIST is active in the 40 mph (60 km/h) to 125 mph (200 km/h) speed range.

The functionality of ATTENTION ASSIST is restricted, and warnings may be delayed or not occur at all, in the following situations:

- The journey lasts less than approximately 30 minutes
- The road condition is poor (uneven road surface or potholes)
- The vehicle is subjected to a strong crosswind
- You have a sporty driving style (high cornering speeds or high rates of acceleration)
- The time is set incorrectly
- You change lanes and vary your speed frequently in active driving situations





The ATTENTION ASSIST drowsiness or alertness assessment is deleted and restarted when continuing the journey in the following situations:

- You switch off the vehicle
- You unfasten your seat belt and open the driver's door (e.g. to change drivers or take a break)

Deactivating or activating ATTENTION ASSIST (vehicles without steering wheel buttons)

On-board computer:



→  **Settings** → **Attention Assist**

- ▶ **To deactivate/activate:** press the  or  button and confirm with the  button. When ATTENTION ASSIST is active, the  indicator lamp lights up in the instrument cluster.

Deactivating or activating ATTENTION ASSIST (vehicles with steering wheel buttons)

On-board computer:

→ **DriveAssist** → **ATTENTION ASSIST**

- ▶ **To change the setting:** press the  button and select the setting. If ATTENTION ASSIST is activated, the  symbol is shown in the status area of the instrument cluster display.

You can choose between the following settings:

- **Off**
- **Standard:** normal system sensitivity.
- **Sensitive:** higher system sensitivity. The driver is warned earlier and the attention level detected by the system is adapted accordingly.

Blind Spot Assist

Function of Blind Spot Assist

Blind Spot Assist uses two lateral, rear-facing radar sensors to monitor the area directly next to and on the side behind the vehicle.

USA only:

This device has been approved by the FCC as a "Vehicular Radar System". The radar sensor is intended for use in an automotive radar system only. Removal, tampering, or altering of the device will void any warranties, and is not permitted by the FCC. Do not tamper with, alter, or use in any non-approved way. Any unauthorized modification to this device could void the user's authority to operate the equipment.

WARNING Risk of accident despite Blind Spot Assist

Blind Spot Assist does not react to either stationary objects or vehicles approaching and overtaking you at a greatly different speed.

Blind Spot Assist cannot warn drivers in these situations.

- ▶ Always pay careful attention to the traffic situation and maintain a safe distance at the side of the vehicle.

Observe the notes on driving systems and your responsibility; you may otherwise fail to recognize dangers (→ page 108).

If a vehicle is detected above speeds of approximately 7.5 mph (12 km/h) and this vehicle subsequently enters the monitoring range directly next to your vehicle, the warning lamp in the outside mirror lights up red.

If a vehicle is detected close to your vehicle in the lateral monitoring range and you switch on the turn signal indicator in the corresponding direction, a warning tone sounds. The red warning lamp in the outside mirror flashes. If the turn signal indicator remains switched on, all other detected vehicles are indicated only by the flashing of the red warning lamp.

When you overtake a vehicle, the warning only occurs if the difference in speed is less than approximately 12 mph (20 km/h).

System limits

Blind Spot Assist may be limited in the following situations:

- If there is dirt on the sensors or the sensors are obscured
- If there is poor visibility, e.g. due to fog, heavy rain, snow or spray
- If narrow vehicles are within the monitoring range, e.g. bicycles
- If the road has very wide or very narrow lanes
- If vehicles are not driving in the middle of their lane

Warnings may be issued in error when driving close to crash barriers or similar solid lane borders. Warnings may be interrupted when driving alongside long vehicles, for example trucks, for a prolonged time.

Blind Spot Assist is not operational when reverse gear is engaged.

If you couple up a trailer, make sure that you have correctly established the electrical connection. Blind Spot Assist is then deactivated and the **Blind Spot Assist Currently Unavailable See Operator's Manual** message appears in the instrument cluster display.

Activating/deactivating Blind Spot Assist

On-board computer:

 DriveAssist  Blind Spot Assist

 **To activate/deactivate:** press the  button.

-  Additionally, the status overview in the assistance menu also displays the status of Blind Spot Assist (→ page 141).

If you switch on the vehicle while Blind Spot Assist is activated, the warning lamps in the outside mirrors light up for approx. 1.5 seconds.

Rear Cross Traffic Alert

Function of Rear Cross Traffic Alert

-  The system is only available for vehicles with Blind Spot Assist.

The system uses the radar sensors in the bumper. This way the area adjacent to the vehicle is continually monitored. If the radar sensors are obscured by vehicles or other objects, detection is not possible.

-  Also read the notes on Blind Spot Assist (→ page 126).

The system can warn of crossing traffic when backing up out of a parking space. If the system detects a vehicle, the warning lamp in the outside mirror on the corresponding side lights up red. In a critical situation, an additional warning tone sounds.

The Rear Cross Traffic Alert function is active under the following conditions:

- Blind Spot Assist is activated.
- Reverse gear is engaged or the vehicle is backing up at walking pace.

The Rear Cross Traffic Alert function is unavailable when driving with a trailer.

Lane Keeping Assist

Function of Lane Keeping Assist

Lane Keeping Assist serves to protect you against unintentionally leaving your lane. You are also warned by a noticeable vibration in the steering wheel and by the status symbol flashing in the instrument cluster. Lane Keeping Assist is only an aid and is not intended to keep the vehicle in the lane without the driver's cooperation.

Observe the notes on driving systems and your responsibility; you may otherwise fail to recognize dangers (→ page 108).

The function is available in the speed range between 40 mph (60 km/h) and 125 mph (200 km/h).

The warning is issued when the following conditions are met at the same time:

- If Lane Keeping Assist detects lane markings.
- If a front wheel drives over lane markings.

To ensure that you are warned only when necessary and in good time if you cross the lane marking, the system detects certain conditions and warns you accordingly.

The warning vibration occurs earlier under the following conditions:

- You approach the outer lane marking on a curve.
- The road has very wide lanes, e.g. a freeway.
- The system detects solid lane markings.

The warning vibration occurs later under the following conditions:

- You are driving on a road with narrow lanes.
- You cut the corner on a curve.



System limits

The system may be impaired or may not function in the following situations:

- If there is poor visibility, e.g. due to insufficient illumination of the road, if there are highly variable shade conditions or in rain, snow, fog or spray.
- Glare from oncoming traffic, direct sunlight or reflections.
- There is dirt on the windshield in the vicinity of the multifunction camera or the camera is fogged up, damaged or obscured.
- No or several unclear lane markings are present for one lane, e.g. in a construction area.
- If the lane markings are worn away, dark or covered up.
- If the distance to the vehicle in front is too short and thus the lane markings cannot be detected.
- The lane markings change quickly, e.g. lanes branch off, cross one another or merge.
- The roadway is very narrow and winding.

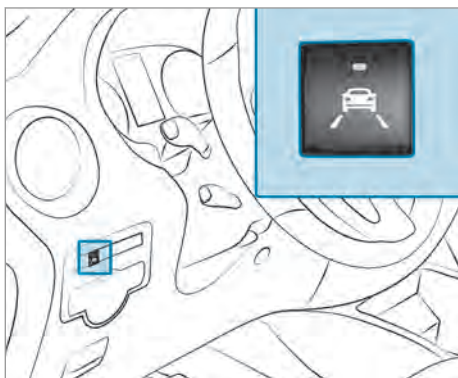
Activating/deactivating Lane Keeping Assist



- ▶ Press the  button. If the indicator lamp in the button lights up and the instrument cluster display shows the  symbol in the status area, Lane Keeping Assist is activated but not ready for use. If you are driving with Lane Keeping Assist activated at speeds above 40 mph (60 km/h) and lane markings are detected, the instrument cluster display shows the  symbol highlighted in the status area. Lane Keeping Assist is then ready for use.

- ⓘ The status overview in the assistance menu also displays the status of Lane Keeping Assist (→ page 141).

Setting the sensitivity of Lane Keeping Assist

On-board computer:

↳ DriveAssist ▶ Lane Keeping Assist

- ▶ Select the **Standard** or **Adaptive** setting.

In the **Standard** setting, no warning vibration occurs in the following situations:

- You operate the turn signal in the corresponding direction. In this event, the warnings are suppressed for a certain period of time.
- A driving safety system intervenes or regulates, such as ABS, BAS or ESP®.

In the **Adaptive** setting, there will also be no warning vibration in the following situations:

- You accelerate hard, e.g. kickdown.
- You brake hard.
- You steer actively, e.g. swerve to avoid an obstacle or change lane quickly.
- You cut the corner on a sharp curve.

Trailer operation

Notes on trailer operation

- ⚠ **WARNING** Risk of accident and injury if the tongue weight is exceeded

The carrier system may detach from the vehicle, thereby endangering other road users.

- ▶ Always comply with the permissible tongue weight when using a carrier.

- ⚠ **WARNING** Risk of accident due to unsuitable ball neck

If you install an unsuitable ball neck, the trailer hitch and the rear axle may be overloaded.

This can significantly impair the driving characteristics and the trailer may become loose. There is a risk of fatal injury.

- ▶ Only install a ball neck that complies with the permissible dimensions and is designed for the requirements of trailer operation.
- ▶ Do not modify the ball neck or the trailer hitch.

You can find specifications regarding the ball neck on the trailer's identification plate. You can find specifications regarding the trailer on the towing vehicle's identification plate and in the Technical Data (→ page 244).

⚠ WARNING Risk of accident and injury due to incorrectly installed ball neck

If the ball neck is not correctly installed and secured, it may become loose during a journey and endanger other road users. There is a risk of fatal injuries.

- ▶ Install and secure the ball neck as described in the ball neck manufacturer's installation instructions.
- ▶ If a ball neck is installed, ensure sure that it is properly secured before every journey.

⚠ WARNING Risk of accident due to a ball neck that is not correctly installed or secured

If the ball neck is not correctly installed and secured, the trailer may come loose.

- ▶ Install and secure the ball neck as described in the ball neck manufacturer's installation instructions.
- ▶ If a ball neck is installed, ensure sure that it is properly secured before every journey.

! NOTE Increased risk of damage to property due to attached ball neck

- ▶ When the trailer is not coupled or the bicycle rack is attached, fold in the ball neck.

! NOTE The operating permit may be invalidated due to the illegal installation of trailer hitches

The installation - including retrofitting - of a non-folding or non-removable trailer hitch that even partially conceals the license plate or the lighting system is prohibited.

- ▶ Observe the applicable legal regulations for the installation of trailer hitches.

You can attach carrier systems such as a bicycle rack or load-bearing implement to the ball neck. When carrier systems are used on the ball neck, the maximum load capacity is 165 lbs (75 kg).

If the trailer coupling is detachable, it is essential to comply with the operating instructions of the trailer coupling manufacturer.

Be sure to comply with the operating instructions of the manufacturer of the trailer coupling and the ball neck.

Place your vehicle/trailer combination on surfaces that are as even as possible and secure it against rolling away (→ page 106). Couple and uncouple the trailer carefully.

Note the following regarding the tongue weight:

- Make full use of the maximum tongue weight, where possible.
- Never fall below a legally prescribed minimum tongue weight; the tongue weight must always be positive.
- Do not exceed or fall below the permissible tongue weights - observe this when loading and unloading the trailer.

Do not exceed the following values:

- Permissible braked or unbraked towing capacity
The maximum permissible towing capacity for unbraked trailers is 1,653 lbs (750 kg).
- Permissible rear axle load for the towing vehicle
- Permissible gross weight of the towing vehicle
- Permissible gross weight of the trailer
- Permissible gross weight of the combination
- Maximum permissible speed of the trailer

The relevant permitted values, which must not be exceeded, are given in the following locations:

- In your vehicle documents
- On the identification plate for the trailer hitch
- On the trailer's identification plate
- On the vehicle identification plate

If there are discrepancies between the values, the lowest one shall apply.

Before driving off, ensure the following:

- The tire pressure on the rear axle of the towing vehicle has been set for the maximum load.
- The headlamps have been adjusted correctly.

Values approved by the manufacturer are given on the identification plates and in the section for the towing vehicle (→ page 205).

If you require explanations regarding the information in the Operator's Manual, contact a Mercedes-Benz Commercial Van Center.

Comply with the maximum permissible speed of 50 mph (80 km/h) or 62 mph (100 km/h), even in countries in which higher speeds are permitted for vehicle/trailer combinations.

Attach only an approved trailer hitch to your vehicle. Use only a ball neck that has been approved for your vehicle. Further information about availability and installation – including that of the trailer electrical system – is available from a qualified specialist workshop.

i Your vehicle's bumpers are not suitable for installing detachable trailer hitches.

Do not attach any rented trailer hitches or any other detachable trailer hitches to the bumpers.

i During trailer operation, remember that PARKTRONIC is available only to a limited extent, if at all.

i The height of the ball head will change depending on the vehicle's load. In this case, use a trailer with a height-adjustable drawbar.

Coupling/uncoupling a trailer

Requirements:

- The ball neck must be engaged in a securely locked position.

Trailers with 7-pin plugs can be connected to the vehicle using the following adapters:

- Adapter plug
- Adapter cable

Coupling a trailer

! **NOTE** Damage to the starter battery due to full discharge

Charging the trailer battery using the power supply of the trailer can damage the starter battery.

- ▶ Do not use the vehicle's power supply to charge the trailer battery.

- ▶ **Vehicles with automatic transmission:** shift the transmission to position **P**.
- ▶ Apply the vehicle's parking brake.
- ▶ Close all the doors.
- ▶ Position the trailer on a level surface behind the vehicle.

i The height of the ball head will change depending on the vehicle's load. In this case, use a trailer with a height-adjustable drawbar.

- ▶ Couple up the trailer.



- ▶ **To install an adapter:** open the cover of the socket.

- ▶ Insert plug **2** with tab **1** in the socket's groove **3**.

- ▶ Turn plug **2** clockwise as far as it will go.

- ▶ Let the cover engage.

- ▶ Attach the cable to the trailer with cable ties (only in the case of adapter cables).

- ▶ Make sure that the cable is always slack for ease of movement during cornering.

- ▶ Establish all electrical and other connections to the trailer. In the process, attach the trailer's breakaway cable to the eyelet on the ball neck.

- ▶ Check that the trailer's lighting system works properly.

A trailer is detected only if the electrical connection is established correctly and the lighting system is in working order. The function of other systems also depends on this, e.g. ESP®, PARKTRONIC, Active Parking Assist, Blind Spot Assist or Lane Keeping Assist.

Even if the trailer is connected correctly, a message may nevertheless appear on the instrument cluster display in the following cases:

- LEDs have been installed in the trailer's lighting system.
- The current has fallen below the trailer lighting system's minimum current (50 mA)

i You can connect accessories up to a maximum of 240 W to the permanent power supply.

- ▶ Remove objects or devices that prevent the trailer from rolling, e.g. chocks.

- ▶ Release the trailer's parking brake.

Observe the maximum permissible trailer dimensions (width and length).

Most states and all Canadian provinces prescribe:

- Safety chains between the towing vehicle and the trailer. The chains should be routed in a criss-cross pattern under the drawbar. They must be connected to the trailer hitch and not to the bumper or to the vehicle's axle.

Leave sufficient slack in the chains. This also allows for sharp cornering.

- A separate brake system for specific trailers.
- Safety shutoff for braked trailers. Determine the specific requirements according to the relevant laws.

If the trailer becomes detached from the towing vehicle, the safety shutoff will activate the trailer brakes.

Uncoupling a trailer

⚠ WARNING Risk of being crushed and becoming trapped when uncoupling a trailer

When uncoupling a trailer with an engaged inertia-activated brake, your hand may become trapped between the vehicle and the trailer drawbar.

▶ Do not uncouple trailers with an engaged overrun brake.

! NOTE Damage during uncoupling with an engaged overrun brake

The vehicle may be damaged if you uncouple with an engaged overrun brake.

▶ Do not uncouple trailers with an engaged overrun brake.

- ▶ Shift the transmission to position **P**.
- ▶ Apply the vehicle's parking brake.
- ▶ Close all the doors.
- ▶ Apply the trailer's parking brake.
- ▶ Further secure the trailer against rolling away with a wheel chock or similar object.
- ▶ Remove the trailer cables and safety chains.
- ▶ Uncouple the trailer.

Information about towing a trailer

Operating a trailer is subject to many statutory regulations such as speed restrictions.

Many states also require an auxiliary separate functional braking system when towing a weight that exceeds a certain limit. For your safety, it is recommended to use a separate functional braking system on any towed vehicle.

Make sure that your trailer combination meets local regulations. This not only applies to your place of residence, but also to your destination. Information on this can be obtained from the police and local authorities.

Comply with the following when driving with a trailer:

- Practice cornering, stopping and backing up in a traffic-free location. In this way, you will gain driving experience and become accustomed to the new handling characteristics.
- Before driving, check the following:
 - that the trailer tow hitch and ball coupling are secure
 - that the safety switch for braked trailers is functioning correctly
 - that the safety chains are secure and undamaged
 - that the electrical connections are secure
 - that the lights are functioning correctly
 - the wheels for damage and correct tire pressure (→ page 202)
- Adjust the outside mirrors so that you have a clear view of the rear section of the trailer.
- If the trailer is equipped with an individual braking system, check before each journey whether the brakes are functioning correctly.
- If the trailer has electronically controlled brakes, pull away carefully with the vehicle/trailer combination. Brake manually using the brake controller and check whether the brakes are functioning correctly.
- Secure the load on the trailer in line with the requirements and rules for load-securing methods.
- When driving with a trailer, check at regular intervals that the load is secure and that the lights and brakes are functioning correctly.
- Bear in mind that the handling characteristics are more unstable when towing a trailer than when driving without a trailer. Avoid sudden steering movements.
- The vehicle/trailer combination is heavier, accelerates more slowly, has a reduced climbing ability and an increased braking distance. It

is more susceptible to side winds and requires careful steering.

- If possible, do not brake suddenly, but rather moderately at first so that the trailer can activate its brakes. Then increase the pressure on the brake pedal.
- If the automatic transmission shifts between gears on uphill or downhill gradients, restrict the shift range. Select shift range 4, 3, 2 or 1. A lower gear and reduced speed decrease the risk of engine damage.
- When driving on a downhill gradient, shift to a lower gear to use the engine's braking effect. Avoid constant braking, as this could cause the vehicle brakes and possibly also the trailer brakes to overheat.
- If the coolant temperature increases significantly when the air-conditioning system is switched on, switch the air-conditioning system off.
Coolant heat can also be dissipated by switching the airflow and the temperature of the heater or air conditioning to the maximum level. Open the windows if necessary.
- When overtaking, pay particular attention to the increased overtaking distance of your vehicle/trailer combination.
Due to the length of your vehicle/trailer combination you will require a longer stretch of road before switching back to the original lane.

Permissible trailer loads and tongue weights

Weight information

⚠ WARNING Risk of accident due to an unbraked trailer with an excessive gross weight

If you pull an unbraked trailer with a gross trailer weight (GTW) of more than 1,653 lbs (750 kg), the vehicle's brake system may overheat.

This increases the braking distance and may even cause the brake system to fail.

- ▶ Always use a trailer with a separate braking system if you are pulling a gross trailer weight (GTW) of more than 1,653 lbs (750 kg).

! **NOTE** Damage to the drive train, transmission or trailer tow hitch due to excess gross combination weight

The permissible gross combination weight is exceeded.

The drive train, the transmission or the trailer tow hitch may be damaged.

- ▶ Comply with the permissible gross combination weight.

For vehicles with a permissible gross weight of 6,614 lbs (3,000 kg), the permissible gross combination weight is less than the sum of the permissible gross vehicle weight and the permissible trailer load. If either the vehicle or the trailer is fully laden, the permitted gross vehicle weight or the permitted trailer load values are reduced accordingly. In this case, you may only partially load the trailer or the vehicle.

The gross trailer weight (GTW) is calculated by adding the weight of the trailer to the weight of its load and equipment. If the trailer is equipped with a separate braking system, the permissible gross trailer weight is 5,000 lbs (2,268 kg).

The maximum drawbar tongue weight on the ball head (TWR) is 500 lbs (227 kg). However, the actual tongue weight must not exceed the value given on the trailer hitch or trailer identification plates. Where the values differ, the lowest shall always apply.

The gross combined weight rating (GCWR) is calculated on the basis of the gross trailer weight plus the gross vehicle weight, including a driver's weight of approximately 150 lbs (68 kg). The maximum permissible gross combination weight is vehicle-specific and equipment-dependent. When driving with a trailer, you should not exceed the maximum permissible gross combination weight rating (GCWR).

The permissible values, which must not be exceeded, can be found in your vehicle documents and on the identification plates of the trailer hitch, the trailer and the vehicle. The values approved by the manufacturer can also be found in the "Technical data" section. Where the values differ, the lowest shall always apply.

Loading the trailer

Use a tongue weight that is as close as possible to the maximum permissible tongue weight. Do not undershoot the minimum permissible tongue weight. Otherwise, the trailer may become detached.

- Distribute the load over the vehicle and the trailer so as not to exceed either the maximum permissible values for the gross vehicle weight rating (GVWR) and gross trailer weight (GTW), the gross combination weight rating (GCWR), or the maximum permissible gross axle weight rating (GAWR) and tongue weight (TWR) of your vehicle.
- Add the rear axle load to the drawbar tongue weight (TWR) on the ball head. This will ensure that you do not exceed the permissible gross axle weight rating (GAWR).
- Add the vehicle load to the drawbar tongue weight (TWR) on the ball head. This will ensure that you do not exceed the permissible gross vehicle weight rating (GVWR).

Checking vehicle and trailer weight

- Make sure that the weights of the towing vehicle and the trailer comply with the maximum permissible values. Have the vehicle/trailer combination weighed on a calibrated weighing machine. The vehicle/trailer combination comprises the towing vehicle including driver, passengers and load as well as the laden trailer.
- Check the maximum permissible gross axle weight rating of the front and rear axles (GAWR), the gross trailer weight (GTW), the gross combination weight rating (GCWR) and the drawbar tongue weight (TWR).

trical system voltage is low. This could completely discharge your vehicle's starter battery.

Further information on the electrical equipment currently installed on your vehicle and on installing the trailer electrics can be obtained at a qualified specialist workshop.

Trailer power supply

Incorrect cabling of the connector plug may interfere with other electronic systems in the vehicle. Mercedes-Benz therefore recommends that you have the cabling of the connector plug carried out at a qualified specialist workshop.

You can connect accessories up to a maximum of 240 W to the permanent power supply. Do not charge a trailer battery using the power supply.

Your vehicle may be equipped with a range of electrical equipment for trailer operation. Depending on your trailer, you may need an adapter for the electrical connection between the trailer and your vehicle.

The trailer socket of your vehicle is equipped with a permanent power supply at the factory.

The permanent power supply is supplied via trailer socket pin 4.

Note that the trailer's permanent power supply is not switched off when the vehicle's on-board elec-

Overview of the instrument cluster



Instrument cluster (vehicles without steering-wheel buttons)

- ① Speedometer
- ② Display
- ③ Tachometer
- ④ Sets the instrument lighting, changes values or settings, scrolls through lists
- ⑤ Selects a submenu or resets values
- ⑥ Selects a menu or display

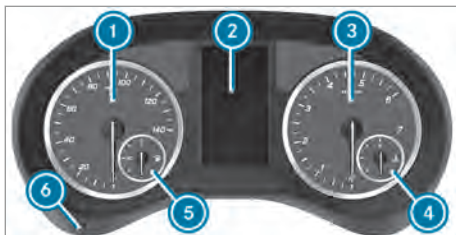

Instrument cluster (vehicles with steering-wheel buttons)

- ① Speedometer
- ② Display
- ③ Tachometer
- ④ Coolant temperature display
- ⑤ Fuel level
 - Fuel filler cap location : the fuel filler cap is on the left
- ⑥ Adjusts the instrument lighting

Speedometer

Vehicles with steering-wheel buttons:

In vehicles with Active Distance Assist DISTRONIC, there are illuminated segments on the speedometer dial.

These segments show you what speed range is available:

- Variable limiter activated (→ page 113)

The segments light up from the start of the scale to the selected limit speed.

- Active Distance Assist DISTRONIC switched on (→ page 114)

One or two segments light up in the saved speed range.

- Active Distance Assist DISTRONIC detects a vehicle in front.

The segments light up from the speed of the vehicle in front up to the saved speed.

You can show the speed as a digital speedometer on the display as well.

If you change your vehicle's wheel size, check its assignment to the wheel size group (→ page 214). If the assignment changes without recoding the control units in the vehicle, the speedometer will not display the speed accurately. The current vehicle speed may then be higher than the speed shown by the speedometer. Driving and driving safety systems may then be operationally impaired or may detect a malfunction and switch themselves off.

In some countries, an audible signal will sound and/or a message will appear on the display when the vehicle reaches the maximum speed permitted by law, e.g. at 75 mph (120 km/h).

Tachometer

! NOTE Engine damage due to maximum engine speed being exceeded

If the maximum permissible engine speed is exceeded, the engine may be damaged.

▶ Avoid driving in the red speed range (danger zone).

Outside temperature display

You should pay special attention to road conditions when temperatures are around freezing point.

The outside temperature is shown on the instrument cluster display (→ page 137).

Changes in the outside temperature will be displayed after a short delay.

Coolant temperature display

⚠ WARNING Risk of burns when opening the hood

If you open the hood in the event of an overheated engine or fire in the engine compartment, the following situations may occur:

- You may come into contact with hot gases.
 - You may come into contact with other escaping hot operating fluids.
- ▶ Before opening the hood, allow the engine to cool down.
- ▶ In the event of a fire in the engine compartment, keep the hood closed and call the fire service.

In vehicles without steering-wheel buttons, you can show the coolant temperature on the display (→ page 140).

In vehicles with steering-wheel buttons, there is an analog coolant temperature display on the instrument cluster's tachometer.

During normal driving and if the coolant level is correct, the display is permitted to rise to the following temperature:

- Vehicles with front-wheel drive: up to 230°F (110°C)
- Vehicles with rear-wheel drive: up to 248°F (120°C)

Overview and operation of the on-board computer (vehicles without steering-wheel buttons)

⚠ WARNING Risk of distraction from information systems and communications equipment

If you operate information systems and communication devices integrated in the vehicle when driving, you could be distracted from the traffic situation. This could also cause you to lose control of the vehicle.

- ▶ Only operate this equipment when the traffic situation permits.
- ▶ If you cannot be sure of this, stop the vehicle whilst paying attention to road and traffic conditions and operate the equipment with the vehicle stationary.

You must observe the legal requirements for the country in which you are currently driving when operating the on-board computer.

⚠ WARNING Risk of accident and injury during intervention by the steering wheel

If you reach through the steering wheel to operate the adjustment knobs while driving, you could lose control of the vehicle.

- ▶ Use the adjustment knobs only when the vehicle is at a standstill.
- ▶ Do not reach through the steering wheel while driving.



- ① ⊖ and ⊕ buttons
- ② Display
- ③ + and - buttons

If you turn the key to position 1 in the ignition lock, the on-board computer will be activated.

If you remove the key, then quickly re-insert it and turn it to position 1, the on-board computer and instrument cluster will not be activated.

You can control the display messages and settings in the on-board computer with buttons ① and ③ on the instrument cluster.

Buttons on the instrument cluster

⊖	<p>Press briefly:</p> <ul style="list-style-type: none"> • Selects a menu or display • In the Settings menu: exits the sub-menu without adopting the last setting and returns to the main menu
⊕	<p>Press and hold:</p> <ul style="list-style-type: none"> • Returns to the standard display or the Distance menu without adopting the last setting

Ⓜ	<p>Press briefly:</p> <ul style="list-style-type: none"> • Selects a submenu or function • Confirms the selected entry on the list or the display, or confirms the setting
Ⓜ	<p>Press and hold:</p> <ul style="list-style-type: none"> • Resets the trip distance and trip computer values • In the main menu of the Settings menu, resets to factory settings • In the Settings menu, resets values and returns to the main menu
+ -	<ul style="list-style-type: none"> • Sets the instrument lighting (not in the Settings menu) • Scrolls through lists • Changes values or settings

Overview and operation of the on-board computer (vehicles with steering-wheel buttons)

⚠ WARNING Risk of distraction from information systems and communications equipment

If you operate information systems and communication devices integrated in the vehicle when driving, you could be distracted from the traffic situation. This could also cause you to lose control of the vehicle.

- ▶ Only operate this equipment when the traffic situation permits.
- ▶ If you cannot be sure of this, stop the vehicle whilst paying attention to road and traffic conditions and operate the equipment with the vehicle stationary.

You must observe the legal requirements for the country in which you are currently driving when operating the on-board computer.

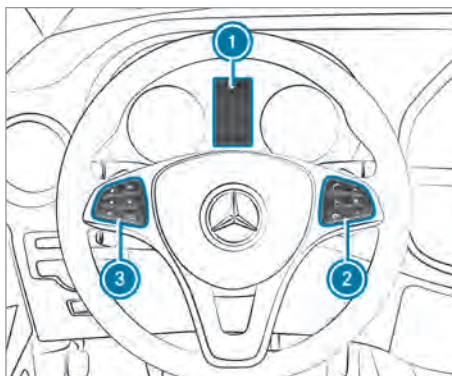

- ① Display
- ② Right control panel
- ③ Left control panel

If you turn the key to position **1** in the ignition lock, the on-board computer will be activated.

You can control the displays and the settings on the on-board computer using the steering-wheel buttons on left control panel **③**.

You can use the steering-wheel buttons on right control panel **②** to control the functions of the multimedia system and switch on the voice control function of the navigation system.

Steering-wheel buttons

Left control panel on the steering wheel



- Call up the menu bar on the display
- Select a menu



Press briefly

- Scroll through lists
- Selects a submenu or function
- In the **Audio** menu, open the track or station list and select a station or audio track
- In the **Telephone** menu, switch to the phone book and select a name or a telephone number.



Press and hold

- Quickly scroll through all lists
- In the **Audio** menu, select a station or audio track using rapid scroll
- In the **Telephone** menu with the phone book open, start rapid scroll.

Left control panel on the steering wheel

OK	<ul style="list-style-type: none"> • Confirm display messages • In all menus, confirm the selected entry in the list or the display • In the Audio menu, stop the station search function • In the Telephone menu, switch to the phone book and start dialing the selected number.
←	Press briefly <ul style="list-style-type: none"> • Back • Hide display messages • In the Audio menu, exit the track or station list • Exit the phone book or redial memory • Vehicles with navigation system: switch off voice control for navigation (see the manufacturer's operating instructions)
←	Press and hold <ul style="list-style-type: none"> • Call up the standard display in the Trip menu

Right control panel on the steering wheel

☎	<ul style="list-style-type: none"> • Make or accept a call • Switch to the redial memory
☎	<ul style="list-style-type: none"> • Reject or end a call • Exit the phone book or redial memory
+ -	<ul style="list-style-type: none"> • Adjust the volume
🗣	<ul style="list-style-type: none"> • Vehicles with navigation system: switch on the voice control function of the navigation system (see the manufacturer's operating instructions)
🔊	<ul style="list-style-type: none"> • Switch the sound on/off

Operating the audio equipment, telephone and voice control using the steering-wheel buttons on the right control panel works only with a Mercedes-Benz audio or navigation system. If you are using an audio or navigation system from another manufacturer, the described functions may be restricted or may not be available at all.

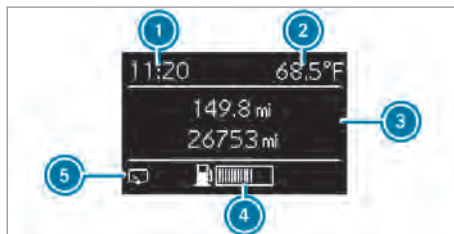
Overview of data shown on the instrument cluster display**Instrument cluster display (vehicles without steering-wheel buttons)**

Display (example)

- ① Time
☎ Cruise control (→ page 113)
- ② Constant display: outside temperature or speed
75 mph (120 km/h)! (for certain countries only) Maximum permitted speed exceeded
- ③ Display section for display messages, menus and menu bar
- ④ Fuel level
Fuel filler flap location indicator : the fuel filler cap is on the left
- ⑤ Rear window wiper (→ page 85)

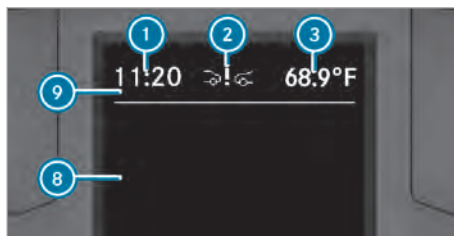
Instrument cluster display (vehicles with steering-wheel buttons)



Display (example)

- 1 Time
- 2 Active Brake Assist (→ page 111)
- 3 Active Parking Assist (→ page 122)
- 4 HOLD function (→ page 118)
- 5 Constant display: outside temperature or speed (→ page 146)
75 mph (120 km/h)! (for certain countries only) Maximum permitted speed exceeded
- 6 Menu bar
Outside temperature (only if header 9 shows the additional speedometer)
- 7 Comfort display (→ page 103)
- 8 Transmission position (→ page 103)
- 9 Status area
- 8 Display section for display messages, menus and menu bar
- 9 Header

You can call up menu bar 6 in the display section by pressing the or steering-wheel button. It will automatically disappear again after a few seconds.

Display section 8 shows the selected menu or submenu as well as display messages.

In status area 7, the display can show the status of the following driving systems:

- ATTENTION ASSIST (→ page 125)
- Lane Keeping Assist (→ page 127)
- Cruise control (→ page 113)
- Rear window wiper (→ page 85)

Adjusting the instrument lighting

⚠ WARNING Risk of accident and injury during intervention by the steering wheel

If you reach through the steering wheel to operate the adjustment knobs while driving, you could lose control of the vehicle.

- ▶ Use the adjustment knobs only when the vehicle is at a standstill.
- ▶ Do not reach through the steering wheel while driving.



Brightness control (example: vehicle with steering-wheel buttons)

The displays on the instrument cluster are illuminated during the day. A dimming function is not possible in daylight.

In vehicles with steering-wheel buttons, the light sensor on the instrument cluster automatically controls the brightness of the display lighting.

When the light has been switched on, the brightness control is influenced by the ambient light. You can then adjust the brightness of the instrument lighting and the display lighting as well.

Vehicles without steering-wheel buttons:

▶ Press the or button on the instrument cluster.

i If the **Settings** menu has been selected on the on-board computer, it will not be possible to adjust the display brightness.

Vehicles with steering-wheel buttons:

▶ Turn brightness control 1 on the instrument cluster.

Overview of menus on the on-board computer

Vehicles without steering-wheel buttons

Press the button on the instrument cluster to scroll through the menus.

You will see the **Settings** menu only if the vehicle is stationary.

If you scroll forwards in the **Settings** menu using the button, the settings for the previous submenu or the previous function will be copied over.

If you press the button in a submenu, the submenu or function will be exited without the setting being adopted.

You can find further operating information in "Overview and operation of the on-board computer" (→ page 135).

Depending on the vehicle equipment, you can call up the following menus, displays or functions:

- Display showing trip distance and total distance (→ page 139)
- Trip computer display (→ page 139)
- Display showing current range
- Display showing current fuel consumption (→ page 139)
- Digital speedometer
- Display showing coolant temperature (→ page 140)
- Display showing display messages in the message memory (→ page 246)

The following menus, displays and functions will also be displayed when the vehicle is stationary:

- Display showing next service due date (→ page 173)
- Electronic check on the engine oil level (→ page 175)
- Tire pressure monitoring system restart (→ page 206)
- The **Settings** menu for adjusting or activating and deactivating driving and driver assistance systems as well as display options (→ page 140)

Vehicles with steering-wheel buttons

Use the ◀ or ▶ steering-wheel button to show the menu bar and scroll through the menus.

Use the ▼ or ▲ steering-wheel button to scroll through their submenus and functions.

You can find further operating information in "Overview and operation of the on-board computer" (→ page 136).

Depending on the vehicle equipment, you can call up the following menus:

- **Trip** menu (→ page 142)
- **Navi** menu (navigation instructions) (→ page 143)
- **Audio** menu (→ page 144)
- **Telephone** menu (→ page 145)
- **DriveAssist** menu (→ page 141)
- **Service** menu (→ page 141)
- **Settings** menu (→ page 146)

Menus and submenus (vehicles without steering wheel buttons)

Calling up the distance menu

Use the buttons on the instrument cluster.

- ▶ **To display the distance:** press and hold the ⊖ button until the display shows the odometer for the trip distance and the total distance.
- ▶ **To reset the trip distance:** press and hold the ⊕ button until the trip distance has been reset.

Trip computer menu

Use the buttons on the instrument cluster.

- ▶ **To display:** press the ⊖ button to select the trip computer display. The values displayed relate to those measured since the trip computer was last reset. The following values will be displayed:
 - Distance
 - Length of journey
 - Average fuel consumption
 - Average speed
- ▶ **To reset values:** press and hold the ⊕ button until all values are reset.

The trip computer will automatically be reset if the value exceeds 9999 hours or 99,999 mi (99,999 km).

Current fuel consumption menu



Current fuel consumption menu (example)

- ① Recuperation display
- ② Current fuel consumption

- ▶ Press the ⊖ button to select the fuel consumption bar display.

Recuperation display ① shows whether and, if so, how much kinetic energy is being transformed into

electric current whilst the vehicle is coasting. The recuperated energy is then stored in the starter battery. Recuperation display  is dependent on the engine installed and is therefore not available in all vehicles.

Coolant temperature menu



⚠ WARNING Risk of burns when opening the hood

If you open the hood in the event of an overheated engine or fire in the engine compartment, the following situations may occur:

- You may come into contact with hot gases.
- You may come into contact with other escaping hot operating fluids.

- ▶ Before opening the hood, allow the engine to cool down.
- ▶ In the event of a fire in the engine compartment, keep the hood closed and call the fire service.

Use the buttons on the instrument cluster.

- ▶ Press the  button to select the coolant temperature bar display . During normal driving and if the coolant level is correct, the display is permitted to rise to the letter H.

Settings menu

Requirements:

- The vehicle is stationary.

Use the buttons on the instrument cluster.

- ▶ **To display the Settings menu:** use the  button to select the **Settings** menu.



Use the  button to scroll through the menu and select its submenus or functions successively.

If you press the  button in a submenu, the submenu or function will be exited without the setting being adopted.

Depending on the equipment, the following is possible:





- Setting the language of the display messages and displays
- Switching ESP[®] on/off (→ page 110)
- Setting the sensitivity of the rain sensor

- Switching ATTENTION ASSIST on/off (→ page 126)
- Setting the unit for distance, consumption and speed displays
- Setting the time and date





- ▶ **To reset to factory settings:** turn the key to position  in the ignition lock and, in the **Settings** menu, press and hold the  button for at least five seconds.

For safety reasons, not all functions will be reset.

Setting the display language

- ▶ Press the  button to select the **Language:** submenu. The display will show the current language selection.
- ▶ Use the  or  button to select a language.
- ▶ Press the  button to confirm. The next submenu will be shown on the display.

Setting the sensitivity of the rain sensor

- ▶ Press the  button to select the **Rain Sensor:** submenu. The display will show the current sensitivity setting.
- ▶ Use the  or  button to select the **Low**, **Standard** or **High** setting. This setting controls the rain sensor's sensitivity to precipitation. This results in the windshield wiper wiping more or less often at the same precipitation intensity.
- ▶ Press the  button to confirm. The next submenu will be shown on the display.

- ⓘ You can find further information under "Windshield wipers" (→ page 84).

Selecting the permanent display function For all countries except the United Kingdom:

Using the **Permanent Display:** function, you can switch the header of the display between outside temperature and speed (additional speedometer).

When the display shows the speed in the header, the outside temperature is shown with the odometers.

The additional speedometer unit in the header is always the inverse of the speedometer unit.

- ▶ Press the **(R)** button to select the **Permanent Display:** submenu.
The display will show the current setting.
- ▶ Change the setting by pressing the **(+)** or **(-)** button.
- ▶ Press the **(R)** button to confirm.
The next submenu will be shown on the display.

Selecting the unit of measurement for distance

You can select whether the display shows some information in miles or kilometers.

- ▶ Press the **(R)** button to select the **Distance Unit:** submenu.
The display will show the current setting.
- ▶ Change the setting by pressing the **(+)** or **(-)** button.
- ▶ Press the **(R)** button to confirm.
The display will show the next submenu or the **Settings** menu again.

The selected unit of measurement for distance applies to the following displays:
 - Digital speedometer
 - Total distance and trip distance
 - Trip computer
 - Range
 - Current consumption
 - Cruise control
 - Service intervals

Setting the time and date

- ▶ Press the **(R)** button to select the time and date display.
- ▶ Use the **(+)** or **(-)** button to set the hours and press **(R)** to confirm.
- ▶ Use the **(+)** or **(-)** button to set the minutes and press **(R)** to confirm.
- ▶ Use the **(+)** or **(-)** button to set the day and press **(R)** to confirm.
- ▶ Use the **(+)** or **(-)** button to set the month and press **(R)** to confirm.
- ▶ Use the **(+)** or **(-)** button to set the year and press **(R)** to confirm.
The display will show the **Settings** menu again.

Menus and submenus (vehicles with steering-wheel buttons)

Service menu

Overview



- ▶ Use the **(◀)** or **(▶)** button to select the **Service** menu.

Depending on the equipment, you have the following options in the Service menu:

- Calling up display messages in the message memory (→ page 246).
- Checking the tire pressure electronically or restarting the tire pressure monitoring system (→ page 207).
- Calling up the service due date (ASSYST PLUS) (→ page 173)

Assistance menu

- ▶ Use the **(◀)** or **(▶)** button to select the **DriveAssist** menu.

Depending on the vehicle's equipment, you have the following options on the **DriveAssist** menu:

- Displaying the status overview
- Showing the assistant display for Active Brake Assist (→ page 111) or Active Distance Assist DISTRONIC (→ page 118).
- Switching ESP® on/off (→ page 110).
- Switching Active Brake Assist on/off (→ page 112).
- Setting the sensitivity of ATTENTION ASSIST (→ page 126)
- Switching Blind Spot Assist on/off (→ page 127)
- Setting the sensitivity of Lane Keeping Assist (→ page 128)

Status overview



Status overview (example)

- ① Blind Spot Assist switched on and active
- ② Rear window wiper switched on
- ③ ATTENTION ASSIST switched on
- ④ Distance warning function of Active Brake Assist switched on
- ⑤ Lane Keeping Assist switched on and ready for use

▶ Use the or button to select the overview.

▶ Press the button.

The status overview shows only the symbols of the driving systems or driving safety systems that have been switched on.

The symbols for Blind Spot Assist and Lane Keeping Assist may vary depending on the system status:

- If the symbol for Blind Spot Assist ① does not show any radar waves between the two vehicles, Blind Spot Assist has been switched on but is not ready for use.

For more information, see "Blind Spot Assist" (→ page 126).

- If the symbol for Lane Keeping Assist ⑤ shows the lane marking as a broken line, Lane Keeping Assist has been switched on but is not ready for use.

For more information, see "Lane Keeping Assist" (→ page 127).

ⓘ In addition, you can display the evaluation of ATTENTION ASSIST or the attention level in the status overview (→ page 125).

Trip menu

Displaying the range and current fuel consumption



- ① Approximate range
- ② Current fuel consumption
- ③ Recuperation display

▶ Use the or button to select the Trip menu.

▶ With the or button, select range and consumption.

If there is only a small amount of fuel left in the fuel tank, the display will show a vehicle being refueled  instead of the approximate range ①.

Recuperation display ③ shows whether and, if so, how much kinetic energy is being converted to electrical energy while the vehicle is coasting. The recuperated energy is then stored in the starter battery.

Displaying trip computer "From start" or "From reset"

▶ Use the or button to select the Trip menu.

▶ Press the or button to select the From Start or From Reset submenu.

The following values will be displayed:

- Distance
- Length of journey
- Average fuel consumption
- Average speed

The values on the From Start submenu relate to those measured since the start of the journey. The values on the From Reset submenu relate to those measured since the submenu was last reset.

The **From Start** trip computer will automatically be reset under the following conditions:

- The vehicle has been switched off for longer than four hours.
- A time of 999 hours has been exceeded.
- A distance of 9999 mi (9999 km) has been exceeded.

The **From Reset** trip computer will automatically be reset under the following conditions:

- A time of 9999 hours has been exceeded.
- A distance of 99,999 mi (99,999 km) has been exceeded.

Displaying the digital speedometer

- ▶ Use the or button to select the **Trip** menu.
- ▶ Select the digital speedometer using the or button.

The following will be shown on the display:

- Gearshift recommendation:
Vehicles with automatic transmission
- Digital speedometer

Resetting values

The values of the following functions can be reset:

- Trip distance
- "From start" trip computer
- "From reset" trip computer

- ▶ Use the or button to select the **Trip** menu.
- ▶ Use the or button to select the function to be reset.
- ▶ Press the button.
- ▶ Use the button to select **Yes** and confirm with the button.

Navigation menu

In the **Navi** menu, the display shows the navigation instructions from the audio and/or navigation system.

- ▶ Switch the audio and/or navigation system on.
- ▶ Use the or button to select the **Navi** menu.
- ▶ Press the button to confirm.

Route guidance not active

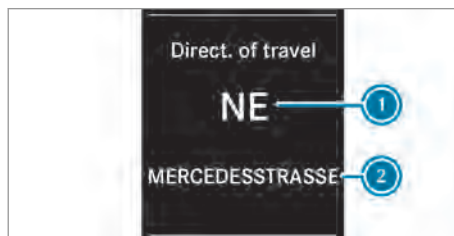

- ① Direction of travel
- ② Name of current road

Route guidance active

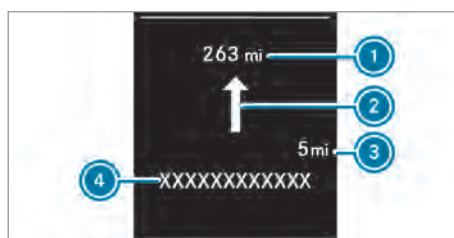

No change of direction announced

- ① Distance to next destination
- ② Change-of-direction symbol
- ③ Distance to next change of direction
- ④ Name of current road

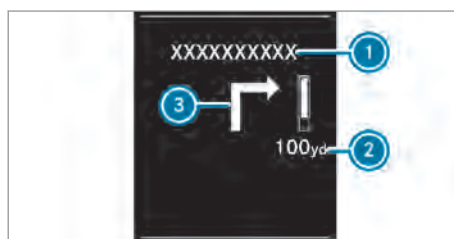

Change of direction announced without lane recommendation

- ① Road to which the change of direction leads
- ② Distance to change of direction and graphical distance indicator
- ③ Change-of-direction symbol

If you need to make a change of direction, a dynamic bar appears in the form of a graphical distance indicator above the displayed distance. ②.

The length of the bar from top to bottom to decreases as you approach the announced change of direction. The bar on the distance indicator dis-

appears when you have reached the point for changing direction.

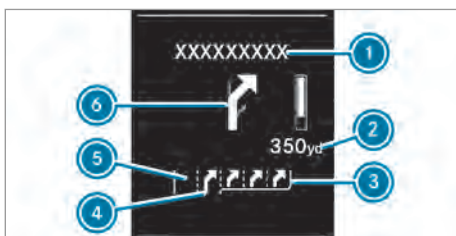

Change of direction announced with lane recommendation

- ① Road to which the change of direction leads
- ② Distance to change of direction and graphical distance indicator
- ③ Recommended lane and new lane for changing direction
- ④ Possible lane
- ⑤ Lane not recommended
- ⑥ Change-of-direction symbol

If the digital map contains the corresponding data, lane recommendations for upcoming changes of direction can be displayed in the case of multi-lane roads. New lanes may be added during the change of direction.

Lane not recommended ⑤: In this lane, the next change of direction is not possible without changing lanes.

Possible lane ④: in this lane will you be able to complete the next change of direction.

Recommended lane ③: in this lane, you will be able to complete both the next change of direction and the one after that.







The following additional navigation status displays are possible:

- **New Route... or Calculating Route...**
A new route is being calculated.
- **Road Not Mapped**
The vehicle's position is within the area of the digital map, but the road is not known, e.g. it may be an unpaved road.
- **No Route**
Not possible to calculate any route to the selected destination.
- 
You have reached the destination or an intermediate destination.



Audio menu

Selecting a radio station

The station is displayed with the station frequency or station name. The memory preset is displayed along with the frequency band only if the station has been stored.











- ▶ Switch on the multimedia system and select the radio function.
- ▶ Use the  or  button to select the **Audio** menu.
The display will show the station currently selected.
- ▶ **To select a stored station:** briefly press the  or  button.
- ▶ **To select a station from the station list:** press and hold the  or  button.

If no station list is received:

- ▶ **To select a station using the station search function:** press and hold the  or  button.

Operating data storage media

With the multimedia system, you can play back audio files from different audio sources, such as an SD card, a USB storage device or a Bluetooth® audio device.

- ▶ Switch on the multimedia system and select the audio source.
- ▶ Use the  or  button to select the **Audio** menu.
- ▶ **To open the track list:** press the  or  button.
- ▶ **To select the next or previous track on the track list:** briefly press the  or  button.
- ▶ **To select a track from the track list using rapid scroll:** press and hold the  or  button until the desired track is reached.
If you press and hold the  or  button, the rapid scroll speed will increase after a short time. Not all audio sources support this function.



Telephone menu

⚠ WARNING Risk of distraction from information systems and communications equipment

If you operate information systems and communication devices integrated in the vehicle when driving, you could be distracted from the traffic situation. This could also cause you to lose control of the vehicle.

- ▶ Only operate this equipment when the traffic situation permits.
- ▶ If you cannot be sure of this, stop the vehicle whilst paying attention to road and traffic conditions and operate the equipment with the vehicle stationary.

When using the phone, you must observe the legal requirements for the country in which you are currently driving.

- ▶ Switch on the multimedia system.
- ▶ Switch on the mobile phone (see the separate operating instructions from the manufacturer).
- ▶ Establish a Bluetooth® connection between the mobile phone and the multimedia system.
- ▶ Use the  or  button to select the **Telephone** menu.

The display will show one of the following messages:

- The name of the mobile phone network provider or **Phone READY:**
The mobile phone has found a network and is ready to receive.
- **Phone No Service:**
No network is available or the mobile phone is searching for a network.
- **Bluetooth Ready:**
You have not yet established a Bluetooth® connection between the mobile phone and the multimedia system.

You can obtain further information about suitable mobile phones and connecting via Bluetooth®:

- At a Mercedes-Benz Commercial Van Center
- On the webpage <https://www.mercedes-benz.com/connect>

Accepting a call







- ▶ Press the  button on the steering wheel.

If someone calls you when you are in the **Telephone** menu, a corresponding message will appear on the display.



Reject or end a call

- ▶ Press the  button on the steering wheel.

Dialing a number from the phone book

- ▶ Use the  or  button to select the **Telephone** menu.
- ▶ Press the ,  or **OK** button to switch to the phone book.
- ▶ Use the  or  button to scroll through the names.
If you press and hold the button for longer than one second, the names in the phone book will be scrolled through rapidly.







or

- ▶ Press and hold the  or  button for longer than five seconds.
Rapid scrolling – the name that starts with the next letter or the previous letter in the alphabet is displayed.
Rapid scrolling will stop when you release the button or reach the end of the list.

If only one telephone number is stored for a name:







- ▶ Press the  or **OK** button.
Dialing will start.



If several telephone numbers are stored for a name:

- ▶ Press the  or **OK** button.
The phone numbers will be displayed.
- ▶ Press the  or  button to select a telephone number.
- ▶ Press the  or **OK** button.
Dialing will start.
- ▶ **To exit the phone book:** press the  or  button.

Redialing

The on-board computer will save the last names or numbers dialed in the redial memory.

- ▶ Use the  or  button to select the **Telephone** menu.
- ▶ Press the  button to switch to the redial memory.
- ▶ Press the  or  button to select a name or telephone number.
- ▶ Press the  or **OK** button.
Dialing will start.



- ▶ **To exit the redial memory:** press the  or  button.

Settings menu







Settings menu (example)

Depending on the vehicle's equipment, you have the following options on the **Settings** menu:





- On the **Instrument Cluster** submenu, changing the display options
 - On the **Time/Date** submenu, changing the time and date
 - On the **Light** submenu, changing the settings for exterior and interior lighting
 - On the **Vehicle** submenu, switching vehicle functions on/off or adjusting them
 - Resetting the settings to **Factory Setting**
- ▶ Use the  or  button to select the **Settings** menu.

Instrument Cluster submenu



- ▶ Use the  or  button to select the **Instrument Cluster** submenu.
 - ▶ Press the  button.
- On the **Instrument Cluster** submenu, you have the following options depending on the equipment:
- Changing the unit of measurement for distance
 - Changing the display language.
 - Selecting the permanent display in the header of the display
- ▶ Use the  or  button to select the desired function.
 - ▶ Choose a setting.

Time/Date submenu

- ▶ Use the  or  button to select the **Time/Date** submenu.

- ▶ Press the  button.
- ▶ Use the  or  button to select the desired function.
- ▶ Press the  button.
- ▶ Choose a setting.
- ▶ Press the  button to confirm.

Light submenu



- ▶ Use the  or  button to select the **Light** submenu.
- ▶ Press the  button.

On the **Light** submenu, you have the following options depending on the equipment:

- Activating/deactivating the surround lighting and switch-off delay time of the exterior lighting
- An activated **Surround Lighting**: function works only in the dark and if the light switch is in the **AUTO** position.
- Activating/deactivating the switch-off delay time of the interior lighting

- ▶ Choose a setting.

Vehicle submenu







- ▶ Use the  or  button to select the **Vehicle** submenu.
- ▶ Press the  button.

On the **Vehicle** submenu, you have the following options depending on the equipment:

- Setting the sensitivity of the rain sensor
- You can find further information under "Windshield wipers" (→ page 84).
- Switching the automatic door lock on/off
- You can find further information under "Automatic locking mechanism" (→ page 46).
- Activating/deactivating the acoustic locking verification signal

- ▶ Choose a setting.

Resetting the settings to factory settings



- ▶ Press the  or  button to select **Factory Setting**.
- ▶ Press the  button. The **Reset All Settings?** function will be displayed.
- ▶ Press the  or  button to select **Yes**.
- ▶ Press the  button.

For safety reasons, not all functions will be reset. The [Limit Speed \(Winter Tires\)](#) function of the permanent limiter can be adjusted only in the [Vehicle](#) submenu.

Mercedes me calls

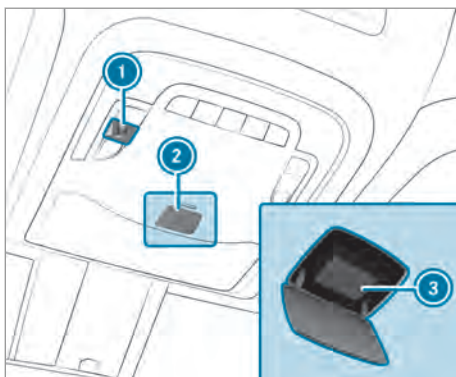
Making a call via the overhead control panel





- ① Breakdown assistance call button 
- ② Cover for  button (SOS button)
- ③  button (SOS button)

Making a breakdown assistance call

- ▶ Press button ①.

Making an emergency call

- ▶ Briefly press the cover on  button ② to open it.
- ▶ Press and hold  button ③ for at least one second.

An emergency call can still be triggered when a breakdown assistance call is active. This has priority over all other active calls.

Information about service calls using the buttons in the overhead control panel

In the event of a breakdown, you will get support:

You can find information on the following topics:

- Activation of Mercedes me connect
- Operating the vehicle
- Other products and services from Mercedes-Benz

Arranging a service appointment via Mercedes me call

If you have activated the maintenance management service, relevant vehicle data is transferred automatically to the Mercedes-Benz customer cen-

ter. You will then receive individual recommendations regarding the maintenance of your vehicle. Regardless of whether you have consented to the maintenance management service, you are reminded in the instrument cluster after a certain amount of time that a service is due.

- ▶ **To arrange a service appointment:** select the info call button (→ page 148). After your confirmation, the vehicle data is sent and the Mercedes-Benz customer center deals with your appointment. The information is then sent to your desired service outlet. They will contact you to confirm the appointment and, if necessary, to discuss the details.

Consenting to data transfer for a Mercedes me call

Requirements:

- There is an active Mercedes me call via the buttons in the overhead control panel (→ page 148).

If the Mercedes me connect services are activated, no query for data transfer appears in the instrument cluster.

If the Mercedes me connect services are not activated, the following message appears in the instrument cluster **Send Data?**.

- ▶ Confirm or decline the query with the \oplus or \ominus buttons in the instrument cluster (→ page 135). If the data protection query is accepted via the \oplus , relevant identification data is transferred automatically.

Transferred data during a Mercedes me call

When you make a service call via Mercedes me, data is transmitted. This enables targeted advice and smooth service.

The following requirements must be met for the data transfer:

- The vehicle is switched on.
- The necessary data transmission technology is supported by the mobile network provider.
- A sufficient mobile phone connection quality is provided.

Multi-stage transmission depends on the following factors:

- Reason for the initiation of the call
- Available mobile radio transmission technology

- Activated Mercedes me connect services
 - Selected service in the voice dialog system
- i** A request for consent to data transmission is only made if the corresponding Mercedes me connect service has not been activated.

Data transmission when Mercedes me connect services are not activated

If no Mercedes me connect services are activated and the data protection query has been confirmed, the following data will be transferred:

- Vehicle identification number
- Time of the call
- Reason for the initiation of the call
- Confirmation of the data protection prompt
- Vehicle country code
- Call number of the communication platform installed in the vehicle

If a call is made for a service appointment via the service reminder, the following data is also transmitted:

- Current mileage and maintenance data

If the Accident and Breakdown Management selection has been made via the voice dialog system and no service has been activated, but the data protection query has been confirmed, the following data can be additionally requested from the vehicle by the Mercedes-Benz customer center:

- Current vehicle location

If the data protection request has been declined, the following data will be transferred to enable targeted advice and a smooth service:

- Reason for the initiation of the call
- Rejection of the data protection prompt
- Vehicle country code
- Call number of the communication platform installed in the vehicle

Data transmission when Mercedes me connect services are activated

Only in the second step, only for the respective activated services, further case-specific data is transmitted in order to enable an optimal service.

An overview of the transmitted data can be found in the respective terms of use for Mercedes me connect services. These can be obtained in the Mercedes me portal: <https://me.secure.mercedes-benz.com>

Data processing

The data transmitted as part of the call will be deleted from the transmitting systems once the call has been completed, provided they are not used for other activated Mercedes me connect services.

The case-related data will be processed and stored in the Mercedes-Benz customer center and, if necessary for case processing, forwarded to the service partners commissioned by the Mercedes-Benz customer center. Please refer to the data protection information on the Mercedes me website at <https://www.mercedes.me> or in the recorded message immediately after the call to the Mercedes-Benz customer center has been set up.

- i** The recorded message is not available in every country.

Mercedes me connect

Information about Mercedes me connect

- i** Mercedes me connect or individual Mercedes me connect services are not available in every country. Contact an authorized Mercedes-Benz Center to find out whether these functions are available in your country.

Mercedes me connect consists of a variety of services.

Mercedes me connect Accident and Breakdown Management and the Mercedes-Benz emergency call center are available to you around the clock.

You will find the breakdown call button and the SOS button in the vehicle's overhead control panel (→ page 148).

Please note that Mercedes me connect is a Mercedes-Benz service. In emergencies, call the national emergency services first using the standard national emergency service phone numbers. In emergencies, you can also use the emergency call system (→ page 185).

Observe the conditions of use for Mercedes me connect and other services. These can be obtained in the Mercedes me Portal: <https://me.secure.mercedes-benz.com>

Further information about Mercedes me connect services can be obtained in the Mercedes me Portal: <https://me.secure.mercedes-benz.com>

Information on Mercedes me connect Accident and Breakdown Management

The Accident and Breakdown Management can, amongst others, include the following functions:

- Supplement to the Emergency Call System (→ page 185)
If necessary, the contact person at the Mercedes-Benz emergency call center forwards the call to Mercedes me connect Accident and Breakdown Management. However, call forwarding is not possible in all countries.
 - Breakdown assistance on location by a technician and/or towing away of the vehicle to the nearest authorized Mercedes-Benz Center
You may be charged for these services.
 - In the event of a breakdown or accident, extended vehicle data is sent, enabling optimum support from the Mercedes-Benz customer center and the appointed service partner or breakdown mechanic.
 - Supplement to the Mercedes me connect telediagnosics service
With the telediagnosics function, the service provider records certain wear and failure messages, insofar as these can be clearly interpreted and are available by monitoring diagnosable components.
- i** These services are subject to technical restrictions such as mobile coverage and mobile network quality and the interpretability of the transmitted data in the processing systems. Under certain circumstances, this may result in delays or omission of the message in the instrument cluster.

Further information about Mercedes me connect services can be obtained in the Mercedes me Portal: <https://me.secure.mercedes-benz.com>

Transmitted data with the Mercedes me connect call services

The data transferred during the Mercedes me connect call depends on:

- The reason for the initiation of the call
- The service selected in the voice dialog system
- The activated Mercedes me connect services

You can find out which data is transferred during the services in the currently valid Mercedes me connect terms of use and the data protection

information for Mercedes me connect. You can find these in your Mercedes me user account.

Mercedes me and apps

Information about Mercedes me

When you log in with a user account to the Mercedes me Portal, then services and offers from Mercedes-Benz will be available to you.

Availability is country-dependent.

For more information consult an authorized Mercedes-Benz Center or visit the Mercedes me portal: <https://me.secure.mercedes-benz.com>

- i** Make sure that you always keep the Mercedes me apps up to date.

Notes on operating safety

⚠ WARNING Risk of distraction from information systems and communications equipment

If you operate information systems and communication devices integrated in the vehicle when driving, you could be distracted from the traffic situation. This could also cause you to lose control of the vehicle.

- ▶ Only operate this equipment when the traffic situation permits.
- ▶ If you cannot be sure of this, stop the vehicle whilst paying attention to road and traffic conditions and operate the equipment with the vehicle stationary.

Observe the legal requirements for the country in which you are currently driving when operating the multimedia system.

Anti-theft protection

This device is equipped with technical provisions to protect it against theft. Further information on theft protection can be obtained from any Mercedes-Benz .

Operating temperature

Observe the following temperature range for the device:

- Operating temperature: -25 °C (-25 °C) to + 70 °C (+ 70 °C)

Specifications

Wireless frequencies/ protocols	2.4 GHz @ 9.5 dBm nominal
Input voltage	From 7.5 to 18.5 V
Maximum operating current	2.5 A

Bluetooth® specification

Properties of the Bluetooth® technology used:

Bluetooth® version	2.0
Energy class	Class 2
Frequency range	2402 to 2480 MHz

Trademark information

© 2019 Garmin Ltd. or their subsidiaries.

Garmin® and the Garmin logo are brands from Garmin Ltd. or their subsidiaries, that are registered in the USA and other countries.

Android™ is a trademark from Google.

Inc. Apple® and the Apple logo are brands from Apple Inc., registered in the USA and other countries.

The BLUETOOTH® word trademark and logo are the property of Bluetooth SIG, Inc.

Every use of this trademark by Garmin is done under license.

HD radio technology manufactured under license from iBiquity Digital Corporation. US and foreign patents. For patents, see <http://dts.com/patents>. HD Radio, Artist Experience and the HD, HD Radio and "ARC" logos are registered trademarks or trademarks of the iBiquity Digital Corporation in the USA and/or other countries.

SiriusXM®, TuneMix™, TuneStart™ and all associated trademarks and logos are trademarks of SiriusXM Radio Inc. All Rights Reserved.

Overview and operation

Overview of the control panel



- ① Press: calls up the home screen.
- ② Press: pairs a phone or uses smartphone functions
- ③ Press: calls up settings
- ④ Press: activates voice control
- ⑤ Turn: navigates through options on the current page
- ⑥ Press: confirms selection
- ⑦ Press: switches off the media display or mutes the sound
- ⑧ Turn: sets the volume for media, navigation announcements or telephone calls
- ⑨ Press: selects the current media source
- ⑩ Press: calls up the navigation map.

Setting the home screen

Calling up the home screen

- ▶ Press on .

Adding or changing buttons

- ▶ **To assign an app to an empty button:** select an empty button.
- ▶ **To change an existing app:** hold down the app icon until the app tile selection window appears on the home screen.
- ▶ Select an app and assign it to the respective tile.

Operating the touchscreen

Tapping

- ▶ Tap on the display to select an element.

Single-finger swipe

- ▶ Draw or swipe a finger across the display to tilt or to scroll.

System settings

Configuring basic settings

- ▶ Press .

The following options are available:

- **Connected Devices:** Options for controlling connected devices that use Android Auto, Apple CarPlay® or Bluetooth® technology.
- **Phone:** Options for use with your smartphone
- **Navigation:** Setting options for navigation and map interaction
- **Notifications:** Settings for different notification types
- **Display and Language:** Settings for display and language
- **Sound:** Sets options for sound and volume
- **Time and Units:** Units of measurement used
- **About:** Displays system information, end user license agreements and advanced settings

Displaying e-labels and legal requirements:

- ▶ Press  and select **Settings** ►► **About** ►► **Regulatory**.

Configuring settings for connected devices

- ▶ Press  and select **Connected Devices**.

The following options are available:

- **Bluetooth:** Options for connecting and configuring devices with Bluetooth® technology
- **Android Auto:** Options for Android Auto app
- **Apple CarPlay:** Options for Apple CarPlay®
- **Bluetooth Name:** Sets a name for a Bluetooth® connection
- **Add a device:** Starts the procedure for pairing the multimedia system with an available Bluetooth® device

Configuring navigation settings

Map settings

- ▶ Press  and select **Navigation** ►► **Map**.

The following options are available:

- **Driving Map View:** Sets the map perspective
- **Map Theme:** Determines the color for the map material
- **Map Layer:** Sets the level of detail of the map
- **Installed Maps:** Specifies the maps to be installed
- **Map Updates:** Defines the procedure for map material updates

Guidance settings

- ▶ Press  and select **Navigation** ►► **Navigation Instructions**.

The following options are available:

- **Calculation Mode:** Sets the route calculation mode
- **Avoidances:** Sets the road types to be avoided on the route
- **Custom Avoidances:** Sets certain roads or areas to be avoided
- **Voice Prompts:** Enables or disables voice prompts during navigation
- **Intersection View:** Enables or disables the view of upcoming intersections while driving
- **GPS Simulation:** The GPS simulator calculates and simulates routes

Traffic settings

- ▶ Press  and select **Navigation** ►► **Traffic**.

The following options are available:

- **Traffic:** Activates traffic messages
- **Automatic Route Optimization:** Uses optimized alternative routes automatically or on request
- **Current Provider:** Sets the provider from which traffic data is obtained. With the **Automatic** option, the best available traffic data is automatically selected.
- **Subscriptions:** Displays the list of current subscriptions for traffic data

Setting position course

▶ Press **[sys]** and select **Navigation** ►► **Location History**.

The following options are available:

- **Travel Data Recording:** Enables the gathering of travel information

Device and privacy settings

▶ Press **[sys]** and select **About**.

The following options are available:

- **System Update:** Starts the software update, if an update is available
- **Map Updates:** Starts or completes an update for the map material
- **System Information:** Displays hardware and software version information
- **EULAs:** Displays the End User License Agreement (EULA) and software license information
- **Regulatory:** displays E-Label with compliance designations and regulatory information
- **Reset to Factory Defaults:** Deletes all data and resets the multimedia system to the factory settings

⚠ WARNING Risk of accidents due to failure of multimedia display functions

While the multimedia system is being reset, its functions such as the rear view camera are not available.

▶ Only reset the multimedia system when the vehicle is stationary.

Configuring notification settings

▶ Press **[sys]** and select **Notifications**.

The following options are available:

- **Incoming Phone Call:** Set to display a notification to answer or reject incoming calls
- **Missed Call:** Set to display a missed call notification
- **Ongoing Call:** Sets a notification to be displayed when a call is received

Configuring display and language settings

▶ Press **[sys]** and select **Display and Language**.

The following options are available:

- **Brightness:** Sets the brightness of the media display
- **Display Color Mode:** Selects day or night color mode
- **System Voice:** Sets the voice for the navigation announcements and other information
- **System language:** Sets the language for text
- **Keyboard:** Sets the keyboard design

Configuring sound settings

▶ Press **[sys]** and select **Sound**.

The following options are available:

- **Adjust Volumes:** Sets the volumes for audible device functions
- **Adjust Sound Quality:** Sets the level for balance, fader, bass, mid-range and treble for the media source
- **Audio Prompts:** Sets the style for audio announcements
- **Equalizer Preset:** Defines the settings for the equalizer function
- **Touch Sounds:** Sets the sound for the selection of symbols on the media display

Calling up the tool menu

▶ Press **[grid]**.

The following options are available:

- **Where Am I?:** Displays information about your current position
- **Detour:** Starts a detour
- **Now Playing:** Displays information about the current media track
- **Nav Assist:** Shows upcoming exits and current location information

- **Traffic:** Displays traffic information along your route
- **Up Ahead:** Displays POIs that are on the route
- **Quick Settings:** Options for activating or deactivating various system functions

Navigation

Navigation overview

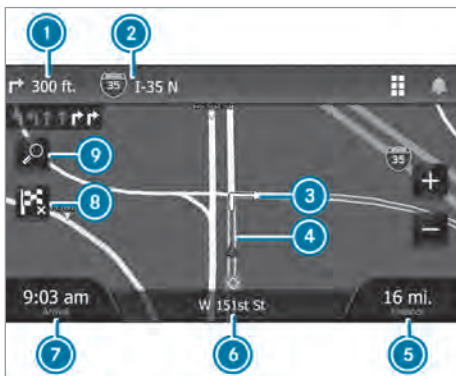

- 1 Next direction change on the route
 - 2 Name of the street or exit linked to the next change of direction
 - 3 Next direction change on the route. Arrows on the map show the positions of the next changes of direction
 - 4 Route marked on the map
 - 5 Estimated distance to destination
 - 6 Name of the street on which the vehicle is located
 - 7 Estimated time of arrival
 - 8 Stops the route
 - 9 Searches for points of interest or starts a new route
- i When you tap 5 or 7, you can adjust the arrival time or distance information.

Destination entry

Notes on destination entry

⚠ WARNING Risk of distraction from operating integrated communication equipment while the vehicle is in motion

If you operate communication equipment integrated in the vehicle when driving, you could

be distracted from the traffic situation. This could also cause you to lose control of the vehicle.

- ▶ Only operate this equipment when the traffic situation permits.
- ▶ If you cannot be sure of this, stop the vehicle whilst paying attention to road and traffic conditions and operate the equipment with the vehicle stationary.

You must observe the legal requirements for the country in which you are currently driving when operating the multimedia system.

Entering a destination using the voice control

The voice control of the multimedia system has been adapted to the officially supported national languages. There is no guarantee that the spoken voice commands will produce correct voice control results if a system language other than the official national language is selected.

Searching for and entering destinations

The search menu helps to find the destination.

The following search options are available:

- To search all location information quickly, enter search terms.
- Browse or search existing points of interest by category.
- To find specific positions, e.g. addresses, intersections or geographical coordinates, use search functions.
- Location search within the vicinity of other cities or areas
- Save favorites.
- Search for previously discovered destinations again.



The results of the destination search are shown in a list.

Finding destinations with the search bar

You can search for specific locations in the search bar by entering a category, brand name, address or location name.



- ▶ Select  on the map.
- ▶ Select **Keyword or Address** in the search bar.
- ▶ Enter all or part of the search term. Suggested search terms are displayed below the search bar.
- ▶ Press **Done**.
- ▶ Select the desired destination.

Changing the search area

- ▶ Select  on the map.
- ▶ Select .
- ▶ Select one of the available options.

Searching for an address

Depending on the available map material, the sequence of steps can be different.

- ▶ Select  on the map.
- ▶ Select  if it is necessary to change the search area.
- ▶ Select **Address**.
- ▶ Follow the instructions on the media display to enter the address information.
- ▶ Select the address.

Searching for a city

Before you can search for a city, you must add the "Cities" shortcut to the search menu.

- ▶ Select  on the map.
- ▶ Select **Cities**.
- ▶ Select one of the following options.
- ▶ Select a city from the list.

or

- ▶ Enter the name of the city you are looking for and press **Done**.

Searching for an intersection

Before you can search for an intersection, you must add the "Intersections" shortcut to the search menu.

You can then search for an intersection or junction between two roads, highways or other road types.

- ▶ Select  on the map.
- ▶ Select **Intersections**.
- ▶ Follow the instructions on the media display to enter the street information.
- ▶ Select an intersection.

Finding a destination using coordinates

Before you find a destination using coordinates, you must add the "Coordinates" shortcut to the search menu.

You can find destinations by specifying longitude and latitude.

- ▶ Select  ▶▶ **Coordinates** on the map.
- ▶ If required, select  ▶▶ **Coordinate Format**.

- ▶ Press on **Change**.
The coordinate format or date is changed.
- ▶ Enter the coordinates in longitude and latitude.
- ▶ Press on **Accept**.

Destination search by categories

- ▶ Select  on the map.
- ▶ Select a category or choose from **Route Preference**.
- ▶ Select a subcategory if necessary.
- ▶ Select a destination.

Parking the vehicle

- ▶ Select  on the map.
- ▶ Press **Route Preference** ▶▶ **Parking**.
- ▶ Choose a parking space.
- ▶ Press on **Go!**.



Displaying and deleting last destinations

Displays

The multimedia system stores a history of the last fifty destinations found.

- ▶ Select  on the map.
- ▶ Select **Recents**.

Deleting

- ▶ Select  on the map.
- ▶ Select **Recents** ▶▶  ▶▶ **Clear All Recent Places** ▶▶ **Clear**.



Displaying POIs

The "POI along the route" function provides information on the next POIs along the road you are traveling on, e.g. restaurants, gas stations or rest areas. If you are driving on a freeway, you can also display information and available points of interest for the nearest intersections and cities.

Displaying the next points of interest

- ▶ Select  ▶▶ **Up Ahead** on the map.
- ▶ Select a display from the list of possible locations for the category, exit or city.

Adjusting categories for points of interest along the route

- ▶ Select  ▶▶ **Up Ahead** on the map.
- ▶ Select a category.
- ▶ Select  ▶▶ **Up Ahead Options**.

The following options are available:

- To move a POI category up or down in the list, select the arrow next to the category name.
- To change a category, select the category and choose a new category from the list.

▶ Select **Save**.

Displaying current location information

You can use the **Where am I?** function to view the current location information.

This function is particularly useful in the following cases:

- To communicate the location in case of emergency.
- To find nearby hospitals, police stations and gas stations.

▶ Select  ▶▶ **Where am I?**
The current location information is displayed.

▶ Select one of the options shown, e.g. the **EV Stations** category.

 Some service categories are not available in all areas. A list of locations for the selected service is displayed, with the nearest locations at the top.

▶ Select the desired destination.

▶ To navigate to the destination, select **Go!**.

or

▶ To call the destination using the paired telephone, select **Call**.



Saving and deleting destinations

Storing

- ▶ Search for a destination (→ page 154).
- ▶ Select a destination from the search results.
- ▶ Press on **Save**.
- ▶ Enter a name and press on **Done**.

Deleting a saved destination

Deleted destinations are not restored.



- ▶ Select  ▶▶  ▶▶ **Select a Saved Place**.
- ▶ Activate the checkbox next to the destination to be deleted.
- ▶ Select **Delete**.

Adding or removing shortcut for destination entry

A shortcut can refer to a destination, a category or a search function.

▶ **To add:** select  ▶▶ **Add Shortcut** on the map.

▶ Select a symbol.

▶ **To remove:** select  ▶▶  ▶▶ **Remove Shortcut(s)** on the map.

▶ Select a shortcut.

▶ Select **Remove**.

Route

Notes on the routes

The following route options are available:

- The multimedia system calculates a recommended route to your destination using the information you specify, including the route calculation mode (→ page 157) and the route options set (→ page 157).
- You can start navigation to your destination immediately with the recommended route or select an alternative route (→ page 156).
- You can add multiple intermediate destinations to the route (→ page 158).

Arrival at your destination

You will receive the following information upon arrival at your destination:

-  Shows the location of the destination on the map, while a voice message informs you that you are approaching the destination.
- When you approach certain destinations, the multimedia system automatically prompts you to find a parking space. With **Yes** you can find nearby parking spaces.
- When you stop at your destination, the multimedia system automatically ends the route. If not, you can end the route by pressing **Stop**.

Starting and ending a route

▶ Press on .

▶ Select .

▶ Select a position.

▶ To start navigation with the recommended route, press on **Go!**.



or

▶ To select an alternative route, press on **Routes** and select a route.

Alternative routes are shown to the left of the map.

The navigation system calculates a route to the selected destination.

Using a map





- ▶ Press on .
- ▶ To display the desired search area, move the section of the map and use the zoom function.
- ▶ If required, select  ▶▶  to filter the displayed POIs according to category. The position marks are shown on the map.
- ▶ Select a position mark.

or

- ▶ Select a point on the map, e.g. a street, intersection or address.
- ▶ Press on **Go!**.

Searching for the "Home Location"

If you are starting a route home for the first time, the navigation system prompts you to enter the "Home location".

- ▶ Press on .
- ▶ Select  ▶▶ **Navigating Home.**
- ▶ If required, enter the "Home position".
- ▶ **To edit the "Home location":** press .
- ▶ Select  ▶▶  ▶▶ **Change Home Location.**

Ending a route

- ▶ Select  on the map.

Selecting route options

Avoiding traffic obstructions along the route

To avoid traffic obstructions, the navigation system automatically optimizes the route. If you have deactivated this function in the traffic information settings, you can see expected traffic obstructions on the media display and avoid them independently.

- ▶ Select the  ▶▶ **Traffic options.**
- ▶ If available, select **Alternative Route to destination.**
- ▶ Press on **Go!**.

Avoiding toll roads

The navigation system can calculate routes that bypass areas with roads requiring a fee, e.g. toll roads or toll bridges, or congestion areas. If no other appropriate routes are available, the navigation system will include any toll road sections in the route.

- ▶ Press .
- ▶ Select the options **Settings** ▶▶ **Navigation** ▶▶ **Navigation Instructions** ▶▶ **Avoidances.**

- ▶ Select **Tolls and Fees.**

Defining your own bypass criteria

Your own bypass criteria allow you to avoid certain areas or road sections. When the navigation system calculates a route, these areas and road sections are avoided unless there is no other reasonable route available.

- ▶ Press .
- ▶ Select the options **Settings** ▶▶ **Navigation** ▶▶ **Navigation Instructions** ▶▶ **Custom Avoidances.**
- ▶ Select **Add Avoidance.**
- ▶ **To avoid a certain section of the road:** select **Avoid Road.**
- ▶ Select the starting point of the road section to be avoided.
- ▶ Select **Next.**
- ▶ Select the end point of the road section.
- ▶ Select **Next.**
- ▶ Select **Done.**
- ▶ **To avoid a specific area:** select **Avoid Area.**
- ▶ Select the upper left corner of the area to be bypassed.
- ▶ Select **Next.**
- ▶ Select the lower right corner of the area to be bypassed.
- ▶ Select **Next.**
- ▶ The selected area is displayed in color.
- ▶ Select **Done.**

Deactivating and deleting your own bypass criteria

- ▶ Press .
- ▶ Select the options **Settings** ▶▶ **Navigation** ▶▶ **Navigation Instructions** ▶▶ **Custom Avoidances.**
- ▶ Select a detour criterion.
- ▶ **To deactivate:** deselect the **Enable** checkbox.
- ▶ **To delete:** select **Delete.**

Selecting route calculation mode

- ▶ Press .
- ▶ Select **Settings** ▶▶ **Navigation** ▶▶ **Navigation Instructions** ▶▶ **Route Preference.**

Select one of the following options for calculating routes:

- **Faster Time:** Faster routes, even if the route is longer
- **Shorter Distance:** Shorter distances, even if more time is needed
- **Less Fuel:** Fuel-efficient routes

Selecting a detour

During navigation, you can select detours for a specified distance or avoid specific roads. This function is useful on construction sites, closed roads or poor road conditions.

▶ Select  ▶▶ **Detour** on the map.

Select one of the following options:

- **Detour by Distance:** Avoids the route for a certain distance
- **Route detoured.:** Avoids a particular road on the route.
- **Detour:** Calculates a completely new route.

Editing a route with intermediate destinations

Requirements:

- A route has already been started (→ page 156).

You can add intermediate destinations in the middle or at the end of your route.

- ▶ Select  on the map.
- ▶ Search for a position.
- ▶ Select a position.
- ▶ Press on **Go!**.

Select one of the following options:



- **Add as Next Stop:** Sets the location as the next intermediate destination on the route.
- **Add as Last Stop:** Adds the location at the end of the route.
- **Add to Active Route:** Adds the location and manages the order of destinations on the route.

The navigation system adds this position to the route. The route is recalculated with the individual destinations in the desired order.

Planning routes with myTrips

With the "myTrips" function you can set and save a route. You can edit a saved route.

Setting a route

- ▶ Select  ▶▶ **myTrips** ▶▶ **Create Trip** on the map.
- ▶ Select **Add Starting Point**.
- ▶ Select a position for the starting point.
- ▶ Select **Add Destinations**.
- ▶ Set a position for the destination and select with **Select**.
- ▶ If required, add more destinations for other positions and then select .
- ▶ Select **Trip Settings** ▶▶ **Trip Name**.
- ▶ Enter the name of the route and select **Done**.

Managing and rearranging positions on a route

- ▶ Select  ▶▶ **myTrips** on the map.
 - ▶ Select a saved route.
 - ▶ Select **Edit Destinations**.
 - ▶ Using the grip symbol next to it, drag the destination to a new position on the route.
- or
- ▶ Select an additional location with **Add Destinations**.

Deleting routes

- ▶ Select  ▶▶ **myTrips** ▶▶ **Delete Trips** on the map.
- ▶ Select one or more routes.
- ▶ Select **Delete**.

Showing traffic information

Real-time traffic data is an optional feature for your vehicle. Contact your authorized Mercedes-Benz Center for more information on traffic functions. Traffic information is not available in all areas.

- ⓘ Mercedes-Benz AG and Garmin are not responsible for the accuracy and timeliness of the traffic information.

Displaying traffic ahead

- ▶ Select  ▶▶ **Traffic**.

Displaying the traffic map

- ▶ Select  ▶▶ **Traffic** ▶▶ **Traffic Map**.

Displaying the traffic legends

- ▶ Select  ▶▶ **Traffic** ▶▶ **Traffic Map** ▶▶  ▶▶ **Traffic Legend**.

Map and compass

Using the map





You can use the map for the following:

- Navigating along a route
- If no route is activated, displaying the map of the area

▶ Press on .

▶ Tap on any point on the map.

The following options are available:

- Move the map to the left, right, up or down.
- To enlarge or reduce the view, select  or .
- To change the display, select **2D** or **3D**.
- To rotate the map, select .
- To filter the POIs shown according to category, select  ▶▶ **Places along the road**.
- To start a route, select a location on the map and then press **Go!**.

Adjusting the map

Adjusting the map layers

You can customize which data is displayed on the map, e.g. symbols for POIs and road conditions.

▶ Select  ▶▶ **Settings** ▶▶ **Navigation** ▶▶ **Map and Vehicle** ▶▶ **Map Layer**.

▶ Tap on the checkboxes of the layers that are to be displayed on the map.

Changing the map data fields

▶ Select a data field on the map.

▶ Select a data type to be displayed.

Changing the map perspective

▶ Select  ▶▶ **Settings** ▶▶ **Navigation** ▶▶ **Map and Vehicle** ▶▶ **Driving Map View**.

▶ Tap on the checkboxes of the layers that are to be displayed on the map.

The following options are available:

- **Track Up:** The map is displayed with the direction of travel upwards and in two dimensions.
- **North Up:** The map is displayed with the compass direction north up and two-dimensional.
- **3D:** The map is displayed three-dimensionally.
- **Split Screen:** The map window is displayed alongside other applications.

Setting functions for smartphones

⚠ WARNING Risk of distraction from operating integrated communication equipment while the vehicle is in motion

If you operate communication equipment integrated in the vehicle when driving, you could be distracted from the traffic situation. This could also cause you to lose control of the vehicle.

▶ Only operate this equipment when the traffic situation permits.

▶ If you cannot be sure of this, stop the vehicle whilst paying attention to road and traffic conditions and operate the equipment with the vehicle stationary.

Observe also the legal requirements for the country in which you are driving.

Requirements:

Bluetooth® mode via the multimedia system is available in conjunction with a Bluetooth®-capable smartphone.

- The smartphone is in the vehicle close to the multimedia system.
- The Bluetooth® function of the multimedia system is switched on.

Pairing smartphones

▶ Press on .

▶ Select **Connect Phone** ▶▶ **Add a device**.

▶ Activate Bluetooth® on your smartphone and make your smartphone visible for other devices.

i You can find additional information in the instruction manual for your smartphone.

▶ Select the name for your smartphone on the multimedia system.

▶ Follow the instructions on the media display to complete the pairing procedure.

Canceling smartphone pairing

▶ Press on .



▶ Select  next to the paired smartphone.

▶ Select **Forget This Device**.



Placing a call

▶ Press on .

The following options are available:

- Enter the telephone number using the keypad  and press on .
- To select a contact from the phone book: press  and select the contact.

The following options are available during a call:

- To transfer the sound output back to your smartphone, press on .
- ① You can use this function if you disconnect Bluetooth® and at the same time wish to maintain the call or conduct a private conversation.
- Call up the dial pad.
- ① You can use this function to use automated systems such as voicemail.
- Press on  to mute the microphone.
- Press on  to end a call.

Saving a telephone number as a preset

You can save up to four contacts as presets on dial pad.

- ▶ Press on .
- ▶ Select **Add Preset Contact** and select a contact.

Displaying messages

- ▶ Select .
- ▶ Select a message.

Connecting Android Auto

- ▶ Make sure that the software on your Android™ smartphone is up to date
- ▶ Download and install the Android Auto app on the smartphone.
- ▶ Connect the Android™ smartphone with the  upper USB media port in the vehicle using a suitable cable.
- ▶ Follow the instructions on the media display to complete the set-up procedure.

Connecting Apple CarPlay®

- ▶ Make sure that the software on the Apple iPhone® is up-to-date.
- ▶ Connect the Apple iPhone® with the  upper USB media port in the vehicle using a genuine Apple® cable.
- ▶ Follow the instructions on the media display to complete the set-up procedure.

Android Auto and Apple CarPlay® are activated by connecting a suitable smartphones with the  USB media port.

Media

Information about supported formats and data storage media

⚠ WARNING Risk of distraction when handling data storage media

If you handle a data storage medium while driving, your attention is diverted from the traffic conditions. This could also cause you to lose control of the vehicle.

▶ Only handle a data storage medium when the vehicle is stationary.

The multimedia system is compatible with many media players, including smartphones and other portable devices. You can connect a compatible media player using Bluetooth® or USB.

The multimedia system is compatible with Android™ devices that support MTP mode.

If you connect an external hard drive, you have to connect this with an external power source.

The multimedia system supports the following formats and data media:

Permissible file systems	FAT16, FAT32, NTFS
Permissible data carriers	USB devices, iPod®/iPhone®, MTP devices, Bluetooth® audio equipment
Supported formats:	MP3, WMA, AAC, WAV, FLAC

① Observe the following notes:

- Due to the wide range of USB devices available on the market, playback cannot be guaranteed for all USB devices.
- Copy-protected music files or DRM (Digital Rights Management) encrypted files cannot be played back.
- MP3 players must support Media Transfer Protocol (MTP).

Overview of the media menu

The information displayed on the media display and visible playback controls may change depending on the media source.



Example: Track is played from a USB device

- ① Active media source
- ② Album cover, if available from a compatible source
- ③ Repeat (once per track)
- ④ Random playback (shuffle mode)
- ⑤ Next track
- ⑥ Controls playback (pause)
- ⑦ Previous track
- ⑧ Timeline (elapsed playing time and playing time of the track)
- ⑨ Details about the track (if available)
- ⑩ Track

Connecting USB devices

! **NOTE** Damage caused by high temperatures

High temperatures can damage USB devices.

- ▶ Remove the USB device after use and take it out of the vehicle.

- ▶ Connect the USB device to the USB media port.
- ▶ Press on .
- ▶ Select **Source** ▶▶ **USB**.

① The Apple CarPlay® and Android Auto functions can be used for Apple® and Android™ devices connected with the upper USB media port. Devices connected with the other

USB media port can be charged and used as mass storage.

Starting media playback

Requirements:

A data storage medium is connected to the multimedia system.

- ▶ Press .
- ▶ Select a media source with **Source**.
- ▶ Select the desired track or station.

Adjusting the volume

- ▶ Press on .
- ▶ Select .
- ▶ Press on or until the desired volume is set.

Information on playback using Bluetooth® devices

When using Bluetooth® devices you can control playback with the control elements on the multimedia system. With some devices you can also search the music library from the menu. On Bluetooth® devices that do not support this type of search, select the track or the playlist directly on the media player itself.

Whether track information such as the song title, artist name, track length and album cover are available, depends on the functions of the media player and the music app.

Radio

Selecting a radio station

- ▶ Select the respective source, e.g. **FM Radio**.

The following options are available:

- To set a lower or higher radio frequency: select or .
- To search for available radio stations: select **Scan**.
- To view a list of the available radio stations: select **Station List**.



Setting DAB stations

DAB stations are not available in all regions.

Station scan for DAB stations

- ▶ Select **DAB Radio**.
- ▶ Press on **Scan**.
When the search is complete, the first available station in the first ensemble found is played.

Changing DAB stations

- ▶ Select **DAB Radio**.
- ▶ If required, select **Scan** to search for a local DAB station.
- ▶ Select  or  to change the DAB station.

Selecting a DAB station from a list

- ▶ Select **DAB Radio**.
- ▶ If required, select **Scan** to search for a local DAB station.
- ▶ Select **Station List**.
- ▶ If required, select a category.
- ▶ Select a station.

Saving a station as a favorite

- ▶ Select the respective source, e.g. **FM Radio**.
- ▶ Select **Favorites**.

The following options are available:

- To store a station in an available preset: select preset.
- To replace a station that has been saved: press and hold on the preset and select **Replace**.

Switching the traffic information service on or off

The traffic information service uses the radio data system (RDS), to provide you with current traffic information. If the system receives a traffic announcement it switches automatically to the station transmitting the traffic announcement. When the announcement is finished the system returns to the previous station.

- ▶ **To switch on the traffic information service:** select .
- ▶ Select **RDS Announcements - TA**.

Satellite radio

Information on satellite radio

SIRIUS XM[®] satellite radio offers more than 140 digital-quality radio channels providing 100% commercial-free music, sports, news and entertainment, for example. SIRIUS XM[®] satellite radio employs a fleet of high-performance satellites to broadcast around the clock throughout the USA

and Canada. The satellite radio program is available for a monthly fee. Information about this can be obtained from a SiriusXM[®] Service Center and at <https://www.siriusxm.com> (USA) or <https://www.siriusxm.ca> (Canada).

- ⓘ Sirius, XM and all related marks and logos are trademarks of SiriusXM Radio Inc. and its subsidiaries. All other marks, channel names and logos are the property of their respective owners. All rights reserved.

Registering satellite radio

Requirements

- Satellite radio equipment
- The registration with a satellite radio provider
- ⓘ If registration is not included when purchasing the system, your credit card details will be required to activate your account

Before you are able to activate your SiriusXM[®] subscription you will need to have the radio ID for your SiriusXM Connect Tuner available. You can call up this radio ID in the SiriusXM[®] settings menu or set your stereo system to channel 0.

- ▶ Select  ▶▶ **SiriusXM Settings** ▶▶ **SiriusXM Radio ID**.

The service information screen appears showing the radio ID and the current subscription status.

- ▶ Establish a telephone connection.
- ▶ Follow the service staff's instructions. The activation process may take up to ten minutes.

- ⓘ You can also have the satellite service activated online. To do so, please visit <https://www.siriusxm.com> (USA) or <https://www.siriusxm.ca> (Canada).

Selecting a satellite radio category

You can make a station selection based on categories.

- ▶ Select SiriusXM[®] as the media source.
- ▶ Select **Browse** ▶▶ **POIs**.
- ▶ Select a category.





Using playback mode

Playback mode is used to control playback of a SiriusXM[®] broadcast.

- ⓘ The device automatically activates the playback mode when stored preset channels are played back.

- ▶ If necessary, select **Live** to switch to playback mode.

The following options are available:

- To continue or pause playback: select  or .
- To stop playback mode: select **Replay**.
- To fast forward or rewind step by step: select  or .

- ⓘ If you fast forward or rewind to the end of the progress bar, playback mode is automatically exited and switched to the current real-time transmission.

Creating a TuneMix™ list

Before you can playback a TuneMix™ list, you must have saved two or more channel presets.

The TuneMix™ function allows you to put together an individual listening experience with your favorite music channels.

- ▶ Set SiriusXM® as the media source and select **Favourites**.
- ▶ Select **TuneMix**.
- ▶ **To end playback:** select **Favourites** ▶▶ **Tune-Mix**.

Switching the TuneStart™ function on or off

When you activate the TuneStart™ function and switch to a preset channel, the track currently playing is played back from the beginning. It does not start at the point at which the live transmission is currently broadcasting.

- ⓘ The TuneStart™ function is only available when you switch on preset channels.
- ▶ Select .
- ▶ Select **SiriusXM Settings** ▶▶ **Tune Start**.
- ⓘ When the TuneStart™ function plays a track from the beginning, a progress bar is shown with which you can control the playback of the track and the playback mode.

Searching unsubscribed channels

You can activate unsubscribed channels as follows:

- ▶ Select SiriusXM® as the media source.
- ▶ Select **SiriusXM Settings** ▶▶ **Unsubscribe Channel List**.
Unsubscribed channels in the channel list are displayed with gray text.
- ▶ Tap on an unsubscribed channel.
The channel name and the name of the artist and track currently playing are displayed.

- ⓘ An unsubscribed channel cannot be set by tapping it.

Deleting user data



All SiriusXM® user information, e.g. presets and other data, can be deleted.

- ▶ Select .
- ▶ Select **SiriusXM Settings** ▶▶ **SiriusXM User Data Reset**.

Updating system software and maps

System software updates provide innovations and improvements in the features and functionality of the multimedia system. They are only small and take a few minutes.

Map updates take into account all current changes in the road layout so the maps are kept up to date. These are extensive and may take several hours.

- ▶ **To update system software:** press .
- ▶ Select **Settings** ▶▶ **About** ▶▶ **System Update**.
- ▶ Follow the instructions on the media display.
- ▶ **To update maps:** press .
- ▶ Select **Settings** ▶▶ **Navigation** ▶▶ **Map and Vehicle** ▶▶ **Map Updates**.
- ▶ Follow the instructions on the media display.

- ⓘ For more information on updating maps and system software <https://auto-oem.garmin.com/landing/site>.

Notes on loading guidelines

⚠ DANGER Risk of poisoning from exhaust gases

Combustion engines emit poisonous exhaust gases, such as carbon monoxide. Exhaust gases can enter the vehicle interior if the tailgate or the rear-end door is open when the engine is running, especially if the vehicle is in motion.

- ▶ Always switch off the engine before opening the tailgate or the rear-end door.
- ▶ Never drive with the tailgate or rear-end door open.

⚠ WARNING Risk of injury from unsecured objects in the vehicle

When objects are unsecured or inadequately secured, they can slip, tip over or be thrown about, striking vehicle occupants.

This also applies to:

- Luggage or loads
- Seats which have been removed and are being transported in the vehicle in an exceptional case

There is a risk of injury, particularly in the event of braking maneuvers or abrupt changes in direction.

- ▶ Always stow objects in such a way that they cannot be tossed about.
- ▶ Before traveling, secure objects, luggage or load to prevent them slipping or tipping over.
- ▶ When a seat is removed, keep it preferably outside the vehicle.

⚠ WARNING Risk of accident due to incorrectly placed load

The center of gravity of the load may be too high and/or too far back.

This can significantly impair the driving, steering and braking characteristics.

- ▶ Always ensure that the center of gravity of the load is between the axles and as low as possible near the rear axle.

⚠ WARNING Risk of accident due to exceeding the permissible wheel/axle loads or the gross vehicle weight

The driving characteristics, as well as steering and braking, may be greatly impaired. Overloaded tires may overheat and burst as a consequence.

- ▶ When transporting a load, always observe the permissible wheel loads, axle loads and the maximum permissible gross mass for the vehicle (including occupants).

⚠ WARNING Risk of injury if unsuitable climbing aids are used

If you use openings in the vehicle's body work or detachable parts as steps, you could:

- Slip and/or fall.
- Damage the vehicle and thus slip and fall.

- ▶ Always use anti-slip, stable climbing aids, e.g. a suitable ladder.

! NOTE Damage caused by the use of openings in the bodywork or detachable part as a step

Using the lower guide of the sliding door (carriage) as a step can damage the trim and/or mechanism of the sliding door.

- ▶ Do not use the guide of the sliding door (carriage) as a step.

If you are using a roof luggage rack, please note the maximum roof load and the maximum load capacity of the roof luggage rack (→ page 245).

The handling characteristics of your vehicle are dependent on the load distribution.

Therefore, please observe the following notes when loading:

- the load must not protrude above the upper edge of the seat backrests.
- if possible, always transport the load in the cargo compartment.
- fasten the load to the tie-down eyes and distribute the load evenly among them.

- if available, use a load protection net to secure the load (→ page 170).
- use tie-down eyes and fastening components which are suitable for the weight and size of the load.

Observe the operating instructions of the manufacturer when using load securing aids or tie downs and the notes on their expiration dates.

In the following cases, load securing aids or tie downs are worn out, should not be used and must be replaced:

- there is missing or illegible identification
- there is cord breakage or damage to load-bearing seams or other traces of cracking
- there are cuts, holes, deformations, crushed areas or other damage
- there is damage to clamping elements or fasteners

If the trunk floor or loading area are damaged in the event of an accident, have the tie-down eyes and the tie downs checked at a qualified specialist workshop.

Even if you adhere to all the loading guidelines, an increased load increases the risk of injury in the event of an accident.

Before loading

! **NOTE** Damage to the vehicle and the load due to anti-slip mats which are no longer suitable

If you use anti-slip mats that display the following characteristics, they must be replaced:

- Permanent deformation and crushed areas
- Traces of cracking
- Cuts or holes

Please observe the following before loading the vehicle:

- Clean the cargo floor, if necessary.
The cargo floor must be free from oil and dust, dry and swept clean to prevent the load from slipping.
- Lay anti-slip mats on the cargo floor.
- Check and, when necessary, adjust the tire pressure (→ page 204).

When loading

Observe the following when loading the vehicle:

- Never exceed the gross axle weight rating or the vehicle's permissible gross mass.
The vehicle's curb weight is increased if accessories or optional equipment are installed. This reduces the maximum payload.
- Observe the notes on load distribution (→ page 165).
- Observe the notes on load securing (→ page 166) and the legal requirements of the country in which you are currently driving.
- Observe the information on the carrier systems (→ page 171).

After loading

Observe the following after loading the vehicle:

- Check that the luggage and/or load is secure before every journey and at regular intervals on long trips.
- Close all doors and the tailgate.
- Adjust the range of the headlamps according to the vehicle load (→ page 77).
- Adjust the tire pressure according to the vehicle load (→ page 204).
- Adapt your driving style according to the vehicle load.

Notes on distributing the load within the vehicle

! **NOTE** Damage to the floor covering due to uneven loading

Excessive point loading on the cargo compartment floor or on the load area can negatively affect the driving characteristics and could damage the floor covering.

- ▶ Distribute the load evenly. When doing so, ensure that the overall center of gravity of the load is always as low and close to the center as possible and between the axles near the rear axle.

Observe the following notes:

- Always transport loads in the cargo compartment and with the seat backrests folded up and properly locked in position.
- Always place the load against the front or rear seat backrests.

- Move large and heavy loads as far as possible towards the front of the vehicle in the direction of travel, against the front or rear seats. Stow loads flush with the rear or front seats.
- Additionally secure the load with suitable load securing aids or tie downs.
- The load must not protrude above the upper edge of the seat backrests.
- Transport loads behind seats that are not occupied.
- If the rear bench seat is not occupied, insert the seat belts crosswise into the seat belt buckle of the opposite seat belt.

Cargo compartment variants

You can vary the cargo compartment according to your transportation requirements as follows:

- By folding the seat backrests forward to the table position
- By removing the rear bench seat

You will find information about rear bench seats in the "Seats" section (→ page 66).

Securing loads

Notes on load securing

⚠ WARNING Risk of accident and injury due to incorrect use of the lashing straps

The following can occur:

- The tie-down eyes may detach or the lashing strap may tear if the permissible load is exceeded
- The load cannot be restrained

The load can slip, tip over or be flung about, striking vehicle occupants.

- ▶ Always tension the lashing straps in the proper manner and only between the described tie-down eyes.
- ▶ Always use lashing straps designed specifically for the loads.

! NOTE Damage to the vehicle if the maximum loading capacity of the cargo tie-down point is exceeded

If you combine various cargo tie-down points to secure a load, always take the maximum

loading capacity of the weakest cargo tie-down point into account.

During maximum full-stop braking, forces may act which can multiply the weight of the load.

- ▶ Always use several cargo tie-down points to distribute the load.
- ▶ Distribute the load on the cargo tie-down points evenly.

Observe the Operating Instructions or the lashing strap manufacturer's instructions for the operation of the lashing strap.

Observe the information relating to the maximum loading capacity of the cargo tie-down points (→ page 245).

As the driver, you are responsible for ensuring the following:

- The load is secured against slipping, tipping, rolling or falling off.
Take usual traffic conditions as well as swerving or full brake application and bad roads into account.
- The applicable requirements and guidelines relating to load-securing practices are met.
If this is not the case, this may constitute a punishable offense, depending on local legislation and any ensuing consequences. Observe country-specific laws.

Make sure that the load is secure before every journey and at regular intervals during a long journey. Adjust the load securing as necessary. Information on how to secure loads correctly can be obtained from the manufacturers of the load securing aids or tie downs for load securing, for example.

Also observe the notes on loading guidelines (→ page 164).

When securing loads, observe the following:

- Fill spaces between the load and the cargo compartment walls or wheel wells. For this purpose, use rigid load securing aids, such as chocks, wooden fixings or padding.
- Attach secured and stabilized loads in all directions.

Use the cargo tie-down points or the tie-down eyes and guide rails in the rear compartment.

Only use tie downs, such as lashing nets and lashing straps, which have been tested in accordance with current standards. Always use

the cargo tie-down points closest to the load and pad sharp edges.

- ① You can obtain tie downs tested in accordance with current standards from a specialist company or from a qualified specialist workshop.

Note on the cargo tie-down points and tie-down eyes on the cargo compartment floor for passenger vehicles (vehicle category M1)

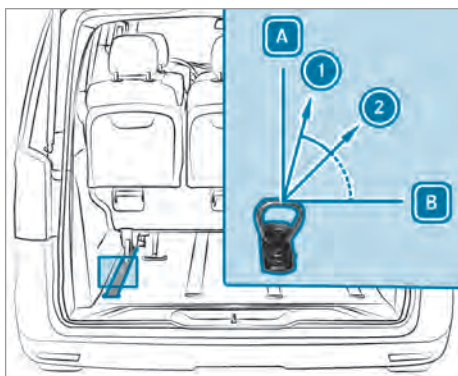

Example: lashing angle for best load security

- A Vertical to the cargo compartment floor
- B Cargo compartment floor
- ① Direction of pull with 75° lashing angle
- ② Direction of pull with 45° lashing angle

The lashing angle is the angle formed between the cargo compartment floor and the tie downs. For optimum load securing in accordance with standard ISO 27955 the lashing angle must be between 45° ② and 75° ①. The maximum nominal tensile load of 786.5 lbf (350 daN) for the tie-down eyes in the cargo compartment floor or in the guide rails may not be exceeded.

Notes on the partition for commercial vehicles (vehicle category N1)

Without a partition, vehicles approved as commercial vehicles (vehicle category N1) do not fulfill the currently valid version of standard ISO 27956. Standard ISO 27956 describes the equipment for properly securing a load in delivery vehicles. If the vehicle is used to transport goods, retrofitting the partition is strongly recommended, as properly securing the load in vehicles without a partition will always be a complex operation.

Overview of cargo tie-down points

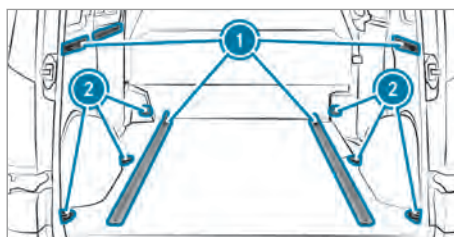

Cargo tie-down points (example: Cargo Van)

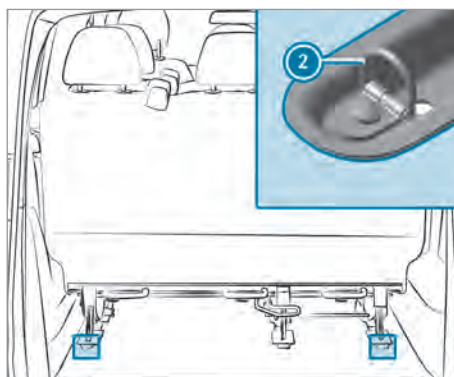

Fixed cargo tie-down points on the floor (example: Tourer with seat anchorages)

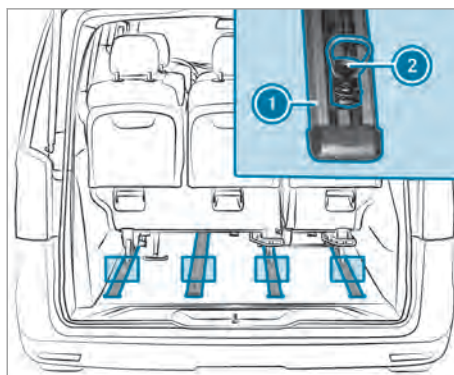

Example: variable cargo tie-down points in the guide rails

- ① Guide/loading rails
- ② Tie-down eye

If your vehicle is equipped with guide or loading rails ① in the cargo compartment floor, you can place lashing rods directly in front of and behind

the load. The lashing rods directly absorb the potential shifting forces.

Securing loads on the cargo compartment floor by lashing them down is only recommended for light-weight loads. Lay anti-slip mats under the load to assist in securing it.

Do not attempt to modify or repair the cargo tie-down points, tie-down eyes or tie downs. Read the information on qualified specialist workshops (→ page 18).

Using lashing straps

Observe the Operating Instructions or the lashing strap manufacturer's instructions for the operation of the lashing strap.

Securing loads on the cargo floor by lashing them down is only recommended for lightweight loads. Lay anti-slip mats under the load to assist in securing it.

- ▶ Observe the notes on securing loads (→ page 166).
- ▶ Observe the maximum loading capacity of the cargo tie-down point and tie-down eyes (→ page 245).

Notes and information on the maximum loading capacity of the lashing strap can be found on the lashing strap label. If the label is missing or illegible, the lashing strap is ready to be discarded and must be replaced. Such a lashing strap must not be used.

If reference stickers were included on delivery, affix them to the vehicle as follows:

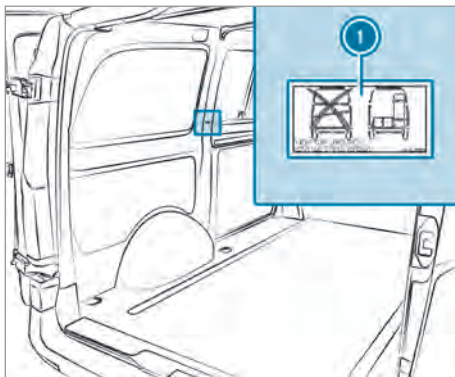

- ▶ Clean the surface before sticker 1 is affixed. The stickers must be affixed to a flat, metallic surface free from grease and dust.

- ▶ Affix stickers 1 on every side of the vehicle in close proximity to the loading rails in a clearly visible location.

Tensioning strap

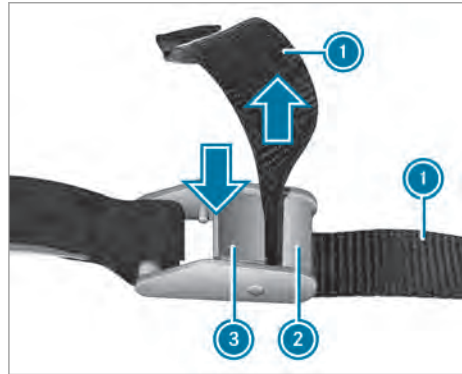

- ▶ Observe the Operating Instructions or the manufacturer's notes on how to use the tensioning strap.

Tightening

- ▶ Press and hold tensioning lever 3.
- ▶ Guide tensioning strap 1 between tensioning lever 3 and brace 2 as illustrated and tighten.
- ▶ Release tensioning lever 3.

Releasing

- ▶ Press and hold tensioning lever 3.
- ▶ Pull tensioning strap 1 out of the strap buckle.

Ratchet strap

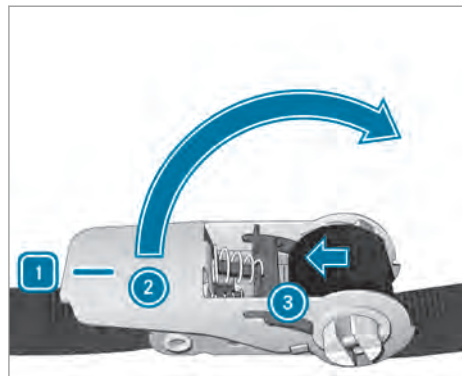

- ▶ Observe the Operating Instructions or the manufacturer's notes on how to use the ratchet strap.

Releasing the tensioning lever

- ▶ Press slider lock ③ outwards in the direction of the arrow and swing tensioning lever ② from detent position ① to the desired position.

Tightening the ratchet strap

- ▶ Release and open tensioning lever ②.

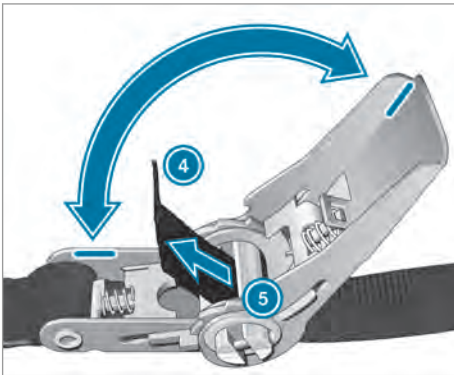

Threading and tensioning

- ▶ Guide ratchet strap ④ through slotted shaft ⑤ from behind as illustrated and tighten it.
- ▶ Swing tensioning lever ② back and forth until ratchet strap ④ has wound around slotted shaft ⑤ and is sufficiently tensioned.
- ▶ Swing tensioning lever ② to detent position ①.

Releasing the ratchet strap

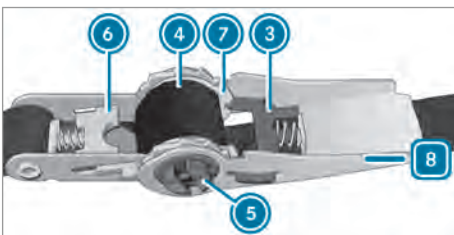

Tensioning lever in the release position

- ▶ Press and hold slider lock ③ outwards.

- ▶ Swing tensioning lever ② as far as it will go to release position ⑧ and release slider lock ③. Slider lock ③ engages in end recess ⑦ and slider lock ⑥ unlocks slotted shaft ⑤.
- ▶ Pull ratchet strap ④ out of the ratchet.

Installing and removing tie-down eyes

▲ WARNING Risk of injury due to incorrectly installed tie-down eyes

If the tie-down eyes are not correctly installed, they can slip or tear out.

This may cause objects, luggage or the load to slip, tip over or be thrown about the vehicle interior, striking vehicle occupants.

- ▶ Make sure that the tie-down eyes are correctly installed and do not move.

- ▶ Observe the notes on loading guidelines and on securing loads (→ page 164).

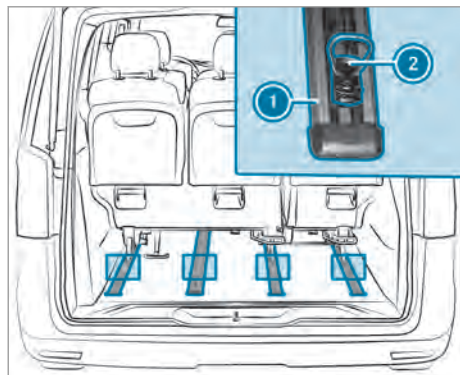

Example: guide rails



Tie-down eyes for guide rails

Installing

- ▶ Turn metal retaining ring ③ so that it is parallel to the long axis of tie-down eye ② as illustrated.
The locking pin can only be pushed down sufficiently and allow the tie-down eye to be installed, moved or removed, if the metal retaining ring is parallel to the long axis of the tie-down eye.
- ▶ Hold tie-down eye ② between your forefinger and middle finger as illustrated, and place your thumb through metal retaining ring ③ and on the central pressure point.
- ▶ Use your thumb to push the locking pin down as far as it will go.
- ▶ Push tie-down eye ② near the load using the notches on guide rail ①, and move it approximately 0.5 in (12 mm).
- ▶ Remove your thumb from the pressure point and slide tie-down eye ② until it engages.
- ▶ Turn metal retaining ring ③ so that it is perpendicular to the long axis of tie-down eye ②. The locking pin cannot be pushed down far if the metal retaining ring is perpendicular to the long axis of the tie-down eye. This prevents the tie-down eye from being released unintentionally, e.g. if the tie-down eye is stepped on.
- ▶ Check that tie-down eye ② is seated correctly.
The tie-down eye cannot be moved.

Removing

- ▶ Turn metal retaining ring ③ so that it is parallel to the long axis of tie-down eye ②.
- ▶ Grip tie-down eye ② as described above under installing and use your thumb to push the locking pin down as far as it will go.
- ▶ Slide tie-down eye ② and pull it up and out through the notch of guide rail ①.

Load securing aid

Removing or installing a load protection net

- ▲ **WARNING** Risk of injury or death due to objects being poorly secured

The load protection net alone cannot restrain or secure heavy objects, luggage or heavy loads.

You could be hit by an unsecured load during sudden changes in direction, braking or in the event of an accident.

- ▶ Always stow objects in such a way that they cannot be thrown about the vehicle.
- ▶ Secure objects, luggage or loads against slipping or tipping over, e.g. by using tie downs, even when you are using the load protection net.

- ▲ **WARNING** Risk of injury due to sitting behind a load protection net

Vehicle occupants can be pressed against the load protection net. There is a risk of injury!

- ▶ Never allow vehicle occupants to sit behind the load protection net.

The load protection net partitions the cargo compartment. It protects vehicle occupants from light objects and/or luggage slipping or tipping over.

You can install the load protection net at an angle behind the front seats or behind the first row of rear seats.

- ▶ Observe the notes on securing loads (→ page 166).

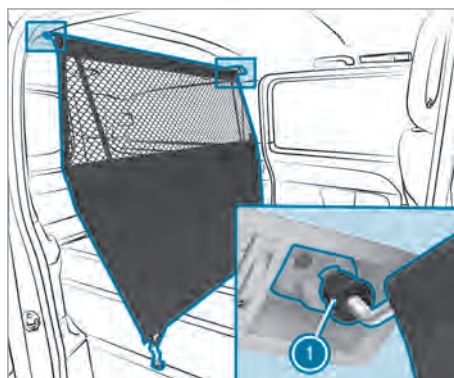

Upper retainer

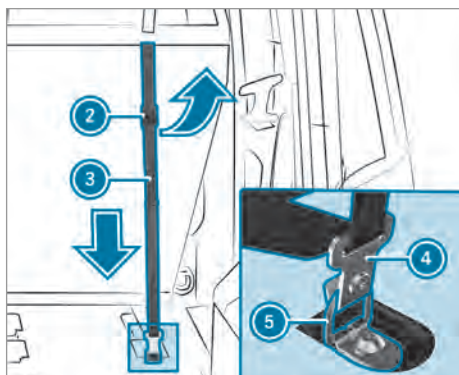

Floor anchorage (example: secured tie-down eye)

Installing

- ▶ Clip the load protection net into upper retainers ① in such a way that tensoning straps ③ face the rear of the vehicle.
- ▶ Install tie-down eyes ⑤ into the guide rails close to the rear seat legs (→ page 169). Position them at least 2 in (5 cm) from the seat legs to allow subsequent movement of the rear seat.
- ▶ Check that tie-down eyes ⑤ are seated correctly. Tie-down eyes ⑤ should not move.
- ▶ Clip hooks ④ on tensoning straps ③ into tie-down eyes ⑤.
- ▶ Fold tensoning element ② up.
- ▶ Pull the loose end of tensoning straps ③ down in the direction of the arrow until tensoning straps ③ are tight.
- ▶ Fold tensoning element ② down to achieve the final tension on the straps.
- ▶ After traveling a short distance, check that the load protection net is taut, and retighten it if necessary.

Removing

- ▶ Fold tensoning element ② up. Tensoning straps ③ are slack.
- ▶ Unclip hooks ④ of tensoning straps ③ from tie-down eyes ⑤ at the bottom.
- ▶ Unclip the load protection net from upper retainers ①.
- ▶ When required, remove tie-down eyes ⑤ (→ page 169).

- ▶ Roll up the load protection net and fasten it, still rolled up, using the Velcro fasteners.

Adjusting the front seat with the load protection net installed

- ▶ Fold tensoning element ② on straps ③ upwards. The load protection net slackens.
- ▶ Correctly adjust the front seat.
- ▶ Re-tension the load protection net.

Carrier systems

Notes on carrier systems

⚠ WARNING Risk of accident due to exceeding the maximum roof load

The vehicle center of gravity and the usual driving characteristics as well as the steering and braking characteristics alter.

If you exceed the maximum roof load, the driving characteristics, as well as steering and braking, will be greatly impaired.

- ▶ Never exceed the maximum roof load and adjust your driving style.

You can find information on the maximum roof load under "cargo tie-down points and carrier systems" (→ page 245).

! NOTE Damage due to exceeding the maximum permissible roof load

If the weight of the roof luggage, including the roof luggage rack, exceeds the maximum permissible roof load, this can cause damage to the vehicle.

- ▶ Do not exceed the maximum permissible roof load.
- ▶ Arrange the supporting feet of the roof luggage rack at an even distance from each other.
- ▶ Install the basic carrier bars for rail in front of and behind the mid-section support.

! NOTE Damage to the threaded holes of the roof luggage rack due to an excessively high tightening torque

An excessively high tightening torque or an insufficient screw-in depth can cause damage

to the thread of the roof luggage rack's threaded holes.

- ▶ Tighten the screws to a maximum torque of 7.4 lb-ft (10 Nm).
- ▶ Comply with the minimum screw penetration of four revolutions in the thread.
- ▶ To avoid damage to the vehicle, use roof and rear luggage racks that have been tested and approved for Mercedes-Benz.

! **NOTE** Damage to the vehicle due to not observing the maximum permitted headroom clearance

If the vehicle height is greater than the maximum permitted headroom clearance, the roof and other parts of the vehicle may be damaged.

- ▶ Observe the signposted headroom clearance.
- ▶ If the vehicle height is greater than the permitted headroom clearance, do not enter.
- ▶ Observe the changed vehicle height with add-on roof equipment.

! **NOTE** The operating permit may be invalidated due to the illegal installation of trailer hitches

The installation – including retrofitting – of a non-folding or non-removable trailer hitch that even partially conceals the license plate or the lighting system is prohibited.

- ▶ Observe the applicable legal regulations for the installation of trailer hitches.

You can install a roof luggage rack on the roof and, for example, a rear bicycle rack on the tailgate.

Install the cover caps of the securing thread after removing the roof luggage rack.

If you have installed a rear luggage rack on the tailgate, the additional weight will restrict the assistance offered by the pneumatic springs when you open the tailgate. You will then need more force to open the tailgate. At low outside temperatures below freezing point, you should provide additional support for the tailgate after opening it in order to prevent it from lowering unintentionally.

Notes on maintenance



ENVIRONMENTAL NOTE Environmental pollution due to disposal in a non-environmentally-friendly manner

If circumstances demand that you have to do some maintenance work yourself, environmental protection requirements must be observed. When disposing of service products, e.g. engine oil, you must comply with the legal requirements. This also includes all components, e.g. filters, which have come into contact with operating fluids.

- ▶ Dispose of empty containers, cleaning cloths and care products in an environmentally responsible manner.
- ▶ Observe the instructions for care products.
- ▶ Do not run the engine for longer than necessary when the vehicle is stationary.

When working on the vehicle, comply with all safety regulations, such as the operating instructions, regulations concerning hazardous materials, environmental protection measures, work safety and accident prevention regulations.

- ⓘ You must secure the vehicle on jack stands of sufficient load-bearing capacity if work is being carried out underneath the vehicle.

Please also refer to the notes about qualified specialist workshops (→ page 18).

The scope and regularity of the inspection and maintenance work primarily depend on the often diverse operating conditions.

You can obtain further information concerning the servicing of your vehicle from a qualified specialist workshop, e.g. an authorized Mercedes-Benz Center.

You will find information about operating fluids approved for Mercedes-Benz and capacities under "Operating Fluids and Capacities" (→ page 238).

Observe the information under "Mercedes-Benz GenuineParts" (→ page 13).

Service interval display

Service interval display function

The ASSYST PLUS service interval display on the instrument cluster display provides information on the remaining time or distance before the next service due date.

Under arduous operating conditions or if the vehicle is subjected to increased loads, the ASSYST PLUS service interval display may shorten the service interval.

You can obtain further information concerning the servicing of your vehicle from a qualified specialist workshop.

Displaying the service due date (vehicles without steering wheel buttons)

Requirements:

- The vehicle is stationary.
- The ignition is switched on.

Use the buttons on the instrument cluster.

- ▶ Press the button to select the service display. The display will show a possible service message.
- ▶ **To exit the display:** press the button on the instrument cluster.

Displaying the service due date (vehicles with steering-wheel buttons)

Requirements:

- The ignition is switched on.

On-board computer:

↪ Service ▶ ASSYST PLUS

The next service due date is displayed.

- ▶ **To exit the display:** press the or steering-wheel button.

Information on regular maintenance work

! **NOTE** Premature wear through failure to observe service due dates

Maintenance work which is not carried out at the right time or incompletely can lead to increased wear and damage to the vehicle.

- ▶ Adhere to the prescribed service intervals.
- ▶ Always have the prescribed maintenance work carried out at a qualified specialist workshop.

Notes on special service requirements

The prescribed service interval is based on normal vehicle use. Maintenance work will need to be performed more often than prescribed if the vehicle is operated under arduous operating conditions or increased loads.

Arduous operating conditions include:

- Regular city driving with frequent intermediate stops
- Frequent short-distance driving
- Frequent operation in mountainous terrain or on poor road surfaces
- When the engine is often left idling for long periods
- Operation in particularly dusty conditions and/or if air-recirculation mode is frequently used

In these or similar operating conditions, have the air filter, engine oil and oil filter, for example, replaced more frequently.

If the vehicle is subjected to increased loads, the tires must be checked more frequently. You can obtain further information at a qualified specialist workshop.

Non-operational times with the battery disconnected

The ASSYST PLUS service interval display can only calculate the service due date when the battery is connected.

- ▶ Display and note down the service due date on the instrument cluster before disconnecting the battery.
 - Displaying the service due date in vehicles without steering wheel buttons (→ page 173).
 - Displaying the service due date in vehicles with steering wheel buttons (→ page 173).

Engine compartment

Opening and closing the hood

- ⚠ **WARNING** Risk of accident due to driving with the hood unlocked

The hood may open and block your view.

- ▶ Never release the hood when driving.

- ▶ Before every trip, ensure that the hood is locked.

- ⚠ **WARNING** Risk of accident and injury when opening and closing the hood

The hood may suddenly drop into the end position.

There is a risk of injury for anyone in the hood's range of movement.

- ▶ Do not open or close the hood if there is a person in the hood's range of movement.

- ⚠ **WARNING** Risk of injury from touching components under voltage

The ignition system and the fuel injection system work under high voltage. You could receive an electric shock.

- ▶ Never touch components of the ignition system or the fuel injection system when the ignition is switched on.

The following are examples of live components:

- Ignition coils
- Spark plug connectors
- Injectors

- ⚠ **WARNING** Risk of burns from hot component parts in the engine compartment

Certain component parts in the engine compartment can be very hot, e.g. the engine, the cooler and parts of the exhaust system.

- ▶ Allow the engine to cool down and only touch component parts described in the following.

- ! **NOTE** Damage to hood or windshield wipers when opening the hood

If the windshield wipers have been folded back from the windshield when the hood is opened, the windshield wipers or the hood may be damaged.

- ▶ Ensure that the windshield wipers have not been folded back from the windshield.

Opening the hood

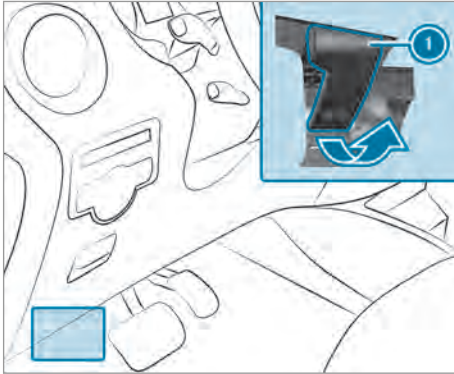

- ▶ Pull handle ① to release the hood.

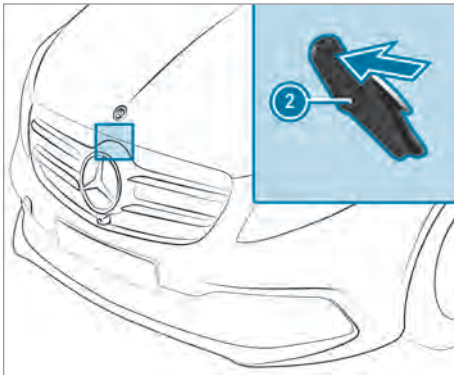

- ▶ Reach into the gap and push lever ② of the hood catch to the left.
- ▶ Lift the hood and hold it in place.

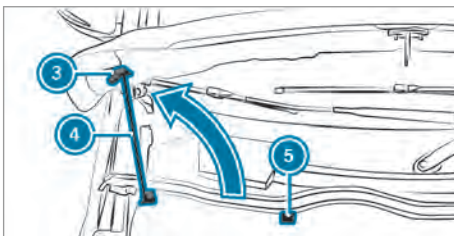

- ▶ Pull support strut ④ out of holder ⑤ and guide it upwards in the direction of the arrow.
- ▶ Lower the hood in such a way that support strut ④ slides into recess ③ and the hood is fixed in place.

Closing the hood

⚠ WARNING Risk of fire due to flammable materials in the engine compartment or on the exhaust system

Flammable materials may ignite.

- ▶ Ensure that there are no flammable external materials in the engine compartment or on the exhaust system after maintenance work has been carried out.

! NOTE Damage to the hood due to pressing it closed manually

Pushing the hood closed with your hands could damage it.

- ▶ To close the hood, let it drop from the specified height.

- ▶ Hold support strut ④ and raise the hood slightly.
- ▶ Guide support strut ④ to holder ⑤ and apply gentle pressure to engage it.
- ▶ Lower the hood and let it fall from a height of approximately 12 in (30 cm), applying a little force as you let it go.
- ▶ If the hood remains slightly open, open it again and let it fall, applying slightly more force as you let it go, until it engages.

Engine oil

Checking the engine oil level with the on-board computer (vehicle without steering-wheel buttons)



Requirements:

- The vehicle is equipped with an oil level sensor (vehicles with rear-wheel drive).
- The vehicle is level during the measuring process.
- The engine is switched off at normal operating temperature.
- A waiting period of five minutes is observed.
- The ignition is switched on.

If no oil level is displayed after five minutes at extremely low temperatures, repeat the engine oil measurement after another five minutes.

If an oil level reading is still not displayed, check the oil level with the oil dipstick (→ page 177). Have the engine oil level checked at a qualified specialist workshop.

Use the buttons on the instrument cluster.

- ▶ Press the  button to select **Oil Level**.
 - ▶ Press the  button to confirm.
- While the engine oil level measurement is in progress, the display shows the **Measuring Engine Oil Level...** message.

The following messages may appear after the engine oil level measurement:

Engine Oil Level OK

- ▶ Do not refill oil.

Add 1,0 liq.gal. Engine Oil

- ▶ Add the specified quantity of oil (→ page 177).
- ▶ Repeat the engine oil measurement after a few minutes.

Engine Oil Level: Reduce Oil Level

- ▶ Siphon off any excess engine oil that has been added. To do so, consult a qualified specialist workshop.

For Eng. Oil Level: Ignition Must Be On

- ▶ Switch on the ignition.

Wait to Check Engine Oil Level

- ▶ If the engine is at normal operating temperature, repeat the engine oil measurement after approximately five minutes.
- ▶ If the engine is not at normal operating temperature, repeat the engine oil measurement after approximately 30 minutes.

Engine Oil Level with Engine Off

- ▶ Switch off the engine and, when it is at normal operating temperature, wait approximately five minutes before measuring the engine oil level.

Check the engine oil level with the on-board computer (vehicle with steering-wheel buttons)

Requirements:

- The engine oil level is determined during driving.
- The engine is at normal operating temperature.
- The vehicle is level during the measuring process.
- The hood is not open.

Depending on the driving profile, the oil level can be displayed only after a driving time of up to

30 minutes and only when the ignition is switched on.

On-board computer:

 **Service**  **Engine Oil Level**

One of the following messages appears on the display of the on-board computer:

Engine Oil Level Measurement in Progress...

- ▶ Measurement of the oil level not yet possible. Repeat the query after driving for a maximum of 30 minutes.

Engine Oil Level OK

The bar for displaying the oil level on the display is green and is between "min" and "max".

- ▶ Do not refill oil. The engine oil level is correct.

Engine Oil Level Warm Up Engine

- ▶ Warm up the engine to operating temperature.

Engine Oil Level Correct Measurement Only if Vehicle Is on Level Ground

- ▶ Park the vehicle on a level surface.

Engine Oil Level Add 1.0 l

The bar for displaying the oil level on the display is orange and is below "min".

The oil level is too low.

- ▶ Add 1.1 US qt (1 l) of engine oil (→ page 177).

Reduce Engine Oil Level

The bar for displaying the oil level on the display is orange and is above "max".

The oil level is too high.

- ▶ Siphon off any excess engine oil that has been added. To do so, consult a qualified specialist workshop.

For Engine Oil Level Ignition Must Be On

- ▶ Switch the ignition on to check the engine oil level.

Engine Oil Level System Inoperative

The fill level sensor is defective or not plugged in.

- ▶ Have the oil level display checked at a qualified specialist workshop.

Engine Oil Level System Currently Unavail.

- ▶ Close the hood.

- ❗ Vehicles with cold oil level display: after the vehicle has been out of use for an extended time, the oil level will automatically be shown on the display. If it is not possible to measure the engine oil level, a message to that effect will appear.

Checking the engine oil level with an oil dipstick

⚠ WARNING Risk of burns from hot component parts in the engine compartment

Certain component parts in the engine compartment can be very hot, e.g. the engine, the cooler and parts of the exhaust system.

- ▶ Allow the engine to cool down and only touch component parts described in the following.

The engine oil becomes dirty during operation, loses quality and also gradually loses volume. Check the oil level regularly and add oil or have it changed if necessary.

Regularly check the fluid level and the major assemblies for leaks. If you detect fluid loss, for example, oil drops on the vehicle parking space, consult a qualified specialist workshop as quickly as possible.

- ▶ Only check the oil level when the engine is at normal operating temperature.

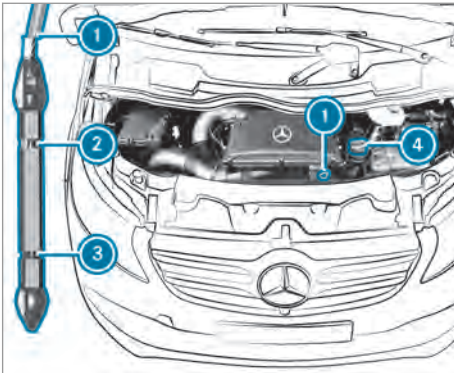

Oil dipstick and engine oil filler opening (example: gasoline engine)

- ▶ Pull oil dipstick ① out of the dipstick tube.
- ▶ Wipe oil dipstick ① using a lint-free cloth.

- ▶ Insert oil dipstick ① back into the guide tube as far as it will go and pull it out again. If the level is between MIN mark ③ and MAX mark ②, the oil level is adequate.
- ▶ If the oil level has dropped to or below minimum mark ③, open cap ④ and add engine oil (→ page 177).

The difference in quantity between marks ② and ③ is about 1.6 US qt (1.5 liters) in the case of gasoline engines.

Adding engine oil

⚠ WARNING Risk of fire and injury from engine oil

If engine oil comes into contact with hot component parts in the engine compartment, it may ignite.

- ▶ Make sure that no engine oil is spilled next to the filler opening.
- ▶ Allow the engine to cool off and thoroughly clean the engine oil from component parts before starting the vehicle.

⚠ WARNING Risk of burns from hot component parts in the engine compartment

Certain component parts in the engine compartment can be very hot, e.g. the engine, the cooler and parts of the exhaust system.

- ▶ Allow the engine to cool down and only touch component parts described in the following.

⚠ NOTE Damage caused by refilling too much engine oil

Too much engine oil can damage the engine or the catalytic converter.

- ▶ Have excess engine oil removed at a qualified specialist workshop.

⚠ NOTE Engine damage due to use of additives in the engine oil

The use of additional additives in the engine oil can damage the engine.

- ▶ Do not use any additional additives in the engine oil.



 **ENVIRONMENTAL NOTE** Environmental damage caused by spilling oil when refilling

Damage is caused to the environment if spilled oil enters the soil.

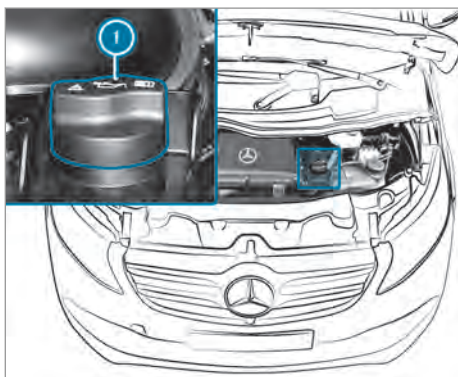
- ▶ When refilling oil, make sure none is spilled.



Example: engine oil filler opening

- ▶ Observe the information regarding approved engine oil under "Operating fluids and capacities" (→ page 239).
- ▶ Unscrew and remove cap .
- ▶ Refill engine oil.
- ▶ Place cap  on the filler opening and tighten. When doing so, make sure that the cap engages correctly.
- ▶ If present, check the oil level using the oil dipstick (→ page 177).
- ▶ In the case of vehicles without an oil dipstick, check the oil level with the on-board computer after the next journey (→ page 175).

It is necessary to run the engine for an extended period after each oil refill to correctly detect the oil level. Fill level changes during oil refills may not be immediately visible. Depending on the driving profile, the new oil level can only be displayed after a driving time of up to 60 minutes.

If necessary, only refill the quantity of oil shown in the instrument cluster display and check the oil level again after the next journey.

Checking/adding coolant

 **WARNING** - Risk of fire and injury from antifreeze

If antifreeze comes into contact with hot component parts in the engine compartment, it may ignite.

- ▶ Allow the engine to cool down before adding antifreeze.
- ▶ Make sure that no antifreeze spills out next to the filler opening.
- ▶ Thoroughly clean off any antifreeze from component parts before starting the vehicle.

 **WARNING** Risk of scalding from hot coolant

If you open the cap, you could be scalded.

- ▶ Let the motor cool down before opening the cap.
- ▶ When opening the cap, wear protective gloves and safety glasses.
- ▶ Open the cap slowly to release pressure.

Check and add coolant only when the vehicle is stationary and in a horizontal position and the engine has cooled down. The coolant temperature must be below 122°F (50°C).

 **WARNING** Risk of burns from hot component parts in the engine compartment

Certain component parts in the engine compartment can be very hot, e.g. the engine, the cooler and parts of the exhaust system.

- ▶ Allow the engine to cool down and only touch component parts described in the following.

Coolant contains glycol and is therefore poisonous.

- ▶ Observe the information under "Operating fluids and capacities" (→ page 241).

 **NOTE** Paintwork damage due to coolant

If coolant gets on painted surfaces, the paintwork can be damaged.

- ▶ Add coolant carefully.
- ▶ Remove spilled coolant.

Regularly check the engine cooling system and the heating system for leaks. If there is a loss of coolant, have the cause determined and rectified in a qualified specialist workshop without delay.

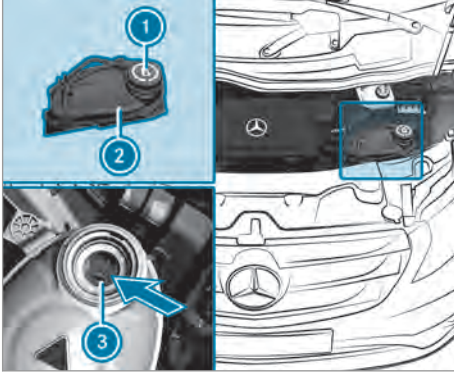

Example: cap and coolant expansion reservoir

Checking the coolant level

- ▶ Slowly turn cap ① of the coolant expansion reservoir ② half a turn counter-clockwise and allow overpressure to escape.
- ▶ Turn cap ① further and remove it.

The coolant level is correct in the following cases:

- Up to marker bar ③ when the engine is cold
- If the engine is warm, up to 0.6 in (1.5 cm) over marker bar ③

Adding coolant

Only use coolant approved for Mercedes-Benz to avoid damaging the engine cooling system.

- ▶ Refer to the information on coolant (→ page 241).
- ▶ Refill the coolant up to marker bar ③ in the filler opening of the coolant expansion reservoir ②.
- ▶ Replace cap ① and tighten in a clockwise direction.
- ▶ Start the engine.
- ▶ Set the temperature in the vehicle interior to the maximum output on the control panel of the climate control.
- ▶ After about five minutes, switch off the engine again and allow it to cool down.
- ▶ Check the coolant level again and add coolant if necessary.

Filling up the windshield washer system

⚠ WARNING Risk of fire and injury from windshield washer concentrate

Windshield washer concentrate is highly flammable.

- ▶ Avoid fire, open flames, smoking and the creation of sparks when using windshield washer concentrate.

⚠ WARNING Risk of burns from hot component parts in the engine compartment

Certain component parts in the engine compartment can be very hot, e.g. the engine, the cooler and parts of the exhaust system.

- ▶ Allow the engine to cool down and only touch component parts described in the following.

⚠ NOTE Damage to the exterior lighting due to unsuitable windshield washer fluid

Unsuitable windshield washer fluid may damage the plastic surface of the exterior lighting.

- ▶ Only use windshield washer fluids that are also suitable for use on plastic surfaces, e.g. MB SummerFit or MB WinterFit.

Adding washer fluid

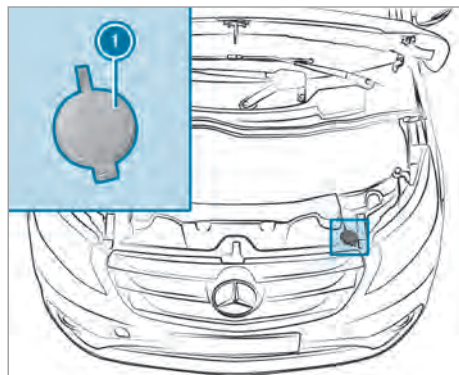

Washer fluid reservoir (example)

- ▶ Observe the notes on windshield washer fluid (→ page 241).
- ▶ Pull cap ① upwards by the tab.
- ▶ Add washer fluid.

- ▶ Push cap  onto the filler opening until it audibly engages.

Cleaning and care

Notes on washing the vehicle in an automatic car wash

⚠ WARNING Risk of accident due to reduced braking effect after washing the vehicle

The braking effect is reduced after washing the vehicle.

- ▶ After the vehicle has been washed, brake carefully while paying attention to the traffic conditions until the braking effect has been fully restored.

! NOTE Damage to the vehicle due to automatic braking

When the following functions are activated, the vehicle brakes automatically in certain situations:

- Active Brake Assist
- Active Distance Assist DISTRONIC
- HOLD function

To avoid damage to the vehicle, deactivate these systems in the following or similar situations:

- ▶ When towing
- ▶ In a car wash

! NOTE Damage due to unsuitable car wash

- ▶ Before driving into a car wash make sure that the car wash is suitable for the vehicle dimensions.
- ▶ Ensure there is sufficient ground clearance between the underbody and the guide rails of the car wash.
- ▶ Ensure that the clearance width of the car wash, in particular the width of the guide rails, is sufficient.

To avoid damage to your vehicle, observe the following before using an automatic car wash:

- Active Brake Assist is deactivated.
- Active Distance Assist DISTRONIC is deactivated.
- The HOLD function is switched off.

- The side windows and roof are completely closed.
- The outside mirrors are folded in and an additional antenna is removed, if present.
- The climate control blower is switched off.
- The windshield wiper switch is in position .

If the vehicle is very dirty, wash off excess dirt before cleaning the vehicle in an automatic car wash.

After leaving the car wash, pay attention to the following:

- The outside mirrors are fully folded out again and an additional antenna is mounted again, if present.
- Remove wax residues on the windshield and wiper rubbers to prevent smearing and reduce wiper noise.

Remove wax residues from the camera lens in vehicles with a rear view camera (→ page 182).

Notes on use of a power washer

⚠ WARNING Risk of an accident when using power washers with round-spray nozzles

The water jet can cause externally invisible damage.

Components damaged in this way may unexpectedly fail.

- ▶ Do not use a power washer with round-spray nozzles.
- ▶ Have damaged tires or chassis parts replaced immediately.

! NOTE Damage to component parts due to improper high-pressure cleaning

Components can be damaged if the distance of the high-pressure nozzle is too small.

- ▶ Maintain a minimum distance of about 12 in (30 cm) between the high-pressure nozzle and car parts.
- ▶ Do not use a power washer with a round-spray nozzle.
- ▶ Keep the water jet moving constantly while cleaning.
- ▶ Do not clean the following components with the power washer:

- Electrical components
- Plug connectors
- Rear view camera
- Drivetrain
- Seals
- Hoses

! **NOTE** Damage caused by the use of a power washer in the vehicle interior

The pressurized water created by the power washer and the associated spray could cause considerable damage to the vehicle.

- ▶ Never use a power washer in the vehicle interior.

! **NOTE** Damage to the exhaust gas after-treatments through incorrect cleaning

Cleaning the system when warm or the effects of direct water jets into the exhaust pipe can damage the exhaust gas aftertreatment.

- ▶ Only clean the system when the system is cold.
- ▶ Do not direct the water jet into the exhaust pipe.

Washing the engine

! **NOTE** Damage and malfunctions due to washing the engine

- ▶ To prevent damage and malfunctions of the engine, observe the following points:
 - When using high-pressure or steam cleaners, do not point the water jet directly at electrical components and the end of electric cables.
 - Make sure that no water enters the vent and ventilation openings.
 - Use preservative agents in the engine after washing the engine.
 - Protect the belt drive from preservation agents.

Washing the vehicle by hand

Observe the legal requirements, e.g. in a number of countries, washing by hand is only permitted in specially designated wash bays.

- ▶ Wash the vehicle with lukewarm water and a soft car sponge. When doing so, do not expose the vehicle to direct sunlight.
- ▶ Use a mild cleaning agent, e.g. a Mercedes-Benz approved car shampoo.
- ▶ Carefully spray the vehicle with water and dry off with a leather cloth. Do not point the water jet directly into the air inlet grille.

When operating the vehicle in winter, remove all traces of road salt deposits carefully and as soon as possible.

Notes on care of paint and matte finish

! **NOTE** Paintwork damage and corrosion due to inadequate care

Failure to promptly and thoroughly remove dirt from bird droppings or other residue could result in paintwork damage and corrosion at a later date.

- ▶ Clean dirt off paint and matte finish thoroughly and as soon as possible.

Observe the notes on cleaning and care to avoid paintwork damage.

Paint

- Insect remains: soak with insect remover and then wash off.
- Bird droppings: soak with water and then wash off.
- Tree resin, oils, fuels and greases: remove by rubbing gently with a cloth soaked in petroleum ether or lighter fluid.
- Coolant and brake fluid: remove with a moist cloth and clean water.
- Tar stains: use tar remover.
- Wax: use silicone remover.
- Do not affix stickers, films or similar.
- Remove dirt as soon as possible.

Matte finish

- Only use care products approved for Mercedes-Benz.
- Do not polish the vehicle and alloy wheels.
- Use only automatic car washes that meet current technological standards.
- Do not use a wash program that ends with a hot wax treatment in automatic car washes.

- Do not use paint cleaners, buffing or polishing products, gloss preservers, e.g. wax.
- Always have paintwork repairs carried out at a qualified specialist workshop.

Notes on the care of vehicle parts

⚠ WARNING Risk of injury if unsuitable climbing aids are used

If you use openings in the vehicle's body work or detachable parts as steps, you could:

- Slip and/or fall.
 - Damage the vehicle and thus slip and fall.
- ▶ Always use anti-slip, stable climbing aids, e.g. a suitable ladder.

⚠ WARNING Risk of entrapment if the windshield wipers are switched on while the windshield is being cleaned

If the windshield wipers are set in motion while you are cleaning the windshield or wiper blades, you can be trapped by the wiper arm.

- ▶ Always switch off the windshield wipers and the ignition before cleaning the windshield or wiper blades.

⚠ WARNING Risk of burns from the tailpipe and tailpipe trims

The exhaust tailpipe and tailpipe trims can become very hot. If you come into contact with these parts of the vehicle, you could burn yourself.

- ▶ Always be particularly careful around the tailpipe and the tailpipe trims and supervise children especially closely in this area.
- ▶ Allow vehicle parts to cool down before touching them.

! NOTE Damage caused by the use of openings in the bodywork or detachable part as a step

Using the lower guide of the sliding door (carriage) as a step can damage the trim and/or mechanism of the sliding door.

- ▶ Do not use the guide of the sliding door (carriage) as a step.

- i** Information on suitable cleaning agents or cleaning cloths can be obtained from a qualified specialist workshop.

To prevent damage to the vehicle, observe the notes for cleaning and care of the following vehicle parts:

Wheels and rims

- Use water and acid-free alloy wheel cleaner.
- Do not use acidic alloy wheel cleaners to remove brake dust. Otherwise, wheel bolts and brake components could be damaged.
- To avoid corrosion of brake discs and brakepads, drive for a few minutes after cleaning before parking the vehicle. The brake discs and brakepads warm up and dry out.

Windows

- Clean the windows inside and outside with a damp cloth and with a cleaning agent recommended for Mercedes-Benz.
- Do not use dry cloths, abrasive cleaning agents or cleaners containing solvents to clean the inside of windows.

Wiper blades

- With the wiper arms folded away, clean the wiper blades with a damp cloth (→ page 85).
- Do not clean the wiper blades too often.

Exterior lighting

- Clean the lenses with a wet sponge and mild cleaning agent, for example, car shampoo.
- Only use cleaning agents or cloths suitable for plastic lenses.

Sensors

- Clean the sensors in the front and rear bumpers with a soft cloth and car shampoo (→ page 108).
- When using a power washer, keep a minimum distance of 12 in (30 cm).

Rear view camera

- Use clean water and a soft cloth to clean the camera lens.
- Do not use a power washer.

Sliding door

- Remove foreign objects from the vicinity of the contact plates and contact pins of the sliding door.
- Clean the contact plates and contact pins with a mild cleaning agent and a soft cloth.
- Do not oil or grease the contact plates and the contact pins.

Tailpipes

- Clean with a cleaning agent recommended for Mercedes-Benz, especially in the winter and after washing the vehicle.
- Do not use acidic cleaning agents.

Trailer hitch

Observe the notes on care in the trailer hitch manufacturer's operator manual.

Notes on the cleaning and care of the interior

⚠ WARNING Risk of injury from plastic parts breaking off after the use of solvent-based care products

Care and cleaning products containing solvents can cause surfaces in the cockpit to become porous. When the airbags are deployed, plastic parts may break away.

- ▶ Do not use any care or cleaning products containing solvents to clean the cockpit.

⚠ WARNING Risk of injury or fatal injuries from bleached seat belts

Bleaching or dyeing seat belts can severely weaken them.

This can, for example, cause seat belts to tear or fail in an accident.

- ▶ Never bleach or dye seat belts.

! NOTE Property damage due to disinfectants

The interior includes a number of sensitive surfaces such as displays, plastics and leather.

Disinfectants can contain alcohol and other substances that penetrate and damage surfaces. Technology behind buttons and displays can also be damaged.

- ▶ Do not use disinfectant on interior surfaces.

To prevent damage to the vehicle, observe the following notes for cleaning and care:

Seat belts

- Clean with lukewarm soapy water.
- Do not use chemical cleaning agents.
- No heating over 176°F (80°C) or drying in direct sunlight.

Instrument cluster

- Clean the surface carefully with a microfiber cloth and acrylic glass care product.
- Do not use any other agents.

Display

- Switch off the display and let it cool down.
- Clean the surface carefully with a microfiber cloth and a suitable display cleaning product (TFT-LCD).
- Do not use any other agents.

Digital inside rearview mirror

- Clean the mirror glass with a cloth moistened with glass cleaner.
- Clean the light sensors of the inside rearview mirror with a dry cotton cloth.
- Do not spray the glass cleaner on the mirror glass.
- Do not use any other agents.

Plastic trim

- Clean with a damp microfiber cloth.
- For heavy soiling: Use a cleaning product recommended for Mercedes-Benz.
- Do not affix stickers, films or similar.
- Do not allow to come into contact with cosmetics, insect repellent and sun creams.

Headliner

- Clean with a brush or dry shampoo.

Carpet

- Use a carpet and textile cleaning agent recommended for Mercedes-Benz.

Genuine leather seat covers

- Clean with a damp cloth and then wipe with a dry cloth.
- Leather care: Use a leather care agent recommended for Mercedes-Benz.
- Do not allow the leather to become too damp.
- Do not use a microfiber cloth.

Imitation leather seat covers

- Clean with a damp cloth and 1% soapy water.
- Do not use a microfiber cloth.

Cloth seat covers

- Clean with a damp microfiber cloth and 1% soap solution and allow to dry.

Steering wheel from genuine leather

! NOTE Damage caused by wrong cleaners

▶ Do not use solvent-based cleaning agents such as tar remover or wheel cleaner; neither should you use polishes or waxes. Otherwise you may damage the finish.

- Clean with a damp cloth and a 1% soapy water solution and then wipe with a dry cloth.
- For heavy soiling: Use a cleaning product recommended for Mercedes-Benz.
- Leather care: Use a leather care agent recommended for Mercedes-Benz.
- Do not allow the leather to become too damp.
- Do not use a microfiber cloth.

i Leather is a natural product. It has natural surface properties, such as differences in structure, marks caused by growth and injury or subtle color differences.

Real wood and trim elements

- Clean with a microfiber cloth.
- Black piano-lacquer look: Clean with a damp cloth and soapy water.
- For heavy soiling: Use a cleaning product recommended for Mercedes-Benz.
- Do not use any cleaning agents, polishes or waxes containing solvents.

Emergency

Removing the safety vest

The safety vest is located in the door storage compartment in the driver's door.

▶ Take the safety vest out of the door storage compartment.

ⓘ Safety vests can also be stored in the door storage compartment of the co-driver's door.

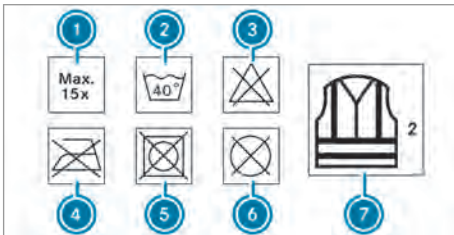

- ① Maximum number of washes
- ② Maximum wash temperature
- ③ Do not bleach
- ④ Do not iron
- ⑤ Do not tumble dry
- ⑥ Do not dry-clean
- ⑦ This is a class 2 vest

The safety vest only fulfills the legally required standards if it is the correct size and is completely closed.

Replace the safety vest in the following cases:

- If damaged or if the reflective strips are dirty
- If the maximum permitted number of washes is exceeded
- If the safety vest's fluorescence has faded

Removing the first-aid kit (soft sided)

The first-aid kit (soft sided) is located in the storage compartment in the co-driver door.

▶ Remove first-aid (soft sided) kit from the storage compartment.

Check the expiration date on the first-aid kit (soft sided) at least once a year. Replace any expired or missing contents.

Observe the legal requirements of the country in which you are currently driving.

Mercedes-Benz emergency call system

Information on the Mercedes-Benz emergency call system

⚠ WARNING Risk of distraction from information systems and communications equipment

If you operate information systems and communication devices integrated in the vehicle when driving, you could be distracted from the traffic situation. This could also cause you to lose control of the vehicle.

- ▶ Only operate this equipment when the traffic situation permits.
- ▶ If you cannot be sure of this, stop the vehicle whilst paying attention to road and traffic conditions and operate the equipment with the vehicle stationary.

Observe the legal requirements for the country in which you are staying.

The Mercedes-Benz emergency call system only functions in areas where mobile phone coverage is available from the relevant contract partner. Insufficient network coverage from the relevant contract partner may result in an emergency call not being transmitted.

The Mercedes-Benz emergency call system can help to decisively reduce the time between an accident and the arrival of emergency services at the site of the accident. It helps locate an accident site in places that are difficult to access.

An emergency call can be initiated automatically or manually using the SOS button (→ page 186).



Only make emergency calls if you or others are in need of rescue. Do not make an emergency call in the event of a breakdown or a similar situation.

Additional information on the transferred data (→ page 187).

You can find more information on the regional availability of the Mercedes-Benz emergency call system at: <https://www.mercedes-benz-mobile.com/extra/ecall/>

Displays in the instrument cluster

After the ignition is switched on, a message appears in the instrument cluster indicating whether your vehicle can be located.

On vehicles without steering wheel buttons, the  **Tracking Active** or  **Tracking not Active** message briefly appears.

On vehicles with steering wheel buttons, the  symbol is only then shown in the status area if the positioning function is active.

SOS NOT READY: The ignition is not switched on or the emergency call system is malfunctioning.

SOS READY: The emergency call system is available again, after a malfunction, for example.

During an active emergency call the  symbol and various messages about the status of the emergency call appear in the display.

If the emergency call system is malfunctioning, the instrument cluster displays a corresponding message.

Triggering an automatic Mercedes-Benz emergency call

Requirements:

- The vehicle is switched on.
- The starter battery is sufficiently charged.

If restraint systems such as airbags or Emergency Tensioning Devices have been activated after an accident, eCall may automatically initiate an emergency call.

When the emergency call is made:

- A voice connection is made to the Mercedes-Benz emergency call center.
- A message with accident data is transmitted to the Mercedes-Benz emergency call center.

The Mercedes-Benz emergency call center can transmit the vehicle position data to one of the emergency call centers.

The SOS button in the overhead control panel flashes until the emergency call is finished.

It is not possible to immediately end an automatic emergency call.

If no connection can be made to the emergency services:

- ▶ Dial the local emergency number on your mobile phone.

If an emergency call has been initiated:

- Remain in the vehicle if the road and traffic conditions permit you to do so until a voice

connection is established with the emergency call center operator.

- Based on the call, the operator decides whether it is necessary to call rescue teams and/or the police to the accident site.
- If no vehicle occupant answers, an ambulance is sent to the vehicle immediately.

Triggering a manual emergency call

Requirements:

- The ignition is switched on.
- The starter battery is sufficiently charged.

If restraint systems such as airbags or Emergency Tensioning Devices are activated during an accident, the Mercedes-Benz emergency call system automatically initiates an emergency call.

Initiating an emergency call manually using the SOS button in the overhead control panel

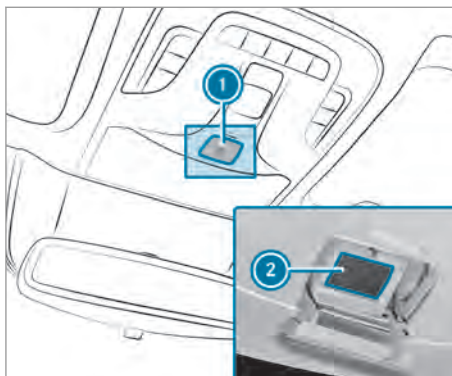

- ▶ To open, briefly press cover **1** for SOS button **2**.
- ▶ Press and hold the SOS button for at least one second. The indicator lamp in SOS button **2** flashes until the emergency call is finished.

When the emergency call is made:

- A voice connection is made to the Mercedes-Benz emergency call center.
- A message with the accident data is transmitted to the Mercedes-Benz emergency call center.

The Mercedes-Benz emergency call center can transmit the vehicle position data to one of the public emergency services call centers.

- Remain in the vehicle if the road and traffic conditions permit you to do so until a voice connection is established with the emergency call center operator.
- Based on the call, the operator decides whether it is necessary to call rescue teams and/or the police to the accident site.
- In certain situations data is also transmitted in the voice channel to the Mercedes-Benz emergency call center.



This allows measures for rescue, recovery or towing to a Mercedes-Benz Commercial Van Center to be initiated quickly.

If the Mercedes-Benz emergency call system cannot connect to the Mercedes-Benz emergency call center, the emergency call is automatically sent to the public emergency services call center.

If no connection can be made to the public emergency services, a corresponding message appears in the display.

- ▶ Dial the local emergency number on your mobile phone.

Ending an unintentional emergency call

- ▶ **Vehicles without steering wheel buttons:** press the  button in the instrument cluster.
- ▶ **Vehicles with steering wheel buttons:** press the  button on the steering wheel.
- ▶ Close the SOS button cover

Data transfer of the Mercedes-Benz emergency call system

In the event of an automatic or manual emergency call, as well as for a **112** emergency call, data is transmitted to the Mercedes-Benz emergency call center or the public emergency services call center.

The following data is transmitted:

- Vehicle's GPS position data
- (G)GPS position data on the route (a few hundred metres before the incident)
- Direction of travel
- Vehicle identification number
- Vehicle drive type
- Number of persons on the front seats
- Whether the emergency call was initiated manually or automatically

- Time of the accident
- Language setting

For accident clarification purposes, the following measures can be taken up to an hour after the emergency call has been initiated:

- The current vehicle position can be called up.
- A voice connection to the vehicle occupants can be established.

Flat tire

Notes on flat tires

WARNING Risk of accident due to a flat tire

A flat tire strongly impairs the vehicle's driving characteristics, as well as its steering and braking characteristics.

- ▶ Do not drive with a flat tire.
- ▶ Replace the flat tire with the spare wheel. Alternatively, consult a qualified specialist workshop.

You will find a sticker with the Mercedes-Benz Service24h telephone number on the B-pillar on the driver's side, for example.

For vehicles with a spare wheel, information in the event of a flat tire can be found under "Wheels and tires" (→ page 213).

Battery

Notes on the starter battery

Work on the battery, e.g. removing or installing, requires specialist knowledge and the use of special tools. Therefore, always have work on the battery carried out at a qualified specialist workshop.

WARNING Risk of an accident due to work carried out incorrectly on the battery

Work carried out incorrectly on the battery can, for example, lead to a short circuit. This can restrict functions relevant for safety systems and impair the operating safety of your vehicle.

You could lose control of the vehicle in the following situations in particular:

- When braking
- In the event of abrupt steering maneuvers and/or when the vehicle's speed is not adapted to the road conditions
- ▶ In the event of a short circuit or a similar incident, contact a qualified specialist workshop immediately.
- ▶ Do not drive on.
- ▶ Always have work on the battery carried out at a qualified specialist workshop.

- Further information on ABS (→ page 109)
- Further information on ESP® (→ page 109)

For safety reasons, Mercedes-Benz recommends that you only use batteries which have been approved for your vehicle by Mercedes-Benz. These batteries provide increased impact protection to prevent vehicle occupants from suffering acid burns should the battery be damaged in an accident.

⚠ WARNING Risk of explosion due to electrostatic charge

Electrostatic charge can ignite the highly explosive gas mixture in the battery.

- ▶ To discharge any electrostatic charge that may have built up, touch the metal vehicle body before handling the battery.

The highly flammable gas mixture is created while the battery is charging and when jump-starting. Make sure that neither you nor the battery is electrostatically charged.

Electrostatic charge can occur in the following cases, for example:

- You are wearing synthetic clothing.
- There is friction between your clothing and the seat.
- If you drag or push the battery across a carpet or other synthetic materials
- You rub the battery with cloths or towels

⚠ WARNING Danger of chemical burns from the battery acid

Battery acid is caustic.

- ▶ Avoid contact with the skin, eyes or clothing.
- ▶ Do not lean over the battery.
- ▶ Do not inhale battery gases.
- ▶ Keep children away from the battery.
- ▶ Immediately rinse battery acid off thoroughly with plenty of clean water and seek medical attention immediately.

🌿 ENVIRONMENTAL NOTE Environmental damage due to improper disposal of batteries



Batteries contain pollutants. It is illegal to dispose of them with the household rubbish.



Dispose of batteries in an environmentally responsible manner. Take discharged batteries to a qualified specialist workshop or to a collection point for used batteries.

Observe the safety notes and protective measures when handling batteries.



Risk of explosion



Fire, open flames and smoking are prohibited when handling the battery. Avoid creating sparks.



Electrolyte or battery acid is corrosive. Avoid contact with the skin, eyes and clothing. Wear suitable protective clothing, in particular gloves, an apron and a safety mask. Immediately rinse electrolyte acid splashes off with clean water. If necessary, seek medical advice.



Wear eye protection.



Keep children at a safe distance.



Observe these Operating Instructions.

Observe the following notes:

- Recharge the battery more frequently in the following cases:
 - You predominantly drive short distances.
 - You predominantly drive at low outside temperatures.
 - You leave the vehicle parked for a lengthy period.

In order for the batteries to achieve their maximum possible service life, they must always be sufficiently charged.

- Consult a qualified specialist workshop if you wish to leave your vehicle parked up for long periods.
- When you park the vehicle, remove the key if you do not require any electrical consumers. The vehicle will then use very little energy, thus conserving battery power.
- If your vehicle requires jump-starting, or if you wish to provide jump-starting assistance to another vehicle, only use the jump-start connection point in the engine compartment (→ page 189).

Installation locations

Your vehicle may be equipped with the following three batteries, depending on the equipment version:

- Starter battery in the seat base of the right-hand front seat
- Support battery in the seat base of the right-hand front seat
- Auxiliary battery in the seat base of the left-hand front seat

Starting assistance and charging the 12 V battery

⚠ WARNING Risk of explosion from a frozen battery

A discharged battery may freeze at temperatures slightly above or below freezing point.

During starting assistance or battery charging, battery gas can be released.

- ▶ Always allow a battery to thaw before charging it or performing starting assistance.

If the warning/indicator lamps do not light up in the instrument cluster at temperatures around or below freezing, it is highly probable that the discharged battery has frozen.

In this case, observe the following points:

- Do not give the vehicle starting assistance or charge the battery.
- The service life of a battery that has been thawed may be reduced drastically.
- The starting behavior may deteriorate, particularly at low temperatures.
- It is recommended that you have a thawed battery checked at a qualified specialist workshop.

⚠ WARNING Risk of explosion due to a mixture of explosive gases

A mixture of explosive gases can escape from the battery during charging and jump starting.

- ▶ Fire, open flames, smoking and creating sparks must be avoided.
- ▶ Make sure that there is sufficient ventilation.
- ▶ Do not stand over the battery.

⚠ WARNING Danger of chemical burns from the battery acid

Battery acid is caustic.

- ▶ Avoid contact with the skin, eyes or clothing.
- ▶ Do not lean over the battery.
- ▶ Do not inhale battery gases.
- ▶ Keep children away from the battery.
- ▶ Immediately rinse battery acid off thoroughly with plenty of clean water and seek medical attention immediately.

Starting assistance

ⓘ NOTE Damage caused by numerous or extended attempts to start the engine

Numerous or extended attempts to start the engine may damage the catalytic converter due to non-combusted fuel.

- ▶ Avoid numerous and extended attempts to start the engine.

Do not use a rapid charging device to start the vehicle. If your vehicle's battery is discharged, the engine can be jump-started from another vehicle or from a donor battery using jumper cables. For this purpose, the vehicle has a jump-start connection point in the engine compartment.

When jump-starting, observe the following points:

- The battery is not accessible in all vehicles. If the other vehicle's battery is not accessible, starting assistance is to be provided using a donor battery or a starting assistance device.
- You may only jump-start the vehicle when the engine and exhaust system are cold.
- If the battery is frozen, do not start the vehicle. Let the battery thaw first.
- Starting assistance may only be provided using batteries with a nominal voltage of 12 V.
- Only use jumper cables that have a sufficient cross-section and insulated terminal clamps.
- If the battery is fully discharged, attach the donor battery for a few minutes before attempting to start. This charges the discharged battery a little.
- Make sure that the two vehicles do not touch.

Jumper cables and further information regarding starting assistance can be obtained at any qualified specialist workshop.

Ensure the following before connecting the jumper cables:

- The jumper cables are not damaged.
 - Parts of the terminal clamps which are not insulated do not come into contact with other metal parts while the jumper cables are connected to the battery.
 - The jumper cables do not touch moving parts when the vehicle is started, such as the V-belt pulley or the fan.
- ▶ Apply the parking brake.
 - ▶ Shift the transmission to position **P**.
 - ▶ Switch off all electrical consumers, e.g. audio equipment, blower.
 - ▶ Switch off the vehicle and remove the key.
 - ▶ Open the hood (→ page 174).

Connecting and disconnecting the jumper cables

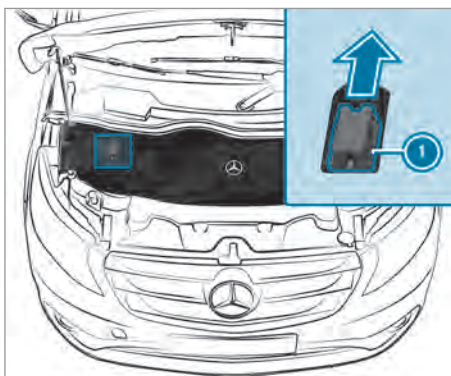

Example: jump-start connection point

- ▶ Push contact protection cover ① of the jump-start connection point towards the rear of the vehicle against the spring pressure as far as it will go. Positive terminal ⑤ of the jump-start connection point is visible.

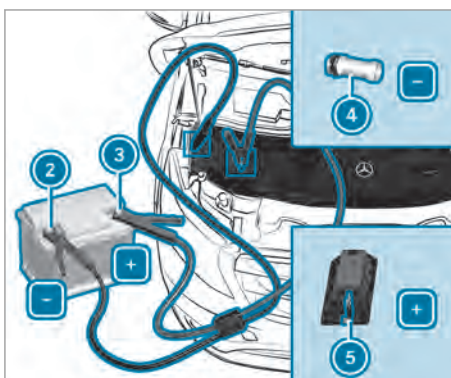

Terminal connection diagram

- ▶ Remove the cover from positive terminal ③ of the donor battery.
- ▶ Connect the positive terminal clamp of the jumper cable to positive terminal ③ of the donor battery, and then to positive terminal ⑤ of the jump-start connection point.
- ▶ Connect the negative terminal clamp of the jumper cable to negative terminal ② of the donor battery, and then to ground contact ④ of your own vehicle.

- ▶ Start the engine of the donor vehicle and run it at idling speed.
- ▶ Start the vehicle and let the engine run for a while.
- ▶ Before disconnecting the jumper cables, switch on an electrical consumer in your own vehicle, e.g. the rear window heater or the lighting.
- ▶ Disconnect the negative terminal clamp of the jumper cable from ground contact ④ and then from negative terminal ② of the donor battery.
- ▶ Disconnect the positive terminal clamp of the jumper cable from positive terminal ⑤ on the jump-start connection point, and then from positive terminal ③ of the donor battery. Contact protection cover ① is automatically returned forwards to its original position by the spring force and the jump-start connection point is closed.
- ▶ Position the cover on positive terminal ③ of the donor battery.
- ▶ Have the battery checked at a qualified specialist workshop.

Charging the 12 V battery

! **NOTE** Damage to the electronics due to unapproved chargers

If you charge an installed battery with a charger not approved for Mercedes-Benz, the on-board electronics can be damaged.

- ▶ Only use a charger approved for Mercedes-Benz which permits charging in the installed condition.
- ▶ Only charge the battery via the jump-start connection point.

A battery charger specially adapted for Mercedes-Benz vehicles and tested and approved for Mercedes-Benz is available as an accessory.

Further information is available from any Mercedes-Benz Commercial Van Center. Read the operating instructions for your charger before charging the battery.

Recharge the battery more frequently if you use the vehicle mainly for short trips and/or drive at low outside temperatures.

- ▶ Connect the battery charger to the positive terminal and ground contact in the same order as

when connecting the donor battery in the jump-starting procedure.

- ⓘ If a battery is not installed and not in service, you should charge it every three months. This helps to counteract self-discharging and prevent damage to the battery.

12 V battery care

! **NOTE** Battery discharging due to leakage current

Dirty battery clamps and battery surfaces cause leakage current. This can lead to the battery discharging.

- ▶ Keep the battery terminals and battery surfaces clean and dry.

! **NOTE** Damage to the battery housing due to improper cleaning

If you use cleaning agents containing fuel, these can damage the battery housing.

- ▶ Do not use cleaning agents containing fuel.

! **NOTE** Damage to the battery through self-discharging

If dirt enters the battery cell, battery self-discharging will accelerate and the battery may be damaged.

- ▶ Only clean batteries when the caps are screwed on.

Observe the following points on battery care:

- ▶ Regularly check the battery terminals and the fastening of the negative cable to the chassis to ensure that they are firmly seated.
- ▶ Lightly grease the undersides of the battery terminal clamps with acid-resistant grease.
- ▶ Only clean the battery housing with commercially available cleaning agents.

Disconnecting and removing the starter battery

⚠ **WARNING** Risk of explosion due to the ignition of hydrogen gas

If there is a short circuit or sparks are created, there is a danger of hydrogen gas igniting when you charge the battery.

- ▶ Make sure that the POSITIVE terminal of a connected battery does not come into contact with vehicle parts.
- ▶ Never place metal objects or tools on a battery.
- ▶ When connecting and disconnecting the battery, always observe the sequence of battery terminals described.
- ▶ During starting assistance, always take care to connect only battery terminals of identical polarity.
- ▶ During starting assistance, observe the sequence described for connecting and disconnecting the jumper cables.
- ▶ Do not connect or disconnect the battery terminals with the engine running.

⚠ WARNING Danger of chemical burns from the battery acid

Battery acid is caustic.

- ▶ Avoid contact with the skin, eyes or clothing.
- ▶ Do not lean over the battery.
- ▶ Do not inhale battery gases.
- ▶ Keep children away from the battery.
- ▶ Immediately rinse battery acid off thoroughly with plenty of clean water and seek medical attention immediately.

! NOTE Damage to electronic components due to work carried out incorrectly on the battery

If the starter battery is disconnected before the key is removed from the ignition lock, electronic components or assemblies, such as the alternator, can be damaged.

- ▶ Switch off the vehicle and remove the key from the ignition lock.
- ▶ Check to see that there are no indicator lamps lit in the instrument cluster.
- ▶ Always disconnect the negative clamp first and then the positive clamp.
- ▶ Do not interchange the battery clamps.

Always have work on the battery performed at a qualified specialist workshop.

If, in exceptional circumstances, you have to disconnect the battery yourself, pay attention to the following:

- Observe the notes on the 12 V battery (→ page 187).
- Secure the vehicle to prevent it from rolling away.
- For vehicles with an automatic transmission, the transmission is locked in position **P** after the battery has been disconnected. You can then no longer move the vehicle.
- The battery and the cover of the positive terminal clamp must be installed securely during operation.

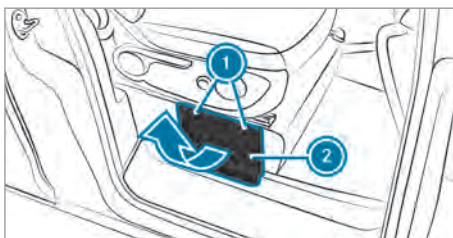

Seat base (example: right-hand front seat)

The following description on connecting and installing the battery uses the example of the starter battery in the seat base of the right-hand front seat.

The auxiliary battery is disconnected and removed in the same way as the starter battery. The auxiliary battery is located in the seat base of the left-hand front seat.

- ▶ Switch off all electrical consumers.
- ▶ Switch off the vehicle and remove the key from the ignition lock.
- ▶ Open the front right-hand door.
- ▶ Press both catch springs ① down and remove cover ② upwards from the seat base.
- ▶ Remove cover ② by pulling upwards at an angle from the seat base.

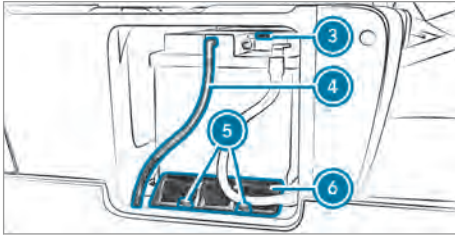

Open seat base (example: right-hand front seat)

- ▶ Remove screws ⑤ from holder ⑥.
- ▶ Remove holder ⑥.
- ▶ Remove vent hose ④ from the top of the battery.
- ▶ Pull the battery out of the seat base until the negative terminal clamp can be released and removed.
- ▶ Disconnect the negative terminal clamp from negative terminal ③.
- ▶ Remove the negative terminal clamp in such a way that the battery terminal clamp no longer touches negative terminal ③.

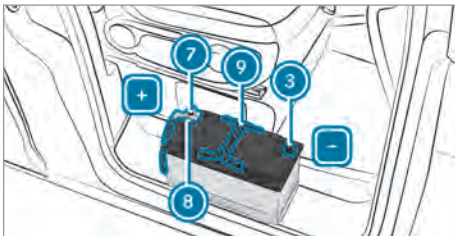

Example: starter battery

- ▶ Remove the battery from the seat base and place it on the door sill as shown. If necessary, hold the battery by handles ⑨.
- ▶ Remove the clamp cover of positive terminal ⑧.
- ▶ Remove positive terminal clamp ⑧ from positive terminal ⑦.
- ▶ Remove positive clamp ⑧ in such a way that it no longer touches positive terminal ⑦.
- ▶ Lift the battery out of the door sill by handles ⑨.

Connecting and installing the starter battery

⚠ WARNING Risk of explosion due to the ignition of hydrogen gas

If there is a short circuit or sparks are created, there is a danger of hydrogen gas igniting when you charge the battery.

- ▶ Make sure that the POSITIVE terminal of a connected battery does not come into contact with vehicle parts.
- ▶ Never place metal objects or tools on a battery.
- ▶ When connecting and disconnecting the battery, always observe the sequence of battery terminals described.
- ▶ During starting assistance, always take care to connect only battery terminals of identical polarity.
- ▶ During starting assistance, observe the sequence described for connecting and disconnecting the jumper cables.
- ▶ Do not connect or disconnect the battery terminals with the engine running.

ⓘ NOTE Damage to the on-board electronics due to interchanging the battery clamps

Incorrectly connecting the battery can damage the on-board electronics.

- ▶ Always connect the battery as described in the following sequence. Never reverse the terminal clamps.

The following description on connecting and installing the battery uses the example of the starter battery in the seat base of the right-hand front seat.

The auxiliary battery is connected and installed in the same way as the starter battery. The auxiliary battery is located in the seat base of the left-hand front seat.

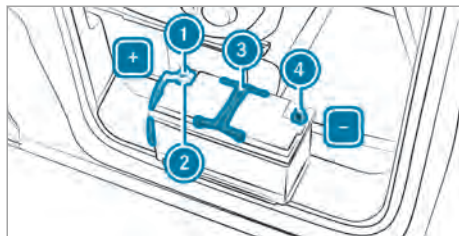

Example: starter battery

- ▶ Place the battery on the door sill as shown and secure with handles ③ if necessary.
- ▶ Connect positive terminal clamp ② to positive terminal ①. The positive lead must be routed parallel to the side of the battery housing in the connection area, as shown.
- ▶ Place the positive terminal clamp cover on positive terminal ①.
- ▶ Fold both handles ③ down onto the battery.
- ▶ Push the battery into the seat base until the negative terminal clamp can be connected.
- ▶ Connect the negative terminal clamp to negative terminal ④.
- ▶ Push the battery into the seat base as far as it will go.

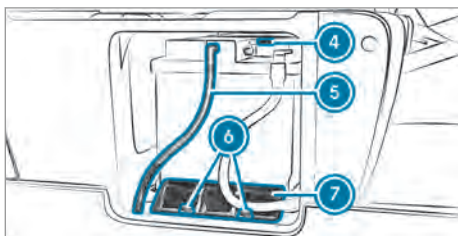

Open seat base with installed battery (example: right-hand front seat)

- ▶ Connect vent hose ⑤ to the battery connection at the top, beside negative terminal ④.
- ▶ Place holder ⑦ over the lower edge of the battery housing and the threaded holes for screws ⑥.
- ▶ Screw on holder ⑦ with screws ⑥. The battery is secured to prevent slipping.

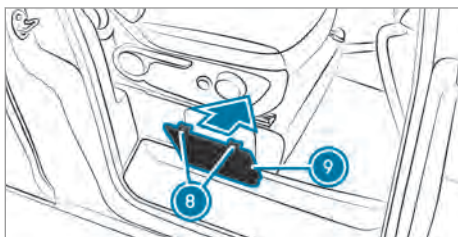

Seat base (example: right-hand front seat)

- ▶ Insert cover ⑨ in front of the battery compartment down into the seat base and close it. Catch springs ⑧ of cover ⑨ should engage audibly.

Perform the following work after connecting the battery:

- ▶ Reset the side windows (→ page 58).
- ▶ Reset the outside mirrors (→ page 87).
- ▶ Reset the electric sliding doors (→ page 51).

Towing or tow-starting

Overview of permissible towing methods

⚠ WARNING Risk of accident due to limited safety-related functions during the towing process

Safety-related functions are limited or no longer available in the following situations:

- The vehicle is switched off.
- The brake system or power steering system is malfunctioning.
- The energy supply or the on-board electrical system is malfunctioning.

When your vehicle is towed away, significantly more effort may be required to steer and brake than is normally required.

- ▶ Use a tow bar.
- ▶ Make sure that the steering wheel can move freely before towing the vehicle away.

⚠ WARNING Risk of accident when towing with steering wheel locking

When the steering wheel locking is engaged, you can no longer steer the vehicle.

- ▶ Always switch on the vehicle when towing with a tow rope or tow bar.

⚠ WARNING Risk of accident when towing a vehicle which is too heavy

If the vehicle to be tow-started or towed away is heavier than the permissible gross mass of your vehicle, the following situations can occur:

- The towing eye may become detached.
- The vehicle/trailer combination may swerve or rollover.

- ▶ Before tow-starting or towing away, check if the vehicle to be tow-started or

towed away exceeds the permissible gross mass.

Details on the permissible gross vehicle weight of your vehicle can be found on the vehicle identification plate (→ page 237).

! **NOTE** Damage to the vehicle due to automatic braking

When the following functions are activated, the vehicle brakes automatically in certain situations:

- Active Brake Assist
- Active Distance Assist DISTRONIC
- HOLD function

To avoid damage to the vehicle, deactivate these systems in the following or similar situations:

- ▶ When towing
- ▶ In a car wash

! **NOTE** Damage due to incorrect connection of the tow bar or improper use of the towing device

- ▶ Only connect the tow rope or tow bar to the towing eyes or the trailer tow hitch.
- ▶ Do not use the towing eyes to recover a vehicle.

! **NOTE** Damage due to pulling force being too high

If you pull away abruptly, excessive pulling force could damage the vehicles.

- ▶ Pull away as straight, slowly and smoothly as possible.

! **NOTE** Damage due to improper towing with a tow rope

If you ignore safety and protective measures when towing with a tow rope, this can result in damage to the vehicle.

Observe the following points:

- ▶ Secure the tow rope on the same side on both vehicles.

- ▶ Secure the tow rope to the towing eyes.
- ▶ Do not exceed the legally prescribed length of the tow rope.
- ▶ Mark the tow rope in the middle, e.g. with a white cloth (12 x 12 in (30 x 30 cm)). This will make other road users aware that a vehicle is being towed.
- ▶ During the journey, observe the brake lamps of the towing vehicle and maintain the distance so that the tow rope does not sag.
- ▶ Do not use steel cables or chains to tow your vehicle.

! **NOTE** Damage due to towing the vehicle at too high a speed or too far

Towing the vehicle at too high a speed or too far can damage the drivetrain.

- ▶ Do not exceed a towing speed of 31 mph (50 km/h).
- ▶ Do not exceed a towing distance of 31 miles (50 km).

! **NOTE** Damage to the automatic transmission when towing due to shifting into transmission position **P**

If you open the driver's or co-driver's door when towing, it can lead to the automatic transmission shifting to position **P** and becoming damaged.



- ▶ Shift the automatic transmission to position **N**.
- ▶ Do not open any doors during the towing process.

When towing away, you must observe the legal requirements for the country in which you are currently driving.

In the event of a breakdown, Mercedes-Benz recommends that you have the vehicle transported instead of towed.

Have the vehicle transported on a transporter or trailer if it has transmission damage.

Permissible towing methods

	 Both axles on the ground	 Front axle raised	 Rear axle raised
Vehicles with automatic transmission	Yes, no further than 31 miles (50 km) at 31 mph (50 km/h)	No	Yes, if the steering wheel is fixed in the center position with a steering wheel lock. Maximum 31 miles (50 km) at 31 mph (50 km/h)

- i** If the transmission cannot be shifted to position **N**, have the vehicle transported (→ page 197). A towing vehicle with lifting equipment is required for vehicle transport.

Towing the vehicle with both axles on the ground

- ▶ Observe the notes on permissible towing methods (→ page 194).
- ▶ Make sure that the battery is connected and charged.

If the battery is discharged, observe the following points:

- The vehicle cannot be switched on.
- The transmission cannot be shifted to position **N**.

Vehicles with automatic transmission

- ▶ Switch on the hazard warning lamps (→ page 77).
- ▶ Install the towing eye (→ page 197).
- ▶ Secure the towing device.
- ▶ Switch on the vehicle.
- ▶ Deactivate automatic locking (→ page 46).
- ▶ Do not activate the HOLD function.
- ▶ Deactivate Active Brake Assist (→ page 112).
- ▶ Deactivate Active Distance Assist DISTRONIC (→ page 115, 116).
- ▶ Shift the transmission to position **N** (→ page 104).
- ▶ Release the parking brake (→ page 107).

Recovering a vehicle that is stuck

! **NOTE** Damage due to pulling force being too high

If you pull away abruptly, excessive pulling force could damage the vehicles.

- ▶ Pull away as straight, slowly and smoothly as possible.

If the drive wheels have become trapped on loose or muddy ground, recover the vehicle with the utmost care. This particularly applies if the vehicle is carrying a load.

- ▶ Observe the notes on permissible towing methods (→ page 194).
- ▶ Never attempt to recover a vehicle that is stuck when a trailer is attached.
- ▶ If possible, tow the vehicle out backwards along the tracks it made before it became stuck.

Towing the vehicle with the axle raised

With the rear axle raised

- ▶ Observe the notes on permissible towing methods (→ page 194).
- ▶ Switch on the hazard warning lamps (→ page 77).
- ▶ Disarm the tow-away alarm (→ page 59).
- ▶ Move the front wheels to the straight-ahead position.
- ▶ Fix the steering wheel in the center position with a steering wheel lock.

- ▶ Release the parking brake (→ page 107).
- ▶ Turn the key to position **[O]** in the ignition lock and remove the key from the ignition lock.
- ▶ Take the key with you when leaving the vehicle.

Do not exceed a towing speed of 31 mph (50 km/h).

Loading the vehicle for transport

! **NOTE** Damage due to incorrect attachment

The vehicle may be damaged when lashing to chassis components.

- ▶ Only lash the vehicle at the wheels.

- ▶ Observe the notes on permissible towing methods (→ page 194).
- ▶ To load the vehicle onto a trailer or transporter, use the trailer tow hitch or the towing eye.

Before loading the vehicle

- ▶ Switch on the vehicle.
- ▶ Shift the transmission to position **[N]**.
- ▶ Release the parking brake (→ page 107).
- ▶ Load the vehicle onto the transporter.

! **NOTE** Damage to the drive train due to incorrect positioning of the vehicle

- ▶ Do not position the vehicle above the connection point of the transport vehicle.

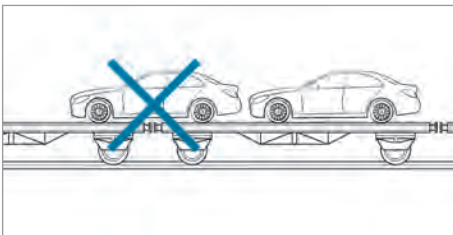

- ▶ Make sure that the front and rear axles come to rest on the same transportation vehicle.

After loading the vehicle

- ▶ Shift the transmission to position **[P]**.
- ▶ Disarm the tow-away alarm (→ page 59).
- ▶ Turn the key to position **[O]** in the ignition lock and remove it from the ignition lock.

- ▶ Use the parking brake to secure the vehicle against rolling away.
- ▶ Secure the vehicle by the wheels.

Towing eye storage location

The towing eye is located in the vehicle tool kit (→ page 198).

Installing/removing the towing eye

Installing and removing the front towing eye

! **NOTE** Damage to the vehicle due to incorrect use of the towing eye

When a towing eye is used to recover a vehicle, the vehicle may be damaged in the process.

- ▶ Only use the towing eye to tow away or tow start the vehicle.

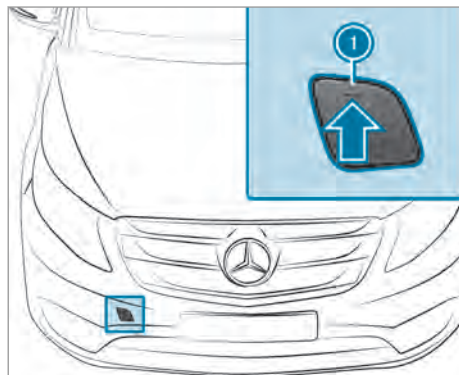

Fixture for the front towing eye in the bumper

- ▶ Take the towing eye and screwdriver from the vehicle tool kit (→ page 198).

Installing

- ▶ Press the arrow on cover **①** and remove cover **①** from the opening. You will see the fixture for the towing eye.
- ▶ Screw in the towing eye clockwise to the stop.
- ▶ Insert the screwdriver into the towing eye and tighten the towing eye.
- ▶ Stow the screwdriver in the vehicle tool kit.

Removing

- ▶ Remove the screwdriver from the vehicle tool kit.

- ▶ Insert the screwdriver into the towing eye and turn the towing eye counter-clockwise.
- ▶ Unscrew and remove the towing eye.
- ▶ Insert cover ① with the lug at the top and press it in at the bottom until it engages.
- ▶ Stow the towing eye and the screwdriver with the vehicle tool kit.

Rear towing eye

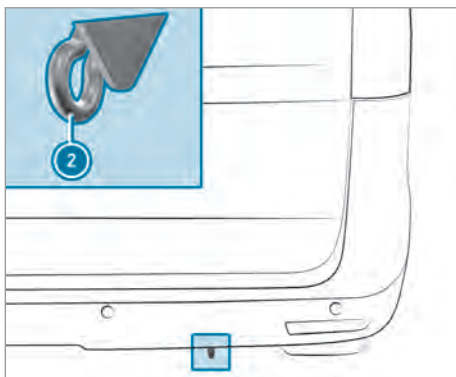

Rear towing eye under the bumper

- ▶ When towing away or tow-starting a vehicle, attach the towing device to rear towing eye ②.
- ▶ If the vehicle is equipped with a trailer tow hitch, attach the towing device to the trailer tow hitch (→ page 244).
- ▶ Observe the notes on permissible towing methods (→ page 194).

Tow-starting the vehicle (vehicle emergency start)

! **NOTE** Damage to the automatic transmission due to tow starting

The automatic transmission may be damaged in the process of tow starting vehicles with automatic transmission.

- ▶ Vehicles with automatic transmission must not be tow started.

- ▶ Observe the notes and information on starting assistance (→ page 189).

Electrical fuses

Notes on electrical fuses

! **WARNING** Risk of accident and injury due to overloaded lines

If you manipulate or bridge a faulty fuse or if you replace it with a fuse with a higher amperage, the electric line could be overloaded.

This could result in a fire.

- ▶ Always replace faulty fuses with specified new fuses containing the correct amperage.

If the new fuse which has been inserted also blows, have the cause traced and rectified at a qualified specialist workshop.

The fuse allocation chart and the information on the fuses can be found in the "Fuse allocation chart" Supplement.

Vehicle tool kit

Information on the vehicle tool kit

The vehicle tool kit storage location depends on the equipment version of the vehicle.

The following are examples of storage locations:

- In the seat base of the left front seat
- In the rear storage compartment
- In the tool holder in the cargo compartment

Apart from some country-specific variants, vehicles without a spare wheel are not equipped with a tire-changing tool.

If your vehicle is equipped with a tire-change tool kit, you can find it in the vehicle tool kit.

If the vehicle tool kit is stored in the driver's seat base, you can find the jack in a separate holder at the rear of the cargo compartment on the right-hand side (→ page 200).

Some tools for changing a wheel are specific to the vehicle. For more information on which tire-change tools are required and approved for performing a wheel change on your vehicle, consult a qualified specialist workshop.

Required tire-change tool kit may include the following, for example:

- Jack
- Wheel wrench
- Ratchet wrench

- i** The jack has a maximum weight of 16.5 lbs (7.5 kg) depending on the vehicle's equipment.

You will find the maximum load capacity of the jack stated on the adhesive label attached to the jack.

The jack is maintenance-free. If there is a malfunction, please contact a qualified specialist workshop.

Opening and closing the stowage compartment in the seat base

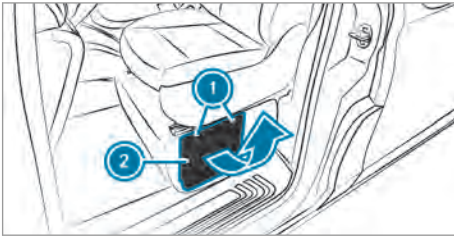

Storage compartment in the seat base of the left front seat

- ▶ **To open:** press catch springs **1** down and release cover **2** upwards from the seat base. Cover **2** can be removed by pulling upwards at an angle from the seat base.
 - ▶ Remove the clamping strap and remove the vehicle tool bag.
- i** For vehicles with a tire-change tool kit, the jack is in a separate holder at the rear right-hand side of the cargo compartment (→ page 200).
- ▶ **To close:** after storing the vehicle tool bag, insert cover **2** below in the seat base and fold shut. Catch springs **1** of cover **2** should engage audibly.

Storage compartment in the rear compartment

Opening the storage compartment

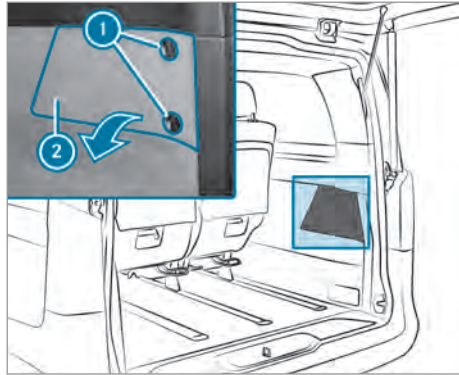

Storage compartment in the rear compartment on the right-hand side of the vehicle

- ▶ If necessary, fold up the rear seat.
- ▶ Turn top rotary catch **1** clockwise and bottom rotary catch **1** counter-clockwise.
- ▶ Remove cover **2**.

Removing the vehicle tool kit and jack from the tool holder

Depending on the equipment version of the vehicle, the vehicle tool kit and the jack are stowed either in a storage tray or in a tool holder with a cover.

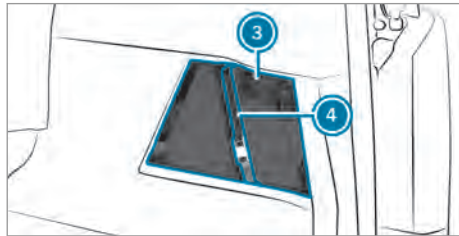

Storage compartment with tool holder

- ▶ Remove clamping strap **4**.
- ▶ Lift off tool holder cover **3**.
- ▶ Carefully pull the vehicle tool kit and jack upwards out of the storage compartment. Lift the jack slightly before removing it and turn it to a diagonal position in the storage compartment.

Removing the vehicle tool kit and jack from the storage tray

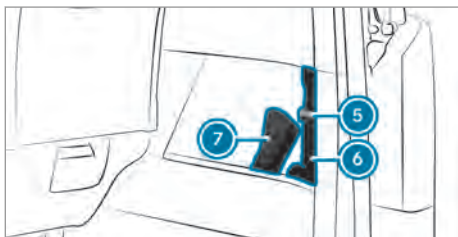

Storage compartment with storage tray

- ▶ Open clamping strap ⑤ and remove jack ⑥ by pulling it upwards at an angle from the storage tray compartment.
- ▶ Remove vehicle tool bag ⑦ upwards from the storage tray compartment.

Stowing the vehicle tool kit and the jack Storage compartment with tool holder

- ▶ Before stowing, wind the jack to the fully closed position and place it so that the handwheel is facing forwards and the plate is facing inwards.
- ▶ Place the jack and vehicle tool kit into the tool holder.
- ▶ Replace cover ③ of the tool holder.
- ▶ Tighten clamping strap ④.

Storage compartment with storage tray

- ▶ Insert vehicle tool bag ⑦ into the front compartment of the storage tray.
- ▶ Before stowing, wind jack ⑥ to the fully closed position and place it so that the handwheel is facing downwards and the plate is facing inwards at an angle.
- ▶ Insert jack ⑥ into the back compartment of the storage tray.
- ▶ Press jack ⑥ into the upper holder and fasten clamping strap ⑤. The jack is secured.

Closing the storage compartment

- ▶ Put on cover ②.
- ▶ Turn top rotary catch ① counter-clockwise and bottom rotary catch ① clockwise.
- ▶ Fold down the rear seat.

Tool holder in the cargo compartment

Removing tools and the jack

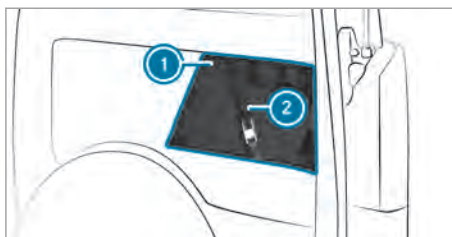

Tool holder in the cargo compartment on the right-hand side of the vehicle (example: Cargo Van)

- ▶ Remove clamping strap ②.
- ▶ Remove cover ① of the tool holder.
- ▶ Carefully pull the vehicle tool kit and jack out of the tool holder.

Storing tools and the jack

- ▶ Before storing, wind the jack to the fully closed position and place it so that the handwheel is facing forwards and the plate is facing inwards.
- ▶ Place the jack and vehicle tool kit into the tool holder.
- ▶ Install cover ① of the tool holder.
- ▶ Tighten clamping strap ②.

Removing the jack from the tool holder

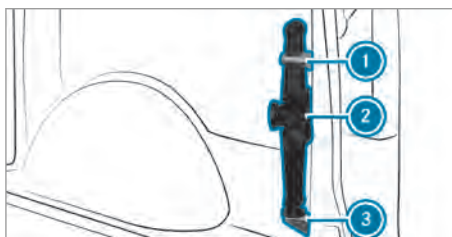

Holder for the jack in the cargo compartment on the right-hand side of the vehicle (for example, Cargo Van)

- ▶ Remove clamping strap ①.
- ▶ Pull jack ② out of the upper holder and from lower bracket ③.
- ▶ The vehicle tool bag or tire-change tool kit is in the seat base of the left front seat (→ page 199).

Storing the jack

- ▶ Before storing, wind the jack as far as it will go and position it with the handwheel facing down and the plate facing inwards.
- ▶ Place jack ② onto lower bracket ③.
- ▶ Press jack ② into the upper holder and fasten clamping strap ①.
The jack is secured.

Information on noise or unusual driving characteristics

While driving, pay attention to vibrations, noises and unusual driving characteristics, e.g. pulling to one side. This may indicate damage to the wheels or tires. If you suspect that a tire is defective, reduce your speed. Stop the vehicle as soon as possible to check if wheels and tires have been damaged or are no longer functioning properly. Hidden tire damage could also be causing the unusual driving characteristics. If no signs of damage can be detected, have the tires and wheels checked at a qualified specialist workshop.

Notes on regularly inspecting wheels and tires

⚠ WARNING Risk of injury through damaged tires

Damaged tires can cause tire pressure loss.

- ▶ Check the tires regularly for signs of damage and replace any damaged tires immediately.

Check the wheels and tires of your vehicle for damage regularly, i.e. at least every two weeks, as well as after driving off-road or on rough roads. Damaged wheels can lead to a loss of tire pressure.

Look out for the following types of damage, for example:

- Cuts in the tires
- Punctures in the tires
- Tears in the tires
- Bulges on tires
- Deformation or severe corrosion on wheels

⚠ WARNING Risk of hydroplaning due to insufficient tire tread

Insufficient tire tread will result in reduced tire grip.

- ▶ Thus, you should regularly check the tread depth and the condition of the tread across the entire width of all tires.

Minimum tread depth for:

- Summer tires: $\frac{1}{8}$ in (3 mm)
- M+S tires: $\frac{1}{6}$ in (4 mm)

- ▶ For safety reasons, replace the tires before the legally prescribed limit for the minimum tread depth is reached.

Conduct the following checks regularly on all wheels, at least once a month or as required, e.g. before a long journey or when driving off-road:

- Check the tire pressure (→ page 204)
- Check the valve caps

Valves must be protected from moisture and dirt with valve caps specifically approved by Mercedes-Benz for your vehicle.

- Visually inspect the tread depth and the tire tread across the whole tire width

The minimum tread depth for summer use is $\frac{1}{8}$ in (3 mm) and for winter use $\frac{1}{6}$ in (4 mm).

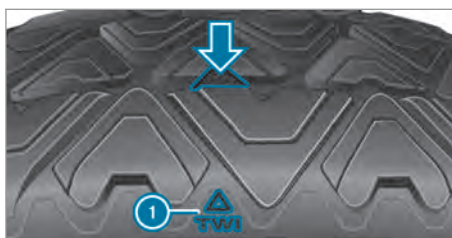

Markings ① show in which places the bar indicators (arrow) are integrated into the tire tread. They are visible as soon as the tread depth is approximately $\frac{1}{16}$ in (1.6 mm).

Information on driving with summer tires

At temperatures below 50 °F (10 °C) summer tires lose elasticity and therefore traction and braking power. Change the tires on your vehicle to M+S tires. Using summer tires at very cold temperatures could cause tears to form, thereby damaging the tires permanently. Mercedes-Benz cannot accept responsibility for this type of damage.

Always observe the maximum permissible speed specified for the summer tires you have installed (→ page 210).

Once you have installed the summer tires:

- Check the tire pressure (→ page 204)
- Restart the tire pressure monitor (→ page 207)

Information on M+S tires

⚠ WARNING Risk of accident caused by incorrect wheel and tire dimensions

The wheel or tire size and the tire type of the emergency spare wheel or spare wheel and the wheel to be replaced may differ.

To prevent hazardous situations:

- ▶ Adapt your driving style accordingly and drive carefully.
- ▶ Never install more than one emergency spare wheel or spare wheel that differs in size.
- ▶ Only use an emergency spare wheel or spare wheel of a different size briefly.
- ▶ Have the emergency spare wheel or spare wheel of a different size replaced at the nearest qualified specialist workshop. The new wheel must have the correct dimensions.

⚠ WARNING Risk of an accident due to insufficient tire tread

M+S tires with a tread depth of less than $\frac{1}{8}$ in (4 mm) are not suitable for use in winter and do not provide sufficient grip.

- ▶ M+S tires with a tread depth of less than $\frac{1}{8}$ in (4 mm) must be replaced immediately.

At temperatures below 50 °F (10 °C), use winter tires or all-season tires that are marked with M+S.

Only winter tires bearing the  snowflake symbol in addition to the M+S marking provide the best possible grip in wintry road conditions.

Only these tires allow driving safety systems such as ABS and ESP® to also function optimally in winter. These tires have been developed specifically for driving in snow.

Use M+S tires of the same make and tread on all wheels to maintain safe handling characteristics.

Observe the maximum permissible speed specified for the M+S tires you have installed (→ page 210).

If you install M+S tires that have a lower maximum permissible speed than the maximum design speed of the vehicle, affix an appropriate warning sign in the driver's field of vision. You can obtain this at a qualified specialist workshop.

Once you have installed the M+S tires, take the following measures:

- Check the tire pressure (→ page 204)
- Restart the tire pressure monitoring system (→ page 207)

Notes on snow chains

⚠ WARNING Risk of accident due to incorrectly installed snow chains

If you have installed snow chains on the front wheels, they may drag against the vehicle body or chassis components.

- ▶ Never install snow chains on the front wheels.
- ▶ Only install snow chains on the rear wheels in pairs.

⚠ WARNING Risk of accident due to unsuitable snow chains

Commercially available snow chains can come loose and damage chassis components or brake hoses.

- ▶ Only install snow chains that have been approved by Mercedes-Benz for these tires.

⚠ WARNING Risk of accident due to snow chains breaking

If you drive too fast with snow chains, they can break, injure other persons, and damage the vehicle.

- ▶ Observe the maximum permissible speed for operation with snow chains.

! NOTE Damage to the wheel trim from mounted snow chains

If snow chains are mounted to steel wheels, the wheel trims can be damaged.

- ▶ Remove the wheel trims of steel wheels before mounting snow chains.

Observe the following notes when using snow chains:

- Snow chains are only permissible for certain wheel/tire combinations. You can obtain infor-

mation on this at a qualified specialist workshop.

- For safety reasons, only use snow chains that have been specifically approved for your vehicle by Mercedes-Benz, or snow chains with the same quality standard.
- The snow chains must be retightened after driving approximately 0.6 miles (1 km). This is the only way to ensure the snow chains are optimally seated with clearance to adjacent components.
- **Vehicles with rear wheel drive:** only install snow chains in pairs and only on the rear wheels. Observe the manufacturer's installation instructions.
- Use snow chains only when the road surface is completely snow-covered. Remove the snow chains as soon as possible when you come to a road that is not snow-covered.
- Local regulations may restrict the use of snow chains. Observe the applicable regulations before installing snow chains.
- If snow chains are installed, the maximum permissible speed is 30 mph (50 km/h).

i You can deactivate ESP® to pull away (→ page 110). This allows the wheels to spin, achieving an increased driving force.

Tire pressure

Notes on tire pressure

⚠ WARNING Risk of accident due to insufficient or excessive tire pressure

Underinflated or overinflated tires pose in particular the following risks:

- The tires can burst.
- The tires can wear excessively and/or unevenly.
- The driving characteristics as well as the steering and braking characteristics may be greatly impaired.

▶ Comply with the recommended tire pressures and check the tire pressure of all tires, including the spare wheel, regularly:

- Monthly
- When the load changes

- Before embarking on a longer journey
- If operating conditions change, e.g. off-road driving

▶ Adjust the tire pressure, if necessary.

Driving with tire pressure that is too high or too low can:

- Shorten the service life of the tires
- Cause increased tire damage
- Adversely affect handling characteristics and thus driving safety, for example, due to hydroplaning

⚠ WARNING Risk of accident due to too low a tire pressure

Tires with pressure that is too low can overheat and burst as a consequence.

In addition, they also suffer from irregular wear, which can significantly impair the braking properties and the handling characteristics.

▶ Avoid excessively low tire pressure.

Tire pressure which is too low can cause:

- Tire malfunctions as a result of overheating
- Impaired handling characteristics
- Irregular wear
- Increased fuel consumption

⚠ WARNING Risk of accident due to too high a tire pressure

Tires with excessively high pressure can burst.

In addition, they also suffer from irregular wear, which can significantly impair the braking properties and the handling characteristics.

▶ Avoid excessively high tire pressures.

Excessively high tire pressure can result in:

- Increased braking distance
- Impaired handling characteristics
- Irregular wear
- Impaired driving comfort
- Susceptibility to damage

⚠ WARNING Risk of accident due to repeated pressure drop in the tires

The wheels, valves or tires could be damaged.

Too low a tire pressure can lead to the tires bursting.

- ▶ Examine the tires for foreign objects.
- ▶ Check whether the tire has a puncture or the valve has a leak.
- ▶ If you are unable to rectify the damage, contact a qualified specialist workshop.

You can find information on recommended tire pressures for the vehicle's factory-installed tires on the following labels:

- Tire and Loading Information placard on the B-pillar of your vehicle .
- Overview of the tire pressure table (→ page 205)

Observe the maximum tire pressure (→ page 210).

Use a suitable pressure gauge to check the tire pressure. The outer appearance of a tire does not permit any reliable conclusion about the tire pressure.

- ⓘ The difference in pressure of the tires of an axle may not be higher than 10 kPa (0.1 bar/ 1.5 psi).

 **ENVIRONMENTAL NOTE** Environmental damage due to insufficient or excessive tire pressure

Overinflating or underinflating your tires will shorten their service life.

- ▶ Check the tire pressure regularly, but at least every 14 days.

Vehicles with a tire pressure monitoring system:

you can also check the tire pressure using the on-board computer.

Only correct tire pressure when the tires are cold. The tires are cold if the following conditions have been met:

- The vehicle has been parked with the tires out of direct sunlight for at least three hours.
- The vehicle has traveled less than 1 mile (1.6 km).

The tire pressure recommended for increased load/speed in the tire pressure table may affect the ride comfort.

 **WARNING** Risk of accident due to unsuitable accessories on tire valves

If you mount unsuitable accessories onto tire valves, the tire valves may be overloaded and malfunction, which can cause tire pressure loss.

- ▶ Only screw standard valve caps or valve caps specifically approved by Mercedes-Benz for your vehicle onto the tire valve.

Notes on trailer operation

The applicable tire pressure for the tires of the rear axle is always the recommended tire pressure for a full load.

Overview of the tire pressure table

Tire Size	1P		2P	
	kPa	psi	kPa	psi
195/65 R16 C 104T / 100T	~230	~33	~250	~36
205/65 R16 C 103H/1	~250	~36	~270	~39
245/45 R19 XL 102Y	~300	~43	~320	~46

100 kPa = 1 bar

The tire pressure table shows the recommended tire pressure for all tires approved at the factory for this vehicle. The recommended tire pressure apply for cold tires under various operating conditions, i.e. loading and/or speed of the vehicle.

If one or more tire sizes precede a tire pressure, the following tire pressure information is only valid for those tire sizes and their respective load condition.

If the preceding tire sizes are supplemented by the  symbol, the tire pressure information following shows alternative tire pressures. Fuel consumption may then increase slightly.

The load conditions "partially laden" and "fully laden" are defined in the table for different numbers of passengers and amounts of luggage. The actual number of seats may differ.

The tire pressure values given for partly laden vehicles are minimum values which offer you good ride comfort. They are not for trailer operation.

You can also use the tire pressure values for a fully laden vehicle. These are always allowed and permissible. However, in a partially laden vehicle, the ride is not as comfortable and fuel consumption is only minimally reduced. In addition, wear is greater in the middle of the tire tread.

Set the correct tire pressure before loading the vehicle. Once the vehicle is laden, check the tire pressures and correct them if necessary.

Vehicles with a gross vehicle weight of 6,340 lbs (2,900 kg)

The following tire pressure values apply to the following vehicles:

- with a permissible gross vehicle weight of 6,340 lbs (2,900 kg)
- the tires referred to under "Wheel and tire combinations" (→ page 218)

Tire pressure for the spare wheel is 350 kPa (3.5 bar/51 psi).

Vehicles with a gross axle weight rating of 3,197 lbs (1,450 kg) on the rear axle

Tires/disk wheel	Partially laden vehicle		Fully laden vehicle	
	Front axle	Rear axle	Front axle	Rear axle
235/60 R 16 100H	250 kPa (2.5 bar/36 psi)	250 kPa (2.5 bar/36 psi)	270 kPa (2.7 bar/39 psi)	270 kPa (2.7 bar/39 psi)
235/55 R 17 XL 103H	260 kPa (2.6 bar/38 psi)	250 kPa (2.5 bar/36 psi)	280 kPa (2.8 bar/41 psi)	280 kPa (2.8 bar/41 psi)

Vehicles with a gross vehicle weight of 6,835 lbs (3,100 kg)

The following tire pressure values apply to the following vehicles:

- with a permissible gross vehicle weight of 6,835 lbs (3,100 kg)
- the tires referred to under "Wheel and tire combinations" (→ page 218)

Tire pressure for the spare wheel is 350 kPa (3.5 bar/51 psi).

Vehicles with a gross axle weight rating of 3,417 lbs (1,550 kg) on the rear axle

Tires/disk wheel	Partially laden vehicle		Fully laden vehicle	
	Front axle	Rear axle	Front axle	Rear axle
235/55 R 17 XL 103H	260 kPa (2.6 bar/38 psi)	250 kPa (2.5 bar/36 psi)	280 kPa (2.8 bar/41 psi)	280 kPa (2.8 bar/41 psi)

Tire pressure monitoring system

Function of the tire pressure monitoring system

The system checks the tire pressure and the tire temperature of the tires installed on the vehicle by means of a tire pressure sensor.



New tire pressure sensors, e.g. in winter tires, are automatically taught-in during the first journey they are used.

It is the driver's responsibility to set the tire pressure to the recommended cold tire pressure suitable for the operating situation (→ page 204).

Note that the correct tire pressure for the current operating situation must first be taught-in to the tire pressure monitoring system. If a substantial loss of pressure occurs, the warning threshold for the warning message is aligned to the taught-in reference values. Restart the tire pressure monitor after adjusting to the cold tire pressure (→ page 207). The current pressures are saved as

new reference values. This will ensure that a warning message will only appear if the tire pressure drops significantly.



The  warning lamp in the instrument cluster displays a detected pressure loss or a malfunction as follows:

- If the  warning lamp is lit continuously, the tire pressure on one or more tires is significantly too low. The tire pressure monitor is not malfunctioning.
- If the  warning lamp flashes for around a minute and then remains lit constantly, the tire pressure monitor is malfunctioning.
- a message also appears in the instrument cluster.

System limits

The system may be impaired or may not function in the following situations:

- The tire pressure has been set incorrectly.
- There is a sudden pressure loss caused, for example, by a foreign object penetrating the tire.
- There is a malfunction caused by another radio signal source.

If the tire pressure monitor is malfunctioning, it may take more than ten minutes for the  tire pressure warning lamp to inform you of the malfunction. When the malfunction has been rectified, the  warning lamp goes out after you have driven for a few minutes.

The tire pressure values indicated by the on-board computer may differ from those measured at a gas station using a pressure gauge.





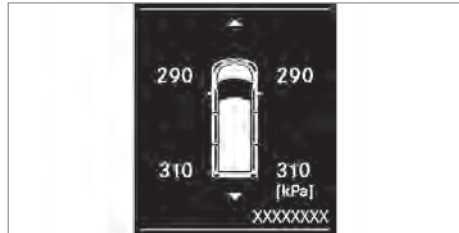

The tire pressures shown by the on-board computer refer to those measured at sea level. At high altitudes, the tire pressure values indicated by a pressure gauge are higher than those shown by the on-board computer. In this case, do not reduce the tire pressure.

Checking the tire pressure electronically (only vehicles with steering wheel buttons)

Requirements:

- The vehicle is switched on.



- ▶ Press the  or  button to select **Service**.
- ▶ Press the  button.
- ▶ Use the  or  button to select **Tire Pressure**.
- ▶ Press the  button.
The display shows the current tire pressure of each wheel.

If the vehicle was parked for longer than 20 minutes, the **Tire pressure will be displayed after driving a few minutes** message appears in the display.







- ▶  Also be sure to observe the notes on tire pressure (→ page 204).

Restarting the tire pressure monitoring system

Requirements:

- The vehicle is switched on.
- The recommended tire pressure is correctly set for the respective operating condition on each of the four wheels (→ page 205).

Vehicles with steering-wheel buttons

- ▶ Use the  or  button to select **Service**.
- ▶ Use the  or  button to select **Tire Pressure**.
- ▶ Press the  button to confirm.
The display shows the current tire pressure of each wheel or the **Tire pressure will be displayed after driving a few minutes** message.
- ▶ Press the  button.
The **Use Current Pressures as New Reference Values:** message is shown in the display.

- ▶ **To confirm restart:** press the **[OK]** button. The **Tire Press. Monitor Restarted** message is shown in the display.

After you have driven for a few minutes, the system checks whether the current tire pressures are within the specified range. The new tire pressures are then saved as reference values and monitored.

- ▶ **To cancel restart:** press the **[↩]** button. The tire pressure values stored at the last restart will continue to be monitored.

Vehicles without steering-wheel buttons

The vehicle must be at a standstill. Use the buttons on the instrument cluster.

- ▶ Press the **[⊖]** button to select the **Tire Pressure** menu.

- ▶ Press the **[R]** button to confirm. The **Monitoring Active** message is shown in the display.

- ▶ Press the **[R]** button to confirm. The **Tire Pressure OK?** message is shown in the display.

- ▶ **To confirm restart:** press the **[+]** button. The display shows the **Distance** menu.

After you have driven for a few minutes, the system checks whether the current tire pressures are within the specified range. The new tire pressures are then saved as reference values and monitored.

- ▶ **To cancel restart:** press the **[−]** button. The display shows the **Tire Pressure** menu.

The tire pressure values stored at the last restart will continue to be monitored.

Tire labeling

Overview of tire labeling

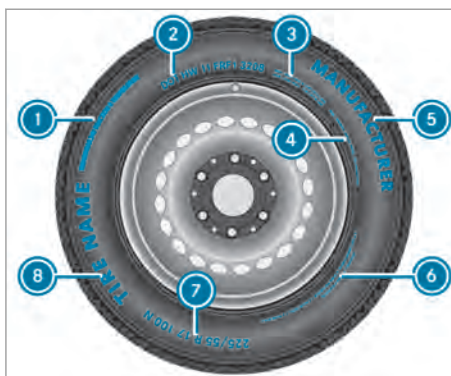

- ① Uniform Tire Quality Grading Standards (→ page 208)
 - ② DOT (Department of Transportation), (TIN) Tire Identification Number (→ page 209)
 - ③ Maximum tire load (→ page 210)
 - ④ Maximum tire pressure (→ page 210)
 - ⑤ Manufacturer
 - ⑥ Characteristics of the tire (→ page 210)
 - ⑦ Tire size designation, load-bearing capacity and speed rating (→ page 210)
 - ⑧ Tire name
- ⓘ The data shown in the illustration is sample data.

Information on tire quality grades

According to the requirements of the U.S. Department of Transportation's "Uniform Tire Quality Grading Standards" tire manufacturers must grade their tires using the following three performance factors:

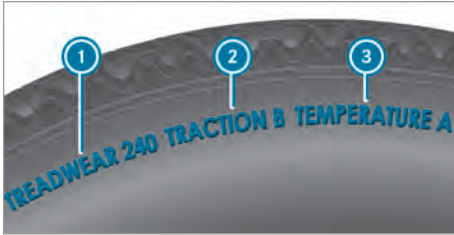

- ① Tread wear grade
- ② Traction grade
- ③ Temperature grade

- ⓘ The data shown in the illustration is sample data.
- ⓘ This grading is not legally prescribed for Canada, but specified in most cases anyway.

Tread wear grade

The tread wear grade is a comparative grading based on tread wear grade tests conducted under controlled conditions on a specified U.S. Department of Transportation test track. For example, a tire graded 150 would wear one and one-half times as well on the government test track as a tire graded 100.

The relative performance of tires depends upon the actual conditions of their use, however, and may depart significantly from the norm due to variations in driving habits, service practices and differences in road characteristics and climate conditions.

Traction grade

- ⚠ **DANGER** Risk of accident due to inadequate traction

The traction grade assigned to this tire is based on straight-ahead braking traction tests.

- ▶ Always adapt your driving style and drive at a speed to suit the prevailing traffic and weather conditions.

- ⚠ **NOTE** Damage to the drivetrain from wheelspin

- ▶ Avoid wheelspin.

The traction grades – from highest to lowest – are AA, A, B and C. These grades relate to the tire's ability to come to a standstill on a wet pavement under controlled conditions on a specified U.S.

government test surface made from asphalt and concrete.

Temperature grade

- ⚠ **WARNING** Risk of accident from tire overheating and tire failure

Excessive speed, underinflation, or excessive loading, either separately or in combination, can cause excessive heat build-up and possible tire failure.

- ▶ Observe the recommended tire pressure.
- ▶ Regularly check the pressure of all the tires.
- ▶ Adjust the tire pressure, if necessary.

The temperature grades are A (highest grade), B and C. These relate to a tire's resistance to heat and its ability to release heat on a specified test wheel in laboratory tests under controlled conditions. Sustained high temperatures can cause the material of the tire to degenerate and reduce tire life. In addition, excessively high temperatures can lead to sudden tire failure. Grade C refers to a performance which all passenger vehicle tires must exhibit, according to the U.S. Department of Transportation's requirements.

Information on DOT and TIN (Tire Identification Number)

U.S. tire regulations indicate that every tire manufacturer or retreader must imprint a TIN in or on the sidewall of each tire produced.



- ⓘ The data shown in the illustration is sample data.

The TIN is a unique identification number for tires and consists of the following components:

- **DOT (Department of Transportation):** tire symbol ① indicates that the tire complies with the

requirements of the U.S. Department of Transportation.

- **Manufacturer identification code:** manufacturer identification code ② provides information about the tire manufacturer. New tires have a code with two symbols. Retreaded tires have a code with four symbols. For further information about retreaded tires, see (→ page 213).
- **Tire size:** identifier ③ describes the tire size.
- **Tire type code:** tire type code ④ can be used by the manufacturer as a code to describe specific characteristics of the tire.
- **Date of manufacture:** date of manufacture ⑤ provides information about the age of a tire. The 1st and 2nd numbers indicate the calendar week and the 3rd and 4th numbers indicate the year of manufacture (e.g. "3208" refers to the 32nd week of the year 2008).

Information on maximum tire load



- ① The data shown in the illustration is sample data.

Maximum tire load ① is the maximum permissible weight for which the tire is approved.

Do not overload the tires by exceeding the maximum permissible load. The maximum permissible load can be found on the vehicle's Tire and Loading Information placard on the B-pillar on the driver's side.

Information on maximum tire pressure

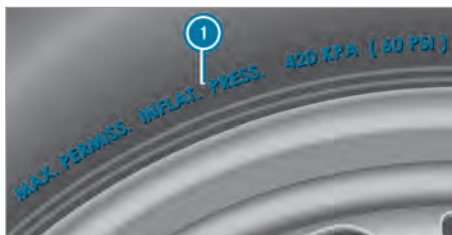

- ① The data shown in the illustration is sample data.

Maximum permitted tire pressure ① must never be exceeded. Always observe the recommended tire pressure for your vehicle when adjusting the tire pressure (→ page 205).

Information on tire characteristics



- ① The data shown in the illustration is sample data.

This information describes the type of tire cord and the number of layers in sidewall ① and under tire tread ②.

Information on tire size designation, load-bearing capacity and speed rating

- ⚠ WARNING** Risk of injury through exceeding the specified tire load-bearing capacity or the permissible speed rating

Exceeding the specified tire load rating or the permissible speed rating may lead to tire damage and to the tires bursting.

- ▶ Therefore, only use tire types and sizes approved for your vehicle model.
- ▶ Observe the tire load rating and speed rating required for your vehicle.

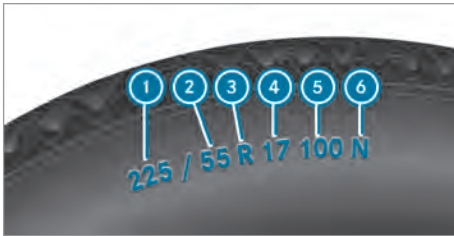

- ❶ Nominal tire width in millimeters
 - ❷ Aspect ratio in %
 - ❸ Tire code
 - ❹ Rim diameter
 - ❺ Load-bearing index
 - ❻ Speed rating
- ⓘ The data shown in the illustration is sample data.

Information about reading tire data can be obtained from a qualified specialist workshop.

Aspect ratio (in percent) ❷:

The size ratio between the tire height and tire width, shown in percent (tire height divided by tire width).

Tire code ❸ (tire type):

- "R": radial tire

Rim diameter ❹:

The diameter of the bead seat (not the diameter of the rim flange). The rim diameter is specified in inches (in).

Load-bearing index ❺:

Numerical code which specifies the maximum load-bearing capacity of a tire ("91" equals, e.g. 1,356 lb (615 kg)).

The tire load-bearing capacity must be at least half the gross axle weight rating of the vehicle. Do not overload the tires by exceeding the maximum permissible load of the tires.

See also:

- Maximum permissible load on the Tire and Loading Information placard
- Maximum tire load (→ page 210)

Speed rating ❻:

Specifies the approved maximum design speed of the tire.

- ⓘ An electronic speed limiter prevents your vehicle from exceeding a speed of 130 mph (210 km/h).

Ensure that your tires have the required speed rating. You can obtain information on the required speed rating at an authorized Mercedes-Benz Center.

Ensure that your tires have the required speed rating. You can obtain information on the required speed rating at a Mercedes-Benz Commercial Van center.

Summer tires

Index	Speed rating
L	Up to 75 mph (120 km/h)
M	Up to 81 mph (130 km/h)
N	Up to 87 mph (140 km/h)
P	Up to 93 mph (150 km/h)
Q	Up to 100 mph (160 km/h)
R	Up to 106 mph (170 km/h)
S	Up to 113 mph (180 km/h)
T	Up to 119 mph (190 km/h)
H	Up to 131 mph (210 km/h)

Winter tires are marked with the ❄️ snowflake symbol and fulfill the requirements of the Rubber Manufacturers Association (RMA) and the Rubber Association of Canada (RAC) regarding the tire traction on snow.

All-season must be marked with the ❄️ snowflake symbol.

Information on definitions (tires and loading)

Tire structure and characteristics: describes the number of layers or the number of rubber-coated layers in the tire tread and the tire wall. These are made of steel, nylon, polyester and other materials.

Bar: metric unit for tire pressure. 14.5038 pounds per square inch (psi) and 100 kilopascals (kPa) are the equivalent of 1 bar.

DOT (Department of Transportation): DOT marked tires fulfill the requirements of the U.S. Department of Transportation.

Average weight of vehicle occupants: the number of occupants for which the vehicle is designed multiplied by 150 lbs (68 kg).

Uniform Tire Quality Grading Standards: a uniform standard to grade the quality of tires with regards

to tread quality, tire traction and temperature characteristics. The quality grading assessment is made by the manufacturer in accordance with test specifications of the U.S. government. The quality grade of a tire is imprinted on the sidewall of the tire.

Recommended tire pressure: the recommended tire pressure is the pressure specified for the tires installed to the vehicle at the factory.

The Tire and Loading Information placard contains the recommended tire pressures for cold tires, the maximum permissible load and the maximum permissible vehicle speed.

The tire pressure table contains the recommended tire pressures for cold tires under various operating conditions, i.e. load and/or speed of the vehicle.

Increased vehicle weight due to optional equipment: the combined weight of all standard and optional equipment available for the vehicle, regardless of whether it is actually installed on the vehicle or not.

Rim: the part of the wheel on which the tire is installed.

GAWR (Gross Axle Weight Rating): GAWR is the axle load. The actual load on an axle must never exceed the Gross Axle Weight Rating. You can find the Gross Axle Weight Rating on the B-pillar on the driver's side.

Speed rating: the speed rating is part of the tire identification. It specifies the speed range for which a tire is approved.

GVW (Gross Vehicle Weight): the Gross Vehicle Weight includes the weight of the vehicle including fuel, tools, the spare wheel, accessories installed, occupants, luggage and the trailer drawbar nose-weight if applicable. The Gross Vehicle Weight must never exceed the Gross Vehicle Weight Rating (GVWR) as specified on the vehicle identification plate on the B-pillar on the driver's side.

GVWR (Gross Vehicle Weight Rating): the GVWR is the maximum permitted gross weight of the fully laden vehicle (weight of the vehicle including all accessories, occupants, fuel, luggage and the trailer drawbar noseweight if applicable). The Gross Vehicle Weight Rating is specified on the vehicle identification plate on the B-pillar on the driver's side.

Maximum weight of the laden vehicle: the maximum weight is the sum of the vehicle's curb weight, weight of the accessories, maximum load

and the weight of the factory installed optional equipment.

Kilopascal (kPa): metric unit for tire pressure. 6.9 kPa are the equivalent of 1 psi. Another unit for tire pressure is bar. 100 kilopascals (kPa) are the equivalent of 1 bar.

Curb weight: the weight of a vehicle with standard equipment including the maximum capacity of fuel, oil and coolant. It also includes the air-conditioning system and optional equipment if these are installed on the vehicle, but does not include passengers or luggage.

Maximum tire load: the maximum tire load is the maximum permissible weight in kilograms or lbs for which a tire is approved.

Maximum permissible tire pressure: maximum permissible tire pressure for one tire.

Maximum load on one tire: maximum load on one tire. This is calculated by dividing the maximum axle load for one axle by two.

PSI (pounds per square inch): standard unit of measurement for tire pressure.

Aspect ratio: relationship between tire height and tire width in percent.

Tire pressure: pressure inside the tire applying an outward force to every square inch of the tire's surface. The tire pressure is specified in pounds per square inch (psi), in kilopascal (kPa) or in bar. The tire pressure should only be corrected when the tires are cold.

Tire pressure on cold tires: the tires are cold when the vehicle has been parked with the tires out of direct sunlight for at least three hours and the vehicle has been driven less than 1 mile (1.6 km).

Tire contact surface: the part of the tire that comes into contact with the road.

Tire bead: the purpose of the tire bead is to ensure that the tire sits securely on the wheel rim. There are several wire cores in the tire bead to prevent the tire from changing length on the wheel rim.

Side wall: the part of the tire between the tread and the tire bead.

Special equipment weight: the combined weight of those optional extras that weigh more than the replaced standard parts and more than 5 lbs (2.3 kg). Special equipment, such as high-performance brakes, level control system, a roof luggage rack or a high-performance battery, are not included in the curb weight and the weight of the accessories.

TIN (Tire Identification Number): a unique identification number which can be used by a tire manufacturer to identify tires, for example for a product recall, and thus identify the purchasers. The TIN is made up of the manufacturer identification code, tire size, tire type code and the manufacturing date.

Load-bearing index: the load-bearing index (also load index) is a code that contains the maximum load-bearing capacity of a tire.

Traction: traction is the result of friction between the tires and the road surface.

Wear indicator: narrow bars (tread wear bars) that are distributed over the tire tread. If the tire tread is level with the bars, the wear limit of 1/16 in (1.6 mm) has been reached.

Distribution of vehicle occupants: distribution of vehicle occupants over designated seat positions in a vehicle.

Maximum permissible payload weight: nominal load and luggage load plus 150 lbs (68 kg) multiplied by the number of seats in the vehicle.

Changing a wheel

Notes on selecting, installing and replacing tires

You can ask for information regarding permitted wheel/tire combinations at a qualified specialist workshop.

⚠ WARNING Risk of accident due to incorrect wheel and tire dimensions

If wheels and tires of the wrong size are installed, the service brakes or components in the brake system and in the wheel suspension may be damaged.

- ▶ Always replace wheels and tires with ones that fulfill the specifications of the original part.

For wheels, pay attention to the following:

- Designation
- Type

For tires, pay attention to the following:

- Designation
- Manufacturer
- Type

⚠ WARNING Risk of injury through exceeding the specified tire load-bearing capacity or the permissible speed rating

Exceeding the specified tire load rating or the permissible speed rating may lead to tire damage and to the tires bursting.

- ▶ Therefore, only use tire types and sizes approved for your vehicle model.
- ▶ Observe the tire load rating and speed rating required for your vehicle.

! NOTE Vehicle and tire damage due to tire types and sizes that have not been approved

For safety reasons, only use tires, wheels and accessory parts which have been specially approved by Mercedes-Benz for your vehicle.

These tires have been specially adapted for use with driving systems and driving safety systems, such as ABS or ESP®.

Otherwise, certain properties, such as handling characteristics, vehicle noise emissions and consumption could be adversely affected. Other wheel sizes may cause the tires to come into contact with the vehicle body and axle components when under load. This may result in damage to the tire or the vehicle.

- ▶ Only use tires, wheels and accessory parts that have been checked and recommended by Mercedes-Benz.

! NOTE Driving safety put at risk by retreaded tires

Retreaded tires are not checked or recommended by Mercedes-Benz, as previous damage is not always detected during the retread process.

Driving safety cannot, therefore, be guaranteed.

- ▶ Do not use used tires when their previous usage is unknown.

! NOTE Possible wheel and tire damage when driving over obstacles

Large wheels have a smaller section width. As the section width decreases, the risk of wheels and tires being damaged when driving over obstacles increases.

- ▶ Avoid obstacles or drive especially carefully.
- ▶ Reduce your speed when driving over curbs, speed bumps, manhole covers and potholes.
- ▶ Avoid particularly high curbs.

! **NOTE** Damage to electronic components due to use of installation tools

Vehicles with tire pressure monitoring system: electronic components are located in the wheel.

- ▶ Do not place any installation tools in the area of the valve.
- ▶ Only have tires replaced at a qualified specialist workshop.

Accessories that are not approved for your vehicle by Mercedes-Benz, or are not being used correctly, can impair operating safety.

Before purchasing and using non-approved accessories, visit a qualified specialist workshop and inquire about:

- Suitability
- Legal stipulations
- Factory recommendations

Observe the following points when selecting, installing and replacing tires:

- Use only tires and wheels of the same type, design (winter tires, all-season tires) and make.
- Only install wheels of the same size and tread design on one axle (left and right).

It is only permissible to install a different wheel size to this in the event of a flat tire in order to drive to the specialist workshop.

- Only install tires of the correct size onto the wheels.
- **Vehicles with a tire pressure monitoring system:** all installed wheels must be equipped with functioning sensors for the tire pressure monitoring system.
- At temperatures below 50 °F (10 °C) use winter tires or all-season tires with the M+S marking on all wheels.

Winter tires bearing the  snowflake symbol in addition to the M+S marking provide the best possible grip in wintry road conditions.

- Only use tires with the same tread.

- Observe the maximum permissible speed for the installed tires.

If this is below the vehicle's maximum permissible speed, this must be indicated in an appropriate label in the driver's field of vision.

- Break in new tires at moderate speeds for the first 60 miles (100 km).
- Replace the tires after six years at the latest, regardless of wear.

For more information on wheels and tires, contact a qualified specialist workshop.

Also observe the following further related subjects:

- Notes on tire pressure (→ page 204)
- Tire and Loading Information placard
- Tire size designation, load-bearing capacity and speed rating (→ page 210)
- Tire pressure table (→ page 205)
- Notes on the emergency spare wheel (→ page 218)

Notes on changing wheels

! **WARNING** Risk of injury through different wheel sizes

Rotating the front and rear wheels can severely impair the driving characteristics.

The wheel brakes or suspension components may also be damaged.

- ▶ Rotate front and rear wheels only if the wheels and tires are of the same dimensions.

On vehicles that have the same size front and rear wheels, rotate the wheels according to the intervals in the tire manufacturer's warranty book in your vehicle documents. If this is not available, rotate the tires every 3,000 (5,000) to 6,000 miles (10,000 km), depending on the degree of wear. Ensure that the direction of rotation is maintained.

It is imperative to observe the instructions and safety notes on "Changing a wheel!" when doing so.

Size categories of wheels

The determined vehicle speed is displayed in the instrument cluster and is important for controlling the driving safety systems and driving systems. The display accuracy of the speedometer and the odometer is legally prescribed. Determining the speed is dependent on the tire size or the rolling

circumference of the tires. The rim diameter is always specified in inches.

For this reason, the vehicle control units can be coded for the following wheel size categories:

Wheel size categories

Wheel size category 1	Wheel size category 2
195/65 R 16 C	225/55 R 17 XL
205/65 R 16 C	235/55 R 17 XL
225/60 R 16 C	245/55 R 17 XL
225/55 R 17 C	245/45 R 18 XL
225/55 R 17 XL	245/50 R 18 XL
245/45 R 18 XL	245/45 R 19 XL

- i** Mercedes-Benz recommends that you stay within a wheel size category when changing a tire. In this way, you avoid recoding the control units.

Due to the legally prescribed accuracy of the speedometer and odometer displays, the following tires are not permitted for taxis and rental cars:

- Wheel size category 1
 - 195/65 R16C
- Wheel size category 2
 - 225/55 R17XL
 - 245/45 R18XL

If the wheel size category changes, you must have your vehicle's control units recoded at a qualified specialist workshop.

Information on the direction of the tires' rotation

Tires with a specified direction of rotation have additional benefits, e.g. if there is a risk of hydroplaning. You will only gain these benefits if the correct direction of rotation is observed.

An arrow on the sidewall of the tire indicates its correct direction of rotation.

You may also install a spare wheel against the direction of rotation. Observe the time restriction on use as well as the speed limitation specified on the spare wheel.

Notes on storing wheels

Observe the following when storing wheels:

- Wheels that have been removed should be stored in a cool, dry and, if possible, dark place.
- Protect the tires from oil, grease and fuel.

Preparing the vehicle for a wheel change

Requirements:

- The tire-change tool kit is available.
- The vehicle is not on a slope.
- The vehicle is on solid, non-slippery and level ground.

- ▶ Apply the parking brake.
- ▶ Move the front wheels to the straight-ahead position.
- ▶ **Vehicles with automatic transmission:** shift the transmission to position **P**.
- ▶ Switch off the vehicle.
- ▶ Make sure that the vehicle cannot be switched on.
- ▶ **On level terrain:** place chocks or other suitable objects under the front and rear of the wheel that is diagonally opposite the wheel to be changed.
- ▶ **On slight inclines:** place chocks or other suitable objects under the wheels on the front and rear axles opposite the wheel to be changed.

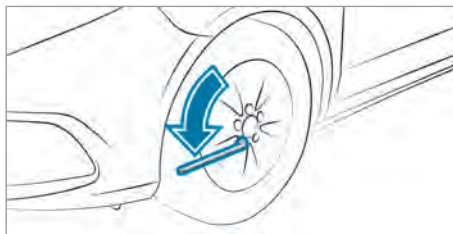

- ▶ If included in the vehicle equipment, take the tire-change tool kit out of the vehicle tool kit (→ page 199).
- ▶ If included in the vehicle equipment, remove the spare wheel from the spare wheel holder (→ page 219).
- ▶ If necessary, remove the wheel trim.
- ▶ Using the lug wrench, loosen the wheel bolts on the wheel you wish to change by about one full turn. Do not unscrew the wheel bolts.

- ▶ Raise the vehicle (→ page 216).

Raising the vehicle when changing a wheel

⚠ WARNING Risk of injury from incorrect positioning of the jack

If you do not position the jack correctly at the appropriate jacking point of the vehicle, the jack could tip with the vehicle raised.

- ▶ Only position the jack at the appropriate jacking point of the vehicle. The base of the jack must be positioned vertically under the jacking point of the vehicle.

⚠ WARNING Risk of injury from vehicle tipping

On slopes, the jack could tip with the vehicle raised.

- ▶ Never change a wheel on a slope.
- ▶ Consult a qualified specialist workshop.

! NOTE Vehicle damage from the jack

If you do not position the jack correctly at the appropriate jack support point of the vehicle, the jack could tip over with the vehicle raised.

- ▶ The jack is designed exclusively for jacking up the vehicle at the jack support points.

Requirements:

- There are no persons in the vehicle.
- The vehicle is prepared for changing a wheel (→ page 215).

Important notes on using the jack:

- Only use the vehicle-specific jack that has been tested and approved by Mercedes-Benz to raise the vehicle. If the jack is used incorrectly, it could tip over while the vehicle is raised.
- The jack is designed only to raise the vehicle for a short time while a wheel is being changed and is not suitable for carrying out maintenance work under the vehicle.
- Avoid changing a wheel on uphill and downhill slopes.

- The jack must be placed on a firm, flat and non-slip surface. If necessary, use a large, flat, load bearing and non-slip underlay.
- The base of the jack is positioned vertically under the jack support point.

Safety instructions while the vehicle is raised:

- Do not put your hands or feet under the vehicle.
- Do not lie underneath the vehicle.
- Do not start the vehicle and do not release the parking brake.
- Do not open or close any doors.

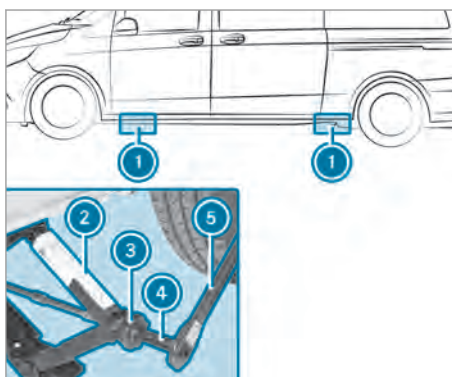

Jack support points ① (rubber stoppers) are located behind the front wheel arches and in front of the rear wheel arches.

- ▶ Place jack ② beneath corresponding jack support point ①.
- ▶ Turn handwheel ③ until the plate of jack ② sits securely on jack support point ①.
- ▶ Ensure that the base of jack ② is positioned vertically under jacking point ①.
- ▶ Assemble adapter ④ and ratchet ⑤ from the vehicle tool kit.
- ▶ Place adapter ④ and ratchet ⑤ on the hexagon nut of jack ② so that the lettering AUF/UP is visible.
- ▶ Turn ratchet wrench ⑤ in the AUF/UP direction until the tire is raised a maximum of 1.2 inch (3 cm) off the ground. When doing so, jack ② may move to one of the side support surfaces.

Removing a wheel

Requirements:

- The vehicle is raised (→ page 216).

When changing a wheel, avoid applying any force to the brake discs since this could impair the level of comfort when braking.

! **NOTE** Damage to threading from dirt on wheel bolts

- ▶ Do not place wheel bolts in sand or on a dirty surface.

- ▶ Remove the wheel bolts.
- ▶ Remove the wheel.

Installing a new wheel

Requirements:

- The wheel is removed (→ page 217).

! **WARNING** Risk of accident from losing a wheel

Oiled, greased or damaged wheel bolt/wheel nut threads or wheel hub/wheel mounting bolt threads can cause the wheel bolts/wheel nuts to come loose.

- ▶ Never oil or grease the threads.
- ▶ In the event of damage to the threads, contact a qualified specialist workshop immediately.
- ▶ Have the damaged wheel bolts or damaged hub threads replaced.
- ▶ Do not continue driving.

! **WARNING** Risk of injury from tightening wheel bolts and nuts

If you tighten the wheel bolts or wheel nuts when the vehicle is raised, the jack could tip.

- ▶ Only tighten wheel bolts or wheel nuts when the vehicle is on the ground.

! **NOTE** Damage to electronic component parts through the use of tire-installing tools

Vehicles with a tire pressure monitoring system: there are electronic component parts in the wheel. Tire-installing tools should not be applied in the area of the valve.

Otherwise, the electronic component parts could be damaged.

- ▶ Always have tires changed at a qualified specialist workshop.

- ▶ Observe the information on the choice of tires (→ page 213).
- ▶ Observe the instructions and safety notes on changing a wheel (→ page 213).
- ▶ For safety reasons, only use wheel bolts or wheel nuts which have been approved by Mercedes-Benz and for the wheel in question.
- ▶ Clean the wheel and wheel hub contact surfaces.
- ▶ Slide the wheel which is to be re-installed onto the wheel hub and push it on.

Lowering the vehicle after a wheel change

! **WARNING** Risk of accident due to incorrect tightening torque

The wheels could come loose if the wheel bolts or wheel nuts are not tightened to the prescribed torque.

- ▶ Ensure that the wheel bolts or wheel nuts are tightened to the prescribed tightening torque.
- ▶ If you are not sure, do not move the vehicle. Contact a qualified specialist workshop and have the tightening torque checked immediately.

Requirements:

- The new wheel has been installed (→ page 217).

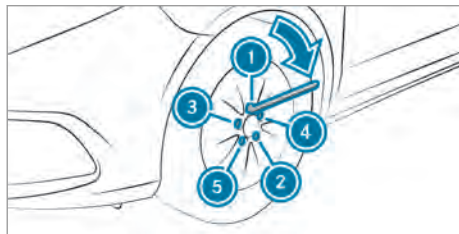

- ▶ Place the adapter and the ratchet on the hexagon head nut of the jack such that the lettering AB/DOWN is visible.
- ▶ **To lower the vehicle:** turn the ratchet of the jack counter-clockwise.

- ▶ **Steel wheels:** tighten the wheel bolts evenly in a crosswise pattern in the sequence indicated (① to ⑤) and to a maximum of 200 Nm.
- ▶ **Alloy wheels:** tighten the wheel bolts evenly in a crosswise pattern in the sequence indicated (① to ⑤) and to a maximum of 180 Nm.
- ▶ Check the tire pressure of the newly installed wheel and adjust it if necessary.

Vehicles with the tire pressure monitor system: all installed wheels must be equipped with functioning sensors.

- ▶ Retighten the wheel bolts to the specified tightening torque after the vehicle has been driven 31 miles (50 km).
- ① When using a wheel or spare wheel with a new or newly painted disk wheel, have the wheel bolts retightened again after approximately 621 to 3,107 miles (1,000 to 5,000 km). Observe the specified tightening torque.

Information on wheel and tire combinations

General notes

Information on tires, wheels and permissible combinations can be obtained at a qualified specialist workshop.

The smaller the cross-section of a tire of a specific wheel size, the worse the driving comfort on poor road surfaces. Ride and damping comfort are reduced and the risk increases that when you drive over obstacles, damage to wheels and tires may result.

If you change wheel size on your vehicle, check it is assigned to the correct wheel size category (→ page 214). If the assignment changes without recoding the control units in the vehicle, the speedometer will not display the speed accurately. Driving safety systems and driving systems may then be operationally impaired or may detect a malfunction and switch themselves off.

You will find a table with the recommended tire pressures for various vehicle loads on the inside of the vehicle's fuel filler flap or under "Tire pressure table" (→ page 205).

Check tire pressure regularly and only when the tires are cold.

Observe the following notes:

- Always equip the vehicle with tires of the same size on a given axle (left/right)
- Always install the same type of wheels on your vehicle at a given time (summer tires, winter tires)

You can obtain information about this from a Mercedes-Benz Commercial Van Center.

- ① Not all wheel/tire combinations can be installed at the factory in all countries.

Spare wheel

Notes on the emergency spare wheel and spare wheel

Emergency spare wheel: wheel and/or tire dimensions as well as the type of tire are different from the wheel to be replaced.

- ① A label with the limit speed and tire pressure can be found on the emergency spare wheel.

Spare wheel: wheel and tire dimensions as well as the type of tire correspond to the other installed wheels.

An installed emergency spare wheel or spare wheel changes the driving characteristics and bears risks.

⚠ WARNING Risk of accident due to incorrect wheel and tire dimensions

Mounting an emergency spare wheel or spare wheel may severely impair the driving characteristics.

There is an increased risk of an accident.

To prevent hazardous situations:

- ▶ Check the tire pressure of the spare wheel or emergency spare wheel once installed and, if necessary, adjust.
- ▶ The emergency spare wheel may only be used temporarily and must be replaced with a standard wheel as soon as possible.
- ▶ Never install more than one emergency spare wheel.
- ▶ Adapt your driving style and drive carefully in emergency spare wheel mode.
- ▶ Do not switch off ESP®.
- ▶ Do not use snow chains on the emergency spare wheel.

▶ Replace the emergency spare wheel after six years at the latest, regardless of wear.

- When using an emergency spare wheel or spare wheel (different from the wheel to be replaced), you must not exceed a permissible top speed of 50 mph (80 km/h).
- Have the emergency spare wheel or spare wheel replaced by a qualified specialist workshop (→ page 213).
- The tire pressure of the emergency spare wheel or spare wheel must be checked before starting a journey and, if necessary, adjusted (→ page 205).

The following should be checked regularly, particularly prior to long journeys:

- that the emergency spare wheel or spare wheel are firmly secured
- the tire pressure of the emergency spare wheel or spare wheel (adjust the tire pressure if necessary) (→ page 205)
- the fastenings of the emergency spare wheel holder or spare wheel holder

The spare wheel is located either on the left in the rear passenger compartment or in a spare wheel holder under the vehicle.

Replace the tires after six years at the latest, regardless of wear. This also applies to the spare wheel.

- ❗ If you have installed a spare wheel, the tire pressure monitor will not function for this wheel. The spare wheel is not equipped with a sensor for monitoring tire pressure.

Installing and removing the spare wheel

Removing the spare wheel in the rear

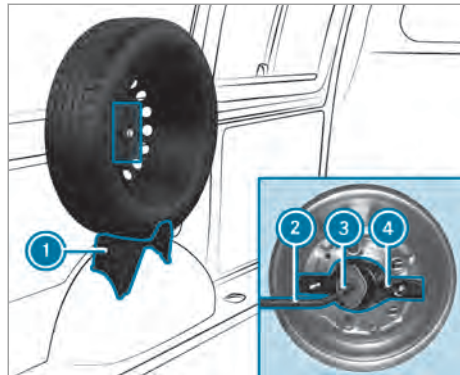

- ▶ Take auxiliary tool ③ and wheel wrench ② out of the vehicle tool kit (→ page 198).
- ▶ Attach auxiliary tool ③ to wheel wrench ②.
- ▶ Unscrew the bolt in the middle of the wheel with wheel wrench ② and attached auxiliary tool ③.
- ▶ Remove spare wheel holder ④.
- ▶ Remove the wheel from spare wheel mounting support ①.

Installing the spare wheel in the rear passenger compartment

- ▶ Take auxiliary tool ③ and wheel wrench ② out of the vehicle tool kit (→ page 198).
- ▶ Place the wheel onto spare wheel holder ① in the wheel arch.
- ▶ Screw on the bolt along with spare wheel holder ④. To do so, use wheel wrench ② with attached auxiliary tool ③.
- ▶ Tighten the bolt using wheel wrench ② and attached auxiliary tool ③.

Removing the spare wheel under the rear of the vehicle

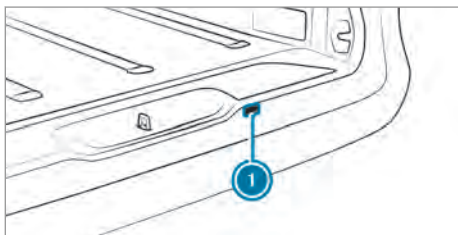

- ▶ Take the wheel wrench and the auxiliary tool for the spare wheel winch out of the vehicle tool kit (→ page 198).
- ▶ Carefully prise off cover cap ① with a suitable tool, e.g. a screwdriver. Be careful not to damage the paintwork or the covering cap when doing so.

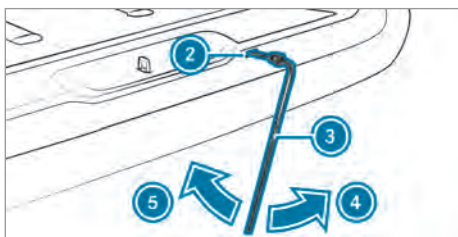

- ▶ Push auxiliary tool ② through the opening into the spare wheel winch guide.
- ▶ Attach wheel wrench ③ to auxiliary tool ② for the spare wheel winch.
- ▶ Turn wheel wrench ③ in the direction of arrow ⑤ until you feel resistance or until the friction clutch of the spare wheel winch overwinds. The spare wheel is lowered.

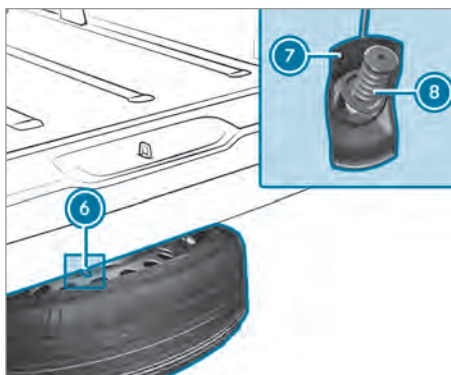

- ▶ Pull the spare wheel out from under the vehicle.
- ▶ Press cable ⑥ downwards and hold spring ⑧ at an angle against wheel gripper ⑦. Wheel gripper ⑦ is released.
- ▶ Pull wheel gripper ⑦ out of the wheel brace.

Installing the spare wheel under the rear of the vehicle

- ▶ **i** Light-alloy wheels cannot be transported under the vehicle. In this case, transport the light-alloy wheel in the load compartment, and only turn up cable ⑥.
- ▶ Take wheel wrench ③ and auxiliary tool ② for the spare wheel lifter out of the vehicle tool kit (→ page 198).
- ▶ Place the wheel on the ground with the wheel brace pointing upwards.
- ▶ Guide wheel gripper ⑦ at an angle on wire ⑥ from above into the wheel brace.
- ▶ Slide the wheel slightly under the vehicle.
- ▶ Attach wheel wrench ③ to auxiliary tool ② for the spare wheel lifter.
- ▶ Turn wheel wrench ③ in the direction of arrow ④ until you feel resistance and the friction clutch of the spare wheel winch overwinds in jerks. The wheel is firmly secured to the underside of the vehicle.
- ▶ Pull wheel wrench ③ and auxiliary tool ② for the spare wheel lifter out of the opening for the spare wheel winch.
- ▶ Close the spare wheel winch opening with cover cap ①.

- ▶ Stow wheel wrench ③ and auxiliary tool ② for the spare wheel lifter in the vehicle tool kit.

Notes on the technical data

The given data only applies to vehicles with standard equipment. You can obtain further information at a qualified specialist workshop.

On-board electronics

Notes on work on the engine electronics

! **NOTES** Premature wear through improper maintenance

Improper maintenance may cause vehicle components to wear more quickly and the vehicle's operating permit may be invalidated.

- ▶ Always have work on the engine electronics and related components carried out at a qualified specialist workshop.

Two-way radios

Installation notes for two-way radios

⚠ **WARNING** Risk of accident due to improper work on two-way radios

If two-way radios are manipulated or retrofitted incorrectly, the electromagnetic radiation from the two-way radios can interfere with the vehicle electronics and jeopardize the operating safety of the vehicle.

- ▶ You should have all work on electrical and electronic components carried out at a qualified specialist workshop.

⚠ **WARNING** Risk of accident due to improper operation of two-way radios

If you use two-way radios in the vehicle improperly, their electromagnetic radiation can disrupt the vehicle's electronics. This is the case in the following situations, in particular:

- The two-way radio is not connected to an exterior antenna.
- The exterior antenna is installed incorrectly or is not a low-reflection antenna.

This could jeopardize the operating safety of the vehicle.

- ▶ Have the low-reflection exterior antenna installed at a qualified specialist workshop.

- ▶ When operating two-way radios in the vehicle, always connect them to the low-reflection exterior antenna.

! **NOTE** Invalidation of the operating permit due to failure to comply with the instructions for installation and use

The operating permit may be invalidated if the instructions for installation and use of two-way radios are not observed.

- ▶ Only use approved frequency bands.
- ▶ Observe the maximum permissible output power in these frequency bands.
- ▶ Only use approved antenna positions.

Use Technical Specification ISO/TS 21609 (Road Vehicles - EMC guidelines for installation of after-market radio frequency transmitting equipment) when retrofitting two-way radios. Comply with the legal requirements for detachable parts.

If your vehicle has installations for two-way radio equipment, use the power supply or antenna connections intended for use with the installation. Observe the manufacturer's supplements during installation.

Two-way radio transmission output

The maximum transmission outputs (PEAK) at the base of the antenna must not exceed the values in the following table:

Frequency band and maximum transmission output

Frequency band	Maximum transmission output
Short wave 3 - 54 MHz	100 W
4 m waveband 74 - 88 MHz	30 W
2 m waveband 144 - 174 MHz	50 W
Trunked radio system/ Tetra 380 - 460 MHz	10 W

Frequency band	Maximum transmission output
70 cm waveband 420 – 450 MHz	35 W
Two-way radio (2G/3G/4G)	10 W

The following devices can be used in the vehicle without restrictions:

- Two-way radios with a maximum transmission output of up to 100 mW
- Two-way radios with transmitter frequencies in the 380 – 410 MHz frequency band and a maximum transmission output of up to 2W (trunked radio system/Tetra)
- Mobile phones (2G/3G/4G)

There are no restrictions when positioning the antenna on the outside of the vehicle for the following frequency bands:

- Trunked radio system/Tetra
- 70 cm waveband
- 2G/3G/4G

Regulatory radio identifications and notes

Regulatory radio identification of small components

Not all regulatory radio identifications can be applied to small components due to their geometric dimensions. Therefore, the following tables list the manufacturers of these components and then the countries/regions with the required regulatory radio identifications.

Manufacturer overview

Manufacturer	Manufacturer information
Bosch	Robert Bosch GmbH, Daimlerstraße 6, 71229 Leonberg, Germany
Hirschmann	Hirschmann Car Communication GmbH, Stuttgarter Straße 45-51, 72654 Neckartenzlingen, Germany

Manufacturer	Manufacturer information
Huf Baolong	Huf Baolong Electronics Bretten GmbH, Gewerbestraße 40, 75015 Bretten, Germany
MARQUARDT	MARQUARDT GmbH, Schloßstraße 16, 78604 Rietheim-Weilheim, Germany
Meta System	Meta System S.P.A., Via T. Galimbreti 5, 42124 Reggio Emilia, Italy
Schrader	Schrader Electronics Ltd., 11 Technology Park, Belfast Road, Antrim BT41 1QS, Northern Ireland, United Kingdom
Veoneer	Veoneer Sweden AB, Wallentinsvägen 22, 44737 Vårgårda, Sweden
WITTE-Velbert	WITTE-Velbert GmbH & Co. KG, Hoferstr. 3-15, 42551 Velbert, Germany

Algeria



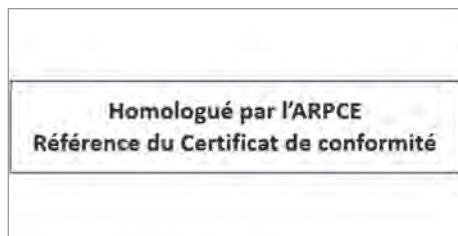

Manufacturer	Model designation	Radio equipment approval number
Continental Automotive	MARS Keyless (Locking system)	122/H/ANF/2021

Argentina



Manufacturer	Model designation	Radio equipment approval number (if available)
Huf Baolong	TSSRE4A (Tire pressure sensor) TSSSG4G6 (Tire pressure sensor)	CNC: H-20027
Schrader	HSW4 (Tire pressure sensor)	CNC: H-12336





Brazil







Manufacturer	Model designation	Radio equipment approval number (if available)
Huf Baolong	TSSRE4A (Tire pressure sensor) TSSSG4G6 (Tire pressure sensor)	ANATEL: 05181-17-06 643 Este equipamento opera em caráter secundário, isto é, não tem direito à proteção contra interferência prejudicial, mesmo de estações do mesmo tipo e não pode causar interferência a sistemas operando em caráter primário.

		
Manufacturer	Model designation	Radio equipment approval number (if available)
Schrader	GG4 (Tire pressure sensor)	ANATEL: 0381-13-800 1 Este equipamento opera em caráter secundário, isto é, não tem direito à proteção contra interferência prejudicial, mesmo de estações do mesmo tipo e não pode causar interferência a sistemas operando em caráter primário.
Schrader	HSW4 (Tire pressure sensor)	ANATEL: 0381-13-800 1 Este equipamento opera em caráter secundário, isto é, não tem direito à proteção contra interferência prejudicial, mesmo de estações do mesmo tipo e não pode causar interferência a sistemas operando em caráter primário.

Indonesia

Manufacturer	Model designation	Radio equipment approval number (if available)
Bosch	LRR3 (Radar sensor)	74264/ SDPPI/2021 7163 
Bosch	MRR1Rear (Radar sensor)	74267/ SDPPI/2021 7163 
Bosch	MRRevo14F (Radar sensor)	74265/ SDPPI/2021 7163 
Bosch	MRRre14FCR (Radar sensor)	74266/ SDPPI/2021 7163 

Manufacturer	Model designation	Radio equipment approval number (if available)	Manufacturer	Model designation	Radio equipment approval number (if available)
Hirschmann	920510A (Locking system)	60598 / SDPPI/2019 7163  Dilarang melakukan perubahan spesifikasi yang dapat menimbulkan gangguan fisik dan/atau elektromagnetik terhadap lingkungan sekitarnya 	HELLA	DM4 (Locking system)	69378 / SDPPI/2020 7163  Dilarang melakukan perubahan spesifikasi yang dapat menimbulkan gangguan fisik dan/atau elektromagnetik terhadap lingkungan sekitarnya 
			Huf Baolong	TSSRE4A (Tire pressure sensor) TSSSG4G6 (Tire pressure sensor)	72438 / SDPPI/2021 7163 

Jordan

Manufacturer	Model designation	Radio equipment approval number (if available)
Huf Baolong	TSSRE4A (Tire pressure sensor)	TRC/LPD/2017/421
Huf Baolong	TSSSG4G6 (Tire pressure sensor)	TRC/LPD/2017/422
Schrader	HSW4 (Tire pressure sensor)	Kingdom of Jordan Type approval for Tyre Pressure Sensor and ECU Type Approval Number: TRC/LPD/2013/48 Type Approval Number: LPD

Canada

Manufacturer	Model designation	Radio equipment approval number (if available)
Huf Baolong	TSSRE4A (Tire pressure sensor) TSSSG4G6 (Tire pressure sensor)	IC: 4008C-TSSRE4A

Malaysia

		
Manufacturer	Model designation	Radio equipment approval number (if available)
Huf Baolong	TSSRE4A (Tire pressure sensor) TSSSG4G6 (Tire pressure sensor)	RAQP/57A/0817/S(17-2424)

Morocco

Manufacturer	Model designation	Radio equipment approval number (if available)
Huf Baolong	TSSRE4A (Tire pressure sensor)	AGREE PAR L'ANRT MAROC MR 14320 ANRT 2017 Date d'agreement: 07/07/2017
Huf Baolong	TSSSG4G6 (Tire pressure sensor)	AGREE PAR L'ANRT MAROC MR 14319 ANRT 2017 Date d'agreement: 07/07/2017
Schrader	HSW4 (Tire pressure sensor)	AGREE PAR L'ANRT MAROC MR7907 ANRT 2013 Date d'agreement: 05/03/2013

Mexico

Manufacturer	Model designation	Radio equipment approval number (if available)
Huf Baolong	TSSRE4A (Tire pressure sensor) TSSSG4G6 (Tire pressure sensor)	IFETEL: RLVHUTS17-0806

Oman

Manufacturer	Model designation	Radio equipment approval number (if available)
Huf Baolong	TSSRE4A (Tire pressure sensor) TSSSG4G6 (Tire pressure sensor)	OMAN - TRAR/4516/17 D100428

Pakistan

Manufacturer	Model designation	Radio equipment approval number (if available)
Hirschmann	920510A (Locking system)	Approved by PTA TAC No. 9.287/2020

Philippines

Manufacturer	Model designation	Radio equipment approval number (if available)
Huf Baolong	TSSRE4A (Tire pressure sensor) TSSSG4G6 (Tire pressure sensor)	NTC Type Approved. No: ESD-1715393 C
Schrader	HSW4 (Tire pressure sensor)	NTC Type Approved. No: ESD-1306995 C

Serbia

Manufacturer	Model designation	Radio equipment approval number (if available)
Hirschmann	920510A (Locking system)	I005 20
MARQUARDT	DC12B (Locking system)	I005 20 P1620124700
MARQUARDT	DC12K (Locking system)	I005 20 P1620124800

Singapore

Manufacturer	Model designation	Radio equipment approval number (if available)
		Complies with IMDA Standards
Bosch	FR5CPCCF (Radar sensor)	DA105282
Bosch	LRR3 (Radar sensor)	DB101762
Bosch	MRR1Rear (Radar sensor)	DA105282
Bosch	MRRRevo14F (Radar sensor)	DA103365
Bosch	MRRre14FCR (Radar sensor)	DB03227
Huf Baolong	TSSRE4A (Tire pressure sensor) TSSSG4G6 (Tire pressure sensor)	DA103787
Meta System	ITS/TPS (Interior protection)	DA103365
Meta System	MUW II (Interior protection)	DA103365
Schrader	HSW4 (Tire pressure sensor)	DA-103365
Veoneer	6208428 (Radar sensor)	N2743-16

Manufacturer	Model designation	Radio equipment approval number (if available)
Veoneer	24 GHz MMR (Radar sensor)	N2955-17
WITTE-Velbert	SDHTAG3NFC (Locking system)	DA107248 N1755-20

South Africa

		
Manufacturer	Model designation	Radio equipment approval number (if available)
Huf Baolong	TSSRE4A (Tire pressure sensor)	TA-2017/1393
Huf Baolong	TSSSG4G6 (Tire pressure sensor)	TA-2017/1391
Schrader	HSW4 (Tire pressure sensor)	TA-2013/461

South Korea

 Manufacturer	Model designation	Radio equipment approval number (if available)
Huf Baolong	TSSRE4A (Tire pressure sensor)	R-CRM-HHF-TSSRE4A 해당 무선 설비 기기는 운용 중 전파혼신 가능성이 있으므로 인명안전과 관련된 서비스는 할 수 없음. (This device is not allowed to provide service related human body since it has possibility of frequency interference during on operation.)

 Manufacturer	Model designation	Radio equipment approval number (if available)
Huf Baolong	TSSSG4G6 (Tire pressure sensor)	R-REM-HHF-TSSSG4G6 해당 무선 설비 기기는 운용 중 전파혼신 가능성이 있으므로 인명안전과 관련된 서비스는 할 수 없음. (This device is not allowed to provide service related human body since it has possibility of frequency interference during on operation.)

South Korea

 Manufacturer	Model designation	Radio equipment approval number (if available)
Huf Baolong	TSSRE4A (Tire pressure sensor)	R-CRM-HHF-TSSRE4A 해당 무선 설비 기기는 운용 중 전파 혼신 가능성이 있으므로 인명 안전과 관련된 서비스는 할 수 없습니다. (This device is not allowed to provide service related human body since it has possibility of frequency interference during on operation.)

 Manufacturer	Model designation	Radio equipment approval number (if available)
Huf Baolong	TSSSG4G6 (Tire pressure sensor)	R-REM-HHF-TSSSG4G6 해당 무선 설비 기기는 운용 중 전파 혼신 가능성이 있으므로 인명 안전과 관련된 서비스는 할 수 없습니다. (This device is not allowed to provide service related human body since it has possibility of frequency interference during on operation.)

Ukraine



Manufacturer	Model designation	Radio equipment approval number (if available)
Hirschmann	920508A (Locking system)	Supplier number: 16833352
Hirschmann	920287B (Locking system)	Supplier number: 16833352
Huf Baolong	TSSRE4A (Tire pressure sensor) TSSSG4G6 (Tire pressure sensor)	UA.TR. 109.0109-17

United Arab Emirates



Manufacturer	Model designation	Radio equipment approval number (if available)
Huf Baolong	TSSRE4A (Tire pressure sensor)	TRA Registered No: ER57807/17 Dealer No: DA36976/14
Huf Baolong	TSSSG4G6 (Tire pressure sensor)	TRA Registered No: ER57806/17 Dealer No: DA36976/14
Schrader	HSW4 (Tire pressure sensor)	TRA Registered No: ER0104996/13 Dealer No: DA0047074/10

United States

Manufacturer	Model designation	Radio equipment approval number (if available)
Huf Baolong	TSSRE4A (Tire pressure sensor) TSSSG4G6 (Tire pressure sensor)	FCC ID: YGOTSSRE4A

Vietnam

		
Manufacturer	Model designation	Radio equipment approval number (if available)
Hirschmann	920510A (Locking system)	C029018121 8AF04A2 Supplier number: 16833352

Manufacturer overview

Manufacturer	Manufacturer information
Garmin	Garmin International, Inc., 1200 E. 151st Street, Olathe, Kansas 66062, United States
Harman Becker	Harman Becker Automotive Systems GmbH, Becker-Goehring-Strasse 18, 76307 Karlsbad, Germany
Visteon	Visteon Electronics GmbH, Amalienbadstraße 41a, 76227 Karlsruhe, Germany

Eurasian Economic Union





		
Manufacturer	Model designation	Radio equipment approval number (if available)
Huf Baolong	TSSRE4A (Tire pressure sensor) TSSSG4G6 (Tire pressure sensor)	—





Regulatory radio identifications - Indonesia









For Indonesia, the following tables list the manufacturers and required regulatory radio identifications of relevant components







-  These are not small components. Information on small components is listed separately in the chapter "Regulatory radio identification of small components" (→ page 223).

Regulatory radio identification

Manufacturer	Model designation	Radio equipment approval number (if available)
Garmin	VIS (Headunit)	69984/SDPPI/ 2020 7163  Dilarang melakukan perubahan spesifikasi yang dapat menimbulkan gangguan fisik dan/atau elektromagnetik terhadap lingkungan sekitarnya 
Harman Becker	NTG6N ENTRY/MID (Headunit) Production: Germany	64019/SDPPI/ 2019 7163  Dilarang melakukan perubahan spesifikasi yang dapat menimbulkan gangguan fisik dan/atau elektromagnetik terhadap lingkungan sekitarnya 

Manufacturer	Model designation	Radio equipment approval number (if available)
Harman Becker	NTG6N HIGH (Headunit) Production: Germany	64018/SDPPI/ 2019 7163  Dilarang melakukan perubahan spesifikasi yang dapat menimbulkan gangguan fisik dan/atau elektromagnetik terhadap lingkungan sekitarnya 
Harman Becker	NTG6N ENTRY/MID (Headunit) Production: Hungary	63775/SDPPI/ 2019 7163  Dilarang melakukan perubahan spesifikasi yang dapat menimbulkan gangguan fisik dan/atau elektromagnetik terhadap lingkungan sekitarnya 

Manufacturer	Model designation	Radio equipment approval number (if available)	Manufacturer	Model designation	Radio equipment approval number (if available)
Harman Becker	NTG6N HIGH (Headunit) Production: Hungary	63774/SDPPI/ 2019 7163  Dilarang melakukan perubahan spesifikasi yang dapat menimbulkan gangguan fisik dan/atau elektromagnetik terhadap lingkungan sekitarnya 	Harman Becker	NTG7 HIGH (Headunit)	70513/SDPPI/ 2020 7163  Dilarang melakukan perubahan spesifikasi yang dapat menimbulkan gangguan fisik dan/atau elektromagnetik terhadap lingkungan sekitarnya 
Harman Becker	NTG7 MID (Headunit)	65544/SDPPI/ 2020 7163  Dilarang melakukan perubahan spesifikasi yang dapat menimbulkan gangguan fisik dan/atau elektromagnetik terhadap lingkungan sekitarnya 	Harman Becker	NTG7 PRE- MIUM (Headunit)	65543/SDPPI/ 2020 7163  Dilarang melakukan perubahan spesifikasi yang dapat menimbulkan gangguan fisik dan/atau elektromagnetik terhadap lingkungan sekitarnya 

Manufacturer	Model designation	Radio equipment approval number (if available)	Manufacturer	Model designation	Radio equipment approval number (if available)
Harman Becker	NTG7 PREMIUM PLUS (Headunit)	70512/SDPPI/2020 7163  Dilarang melakukan perubahan spesifikasi yang dapat menimbulkan gangguan fisik dan/atau elektromagnetik terhadap lingkungan sekitarnya 	Harman Becker	NTG7 RSU (Control unit)	66387/SDPPI/2020 7163  Dilarang melakukan perubahan spesifikasi yang dapat menimbulkan gangguan fisik dan/atau elektromagnetik terhadap lingkungan sekitarnya 
			Visteon	Connect 5 (Headunit)	61671/SDPPI/2019 7163  Dilarang melakukan perubahan spesifikasi yang dapat menimbulkan gangguan fisik dan/atau elektromagnetik terhadap lingkungan sekitarnya 

Information on installation clearances

Radar sensors

FR5CPCCF (Bosch), MRR1REAR (Bosch), MRREVO14F (Bosch), MRRe14FCR (Bosch), LRR3 (Bosch), 6208428 (Veoneer), 24 GHz MMR (Veoneer)

Radiofrequency radiation exposure Information:

This equipment complies with FCC radiation exposure limits set forth for an uncontrolled environment. This equipment should be installed and

operated with minimum distance of 20 cm between the radiator and your body.

This transmitter must not be co-located or operating in conjunction with any other antenna or transmitter.

This equipment should be installed and operated with minimum distance of 20 cm between the radiator and your body. Cet équipement doit être installé et utilisé avec un minimum de 20 cm de distance entre la source de rayonnement et votre corps.

Vehicle identification plate, vehicle identification number (VIN) and engine number

Vehicle identification plate



Vehicle identification plate ① is on the B-pillar on the driver's side.

- ① The data is vehicle-specific and can differ from that shown. Always observe the specifications on your vehicle's identification plate.

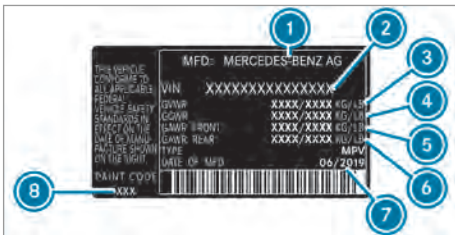

Example: vehicle identification plate (US vehicles)



Example: vehicle identification plate (Canada vehicles)

- ① Vehicle manufacturer
- ② VIN
- ③ Permissible gross mass of the vehicle
- ④ Permissible gross mass of vehicle combination
- ⑤ Permissible front axle load
- ⑥ Permissible rear axle load
- ⑦ Date of manufacture
- ⑧ Paint code

Engraved VIN in the engine compartment

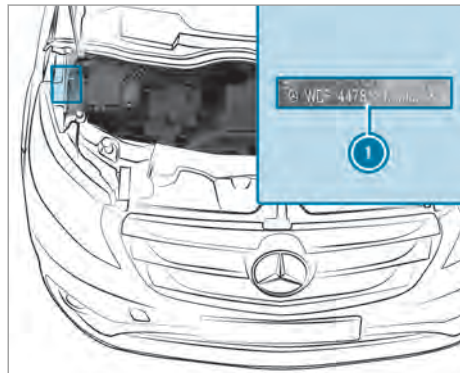

VIN ① is engraved into the longitudinal member in the engine compartment next to the fuse box.

Engine number

The engine number is stamped onto the crankcase. You can obtain further information from a qualified specialist workshop.

Operating fluids and capacities

Notes on operating fluids

⚠ WARNING Risk of injury from operating fluids harmful to your health

Operating fluids may be poisonous and harmful to your health.

- ▶ Observe the text on the original containers when using, storing or disposing of operating fluids.
- ▶ Always store operating fluids sealed in their original containers.
- ▶ Always keep children away from operating fluids.

🌿 ENVIRONMENTAL NOTE Environmental pollution due to disposing of operating fluids in a non-environmentally responsible manner

Incorrect disposal of operating fluids can cause considerable damage to the environment.

- ▶ Dispose of operating fluids in an environmentally responsible manner.

Operating fluids include the following:

- Fuels
- Lubricants
- Coolant
- Brake fluid
- Windshield washer fluid
- Climate control system refrigerants

Only use products which have been approved for your vehicle by Mercedes-Benz. Damage caused by the use of products that have not been approved is not covered by the Mercedes-Benz guarantee or goodwill gestures.

You can identify operating fluids approved by Mercedes-Benz by the following inscriptions on the container:

- MB-Freigabe (e.g. MB-Freigabe 229.51)
- MB-Approval (e.g. MB-Approval 229.51)

Further information on approved operating fluids is available at the following locations:

- In the MB Specifications for operating fluids at <https://bevo.mercedes-benz.com> (by entering the designation)
- At a qualified specialist workshop

Additives for approved operating fluids are neither required nor permitted. Approved fuel additives are the exception. Additives can cause engine damage and must therefore not be added to the operating fluids.

The use of additives is always the responsibility of the vehicle operator. The use of additives may result in the restriction or loss of your warranty claims.

⚠ WARNING Risk of fire or explosion from fuel

Fuels are highly flammable.

- ▶ Fire, open flames, smoking and creating sparks must be avoided.
- ▶ Before refueling, switch off the vehicle and, if installed, the stationary heater, and leave them switched off during refueling.

⚠ WARNING Risk of injury from fuels

Fuels are poisonous and hazardous to your health.

- ▶ Do not swallow fuel or let it come into contact with skin, eyes or clothing.
- ▶ Do not inhale fuel vapor.
- ▶ Keep children away from fuel.
- ▶ Keep doors and windows closed during the refueling process.

If you or other people come into contact with fuel, observe the following:

- ▶ Immediately rinse fuel off your skin with soap and water.
- ▶ If fuel comes into contact with your eyes, immediately rinse them thoroughly with clean water. Seek medical attention immediately.
- ▶ If you swallow fuel, seek medical attention immediately. Do not induce vomiting.
- ▶ Change immediately out of clothing that has come into contact with fuel.

Fuel

Notes on fuel quality for vehicles with a gasoline engine

Observe the notes on operating fluids (→ page 238).

! NOTE Damage due to incorrect fuel

Even small amounts of the wrong fuel could result in damage to the fuel system, engine and exhaust system.

- ▶ Only refuel using low-sulfur, premium-grade unleaded gasoline with at least 91 AKI/95 RON.

This fuel may contain up to 10% ethanol by volume. Your vehicle is suitable for use with E10 fuel.

Never refuel with the following:

- Diesel
- Gasoline with more than 10% ethanol by volume, e.g. E15, E20, E85, E100
- Gasoline with more than 3% methanol by volume, e.g. M15, M30, M50, M85, M100
- Gasoline with additives containing metal

- ▶ Do not mix such fuels with the fuel recommended for your vehicle.

If you have accidentally refueled with the wrong fuel:

- ▶ Do not switch on the vehicle.
- ▶ Consult a qualified specialist workshop.

! NOTE Malfunction due to contaminated fuel

Impurities in the fuel can lead to malfunctions of the fuel system.

- ▶ If you are using drums or canisters to refuel the vehicle, you should filter the fuel before filling.

If the available fuel is not sufficiently low in sulfur, this can produce unpleasant odors.

The recommended octane number for your vehicle can be found on the information label in the fuel filler flap (→ page 105).

Further information on fuel can be obtained at a gas station or a qualified specialist workshop.

Notes on additives in gasoline

Observe the notes on operating fluids (→ page 238).

! NOTE Damage from use of unsuitable additives

Even small amounts of the wrong additive may lead to malfunctions.

- ▶ Only add cleaning additives recommended for Mercedes-Benz to the fuel.

Mercedes-Benz recommends using brand-name fuels with additives.

In some countries, the available fuel may not contain sufficient amounts of additives. Deposits could build up in the fuel injection system as a result.

In this case, in consultation with a Mercedes-Benz Commercial Van Center, the fuel should be mixed with the cleaning additive recommended by Mercedes-Benz.

You must observe the notes and mixing ratios indicated on the tank.

Tank content and fuel reserve

Capacity

Model	Total capacity
All models	Approximately 18.5 US gal (70 liters)
Model	Of which reserve fuel
All models	Approximately 3.2 US gal (12 liters)

Engine oil

Notes on engine oil

Observe the notes on operating fluids (→ page 238).



I **NOTE** Engine damage caused by an incorrect oil filter, incorrect oil or additives

- ▶ Do not use engine oils or oil filters other than those which meet the specifications necessary for the prescribed service intervals.
- ▶ Do not alter the engine oil or oil filter in order to achieve longer change intervals than prescribed.
- ▶ Do not use additives.
- ▶ Have the engine oil changed after the prescribed intervals.

Mercedes-Benz recommends having the oil changed at a qualified specialist workshop.

Further information on engine oil and oil filter:

- In the MB Specifications for operating fluids at <https://bevo.mercedes-benz.com> (by entering the designation)
- At a qualified specialist workshop

Quality and capacity of engine oil

MB-Freigabe or MB-Approval

Models	MB-Freigabe or MB-Approval
--------	----------------------------

All models	229.5, 229.6 ¹
------------	---------------------------

1 Recommended for lowest possible fuel consumption (lowest SAE viscosity class in each case; observe possible restrictions of the approved SAE viscosity classes).

To achieve the lowest possible fuel consumption, it is recommended to use the engine oil specifications marked in the table for the lowest SAE viscosity class. Observe any possible restrictions of the approved SAE viscosity classes.

If the engine oils listed in the table are not available, you may add a maximum of 1.1 US qt (1.0 liter) of the engine oils with MB-Freigabe or MB-Approval 229.3 or ACEA A3/B4.

Engine oil filling capacity

Engine oil	Approx. 2 US gal (7.7 liters)
------------	-------------------------------

Transmission oil

Automatic transmission

Operating fluid: automatic transmission fluid

Product description/ number	Maintenance interval
Mobil ATF 134 FE	-
Valvoline ATF Pro 236.15	
MB Sheet Number 236.15	

You can obtain further information at a qualified specialist workshop.

Rear axle

Operating fluid: transmission oil

Product description/ number	Maintenance interval
Mobilube FE 75W-85	-
Mobilube FE Plus NG 75W-85	
MB Sheet Number 235.7	

You can obtain further information at a qualified specialist workshop.

Notes on brake fluid

Observe the notes on operating fluids (→ page 238).

⚠ WARNING Risk of an accident due to vapor pockets forming in the brake system

The brake fluid constantly absorbs moisture from the air. This lowers the boiling point of the brake fluid. If the boiling point is too low, vapor pockets may form in the brake system when the brakes are applied hard.

This causes the braking effect to be impaired.

- ▶ Have the brake fluid renewed at the specified intervals.

I **NOTE** Damage to paint, plastic or rubber by brake fluid

There is a risk of damage to property if brake fluid comes into contact with paint, plastic or rubber.

▶ If paint, plastic or rubber comes into contact with brake fluid, rinse with water immediately.

Observe the notes on paintwork/matte finish paintwork care (→ page 181).

Have the brake fluid renewed every two years at a qualified specialist workshop.

Only use brake fluid approved by Mercedes-Benz in accordance with MB-Freigabe or MB-Approval 331.0.

Information on brake fluid is available at the following locations:

- In the MB Specifications for operating fluids 331.0
 - At <https://bevo.mercedes-benz.com>
 - In the BeVo app
- At a qualified specialist workshop

Coolant

Notes on coolant

Observe the notes on operating fluids (→ page 238).

⚠ WARNING Risk of Fire and injury due to antifreeze

If antifreeze comes into contact with hot components in the engine compartment, it may ignite.

- ▶ Allow the vehicle to cool down before refilling with antifreeze.
- ▶ Make sure that antifreeze does not spill out over the filler neck.
- ▶ Before starting the vehicle, thoroughly clean the components contaminated with antifreeze.

! **NOTE** Damage caused by incorrect coolant

- ▶ Only add coolant that has been premixed with the required antifreeze protection.

Information on coolant is available at the following locations:

- In the MB Specifications for operating fluids 320.1
 - At <https://bevo.mercedes-benz.com>
 - In the BeVo app
- At a qualified specialist workshop

! **NOTE** Overheating at high outside temperatures

If an inappropriate coolant is used, the engine cooling system is not sufficiently protected against overheating and corrosion at high outside temperatures.

- ▶ Always use coolant approved for Mercedes-Benz.
- ▶ Observe the instructions in the MB Specifications for operating fluids 320.1.

! **NOTE** Paintwork damage due to coolant

- ▶ Do not spill coolant on painted surfaces.

Have the coolant regularly replaced at a qualified specialist workshop.

Note the proportion of anti-corrosion agent/antifreeze in the engine cooling system within the following temperature ranges:

- A minimum of 50% (antifreeze protection down to about -35°F (-37°C))
- A maximum of 55% (antifreeze protection down to -49°F (-45°C))

Coolant capacities

Engine cooling system

Model	Capacity
All models	Approx. 11 US qt (10.4 l)

Windshield washer fluid

Notes on windshield washer fluid

Observe the notes on operating fluids (→ page 238).

⚠ WARNING - Risk of fire and injury from windshield washer concentrate

Windshield washer concentrate is highly flammable. It could ignite if it comes into contact

with hot engine component parts or the exhaust system.

- ▶ Make sure that no windshield washer concentrate spills out next to the filler opening.

! **NOTE** Damage to the exterior lighting due to unsuitable windshield washer fluid

Unsuitable windshield washer fluid may damage the plastic surface of the exterior lighting.

- ▶ Only use windshield washer fluid which is also suitable for use on plastic surfaces, e.g. MB SummerFit or MB WinterFit.

! **NOTE** Blocked spray nozzles caused by mixing windshield washer fluids

- ▶ Do not mix MB SummerFit and MB WinterFit with other windshield washer fluids.

Do not use distilled or de-ionized water. Otherwise, the fill level sensor may give a false reading.

Recommended windshield washer fluid:

- Above freezing point: e.g. MB SummerFit
- Below freezing point: e.g. MB WinterFit

For the correct mixing ratio, refer to the information on the anti-freeze container.

Mix the washer fluid with windshield washer fluid all year round.

Refrigerant

Notes on refrigerant

Observe the notes on operating fluids (→ page 238).

- i** **USA:** Your vehicle's climate control system is filled with the refrigerant R-134a. The refrigerant R134a contains fluorinated greenhouse gas.

Canada: Your vehicle's climate control system is filled with the refrigerant R-1234yf.

The refrigerant type of your vehicle can be found on the information label of the climate control system. The information label can be found on the radiator cross-member.

! **NOTE** Damage due to incorrect refrigerant

If the incorrect refrigerant or refrigerant compressor oil (PAG oil) is used, this can damage the climate control system.

- ▶ Use only refrigerant and the PAG oil approved for your vehicle by Mercedes-Benz.

- ▶ Do not mix the approved PAG oil with another PAG oil.

Maintenance work, such as adding refrigerant or replacing components, may be carried out only by a qualified specialist workshop. All applicable regulations, as well as SAE standard J639, must be adhered to.

Have all work on the climate control system carried out at a qualified specialist workshop.



Refrigerant information label (example - USA)

- ① Symbols for hazard and service information
- ② Refrigerant capacity
- ③ Applicable standards
- ④ PAG oil part number
- ⑤ Refrigerant type



Information label (example - Canada)

- ① Symbols for hazard and service information
- ② Refrigerant capacity
- ③ Applicable standards
- ④ PAG oil part number
- ⑤ Global warming potential
- ⑥ Refrigerant type

Symbols ① advise you of the following:

- Potential dangers
- The performance of maintenance work at a qualified specialist workshop

Refrigerant capacity

Front air conditioning

Model	Refrigerant
All models	21.2 oz (600 g)
Model	PAG oil
All models	2.8 oz (79 g)

Rear air conditioning system

Model	Refrigerant
All models	33.5 oz (950 g)
Model	PAG oil
All models	4.9 oz (139 g)

Vehicle data

Information on vehicle dimensions

The following section contains important technical data for your vehicle. Your vehicle documents contain further vehicle-specific and equipment-dependent technical data such as vehicle dimensions and weights.

The values specified may vary as a result of the following variables:

- Tires
- Load
- Condition of the suspension
- Optional equipment

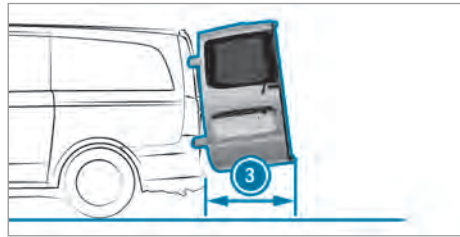
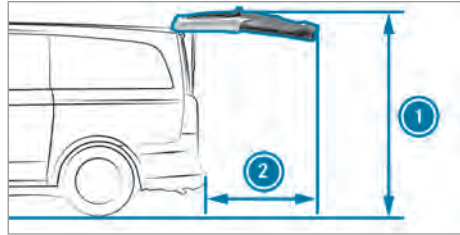

Opening range

Cargo Van	
① Height of the tailgate when opened	86.0 in (2185 mm)
② Opening range of the tailgate	41.2 in (1047 mm)
③ Opening range of the rear-end doors	33.4 in (849 mm)
Passenger Van	
① Height of the tailgate when opened	84.6 in (2150 mm)
② Opening range of the tailgate	41.2 in (1047 mm)
③ Opening range of the rear-end doors	33.4 in (849 mm)

Vehicle dimensions

Cargo Van	
Vehicle length	202.4 in (5140 mm)
Vehicle width including outside mirrors	88.3 in (2244 mm)
Vehicle width excluding outside mirrors	75.9 in (1928 mm)
Load width	50.0 in (1270 mm)

Cargo Van	
Max. load width	66.3 in (1685 mm)
Vehicle height	75.2 in (1910 mm)
Loading height	53.8 in (1367 mm)
Wheelbase	126.0 in (3200 mm)
Passenger Van	
Vehicle length	202.4 in (5140 mm)
Vehicle width including outside mirrors	88.3 in (2244 mm)
Vehicle width excluding outside mirrors	75.9 in (1928 mm)
Load width	47.4 in (1205 mm)
Maximum load width	61.1 in (1552 mm)
Vehicle height	74.4 in (1890 mm)
Loading height	52.2 in (1326 mm)
Wheelbase	126.0 in (3200 mm)

Trailer hitch

Notes on the trailer hitch

⚠ WARNING Risk of accident due to impermissible attachment of a trailer tow hitch

If you install a trailer tow hitch or other components, the longitudinal frame member is weakened and can break. The trailer may become detached from the vehicle.

There is a risk of an accident.

Only retrofit a trailer tow hitch if permissible.

Observe the notes on trailer operation (→ page 128).

Retrofitting a trailer hitch is only permissible if a towing capacity is specified in your vehicle documents.

You can obtain further information on the trailer hitch at a qualified specialist workshop.

Mercedes-Benz recommends having a trailer hitch retrofitted at a Mercedes-Benz Van Dealer.

Only use a trailer hitch which has been tested and specially approved by Mercedes-Benz for your vehicle.

Only use a ball neck for your Metris trailer hitch if it has been approved for your vehicle. Notes on the permissible dimensions of the ball neck can also be found on the identification plate of the trailer hitch.

Trailer loads

Make sure that you adhere to the local legal requirements for trailer loads. Use a calibrated weighing machine to check that the weight restrictions have been complied with before you start your journey.

The permissible weights and loads which must not be exceeded can also be obtained from the following sources of information:

- Vehicle documents
- The type plates of the trailer hitch, trailer and vehicle

The values approved by the manufacturer can be found in the following table. If the values differ, the lowest value applies.

Maximum permissible gross weight, axle loads, trailer loads and tongue weight

Gross vehicle weight GVWR	6614 lb (3000 kg)
Front axle load GAWR (FA)	3307 lb (1500 kg)
Rear axle load GAWR (RA)	3307 lb (1500 kg)
Permissible gross weight of vehicle combination ¹ GCWR	11614 lb (5268 kg)

¹ Maximum permissible gross weight of vehicle with trailer.

Towing capacity, braked ² GTW	5000 lb (2268 kg)
Tongue weight of the trailer drawbar TWR	500 lb (227 kg)

Cargo tie-down points and carrier systems

Loading capacity of the cargo tie-down points and tie-down eyes

Observe the notes on securing loads (→ page 166).

Nominal tensile load is the maximum permissible pulling force on the cargo tie-down point.

Tie-down eyes

Nominal tensile load of tie-down eyes

Tie-down eyes	Nominal tensile load
Tourer	786.5 lbf (350 daN)
Cargo Van	1 124.0 lbf (500 daN)

Guide and loading rails

Rated tensile force of the cargo tie-down point of a guide or loading rail

Cargo tie-down point	Nominal tensile load
Guide rails	786.5 lbf (350 daN)
Loading rails on cargo compartment floor	1 124.0 lbf (500 daN)
Loading rail on side wall	225.0 lbf (100 daN)

The values specified apply only to loads resting on the cargo compartment floor if you observe the following:

- The load is secured to two cargo tie-down points on the rail
- The distance to the nearest load-securing point on the same rail is approximately 3 ft (1 m)

Information about roof luggage racks

Observe the notes on the carrier systems (→ page 171).

NOTE Damage due to exceeding the maximum permissible roof load

If the weight of the roof luggage, including the roof luggage rack, exceeds the maximum permissible roof load, this can cause damage to the vehicle.

- ▶ Do not exceed the maximum permissible roof load.
- ▶ Arrange the supporting feet of the roof luggage rack at an even distance from each other.
- ▶ Install the basic carrier bars for rail in front of and behind the mid-section support.

Maximum roof load/pairs of roof rack supports

Maximum roof load	Minimum number of pairs of supports
331 lbs (150 kg)	3

This information applies if the load is distributed evenly across the entire roof area.

If the roof luggage rack is shorter, reduce the load proportionately. The maximum permitted load per pair of roof rack supports is 110 lbs (50 kg). The maximum permitted load of basic carrier bars for rail is 220 lbs (100 kg).

The driving, braking and steering characteristics of the vehicle will change with the type of load, the weight and the center of gravity of the load. Comply with the loading guidelines and further information about load distribution (→ page 165).

² Maximum permissible gross mass of the trailer, for trailers with independent brake system

Display messages

Introduction

Notes on display messages

⚠ WARNING Risk of accident due to an instrument cluster malfunction

If the instrument cluster has failed or malfunctioned, you may not notice restrictions to safety-relevant system functions.

The operating safety of your vehicle may be impaired.

- ▶ Drive on carefully.
- ▶ Have the vehicle checked immediately at a qualified specialist workshop.

The on-board computer shows messages and warnings from specific systems on the instrument cluster display. Ensure that your vehicle is operating safely at all times.

If you are uncertain regarding the operational safety of your vehicle, park the vehicle safely as soon as possible. Inform a qualified specialist workshop.

Display messages with graphic symbols are simplified in the Operator's Manual and may differ from the symbols on the display.

Vehicles without steering-wheel buttons

A warning tone will also sound for specific display messages.

Please act in accordance with the display messages and follow the additional notes in this Operator's Manual.

You can hide low-priority display messages using the **(R)** button on the instrument cluster. The display messages will be saved to the message memory. Rectify the cause of a display message as quickly as possible.

High-priority display messages cannot be hidden. The display will show these display messages permanently until the cause of the display message has been rectified.

Vehicles with steering-wheel buttons

The display shows high-priority display messages in red. A warning tone will also sound for specific display messages.

Please act in accordance with the display messages and follow the additional notes in this Operator's Manual.

You can hide low-priority display messages using the **(OK)** or **(☞)** steering-wheel button. The display messages will be saved to the message memory. Rectify the cause of a display message as quickly as possible.

High-priority display messages cannot be hidden. The display will show these display messages permanently until the cause of the display message has been rectified.

Calling up saved display messages

Vehicles without steering-wheel buttons

The on-board computer saves specific display messages to the message memory. You can call up the saved display messages. Use the buttons on the instrument cluster.

- ▶ Press the **(☞)** button to select the message memory. If display messages are available, the display will show the number of saved messages. If there are no display messages, the display will show **No Messages**.
- ▶ Press the **(R)** button to scroll forwards through the display messages. After the last saved display message, the display will again show the start screen of the message memory with the number of saved messages.
- ▶ Press the **(☞)** button to jump to the start screen of the message memory.

Vehicles with steering-wheel buttons



The on-board computer saves specific display messages to the message memory. You can call up the saved display messages. Use the buttons on the steering wheel.

- ▶ With the **(◀)** or **(▶)** button, select the **Service** menu.
- ▶ With the **(▼)** or **(▲)** button, select **Announcements**. The bar will show the number of saved messages.
- ▶ Press **(OK)** to confirm. The first saved display message will be displayed. If there are no display messages, the display will show **No Messages**.
- ▶ Press the **(▼)** or **(▲)** button to scroll through the display messages. All saved display messages are numbered in the message memory. The current message number is shown on the lowest bar of the dis-

play as a means of orientation, together with the number of saved display messages.

- ▶ Press  to exit the display messages screen.

Safety systems

Display messages	Possible causes/consequences and ▶ Solutions
 <p>ABS, ESP Inoperative</p>	<p>* ABS, BAS, Hill Start Assist and ESP® as well as its driving safety systems are unavailable due to a malfunction. ATTENTION ASSIST is deactivated and other driving systems could be automatically deactivated. The brake system continues to function normally, but without the functions listed above.</p> <div style="background-color: #f0f0f0; padding: 5px;"> <p>▲ WARNING Risk of skidding if ABS and ESP® are malfunctioning</p> <p>The wheels may block during braking and ESP® does not perform any vehicle stabilization. The steerability and braking characteristics are heavily impaired and the braking distance may increase. In addition, other driving safety systems are switched off.</p> <ul style="list-style-type: none"> ▶ Drive on carefully. ▶ Have ABS and ESP® checked immediately at a qualified specialist workshop. </div> <ul style="list-style-type: none"> ▶ Switch off the vehicle, wait a short while, then switch it on again. ▶ Check whether the display message has disappeared and ESP® is operational. <p>If the display message continues to be shown:</p> <ul style="list-style-type: none"> ▶ Drive on carefully. ▶ Consult a qualified specialist workshop immediately.
 <p>Inoperative See Operator's Manual</p>	<p>* ABS, BAS, Hill Start Assist and ESP® as well as its driving safety systems are unavailable due to a malfunction. ATTENTION ASSIST is deactivated and other driving systems could be automatically deactivated. The brake system continues to function normally, but without the functions listed above.</p> <div style="background-color: #f0f0f0; padding: 5px;"> <p>▲ WARNING Risk of skidding if ABS and ESP® are malfunctioning</p> <p>The wheels may block during braking and ESP® does not perform any vehicle stabilization. The steerability and braking characteristics are heavily impaired and the braking distance may increase. In addition, other driving safety systems are switched off.</p> <ul style="list-style-type: none"> ▶ Drive on carefully. </div>

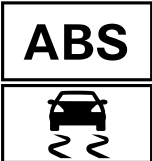
Display messages	Possible causes/consequences and ► Solutions
	<ul style="list-style-type: none"> ► Have ABS and ESP® checked immediately at a qualified specialist workshop. ► Drive on carefully. ► Have ABS and ESP® checked immediately at a qualified specialist workshop.
<div style="text-align: center;">  <p>ABS, ESP Curr. Unavail.</p> </div>	<p>* ABS, BAS, Hill Start Assist and ESP® as well as its driving safety systems are temporarily unavailable. ATTENTION ASSIST is deactivated and other driving systems could be automatically deactivated.</p> <p>The on-board electrical system voltage may be insufficient, for example.</p> <p>The brake system continues to function normally, but without the functions listed above.</p> <div style="border: 1px solid gray; padding: 5px; margin: 10px 0;"> <p>⚠ WARNING Risk of skidding if ABS and ESP® are malfunctioning</p> <p>The wheels may block during braking and ESP® does not perform any vehicle stabilization.</p> <p>The steerability and braking characteristics are heavily impaired and the braking distance may increase. In addition, other driving safety systems are switched off.</p> <ul style="list-style-type: none"> ► Drive on carefully. ► Have ABS and ESP® checked immediately at a qualified specialist workshop. </div> <ul style="list-style-type: none"> ► Drive on carefully and, on a suitable stretch of road, make some slight steering movements at a speed above 12 mph (20 km/h). ► Switch off the vehicle, wait a short while, then switch it on again. ► Check whether the display message has disappeared and ESP® is operational. <p>If the display message continues to be shown:</p> <ul style="list-style-type: none"> ► Drive on carefully. ► Consult a qualified specialist workshop immediately.
<div style="text-align: center;">  <p>Currently Unavail. See Operator's Manual</p> </div>	<p>* ABS, BAS, Hill Start Assist and ESP® as well as its driving safety systems are temporarily unavailable. ATTENTION ASSIST is deactivated and other driving systems could be automatically deactivated.</p> <p>The on-board electrical system voltage may be insufficient, for example.</p> <p>The brake system continues to function normally, but without the functions listed above.</p>





Display messages	Possible causes/consequences and ► Solutions
	<p>▲ WARNING Risk of skidding if ABS and ESP® are malfunctioning</p> <p>The wheels may block during braking and ESP® does not perform any vehicle stabilization.</p> <p>The steerability and braking characteristics are heavily impaired and the braking distance may increase. In addition, other driving safety systems are switched off.</p> <ul style="list-style-type: none"> ▶ Drive on carefully. ▶ Have ABS and ESP® checked immediately at a qualified specialist workshop. <p>► Drive on carefully and, on a suitable stretch of road, make some slight steering movements at a speed above 12 mph (20 km/h).</p> <p>► Check whether the display message has disappeared and ESP® is operational.</p> <p>If the display message continues to be shown:</p> <ul style="list-style-type: none"> ► Drive on carefully. ► Consult a qualified specialist workshop immediately.
 <p>Front Passenger Airbag Disabled</p>	<p>* The front passenger airbag is disabled while the vehicle is in motion even though an adult or a person with a corresponding build is occupying the front passenger seat.</p> <p>If additional forces are applied to the seat or the front passenger is not sitting on the seat surface properly (→ page 31), the weight the system detects may be too low.</p> <p>▲ WARNING Risk of injury or fatal injury due to a disabled front passenger airbag</p> <p>If the front passenger airbag is disabled, the front passenger airbag will not be deployed in the event of an accident and cannot perform its intended protective function.</p> <p>A person in the front passenger seat could then, for example, come into contact with the vehicle's interior, especially if the person is sitting too close to the cockpit.</p> <ul style="list-style-type: none"> ▶ Make sure, both before and during the journey, that the status of the front passenger airbag is correct. <ul style="list-style-type: none"> ► Stop the vehicle immediately in accordance with the traffic conditions. ► Secure the vehicle against rolling away. ► Ensure that no objects have become trapped beneath the front passenger seat. ► Switch off the vehicle. ► The front passenger must get out of the vehicle. ► Make sure that the front passenger seat is unoccupied, close the front passenger door and switch on the vehicle.



Display messages	Possible causes/consequences and ► Solutions
	<ul style="list-style-type: none"> ► Observe the PASSENGER AIRBAG OFF indicator lamp on the center console and the display messages. ► With the seat unoccupied and the vehicle switched on, check the following: <ul style="list-style-type: none"> • The PASSENGER AIRBAG OFF indicator lamp must light up continuously. If the indicator lamp is lit, the occupant classification system (OCS) has disabled the front passenger airbag (→ page 31). • The display must not show the messages Front Passenger Airbag Enabled or Front Passenger Airbag Disabled. ► Wait for at least one minute until the necessary system checks have been completed. ► Ensure that the display does not show either of the two display messages about the front passenger airbag. <p>If these conditions are met, the front passenger seat can be occupied again.</p> <p>If these conditions are not met, the occupant classification system (OCS) is malfunctioning.</p> <ul style="list-style-type: none"> ► Consult a qualified specialist workshop immediately. <p>Further information on airbag shutoff can be found under "Occupant classification system (OCS)" (→ page 31).</p>
<p>Front Passenger Airbag Disabled See Operator's Manual</p>	<p>* The front passenger airbag is disabled while the vehicle is in motion even though an adult or a person with a corresponding build is occupying the front passenger seat.</p> <p>If additional forces are applied to the seat or the front passenger is not sitting on the seat surface properly (→ page 31), the weight the system detects may be too low.</p> <div style="border: 1px solid black; padding: 5px; margin: 10px 0;"> <p>⚠ WARNING Risk of injury or fatal injury due to a disabled front passenger airbag</p> <p>If the front passenger airbag is disabled, the front passenger airbag will not be deployed in the event of an accident and cannot perform its intended protective function.</p> <p>A person in the front passenger seat could then, for example, come into contact with the vehicle's interior, especially if the person is sitting too close to the cockpit.</p> <ul style="list-style-type: none"> ► Make sure, both before and during the journey, that the status of the front passenger airbag is correct. </div> <ul style="list-style-type: none"> ► Stop the vehicle immediately in accordance with the traffic conditions. ► Secure the vehicle against rolling away. ► Ensure that no objects have become trapped beneath the front passenger seat. ► Switch off the vehicle. ► The front passenger must get out of the vehicle.

Display messages	Possible causes/consequences and ► Solutions
	<ul style="list-style-type: none"> ► Make sure that the front passenger seat is unoccupied, close the front passenger door and switch on the vehicle. ► Observe the PASSENGER AIRBAG OFF indicator lamp on the center console and the display messages. ► With the seat unoccupied and the vehicle switched on, check the following: <ul style="list-style-type: none"> • The PASSENGER AIRBAG OFF indicator lamp must light up continuously. If the indicator lamp is lit, the occupant classification system (OCS) has disabled the front passenger airbag (→ page 31). • The display must not show the messages Front Passenger Airbag Enabled See Operator's Manual or Front Passenger Airbag Disabled See Operator's Manual. ► Wait for at least one minute until the necessary system checks have been completed. ► Ensure that the display does not show either of the two display messages about the front passenger airbag. <p>If these conditions are met, the front passenger seat can be occupied again.</p> <p>If these conditions are not met, the Occupant Classification System (OCS) is malfunctioning.</p> <ul style="list-style-type: none"> ► Consult a qualified specialist workshop immediately. <p>Further information on airbag shutoff can be found under "Occupant classification system (OCS)" (→ page 31).</p>
<div style="text-align: center;">  </div> <p>Front Passenger Airbag Enabled</p>	<p>* The front passenger airbag is enabled while the vehicle is in motion although:</p> <ul style="list-style-type: none"> • The front passenger seat is occupied by a child in a child restraint system or a person of small stature. <li style="padding-left: 20px;">or • The front passenger seat is not occupied. <p>The system may detect objects or forces that are adding to the weight applied to the seat.</p> <div style="border: 1px solid gray; background-color: #f0f0f0; padding: 5px; margin-top: 10px;"> <p>▲ WARNING Risk of injury or fatal injury when using a rearward-facing child restraint system while the co-driver airbag is enabled</p> </div> <p>If you secure a child in a rearward-facing child restraint system on the co-driver seat and the PASSENGER AIR BAG OFF indicator lamp is off, the co-driver airbag can deploy in the event of an accident.</p> <p>The child could be struck by the airbag.</p> <ul style="list-style-type: none"> ► Always ensure that the co-driver airbag is disabled. The PASSENGER AIR BAG OFF indicator lamp must be lit.





Display messages	Possible causes/consequences and ► Solutions
	<div data-bbox="506 259 1125 349" style="border: 1px solid gray; padding: 5px; margin-bottom: 10px;"> <p>► NEVER use a rearward-facing child restraint system on a seat with an ENABLED FRONT AIRBAG; DEATH or SERIOUS INJURY to the CHILD can occur.</p> </div> <ul style="list-style-type: none"> ► Stop the vehicle immediately in accordance with the traffic conditions. ► Secure the vehicle against rolling away. ► Ensure that no objects have become trapped beneath the front passenger seat. ► Switch off the vehicle. ► Open the front passenger door. ► Remove the child and the child restraint system from the front passenger seat. ► Make sure there are no objects applying additional weight to the seat. The system may otherwise detect the additional weight and interpret the vehicle occupant's weight on the front passenger seat as greater than it actually is. ► Make sure that the front passenger seat is unoccupied, close the front passenger door and switch on the vehicle. ► Observe the PASSENGER AIRBAG OFF indicator lamp on the center console and the display. ► With the seat unoccupied and the vehicle switched on, check the following: <ul style="list-style-type: none"> • The PASSENGER AIRBAG OFF indicator lamp must light up continuously. If the indicator lamp is lit, the occupant classification system (OCS) has disabled the front passenger airbag. • The display must not show the messages Front Passenger Airbag Enabled or Front Passenger Airbag Disabled. ► Wait for at least one minute until the necessary system checks have been completed. ► Ensure that the display does not show either of the two display messages about the front passenger airbag. <p>If these conditions are met, the front passenger seat can be occupied again. Observe the notes on the occupant classification system (OCS) (→ page 31).</p> <p>If these conditions are not met, the automatic front passenger airbag actuation is malfunctioning.</p> <ul style="list-style-type: none"> ► Fit the child restraint system to a suitable rear seat. <p>or</p> <ul style="list-style-type: none"> ► Seat a person of small stature on a suitable rear seat. ► Consult a qualified specialist workshop immediately. <p>Further information on airbag shutoff can be found under "Occupant classification system (OCS)" (→ page 31).</p>



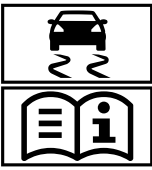





Display messages	Possible causes/consequences and ► Solutions
<p data-bbox="185 258 405 329">Front Passenger Airbag Enabled See Operator's Manual</p>	<p data-bbox="461 258 1080 306">* The front passenger airbag is enabled while the vehicle is in motion although:</p> <ul data-bbox="488 318 1100 431" style="list-style-type: none"> <li data-bbox="488 318 1100 367">• The front passenger seat is occupied by a child in a child restraint system or a person of smaller stature. <li data-bbox="514 378 534 396">or <li data-bbox="488 408 879 431">• The front passenger seat is not occupied. <p data-bbox="479 449 1102 498">The system may detect objects or forces that are adding to the weight applied to the seat.</p> <div data-bbox="484 516 1102 897" style="border: 1px solid gray; padding: 5px;"> <p data-bbox="492 526 1094 598">▲ WARNING Risk of injury or fatal injury when using a rearward-facing child restraint system while the co-driver airbag is enabled</p> <p data-bbox="492 616 1087 713">If you secure a child in a rearward-facing child restraint system on the co-driver seat and the PASSENGER AIR BAG OFF indicator lamp is off, the co-driver airbag can deploy in the event of an accident.</p> <p data-bbox="492 723 847 747">The child could be struck by the airbag.</p> <ul data-bbox="492 758 1058 888" style="list-style-type: none"> <li data-bbox="492 758 1021 806">► Always ensure that the co-driver airbag is disabled. The PASSENGER AIR BAG OFF indicator lamp must be lit. <li data-bbox="492 817 1058 888">► NEVER use a rearward-facing child restraint system on a seat with an ENABLED FRONT AIRBAG; DEATH or SERIOUS INJURY to the CHILD can occur. </div> <ul data-bbox="479 915 1100 1490" style="list-style-type: none"> <li data-bbox="479 915 1100 964">► Stop the vehicle immediately in accordance with the traffic conditions. <li data-bbox="479 974 863 998">► Secure the vehicle against rolling away. <li data-bbox="479 1008 1076 1057">► Ensure that no objects have become trapped beneath the front passenger seat. <li data-bbox="479 1068 711 1091">► Switch off the vehicle. <li data-bbox="479 1102 793 1125">► Open the front passenger door. <li data-bbox="479 1136 1067 1184">► Remove the child and the child restraint system from the front passenger seat. <li data-bbox="479 1195 1094 1315">► Make sure there are no objects applying additional weight to the seat. The system may otherwise detect the additional weight and interpret the vehicle occupant's weight on the front passenger seat as greater than it actually is. <li data-bbox="479 1326 1094 1374">► Make sure that the front passenger seat is unoccupied, close the front passenger door and switch on the vehicle. <li data-bbox="479 1385 1100 1433">► Observe the PASSENGER airbag OFF indicator lamp on the center console and the display. <li data-bbox="479 1444 1094 1490">► With the seat unoccupied and the vehicle switched on, check the following:



Display messages	Possible causes/consequences and ► Solutions
	<ul style="list-style-type: none"> • The PASSENGER AIRBAG OFF indicator lamp must light up continuously. If the indicator lamp is lit, the occupant classification system (OCS) has disabled the front passenger airbag. • The display must not show the messages Front Passenger Airbag Enabled See Operator's Manual or Front Passenger Airbag Disabled See Operator's Manual. <p>► Wait for at least one minute until the necessary system checks have been completed.</p> <p>► Ensure that the display does not show either of the two display messages about the front passenger airbag.</p> <p>If these conditions are met, the front passenger seat can be occupied again. Observe the notes on the occupant classification system (OCS) (→ page 31).</p> <p>If these conditions are not met, the automatic front passenger airbag actuation is malfunctioning.</p> <p>► Install the child restraint system on a suitable rear seat. or</p> <p>► Seat a person of smaller stature on a suitable rear seat.</p> <p>► Consult a qualified specialist workshop immediately.</p> <p>Further information on airbag shutoff can be found under "Occupant classification system (OCS)" (→ page 31).</p>
 <p>(equipment-dependent) Check Brake Pad Wear</p>	<p>* The brakepads have reached their wear limit.</p> <p>► Consult a qualified specialist workshop.</p>
 <p>(USA only)</p>  <p>(Canada only) Check Brake Fluid Level</p>	<p>* There is insufficient brake fluid in the brake fluid reservoir.</p> <div style="border: 1px solid black; padding: 5px;"> <p>▲ WARNING Risk of an accident due to low brake fluid level</p> <p>If the brake fluid level is too low, the braking effect and the braking characteristics may be impaired.</p> <ul style="list-style-type: none"> ► Pull over and stop the vehicle safely as soon as possible, paying attention to road and traffic conditions. Do not continue driving under any circumstances. ► Consult a qualified specialist workshop. ► Do not add brake fluid. </div>
 <p>EBD, ABS, ESP Inoperative</p>	<p>* EBD is unavailable due to a malfunction. This means that ABS, BAS, Hill Start Assist and ESP® as well as its driving safety systems, for example, are also unavailable.</p> <p>ATTENTION ASSIST is deactivated and other driving systems could be automatically deactivated.</p> <p>The brake system continues to function normally, but without the functions listed above.</p>

Display messages	Possible causes/consequences and ► Solutions
	<p>▲ WARNING Risk of skidding if EBD, ABS and ESP® are malfunctioning</p> <p>The wheels may block during braking and ESP® does not perform any vehicle stabilization.</p> <p>The steerability and braking characteristics are heavily impaired and the braking distance may increase. In addition, other driving safety systems are switched off.</p> <ul style="list-style-type: none"> ▶ Drive on carefully. ▶ Have the brake system checked immediately at a qualified specialist workshop. <p>► Switch off the vehicle, wait a short while, then switch it on again.</p> <p>► Check whether the display message has disappeared and ESP® is operational.</p> <p>If the display message continues to be shown:</p> <ul style="list-style-type: none"> ► Drive on carefully. ► Consult a qualified specialist workshop immediately.
<div style="border: 1px solid black; padding: 5px; margin-bottom: 5px; text-align: center; font-weight: bold; font-size: 1.2em;">EBD</div> <div style="border: 1px solid black; padding: 5px; margin-bottom: 5px; text-align: center; font-weight: bold; font-size: 1.2em;">ABS</div> <div style="border: 1px solid black; padding: 5px; margin-bottom: 5px; text-align: center;">  </div> <p>Inoperative See Operator's Manual</p>	<p>* EBD is unavailable due to a malfunction. This means that ABS, BAS, Hill Start Assist and ESP® as well as its driving safety systems, for example, are also unavailable.</p> <p>ATTENTION ASSIST is deactivated and other driving systems could be automatically deactivated.</p> <p>The brake system continues to function normally, but without the functions listed above.</p> <p>▲ WARNING Risk of skidding if EBD, ABS and ESP® are malfunctioning</p> <p>The wheels may block during braking and ESP® does not perform any vehicle stabilization.</p> <p>The steerability and braking characteristics are heavily impaired and the braking distance may increase. In addition, other driving safety systems are switched off.</p> <ul style="list-style-type: none"> ▶ Drive on carefully. ▶ Have the brake system checked immediately at a qualified specialist workshop.
<div style="border: 1px solid black; padding: 5px; margin-bottom: 5px; text-align: center;">  </div> <div style="border: 1px solid black; padding: 5px; margin-bottom: 5px; text-align: center;">  </div> <p>Inoperative</p>	<p>* ESP®, BAS and Hill Start Assist are unavailable due to a malfunction.</p> <p>ATTENTION ASSIST is deactivated and other driving systems could be automatically deactivated.</p> <p>The brake system continues to function normally, but without the functions listed above. The wheels could therefore lock up at an early stage in the event of maximum full-stop braking, for example.</p> <p>This will severely impair steerability and braking. Braking distance may increase in an emergency braking situation.</p>

Display messages	Possible causes/consequences and ► Solutions
	<p>▲ WARNING Risk of skidding if ESP® is malfunctioning</p> <p>If ESP® is malfunctioning, ESP® cannot carry out vehicle stabilization. In addition, other driving safety systems are switched off.</p> <ul style="list-style-type: none"> ► Drive on carefully. ► Have ESP® checked at a qualified specialist workshop. <p>► Switch off the vehicle, wait a short while, then switch it on again.</p> <p>► Check whether the display message has disappeared and ESP® is operational.</p> <p>If the display message continues to be shown:</p> <ul style="list-style-type: none"> ► Drive on carefully. ► Consult a qualified specialist workshop immediately.
 <p>Inoperative See Operator's Manual</p>	<p>* ESP®, BAS and Hill Start Assist are unavailable due to a malfunction. ATTENTION ASSIST is deactivated and other driving systems could be automatically deactivated.</p> <p>The brake system continues to function normally, but without the functions listed above. The wheels could therefore lock up at an early stage in the event of maximum full-stop braking, for example.</p> <p>This will severely impair steerability and braking. Braking distance may increase in an emergency braking situation.</p> <p>▲ WARNING Risk of skidding if ESP® is malfunctioning</p> <p>If ESP® is malfunctioning, ESP® cannot carry out vehicle stabilization. In addition, other driving safety systems are switched off.</p> <ul style="list-style-type: none"> ► Drive on carefully. ► Have ESP® checked at a qualified specialist workshop.
 <p>Currently Unavail.</p>	<p>* ESP®, BAS and Hill Start Assist are unavailable due to a malfunction. Self-diagnosis is not yet complete, for example.</p> <p>ATTENTION ASSIST is deactivated and other driving systems could be automatically deactivated.</p> <p>The brake system continues to function normally, but without the functions listed above. The wheels could therefore lock up at an early stage in the event of maximum full-stop braking, for example.</p> <p>This will severely impair steerability and braking. Braking distance may increase in an emergency braking situation.</p> <p>▲ WARNING Risk of skidding if ESP® is malfunctioning</p> <p>If ESP® is malfunctioning, ESP® cannot carry out vehicle stabilization. In addition, other driving safety systems are switched off.</p> <ul style="list-style-type: none"> ► Drive on carefully. ► Have ESP® checked at a qualified specialist workshop.

Display messages	Possible causes/consequences and ► Solutions
	<ul style="list-style-type: none"> ► Drive carefully on a suitable stretch of road, making slight steering movements at a speed above 12 mph (20 km/h). The functions mentioned above will be available again when the display message goes out. ► Switch off the vehicle, wait a short while, then switch it on again. ► Check whether the display message has disappeared and ESP® is operational. <p>If the display message continues to be shown:</p> <ul style="list-style-type: none"> ► Drive on carefully. ► Consult a qualified specialist workshop immediately.
 <p>Currently Unavail. See Operator's Manual</p>	<p>* ESP®, BAS and Hill Start Assist are unavailable due to a malfunction. Self-diagnosis is not yet complete, for example. ATTENTION ASSIST is deactivated and other driving systems could be automatically deactivated. The brake system continues to function normally, but without the functions listed above. The wheels could therefore lock up at an early stage in the event of maximum full-stop braking, for example. This will severely impair steerability and braking. Braking distance may increase in an emergency braking situation.</p> <div style="border: 1px solid black; padding: 5px; margin: 10px 0;"> <p>▲ WARNING Risk of skidding if ESP® is malfunctioning</p> <p>If ESP® is malfunctioning, ESP® cannot carry out vehicle stabilization. In addition, other driving safety systems are switched off.</p> <ul style="list-style-type: none"> ► Drive on carefully. ► Have ESP® checked at a qualified specialist workshop. </div> <ul style="list-style-type: none"> ► Drive carefully on a suitable stretch of road, making slight steering movements at a speed above 12 mph (20 km/h). The functions mentioned above will be available again when the display message goes out. <p>If the display message continues to be shown:</p> <ul style="list-style-type: none"> ► Drive on carefully. ► Consult a qualified specialist workshop immediately.
 <p>(USA only)</p>  <p>(Canada only)</p> <p>Please Release Parking Brake</p>	<p>* The red  (USA only) or  (Canada only) indicator lamp on the instrument cluster lights up. A warning tone also sounds. You are driving with the parking brake applied or performing emergency braking using the parking brake.</p> <ul style="list-style-type: none"> ► Release the parking brake (→ page 107).

Display messages	Possible causes/consequences and ► Solutions
 <p data-bbox="207 347 429 372">Malfunction Visit Dealer</p>	<p data-bbox="484 258 1115 310">* The restraint system is malfunctioning. In addition, the  warning lamp on the instrument cluster lights up.</p> <div data-bbox="505 324 1126 516" style="border: 1px solid gray; padding: 5px;"> <p data-bbox="514 333 1093 385">▲ WARNING Risk of injury due to malfunctions in the restraint system</p> <p data-bbox="518 396 1109 448">Components in the restraint system may be activated unintentionally or not deploy as planned in an accident.</p> <ul data-bbox="518 453 1093 505" style="list-style-type: none"> ► Have the restraint system checked and repaired immediately at a qualified specialist workshop. </div> <p data-bbox="501 530 1115 582">► Have the restraint system checked and repaired immediately at a qualified specialist workshop.</p> <p data-bbox="501 594 1106 646">Further information on the restraint system and its components can be found under "Occupant safety".</p>
 <p data-bbox="207 754 365 802">SRS Malfunction: Service Required</p>	<p data-bbox="484 664 1115 716">* The restraint system is malfunctioning. In addition, the  warning lamp on the instrument cluster lights up.</p> <div data-bbox="505 731 1126 922" style="border: 1px solid gray; padding: 5px;"> <p data-bbox="514 740 1093 792">▲ WARNING Risk of injury due to malfunctions in the restraint system</p> <p data-bbox="518 802 1109 854">Components in the restraint system may be activated unintentionally or not deploy as planned in an accident.</p> <ul data-bbox="518 860 1093 912" style="list-style-type: none"> ► Have the restraint system checked and repaired immediately at a qualified specialist workshop. </div> <p data-bbox="501 937 1106 989">Further information on the restraint system and its components can be found under "Occupant safety".</p>
 <p data-bbox="207 1091 400 1139">Fr. Left Malf. Service Req. (example)</p>	<p data-bbox="484 1001 1119 1053">* The corresponding restraint system is malfunctioning. In addition, the  warning lamp on the instrument cluster lights up.</p> <div data-bbox="505 1068 1126 1259" style="border: 1px solid gray; padding: 5px;"> <p data-bbox="514 1076 1093 1128">▲ WARNING Risk of injury due to malfunctions in the restraint system</p> <p data-bbox="518 1139 1109 1191">Components in the restraint system may be activated unintentionally or not deploy as planned in an accident.</p> <ul data-bbox="518 1197 1093 1249" style="list-style-type: none"> ► Have the restraint system checked and repaired immediately at a qualified specialist workshop. </div> <p data-bbox="501 1274 1001 1300">► Consult a qualified specialist workshop immediately.</p>
 <p data-bbox="207 1404 431 1480">Front Left Malfunction Service Required (example)</p>	<p data-bbox="484 1315 1119 1367">* The corresponding restraint system is malfunctioning. In addition, the  warning lamp on the instrument cluster lights up.</p> <div data-bbox="505 1381 1126 1573" style="border: 1px solid gray; padding: 5px;"> <p data-bbox="514 1390 1093 1442">▲ WARNING Risk of injury due to malfunctions in the restraint system</p> <p data-bbox="518 1453 1109 1505">Components in the restraint system may be activated unintentionally or not deploy as planned in an accident.</p> <ul data-bbox="518 1510 1093 1562" style="list-style-type: none"> ► Have the restraint system checked and repaired immediately at a qualified specialist workshop. </div> <p data-bbox="501 1587 1001 1614">► Consult a qualified specialist workshop immediately.</p>

Display messages	Possible causes/consequences and ► Solutions
<p>Left Curtain Airbag Service Required (example)</p>	<p>* The corresponding window airbag is malfunctioning. In addition, the  warning lamp on the instrument cluster lights up.</p> <p>▲ WARNING Risk of injury or fatal injury due to a malfunction in the window curtain airbag</p> <p>The window curtain airbag might be triggered unintentionally or might not be triggered at all in the event of an accident.</p> <p>► Have the window curtain airbag checked and repaired immediately at a qualified specialist workshop.</p> <p>► Consult a qualified specialist workshop immediately.</p>
<p> Left Curtain Airbag Malfunction: Service Required (example)</p>	<p>* The corresponding window airbag is malfunctioning. In addition, the  warning lamp on the instrument cluster lights up.</p> <p>▲ WARNING Risk of injury or fatal injury due to a malfunction in the window curtain airbag</p> <p>The window curtain airbag might be triggered unintentionally or might not be triggered at all in the event of an accident.</p> <p>► Have the window curtain airbag checked and repaired immediately at a qualified specialist workshop.</p> <p>► Consult a qualified specialist workshop immediately.</p>

Driving systems

Display messages	Possible causes/consequences and ► Solutions
<p>120 km/h or Maximum Speed 120 km/h</p>	<p>* For certain countries only: the maximum permissible speed has been exceeded.</p> <p>► Drive more slowly.</p>
<p>120 km/h Maximum Speed Exceeded</p>	<p>* For certain countries only: the maximum permissible speed has been exceeded.</p> <p>► Drive more slowly.</p>
<p> Attent. Asst Inoperative</p>	<p>* ATTENTION ASSIST has failed.</p> <p>► Consult a qualified specialist workshop.</p>
<p> Attention Assist Inoperative</p>	<p>* ATTENTION ASSIST has failed.</p> <p>► Consult a qualified specialist workshop.</p>



Display messages	Possible causes/consequences and ► Solutions
 <p data-bbox="207 349 434 372">Attent. Asst Take Break!</p>	<p data-bbox="484 259 1118 304">* Based on certain criteria, ATTENTION ASSIST has detected fatigue or increasing lapses in concentration on the part of the driver.</p> <p data-bbox="500 313 756 340">A warning tone also sounds.</p> <p data-bbox="500 349 769 376">► If necessary, take a break.</p> <p data-bbox="500 385 1125 439">On long journeys, take regular and timely breaks that allow you to rest properly.</p>
<p data-bbox="207 456 388 501">Attent. Asst Take a Break!</p>	<p data-bbox="484 456 1118 501">* Based on certain criteria, ATTENTION ASSIST has detected fatigue or increasing lapses in concentration on the part of the driver.</p> <p data-bbox="500 510 756 537">A warning tone also sounds.</p> <p data-bbox="500 546 769 573">► If necessary, take a break.</p> <p data-bbox="500 582 1125 636">On long journeys, take regular and timely breaks that allow you to rest properly.</p>
<p data-bbox="207 654 414 698">Active Distance Assist --- mph</p>	<p data-bbox="484 654 1118 698">* An activation condition for Active Distance Assist DISTRONIC has not been fulfilled.</p> <p data-bbox="500 707 1105 761">► Comply with the activation conditions for Active Distance Assist DISTRONIC (→ page 114).</p>
<p data-bbox="207 779 414 824">Active Distance Assist Off</p>	<p data-bbox="484 779 1006 824">* Active Distance Assist DISTRONIC has been deactivated (→ page 114).</p> <p data-bbox="500 833 1085 887">In the event of a deactivation not initiated by the driver, a warning tone also sounds.</p>
<p data-bbox="207 904 414 949">Active Distance Assist Inoperative</p>	<p data-bbox="484 904 1125 949">* A warning tone also sounds. Active Distance Assist DISTRONIC is malfunctioning. In addition, BAS may have failed.</p> <p data-bbox="500 958 888 985">► Consult a qualified specialist workshop.</p>
<p data-bbox="207 994 421 1039">Active Distance Assist and Limiter Inoperative</p>	<p data-bbox="484 994 1105 1039">* A warning tone also sounds. Active Distance Assist DISTRONIC and the limiter are malfunctioning.</p> <p data-bbox="500 1048 888 1075">► Consult a qualified specialist workshop.</p>
<p data-bbox="207 1102 440 1146">Act. Distance Assist Sus- pended</p>	<p data-bbox="484 1102 1085 1146">* You are accelerating. Active Distance Assist DISTRONIC does not intervene for the duration of the acceleration process.</p> <p data-bbox="500 1155 1046 1200">► Remove your foot from the accelerator pedal. Active Distance Assist DISTRONIC will be activated again.</p>
<p data-bbox="207 1227 414 1290">Active Distance Assist Curr. Unavailable See Oper. Manual</p>	<p data-bbox="484 1227 1112 1299">* A warning tone also sounds. Active Distance Assist DISTRONIC has been switched off and is temporarily non-operational.</p> <p data-bbox="500 1308 809 1335">The following causes are possible:</p> <ul data-bbox="506 1344 1118 1514" style="list-style-type: none"> • The function is impaired due to heavy rain or snow. • The radar sensor system is temporarily non-operational, e.g. due to electromagnetic radiation close to TV or radio transmitting stations or other sources of radiation. • The system is outside the operating temperature range. • The on-board electrical system voltage is too low. <p data-bbox="500 1532 1112 1603">If the causes mentioned above no longer apply, the display message will disappear and Active Distance Assist DISTRONIC will be operational again.</p>





Display messages	Possible causes/consequences and ► Solutions
	If the display message does not disappear: <ul style="list-style-type: none"> ► Stop in accordance with the traffic conditions. ► Secure the vehicle against rolling away. ► Restart the vehicle.
Active Brake Assist System Inoperative	* Active Brake Assist is unavailable due to a malfunction. <ul style="list-style-type: none"> ► Consult a qualified specialist workshop.
Active Brake Assist Currently Unavail.	* Active Brake Assist is temporarily non-operational. The following causes are possible: <ul style="list-style-type: none"> • The sensors in the front bumper are dirty. • The function is impaired due to heavy rain or snow. • The radar sensor system is temporarily non-operational, e.g. due to electromagnetic radiation close to TV or radio transmitting stations or other sources of radiation. • The system is outside the operating temperature range. • The on-board electrical system voltage is too low. If the causes mentioned above no longer apply, the display message will disappear and Active Brake Assist will be operational again. If the display message does not disappear: <ul style="list-style-type: none"> ► Stop in accordance with the traffic conditions. ► Secure the vehicle against rolling away. ► Switch off the vehicle. ► Clean the sensors in the front bumper (→ page 182). ► Restart the vehicle.
Active Distance Assist Now Available	* Active Distance Assist DISTRONIC is operational again following temporary non-availability. You can now switch Active Distance Assist DISTRONIC on again (→ page 115, 116).
Cruise Control --- mph	* An activation condition for cruise control has not been met. For example, you are aiming to store a speed below 20 mph (30 km/h). <ul style="list-style-type: none"> ► If conditions permit, drive at a speed greater than 20 mph (30 km/h) and store the speed. ► Observe the activation conditions for cruise control (→ page 113).
Cruise Control and Limiter Inoperative	* A warning tone also sounds. Cruise control and the limiter are malfunctioning. <ul style="list-style-type: none"> ► Visit a qualified specialist workshop.
Blind Spot Assist Inoperative	* Blind Spot Assist is malfunctioning. <ul style="list-style-type: none"> ► Consult a qualified specialist workshop.
Blind Spot Assist Currently Unavail. See Operator's Manual	* Blind Spot Assist is temporarily non-operational.

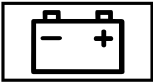

Display messages	Possible causes/consequences and ► Solutions
	<p>The following causes are possible:</p> <ul style="list-style-type: none"> • You have coupled up a trailer. • The sensors in the rear bumper are dirty. • The function is impaired due to heavy rain or snow. • The radar sensor system is temporarily non-operational, e.g. due to electromagnetic radiation close to TV or radio transmitting stations or other sources of radiation. • The system is outside the operating temperature range. <p>If the causes mentioned above no longer apply, the display message will disappear and Lane Keeping Assist will be operational again.</p> <p>If the display message does not disappear:</p> <ul style="list-style-type: none"> ► Stop in accordance with the traffic conditions. ► Secure the vehicle against rolling away. ► Switch off the vehicle. ► Clean the sensors in the rear bumper (→ page 182). ► Restart the vehicle.
Park Assist Canceled	<p>* An acoustic signal also sounds. The active parking assistance systems have been canceled and Active Parking Assist will automatically be aborted. You have touched the steering wheel, for example, or have driven at too high a speed.</p> <ul style="list-style-type: none"> ► Steer and brake manually. ► Repeat the parking procedure if necessary. Comply with the deactivation conditions (→ page 122).
Park Assist Inoperative	<p>* PARKTRONIC is malfunctioning or malfunctioning.</p> <ul style="list-style-type: none"> ► Comply with the instructions and aids in "Function of PARKTRONIC"(→ page 119). ► If the display message continues to be displayed, consult a qualified specialist workshop: <p>* Active Parking Assist is not available or is malfunctioning.</p> <ul style="list-style-type: none"> ► Switch off the vehicle, wait a short while, then switch it on again. <p>If the display message continues to be displayed, or if the display does not show the P symbol:</p> <ul style="list-style-type: none"> ► Consult a qualified specialist workshop.
Lane Keeping Assist Inoperative	<p>* Lane Keeping Assist is malfunctioning.</p> <ul style="list-style-type: none"> ► Consult a qualified specialist workshop.
Lane Keeping Assist Currently Unavail. See Oper. Manual	<p>* Lane Keeping Assist has been switched off and is temporarily non-operational.</p> <p>The following causes are possible:</p> <ul style="list-style-type: none"> • The windshield is dirty in the camera's field of vision. • Visibility is impaired due to heavy rain, snow or fog.





Display messages	Possible causes/consequences and ► Solutions
	<ul style="list-style-type: none"> • Lane markings are absent for a long period of time. • The lane markings are worn, dark or covered by dirt or snow, for example. <p>If the causes mentioned above no longer apply, the display message will disappear and Lane Keeping Assist will be operational again.</p> <p>If the display message does not disappear:</p> <ul style="list-style-type: none"> ► Stop in accordance with the traffic conditions. ► Secure the vehicle against rolling away. ► Clean the windshield.

Engine

Display messages	Possible causes/consequences and ► Solutions
	<p>* A warning tone also sounds.</p> <p>The battery is no longer being charged for one of the following reasons:</p> <ul style="list-style-type: none"> • Malfunctioning alternator • Torn poly-V belt • Malfunction in the electronics <ul style="list-style-type: none"> ► Stop the vehicle immediately in accordance with the traffic conditions and switch it off. Do not continue driving. If you do, the engine may overheat. ► Secure the vehicle against rolling away. ► Consult a qualified specialist workshop.
 <p>Stop Vehicle Turn Eng. Off</p>	<p>* A warning tone also sounds. The coolant is too hot.</p> <ul style="list-style-type: none"> ► Stop the vehicle immediately in accordance with the traffic conditions and switch it off. <div style="border: 1px solid gray; padding: 5px; margin: 5px 0;"> <p>▲ WARNING Risk of burns when opening the hood</p> <p>If you open the hood in the event of an overheated engine or fire in the engine compartment, the following situations may occur:</p> <ul style="list-style-type: none"> • You may come into contact with hot gases. • You may come into contact with other escaping hot operating fluids. <ul style="list-style-type: none"> ► Before opening the hood, allow the engine to cool down. ► In the event of a fire in the engine compartment, keep the hood closed and call the fire service. </div> <div style="border: 1px solid gray; padding: 5px; margin: 5px 0;"> <p>▲ WARNING Risk of scalding from hot coolant</p> <p>If you open the cap, you could be scalded.</p> <ul style="list-style-type: none"> ► Let the motor cool down before opening the cap. </div>

Display messages	Possible causes/consequences and ► Solutions
	<ul style="list-style-type: none"> ► When opening the cap, wear protective gloves and safety glasses. ► Open the cap slowly to release pressure. <ul style="list-style-type: none"> ► Observe the coolant temperature display (→ page 140). ► Wait until the engine has cooled down. ► Ensure that the air supply to the radiator is not obstructed. ► Avoiding high engine loads, drive on to the nearest qualified specialist workshop. In doing so, ensure that the coolant temperature display remains below the letter H.
<div style="text-align: center;">  </div> <p data-bbox="207 654 414 725">Coolant Too Hot: Stop Vehicle Switch Engine Off</p>	<p data-bbox="484 564 954 587">* A warning tone also sounds. The coolant is too hot.</p> <div style="background-color: #e0e0e0; padding: 5px; margin-bottom: 10px;"> <p data-bbox="513 609 987 636">▲ WARNING Risk of burns when opening the hood</p> </div> <p data-bbox="519 654 1092 698">If you open the hood in the event of an overheated engine or fire in the engine compartment, the following situations may occur:</p> <ul style="list-style-type: none"> • You may come into contact with hot gases. • You may come into contact with other escaping hot operating fluids. <ul style="list-style-type: none"> ► Before opening the hood, allow the engine to cool down. ► In the event of a fire in the engine compartment, keep the hood closed and call the fire service. <div style="background-color: #e0e0e0; padding: 5px; margin-bottom: 10px;"> <p data-bbox="513 922 947 949">▲ WARNING Risk of scalding from hot coolant</p> </div> <p data-bbox="519 967 894 994">If you open the cap, you could be scalded.</p> <ul style="list-style-type: none"> ► Let the motor cool down before opening the cap. ► When opening the cap, wear protective gloves and safety glasses. ► Open the cap slowly to release pressure. <ul style="list-style-type: none"> ► Stop the vehicle immediately in accordance with the traffic conditions and switch it off. ► Monitor the  coolant temperature display on the instrument cluster. ► Wait until the engine has cooled down. ► Ensure that the air supply to the radiator is not obstructed. ► Avoiding high engine loads, drive on to the nearest qualified specialist workshop. In doing so, ensure that the coolant temperature display remains below the red marking.
<div style="text-align: center;">  </div>	<p data-bbox="484 1415 736 1442">* The fan motor is defective.</p> <p data-bbox="500 1447 861 1474">Vehicles without steering-wheel buttons:</p> <ul style="list-style-type: none"> ► Check the coolant temperature (→ page 140). <p data-bbox="500 1532 835 1559">Vehicles with steering-wheel buttons:</p> <ul style="list-style-type: none"> ► Check the coolant temperature display  on the instrument cluster.

Display messages	Possible causes/consequences and ► Solutions
	<p>If the coolant temperature is below the maximum value specified below, you can continue driving to the nearest qualified specialist workshop.</p> <p>In doing so, avoid high engine loads, e.g. driving in mountainous terrain or stop-and-go driving.</p> <p>During normal driving and if the coolant level is correct, the coolant temperature display is permitted to rise to letter H.</p>
 <p data-bbox="185 557 373 578">Check Coolant Level</p>	<p>* The coolant level is too low.</p> <div data-bbox="484 507 1102 587" style="border: 1px solid black; padding: 5px;"> <p>! NOTE Engine damage due to insufficient coolant</p> <p>► Avoid long journeys with insufficient coolant.</p> </div> <p>► Add coolant, following the notes on coolant (→ page 178).</p> <p>If you frequently need to add coolant:</p> <p>► Have the engine cooling system checked at a qualified specialist workshop.</p>
 <p data-bbox="185 844 415 892">Check Coolant Level See Oper. Manual</p>	<p>* The coolant level is too low.</p> <div data-bbox="484 793 1102 874" style="border: 1px solid black; padding: 5px;"> <p>! NOTE Engine damage due to insufficient coolant</p> <p>► Avoid long journeys with insufficient coolant.</p> </div> <p>► Add coolant, following the notes on coolant (→ page 178).</p> <p>If you frequently need to add coolant:</p> <p>► Have the engine cooling system checked at a qualified specialist workshop.</p>
 <p data-bbox="185 1130 389 1202">Check Engine Oil Level or Check Engine Oil At Next Refueling</p>	<p>* A warning tone also sounds. The oil level in your vehicle has fallen to the minimum.</p> <div data-bbox="484 1105 1102 1211" style="border: 1px solid black; padding: 5px;"> <p>! NOTE Engine damage caused by driving with insufficient engine oil</p> <p>► Avoid long journeys with insufficient engine oil.</p> </div> <p>► Check the oil level when next refueling, at the latest (→ page 177).</p> <p>► If necessary, add engine oil (→ page 177).</p> <p>If engine oil frequently needs to be topped up:</p> <p>► Have the engine checked at a qualified specialist workshop.</p>
<p data-bbox="185 1408 415 1430">Manually Check Oil Level</p>	<p>* Reminder to check the oil level.</p> <div data-bbox="484 1451 1102 1557" style="border: 1px solid black; padding: 5px;"> <p>! NOTE Engine damage caused by driving with insufficient engine oil</p> <p>► Avoid long journeys with insufficient engine oil.</p> </div>

Display messages	Possible causes/consequences and ► Solutions
	<ul style="list-style-type: none"> ► Check the oil level when next refueling, at the latest (→ page 177). ► If necessary, add engine oil (→ page 177). ► To confirm the oil level check: press and hold the (R) button.
 <p data-bbox="207 480 439 503">Manually Check Oil Level</p>	<p data-bbox="484 390 781 413">* Reminder to check the oil level.</p> <div data-bbox="505 431 1126 539" style="border: 1px solid black; padding: 5px;"> <p data-bbox="514 440 1060 491">! NOTE Engine damage caused by driving with insufficient engine oil</p> <p data-bbox="514 503 968 526">► Avoid long journeys with insufficient engine oil.</p> </div> <ul style="list-style-type: none"> ► Check the oil level when next refueling, at the latest (→ page 177). ► If necessary, add engine oil (→ page 177). ► To confirm the oil level: press the [OK] button.
 <p data-bbox="207 777 415 827">Stop Vehicle Turn Eng. Off</p>	<p data-bbox="484 688 1001 711">* The oil level is too low. There is a risk of engine damage.</p> <ul style="list-style-type: none"> ► Stop the vehicle immediately in accordance with the traffic conditions and switch it off. ► Secure the vehicle against rolling away. ► Check the oil level (→ page 177). ► If necessary, add engine oil (→ page 177).
 <p data-bbox="207 974 429 1050">Eng. Oil Level Low: Stop Vehicle Switch Engine Off</p>	<p data-bbox="484 885 1001 908">* The oil level is too low. There is a risk of engine damage.</p> <ul style="list-style-type: none"> ► Stop the vehicle immediately in accordance with the traffic conditions and switch it off. ► Secure the vehicle against rolling away. ► Check the oil level (→ page 177). ► If necessary, add engine oil (→ page 177).
 <p data-bbox="207 1171 343 1195">Fuel Level Low</p>	<p data-bbox="484 1082 961 1105">* The fuel supply has dropped into the reserve range.</p> <ul style="list-style-type: none"> ► Refuel the vehicle.
	<p data-bbox="484 1220 843 1243">* There is very little fuel in the fuel tank.</p> <ul style="list-style-type: none"> ► It is absolutely essential to refuel at the nearest gas station.

Tires

Display messages	Possible causes/consequences and ► Solutions
<p data-bbox="207 1447 435 1498">Please Correct Tire Pressure</p>	<p data-bbox="484 1447 1100 1498">* The tire pressure is too low in at least one of the tires, or the difference in tire pressure between the individual wheels is too great.</p> <ul style="list-style-type: none"> ► Check the tire pressure at the next opportunity (→ page 207). ► Correct the tire pressure as necessary. ► Restart the tire pressure monitoring system (→ page 207).



Display messages	Possible causes/consequences and ► Solutions
<p>Check Tires</p>	<p>* A warning tone also sounds. The tire pressure in one or more tires has dropped significantly.</p> <div style="border: 1px solid gray; padding: 5px; margin: 10px 0;"> <p>▲ WARNING Risk of an accident due to insufficient tire pressure</p> <ul style="list-style-type: none"> • The tires can burst. • The tires can wear excessively and/or unevenly. • The driving characteristics as well as the steering and braking may be greatly impaired. <p>You could then lose control of the vehicle.</p> <ul style="list-style-type: none"> ► Observe the recommended tire pressures. ► Adjust the tire pressure if necessary. </div> <ul style="list-style-type: none"> ► Stop the vehicle without steering or braking suddenly. Pay attention to the traffic conditions. ► Secure the vehicle against rolling away. ► Check the tires. If necessary, replace the wheel (→ page 215). ► Check the tire pressure (→ page 207). Correct the tire pressure as necessary.
<p>Warning Tire Malfunction</p>	<p>* The tire pressure in one or more tires has dropped suddenly.</p> <div style="border: 1px solid gray; padding: 5px; margin: 10px 0;"> <p>▲ WARNING Risk of an accident from driving with a flat tire</p> <ul style="list-style-type: none"> • The tires can overheat and cause a fire. • The driving characteristics as well as the steering and braking may be greatly impaired. <p>You could then lose control of the vehicle.</p> <ul style="list-style-type: none"> ► Do not drive on with a flat tire. ► Observe the notes on flat tires. </div> <ul style="list-style-type: none"> ► Stop the vehicle without steering or braking suddenly. Pay attention to the traffic conditions. ► Secure the vehicle against rolling away. ► Check the tires. If necessary, replace the wheel (→ page 215).
<p>Tire Press. Monitor Currently Unavail.</p>	<p>* Due to a source of radio interference, no signals from the tire pressure sensors are being received. The tire pressure monitoring system is temporarily malfunctioning. The tire pressure monitoring system restarts automatically as soon as the cause has been rectified.</p>
<p>Wheel Sensor(s) Missing</p>	<p>* There is no signal from the tire pressure sensor of at least one tire. The display is not showing any pressure value for the tire in question.</p> <ul style="list-style-type: none"> ► Have the faulty tire pressure sensor replaced at a qualified specialist workshop.
<p>Tire Pressure Monitor Inoperative No Wheel Sensors</p>	<p>* The wheels installed do not have suitable tire pressure sensors. The tire pressure monitoring system is deactivated.</p>



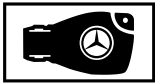

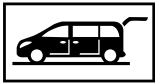

Display messages	Possible causes/consequences and ► Solutions
	<ul style="list-style-type: none"> ► Equip wheels with suitable tire pressure sensors. The tire pressure monitoring system will switch on after a few minutes of driving.
Tire Press. Monitor Inoperative	<ul style="list-style-type: none"> * The tire pressure monitoring system is malfunctioning and switched off. Either the wheels installed do not have suitable tire pressure sensors or the system is malfunctioning, e.g. because a tire pressure sensor is faulty. <ul style="list-style-type: none"> ► Install wheels with suitable tire pressure sensors. The tire pressure monitoring system will switch on after a few minutes of driving. or ► Consult a qualified specialist workshop.
Tire Pressure Monitor Inoperative	<ul style="list-style-type: none"> * The tire pressure monitoring system is malfunctioning. <ul style="list-style-type: none"> ► Consult a qualified specialist workshop.

Key

Display messages	Possible causes/consequences and ► Solutions
 <p>Obtain a New Key</p>	<ul style="list-style-type: none"> * The SmartKey needs to be replaced. <ul style="list-style-type: none"> ► Consult a qualified specialist workshop.





Vehicle

Display messages	Possible causes/consequences and ► Solutions
 <p>Tracking Active or Tracking not Active</p>	<ul style="list-style-type: none"> * The Vehicle Tracker has been activated or deactivated depending on the display message. <p>If the display shows the message Tracking Active:</p> <p>The vehicle has activated services from Mercedes PRO at its disposal (Mercedes me) (→ page 149).</p> <p>Locating the vehicle may be possible with Mercedes PRO connect (Mercedes me).</p> <ul style="list-style-type: none"> ► Check the status of the activated services at https://mercedes.pro or https://mercedes.me. ► Ask the vehicle owner for the details.
	<ul style="list-style-type: none"> * The tailgate is open. <ul style="list-style-type: none"> ► Close the tailgate.
	<ul style="list-style-type: none"> * The rear-end door is open. <ul style="list-style-type: none"> ► Close the rear-end door(s).

Display messages	Possible causes/consequences and ► Solutions
	<p>* A warning tone also sounds. The hood is open.</p> <div style="border: 1px solid black; padding: 5px; margin: 10px 0;"> <p>▲ WARNING Risk of accident due to driving with the hood unlocked</p> <p>The hood may open and block your view.</p> <ul style="list-style-type: none"> ▶ Never release the hood when driving. ▶ Before every trip, ensure that the hood is locked. </div> <ul style="list-style-type: none"> ▶ Stop the vehicle immediately in accordance with the traffic conditions. ▶ Secure the vehicle against rolling away. ▶ Close the hood.
 or 	<p>* In addition, a warning tone sounds while the vehicle is in motion. The display shows the open door or doors.</p> <ul style="list-style-type: none"> ▶ Close all the doors.
 Check Washer Fluid	<p>* The washer fluid level in the washer fluid reservoir has dropped below the minimum.</p> <ul style="list-style-type: none"> ▶ Add washer fluid (→ page 179).
  Pwr. Steering Malfunc.	<p>* A warning tone also sounds. The power assistance for the steering could be malfunctioning. You may need to steer more forcefully.</p> <ul style="list-style-type: none"> ▶ Carefully continue to a qualified specialist workshop and have the steering checked immediately.
 Power Steering Malfunction See Oper. Manual	<p>* A warning tone also sounds. The power assistance for the steering could be malfunctioning. You may need to steer more forcefully.</p> <ul style="list-style-type: none"> ▶ Carefully continue to a qualified specialist workshop and have the steering checked immediately.
Phone No Service	<p>* Your vehicle is outside the transmission and receiver range of the mobile phone network provider.</p>
Shift to 'P' or 'N' to Start Engine	<p>* You have attempted to start the vehicle in transmission position R or D.</p> <ul style="list-style-type: none"> ▶ Shift the transmission to position P or N.
Auxiliary Battery Malfunction	<p>* The auxiliary battery for the transmission is no longer being charged.</p> <ul style="list-style-type: none"> ▶ Consult a qualified specialist workshop.

Display messages	Possible causes/consequences and ► Solutions
Apply Brake to Shift from 'P'	<p>* You have tried to shift the transmission to position [D], [R] or [N] without applying the brake.</p> <p>► Depress the brake pedal.</p>
To Engage R First Depress Brake	<p>* You have tried to shift the transmission to position [R] without applying the brake.</p> <p>► Depress the brake pedal.</p> <p>► Shift the transmission position to [R].</p>
Permanent N Activated Risk of Rolling	<p>* A warning tone also sounds. While the vehicle is rolling or driving, the transmission was shifted to position [N].</p> <p>► To stop, depress the brake pedal and, when the vehicle is at a standstill, shift the transmission to position [P].</p> <p>► To continue your journey, shift the transmission to position [R] or [D].</p>
Risk Of Rolling Driver's Door Open And Transmission Not In P	<p>* A warning tone also sounds. The driver's door is open and the transmission is in position [N], [R] or [D].</p> <p>► Shift the transmission to position [P].</p> <p>► Secure the vehicle against rolling away.</p>
Do Not Shift Gears Service Required	<p>* A warning tone also sounds. You can no longer change the transmission position due to a malfunction.</p> <p>If transmission position [D] has been selected:</p> <p>► Without changing the transmission position, consult a qualified specialist workshop.</p> <p>If transmission position [P], [R] or [N] has been selected:</p> <p>► Inform a qualified specialist workshop.</p>
Reversing Not Possible: Service Required	<p>* The transmission is malfunctioning. Transmission position [R] cannot be selected.</p> <p>► Inform a qualified specialist workshop.</p>
Transmission Malfunction: Stop	<p>* The transmission is malfunctioning. The transmission automatically switches to neutral [N].</p> <p>► Stop the vehicle immediately in accordance with the traffic conditions.</p> <p>► Shift the transmission to position [P].</p> <p>► Inform a qualified specialist workshop.</p>
Only Shift to 'P' when Vehicle is Stationary	<p>* The vehicle is still moving.</p> <p>► Stop in accordance with the traffic conditions.</p> <p>► Shift the transmission to position [P].</p>

Lights



Display messages	Possible causes/consequences and ► Solutions
 <p>Check Left Low Beam (example)</p>	<ul style="list-style-type: none"> * The corresponding light source is defective. Have defective LED lights replaced at a qualified specialist workshop. ► Observe the notes on changing a bulb (→ page 79). ► Replace the malfunctioning bulb at the front (→ page 80) or rear (→ page 82).
 <p>Auto Lamps Inoperative</p>	<ul style="list-style-type: none"> * The light sensor is faulty. The automatic driving lights are malfunctioning. ► Switch the light functions on/off manually (→ page 76). ► Consult a qualified specialist workshop.
 <p>Auto Lamp Function Inoperative</p>	<ul style="list-style-type: none"> * The light sensor is faulty. The automatic driving lights are malfunctioning. ► Switch the light functions on/off manually (→ page 76). ► Consult a qualified specialist workshop.
 <p>Malfunction See Operator's Manual</p>	<ul style="list-style-type: none"> * The exterior lighting is malfunctioning. ► Consult a qualified specialist workshop. * Vehicles with trailer hitch: a fuse may be defective. <div style="border: 1px solid gray; padding: 5px; margin: 10px 0;"> <p>! NOTE Electrical fuses</p> <ul style="list-style-type: none"> ► Observe the information in the supplement. You may otherwise fail to recognize dangers. </div> <ul style="list-style-type: none"> ► Check the fuses and replace any blown fuses (see "Fuse assignment" supplement). <p>If the display continues to show the message:</p> <ul style="list-style-type: none"> ► Consult a qualified specialist workshop.

Indicator and warning lamps



Indicator and warning lamps on the instrument cluster

Some systems will perform a self-test when the vehicle is switched on. Some indicator and warning lamps may briefly light up or flash. This behavior is non-critical. These indicator and warning lamps indicate a malfunction only if they light up or flash after the vehicle has been started or during a journey.



Safety systems

Warning/indicator lamp	Possible causes/consequences and ► Solutions
 <p data-bbox="207 390 435 437">Restraint system warning lamp</p>	<p data-bbox="480 301 1084 347">*The red restraint system warning lamp is on while the vehicle is on. The restraint system is malfunctioning.</p> <div data-bbox="488 365 1126 551" style="border: 1px solid gray; padding: 5px;"> <p data-bbox="501 372 1080 419">▲ WARNING Risk of injury due to malfunctions in the restraint system</p> <p data-bbox="501 437 1093 483">Components in the restraint system may be activated unintentionally or not deploy as planned in an accident.</p> <ul data-bbox="501 494 1080 541" style="list-style-type: none"> ► Have the restraint system checked and repaired immediately at a qualified specialist workshop. </div> <ul data-bbox="488 569 1126 688" style="list-style-type: none"> ► Pay attention to the display messages. ► Drive on carefully. ► Have the restraint system and its components checked immediately at a qualified specialist workshop. <p data-bbox="485 706 1119 752">Further information on the restraint system and its components can be found under "Occupant safety".</p>
<div data-bbox="217 766 369 849" style="border: 1px solid black; padding: 5px; text-align: center;"> <p data-bbox="225 784 361 831">BRAKE</p> </div> <p data-bbox="207 856 405 903">Brake system warning lamp</p> <div data-bbox="217 910 369 992" style="border: 1px solid black; padding: 5px; text-align: center;">  </div> <p data-bbox="207 999 405 1046">Brake system warning lamp</p> <div data-bbox="217 1053 369 1136" style="border: 1px solid black; padding: 5px; text-align: center;"> <p data-bbox="225 1071 361 1118">ABS</p> </div> <p data-bbox="207 1143 369 1171">ABS warning lamp</p>	<p data-bbox="480 766 1119 892">*BRAKE (USA only) or  (Canada only): The ABS and brake warning lamps are on while the engine is running. EBD is unavailable due to a malfunction. This means that ABS, BAS, Hill Start Assist and ESP® as well as its driving safety systems, for example, are also unavailable.</p> <p data-bbox="485 903 1102 949">ATTENTION ASSIST is deactivated and other driving systems could be automatically deactivated.</p> <div data-bbox="488 967 1126 1279" style="border: 1px solid gray; padding: 5px;"> <p data-bbox="501 974 1100 1021">▲ WARNING Risk of skidding if EBD, ABS and ESP® are malfunctioning</p> <p data-bbox="501 1046 1087 1093">The wheels may block during braking and ESP® does not perform any vehicle stabilization.</p> <p data-bbox="501 1103 1106 1179">The steerability and braking characteristics are heavily impaired and the braking distance may increase. In addition, other driving safety systems are switched off.</p> <ul data-bbox="501 1189 1054 1268" style="list-style-type: none"> ► Drive on carefully. ► Have the brake system checked immediately at a qualified specialist workshop. </div> <ul data-bbox="488 1297 1106 1379" style="list-style-type: none"> ► Switch off the vehicle, wait a short while, then switch it on again. ► Check whether the display message has disappeared and ESP® is operational. <p data-bbox="485 1404 896 1430">If the display message continues to be shown:</p> <ul data-bbox="488 1440 984 1494" style="list-style-type: none"> ► Drive on carefully. ► Consult a qualified specialist workshop immediately.



Warning/indicator lamp	Possible causes/consequences and ► Solutions
<div data-bbox="194 261 346 342" data-label="Image"> </div> <p data-bbox="185 351 382 396">Brake system warning lamp</p> <div data-bbox="194 404 346 485" data-label="Image"> </div> <p data-bbox="185 494 382 539">Brake system warning lamp</p>	<p data-bbox="457 261 1093 333">* BRAKE (USA only) or  (Canada only): The red brake warning lamp is on while the engine is running. There is insufficient brake fluid in the brake fluid reservoir.</p> <div data-bbox="471 351 1093 387" data-label="Text"> <p>▲ WARNING Risk of an accident due to low brake fluid level</p> </div> <p data-bbox="481 396 1073 449">If the brake fluid level is too low, the braking effect and the braking characteristics may be impaired.</p> <ul data-bbox="481 458 1060 602" style="list-style-type: none"> ► Pull over and stop the vehicle safely as soon as possible, paying attention to road and traffic conditions. Do not continue driving under any circumstances. ► Consult a qualified specialist workshop. ► Do not add brake fluid. <p data-bbox="464 620 846 646">► Secure the vehicle against rolling away.</p>
<div data-bbox="194 664 346 745" data-label="Image"> </div> <p data-bbox="185 754 350 781">ABS warning lamp</p>	<p data-bbox="457 664 1093 763">* The yellow ABS warning lamp is on while the engine is running. ABS has been switched off due to a malfunction. As a result, BAS, Hill Start Assist and ESP® as well as its driving safety systems, for example, have also been switched off.</p> <p data-bbox="464 772 1080 826">ATTENTION ASSIST is deactivated and other driving systems could be automatically deactivated.</p> <div data-bbox="471 844 1093 879" data-label="Text"> <p>▲ WARNING Risk of skidding if ABS and ESP® are malfunctioning</p> </div> <p data-bbox="481 888 1060 942">The wheels may block during braking and ESP® does not perform any vehicle stabilization.</p> <p data-bbox="481 951 1087 1023">The steerability and braking characteristics are heavily impaired and the braking distance may increase. In addition, other driving safety systems are switched off.</p> <ul data-bbox="481 1032 1047 1121" style="list-style-type: none"> ► Drive on carefully. ► Have ABS and ESP® checked immediately at a qualified specialist workshop. <p data-bbox="464 1139 1034 1166">► Switch the engine off, wait briefly and start the engine again.</p> <p data-bbox="464 1175 1080 1229">► Check whether the display message has disappeared and ESP® is operational.</p> <p data-bbox="464 1247 869 1274">If the display message continues to be shown:</p> <ul data-bbox="464 1283 955 1345" style="list-style-type: none"> ► Drive on carefully. ► Consult a qualified specialist workshop immediately. <p data-bbox="464 1354 1087 1408">If the ABS control unit is malfunctioning, other systems may be available only with restrictions or may be unavailable.</p>
<div data-bbox="194 1426 346 1507" data-label="Image"> </div> <p data-bbox="185 1516 356 1542">ESP® warning lamp</p>	<p data-bbox="457 1426 1087 1507">* The yellow ESP® warning lamp flashes while the vehicle is in motion. ESP® or traction control intervenes because there is a risk of skidding or at least one wheel is spinning.</p> <p data-bbox="464 1516 915 1542">Cruise control has been automatically switched off.</p> <ul data-bbox="464 1551 1034 1605" style="list-style-type: none"> ► When pulling away, accelerate only as much as is necessary. ► Depress the accelerator pedal less during your journey.

Warning/indicator lamp	Possible causes/consequences and ► Solutions
	<ul style="list-style-type: none"> ► Adapt your driving style to suit the road and weather conditions. ► Do not switch off ESP®. <p>In exceptional cases, it may be better to switch off ESP® (→ page 109).</p>
 <p>ESP® warning lamp</p>	<p>*The yellow ESP® warning lamp is on while the vehicle is switched on. ESP®, BAS, Hill Start Assist, ESP® trailer stabilization and Crosswind Assist are not available due to a malfunction.</p> <p>ATTENTION ASSIST is deactivated and other driving systems could be automatically deactivated.</p> <div style="border: 1px solid black; padding: 5px; margin: 10px 0;"> <p>▲ WARNING Risk of skidding if ESP® is malfunctioning</p> <p>If ESP® is malfunctioning, ESP® cannot carry out vehicle stabilization. In addition, other driving safety systems are switched off.</p> <ul style="list-style-type: none"> ► Drive on carefully. ► Have ESP® checked at a qualified specialist workshop. </div> <ul style="list-style-type: none"> ► Switch off the vehicle, wait a short while, then switch it on again. ► Check whether the display message has disappeared and ESP® is operational. <p>If the display message continues to be shown:</p> <ul style="list-style-type: none"> ► Drive on carefully. ► Consult a qualified specialist workshop immediately.
 <p>ESP® OFF warning lamp</p>	<p>*The yellow ESP® OFF warning lamp is on while the engine is running. ESP® has been switched off. ESP® trailer stabilization and Crosswind Assist have been deactivated.</p> <div style="border: 1px solid black; padding: 5px; margin: 10px 0;"> <p>▲ WARNING Risk of skidding when driving with ESP® deactivated</p> <p>ESP® does not act to stabilize the vehicle. The availability of further driving safety systems is also limited.</p> <ul style="list-style-type: none"> ► Drive on carefully. ► Deactivate ESP® only for as long as the situation requires. <p>If ESP® cannot be activated, ESP® is malfunctioning.</p> <ul style="list-style-type: none"> ► Have ESP® checked immediately at a qualified specialist workshop. </div> <ul style="list-style-type: none"> ► Switch ESP® on again. <p>In exceptional cases, it may be better to switch off ESP® (→ page 109).</p> <ul style="list-style-type: none"> ► Adapt your driving style to suit the road and weather conditions. <p>If ESP® cannot be switched on:</p> <ul style="list-style-type: none"> ► Drive on carefully. ► Have ESP® checked at a qualified specialist workshop.

Seat belt



Warning/indicator lamp	Possible causes/consequences and ► Solutions
 <p data-bbox="185 390 392 413">Seat belt warning lamp</p>	<p data-bbox="457 301 1102 347">*The red seat belt warning lamp lights up or flashes after the vehicle has started. A warning tone may also sound.</p> <p data-bbox="457 354 1110 401">For certain countries only: The red seat belt warning lamp lights up for a maximum of six seconds after the vehicle has been switched on.</p> <p data-bbox="457 408 1084 455">The seat belt warning lamp reminds the driver and front passenger to fasten their seat belts.</p> <ul data-bbox="465 462 813 491" style="list-style-type: none"> ► Fasten your seat belt (→ page 28).
 <p data-bbox="185 596 392 620">Seat belt warning lamp</p>	<p data-bbox="457 507 1102 553">*The red seat belt warning lamp lights up after the vehicle starts as soon as the driver's or front passenger door has been closed.</p> <p data-bbox="457 560 979 584">The driver's or front passenger's seat belt is not fastened.</p> <ul data-bbox="465 591 813 637" style="list-style-type: none"> ► Fasten your seat belt (→ page 28). The warning lamp will go out. <p data-bbox="457 645 1063 691">In vehicles with the occupant classification system (OCS), there are objects on the front passenger seat.</p> <ul data-bbox="465 698 1071 777" style="list-style-type: none"> ► Take the objects off the front passenger seat and stow them in a well-secured place. The warning lamp will go out.
 <p data-bbox="185 879 392 903">Seat belt warning lamp</p>	<p data-bbox="457 790 1102 836">*The red seat belt warning lamp flashes and an intermittent warning tone sounds.</p> <p data-bbox="457 844 1102 915">The driver's or front passenger's seat belt is not fastened. You are driving at a speed greater than 15 mph (25 km/h) or have briefly exceeded 15 mph (25 km/h).</p> <ul data-bbox="465 922 1102 1130" style="list-style-type: none"> ► Fasten your seat belt (→ page 28). The warning lamp and the intermittent warning tone will go out. <p data-bbox="457 976 1102 1048">In vehicles with automatic co-driver airbag shutoff, there are objects on the co-driver's seat. You are driving at a speed greater than 15 mph (25 km/h) or have briefly exceeded 15 mph (25 km/h).</p> <ul data-bbox="465 1062 1071 1130" style="list-style-type: none"> ► Take the objects off the front passenger seat and stow them in a well-secured place. The warning lamp and the intermittent warning tone will go out.

Driving systems



Warning/indicator lamp	Possible causes/consequences and ► Solutions
 <p data-bbox="185 1367 418 1413">Warning lamp for distance warning function</p>	<p data-bbox="457 1277 1102 1324">*The red distance warning lamp lights up while the vehicle is in motion. The distance to the vehicle in front is too small for the selected speed.</p> <ul data-bbox="465 1331 892 1360" style="list-style-type: none"> ► Increase the distance to the vehicle in front.
 <p data-bbox="185 1519 418 1566">Warning lamp for distance warning function</p>	<p data-bbox="457 1430 1102 1476">*The red distance warning lamp lights up while the vehicle is in motion. A warning tone also sounds.</p> <p data-bbox="457 1483 1102 1530">You are approaching a vehicle or a stationary obstacle on your anticipated route at excessive speed.</p> <ul data-bbox="465 1537 1102 1616" style="list-style-type: none"> ► Be ready to apply the brakes immediately. ► Pay careful attention to the traffic situation. If necessary, apply the brakes or avoid an obstacle.

Warning/indicator lamp	Possible causes/consequences and ► Solutions
	You can find further information about the distance warning function in "Active Brake Assist" (→ page 111).

Vehicle

Warning/indicator lamp	Possible causes/consequences and ► Solutions
 <p>Power steering system warning lamp</p>	<p>*The red power steering warning lamp is on while the vehicle is switched on. A warning tone also sounds. The power assistance for the steering could be malfunctioning. You may need to steer more forcefully.</p> <p>► Carefully continue to a qualified specialist workshop and have the steering checked immediately.</p>
 <p>Door indicator lamp</p>	<p>*The yellow "door open" indicator lamp is lit. A door is not fully closed.</p> <p>► Close all the doors.</p>

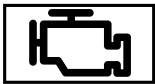

Engine

Warning/indicator lamp	Possible causes/consequences and ► Solutions
 <p>Check Engine warning lamp</p>	<p>*The yellow Check Engine warning lamp is on while the vehicle is switched on.</p> <p>There may be a malfunction in the following vehicle systems:</p> <ul style="list-style-type: none"> • Engine management • Transmission management • Injection • Exhaust system • Ignition system (in vehicles with a gasoline engine) • Fuel system <p>This can cause the emissions limit values to be exceeded and the engine to run in emergency mode.</p> <p>► Have the vehicle checked immediately at a qualified specialist workshop.</p>
 <p>Fuel reserve warning lamp</p>	<p>*The yellow fuel reserve warning lamp is on while the vehicle is switched on. The fuel supply has dropped into the reserve range.</p> <p>► Refuel the vehicle.</p>
 <p>Coolant warning lamp</p>	<p>*The red coolant warning lamp is on while the vehicle is switched on. In vehicles with steering-wheel buttons, the coolant temperature display on the instrument cluster is at the start of the scale. In vehicles without steering-wheel buttons, the coolant temperature display is at the start of the bar display (→ page 140).</p> <p>The temperature sensor for the coolant temperature display is defective.</p>

Warning/indicator lamp	Possible causes/consequences and ► Solutions
	<p>The coolant temperature is no longer being monitored. If the coolant is too hot, the engine may be damaged.</p> <ul style="list-style-type: none"> ► Stop the vehicle immediately in accordance with the traffic conditions and switch it off. Do not continue driving! ► Secure the vehicle against rolling away. ► Consult a qualified specialist workshop.
<div style="text-align: center;">  </div> <p>Coolant warning lamp</p>	<p>*The red coolant warning lamp is on while the vehicle is on. The coolant level is too low.</p> <p>If the coolant level is correct, the air supply to the radiator may be impaired or the radiator's electric fan may be faulty.</p> <p>The coolant is too hot and the engine is not being adequately cooled.</p> <div style="border: 1px solid gray; padding: 5px; margin: 10px 0;"> <p>▲ WARNING Risk of burns when opening the hood</p> <p>If you open the hood in the event of an overheated engine or fire in the engine compartment, the following situations may occur:</p> <ul style="list-style-type: none"> • You may come into contact with hot gases. • You may come into contact with other escaping hot operating fluids. <ul style="list-style-type: none"> ► Before opening the hood, allow the engine to cool down. ► In the event of a fire in the engine compartment, keep the hood closed and call the fire service. </div> <ul style="list-style-type: none"> ► Pay attention to the display messages. ► Stop the vehicle immediately in accordance with the traffic conditions and switch it off. ► Secure the vehicle against rolling away. ► Exit the vehicle and keep a safe distance from it until the engine has cooled down. ► Check the coolant level and add coolant, complying with the instructions (→ page 178). ► If the coolant has to be topped up frequently, have the engine cooling system checked at a qualified specialist workshop. ► Ensure that the air supply to the radiator is not impaired, e.g. by a plastic bag that has been blown onto the grille. ► Check the coolant temperature: <ul style="list-style-type: none"> • In vehicles without steering-wheel buttons – via the display on the on-board computer • In vehicles with steering-wheel buttons – via the analog display on the instrument cluster ► Do not restart the vehicle until the coolant temperature is under the maximum value specified below. If you do, the engine may be damaged. ► Drive on to the nearest qualified specialist workshop. Avoid high engine loads, e.g. driving in mountainous terrain or stop-and-go driving.

Warning/indicator lamp	Possible causes/consequences and ► Solutions
 <p data-bbox="207 415 405 439">Coolant warning lamp</p>	<p data-bbox="486 259 1092 308">During normal driving and if the coolant level is correct, the coolant temperature display is permitted to rise to letter H or the red mark.</p> <p data-bbox="476 326 1102 372">*The red coolant warning lamp is on while the vehicle is on. A warning tone also sounds.</p> <p data-bbox="484 376 1098 451">The coolant temperature has exceeded the maximum value specified below. The air supply to the radiator may be impaired or the coolant level may be too low.</p> <p data-bbox="484 456 1076 483">The engine has not been sufficiently cooled and may be damaged.</p> <div data-bbox="489 498 1129 797" style="border: 1px solid gray; padding: 5px;"> <p data-bbox="497 505 973 534">▲ WARNING Risk of burns when opening the hood</p> <p data-bbox="502 546 1098 594">If you open the hood in the event of an overheated engine or fire in the engine compartment, the following situations may occur:</p> <ul data-bbox="510 605 1085 689" style="list-style-type: none"> <li data-bbox="510 605 918 630">• You may come into contact with hot gases. <li data-bbox="510 636 1085 689">• You may come into contact with other escaping hot operating fluids. <ul data-bbox="502 702 1052 788" style="list-style-type: none"> <li data-bbox="502 702 1039 731">► Before opening the hood, allow the engine to cool down. <li data-bbox="502 734 1052 788">► In the event of a fire in the engine compartment, keep the hood closed and call the fire service. </div> <ul data-bbox="484 815 1129 1433" style="list-style-type: none"> <li data-bbox="484 815 861 842">► Pay attention to the display messages. <li data-bbox="484 845 1105 896">► Stop the vehicle immediately in accordance with the traffic conditions and switch it off. <li data-bbox="484 904 868 931">► Secure the vehicle against rolling away. <li data-bbox="484 935 1129 985">► Exit the vehicle and keep a safe distance from it until the engine has cooled down. <li data-bbox="484 994 1059 1048">► Check the coolant level and add coolant, complying with the instructions (→ page 178). <li data-bbox="484 1053 1118 1107">► If the coolant has to be topped up frequently, have the engine cooling system checked at a qualified specialist workshop. <li data-bbox="484 1111 1105 1164">► Ensure that the air supply to the radiator is not impaired, e.g. by a plastic bag that has been blown onto the grille. <li data-bbox="484 1168 809 1197">► Check the coolant temperature: <li data-bbox="484 1200 1105 1254">► In vehicles without steering-wheel buttons - via the display on the on-board computer (→ page 140). <li data-bbox="484 1257 1105 1311">► In vehicles with steering-wheel buttons - via the analog display on the instrument cluster <li data-bbox="484 1317 1125 1370">► If the coolant temperature is below the maximum value specified below, continue driving to the nearest qualified specialist workshop. <li data-bbox="484 1376 1125 1433">► In doing so, avoid high engine loads, e.g. driving in mountainous terrain or stop-and-go driving. <p data-bbox="484 1442 1092 1496">During normal driving and if the coolant level is correct, the coolant temperature display is permitted to rise to letter H or the red mark.</p>

Tires

Warning/indicator lamp	Possible causes/consequences and ► Solutions
 <p>Tire pressure monitoring system warning lamp</p>	<p>*The yellow tire pressure monitoring system warning lamp (pressure loss/malfunction) is on. The tire pressure monitoring system has detected a loss of pressure in at least one tire.</p> <p>▲ WARNING Risk of an accident due to insufficient tire pressure</p> <ul style="list-style-type: none"> • The tires can burst. • The tires can wear excessively and/or unevenly. • The driving characteristics as well as the steering and braking may be greatly impaired. <p>You could then lose control of the vehicle.</p> <ul style="list-style-type: none"> ► Observe the recommended tire pressures. ► Adjust the tire pressure if necessary. <p>► Stop the vehicle without steering or braking suddenly. Pay attention to the traffic conditions.</p> <p>► Secure the vehicle against rolling away.</p> <p>► Pay attention to the display messages.</p> <p>► Check the tires and, if necessary, replace the wheel (→ page 215).</p> <p>► Check the tire pressure.</p> <p>In vehicles with steering-wheel buttons, you can check the tire pressure electronically (→ page 207).</p> <p>► Correct the tire pressure as necessary.</p>
 <p>Tire pressure monitoring system warning lamp</p>	<p>*The yellow tire pressure monitoring system warning lamp (pressure loss/malfunction) flashes for approximately one minute and then remains lit. The tire pressure monitoring system is malfunctioning.</p> <p>▲ WARNING There is a risk of an accident if the tire pressure monitoring system is malfunctioning</p> <p>The tire pressure monitoring system cannot issue a warning if there is pressure loss in one or more of the tires.</p> <p>Tires with insufficient tire pressure may impair the driving characteristics as well as steering and braking.</p> <ul style="list-style-type: none"> ► Have the tire pressure monitoring system checked at a qualified specialist workshop. <p>► Pay attention to the display messages.</p> <p>► Visit a qualified specialist workshop.</p>

- 1, 2, 3 ...**
- 3-zone automatic climate control (control panel)**..... 91
- 12 V socket**
see Socket (12 V)
- A**
- ABS (anti-lock braking system)**..... 109
- Acceleration**
see Using kickdown
- Accident and Breakdown Management**
Mercedes me connect..... 150
- Active Brake Assist**
Function/notes..... 111
Setting..... 112
- Active Distance Assist DISTRONIC**
Calling up a speed..... 115, 116
Displays..... 118
Function..... 114
Increasing/decreasing the speed
..... 115, 116
Storing a speed..... 115, 116
Switching off/deactivating..... 115, 116
Switching on/activating..... 115, 116
System limitations..... 114
- Active Parking Assist**
Exiting a parking space..... 124
Function..... 122
Parking..... 124
System limits..... 122
- Adaptive cruise control**
see Active Distance Assist DISTRONIC
- Adaptive Highbeam Assist**
Function..... 78
Switching on/off..... 79
- Add-on equipment**..... 13
- Add-on equipment guidelines**..... 13
- Additional turn signal light**
Replacing light sources..... 82
- Additive**
Engine oil..... 239
- Additives**
Fuel..... 239
- Additives (engine oil)**
see Additive
- Additives (fuel)**
see Fuel
- Adjusting the air vents**..... 95
- After-sales service**
see ASSYST PLUS service interval display
- Air recirculation button**
Convenience opening/closing..... 95
- Airbag**
Activation..... 25
Automatic front passenger airbag shutoff..... 31
Front airbag..... 29
Installation locations..... 29
Overview..... 29
PASSENGER AIR BAG indicator lamp..... 32
Protection impaired..... 30
Protection provided..... 29
Side airbag..... 29
Window airbag..... 29
- Alarm system**
see ATA (Anti-Theft Alarm system)
- Android Auto (multimedia system)**
Connecting..... 159
Settings..... 152
- Animals**
Pets in the vehicle..... 42
- Anti-lock braking system**
see ABS (anti-lock braking system)
- Anti-skid chains**
see Snow chains
- Anti-theft alarm system**
see ATA (Anti-Theft Alarm system)
- Anti-theft protection**
Immobilizer..... 58
- Anti-theft protection**
see ATA (Anti-Theft Alarm system)
- Apple CarPlay® (multimedia system)**
Connecting..... 159
Settings..... 152
- Ashtrays**
In the windshield stowage compartment..... 74
- Assistance Systems**
see Driving safety system
- ASSYST**
see ASSYST PLUS service interval display
- ASSYST PLUS service interval display**
Displaying the service due date (vehicle with steering wheel buttons)... 173
Displaying the service due date (vehicle without steering wheel buttons)..... 173
Function/notes..... 173

- Non-operational times with the battery disconnected..... 174
 Regular maintenance work..... 173
 Special service requirements..... 174
- ATA (Anti-Theft Alarm system)**
 Activating/deactivating the interior motion sensor..... 60
 Arming/disarming..... 59
 Arming/disarming the tow-away alarm..... 59
 Function..... 58
 Interior motion sensor function..... 60
 Tow-away alarm function..... 59
- Attachments**..... 13
- ATTENTION ASSIST**
 Function..... 125
 Switching on/off (vehicles with steering-wheel buttons)..... 126
 Switching on/off (vehicles without steering-wheel buttons)..... 126
 System limits..... 125
- Attention assistant**
 see ATTENTION ASSIST
- Authorized workshop**
 see Qualified specialist workshop
- Automatic climate control (operating unit)...** 90
- Automatic co-driver airbag shutoff**
 PASSENGER AIR BAG indicator lamp..... 32
- Automatic distance control**
 see Active Distance Assist DISTRONIC
- Automatic driving lights**..... 76
- Automatic front passenger airbag shutoff**
 Function of the front passenger airbag shutoff..... 31
- Automatic measures after an accident**..... 34
- Automatic transmission**
 DIRECT SELECT lever..... 103
 Engaging drive position..... 104
 Engaging neutral..... 104
 Engaging reverse gear..... 104
 Kickdown..... 105
 Restricting the shift range..... 104
 Selecting park position..... 104
 Transmission position display..... 103
 Transmission positions..... 103
- Axle load**..... 237
- B**
- Back support**
 see Lumbar support (4-way)
- Backing up warning device**
 Notes..... 119
- BAS (Brake Assist System)**..... 109
- Battery**
 Care..... 189
 Charging..... 189
 Charging a vehicle battery..... 189
 Connecting and installing the auxiliary battery..... 193
 Connecting and installing the starter battery..... 193
 Disconnecting and removing the auxiliary battery..... 191
 Disconnecting and removing the starter battery..... 191
 Jump-starting (vehicle)..... 189
 Key..... 44
 Notes (vehicle)..... 187
- Belt**
 see Seat belt
- Belt warning**
 see Seat belt
- Blind Spot Assist**
 Function..... 126
 Rear Cross Traffic Alert..... 127
 Switching on/off..... 127
 System limits..... 126
- Bluetooth® Audio (multimedia system)**
 Information..... 161
- Bluetooth® settings (multimedia system)...** 152
- Bottle holder**..... 74
- Brake**
 ABS (anti-lock braking system)..... 109
 Activating/deactivating the HOLD function..... 118
 Active Brake Assist..... 111
 BAS (Brake Assist System)..... 109
 Braking with the parking brake..... 99
 Downhill gradient..... 99
 Driving instructions..... 99
 EBD (Electronic Brakeforce Distribution)..... 111
 Heavy and light loads..... 99
 HOLD function..... 118
 Limited braking effect (salt-treated roads)..... 99
 New brake discs and brakepads..... 99
 Wet roadway..... 99
- Brake Assist System**
 see BAS (Brake Assist System)
- Brake Assistance**
 see BAS (Brake Assist System)

- Brake fluid**
Notes..... 240
- Brakeforce Distribution**
EBD (Electronic Brakeforce Distribution)..... 111
- Brakes**
Breaking in notes..... 97
New/replaced brake discs and brakepads..... 97
- Breakdown**
Changing a wheel..... 215
Recovering the vehicle..... 196
Roadside Assistance..... 15
Tow-starting..... 198
Towing (both axles on the ground)..... 196
Towing away (raised front or rear axle)..... 196
Transporting the vehicle..... 197
Trapped vehicle..... 196
- Breakdown**
see Flat tire
- Breaking in notes**..... 97
- Buttons on the steering wheel**..... 9
- C**
- Calling (multimedia system)**
Smartphone..... 159
- Camera**
Information..... 108
- Camera**
see Rear view camera
- Car wash**
see Care
- Car wash (care)**..... 180
- Care**
Automatic car wash..... 180
Carpet..... 183
Display..... 183
Exterior lighting..... 182
Headliner..... 183
Instrument cluster..... 183
Matte finish..... 181
Paint..... 181
Plastic trim..... 183
Power washer..... 180
Real wood/trim elements..... 183
Rear view camera..... 182
Seat belt..... 183
Seat cover..... 183
Sensors..... 182
Tailpipes..... 182
Trailer hitch..... 182
Washing by hand..... 181
Wheels/rims..... 182
Windows..... 182
Wiper blades..... 182
- Cargo compartment and rear compartment interior lamps**
Replacing light sources..... 83
- Cargo tie-down points**
Information..... 245
Overview..... 167
- Carpet (care)**..... 183
- Carrier systems**
Notes..... 171
- Center console**
Top (overview)..... 10
- Changing a bulb**
see Changing bulbs
- Changing a wheel**
Lowering the vehicle..... 217
Preparing..... 215
Raising the vehicle..... 216
Removing a wheel..... 217
- Changing address**..... 15
- Changing bulbs**
Light bulb types halogen headlamps..... 80
Notes..... 79
- Changing lamps**
see Changing bulbs
- Changing owner**..... 15
- Changing settings on the on-board computer (vehicle with steering-wheel buttons)**..... 146
- Changing settings on the on-board computer (vehicle without steering-wheel buttons)**..... 140
- Characteristics of the tire**..... 210
- Charging**
Battery..... 189
- Child safety lock**
Hinged windows..... 42
Sliding door..... 41
- Child seat**
Attaching (notes)..... 36
Basic instructions..... 34
Front-passenger seat (notes)..... 39
LATCH-type (ISOFIX) (installing)..... 37
Notes on risks and dangers..... 35
Securing on the co-driver's seat..... 40
Securing on the rear seat..... 39

- Top Tether..... 38
 - Children**
 - Avoiding dangers in the vehicle..... 35
 - Basic instructions..... 34
 - Special seat belt retractor..... 37
 - Cigarette lighter**
 - Front center console..... 75
 - Cleaning**
 - see Care
 - Climate control**
 - Activating/deactivating..... 91
 - Adjusting the air vents..... 95
 - Air distribution settings..... 93
 - Automatic climate control operating unit..... 90
 - Automatic control..... 92
 - Control panel for 3-zone automatic climate control..... 91
 - Defrosting the windshield..... 94
 - Defrosting windows..... 94
 - Filling capacity for refrigerant and PAG oil..... 243
 - Refrigerant..... 242
 - Setting the air distribution..... 93
 - Setting the airflow..... 93
 - Setting the temperature..... 93
 - Switching air-recirculation mode on/off..... 94
 - Switching residual heat utilization on/off..... 95
 - Switching the A/C function on/off..... 92
 - Switching the rear window heater on/off..... 95
 - Switching the reset function on/off (control panel)..... 94
 - Ventilating the vehicle (convenience opening)..... 57
 - Cockpit (overview)..... 6**
 - Combination switch**
 - see Headlamp flashing
 - see High beam
 - see Turn signal light
 - Configuring sound settings (multimedia system)..... 153**
 - Convenience closing..... 58**
 - Convenience opening..... 57**
 - Convenience opening/closing..... 95**
 - Conversions..... 13**
 - Coolant**
 - Checking level..... 178
 - Filling capacities..... 241
 - Refilling..... 178
 - Coolant (engine)**
 - Displaying the temperature (vehicle without steering-wheel buttons)..... 140
 - Notes..... 241
 - Copyright**
 - License..... 24
 - Copyrights**
 - Trademarks..... 24
 - Crosswind Assist**
 - Function/notes..... 110
 - Cruise control**
 - Activating..... 113
 - Calling up a speed..... 113
 - Deactivating..... 113
 - Function..... 113
 - Increasing/decreasing speed..... 113
 - Lever..... 113
 - Requirements:..... 113
 - Selecting..... 113
 - Setting the speed..... 113
 - Storing a speed..... 113
 - System limits..... 113
 - Cup holders**
 - Cockpit..... 74
 - Customer Assistance Center (CAC)..... 19**
 - Customer Relations Department..... 19**
- D**
- DAB radio (multimedia system)..... 161**
 - Dashboard lighting**
 - see Instrument lighting
 - Data acquisition (vehicle)..... 20**
 - Data protection rights**
 - Data storage..... 23
 - Data storage**
 - Data protection rights..... 23
 - Electronic control units..... 20
 - Service provider..... 22
 - Daytime running lamp mode**
 - see Daytime running lamps
 - Daytime running lamps**
 - Activating/deactivating..... 76
 - Replacing light sources..... 80
 - Deactivating the alarm (ATA)..... 59**
 - Dealership**
 - see Qualified specialist workshop
 - Declaration of conformity**
 - Vehicle components which receive and/or transmit radio waves..... 17

- Definitions (tires and loading)..... 211
- Defrosting windows..... 94
- Destination (multimedia system)
 - Editing intermediate destinations..... 158
- Destination entry (multimedia system)
 - Adding or removing shortcuts..... 156
 - Displaying current location information..... 156
 - Displaying or deleting last destination..... 155
 - Notes..... 154
 - Saving and deleting destinations..... 156
 - Searching for and entering destinations..... 154
 - Selecting a POI..... 155
- Diagnostics connection..... 17
- Digital inside rearview mirror..... 88
- DIRECT SELECT lever
 - Engaging drive position..... 104
 - Engaging neutral..... 104
 - Engaging park position automatically... 104
 - Engaging reverse gear..... 104
 - Function..... 103
 - Selecting park position..... 104
 - Transmission positions..... 103
- Display (care)..... 183
- Display (instrument cluster)..... 137
- Display (multimedia system)
 - Operating..... 152
- Display message
 - Calling up (on-board computer)..... 246
 - Notes..... 246
- Display settings (multimedia system)..... 153
- Displaying location information (multimedia system)..... 156
- Distance control
 - see Active Distance Assist DISTRONIC
- Distance warning function
 - see Active Brake Assist
- DISTRONIC
 - see Active Distance Assist DISTRONIC
- Door
 - Locking (emergency key)..... 47
 - Opening (from the inside)..... 45
 - Switch automatic locking on/off (key)... 46
 - Unlocking (emergency key)..... 47
 - Unlocking (from the inside)..... 45
- Door control panel..... 12
- DOT, Tire Identification Number (TIN)..... 209
- Drink driving..... 98
- Drinking and driving..... 98
- Driver's seat
 - see Seat
- Driving characteristics (unusual)..... 202
- Driving instructions
 - Brakes..... 99
 - Breaking in notes..... 97
 - Downhill gradient..... 99
 - Drinking and driving..... 98
 - General driving tips..... 98
 - Limited braking effect (salt-treated roads)..... 99
 - New brake discs and brakepads..... 99
 - Parking brake..... 99
 - Subjecting brakes to a load..... 99
 - Wet roadway..... 99
- Driving lights
 - see Automatic driving lights
- Driving notes
 - Transport by rail..... 99
- Driving safety system
 - ABS (anti-lock braking system)..... 109
 - Active Brake Assist..... 111
 - BAS (Brake Assist System)..... 109
 - Cameras..... 108
 - EBD (Electronic Brakeforce Distribution)..... 111
 - ESP® Crosswind Assist..... 110
 - ESP® trailer stabilization..... 110
 - Overview..... 109
 - Radar and ultrasonic sensors..... 108
 - Responsibility..... 108
- Driving system
 - see Active Distance Assist DISTRONIC
 - see Active Parking Assist
 - see ATTENTION ASSIST
 - see Blind Spot Assist
 - see Cruise control
 - see Driving safety system
 - see HOLD function
 - see Lane Keeping Assist
 - see PARKTRONIC
 - see Rear view camera
- Driving tips
 - Driving off-road..... 101
 - Driving on flooded roads..... 100
 - Driving on wet roads..... 100
 - Hydroplaning..... 100
 - Mountainous terrain..... 103
- Drowsiness detection
 - see ATTENTION ASSIST

E

- E10**..... 239
- EASY-ENTRY easy entry and exit feature**
 - Folding the EASY-ENTRY section
 - forwards/back (rear bench seat)..... 67
 - Using (rear bench seat)..... 67
- EASY-PACK tailgate**
 - Notes..... 52
 - Opening and closing..... 52
- EBD (Electronic Brakeforce Distribution)**.... 111
- Electric sliding door**
 - Function..... 48
 - Opening/closing (from the inside)..... 49
 - Opening/closing (with the SmartKey).... 50
 - Opening/closing from the outside..... 50
 - Opening/closing with the door handle... 50
 - Opening/closing with the SmartKey..... 50
 - Problems..... 51
 - Programming the key button..... 50
 - Programming the SmartKey..... 50
 - Resetting..... 51
- Electric sliding door**
see Electric sliding door
- Electronic Stability Program**
see ESP® (Electronic Stability Program)
- Electronics**..... 222
- Emergency**
 - First-aid kit (soft sided)..... 185
 - Safety vest..... 185
- Emergency braking**
 - Manual parking brake..... 107
- Emergency call**
see Mercedes-Benz emergency call system
- Emergency key**
 - Locking the door..... 47
 - Removing/inserting..... 44
 - Unlocking the door..... 47
- Emergency Tensioning Devices**
 - Activation..... 25
- Engaging drive position (automatic transmission)**..... 104
- Engaging neutral (automatic transmission)**..... 104
- Engaging reverse gear**..... 104
- Engine**
 - Engine number..... 237
 - Starting assistance..... 189
- Engine electronics (notes)**..... 222
- Engine number**..... 237
- Engine oil**
 - Additive..... 239
 - Checking the oil level using the on-board computer..... 175, 176
 - Checking the oil level with a dipstick... 177
 - Filling capacity..... 240
 - Refilling..... 177
- Engine output**
 - Notes on changes..... 18
- Environmental protection**
 - Notes..... 13
- ESC (Electronic Stability Control)**
see ESP® (Electronic Stability Program)
- ESP®**
 - Crosswind Assist..... 110
 - Trailer stabilization..... 110
- ESP® (Electronic Stability Program)**
 - Activating/deactivating (on-board computer without steering wheel buttons)..... 110
 - Function/notes..... 109
 - Switching on/off (button)..... 110
 - Switching on/off (on-board computer with steering wheel buttons)..... 110
- Exhaust emission monitoring**..... 99
- Exterior lighting**
 - Care..... 182
- Exterior lighting**
see Lights

F

- Factory settings (vehicle with steering-wheel buttons)**..... 146
- Factory settings (vehicle without steering-wheel buttons)**..... 140
- Fatigue detection**
see ATTENTION ASSIST
- Fault message**
see Display message
- First-aid kit (soft sided)**..... 185
- Flat tire**
 - Changing a wheel..... 215
 - Notes..... 187
- Foil covering**
 - Radar and ultrasonic sensors..... 108
- Free software**..... 24
- Frequencies**
 - Mobile phone..... 222
 - Two-way radio..... 222

- Front airbag**..... 29
- Front passenger airbag shutoff**
see Automatic front passenger airbag shutoff
- Front wheel arch**
Fender..... 80
Installing/removing the cover..... 80
- Fuel**
Additives..... 239
E10..... 239
Flexible fuel vehicles..... 239
Fuel reserve..... 239
Gasoline..... 239
Quality (gasoline)..... 239
Refueling..... 105
Sulfur content..... 239
Tank content..... 239
- Fuel consumption**
Displaying current (vehicle without steering-wheel buttons)..... 139
Displaying the average (vehicle with steering-wheel buttons)..... 142
Displaying the average (vehicle without steering-wheel buttons)..... 139
- Fuses**..... 198
- G**
- Gasoline**..... 239
- General operating permit number (EC)**..... 237
- Genuine parts**..... 13
- Glasses compartment**..... 74
- Glove box**
Opening/closing..... 73
- Gross axle weight rating**..... 237
- H**
- Handbrake (manual)**
see Manual parking brake
- Hazard warning light system**
Switching on/off..... 77
- Hazardous substances**
Information..... 16
- Head restraint**
Adjusting electrically..... 71
Adjusting mechanically..... 70
- Headlamp flashing**..... 77
- Headliner (care)**..... 183
- Help call**
see Mercedes-Benz emergency call system
- High beam**
Adaptive Highbeam Assist..... 78
Replacing light sources..... 80
Switching on/off..... 77
- Hill Start Assist**..... 118
- Hinged windows**
Child safety lock..... 42
- HOLD function**
Notes..... 118
Switching on/off..... 118
- Home screen (multimedia system)**
Changing the arrangement of the applications..... 152
- Hydroplaning**..... 100
- I**
- Identification plate**
Engine..... 237
Refrigerant..... 242
Vehicle..... 237
- Ignition key**
see Key
- Ignition lock**..... 97
- Immobilizer**..... 58
- Indicator lamps**
see Warning/indicator lamps
- Inside rearview mirror**
Anti-glare mode (automatic)..... 88
- Inside rearview mirror**
see Outside mirrors
- Installations**..... 13
- Instrument cluster**
Adjusting the lighting..... 138
Care..... 183
Displays..... 134
Information on the display..... 137
Notes on warning/indicator lamps..... 271
Overview of displays..... 134
Warning/indicator lamps overview..... 7, 8
- Instrument lighting**..... 138
- Instrument panel**
see Cockpit (overview)
- Intelligent light system**
Adaptive Highbeam Assist..... 78
- Interior lighting**
Replacing light sources..... 83
Setting..... 79
- Interior motion sensor**
Activating/deactivating..... 60

- Function..... 60
- Intermediate destination**
- Editing..... 158
- J**
- Jack**
- Storage compartment in the rear compartment..... 199
- Storage location..... 198
- Tool holder in the cargo compartment..... 200
- Jump-start connection point**..... 189
- K**
- Key**
- Battery..... 44
- Emergency key..... 44
- Fastening to keyring..... 44
- Functions..... 43
- Overview..... 43
- Problem..... 44
- Programming the button for the electric sliding door..... 50
- Starting the vehicle..... 97
- Unlocking setting..... 43
- Key positions**..... 97
- L**
- Labeling (tires)**
- see Tire labeling
- Lane Keeping Assist**
- Activating/deactivating..... 128
- Function..... 127
- Sensitivity..... 128
- Language settings (multimedia system)**..... 153
- Lashing straps**
- Securing a load..... 168
- Last destinations (multimedia system)**
- Selecting or deleting..... 155
- LATCH-type (ISOFIX) child seat anchor**
- Installing..... 37
- Light switch (overview)**..... 76
- Lighting**
- see Lights
- Lights**
- Adaptive Highbeam Assist..... 78
- Adjusting the instrument lighting..... 138
- Automatic driving lights..... 76
- Combination switch..... 77
- Hazard warning light..... 77
- Headlamp flashing..... 77
- Headlamp range..... 77
- High beam..... 77
- Light switch..... 76
- Low beam..... 76
- Parking lights..... 76
- Rear fog light..... 76
- Responsibility with lighting systems..... 76
- Standing lights..... 76
- Turn signal light..... 77
- Limited Warranty (vehicle)**..... 20
- Limiting the opening angle (tailgate)**..... 53
- Load distribution**..... 165
- Load protection net**..... 170
- Load securing**
- Cargo tie-down points..... 167
- Installing and removing tie-down eyes..... 169
- Lashing straps..... 168
- Notes..... 166
- Removing/installing a load protection net..... 170
- Load securing aid**
- Removing/installing a load protection net..... 170
- Load-bearing capacity (tires)**..... 210
- Loading**
- Definitions..... 211
- Loading guidelines**..... 164
- Locking/unlocking**
- Opening the door (from the inside)..... 45
- Switch automatic locking on/off (key)... 46
- Unlocking the door (from the inside)..... 45
- Low beam**
- Replacing light sources..... 80
- Switching on/off..... 76
- Lubricant additives**
- see Additive
- Lumbar support (4-way)**..... 64
- M**
- M+S tires**..... 203
- Maintenance**
- Notes..... 173
- Vehicle..... 15
- Maintenance**
- see ASSYST PLUS service interval display
- Malfunction**
- Restraint system..... 25
- Manual parking brake**
- Applying/releasing..... 107

- Emergency braking..... 107
- Map**
Using..... 159
- Map (multimedia system)**
Adjusting..... 159
- Matte finish (cleaning instructions)..... 181**
- Maximum gross vehicle weight..... 237**
- Maximum tire load..... 210**
- Maximum tire pressure..... 210**
- Media mode**
Connecting USB devices..... 161
Overview of the media menu..... 161
Starting media playback..... 161
Supported formats and data storage media..... 160
- Medical aids..... 19**
- Memory function (seat)..... 65**
- Menu overview (on-board computer)..... 138**
- Mercedes me app**
Information..... 150
- Mercedes me calls**
Arranging a service appointment..... 148
Consenting to data transfer..... 148
Information..... 148
Transferred data..... 148
- Mercedes me connect**
Accident and Breakdown Management..... 150
Information..... 149
Making a call via the overhead control panel..... 148
Transferred data..... 150
- Mercedes-Benz emergency call system**
Automatic emergency call..... 186
Data transfer..... 187
Information..... 185
Manual emergency call..... 186
Overview..... 185
- Message (display section of the instrument display)**
see Display message
- Message memory..... 246**
- Mirrors**
Digital inside rearview mirror..... 88
- Mirrors**
see Outside mirrors
- Mobile phone**
Frequencies..... 222
Transmission output (maximum)..... 222
- Mobile phone**
see Mobile phone
see Smartphone (multimedia system)
- Model series**
see Vehicle identification plate
- Mounting a load..... 164**
- Multi Purpose Vehicle (MPV)..... 19**
- Multimedia system**
Adjusting the volume..... 161
Anti-theft protection..... 151
Calling up the tool menu..... 153
Configuring basic settings..... 152
Configuring display settings..... 153
Configuring language settings..... 153
Configuring navigation settings..... 152
Configuring notification settings..... 153
Configuring settings for connected devices..... 152
Configuring sound settings..... 153
Functions overview..... 151
Operating safety..... 151
Operating temperature..... 151
Overview of the control panel..... 151
Setting smartphone functions..... 159
- Multimedia system (on-board computer).... 144**
- N**
- Navigation..... 143**
- Navigation**
see Destination entry (multimedia system)
see Route (multimedia system)
- Navigation (multimedia system)**
Configuring settings..... 152
Overview..... 154
Updating maps..... 163
- Notification settings (multimedia system).. 153**
- O**
- Occupant safety**
see Airbag
see Automatic front passenger airbag shutoff
see Automatic measures after an accident
see Pets in the vehicle
see Restraint system
see Seat belt
- Odometer**
Displaying (vehicle without steering-wheel buttons)..... 139
- On-board computer**
Display..... 137

- Menu overview..... 138
 - Operation (vehicles with steering-wheel buttons)..... 136
 - Operation (vehicles without steering-wheel buttons)..... 135
 - Overview (vehicles with steering-wheel buttons)..... 136
 - Overview (vehicles without steering-wheel buttons)..... 135
 - On-board computer (vehicle with steering wheel buttons)**
 - Displaying the service due date..... 173
 - Service menu..... 141
 - Telephone menu..... 145
 - On-board computer (vehicle with steering-wheel buttons)**
 - Assistance menu..... 141
 - Audio menu..... 144
 - Digital speedometer..... 142
 - Factory settings..... 146
 - Navigation menu..... 143
 - Selecting the permanent display function..... 146
 - Selecting the unit of measurement for distance..... 146
 - Setting the display language..... 146
 - Setting the sensitivity of the rain sensor..... 146
 - Setting the surround lighting..... 146
 - Setting the time and date..... 146
 - Settings menu..... 146
 - Showing the range..... 142
 - Status overview of driving systems..... 141
 - Trip menu..... 142
 - On-board computer (vehicle without steering wheel buttons)**
 - Displaying the service due date..... 173
 - On-board computer (vehicle without steering-wheel buttons)**
 - Coolant temperature display..... 140
 - Current fuel consumption..... 139
 - Factory settings..... 140
 - Odometer..... 139
 - Recuperation display..... 139
 - Selecting the permanent display function..... 140
 - Selecting the unit of measurement for distance..... 140
 - Setting the display language..... 140
 - Setting the sensitivity of the rain sensor..... 140
 - Setting the time and date..... 140
 - Settings menu..... 140
 - Trip computer..... 139
 - Trip distance..... 139
 - On-board diagnostics interface**
see Diagnostics connection
 - On-board electronics**
 - Engine electronics..... 222
 - Notes..... 222
 - Two-way radios..... 222
 - Onboard Logic Unit**
 - Online services..... 22
 - Vehicle data storage..... 22
 - Online services**
 - Data storage..... 22
 - Open-source software**..... 24
 - Opening/closing the hood**..... 174
 - Operating fluids**
 - Additives (fuel)..... 239
 - Brake fluid..... 240
 - Coolant (engine)..... 241
 - Engine oil..... 239
 - For drive axles and transmissions..... 240
 - Fuel (gasoline)..... 239
 - Notes..... 238
 - Transmission oil..... 240
 - Windshield washer fluid..... 241
 - Operating Instructions (vehicle equipment)**..... 14
 - Operating safety**
 - Changes in the engine output..... 18
 - Declaration of conformity (wireless vehicle components)..... 17
 - Information..... 16
 - Outside mirrors**
 - Anti-glare mode (automatic)..... 88
 - Folding in/out..... 87
 - Setting..... 87
 - Setting options..... 12
 - Overhead control panel**
 - Adjusting the interior lighting..... 79
 - Overview..... 11
- P**
- Paint (cleaning instructions)**..... 181
 - Paint code**..... 237
 - Park position**
 - Engaging..... 104
 - Engaging automatically..... 104
 - Parking aid**
see PARKTRONIC
 - Parking brake (manual)**
see Manual parking brake













- Parking for an extended period**..... 108
- Parking lights**..... 76
- PARKTRONIC**
- Function..... 119
 - Switching on/off..... 121
- PASSENGER AIR BAG status indicator**
see Automatic co-driver airbag shutoff
- Permissible gross mass**..... 237
- Permissible towing methods**..... 194
- Pets in the vehicle**..... 42
- Plastic trim (care)**..... 183
- POI**
- Selecting..... 155
- Power supply**
- Activating..... 97
- Power washer (care)**..... 180
- Q**
- QR code (rescue card)**..... 20
- Qualified specialist workshop**..... 18
- R**
- Radar and ultrasonic sensors**
- Damage..... 108
- Radio (multimedia system)**
- Setting DAB stations..... 161
 - Setting stations..... 161
 - Storing radio stations..... 162
 - Switching traffic announcements on/off..... 162
- Rain sensor**
- Setting the sensitivity (vehicle with steering-wheel buttons)..... 146
 - Setting the sensitivity (vehicle without steering-wheel buttons)..... 140
- Range**
- Displaying (vehicle with steering-wheel buttons)..... 142
- Real wood (care)**..... 183
- Rear bench seat**
- Folding forwards and backwards..... 69
 - Moving..... 68
 - Notes..... 66
 - Using the easy entry and exit feature (EASY-ENTRY)..... 67
- Rear compartment and cargo compartment lamps**
- Replacing light sources..... 83
- Rear Cross Traffic Alert**..... 127
- Rear fog light**..... 76
- Rear luggage rack**
- Notes..... 171
- Rear seats**
- Notes..... 66
 - Seat anchorage..... 66
 - Seating variants..... 66
- Rear view camera**
- Care..... 182
 - Function..... 121
- Rear window**
- Opening and closing separately..... 54
- Rear window wiper**
- Replacing..... 86
 - Switching on/off..... 85
- Rear-end doors**
- Opening 180° or 270°..... 55
 - Opening/closing (from the inside)..... 55
 - Opening/closing (from the outside)..... 54
- Refrigerant (air conditioning)**
- Notes..... 242
- Refueling**
- Refueling the vehicle..... 105
- Registration**
- Vehicle..... 18
- Regulating headlamp range**..... 77
- Regulation of vehicle dynamics**
see ESP® (Electronic Stability Program)
- Regulatory radio identification**
- Indonesia..... 233
 - Small components..... 223
- Regulatory radio information**
- Installation clearances..... 236
- Replacing a wheel**
- Installing a new wheel..... 217
- Replacing bulbs**
- Tail lamp types..... 82
 - Tail lamps..... 82
- Replacing light sources**
- Additional turn signal light..... 82
 - Daytime running lamps..... 80
 - High beam..... 80
 - Installing/removing cover (front wheel arch)..... 80
 - Low beam..... 80
 - Rear compartment and cargo compartment lamps..... 83
 - Standing/parking lamps..... 80
 - Surround lighting..... 83
 - Turn signal light..... 80

- Reporting safety defects**..... 20
 - Rescue card**..... 20
 - Residual heat utilization**
 - Activating/deactivating..... 95
 - Restraint system**
 - Basic instructions for children..... 34
 - Function in an accident..... 25
 - Functionality..... 25
 - Malfunction..... 25
 - Protection limited..... 25
 - Protection provided..... 25
 - Self-test..... 25
 - Warning lamps..... 25
 - Restricting the shift range**..... 104
 - Roadside Assistance (breakdown)**..... 15
 - Roll away protection**
 - see HOLD function
 - Roof carrier**
 - see Roof luggage rack
 - Roof luggage rack**
 - Notes..... 171
 - Route (multimedia system)**
 - Calculating..... 157
 - Notes..... 156
 - Planning with myTrips..... 158
 - Selecting a detour..... 158
 - Selecting options..... 157
 - Starting and ending..... 156
- S**
- Safety systems**
 - see Driving safety system
 - Safety vest**..... 185
 - Satellite radio**
 - Activating/deactivating TuneStart..... 163
 - Deleting user data..... 163
 - Information..... 162
 - Logging in..... 162
 - Searching unsubscribed channels..... 163
 - Selecting a category..... 162
 - Using playback mode..... 162
 - Seat**
 - Correct driver's seat position..... 61
 - Seat belt**
 - Adjusting the height..... 28
 - Care..... 183
 - Fastening..... 28
 - Protection..... 26
 - Protection impaired..... 27
 - Releasing..... 28
 - Warning lamps..... 28
 - Seat cover (care)**..... 183
 - Seats**
 - 4-way lumbar support..... 64
 - Adjusting (electrically)..... 63
 - Adjusting (manually)..... 61
 - Adjusting armrests..... 65
 - Adjusting the head restraint electrically..... 71
 - Adjusting the head restraints mechanically..... 70
 - Operating the memory function..... 65
 - Securing luggage**..... 164
 - Selector lever**
 - see DIRECT SELECT lever
 - Self-test**
 - Automatic co-driver airbag shutoff..... 32
 - Sensors (care)**..... 182
 - Service**
 - see ASSYST PLUS service interval display
 - Service center**
 - see Qualified specialist workshop
 - Service products**
 - Refrigerant (air conditioning)..... 242
 - Setting the airflow**..... 93
 - Setting the date (vehicle with steering-wheel buttons)**..... 146
 - Setting the date (vehicle without steering-wheel buttons)**..... 140
 - Setting the language (vehicle with steering-wheel buttons)**..... 146
 - Setting the language (vehicle without steering-wheel buttons)**..... 140
 - Setting the speed**
 - see Cruise control
 - Setting the time (vehicle with steering-wheel buttons)**..... 146
 - Setting the time (vehicle without steering-wheel buttons)**..... 140
 - Setting units on the on-board computer (vehicle with steering-wheel buttons)**..... 146
 - Setting units on the on-board computer (vehicle without steering-wheel buttons)**..... 140
 - Shortcuts (destination entry)**..... 156
 - Showing traffic information (multimedia system)**..... 158
 - Side airbag**..... 29
 - Side window**
 - Closing using the key..... 58

- Convenience closing..... 58
 Problems..... 58
- Side windows**
 Closing..... 56
 Convenience opening..... 57
 Opening..... 56
 Opening with the key..... 57
 Opening/closing the sliding window..... 58
 Resetting..... 58
- Size designation (tires)**..... 210
- Sliding door**
 Child safety lock..... 41
 Closing (from the inside)..... 47
 Closing (from the outside)..... 47
 Opening (from the inside)..... 47
 Opening (from the outside)..... 47
- Sliding windows**
 Opening/closing..... 58
- SmartKey**
 Convenience opening..... 95
- Smartphone (multimedia system)**
 Pairing..... 159
 Placing a call..... 159
 Setting functions..... 159
- Snow chains**..... 203
- Socket (12 V)**
 Front center console..... 75
- Spare wheel**
 Installing/removing..... 219
 Notes..... 218
- Special seat belt retractor**..... 37
- Specialist workshop**
 see Qualified specialist workshop
- Speed rating (tires)**..... 210
- Speedometer**..... 134
- Standard rear bench seat**
 Removing/installing..... 69
- Standing lights**..... 76
- Standing/parking lamps**
 Replacing light sources..... 80
- Starting assistance**
 see Jump-start connection point
- Starting the engine**
 see Vehicle
- Starting-off aid**
 see Hill Start Assist
- Steering wheel**
 Adjusting..... 73
- Steering wheel buttons**..... 9
- Storage compartment in the rear compartment**
 Jack..... 199
 Vehicle tool kit..... 199
- Storage compartment in the seat base**
 Vehicle tool kit..... 199
- Stowage space**
 Glasses compartment..... 74
- Sulfur content**..... 239
- Summer tires**..... 202
- Surround lighting**
 Setting (vehicle with steering-wheel buttons)..... 146
- Switch-off delay time**
 Setting (vehicle with steering-wheel buttons)..... 146
- Switching air-recirculation mode on/off**..... 94
- Switching off engine**
 see Vehicle
- Switching on the ignition**
 see Vehicle
- Switching seat heating on/off**..... 72
- Switching the A/C function on/off**..... 92
- Switching the rear window heater on/off**..... 95
- Switching the reset function on/off (control panel)**..... 94
- T**
- Tail lamps (replacing bulbs)**..... 82
- Tailgate**
 EASY-PACK..... 52
 Limiting the opening angle..... 53
 Opening in an emergency..... 51
 Opening/closing..... 51
 Programming the key button..... 54
 Resetting..... 53
 Separately opening rear window..... 54
- Tailpipes (care)**..... 182
- Tank content**
 Fuel..... 239
 Reserve (fuel)..... 239
- Technical data**
 Information..... 222
 Notes (trailer hitch)..... 244
 Regulatory radio identification (Indonesia)..... 233
 Regulatory radio identification of small components..... 223
 Regulatory radio information..... 236
 Transmission oil..... 240

- Vehicle identification plate..... 237
- Telephone**
 - Operation via the on-board computer (vehicle with steering wheel buttons)..... 145
- Temperature**
 - Coolant (display in the on-board computer)..... 140
 - Setting (heating/air conditioning)..... 93
- Tie-down eyes**..... 169
- Tire Identification Number (TIN)**..... 209
- Tire labeling**
 - Characteristics..... 210
 - DOT, Tire Identification Number (TIN).. 209
 - Load-bearing capacity..... 210
 - Maximum tire load..... 210
 - Maximum tire pressure..... 210
 - Overview..... 208
 - Size designation..... 210
 - Speed rating..... 210
 - Temperature grade..... 208
 - Tire quality grades..... 208
 - Tread wear grade..... 208
- Tire load (maximum)**..... 210
- Tire pressure**
 - Checking (tire pressure monitoring system)..... 207
 - Maximum..... 210
 - Notes..... 204
 - Restarting the tire pressure monitoring system..... 207
 - Tire pressure monitoring system (function)..... 206
 - Tire pressure table..... 205
- Tire pressure monitor**
 - Checking the tire pressure..... 207
 - Checking the tire temperature..... 207
 - Function..... 206
- Tire pressure monitoring system**
 - Restarting..... 207
- Tire pressure table**..... 205
- Tire temperature**
 - Checking (tire pressure monitoring system)..... 207
 - Tire pressure monitoring system (function)..... 206
- Tire tread**..... 202
- Tires**
 - Characteristics..... 210
 - Checking..... 202
 - Checking the tire pressure (tire pressure monitoring system)..... 207
 - Definitions..... 211
 - Direction of rotation..... 215
 - DOT, Tire Identification Number (TIN).. 209
 - Flat tire..... 187
 - Installing..... 217
 - Load-bearing capacity..... 210
 - M+S tires..... 203
 - Maximum tire load..... 210
 - Maximum tire pressure..... 210
 - Noise..... 202
 - Notes on installing..... 213
 - Overview of tire labeling..... 208
 - Removing..... 217
 - Replacing..... 213, 215
 - Restarting the tire pressure monitoring system..... 207
 - Selection..... 213
 - Size designation..... 210
 - Snow chains..... 203
 - Speed rating..... 210
 - Storing..... 215
 - Summer tires..... 202
 - Tire pressure (notes)..... 204
 - Tire pressure monitoring system (function)..... 206
 - Tire pressure table..... 205
 - Tire quality grades..... 208
 - Unusual driving characteristics..... 202
 - Wheel size categories..... 214
 - Wheel/tire combinations..... 218
- Tires**
 - see Wheels
- Tool**
 - see Vehicle tool kit
- Tool holder in the cargo compartment**
 - Jack..... 200
 - Vehicle tool kit..... 200
- Top Tether**..... 38
- Topping up the windshield washer system**..... 179
- Touchscreen (multimedia system)**
 - Operating..... 152
- Tow-away alarm**
 - Arming/disarming..... 59
 - Function..... 59
- Tow-starting**..... 198
- Towing away**
 - Both axles on the ground..... 196
 - Raised front or rear axle..... 196

- Towing eye**
 - Installing/removing..... 197
 - Storage location..... 197
 - Towing methods**..... 194
 - Traffic announcements (multimedia system)**
 - Switching on/off..... 162
 - Trailer hitch**
 - Care..... 182
 - General notes..... 244
 - Information..... 131
 - Information about trailer operation..... 128
 - Permissible trailer loads and trailer drawbar noseweights..... 132
 - Power supply..... 133
 - Socket..... 130
 - Trailer loads**..... 244
 - Trailer operation**
 - Coupling/Decoupling the trailer..... 130
 - Gross axle weight rating..... 237
 - Information..... 131
 - Notes..... 128
 - Permissible trailer loads and trailer drawbar noseweights..... 132
 - Power supply..... 133
 - Socket..... 130
 - Trailer loads..... 244
 - Trailer stabilization**..... 110
 - Transmission oil**
 - General notes..... 240
 - Quality..... 240
 - Transmission position display**..... 103
 - Transport by rail**..... 99
 - Transporting the vehicle (vehicle breakdown)**..... 197
 - Trim element (care)**..... 183
 - Trip computer**
 - Resetting (vehicle with steering-wheel buttons)..... 142
 - Resetting (vehicle without steering-wheel buttons)..... 139
 - Trip distance**
 - Resetting (vehicle without steering-wheel buttons)..... 139
 - TuneMix™**
 - Creating a list..... 163
 - Turn signal indicators**
 - see Turn signal light
 - Turn signal light**
 - Additional turn signal lamp (replacing bulbs)..... 82
 - Replacing light sources..... 80
 - Switching on/off..... 77
 - Two-way radio telephone**
 - see Mobile phone
 - Two-way radios**
 - Frequencies..... 222
 - Notes on installation..... 222
 - Transmission output (maximum)..... 222
- U**
- Updating software (multimedia system)**..... 163
 - USB port (multimedia system)**
 - Connecting devices..... 161
 - Using a sun visor**..... 89
 - Using kickdown**..... 105
- V**
- Vehicle**
 - Correct use..... 18
 - Data acquisition..... 20
 - Deactivating..... 106
 - Diagnostics connection..... 17
 - Equipment..... 14
 - Limited Warranty..... 20
 - Locking (from the inside)..... 45
 - Locking/unlocking (emergency key)..... 47
 - Lowering..... 217
 - Maintenance..... 15
 - Medical aids..... 19
 - Notifying problems..... 19
 - Parking..... 106
 - Parking for an extended period..... 108
 - QR code rescue card..... 20
 - Qualified specialist workshop..... 18
 - Raising..... 216
 - Registration..... 18
 - Starting (key)..... 97
 - Switch automatic locking on/off (key)... 46
 - Switching on the power supply..... 97
 - Unlocking (from the inside)..... 45
 - Ventilating (convenience opening)..... 57
 - Vehicle camera**
 - Information..... 108
 - Vehicle components which receive and/or transmit radio waves**
 - Declaration of conformity..... 17
 - Vehicle data**
 - Vehicle height..... 243
 - Vehicle length..... 243

- Vehicle width..... 243
 Wheelbase..... 243
- Vehicle data storage**
 Event data recorders..... 23
 Onboard Logic Unit..... 22
- Vehicle dimensions**..... 243
- Vehicle emergency start**..... 198
- Vehicle identification number**
 see VIN
- Vehicle identification plate**
 EC general operating permit number... 237
 Gross axle weight rating..... 237
 Maximum permissible gross vehicle weight..... 237
 Paint code..... 237
 VIN..... 237
- Vehicle key**
 see Key
- Vehicle maintenance**
 see ASSYST PLUS service interval display
- Vehicle operation**
 Outside the USA or Canada..... 15
- Vehicle sensors**
 Information..... 108
- Vehicle tool kit**
 Information..... 198
 Jack..... 198
 Storage compartment in the rear compartment..... 199
 Storage compartment in the seat base..... 199
 Tool holder in the cargo compartment..... 200
 Towing eye..... 197
- VIN**
 Identification plate..... 237
 Reading out..... 237
 Seat..... 237
 Windshield..... 237
- Vision**
 Defrosting windows..... 94
- W**
- Warning system**
 see ATA (Anti-Theft Alarm system)
- Warning/indicator lamp**
 ABS warning lamp..... 272, 273
 Brake system warning lamp
 272, 273
 Check Engine warning lamp..... 276
 Coolant warning lamp
 276, 277, 278
 Door indicator lamp..... 276
 ESP® OFF warning lamp..... 274
 ESP® warning lamp..... 273, 274
 Fuel reserve warning lamp..... 276
 Power steering system warn-
 ing lamp..... 276
 Restraint system warning lamp... 272
 Seat belt warning lamp..... 275
 Tire pressure monitoring sys-
 tem warning lamp..... 279
 Warning lamp for distance
 warning function..... 275
 Notes..... 271
 PASSENGER AIR BAG..... 32
- Warning/indicator lamps**
 Overview..... 7, 8
- Warranty**..... 20
- Warranty terms and conditions**..... 15
- Washer fluid**
 see Windshield washer fluid
- Washing by hand (care)**..... 181
- Washing the engine**..... 180
- Wheel rotation**..... 214
- Wheels**
 Care..... 182
 Changing..... 214
 Characteristics of the tire..... 210
 Checking..... 202
 Checking the tire pressure (tire pressure monitoring system)..... 207
 Definitions..... 211
 DOT, Tire Identification Number (TIN).. 209
 Flat tire..... 187
 Installing..... 217
 Load-bearing capacity..... 210
 Maximum tire load..... 210
 Maximum tire pressure..... 210
 Noise..... 202
 Notes on installing..... 213
 Overview of tire labeling..... 208
 Removing..... 217
 Replacing..... 213, 215
 Restarting the tire pressure moni-
 toring system..... 207
 Selection..... 213
 Size designation..... 210

- Snow chains..... 203
- Speed rating..... 210
- Storing..... 215
- Technical data..... 218
- Tire pressure (notes)..... 204
- Tire pressure monitoring system
(function)..... 206
- Tire pressure table..... 205
- Tire quality grades..... 208
- Tread wear grade..... 208
- Unusual driving characteristics..... 202
- Wheel size categories..... 214
- Wheel/tire combinations..... 218
- Wheels (care)**..... 182
- Window airbag**..... 29
- Window lifter**
see Side windows
- Windows**
see Side windows
- Windows (care)**..... 182
- Windshield**
Defrosting..... 94
Replacing the wiper blades..... 85
- Windshield**
see Windshield
- Windshield washer fluid**..... 241
- Windshield wipers**
Replacing the wiper blades..... 85
Switching on/off..... 84
- Windshield wipers**
see Rear window wiper
- Winter driving (snow chains)**..... 203
- Winter tires**..... 203
- Wiper blades**
Care..... 182
Replacing (rear window)..... 86
Replacing (windshield)..... 85
- Workshop**
see Qualified specialist workshop