



The EQS

Effective from October 2021 Production.

MERCEDES-EQ





Book a test drive



Buy your EQS



Find a Retailer



Some of the model features, optional extras and colours shown may not be available, or may only be available in a different specification, or at a different price.

Design	Sustainability	Technology	Safety	Mercedes-EQ	Model lines	Upholstery	Model prices	Personalisation	Standard equipment	Genuine accessories	Technical data	Additional information
--------	----------------	------------	--------	-------------	-------------	------------	--------------	-----------------	--------------------	---------------------	----------------	------------------------



Book a test drive



Buy your EQS



Find a Retailer



D S EQ 2971E

Some of the model features, optional extras and colours shown may not be available, or may only be available in a different specification, or at a different price.

Design	Sustainability	Technology	Safety	Mercedes-EQ	Model lines	Upholstery	Model prices	Personalisation	Standard equipment	Genuine accessories	Technical data	Additional information
--------	----------------	------------	--------	-------------	-------------	------------	--------------	-----------------	--------------------	---------------------	----------------	------------------------



Book a test drive



Buy your EQS



Find a Retailer



Some of the model features, optional extras and colours shown may not be available, or may only be available in a different specification, or at a different price.

Design	Sustainability	Technology	Safety	Mercedes-EQ	Model lines	Upholstery	Model prices	Personalisation	Standard equipment	Genuine accessories	Technical data	Additional information
--------	----------------	------------	--------	-------------	-------------	------------	--------------	-----------------	--------------------	---------------------	----------------	------------------------

[Book a test drive](#)[Buy your EQS](#)[Find a Retailer](#)

Some of the model features, optional extras and colours shown may not be available, or may only be available in a different specification, or at a different price.

Design	Sustainability	Technology	Safety	Mercedes-EQ	Model lines	Upholstery	Model prices	Personalisation	Standard equipment	Genuine accessories	Technical data	Additional information
------------------------	--------------------------------	----------------------------	------------------------	-----------------------------	-----------------------------	----------------------------	------------------------------	---------------------------------	------------------------------------	-------------------------------------	--------------------------------	--



Book a test drive



Buy your EQS



Find a Retailer



EQS

Sustainability

Design

Sustainability

Technology

Safety

Mercedes-EQ

Model lines

Upholstery

Model prices

Personalisation

Standard
equipment

Genuine
accessories

Technical data

Additional
information



Book a test drive



Buy your EQS



Find a Retailer

Sustainable production.

The roof of Factory 56, EQS's production facility, is equipped with 12,000 photovoltaic modules. These have a maximum output of around 5,000 kWp and can thus cover around 30% of the factory's energy needs on an annual average. All in all, the energy requirement of Factory 56 is 25% lower than that of other assembly buildings. The bottom line is that Factory 56 will be a zero-carbon factory – completely CO₂-neutral.



Sustainable materials.

To ensure the responsible mining of cobalt, lithium and other battery raw materials, Mercedes-Benz has already made the IRMA Standard for Responsible Mining a contractual component for all future vehicle projects.

Sustainable mobility.

Locally emission-free driving pleasure, virtually silent with full access to inner city zones. All our EQ vehicles come as standard with an external acoustic warning to alert pedestrians or cyclists at speeds under 19 mph.



Design

Sustainability

Technology

Safety

Mercedes-EQ

Model lines

Upholstery

Model prices

Personalisation

Standard equipment

Genuine accessories

Technical data

Additional information



Book a test drive



Buy your EQS



Find a Retailer

Mercedes me Charge - Green charging



To promote the use of electricity from renewable energies, Mercedes-Benz uses guarantees of origin to 'green' the charging process.

This ensures that an equivalent amount of electricity from renewable resources is fed into the grid to compensate for the charging of your EQS.

All new EQSs have three years of Mercedes me Charge as standard and the Green Charging guarantee is included with this.

Design	Sustainability	Technology	Safety	Mercedes-EQ	Model lines	Upholstery	Model prices	Personalisation	Standard equipment	Genuine accessories	Technical data	Additional information
--------	----------------	------------	--------	-------------	-------------	------------	--------------	-----------------	--------------------	---------------------	----------------	------------------------



Book a test drive



Buy your EQS



Find a Retailer



EQS

Technology

Design	Sustainability	Technology	Safety	Mercedes-EQ	Model lines	Upholstery	Model prices	Personalisation	Standard equipment	Genuine accessories	Technical data	Additional information
------------------------	--------------------------------	----------------------------	------------------------	-----------------------------	-----------------------------	----------------------------	------------------------------	---------------------------------	------------------------------------	-------------------------------------	--------------------------------	--

Mercedes me connect

Stay connected any time, anywhere.

Mercedes me

Mercedes me is a range of innovative online services designed to enhance your Mercedes-Benz experience. Accessible via mobile, tablet or PC, Mercedes me lets you enjoy the highest standards of care and support, in a way that integrates seamlessly with your busy lifestyle.

Safety and Service – Mercedes me connect helps to keep you and your car safe

Check your car's washer fluid level, tyre pressure and battery level from your phone so you'll be ready for every journey.

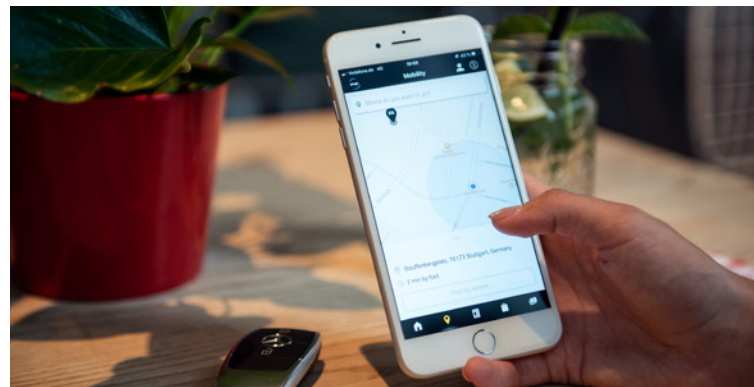

Infotainment – Online and Entertainment services from Mercedes me connect

Love music? Get a 3-month free subscription to Tidal when you connect your car.

Live Traffic Information, Parked Vehicle Locator and much more with Mercedes me connect

Forgot where you've parked? Parked Vehicle Locator¹ will show you exactly where your car is as long as you're in a 1-mile radius of where you parked. Real-time traffic data and dynamic route with shorter journey times.

For more information speak to your local Retailer or visit the Mercedes me connect store at shop.mercedes-benz.com/en-gb/connect

Comfort – connect to your car anytime, anywhere

Forgot to lock your car? With Remote Car Lock² you will receive a notification on your smartphone to let you know. With one tap, you can lock and unlock your vehicle so you never have to worry.

Mercedes-EQ specific services

Check your charging status on the go and programme your pre-entry climate control and charging settings remotely. The Mercedes-EQ specific navigation considers electrical range, topography and charging stations.



¹Available on all models with the Vehicle Monitoring package. This option may vary between standard and additional cost dependent on the model

²Part of the Vehicle Status package. This option may vary between standard and additional cost dependent on the model

Images shown are for illustration purposes only



Mercedes-Benz User Experience (MBUX)

Transforming the in-car user experience, thanks to MBUX: Controlled via voice, touch or gesture (where fitted) input, the innovative infotainment system can over time even predict personal habits thanks to artificial intelligence.

Voice control

- Activated by the keywords “Hey Mercedes”, the new intelligent voice control LINGUATRONIC¹ lets you control many of the infotainment functions, including destination input, phone calls or music selection
- MBUX is able to understand different accents and will adjust to you over time
- MBUX even understands indirect commands. Feeling chilly? Just say “I feel cold” and MBUX will adjust the temperature for you
- MBUX is able to understand which individual seat the request has come from, and will therefore only respond to their specific request (e.g. adjusting the temperature for just the front passenger)

Touch inputs

- Beside voice control you can operate MBUX via touchscreen, the touch controls on the centre console, as well as touch control buttons on the steering wheel
- The touchpad recognises your handwriting should you wish to enter addresses or phone numbers silently

Personalisation

- Turn the new EQS into your very own Mercedes-Benz by personalising driving modes, radio stations, ambient lighting and much more
- Your personal settings can be saved in up to seven different profiles, making your driving experience the best one possible
- Thanks to artificial intelligence, MBUX is able to learn and adapt over time. It will be able to predict your personal habits, such as navigation for frequently-driven routes, or the radio station you like to listen to on your way home from work

Maintenance and service

- Wondering when the next service is due? Or how much further you can drive until you need to stop at a charging station? Just ask your MBUX – it will tell you the answer



MBUX multimedia system

¹LINGUATRONIC off-board functions are currently only available for three years

Design	Sustainability	Technology	Safety	Mercedes-EQ	Model lines	Upholstery	Model prices	Personalisation	Standard equipment	Genuine accessories	Technical data	Additional information
------------------------	--------------------------------	----------------------------	------------------------	-----------------------------	-----------------------------	----------------------------	------------------------------	---------------------------------	------------------------------------	-------------------------------------	--------------------------------	--



EQS

Safety

[Book a test drive](#)[Buy your EQS](#)[Find a Retailer](#)

DIGITAL LIGHT High-definition headlamps with innovative features

The new innovative DIGITAL LIGHT headlamps works like a projector with more than one million pixels per headlamp and responds with brilliant light to changing traffic, road or weather conditions. Its ULTRA RANGE Highbeam with 650 m makes you feel like driving at daylight.

Standard on all model lines, except AMG Line



Design	Sustainability	Technology	Safety	Mercedes-EQ	Model lines	Upholstery	Model prices	Personalisation	Standard equipment	Genuine accessories	Technical data	Additional information
------------------------	--------------------------------	----------------------------	------------------------	-----------------------------	-----------------------------	----------------------------	------------------------------	---------------------------------	------------------------------------	-------------------------------------	--------------------------------	--

[Book a test drive](#)[Buy your EQS](#)[Find a Retailer](#)

Driving Assistance package Plus Cares for what matters.

The new EQS comes with standard ground-breaking innovations in safety, comfort and driving functions, to help you stay safe on the road.

Driving Assistance package (code P20) – designed and priced as a package **Standard on AMG Line**

Blind Spot Assist

Active Distance Assist DISTRONIC now responds to stationary road users to prevent collisions up to 80 mph (previously 37 mph)

Active Lane Keeping Assist with enhanced comfort thanks to active steering intervention (instead of braking intervention) and additional hazard indication



Active Lane Keeping Assist

Driving Assistance package Plus (code P79) – designed and priced as a package **Standard on all model lines, except AMG Line**

Active Blind Spot Assist expanded with blind spot monitoring towards the front and side. Additional hazard indication of the blind spot warning system as well as exit warning function

Active Brake Assist with cross-traffic function now with turning manoeuvre function (responding to (among other things) crossing pedestrians when making a turn). Operating range on urban routes expanded to 74 mph (previously 44 mph)

Active Distance Assist DISTRONIC now responds to stationary road users to prevent collisions up to 80 mph (previously 37 mph)

Active Emergency Stop Assist: now able to assist in manual mode (previously only in DISTRONIC mode). Optional lane change by one lane (at 49 mph where no obstacles detected)

Active Evasive Steering Assist: now responds to cyclists and ends of tailbacks in addition to pedestrians. Operating range on urban routes expanded to 67 mph (previously 44 mph)

Active Lane Keeping Assist with enhanced comfort thanks to active steering intervention (instead of braking intervention) and additional hazard indication

Active Speed Limit Assist ensures detected speed limits are automatically adopted as the set speed for Active Distance Assist DISTRONIC

Congestion emergency braking function

Emergency corridor function

Exit warning function when hand moves towards the door handles

Extended automatic restart on motorways

Hazard display via ambience lighting

Increased availability and cornering performance on carriageways with **Active Steering Assist**, more stern warnings to put hands on the steering wheel with new capacitive steering wheel

PRE-SAFE® PLUS and Impulse Side with body-raising function: when a rear-end collision threatens, PRE-SAFE® PLUS can initiate preventive measures, including warning following traffic and locking the brakes on standstill

Route-based speed adjustment with end of traffic jam function and Active Stop-and-Go Assist adaption of speed before curves, roundabouts and junctions with end of traffic jam function



Active Distance Assist DISTRONIC

[Design](#)[Sustainability](#)[Technology](#)[Safety](#)[Mercedes-EQ](#)[Model lines](#)[Upholstery](#)[Model prices](#)[Personalisation](#)[Standard equipment](#)[Genuine accessories](#)[Technical data](#)[Additional information](#)



Book a test drive



Buy your EQS



Find a Retailer

EQS

Mercedes-EQ



Design	Sustainability	Technology	Safety	Mercedes-EQ	Model lines	Upholstery	Model prices	Personalisation	Standard equipment	Genuine accessories	Technical data	Additional information
------------------------	--------------------------------	----------------------------	------------------------	-----------------------------	-----------------------------	----------------------------	------------------------------	---------------------------------	------------------------------------	-------------------------------------	--------------------------------	--

Benefits of driving Mercedes-EQ

MERCEDES-EQ

The EQS is the first all-electric luxury saloon from Mercedes-EQ. With it, Mercedes-EQ is redefining this vehicle segment. The EQS is also the first model to be based on the modular architecture for luxury and executive-class electric vehicles.

Lower running costs

Did you know that electric cars could cost up to a third less than a diesel or petrol car to run, as well as being cheaper to maintain? We've partnered with Go Ultra Low, a joint Government and car industry campaign, to give you unbiased advice on making the switch to an electric car. Use Go Ultra Low's cost saving calculator to see how much you can save.

[Discover more](#)

No road fund licence

Mercedes-EQ vehicles have no local emissions – this means you pay no road tax.

Cleaner vehicle discount

Mercedes-EQ battery electric vehicles are congestion charge and ultra low emission zone charge exempt in London and other cities.

Business benefits

With 100% first-year capital allowances¹ and 1% BIK tax, electric cars offer significant benefits to businesses and employees.

Performance

Instant torque provides a whole new dimension to driving performance.

Refinement

Acoustically optimised glass and a near-silent powertrain means that driving Mercedes-EQ provides a sensory experience of luxurious refinement.

¹100% first-year capital allowances only apply to vehicles less than 50 g CO₂/km



Some of the model features, optional extras and colours shown may not be available, or may only be available in a different specification, or at a different price.

[Click here for more information](#)

Design	Sustainability	Technology	Safety	Mercedes-EQ	Model lines	Upholstery	Model prices	Personalisation	Standard equipment	Genuine accessories	Technical data	Additional information
--------	----------------	------------	--------	-------------	-------------	------------	--------------	-----------------	--------------------	---------------------	----------------	------------------------

[Book a test drive](#)[Buy your EQS](#)[Find a Retailer](#)

EQS

MERCEDES-EQ

Vehement power immediately from standstill: An electric motor at the rear axle converts electrical into mechanical energy, and delivers impressive forward thrust. The intelligent operating strategy of the powertrain components supplies the power always wherever it is needed at the moment – efficiently and nearly silently.

EQS 450+

Battery electric vehicle, 333 hp/245 kW
Electric range 407–453 miles – WLTP

OTR from **£99,995¹**



Standard equipment

- AIRMATIC air suspension
- Charging system – AC charging system rated at 11 kW AC
- Charging system – DC charging system rated at 110 kW DC
- Charging socket
- Charging cable for wallbox and public charging stations, Type 2 (Mode 3) – 5 metres
- Charging cable for domestic plug socket, Type G (Mode 2) – 5 metres
- Pre-entry climate control
- Radar-based recuperation



Technical details

Electric range ²	407–453 miles
Charging time	
Public Rapid charger (200 kW DC) 10–80% ³	31 mins
Wallbox (11 kW AC) 10–100% ⁴	10 hrs
Home wallbox (7.4 kW AC) 10–100% ³	15 hrs 30 mins
Range power consumption, combined ^{2,3}	193–170 Wh/km
Battery type (capacity)	lithium-ion (107.8 kWh)
Capacity on-board charger	11 kW AC; 200 kW DC

Attention

- Please be aware that external factors such as weather, gradient and ambient temperature amongst others can significantly impact range.
- Please also note that internal factors such as driving style and climate control settings etc. can also significantly impact range.
- Using the pre-entry climate control when plugged into a charge point will ensure the perfect ambience and ensure that your car is just how you like it, as well as making sure that your battery isn't used unnecessarily to heat/cool the vehicle (maximising range).

¹The recommended on-the-road price includes the Road Fund Licence applicable to the standard model plus delivery charge (£715.00 incl. VAT), new vehicle registration fee (£55.00) and number plates (£25.00 incl. VAT). VAT is calculated at the standard rate of 20%. Some of the model features, optional extras and colours shown may not be available, or may only be available in a different specification, or at a different price. ²Figures shown are for comparability purposes; only compare with other cars tested to the same technical procedures. Figures may not reflect real life driving results, which will depend upon a number of factors including the starting charge of the battery, factory-fitted options, accessories fitted (post registration), variations in weather, driving styles and vehicle load. Further information about the test used to establish range, power consumption and CO₂ figures can be found at <http://www.mercedes-benz.co.uk/WLTP> ³Specified voltage and current values refer to network infrastructure and can be limited by the vehicle. Times are from 10–80% charge using public rapid charging at 110 kW ⁴Specified voltage and current values refer to network infrastructure and can be limited by the vehicle. Times are from 10–100% charge using a wallbox (three-phase) or standard socket (single-phase) ⁵If you are planning to charge your Mercedes-Benz plug-in electric vehicle using a 3-pin domestic plug socket you must get a qualified electrician to inspect and sign off the socket to confirm it is safe and suitable to charge your vehicle. Do not use an electric vehicle 3-pin charge cable with an extension cord)



Book a test drive



Buy your EQS



Find a Retailer

Mercedes me Charge One registration, one contract, one billing.

Mercedes *me*

Mercedes me Charge provides access to a multitude of public charging stations located in shopping centers, hotels or at motorway services. A smartphone app as well as the vehicle's navigation system show the precise location, current availability and price at the selected charging station.

Tens of thousands charging stations in the UK

Growing network of charging providers includes bp pulse the largest charging network in the UK. Customers also get six months free bp pulse membership which reduces the electricity price when charging.



Access to fast-charging stations

Enables customers to get access to charging stations of different providers with:

- Mercedes me app
- RFID card
- Mercedes-EQ Vehicle Head unit

Charging with IONITY

IONITY unlimited – free rapid charging for one year at all IONITY stations.

Green charging

All charging using Mercedes me Charge, will be retrospectively 'greened' by Mercedes-Benz. Please click [here](#) for more info.

Transparent and easy billing

One invoice charging processes for payment.

Easy access

Charging stations are displayed in Mercedes me app and in MBUX multimedia system.

No fees

Mercedes me Charge is standard for three years with EQS.



Design	Sustainability	Technology	Safety	Mercedes-EQ	Model lines	Upholstery	Model prices	Personalisation	Standard equipment	Genuine accessories	Technical data	Additional information
--------	----------------	------------	--------	-------------	-------------	------------	--------------	-----------------	--------------------	---------------------	----------------	------------------------



Book a test drive



Buy your EQS



Find a Retailer

bp pulse home charger Simple, convenient, fast charging.



Mercedes-Benz plug-in vehicle customers with off-street parking can benefit from the convenience and speed of charging at home by installing a bp pulse home charger. Simply charge your EQS overnight – the 7 kW bp pulse home charger delivers a full charge in 15 hours and 30 minutes.¹

bp pulse home charger 7 kW: £525* incl. VAT & installation

Key benefits of the 7 kW bp pulse home charger:

Robust and weatherproof, for indoor or outdoor use, and comes with a three year warranty

The cost for a fully-installed charge point at your home includes the £350 OZEV (EVHS) grant²

As a Mercedes-Benz driver, when you install a bp pulse home charger you will automatically receive three months FREE membership to bp pulse, the UK's largest public charging network with over 7,000 charge points

Questions? Please contact your local Retailer to submit an enquiry on your behalf. To find your local Retailer, please click the button at the top right hand corner.

Warning! If you are planning to charge your Mercedes-Benz plug-in electric vehicle using a 3-pin domestic plug socket you must get a qualified electrician to inspect and sign off the socket to confirm it is safe and suitable to charge your vehicle. Do not use an electric vehicle 3-pin charge cable with an extension cord.

*Price includes £350 OZEV EVHS Grant. Price correct at time of publication, subject to change

¹Based on 7kW power output ²The bp pulse home charger £350 Grant (including VAT) is only available to customers who meet the criteria of the Office for Zero Emission Vehicles (OZEV) and is provided and installed by bp pulse home charger plc. For full details and eligibility criteria for the OZEV EVHS Grant, see <https://www.gov.uk/government/publications/electric-vehicle-homecharge-scheme-guidance-for-customers-version-21>. For full bp pulse home charger Terms & Conditions visit https://chargemasterplc.com/terms_conditions



Some of the model features, optional extras and colours shown may not be available, or may only be available in a different specification, or at a different price.

Design	Sustainability	Technology	Safety	Mercedes-EQ	Model lines	Upholstery	Model prices	Personalisation	Standard equipment	Genuine accessories	Technical data	Additional information
--------	----------------	------------	--------	-------------	-------------	------------	--------------	-----------------	--------------------	---------------------	----------------	------------------------



Book a test drive



Buy your EQS



Find a Retailer

EQS Model lines overview



Design	Sustainability	Technology	Safety	Mercedes-EQ	Model lines	Upholstery	Model prices	Personalisation	Standard equipment	Genuine accessories	Technical data	Additional information
--------	----------------	------------	--------	-------------	-------------	------------	--------------	-----------------	--------------------	---------------------	----------------	------------------------

EQS AMG Line



The AMG Line presents a performance-focussed aesthetic.

On the exterior this combines AMG bodystyling with 20" AMG alloys. The sporting pretensions are clear in the interior with a flat-bottomed sports steering wheel, sports pedals and a full leather upholstery.

EQS AMG Line

OTR from £99,995¹

¹The recommended on-the-road price includes the Road Fund Licence applicable to the standard model plus delivery charge (£715.00 incl. VAT), new vehicle registration fee (£55.00) and number plates (£25.00 incl. VAT). VAT is calculated at the standard rate of 20%. Some of the model features, optional extras and colours shown may not be available, or may only be available in a different specification, or at a different price

Design	Sustainability	Technology	Safety	Mercedes-EQ	Model lines	Upholstery	Model prices	Personalisation	Standard equipment	Genuine accessories	Technical data	Additional information
--------	----------------	------------	--------	-------------	-------------	------------	--------------	-----------------	--------------------	---------------------	----------------	------------------------

EQS AMG Line Standard equipment highlights



Exterior

20" AMG alloy wheels – 5-spoke design, painted black with aero-elements in matt tantalite grey (code RRU)

AMG front bumper painted in vehicle colour with A-wing in high-gloss black and trim in chrome, front splitter in high-gloss chrome with flics and fins at the left and right air inlets in high-gloss black with chrome trim

AMG rear apron painted in vehicle colour with diffuser-look inserts in high-gloss black, double trim strip in chrome and flics at the left and right air outlets in grained black

Headlamps – static LED headlamps with Highbeam Assist

KEYLESS-GO

Panoramic roof

Side skirts painted in high-gloss black with insert in chrome

Steering – 4.5° rear axle steering

Summer tyres





Communications, Safety and Assistance Systems

12.3-inch driver display and MBUX multimedia system with 12.8-inch OLED central display

Driving Assistance package

MBUX augmented reality for navigation

Parking package with Active Parking Assist and reversing camera

URBAN GUARD Plus vehicle protection



Interior

AMG brushed stainless steel sports pedals with black rubber studs

AMG floor mats

AMG multifunction sports steering wheel in nappa leather

AMG sports seat in leather upholstery

Dashboard and beltlines in space grey ARTICO man-made leather with NEOTEX grain and red topstitching

Heated front and rear seats

HEPA Air Filter

Privacy glass

Roof liner in black fabric

Trim and Upholstery

Leather – black/space grey

Anthracite linestructure lime wood



EQS AMG Line Premium



The AMG Line Premium elevates the EQS to the next level.

Visually through the 21" AMG multi-spoke light-alloy wheels and ambient lighting. Technologically this model line has been designed to enhance the driving experience through greater comfort and ease of use.

EQS AMG Line Premium
Upgrade price from EQS AMG Line

OTR from £106,995¹
£7,000

¹The recommended on-the-road price includes the Road Fund Licence applicable to the standard model plus delivery charge (£715.00 incl. VAT), new vehicle registration fee (£55.00) and number plates (£25.00 incl. VAT). VAT is calculated at the standard rate of 20%. Some of the model features, optional extras and colours shown may not be available, or may only be available in a different specification, or at a different price

Design	Sustainability	Technology	Safety	Mercedes-EQ	Model lines	Upholstery	Model prices	Personalisation	Standard equipment	Genuine accessories	Technical data	Additional information
--------	----------------	------------	--------	-------------	-------------	------------	--------------	-----------------	--------------------	---------------------	----------------	------------------------

EQS AMG Line Premium Standard equipment highlights



In addition to/replacement of AMG Line:

Exterior

21" AMG alloy wheels - multi-spoke design, aerodynamically optimised, painted black with a high-shine finish (code RWX)

Headlamps - DIGITAL LIGHT

Steering - 10° rear axle steering

Summer tyres





No-cost option shown: leather in neva grey/balao brown (code: 229A)



No-cost option shown: leather in neva grey/balao brown (code 229A)

Interior

Ambient lighting

Communications, Safety and Assistance Systems

Burmester® surround sound system

Driving Assistance package Plus

Parking package with Active Parking Assist and 360° camera



Burmester® surround sound system

Trim and Upholstery

Leather – black/space grey

Anthracite linestructure lime wood

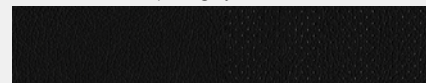

EQS AMG Line Premium Plus



The AMG Line Premium Plus is the ultimate modern choice.

Character is refined through use of the MBUX Interior Assistant (front) and remote parking. Designed around sensory excellence, the interior features Burmester® surround sound and head-up display.

EQS AMG Line Premium Plus
Upgrade price from EQS AMG Line Premium

OTR from £113,995¹
£7,000

¹The recommended on-the-road price includes the Road Fund Licence applicable to the standard model plus delivery charge (£715.00 incl. VAT), new vehicle registration fee (£55.00) and number plates (£25.00 incl. VAT). VAT is calculated at the standard rate of 20%. Some of the model features, optional extras and colours shown may not be available, or may only be available in a different specification, or at a different price

Design	Sustainability	Technology	Safety	Mercedes-EQ	Model lines	Upholstery	Model prices	Personalisation	Standard equipment	Genuine accessories	Technical data	Additional information
--------	----------------	------------	--------	-------------	-------------	------------	--------------	-----------------	--------------------	---------------------	----------------	------------------------

EQS AMG Line Premium Plus Standard equipment highlights



In addition to/replacement of AMG Line Premium:

Exterior

21" alloy wheels - multi-spoke design, aerodynamically optimised, painted high-gloss black with a high-shine finish (code RWY)

Summer tyres

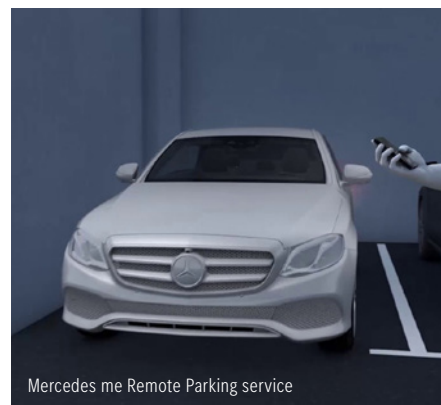

**Interior**

Acoustic privacy glass

Head-up display

Communications, Safety and Assistance Systems

MBUX Interior Assistant (front)

Multifunction telephony

Parking package with Active Parking Assist, 360° camera and remote parking includes three year subscription to Mercedes me Remote Parking service

Trim and Upholstery

Leather - black/space grey

Anthracite linestructure lime wood



EQS Luxury



Option shown: designo diamond white metallic (code 799)

The Luxury line is designed for the classic Mercedes-Benz customer.

Character is refined with use of our all new ARTICO man-made leather/MICROCUT microfibre combined with ship's deck open-pore walnut wood trim and progressive bodystyling. Designed around sustainable luxury and excellence. The interior features comfort seats with comfort headrests along with a heated steering wheel.

EQS Luxury
Upgrade price from EQSAMG Line

OTR from £106,995¹
£7,000

¹The recommended on-the-road price includes the Road Fund Licence applicable to the standard model plus delivery charge (£715.00 incl. VAT), new vehicle registration fee (£55.00) and number plates (£25.00 incl. VAT). VAT is calculated at the standard rate of 20%. Some of the model features, optional extras and colours shown may not be available, or may only be available in a different specification, or at a different price

Design	Sustainability	Technology	Safety	Mercedes-EQ	Model lines	Upholstery	Model prices	Personalisation	Standard equipment	Genuine accessories	Technical data	Additional information
--------	----------------	------------	--------	-------------	-------------	------------	--------------	-----------------	--------------------	---------------------	----------------	------------------------

EQS Luxury

Standard equipment highlights



In addition to/replacement of AMG Line Premium Plus:

Exterior

22" alloy wheels – 5-twin-spoke design, aerodynamically optimised, painted black with a high-shine finish (code 00R)

Electric art exterior with front apron with chrome trim in the upper and lower sections

Rear apron painted in the vehicle colour with lower section in graphite grey metallic and chrome

Side skirts painted in graphite grey with chrome inserts

Summer tyres



Design	Sustainability	Technology	Safety	Mercedes-EQ	Model lines	Upholstery	Model prices	Personalisation	Standard equipment	Genuine accessories	Technical data	Additional information
--------	----------------	------------	--------	-------------	-------------	------------	--------------	-----------------	--------------------	---------------------	----------------	------------------------



Interior

Acoustic privacy glass

Heated steering wheel

Electric art interior

Heated windscreen

Comfort front headrests

Vehicle key in black with

Comfort seats

ornamental surround in rosé gold



Trim and Upholstery

ARTICO man-made leather/MICROCUT microfibre – black/space grey

Ship's deck open-pore walnut wood

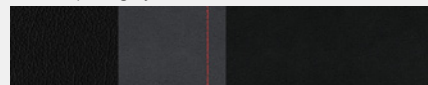

EQS Exclusive Luxury



The Exclusive Luxury model elevates the EQS for the discerning customer.

Boasting multi-contour seats with energizing massage function, the focus is on elegance combined with technology to achieve the ultimate opulent experience.

EQS Exclusive Luxury
Upgrade price from EQS Luxury

OTR from £113,995¹
£7,000

¹The recommended on-the-road price includes the Road Fund Licence applicable to the standard model plus delivery charge (£715.00 incl. VAT), new vehicle registration fee (£55.00) and number plates (£25.00 incl. VAT). VAT is calculated at the standard rate of 20%. Some of the model features, optional extras and colours shown may not be available, or may only be available in a different specification, or at a different price

Design	Sustainability	Technology	Safety	Mercedes-EQ	Model lines	Upholstery	Model prices	Personalisation	Standard equipment	Genuine accessories	Technical data	Additional information
--------	----------------	------------	--------	-------------	-------------	------------	--------------	-----------------	--------------------	---------------------	----------------	------------------------

EQS Exclusive Luxury Standard equipment highlights



In addition to/replacement of Luxury:

Exterior

22" alloy wheels – 5-twin-spoke design, aerodynamically optimised, painted black with a high-sheen finish (code 00R)

Summer tyres





Interior

Multi-contour seats with energizing massage function

Trim and Upholstery

Nappa leather - black/space grey

Ship's deck open-pore walnut wood

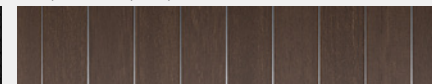



Book a test drive



Buy your EQS



Find a Retailer

Upholstery

● Standard □ No-cost option



231A Leather¹ – black/space grey

AMG Line	●
AMG Line Premium	●
AMG Line Premium Plus	●



229A Leather¹ – neva grey/balao brown

AMG Line	□
AMG Line Premium	□
AMG Line Premium Plus	□

¹100% of seat upholstery is pure leather Please note that, owing to limitations of on-screen representation, paint colours may differ from those shown



Book a test drive



Buy your EQS



Find a Retailer

Upholstery

Standard No-cost option



111A ARTICO man-made leather/MICROCUT microfibre - black/space grey

Luxury



105A ARTICO man-made leather/MICROCUT microfibre - macchiato beige/space grey

Luxury



121A ARTICO man-made leather/MICROCUT microfibre - black/balao brown

Luxury



Please note that, owing to limitations of on-screen representation, paint colours may differ from those shown

Design	Sustainability	Technology	Safety	Mercedes-EQ	Model lines	Upholstery	Model prices	Personalisation	Standard equipment	Genuine accessories	Technical data	Additional information
--------	----------------	------------	--------	-------------	-------------	------------	--------------	-----------------	--------------------	---------------------	----------------	------------------------



Book a test drive



Buy your EQS



Find a Retailer

Upholstery

● Standard □ No-cost option



801A Nappa leather¹ - black/space grey

Exclusive Luxury



805A Nappa leather¹ - macchiato beige/space grey

Exclusive Luxury



811A Nappa leather¹ - black/balao brown

Exclusive Luxury



¹100% of seat upholstery is pure leather

Please note that, owing to limitations of on-screen representation, paint colours may differ from those shown

Design	Sustainability	Technology	Safety	Mercedes-EQ	Model lines	Upholstery	Model prices	Personalisation	Standard equipment	Genuine accessories	Technical data	Additional information
--------	----------------	------------	--------	-------------	-------------	------------	--------------	-----------------	--------------------	---------------------	----------------	------------------------

[Book a test drive](#)[Buy your EQS](#)[Find a Retailer](#)

Model prices

Model line	Powertrain	CO ₂ WLTP ^{1,*}	Basic RRP excl. VAT (£)	Total RRP incl. VAT (£)	Road Fund Licence (£) ² WLTP	Rec. OTR price (£) ³ WLTP	P11D value (£)	BiK tax rate 2021/22 (%) ²
AMG Line								
EQS 450+	Battery electric vehicle, 333 hp/245 kW Electric range up to 453 miles – WLTP ¹	0	82,666.67	99,200.00	0.00	99,995.00	99,940.00	1
AMG Line Premium								
EQS 450+	Battery electric vehicle, 333 hp/245 kW Electric range up to 443 miles – WLTP ¹	0	88,500.00	106,200.00	0.00	106,995.00	106,940.00	1
AMG Line Premium Plus								
EQS 450+	Battery electric vehicle, 333 hp/245 kW Electric range up to 439 miles – WLTP ¹	0	94,333.33	113,200.00	0.00	113,995.00	113,940.00	1
Luxury								
EQS 450+	Battery electric vehicle, 333 hp/245 kW Electric range up to 412 miles – WLTP ¹	0	88,500.00	106,200.00	0.00	106,995.00	106,940.00	1
Exclusive Luxury								
EQS 450+	Battery electric vehicle, 333 hp/245 kW Electric range up to 407 miles – WLTP ¹	0	94,333.33	113,200.00	0.00	113,995.00	113,940.00	1

¹The indicated values were determined according to the prescribed measurement method - Worldwide Harmonised Light Vehicle Test Procedure (WLTP). Figures shown may include options which are not available in the UK. Battery Electric Vehicles (BEV) require mains electricity for charging, range figures determined with the battery fully charged. ²Figures shown are for comparability purposes; only compare with other cars tested to the same technical procedures. Figures may not reflect real life driving results, which will depend upon a number of factors including the starting charge of the battery, factory-fitted options, accessories fitted (post registration), variations in weather, driving styles and vehicle load. Further information about the test used to establish range, power consumption and CO₂ figures can be found at <http://www.mercedes-benz.co.uk/WLTP> ³A different first year rate of Vehicle Excise Duty (Road Fund Licence) applies for new cars. Please refer to page 51 for the relevant rate for the second and subsequent years ³The recommended on-the-road price includes the Road Fund Licence applicable to the standard model plus delivery charge (£715.00 incl. VAT), new vehicle registration fee (£55.00) and number plates (£25.00 incl. VAT). VAT is calculated at the standard rate of 20%. Some of the model features, optional extras and colours shown may not be available, or may only be available in a different specification, or at a different price

[Book a test drive](#)[Buy your EQS](#)[Find a Retailer](#)

Colour options

Standard No-cost option

Total prices incl. VAT



197 obsidian black metallic



831 graphite grey metallic



297 designo selenite grey magno £2,145.00



346 onyx black metallic



842 sodalite blue metallic



799 designo diamond white metallic £695.00



595 nautic blue metallic



922 high tech silver metallic



996 designo hyacinth red metallic £695.00

Please note that, owing to limitations of on-screen representation, paint colours may differ from those shown

Design	Sustainability	Technology	Safety	Mercedes-EQ	Model lines	Upholstery	Model prices	Personalisation	Standard equipment	Genuine accessories	Technical data	Additional information
--------	----------------	------------	--------	-------------	-------------	------------	--------------	-----------------	--------------------	---------------------	----------------	------------------------



Rear Luxury Lounge package

Optimum seating comfort in the rear: control your ideal seating position and enjoy a range of massage programmes achieved with the multi-contour seats – all of which is controlled by the MBUX tablet in the rear armrest.

Transform the rear passenger compartment into a connected lounge that includes electrically adjustable backrests and seat climate control.

Rear Luxury Lounge package (code PAT & P43) – designed and priced as a package.

Available for Exclusive Luxury only

Total incl. VAT £3,995.00

Consisting of:

Adaptive interior lighting

Additional USB ports

Climate control for rear seats

COMAND centre rear (tablet)

Comfort rear armrest with wireless charging¹

Electrically adjustable rear seats

Massage rear seats including neck warmer and luxury head restraints

MBUX Interior Assistant

¹Compatible mobile phone required



[Book a test drive](#)[Buy your EQS](#)[Find a Retailer](#)

Hyperscreen package (deliveries from Q2 2022)

Enhance your interior with an impressive design feature. As if cast from a single mould, 3 displays seamlessly blend together beneath a glass panel to create one large MBUX hyperscreen. Brilliant OLED technology enhances your display comfort, while the haptic feedback helps to simplify input on the touchscreen.

Hyperscreen package (PAG & 445) – designed and priced as a package. Available on all model lines, except AMG Line Total incl. VAT £7,995.00

Consisting of:

17.7-inch central display and a 12.3-inch passenger display

Augmented navigation head-up display – this head-up display projects visual information into your field of vision without distracting you. For example, large direction arrows float above a junction where you need to make a turn. You immediately know what needs to be done

Fingerprint scanner

OLED high-end screens are right next to each other, with minimal space in between to give the impression that this is one large screen



Design	Sustainability	Technology	Safety	Mercedes-EQ	Model lines	Upholstery	Model prices	Personalisation	Standard equipment	Genuine accessories	Technical data	Additional information
------------------------	--------------------------------	----------------------------	------------------------	-----------------------------	-----------------------------	----------------------------	------------------------------	---------------------------------	------------------------------------	-------------------------------------	--------------------------------	--

[Book a test drive](#)[Buy your EQS](#)[Find a Retailer](#)

Standard equipment

● Standard – Not available

Battery and Charging

	AMG Line	AMG Line Premium	AMG Line Premium Plus	Exclusive Luxury	Luxury
11kW on-board charger	●	●	●	●	●
107.8kWh battery	●	●	●	●	●
200kW on-board charger	●	●	●	●	●
CCS-2 connector (DC charging with Combined Charging System, compatible with AC and DC)	●	●	●	●	●
Charging cable – Mode 2 cable (5 metres), Type G, enables you to charge the vehicle battery via a domestic plug socket	●	●	●	●	●
Charging cable – Mode 3 cable (5 metres), Type 2, enables you to charge the vehicle battery via the wallbox or at public charging stations	●	●	●	●	●
IONITY unlimited – free rapid charging for one year at all IONITY stations	●	●	●	●	●
Mercedes me Charge – three year subscription – fully integrated access to a host of public charging stations. A single contract covers all billing. One-time registration and activation as part of Mercedes me connect. Use via app, MBUX multimedia system or RFID card	●	●	●	●	●

Steering, Transmission and Suspension

AIRMATIC air suspension struts with integrated adaptive damping system at the front and rear axle – automatic level control system, depending on load: load detection for a constant suspension level. Suspension level can be raised for rough roads and is automatically lowered at high speeds, MBUX can remember these actions and suggest them when arriving at the same location	●	●	●	●	●
DYNAMIC SELECT – three different drive programs, ECO, COMFORT and SPORT with the ability to save an INDIVIDUAL program, five recuperation levels: D Auto (ECO Assist, standard setting), D + (coasting), D (low recuperation), D - (medium recuperation), D - - (high recuperation)	●	●	●	●	●
Steering – 4.5° rear axle steering	●	–	–	–	–
Steering – 10° rear axle steering	–	●	●	●	●

Exterior

	AMG Line	AMG Line Premium	AMG Line Premium Plus	Exclusive Luxury	Luxury
Acoustic privacy glass	–	●	●	●	●
AMG exterior styling	●	●	●	–	–
Headlamps – static LED headlamps with Highbeam Assist	●	–	–	–	–
Headlamps – DIGITAL LIGHT	–	●	●	●	●
Heat-insulating, noise-insulating and infrared-reflecting laminated glass	●	●	●	●	●
Heated windscreen washer system	●	●	●	●	●
Mirror package – electrically folding exterior mirrors, automatically dimming interior and exterior driver mirror, surround lighting in both outside mirrors with brand logo projection to illuminate the entrance area	●	●	●	●	●
Panoramic sliding sunroof	●	●	●	●	●
Privacy glass	●	–	–	–	–

Wheels

20" AMG alloy wheels – 5-spoke design, painted black with aero-elements in matt tantalite grey with 255/45 R20 tyres (code RRU)	●	–	–	–	–
21" AMG alloy wheels – multi-spoke design, aerodynamically optimised, painted black with a high-sheen finish with 265/40 R21 tyres (code RWX)	–	●	–	–	–
21" alloy wheels – multi-spoke design, aerodynamically optimised, painted high-gloss black with a high-sheen finish with 265/40 R21 tyres (code RWY)	–	–	●	–	–
22" alloy wheels – 5-twin-spoke design, aerodynamically optimised, painted black with a high-sheen finish with 265/35 R22 tyres (code OOR)	–	–	–	●	●
Summer tyres	●	●	●	●	●



Standard equipment

● Standard – Not available

Interior

	AMG Line Premium Plus	AMG Line Premium	AMG Line	Exclusive Luxury	Luxury
Air Quality package – infrared quality sensor plus a fine particle sensor on outside and inside includes Course, HEPA fine particle and Broad spectrum filter against fine particles (PM2.5), pollen, nitrogen dioxides (NOx), sulphur dioxides (SO2) and certain viruses. Antibacterial effect reduces the growth of fungi and bacteria on the interior air filter. Automatic switching between air recirculation or fresh air depending on the measured air quality. Air quality menu in the MBUX multimedia system	●	●	●	●	●
AMG Interior Design package – AMG sports steering wheel, AMG pedals, AMG door sills with AMG illuminated lettering and AMG velour floor mats	●	●	●	–	–
Black velour floor mats	–	–	–	●	●
Heated windscreen	–	–	–	●	●
Lighting – ambient lighting – 64 colours with direct light lines	●	●	●	●	●
Lighting – Interior Light package	●	●	●	●	●
Luxury front head restraints	–	–	–	●	●
Memory package – electrical adjustment and memory function for front seats, steering wheel, outside mirror, heated areas of the seat cushion and seat backrest, head-up display (where fitted), four-way front lumbar support and seat cushion length. Includes PRE-SAFE® positioning function for front passenger seat	●	●	●	●	●
Seats – heated (front and rear)	●	●	●	●	●
Seats – multi-contour seats – with energizing massage function	–	–	–	–	●
Seats – split fold rear seats	●	●	●	●	●
Steering wheel – AMG multifunction sports steering wheel in nappa leather	●	●	●	●	●

	AMG Line Premium Plus	AMG Line Premium	AMG Line	Exclusive Luxury	Luxury
Steering wheel – heated	–	–	–	●	●
Storage compartment under center console	●	●	●	●	●
THERMOTRONIC automatic climate control	●	●	●	●	●

Paint, Trim and Upholstery

	AMG Line Premium Plus	AMG Line Premium	AMG Line	Exclusive Luxury	Luxury
Dashboard in leather look	●	●	●	●	●
Paint – metallic	●	●	●	●	●
Trim – lower trim (when Hyperscreen package ¹ not selected) – black fine structure	●	●	●	●	●
Trim – main trim – anthracite linestructure lime wood	●	●	●	–	–
Trim – main trim – ship's deck open-pore walnut wood	–	–	–	●	●
Roof lining – black fabric	●	●	●	–	–
Roof lining – grey fabric	–	–	–	●	●
Upholstery – ARTICO man-made leather/MICROCUT microfibre – black/space grey	–	–	–	●	–
Upholstery – leather	●	●	●	–	–
Upholstery – nappa leather	–	–	–	–	●
Vehicle key in black with ornamental surround in rosé gold	–	–	–	●	●

¹Deliveries from Q2 2022

[Book a test drive](#)[Buy your EQS](#)[Find a Retailer](#)

Standard equipment

● Standard – Not available

Safety and Assistance Systems

	AMG Line	AMG Line Premium	AMG Line Premium Plus	Exclusive Luxury	Luxury
Active Traffic Sign Assist	●	●	●	●	●
Driving Assistance package	●	–	–	–	–
Driving Assistance package Plus	–	●	●	●	●
EASY-PACK tailgate	●	●	●	●	●
KEYLESS-GO Comfort package	●	●	●	●	●
Mercedes-Benz emergency call system	●	●	●	●	●
Parking package with Active Parking Assist and reversing camera	●	–	–	–	–
Parking package with Active Parking Assist and 360° camera	–	●	–	–	–
Parking package with Active Parking Assist, 360° camera and remote parking includes three year subscription to Mercedes me Remote Parking service	–	–	●	●	●
Tirefit	●	●	●	●	●
URBAN GUARD Plus with anti-theft protection hardware including alarm and immobilizer. Theft notification and park damage detection ¹ , stolen vehicle locator ¹ , 360° surroundview-camera snapshots ¹ and remote key immobilizer ¹	●	●	●	●	●

Communications and In-Car Entertainment

	AMG Line	AMG Line Premium	AMG Line Premium Plus	Exclusive Luxury	Luxury
12.3-inch digital instrument cluster display	●	●	●	●	●
12.8-inch media display	●	●	●	●	●
Digital radio	●	●	●	●	●
EQ navigation services – navigation optimised for Mercedes-Benz EQ, range on map (range display), display of charging stations (info on availability, programming of charging settings and Pre-Entry Climate Control incl. remote retrieval of charging status and range	●	●	●	●	●
Fingerprint scanner – colour-illuminated fingerprint scanner in the trim strip below the OLED media display, two fingerprints per user can be stored, quick access replaces PIN entry, protects personal data such as profiles plus office and payment functions	●	●	●	●	●
Hard-disc navigation	●	●	●	●	●
Head-up display	–	–	●	●	●
Live traffic information – 3 years	●	●	●	●	●
MBUX augmented reality for navigation	●	●	●	●	●
MBUX Interior Assistant (front)	–	–	●	●	●
Pre-entry climate control	●	●	●	●	●
Pre-installation for Car Sharing	●	●	●	●	●
Sound system – Burmester® surround sound system	–	●	●	●	●
Sound system – Mercedes-Benz sound system	●	–	–	–	–
USB package – six fast charging USB-C ports including four compatible for data transfer	●	●	●	●	●
Wireless smartphone integration (front) ²	●	●	●	●	●

¹Free of charge for three years from activation²Compatible smartphone required. For further details please visit <https://www.mercedes-benz-mobile.com/>



Standard equipment

● Standard – Not available

Services

	AMG Line	AMG Line Premium	AMG Line Premium Plus	Exclusive Luxury	Luxury
Geofencing – available to use free of charge for three years following activation ¹ , denotes a specific area and notifies via push message when the vehicle leaves or enters this area	●	●	●	●	●
Parked vehicle locator – available to use free of charge for three years following activation ¹ , shows the position of the parked vehicle in a radius of approx. 1.5 km	●	●	●	●	●
Personalisation – available to use free of charge for three years following activation ¹ , stores settings such as the radio station or navigation destination in the personal driver profile and enables these to be used in vehicles with the same telematics generation, the profile can be linked to the key, and the functions can therefore already be activated before getting in	●	●	●	●	●
Programming of auxiliary heater/ventilation	●	●	●	●	●
Remote door locking and unlocking – available to use free of charge for three years following activation ¹ , provides convenient remote monitoring	●	●	●	●	●
Remote retrieval of vehicle status ¹ – shows mileage, tyre pressure, washer fluid level, etc.	●	●	●	●	●
Remote vehicle finder – available to use free of charge for three years following activation ¹ indicators activated via the app help to draw attention to the vehicle, for example in large, confusing car parks	●	●	●	●	●
Sliding sunroof/windows with remote closing and opening including ventilation function to use free of charge for three years following activation ¹ for a breath of fresh air in the vehicle available	●	●	●	●	●
Send2Car function – available to use free of charge for three years following activation ¹ , sends selected addresses via the app to the vehicle's navigation system, for example POIs or restaurants	●	●	●	●	●
Speedfencing	●	●	●	●	●

Stolen Vehicle Help (free of charge for 3 years from activation) – this service reduces the bureaucratic effort required and gives you an advantage in terms of time. In the event of theft, you can report it to the police. You can transfer the police file number (depending on country) plus the relevant vehicle and owner information quite simply via app to our certified partner's security centre. This centre will then coordinate with the local police station to track your vehicle

Valet protect – available to use free of charge for 3 years following activation¹ notifies via the app when the ignition is switched on/off and when the vehicle moves outside a defined radius (1 km, 2.5 km or 5 km)

Vehicle Tracking

	AMG Line	AMG Line Premium	AMG Line Premium Plus	Exclusive Luxury	Luxury
Stolen Vehicle Help (free of charge for 3 years from activation) – this service reduces the bureaucratic effort required and gives you an advantage in terms of time. In the event of theft, you can report it to the police. You can transfer the police file number (depending on country) plus the relevant vehicle and owner information quite simply via app to our certified partner's security centre. This centre will then coordinate with the local police station to track your vehicle	●	●	●	●	●
Valet protect – available to use free of charge for 3 years following activation ¹ notifies via the app when the ignition is switched on/off and when the vehicle moves outside a defined radius (1 km, 2.5 km or 5 km)	●	●	●	●	●
Vehicle Tracking	●	●	●	●	●

¹To use this service, you must register on the Mercedes me portal and also accept the Terms of Use for the Mercedes me connect services. In addition, the respective vehicle must be paired with the user account. Upon expiry of the initial term, the services can be extended for a fee. Initial activation of the services is possible within 1 year of first registration or commissioning by the customer, whichever occurs first

Genuine accessories

We've developed a range of accessories you can add to help personalise and enhance your EQS.

Velour floor mats CLASSIC, set, 4-piece

Floor mats have to undergo rigorous testing before they are deemed worthy of the star logo. Available in three colours, black, space grey and macchiato beige, these mats are precision-tailored to your Mercedes-Benz. They can be clip-fastened to the floor of the vehicle to prevent slipping. Elegant, high-quality tufted velour mats with embroidered Mercedes-Benz label.

black: A29768003089J74

space grey: A29768003081D57

macchiato beige: A29768003088U20



Bluetooth® headphones

Bluetooth® headphones with optimum fit and high wear comfort for perfect listening pleasure even over extended periods. Thanks to the 3D sound effect, the headphones offer a spacious sound and the Hybrid Active Noise Cancelling ensures optimum sound reproduction without disruptive ambient noise. Should exterior noise ever need to be heard by the wearer, however, this is possible thanks to transparency mode. The headset function allows the wearer to make and receive make phone calls, with a touch pad that allows simple and intuitive operation. These headphones are the result of intensive development on an automotive level and are worthy of carrying the shining chrome Mercedes-Benz star. (A2238209903)



Coolbox

Be it cool drinks, a picnic or baby food: the thermoelectric refrigerator box cools upon request and is the perfect companion on any day out. Thanks to its extra thick insulation it can cool up to 5°C, but a max. of 20°C under the outside temperature. It fits perfectly into every Mercedes-Benz vehicle and holds 13 litres. (A0008205409)



All the above accessories are subject to availability and compatibility. Please ask your Mercedes-Benz Retailer for more information. Images shown are for illustration purposes only.

[Book a test drive](#)[Buy your EQS](#)[Find a Retailer](#)

Technical data

- Standard

Model	EQS 450+	
Motor		
Battery type	lithium-ion high-voltage	
Electric motor type	asynchronous	
Battery capacity	kWh	107.8
Power ¹	hp (kW)	333 (245)
Torque ¹	Nm at rpm	568/4,060
On-board charger	11kW AC; 200kW DC	
Emissions standard	EU6	

Transmission		
Single-speed automatic	●	

Performance		
Acceleration 0–62 mph	sec	6.2
Top speed	mph	130
Charging time		
Public Rapid charger (200 kW DC) 10–80% ³	31 mins	
Wallbox (11kW AC) 10–100% ⁴	10 hrs	
Home wallbox (7.4 kW AC) 10–100% ³	15 hrs 30 mins	
Range power consumption combined ^{4,5}	Wh/km	193–170
Electric range – WLTP ⁴	miles	407–453

Model	EQS 450+	
Weights and capacities		
Kerb weight ⁵	kg	2,480
Perm. Gross Vehicle Weight	kg	2,945
Boot capacity – seats up/down	l	610/1,770
Towing capacity – unbraked/braked	kg	750/750
Turning circle	m	11.9

Insurance		
All variants	50E	
Insurance ratings may vary depending on model line and specification. Please refer to http://www.thatcham.org/abigrouprating/ for further details		

¹Figures according to Regulation (EC) No. 595/2009 in the currently applicable version ²Specified voltage and current values refer to network infrastructure and can be limited by the vehicle. Times are from 10-100% charge using a wallbox (three-phase) or standard socket (single-phase) ³If you are planning to charge your Mercedes-Benz plug-in electric vehicle using a 3-pin domestic plug socket you must get a qualified electrician to inspect and sign off the socket to confirm it is safe and suitable to charge your vehicle. Do not use an electric vehicle 3-pin charge cable with an extension cord) ⁴Figures shown are for comparability purposes; only compare with other cars tested to the same technical procedures. Figures may not reflect real life driving results, which will depend upon a number of factors including the starting charge of the battery, factory-fitted options, accessories fitted (post registration), variations in weather, driving styles and vehicle load. Further information about the test used to establish range, power consumption and CO₂ figures can be found at <http://www.mercedes-benz.co.uk/WLTP> ⁵Specified voltage and current values refer to network infrastructure and can be limited by the vehicle. Times are from 10-80% charge using public rapid charging at 100kW ⁶Mass of the vehicle in running order with at least 90% full fuel tank, plus the mass of the driver (estimated by law at 75 kg), fuel and fluids, equipped with the standard equipment as specified by the manufacturer as well as, where applicable, the mass of the body, cab, trailer coupling and spare wheel(s) as well as tools. Optional extras, additional equipment and accessories can influence the weight, residual payload, rolling resistance, aerodynamics, etc., and therefore also affect the consumption/CO₂ values

[Book a test drive](#)[Buy your EQS](#)[Find a Retailer](#)

Electric range and consumption

Model	Power Consumption Combined (WLTP) (Wh/km) ^{1,2}	All Electric Range (WLTP) (miles) ²
EQS 450+ AMG Line	170	453
EQS 450+ AMG Line Premium	174	443
EQS 450+ AMG Line Premium Plus	176	439
EQS 450+ Luxury	189	412
EQS 450+ Exclusive Luxury	191	407

¹Specified voltage and current values refer to network infrastructure and can be limited by the vehicle. Times are from 10-80% charge using public rapid charging at 100 kW. ²Figures shown are for comparability purposes; only compare with other cars tested to the same technical procedures. Figures may not reflect real life driving results, which will depend upon a number of factors including the starting charge of the battery, factory-fitted options, accessories fitted (post registration), variations in weather, driving styles and vehicle load. Further information about the test used to establish range, power consumption and CO₂ figures can be found at <http://www.mercedes-benz.co.uk/WLTP>

[Book a test drive](#)[Buy your EQS](#)[Find a Retailer](#)

EQS

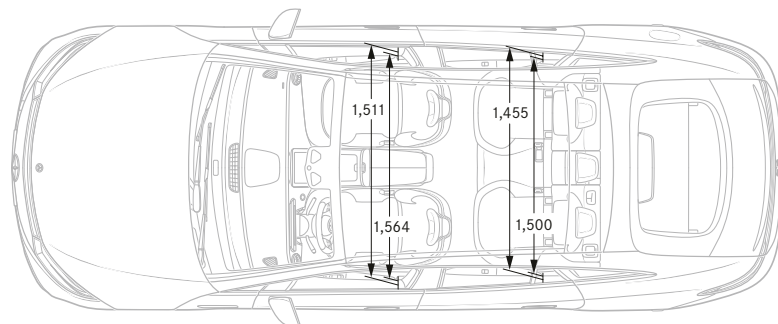
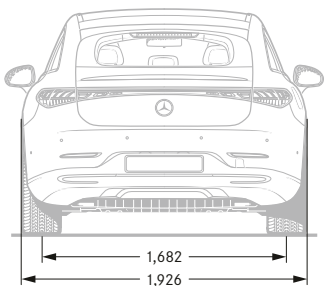
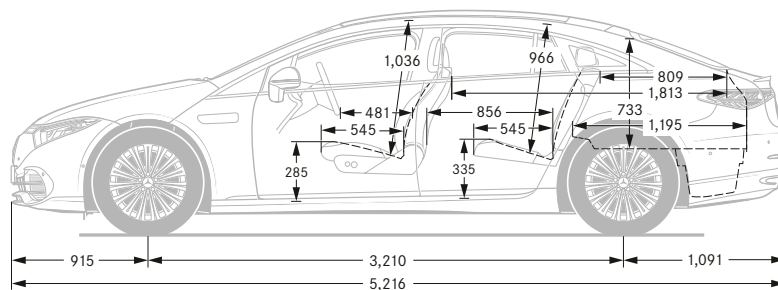
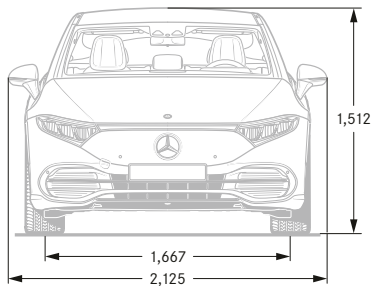

All measurements in millimetres. The dimensions shown are mean values and apply to standard-specification, unladen vehicles. Dimensions may vary slightly depending on the engine. Please consult your Retailer for further information

Design	Sustainability	Technology	Safety	Mercedes-EQ	Model lines	Upholstery	Model prices	Personalisation	Standard equipment	Genuine accessories	Technical data	Additional information
--------	----------------	------------	--------	-------------	-------------	------------	--------------	-----------------	--------------------	---------------------	----------------	------------------------



Road Fund Licence

All road vehicle registrations are subject to Vehicle Excise Duty (Road Fund Licence), which varies in accordance with the vehicle's CO₂ emissions. A first year rate for each taxation band will apply. The table below shows the bands (A–M) created by the DVLA and the corresponding Road Fund Licence. CO₂ emissions and the relevant Excise Duty are shown on the model pricing page.

Band	CO ₂ emissions (g/km)	First year rate petrol and RDE2 diesel (£)	First year rate all other diesel (£) ¹	First year rate alternative fuel (£)	Electric vehicles		Alternative fuel vehicles		Petrol/diesel vehicles	
					Standard rate (£)	Premium rate (£) ²	Standard rate (£)	Premium rate (£) ²	Standard rate (£)	Premium rate (£) ²
A	0	0.00	0.00	0.00	0.00	0.00	0.00	0.00	0.00	0.00
B	1 to 50	10.00	25.00	0.00	0.00	0.00	145.00	480.00	155.00	490.00
C	51 to 75	25.00	115.00	15.00	0.00	0.00	145.00	480.00	155.00	490.00
D	76 to 90	115.00	140.00	105.00	0.00	0.00	145.00	480.00	155.00	490.00
E	91 to 100	140.00	160.00	130.00	0.00	0.00	145.00	480.00	155.00	490.00
F	101 to 110	160.00	180.00	150.00	0.00	0.00	145.00	480.00	155.00	490.00
G	111 to 130	180.00	220.00	170.00	0.00	0.00	145.00	480.00	155.00	490.00
H	131 to 150	220.00	555.00	210.00	0.00	0.00	145.00	480.00	155.00	490.00
I	151 to 170	555.00	895.00	545.00	0.00	0.00	145.00	480.00	155.00	490.00
J	171 to 190	895.00	1,345.00	885.00	0.00	0.00	145.00	480.00	155.00	490.00
K	191 to 225	1,345.00	1,910.00	1,335.00	0.00	0.00	145.00	480.00	155.00	490.00
L	226 to 255	1,910.00	2,245.00	1,900.00	0.00	0.00	145.00	480.00	155.00	490.00
M	over 255	2,245.00	2,245.00	2,235.00	0.00	0.00	145.00	480.00	155.00	490.00

Some of the model features, optional extras and colours shown may not be available, or may only be available in a different specification, or at a different price.

¹Applies to all Mercedes-Benz diesel models which do not comply with RDE (Real Driving Emissions) Step 2 Certified (Euro 6d)

²Premium rate only applicable to vehicles where the list price is over £40,000 including any factory-fitted options, standard UK delivery charge, number plates, fuel and VAT

Design	Sustainability	Technology	Safety	Mercedes-EQ	Model lines	Upholstery	Model prices	Personalisation	Standard equipment	Genuine accessories	Technical data	Additional information
--------	----------------	------------	--------	-------------	-------------	------------	--------------	-----------------	--------------------	---------------------	----------------	------------------------

Services and insurance

Mercedes-Benz ServiceCare

We believe that servicing costs should be as flexible and affordable as possible for your EQS, which is why we offer ServiceCare, an easy way to budget for all your servicing costs. It spreads your bills into manageable payments based on whether you have a new or used Mercedes-Benz.

With ServiceCare we guarantee the price of parts and labour for up to four services and safeguard against any further inflation.

You can choose either to add your servicing costs into your monthly spend or pay the full amount in a one-off payment, giving you peace of mind that they are taken care of for the period of the plan.

[Click here for more information](#)

Warranty and breakdown cover

Every Mercedes-Benz comes with a three-year unlimited mileage warranty against manufacturing or material defects¹ and up to 30 years warranty against perforation due to corrosion from the inside out.² What's more, it's also covered by Mercedes-Benz Roadside Assistance – a unique package comprising up to 30 years pan-European breakdown assistance.²

Battery Warranty

The battery comes with a 10-year 155,000-mile warranty.

Motor Insurance

We know that once you have chosen your Mercedes-Benz you can't wait to drive it – that's why we created First Cover³. It gives you 7 days' free comprehensive Motor Insurance when you buy a new or used vehicle from a Mercedes-Benz Retailer. We will also send you a quote for annual cover, so you can enjoy the same peace of mind all year round.

[Apply for First Cover](#)

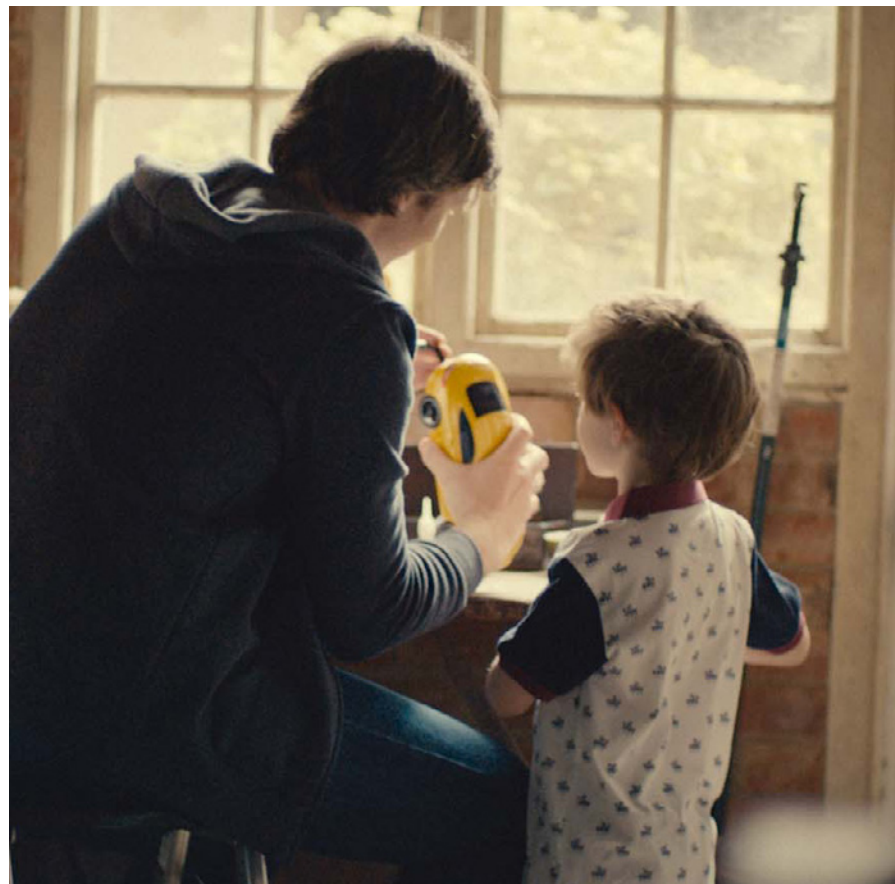

¹Applies to vehicles sold by Mercedes-Benz in the UK to its franchised Retailers

²Subject to full Terms and Conditions, dependent on date of registration, available upon request

³Terms and Conditions apply. We are an independent intermediary dealing with selected insurers in respect of annual insurance



Effective from October 2021 Production. Information correct at time of publication 14.09.2021.
Prices and specifications are subject to change without prior notice.
MBV297PL/1121

Mercedes-Benz Cars UK Limited, Tongwell, Milton Keynes, MK15 8BA. Company number 2448457 www.mercedes-benz.co.uk

