

1984 FORD BRONCO



The Best-Built American Trucks Are Built Ford Tough



At Ford, Quality is Job 1.

At Ford, quality is our top priority. Nothing ranks higher in the design, engineering, manufacture, sale and service of our cars and trucks.

We're determined to make the finest cars and trucks in the world. No exceptions.

Our product philosophy begins with the vision of a customer — of you — sitting behind the wheel of a new car or truck in one of our dealers' showrooms asking a series of questions about quality.

Does this Ford vehicle have the best quality I can find? Will it give me value and pleasure in use? Will it last? Will I get good service? Can I trust the manufacturer and the dealer?

We know that the answers to those questions will determine whether you buy our product or someone else's car or truck. So that's why quality is really Job 1 at Ford.

Our quality system is based on the concept of preventing quality problems, not merely detecting problems and trying to fix them.

Also, we're committed to an operating philosophy of continuous improvement in quality and every other aspect of our business. There is no upper limit to our quality performance. We believe further improvements are always possible.

And most important, Ford employees are directly or indirectly involved in improving the quality of Ford cars and trucks. We know that our jobs and the success of Ford Motor Company depend on building high quality vehicles that meet your needs and expectations.

Donald E. Petersen
President
Ford Motor Company

**Best-Built
American Trucks**

Ford's commitment to quality results in the best-built American trucks, based on a survey of owner-reported problems during the first three months of ownership of 1983 trucks. And the commitment continues in 1984.

FORD BRONCO XLT

XLT is a top-line family 4-wheeler with added comfort and convenience items designed to make you look good in town or out in the country. Its well-appointed interior includes cloth and vinyl trimmed seats, full-length color-keyed carpeting, vinyl headliner, deluxe color-keyed belts, plus other comfort and convenience items over the standard Bronco.

FORD BRONCO

The standard Ford Bronco provides a good start for XLT to build on. There's plenty of room for cargo and five-passengers (six with optional front bench) plus a high level of standard equipment. Start with vinyl trimmed seating, standard flip/told rear bench seat, rubber color-keyed front floor mat, and instrumentation that includes gauges for oil pressure, coolant temperature, ammeter and AM radio.

**A Word About This
Catalog**

Some of the equipment shown or described throughout the catalog is available at extra cost.



Table of Contents

Power & Efficiency	4
Ride & Handling	5
The Ford Bronco Environment	6
Quality & Construction	7
Ford Bronco XLT	8
Ford Bronco	9
Ford Bronco Trailer Towing, Snow Plowing, Exterior Colors & Tu-Tones	11
Ford Bronco Options & Dimensions	12-13
Ford Bronco Trim Content, Specifications, Powerteams & Safety Features	14-15

POWER & EFFICIENCY

In a full-size 4x4 of Bronco's capabilities, you expect power to get to those out of the way places and you get it. The pleasant surprise is that Bronco's powerteam also provides the efficiency required for driving around town.

Last year, Bronco's 4.9L I-6-cylinder engine — the biggest six-cylinder engine in the industry — and optional 4-speed manual overdrive transmission provided ratings of 24 est. hwy. and 16 EPA est. mpg.* And even though official EPA ratings were not available at the time this catalog was published, the standard power-team is expected to equal the ratings of last year.

For the extra power required for Class III trailer towing or heavy off-roading, there's the optional 5.8L V-8 with 2-barrel carburetor.

The addition of computer control

For 1984, the 4.9L 6-cylinder and 5.8L V-8 engines include Ford's electronic engine control system, or EEC-IV, the most advanced on-board computer control system in the world. EEC-IV is a fourth generation micro-processor capable of thousands of command decisions per second. This provides precise and instantaneous control over such vital engine functions as ignition spark control and air/fuel mixture.

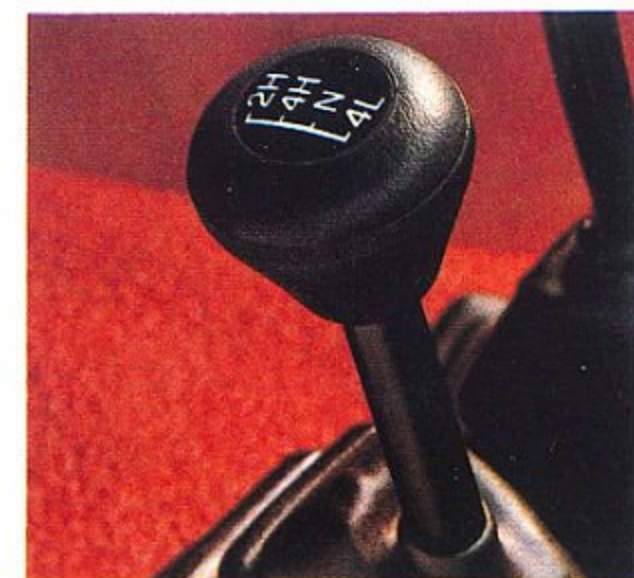
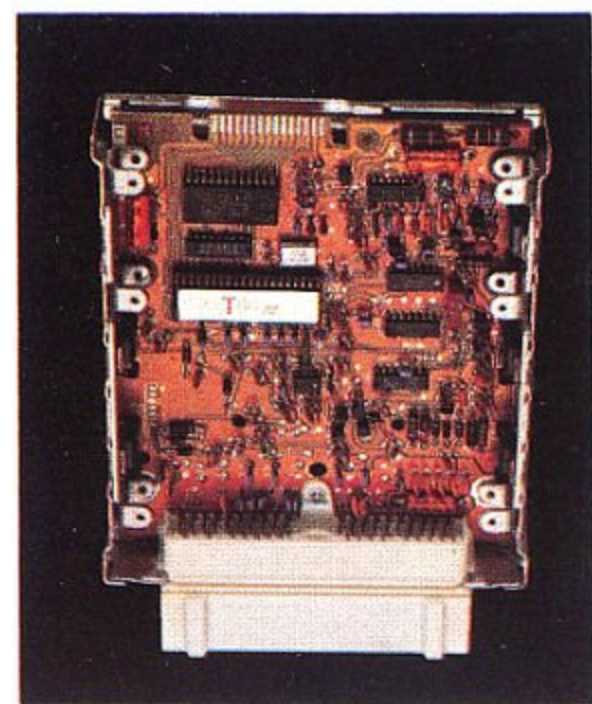

Efficient transfer case

The 2-speed, part-time transfer case is chain-driven in the 4-wheel-drive mode with special gears for easy shifting. Lubrication is provided by a constant-displacement hydraulic pump. This permits Bronco to be towed for unlimited



The Sand Wash challenges Bronco's traction and high pulling power at Ford's Arizona Proving Ground.

distances at speeds up to 55 mph without disconnecting the driveshafts or lifting the front wheels off the ground. Not all 4-wheel drive vehicles have this capacity.

New, more powerful 5.8L V-8 (4V)

For outstanding performance — including trailering applications — the new Ford 5.8L V-8 (4V) will be offered in November, 1984. This engine develops 27% more horsepower (SAE standard J-245) than its closest competition today. Big, free-breathing "Holley 4180" four-barrel carburetor, large 17-in. air cleaner, and special low back-pressure exhaust system provide load-moving pick up and power. This engine is available with SelectShift automatic transmission.

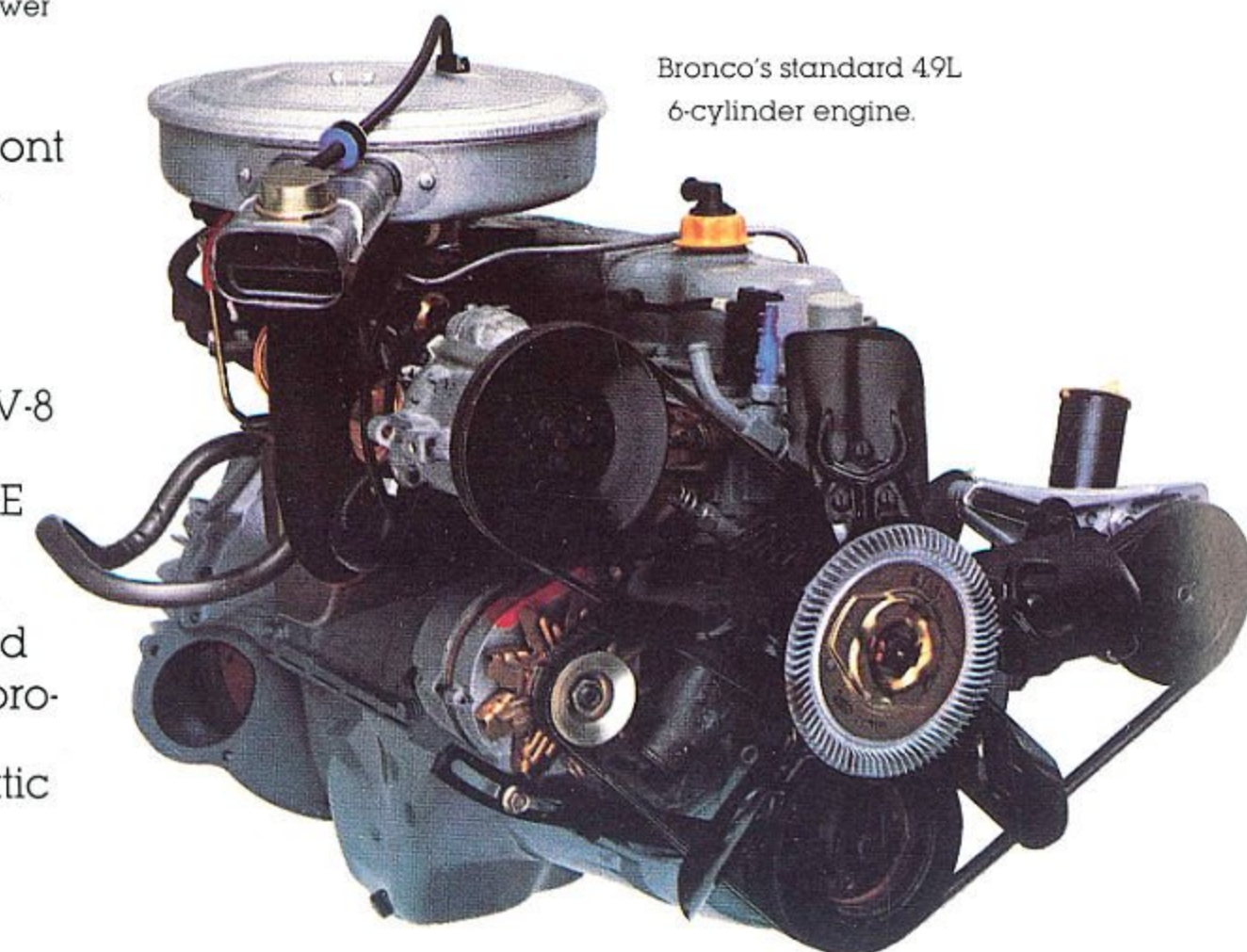

Bronco's standard 4.9L 6-cylinder engine.

New clutch interlock system

With manual transmissions, a new clutch interlock prevents inadvertent starting of the engine before the clutch is completely depressed.

Hydraulic clutch actuation

Smooth operating hydraulic clutch actuation is now standard with manual transmissions. This system is self-adjusting for the life of the clutch, eliminating periodic adjustment maintenance. System also provides damped engagement control to reduce torsional shock and impact loads on the driveline.

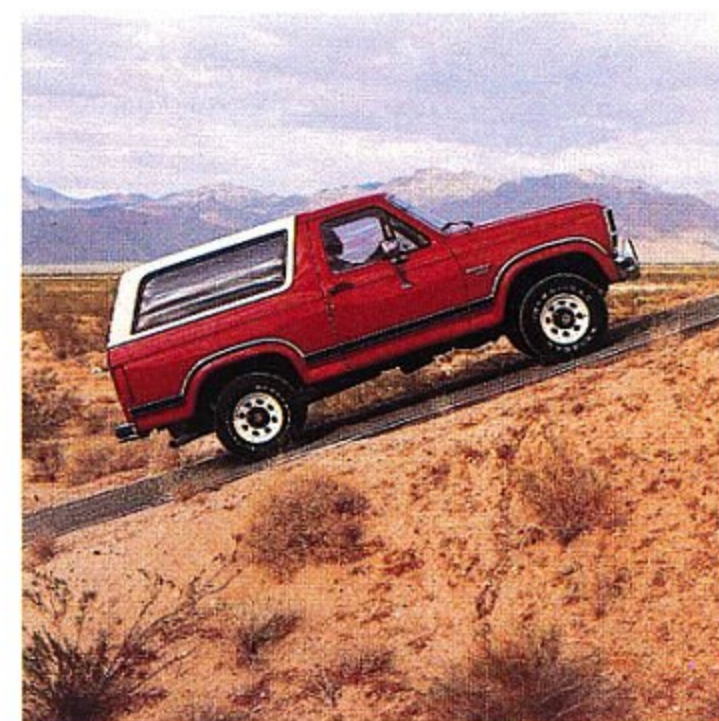

A 30% grade is used to test Bronco's parking brake hold under a full load.

*Use estimates for comparison. Your mileage may differ depending on speed, distance and weather. Actual highway mileage will probably be lower. See your Ford Dealer for 1984 EPA mileage ratings.

RIDE & HANDLING

Bronco's excellent ride and handling characteristics, both on and off road, can be attributed to features in a number of key areas. Computer selected suspension components, a proven independent front drive system, and power assisted features like steering and brakes that add to Bronco's ease of maneuverability.

Computer selected suspension

Bronco suspension system consists of front coil springs and rear leaf springs, both computer selected to match specific computer selected GVWRs. The front shock absorbers are heavy-duty rated, well suited to rugged going.

Twin-Traction Beam front drive system

Soaking up the bumps is what Bronco's front drive system is all about. The Twin-Traction

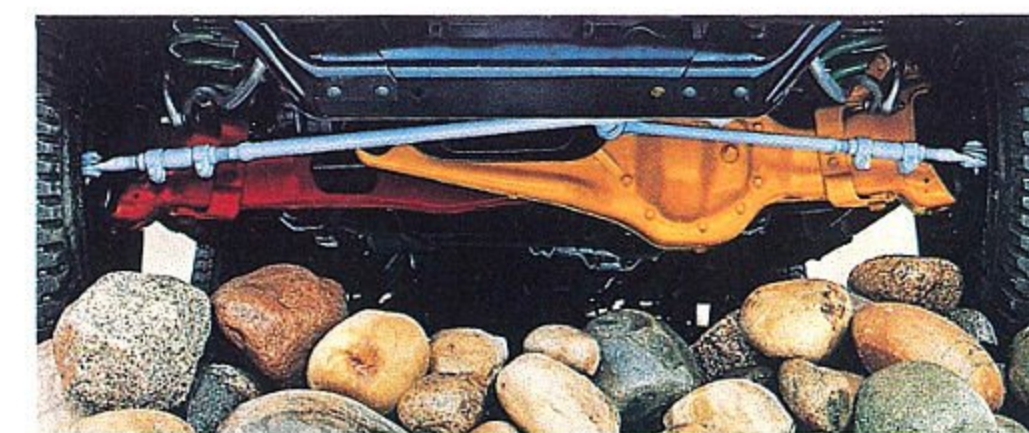

Beam system features an independent design that allows the front wheels to step over bumps independently, providing improved ride and better off-road control than conventional solid axle systems with leaf springs.

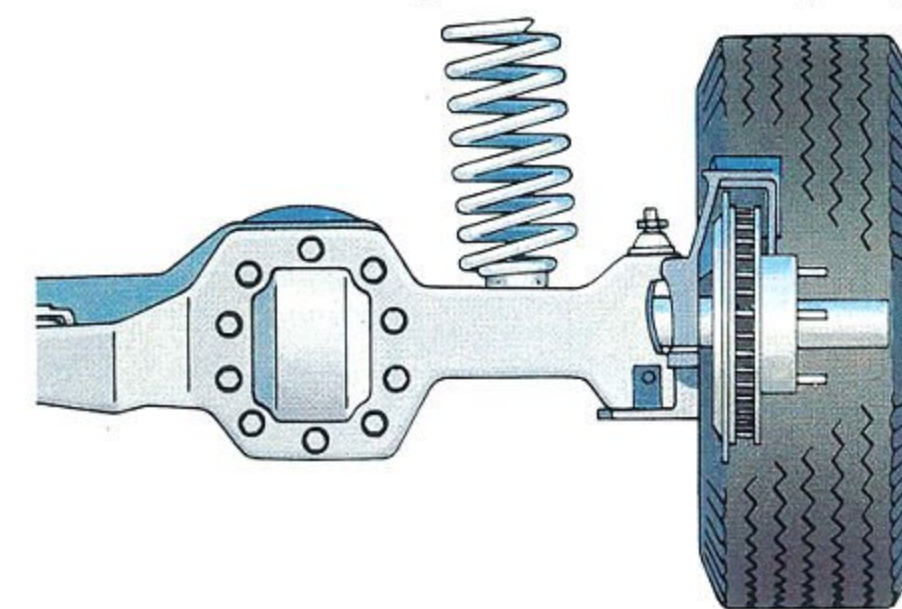

The system also includes other design innovations such as lubed-for-life ball joints, adjustable camber and an integral differential carrier skid plate for added protection.

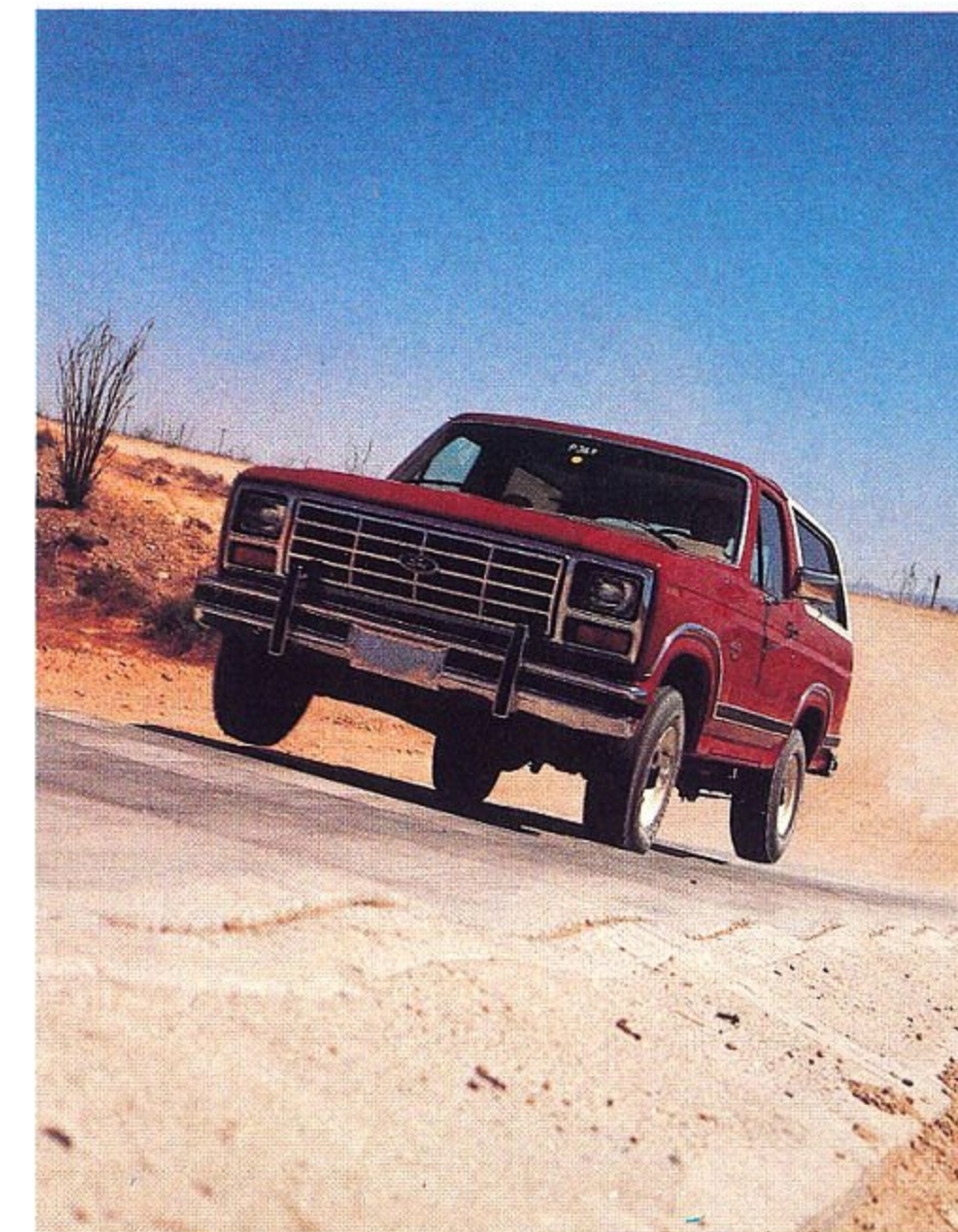

Power Hop Hill tests the ability of Bronco's drive train components to withstand severe shock loading at Ford's Arizona Proving Ground.

Free running front hubs

Another Bronco asset is the ability to completely disengage the front drive system from the front hubs. This is important because when not traveling in 4-wheel drive mode, the front hubs run free, leaving the front drive axles and drive shaft motionless. This reduces friction and wear on front drive components, thus adding to their operating life.

The front hubs utilize a proven manual locking design that requires only a twist of the wrist to lock in the front wheels.

There is also an automatic locking hub option that provides the driver the added convenience of locking the front hubs without leaving the vehicle.

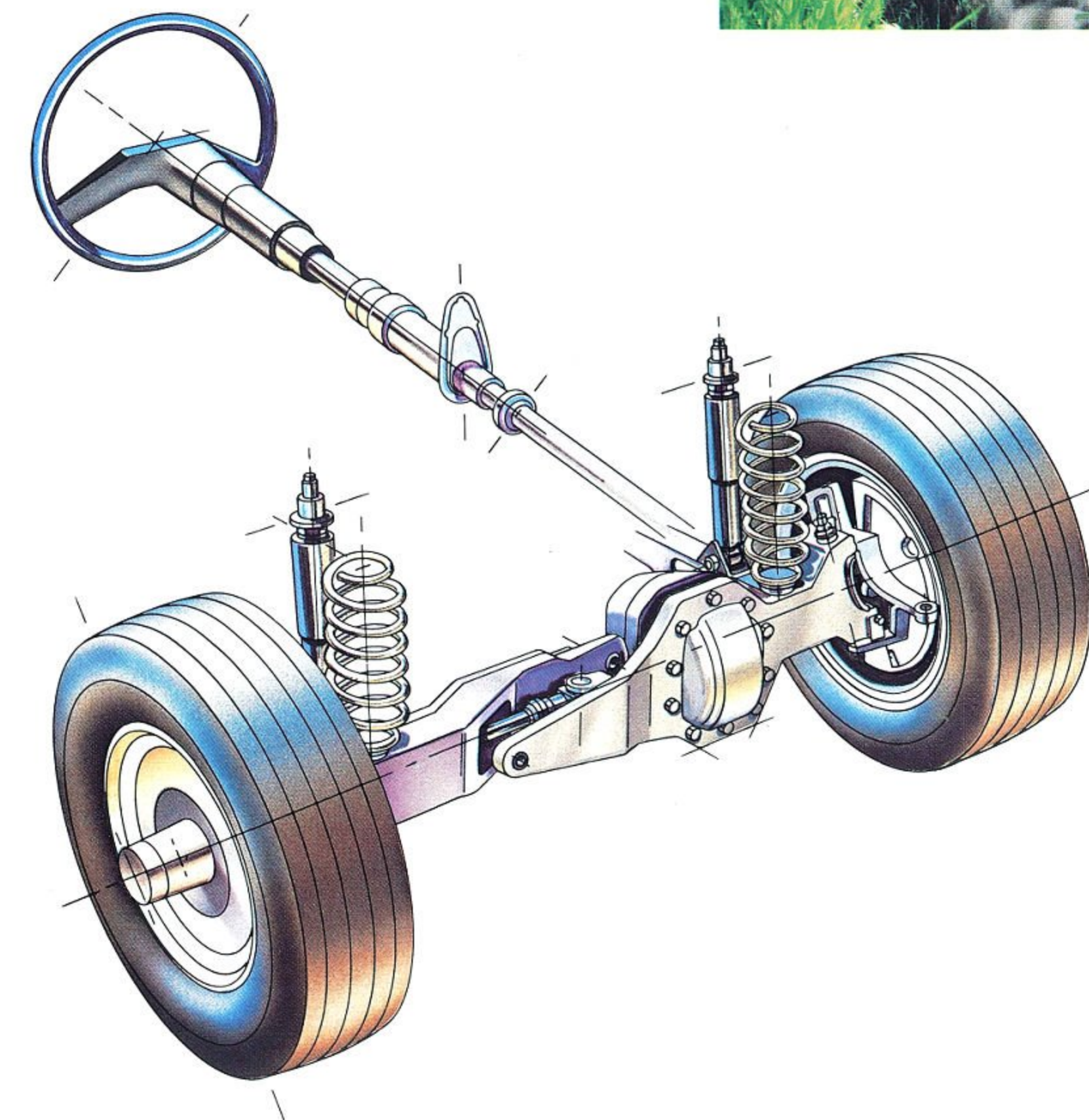
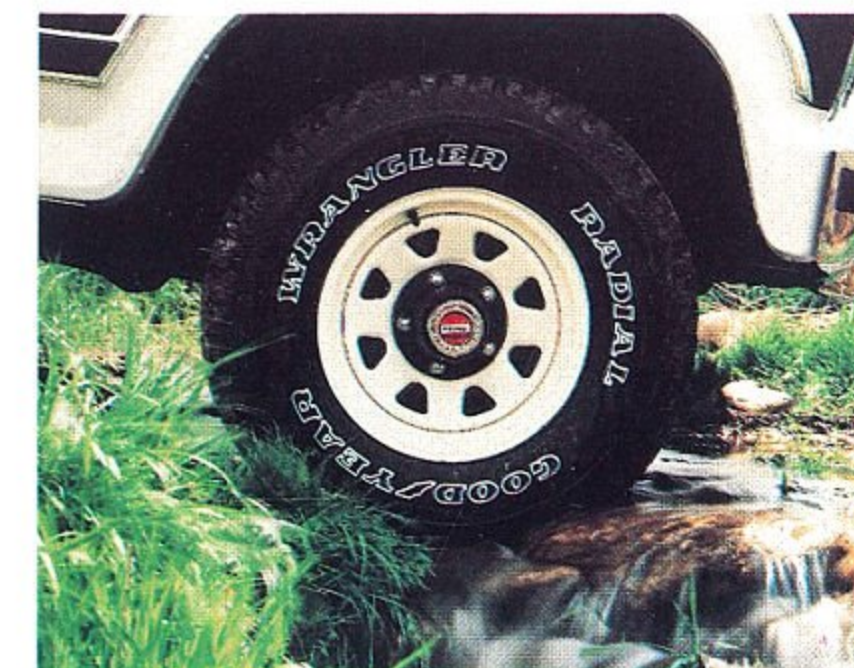

THE FORD BRONCO ENVIRONMENT

Even though Bronco is a 4-wheel drive vehicle, it doesn't scrimp on interior room or comfort.

Room for five or six

Bronco's standard seating arrangement of front bucket seats and flip/fold rear bench provide ample room for five passengers. Order the optional front bench seat and there's room for six passengers.

The front buckets feature foam construction on a sprung steel base. Side bolsters provide full foam lateral support, an important feature for off-roading.



Optional Captain's Chairs with folding armrests and reclining seat back.

To make Bronco's interior even more appealing, there's a complete list of optional comfort/convenience items that includes dual Captain's Chairs that recline for individual comfort, air conditioning, automatic transmission, electric rear window defroster, sliding rear quarter windows. Plus much more, all designed to increase driving enjoyment while adding value too.

Comfort from all angles

Bronco comfort goes beyond the seats into areas you can't see. In the suspension, for instance, rubber insulators are used between springs and spring seats, and strategically located body-to-frame insulators help isolate occupants from road noise and vibration. For 1984, insulation is applied to key areas such as door and quarter trim panels, front floor and in the double-wall metal roof.

Ergonomics and the driver environment

Providing driver comfort is a multisided accomplishment in Bronco. The seating provides comfortable support with 5.5 inches of seat travel adjustment. The steering wheel is positioned to limit driver arm fatigue. Instrumentation including ammeter, oil pressure and coolant temperature gauges is strategically clustered providing a clear view through the steering wheel. The climate control and entertainment systems are grouped in the center of the dash within comfortable reach and are angled slightly toward the driver. The bend in the floor shift places the shift knob at the driver's right hand.

Variable passenger/cargo area

For those times when there is more gear than passengers, Bronco's rear seat folds forward forming a cargo hold that's over four feet long



and over 50 inches wide at the wheelhouse. Enough room for 81.6 cu. ft. of cargo. Remove the rear seat completely and you have over 102 cu. ft. of cargo capacity.

More conveniences — all part of Bronco's style

Bronco includes many standard comfort and convenience items all designed to add to Bronco owner satisfaction.

Power steering and power brakes, important items in a full-size 4x4, provide ease of operation. Likewise the power tailgate window. The 3-speed heater/defroster has a blend-air design that allows mixing of outside air for constant ventilation. Interval wipers help you cope with heavy downpours or light mist. Pivoting front vent windows also aid in varying the amount of ventilation and all windows are tinted to reduce glare. Doors can be locked without using a key. And door/ignition keys are reversible so there's no fumbling around. An integral coin holder and cup depressions are incorporated in the glove box door. And, there's a storage bin in the instrument panel for small items.

QUALITY & CONSTRUCTION

Computer-Assisted Design/Computer-Assisted Manufacturing

Human ingenuity and computer technology are close partners in the design and production of Ford light trucks.

Today, Ford is one of the biggest users of computer software and graphics equipment to assist in the design, performance, and even the machining of molds for manufacturing parts.

Newly designed parts can be "stress-tested" with computer 3-dimensional simulations to find (and redesign or reinforce if necessary) high stress areas before the first prototype is ever built. Then, after computer-assisted design and development, components are tested in the laboratory and complete trucks are tested on proving grounds to confirm the computer findings. In addition, Ford has a special pilot plant where new vehicles are assembled to work out any production problems before general assembly is begun across the country.

Quality, a team effort

Engineers and assembly personnel work closely to improve the production process through Ford's Employee Involvement Program. There are more than 1,100 Employee Involvement Groups in America alone. Defect detection is not the principal concern. Emphasis is primarily on defect prevention. This is a true team effort, from the workers on the line all the way up to Donald Petersen, President of Ford Motor Company.

Built Ford Tough

Market research data in early 1983 revealed that customers perceived an average 47% improvement in the quality of Ford light trucks compared with 1980 models based on things gone wrong.*

Scheduled Maintenance

Ford wants to reduce the frequency and cost of scheduled maintenance on its trucks to an absolute minimum. Here are some examples of scheduled maintenance for the new Ford Bronco. For complete maintenance recommendations, refer to the Bronco Owner Guide.

Engine Oil Change	each 10,000 miles
Spark Plug Change	each 30,000 miles
Air Filter Replacement	each 30,000 miles
Engine Coolant Replacement	each 52,500 miles or 3 years

Tough brilliant finish

Bronco has a deep, lustrous finish that resists nicking, cracking and peeling. Ford takes a number of carefully controlled steps to produce Bronco's quality finish.

An essential step in the process is properly preparing the sheetmetal to ensure adhesion of the primers and paint. So every Bronco body is first cleaned in a phosphate system to remove dirt, grease and oil to prepare the surface for priming.

The priming processes applied to Bronco is called Electrocoating. It uses the bonding powers of electricity.

Electrocoat priming uses opposite electrical charges on the body and an epoxy-based primer. As the body is immersed in the primer, the electrical attraction provides a thorough, even coating to all areas of the body.

Two coats of primer are applied and heat-cured before the final three coats of tough acrylic enamel are applied.

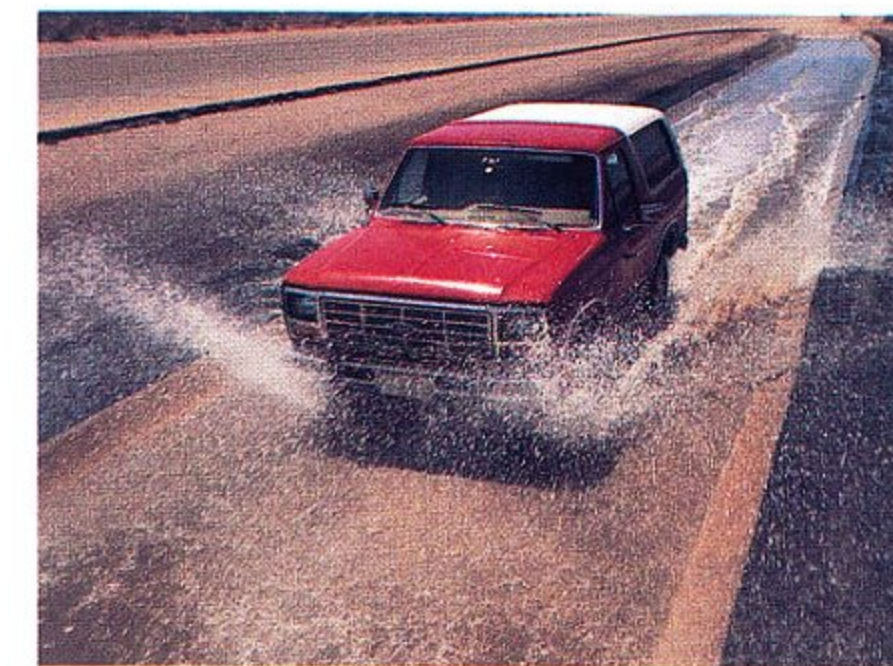

Ford's extensive corrosion testing includes a salt bath, which exposes all areas of Bronco's underbody and engine compartment to corrosive spray.

Ford takes tough measures to protect the good-looking finish from the damaging effects of corrosion. Galvanized steel is used in the forming of important underbody and structural parts, while zinc-coated metal is used primarily in locations such as the hood, doors and fenders. Additional special treatments include aluminum-filled wax and spray-on vinyl sealers.

Computer matchup

Ford computers are tied into a complete informational system that allows Body Engineering, Chassis Design and Metal Stamping Division to draw needed design drawings at anytime to insure proper coordination so everything goes together right.

During actual assembly on the line, special attention is given to careful fit of doors, hood, pickup box, and sheetmetal. And even small things as tape strips and moldings must run true.

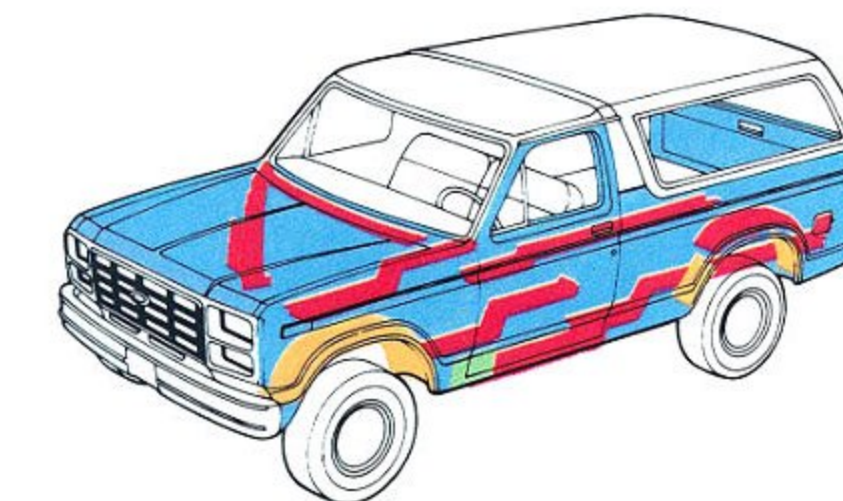

- SPRAY-APPLIED SEALERS
- PLASTIC PARTS
- GALVANIZED METAL
- ZINC-COATED METAL

Ford Lifetime Service Guarantee

Participating Ford Dealers are now offering the Lifetime Service Guarantee, which guarantees their work for as long as you own your truck. It means that you pay a covered repair on your Ford light truck once — and never again. If it ever has to be fixed again, the repairing dealer will fix it free. Free parts. Free labor. Even if you keep your truck a lifetime. It doesn't matter where you bought your truck, or whether it's new or used, the work is still covered by the repairing dealer.

This limited warranty covers vehicles in normal use. Items not covered are routine maintenance parts, belts, hoses, sheetmetal and upholstery. See any participating Ford Dealer for details.

*Based on a Ford Motor Company survey of 6,500 owners of early 1983 model Ford cars and trucks.

FORD BRONCO XLT

Step up to traditional XLT comfort and convenience.

In addition to all the highly desirable features of the standard Bronco, XLT provides an extra level of comfort with bucket seats and flip-fold rear bench trimmed in cloth and vinyl. Or, order the optional Dual Captain's Chairs (shown) that have reclining seat backs and

individual folding armrests. There's also full length 16-oz. color-keyed carpeting and vinyl headliner. In the way of convenience, there's LH and RH door operated courtesy light switches, cargo area light, integral door panel storage bins and rear molded quarter trim panels with armrests, speaker grilles (when optional stereo radio is ordered) and LH storage bin.

XLT's handsome exterior includes lower body-side protection molding, brushed aluminum tailgate applique and bright quarter window moldings to go along with the standard bright windshield molding.

Bronco XLT shown with optional captain's chairs, Victoria Tu-Tone paint, chrome rear step bumper, bright grille, outside swingaway spare tire carrier, exterior protection group, white styled steel wheels, RWL tires.



STANDARD FORD BRONCO

Setting the pace for family 4-wheelers.

Bronco is equipped the way all family 4-wheelers should be with a lot of built-in value inside and out.

Inside, driver and passengers sit up above the traffic on vinyl front bucket seats and rear flip-fold bench seat. Instrumentation includes ammeter, oil pressure and coolant temperature gauges. Power steering, power front disc/rear drum brakes, pivoting front vent windows, power tailgate window and AM radio (may be deleted for credit) are also standard.

Outside Bronco takes a tough stance with 15-inch P-metric glass-belted radials, sport wheel covers, dual bright fold-away mirrors, bright contour bumpers front and rear, black grille with bright surround and tinted glass all around.

Bronco, a well-equipped, good-looking 4-wheeler, designed and built for the whole family to enjoy.

Bronco shown with optional white styled steel wheels, RWL tires.





FORD BRONCO FOR TRAILER TOWING

Bronco is a great vehicle for off-road hunting and fishing excursions or vacationing with your trailer in tow. Properly equipped, Bronco is capable of hauling Class III trailers (including large dual axle travel trailers) up to 6400-lb.

Order the Trailer Towing Package that includes: 7-wire trailer wiring harness, 60-amp. alternator, 63 amp-hr. maintenance-free battery, extra engine cooling, auxiliary transmission oil cooler with automatic transmission, heavy-duty flasher and the Handling Package that includes front and rear stabilizer bars, quad front and heavy-duty rear shock absorbers.

Also recommended for trailers of 2000 lb. or more is the SelectShift automatic transmission and 3.55 axle ratio. For trailers of 5500 lb. the 5.0L V-8 is recommended. For trailers up to 6400 lb. and 11,000 lb. GCWR, order the 5.8L V-8. For more information, see your Ford Dealer.

FORD BRONCO FOR SNOW PLOWING

People who live in the snow belt can make good use of Bronco with a new combined Heavy Duty Front Suspension/Snow Plow Package. It includes everything needed to prepare Bronco for the added rigors of plowing: 3800-lb. rated heavy-duty front axle and springs, front stabilizer bar, heavy-duty rear shock absorbers, 3.55 axle ratio, 63-amp battery and heavy-duty 70-amp. alternator.



Bronco XLT equipped with the Heavy-Duty Front Suspension/Snow Plow Package and owner added snow plow.

BRONCO COLORS



Bronco Roof Colors

Enhance the appearance of Bronco with the selection of a color-coordinated rear fiberglass roof to create a Tu-Tone effect. Available in:

Black
White
Tan
Midnight Blue

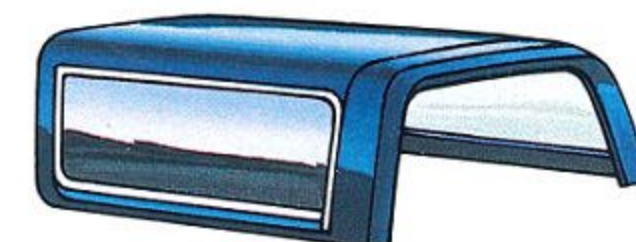
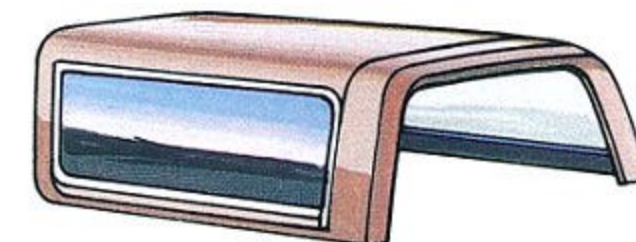
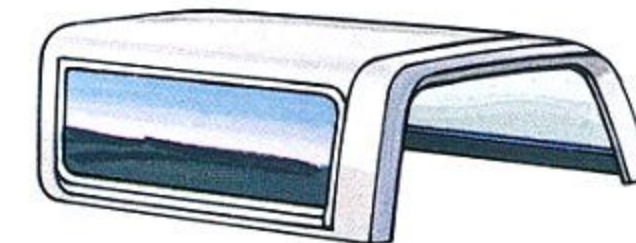
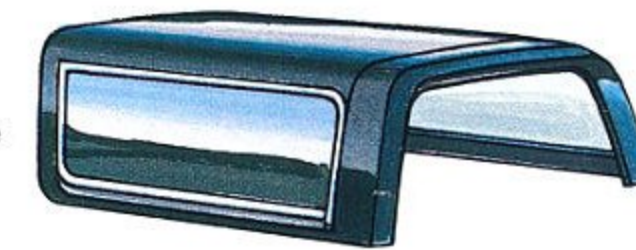

TU-TONE PAINTS

■ Body Color
□ Accent Color

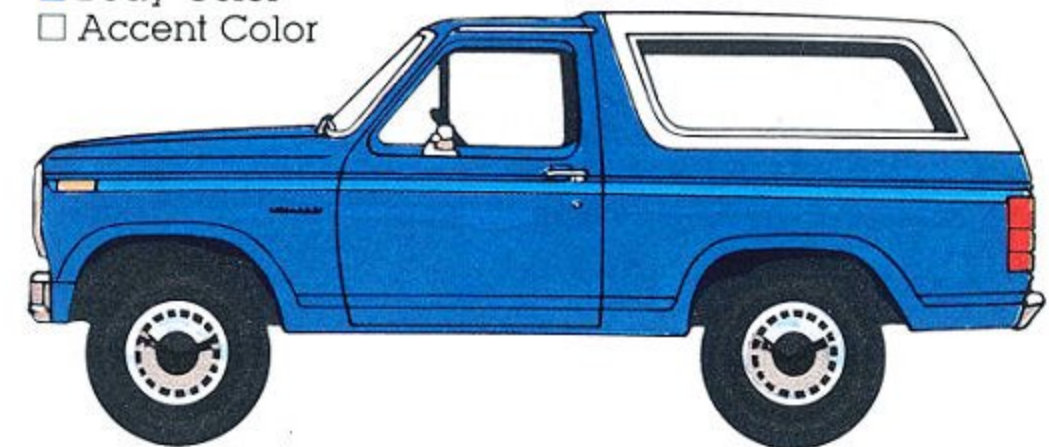

Tu-Tone Effect — Exterior color accented by rear fiberglass roof available in four different colors.

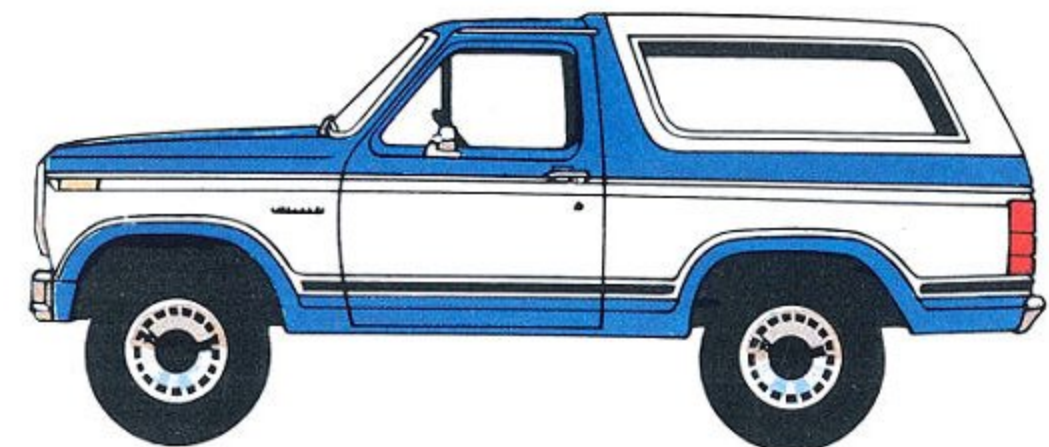

Deluxe Tu-Tone — Includes accent color on center bodyside area and on tailgate between upper molding and lower bodyside molding.

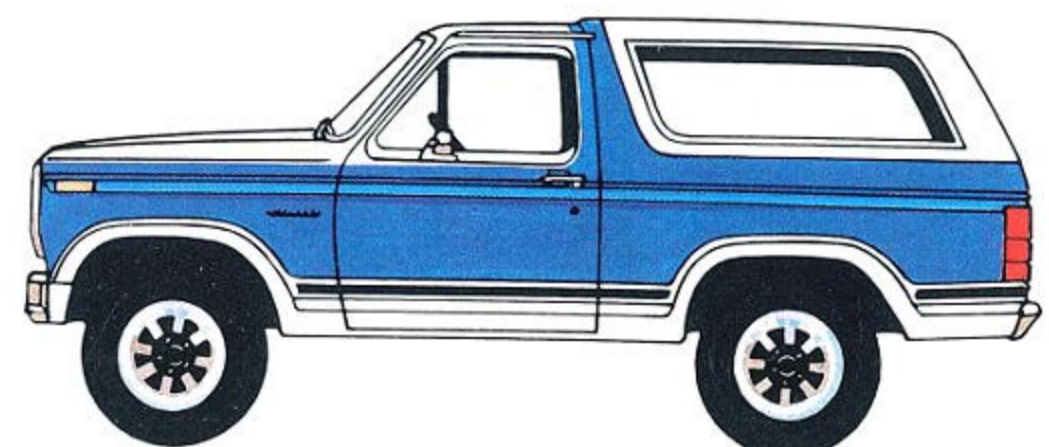

Victoria Tu-Tone — Includes accent color on hood, upper fender, around door window and the lower bodyside.

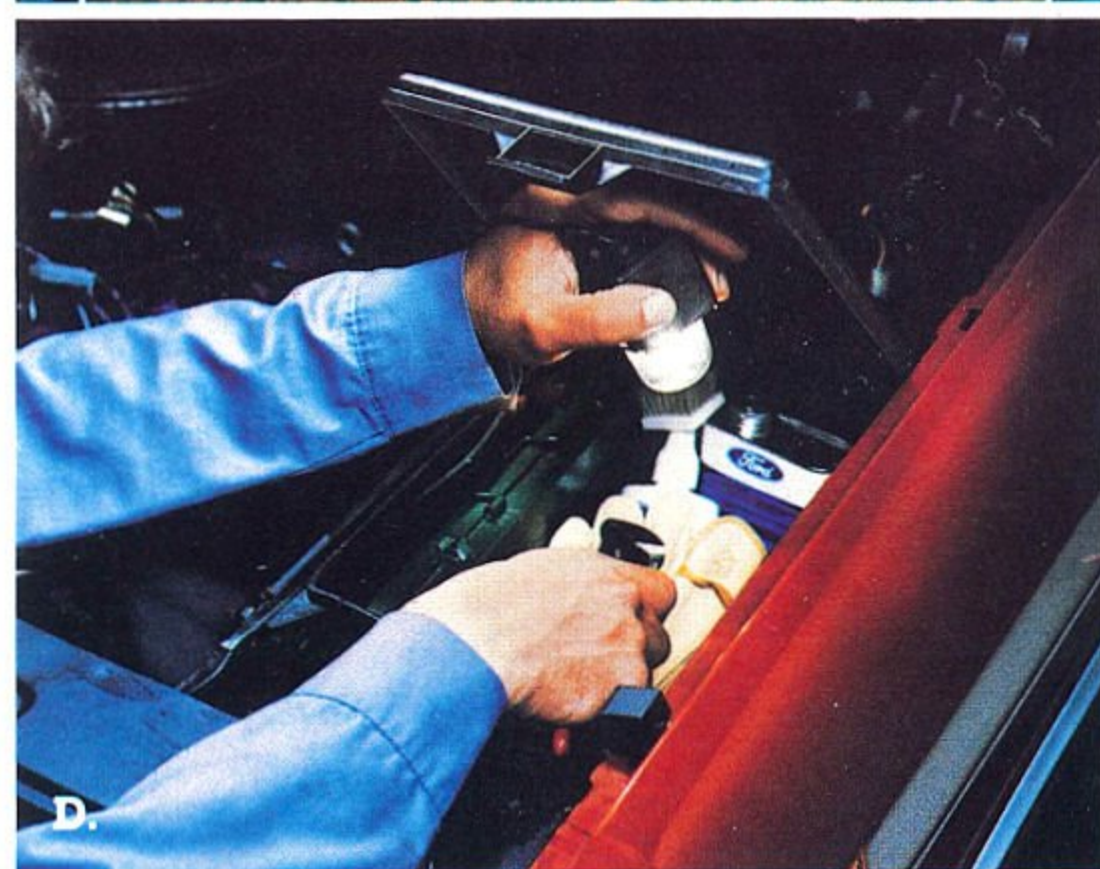
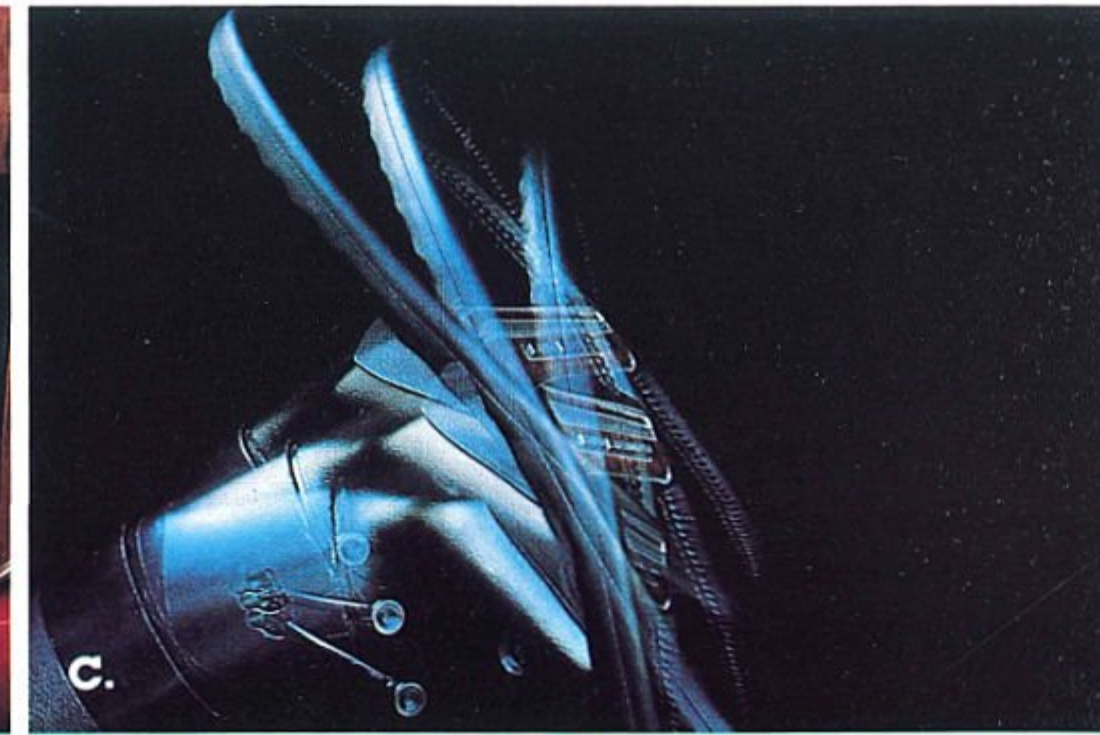

OPTIONS

Appearance

- Chrome grille
- Tricolor tape stripe (available in three color combinations)
- GT bar. Tubular design painted black with black padding.

Audio

All stereo systems include four speakers. And all Ford radios include a traveler's advisory setting.

- AM/FM monaural
- AM/FM stereo
- (A)** AM/FM stereo with cassette tape player

Comfort/Convenience

- (B)** Air conditioning
- High output heater
- Electric rear window defroster
- Light Group includes movable underhood worklight with 20-ft. retractable cord plus lights in glove box, under instrument panel, dual beam dome/map light (standard dome lights only with optional front bench seat), RH door courtesy light switch (Standard Bronco), and headlights-on warning buzzer.
- (C)** Fingertip Speed Control with resume feature.
- (C)** Tilt steering wheel
- Sliding rear quarter windows (tinted)
- Power front door locks/windows
- Privacy® glass in fixed quarter windows.
- (D)** Tool storage box. Located under hood.

Mirrors

- Electric remote control swingaway mirrors (7-3/8" x 5-3/8")
- (E)** Swing-Out Recreational Mirrors — bright (6-3/4" x 9-1/2")

(F) Swingaway outside spare tire carrier with lock and black or white cover. Included with 10/10R x 15C tires.

- Electronic digital clock tells the time, date and elapsed time at the push of a button (not available with radio credit option).
- Center console (between bucket seats or Captain's Chairs)

Seats

(G) Captain's Chairs (reclining driver and passenger). Includes deluxe seat belts.

- Front bench seat, split back
- Flip/fold rear bench seat delete

Performance

- (H)** Automatic locking hubs
- 4-speed manual overdrive transmission
- SelectShift automatic transmission
- Limited-slip front axle
- Traction-Lok rear axle
- Handling Package includes front and rear stabilizer bars quad front and dual HD rear shock absorbers.
- Heavy-duty front suspension/snow plow package includes 3800-lb. HD front axle, 3800-lb. HD front springs, HD rear shock absorbers and 3.55 axle ratio, HD alternator 70 amp-hr and 62 amp-hr. battery.

NOTE: Total weight of plow, and associated hardware not to exceed 680 lb. Maximum weight of permanently attached equipment not to exceed 270 lb.

- Heavy-duty rear shock absorbers
- Front and rear stabilizer bars (front stabilizer bar standard on 5950-lb. GVWR's and higher).
- Heavy-duty air cleaner
- HD maintenance-free battery (63 amp-hr.)
- Sports Instrumentation includes tachometer and trip odometer.
- Engine block heater: single with 4.9L (300) Six and 5.0L (302) V-8, dual with 5.8L (351) V-8.
- Super Engine Cooling Package

Auxiliary transmission oil cooler (with SelectShift automatic and V-8 engine)

Trailer Towing Package. Includes 7-wire trailer wiring harness, 60 amp. alternator, 63 amp-hr. maintenance-free battery, extra engine cooling package, auxiliary transmission oil cooler with automatic transmission, HD flasher and handling package.

- California emissions system
- High altitude emissions system
- Exterior sound package

Protection

- Skid plate — transfer case
- Dual electric horns
- Exterior Protection Group includes front bumper guards and rub strip.
- Security Lock Group includes locking gas cap, and locks on inside hood release, glove box and inside spare tire.

Bumpers

- Argent rear step bumper
- (I)** Chrome rear step bumper

Wheels and Wheel Covers

- (K)** Cast aluminum wheels (4)
- (L)** White styled steel (4*)

*Or five with 10/15C tires.

Options Availability

1984 Bronco options are not confined to these pages but are shown throughout the catalog. Options, whether or not they are identified, are offered at extra cost. Some options are included, required, or are not available, in combination with other options. Availability of some models and features described here and elsewhere may be subject to delay. Consult your Ford Dealer for the latest information.

DIMENSIONS

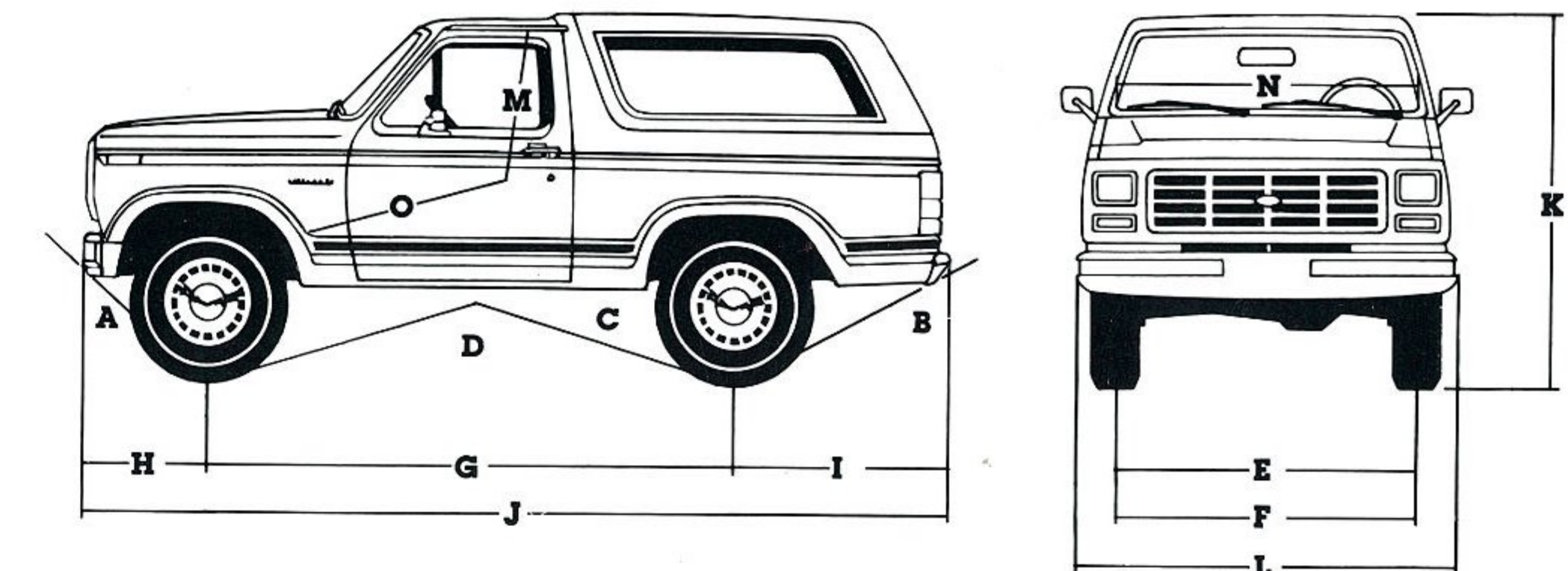

A. Angle of approach	34.1°	I. Rear overhang	44.3"
B. Angle of departure	20.6°	J. Overall length	177.6"
C. Ramp breakover angle	20.2°	K. Overall height	74.0"
D. Ground clearance at transfer case	9.1"	L. Overall width	77.2"
E. Front tread	65.1"	M. Head room (front/rear)	41.1"/39.2"
F. Rear tread	64.4"	N. Shoulder room	64.2"/64.2"
G. Wheelbase	104.7"	O. Leg room (front)	41.0"
H. Front overhang	28.7"	Turning diameter (curb to curb)	36.5"

A. AM/FM stereo radio with cassette
B. Air Conditioner
C. Tilt steering wheel/fingertip speed control
D. Underhood tool box

E. Low-mount western mirrors (now standard equipment)
F. Outside swingaway spare tire carrier
G. Captain's Chairs

H. Automatic Locking Hubs
I. Chrome rear step bumper
K. Cast aluminum wheel
L. White styled steel wheel

FORD BRONCO TRIM CONTENT

Functional	Standard Bronco	XLT
EEC-IV (electronic engine control)	STD	STD
Ammeter, oil pressure and temperature gauges	STD	STD
Foot operated parking brake	STD	STD
Dual function brake warning light system (5)	STD	STD
Two-speed electric windshield wiper system with intermittent feature	STD	STD
Power tailgate window	STD	STD
Coolant recovery system	STD	STD
Fuel tank skid plate	STD	STD
Viscous fan clutch	STD	STD
Tinted glass	STD	STD
Exterior		
Bright front and rear bumpers	STD	STD
Sport wheel covers	STD	STD
Rectangular Halogen headlamps	STD	STD
Wraparound taillamps	STD	STD
Rearview mirrors, LH and RH bright foldaway	STD	STD
Bright windshield molding	STD	STD
Bright quarter window molding	NA	STD
Lower bodyside protection molding with vinyl insert (1)	O	STD
Removable rear fiberglass roof (2)	STD	STD
Swing-down type tailgate	STD	STD
Double wall construction (3)	STD	STD
Interior		
Dome lamp	STD	STD
Courtesy light switches (door operated)	LH	LH/RH
Floor covering (color-keyed)	Rubber Mat (front)	16-oz. carpeting (front and rear)
Door trim panels (color-keyed)	STD	STD with bright surround molding, woodtone applique, full-length storage bin
Vinyl headliner (color-keyed)	NA	STD
Sun visors LH/RH (color-keyed)	STD	STD
Pivoting front vent windows	STD	STD
Day/Night rearview mirror	STD	STD
Passenger side visor vanity mirror	NA	STD
Instrument panel and pad (color-keyed)	STD	STD
Instrument panel appliques	Argent	Wood-tone with bright molding
Cluster brow warning lights	STD	STD
Steering wheel	Black, 2-spoke	Black, soft-wrapped with woodtone applique
Cigarette lighter	STD	STD
AM radio (4)	STD	STD
3-speed heater defroster	STD	STD
Fresh air vents, slide control LH/RH	STD	STD
Inside hood release	STD	STD
Color-keyed "A" pillar, windshield header moldings and cowl side moldings	STD	STD
Rear quarter trim panels	Black, hard board	Color-keyed with arm rests storage bin and cargo light
Front bucket seats	STD	STD
Rear flip/fold bench seat	STD	STD
Flip forward front passenger seat	STD	STD
Seat trim	Vinyl	Cloth/vinyl
Seat belts	Black	Deluxe, color-keyed
Scuff plates	Black, (front doors), Bright (tailgate)	Bright
Spare tire cover, black	STD	STD

1. Included with Tu-Tone paints. 2. Available in choice of 4 colors. 3. Double wall construction in hood, doors and front metal roof. 4. May be deleted for credit or upgraded at extra cost. 5. System indicates when parking brake is engaged and/or hydraulic system failure.

A COMMITMENT TO SAFETY

Trucks built with a concern for safety are designed and engineered by people who are committed to safety.

Occupant Safety

To help protect passengers in the event of an accident, Ford trucks are equipped with numerous safety-design features, including those listed here under the category "Occupant Protection."

Ford commits enormous resources every year to the development and testing of all truck lines and their occupant protection features.

Body structures — front and rear end assemblies, roof and doors — are carefully designed from the start with passenger safety as a primary concern. After they are validated for theoretical soundness, structures are assembled into prototype vehicles and subjected to exhaustive testing in the Crash Barrier Building at Ford's Dearborn, Michigan, Proving Ground.

Thorough evaluations of instrument panel and steering column designs, seats, head restraints and seat belts are also involved in all phases of safety testing.

Operating Safety

This term applies to a vehicle's ability, with the aid of the driver, to avoid an accident.

Most important to operating safety are the major chassis systems — the front and rear suspensions, steering and brakes. Ford trucks are engineered to do their part — provide suspension and steering systems designed for handling responsiveness and control, as well as a brake system that delivers fast stopping action along with fade resistance.

Of course, it's up to the driver to make the best use of the vehicle's accident-avoidance equipment. This involves driving defensively and reacting in time, and such seemingly small things as regulating the interior heating/cooling system for proper ventilation (to help the driver stay alert) and maintaining the radial tires at recommended inflation pressures (to keep them at safe temperatures).

Get it together — Buckle up.

Ford Motor Company strongly encourages all passengers to use their safety belts. In all Ford trucks, front seat lap and shoulder belts are equipped with automatic retractors and tension relievers, so they're very convenient to put on and comfortable to wear. Rear seat positions also have lap belts.

Ford also urges the use of child and infant restraints, even in states where they are not required by law. Ford's Tot-Guard (for children 20 to 50 pounds) and Infant Carrier (for children up to 20 pounds) are available at all Ford Dealers. These restraint systems are easy to install and meet all state and federal standards. If a child restraint requires a top-tether, Ford trucks provide a special anchorage at each rear outboard seating position.

1984 FORD BRONCO LIFEGUARD DESIGN SAFETY FEATURES

Vehicle Operation

- Dual service hydraulic brake system with warning light
- Front disc brakes
- Hazard warning flasher
- Two-speed windshield wipers
- Safety hood latch system

POWERTEAM AVAILABILITY

Engine	Trans.	49 States		California		High Altitude	
		Base	Optional	Base	Optional	Base	Optional
4.9L I-6	M4M4OD	3.08	3.08TL/3.55/ 3.55TL	3.55	3.55TL	3.55	3.55TL
5.0L V-8	SelectShift Automatic M4M4OD	3.55	3.55TL	3.55	3.55TL	3.55	3.55TL
5.8L V-8 (2V)*	SelectShift Automatic M4M4OD	3.55	3.55TL	NA	NA	3.55	3.55TL
	SelectShift Automatic	3.50	3.50TL	3.55	3.55TL	3.50	3.50TL
		3.50	3.50TL	NA	NA	3.50	3.50TL
		3.50	3.50TL	3.50	3.50TL	3.50	3.50TL

*5.8L V-8 (4V) replaces 2V in late '83 calendar year.

Occupant Protection

- Safety door latches and hinges
- Integral lap and shoulder belts for front seat occupants
- Positive seat belt fastening reminder warning light and buzzer for the driver
- Lap belts with buckles for center front passenger (with optional three-passenger front seat) and all rear seating positions
- Energy-absorbing steering column and steering wheel
- Energy-absorbing instrument panel with padding for front seat passenger (right and center front passengers with optional three-passenger front seat)
- Impact absorbing laminated safety glass windshield
- Flame resistant interior materials

Anti-Theft

- Locking steering column with key warning buzzer reminder
- Visible vehicle identification number
- Separate keys for ignition and door entry

Ford-Paid Repair Programs after the Warranty Period

Sometimes Ford offers adjustment programs to pay all or part of the cost of certain repairs. These programs are intended to assist owners and are in addition to the warranty or to required recalls. Ask Ford or your dealer about such programs relating to your Ford or Lincoln-Mercury vehicle.

To get copies of any adjustment program for your vehicle or the vehicle of interest to you. Call Ford toll-free at 1-800-241-3673. Alaska and Hawaii call 1-800-243-3711 and in Georgia call 1-800-282-0959.

Or write Ford at: Ford Customer Information System, Post Office Box 95427, Atlanta, Georgia 30347.

We'll need your name and address, year, make, and model vehicle, as well as engine size, and whether you have a manual or automatic transmission.

Technical Service Bulletins

All vehicles need repairs during their lifetime. Sometimes Ford issues Technical Service Bulletins (TSBs) and easy-to-read explanations describing unusual engine or transmission conditions which may lead to costly repairs, the recommended repairs, and new repair procedures. Often a repair now can prevent a more serious repair later. Ask Ford or your dealer for any such TSBs and explanations relating to your Ford or Lincoln-Mercury vehicle.

To get copies of these Technical Service Bulletins and explanations for your vehicle or vehicles of interest to you. Call Ford toll-free at 1-800-241-3673. Alaska and Hawaii call 1-800-243-3711 and in Georgia call 1-800-282-0959.

FORD BRONCO SPECIFICATIONS

Equipment	Standard	Optional
Axle, front rating	3,550 lb.	Limited slip
Axle, rear rating	3,750 lb.	Traction-Lok
Brakes, front disc/rear drum	Power	—
Clutch	10-in.	—
Electrical		
Battery, maintenance-free	36 amp-hr.	63 amp-hr.
Alternator	40 amp.	See Powerteam Chart, page 15
Engine	4.9L 6 cyl.	Automatic locking
Front hubs, free-running	Manual locking	—
Fuel tank	32 gal.	HD rear
Shock absorbers	front (HD), rear	—
Springs, front	Coil	—
Springs, rear	Leaf, single stage	—
Stabilizer bar	—	Front and rear
Steering	Power	—
Transfer case (part-time)	2-speed	—
Transmission	4-speed	M4OD, Automatic
Tires, P-metric, glass-belted radials	P-215/75R 15 SL	Both glass and steel belted radials with All-Season or All-Terrain tread are available. Use adequate tires for type of service. Consult your Ford Dealer.

Or write Ford at: Ford Customer Information System, Post Office Box 95427, Atlanta, Georgia 30347.

We'll need your name and address, year, make, and model vehicle, as well as engine size, and whether you have a manual or automatic transmission.

EXTENDED SERVICE PLAN

Also well worth considering...

Ford Motor Company's optional Extended Service Plan covers major components on new Ford cars and light trucks for longer than the vehicle's basic warranty. The cost is so moderate for the protection you get that it could pay for itself the first time you need it.

Your Ford Dealer will be happy to detail the Plan for you. Available on all cars and most light trucks, it is honored by more than 6,300 Ford and Lincoln-Mercury dealers nationwide and in Canada.

"Ask Your Ford Dealer"

Specifications, descriptions and illustrative material contained herein were as accurate as known at the time this publication was approved for printing. Ford Division reserves the right to discontinue models or options at any time or change specifications and materials, equipment or design without notice and without incurring obligation. All options and accessories illustrated or referred to as optional or available in this publication are at extra cost. Some options are required in combination with other options. For the price of the model with the equipment you desire or verification of specifications contained herein, see your Ford Dealer.

Some of the items shown on vehicles in this publication are available through retail organizations and establishments not connected with Ford Motor Company. Availability, price, quality and durability of these items rest solely with the respective manufacturers and their sales organizations and Ford assumes no responsibility for their use.

Following publication of this catalog, certain changes in standard equipment, options, prices and the like may have occurred which would not be included in these pages. Your Ford Dealer is your best source for up-to-date information.



Get it together – Buckle up.

FORDNEY CAR & TRUCK, INC.

FORD BRONCO

FORD DIVISION

