



2016



CLS



Mercedes-Benz

PROFOUND PROFILE

*CONCEIVED TO REDEFINE WHAT A COUPE CAN BE, THE
CLS HAS CHANGED THE WAY THE WORLD SEES CARS.*



AN ARC, A SPARK, A TRAJECTORY

The CLS is a designer's dream brought to life—a pure expression that's unrestrained by convention. It wraps advanced innovation in a muscular body—its sleek profile crowned by a tensed arch of frameless side glass. Igniting power with passion, it takes to the road with poise and precision—the essence of a Mercedes-Benz coupe. The CLS welcomes its four fortunate occupants into four sculpted seats—and like no coupe before, each via their own door. Its breakthrough design sparked a global trend, inspiring countless sedans to emulate its body. None of them can duplicate its soul.



INSPIRING BY DESIGN

*WHEN YOU CAN SEE A CAR'S SOUL ON THE OUTSIDE,
IMAGINE WHAT YOU CAN FEEL FROM THE INSIDE.*



BRILLIANCE SHINES FROM WITHIN

Even at a standstill, the shape of its body is a direct reflection of the muscle and agility the CLS displays in motion. AMG body styling embraces the substantial wheels as they cling to the road. Every detail is executed with jewel-like precision—a trait it shares with the finest timepieces. Each of the 260 chrome pins in its grille is individually sized and placed by its designer. Camera-based ACTIVE MULTIBEAM LED® headlamps can adapt more than 50 LED elements 100 times per second, to brighten your path proactively. All to keep you brilliantly ahead of every curve.



NOT JUST TRIMMED, TAILORED

ITS SEATS ARE FITTED BY HAND WITH ANY OF 14 LEATHERS. ONE OF FIVE HAND-FINISHED WOODS INLAYS THE DASH, DOORS AND FULL CONSOLE. IN A CLS, FIT AND FINISH START BY SUITING YOU.

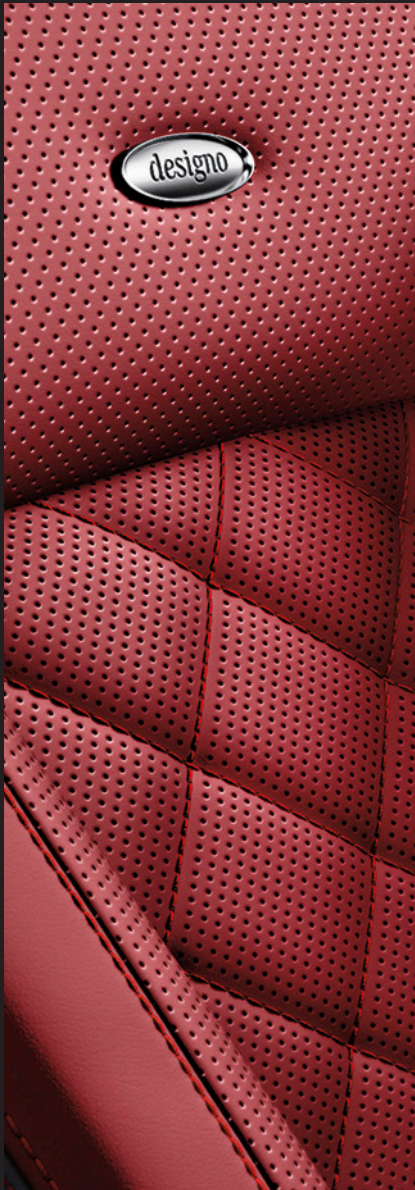



FOUR INDIVIDUAL SEATS

An elegantly finished and thoughtfully outfitted console cascades the length of the CLS cabin, creating an intimate yet spacious comfort zone for each of its four occupants. From their own individually contoured seats, passengers can enjoy convenient storage, generous legroom, multicolor LED ambient lighting, and their own power window—all in the style and substance that have defined Mercedes-Benz coupes for decades. The CLS also treats its four occupants to a tradition it started on its own: Each of them can enter and exit through their own wide door.

SINGULAR IN EXPERIENCE

Indulgent, richly grained leather is hand-fitted to each seat of your CLS 400 or CLS 550. Five color choices include timeless Saddle Brown or ultramodern Porcelain. In the AMG CLS 63 S, Black is anything but basic: It's smooth, supple Nappa leather with Silver stitching and seat belts to match. You can also appoint any CLS with extraordinarily supple semi-aniline leather. For a CLS 400 or CLS 550, contrasting stitching in crisp Grey or racy Red sets off Black cabins in two sporty styling packages. You can choose cabin accents from five sustainably forested, hand-finished woods, plus carbon fiber for the AMG model. And beneath the elegant surfaces, steam-expanded foams—a process Mercedes-Benz pioneered—eliminate harmful chemicals, while products from flax, coconut and olives support the seats and many trim components. The net effect is a cabin that's crafted to feel in harmony with nature—and with your nature.

DISTINCTIVE INSTINCT

*IT'S NO COINCIDENCE THAT THE MUSCULAR
CLS LOOKS LIKE A CHEETAH READY TO POUNCE.*



EVERYTHING IN THE WAY IT MOVES

The quick reflexes of a CLS are the sum of a thousand moves—each at lightning speed, all in total concert. Biturbo engines turn forced air into free-flowing power. Rev-happy but never rev-needy, they serve up 100% of their peak torque before the tach passes 2,000 rpm. Shift paddles put seven or even nine speeds at your fingertips. Available 4MATIC® puts grip at your feet. And semi-active AIRMATIC® suspension can flex its muscle in corners, or crouch at speed to cheat the wind. A CLS has many ways to move you.



HANDCRAFTED BY RACERS

THE PERFORMANCE FANATICS WHO BUILD AND RACE CHAMPIONSHIP MERCEDES-AMG RACECARS ARE THE SAME PEOPLE WHO CREATE CARS LIKE THE AMG CLS 63 S. AS IF ANY OTHER CAR IS LIKE THE AMG CLS 63 S.



"One man, one engine" is more than a motto for AMG. It's a guiding philosophy and a process rooted in racing, where precision and endurance are proven in record time. The heart of a Mercedes-AMG CLS 63 S is its 577-hp biturbo V-8. Each one is crafted by the hands of its own master engine builder, who visually inspects and records every component, and computer-verifies each torque spec. Only after the V-8 is individually bench-tested does it earn his signature—on a metal plaque that he affixes atop the engine. This degree of detail-obsession is evident throughout the car—from its mighty brake hardware to its range of driver-selected modes to its finely stitched, hand-fitted Nappa leather upholstery.

It takes more than a stampede of horsepower to make the quickest car in its highly competitive market class. Thanks to AMG Performance 4MATIC® all-wheel drive, the CLS 63 S converts torque into traction brilliantly. Its 33:67 front/rear torque split joins forces with the 7-speed multiclutch AMG SPEEDSHIFT® transmission, a Torque Vectoring Brake feature, plus multistage ESP® and an AMG Adaptive Suspension—both with Sport handling modes. Collectively, they expertly transfer power to pavement—whether at launch or rocketing out of a corner. So along with a class-leading 0–60 time of 3.6 seconds,¹ they preserve the legendary agility that AMG drivers have cherished—on road and track—for decades.



AMG

DRIVING PERFORMANCE

PROACTIVE PROTECTOR

SEEING THE FUTURE ISN'T NEARLY AS MEANINGFUL AS CHANGING IT—ESPECIALLY THE PART THAT'S JUST SECONDS AHEAD OF YOU. WITH INTELLIGENT DRIVE, A 360° NETWORK OF CAMERAS, RADAR AND OTHER SENSORS CAN SEE MORE THAN THE HUMAN EYE, TO HELP YOU GET OUT OF DANGER BEFORE YOU'RE IN IT.



COLLISION PREVENTION ASSIST PLUS

Radar-based technology alerts you if you're following a vehicle too quickly or too closely. As soon as you start to brake, Adaptive Brake Assist automatically adjusts the braking to an ideal level, to help prevent a collision or reduce its severity. The system can apply the brakes autonomously from speeds up to 65 mph.² It can also activate PRE-SAFE[®], the predictive system that can tighten the front seat belts and close the windows in the moments before a collision.³

ATTENTION ASSIST

By continuously monitoring as many as 70 parameters of driving behavior, ATTENTION ASSIST[®] can alert you both visually and audibly if it detects signs of driver-drowsiness on long trips. Its enhanced sensitivity helps the system detect drivers who begin their trip drowsy. A display in the gauge cluster can help you track your own attention level and driving time along your journey.⁴

ACTIVE LANE KEEPING ASSIST

By monitoring visible road markings at speeds above 37 mph, Active Lane Keeping Assist helps detect unintended drifting off-course, and alerts you by vibrating the steering wheel. If you continue to drift, it can selectively brake individual wheels to help guide the car back into its lane. It can also help detect and alert you to overtaking vehicles, vehicles you'll need to overtake if you change lanes, and even oncoming traffic in the adjacent lane.⁴

ACTIVE BLIND SPOT ASSIST

When driving above 20 mph, radar technology helps sense when a vehicle enters the blind-spot area on either side of you, and alerts you by illuminating an icon in the side mirror. A warning tone sounds if you activate a turn signal while a vehicle is detected. And if you begin to change lanes, advanced active technology can help guide the car back by applying the brakes on one side.⁵



DISTRONIC PLUS WITH STEERING ASSIST

Radar-based cruise control adapts your set speed to the flow of traffic ahead, automatically slowing until your path is clear again. If the vehicle ahead slows to a stop, DISTRONIC PLUS[®] can brake to a full halt. When traffic moves, you can resume with just a tap, or automatically if the stop is under a second. The Steering Assist feature helps the driver keep the vehicle centered in between the lane markings while cruising on straight roads, or even in gentle curves.⁶

PRE-SAFE BRAKE WITH PEDESTRIAN RECOGNITION

PRE-SAFE Brake can help detect an impending collision and automatically apply up to 100% braking force to help reduce the severity of impact. At speeds up to approximately 35 mph, it can also help detect if pedestrians have entered your path and automatically apply the brakes.⁷ The features are active whether using the cruise control functions of DISTRONIC PLUS or not.

BRAKE ASSIST PLUS WITH CROSS-TRAFFIC ASSIST

BAS[®] PLUS uses radar sensors to scan the road ahead at driving speeds up to approximately 45 mph. Cross-Traffic Assist uses radar plus advanced cameras to help detect a potential collision with vehicles approaching from either side of an intersection ahead, or with pedestrians in the car's path. When the driver responds to the system's alert by braking, Brake Assist PLUS precisely applies the maximum braking force required to help prevent such an accident.⁷

PARKTRONIC WITH ACTIVE PARKING ASSIST

As you drive by open parking spaces, sensors help you size them up. When you decide to back into one, it can expertly steer and brake for you—and steer you back out later. In any low-speed maneuver, PARKTRONIC's ultrasonic sensors in the bumpers help detect nearby objects within its field of view. Audible and visual indicators in the cabin help you navigate tight spaces with confidence.

STATE OF THE ARTISTRY

ALL CARS ARE DESIGNED TO DRIVE. A CLS IS CREATED TO DRIVE DESIRE.



THINKING AND THOUGHTFULNESS

Taking center stage in the finely crafted CLS dash are two visual highlights—both as distinctive as they are distinct from each other. The classic analog clock connects the CLS to a legacy of elegance. Above it, a large yet low-profile 8" screen delivers up-to-the-second information and a world of entertainment with intuitive simplicity. Whether devoted to a single function or multitasking many, every detail is thoughtfully engineered to feel at one with your thinking.



EXCLUSIVELY ACCESSIBLE

The CLS cabin is engineered to let all four of its occupants share in an exclusive set of benefits. It does it by providing an experience shared with no other coupe. Incoming air is filtered two ways: to sweep away dust and pollen, and to neutralize odors with activated charcoal. It's the only car in its class to earn the Seal for Allergy Friendliness from the European Centre for Allergy Research Foundation (ECARF).⁸ It also offers two options in 14-speaker digital surround sound: 610 watts of lush harman/kardon LOGIC7[®] audio, or an audiophile-quality Bang & Olufsen BeoSound[®] system with 1,200 total watts and illuminated Acoustic Lens tweeters. You can further fine-tune the mood with multicolor ambient cabin lighting—one of numerous features the driver can personalize via the 8" screen and central controller. Innovative tech with a human touch makes the CLS a one-of-a-kind treat for four.



UNITING INTUITIVE TECHNOLOGY WITH INDULGENT LUXURY, THE CLS CABIN IS AN ADVANCED RETREAT.

FOUR SEATS AT THE FOREFRONT OF IT ALL



TOGETHER WHEREVER

IT'S PERFECTLY NATURAL TO DEVELOP AN EMOTIONAL ATTACHMENT TO YOUR MERCEDES-BENZ. WITH MBRACE, ENJOYING A TECHNOLOGICAL CONNECTION IS JUST AS EASY.

With Mercedes-Benz mbrace,[®] your car is only a click away. Five years of mbrace Connect benefits and services⁹ come standard with every new 2016 Mercedes-Benz, providing you with remote access to your vehicle from your smartphone or computer. With the mbrace Mobile App,¹⁰ you can lock, unlock and locate your car—and more—from your phone. You can access Google and Yelp from your car with an ever-evolving variety of in-vehicle apps. You can send destinations to your car's available COMAND[®] navigation system from your computer or phone. Even your car can reach out, with remote diagnostics and a direct connection to Mercedes-Benz Roadside Assistance.¹¹ Three additional packages bring you even more connections—from added safety to a personal concierge to streaming music, live traffic cams and in-car WiFi for you and your friends. With mbrace, your Mercedes-Benz helps you stay connected not just to your car, but to your world—from anywhere you are, and wherever tomorrow takes you.

mbrace Connect

5 years included

State-of-the-art convenience with remote vehicle access, in-vehicle apps and over-the-air updates

Package includes:

- mbrace Mobile App for Android or iPhone
- Remote lock/unlock and more via Mobile App
- Access to mbrace Web services at mbrace.MBUSA.com
- In-car connection to Mercedes-Benz Roadside Assistance
- Remote diagnostics with direct dealer connection
- Valet Protect
- Over-the-air updates of many mbrace features and apps
- An evolving selection of Mercedes-Benz Apps, such as:
 - Internet browser
 - Google™ Local Search
 - Yelp
 - Fuel station finder with prices
 - Viewable traffic cams in many metro markets
 - Weather reports locally and around the world
 - Airport flight status
 - Local movie theater showtimes

mbrace Secure

6-month trial included

Requires mbrace Connect

Added peace of mind from safety and security features for you, your family, and your vehicle

Package includes:

- Automatic Collision Notification
- Emergency calling from your car's SOS button or the Mobile App
- Automatic Alarm Notification
- Stolen vehicle location assistance
- Agent-assisted remote locking and unlocking
- Dealer connect

mbrace Concierge

3-month trial included

Requires mbrace Secure

Personal assistance from highly knowledgeable professionals with access to a world of resources

Package includes:

- Personal concierges to help you stay more productive on the road, or from the Mobile App on your smartphone
- Expert recommendations and reservations for dining out, and for tickets to events
- Turn-by-turn directions from a live assistant or sent to your car
- Travel assistance, including reservations and changes for hotels, airlines and car rentals
- Answers to most any question, help with most any request

mbrace Entertain

3-month trial included

Requires mbrace Secure

Online, on-the-road enjoyment from streaming entertainment to online maps

Package includes:

- Streaming audio and data via widely available 3G coverage
- Online maps, powered by Google
- A selection of streaming audio apps, including:
 - TuneIn[®] radio
 - iHeart Radio[®] Available starting Fall 2015
 - Mercedes-Benz Radio



CAR IN YOUR POCKET

The mbrace Mobile App on your iPhone or Android phone includes a number of convenient remote vehicle controls. You can lock and unlock the doors from any distance. Locate your car on a map from up to a mile away. Or flash its lights and sound the horn. You can even look up an address, and send it directly to your car's COMAND navigation system.

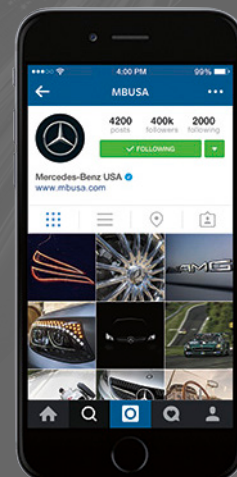

OUR WORLD IS YOURS

The online world of Mercedes-Benz is one of many ways you can enjoy being part of the family. You can keep up to date with news and events, or take in an entertaining film. You can get more from your vehicle with helpful tutorial videos and downloadable manuals. And you can check out photos from other Mercedes-Benz drivers and fans, and best of all, share yours as well.



BUILD YOUR OWN

MBUSA.com/CLS

Specifications

| | | CLS 400 | CLS 550 | AMG CLS 63 S |
|---|--------|--|--|---|
| Engine | Type | 3.0-liter biturbo Direct Injection V-6 | 4.7-liter biturbo Direct Injection V-8 | Handcrafted AMG 5.5-liter biturbo Direct Injection V-8 |
| | Power | 329 hp @ 5,250–6,000 rpm | 402 hp @ 5,250–5,750 rpm | 577 hp @ 5,500 rpm |
| | Torque | 354 lb-ft @ 1,600–4,000 rpm | 443 lb-ft @ 1,600–4,750 rpm | 590 lb-ft @ 2,000–4,000 rpm |
| | | | | |
| Transmission | | 7-speed automatic with shift paddles | 9-speed automatic with shift paddles | 7-speed AMG SPEEDSHIFT® MCT with shift paddles |
| Acceleration, 0–60 mph¹ | RWD | 5.3 sec | 5.1 sec | — |
| | 4MATIC | 5.3 sec | 5.2 sec | 3.6 sec |
| Wheels | | Staggered-width 18" twin 5-spoke ¹² | Staggered-width 18" twin 5-spoke ¹² | Staggered-width 19" AMG® 10-spoke ¹² |
| Suspension | | Comfort-tuned multilink | Sport-tuned 4-wheel multilink, AIRMATIC® with Adaptive Damping System (ADS), 4-wheel level control and two modes | AMG Adaptive Sport Suspension with rear air springs, rear level control and three modes |
| Drivetrain | | Rear-wheel drive or 4MATIC® all-wheel drive | Rear-wheel drive or 4MATIC all-wheel drive | AMG Performance 4MATIC all-wheel drive |

Dimensions

| | | CLS 400 | CLS 550 | AMG CLS 63 S |
|-----------------------------------|--------|-------------------|-------------------|-------------------|
| Wheelbase | | 113.1" | 113.1" | 113.1" |
| Overall length | | 194.5" | 194.5" | 196.7" |
| Overall height | | 55.8" | 55.8" | 55.4" |
| Overall width | | 81.7" (w/mirrors) | 81.7" (w/mirrors) | 81.7" (w/mirrors) |
| Curb weight | RWD | 4,034 lbs | 4,233 lbs | — |
| | 4MATIC | 4,189 lbs | 4,376 lbs | 4,420 lbs |
| Headroom (front/rear) | | 36.9" / 36.1" | 36.9" / 36.1" | 36.9" / 36.1" |
| Legroom (front/rear) | | 42.1" / 35.0" | 42.1" / 35.0" | 42.1" / 35.0" |
| Shoulder room (front/rear) | | 57.1" / 56.5" | 57.1" / 56.5" | 57.1" / 56.5" |
| Cargo capacity | | 11.0 cu ft | 11.0 cu ft | 11.0 cu ft |

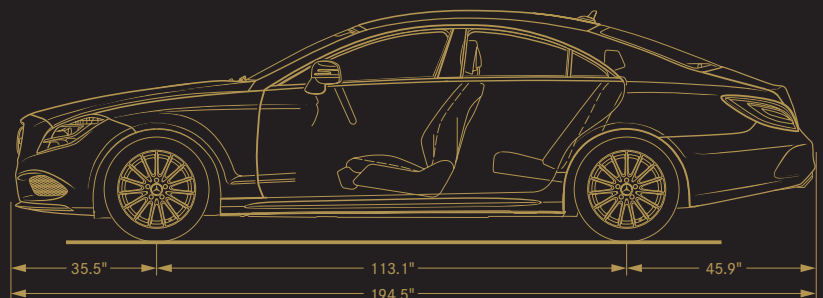
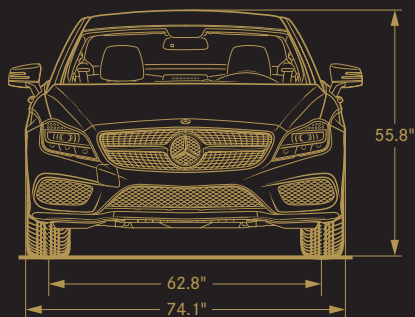

KEY STANDARD FEATURES

CLS 400
CLS 550
AMG CLS 63 S

Performance and efficiency

- ● ● ECO Start/Stop system
- ● ● Manual shift mode for transmission
- — ● AMG Performance 4MATIC all-wheel drive
- — ● AMG limited-slip differential

Safety and security

- ● ● COLLISION PREVENTION ASSIST PLUS
- ● ● ATTENTION ASSIST®
- ● ● PRE-SAFE®
- ● ● Electronic Stability Program (ESP®)
- ● ● Adaptive braking technology: Predictive Brake Priming, Automatic Brake Drying, Hill-Start Assist, and Brake HOLD feature
- ● ● Emergency-sensing Brake Assist (BAS®)
- ● ● Advanced Tire Pressure Monitoring System
- ○ ● PARKTRONIC with Active Parking Assist
- ● ● 12-way air bag protection
- ● ● NECK-PRO® front head restraints
- ● ● LED Daytime Running Lamps
- ● ● Full-LED headlamps
- ○ ● ACTIVE MULTIBEAM LED® headlamps
- ○ ● Adaptive Highbeam Assist
- ● ● Full-LED taillamps
- ● ● SmartKey remote locking and starting system
- ○ ● KEYLESS-GO®
- ● ● Antitheft alarm system with remote panic feature

CLS 400
CLS 550
AMG CLS 63 S

Comfort and convenience

- ● ● 14-way power front seats with memory
- ● ● Heated front seats
- ● ● Individual rear seats w/center storage console
- ○ ● Split-folding rear seats
- ● ● Power tilt/telescoping steering column
- ● ● Multifunction steering wheel w/Nappa leather trim
- ● ● Dual-zone digital automatic climate control
- ● ● Power tilt/sliding tinted glass sunroof
- ● ● Multicolor ambient lighting
- ○ ● Power rear-window sunshade
- ● ● Rain-sensing windshield wipers
- ● ● Heated, power-folding side mirrors
- ● ● Auto-dimming driver-side and inside rearview mirrors

Entertainment and navigation

- ● ● COMAND® system with central controller and 8" color display
- — — Garmin® MAP PILOT® navigation¹³
- ● ● COMAND navigation w/80GB hard drive¹³
- ○ ● SiriusXM Traffic and Weather w/5 years of service¹⁴
- ● ● Voice control w/learning feature
- ● ● No-charge navigation map updates for 3 years
- ● ● harman/kardon LOGIC7® sound system
- ● ● Bluetooth® audio streaming
- ● ● USB audio port
- ● ● SiriusXM Radio w/6-month All Access trial¹⁴
- ● ● HD Radio™ receiver
- ● ● In-dash DVD/CD player and SD card reader
- ● ● Hands-free Bluetooth interface
- ● ● Mercedes-Benz mbrace®
- ● ● 5 years of mbrace Connect services⁹

● Standard ○ Optional — Not available

Please see endnotes at back of brochure.

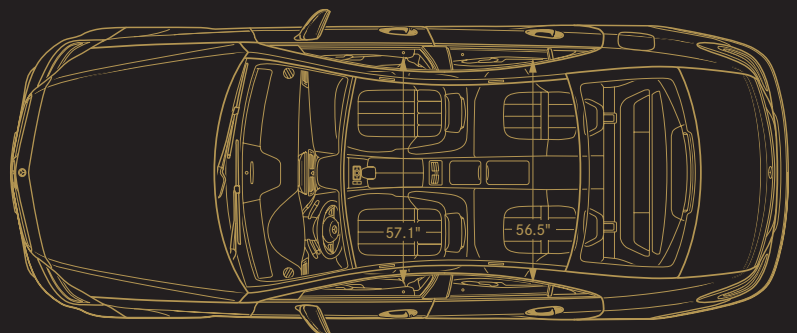
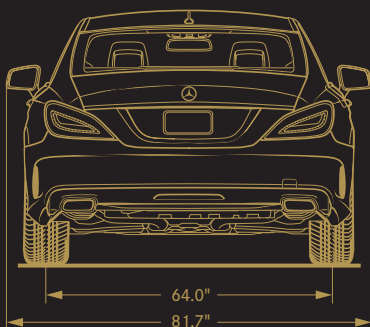



Option Packages

| | CLS 400 | CLS 550 | AMG CLS 63 S |
|--|---------|---------|--------------|
| Premium 1 Package | ○ | — | — |
| <ul style="list-style-type: none"> harman/kardon LOGIC7® surround-sound system with Dolby Digital 5.1 <i>Standard on CLS 550, AMG CLS 63</i> SiriusXM Radio¹⁴ (with 6-month trial of All Access plan) <i>Standard on CLS 550, AMG CLS 63</i> Ventilated front seats KEYLESS-GO® Electronic trunk closer Power-folding side mirrors Rearview camera¹⁵ | | | |
| Premium 2 Package <i>All items standard on AMG CLS 63</i> | ○ | — | — |
| <ul style="list-style-type: none"> ACTIVE MULTIBEAM LED® headlamps Adaptive Highbeam Assist COMAND® navigation with 3 years of map updates¹³ <i>Also standard on CLS 550</i> SiriusXM Traffic and Weather¹⁴ (with 5 years of service) <i>Also standard on CLS 550</i> Voice control with learning feature <i>Also standard on CLS 550</i> Power rear-window sunshade | | | |
| Premium Package | — | ○ | ○ |
| <ul style="list-style-type: none"> ACTIVE MULTIBEAM LED headlamps <i>Standard on AMG CLS 63</i> Adaptive Highbeam Assist <i>Standard on AMG CLS 63</i> Ventilated front seats Active multicontour driver seat with massage <i>AMG CLS 63 only</i> KEYLESS-GO Electronic trunk closer Rearview camera¹⁵ Power rear-window sunshade <i>Standard on AMG CLS 63</i> | | | |
| Wheel Package <i>Not available with Night Package Plus</i> | ○ | ○ | — |
| <ul style="list-style-type: none"> 18" AMG® 5-spoke wheels¹² Sport-tuned suspension <i>CLS 400 only</i> Flat-bottom sport steering wheel Black headliner, Grey contrasting stitching <i>Only with Black interior</i> Manual mode for transmission <i>Standard on CLS 550</i> Rubber-studded aluminum pedals | | | |
| Night Package Plus <i>Not available with Wheel Package</i> | ○ | ○ | — |
| <ul style="list-style-type: none"> Gloss Black exterior accents, including rear spoiler 19" AMG twin 7-spoke wheels, Black¹² Exclusive interior in Black leather w/red topstitching, red cabin accents, and flat-bottom sport steering wheel w/red stitching Manual mode for transmission <i>Standard on CLS 550</i> Rubber-studded aluminum pedals | | | |
| AMG Night Package | — | — | ○ |
| <ul style="list-style-type: none"> Gloss Black side mirror covers; front air dam and side sill inserts; and rear spoiler Tailpipes in black chrome | | | |
| AMG Exterior Carbon Fiber Package | — | — | ○ |
| <ul style="list-style-type: none"> Carbon fiber side mirror covers; front air dam, rear valence and side sill inserts; and rear diffuser | | | |

● Standard ○ Optional △ No-charge option — Not available

Option Packages *continued*

| | CLS 400 | CLS 550 | AMG CLS 63 S |
|---|---------|---------|--------------|
| Parking Assist Package | ○ | ○ | — |
| <ul style="list-style-type: none"> Surround View System¹⁵ <i>Available separately on AMG CLS 63</i> PARKTRONIC w/Active Parking Assist <i>Standard on AMG CLS 63</i> | | | |
| Lane Tracking Package <i>Requires Premium Package</i> | ○ | ○ | ○ |
| <ul style="list-style-type: none"> Blind Spot Assist Lane Keeping Assist | | | |
| Driver Assistance Package | ○ | ○ | ○ |
| <ul style="list-style-type: none"> DISTRONIC PLUS® with Steering Assist PRE-SAFE® Brake with Pedestrian Recognition BAS® PLUS with Cross-Traffic Assist PRE-SAFE PLUS rear-end collision protection Active Blind Spot Assist Active Lane Keeping Assist | | | |
| Individual options | | | |
| 4MATIC all-wheel drive <i>AMG Performance 4MATIC on AMG CLS 63</i> | ○ | ○ | ● |
| AIRMATIC® semi-active air suspension | ○ | ● | — |
| AMG Carbon Ceramic Braking System ¹⁶ | — | — | ○ |
| Carbon fiber engine cover | — | — | ○ |
| Surround View System ¹⁵ <i>Also in Parking Assist Package</i> | — | — | ○ |
| Bang & Olufsen BeoSound® premium sound system ¹⁷ | ○ | ○ | ○ |
| Active multicontour driver seat with massage feature <i>Requires Premium Package on CLS 400, CLS 550</i> <i>Included in Premium Package on AMG CLS 63</i> | ○ | ○ | — |
| Heated rear seats | — | — | ○ |
| Heated steering wheel ¹⁸ | ○ | ○ | — |
| Wood/leather steering wheel ¹⁸ | ○ | ○ | — |
| 18" twin 5-spoke wheels ¹ <i>Not available w/ Night or Wheel Package</i> | ○ | ○ | — |
| 19" AMG® multispoke wheels ¹ <i>Requires Sport Package</i> | ○ | ○ | — |
| 19" AMG 10-spoke wheels, Black ¹ | — | — | ○ |
| 19" AMG cross-spoke forged-alloy wheels, Black or Titanium ¹ | — | — | ○ |
| Nappa leather upholstery | — | — | ● |
| Semi-aniline leather upholstery | ○ | ○ | △ |
| <i>designo</i> semi-aniline leather upholstery | ○ | ○ | ○ |
| Black Ash, Burl Walnut or Linden wood trim | △ | △ | △ |
| Satin Light Brown Poplar wood trim | △ | △ | △ |
| <i>designo</i> Black Piano Lacquer wood trim | ○ | ○ | △ |
| Carbon fiber/Black Piano Lacquer wood trim | — | — | ○ |
| Accessories <i>Selected items shown at left</i> | | | |
| 19" 10-spoke wheels ¹² | ○ | ○ | — |
| Illuminated Star <i>Not available w/Driver Assistance Package</i> | ○ | ○ | ○ |
| Rear spoiler | ○ | ○ | ○ |
| Roof rack basic carrier | ○ | ○ | ○ |
| Ski/snowboard and bicycle racks <i>Requires basic carrier</i> | ○ | ○ | ○ |
| Mercedes-Benz roof boxes <i>3 sizes available; requires basic carrier</i> | ○ | ○ | ○ |
| Comfort box <i>Retractable trunk bin</i> | ○ | ○ | ○ |
| iPad® Docking Station <i>Up to 2 per car, iPad not included</i> | ○ | ○ | ○ |

COLOR AND TRIM

UPHOLSTERY STYLES



Leather

● CLS 400, CLS 550

Semi-aniline leather

○ CLS 400, CLS 550



AMG Nappa leather

● AMG CLS 63 S

AMG semi-aniline leather

△ AMG CLS 63 S



designo semi-aniline leather¹⁹

○ CLS 400, CLS 550

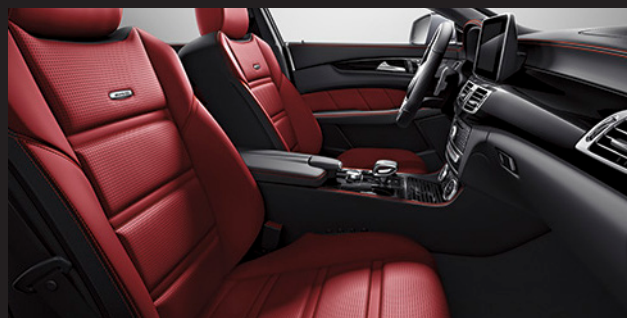

AMG *designo* semi-aniline leather¹⁹

○ AMG CLS 63 S

UPHOLSTERY COLORS



Black

Leather, semi-aniline leather,
AMG semi-aniline leather

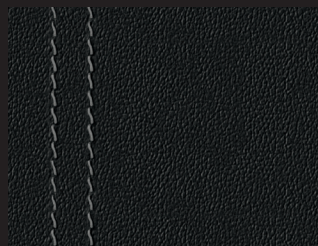

Black with Grey stitching

Leather CLS 400, CLS 550 Wheel Package
AMG Nappa leather



Crystal Grey/Seashell Grey

Leather, semi-aniline leather,
AMG semi-aniline leather

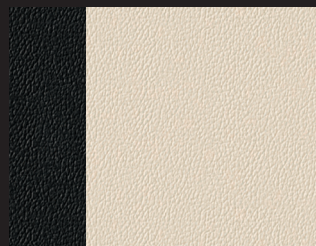

Porcelain/Black

Leather, semi-aniline leather

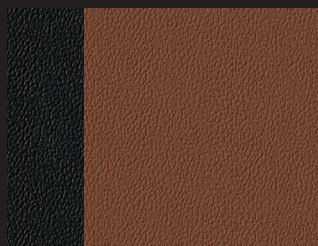

Saddle Brown/Black

Semi-aniline leather

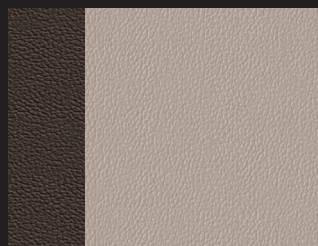

Silk Beige/Espresso Brown

Leather, semi-aniline leather,
AMG semi-aniline leather



designo Classic Red/Black

designo semi-aniline leather,
AMG *designo* semi-aniline leather



designo Saddle Brown/Silk Beige

designo semi-aniline leather,
AMG *designo* semi-aniline leather

INTERIOR TRIM



Burl Walnut wood



Black Ash wood

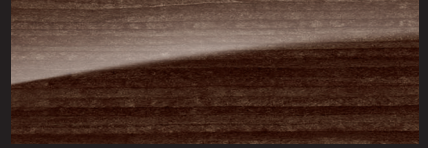

Linden wood



Satin Light Brown Poplar wood

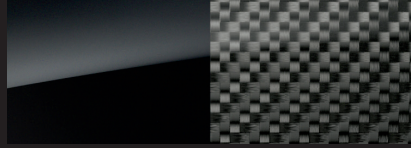

Carbon fiber/Black Piano Lacquer wood
(AMG CLS 63 only)



designo Black Piano Lacquer wood¹⁹

PAINTWORK



Black

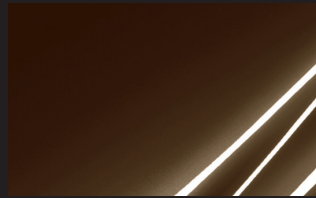

Dakota Brown metallic



Diamond Silver metallic



Iridium Silver metallic

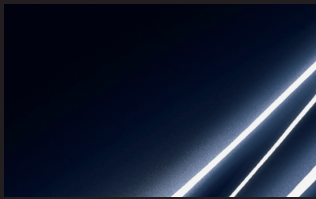

Lunar Blue metallic



Magnetite Black metallic



Obsidian Black metallic



Selenite Grey metallic²⁰



Steel Grey metallic



designo Cardinal Red metallic¹⁹



designo Diamond White metallic¹⁹



designo Mocha Black metallic¹⁹

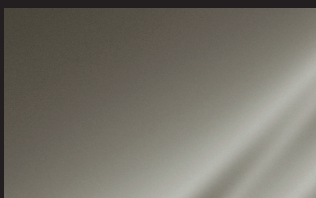

designo Magno Sintered Bronze
(matte)¹⁹



designo Magno Alanite Grey
(matte)¹⁹

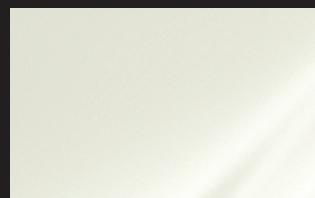

designo Magno Cashmere White
(matte)¹⁹

WHEEL CHOICES



18" twin 5-spoke¹²

● CLS 400



18" twin 5-spoke¹²

● CLS 550



19" twin 5-spoke¹²

○ CLS 400, CLS 550



18" AMG 5-spoke¹²

○ CLS 400, CLS 550 Wheel Package



19" AMG multispoke¹²

○ CLS 400, CLS 550 *Requires Wheel Package*



19" AMG twin 7-spoke, Black¹²

○ CLS 400, CLS 550 Night Package Plus



19" AMG 10-spoke, Titanium¹²

● AMG CLS 63 S



19" AMG 10-spoke, Black¹²

○ AMG CLS 63 S



19" AMG forged cross-spoke, Silver or Black¹²

○ AMG CLS 63 S

● Standard ○ Optional

©2015 Mercedes-Benz USA, LLC • One Mercedes Drive, Montvale, NJ 07645 • 1-800-FOR-MERCEDES • MBUSA.com

Marketing Communications. All illustrations and specifications contained in this brochure are based on the latest product information available at the time of publication. Mercedes-Benz reserves the right to make changes at any time, without notice, to colors, materials, equipment, specifications and models. Any variations in colors shown are due to reproduction variations of the printing process. Illustrations may include test situations. Some vehicles may be shown with non-U.S. equipment. Some vehicles are shown with optional equipment. iPad, iPhone and iPod are registered trademarks or service marks of Apple Inc. Bang & Olufsen and BeoSound are registered trademarks of Bang & Olufsen a/s. Bluetooth is a registered trademark of Bluetooth SIG, Inc. Garmin is a registered trademark of Garmin Ltd. Android and Google Maps are registered trademarks of Google Inc. harman/kardon and LOGIC7 are registered trademarks of Harman International Industries, Inc. HD Radio is a proprietary trademark of iBiquity Digital Corporation. Sirius, XM and all related marks and logos are trademarks of Sirius XM Radio Inc. Tuneln is a registered service mark of Tuneln, Inc. Twitter is a registered trademark of Twitter, Inc. Yelp is a registered trademark of Yelp Inc.

ENDNOTES

- 1 Stated rates of acceleration are estimated based upon manufacturer's track results and may vary depending on model, environmental and road surface conditions, driving style, elevation and vehicle load.
- 2 COLLISION PREVENTION ASSIST PLUS may not be sufficient to avoid an accident. It does not react to certain stationary objects, nor recognize or predict the curvature and/or lane layout of the road or every movement of vehicles ahead. It is the driver's responsibility at all times to be attentive to traffic and road conditions, and to provide the steering, braking and other driving inputs necessary to retain control of the vehicle. Drivers are cautioned not to wait for the system's alerts before braking, as that may not afford sufficient time and distance to brake safely. Autonomous braking is available at speeds between approximately 5 and 65 mph for moving vehicles, or 5 and 31 mph for stationary objects.
- 3 PRE-SAFE® closes the front side windows when the system's sensors detect side movements that suggest a possible rollover or side impact. A small gap is left near the fully closed position.
- 4 Driving while drowsy or distracted is dangerous and must be avoided. ATTENTION ASSIST® and/or Lane Keeping Assist may be insufficient to alert a fatigued or distracted driver of lane drift and cannot be relied on to avoid an accident or serious injury. Lane Keeping Assist operates at speeds above approximately 37 mph.
- 5 Blind Spot Assist may not be sufficient to avoid all accidents involving vehicles in your blind spot and does not estimate the speed of approaching vehicles. It must not be used as a sole substitute for driver awareness and checking of surrounding traffic conditions. Blind Spot Assist operates at speeds above approximately 20 mph.
- 6 DISTRONIC PLUS® adaptive cruise control is no substitute for active driving involvement. It does not adapt cruising speed in response to stationary objects, nor does it predict the curvature and lane layout of the road ahead or the movement of vehicles ahead. It is the driver's responsibility at all times to be attentive to traffic and road conditions, and to provide the steering, braking and other driving inputs necessary to retain control of the vehicle. Drivers are cautioned not to wait for the DISTRONIC Proximity Warning System before braking, as that may not afford sufficient time and distance to brake safely.
- 7 Braking effectiveness also depends on proper brake maintenance, and tire and road conditions.
- 8 For more information on the European Centre for Allergy Research Foundation (ECARF), visit ECARF.org/en
- 9 All Mercedes-Benz mbrace® services operate only where cellular and Global Positioning System satellite signals are available, which are provided by third parties and not within the control of Mercedes-Benz USA, LLC. Five years of the mbrace Connect package are included with new-vehicle sales and leases at an authorized Mercedes-Benz dealer. Subscriber Agreement is required for service to be active. Some services are only available on select vehicles. Your PIN is required in order to use certain services. Some services may be limited or restricted in some areas. Apps may be introduced and updated at varying dates, and may also require a vehicle software update. Driver is responsible for complying with traffic and other laws. See your dealer or MBUSA.com/mbrace for details, including a list of compatible smartphones. Streaming Internet-based features require an active subscription to the mbrace Entertain Package. Connection may be limited by cellular signal.
- 10 Roadside Assistance repairs may involve charges for parts, service and towing. Vehicle must be accessible from main roads. Depending on the circumstance, these services may be provided by an outside provider, courtesy of Mercedes-Benz Roadside Assistance. Restricted roadways, acts of nature and vehicle accessibility may limit our ability to provide services to you. For full details, eligibility requirements, and limitations/exclusions of Sign and Drive services, as well as the Roadside Assistance Program, please see your dealer.
- 11 The mbrace Mobile App is compatible with Apple iPhone® models running iOS 7.0 or later, and Android-based phones running OS 2.3 or later. Please visit MBUSA.com/mbrace for more information.
- 12 Lower aspect ratio tires and accompanying wheels provide substantially increased treadwear, increased tire noise and reduced ride comfort. Serious wheel and tire damage may occur if the vehicle is operated on rough or damaged road surfaces or upon encountering road debris or obstacles. These tires are not designed for use on snow and ice. Winter tires mounted on appropriately sized and approved wheels are recommended for driving in those conditions.
- 13 While the navigation system provides directional assistance, the driver must remain focused on safe driving behavior, including paying attention to traffic and street signs. The driver should utilize the system's audio cues while driving and should only consult the map or visual displays once the vehicle has been stopped in a safe place. Maps do not cover all areas or all routes within an area.
- 14 The purchase or lease of a new, satellite radio-enabled vehicle includes a 6-month introductory subscription to the Sirius All Access package, as well as a 5-year introductory subscription to SiriusXM Traffic and SiriusXM Weather when equipped with COMAND® navigation. SiriusXM Traffic and Weather services are available for select markets. SiriusXM Satellite Radio, SiriusXM Traffic and SiriusXM Weather subscriptions are sold separately or as a package after trial period. If you decide to continue your subscription after your trial, the plan you choose will automatically renew and you will be charged according to your chosen payment method at then-current rates. Fees and taxes apply. To cancel you must call SiriusXM at 1-866-635-2349. See SiriusXM Customer Agreement for complete terms at siriusxm.com. All fees and programming subject to change.
- 15 Rearview camera and Surround View System do not audibly notify driver of nearby objects and are not a substitute for actively checking around the vehicle for any obstacles or people. Images displayed may be limited by camera field of view, weather, lighting conditions and the presence of dirt, ice or snow on the cameras.
- 16 The carbon-ceramic brakes are designed expressly for high-performance braking. It is a characteristic of their materials and design that brake noise/squeal may result, along with differing brake pedal feel at lower brake temperatures compared to higher operating temperatures.
- 17 Option significantly reduces trunk space. Please see your dealer. Includes Extended Mobility tires and deletes spare tire on CLS 400 and CLS 550 models with standard 18" wheels. Requires Premium 2 Package on CLS 400. Not available in combination with accessory Comfort Box.
- 18 Wood/leather steering wheel and heated steering wheel may not be ordered together. Heated steering wheel requires Lane Tracking or Driver Assistance Package.
- 19 Extra-cost option. Some *designo* paintwork, upholstery and trim options may require additional production time.
- 20 Introduction dates vary. Please see your dealer.



The personal rewards of striving to be the best are even more meaningful in the development of young people than they are for automobiles. Instilling the values of leadership, goal-setting, discipline and teamwork in youth is an investment in everyone's future. It's why Mercedes-Benz USA is collaborating with the Laureus Sport for Good Foundation, with an ongoing commitment to train and place hundreds of coaches for after-school and in-school sports programs in communities around the country. Sports offer kids more than the chance to be physically active and have fun. It's also an opportunity to have a mentor who can guide them, help them learn how to deal with major life issues, and help them grow stronger not just physically but in their character. As a Mercedes-Benz driver, you become a part of this effort to give hundreds of thousands of kids a better life today, and all of us a brighter tomorrow.

Learn more about how Mercedes-Benz USA believes in giving back at MBUSA.com/community