



# Fire Monitoring Handbook



National Park Service  
U.S. Department of the Interior

Fire Management Program Center  
National Interagency Fire Center



---

# Fire Monitoring Handbook

# Abstract

---

Fire is a powerful and enduring force that has had, and will continue to have, a profound influence on National Park Service (NPS) lands. Fire management decisions within the National Park Service require information on fire behavior and on the effects of fire on park resources. With good reason, the public is holding park management increasingly accountable, especially in the area of fire management. Federal and state agencies are instituting progressively more stringent guidelines for burning, monitoring, and evaluation. The impetus behind these guidelines and the purpose of this handbook are to ensure that management objectives are being met, to provide guidance that can prevent fire management problems from developing, to limit possible legal actions against the agency, and to ensure that all parks collect at least the minimum information deemed necessary to evaluate their fire management programs.

There are many benefits to establishing these standardized data collection procedures. Uniformly-gathered data will facilitate information exchange among parks and provide historical program documentation and databases useful for refinements of the parks' fire management programs. In addition, standard procedures will enable fire monitors to move to or assist other parks without additional training.

The fire monitoring program described in this Fire Monitoring Handbook (FMH) allows the National Park Service to document basic information, to detect trends, and to ensure that each park meets its fire and resource management objectives. From identified trends, park staff can articulate concerns, develop hypotheses, and identify specific research studies to develop solutions to problems.

This handbook is intended to facilitate and standardize monitoring for National Park Service units that are subject to burning by wildland or prescribed fire. This handbook defines and establishes levels of monitoring activity relative to fire and resource management objectives and fire management strategies. At each successive level, monitoring is more extensive and complex. level 1 covers environmental monitoring, and levels 2, 3, and 4 call for monitoring of fire conditions, short-term change, and long-term change, respectively.

The levels are cumulative, requiring users to include all levels below the highest specified.

The standards outlined in this handbook require monitoring at all four levels for prescribed fires. For levels 1 to 3, the handbook describes Recommended Standard variables, including fire conditions and vegetation parameters. Procedures and recommended frequencies for monitoring and analysis are also specified. Depending on a park's management objectives, a park may need a specific monitoring design beyond or instead of the design covered in this handbook. References to different monitoring procedures are provided in the appendices.

A standardized system to cover the wide diversity of areas within the National Park Service will need fine-tuning from park to park. To facilitate this, each park will receive oversight and review for its monitoring program from its regional fire monitoring program manager, and refinements to this Fire Monitoring Handbook will be made as necessary. Until a subsequent revision of this handbook is published, these refinements will be made available on the Internet at <[www.nps.gov/fire/fire/fir\\_eco\\_monitoring.html](http://www.nps.gov/fire/fire/fir_eco_monitoring.html)> Also at this website is information on how parks are using their data and how to download the associated software.

**USDI National Park Service. 2003. Fire Monitoring Handbook. Boise (ID): Fire Management Program Center, National Interagency Fire Center. 274p.**

**Keywords:** Fire Behavior, Fire Monitoring, Adaptive Management, Vegetation Monitoring, Sampling, Sampling Design, Objective Development, Wildland Fire, Prescribed Fire.

*Printed on Recycled Paper*



# Acknowledgments

---

Many have worked toward the development of this handbook. While we cannot possibly acknowledge all contributors, including all the people who used this methodology and provided us with comments, we would like to recognize individuals who were critical to this effort.

## Fire Monitoring Steering Committee, 1977

Stephen J. Botti (Task Force Chairperson), National Park Service, National Interagency Fire Center

Craig Allen, US Geological Survey, Biological Resources Division, Bandelier National Monument

Elizabeth Anderson, National Park Service, Intermountain Regional Office, retired

MaryBeth Keifer, Sequoia and Kings Canyon National Parks

Dan O'Brien, National Park Service, Intermountain Regional Office, retired

Rebecca Power (Representative, Region 3 Fire Monitoring Task Force), US Fish and Wildlife Service, Necedah National Wildlife Refuge

Doug Wallner, National Park Service, Philadelphia Support Office

## Task Force Consultants and Reviewers

Jonathan Arnold  
Lassen Volcanic National Park

Henry Bastian, Zion National Park

Pam Benjamin, National Park Service, Intermountain Regional Office

Ed Berg, US Fish and Wildlife Service, Kenai National Wildlife Refuge

Frank Boden, Bureau of Indian Affairs, retired

Beth Buchanan, Daniel Boone National Forest

Dan Buckley, Yosemite National Park

Gary Davis, Channel Islands National Park

John Dennis, National Park Service, Natural Resource, Information Division

Robert Dellinger, Great Smoky Mountains National Park

Dennis Divoky, Glacier National Park

Gregory Eckert, National Park Service, Biological Resource Management Division

Steve Fancy, National Park Service, Natural Resource, Information Division

Patti Haggarty, Corvallis Forest Science Laboratory

Walter Herzog, Bureau of Land Management, Redding Resource Area

Laura Hudson, National Park Service, Intermountain Regional Office

Roger Hungerford, USDA Forest Service Intermountain Research Station, retired

Ben Jacobs, Point Reyes National Seashore

Evelyn Klein, Lyndon B. Johnson National Historical Park, retired

Mary Kwart, US Fish and Wildlife Service, Tetlin National Wildlife Refuge

Bill Leenhouts, Fish and Wildlife Service, National Interagency Fire Center

Michael Loik, University of California

Mack McFarland, Grand Teton National Park

Melanie Miller, Bureau of Land Management, National Interagency Fire Center

Wesley Newton, US Geological Survey Biological Resources, Division Northern Prairie Wildlife Research Center

Howard T. Nichols, Pacific West Regional Office

Larry Nickey, Olympic National Park

Tonja Opperman, Bitterroot National Forest

William Patterson III, University of Massachusetts

Arnie Peterson, Lassen Volcanic National Park

Nathan Rudd, The Nature Conservancy, Oregon Field Office

Kevin Ryan, Intermountain Fire Sciences Lab

Kathy Schon, Saguaro National Park

Tim Sexton, National Park Service National Interagency Fire Center

Carolyn Hull Sieg, Rocky Mountain Research Station

Geoffrey Smith  
Apostle Islands National Lakeshore

Tom Stohlgren, US Geological Survey Biological Resources Division, Colorado State University

Tim Stubbs, Carlsbad Caverns National Park

Gary Swanson, US Fish and Wildlife Service, Sherburne National Wildlife Refuge

Charisse Sydoriak, Bureau of Land Management

Alan Taylor  
Pennsylvania State University

Lisa Thomas, Wilson's Creek National Battlefield

Laura Trader, Bandelier National Monument

Jan Van Wagtendonk, US Geological Survey Biological Resources Division, Yosemite Field Station

C. Phillip Weatherspoon, US Forest Service Pacific Southwest Forest and Range Experiment Station

Meredith Weltmer, US Fish and Wildlife Service, Region 3

John Willoughby, Bureau of Land Management, California State Office

### **Steering Committee Support Staff:**

#### **Rewrite Committee**

Paul Reeberg (Coordinator, Content Editor)  
National Park Service, Pacific West Regional Office

Eric Allen, Jewel Cave National Monument

MaryBeth Keifer, Sequoia and Kings Canyon National Parks

Richard Bahr, National Interagency Fire Center

Elizabeth Anderson, National Park Service, Intermountain Regional  
Office, retired

Tony LaBanca, California Department of Fish and Game, Northern  
California-North Coast Region

Stassia Samuels, Redwood National and State Parks

Rick Anderson, Archbold Biological Station

Jeanne E. Taylor, Golden Gate National Recreation Area, retired

John Segar, Boise National Forest

Dale Haskamp, Redwood National and State Parks, retired

#### **Data Entry and Processing Software**

Walter M. Sydoriak (Developer), Bandelier National Monument

Tim Sexton (Coordinator), National Interagency Fire Center

#### **Editorial Review**

Kathy Rehm Switky, Menlo Park, CA

#### **Formatting**

Paul Reeberg and Brenda Kauffman  
National Park Service, Pacific West Regional Office

#### **Design and Illustration**

Eugene Fleming  
National Park Service, Pacific West Regional Office

#### **Cover Photography**

Fire on the Ridge: © Richard Blair, [www.richardblair.com](http://www.richardblair.com)  
Shoot emerging from pine needles: © Michael S. Quinton, National  
Geographic Society

# Contents

---

	Abstract	ii
	Acknowledgments	iii
	Use of this Handbook	ix
	Symbols Used in this Handbook	x
<b>Chapter 1</b>	<b>Introduction</b>	<b>1</b>
	<i>Fire Monitoring Policy</i>	1
	<i>Recommended Standards</i>	2
	<i>Some Cautions</i>	2
	<i>Fire Management Strategies</i>	3
	<i>Program Responsibilities of NPS Personnel</i>	4
	<i>Fire Monitoring Levels</i>	4
<b>Chapter 2</b>	<b>Environmental &amp; Fire Observation</b>	<b>7</b>
	Monitoring Level 1: Environmental Monitoring	7
	<i>Monitoring Schedule</i>	7
	<i>Procedures and Techniques</i>	7
	Monitoring Level 2: Fire Observation	9
	Reconnaissance Monitoring	9
	<i>Monitoring Schedule</i>	9
	<i>Procedures and Techniques</i>	9
	Fire Conditions Monitoring	11
	<i>Monitoring Schedule</i>	11
	<i>Procedures and Techniques</i>	11
	<i>Postburn Report</i>	15
<b>Chapter 3</b>	<b>Developing Objectives</b>	<b>19</b>
	Objectives	20
	<i>Management Objectives</i>	20
	<i>Monitoring Objectives</i>	23
	Objective Variables	29
	<i>Comparing Vegetation Attributes</i>	30
	<i>Point Intercept Method</i>	31
	<i>Other Methods</i>	32
<b>Chapter 4</b>	<b>Monitoring Program Design</b>	<b>33</b>
	Monitoring Types	34
	<i>Defining Monitoring Types</i>	34
	Variables	41
	<i>Level 3 and 4 Variables</i>	41
	<i>RS Variables</i>	41
	Sampling Design	43
	<i>Pilot Sampling</i>	43
	<i>Deviations or Additional Protocols</i>	47
	<i>Considerations Prior to Further Plot Installation</i>	48
	<i>Sampling Design Alternatives</i>	48
	<i>Calculating Minimum Sample Size</i>	49
	<i>Monitoring Design Problems</i>	50
	<i>Control Plots</i>	52
	<i>Dealing with Burning Problems</i>	53
<b>Chapter 5</b>	<b>Vegetation Monitoring Protocols</b>	<b>55</b>
	<i>Methodology Changes</i>	55

<i>Monitoring Schedule</i>	- - - - -	55
Generating Monitoring Plot Locations	- - - - -	59
<i>Creating Equal Portions for Initial Plot Installation</i>	- - - - -	60
<i>Creating n Equal Portions Where Plots Already Exist</i>	- - - - -	60
<i>Randomly Assigning Plot Location Points</i>	- - - - -	60
Plot Location	- - - - -	62
<i>Step 1: Field Locating PLPs</i>	- - - - -	62
<i>Step 2: Assessing Plot Acceptability and Marking Plot Origin</i>	- - - - -	62
Laying Out and Installing Monitoring Plots	- - - - -	64
<i>Grassland and Brush Plots</i>	- - - - -	64
<i>Forest Plots</i>	- - - - -	67
Labeling Monitoring Plot Stakes	- - - - -	70
Photographing the Plot	- - - - -	71
<i>Grassland and Brush Plots</i>	- - - - -	71
<i>Forest Plots</i>	- - - - -	71
<i>RS Procedures</i>	- - - - -	71
<i>Equipment and Film</i>	- - - - -	72
Field Mapping the Monitoring Plot	- - - - -	75
<i>Complete Plot Location Data Sheet</i>	- - - - -	75
Monitoring Vegetation Characteristics	- - - - -	80
<i>All Plot Types</i>	- - - - -	80
<i>Herbaceous and Shrub Layers</i>	- - - - -	80
<i>Brush and Forest Plots</i>	- - - - -	87
Monitoring Overstory Trees	- - - - -	91
<i>Tag and Measure All Overstory Trees</i>	- - - - -	91
<i>Optional Monitoring Procedures</i>	- - - - -	93
Monitoring Pole-size Trees	- - - - -	100
<i>Measure Density and DBH of Pole-size Trees</i>	- - - - -	100
<i>Optional Monitoring Procedures</i>	- - - - -	100
Monitoring Seedling Trees	- - - - -	102
<i>Count Seedling Trees to Obtain Species Density</i>	- - - - -	102
<i>Optional Monitoring Procedures</i>	- - - - -	102
Monitoring Dead and Downed Fuel Load	- - - - -	103
<i>RS Procedures</i>	- - - - -	103
<i>Deal with Sampling Problems</i>	- - - - -	105
Monitoring Fire Weather and Behavior Characteristics	- - - - -	106
<i>Rate of Spread</i>	- - - - -	106
<i>Flame Length and Depth</i>	- - - - -	106
Monitoring Immediate Postburn Vegetation & Fuel Characteristics	- - - - -	108
<i>Grassland and Brush Plots</i>	- - - - -	108
<i>Forest Plots</i>	- - - - -	108
<i>Monitor Postburn Conditions</i>	- - - - -	108
<i>Optional Monitoring Procedures</i>	- - - - -	111
File Maintenance & Data Storage	- - - - -	112
<i>Plot Tracking</i>	- - - - -	112
<i>Monitoring Type Folders</i>	- - - - -	112
<i>Monitoring Plot Folders</i>	- - - - -	112
<i>Slide—Photo Storage</i>	- - - - -	112
<i>Field Packets</i>	- - - - -	112
<i>Data Processing and Storage</i>	- - - - -	113
Ensuring Data Quality	- - - - -	114
<i>Quality Checks When Remeasuring Plots</i>	- - - - -	114
<i>Quality Checks in the Field</i>	- - - - -	115

	<i>Quality Checks in the Office</i>	115
	<i>Quality Checks for Data Entry</i>	116
<b>Chapter 6</b>	<b>Data Analysis and Evaluation</b>	119
	<i>Level 3: Short-term Change</i>	119
	<i>Level 4: Long-term Change</i>	119
	The Analysis Process	121
	<i>Documentation</i>	121
	<i>Examining the Raw Data</i>	121
	<i>Summarizing the Data</i>	122
	<i>Recalculating the Minimum Sample Size</i>	124
	Additional Statistical Concepts	126
	<i>Hypothesis Tests</i>	126
	<i>Interpreting Results of Hypothesis Tests</i>	128
	The Evaluation Process	130
	<i>Evaluating Achievement of Management Objectives</i>	130
	<i>Evaluating Monitoring Program or Management Actions</i>	131
	<i>Disseminating Results</i>	134
	<i>Reviewing the Monitoring Program</i>	135
<b>Appendix A</b>	<b>Monitoring Data Sheets</b>	137
<b>Appendix B</b>	<b>Random Number Generators</b>	189
	<i>Using a Table</i>	189
	<i>Using Spreadsheet Programs to Generate Random Numbers</i>	191
<b>Appendix C</b>	<b>Field Aids</b>	193
	Collecting & Processing Voucher Specimens	193
	<i>Collecting</i>	193
	<i>Tools and Supplies</i>	194
	<i>Pressing and Drying</i>	195
	<i>Mounting Labeling and Storing</i>	197
	Identifying Dead & Dormant Plants	199
	<i>Resources</i>	199
	<i>Observations</i>	199
	Navigation Aids	201
	<i>Compass</i>	201
	<i>Using a Compass in Conjunction with a Map</i>	201
	<i>Clinometer</i>	202
	<i>Determining Distances in the Field</i>	203
	<i>Some Basic Map Techniques</i>	204
	<i>Global Positioning System Information</i>	205
	Basic Photography Guidelines	207
	Conversion Tables	209
<b>Appendix D</b>	<b>Data Analysis Formulae</b>	213
	<i>Cover</i>	213
	<i>Tree, Herb, and Shrub Density</i>	213
	<i>Fuel Load</i>	214
	<i>Data Analysis Calculations</i>	216
<b>Appendix E</b>	<b>Equipment Checklist</b>	221
	<i>Locating Marking and Installing a Monitoring Plot</i>	221
	<i>Monitoring Forest Plots</i>	221
	<i>Monitoring Brush and Grassland Plots</i>	222
	<i>Monitoring During a Prescribed Fire</i>	222
	<i>Monitoring During a Wildland Fire</i>	223
	<i>Optional Equipment</i>	224
<b>Appendix F</b>	<b>Monitoring Plan Outline</b>	225



	<i>Introduction (General)</i>	225
	<i>Description of Ecological Model</i>	225
	<i>Management Objective(s)</i>	225
	<i>Monitoring Design</i>	225
<b>Appendix G</b>	<b>Additional Reading</b>	229
	References for Nonstandard Variables	229
	<i>General</i>	229
	<i>Fire Conditions and Observations</i>	230
	<i>Air, Soil and Water</i>	231
	<i>Forest Pests (Mistletoe, Fungi, and Insects)</i>	232
	<i>Amphibians and Reptiles</i>	233
	<i>Birds</i>	234
	<i>Mammals</i>	236
	<i>Vegetation</i>	237
	<i>Fuels</i>	237
	<i>Adaptive Management</i>	239
	Vegetative Keys	240
<b>Glossary of Terms</b>		247
<b>References</b>		259
	<i>Cited References</i>	259
	<i>Additional References</i>	261
<b>Index</b>		263

# Use of this Handbook

---

The handbook presents detailed instructions for fire monitoring in a variety of situations. The instructions are organized around the management strategies frequently used to meet specific objectives.

Each chapter covers a different aspect of fire effects monitoring. You will find an overview of each area, and the functions within that area, at the beginning of each chapter.

**Chapter 1:** Introduction—an overview of the entire National Park Service Fire Monitoring program.

**Chapter 2:** Environmental and Fire Observation—a detailed discussion of the monitoring schedule and procedures involved with monitoring levels 1 (environmental) and 2 (fire observation).

**Chapter 3:** Developing Objectives—development of objectives and the basic management decisions necessary to design a monitoring program. This basic design is expanded upon in chapter four.

**Chapter 4:** Monitoring Program Design—detailed instructions for designing a monitoring program for short-term and long-term change, randomizing monitoring plots, and choosing monitoring variables.

**Chapter 5:** Vegetation Monitoring Protocols—detailed procedures for reading plots designed to monitor prescribed fires (at levels 3 and 4) for forest, grassland and brush plot types.

**Chapter 6:** Data Analysis and Evaluation—guidance for data analysis and program evaluation.

**Appendices:** data record forms, random number tables, aids for data collection, useful equations, references describing methods not covered in this handbook, and handbook references.

This handbook is designed to be placed in a binder so that you can remove individual chapters and appendices. You can detach the instructions for the applicable monitoring level required for a fire from the binder and carry them into the field for easy reference.

---

## Field Handbook



If you need a small portable version of this handbook, use a copy machine to create a ¼ size version of the pages you will need in the field (e.g., Chapter 5, Appendix C).

---

# Symbols Used in this Handbook

---

**Note:** Refer to the Index for the location of the following symbols within this handbook.

## Reminder



This symbol indicates information that you won't want to forget!

---

## Tip from the Field



This symbol indicates advice from experienced field folks. Additional field tips may be found in Elzinga and others (1998), pages 190–1 (marking the plot), 192–6 (field equipment) and page 406 (general field tips).

---

## Warning



This symbol denotes potentially hazardous or incorrect behavior. It is also used to indicate protocol changes since the last revision of this Fire Monitoring Handbook (NPS 1992).

---

*“Not everything that can be counted counts, and not everything that counts can be counted.”*

—Albert Einstein

Fire is a powerful and enduring force that has had, and will continue to have, a profound influence on National Park Service (NPS) lands. Restoring and maintaining this natural process are both important management goals for many NPS areas. Therefore, information about the use and effects of prescribed fire on park resources is critical to sound, scientifically-based management decisions. Using results from a high quality monitoring program to evaluate your prescribed fire management program is the key to successful adaptive management. By using monitoring results to determine whether you are meeting your management objectives, you can verify that the program is on track, or conversely, gather clues about what may not be working so that you can make appropriate changes.

This fire monitoring program allows the National Park Service to document basic information, to detect trends, and to ensure that parks meet their fire and resource management objectives. From identified trends, park staff can articulate concerns, develop hypotheses, and identify specific research projects to develop solutions to problems. The goals of the program described here are to:

- Document basic information for all wildland fires, regardless of management strategy
- Document fire behavior to allow managers to take appropriate action on all fires that either:
  - have the potential to threaten resource values
  - are being managed under specific constraints, such as a prescribed fire or fire use
- Document and analyze both short-term and long-term prescribed fire effects on vegetation
- Establish a recommended standard for data collection and analysis techniques to facilitate the sharing of monitoring data
- Follow trends in plant communities where fire effects literature exists, or research has been conducted
- Identify areas where additional research is needed

This Fire Monitoring Handbook (FMH) describes the procedures for this program in National Park Service units.

## **FIRE MONITORING POLICY**

Staff in individual parks document the rationale, purpose, and justification of their fire management programs in their Natural Resource Management Plans and Fire Management Plans. Director’s Order #18: Wildland Fire Management (DO-18) (USDI National Park Service 1998) outlines National Park Service fire management policies, which are expanded upon in Reference Manual-18: Wildland Fire Management (RM-18) (USDI National Park Service 2001a).

### **Provisions of NEPA**

The National Environmental Policy Act (42 USC 4321–4347), NEPA (1969), mandates that monitoring and evaluation be conducted to mitigate human actions that alter landscapes or environments. The Code of Federal Regulations (CFR) provides the following legal directives:

#### 40 CFR Sec. 1505.03

“Agencies may provide for monitoring to assure that their decisions are carried out and should do so in important cases.”

#### 40 CFR Sec. 1505.2(c)

“A monitoring and enforcement program shall be adopted and summarized when applicable for any mitigation.”

### **DO-18: Wildland Fire Management**

DO-18: Wildland Fire Management (USDI NPS 1998) directs managers to monitor all prescribed and wildland fires. Monitoring directives (summarized here from DO-18) are:

Fire effects monitoring must be done to evaluate the degree to which objectives are accomplished

Long-term monitoring is required to document that overall programmatic objectives are being met and undesired effects are not occurring. Evaluation of fire effects data are the joint responsibility of fire management and natural resource management personnel.

Neither DO-18 nor RM-18 describes how monitoring is to be done. This handbook provides that guidance by outlining standardized methods to be used throughout the National Park Service for documenting, monitoring, and managing both wildland and prescribed fires.

## RECOMMENDED STANDARDS

This handbook outlines **Recommended Standards (RS)** for fire monitoring within the National Park Service. These standard techniques are mandatory for Environmental (level 1) and Fire Observation (level 2) monitoring. The techniques presented for Short-term change (level 3) and Long-term change (level 4) monitoring are confined to vegetation monitoring, and will not answer all questions about the effects of fire management programs on park ecosystems. Many parks will require additional research programs to study specific issues such as: postburn erosion, air and water quality, wildlife, cultural resources, and the cumulative effects of burning on a landscape scale. Parks are encouraged to expand long-term monitoring to include any additional physical or biotic ecosystem elements important to management but not covered by these Recommended Standards.

Consult a regional fire monitoring coordinator, local researcher, resource manager, and/or fire manager before eliminating or using protocols other than the Recommended Standards. For example, park managers should not eliminate fuel transects in a forest plot because they do not want to spend the time monitoring them. However, if during the pilot sampling period (see page 43) another sampling method performs better statistically than a method prescribed by this handbook, it is then recommended that you substitute this other sampling method.

## SOME CAUTIONS

### Monitoring vs. Research

Monitoring (as defined in the Glossary) is always driven by fire and resource management objectives,

and is part of the adaptive management cycle. As part of this cycle, it is used to measure change over time, and can therefore help evaluate progress toward or success at meeting an objective. Monitoring can also provide a basis for changing management actions, if needed.

Research (as defined in the Glossary) is often focused on identifying correlation of change with a potential cause. Few monitoring projects can identify this correlation. As you move along the continuum from monitoring to research, you gain increased confidence as to the cause of a response, often with an associated increase in study costs. Because a monitoring program does not control for potential causes, monitoring data should not be mistaken for information on cause and effect. If you need causality data for a management objective, you will need input from a statistician and/or research scientist for a research study design.

A distinction has traditionally been made between research and monitoring, but as monitoring programs become better designed and statistically sound, this distinction becomes more difficult to discern. A monitoring program without a well-defined objective is like a research experiment without a hypothesis. Likewise, statistically testing whether an objective has been met in a monitoring program is very similar to hypothesis testing in a research experiment. Knowing which statistical test is appropriate, along with the assumptions made by a particular test, is critical in order to avoid making false conclusions about the results. Because statistical procedures can be complex, it is recommended that you consult with a statistician when performing such tests.

### Control Plots

Install control plots (see Glossary, and page 52) when it is critical to isolate the effects of fire from other environmental or human influences, or to meet specific requirements, e.g., a prescribed fire plan. Control plot sampling design will necessarily be specific to the site and objective, and will require assistance from subject-matter experts.

### Alternative Methods

**If your management staff chooses objectives that you cannot monitor using the protocols discussed in this handbook, you will need to develop appropriate sampling methods.** For example, objectives

set at the landscape level (large forest gaps), or that relate to animal populations would require additional methods. Appendix G lists several monitoring references for other sampling methods. Develop customized monitoring systems with the assistance of subject-matter experts. Your regional fire monitoring coordinator must review any alternative methodology.

### Required Research

Park staff should have fire management program objectives that are definable and measurable (see page 20) and knowledge to reasonably predict fire effects. If these criteria are not met, fire ecologists should conduct research to determine the role of fire in the park and develop prescriptions capable of meeting park management objectives. The park may need to delay implementation of its prescribed fire management program until these issues are resolved. Following this resolution, monitoring **must** be initiated to assess the need for changes in the program.

## FIRE MANAGEMENT STRATEGIES

This handbook is organized around fire management strategies that are directed by resource and fire management objectives. A Recommended Standard monitoring level is given for each management strategy. Table 1 outlines monitoring levels required for wildland fire management strategies. The information collected at each of these levels is the recommended minimum; park staffs are encouraged to collect additional information within their monitoring programs as they see fit.

### Suppression

Park managers often set fire suppression goals in order to minimize negative consequences of wildland fires. A fire suppression operation will have well-established and standardized monitoring needs based on these goals. For most suppressed wildland fires, monitoring means recording data on fire cause and origin, discovery, size, cost, and location. This is the reconnaissance portion of level 2 monitoring (fire observation; see page 9).

Monitoring the effect of suppressed wildland fires on vegetation or other area-specific variables of special concern may produce valuable information on fire effects, identify significant threats to park resources, or permit adjustments to appropriate suppression actions. This information may drive the need for a rehabilitation response to a wildland fire.

An additional caution here is that fire funds will not pay for levels 3 and 4 monitoring of suppression fires.

### Wildland Fire Use

Fire management programs that focus on maintaining natural conditions in native ecosystems generally need different management strategies and have different monitoring needs. These programs will meet the Recommended Standard by collecting the data needed to complete Stage I of the Wildland Fire Implementation Plan (see Glossary). This is Fire Observation level 2 monitoring, which includes reconnaissance (see page 9) and fire conditions (see page 11).

Table 1. Wildland fire management strategies and Recommended Standard (RS) monitoring levels.

Management Strategy	RS Level
<b>Suppression:</b> All management actions are intended to extinguish or limit the growth of the fire.	1. Environmental 2. Fire Observation –Reconnaissance
<b>Wildland Fire Use:</b> Management allows a fire started by a natural source to burn as long as it meets prescription standards.	1. Environmental 2. Fire Observation –Reconnaissance –Fire Conditions
<b>Prescribed Fire:</b> Management uses intentionally set fires as a management tool to meet management objectives.	1. Environmental 2. Fire Observation –Reconnaissance –Fire Conditions 3. Short-term Change 4. Long-term Change

## Prescribed Fire

Prescribed fire requires a much more complex monitoring system to document whether specific objectives are accomplished with the application of fire. The Recommended Standard here includes a hierarchy of monitoring levels from simple reconnaissance to the complex monitoring of prescriptions, immediate postburn effects, and the long-term changes in vegetation community structure and succession. Measuring the effectiveness of prescribed fire for natural ecosystem restoration may take decades.

Managers can use **research burns** to expand their knowledge of fire ecology. However, this handbook does not cover the sampling design necessary for these burns. Your regional fire ecologist can assist you with this design.

## PROGRAM RESPONSIBILITIES OF NPS PERSONNEL

Implementation of this monitoring program requires substantial knowledge. Park fire management officers and natural resource managers must understand ecological principles and basic statistics.

Park superintendents are responsible for implementing and coordinating a park's fire monitoring program. They also may play active roles on program review boards established to assess whether monitoring objectives are being met, and whether information gathered by a monitoring effort is addressing key park issues.

Fire management personnel are responsible for assuring the completion of environmental monitoring (level 1) as part of the fire management plan process, as well as daily observations and continual field verification.

Fire management personnel are also responsible for collecting fire observation monitoring data (level 2) for each fire. These observations are needed as part of the Initial Fire Assessment, which documents the decision process for the Recommended Response Action. This then becomes Stage I in the Wildland Fire Implementation Plan for a "go" decision to elicit the appropriate management response.

Natural resource and fire management personnel are responsible for monitoring design and the evaluation

of short-term and long-term change data (levels 3 and 4). They are also responsible for quality control and quality assurance of the monitoring program.

Field technicians are responsible for collecting and processing plot data, and must be skilled botanists.

Park and regional science staff, local researchers, statisticians and other resource management specialists may act as consultants at any time during implementation of the monitoring program. Consultants may be particularly valuable in helping to stratify monitoring types, select monitoring plot locations, determine the appropriate numbers of monitoring plots, evaluate preliminary and long-term results, and prepare reports.

Local and regional scientists should assure that those research needs identified by monitoring efforts are evaluated, prioritized, designed, and incorporated into the park's Resource Management Plan. These staff should assist, when needed, in the sampling procedures designed to determine whether short-term objectives are met, and in the analysis of short-term change and long-term change monitoring data. They should work with resource management staff to evaluate fully any important ecological results and to facilitate publication of pertinent information. These efforts should validate the monitoring program, or provide guidance for its revision. Local researchers should also serve on advisory committees for park units as well as on program review boards.

The National Office (located at the National Inter-agency Fire Center (NIFC)) will ensure that minimum levels of staff and money are available to meet program objectives. This includes the assignment of a regional fire monitoring specialist to ensure 1) consistency in handbook application; 2) quality control and quality assurance of the program; 3) timely data processing and report writing; and 4) coordination of periodic program review by NPS and other scientists and resource managers. See the NPS policy document RM-18 for the essential elements of a program review (USDI NPS 2001a).

## FIRE MONITORING LEVELS

The four monitoring levels, in ascending order of complexity, are **Environmental**, **Fire Observation**, **Short-term Change**, and **Long-term Change**. These

four levels are cumulative; that is, implementing a higher level usually requires that you also monitor all lower levels. For example, monitoring of short-term change and long-term change is of little value unless you have data on the fire behavior that produced the measured change.

### **Gathering and Processing Data**

Data are gathered following the directions and standards set in this handbook. Instructions are in each chapter and the forms are located in Appendix A. Software is available (Sydoriak 2001) for data entry and basic short-term and long-term change data analyses. You can order the FMH.EXE software and manual from the publisher of this handbook, or via the Internet at <[www.nps.gov/fire/fmh/index.htm](http://www.nps.gov/fire/fmh/index.htm)>.

Data entry, editing, and storage are major components of short-term change and long-term change monitoring (levels 3 and 4). For levels 3 and 4, monitoring staff should expect to spend 25 to 40 percent of their time on such data management.

### **Level 1: Environmental**

This level provides a basic overview of the baseline data that can be collected prior to a burn event. Information at this level includes historical data such as weather, socio-political factors, terrain, and other factors useful in a fire management program. Some of these data are collected infrequently (e.g., terrain); other data (e.g., weather) are collected regularly.

### **Level 2: Fire Observation**

Document fire observations during all fires. Monitoring fire conditions calls for data to be collected on ambient conditions as well as on fire and smoke characteristics. These data are coupled with information gathered during environmental monitoring to predict fire behavior and identify potential problems.

### **Level 3: Short-term Change**

Monitoring short-term change (level 3) is required for all prescribed fires. Monitoring at this level provides information on fuel reduction and vegetative change within a specific vegetation and fuel complex (monitoring type), as well as on other variables, according to your management objectives. These data allow you to make a quantitative evaluation of whether a stated management objective was met.

Vegetation and fuels monitoring data are collected primarily through sampling of permanent monitoring plots. Monitoring is carried out at varying frequencies—preburn, during the burn, and immediately postburn; this continues for up to two years postburn.

### **Level 4: Long-term Change**

Long-term change (level 4) monitoring is also required for prescribed fires, and often includes monitoring of short-term change (level 3) variables sampled at the same permanent monitoring plots over a longer period. This level of monitoring is also concerned with identification of significant trends that can guide management decisions. Some trends may be useful even if they do not have a high level of certainty. Monitoring frequency is based on a sequence of sampling at some defined interval (often five and ten years and then every ten years) past the year-2 postburn monitoring. This long-term change monitoring continues until the area is again treated with fire.

This handbook's monitoring system does not specify the most appropriate indicators of long-term change. Establishment of these indicators should include input from local and/or regional ecologists and should consider: 1) fire management goals and objectives, 2) local biota's sensitivity to fire-induced change, and 3) special management concerns.





# 2

## Environmental & Fire Observation

*“Yesterday is ashes, tomorrow is wood, only today does the fire burn brightly.”*

—Native North American saying

The first two monitoring levels provide information to guide fire management strategies for wildland and prescribed fires. Levels 1 and 2 also provide a base for monitoring prescribed fires at levels 3 and 4.

### Monitoring Level 1: Environmental Monitoring

Environmental monitoring provides the basic background information needed for decision-making. Parks may require unique types of environmental data due to the differences in management objectives and/or their fire environments. The following types of environmental data can be collected:

- Weather
- Fire Danger Rating
- Fuel Conditions
- Resource Availability
- Concerns and Values to be Protected
- Other Biological, Geographical or Sociological Data

#### MONITORING SCHEDULE

Collect environmental monitoring data hourly, daily, monthly, seasonally, yearly, or as appropriate to the rate of change for the variable of interest, regardless of whether there is a fire burning within your park.

You can derive the sampling frequency for environmental variables from management objectives, risk assessments, resource constraints or the rate of ecological change. Clearly define the monitoring schedules at the outset of program development, and base them on fire and resource management plans.

#### PROCEDURES AND TECHNIQUES

This handbook does not contain specific methods for level 1 monitoring, but simply discusses the different types of environmental monitoring that managers may

use or need. You may collect and record environmental data using any of a variety of methods.

#### Weather

Parks usually collect weather data at a series of Remote Automatic Weather Stations (RAWS) or access data from other sources, e.g., NOAA, Internet, weather satellites. These data are critical for assessment of current and historical conditions.

You should collect local weather data as a series of observations prior to, during and after the wildland or prescribed fire season. Maintain a record of metadata (location, elevation, equipment type, calibration, etc.) for the observation site.

#### Fire Danger Rating

Collect fire weather observations at manual or automated fire weather stations at the time of day when temperature is typically at its highest and humidity is at its lowest. You can then enter these observations are into processors that produce National Fire Danger Rating System (NFDRS) and/or Canadian Forest Fire Danger Rating System (CFFDRS) indices. These indices, in combination with weather forecasts, are used to provide information for fire management decisions and staffing levels.

#### Fuel Conditions

The type and extent of fuel condition data required are dependent upon your local conditions and management objectives.

- **Fuel type:** Utilize maps, aerial photos, digital data, and/or surveys to determine and map primary

fuel models (Fire Behavior Prediction System fuel models #1–13 or custom fuel models).

- **Fuel load:** Utilize maps, aerial photos, digital data, and/or surveys to determine and map fuel load.
- **Plant phenology:** Utilize on-the-ground observations, satellite imagery, or vegetation indices to determine vegetation flammability.
- **Fuel moisture:** Utilize periodic sampling to determine moisture content of live fuels (by species) and/or dead fuels (by size class). This information is very important in determining potential local fire behavior.

### Resource Availability

Track the availability of park and/or interagency resources for management of wildland and prescribed fires using regular fire dispatch channels.

### Concerns and Values to be Protected

The identification and evaluation of existing and potential concerns, threats, and constraints concerning park values requiring protection is an important part of your preburn data set.

**Improvements:** Including structures, signs, boardwalks, roads, and fences

**Sensitive natural resources:** Including threatened, endangered and sensitive species habitat, endemic species and other species of concern, non-native plant and animal distributions, areas of high erosion potential, watersheds, and riparian areas

**Socio-political:** Including public perceptions, cooperator relations, and potential impacts upon staff, visitors, and neighbors

**Cultural-archeological resources:** Including artifacts, historic structures, cultural landscapes, traditional cultural properties, and viewsheds

**Monitoring-research locations:** Including plots and transects from park and cooperator projects

**Smoke management concerns:** Including non-attainment zones, smoke-sensitive sites, class 1 airsheds, and recommended road visibility standards

### Other Biological, Geographical and Sociological Data

In addition to those data that are explicitly part of your fire management program, general biological, geographical and sociological data are often collected as a basic part of park operations. These data may include: terrain, plant community or species distribution, species population inventories, vegetation structure, soil

types, long-term research plots, long-term monitoring plots, and visitor use.

### *Using data for decision-making*

Any of several software packages can help you manage biological and geographical data from your fire monitoring program, and make management decisions. Obtain input from your regional, national or research staff in selecting an appropriate software package.

## Monitoring Level 2: Fire Observation

---

Fire observation (level 2) monitoring, includes two stages. First, reconnaissance monitoring is the basic assessment and overview of the fire. Second, fire conditions monitoring is the monitoring of the dynamic aspects of the fire.

### Reconnaissance Monitoring

---

Reconnaissance monitoring provides a basic overview of the physical aspects of a fire event. On some wildland fires this may be the only level 2 data collected. Collect data on the following variables for all fires:

- Fire Cause (Origin) and Ignition Point
- Fire Location and Size
- Logistical Information
- Fuels and Vegetation Description
- Current and Predicted Fire Behavior
- Potential for Further Spread
- Current and Forecasted Weather
- Resource or Safety Threats and Constraints
- Smoke Volume and Movement

#### MONITORING SCHEDULE

Reconnaissance monitoring is part of the initial fire assessment and the periodic revalidation of the Wildland Fire Implementation Plan. Recommended Standards are given here.

##### **Initial Assessment**

During this phase of the fire, determine fire cause and location, and monitor fire size, fuels, spread potential, weather, and smoke characteristics. Note particular threats and constraints regarding human safety, cultural resources, and threatened or endangered species or other sensitive natural resources relative to the suppression effort (especially fireline construction).

##### **Implementation Phase**

Monitor spread, weather, fire behavior, smoke characteristics, and potential threats throughout the duration of the burn.

##### **Postburn Evaluation**

Evaluate monitoring data and write postburn reports.

#### PROCEDURES AND TECHNIQUES

Collect data from aerial or ground reconnaissance and record them on the Initial Fire Assessment. Forms FMH-1 (or -1A), -2 (or -2A), and -3 (or -3A) (Appen-

dix A) will help with documentation of repeated field observations.

##### **Fire Cause (Origin), and Ignition Point**

Determine the source of the ignition and describe the type of material ignited (e.g., a red fir snag). It is important to locate the origin and document the probable mechanism of ignition.

##### **Fire Location and Size**

Fire location reports must include a labeled and dated fire map with appropriate map coordinates, i.e., Universal Transverse Mercator (UTM), latitude and longitude, legal description or other local descriptor. Also, note topographic features of the fire location, e.g., aspect, slope, landform. Additionally, document fire size on growth maps that include acreage estimates. Record the final perimeter on a standard topographic map for future entry into a GIS.

##### **Logistical Information**

Document routes, conditions and directions for travel to and from the fire.

##### ***Fire name and number***

Record the fire name and number assigned by your dispatcher in accordance with the instructions for completing DI-1202.

##### ***Observation date and time***

Each observation must include the date and time at which it was taken. Be very careful to record the observation date and time for the data collection period; a common mistake is to record the date and time at which the monitor is filling out the final report.

##### ***Monitor's name***

The monitor's name is needed so that when the data are evaluated the manager has a source of additional information.

##### ***Fire weather forecast for initial 24 hours***

Record the data from the fire or spot weather forecast (obtained following on-site weather observations taken

for validation purposes). If necessary, utilize local weather sources or other appropriate sources (NOAA, Internet, television).

### **Fuel and Vegetation Description**

Describe the fuels array, composition, and dominant vegetation of the burn area. If possible, determine primary fuel models: fuel models #1–13 (Anderson 1982) or custom models using BEHAVE (Burgan and Rothermel 1984).

### **Current and Predicted Fire Behavior**

Describe fire behavior relative to the vegetation and the fire environment using adjective classes such as smoldering, creeping, running, torching, spotting, or crowning. In addition, include descriptions of flame length, rate of spread and spread direction.

### **Potential for Further Spread**

Assess the fire's potential for further spread based on surrounding fuel types, forecasted weather, fuel moisture, and natural or artificial barriers. Record the directions of fastest present rates of spread on a fire map, and then predict them for the next burn period.

### **Current and Forecasted Weather**

Measure and document weather observations throughout the duration of the fire. **Always indicate the location of your fire weather measurements and observations.** In addition, attach fire weather forecast reports to your final documentation.

### **Resource or Safety Threats and Constraints**

Consider the potential for the fire to leave a designated management zone, impact adjacent landowners, threaten human safety and property, impact cultural resources, affect air quality, or threaten special environmental resources such as threatened, endangered or sensitive species.

### **Smoke Volume and Movement**

Assess smoke volume, direction of movement and dispersal. Identify areas that are or may be impacted by smoke.

# Fire Conditions Monitoring

---

The second portion of level 2 monitoring documents fire conditions. Data on the following variables can be collected for all fires. Your park's fire management staff should select appropriate variables, establish frequencies for their collection, and document these standards in your burn plan or Wildland Fire Implementation Plan—Stage II: Short-term Implementation Action and Wildland Fire Implementation Plan—Stage III: Long-term Implementation Actions.

- Topographic Variables
- Ambient Conditions
- Fuel Model
- Fire Characteristics
- Smoke Characteristics
- Holding Options
- Resource Advisor Concerns

## MONITORING SCHEDULE

The frequency of Fire Conditions monitoring will vary by management strategy and incident command needs. Recommended Standards are given below.

## PROCEDURES AND TECHNIQUES

Collect data from aerial or ground reconnaissance and record them in the Wildland Fire Implementation Plan. These procedures may include the use of forms FMH-1, -2, and -3 (Appendix A). Topographic variables, ambient condition inputs, and fire behavior prediction outputs must follow standard formats for the Fire Behavior Prediction System (Albini 1976; Rothermel 1983). **For specific concerns on conducting fire conditions monitoring during a prescribed fire in conjunction with fire effects monitoring plots, see page 106.**

Collect data on the following fire condition (RS) variables:

### Topographic Variables

#### *Slope*

Measure percent slope using a clinometer (for directions on using a clinometer, see page 203). Report in percent. A common mistake is to measure the slope in degrees and then forget to convert to percent; a 45° angle is equal to a 100% slope (see Table 34, page 211 for a conversion table).

#### *Aspect*

Determine aspect. Report it in compass directions, e.g., 270° (for directions on using a compass, see page 201).

#### *Elevation*

Determine the elevation of the areas that have burned. Elevation can be measured in feet or meters.

### Ambient Conditions

Ambient conditions include all fire weather variables. You may monitor ambient weather observations with a Remote Automatic Weather Station (RAWS), a standard manual weather station, or a belt weather kit. More specific information on standard methods for monitoring weather can be found in Fischer and Hardy (1976) or Finklin and Fischer (1990). Make onsite fire weather observations as specified in the Fire-Weather Observers' Handbook (Fischer and Hardy 1976) and record them on the Onsite weather data sheet (form FMH-1) and/or the Fire behavior-weather data sheet (FMH-2). Samples of these forms are in Appendix A.

Fuel moisture may be measured with a drying oven (preferred), a COMPUTRAC, or a moisture probe, or may be calculated using the Fire Behavior Prediction System (BEHAVE) (Burgan and Rothermel 1984). Record in percent.

#### *Dry bulb temperature*

Take this measurement in a shady area, out of the influence of the fire and its smoke. You can measure temperature with a thermometer (belt weather kit) or hygrothermograph (manual or automated weather station), and record it in degrees Fahrenheit or degrees Celsius (see Table 33, page 209 for conversion factors).

#### *Relative humidity*

Measure relative humidity out of the influence of the fire using a sling psychrometer or hygrothermograph at a manual or automated weather station. Record in percent.

#### *Wind speed*

Measure wind speed at eye level using a two-minute average. Fire weather monitoring requires, at a minimum, measurement of wind speed at a 20 ft height, using either a manual or automated fire weather station. Record wind speed in miles/hour, kilometers/

hour, or meters/second (see Table 33, page 209 for conversion factors).

### ***Wind direction***

Determine the wind direction as the cardinal point (N, NE, E, SE, S, SW, W, or NW) from which the wind is blowing. Record wind direction by azimuth and relative to topography, e.g., 90° and across slope, 180° and upslope.

### ***Shading and cloud cover***

Determine the combined cloud and canopy cover as the fire moves across the fire area. Record in percent.

### ***Timelag fuel moisture (10-hr)***

Weigh 10-hr timelag fuel moisture (TLFM) sticks at a standard weather station or onsite. Another option is to take the measurement from an automated weather station with a 10-hr TLFM sensor. If neither of these methods is available, calculate the 10-hr TLFM from the 1-hr TLFM—which is calculated from dry bulb temperature, relative humidity, and shading. Record in percent.

### ***Timelag fuel moisture (1-, 100-, 1000-hr)***

If required for fire behavior prediction in the primary fuel models affected, measure 1-hr, 100-hr, and 1000-hr TLFM as well, in the same manner as 10-hr using an appropriate method. If you decide to determine fuel moisture by collecting samples, use the following guidelines:

- Collect most of your samples from positions and locations typical for that type of fuel, including extremes of moistness and dryness to get a suitable range.
- Take clear concise notes as to container identification, sample location, fuel type, etc.
- Use drafting (not masking or electrical) tape or a tight stopper to create a tight seal on the container. Keep samples cool and shaded while transporting them.
- Carefully calibrate your scale.
- Weigh your samples as soon as possible. Weigh them with the lid removed, but place the lid on the scale as well. If you cannot weigh them right away, refrigerate or freeze them.
- Dry your samples at 100° C for 18–24 hours.
- Remove containers from the oven one at a time as you weigh them, as dried samples take up water quickly.
- Reweigh each dried sample.
- Use the formula on page 215 to calculate the moisture content.

You can find further advice on fuel moisture sampling in two publications written on the subject (Countryman and Dean 1979; Norum and Miller 1984); while they were designed for specific geographic regions, the principles can be applied to other parts of the country.

### ***Live fuel moisture***

Fuel models may also require measurement of woody or herbaceous fuel moisture. Follow the sampling guidelines described under “Timelag fuel moisture (1-, 100-, 1000-hr)” on page 12. Live fuel moisture is measured in percent.

### ***Drought index***

Calculate the drought index as defined in your park’s Fire Management Plan. Common drought indices are the Energy Release Component (ERC) or the Keetch-Byram Drought Index (KB DI). Other useful indices are the Palmer Drought Severity Index (PDSI) and the Standardized Precipitation Index (SPI).

### ***Duff moisture (optional)***

Monitor duff moisture when there is a management concern about burn severity or root or cambial mortality. Duff moisture affects the depth of the burn, resonance time and smoke production. Measure duff samples as described above for Timelag fuel moisture (1-, 100-, 1000-hr). Duff moisture is measured in percent.

---

## **Duff Moisture**



Duff moisture can be critical in determining whether fire monitoring plots are true replicates, or they are sampling different treatments. It is assumed that if plots within a monitoring type identified in a five-year burn plan are burned with the same fire prescription, they are subject to the same treatment. These plots should only be considered to have been treated the same if the site moisture regimes, as influenced by long term drying, were similar. Similar weather but a different site moisture regime can result in significant variation in postfire effects, which can be extremely difficult to interpret without documentation of moisture. This is particularly important when studying prescribed fires.

---

### ***State of the weather (optional)***

Monitor state of the weather when there is a management recommendation for this information. Use a one-digit number to describe the weather at the time

of the observation. 0-clear, less than 10% cloud cover; 1-scattered clouds, 10–50% cloud cover; 2-broken clouds; 60–90% cloud cover; 3-overcast, 100% cloud cover; 4-fog; 5-drizzle or mist; 6-rain; 7-snow; 8-showers; 9-thunderstorms.

Only use state of the weather code 8 when showers (brief, but heavy) are in sight or occurring at your location. Record thunderstorms in progress (lightning seen or thunder heard) if you have unrestricted visibility (i.e., lookouts) and the storm activity is not more than 30 miles away. State of the weather codes 5, 6, or 7 (i.e., drizzle, rain, or snow) causes key NFDRS components and indexes to be set to zero because generalized precipitation over the entire forecast area is assumed. State of weather codes 8 and 9 assume localized precipitation and will not cause key NFDRS components and indexes to be set to zero.

### **Fuel Model**

Determine the primary fuel models of the plant associations that are burning in the active flaming front and will burn as the fire continues to spread. Use the Fire Behavior Prediction System fuel models #1–13 (Anderson 1982) or create custom models using BEHAVE (Burgan and Rothermel 1984).

---

### **Fireline Safety**



If it would be unsafe to stand close to the flame front to observe ROS, you can place timing devices or firecrackers at known intervals, and time the fire as it triggers these devices.

Where observations are not possible near the monitoring plot, and mechanical techniques such as firecrackers or in-place timers are unavailable, establish alternate fire behavior monitoring areas near the burn perimeter. Keep in mind that these substitute observation intervals must be burned free of side-effects caused by the ignition source or pattern.

---

### **Fire Characteristics**

**For specific concerns on monitoring fire characteristics during a prescribed fire in conjunction with fire effects monitoring plots, see page 106.** Collect data on the following fire characteristics (RS):

#### ***Rate of spread***

Rate of Spread (ROS) describes the fire progression across a horizontal distance; it is measured as the time it takes the leading edge of the flaming front to travel a

given distance. In this handbook, ROS is expressed in chains/hour, but it can also be recorded as meters per second (see Table 33, page 209 for conversion factors).

Make your observations only after the flaming front has reached a steady state and is no longer influenced by adjacent ignitions. Use a stopwatch to measure the time elapsed during spread. The selection of an appropriate marker, used to determine horizontal distance, is dependent on the expected ROS. Pin flags, rebar, trees, large shrubs, rocks, etc., can all be used as markers. Markers should be spaced such that the fire will travel the observed distance in approximately 10 minutes.

If the burn is very large and can be seen from a good vantage point, changes in the burn perimeter can be used to calculate area ROS. If smoke is obscuring your view, try using firecrackers, or taking photos using black-and-white infrared film. Video cameras can also be helpful, and with a computerized image analysis system also can be used to accurately measure ROS, flame length, and flame depth (McMahon and others 1987).

#### ***Perimeter or area growth***

Map the perimeter of the fire and calculate the perimeter and area growth depending upon your park's situational needs. As appropriate (or as required by your park's Periodic Fire Assessment), map the fire perimeter and calculate the area growth. It's a good idea to include a progression map and legend with the final documentation.

#### ***Flame length***

Flame length is the distance between the flame tip and the midpoint of the flame depth at the base of the flame—generally the ground surface, or the surface of the remaining fuel (see Figure 1, next page). Flame length is described as an average of this measurement as taken at several points. Estimate flame length to the nearest inch if length is less than 1 ft, the nearest half foot if between 1 and 4 ft, the nearest foot if between 4 and 15 ft, and the nearest 5 ft if more than 15 ft long. Flame length can also be measured in meters.



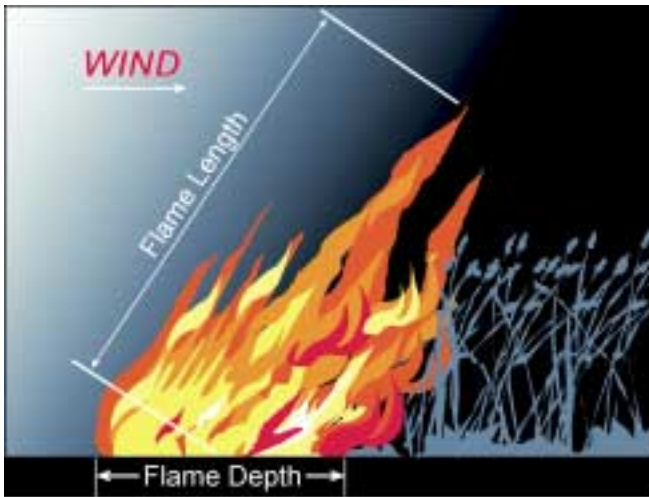

Figure 1. Graphical representation of flame length and depth.

### ***Fire spread direction***

The fire spread direction is the direction of movement of that portion of the fire under observation or being projected. The fire front can be described as a head (H), backing (B), or flanking (F) fire.

### ***Flame depth (optional)***

Flame depth is the width, measured in inches, feet or meters, of the flaming front (see Figure 1). Monitor flame depth if there is a management interest in residence time. Measure the depth of the flaming front by visual estimation.

### **Smoke Characteristics**

These Recommended Standards for smoke monitoring variables are accompanied by recommended thresholds for change in operations following periods of smoke exposure (Table 2, page 17). **These thresholds are not absolutes, and are provided only as guidelines.** The following smoke and visibility monitoring variables may be recorded on the “Smoke monitoring data sheet” (FMH-3 or -3A) in Appendix A.

### ***Visibility***

This is an important measurement for several reasons. The density of smoke not only affects the health of those working on the line but also can cause serious highway concerns. Knowing the visibility will help law enforcement personnel decide what traffic speed is safe for the present conditions, and help fire management personnel decide the exposure time for firefighters on the line.

Visibility is monitored by a measured or estimated change in visual clarity of an identified target a known

distance away. Visibility is ocularly estimated in feet, meters or miles.

### ***Particulates***

Park fire management plans, other park management plans, or the local air quality office may require measurement of particulates in order to comply with federal, state, or county regulations (see Table 2, page 17). The current fine particulate diameter monitoring standards are PM-2.5 and PM-10, or suspended atmospheric particulates less than 2.5 (or 10) microns in diameter.

### ***Total smoke production***

Again, measurement of total smoke production may be required by your fire management plan, other park management plans, or the local air quality office to comply with federal, state, or county regulations. Use smoke particle size–intensity equations, or an accepted smoke model to calculate total smoke production from total fuel consumed or estimates of intensity. Record in tons (or kilograms) per unit time.

### ***Mixing height***

This measurement of the height at which vertical mixing occurs may be obtained from spot weather forecast, mobile weather units, onsite soundings, or visual estimates. The minimum threshold for this variable is 1500 ft above the elevation of the burn block.

### ***Transport wind speeds and direction***

These measurements also can be obtained from spot weather forecasts, mobile weather units, or onsite soundings. The minimum threshold for this variable is 5 to 7 mph at 1500 ft above the elevation of the burn block.

### ***Ground wind speeds and direction***

See wind speed and direction on page 11.

### ***Documented complaints from downwind areas***

Your local air quality office will forward any written or verbal complaints to your park headquarters. The maximum allowable number of “recordable” complaints per treatment is defined by each air quality office.

### ***Carbon monoxide (optional)***

You can measure carbon monoxide on the fireline using a badge sampler or dosimeter (Reinhardt and others 2000), or by extrapolating from visibility measurements. Burn crew-members should not be exposed to areas of <100 ft visibility any longer than two hours.

### ***Observer location and elevation (optional)***

Recording the location and elevation of the observer can be important, as your view can be affected by your position. For example, visibility at 1,000 m may be fairly clear, but down at 500 m an inversion may be trapping smoke, and thus causing a greater concern to people living at that elevation. If you don't include the fact that your observation was made above that zone, it may appear that your records are inaccurate. Naturally, if you can see the inversion below you, and can approximate its ceiling, that should also be reported. Elevation can be recorded in feet or meters.

### ***Elevation of smoke column above ground (optional)***

The elevation of the top of the smoke column should be recorded in feet or meters above ground level. Features such as nearby mountains of known heights can be useful in making such an estimate.

### ***Smoke column direction (optional)***

The direction in which the column is pointed can be important, as this will help to predict possible smoke concerns downwind. Noting any breaks or bends in the column can also help predict possible spot fire conditions that may result.

### ***Smoke inversion layer elevation (optional)***

Information on inversion layers is critical to air quality and fire behavior management. Again, the top of the layer should be reported in feet or meters above the ground. Inversions can be identified by dark, "heavy" bands of air that are obviously clouded by smoke. Very often, this dense air will have an abrupt ceiling to it, above which the air is clear. Objects of known height can help you to accurately estimate the elevation of that inversion layer.

### ***Smoke column (optional)***

It may be pertinent to describe the characteristics of the smoke column. Is the column bent or leaning in a particular direction, or does it rise straight up for several thousand feet? Is it sheared, and if so, at what height? What color is the column? All of this information will help to quantify how the fire was burning and under what atmospheric conditions. Using the guide on the back of FMH-3A, describe the observed smoke column characteristics and atmospheric conditions.

### ***Use of the Smoke monitoring data sheet (FMH-3)***

The Smoke monitoring data sheet (FMH-3, in Appendix A) is intended for use on both wildland and prescribed fires. Each box on the data sheet is divided in two; place the time of your observation in the top por-

tion of the box, and the observation value in the lower portion of the box. When you use this form, it is important to note the following:

- Formulas for determining appropriate highway visibilities (variable #2 on the form) can be found in the RX-450 Training Manual (NWCG 1997).
- Monitor the number of public complaints (monitoring variable #4) by time interval (two to four hours post-ignition), rather than at any specific time. "Recordable complaints" can be monitored via the local air quality office, park information desk or telephone operator.
- The monitoring frequency for surface winds (variable #8) should be determined by each park since this parameter is a frequent and critical source of data collection. At a minimum, however, collect these data once every 24 hours. Record monitoring frequencies along with wind speed in miles per hour (mph) or meters/sec (m/s) (see Table 33, page 209 for conversion factors).
- The formula for computing total emissions production (TEP) is found on the back of the FMH-3 form. TEP, in tons/acre is recorded under "OTHER," line 1. You can derive the emission factors included in this formula from factors available in the RX-450 training manual (NWCG 1997).

### **Holding Options**

Identify areas or features that will slow the spread of the fire. Also identify vegetative conditions that provide for rapid fireline construction, should that become the appropriate management response.

### **Resource Advisor Concerns**

The Resource Advisor may indicate specific variables that need to be observed as part of the monitoring process. This might include fire behavior upon contact with certain species, disturbance of wildlife, fire management impacts, etc.

### ***Fire severity mapping (optional)***

The postburn effects of a large fire are numerous and may include plant mortality, mud slides, and flooding. A quick assessment of the ecosystem can help you determine whether rehabilitation measures are needed. Managers may use this assessment to understand future patterns of vegetation and faunal distribution.

One critical step in this analysis is burn severity mapping. This type of survey can be done using any of several methods, including data from LANDSAT (White

and others 1996), or from digital cameras (Hardwick and others 1997). For more specific information see the Burned Area Emergency Handbook (USDA Forest Service 1995), or call your regional or national BAER coordinator.

## POSTBURN REPORT

Fire managers often need a summary of information immediately following a fire. While detailed information on fire effects are not immediately available, detailed information regarding fire observations and fire conditions can and should be summarized soon after the fire. This information may be used to refine prescriptions, strategy, and tactics over both the short and long term. **Decide in advance who is responsible for preparing this report.** A fire monitor can collect most of the information recommended. Consultation with the Burn Boss or Incident Commander is recommended.

Currently there is no standardized format for post burn reporting; the following list contains items to consider including in this report.

- Fire name
- Resource numbers and type (personnel and equipment)
- Burn objectives
- Ignition type and pattern
- Holding strategy
- Fuel moisture information (e.g., 1000-hr, live woody and herbaceous, foliar)
- Drought index information
- Fire behavior indices information (e.g., ERC)
- Precipitation information
- Test burn description
- Chronology of ignition
- Chronology of fire behavior
- Chronology of significant events
- Chronology of smoke movement and dispersal
- Temperature (range, minimum and maximum)
- Relative humidity (range, minimum and maximum)
- Accuracy of spot weather forecast
- Initial qualitative assessment of results (were short-term objectives achieved?)
- Future monitoring plan for area (e.g., plots, photo points)
- Acres burned
- Additional comments

Attachments:

- Map of area burned
- Fire weather observations data sheets
- Fire behavior observations data sheets
- Smoke observations data sheets
- Weather station data
- Fire severity map

**Table 2. Smoke monitoring variables (RS) with techniques, frequencies, and recommended thresholds.**

Variable	Location	Technique	Frequency	Threshold	
<b>Visibility:</b> Duration of impairment by distance	Fireline	• Visual estimate	30 minutes	Exposure of burn crew-members to areas of <100 ft visibility not to exceed 2 hours	
	Vicinity of fire (highways, concessions, residential areas, schools, etc.)	• Visual estimate	30 minutes	Exposure dependent on state Minimum Acceptable Visibility (MAV) standards	
<b>Duration of impairment by distance; no. people and sensitive areas affected</b>	Downwind	• Visual estimate using known milestones or photographic standards	2 hours	Pop.	Min. distance (miles)
				1K–5K >5K–50K >50K	2–5 4–7 7–9
<b>Particulates:</b> PM-2.5/10; amount and duration <sup>1</sup>	Fireline, population centers and critical areas where smoke contribution is presumed to be significant	• PM-2.5/10 sampler • Established state and agency monitoring programs	24 hours/Annual	PM-2.5	PM-10
				65µg/m <sup>3</sup> 15µg/m <sup>3</sup>	150µg/m <sup>3</sup> 50µg/m <sup>3</sup>
<b>Total Smoke Production:</b> Tons (kilograms)/unit time	Burn site or office	• Calculated from total fuel consumed • Intensity estimate • Smoke particle size–intensity equations	Preburn estimate followed by postburn reaffirmation	May be determined by state or local permit	
<b>Mixing Height:</b> Height Temperature Gradient	Ground	• Spot weather forecast • Mobile weather unit • Onsite sounding • Visual estimate	1 hour	1500 ft above burn elevation; do not violate for more than 3 h or past 1500 hours	
<b>Transport Winds:</b> Speed	Burn site	• Spot weather forecast • Mobile weather unit • Onsite sounding	1 hour	5 to 7 mph at 1500 ft above burn elevation; do not violate for more than 3 hours or past 1500 hours	
<b>Ground Winds:</b> Speed	Ground	• Wind gauge held at eye level • Mobile weather unit	1 to 6 hours (depending upon threat to safety and proximity of roads)	1 to 3 mph—day 3 to 5 mph—night	
<b>Complaints:</b> Number	Received at headquarters or from an air quality resource district	• Written • Verbal	NA	The maximum allowable number of “recordable” complaints per treatment, as defined by the local air quality control district.	
<b>CO Exposure:</b> ppm or duration of visibility impairment	Fireline	• Badge sampler or extrapolation with visibility • Dosimeter	30 minutes	Exposure of burn crew members to areas of <100 ft visibility not to exceed 2h. If exceeded, 24 hour detoxification is required before crew members can return to fireline duty	

<sup>1</sup>PM-2.5 and PM-10 monitoring is mandatory only if a critical target exists within park boundaries or within 5 miles of a park boundary, and may be impacted by smoke of unknown quantities. The controlling air quality district may provide a PM-2.5 or PM-10 monitor in the surrounding area under any circumstances. The key is that the air quality district has the ultimate authority for determining when particulate matter standards are violated and when land managers must take appropriate actions to comply with established district, state and federal standards. A variety of occupational exposure limits exist, ranging from the OSHA Permissible Exposure limits to the American Conference of Governmental Industrial Hygienists (ACGIH) Threshold limit values and the NIOSH Recommended Exposure Limits.

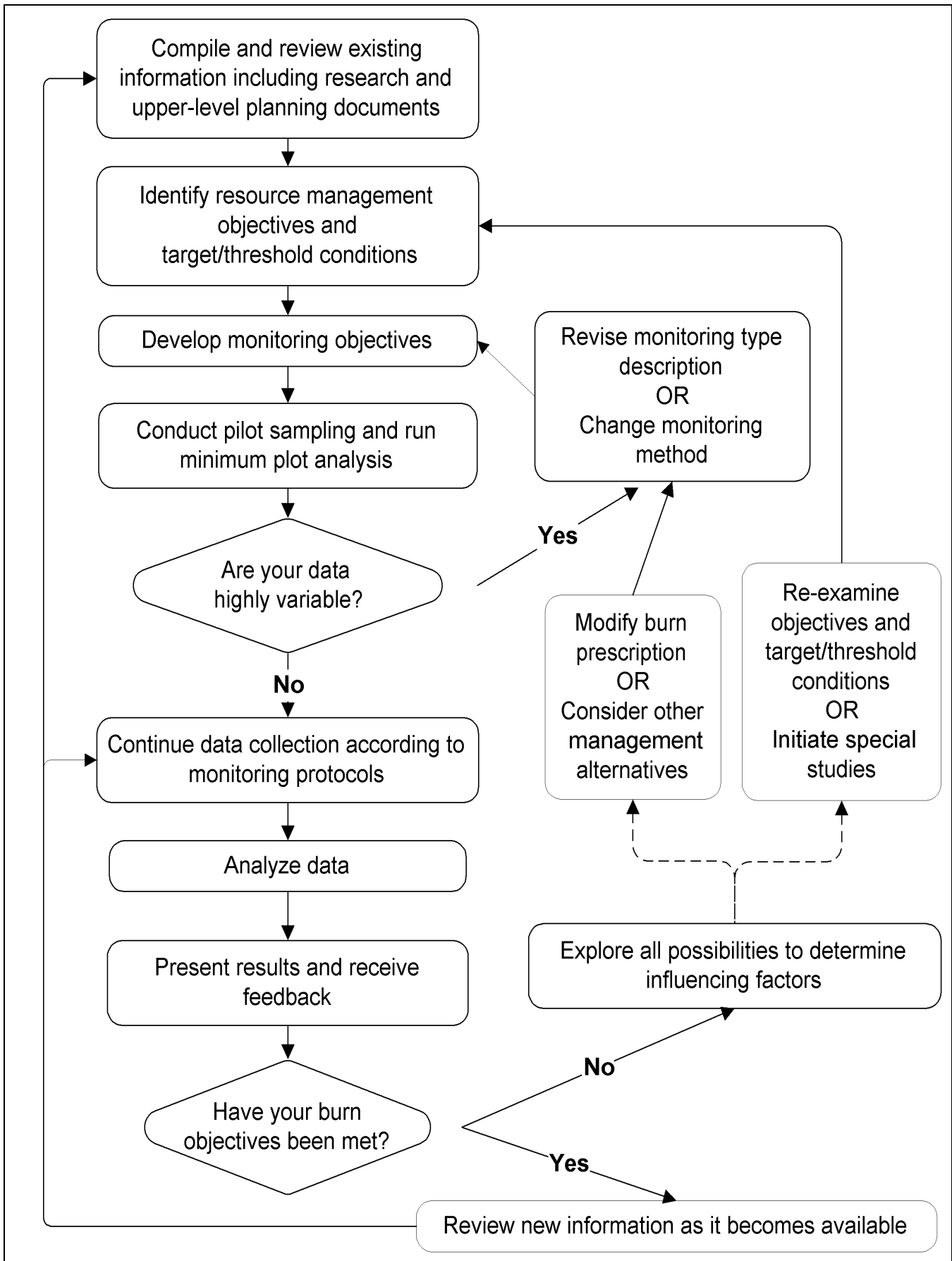

Figure 2. Steps in a fire effects monitoring program.

# 3

## Developing Objectives

*“You got to be very careful if you don’t know where you’re going, because you might not get there.”*

—Yogi Berra

Proper design is essential to any monitoring program. The consequences of poor design are numerous, and all bad. Lost time and money, unnoticed resource deterioration, inadequate management decisions, and reduced credibility are a few of the negative repercussions of faulty planning and design. Take time to design a program that will monitor the conditions essential to meeting your management objectives.

Chapters three and four have been created to assist you in the design of a high quality, defensible monitoring program. By developing sound objectives using the concepts put forth in Chapter 3, you will build a solid foundation that will enable you to make the necessary design decisions as covered in Chapter 4.

Natural area managers, like family physicians, should monitor ecosystem health to prevent or identify dysfunction and repair damage. Monitoring can tell you the condition of the resource and detect change or abnormal conditions. When you reintroduce a natural process such as fire into the landscape, a monitoring program will help you document any linkage between the treatment and changes in resource condition, as well as provide feedback on prescriptions and return intervals.

The fire effects monitoring program flow diagram (Figure 2, facing page) is designed to provide a concise reference for the entire design, implementation and analysis process involved in establishing an effective fire effects monitoring program. It can be used as a guide in the design of a monitoring program. Portions of the flowchart will be expanded and detailed in this and following chapters.

Development of a fire effects monitoring program, including methodology and analytical techniques, must be preceded by the development of fire-related resource management objectives. The reduction of hazard fuels, for example, should logically be accompanied by fire behavior modeling using postburn fuels data that demonstrate that the hazard has in fact been abated, and that the stated fuel

reduction objectives have been met. This would logically have been preceded by an analysis of the nature of the hazard presented by the preburn fuel characteristics.

Monitoring objectives are derived from resource management and fire management program objectives. From this, it should be apparent that fire managers and resource managers must work together closely to ensure that fire, whether managed as a natural process or as a tool, is effective in meeting resource objectives. Fire may meet fuel reduction objectives, for example, but cause significant unwanted resource degradation.

# Objectives

## MANAGEMENT OBJECTIVES

This handbook is organized around the development of a monitoring program that is based on resource and fire management objectives. Management objectives are often misrepresented as goals (see the Glossary for definitions of **goal** vs. **objective**). Developing clearly articulated management objectives is a specific step toward the accomplishment of a broader goal, and is a critical step in any management-monitoring feedback loop. This is true whether you use a more traditional decision-making approach (such as those based solely on cost, political considerations, or anecdotal knowledge), or a more cooperative integrated approach such as adaptive management (see below). Management objectives serve as the foundation for all activities that follow, including the proposed management activity, monitoring, evaluation and alternative management.

Objectives should be:

- **Realistic and achievable.** Create objectives that are biologically meaningful and achievable within the bounds of management possibilities. In addition, if you have multiple objectives, make sure that they do not conflict. For example, you may have trouble meeting both of the following objectives: 1) dramatically reducing fuel load and 2) maintaining all your overstory trees.
- **Specific and measurable.** Your objectives should be quantifiable (measurable). They should also identify a **target/threshold condition** or include the **amount and direction of change** desired. Specific quantitative elements will allow you to evaluate the success or failure of your management.
- **Clearly articulated and focused.** Write clear objectives that contain all the components described on pages 22 (management) and 23 (monitoring), and presented in Figure 3. Clear and focused objectives will allow current and future stakeholders to have focused discussions regarding the desired state of the resource.

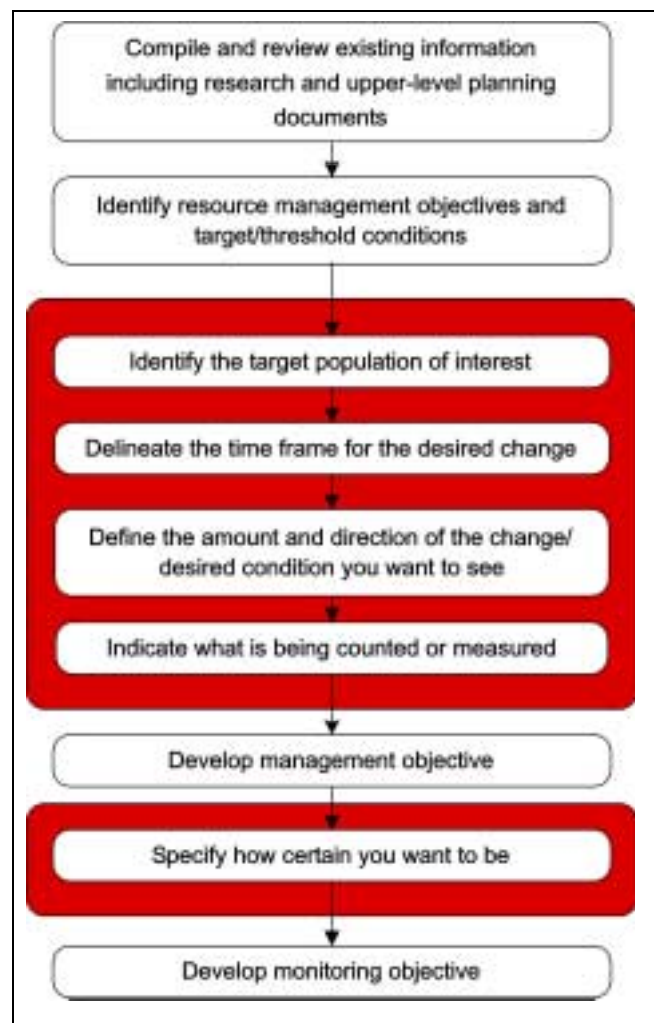

Figure 3. Steps in developing management and monitoring objectives.

The key elements of an objective are highlighted in red.

## Adaptive Management

Adaptive management is an iterative process—planning, action, monitoring, evaluation, and adjustment—which uses the results of management actions as observations that help develop an enhanced understanding of ecosystem response, in this case, the effects of fire. Adaptive management is learning by doing.

Adaptive management requires input from many sources. By incorporating the views and knowledge of all stakeholders—citizens, administrators, managers, researchers—you create a working dialogue. In establishing a working dialogue, you can articulate sound management objectives, increase your ability to implement management, gather reliable knowledge of

all elements in the natural system of concern, and make adjustments to management actions.

The adaptive process requires integrating the concepts of observation, uncertainty, and surprise. Ideally, the result will be not a single optimal state but a range of outcomes, acceptable to all stakeholders, that avoid irreversible negative effects on a highly valued resource from the use of fire as a management tool.

Keep in mind that the process of setting objectives is a dynamic process, and must include responses to new information. It may be difficult to establish measurable objectives due to lack of knowledge about a portion or portions of the population, community or ecosystem in question. Managers should use the best of available information, and focus on creating knowledge-based, measurable objectives.

---

### Management Objectives and Adaptive Management



As you learn more about the vegetative response to fire, you will begin to have a better idea of the specifics of the target/threshold conditions and how achievable your objectives are. It is important to remember that both management and monitoring objectives need revisiting as a program evolves (see page 133).

As shown in the fire effects monitoring flow diagram (Figure 2, page 18), as a general guide, objectives should be reconsidered at least twice in a monitoring cycle—this is the adaptive management approach (see below, or review the references on page 238, Appendix G.).

---

### Planning Documents

The process of moving from broad, policy-related goals to specific, quantifiable management objectives can require steps at many levels. The steps taken to get from tier to tier will vary from agency to agency, as well as from park to park. Different methods will be used to move through the “grey zone” from broad goal to specific management objective. Prescribed fire programs, and their objectives, are part of a larger, multi-tiered framework of goals, target/threshold conditions, strategies and objectives stated in the General Management Plan (GMP), Resource Management Plan (RMP), and Fire Management Plan (FMP) for your unit.

The development of management objectives begins with the policy and regulations that guide the agency. Monitoring program managers may not refer to these documents directly, but are familiar with their general content. Guidelines and laws, such as the National Environmental Policy Act (NEPA), the National Historic Preservation Act (NHPA), and policy guidelines established by a specific agency drive the development of goals put forth in General Management Plans and other management statements. Again, these goals are expressed in broad terms.

A Resource Management Plan (RMP) and other resource related documents (e.g., an ecological model of the resource) will identify target/threshold conditions, as well as problems that may prevent managers from reaching the stated goals. What are the problems that prevent managers from protecting and perpetuating natural, scenic and cultural resources? What impediments block managers from restoring biological diversity? What is the target/threshold condition or state of a forest stand or landscape unit?

A Fire Management Plan (FMP) outlines the strategy of using fire to achieve the target/threshold conditions. From the FMP, you will create specific fire management objectives that will set measurable criteria. The accompanying objective variables will help you assess the effectiveness of treatment with prescribed fire to meet those objectives.

---

### Resource Management Plan



The need for prescribed fire, and what it should accomplish, must be stated at least generally in the RMP. This, in turn, should be supported by fire ecology information which guides the development of the FMP.

Perceived weaknesses in the value of monitoring data may be due more to the lack of clarity of program objectives than to flaws in the monitoring system. Monitoring systems cannot be designed to monitor everything, nor can they (without great cost) monitor many things with a high degree of confidence. Therefore, the value of monitoring is directly related to a well-defined management objective.

---

### *Fire monitoring plan*

The fire monitoring plan is where you record the background information used to define your management objectives, as well as additional planning



information needed to drive your monitoring program. The plan will include an ecological model that provides a summary of what is known, as well as gaps in knowledge, about the ecology of each species being monitored (see page 225, Appendix F, for more information on these models). The monitoring plan should also include how management will respond if you do not meet your objectives. Include in this planning process any person who could influence a change in management, both within the park and external to the park. Create your plan with input from fire and resources management specialists and field technicians, and have it reviewed by your regional fire effects program coordinator. The outline provided in Appendix F should help you to develop an organized plan for your park. **RM-18 requires that all NPS units applying prescribed fire must prepare a fire monitoring plan (USDI NPS 2001a), regardless of whether they use the protocols outlined in this handbook.**

### Management Objective Components

Your planning documents should contain four key components needed to create well-articulated management objectives.

- Target population
- Time frame
- Amount and direction of change or target/threshold condition
- Variable

### Target population—monitoring type

Identify the **target population**, or portion of a population, to be monitored.

- Carefully define the groups to be examined (e.g., species or group of species).
- Define the individuals to be included (e.g., should you monitor every age class of all tree species in a vegetation association or should you monitor only the seedlings of a particular species?).
- Determine the geographic boundaries of interest (for example, is the fuel load along the park boundary the only fuel load of interest, or should you collect data on fuels within one vegetation association throughout the entire park?).

Identifying the target population provides a quantitative picture of a plant association being influenced by fire. It is the first step to creating a monitoring type description (see Glossary). The

discussion on defining monitoring types begins on page 34.

A five-year burn plan can be a starting point for defining monitoring types. It will also play a role in scheduling plot installation (see page 55). Burn units identified in the five-year burn plan will help you identify the target populations and the vegetation types that are a high priority for monitoring type creation.

### Time frame

Delineate the time frame for monitoring change. Use a time frame that is realistic biologically (how rapidly will the resource respond to fire?), as well as in terms of management (how quickly can alternatives be implemented in response to the trends indicated?).

The life history of the target organism will also help you determine an appropriate time frame. In general, long-lived, stable species will have longer monitoring periods than short-lived, sensitive species. Also consider the risk of rapid decline of a population, either through loss of rare species or the establishment of non-native competition.

### Amount and direction of change or target/threshold condition

Define the range of change (positive, negative, or no change) you want to see or are willing to accept, or state the actual target/threshold condition defined by your management objectives. Again, the life history of your target species and biology will dictate how much change is possible and necessary. Because our knowledge of fire ecology is poor for many plants and plant associations, this is often the most difficult step in this process. However, once you have determined the direction of desirable change, determine a range of acceptable target levels.

#### Examples:

Examples may include:

- Reduce mean (average) total non-native species cover by 50–75%
- Maintain mean overstory tree density to within 10% of preburn
- Reduce mean total fuel load to less than 20 tons per acre
- Increase the mean density of desired tree seedlings to 500 per hectare

### **Variable**

Indicate what you will count or measure in your monitoring program. Describe the specific attribute that the prescribed treatment will change or maintain. When choosing a variable, consider the morphology and life history of the species. Counting extremely small, numerous individuals of a species may prove costly, and because it is virtually impossible to do accurately, variation in results may be an artifact of sampling rather than a meaningful observation.

#### **Examples:**

Examples of variables may include:

- Fuel load—this can be broken down into size classes or considered in total
- Percent scorch or percent mortality
- Density, frequency, relative or percent cover of a given species or group of species
- Height of a given tree species, group of species (by height class) or total understory

(See page 41 for additional variables)

### **Types of Management Objectives**

Management objectives fall into two broad types, change and condition. Each type of objective will require different considerations for monitoring objectives (page 23) and data analysis (page 130).

#### **Change objectives**

Use this type of objective when you want to track relative change in a variable over time. This type of objective is used when the trend over time is more important than the specific current or future state, e.g., a reduction of 40% may be more important than a decline to 500 individuals per hectare.

#### **Examples:**

The critical elements are highlighted:

- In the **pine-oak forest** monitoring type, we want to **reduce** the **mean total fuel load** by **50–80%** within **one year** of the initial prescribed fire.
- We want to **increase** the **mean percent cover** of **native perennial grasses** by at least **40%**, in **tallgrass prairie**, **10 years** after the initial application of prescribed fire.

#### **Condition objectives**

Use this type of objective when you have enough information to describe a specific target/threshold

condition. Here you will measure your success by considering whether your variable reaches a target or threshold.

#### **Examples:**

The critical elements are highlighted:

- Within the **cypress savanna** monitoring type, we want to **decrease** the **mean density** of ***Taxodium distichum*** to less than **200 individuals** per hectare within **six months postburn**.
- In the **ponderosa pine forest** monitoring type, we want to **maintain** a **mean density** of **90–120 overstory trees** per hectare within **five years** of the initial prescribed fire.

### **MONITORING OBJECTIVES**

Monitoring objectives differ from management objectives in that management objectives describe the target/threshold or change in the condition desired, while monitoring objectives describe how to monitor progress toward that condition or change. Monitoring objectives contain explicit statements about the certainty of your results.

Development of sound monitoring objectives is a critical step in any monitoring program. A common mistake is for managers to collect data first and rely on statistics to generate a question or objective later.

#### **Certainty**

Managers almost always need to rely upon incomplete information to make decisions. Statistics can help managers make decisions based on available information. A carefully planned monitoring design can ensure that you gather the data required for using statistics appropriately to guide decision-making. Your monitoring objectives will specify how certain you want to be in your results.

For any monitoring program, a high degree of certainty is desirable. Keep in mind, however, that increased certainty often means increased money and time. Fiscal and time limitations may restrict the amount of sampling (number of plots), so you will need to balance desired certainty with feasibility.

#### **Sampling Principles**

A true population value exists for every monitoring variable. Measuring the entire population would reveal the true value, but would likely be cost-prohibitive.

Sampling procedures provide a method for reasonably estimating these true values by measuring an adequate portion of the population. The scientific method provides a sound way to obtain a sample sufficient to allow inferences to be made to larger populations. In other words, when proper sampling procedures are followed, data from monitoring plots (sample) are used to infer results for the monitoring type as a whole (population).

In most cases the entire population of interest cannot be measured to determine the true population mean. Since it is possible to determine the certainty with which the sample estimates the true population value, the protocols in this handbook involve sampling a portion of the population. The greater the variability in the sample data, the more uncertainty exists in the estimation of true population values and differences among populations. Generally, the larger the sample size (number of plots), the greater the certainty.

### **Sample**

**The aggregate of all monitoring plots for a particular monitoring type constitutes a sample.**

An example of the layout of a sample is shown in Figure 4. All monitoring plots within a given sample are analyzed as a single data set. Monitoring plots are randomly distributed throughout each significant monitoring type occurring within the burn units that are scheduled for burning within the **next five years**.

Due to fiscal and physical constraints, you cannot install the number of plots needed for a high degree of certainty (in the results) for **every** fire, or for **every** RS variable. The use of a sample is specifically designed to eliminate the need for plots in every prescribed burn unit; this body of data should represent a large number of burns and thus lessen the total amount of data collected.

The sample database should not be used for quantitative assessments of immediate postburn effects or long-term change until all monitoring plots comprising the sample have been treated. However, analysis of those plots treated first can help you to fine-tune your protocols, as well as to examine how well you defined your monitoring type. Realistically, depending on your burn schedule, it could take more than five years to complete the immediate postburn effects databases for a sample.

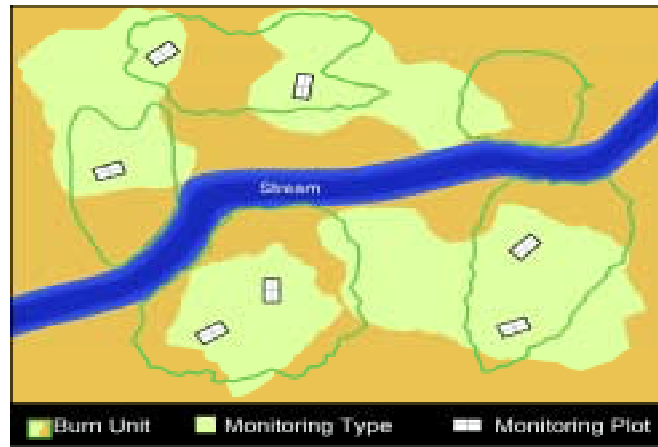

Figure 4. Graphical representation of a sample (all seven monitoring plots combined).

### **Scientific method**

Using the **scientific method**, sampling must follow three principles: objectivity, replication, and representativeness.

**Objectivity**—To be **objective**, or unbiased, sampling must be **random with respect to the question or issue**.

#### **Example:**

Plots are located randomly within monitoring types (areas of relatively homogenous vegetation and fuel). They are not, however, located randomly in **all** possible areas within a monitoring type, because only the areas planned for prescribed burning are addressed by the monitoring objectives. Locating plots in areas that you do not plan on burning would be impractical and would fail to serve the purpose of the monitoring program. Finally, your monitoring type descriptions should be written to limit the amount of subjectivity in locating plots.

**Replication**—A replicated study includes sampling of multiple units; measurement and treatment methods are the same among sampling units.

#### **Example:**

Information from one monitoring plot, or from multiple plots in one prescribed burn unit, will not provide sufficient information about the effects of prescribed fire. Additionally, measuring brush density in a 1 m belt transect in one plot and a different belt width in another would introduce variability in sampling that could seriously confound the results. Similarly, burning one plot, mowing another, and then combining the data from the two, would not yield clear results for either treatment.

**Representativeness**—To be **representative**, the observations or individuals measured must reflect the population of interest.

**Example:**

Locating plots in areas that do not fit the monitoring type would mean that the sample would not reveal anything about fire effects in that monitoring type.

If these sampling principles are followed, then the results from the sample can be used in inferential statistics. This type of statistics attempts to provide information about populations from information gathered from a relatively small sample that has a certain degree of variability.

### **Variability**

In order to make inferences from the sample to the larger population you must collect a sample that will sufficiently estimate the population parameter of interest as well as be objective, representative and replicated. Knowing the **variability** of the data reveals something about how good the sample (or estimate of the population mean) is. If the data are not highly variable (i.e., values for an objective variable, or differences in these values over time, are very similar from plot to plot), then it is likely that the sample mean is a good estimate of the population mean. Highly variable data (i.e., values for an objective variable, or differences in these values over time, are very different from plot to plot) means that it is less certain that our sample mean is a good representation of the population mean.

In either case, once you know the variability of your data, you can calculate how many plots you need to establish to provide a good estimate of the population mean. If the natural variability of an objective variable is high, then you will usually need more plots to describe that variability. If the variability is low, then you will find that fewer plots are sufficient to obtain a reasonable estimate of the population mean.

Determining the minimum sample size based on estimates of the population variability is discussed on page 49.

### **Certainty Decisions**

In designing a monitoring program, you will need to make several choices related to certainty for each objective variable, depending on the type of management objective (condition or change (see page 23)). Make these choices carefully, because they will be

used to determine how many plots you will need to achieve the desired certainty.

### **Change objectives**

For change objectives, you want to determine whether a change in the population of interest has taken place between two time periods (for example, between preburn and year-1 postburn). For change-related management objectives, the monitoring objective will specify:

- The **minimum detectable change** desired
- A chosen level of **power**
- A chosen **significance level (alpha)**

You will use these later to calculate the minimum sample size needed to detect the desired change.

**Minimum detectable change**—The size or amount of change that you want to be able to detect between two time periods is called the minimum detectable change (MDC). You need to determine how much of a change is biologically meaningful for the population of interest. Is a 10% change meaningful? 30%? 50%? 80%? Your management objectives should provide the specific quantifiable levels of change desired. Looking at these objectives, use the low end of a range of values for your MDC. For example, if your management objective states that you want to see a 50–80% change, use 50% as the MDC.

The initial level of minimum detectable change, set during the design phase, can be modified once monitoring or new research provides information about the size and rate of fluctuations of the population. For example, you may discover that the 10% decrease in the mean percent cover of the “nonnative” species you choose was not biologically significant. This information might have come from recent research that found the percent cover of this species can fluctuate by more than 30% a year based on weather conditions alone.

### **Minimum Detectable Change**



If you choose a minimum detectable change amount of less than 30%, consider reevaluating this decision. Extremely variable populations may require a larger sample than you can afford in order to detect these low levels of change.

**Power**—The amount of certainty that you want to have in detecting a particular change is called power (see page 127). You must determine how certain you want to be of observing the desired minimum detectable change.

**Significance level**—The probability that an apparent difference occurred simply due to random variability is called the level of significance, or  $\alpha$  (alpha). You need to decide the acceptable probability that the observed difference was obtained by chance and is therefore not attributable to the treatment.

**Example:**

These monitoring objectives are based on the examples of change management objectives on page 23; the critical elements are highlighted:

- In the pine-oak forest monitoring type, we want to be **80% certain** of detecting a **50% reduction** in the mean total fuel load within 10 years of the initial prescribed fire. We are also willing to accept a **20% chance** of saying that a 50% reduction took place when it did not.

Here: power = 80%, MDC = -50%, and  $\alpha$  = 20% (0.20).

- In the tallgrass prairie monitoring type, we want to be **95% certain** of detecting a **40% increase** in the mean percent cover of native perennial grasses within ten years of the first burn. We are willing to accept a **5% chance** of saying that a 40% increase took place when it did not.

Here: power = 95%, MDC = +40%, and  $\alpha$  = 5% (0.05).

**Condition objectives**

If you want to determine whether the population of interest achieves a stated condition, either a target or a threshold, then you will use confidence intervals to determine whether your objectives have been met. For condition objectives the monitoring objective will specify:

- The confidence level (i.e., the likelihood that the confidence interval contains the true population value, e.g., 80% or 95%)
- The desired precision level (closeness with which the true population value is estimated)

You will use these later to calculate the minimum sample size needed to ensure a certain probability that your preburn and postburn sample means are within a given percentage of the true preburn and postburn means.

**Example:**

These monitoring objectives are based on the examples of condition management objectives on page 23; critical elements are highlighted:

- Within the cypress savanna monitoring type, we want to be **90% confident** that the sample mean, within six months postburn, of *Taxodium distichum* density is within **25%** of a true mean of less than 200 individuals per hectare.
- Within the ponderosa pine monitoring type, we want to be **80% confident** that the sample mean, preburn and five years postburn, of overstory tree density is within **25%** of a true mean of 90–120 trees per hectare.

**Confidence intervals**—Certainty can be expressed statistically by confidence intervals. A confidence interval is a range of values that has a stated probability of including the true population value for a variable. This range of values, or confidence interval, is like a measurement target with a certain probability that the estimated true population mean falls somewhere on the target.

**Example:**

A 95% confidence interval is a range of variable values which has a 95% probability of including the true population value, i.e., approximately 19 out of 20 times (see Figure 5). An 80% confidence interval means that there is an 80% probability that our confidence interval includes the true mean value, i.e., approximately 16 out of 20 times (see Figure 6).

The mean value for a variable obtained from a sample (all plots in a monitoring type) will always be located in the center of this interval. The lower and upper ends of the confidence interval are sometimes referred to as confidence limits.

In the design of a monitoring program, you will need to make two choices related to certainty for each objective variable: the confidence level, and the desired precision associated with the confidence interval. These choices must be made carefully, because they

will be used to determine how many plots are needed to achieve the desired certainty.

**Confidence level**—The confidence level is the selected probability for the confidence interval (95%, 90%, or 80%). This level indicates the probability that the confidence interval will include the estimated true population mean (in other words, the probability of “hitting the measurement target”). A critical management decision involving ecologically or politically sensitive species requires a high level of confidence. For less sensitive decisions, managers often may be willing to accept less certainty. General guidelines for choosing the confidence level are as follows:

- Choose an 80% confidence level for most objective variables.
- Choose a 90% or 95% confidence level if the objective variable is potentially sensitive, or when being confident of the monitoring results is critical (e.g., when a vital management issue is involved, such as that regarding an endangered species).

For a given sample size, the confidence level and confidence interval width are directly proportional. This means that if the confidence level increases (increased probability of hitting the measurement target), then the confidence interval is wider. Likewise, if the confidence interval width is more narrow, it is less likely that the target will be hit (lower level of confidence) (see Figure 7).

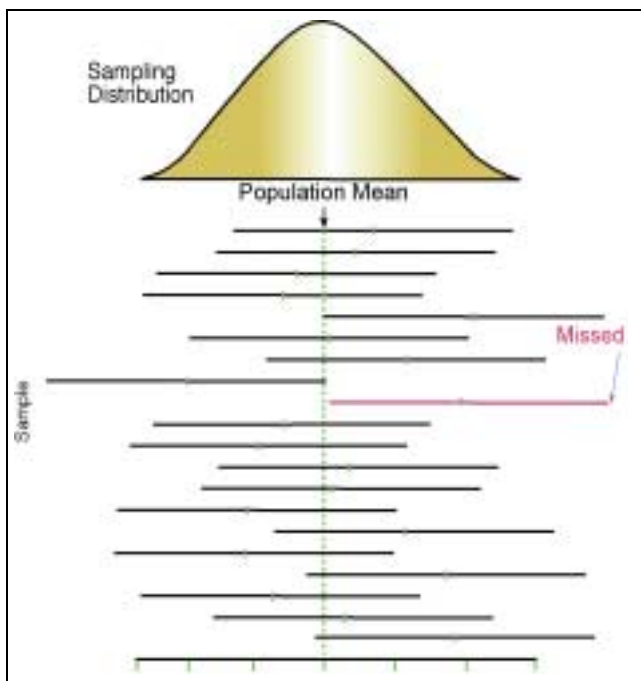

Figure 5. 95% confidence intervals.

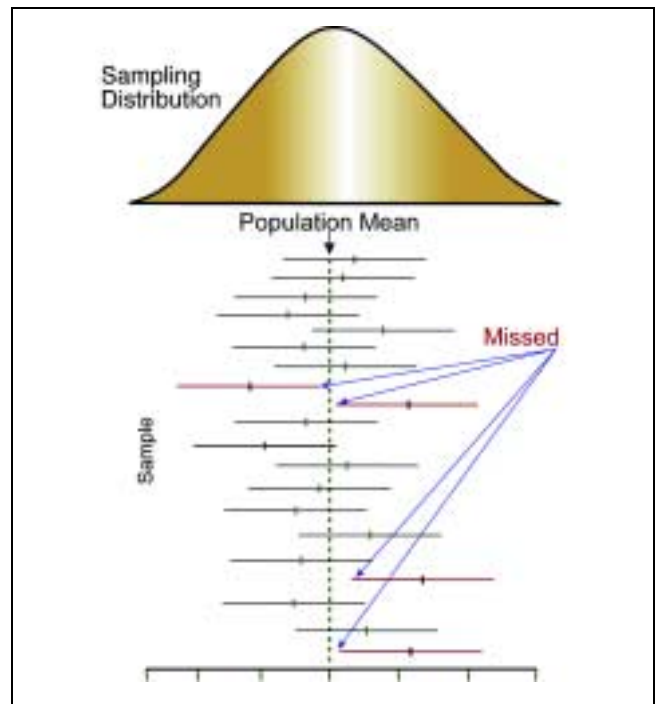

Figure 6. 80% confidence intervals.

**There are two ways to increase confidence level and reduce confidence interval width: increase the sample size or decrease the standard deviation** (see Sampling Design Alternatives, page 48). Choosing a confidence level and desired precision of the mean will be used to calculate the number of plots needed to achieve the desired certainty of the results.

**Desired precision level**—In addition to the confidence level, managers must decide on the precision of the estimate. The precision of a sample statistic is the closeness with which it estimates the true population value (Zar 1996). Do not confuse it with the precision of a measurement, which is the closeness of repeated measurements to each other. The desired precision level is expressed as the width of the maximum acceptable confidence interval. In the

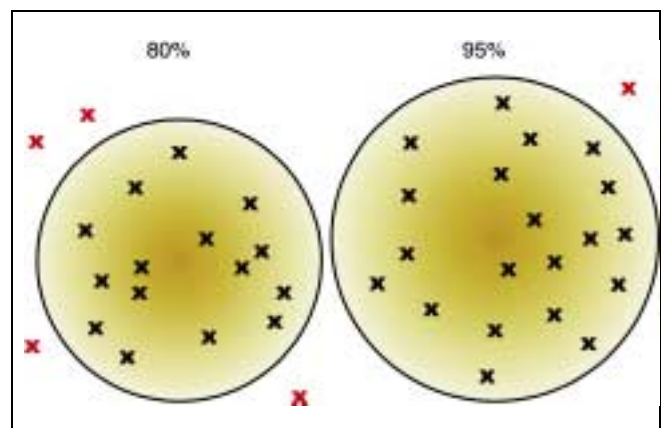

Figure 7. Comparing 80% and 95% confidence interval widths.

case of most objective variables, the desired precision level indicates how close the sample value is likely to be to the true population value.

In the FMH software (Sydoriak 2001), the desired level of precision is chosen by selecting a percentage of the estimated population mean (e.g., must be  $\leq 25\%$ ). This means that you are willing to accept a certain range around the estimated value (e.g., the true mean is within 25% of the estimated mean).

**The precision selected should be related to the need to have very close estimates of the true population mean.** General guidelines for choosing the desired precision are as follows:

- Choose 25% precision for most objective variables when the exact values are not critical; if small changes are not of a concern, then being within 25% of the true mean is probably sufficient.
- Choose 5–20% precision if the estimated mean must be within a small percentage of the true population mean (e.g., if a population's survival depends on only slight changes).

#### Example:

In a deciduous northeast woodland, the sample mean for the density of understory shrubs in 10 plots is 480 individuals per hectare. Managers need to be accurate in their density estimates, because density is a critical element of habitat suitability for the golden-winged warbler, a species of concern. To keep sampling costs down, but still collect data with a high precision level, managers chose a confidence interval width of 20% of the estimated true mean. In this case, the acceptable confidence interval width is within 96 individuals per hectare (plus or minus) of the estimated true population mean. If the golden-winged warbler, or any other species of concern, did not inhabit this woodland, managers could use a wider confidence interval width.

## Precision



For the purposes of this monitoring program, the desired precision cannot be greater than 25% of the estimated population mean.

# Objective Variables

The Recommended Standard (RS) variables for monitoring short-term and long-term change (levels 3 and 4) in **the three plot types** are outlined in Chapter 4 (see page 41). While each of these variables should be monitored, you do not need to measure each with a high level of certainty. A minimum level of certainty is required, however, for a variable derived from each management objective—a variable called the objective variable (see Glossary).

### Example:

If your primary management concern is to increase the dominance of a suppressed shrub species, you might choose only the **percent cover** of that species for a high level of certainty, even though it is not the dominant species in the preburn environment. You would then use only this variable to calculate your sample size. So the relationship between your objectives and your objective variable might look like this:

- **Management objective:** We want to see a 40% increase in the mean percent cover of all hazel species (*Corylus* spp.), in eastern white pine forest, 5 years after the application of prescribed fire.
- **Monitoring objective:** We want to be 80% sure of detecting a 40% change in the mean percent cover of all hazel species (*Corylus* spp.), 5 years after the application of prescribed fire and we are willing to accept a 20% chance of saying a change took place when it really didn't.
- **Objective variable:** mean percent cover of all hazel species (*Corylus* spp.).

You should monitor all the objective variables contained within your monitoring objectives. Your park natural resource specialist or ecologist, or a local person with that expertise, is responsible for identifying and defining the monitoring type, and for creating monitoring objectives from your management objectives. If local staff do not have the expertise needed to make these decisions, you should seek outside assistance.

## Objective Variables Not Covered by this Handbook



Your park's fire management plan may specify objectives that call for variables not discussed in this handbook; for example: Increase the population of **raptors** in all grasslands to >500 individuals. **If park management chooses objective variables that are not covered in this handbook, you will need to develop appropriate sampling methods.** Appendix G lists several monitoring references for other sampling methods for organisms of special management concern (e.g., forest insects and pathogens, birds, reptiles, and mammals). These references are limited, but should serve as a useful guide. Take care to develop such customized monitoring or research systems with the assistance of subject-matter experts.

In addition, when choosing objective variables not covered in this handbook, keep in mind that some protocols may lend themselves to being sampled in association with fire effects monitoring plots, e.g., songbird point counts. Integrating objective variables as much as possible can be efficient and cost-effective.

### Examples of Objective Variables

The objective variable that you choose should be the most efficient measure of the change that you are trying to achieve. The following are some potential objective variables, some of which are recommended (RS) variables (see Table 3, page 42).

**Grasslands-brush**—Percent cover for each of the three most dominant species; percent non-native species; density of shrub species.

**Forest-woodland**—Density of three most dominant overstory trees; density of two dominant understory trees; total fuel load; or any of those mentioned under grasslands-brush.

**Biological diversity**—Species richness; diversity indices.

**Animal population dynamics**—Birth-death rates; number of individuals; size and shape of territory.



**Rare species occurrence**—Number of individuals; reproductive rates; dispersion. These types of variables will be important if you are trying to enhance the habitat of a rare species by burning.

**Plant mortality and recruitment**—Death and establishment rates of selected plant species. These variables could be very important in attempts to encourage or discourage particular species.

The objective variables you chose to measure will determine the sample size, and therefore labor costs, for your monitoring program. Where there is a great deal of variability among plots, a sparsely distributed species, or a need for a high level of precision or confidence in the results, the total number of plots might be very high (see page 49 for a discussion of minimum sample size).

## COMPARING VEGETATION ATTRIBUTES

The following discussion will help you decide whether to use density, cover or frequency for your objective variable. This section also includes a discussion of the point intercept method for measuring cover. Change in all three of these variables may be expressed in absolute or relative terms, e.g., percent cover and relative cover. Use absolute values when you are looking at how a variable changes on a per unit area or sample basis. Use relative values when you are looking at changes as a proportion of the total.

### Density

Density is the number of individuals per unit area. Density, used to estimate the abundance of a particular species, is one of the most useful vegetational attributes. Density is independent of cover, the proportion of area covered by vegetation. For example, two shrub species could have the same percent cover where one consists of many small individuals (high density) and the other of few large individuals (low density). The adequacy of the sample size for density measurements is dependent on the shape and size of the plot used. Rectangular plots are best to minimize the variation within plots for plants with a clumped distribution. Since most plants grow in clumps, rectangular plots may be your best bet. To minimize the edge effect of non-circular plots, establish an edge rule, e.g., 50% of the rooted base must lie within the plot, or count plants with rooted bases on one edge of the plot, but not those on the opposing edge.

### *Advantages of using density as an objective variable*

- Density can be used to determine if the number of individuals of a particular species is increasing or decreasing.
- Density is an easily understood vegetational attribute.
- If individuals are distinguishable, density measurements are repeatable over time.
- Density is useful for monitoring threatened, endangered, or sensitive plant species, because it samples the number of individuals per unit area.
- Density is useful when comparing similar life forms, e.g., two species of shrubs that are approximately the same size.

### *Limitations of density measurements*

- In some species, it can be hard to identify an individual. This is especially true for species that are capable of vegetative reproduction, e.g., rhizomatous plants. For such plants, measure stem density instead of the number of individuals. No matter which is chosen, the individual unit of interest must be objectively identified and must remain the same throughout the duration of the monitoring effort.
- Because plant species vary in size, density measures lose a large amount of information about the plant community being studied. For example, two species may have identical densities, but the species that is larger in size will appear to have the greater ecological importance.
- Comparisons between densities of different growth forms are meaningless; for example, densities of trees and forbs cannot be compared.
- Seedling density, especially for herbaceous species, is directly related to environmental conditions, which can lead to misinterpretations of both positive and negative trends.

### Cover

Cover is an important vegetational attribute to which ecologists have applied a wide range of meanings. One of the most commonly used types of cover is canopy cover, which is expressed as a percentage of the total area measured, and defined as the vertical projection of vegetation onto the ground surface, when viewed from above. It is used in various ways to determine the contribution each species makes to a particular plant community. Cover measurement can provide a quantitative and rapid measure for species that cannot be effectively measured by density or biomass.

**Note:** Typically, canopy cover of trees is assumed to correlate with basal area or DBH. Relative dominance also is used as a synonym for relative basal area or relative cover.

#### ***Advantages of using cover as an objective variable***

- Cover is one of the most widely used measures of plant abundance because it is not biased by the size or the distribution of the individuals.
- Cover provides a good indication of the relative influence of a species.
- Cover measurements can be used for species in which identification of individuals is difficult.

#### ***Limitations of cover measurements***

- Cover, in herbaceous plants in particular, is very sensitive to changes in climatic and biotic factors.
- Cover measurements favor species with larger leaves or spreading growth forms. Additionally, species that hold their leaves horizontally will have higher cover values than species with acute or obtuse leaf angles.
- Because cover does not measure individuals, it does not readily indicate changes in recruitment or mortality.

#### **Frequency**

Frequency is a measure of the abundance and distribution of a species. Frequency is the percentage of all sampling units for which the canopy of a species is present. Frequency is best measured by nested plots, because it is very sensitive to plant size, dispersal patterns and density. The point intercept method does not measure frequency in the true sense of the word, nor is it the best method to measure this variable.

Frequency is useful for monitoring changes in vegetation over time, and for making comparisons among different plant communities. Since it is a variable that is not easily visualized across the landscape, you should use it in addition to—but not in place of—biomass, cover, or density.

#### ***Advantages of using frequency as an objective variable***

- Frequency sampling is highly repeatable, because it is easier to determine presence or absence within a plot than to measure cover or density.
- Frequency is a quick and inexpensive way to gather statistical evidence of change in vegetation.
- Frequency is very sensitive to invasions of undesirable species.
- Frequency is also very sensitive to relative change over time for key species.

#### ***Limitations of frequency measurements***

- Frequency is influenced by the size and shape of the quadrat used. What is an appropriate size for one species will not be for another; thus nested quadrats should be used in most frequency sampling. With inappropriate plot shape and size, frequency can easily be over- or underestimated.
- To accurately determine change, the frequency for the species in question must be between 20% and 80% (some say 30–70%).
- Frequency is very sensitive to changes that occur due to seedling establishment. This can be offset by collecting seedling information separately.
- Frequency is sensitive to changes in plant distribution in the sampled area, which hinders interpretation of changes.
- Interpretation of change is difficult because of the inability of the observer to determine what attribute of the vegetation changed. Frequency cannot tell you if the change was due to change in basal area, plant size, density, or pattern of distribution.

#### **POINT INTERCEPT METHOD**

The point intercept method uses the contact of a point to measure cover. Many variations on this method have been used to obtain estimates that are both statistically sound and economically efficient. The method used in this handbook is one such variation.

The theory behind this method is that if an infinite number of points are placed in a two-dimensional area, the exact cover of a plant species can be determined by counting the number of points that hit that species. This method then estimates the values from the infinite number of points through the use of a sample number of points.

#### **Advantages of Using the Point Intercept Method**

- This is considered the most objective way to measure cover—either a plant contacts the point or it does not.
- Point intercept sampling is highly repeatable.
- This method is more precise than cover estimates using quadrats.
- Point intercept sampling is more efficient than line intercept techniques, especially for herbaceous vegetation.
- This is the best method for determining the cover of the more dominant species.
- A minimum of training is needed to show field technicians how to lay out and read point intercept transects.

### **Limitations of the Point Intercept Method**

- Sampling errors can occur if the pin is not lowered plumb to the ground.
- Rare species with low cover values are often under-sampled.
- Wind increases the time required for sampling.
- A large sample size is often required to obtain reasonable accuracy and precision, especially for species with low cover values.
- The technique can be slow.
- Use of the point intercept method is difficult in tall vegetation types, because the “point” needs to be taller than the vegetation.

### **OTHER METHODS**

For an excellent reference on other methods of measuring cover, and guidelines for when they are appropriate, see Elzinga and others (1998 and 2001).

# 4

## Monitoring Program Design

*“To the person who only has a hammer in the toolkit, every problem looks like a nail.”*

—Abraham Maslow

At the onset of the design of a monitoring program, you will need to make a few basic decisions (see Figure 8):

- Which attribute will best indicate whether each of your management objectives (see page 20) was met? Identifying this attribute, or objective variable (see page 29), is a critical step in creating a monitoring objective.
- What is the appropriate size and shape of each sampling unit? See page 44 (Plot specifications) for more details.
- How many plots do you need to monitor? See page 49 (Calculating minimum sample size) for more details.

You will make these decisions for each monitoring type based on site-specific information and site-specific objectives. There is no such thing as one-size-fits-all monitoring.

Once you have formulated a design, you can refine it based on pilot sampling (see page 43). Pilot sampling

may reveal that it is impossible to address your objectives within the time and money constraints of your monitoring program. In such an instance, you could refine your design in any of four ways:

- Change the type of monitoring to a less resource-intensive type (which will have less statistical certainty), perhaps one that is more qualitative or semi-quantitative (e.g., photo monitoring, cover or density classes).
- Narrow the definition of the monitoring type (see Glossary) and create two or more monitoring types (e.g., split mixed grass prairie into *Hesperostipa comata*–*Carex filifolia* and *Bouteloua curtipendula*–*Nassella viridula* herbaceous vegetation associations).
- Change the monitoring objectives (see page 23) to less precisely estimate the variable on which your minimum sample size is based, or modify them to detect only larger changes.
- Modify your management objective so that you can choose to measure a different vegetational attribute.

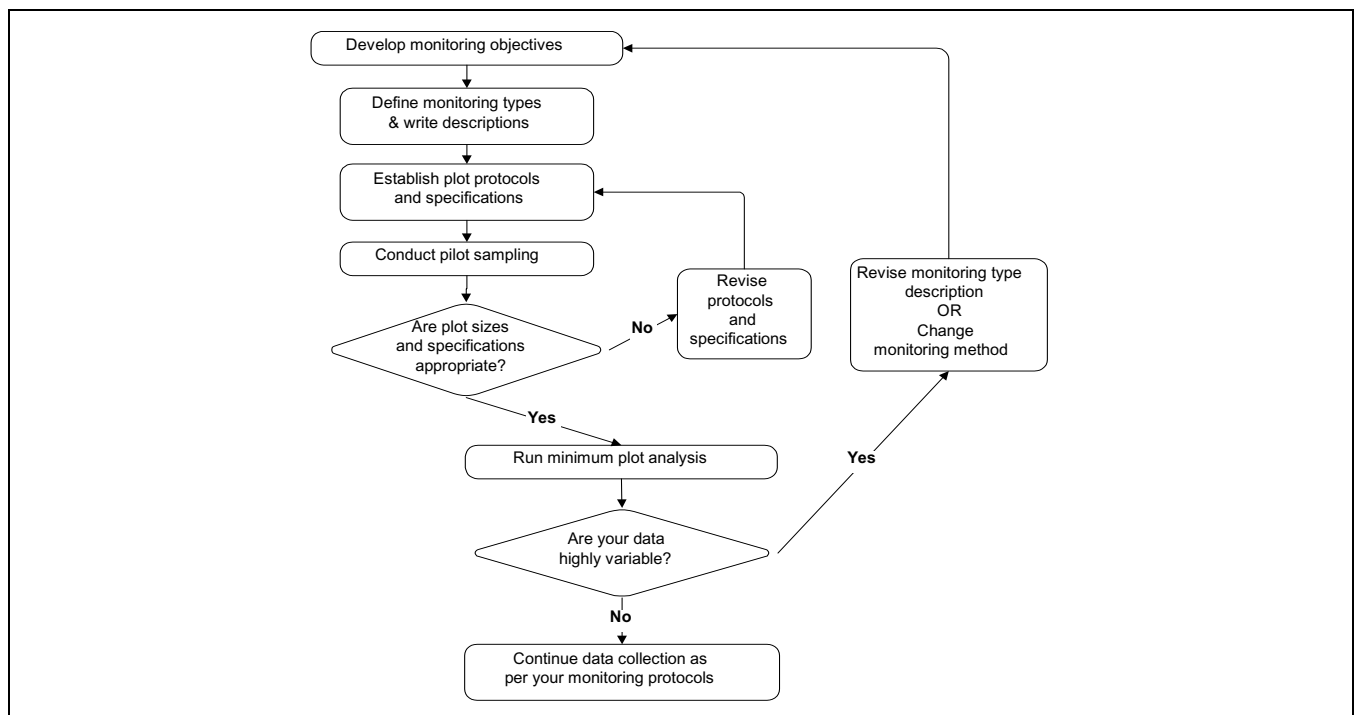

Figure 8. Steps in creating and refining monitoring type descriptions.

# Monitoring Types

---

Using Chapter 3 as a general guide, you have worked your way through the development of management and monitoring objectives in the fire effects monitoring flowchart (Figure 2, page 18). Once you have clear, measurable objectives, your next step is to define the population that you will monitor. For the purposes of this handbook, this population is called a monitoring type.

## DEFINING MONITORING TYPES

A monitoring type is a major fuel-vegetation complex or vegetation association that is treated with a particular burn prescription (which includes the season of the burn), or a combination of a burn prescription and a mechanical or other treatment, e.g., browsing, grazing, herbicide, seeding, or thinning. For example, a monitoring type could be defined as: a red pine dominated ( $\geq 50\%$  of the mean total basal area) conifer forest, fuel model 9, burned in the spring during green-up.

Defining a monitoring type requires considerable judgment. It should be done after careful field reconnaissance and in consultation with a fire or vegetation ecologist. The process as defined in this handbook calls for stratifying monitoring types by selecting appropriate defining and rejecting criteria.

Each monitoring type must be relatively homogeneous. If a monitoring type is not homogeneous, its high level of variability will likely indicate the need for an unreasonably high number of monitoring plots. However, if a monitoring type includes vegetational complexes of similar composition spread across a changing landscape, then it might include a range of stand densities, structure, fuel load, understory, and herbaceous associates.

If a monitoring type includes vegetation complexes of similar species composition, but the conditions that relate to your management objectives (e.g., fuel load) vary across the type, then there are two ways to reduce statistical variability:

- You can create highly variable monitoring types that may require a large number of plots within each monitoring type to pick up the within-sample

variability. However, this may reduce the total number of plots that are rejected in the field.

- You can create strictly homogeneous monitoring types that can decrease the sample size within a type, but could dramatically increase the total number of plots needed to monitor the greater number of monitoring types being used.

### Example:

Two types of white pine forest are intermingled throughout a park, one dominated primarily by white pine, and another with a mixture of eastern hemlock and hardwoods. The management objective for both plant associations is to create a forest with a mean density of overstory white pine between 75–110 individuals per hectare within 50 years of the initial treatment. Park managers may want to consider lumping these two plant associations together into one monitoring type. Lumping these two associations will probably reduce monitoring costs by decreasing the total number of plots and by increasing sampling efficiency, as monitors will be less likely to reject plots that contain the intermingled forest types.

---

Define the minimum number of monitoring types that will represent the major fuel-vegetation complexes or vegetation associations within the units that you will manage using prescribed fire. Try to resist the temptation to identify all possible types. A park of moderate topographic and vegetational complexity could easily have 50 to 100 possible types using the criteria listed above; however, this creates an impractical monitoring design. The necessary compromise should be developed with the assistance of a vegetation management specialist and/or fire ecologist. You will then further refine each monitoring type through pilot sampling (see page 43).

## Monitoring Types



In the interest of efficiency, start with highly variable monitoring types, and then divide them if necessary. Start by delineating a type where your objectives are the same or similar. Then, look at the variability of your objective variables within that type. If there is a wide range of values for these objective variables, then it may be wise to further divide your type. If not, keep the type as is.

If you know of another park that has similar vegetation types, management objectives, burn prescriptions, etc., consider using that monitoring type description, including any changes necessary to compensate for local differences. This can potentially reduce the total number of plots needed in each park. If another park has similar vegetation types, but different objectives, you should at least review their monitoring type descriptions to see where your similarities lie.

### Step 1: Establish Selection Criteria

The first step is to establish the specific criteria used to identify each monitoring type. By defining selection criteria, monitors can determine whether each randomly selected monitoring plot is truly representative of the type. Defining criteria quantitatively (e.g., >75% basal area of table mountain pine with <30% white oak; or >60% cover of blackbrush with <10% cover of Joshua tree) should permit a qualitative or even quantitative comparison of trends among monitoring types or even among similar monitoring types from different parks.

Types **may** be differentiated on the basis of one or a combination of the following elements:

#### **Vegetation composition**

Vegetation composition is defined, according to a federal standard (FGDC 1996), by the mixture of plant species that form a community. Plant community is a general term that can be applied to any vegetation unit, from the regional to the very local. A qualified resource manager or researcher establish the range and limits of compositional variability for any named plant community (e.g., association, alliance). Examples are *Quercus gambelii*–*Amelanchier alnifolia* shrubland association, *Danthonia intermedia*–*Solidago multiradiata* herbaceous vegetation association, and *Quercus virginiana*–*Sabal palmetto* forest alliance. For the current list of fed-

eral standard plant associations, see The Nature Conservancy (1998) on the subject.

#### **Vegetation structure**

Vegetation structure refers to the distribution of the composite elements—i.e., how abundant various plant species are within a plant association, and how many different layers they form. Examples of vegetation structure are: dense herbaceous cover within a forest type; pine with scattered shrubs; oak stands without reproduction with a continuous non-native grassland understory; dense cover of native perennial bunchgrasses; and dense palmetto with scattered slash pine.

#### **Sensitive species**

Monitoring types are occasionally defined by individual species that are considered sensitive due to environmental, political or other factors. For example, some biotic elements are adapted to a strict fire regime or are extremely sensitive to a certain type of fire. Some areas may require a fire regime very different from the norm for that vegetation type in order to respond to political concerns. Examples of sensitive elements are: endangered plant populations or habitat, politically or environmentally sensitive species or habitats, and popular habitats such as giant sequoia groves or vernal pools.

#### **Physiography**

Topography is often critical for identifying the distribution of small monitoring types, especially if the types include rare species. Physiographic changes in slope, aspect, topographic position, or elevation can define a monitoring type. Stratification based solely on these elements for larger monitoring types, however, is generally inappropriate, since the biological elements frequently cross physiographic “boundaries,” or occur over a broad range of conditions.

#### **Fuel characteristics**

If the strata in your park vary significantly, you may divide classic (Anderson 1982) or custom fuel models into different monitoring types. Examples are change in dead and downed loads, standing fuel density, duff loads, biomass, height, and continuity. Conversely, you may include multiple vegetation types within a single fuel model.

#### **Burn prescription**

Burn prescriptions identify desired fire behavior (e.g., flame length) and amount of fuel consumption and smoke production, and therefore predict expected burn results. Burn prescriptions also define the frequency (the return interval) and the season of the burn. Examples of how a burn prescription might dif-

ferentiate a monitoring type are: a shrub association being burned in the spring in one part of the park and in the fall in another part of the park, or a perennial grassland being burned with a frequent return interval (1–4 years) in one area, and on a longer fire return interval (7–15 years) in another. Note that in each of these examples, you would need different management objectives to truly separate these types.

### **Other treatments**

Occasionally, managers use other tools in conjunction with fire to achieve management objectives. These might include browsing, grazing, herbicide, thinning, or seeding. Areas subject to more than one type of treatment should **not** be lumped with prescribed fire-only treatments.

### **Plot type**

When choosing a plot type (forest, brush or grassland), keep in mind your objective variable or other variables you want to measure. If you need to use forest plot protocols (e.g., to track the height of tree-like shrub individuals), use a forest plot even in a treeless monitoring type. **Note:** If you use a forest plot in this situation, use only the protocols that you need and disregard the rest.

Additionally, think about the future structure, composition and characteristics of your monitoring type. Using a forest plot in a grassland area is appropriate if you intend to monitor the encroachment of trees into an area. Likewise, you would use a brush plot to monitor the encroachment of shrubs into a grassland area. You can use grassland plots to monitor the encroachment of non-native species into native grassland, or to capture the migration of a species into or out of an area.

## **Step 2: Describe the Monitoring Type**

A detailed description of each monitoring type is essential to define the appropriate location for monitoring plots, monitor the biophysical elements of concern, and qualitatively and/or quantitatively compare variables between areas or plots.

On the Monitoring type description sheet (FMH-4 in Appendix A) record all of the following information (see page 39 for an example):

### **Park unit 4-character alpha code**

This is the four letter code given to every National Park unit, generally designating the first two letters of the first two words, or the first four letters if only one

word, e.g., NOCA = North Cascades National Park, or BAND = Bandelier National Monument.

### **Monitoring type code**

Each monitoring type must be identified by a standardized code to facilitate computerization and comparative analyses within and among NPS units.

### **Assign a unique multi-character code as described here:**

Plot Type: F = forest, B = brush, G = grassland

Dominant Species Code (see page 83): if no clear dominant exists, or if you have more than one monitoring type with the same dominant, create your own code, e.g., MIPR1 = mixed prairie.

Burn Season Phenology (phenological stage of key plants affected by or carrying the fire during a burn (a burn prescription element)):

G = green-up (period of active plant growth)  
T = transition (active growth phase nearly over; plants setting and dispersing seed)  
D = dormant (plants cured, dormant; deciduous trees lost leaves)

Fuel Model: #01–13 or custom model

### **Examples:**

**FSEGI2T08**—(forest plot, dominated by *Sequoiadendron giganteum*, burned during transition, fuel model 8)

**BCLMAJG03**—(brush plot, dominated by *Cladium mariscus* ssp. *jamaicense*, burned during green-up, fuel model 3. Note that here managers are using a brush plot in a “grassland” plant association to track the encroachment of shrubs)

**GAGCRD01**—(grassland transect, dominated by *Agropyron cristatum*, burned when dormant, fuel model 1)

### **Monitoring type name**

Use a name that most people will recognize as representing the plant association(s) in which you are working. For example, chamise chaparral, Madrean pine-oak woodland, northern pine barrens.

### **FGDC (Federal Geographic Data Committee) association(s)**

Note the federal standard plant association(s) (FGDC 1996; The Nature Conservancy 1998) that your moni-

toring type description encompasses. For example, *Andropogon gerardii*–*Panicum virgatum* Dakota sandstone herbaceous vegetation, *Artemisia tridentata*–*Chrysothamnus nauseosus* shrubland. Consult state, agency, The Nature Conservancy or other ecologists involved in developing local level association descriptions if you have any doubt as to the names of plant associations in your area.

### ***Burn prescription***

Provide detailed information regarding the prescription and any other management treatments (as discussed on page 35) that you will use throughout the type. **Note:** Include the full range of conditions under which you will burn the type.

### ***Objectives***

**Management objective(s)**—Include your management objective(s) as discussed on page 20.

**Monitoring objective(s)**—Include your fire monitoring objective(s) as discussed on page 23.

### ***Objective variable(s)***

It is strongly suggested that you monitor one variable to a chosen level of certainty for every management objective. For a more complete discussion of objective variables, see page 29.

### ***Physical description***

Describe the physical elements selected in Step One (page 35) that characterize the type. This includes the range of geologic and topographic features included in the type—soil type(s), aspect(s), elevational range, gradient, landforms, etc.

### ***Biological description***

Quantitatively and qualitatively describe the species that dominate or characterize the vegetation association selected in Step One (page 35). Indicate the acceptable range of values for the elements that define each stratum.

### ***Rejection criteria***

Establish rejection criteria that would make a potential plot site unsuitable for monitoring. Note that your rejection criteria may differ among monitoring types; rejection criteria for one monitoring type may in fact be representative of another type. Examples of possible rejection criteria include:

- High percentages of rock outcrops, barren spots, soil, and/or vegetation anomalies (e.g., a small meadow in a forest)

- Locations close (<30 m) to a road, trail, potential development site, proposed fireline, developed area, or monitoring type boundary (ecotone)
- Areas to be blacklined or manually cleared before burning (unless the entire burn unit is to receive this “treatment”)
- Evidence of more recent fire than that in rest of the monitoring type
- Inclusion of archeological sites
- Areas with >50% slope (installing and monitoring plots on steep slopes can result in excessive damage to the herbaceous vegetation and fuel bed. Where practical, it is recommended that you avoid such slopes)
- Threatened or endangered species habitat that park management wants to protect from fire
- Substantial disturbance by rodents, vehicular traffic, or blow downs, volcanic activity, etc.
- Intersection by a stream; seep or spring present
- Safety issues, e.g., known high density rattlesnake habitat
- Inventory, monitoring, or research plots that would be compromised by the co-location of plots
- Other locally defined conditions that present problems

By establishing clear monitoring type descriptions and rejection criteria, you can avoid bias. Examples of reasons **not** to reject monitoring plot locations:

- **Not typical:** Plot location is thought to be atypical (a plot is either in the type or not; it should be rejected only because it does not meet the monitoring type description)
- **Too difficult to sample:** It would be too difficult to put in transect at this location (shrubs too dense, or plot location is hot and lacking shade trees)

### ***Notes***

In this section, identify any deviations from or additions to protocols listed in this handbook. Describe your pilot sampling design as well as any special sampling methods, including any variation in plot size or shapes to accommodate individual species. This section should also note any species for which you will collect DRC instead of DBH, and list any shrub species that are clonal or rhizomatous, and therefore not counted in the belt transects.

### ***Additional headers***

If you recreate your Monitoring type description sheet using a word processing software program you may find it useful to add other sections, such as: “Variable(s) of Interest” (any variable of concern you might



want to track, but not necessarily to a chosen level of certainty) or “Target Condition” (attributes that you are using fire management to maintain or restore).

### ***Plot protocols***

On the second page of the Monitoring type description sheet (FMH-4 in Appendix A), indicate the optional variables to be measured, the areas in which Recommended Standard (RS) variables are to be measured, and all other protocols that apply to each individual monitoring type. See the example in the next column.

#### **Example:**

The plot protocols example on page 40 indicates that you:

- Use abbreviated tags, collect voucher specimens, and install all 17 stakes
- Measure the following optional variables preburn: herbaceous height, tree damage (live only), overstory crown position (live and dead), pole-size and seedling tree height, and dead seedling density
- Sample the following areas:
  - Q4–Q1 and Q3–Q2 for herbaceous cover
  - species not intercepted but seen on both sides of the herbaceous transect—5 m wide on both herbaceous transects
  - shrub density—5 m wide belt transect on both herbaceous transects
  - overstory trees—all quarters of a 50 × 20 m plot
  - pole-size trees—Q1
  - seedling trees—a 5 × 10 subset of Q1
  - fuel load—6, 6, 12, and 50 foot transects
- Measure the following optional variables during the burn: duff moisture and flame depth
- Collect burn severity data along the fuel transects, and measure the following optional variable immediately postburn: char height

---

### **Pilot Sampling and Monitoring Types**

Monitoring type selection and description will be tested, and may be modified, during a process known as pilot sampling (see page 43). This process of fine-tuning uses a range of plot protocols and a limited number of plots to ascertain the extent of variability

within a monitoring type and among the variables of importance that have been selected.

#### **Example:**

A monitoring type description should include the level of effort and quantitative information found on the next page.

---

**Monitoring Type Code:** F P I P O T 0 9**Date Described:** 1/10/01**Monitoring Type Name:** Ponderosa Pine Forest**FGDC Association(s):** *Pinus ponderosa* – *Quercus macrocarpa* Woodland; *Pinus ponderosa* – *Prunus virginiana* Forest**Preparer(s):** G. San Miguel, B. Adams, G. Kemp, P. Reeberg**Burn Prescription (including other treatments):** Units will be burned between Labor Day and the end of September. Flame length 0.5–3 ft; rate of spread 0–3 ch/hr. Temperature 30° +85°F.; Relative humidity 25–55%; Midflame wind speed 0–20 mph; Fuel moisture as follows: 1-hr 6–14%, 10-hr 8–15%, 100-hr 10–30%.**Management Objectives:** Reduce the mean total fuel load by 50–80% immediate postburn and maintain for at least two years postburn; reduce mean overstory density by 20–40% by the fifth year postburn; and increase the mean herbaceous and shrub cover by 25–45% within 10 years postburn.**Monitoring Objectives:** We want to be 80% confident of detecting a 50% decrease in the mean total fuel load (immediate and two years postburn), and a 20% reduction in the mean density of all overstory trees, five years after the application of prescribed fire. For both of these objectives we are willing to accept a 20% chance of saying these reductions took place when they really did not. In addition, we want to be 90% confident of detecting a 25% increase in the mean percent cover of understory species and we are willing to accept a 10% chance of saying that this increase took place when it really did not.**Objective Variable(s):** Mean total fuel load; mean density of overstory ponderosa pine; mean total understory cover.**Physical Description:** Includes upland sites on all aspects and slopes with an elevation from 4,000' to 6,000', which includes upper, mid and lower slopes. Talus slopes and steep slopes (>40% slope) are excluded. Characteristic soils consist of deep, well-drained clay, or sandy loam of the Larkson–Lakoa Series. There are also some areas of exposed sandstone.**Biological Description:** Overstory dominated (greater than 65% of the canopy cover) by ponderosa pine (*Pinus ponderosa*). Understory trees (15–60% cover) include: bur oak (*Quercus macrocarpa*), chokecherry (*Prunus virginiana*), and American plum (*Prunus americana*). Shrubs (0–30% cover) include: Oregon grape (*Mahonia repens*), common juniper (*Juniperus communis*), pink current (*Ribes cereum*). Grasses and forbs (0–20% cover) include: poverty oat grass (*Danthonia spicata*), needle and thread (*Stipa comata*), Western wheatgrass (*Agropyron smithii*), big bluestem (*Andropogon gerardii*), and Kentucky bluegrass (*Poa pratensis*).**Rejection Criteria:** Large outcroppings or barren areas >20% of the plot; areas with anomalous vegetation; monitoring type boundaries; riparian areas; areas dominated by deciduous trees (>30% cover); areas within 30 m of roads, burn unit boundaries, or human made trails or clearings; and areas within 20 m of woodlands. Research exclosures are to be rejected.**Notes:** Do not collect shrub density for Oregon grape because it has underground stolons, and therefore it is difficult to identify individuals for this species.

GENERAL PROTOCOLS		(Circle One)	(Circle One)
<b>Preburn</b>	Control Treatment Plots (Opt)	<i>N</i>	Herb Height (Opt) <i>Y</i>
	Herbaceous Density (Opt)	<i>N</i>	Abbreviated Tags (Opt) <i>Y</i>
	OP/Origin Buried (Opt)	<i>N</i>	Herb. Fuel Load (Opt) <i>N</i>
	Voucher Specimens (Opt)	<i>Y</i>	Brush Fuel Load (Opt) <i>N</i>
	Count Dead Branches of Living Plants as Dead (Opt)		<i>N</i>
Width Sample Area for Species Not Intercepted But Seen in Vicinity of Herbaceous Transect(s): <i>5 m</i>			
Length/Width Sample Area for Shrubs: <i>50 × 5 m</i>		Stakes Installed: <i>All</i>	
Herbaceous Frame Dimensions: <i>Not Applicable</i>			
Herbaceous Density Data Collected At: <i>Not Applicable</i>			
<b>Burn</b>	Duff Moisture (Opt)	<i>Y</i>	Flame Depth (Opt) <i>Y</i>
<b>Postburn</b>	100 Pt. Burn Severity (Opt)	<i>N</i>	Herb. Fuel Load (Opt) <i>N</i>
Herbaceous Data (Opt): FMH- <del>45/46/47/48</del> : <i>Do Not Collect</i>			

FOREST PLOT PROTOCOLS		(Circle One)	(Circle One)
<b>Overstory (&gt;15 cm)</b>	Live Tree Damage (Opt)	<i>Y</i>	Live Crown Position (Opt) <i>Y</i>
	Dead Tree Damage (Opt)	<i>N</i>	Dead Crown Position (Opt) <i>Y</i>
	Record DBH Year-1 (Opt)	<i>N</i>	
Length/Width of Sample Area: <i>50 × 20 m</i>		Quarters Sampled: <i>Q1 w Q2 w Q3 w Q4</i>	
<b>Pole-size (≥2.5≤15)</b>	Height (Opt)	<i>Y</i>	Poles Tagged (Opt) <i>N</i>
	Record DBH Year-1 (Opt)	<i>N</i>	Dead Pole Height (Opt) <i>N</i>
	Length/Width of Sample Area: <i>25 × 10 m</i>		Quarters Sampled: <i>Q1</i>
<b>Seedling (&lt;2.5 cm)</b>	Height (Opt)	<i>Y</i>	Seedlings Mapped (Opt) <i>N</i>
	Dead Seedlings (Opt)	<i>Y</i>	Dead Seedling Height (Opt) <i>N</i>
	Length/Width of Sample Area: <i>10 × 5 m</i>		Quarters Sampled: <i>Subset</i>
<b>Herbaceous</b>	Cover Data Collected at: <i>Q4-Q1 w Q3-Q2</i>		
<b>Fuel Load</b>	Sampling Plane Lengths: <i>6 1 hr w 6 10 hr w 12 100 hr w 50 1,000 hr-s w 50 1,000 hr-r</i>		
<b>Postburn</b>	Char Height (Opt)	<i>Y</i>	Poles in Assessment (Opt) <i>N</i>
Collect Severity Along: <b>Fuel Transects</b>			

## Variables

---

Variables (see Glossary) are monitored by sampling according to a standardized design. Customized methods may also be needed for special concerns; however, your regional ecologist and/or fire effects monitoring specialist should review any customized methods or form modifications.

### LEVEL 3 AND 4 VARIABLES

Procedures for monitoring levels 3 and 4 are similar, but differ in timing and emphasis. The **Recommended Standard (RS)** for monitoring short-term change (level 3) is to collect detailed descriptive information on fuel load, vegetation structure, and vegetation composition. This information is determined only broadly at level 2, Reconnaissance–Fire Conditions. Wildland fire management may also require the collection of some or all of these data.

If your program has both short-term and long-term management objectives, you may be required to use different variables and different monitoring frequencies for monitoring levels 3 and 4. For example, a management objective of using fire to open up a woodland stand and improve native grass and forb populations by reducing the density of live pole-size trees would require a monitoring objective to assess the mortality of pole-size trees preburn to immediate postburn. A short-term (level 3) objective variable could be live pole-size tree density. To assess the herbaceous response preburn to year-2, or even year-5 postburn, a long-term (level 4) objective variable could be herbaceous cover. The objective variable contained within the long-term objective becomes the long-term RS for level 4 monitoring.

If a program has only short-term management objectives (for example, to reduce fuel load or shrub density), the RS for level 4 monitoring is to continue monitoring all level 3 variables over an extended period of time. Both situations include using the change over time minimum sample size equation (see pages 49 and 124 for discussion; for formula, see page 217 in Appendix D) for all objective variables using the time periods specified in your management objectives.

A monitoring program can and should be customized to address specific park needs; however, any modifications in the program must be approved by your park's

resource management specialist and fire management officer, and reviewed by a park scientist or local research scientist. These proposed changes should then be sent to your regional office for review.

Monitoring for long-term change requires collecting information on trends, or change over time, in an ecosystem. Such change can be neutral, beneficial or detrimental. If your monitoring program detects a trend of concern, you can implement a research program or appropriate management response to obtain more information. For example, the National Park Service did not formally conduct long-term monitoring during its policy of fire suppression up until 1968. As a result, undesired effects in many parks were not formally recognized for about 90 years, and only after considerable (and often irreversible) damage had been done. With a systematic process of monitoring and evaluation, managers might have reevaluated the suppression policy earlier. Similarly, current fire management strategies also have the potential to cause undesired change. For this reason, long-term monitoring should accompany all types of fire management strategies.

The existence of a long-term trend is revealed by continued monitoring of the short-term (level 3) objective variables. Select objective variables that are good indicators of both short-term and long-term change. This handbook does not specify the most appropriate indicators of long-term change, as they will be different for each park and monitoring type. Park staff should select objective variables (with input from resource management specialists and other scientists as needed) by examining 1) fire management goals and objectives, 2) their biota's sensitivity to fire-induced change, and 3) special management concerns.

The RS variables listed should be monitored according to the monitoring schedule (for the schedule of level 3 and 4 variables, see page 57). Monitoring methods and procedures for monitoring plots are described in Chapter 5.

### RS VARIABLES

Recommended Standard (RS) variables (Table 3, next page) can be used to track both short- and long-term change in the vegetation and fuel components of your ecosystem. After following these variables over the

long term, while only a few will have a high level of certainty, the results from all variables will help you identify topics for follow-up research or necessary changes in your monitoring objectives or sampling protocols.

**Example:**

In a sugar pine (*Pinus lambertiana*) monitoring type, the objective variables are the density of overstory sugar pine and total fuel load. After collecting data for five years, the fire manager notices that the mean percent cover of *Ribes nevadense* is 30 times the pre-burn cover. The manager suspects that the fire has caused this increase and is concerned since *Ribes nevadense* is an alternate host for the non-native white pine blister rust, which kills sugar pines.

In this example, the manager recognized a trend based on a variable (mean percent cover of *Ribes nevadense*) that was not an objective variable. The manager now must determine whether the measured increase in *Ribes nevadense* is either biologically significant (does this change in cover necessarily increase the threat that these shrubs will spread blister rust?) or statistically significant. The next step might be to install control plots, examine plots from other studies (outside of the burned area, but within the monitoring type), or initiate a research study to address this issue.

**Table 3. Recommended Standard variables for monitoring (level 3 & 4) grassland, brush, and forest plots.**

Plot Type	Variables
Grassland	<ul style="list-style-type: none"> <li>• Percent cover by species</li> <li>• Relative cover by species</li> <li>• Number of non-native species</li> <li>• Number of native species</li> <li>• Burn severity</li> </ul>
Brush or Shrubland	All grassland variables, plus <ul style="list-style-type: none"> <li>• Shrub density by species</li> <li>• Shrub age by species</li> </ul>
Forest or Woodland	All grassland and brush variables, plus <ul style="list-style-type: none"> <li>• Tree density by species</li> <li>• Tree diameter by species</li> <li>• Fuel load by size class</li> <li>• Total fuel load</li> <li>• Duff depth</li> <li>• Litter depth</li> <li>• Average scorch height</li> <li>• Percent of crown scorched</li> </ul>

# Sampling Design

## PILOT SAMPLING

Once you have defined your monitoring type, you will fine-tune it with a process called pilot sampling. This initial step will help you determine whether your plot sizes and/or shapes are appropriate, and whether the protocols discussed in this handbook are appropriate for your park.

The first step in pilot sampling is to collect and analyze field data. While you are collecting and entering these data, consider the questions listed under “Considerations Prior to Further Plot Installation” (page 47). If your answers to any of these questions is “no,” you should explore sampling design alternatives.

Install ten initial plots in a monitoring type using the restricted random sampling method discussed on page 59. Then analyze all plot variables and adjust your sampling design as necessary. If the density of the species being sampled (trees, shrubs or herbs) is relatively high, use smaller sampling areas (eliminating the counting of hundreds of plants in each plot) throughout the monitoring type. Conversely, if the density is relatively low, use a larger sampling area to avoid having a sampling area in which no plants occur. See pages 44–47 for some guidelines to follow when making these decisions.

In addition, calculate the coefficient of variation (see Appendix D, page 218, for the equation) for each variable (not just your objective variable(s)), checking to see which size-shape combination gives you the lowest coefficient of variation. This will help you decide on the most efficient design for your sampling areas.

**Note:** Also use this process if you are using different sampling attributes or areas postburn. After adjusting sampling areas and revisiting plots to resample, you can calculate minimum sample size (see page 49).

## Sampling Area Consistency



Once you have refined the size and shape of a sampling area for a variable through pilot sampling, do not change the sampling area. Sampling area (size and shape) must be consistent among plots within a monitoring type, and should be consistent for each variable. If the size or shape of the sampling area is changed, all plots installed prior to the change must be revisited so that every plot within a monitoring type has the same sampling design.

## Redesigning an Existing Sampling Design



If you have plots that were established without using the pilot sampling process, you might be able to reassess your sampling design, provided that you have well-documented data sets. For example, if you have excellent pole-size tree maps, then you can conduct pilot sampling by trying different plot shapes and sizes on your maps. If you have poor maps, or you find that you need larger sampling areas, consult with a specialist in sampling design before you make any changes to your study design.

## Pilot Sampling



When you visit the first plots in a monitoring type, sample pole-size and seedling trees as well as shrubs in a larger area, and map the location of each tree or shrub (or separate the brush belt into smaller widths). This way when the ultimate sampling area is chosen you can refer to the map (or smaller belt width) and delete the data that do not belong in this final sampling area without having to revisit the plot. This is a good tip for situations where you end up using a “larger” area or an “unusual” plot shape, or the plot is difficult to access. It may be inefficient in other cases.

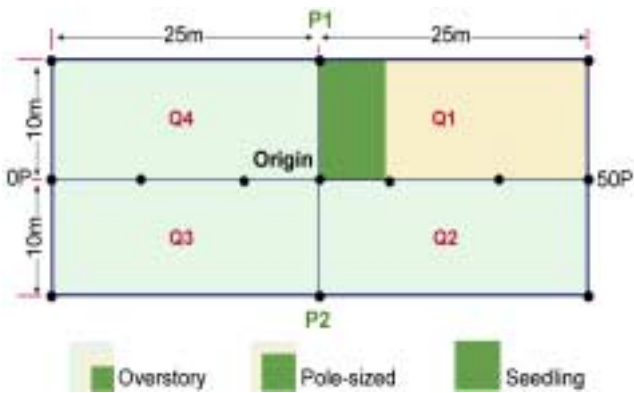

Figure 9. Suggested sampling areas for forest variables.

### Plot Specifications

Suggested plot size and sampling locations vary for each variable (see Figure 9 and Table 4). The plot sizes and transect lengths in Table 4 are adequate for many forest types, but revisions will in some cases be necessary to reduce excessive data collection or to increase data precision for a particular variable. These adjustments may be particularly important when an objective variable is sparsely distributed. All adjustments should be done by resource and/or fire managers in consultation with a fire or vegetation ecologist.

Where variability is high, the calculated minimum sample size (number of plots, see page 49) may exceed 50. There are five basic ways you can reduce this variability:

1. Increase the area, number of sample points, or transect lengths monitored for variables with high variability throughout the monitoring type.
2. Change the shape of your sampling area.
3. Use another method to measure that variable (e.g., temporary plots are better than permanent plots at monitoring changes in some annual plant populations).
4. Install a large number of monitoring plots.

Table 4. Suggested forest plot specifications, by variable.

Variable	Plot Size or Transect Length	Location
Overstory Trees	Plot: 20 m × 50 m (0.1 ha)	Quarters 1, 2, 3, 4
Pole-size Trees	Plot: 10 m × 25 m (0.025 ha)	Quarter 1
Seedling Trees	Plot: 5 m × 10 m (0.005 ha)	Portion of Quarter 1
Dead and Downed Fuels	Transect: four, 50 ft each (200 ft)	Quarters 1, 2, 3, 4
Shrub and Herbaceous Layer	Transect: two, 50 m each (100 m)	Outer portions of Quarters 1, 2, 3, 4
Shrub Density	Plot: two, 1 m × 50 m (0.01 ha)	Outer portions of Quarters 1, 2, 3, 4

5. Further stratify the monitoring types and create additional sets of monitoring plots (see page 34 for a discussion of splitting your monitoring types).

Locating and installing additional plots (needed for the last two options) is very time-consuming; therefore, of the options listed above, options one, two and three are the preferred means of reducing variability.

### Tree size classes

The suggested size class definitions for overstory (DBH (diameter at breast height) >15 cm), pole-size (DBH ≥2.5 cm and ≤15 cm), seedling (DBH <2.5 cm) trees may work in some areas but not in others. If you find that these definitions are not useful, and your park ecologist, regional ecologist or fire effects monitoring program manager agrees, you can redefine them. Be sure to note any changes on the back of the Monitoring type description sheet (FMH-4 in Appendix A).

### Overstory trees

The 20 m × 50 m plot size may be unnecessarily large for dense stands of overstory (DBH >15 cm) trees. In these preburn situations, try using a pilot sampling regime, such as the example displayed in Figure 10. Where the overstory trees are very sparse (e.g., giant sequoias, large mature trees) try enlarging (e.g., doubling) the default sampling area during the pilot sampling period. If only one species or size class is very sparsely distributed, you may try larger sampling areas for that species or size class alone during pilot sampling. In this example, some plot sizes/shapes that you could try for giant sequoia overstory trees might be: 20 m × 100 m or 40 m × 100 m; using 20 m × 50 m for all other overstory species (not illustrated). In addition, please read the Tip “Different Sizes and Shapes of Sampling Areas” on page 47 and the Reminder “Consistent Sampling Areas” on page 47.

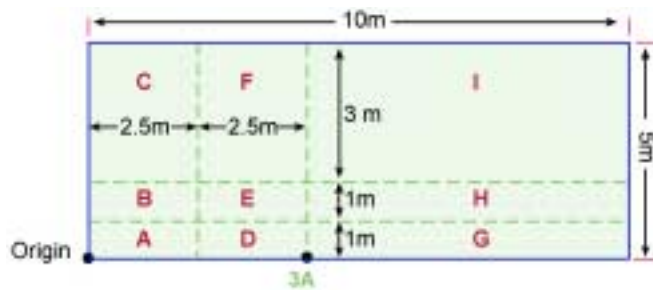

**Figure 10. An example pilot sampling scenario for extremely dense overstory or pole-sized trees.**

**Note:** This example may not be suitable for your situation. The shape and size combinations that can be tested here include: 2.5 × 1 m (A), 2 × 2.5 (A+B), 2.5 × 5 (ABC), 5 × 5 (A–F), 1 × 5 (A+D), 1 × 10 (A+D+G), 2 × 10 (A+D+G+B+E+H), 5 × 10 m (All).

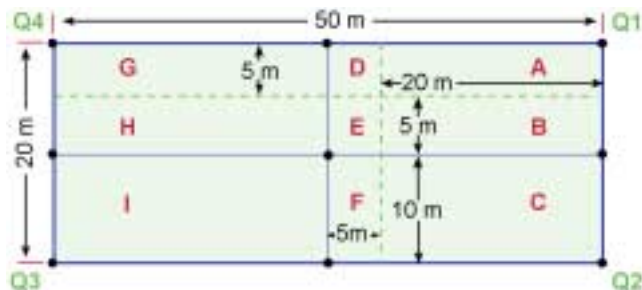

**Figure 11. An example pilot sampling scenario for sparse pole-sized or seedling trees.**

**Note:** This example may not be suitable for your situation. The shape and size combinations that can be tested here include: 5 × 20 m (A), 20 × 10 (A+B), 20 × 20 (ABC), 25 × 20 (A–F), 25 × 5 (A+D), 50 × 5 (A+D+G), 50 × 10 (A+D+G+B+E+H), 50 × 20 (All).

### ***Pole-size trees***

Where the preburn density of pole-size trees (DBH  $\geq 2.5$  cm and  $\leq 15$  cm) is **dense** (averaging  $\geq 50/250$  m<sup>2</sup> (Q1)), try using a pilot sampling regime, such as the example displayed in Figure 10. Where pole-size trees are **sparse** (averaging  $\leq 20/250$  m<sup>2</sup>), try using a pilot sampling regime, such as the example displayed in Figure 11. If only one species is sparsely distributed, you may try larger sampling areas for that species alone during pilot sampling. In addition, please read the Tip “Different Sizes and Shapes of Sampling Areas” on page 47 and the Reminder “Consistent Sampling Areas” on page 47.

### ***Seedling trees***

Where the preburn density of seedling trees (DBH  $< 2.5$  cm) is **dense** (averaging  $\geq 50/50$  m<sup>2</sup> (subset of Q1)), try using a pilot sampling regime such as the example displayed in Figure 12. Where seedling trees are **sparse** (averaging  $\leq 20/50$  m<sup>2</sup>), try using a pilot sampling regime such as the example displayed in Figure 11. In addition, please read the Tip “Different Sizes and Shapes of Sampling Areas” on page 47 and the Reminder “Consistent Sampling Areas” on page 47.

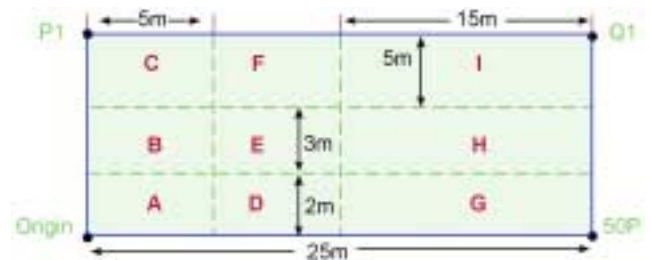

**Figure 12. An example pilot sampling scenario for dense seedling trees.**

**Note:** This is only an example, and it may not be suitable for your situation. The shape and size combinations that can be tested here include: 2 × 5 m (A), 5 × 5 (A+B), 5 × 10 (A+B+C), 10 × 10 (A–F), 2 × 10 (A+D), 2 × 25 (A+D+G), 5 × 25 (A+D+G+B+E+H), 25 × 10 m (All).

### ***Dead and downed fuels***

During the pilot sampling period, on average, 75% of the dead and downed sampling planes within a monitoring type should intercept a 3 in or larger diameter log. If 3+ in intercepts are **sparse** (on average  $< 75\%$  of the sampling planes intersect a 3+ in intercept) try extending the 50 ft sampling plane to 75 or 100 ft, or longer, during pilot sampling. Designate intercepts that lie along each section (e.g., 0–50, 50–75, and 75–100) separately so that you can test the efficiency of each length, and possibly shorten the plane length. Conversely, if 3+ in intercepts are **dense** (average number of intercepts  $> 30$ –40, e.g., heavy continuous slash), try breaking up the 50 ft plane into 5 ft intervals starting at 15 ft, recording each interval separately so that you can test the efficiency of each length. You can also modify the sampling planes for 0–3 in intercepts. For further details refer to Brown and others 1982. After pilot sampling, indicate the final lengths of the sampling planes on the back of the FMH-4. In addition, please read the Reminder “Consistent Sampling Areas” on page 47.

### ***Shrub and herbaceous layer***

You may need to try different lengths of point intercept transects to intercept an adequate amount of brush, grass and herbs during pilot sampling. In most forested areas, 332 intercepts (two 50 m transects) may be barely adequate since the shrub, forb, and grass elements are often **sparse** (an average of  $> 55$  and  $< 110$  hits/transect). Where the vegetation is **extremely sparse** (an average of  $\leq 55$  hits/transect) and one or several of your herbaceous variables are objective variables, try reading the plot midline (0P to 50P; see Figure 9, page 44) as a third transect during pilot sampling. Where the vegetation is **dense** (an average of  $\geq 110$  and  $\leq 140$  hits/transect), monitor only one of the 50 m transects (monitor transect Q4–Q1 as a minimum; see Figure 9, page 44). If the vegetation is



**extremely dense** (an average of >140 hits/transect), try monitoring only 30 m of the 50 m transect (Q4–30 m). **Note:** During pilot sampling, you can easily test the efficiency of shorter or fewer transects in each of these scenarios by separating out those data. After pilot sampling, indicate the final number and length of the transect(s) on the back of the FMH-4. In addition, please read the Reminder “Consistent Sampling Areas” on page 47.

**Basal cover**—Because the cover of herbaceous species and subshrubs can vary widely with climatic fluctuations, it is often difficult to interpret changes in their aerial cover. Such changes may be due to fire management, weather, or a combination of both. Basal cover is much less sensitive to climatic fluctuations and can be a better trend indicator for species that are suited to basal cover measurement (e.g., perennial bunchgrasses). However, the aerial cover of most woody shrubs does not tend to vary as much with climatic fluctuations, and aerial cover is often used as an indicator for these species.

If you do sample basal cover rather than aerial cover (FMH default), place a note in the “Notes” section of the Monitoring type description sheet, and follow the directions on page 81. Be sure to use a line intercept transect in your pilot sampling, as this is the traditional method used to sample basal cover.

**Species not intercepted but seen in the vicinity of the herbaceous transect**—Where the preburn number of herbaceous species is **high**—averaging  $\geq 50$  species/plot (using a 5 m belt), try using a pilot sampling regime such as the example displayed in Figure 13. In areas with **low** numbers of species (averaging  $\leq 20$  species/plot, using a 5 m belt), try using a pilot sampling regime such as the example displayed in Figure 14. Once you have selected a belt width, use that width for preburn and postburn measurements for all plots within that monitoring type. In addition, please read the Reminder “Consistent Sampling Areas” on page 47.

### Shrub density

Where the preburn density of shrubs is **dense** (averaging  $\geq 50$  individuals/plot, using a 1-m belt), try using a pilot sampling regime such as the example displayed in Figure 13. In areas with **sparse** shrubs (averaging  $\leq 20$  individuals/plot, using a 1-m belt), try using a pilot sampling regime such as the example displayed in Figure 14. In addition, please read the Tip “Different Sizes and Shapes of Sampling Areas,” on page 47, and

the Reminder “Consistent Sampling Areas” on page 47.

In some shrub species, it can be hard to identify an individual (see page 88 for more details). This is especially true for species that are capable of vegetative reproduction, e.g., clonal or rhizomatous plants. In these cases stem density (**optional**) can be used instead of the number of individuals. Use the aforementioned guidelines (replacing the counting of individuals with the counting of stems) to select the appropriate sampling area for stem density.

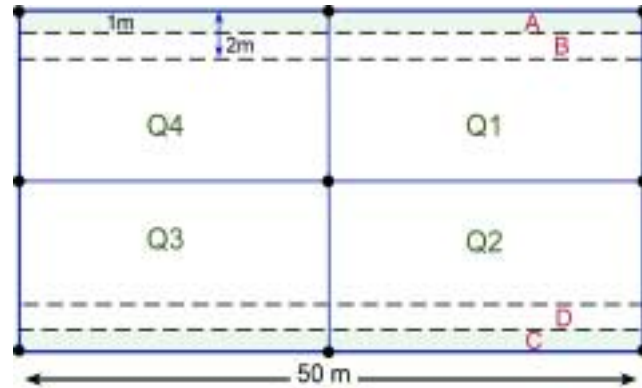

**Figure 13.** An example pilot sampling scenario for dense shrubs.

**Note:** This is only an example, and it may not be suitable for your situation. The shape and size combinations that can be tested here include:  $1 \times 5$ ,  $10 \dots 50$  (A broken into 5 m intervals),  $2 \times 5$ ,  $10 \dots 50$  (A+B broken into 5 m intervals). You would include C and D if you use Q3–Q2 for herbaceous sampling during the pilot sampling period.

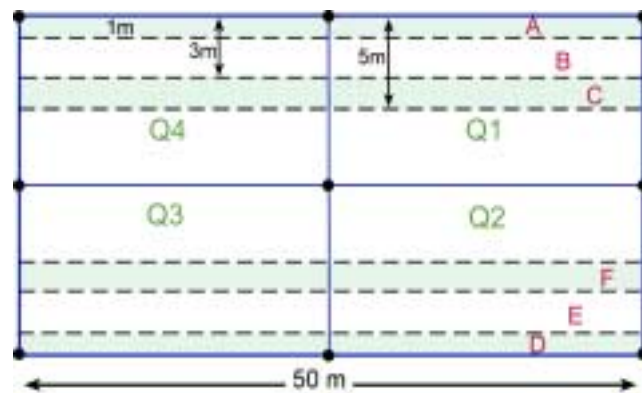

**Figure 14.** An example pilot sampling scenario for sparse shrubs.

**Note:** This is only an example, and it may not be suitable for your situation. The shape and size combinations that can be tested here include:  $1 \times 5$ ,  $10 \dots 50$  (A broken into 5 m intervals),  $3 \times 5$ ,  $10 \dots 50$  (A+B broken into 5 m intervals),  $5 \times 5$ ,  $10 \dots 50$  (A+B+C broken into 5 m intervals). You would include D, E and F if you use Q3–Q2 for herbaceous sampling during the pilot sampling period.

## Different Sizes and Shapes of Sampling Areas



To decide which sizes and shapes of sampling areas to try, observe the distribution of plants in the field. Ask yourself which sizes and shapes, on average, would include one or more of the largest individuals or patches, while minimizing the number of empty quadrats. Be sure to try and include long and thin rectangles ( $0.25 \times 4$  m instead of  $1 \times 1$  m), and/or shapes that are proportional to your other sampling areas, e.g.,  $20 \times 50$  m for overstory trees,  $10 \times 25$  m for pole size trees, and  $5 \times 12.5$  m for seedling trees. Both have been shown to have statistical advantages. In addition, if only one species or size class is sparsely (or densely) distributed, you may try larger (or smaller) sampling areas for that species or size class alone during pilot sampling.

## Consistent Sampling Areas



You must have consistent sampling areas for each variable within a monitoring type. In other words, keep the length or size/shape of all transects or areas where you collect data (e.g., fuels, shrub density, herbaceous cover, overstory, pole-size and seedling tree density) the same for a given variable throughout a monitoring type. See page 88 (shrub seedlings) and 102 (tree seedlings) for the only exceptions to this rule. **Note:** After pilot sampling, indicate the final shape and size of the sampling area on the back of the FMH-4.

## Optional Variables

### *Diameter at root crown for woodland species*

Woodland species such as juniper, pinyon pine, some maples and oaks commonly have multiple stems and are often extremely variable in form. For these species, diameter at root crown (DRC) is a more meaningful measurement than DBH (USDA Forest Service 1997). Indicate each species that you will measure using DRC in the “Notes” section of the Monitoring type description sheet (FMH-4). Pilot sampling procedures are the same as for overstory and pole-size trees: see above.

### *Herbaceous density*

Where the preburn density of forbs and grasses is **dense** (averaging  $\geq 50$  individuals/plot, using  $1 \text{ m}^2$  frames), try a pilot sampling regime using smaller frames of differing shapes. You may also find that you

are sampling too many frames. In preburn situations where forbs and grasses are **sparse** (averaging  $\leq 20$  individuals/plot, using  $1 \text{ m}^2$  frames), try a pilot sampling regime using larger frames of differing shapes, or try using a pilot sampling regime such as the examples displayed in Figure 13 and 14.

### *Biomass*

Estimate preburn biomass (tons/acre) when smoke management is a specific concern, or hazard fuel reduction is the primary burn objective. This handbook mentions three methods of measuring biomass: the dead and down fuel methods discussed above (forest), estimation (brush, page 89); and clipping (grassland, page 90). To determine appropriate plot size for estimation, see Mueller-Dombois and Ellenberg 1974. **Note:** Use the pilot sampling process to choose the most efficient sampling areas.

To determine the appropriate quadrat size for clipping, see Chambers and Brown 1983. There are several other methods for estimating biomass: relative weight, height-weight curves, photo keys, capacitance meters, remote sensing, and double sampling. For an excellent list of references, see Elzinga and Evenden 1997 under the keyword biomass, or review the references on page 237 in Appendix G. Once you choose a methodology, write a “handbook” for your field protocols so that others can collect these data exactly the same way you do. Refer to this “handbook” in the “Notes” section of the FMH-4 for that monitoring type.

### *Percent dead brush*

To develop a custom fuel model for BEHAVE or other fire behavior predictions, estimate the preburn percent dead brush with one of the following techniques: onsite visual estimation, estimation based upon a photo series, or direct measurement of the live-dead ratio. Again, once you choose a methodology, write a “handbook” for your field protocols so that others can collect these data exactly the same way you do. Refer to this “handbook” in the “Notes” section of the FMH-4 for that monitoring type.

## DEVIATIONS OR ADDITIONAL PROTOCOLS

Rarely will a sampling design work smoothly in the field; you will often find that modifications are needed. You may also find that in some situations the methods in this handbook will not work to sample your ecological attribute of interest. If this is the case, refer to a reputable vegetation monitoring source such as Bon-

ham 1989, or to a bibliography of vegetation monitoring references such as Elzinga and Evenden 1997.

The FMH software (Sydoriak 2001) that accompanies this handbook is designed for the protocols in this handbook, and facilitates data storage and analysis. In some cases, where other methods are used, you will need to set up an alternative database and perform analyses with a commercial statistical software package. It is important to document all deviations from the standard protocols used in this handbook, no matter how insignificant they may seem. These notes are critical links for the people who follow you, and will ensure that the appropriate protocols are continued until the end of the project. Reference any additional protocols in the “Notes” section of the Monitoring type description sheet (FMH-4 in Appendix A), and describe them completely in your monitoring plan (Appendix F).

## CONSIDERATIONS PRIOR TO FURTHER PLOT INSTALLATION

After you have completed your pilot sampling, answer these questions:

- Are the sampling units for each protocol a reasonable size for the average number of plants?
- Did you choose the most appropriate vegetation attribute—one that is easy to measure and the most sensitive to change—that will meet your monitoring objectives?
- Will you and your successors be able to relocate your monitoring plots in future years using the proposed documentation method?
- Is the time you allotted for the field portion of the monitoring adequate?
- Is the time you allotted for the data management portion of the monitoring program adequate? (This typically takes 25-40% of the time required for a monitoring program). Do you have ready access to a computer for data entry and analysis? On average, do you have a small number of transcription errors?
- Will it be easy for monitors to avoid seriously trampling vegetation? (If not, is this acceptable?)
- Do monitors find it difficult to accurately position a tape because of dense growth?
- Are your field personnel skilled, with only a minor need for additional training?
- Did you meet your precision and power objectives? Does the amount of change you have chosen for your minimum detectable change seem

realistic? Does the time period for this change seem realistic?

## SAMPLING DESIGN ALTERNATIVES

If you answered no to one or more of the above questions, consider adjusting your monitoring design. Here are some alternatives to consider:

**Start over from the beginning of the process—**Revisit your monitoring objective with the realization that it is not cost-effective to monitor that objective with a reasonable level of statistical precision or power.

**Accept lower confidence levels—**Ask yourself whether you would find a lower confidence level acceptable. It can be very costly to set up a monitoring program with a 95% confidence of detecting a change. However, you might find it quite possible to use your available resources to monitor at a 80% confidence level. Look at the results from your pilot study and ask yourself if you could be comfortable with a higher error rate.

**Request more resources for monitoring—**You can try to get additional funding from other sources, such as grants or park-wide funding. Also, consider using interns, students, and volunteers to supplement your staff.

**Reconsider the scale of the study—**Choose to sample a smaller subsection of your monitoring type. Note that this may diminish the statistical applicability of your results.

**Reconsider your sampling design—**Adjust the shape or size of the sampling area for a troublesome variable. For example, based on the pilot study, create a different size and/or shape for the brush sampling area.

**Look for data entry or data collection errors—**Occasionally, an appropriate sampling design may combine with a sufficient number of data errors to give the appearance of a flawed sampling design. Check the data collected during the pilot study for field errors; also check for data entry errors. Simple errors can significantly skew calculations such as the standard deviation. See the “Verifying Results” section on page 131 for more details.

## CALCULATING MINIMUM SAMPLE SIZE

The minimum sample size for your monitoring design is the number of plots needed (based on your initial 10-plot sample mean and variability to provide results with your chosen degree of certainty (see pages 23 and 122). An estimate of the variability found for a particular objective variable gives an idea of the number of plots needed to obtain a reasonable estimate of the population mean with the desired confidence level and precision (see page 27).

To calculate the initial minimum sample size, you need the following inputs:

- **Mean and standard deviation of the sample**—data from the 10 initial plots in each monitoring type are used as estimates of the mean and variability for each objective variable
- **Desired level of certainty**—confidence level (80, 90, or 95%) and precision level ( $\leq 25\%$  of the mean) from your monitoring objective

Once you have these inputs, you can use the formula on page 216 (Appendix D) to calculate the minimum sample size (number of plots) needed to provide the chosen levels of certainty for estimating the mean(s) of the objective variable(s) in a monitoring type.

---

### Minimum Sample Size



Keep in mind that the minimum sample size only applies to the monitoring variable that is used in the calculation(s), not to all of the variables measured within the plot. See page 217 for an example of calculating minimum sample size for each type of management objective—condition and change.

Calculate the minimum sample for each objective variable in a monitoring type, then use the largest sample size when installing plots.

---

#### Example:

Two objective variables in a monitoring type are total percent cover of live shrub species and native perennial relative cover. The calculated minimum sample size is 17 plots for total shrub percent cover and 15 plots for native perennial relative cover; 17 plots should be installed.

---

If the minimum sample size calculated is high ( $>30$  plots) based on the initial 10 plots, install several more plots (2–5) and then recalculate the minimum sample size. If the minimum sample size continues to be high, refer to the advice on page 44. The monitoring type may be too broad or the method used to measure the monitoring variable may not be appropriate. As always, consult with your regional fire effects program coordinator for assistance if needed.

If the minimum sample size is very low, you may be able to increase the degree of certainty in the sample simply by installing a few more plots. Only add additional plots if it will not require a great deal of extra time and effort and if it will provide a useful increase in the certainty of the results. **Note:** Increase the confidence level before increasing the precision level; in other words, be more confident in your results before attempting to be within a smaller percentage of the estimated true population value.

---

#### Example:

Only ten plots are needed to be 80% confident of being within 25% of the estimated true population mean for the density of tamarisk (*Tamarix ramosissima*). The resources to install a few more plots are available; therefore, recalculate the minimum sample size with a 90 or 95% confidence level to see if the resulting number of additional plots is practical.

---

### Confidence Level and Precision



Always choose the confidence level and precision desired **BEFORE** performing the minimum sample size calculation. It is not appropriate to run all possibilities and choose the preferred minimum sample size!

---

---

## Change Over Time



Your management objectives define either the amount of change or a postburn condition desired for a monitoring variable. Ideally, you should calculate the minimum sample size needed to detect the desired minimum amount of detectable change or postburn condition. In order to do this, however, you need an estimate of the mean and variability of the monitoring variable for both preburn and postburn conditions. Since managers must design the monitoring program before burning, your initial minimum sample size calculations must be based only on the preburn data.

---

### Recalculate Minimum Sample Size

The initial minimum sample size calculation is performed on the preburn data so that a sufficient number of plots can be distributed in areas before they are burned. Since the management objectives usually involve assessing postburn conditions, you should recalculate the minimum sample size for the appropriate postburn time interval when it is reached. For change objectives, a separate formula is used to determine the number of plots needed to detect the minimum amount of change stated in the objective (see page 217).

---

## Minimum Sample Size for Minimum Detectable Change



This formula is a critical new addition to this handbook. For change objectives, calculate the minimum sample size for the minimum detectable change you desire before you fully evaluate whether you have met your objectives. See pages 124 and 217.

---

## MONITORING DESIGN PROBLEMS

### Small Areas

Some monitoring types may occupy areas that are small as compared to the majority of the monitoring types in your park. This monitoring program is designed to support the monitoring of the monitoring types that constitute the most significant amount of acreage that is being burned in your park. However, you might consider monitoring small areas if they contain species of management concern. In these cases, managers might consider using a sampling design better suited to a smaller scale or species-specific moni-

toring, which you should have reviewed by your regional ecologist and fire effects monitoring specialist.

### Gradient Monitoring

In many instances your objectives will require monitoring in vegetation that does not occur in one discrete unit or in a homogeneous vegetation type. This will be the case when you monitor ecotones, or other areas of encroachment, e.g., grasslands being invaded by shrubs, trees, and/or non-native plant species.

No single set of protocols will serve all monitoring programs. This handbook is not intended to be a definitive “how-to” guide on monitoring. The protocols of this handbook are designed to monitor trends in a relatively homogeneous complex of vegetation—a monitoring type. They are not specifically designed to measure changes across a gradient.

With this in mind, you can make modifications to the protocols of this handbook to monitor changes across a gradient or movement of a transition zone. It is important to determine the variable of concern and direction you wish to take the system with the use of fire.

**Note:** Before you make these modifications, find out if other park units have similar objectives. Others may have developed modifications to the protocols in this handbook, or use alternative sampling methods that may be useful to you.

### Species Difficult to Monitor

#### *Ephemeral annuals or annuals with long-lived seed banks*

If your monitoring objectives concern annual plants that appear only once every few years or decades, or that have long-lived seed banks, short-term data may misrepresent the species’ presence in the ecosystem. Interpretations of field measurements on annual species are confounded by the yearly variability of their distribution and abundance. In such situations, an alternative may be to monitor the critical elements of the habitat of this species, e.g., changes in the type and amount of disturbance (fire, flood, trampling, etc.), and changes in community composition and structure. When dealing with such annuals, it is extremely helpful to know what factors promote or infringe upon the vitality of the species.

### Example:

A park with chaparral plant communities seeks to manage the postfire species seed bank by burning at an interval that is less than the average seed longevity (which is largely unknown for the majority of the species in the seed bank). Managers are confident that a return interval of 50–100 years will keep this seed bank replenished. The majority of species that appear postburn are annuals, and so will have an unpredictable distribution pattern for several years postburn. Since monitoring species with an unpredictable distribution pattern can be cost prohibitive, managers have decided to monitor the factors that affect the species distribution: gaps in canopy cover, and the frequency and intensity of soil disturbances.

#### ***Extremely long-lived plants***

Plants that live a long time pose an opposite problem; variation in population size is very long-term, so change is difficult to measure. Reproduction and/or seedling establishment can be a rare event (although for some long-lived species, seedlings are dynamic and very sensitive to adverse change). Once again, monitoring changes in the plants' habitat may be more appropriate than measuring the plants themselves.

#### ***Anticipated dramatic increases in postburn density***

The seed banks of some species may germinate profusely following a burn. Rather than count thousands of seedlings, it may be more efficient to subsample the plot during temporary high density periods. See pages 88 and 102 for details.

#### **Monitoring Type Description Quality Control**

Ensuring consistency in the definition of a monitoring type—and thus in the establishment of plots—is critical to the accuracy of a monitoring program. Often, plots are established before the creation of monitoring type descriptions. In addition, if Monitoring type description sheets are unclear or vague, monitors may establish plots that should be rejected.

All managers can benefit from reviewing some or all of their plots to ensure that each plot belongs within the designated monitoring type. Any plots that should be rejected can be erased from the database and the plot markers (rebar) removed, and the respective folders discarded, unless resource management has further use for these plots. Rejected plots may be useful for training purposes or resource management needs. Before

you erase data and remove any rebar, consult with both fire and resource management personnel.

#### **Professional Input and Quality Control**



It is very important that the monitoring program be designed with enough professional input to reduce problems associated with improper data collection. Equally important is the provision of quality control during the data collection process. Ignoring either of these critical elements could mean bad or useless results. If poor design or quality are problems, the first monitoring protocol adjustment is to start over and ensure that proper monitoring protocols are applied throughout the data collection period the next time around.

A common problem is inadequate attention to the design and documentation of the monitoring protocols and/or insufficient supervision of the data collection team. The fire effects monitors may make poor decisions, especially if their decision makes their job easier (e.g., switching quadrats because of the large number of trees present in the designated quadrat).

Thoughtless data collection can lead to the omission of whole categories of variables. Alternatively, more data may be collected than prescribed in the sampling design, wasting valuable time and energy. Extra work is then required to sort out which datasets are valid and which components of these datasets are not comparable. The key is to prevent problems by properly designing, supervising, and periodically checking the monitoring protocols used.

Decide and document when and how monitoring protocols will be adjusted, and who is responsible. No matter how carefully you design a monitoring program or how expertly it is carried out, data collection problems will arise and monitoring protocols will have to be adjusted. Such adjustments should be made not by the field technicians, but by the program managers and ecologists. The more managers are involved in the data collection process, the sooner they will recognize protocol problems.

Establish a decision-action trail by documenting protocol changes. All changes to established monitoring protocols must be documented so that the changes can be replicated every time you remeasure your plots. The following tips will help you document your monitoring

protocol, make any necessary changes, and ensure its consistent use:

- Educate everyone involved about the importance of strictly adhering to monitoring protocols.
- Establish a process for changing protocols based on field work and analytic results, with input from your data collectors.
- Consult with your regional fire effects program manager on the protocols, as well as on any changes.
- Diligently record all protocol changes.
- Mark all changes in colored ink. Label changes in clear bright colors, or place them collectively on bright colored paper.
- Enter any protocol deviation into a database comment field for that plot or monitoring type.
- Communicate, as often as possible, with all interested parties.
- Put the monitoring protocols in writing in your Monitoring type description sheet (FMH-4) and your monitoring plan (Appendix F), and place them in the plot folder. Make sure that originals are never lost and that copies are always in the possession of the data collectors.

## CONTROL PLOTS

**It is not currently national policy to use fire funds to pay for the installation of control plots** (see Glossary), but control plots can be necessary to evaluate whether specific management objectives are met. Depending on your objectives, it may be important to make observations and collect data outside of prescribed burned areas.

Frequently, control plots are not considered until post-burn observations indicate their need. It is often appropriate to establish control plots after the burn when you need to address a specific question. In the case of wildland fires, some managers may wish to establish control plots outside the burn perimeter during the field season following the fire.

When control plots are established to measure specific variables, use methods and certainty levels comparable to their preburn counterparts. Decisions about when and how to install control plots will require consultation with an ecologist, statistician, or other subject matter expert. In many cases the implementation of a formal research project may be more appropriate.

When deciding not to install control plots, the park manager recognizes either that an adequate fire effects information base is available to start or continue a burn program, or that ongoing research programs are adequate to address management concerns.

---

## Control Plots



Comparing your data with those from other parks that have similar monitoring types, or from other types of studies internal or external to your park **may** eliminate the need for you to set up control plots. Consult an ecologist, statistician and/or regional fire effects monitoring specialist for further assistance.

---

## Short-term Change Control Plots

Control plots are often necessary to determine whether the prescribed fire program caused a particular short-term effect.

### Example:

A burn block area has been invaded to a small extent by non-native species. Non-native species have been increasing throughout the region for the last 20 years, and the park manager does not want to worsen the problem by using prescribed fire. In fact, one of the management objectives is to reduce the mean non-native species percent cover by 20–60% within two years of the burn. You know that your prescription can meet your other management objectives, but you suspect that the slow and incessant march of non-native plants could be accelerated by the prescribed fire.

In this example, and in many situations involving non-native species, it is important to set up control plots to test whether the result observed (a change in non-native species percent cover) in the prescribed fire area is attributable to fire or to another factor, such as climatic change, moisture regimes, or grazing.

## Long-term Change Control Plots

Establishing control plots for evaluating long-term change is helpful for testing specific hypotheses comparing non-treatment effects (areas not treated with prescribed fire) with treatment or treatment-plus-time effects.

**Example:**

A shrubland is burned every 20 years to reduce the fuel hazard. The natural fire return interval is estimated to be 50 years. After 100 years of fuels treatment by fire, it is hypothesized that a difference in composition and density exists between those stands that have been burned every 20 years and the unmanaged stand.

If you wish to evaluate control plots for long-term change, you will need to consult a competent research scientist or fire ecologist to ensure adequate research design and execution.

## DEALING WITH BURNING PROBLEMS

### Burning the Prescribed Fire Units

Consistency of treatment is essential to ensure accurate monitoring data. All monitoring plots within a sample must be burned under the same prescription. Similarly, burn units with monitoring plots must be treated the same as units without monitoring plots. If a burn unit is ignited but the monitoring plots contained within it do not burn, data on those monitoring plots are still a valid part of the sample database. Avoid biasing results by igniting a monitoring plot prior to igniting the surrounding area, or igniting the plots at a later time because they did not burn initially (unless, of course, the burn prescription calls for this action). All ignition personnel should be informed that they need to ignite every burn unit as if the plots do not exist, so that burning patterns will not be biased.

### *Partially burned plots*

Fire rarely spreads uniformly across a fuel bed. Unburned patches are frequently part of the fire regime and should not be of concern as long as the plot was burned similarly to the remainder of the burn unit. A partially burned plot, if burned within prescription, should be considered part of the database.

### Plot Burning Off-Schedule

Monitoring plots may reburn because of unplanned ignitions (natural or human-caused) or short burn prescription intervals. Other plots may be burned at a time different from the rest of the unit. As a manager, you need to decide when to eliminate such plots from the sample, and whether to reinitialize the monitoring schedule for that plot.

### *Unplanned ignitions*

Unplanned ignitions that are permitted to burn because they meet the prescription criteria of a pre-

scribed fire regime (and essentially replace a prescribed ignition) will be treated as a component of the managed fire regime. Monitoring schedules for plots in such areas should not be altered. However, it is recognized that considerable variation may enter the system and affect index parameters if many monitoring plots burn more frequently than prescribed. Managers will have to keep this in mind and make evaluation adjustments when examining results. In any case, it is essential to record the data collected from any unplanned ignition in appropriate plot database files. Fire behavior and weather data should also be included.

### *Plot burns at different time than the burn unit*

Occasionally a plot may burn before or after the majority of the burn unit. Are the data from this plot still valid? That depends. If the area surrounding and including the plot is burned within prescription using the same ignition techniques, the plot data should be valid. However, the plot should not be allowed to burn off-schedule, i.e., more often or less often than the burn prescription calls for.

### *Short fire intervals*

In this situation, you will generally want to monitor the responses from the prescribed fire regime rather than from a single fire, as the changes caused by a single fire are usually not as important. When the intervals between prescribed fires are very short (one to two years), resulting in frequent burn repetitions, conduct immediate postburn (within two months postburn), and year-1 postburn monitoring on the first and subsequent burns until you can predict responses (if year-1 postburn monitoring is not possible, you can substitute measurements from the next field season). Choose the most representative time(s) to track the changes you would like to detect (e.g., six months after every burn combined with monitoring on a five-year rotation), regardless of how often each plot burns.

If the fire interval is longer than two years, conduct immediate postburn (within two months postburn), year-1, year-2 and year-5 (if possible) postburn monitoring on the first and subsequent burns until you can predict responses. Choose the most representative time(s) between burns. In some situations, pre- and immediate postburn monitoring will be your best choice. For example, add a “preburn” measurement for each subsequent burn, e.g., year-2 for a two-year return interval, year-3 for a three-year return interval or year-4 for a four-year return interval.



***Plot burned out-of-prescription***

Eliminate monitoring plots from the sample database if they are burned by planned or unplanned fires that exceed the ecological parameters of the management prescription. Keep in mind that you may want to continue to monitor these plots in order to gain information about the response from a different prescription.

# 5

## Vegetation Monitoring Protocols

*“It takes less time to do a thing right than it does to explain why you did it wrong.”*

—Henry Wadsworth Longfellow

As indicated in Chapter 4, for short-term and long-term monitoring (levels 3 and 4), you will monitor Recommended Standard (RS) variables by sampling according to a standardized design. When combined, monitoring plots form a sample for each monitoring type, with or without control plots. This chapter details variables and procedures for establishing monitoring plots, and for collecting and recording data from them. **Note:** This handbook addresses most common situations; special concerns may require customized methods.

This handbook establishes RS variables for grassland, brush, and forest plot types. The monitoring variables sampled for each type are cumulative, with increasingly complex plot types (grassland to brush to forest) including variables in addition to those sampled on the simpler types (see Table 3, page 42).

The procedures described for monitoring RS variables require the use of standardized forms to record data; these are provided in Appendix A. Methods and data collection forms also are provided for most of the optional monitoring variables.

Establishing a plot network for a given monitoring type is a three-phase process. As discussed in Chapter 4, this process begins with the installation of ten pilot sampling plots. Once these plots are installed, minimum plot calculations and projections are conducted; the process ends with the installation of the balance of plots required by the minimum plot analyses. This section outlines the methods that you will follow for the establishment of all plots.

### METHODOLOGY CHANGES

Some sampling methods described here are significantly different from methods presented in previous versions of this handbook. In a monitoring type with previously burned plots, exercise extreme caution before changing your methods; **in most cases methods should not be changed.** If you do intend to change monitoring methodologies, then monitor using both methods for **a minimum of two plot visits (for**

**each plot affected)**, or until you can establish a correlation between the different protocols. If no plots have burned within this time period, revisit all plots in the type and collect data according to the new protocol. Additional procedures for handling the switch-over can be found in “warning” boxes on specific topics, e.g., crown position (page 96) and DRC (page 98).

### MONITORING SCHEDULE

Sample during the **phenological peak** of the season (flowering, as opposed to green-up, transition or dormant) in which the plants can most easily be identified and when biomass is greatest. This may occur in the spring in low-lying areas with warm climates, and as late as late summer for alpine regions; the peak sampling season may occur twice in one year in some areas, e.g., those with summer “monsoons.” The actual date of this phenological stage will vary from year to year, depending on climatic conditions. Schedule your sampling to minimize seasonal variation among visits. From year to year, base your sampling schedule on the original date of establishment; however, you may have to change the date of the visit due to seasonal irregularities such as prolonged snow cover or an early, warm spring. Except immediate postburn, conduct all visits when phenology is comparable for the most ephemeral species recorded in the initial survey. Take notes on the phenological state of the plants at each visit so that you can consider whether these differences are the result of burning or due to other factors such as weather variations. **It is recommended that you monitor all plots at the intervals discussed below.**

### Plot Installation

To prepare for plot installation you will need the following: a five-year burn plan, delineated areas for plot installation, and randomly selected plot location points. After you have completed your pilot sampling and you have ten plots in a single monitoring type, you can then analyze the monitoring variables to determine their variability within your sample. Use this information to determine how many plots are required to meet the specified confidence and precision levels (see page 49 for details). The additional plots should

then be installed in the same manner as the initial ten plots (using the restricted random method, page 59). Ideally, all plots should be installed before any of the available plot area has been burned, otherwise the total area available for additional plot installation will be reduced, which could result in a bias in the data. If it is not possible to install all plots before burning any of the monitoring type, then install your initial group of plots in the first units to be burned.

---

### Plot Location and Burn Units



- Monitoring types should not be directly associated with individual burn units. Use the sample approach, which states that random plot location points shall be installed in all areas within a particular monitoring type that are scheduled to be burned in the next five years. Plot location points should be randomly selected within a monitoring type, not a burn unit.
- Choose your burn units and write your monitoring type descriptions before you install any plots.
- Note that plots do not need to be placed in **every** burn unit.

---

### Limited Amount of the Monitoring Type Available for Burning



If the amount of the monitoring type available for burning is limited, plan carefully. Check the burn schedule relative to your potential plots, and be sure to include plots in all representative areas using restricted randomization. Remember, when fire managers burn a section of monitoring type before you install the minimum number of plots, that section can no longer be included in your sample, i.e., you cannot install any additional plots in that section.

---

### Preburn

Establish plots during the time of year in which you can identify the greatest number of species (particularly the most ephemeral), so that you can obtain the most complete species composition data within a monitoring type. Ideally, the plots are burned the same year in which the preburn data are collected. If more than two years have passed since establishment or the last data collection, remeasure variables prior to burn treatment.

### During Burn

Make fire behavior observations in an area near to, but not necessarily at, each plot, and in the same fuel model and vegetation type as that in which the plot is located.

### Immediate Postburn

Assess burn severity as soon as possible after the duff stops smoldering. Assess all other RS measurements between two weeks and two months after the burn treatment.

### Postburn

The recommended schedule for re-measuring plots that have burned is one, two, five and 10 years post-burn. After 10 years, continue the monitoring at 10-year intervals either until each unit is placed within an area approved for fire use (formerly PNF zones), or the area is burned again. If the area is burned again, the monitoring cycle begins again. For the monitoring schedule for monitoring types that will be burned frequently, or for situations in which plots should otherwise be read on a different schedule, see page 53. Recommended Standard (RS) variables to be monitored pre- and postburn are listed in Tables 5–7.

In most cases, collect the preburn and postburn (except immediate postburn) data during the **phenological peak** (see page 55). For example, if you conduct a preburn visit in July 2001, and the plot burns in October 2001, the year-1 data should be collected at the phenological peak in or near July 2002. If the plots are burned in the season preceding the phenological peak, collect postburn data a full year later. For example, if you read a preburn plot in August of 2002, and that plot burns in March 2003, collect the year-1 data in or near August 2004. In moist areas, where vegetation recovers quickly, it may be desirable to collect data sooner than year-1. In that case, code that data collection period as an interim data collection visit (e.g., six months) and collect this information in addition to your other plot visits.

**Table 5. Grassland plot RS variables to be monitored pre- and postburn.**

RS Variables	PRE	Immediate Postburn	Year-1+
Herbaceous Cover (FMH-16)	n	Optional	n
Burn Severity (FMH-22)		n	
Photographs (FMH-23)	n		n

**Table 6. Brush plot RS variables to be monitored pre- and postburn.**

RS Variables	PRE	Immediate Postburn	Year-1+
Herbaceous Cover (FMH-16)	n	Optional	n
Shrub Density (FMH-17)	n	Optional	n
Burn Severity (FMH-22)		n	
Photographs (FMH-23)	n		n

**Table 7. Forest plot RS variables to be monitored pre- and postburn.**

RS Variables	Data Sheet(s)	PRE	Immediate Postburn	Year 1	Year 2+
Tree Density	Overstory (FMH-8)	n		n	n
	Pole (FMH-9)	n	Optional	n	n
	Seedling (FMH-10)	n	n	n	n
DBH/DRC	Overstory (FMH-8)	n		Optional	n
	Pole (FMH-9)	n		Optional	n
Live/ Dead	Overstory (FMH-8, FMH-20)	n	n	n	n
	Pole (FMH-9, FMH-20)	n	Optional	n	n
Fuel Load	(FMH-19)	n	n	n	n
Herbaceous/Shrub	Cover (FMH-15 or FMH-16)	n	Optional	n	n
	Density (FMH-17)	n	Optional	n	n
Burn Severity	(FMH-21 or FMH-22)		n		
Photographs	(FMH-23)	n	n	n	n
% Crown Scorch	Overstory (FMH-20)		n		
	Pole (FMH-20)		Optional		
Scorch Height	Overstory (FMH-20)		n		
	Pole (FMH-20)		Optional		
Char Height	Overstory (FMH-20)		Optional		
	Pole (FMH-20)		Optional		



Previous versions of the Fire Monitoring Handbook stated that DBH should be measured at every plot visit with the exception of immediate postburn. The new recommendation is to skip this measurement at the year-1 visit and to remeasure it at the year-2 visit. DBH is a fairly gross measure for tracking tree growth; in most cases the most important reason for tracking tree growth is to assign the tree to a size class, and preburn and year-2 measurements are usually sufficient for this. If you feel that you have good justification for measuring DBH at year-1, then by all means measure it!

---

## Generating Monitoring Plot Locations

First, using the restricted random sampling method discussed below, randomly locate ten monitoring plots per monitoring type throughout all units proposed for prescribed burning in the next five years. These plots will provide quantitative information for pilot sampling (see page 43), and will be used to determine the minimum sample size required to meet your monitoring objectives.

To disperse your plots across the landscape, use a variant of stratified random sampling called **restricted random sampling**. This randomization method ensures that your plots are dispersed throughout your monitoring type. First, choose the number,  $n$ , of sampling units that you will need to meet your monitoring objective. As a guideline, use an  $n$  of 10 for areas that are small or when the variability of your objective variable(s) is low. For objective variables that are moderately variable, use an  $n$  of 20, and for those that are highly variable, use an  $n$  of 30. (These numbers may be adjusted once you have your initial 10 plots installed.) Then divide your monitoring type into  $n$  equal portions (see Figure 15). You will then choose at least three to five (depending on the likelihood of initial plot rejection, see below) plot location points (PLPs) per portion. Then establish a monitoring plot within each of these portions (see page 62).

### Restricted Random Sampling



If you have currently-established plots within a monitoring type that were not chosen with restricted random sampling, follow the above directions, and when you divide your monitoring type into equal portions, do so in such a way that each portion only has one pre-established plot within it. You can then concentrate your plot establishment efforts in those portions without pre-established plots.

The likelihood of initial plot rejection depends on several factors: the odds of encountering one of your rejection criteria (e.g., large rocky areas); how your monitoring type is distributed across the landscape (e.g., if the type has a patchy distribution, your PLPs may not always land in the middle of a patch); the quality of your vegetation maps (i.e., if you have poor quality maps, your PLPs may not always land within the

type); and the quality of your Monitoring type description sheet (FMH-4) (e.g., you may have written a more narrow biological or physical description than you intended, and as a result the type that you have described only represents a small portion of the fuel-vegetation complex that you are sampling). Most of this information requires input from field technicians, so initially you will need to make your best guess as to the likelihood of plot rejection.



**Figure 15. Using restricted random sampling to generate plot locations.**

In this example, the monitoring type is first divided into 20 equal portions (notice that portion number 17 is shared between two burn units, as the two parts of this portion combined is equal in acreage to each of the other portions). Second, within each portion, random points A–D (PLPs) are placed using one of the methods described on page 60.

### Locating Your First Plots



Ideally, before you burn within a new monitoring type, you would install all your plots in that type throughout all units proposed for burning in the next five years. However, when fire managers have scheduled burning to begin before you can install all your plots, a practical alternative is to prioritize plot locations in the “ $n$  equal portions” that fall in burn units that fire managers plan to burn within the next year or two. To avoid biasing your plot locations toward burn units that will burn first, divide up your monitoring type using the aforementioned guidelines for the number of “ $n$  equal portions.”

## CREATING EQUAL PORTIONS FOR INITIAL PLOT INSTALLATION

### Method 1: Using a Geographic Information System

In ArcView, use the GRID function to make a 60 × 60 m grid for forest plots, and a 40 × 40 m grid for grass and brush plots. Then, eliminate the cells in the grid that are not in the preselected areas, i.e., the monitoring type. After that, have ArcView number the gridline intersection points from one to x. Then divide x (the total number of points) by the number of plots you anticipate installing, e.g., if you think you will need 25 plots, then you would divide x by 25. You can then use the GIS method discussed on page 61, or simply use one of the random number methods listed in Appendix B, to pick your plot location points (PLPs), in order, within each 1/25th of the monitoring type. For a monitoring type that contains 1,000 potential plot locations choose random numbers from 1-40, 41-80, 81-120, etc.

### Method 2: Topographic Map Method

First, use a dot grid to measure the total acreage of your monitoring type (the portion that will be burned over the next five years). Divide the total acreage of that monitoring type by the number of plots you anticipate installing. For example, if you have 100 hectares of monitoring type, anticipate needing 25 plots, then divide 100 hectares by 25. Calculate how many dots on a dot grid are needed to encompass that size portion (the total acreage divided by the potential *n* equal portions). Use the dot grid to then draw the boundaries of the *n* equal portions (in this example, 4 hectares each) on your map. You can then use the Grid or XY coordinates methods discussed on page 61 to establish your plot location points (PLPs).

## CREATING *n* EQUAL PORTIONS WHERE PLOTS ALREADY EXIST

### Method 1: Using a Geographic Information System

Calculate the total acreage of your monitoring type, then divide by the number of plots you plan on installing. Then calculate the radius of a circle (using the

equation below) around which no other plots would be established.

$$r = \sqrt{A/\pi}$$

where:

r = radius

A = area (acreage of *n* equal portions)

For example, if each *n* equal portion equals 40 hectares, you will need each existing plot to have a buffer of 357 m.

In this example you would use the BUFFER command to create a 357 m buffer around each point in your monitoring plot point coverage. This will produce 40-hectare circles around each plot. You will then have a polygon coverage of circles. Then use a spatial overlay function (or CLIP command) to eliminate from your grid all points that fall within these circles. Pull this new coverage into ArcView and begin the GRID process as described above.

### Method 2: Topographic Map Method

Follow the directions listed in method 1 above, and divide each portion so that each portion contains only one previously installed plot.

## RANDOMLY ASSIGNING PLOT LOCATION POINTS

The next step is to randomly assign plot location points (PLPs) within each of the *n* portions of your monitoring type. Each of the three methods presented here for locating a monitoring plot on a map, orthophoto (an aerial photograph that corresponds to a USGS 7.5 minute quad), or other locator, presumes that you have divided your monitoring type into *n* equal portions (see above). All three methods require very accurate base and burn unit maps before you can begin randomization or monitoring. This step, along with finding the equivalent field location, can actually be the most time-consuming activity in monitoring. In all three methods, you will need to establish a random point, called the plot location point (PLP), from which the plot origin point will be determined in the field.

As you use one of these three methods to select plots, be sure to **number** the selected PLPs or grid units on your map or locator—in the order that you select them within each *n* equal portion—before going to the field. If you can generate UTM coordinates for

your PLPs, you can use these with a Global Positioning System (GPS) unit in the field.

Discard any PLPs or grid units that meet the rejection criteria you have identified and recorded on FMH-4, e.g., a plot location point in a riparian area. Ideally—with an intimate knowledge of the monitoring type and good maps—you would identify and exclude such areas prior to gridding and randomly selecting the PLP or grid unit.

### **Method 1: Using a Geographic Information System**

You can use a Geographic Information System (GIS) to select and record random monitoring plot origin points in the field. In order to use GIS to randomly assign sample plot locations you need several base cartographic layers. These layers should include your best available vegetation layers as well as elevation, slope, and aspect. It would also be useful to have a layer that displays the location and type of all existing sample plots.

There are currently three approaches available to randomly select PLPs using GIS tools:

- ArcView extension (for version 3.1) developed by Alaska Support Office GIS (USDI NPS 2001b)
- ArcView extension developed by SEKI GIS
- ArcInfo Grid function <Rand>

The first two approaches offer a fairly automated procedure for experienced users of ArcView. The third approach offers the most control and flexibility for advanced users of ArcInfo. For further information or to obtain copies of the ArcView extensions, contact your GIS coordinator, or visit the FMH web page <[www.nps.gov/fire/fmh/index.htm](http://www.nps.gov/fire/fmh/index.htm)> for contacts.

---

### **Grid or XY Coordinates Method**



If you use graph paper for your grid, enlarge your monitoring type map so that each section of the graph paper is roughly equivalent to your plot size (50 m × 50 m for forest types or 30 m × 30 m for brush and grassland plot types).

---

### **Method 2: Grid Map Method**

The random grid map method is a low-tech method for random selection of monitoring plots. On a map, draw (or place) a grid atop each of the *n* portions of

your monitoring type. Assign each cell of the grid a unique number, and randomly select cells in each portion (between two and ten, depending on the likelihood of rejecting the plot location points; refer to Appendix B for random number generation). The center point of the cell is the PLP.

### **Method 3: XY Coordinates Method**

This method is similar to the grid map method, but uses an XY grid. Overlay an XY grid on the map or orthophoto containing the portion of the monitoring type. A clear plastic ruler or transparent grid works well for this purpose. Using the lower left-hand corner as the origin where X, Y = 0, 0, select pairs of random numbers to define X and Y points on the grid (see Appendix B). The intersection of the XY coordinates on the map is the PLP. As in the grid map method, you will randomly select a certain number of PLPs in each portion of the monitoring type.



## Plot Location

---

Your randomly selected plot location points (PLPs) (see page 60) will serve as the starting point for actual plot location, which is done in the field. From the PLP, you will measure a random direction and distance to a plot origin point.

### STEP 1: FIELD LOCATING PLPs

With your map of numbered PLPs in hand, you are ready to locate plots in the field. If you generated these PLPs using a GIS, you have UTM coordinates, and you can use a GPS unit to find your points. To eliminate bias, visit potential plot locations in the order in which they were randomly selected within each portion of the monitoring type (see page 59). This will eliminate any tendency to avoid plots located in difficult terrain or that are otherwise operationally less desirable.

Verify plot suitability by visiting each PLP identified on the map. To locate your PLP, first choose a landmark near your point that you can easily locate on your map (or aerial photo). Determine the actual distance and bearing from the landmark to the PLP. Once you've found the landmark in the field, use a compass, adjusted for the local declination, and measure (tape, hip chain, or pace) the distance to the point using this information. If your points were generated with GIS, use of a GPS unit will greatly increase your accuracy in locating the PLP.

Once you have found the PLP, you will select a plot origin point. To do this, select a random compass direction (0° to 359°) from a list of random azimuths, which you can create using a random number generator (Appendix B).

Next, select a random distance (0 to 20 m) from a list of random distances, which you can create using a random number generator. Locate the plot origin point by moving the indicated direction and distance.

---

### Navigation Aids



If you need assistance using a compass, using declination, using a clinometer, measuring distances in the field, or other navigation techniques, see pages 201–206 in Appendix C.

---

---

### Randomization



For each plot you plan to install, generate two or three sets of random numbers, six random azimuths (0–359) (one for plot location, one as the plot azimuth and four for the fuel transects) and one random distance (0–20 m), ahead of time. An excellent idea is to generate all the random azimuths and distances that you will need for the entire season at once, using a spreadsheet program (e.g., Microsoft Excel or Lotus 123) (see page 191). **Make sure that you cross each number out after you use it.** In a pinch, you may generate a random azimuth by randomly spinning the dial of your compass. However, remember that this not the preferred method.

---

### STEP 2: ASSESSING PLOT ACCEPTABILITY AND MARKING PLOT ORIGIN

From the plot origin point you've just identified, check the area against the monitoring type description and rejection criteria on FMH-4 (Monitoring type description sheet). If the monitoring plot origin point and the area roughly within a 50 m radius of that point meet the criteria for the monitoring type, proceed to mark and establish the monitoring plot.

If the origin point and surrounding area meet one or more rejection criteria for the monitoring type, return to the PLP, orient 180° away from the previous randomly selected azimuth, and move a distance of 50 m to a new plot origin point. If the second location meets one or more rejection criteria, reject the PLP and proceed to the next one (return to Step 1) (see Figure 16).



**Figure 16. Initial steps of plot location.**

In this example, a monitoring crew first visits PLP A and rejects that point after trying a random number and distance, then trying 50 m at 180°. The crew successfully accepted the plot near PLP B after going a new random direction and distance from that point.

**Note:** PLPs were visited in the order that they were chosen (A–D).

If the area around your origin point meets the criteria for the monitoring type, install a stake, which serves as the plot origin point (the center point of the forest plot or the 0 point of a grassland or brush plot). Marking the plot is described in detail under the plot layout and installation section (page 64).

### Increase Your Chances of Accepting a Plot Location Point



Within narrow monitoring types (e.g., riparian, canyon edges, and where the PLP falls at a location that would likely lead to an acceptable plot site only within a range of directions), the random azimuth generation may be restricted to that range, provided that the range of available azimuths is fairly generous (at least 60 degrees).

### Working on Steep Slopes



Where steepness of the slope characterizes the monitoring type, wear light boots or shoes (if safe to do so) and take extra care to minimize activity within the plot boundaries.

# Laying Out & Installing Monitoring Plots

Plot layout and installation methods vary with plot type; here, each method is presented separately. Two monitors are recommended for grassland, and three for brush plot installation. A minimum of two monitors are needed for forest plot installation, but a third and even fourth monitor will make it go more than twice as fast and are especially important where vegetation is very dense. In all plots you will need your Monitoring type description sheet (FMH-4) and Plot location data sheet (FMH-5), a compass, and stakes. Stake labels (tags) are used in all types of plots and are discussed following the section on forest plot layout and installation. For a complete equipment list, see Appendix E.

## GRASSLAND AND BRUSH PLOTS

As described earlier in this chapter (page 62) you have generated a plot origin point from your PLP, and have marked this point by installing an origin stake. From this origin stake, select a random azimuth (Appendix B) and lay out a 30 m+ tape from the origin stake along this azimuth (see Figure 17). Suspend the transect line, defined by the tape, above the vegetation (brush plots may require special techniques—see tip on page 65). This may require construction of two tripod scaffolds—one for each end of the tape. The entire 30 m line and 5 m on either side of it must lie within the identified monitoring type.

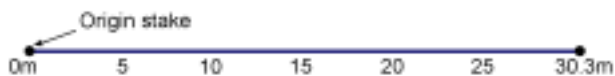

**Figure 17. Grassland or brush monitoring transect.** Place a stake at each point marked with a black circle (•). Note that the endpoint is installed 0.3 m past the endpoint of the transect to minimize interference.

### Mark the Plot

Mark the transect dimensions by installing two 0.5 in diameter rebar (rebar is recommended throughout the text, but other materials may be used, see Appendix E) stakes at 0 and 30.3 m. Installing a stake at 30.3 m (30P) minimizes stake interference in the point intercept transect at the 30 m data point. Stake height above the ground should allow easy relocation of the stakes. Stakes should be installed deep enough to provide adequate basal stability relative to the height necessary to bring the stake into view. Suggested stake lengths are 0.5 to 1 m for grassland transects, and 2 m or more for brush transects. It is generally best to

overestimate the stake heights needed, to compensate for snow creep and vegetation growth.

Burial of the origin stake (0 point) is recommended, especially in areas subject to vandalism or disturbance. A metal detector (or magnetic locator) can be used later to relocate the plot if all of the above-ground stakes are lost. In high-use areas it may be necessary to partially camouflage stakes, or to mark beginning and end points with buried metal markers that can be relocated with a metal detector (or a magnetic locator). Electronic Marker Systems, or “cyberstakes,” may be useful under these circumstances (see page 224).

Color code plot beginning and ending stakes (orange for 0P, blue for the 30P) with heat-resistant paints, e.g., automotive engine paint. Place a piece of cardboard behind the stake while you are painting it to protect the surrounding vegetation. Repaint the stakes after each burn.

Install permanent plot identification tags on each stake as described on page 70.

## Defining the Brush Belt



You may find it useful to define the brush belt for future monitors by installing two additional stakes, each a belt width away from 0P and 30P. These two stakes should be 30 m apart instead of the 30.3 m distance separating 0P and 30P.

---

## Advice for Installing Brush Plots



Shrubland types can be very difficult (and sometimes painful) to navigate in, make straight lines through and photograph. Here are some tips to aid intrepid shrubland monitors.

- The best way to string a straight tape in a shrubland depends on the height, density and pliability of the species concerned. If the average height of the shrubs is  $<1.5$  m, pound the rebar to within a decimeter or two of the average height (use rebar long enough for you to bury a third to half of the stake), and string the tape over the top of the vegetation. If the shrubs are  $>1.5$  m and have a relatively open understory, run the tape along the ground. However, if these tall shrubs are fairly continuous, you may be better off trying to string the tape right through the stems. No matter how you string the tape, record on the FMH-5 where you string it, so future monitors can replicate your work.
- Three may be the best number of monitors for installing brush plots, with two people setting up the transect and the third mapping and photographing. When re-reading the plot, two people can collect transect data and the third can collect density data and photograph the plot.
- When on slopes, approach the plot from above. You will find it easier to move, toss equipment, and sight from above than below. Examine where your plot might go, and plan out your sampling strategy to minimize movement from one end of the plot to the other.
- Play leapfrog to navigate to the plot, or when stringing the tape along the azimuth. The first person sights along the azimuth while the second person moves through the brush to the farthest point at which she or he can still see the first person. **Note:** Rather than trampling directly down the actual transect line, take a circuitous route. Two monitors will sight on each other trading the compass and the tape. Then the first person works his or her way around past the second person to the next point where a line of sight can still be maintained. They sight on each other once again and toss the tape, and continue until the destination is reached.
- Use a tall, collapsible, brightly painted sampling rod and include it in your photos. This will make the opposite stake (0 or 30P) more visible in the photos, and will let your fellow monitors know where you are.
- Wear a brightly colored shirt, hat or vest. Flag the sampling rod. Flag your glasses. Flag your hat. Do whatever you have to do to be seen.
- In addition to using a GPS unit to record the plot location, make the plot easier to find by installing reference stakes or tagging reference trees, and locating at least three other highly visible reference features. Take bearings to three of these features, so that returning monitors can locate the plot by triangulation.
- You may find it useful to set up a photo point from an adjacent ridge to get a community-wide view of change over time.

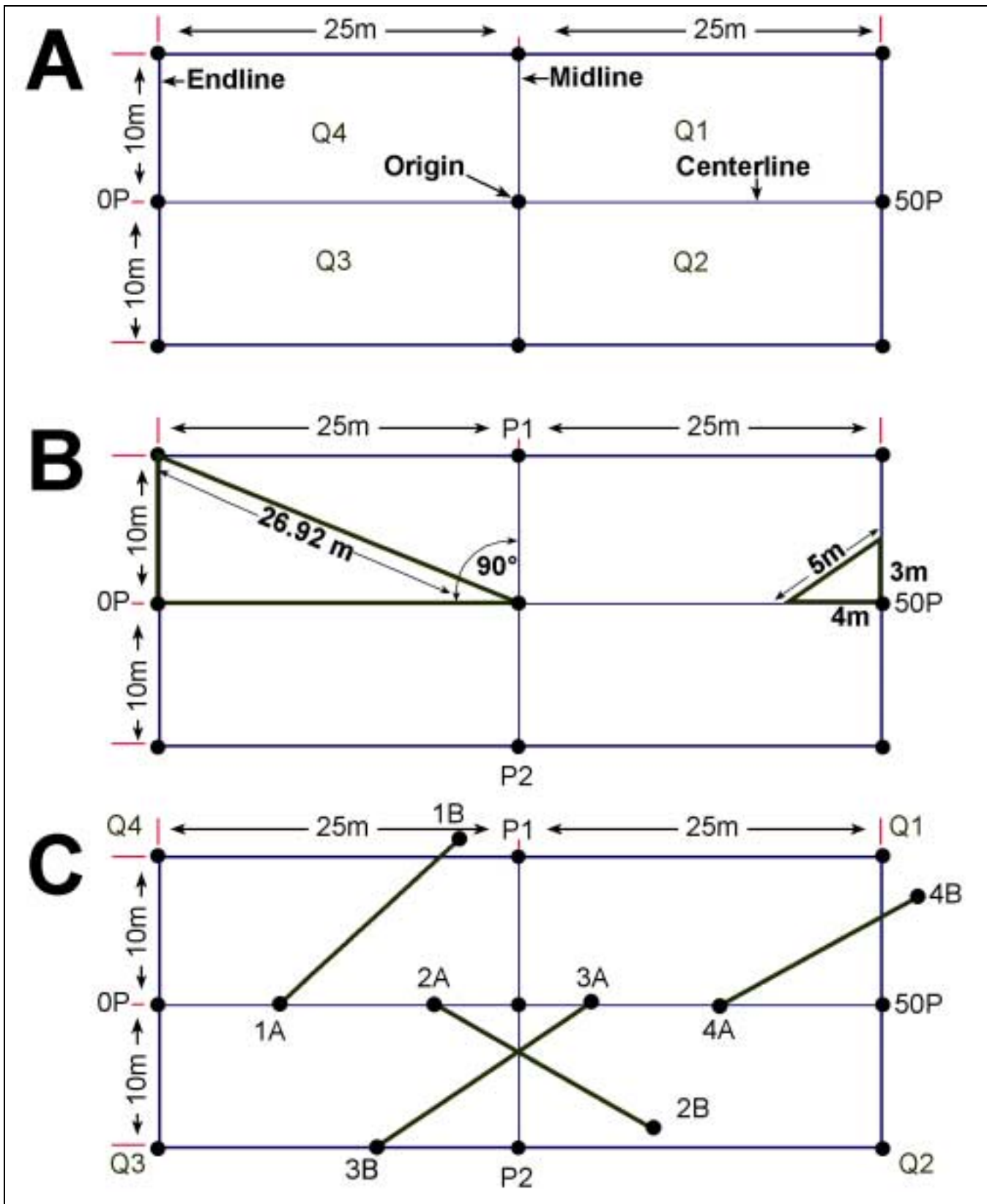

Figure 18. Steps in laying out a forest plot.

A) place stakes at points marked with a black circle (•); B) lay out 90° angles and adjust the corner stakes; C) place remaining plot stakes.

## FOREST PLOTS

### Locate the Plot Origin

For forest plots, your origin point (see page 62), marked by a stake, serves as your plot center (see Figure 18A).

### Establish the Plot Centerline

You will use this origin to lay out a rectangular plot (Figure 18). Select a random azimuth (Appendix B) and measure a 50 m line along this azimuth, using the origin point as its center. The centerline is defined by a tape measure laid as straight as possible. To lay out this 50 m tape, stand at the plot origin and run the 0 end of the tape toward the 0P point (along the back azimuth) and the 50 m end of the tape to the 50P (Figure 18A). Record the plot azimuth on the Forest plot data sheet (FMH-7).

### Establish the Plot Boundaries

Laying out the tape to define the plot boundaries requires at least two monitors—one for each end. The monitors must take time to lay out the plot as a true rectangle. These plots are large and one monitor could lose sight of the other, making it difficult to “square” the plot corners (90° angles). A few helpful hints to accomplish this task are provided here.

Lay out the plot centerline as straight as possible. Next, lay out three 20 m (or 30 m) tapes perpendicular to the centerline, also as straight as possible, and such that the tapes intersect at right angles. Start with either line P1–P2 or Q4–Q3. To accomplish this use the principle of the 3, 4, 5 triangle. For every right angle, measure 3 m along the 20 m tape where it intersects the centerline; mark the measurement. Measure 4 m along the centerline; mark the measurement. The hypotenuse of the resulting triangle should be 5 m (as illustrated in Figure 18B). If the hypotenuse is not 5 m, adjust the 20 m tape so that it is.

In sparsely vegetated forest types you may be able to triangulate using larger triangles. For example, in Figure 18B the hypotenuse of the triangle from the centerline 0P to point P1 is 26.92 m.

Lay out the endline (Figure 18A) and midline tapes, making sure that the “0” end of each tape starts at the same end of the plot.

If the plot encompasses variable slopes, such as a ravine (and this does not cause you to reject it), lay out the tapes so that you are measuring slope distance (see

Glossary) rather than horizontal distance—FMH.EXE software will correct for this. In such a case, it will be impossible to perfectly square the plot, but this allows for the most true representation of the area on the ground. For plots with an understory of dense shrubs, see page 65 for tips on installing plots in brush.

---

### Plot Squaring Priorities



Squaring a plot can be tedious and time-consuming. Keep in mind that the variables affected by this process are density of overstory, pole-size and possibly seedling trees. The degree to which the plot should be perfectly square depends on the density of trees, particularly if there are any trees right on the boundary in question. If trees are dense and there are one or more trees on the boundary, it is important to get the corners as square as possible. A good guideline is that the 3, 4, 5 triangle be no more than 1 dm off on each side. If trees are sparse and there are no trees on the boundary, squareness is less critical and an error of 30 dm may be acceptable. **Accuracy Standards:**  $\pm 0.5$  m for the length, and  $\pm 0.2$  m for the width, of a forest plot (Table 8, page 69).

---

### Orient the Plot Quarters

Once your plot is squared, divide the plot into quarters and assign numbers according to the following protocol. If you stand at the plot origin, with both feet on the centerline and the 0 point (0P) on your left, Quarter 1 (Q1) is to your forward-right. Quarters 2, 3, and 4 are numbered clockwise from Q1 as shown in Figure 18A.

---

### Carrying Rebar



If you backpack into your plots, try using the bottom of a plastic soda bottle to carry your rebar stakes, in order to protect your pack.

---

### Mark the Plot

Define the plot, quarters, and fuel inventory lines as shown in Figure 18C with rebar stakes (rebar is recommended throughout the text, but other materials may be used, see Appendix E). Bury a 0.5 in diameter rebar stake (the origin stake) at the plot center or origin. Install rebar stakes at each of the four corners of the 20 m  $\times$  50 m plot (Q1, Q2, Q3, and Q4) and at the starting points along the centerline for the four fuel

inventory transects (1A, 2A, 3A, and 4A). Place a stake at either end of the center line (points 0P and 50P), and a stake at either end of the short axis midline (points P1 and P2).

Define the end points of the fuels inventory lines by installing rebar stakes at these points (1B, 2B, 3B, and 4B) using four random azimuths. Often the end points of the fuel transects will be 50 ft from the beginning points (A), but in some types they may be longer. Check the protocols (FMH-4) and install to the appropriate length.

Stake height above the ground should be sufficient to allow easy relocation of the stakes. Install the stakes deep enough to provide adequate basal stability relative to the height necessary to bring the stake into view. Suggested stake lengths are: 0.5 m–1 m for forest plots, or taller if undergrowth is tall and thick. It is generally best to overestimate the stake heights needed, to compensate for snow creep and vegetation growth.

Burial of the plot reference or origin (center) stake is recommended, especially in areas subject to vandalism or disturbance. The other key stakes (Q1, Q2, Q3, Q4, 0P, and 50P) may also be considered for burial, but only as a last choice, as buried stakes can be difficult to install, locate, and remove. Buried stakes can be relocated with a metal detector (or a magnetic locator).

Color-code the plot beginning and ending stakes (orange for 0P, blue for the 50P) using heat-resistant paints, e.g., automotive engine paint. Repaint the stakes after each burn.

Park managers will have to determine whether plot marking standards recommended in this handbook are appropriate for their unit. This handbook calls for the placement of seventeen 0.5 in diameter rebar stakes for each forest plot. These markers are important for the relocation of plots and transects. In some situations, however, these rebar stakes may be hazardous, destructive to cultural resources, or visually or philosophically intrusive. Plastic caps placed on the top of the stakes may prevent injuries and can increase stake visibility (and in some places are required by law). At an absolute minimum, the origin stake and the four corner stakes (Q1, Q2, Q3, and Q4) must be installed. These stakes can be camouflaged by paint or by total or partial burial. You may also consider using “cyber-stakes” (see page 224). Any innovations or deviations from the above should be well documented.

Plots are distinguishable from one another through identification codes etched onto metal tags which attach to the rebar stakes. Directions for preparing and installing these tags follow this section.

---

### Large Obstructions Encountered on the Transect



Follow this procedure if you encounter a large obstruction, like a very large tree or tall rock, along a forest plot boundary line (refer to Figure 19):

- Lay the tape straight, along the transect, until the point at which the obstruction is encountered.
- Pound a permanent stake at this point.
- Deviate from the transect at a 90-degree angle in the direction enabling the shortest offset, until you are clear of the obstruction, and pound a temporary stake there.
- Lay the tape to the end of the obstruction, following the original transect azimuth, and pound another temporary stake there.
- Measure and record the distance between the two temporary stakes.
- Divert 90 degrees again back to where the original line would pick up and pound another permanent stake.
- At this point, you may remove the temporary stakes and secure the tape back at the permanent stake preceding the obstruction.
- Add the distance measured between the two temporary stakes to the distance on the tape at the point at which the deviation was made and the first permanent rebar was installed.
- Unwind a second tape out to this distance and attach it at this point to the permanent stake following the obstruction, then lay the remainder of it out to the end of the transect.
- If this occurs on a transect on which herbaceous and woody plant data are collected, the code for the obstruction (2BOLE, 2RB, etc., see Table 15, page 86) is recorded for each missed interval.

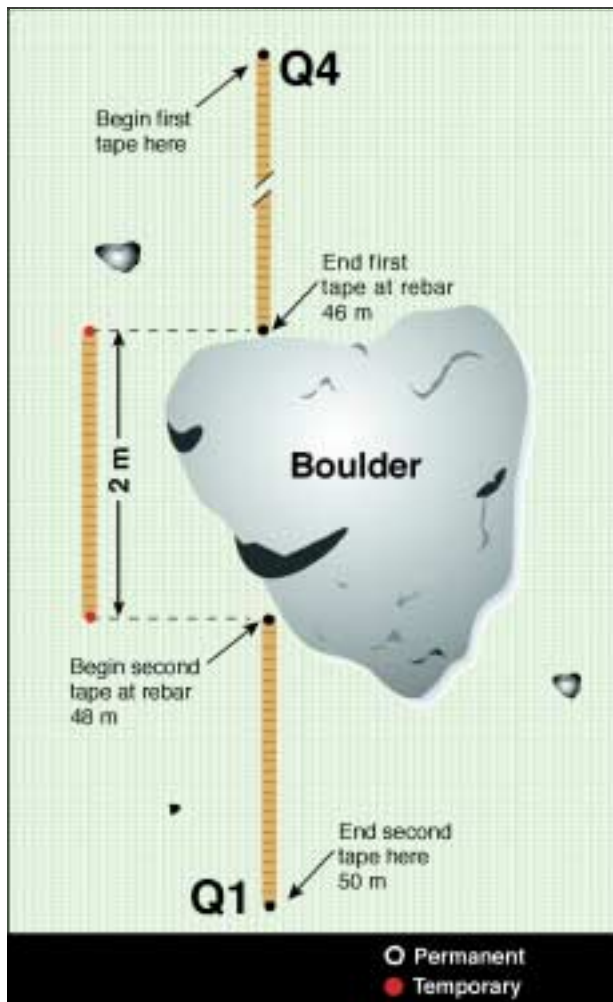

Figure 19. Procedure for circumventing a large transect obstruction.

### When The Rebar Won't Go In



At times rebar cannot be satisfactorily pounded into the ground. If this is the case at one of your plot points, try installing the rebar out a little further along the tape, or sinking it in at an angle so that the top is in the correct location. You can also use a “rock drill” or cordless drill to drill holes prior to placing rebar (in areas that are subject to seasonal flooding, it may be a good idea to secure them with marine epoxy). Alternatively, you can pile up rocks around the rebar, but only if that won't affect the variable you are sampling and the cairn has a reasonable chance of remaining undisturbed.

Table 8. Accuracy standards for plot layout.

Plot Layout	
Dimensions	$\pm 0.5$ m (or 1%), forest plot length $\pm 0.2$ m (or 1%), forest plot width



## Labeling Monitoring Plot Stakes

Install permanent plot identification tags on each stake as described below.

- Use rectangular or oblong brass tags; aluminum tags are likely to melt (Appendix E).
- Each tag should include the monitoring stake location code, plot purpose, plot identification code, plot number and date.

code, and date of initial installation. An abbreviated format may be used to reduce the amount of minting. It includes the monitoring stake location code, plot purpose, vegetation code from the plot identification code, plot number and date. The two formats are displayed in Figure 20.

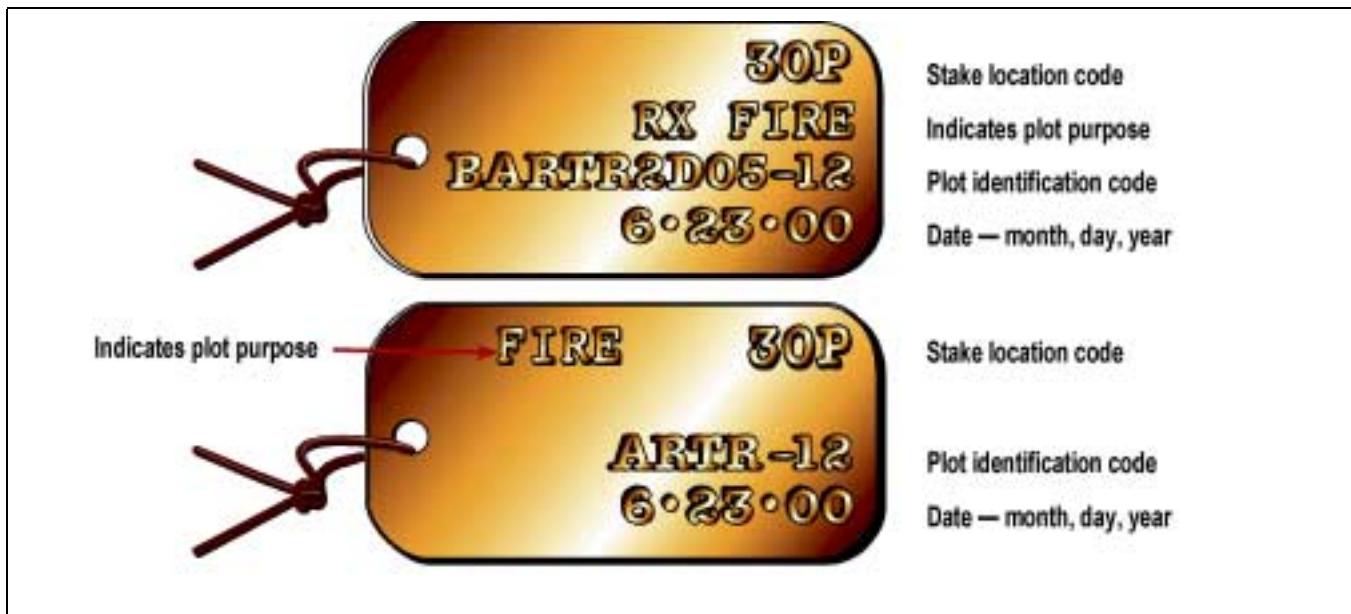

Figure 20. Two formats for labeling plot stake tags.

The stake location codes are identified in Figure 17, page 64 (brush or grassland plots) and Figure 18, page 66 (forest plots).

### Save Time Stamping



Stamping the tags using a die set produces the most wear-resistant results, but is very time-consuming. Stamp the tags (except the date and the plot number, which can be added once the plot has been accepted) before going into the field and consider stamping only the Q1, Q2, Q3 Q4 and Origin stake tags, and using an electric engraver to encode the others in the field.

### Nonstandard Stamp Additions



You may find it useful to include the plot azimuth or other additional information on each tag.

# Photographing the Plot

Once all the tapes are laid out, take a minimum of two photos at each grassland or brush plot (Table 9), and eight photos at each forest plot (Table 10), following the “Subject” sequence listed below (also included on FMH-7). If necessary to better characterize the vegeta-

tion at the site, take additional photos from a well-documented location. To minimize the effect of vegetation trampling on the photo, photograph the monitoring plot before you sample other variables, staying outside the plot as much as possible.

## GRASSLAND AND BRUSH PLOTS

Table 9. Sequence for grassland and brush plot photos.

Subject	Code
1. From 0P toward 30P	0P–30P
2. From 30P toward 0P	30P–0P
3. From 0P toward reference feature	0P–REF
4. From reference feature toward 0P	REF–0P

## FOREST PLOTS

Table 10. Sequence for forest plot photos.

Subject	Code
1. From 0P toward the Origin stake (plot center)	0P-Origin
2. From stake Q4 toward stake Q1	Q4-Q1
3. From stake P1 toward the Origin stake	P1-Origin
4. From stake Q1 toward stake Q4	Q1-Q4
5. From 50P toward the Origin stake	50P-Origin
6. From stake Q2 toward stake Q3	Q2-Q3
7. From stake P2 toward the Origin stake	P2-Origin
8. From stake Q3 toward stake Q2	Q3-Q2
9. From the Origin toward reference feature	Origin–REF
10. From reference feature toward Origin	REF–Origin

## RS PROCEDURES

- A coded photograph identification “card” (see photo card tip below) should be prepared and made visible in every photograph. The card should display, in large black letters, the plot identification code, date (if camera is not equipped with a databack), subject code and any other information that may be useful, e.g., park code, burn unit, or burn status.
- **Use the same kind of camera, lens, and film each time you rephotograph.** Note: Use relatively stable technology such as 35 mm cameras

and film rather than the latest digital camera. Try to retake the photo at the same time of day, and at about the same phenological stage of the shrub and herbaceous species. To avoid shadows, take photographs when the sun is directly overhead, when possible.

- Place a flagged rangepole or other tall marker at the midpoint or the end of the line being photographed. The pole should be located at the same point each time the plot is rephotographed. This can provide for clearer comparisons over time.

## Photographic Protocols



The following procedure differs from that recommended in previous versions of this handbook. Previously established photopoints should **always** be rephotographed using the protocols that were used when the points were originally established.

- Using a tripod or monopod, raise the camera to a height of 4 ft and set it back from the starting point just far enough to get the top of the closest stake in the field of view. Exactly how you frame the shot will also depend on the slope and horizon—on a hillside or ravine, angle the camera with the slope. Align the camera horizontally for the recommended photos. Take an additional vertical shot, if that better characterizes the plot, due to an obstruction, dense shrubs, tree bole, large rock, etc., in the camera's field of view. Make sure that the light meter reading doesn't include any sky. If it does, first point the camera at the vegetation only and note the reading given there, then reposition the camera. The photo should include the tape as well as the stakes at either end of the transect along which you are shooting.

## Rephotographing Plots



Remember that when you are photographing plots that have already burned, you should make every attempt to duplicate the preburn photos, no matter what technique was used, unless the previous photos are poor, e.g., pictures of plot stakes, but not the plot itself. If possible, bring a reference photo (a color photocopy of the original) along to facilitate duplication of earlier shots.

- Basic photography guidelines can be found on page 207 in Appendix C.
- Record photographic information on the Photographic record sheet (FMH-23 in Appendix A).
- As soon as the film has been developed, label all slides as per Figure 21. The Photographic record sheet should be used as a reference. It may be helpful to add the park code if more than one park is served by the same monitoring team.



Figure 21. Suggested format for labeling slides.

## Importance of Good Preburn Photos



The importance of the highest quality preburn data cannot be overemphasized. Returning to plots to retake photos is costly and time-consuming, but absolutely necessary if you take poor photos the first time. This is especially critical at the preburn stage as the value of postburn photos is dependent upon good preburn photos for comparison. Extra time and care taken to get good photos the first time will be repaid, as poor quality images will require a return visit to the plot to reshoot the photos.

## Taking Slides into the Field



Never take original slides into the field; they will be degraded by light exposure and abrasion, and could be lost entirely.

## EQUIPMENT AND FILM

Use a 35 mm camera with a 35 mm lens. A 28 mm lens will give you an even wider field of view, but may be harder to come by. A databack camera may be used to ensure that the date and time are recorded on the film, but is not necessary. In the near future, high resolution

digital cameras may become the best technology for photo documentation. However, as of this writing, the quality of camera necessary to produce clear, well-defined projectable slides is prohibitively expensive for most monitoring programs. **Note:** Choose one type of equipment and use it for the duration of the monitoring program.

Use the highest quality film type available for long-term storage. Exposure to UV light is extremely detrimental to image longevity, and light damage is cumulative. At this writing, the most stable slide film available for long-term dark storage is Kodachrome, however it is unstable when exposed to light, especially projector bulbs. Fujichrome has superior projection-fading stability. A balance should be sought between projector-fading and dark fading stability (Wilhelm and Brower 1993). Under the best storage conditions, slides from both films will last up to fifty years. **Note:** Some programs may want to consider using black and white prints for archival purposes. This medium will hold up longer than slides, and allows for very nice visual comparisons, but can be costly and require a lot of storage space for programs with an extensive plot network.

Choose film speed according to the amount of light generally available in the monitoring type, or likely to be available during the data collection visit. At times this could necessitate changing the film mid-roll and rewinding it for later use or wasting the remaining film on the roll, but this is preferable to poor photo quality and will be less expensive than having to return to the plot to rephotograph it if the photos are not acceptable. More details on film and basic photography guidelines can be found starting on page 207.



- Always bring a **copy** of the preburn photos into the field to facilitate replication of earlier shots. This can be a set of photographic prints, scanned images, color photocopies or slide duplicates generated for this purpose and included in the “field packet” (see page 112).
- Photos will be more useful if they show primarily the vegetation, and space taken up by the board and monitor is minimized. Have someone hold the board so that the codes are just visible in each photograph, but the board itself is as unobtrusive as possible. While it would make for great reminiscing, the person holding the board and the other data collectors should not be visible in the photo.
- A convenient photo board can be fashioned out of a piece of white paper (or card stock) laminated with 10 mil plastic; dry erase markers can then be used to mark the board. Such a board will last one field season. For a more permanent tool, try using a dry erase board, or a magnetic board as developed by the Glacier National Park sign shop (details are provided in Appendix E).
- Use the same lens focal length each time you rephotograph.
- If it is not clear what the best camera settings are, bracketing the photos (taking three photos of the same subject using a range of settings) will decrease the chance that a revisit will be necessary.
- If the closest stake that should be in the photo is obstructed by a shrub or tree limbs, take the photo anyway, flagging the stake and moving as little vegetation as possible. You may then take an oblique shot of the photo transect if desired, noting the exact location from which this shot was taken and that this photo should always be repeated on subsequent visits.

If obtrusive vegetation prevents you from placing the camera in such a spot that you can get the closest stake in the picture, it may be acceptable to take the photo while standing at the stake itself, or from a different height (but not above 5 ft), as long as this is noted and repeated on all subsequent visits, even if the intruding vegetation is later consumed. Never prune vegetation from a plot.

- Retake the photo when the shrub and herbaceous species are at the same phenological stage as they were in the original photos.
  - Processing slides promptly will allow you time to retake poor photos while the vegetation is still at the phenologically correct stage.
  - If you find that the Photographic record sheet (FMH-23) is too large, or if you use multiple cameras, keep a small notebook with appropriately labeled pages in the camera bag at all times. Attaching the notebook to the camera bag will reduce the risk of losing the entire notebook and all the data with it.
-

## Field Mapping the Monitoring Plot

Copies of your field maps should be included in each plot folder, in the “field packet,” and possibly also in a general monitoring type file (see page 112 for a discussion on field packets and plot folders). Note the location of monitoring plots on each of the following types of maps:

- USGS 7.5-minute or 15-minute topographic quad, detailed trail map, GIS map, or best available map for your park
- Orthophoto quad or aerial photo, if appropriate (note that in open country, aerial photos can make relocation of the monitoring plots much easier, but they are not as useful in closed forest types)
- Hand-drawn route map, including a plot diagram and reference features
- Full park or small-scale map (for inclusion in a monitoring type or monitoring program general file)

### Mapping



Those who follow in your footsteps won't have your footsteps to follow. When mapping, keep in mind that your map may be used by monitors who are unfamiliar with your park, and make the map as clear as you possibly can. Include as many geographic features as possible to reassure future monitors that they are on the right course, and indicate when they have arrived. Remember to include enough information (e.g., azimuths and distances to multiple reference features) in your maps for future monitors to easily recreate the plot if one or more rebar are missing. This is especially critical for grassland and brush plots, as they have only two stakes. **Note:** Accuracy standards for plot location measurements are located in Table 11, page 76.

### Reference Features



In difficult terrain, or for distances longer than your longest tape, use a Global Positioning System (GPS) unit to find the azimuth and distance from the reference feature to the plot. For assistance using a GPS unit, see page 205 in Appendix C.

## COMPLETE PLOT LOCATION DATA SHEET

Follow along with the completed Plot location data sheet (FMH-5) on page 77 as you read the steps on the following two pages. A blank FMH-5 is available in Appendix A.

- Assign and record the plot identification code. The plot ID number consists of the monitoring type code (see page 36), and a two digit plot number; ex.: FSEGI2T08-01 or BARTR2D05-01. The last two digits (plot number) should start with 01 for each monitoring type and continue sequentially within each type.
- Circle whether the plot is a burn plot or a control plot (B/C). Record the date you completed the form, the burn unit name or number (or both), the people that completed the form, the topographic quad containing the plot, the azimuth of the transect, and the declination (see page 202) that you used for all azimuths.
- Record Universal Transverse Mercator values (UTMs) or longitude and latitude. If appropriate, record township and range as well. Record whether the location was determined with a map and compass or a GPS unit. If you use a GPS unit, record the Position Dilution of Precision (PDOP) or Estimated Horizontal Error, 2D (EHE) if you are using a PLGR, and specify the datum used (e.g., North American Datum-1927, NAD27). See page 205, Appendix C for a discussion of PLGR use and datums. **Note:** If you map the location of the plot with a GPS unit on a date different from that on which you installed the plot, be sure to note this on the History of site visits (FMH-5A).
- Record the average percent slope that the plot azimuth follows, the average percent slope, the aspect, and elevation (from a GPS unit or a topographic quad) of the plot location.
- Describe the fire history of the plot. At a minimum, include the date of the last fire, if known.
- Record the travel route used to access the monitoring plot (also show this on a topographic map).
- Record the **true** compass bearing (includes declination) followed from the road or trail (or other relatively permanent reference point) to locate the monitoring plot. Mark on the topographic map

where you left this well-known trail or road, and photograph this location if necessary.

- Describe how to get to the monitoring plot, referring to the hand-drawn map. **Note:** Some people can easily follow written directions, while others prefer visual directions. Use the hand-drawn map to illustrate the written directions by including all your geographic references, including the highly visible features from which you took bearings.
- Identify permanent or semi-permanent reference features on the site in case the origin stake is hard to find or disappears. The reference feature should be easy to relocate, such as an obtrusive and distinctive living tree or large boulder, peak, or cliff. Install a reference stake if no reference features are available, but use them sparingly and place them carefully to avoid attracting vandalism.
- Record the **true** compass bearing (includes declination) and distance in meters from the reference feature to the origin stake.
- Describe the plot location accurately and thoroughly, referring to the hand-drawn map.
- Complete the History of site visits (FMH-5A) every time you visit the plot.
- Enter the FMH-5 into the FMH database (Sydoriak 2001).
- Fill out the Forest plot data sheet (FMH-7); see the warning box below.

## Forest Plot Data Sheet (FMH-7)



The Forest plot data sheet (FMH-7) has been modified from a photo record sheet to a place where you can record the azimuth and slope of each fuel transect line and draw in the transect lines and the sampling areas for overstory, pole and seedling trees. See the example on page 79.

**Table 11. Accuracy standards for plot location description.**

Plot Mapping	
% Slope	± 5%
Elevation	± 100 ft (30 m)
UTM	± 30 m (by GPS unit) ± 100 m (by hand)
Lat/Long	± 2 seconds (by GPS unit) ± 5 seconds (by hand)

FMH-5

## PLOT LOCATION DATA SHEET

Plot ID: FPIRIG08-04

B/C (Circle One)

Date: 7 / 31 / 00Burn Unit: RCWRecorder(s): Blozan, FeeleyTopo Quad: CalderwoodTransect Azimuth: 134°Declination: 3°W

UTM ZONE: _____	Lat: <u>35° 32' 30"</u>	Section: _____	Slope (%) along Transect Azimuth: <u>10%</u>
UTMN: _____	Long: <u>85° 55' 0"</u>	Township: _____	Slope (%) of Hillside: <u>23%</u>
UTME: _____		Range: _____	Aspect: <u>224°</u> Elevation: <u>1360'</u>

Location Information Determined by (Circle One): Map & Compass GPS

If determined by GPS: Datum used: \_\_\_\_\_ (Circle One) PDOP/EHE: \_\_\_\_\_

Fire History of the Plot (including the date of the last known fire): Burned in a wildland fire (human caused ignition) in 1971 and (natural ignition) in 1958. Additional information is unavailable prior to 1943.

- Road and trail used to travel to the plot: Take 441 from park headquarters to 321; make a left on 321. Take 321 to Route 129; turn left on Route 129.
- True compass bearing at point where road/trail is left to hike to plot: 50°
- Describe the route to the plot; include or attach a hand-drawn map illustrating these directions, including the plot layout, plot reference stake and other significant features. In addition, attach a topo, orthophoto, and/or trail map.

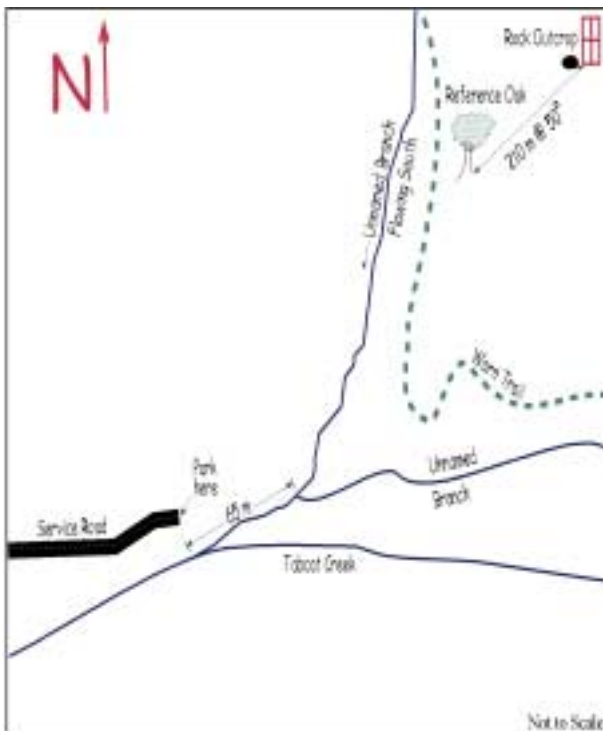

Plot can be reached from Route 129 beginning at the utility line service gate. Follow the service road under the power lines and over the crest of small, steep hill toward Tabcat Creek. Continue following the road upstream (southeast). The road will cross the stream three times, the third being a relatively wide and shallow section (2.1 mi. to third crossing). This crossing is also a split in the service road. Veer left and continue up Tabcat Creek, following the overgrown service road, crossing first under the four strand power lines and then the main lines (twin sets). You may have to cross the stream several times for ease of passage. Travel upstream to the junction of an unnamed creek branch, 0.6 mi from service road split and 250 m east of Cattail Branch on the north side of Tabcat. The road becomes impassible at this point, park here. Follow the branch 65 m (paced) to its junction with a tributary flowing almost due south. A worn trail will be apparent east of the creek. Cross the creek and follow the trail up to the crest of the ridge and look for a lone, stately old chestnut oak (*Quercus prinus*, DBH 83 cm) with a tag on its south side. The tag says: RXFire FPIRIG08 Ref. #1. From the tagged oak, travel 210 m (paced) at 50° to Q3. The plot is located on the northeast side of a large rock outcrop.

- Describe reference feature: *Q. prinus*, DBH = 82.8 cm
- True compass bearing from plot reference feature to plot reference stake: 50°
- Distance from reference feature to reference stake: 210 m
- Problems, comments, notes: It is difficult to see the plot until you are almost upon it. The Q4-Q1 line goes to the uphill side of the large boulder at 39 m.



Plot ID: FPIRIG08-04

**(B)** C (Circle One)

Burn Unit: RCW

Date	Burn Status	Purpose	Comments
7/28/00	PRE	Install Plot/Begin Data Collection	
7/31/00	PRE	Complete Data Collection	
9/8/00	01 Burn	Burn Plot, Collect Fire Behavior data	Only 1/2 of the Plot Burned
10/22/00	01 Post	Replace Tag 2A, OT Tags 29-32	
6/17/01	01 yr01	Data Collection	Identified 2GRAM3!
7/13/01	01 yr01	Retake 01 Yr01 Photos	6/17 Photos Too Dark
5/11/02	01 yr02	Data Collection	GPS Plot Location
5/4/05	01 yr05	Data Collection	2B Stake Is Missing
5/20/05	01 yr05	Replace 2B Stake	
6/23/10	01 yr10	Data Collection	
8/24/10	02 Burn	Burn Plot, Collect Fire Behavior data	Entire Plot Burned
10/5/10	02 Post	Data Collection	Q3 & OP Rebar Missing
2/2/11		Reinstall Rebar	
6/17/11	02 yr01	Data Collection	

FMH-7

**FOREST PLOT DATA SHEET**

Plot ID: FPIRIG08-04

**B/C** (Circle One)

Date: 7 / 31 / 00

Burn Unit: RCW

Recorders: Blozan, Feeley

Burn Status: Circle one and indicate number of times treated, e.g., 01-yr01, 02-yr01

**00-PRE** POST \_\_\_-yr01 \_\_\_-yr02 \_\_\_-yr05 \_\_\_-yr10 \_\_\_-yr20 Other: \_\_\_-yr\_\_\_; \_\_\_-mo\_\_\_

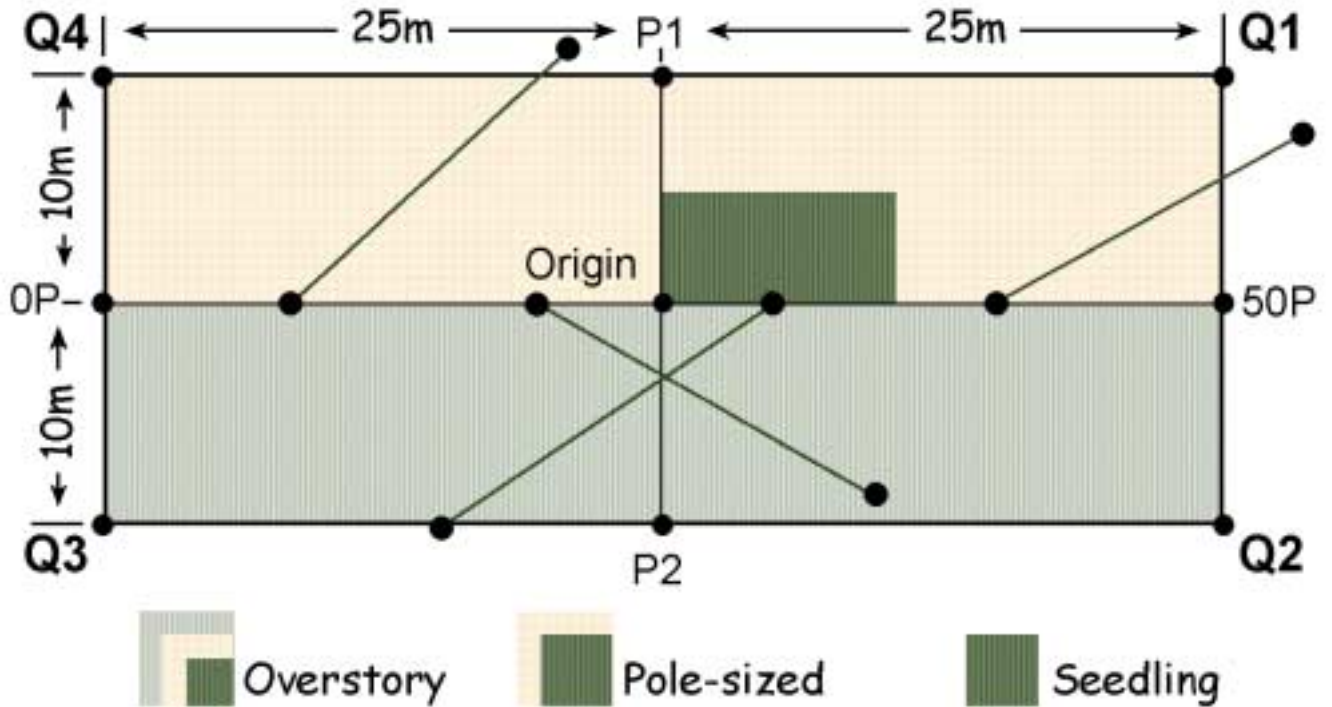

Overstory: 1,000 m<sup>2</sup> in Q 1-4 Pole: 250 m<sup>2</sup> in Q 1 Seedling: 62.5 m<sup>2</sup> in Q 1

**Sampling Areas:** Shrub: 150 m<sup>2</sup> along Q4-Q1 w Q3-Q2 w OP-50P w **Q4-30 m**

Shade in the sampling areas for each tree class and for the shrub sampling area(s) on the plot layout above.

**Photo Subject Order**

- |                 |                  |
|-----------------|------------------|
| 1. 0P ⊕ Origin  | 6. Q2 ⊕ Q3       |
| 2. Q4 ⊕ Q1      | 7. P2 ⊕ Origin   |
| 3. P1 ⊕ Origin  | 8. Q3 ⊕ Q2       |
| 4. Q1 ⊕ Q4      | 9. Origin ⊕ REF  |
| 5. 50P ⊕ Origin | 10. REF ⊕ Origin |

**Fuel Load Transects**

	Azimuth	Slope
1	<u>234°</u>	<u>3%</u>
2	<u>130°</u>	<u>12%</u>
3	<u>41°</u>	<u>5%</u>
4	<u>323°</u>	<u>7%</u>

Record photo documentation data for each visit on FMH-23, Photographic record sheet

Draw in fuel load transect lines on the plot layout above.

# Monitoring Vegetation Characteristics

## ALL PLOT TYPES

This section describes specific methods for data collection. Each variable may be sampled in various levels of intensity depending on the monitoring type characteristics. These protocols are predetermined for each monitoring type; sample each variable the same way for every plot within a monitoring type (see page 43). Before you begin data collection, refer to the Monitoring type description sheet (FMH-4) and review the exact protocols to be followed for each specific monitoring type. For quick reference, use the Forest plot data sheet (FMH-7) to record and shade in the sampling areas for overstory, pole-size and seedling trees; see previous page.

---

## Accuracy Standards



Accuracy standards for each variable are listed at the end of each subsection of this chapter.

---

## Form Headings

Fill out the form heading completely. Record the monitoring plot ID code, whether it is a burn plot (B) or a control plot (C), the date the data were collected, the burn unit name or number, the names of the data collector and recorder (in that order), and the burn status (with the first two digits referring to the treatment number, and the last four letters and numbers referring to the visit relative to the last treatment). For example, 01 yr02 refers to a year-2 data collection visit the next sampling season after the first burn or other treatment (thinning, etc.), 03 Post refers to the immediate post-burn data collection following the third burn or other treatment. Preburn data are always coded 00 PRE, but if preburn data are updated before the first burn, the code for the original preburn data in the database will change to 00 PR01. If preburn data are collected a third time before the plot burns, the second preburn data will be re-coded 00 PR02 and so on. The code 00 PRE is always used for the newest set of preburn data.

---

## Streamlining the Form Filling Process



Fill out form headings (minus the date and recorders) and other transferable information (fuel transect azimuths, tree tag numbers, etc.) before you go into the field. Forms can be assembled for each plot during slow periods in the office, during bad weather, or when there is a little extra time.

---

## Before You Visit a Previously Established Plot



Use the Plot maintenance log (FMH-25) to document any items that you notice during a plot visit that need to be attended to during the next plot visit. Once you establish a plot, maintain the plot log and update it after each visit. By reviewing this log before visiting the plot, you can gather the necessary items to “fix” the problem noted previously. This form provides a reliable method of communication with monitors of the future. Examples of plot maintenance needs: replacement of a tag that was missing on the last visit, a missing rebar, or verification of a species identification.

---

## HERBACEOUS AND SHRUB LAYERS

### RS Procedures

Use form FMH-16 for 30 m transects or FMH-15 for 50 m transects (both are found in Appendix A). Use a point intercept method to record the number of transect hits and to obtain relative and percent cover by species over time. On forest and brush plots, also measure shrub density within a brush belt for the same distance, along the same transect. The collection of voucher specimens is strongly recommended; this is discussed on page 87.

---

## Be Kind to the Fragile Herbage, Fine Fuels and Soils Beneath Your Feet



In order to minimize the effect of trampling on the data, stay outside the plot as much as possible, and sample forest types in the following sequence:

- Lay out tapes
- Photograph plot
- Collect herbaceous and shrub data, and fuels data (decide which layer is the most fragile, and collect those data first)
- Collect seedling tree data
- Collect overstory and pole-size tree data

Avoid heavy boots in favor of light shoes; set down sampling equipment, backpacks etc., to the side or below the plot, not in or above it; and minimize the number of people working in the plot. Additionally, use extreme caution on steep slopes.

---

## Herbaceous and Shrub Layer Accuracy Standards



Accuracy standards for each variable discussed in this section are listed at the end of this section (Table 16, page 90).

### ***Locate the 0 point on the point intercept transect***

The data collection starting point is at the 0P (origin stake) on grassland and brush plots, and the Q4 (and possibly Q3 and 0P) on forest plots. The length and number of transects is determined during the monitoring design process (Chapter 4). Check your protocols on the Monitoring type description sheet (FMH-4) before proceeding.

### ***Collect number of transect hits—grassland, brush and forest types***

Start 30 cm from the 0P or Q4. Drop a ¼ in diameter pole (a rigid plumb bob), graduated in decimeters, gently so that the sampling rod is plumb to the ground (on slopes this will not be perpendicular to the ground), every 30 cm along the transect line. Where the transect length is 30 m, there will be 100 points from 30 to 3,000 cm. On forest plots where the transect is read along the full 50 m, there will be 166 points from 30 to 5,000 cm. In either case, the first intercept hit is at 30 cm, not at 0.

At each “point intercept” (Pnt), gently drop the pole to the ground, and record each species (Spp) that touches the pole on the appropriate data sheet (FMH-16 for grassland and brush plots, FMH-15 for most forest plots, and FMH-16 for forest monitoring types that use only the Q4–30 m line). Count each species only once at each point intercept even if the pole touches it more than once. Record the species from tallest to the shortest. If the pole fails to intercept any vegetation, record the substrate (bare soil, rock, forest litter, etc. (see Table 15, page 86)). **Note:** You can occasionally find vegetation under a substrate type; in this case you would ignore the substrate and record the vegetation. If the rod encounters multiple types of substrate, record only that which the pole hits first.

Do not count foliage or branches intercepted for trees over 2 m tall, but count all other vegetation, including shrubs, no matter its height. (This is because trees are better sampled using other procedures, and the target variables using the point intercept transect are shrubs and herbs.) If the sampling rod intersects the bole of a tree that is over 2 m tall, record “2BOLE,” or “2SDED” if the tree is dead. **Note:** Record species not intercepted but seen in the vicinity (in a belt on either side of the brush and herbaceous layer transect) on the bottom of the data sheet (FMH-15 or -16). The width of this belt is specified on your Monitoring type description sheet (FMH-4).

**Note:** If you have selected to use the point intercept method to calculate basal cover (see page 46), record only the bottom hit for each point, regardless of whether it is substrate or vegetation.

---

## Sampling Rods



A useful sampling rod can be made in any of several ways. Choose one that best suits your needs (see Table 12, page 82). One-dm markings can be made with an engraver, then filled in with a permanent marker; road paint and road sign adhesives can also be useful. Note that surface marking with most pens or paints wears off quickly, and many adhesives get gooey in the heat.

Table 12. Types of sampling rods.

Pole Type	Pros	Cons
<b>Fiberglass Rod:</b> This is the preferred choice.	Moderately available (your maintenance shop may already have some, or you can buy a bicycle whip (remove the flag)), moderate in price, lightweight, easy to carry, can be screwed together to adjust size and all pieces need not be carried if not needed, very durable.	None to note.
<b>Tent Pole:</b> Fiberglass with shock cord. This is the second choice.	Readily available (sporting good store), moderately priced, lightweight, foldable, durable.	Possibly hard to find 0.25" diameter, shock cord can break.
<b>Steel Rod:</b>	Readily available (hardware stores), moderately priced, extremely durable.	Bend, heavy, difficult to carry in the field.
<b>Wooden Dowel:</b>	Readily available (hardware stores), cheap, lightweight.	Fragile, inconvenient to carry.

### Tall Vegetation Sampling Problems



If your protocols (FMH-4) require you to record height and the vegetation is **unexpectedly** taller than the sampling rod, try dropping the rod at the sampling point, then placing your hand at the 1 or 1.5 m point on the rod and sliding the rod up (without looking up), elevating it by 1 or 1.5 m and recording where it touches the vegetation above you. If the vegetation is consistently taller, find a taller sampling rod.

### Dead Herbaceous and Shrub Species Sampling Problems



You may encounter dead standing vegetation along your transects. Always record dead **annual** vegetation in the same way you record live individuals. Record dead **biennial** and **perennial** vegetation (except dead branches of living plants) by placing a "D" at the end of the species code. This permits dead vegetation to be treated separately from live vegetation. Dead perennials may not be included in species abundance indices, but their presence may provide information for estimating fire behavior and determining mortality. In general (see the warning box below for exceptions) count **dead branches of living plants** as a live intercept. In the case of shrub and herbaceous species, this also applies if the main plant is dead but sprouting, and the dead part is encountered.

### Counting Dead Branches of Living Plants as Dead (Optional)



In some cases, such as where animal habitat or aerial fuels are a concern, you may want to know the cover of dead branches, regardless of whether they are attached to living bases. If your monitoring type requires it, you may count dead branches of living plants as dead. However consistency is essential—if transects were not initially read this way for a monitoring type, a change "midstream" will cause an apparent dip in the cover of live shrubs that is not necessarily true.

### Sprouting Dead Trees



**Trees under 2 m tall:** If the bole (>2 m tall) is dead but sprouting at the base, consider any live sprout (<2 m tall) you encounter as live.

**Trees over 2 m tall:** If you encounter a live basal sprout over 2 m tall, the sprout should be considered a tree (2BOLE) in its own right.

## Optional Monitoring Procedures

### *Shrub and herbaceous layer height*

At every sampling point, measure the height of the tallest living or dead individual of each species (to the nearest decimeter, in meters) at the highest place on the sampling rod touched by vegetation. Record this height (Hgt) on FMH-15 or -16. A ¼ in wide sampling rod graduated in decimeters should make this measurement relatively easy. Do not record data for aerial substrate such as the leaves or stems attached to a dead and downed tree.

### Record Species Codes

Species codes are assigned in a systematic way following Natural Resource Conservation Service methodology, as used in the USDA PLANTS Database (USDA NRCS 2001). For existing programs, see the warning box below. This naming convention uses a 4–7 character alpha code beginning with the first two letters of the genus name and the first two letters of the species name. The following 0–3 characters are assigned as needed to avoid confusion of plants with duplicate codes. If there is no subspecies or variety, the next character(s) may not be needed or will simply be a one or two digit number representing the alphabetical ranking of that plant on the national list.

#### Examples:

<b>DACA</b>	<i>Dalea californica</i>
<b>DACA3</b>	<i>Danthonia californica</i>
<b>DACA13</b>	<i>Dasistoma calycosa</i>

If the plant is a subspecies or variety, then the character in the fifth position will be the first letter of that infraspecific name, and if there are duplicates, a number will follow.

#### Examples:

<b>ACRUT</b>	<i>Acer rubrum</i> var. <i>trilobum</i>
<b>ACRUT3</b>	<i>Acer rubrum</i> var. <i>tridens</i>
<b>DACAP</b>	<i>Dalea carthagenensis</i> var. <i>portoricana</i>
<b>DACAP3</b>	<i>Danthonia californica</i> var. <i>palousensis</i>

## Assigning Species Codes



If you have an existing monitoring program it is not necessary to look up every species in your Species code list (FMH-6). The FMH.EXE software will convert your species codes for you.

If you are starting a new program, simply enter the genus, species, and infraspecific name (if appropriate) into the FMH.EXE software, and the software will look up the species code for you.

When you add a new species to the database, you must note certain other information as well. This includes the species code, its lifeform (see the warning box below) the full name, whether the species is native or non-native, and whether it is annual, biennial, or perennial. This information is recorded on the Species code list (FMH-6).

### Life Form



Life form categories and their codes are as follows; see Glossary for full definitions.

A - Fern or fern ally	S - Shrub
F - Forb	T - Tree
G - Grass	U - Subshrub
N - Non-vascular	V - Vine
R - Grass-like	* - Substrate
Blank - Unknown, non-plant	

**Note:** If blank is selected, you may also leave the following codes blank—whether the species is native or non-native, and whether it is annual, biennial, or perennial.

The FMH-6 serves as a running list of species codes. Keep only one list for the entire monitoring program in a given park, to avoid assigning incorrect codes. You should carry this sheet whenever you are collecting data, and you should refer to it every time you assign a species code. If you are unsure of the official code for a new plant (see page 83 for coding guidelines), assign a temporary code, then correct it on your data sheets and species list once you look up the official code. Once you enter the initial data into the FMH software (Sydoriak 2001), you may print out the Species code list from the database. Using this form will keep the

same code from being used for two different species, and will greatly facilitate data processing.

### ***Dealing with unknown plants***

Use an identification guide to make every attempt to identify every plant to the species (and subspecies or variety) level. If you cannot identify a plant because you need to have specific parts (e.g., flowers, fruits, etc.) not available during your sampling time (see page 199 for guidance on identifying dead and dormant plants), or you need to use a dissecting scope, take steps to allow future identification. Collect the plant (**from off the plot**), label it, describe it in detail, and then press it (see page 193 for guidelines on voucher collections). Assign an unknown code that is unique from all other unknown codes in the park and note a detailed description of the plant.

**ALWAYS** collect (or draw) and describe unknowns in the field, so that future field technicians will record the same unknown with the same code.

Management of unknown species can easily get out of hand, especially if there is a turnover of monitors from year to year, the flora is particularly diverse and complex, monitors are overworked or monitors lack the requisite plant identification skills. The remedies for these conditions are obvious: try to retain monitors from year to year, stress good documentation and quality, hire monitors who are trained in plant identification, and be realistic about their workload. But even under the best of circumstances, you will encounter the occasional unknown species.

Here are some tips that may help you keep your unknowns straight and get them identified.

- Keep meticulous notes including a detailed, botanical description of all the plant parts, location and micro-habitat, as well as any guesses as to genus or species.

#### **Example:**

Plants are herbaceous, 15–25 cm tall (but have been browsed) with several stems originating from the base. Leaves are 2–3 cm long, 0.5–1 cm wide, alternate, oblanceolate with finely dentate margins, glabrous above and tomentose below. Leaf tips are acuminate. No fruits or flowers are present. Plant is occasional in light openings in the ponderosa pine understory.

- Collect the plants (off the plot) and sketch if necessary.
- Make vouchers for the herbarium, but be sure to also make a set of field reference vouchers for unknowns.
- Refer to the vouchers or field reference often throughout the season to see if last year's unknown is this year's well-known friend.
- Keep a list of unknowns with notes as to why they were not able to be identified. Review the list in the early season and make a special trip to try to get the plants that were encountered after they had flowered and fruited.
- Scout around in similar areas for other individuals that may be more easily identifiable.
- Ask an expert, in park or out. Botanically-minded folk from a nearby university or the local native plant club are usually more than happy to help. Also consider taking digital photos and distributing them over the Internet to groups who have botanical expertise.

Assign each unknown plant a unique code; make every effort to match up duplicates of the same unknown. The PLANTS database has a series of default codes for unknowns (Table 13), and genera (see database (USDA NRCS 2001)). If you have more than one unknown (whether vascular or non-vascular) that matches the code of the category or where you can only key it to genus, then add a number to the codes as shown below. **Note:** Some genera have numbers at the end of their codes; always check the PLANTS database to be sure that the code you intend to use is not used by another genus or species. In the example below, the code for *Dryopteris* is DRYOP, however the code DRYOP2 is used for *Dryopetalon*, so monitors had to use numbers starting with 3 to avoid conflicts.

**Examples:**

- 2GLP1** for unknown perennial grass number 1 (a densely tufted grass, with basal and cauline flat spreading leaves, hairy ligules)
- 2GLP2** for unknown perennial grass number 2 (a loose rhizomatous grass, with rolled basal and cauline leaves, no ligules)
- DRYOP3** for unknown *Dryopteris* number 1 (petioles less than one quarter the length of the leaf, blade elliptic, 2-pinnate, marginal teeth curved, growing on limestone)
- DRYOP4** for unknown *Dryopteris* number 2 (petioles one-third the length of the leaf, scales with a dark brown stripe; blade deltate-ovate, 3-pinnate, pinnule margins serrate)

**Table 13. Species codes for unknown vascular plants.**

<b>2FA</b>	Forb, annual
<b>2FB</b>	Forb, biennial
<b>2FD</b>	Forb, dicot
<b>2FDA</b>	Forb, dicot, annual
<b>2FDB</b>	Forb, dicot, biennial
<b>2FDP</b>	Forb, dicot, perennial
<b>2FERN</b>	Fern or Fern Ally
<b>2FM</b>	Forb, monocot
<b>2FMA</b>	Forb, monocot, annual
<b>2FMB</b>	Forb, monocot, biennial
<b>2FMP</b>	Forb, monocot, perennial
<b>2FORB</b>	Forb (herbaceous, not grass nor grasslike)
<b>2FP</b>	Forb, perennial
<b>2FS</b>	Forb, succulent
<b>2FSA</b>	Forb, succulent, annual
<b>2FSB</b>	Forb, succulent, biennial
<b>2FSP</b>	Forb, succulent, perennial
<b>2GA</b>	Grass, annual
<b>2GB</b>	Grass, biennial
<b>2GL</b>	Grasslike (not a true grass)
<b>2GLA</b>	Grasslike, annual

**Table 13. Species codes for unknown vascular plants. (Ctd.)**

<b>2GLB</b>	Grasslike, biennial
<b>2GLP</b>	Grasslike, perennial
<b>2GP</b>	Grass, perennial
<b>2GRAM</b>	Graminoid (grass or grasslike)
<b>2GW</b>	Grass, woody (bamboo, etc.)
<b>2PLANT</b>	Plant
<b>2SB</b>	Shrub, broadleaf
<b>2SD</b>	Shrub, deciduous
<b>2SDB</b>	Shrub, deciduous, broadleaf
<b>2SDBD</b>	Shrub, deciduous, broadleaf, dicot
<b>2SDBM</b>	Shrub, deciduous, broadleaf, monocot
<b>2SDN</b>	Shrub, deciduous, needleleaf
<b>2SE</b>	Shrub, evergreen
<b>2SEB</b>	Shrub, evergreen, broadleaf
<b>2SEBD</b>	Shrub, evergreen, broadleaf, dicot
<b>2SEBM</b>	Shrub, evergreen, broadleaf, monocot
<b>2SEN</b>	Shrub, evergreen, needleleaf
<b>2SHRUB</b>	Shrub (>.5m)
<b>2SN</b>	Shrub, needleleaf (coniferous)
<b>2SSB</b>	Subshrub, broadleaf
<b>2SSD</b>	Subshrub, deciduous
<b>2SSDB</b>	Subshrub, deciduous, broadleaf
<b>2SSDBD</b>	Subshrub, deciduous, broadleaf, dicot
<b>2SSDBM</b>	Subshrub, deciduous, broadleaf, monocot
<b>2SSDN</b>	Subshrub, deciduous, needleleaf
<b>2SSE</b>	Subshrub, evergreen
<b>2SSEB</b>	Subshrub, evergreen, broadleaf
<b>2SSEBD</b>	Subshrub, evergreen, broadleaf, dicot
<b>2SSEBM</b>	Subshrub, evergreen, broadleaf, monocot
<b>2SSEN</b>	Subshrub, evergreen, needleleaf
<b>2SSN</b>	Subshrub, needleleaf (coniferous)
<b>2SUBS</b>	Subshrub (<.5m)
<b>2TB</b>	Tree, broadleaf
<b>2TD</b>	Tree, deciduous
<b>2TDB</b>	Tree, deciduous, broadleaf
<b>2TDBD</b>	Tree, deciduous, broadleaf, dicot
<b>2TDBM</b>	Tree, deciduous, broadleaf, monocot



**Table 13. Species codes for unknown vascular plants. (Ctd.)**

<b>2TDN</b>	Tree, deciduous, needleleaf
<b>2TE</b>	Tree, evergreen
<b>2TEB</b>	Tree, evergreen, broadleaf
<b>2TEBD</b>	Tree, evergreen, broadleaf, dicot
<b>2TEBM</b>	Tree, evergreen, broadleaf, monocot
<b>2TEN</b>	Tree, evergreen, needleleaf
<b>2TN</b>	Tree, needleleaf (coniferous)
<b>2TREE</b>	Tree
<b>2VH</b>	Vine, herbaceous
<b>2VHA</b>	Vine, herbaceous, annual
<b>2VHD</b>	Vine, herbaceous, dicot
<b>2VHDA</b>	Vine, herbaceous, dicot, annual
<b>2VHDP</b>	Vine, herbaceous, dicot, perennial
<b>2VHM</b>	Vine, herbaceous, monocot
<b>2VHMA</b>	Vine, herbaceous, monocot, annual
<b>2VHMP</b>	Vine, herbaceous, monocot, perennial
<b>2VHP</b>	Vine, herbaceous, perennial
<b>2VHS</b>	Vine, herbaceous, succulent
<b>2VHSA</b>	Vine, herbaceous, succulent, annual
<b>2VHSP</b>	Vine, herbaceous, succulent, perennial
<b>2VW</b>	Vine, woody
<b>2VWD</b>	Vine, woody, deciduous
<b>2VWDD</b>	Vine, woody, deciduous, dicot
<b>2VWDM</b>	Vine, woody, deciduous, monocot
<b>2VWE</b>	Vine, woody, evergreen
<b>2VWED</b>	Vine, woody, evergreen, dicot
<b>2VWEM</b>	Vine, woody, evergreen, monocot

Make frequent checks of new unknowns against existing unknowns throughout the field season to avoid assigning the same code to two different species, or two different codes to the same species. Become familiar with your unknowns so that you can be on the lookout for the plant in a stage that is more easily identifiable. If the unknown is identified at a later date, the code (ex.: 2VWE1, etc.) must be corrected globally throughout your data sheets and in the FMH database. The FMH software will automatically change a species code in all databases when you change it on the FMH-6 data form.

***Non-vascular plants***

For the plants that you may have difficulty identifying, e.g., non-vascular plants like bryophytes, fungi, and algae, you can use broad codes as shown below.

**Table 14. Species codes for non-vascular plants.**

<b>2AB</b>	Alga, Brown
<b>2AG</b>	Alga, Green
<b>2ALGA</b>	Alga
<b>2AR</b>	Alga, Red
<b>2BRY</b>	Bryophyte (moss, liverwort, hornwort)
<b>2CYAN</b>	Cyanobacteria, cryptobiotic/cryptogamic/microbiotic/microphytic soil or crust
<b>2FF</b>	Fungus, fleshy (mushroom)
<b>2FJ</b>	Fungus, Jelly
<b>2FR</b>	Fungus, Rust
<b>2FSMUT</b>	Fungus, Smut
<b>2FUNGI</b>	Fungus
<b>2HORN</b>	Hornwort
<b>2LC</b>	Lichen, crustose
<b>2LF</b>	Lichen, foliose
<b>2LICHN</b>	Lichen
<b>2LU</b>	Lichen, fruticose
<b>2LW</b>	Liverwort
<b>2MOSS</b>	Moss
<b>2PERI</b>	Periphyton
<b>2SLIME</b>	Slime Mold

***Dead or inorganic material***

Dead or inorganic material should be coded in the following way (Table 15):

**Table 15. Codes for dead or inorganic material.**

<b>2BARE</b>	Bare ground, gravel, soil, ash; soil particles <1 in diameter.
<b>2DF</b>	Forest duff. Duff is the fermentation and humus layer. It usually lies below the litter and above mineral soil.
<b>2LTR</b>	Vegetation litter. Forest litter includes freshly fallen dead plant parts other than wood, including cones, bracts, seeds, bark, needles, and detached leaves that are less than 50% buried in the duff layer.
<b>2LTRH</b>	Litter, herbaceous
<b>2LTRL</b>	Litter, lichen

Table 15. Codes for dead or inorganic material. (Ctd.)

2LTRWL	Litter, woody, >2.5 cm
2LTRWS	Litter, woody, <2.5 cm
2RB	Rock, bedrock or mineral particles >1 in diameter.
2RF	Rock, fragments <1 in diameter.
2SC	Native, exotic, and feral animal scat.
2SDED	Standing dead tree.
2ST	Tree stump, no litter at intercept point.
2W	Water; permanent body of water or running water present six months of the year or more.

### Make Voucher Collection

General protocols for collecting voucher specimens are included here; a detailed discussion on collecting, processing, labeling and preserving plant specimens is located in Appendix C. Collect vouchers when there is any doubt as to the identification of a plant species recorded in the data set, unless the species is threatened or endangered, or the plant cannot be found outside of the plot.

Identify specimens within two days. Prompt identification is essential for data accuracy, and saves time and money. For the initial phase of this monitoring program, collection of voucher specimens of all plants present is strongly recommended.

Collection of vouchers using the following guidelines (which are the same for all plot types) should enable consistent and correct identifications:

- Collect the voucher specimen off or outside of the monitoring plot. Collect enough of the plant to enable identification. Do not collect plants that are—or are suspected to be—rare, threatened, or endangered; sketch these plants and take pictures as vouchers.
- Press the plant materials immediately, but retain some unpressed flowers for easier identification.
- Record collection information on a form (see page 195) that you press with the voucher specimen.
- Keep all specimens in proper herbarium storage. See Appendix C for more information on proper herbarium storage.
- A field notebook of pressed specimens (including unknowns) is a very useful way to verify species identifications in the field.

## Documenting Rare Plants



**Do not collect a plant that is or may be rare, threatened, or endangered!** Sketch or photograph these plants and substitute pictures for vouchers. In all cases your collection should follow the one in twenty rule: remove no more than one plant per twenty plants; remove no plants if there are less than twenty.

## Voucher Label



The handbook now contains a voucher collection data sheet. You will find this data sheet on the back of the Species code list (FMH-6).

## BRUSH AND FOREST PLOTS

### Collect and Record Shrub Density Data

Record shrub density along a brush belt adjacent to the point intercept transect. The width of this belt is specified on your Monitoring type description sheet (FMH-4). Count each individual having >50% of its rooted base within the belt transect. For brush plots, the belt will be on the uphill side of the transect. When it is not clear which side of the transect is the uphill side, use the right side of the transect when viewed from OP looking down the transect towards 30P. For forest plots, the belt will be inside the plot (Figure 22).

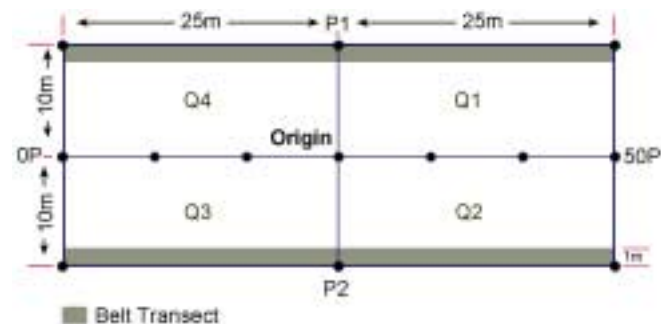

Figure 22. Belt transect for forest plots (see Figure 18, page 66, for stake codes).

Use the Shrub density data sheet (FMH-17) to record the data. You may divide the belt transect into 5 m intervals to facilitate counts. Number each 5 m interval from 1 to 6 (30 m), or 1 to 10 (50 m); interval 1 is from 0 to 5 m and so on. Record the interval (Int). Record data by species (Spp), age class (Age), whether it is living (Live), and number of individuals (Num) of that species. Tally any change in species, age, or live-dead as a separate entry on the data sheet, e.g., ARTR1, M, L,

would be tallied separately from ARTR1, M, D. Under age class, identify each plant as either a immature-seedling (I), a resprout (R), or as a mature-adult (M) (see Glossary for definitions).

---

## Subshrubs in Shrub Density



Generally, shrub density data should not include data on subshrubs (see Glossary), unless there are specific objectives tied to density of those species. If you have objectives tied to subshrubs, use the herbaceous density sampling methods discussed below.

---

## Troubleshooting Shrub Data Collection

### *Dead burls*

After dead burls have been counted at least once since dying, you can omit them from density sampling, but it may be useful to note them on the form in case they sprout again in another year.

### *Clonal or rhizomatous species*

Shrub individuals may be very difficult to define in some species, and monitors may get very different numbers depending on their perception of what an individual is. Relative or percent cover may be a more accurate way to describe these species. However, it may be appropriate to count something other than the individual in this case, e.g., a surrogate plant part such as culm groups, inflorescences, or stems.

## Examples:

*Arctostaphylos* spp. stems are often easy to trace to a basal burl. This usually defines the individual. The “burl unit” may be an appropriate delineator of individuals, even when two or more individuals have grown together.

*Vaccinium* spp. are often rhizomatous, making it difficult to distinguish an “individual.” The recommended response for dealing with rhizomatous or clonal species is to ignore these species when you collect shrub density data. **Note:** If these species are ecologically significant (e.g., for wildlife habitat), count stem density instead of individual density. The “stem unit,” in this case, becomes the basis for quantifying density.

The usefulness of these surrogates depends on the biological significance of changes within these surrogates. Consult with resource and fire managers before you use a surrogate, or omit a species from shrub density sampling. Note any species for which you plan to use surrogates, or omit from monitoring, in the “Notes” section of the FMH-4.

---

### *Resprouts*

Once a disturbance has caused a plant to die back and resprout, the plant should be considered a resprout for the first year, and then an immature until it is once again reproductive (mature).

### *Anticipated dramatic increases in postburn shrub density*

It may be advantageous to establish a protocol to count seedlings in density plots only after their second or third year of survivorship. However, you should at least estimate seedling presence in all cases, with estimates such as 10/m<sup>2</sup> or 50/m<sup>2</sup>.

You may wish to subsample the density plot during temporary high density periods. To subsample, grid the plot and randomly select an appropriate subsample (i.e., 10%, 20%) of the area. Then proceed to count the individuals in the subsample area and extrapolate to the sample area listed on your FMH-4. Again, this should be done only in consultation with resource and fire managers.

## Optional Monitoring Procedures

### *Herbaceous layer species density*

**Grassland and brush plots**—To measure the density of forbs and/or grasses, place a frame (the size and shape of which is determined during pilot sampling; see page 47) on the uphill side of the shrub and herbaceous layer transect every 10 m (unless you are using a belt transect because the vegetation is sparse). When it is not clear which side of the transect is the uphill side, use the right side of the transect when viewed from 0P looking down the transect towards 30P. It is important to record on the Herbaceous density data sheet (FMH-18) which side of the transect you sampled so future monitors will repeat your actions. The highest corner of the first frame would be at the 10 m mark, therefore, sampling frame 1 would fall between 6 and 10 m on the tape if you use a  $0.25 \times 4$  m ( $1 \text{ m}^2$ ) frame; the next sampling areas would be between 16 and 20 m (frame 2), and 26 and 30 m (frame 3) (see Figure 23). The total area sampled using this example would be  $3 \text{ m}^2$ . Record these density data on the Herbaceous density data sheet (FMH-18).

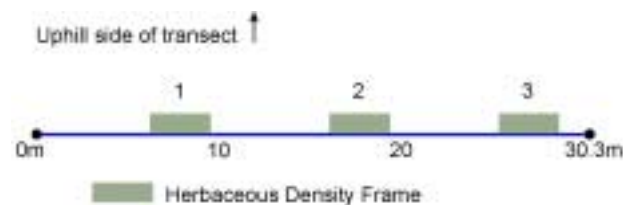

Figure 23. Density sampling frames ( $1 \text{ m}^2$ ) for herbaceous species in a grassland or brush plot.

**Forest plots**—For forest plots the procedure is the same as for grassland and brush plots; the only difference is frame placement. Place the frame on the plot side (interior) of the shrub and herbaceous layer transect (Q4–30 m or Q4–Q1 and/or Q3–Q2) every 10 m (unless you are using a belt transect because the vegetation is sparse). The highest corner of the first frame would be at the 10 m mark; therefore, the first sampling frame would fall between 6 and 10 m on the tape if you use a  $0.25 \times 4$  m ( $1 \text{ m}^2$ ) frame; the next sampling areas would be from 16 to 20 m (frame 2), 26 to 30 m (frame 3) (stop here for Q4–30 m plots), 36 to 40 m (frame 4), and 46 to 50 m (frame 5). Repeat this process on the Q3–Q2 line in frame numbers 6–10, if you are reading the Q3–Q2 line with the point intercept transect (see Figure 24). The total area sampled using the above example would be  $10 \text{ m}^2$  ( $5 \text{ m}^2$  sampled on each transect). Record these density data on the Herbaceous density data sheet (FMH-18).

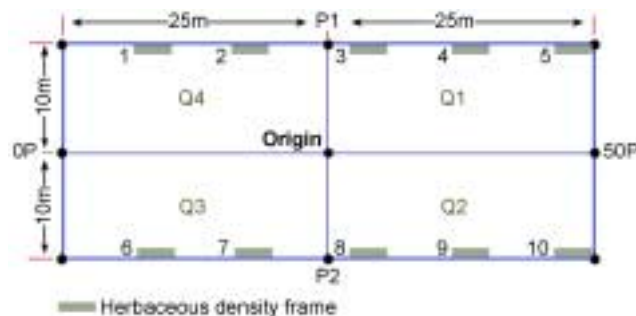

Figure 24. Density sampling frames ( $1 \text{ m}^2$ ) for herbaceous species in a forest plot.

### *Brush fuel load*

Total biomass (fuel) and percent dead (live to dead ratio) may be determined in brush types with sufficient accuracy to make fire behavior predictions. When required for smoke management, total brush biomass must also be measured. Use standard biomass estimating techniques or existing species-specific estimating equations to determine fuel load.

### *Brush biomass*

Use standard biomass estimating techniques or existing biomass estimating equations to estimate the biomass of each shrub in the plot. There are several other methods to estimate biomass, height-weight curves, capacitance meters, and double sampling; see Elzinga and Evenden 1997 under the keyword biomass for an excellent list of references, or review the references on page 237 (Appendix G).

### *Percent dead brush*

There are three techniques to estimate percent dead brush: visual estimates; estimates based upon existing publications such as a photo series; or direct measurement of live-dead ratio using the following procedure:

- Randomly select a sample shrub of each species of concern within a 1 acre area, outside of your monitoring plot.
- Remove all branches 0.25 in or less in diameter, and place in separate airtight bags according to whether they are alive or dead. Take a subsample of the shrub if the shrub is very large.
- Determine the net weight of the live portion and the dead portion.
- Dry at  $100^\circ\text{C}$ .
- Determine oven dry weight of live portion and dead portion. Use a subsample if necessary. If you use a subsample, take care to weigh the sample and subsample at the same time before drying.
- After determining the dry weights separately, calculate the biomass in kilograms/hectare or tons/

acre for live and dead portions (see page 216, Appendix D).

### **Grass biomass**

When smoke management is a specific concern, or hazard fuel reduction is the primary burn objective, you need to estimate biomass. For information on other methods see the note under “Brush Biomass” above. Use this procedure to qualitatively determine grass biomass:

Randomly toss a rigid quadrat of known area into the plot. Do this six times. Each time:

- Clip all the vegetation to within 1 cm of the ground.
- Place the clipped vegetation into paper bags. Each quadrat should have one bag.
- Label each container with the plot identification code, the bag number, and the collection date.
- Determine the sample dry weight by drying the material in their bags until the weight stabilizes. The oven temperature should be 100°C. Check your samples 24 hours after they have been in the oven.
- Calculate the kilograms/hectare or tons/acre for each sample (see page 216, Appendix D).

**Table 16. Accuracy standards for herbaceous (RS) variables.**

<b>Herbaceous Layer</b>		
Herbaceous Density	# of Individuals	± 5%
Shrub Density	# of Individuals	± 5%
Herb Height		± 0.5 decimeters

# Monitoring Overstory Trees

Overstory trees are defined in this handbook as living and dead trees with a diameter at breast height (DBH) of >15 cm. Diameter at breast height is measured at breast height (BH) 1.37 m (4.5 ft) from ground level. You may modify this definition for your purposes; see page 44 for details.

## Overstory Tree Accuracy Standards



Accuracy standards for each variable discussed in this section are listed at the end of this section (Table 21, page 99).

## TAG AND MEASURE ALL OVERSTORY TREES

### RS Procedures

Measure DBH for and tag all overstory trees within the sampling area chosen during the monitoring design process (see page 44). Check your protocols (FMH-4) before proceeding. Living and dead trees are tagged with sequentially numbered brass tags nailed into the trees at BH (for each plot, use tag numbers different from those used for the pole-size trees, e.g., 1-100 for poles and 500-600 for overstory). Orient the tags so that each faces the plot center (see Figure 25), except in areas (e.g., near trails) where you will need to orient the tags to make them less visually obtrusive.

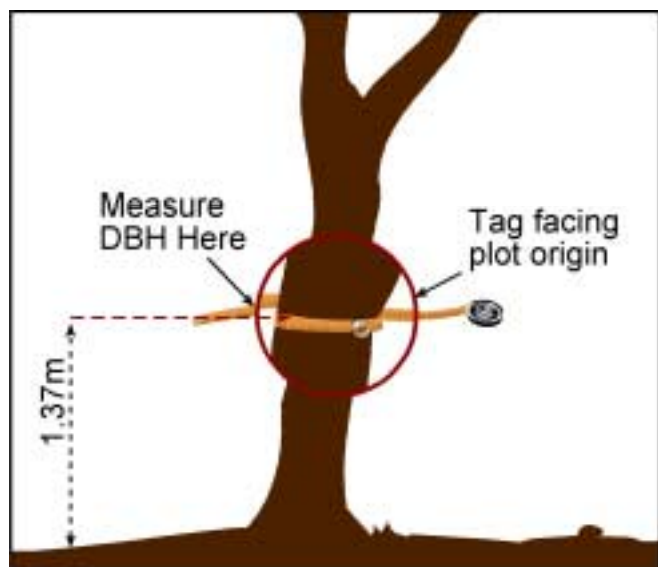

Figure 25. DBH measurement and tag placement.

For a tree on a slope, determine the DBH while standing at the midslope side of the tree. Measure the DBH of a leaning tree by leaning with the tree and measuring perpendicular to the bole.

First, drive an aluminum nail into the tree at BH, so that the tag hangs down and away from the tree and several centimeters of nail remains exposed, leaving ample space for tree growth.

Second, measure DBH (in centimeters) to the nearest mm, just above the nail. Include trees on the plot boundary line if >50% of their bases are within the plot. Start in Quarter 1 and tag through Quarters 2, 3, and 4 consecutively.

For non-sprouting tree species forked below BH, individually tag and measure each overstory-size bole (Figure 26). For sprouting tree species, tag and measure only the largest bole (in diameter) of the cluster. For clonal tree species, e.g., aspen, treat each bole as an individual tree. Tally seedling-size sprouts as resprout class seedlings until they grow into the pole tree size class. **Note:** If the main bole of a sprouting species has died, but the tree is sprouting from the base, consider the main bole dead.

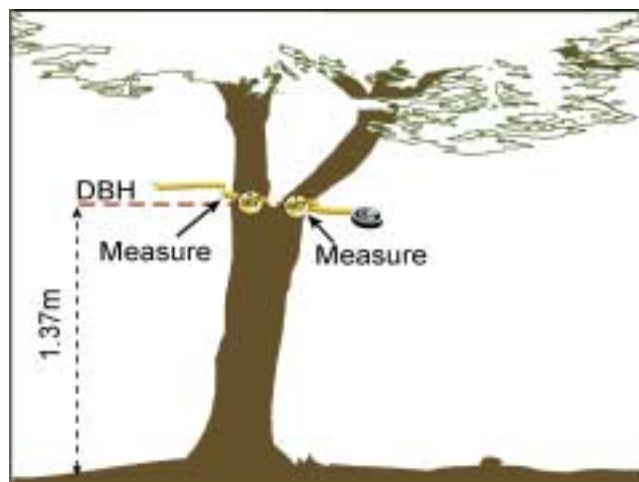

Figure 26. DBH measurement for non-sprouting trees forked below BH.

If the bole of a fallen tree is below BH, and the individual is resprouting, treat the sprouting branches as individuals and place them in the appropriate size class (seedling, pole, or overstory). Include clarifying comments on the data sheet, especially for resprouting trees.

## Sampling Problems with DBH



**Note:** The following tips are additions to this hand-book; incorporate them with caution.

**Swelling at BH** If a swell or other irregularity occurs at the standard 1.37 m height for DBH, place the tag above or below the swell and DBH measured at the tag. Make every attempt to keep the tag (and thus the DBH measurement) between 1 and 2 m above the ground, trying above the obstruction first. If you do not measure DBH at BH, note this on the data sheet (Comments) (See Figure 27).

## Void at BH



If you find a void caused by a fire scar or other abnormality, and a large part of the bole is missing at BH, and it would be impractical to simply measure above or below it, it may be necessary to estimate what the DBH would be, were the bole intact. If this is done, be sure to note in the comments field that the DBH was estimated (See Figure 28).

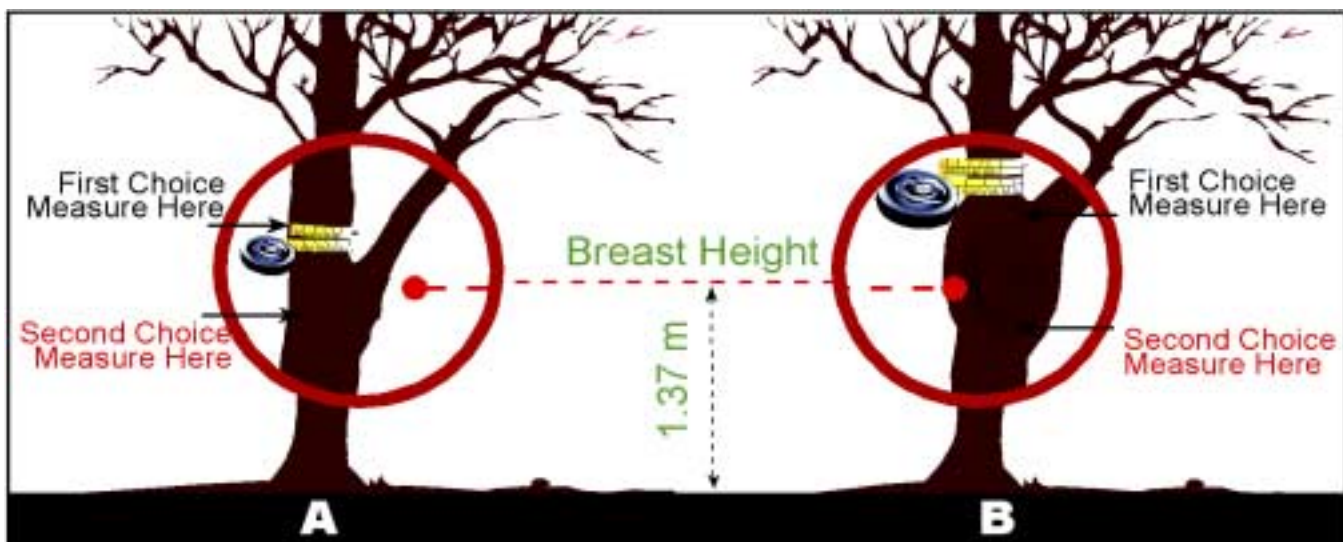

Figure 27. Handling irregularities at BH.

A) a tree with a branch at BH, B) a tree with a swell at BH.

## Measure DBH

Wrap a diameter tape (not a standard tape) around the tree in the plane of the nail, making sure the tape does not sag, and read the diameter. Take care to read at the measurement line, not at the end of the tape. Record the heading information on Overstory tagged tree data sheet (FMH-8 in Appendix A). For all overstory trees, record the plot quarter in which the tree occurs (Qtr), the tree tag number (Tag), species (Spp), and diameter (DBH), and circle whether the tree is alive. Record miscellaneous overstory tree information in Comments. Map each overstory tree by tag number on the appropriate tree map (FMH-11, -12, -13, or -14).

## Measuring DBH without a Diameter Tape



If you do not have (or have forgotten) a diameter tape, you can use a standard tape to measure circumference, and then calculate diameter as follows:

$$DBH = \frac{\text{circumference}}{\pi}$$

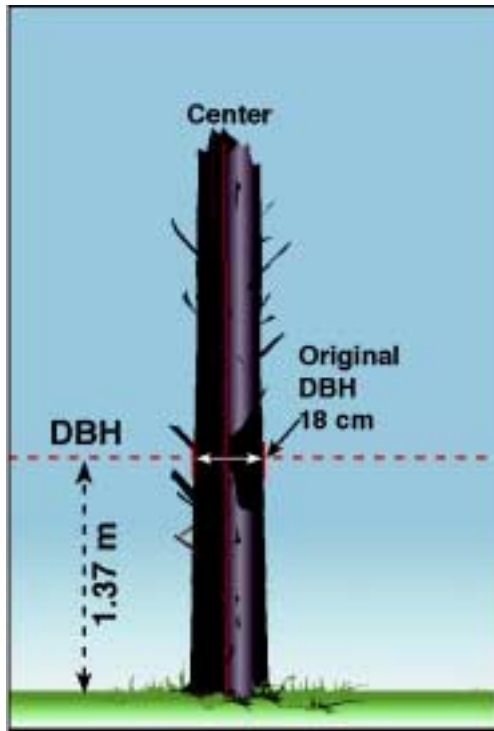

Figure 28. Reconstruct DBH when it would provide a better estimate of the regular bole of the tree.

for dead and down or completely consumed (CPC 10), (B) for broken below DBH (CPC 11), and (S) for cut stump (CPC 12). Note that these three codes are used only once during data collection.

## Toxic Plants at DBH



If toxic plants embrace the bole at BH, carefully place the tag at an appropriate location. It may also be acceptable to estimate DBH in some cases, after consultation with resource and fire specialists.

## OPTIONAL MONITORING PROCEDURES

### Crown Position and Tree Damage

If possible, also monitor the optional variables crown position (CPC) and tree damage (Damage). Space is provided on the FMH-8 data sheet for these data.

#### *Crown position*

Crown position, an assessment of the canopy position of live overstory trees (Avery and Burkhart 1963), is recorded in the column marked CPC (crown position code) using a numeric code (1–5) (see Table 17, page 94 and Figure 29, page 94). Codes for dead trees (Thomas and others 1979) can also be recorded using numeric snag classes (6–12) (see Table 18, page 95 and Figure 30, page 95).

During the immediately postburn visit use the “Live” column on FMH-20 for CPC codes (10–12). Use (C)





**Figure 29. Crown position codes for live trees.**

A fifth code (5) is used for isolated trees.

**Table 17. Descriptions of live tree crown position codes.**

<b>1 Dominant</b>	Trees with crowns extending above the general level of the crown cover, and receiving full light from above and at least partly from the side; these trees are larger than the average trees in the stand and have well-developed crowns, but may be somewhat crowded on the sides.
<b>2 Co-dominant</b>	Trees with crowns forming the general level of the crown cover and receiving full light from above, but comparatively little from the sides; these trees usually have medium-size crowns, and are more or less crowded on the sides.
<b>3 Intermediate</b>	Trees shorter than those in the two preceding classes, but with crowns either below or extending into the crown cover formed by co-dominant and dominant trees, receiving little direct light from above, and none from the sides; these trees usually have small crowns and are considerably crowded on the sides.
<b>4 Subcanopy</b>	Trees with crowns below the general level of the crown cover and receiving no direct light from above or from the sides.
<b>5 Open Growth/ Isolated</b>	Trees receiving full sunlight from above and all sides. Typically, these are single trees of the same general height and size as other trees in the area, but where the stand is open and trees are widely separated so dominance is difficult to determine.

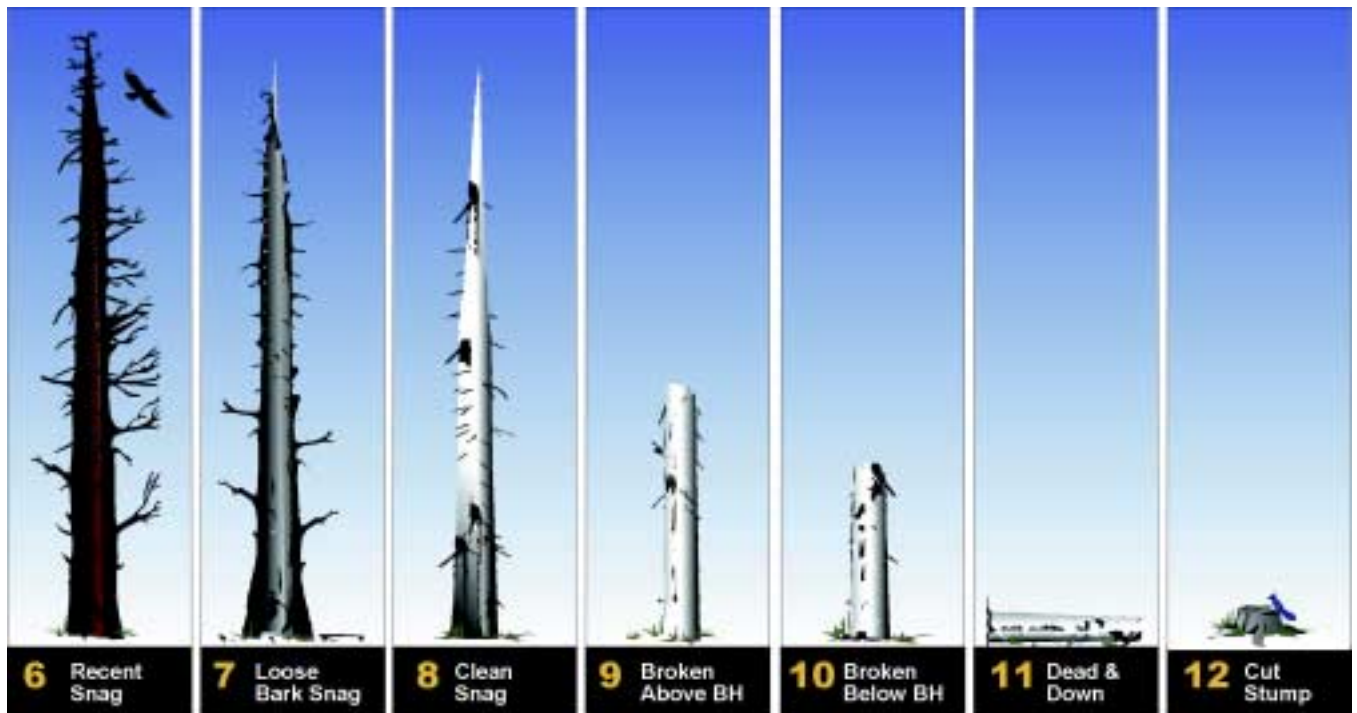

Figure 30. Crown position codes for dead trees.

Table 18. Descriptions of dead tree crown position codes.

6	<b>Recent Snag</b>	Trees that are recently dead with bark intact. Branches and needles may also be intact.
7	<b>Loose Bark Snag</b>	Trees that have been dead several years on which the bark is partially deteriorated and fallen off; tops are often broken.
8	<b>Clean Snag</b>	Trees that have been dead several years with no bark left. Usually most of the branches will be gone as well; tops are often broken.
9	<b>Broken Above BH</b>	Trees that have been dead a long time with no bark, extensive decay, and that are broken above BH.
10	<b>Broken Below BH</b>	Postburn trees that extended above BH preburn, but no longer do. <b>Note:</b> Only record data for a tree the first time you find it broken.
11	<b>Dead and Down</b>	Postburn trees that stood preburn and have since fallen or been consumed. <b>Note:</b> Only record data for a tree the first time you find it down.
12	<b>Cut Stump</b>	Postburn trees that stood preburn and has been cut as a result of fire operations. <b>Note:</b> Only record data for a tree the first time you find the stump.

## Crown Position Codes (CPC)



Earlier editions of the Fire Monitoring Handbook (USDI NPS 1992) used only the first four crown position codes. For plots established earlier, there is no harm in adopting this new protocol and assigning codes to snags after plots have burned. As plots are revisited according to their normal schedule, previously dead trees should be assessed for their snag codes. An effort can also be made to determine what the code might have been at the previous visits. For example, a clean snag (CPC 8) encountered during the year-2 visit was probably a clean snag at year-1, and possibly even at preburn. Any estimated data should be added to the database retroactively for those previous visits along with a comment noting that the CPC is a guess. In many cases a comment might have been made as to the status of the snag during the past visit.

## Data Collection on Trees with a CPC of 10–12



Only collect data for trees that are newly fallen, consumed, cut, or broken below BH (CPC 10–12) the first time you encounter them **after** the preburn visit. Never record a dead and down, cut, or broken below BH tree during the preburn visit. Once you record data for a newly fallen, consumed, broken, or cut tree, **ignore** it in your tree density data collection from that point onward. For example, if you find a tree with a CPC of 11 during the immediate postburn visit, for your year-1 re-measurement of that plot you would not record any data for that tree.

**Immediate postburn**—See page 111 under “Scorch Height.”

**Year-1 postburn and beyond**—For a dead tree with a CPC of 10–12 that you encounter in year-1 and beyond, you only need to record data for that tree once. For example, a tree’s bole breaks off below BH **between** the year-1 and year-2 plot visits. You would assign this tree a CPC of 10 in the year-2 visit, and then in subsequent visits you would not record any data for that tree.

### *Tree damage*

You may wish to identify living overstory trees exhibiting signs of stress (loss of vigor) before the burn. By doing this you can infer that if those trees die relatively

soon following the fire, their death may not be wholly attributable to the fire, but to a combination of factors.

The monitor’s ability to evaluate preburn damage will determine the value of the data. A trained specialist will undoubtedly observe more than a novice in the field. **Note:** Appendix G contains several forest pest and disease references; see page 229.

The following list (Table 19) of structural defects and signs of disease is simplistic (and certainly not all-inclusive), but should serve as a useful guideline. Parks may add categories to include damage of local importance in the “Comments” column. Record these data for living overstory trees (tree damage assessment is optional for dead trees) under Damage on the FMH-8 form in Appendix A.

Table 19. Damage codes for overstory trees.

<b>ABGR</b>	Abnormal growth pattern for the species of concern. This category would include a range of physical deformities not included in the remainder of the damage codes.
<b>BIRD</b>	Bird damage such as woodpecker or sapsucker holes.
<b>BLIG</b>	Blight is generally defined as any plant disease or injury that results in general withering and death of the plant without rotting. Blight can result from a wide variety of needle, cone, and stem rusts, as well as canker diseases, and is often species- or genus-specific. Consultation with local plant pathologists may assist in identifying specific blight conditions.
<b>BROK</b>	Broken top of the tree.
<b>BROM</b>	Witches’ broom diseases are characterized by an abnormal cluster of small branches or twigs on a tree as a result of attack by fungi, viruses, dwarf mistletoes, or insects. Brooms caused by dwarf mistletoe and from yellow witches’ broom disease are common in the west.
<b>BURL</b>	A hard, woody, often rounded outgrowth on a tree. This occurs naturally in some tree and shrub species, and is a sign of an infection or disease in other species.
<b>CONK</b>	The knobby fruiting body of a tree fungal infection visible on a tree bole, such as a shelf fungus.
<b>CROK</b>	Crooked or twisted bole for species in which this is uncharacteristic.
<b>DTOP</b>	Dead top.
<b>EPIC</b>	Epicormic sprouting, adventitious shoots arising from suppressed buds on the stem; often found on trees following thinning or partial girdling.
<b>EPIP</b>	Epiphytes present.
<b>FIRE</b>	Fire scar or cambial damage due to fire.

Table 19. Damage codes for overstory trees. (Continued)

<b>FORK</b>	Forked top of a tree or multiple primary leaders in a tree crown for species in which this is uncharacteristic. Forks assume vertical growth and should be distinguished from branches, which assume horizontal growth.
<b>FRST</b>	Frost crack or other frost damage.
<b>GALL</b>	Galls found on stems, leaves or roots. Galls are formed by infection of the plant by bacteria or fungi, or by an attack by certain mites, nematodes, or insects, most notably wasps.
<b>HOLW</b>	Hollowed-out trees. Repeated hot fires can burn through the bark and the tree's core may then rot out, especially in trees with tough bark, but soft heartwood, e.g., sequoia, coast redwood. These hollowed-out trees are sometimes called "goose pens" because early settlers kept poultry in them.
<b>INSE</b>	Visible insects in the tree bole or the canopy, or their sign, such as frass, pitch tubes or bark beetle galleries.
<b>LEAN</b>	Tree is leaning significantly. If on a slope, tree deviates considerably from plumb.
<b>LICH</b>	Lichens present.
<b>LIGT</b>	Lightning scar or other damage to the tree caused by lightning.
<b>MAMM</b>	Damage caused by mammals, such as bear claw marks, porcupine or beaver chewings, and deer or elk rubbings.
<b>MISL</b>	Mistletoe is visible in the tree (as opposed to signs of mistletoe, such as broom, without visible mistletoe).
<b>MOSS</b>	Moss present.
<b>OZON</b>	Ozone damage. Ozone injury is often seen in the form of stippling or speckling on the leaves or needles of trees. This discoloration varies among species and ranges in color from red or purple to yellow or brown. Susceptible species often drop their leaves prematurely.
<b>ROOT</b>	Large exposed roots.
<b>ROTT</b>	A rot of fungus other than a conk, often associated with a wound or crack in a tree.
<b>SPAR</b>	Unusually sparse foliage for that species and size of tree.
<b>SPRT</b>	Basal sprouting; new shoots arising from the root collar or burl.
<b>TWIN</b>	A tree that forks below BH and has two or more boles. Use this code for tree species that typically have single boles.
<b>UMAN</b>	Human-caused damage such as axe marks, embedded nails or fence wire, or vandalism.
<b>WOND</b>	A wound to a tree that cannot be identified by one of the other damage codes, including wounds or cracks of unknown cause.

## Damage Codes



Some damage codes may not be applicable to all species. For example, some species of oak are characterized by complex forking above BH, so the FORK code would not indicate damage or abnormality and would not be of use.

If several types of insect damage are present, it may be desirable to distinguish among them in the comments field on the FMH-8.

After the initial preburn data collection visit, you may find it advantageous to copy the damage codes, crown position codes and comments from the previous visit's tagged tree data sheet to the current visit's data sheet. This will encourage consistency between visits and minimizes the risk of one data collector seeing something like mistletoe one year, the next year's data collector missing it and the subsequent visit's collector seeing it again, leading to the erroneous assumption that it has actually come and gone. **Note:** Document any damage noted in past years that you could not find.

### Measuring Diameter at Root Crown (DRC) for Woodland Species

Measurement of a tree's diameter at root crown is an alternative to DBH measurements for tree species that are typically highly forked. **Note:** Do not use this method for unusual individual trees that have many boles. With this method, trees with stems that fork underground, or with several stems clumped together that appear to be from the same root origin, are treated as a single tree. The single diameter of the root crown should be measured directly if branching occurs above ground and the single diameter accurately reflects the cumulative volume of the stems it supports. Alternatively, if the stems fork below ground level, or the base is deformed and its diameter would grossly overestimate the volume of the individual stems, the DRC should be calculated from the individual stem diameters (see page 214, Appendix D for this equation).

To measure a single stem, or each of multiple stems forked underground, carefully remove the loose material to the mineral soil (remember to replace it when finished) at the ground line or stem root collar, whichever is higher. Measure DRC just above any swells present, and in a location such that the diameter measurements are reflective of the volume above the stems. For measurement of multiple stems, forked

above ground, measure DRC just above the fork, and above any swells (see Figure 31).

Where a stem is missing or damaged, estimate what its diameter would have been. If a stem is now dead, but previously contributed to the crown, count it. Individual stems must be (or have been prior to damage) at least 1.37 m tall and must have a DRC of at least 2.5 cm to qualify for measurement.

Attach a tag (optional) to the largest or main stem, facing the plot origin and approximately one foot above ground level.

## Diameter at Root Crown



Diameter at root crown is a new addition to the handbook with this edition. Resource and fire managers may determine that it would be a more useful measure for a given species than diameter at breast height (DBH). If this is the case, then both methods should be used for a minimum of two years, or until a correlation between DBH and DRC can be established for that species at that site.

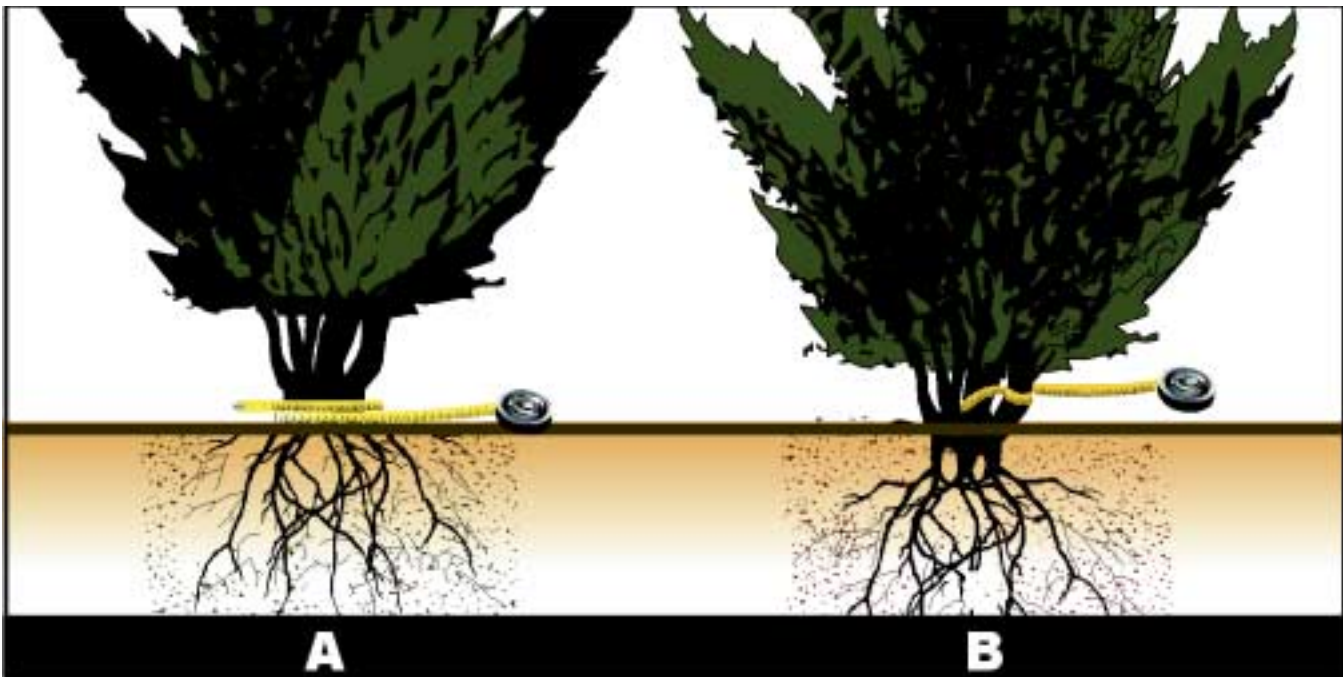

**Figure 31. Measuring multiple stems forked above ground with DRC.** Measure just above the fork, and above any swells. Measurement of: A) multiple stems forked above ground, B) single stems, or stems forked underground.

## Diameter Groupings

**Overstory trees.** This includes single-stemmed trees >15 cm DRC and multi-stemmed trees with a cumulative DRC >15 cm (though you can modify this definition; see page 44).

**Pole-size trees.** This includes single-stemmed trees between 2.5 cm and 15 cm DRC, and multi-stemmed trees with a cumulative DRC between 2.5 cm and 15 cm (though you can modify this definition; see page 44).

For trees with several small stems, the following guidelines (Table 20) may help in determining whether a tree will qualify as an overstory tree (if there is any question, measure the stems).

**Table 20. Guidelines to determine whether a tree is considered an overstory tree.**

Approximate Stem Size (cm)	Approx. Number of Stems Needed to Exceed 15.0 cm DRC
10.5	2
8.5	3
5.0	9
3.5	18
2.5	35

**Table 21. Accuracy standards for overstory tree (RS) variables.**

<b>Overstory Tree</b>		
DBH/DRC	15.1–50 cm	± 0.5 cm
	51–100 cm	± 1 cm
	>100 cm	Not Applicable
Tree Damage		Best Judgment
Crown Position		Best Judgment
# of Individuals		± 5%

## Monitoring Pole-size Trees

---

Pole-size trees are defined in this monitoring system as standing living and dead trees with a diameter at breast height (DBH)  $\geq 2.5$  cm and  $\leq 15$  cm. You may modify this definition for your purposes; see page 44 for details.

---

### Pole-size Tree Accuracy Standards



Accuracy standards for each variable discussed in this section are listed at the end of this section (Table 23, page 101).

---

### MEASURE DENSITY AND DBH OF POLE-SIZE TREES

#### RS Procedures

Count and measure DBH for all pole-size trees within the sampling area chosen during the monitoring design process (see page 45). Check your protocols (FMH-4) before proceeding.

Tagging pole-size trees is optional. If you choose to tag pole-size trees, for each plot be sure to use numbers different from those used for overstory trees, e.g., 1-100 for poles and 500-600 for overstory. The procedure is as for overstory trees: drive an aluminum nail into **each** tree at BH so that the tag hangs down and away from the tree and several centimeters of nail remain exposed, leaving ample space for tree growth. Second, measure DBH (in centimeters) to the nearest mm, just above the nail. When the tree is too small to tag at BH, or the tagging nail could split the trunk, place the tag at the base of the tree.

On the Pole-size tree data sheet (FMH-9) record the quarter in which the tree occurs (Qtr), tag or map number, the species (Spp), the diameter (DBH) of each tree, and whether it is alive (Live).

For non-sprouting tree species forked below BH, individually tag and measure each pole-size bole. For sprouting tree species, tag and measure only the largest bole (in diameter) of the cluster. Remember that if the largest bole has a DBH of  $>15$  cm, the tree is an overstory tree. Tally seedling-size sprouts as resprout class seedlings until they grow into the pole tree size class. **Note:** If the main bole of a sprouting species has died,

but the tree is sprouting from the base, consider the main bole dead.

If the bole of a fallen tree is below BH, and the individual is resprouting, treat the sprouting branches as individuals and place them in the appropriate size class (seedling, pole, or overstory). Include clarifying comments on the data sheet, especially for resprouting trees.

For trees with swellings or voids at BH, refer to page 92 in the overstory tree section.

If you do not individually tag trees, you can assign a map number for each tree, or simply count them by species (and height class, if desired). Finally, map each tree using a map (or tag) number on the appropriate tree map (FMH-11, -12, -13, or -14).

### OPTIONAL MONITORING PROCEDURES

#### Measuring Diameter at Root Crown for Woodland Species

Measurement of a tree's diameter at root crown (DRC) is an alternative to DBH measurement for tree species that are typically highly forked. This method is presented in the Overstory Tree section (page 97).

#### Measure Pole-size Tree Height

If you choose to measure this optional dataset, measure and record pole-size tree height (Hgt) on the Pole-size tree data sheet (FMH-9) for each tree encountered. Use height class codes five through 13 (Table 22, also available for reference on FMH-9).

**Table 22. Height class codes for pole-size trees.**

A tree must be breast height (1.37 cm) or taller to be classified as pole-size.

Code	Height (cm)	Code	Height (cm)	Code	Height (cm)	Code	Height (cm)
1	0–15	5	100.1–200	9	500.1–600	13	900.1+
2	15.1–30	6	200.1–300	10	600.1–700		
3	30.1–60	7	300.1–400	11	700.1–800		
4	60.1–100	8	400.1–500	12	800.1–900		

**Note:** Measure height from ground level to the highest point of growth on the tree. The highest point on a bent tree would be down the trunk of the tree instead of at the growing apex Only use height codes 1-4 for leaning trees.

**Table 23. Accuracy standards for pole-size tree (RS) variables.**

Pole Tree	
DBH/DRC	± 0.5 cm
Pole Height	Within Class
Number of Individuals	± 5%



# Monitoring Seedling Trees

Seedling trees are defined in this monitoring system as living trees with a diameter at breast height (DBH) <2.5 cm (**recording information on dead seedlings is optional**). Trees that are less than the height required for DBH are treated as seedlings, regardless of age and diameter. By definition, a tree cannot be pole-size **and** less than the height necessary for DBH. You may modify this definition for your purposes; see page 44 for details. **Note:** Accuracy standards for each seedling tree variable are listed in Table 24.

Table 24. Accuracy standards for seedling tree (RS) variables.

Seedling Tree		
DBH	<2.5 cm	No Errors
Seedling Height		Within Class
# of Individuals		± 5%

## COUNT SEEDLING TREES TO OBTAIN SPECIES DENSITY

Count the number of seedling trees by species within the sampling area chosen during the monitoring design process (see page 45). Check your protocols (FMH-4) before proceeding.

### RS Procedures

Record the heading information on the Seedling tree data sheet (FMH-10 in Appendix A). For all seedling trees, record the number of individuals (Num) by species (Spp) on the FMH-10. An optional sketch map of the seedling tree aggregates may be made on any tree map (FMH-11, -12, -13, or -14). In areas with few seedlings in the understory or where tracking individual seedlings through time is important, an optional

Table 25. Height class codes for seedling trees.

Code	Height (cm)	Code	Height (cm)	Code	Height (cm)	Code	Height (cm)
1	0–15	5	100.1–200	9	500.1–600	13	900.1+
2	15.1–30	6	200.1–300	10	600.1–700		
3	30.1–60	7	300.1–400	11	700.1–800		
4	60.1–100	8	400.1–500	12	800.1–900		

**Note:** Measure height from ground level to the highest point of growth on the tree. The highest point on a bent tree would be down the trunk of the tree instead of at the growing apex.

mapping procedure is to give individual seedlings sequential map numbers (Map#), so that data can be correlated between the Seedling tree data sheet (FMH-10) and the appropriate tree map (FMH-11, -12, -13, or -14). On the data sheet, indicate whether each group of tallied trees is alive or dead (Live) or a resprout (Rsprt).

## Seedling Resprout Class



Seedlings can now be classed as **resprouts**. See page 255 in the Glossary for a definition.

### *Anticipated dramatic increases in postburn seedling density*

The seed banks of some tree species may germinate profusely following a burn. Rather than count thousands of seedlings, it may be more efficient to subsample the plot during temporary high density periods. To subsample, grid the sample area listed on your FMH-4 and randomly select an appropriate subsample (i.e., 10%, 20%) of the area. Then proceed to count the individuals in the subsample area and extrapolate to the full sample area listed on your FMH-4. Again, this should only be done in consultation with resource and fire managers.

## OPTIONAL MONITORING PROCEDURES

### Measure Seedling Tree Height

Record the number of seedling trees (Num) by species (Spp) in each height class (Hgt) on the Seedling tree data sheet (FMH-10) for each tree encountered. Use the following height class codes (Table 25, also available for reference on FMH-10):

# Monitoring Dead & Downed Fuel Load

On all forest monitoring plots, measure dead and detached woody fuel as well as duff and litter depths. These measurements are taken along fuel inventory transects, which must be relocatable to allow evaluation of postburn fuel load. Transects extend in random directions originating from the centerline at 10, 20, 30, and 40 m (Figure 32).

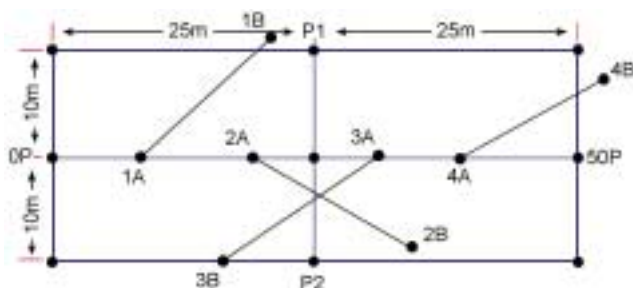

Figure 32. Location of fuel inventory transects.

Unlike herbaceous transects, fuel load transects can cross each other (Brown 1996). In many monitoring types the transect length is 50 ft, but in types with sparser fuels it may exceed that (see page 45). Check your protocols (FMH-4) before proceeding.

## Fuel Load Measurements



Fuel load measurements and the transects used to sample them traditionally use English measurements, **not** metric.

Lay out the appropriate length tape along the transect in a random direction (Appendix B). Place a labeled tag at each end of the transect (see page 70 for a description of how to label tags). Measure the percent slope of the transect (from end to end) in percent.

## When an Obstruction is Encountered Along the Fuel Transect



If the fuel transect azimuth goes directly through a rock or stump, in most cases you can run the tape up and over it. If the obstruction is a tree, go around it and pick up the correct azimuth on the other side. Be sure to note on the FMH-19 on which side of the bole the tape deviated so that it will be strung the same way in the future.

## Fuel Load Accuracy Standards



Accuracy standards for each variable discussed in this section are listed at the end of this section (Table 27, page 105).

## RS PROCEDURES

Working along the distances defined in the monitoring type protocols (FMH-4), tally each particle intersected along a preselected side of the tape, categorized by size class. A go-no-go gauge with openings (0.25, 1, and 3 in) works well for separating borderline particles into size classes and for training the eye to recognize these size classes (Figure 33). Measurement of all particles is taken perpendicular to the point where the tape crosses the central axis (Figure 34, page 104). Count intercepts along the transect plane up to 6 ft from the ground. Count dead and down woody material, but not cones, bark, needles and leaves. Do not count stems and branches attached to standing shrubs or trees (Brown 1974; Brown and others 1982). For additional details on tallying downed woody material, refer to the notes on the reverse side of FMH-19.

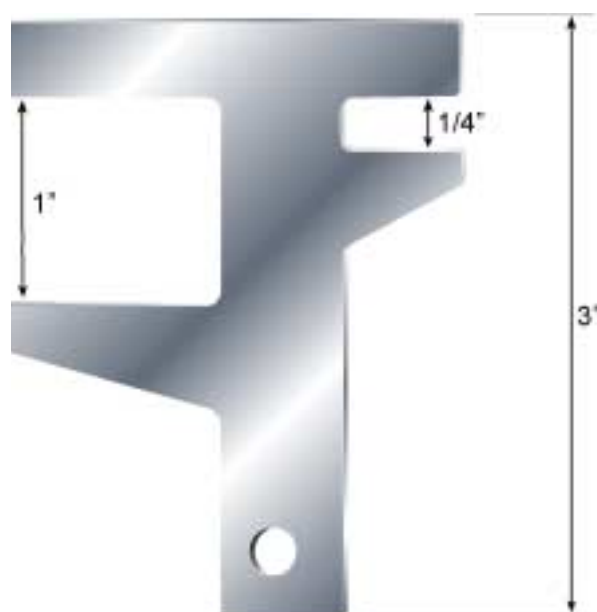
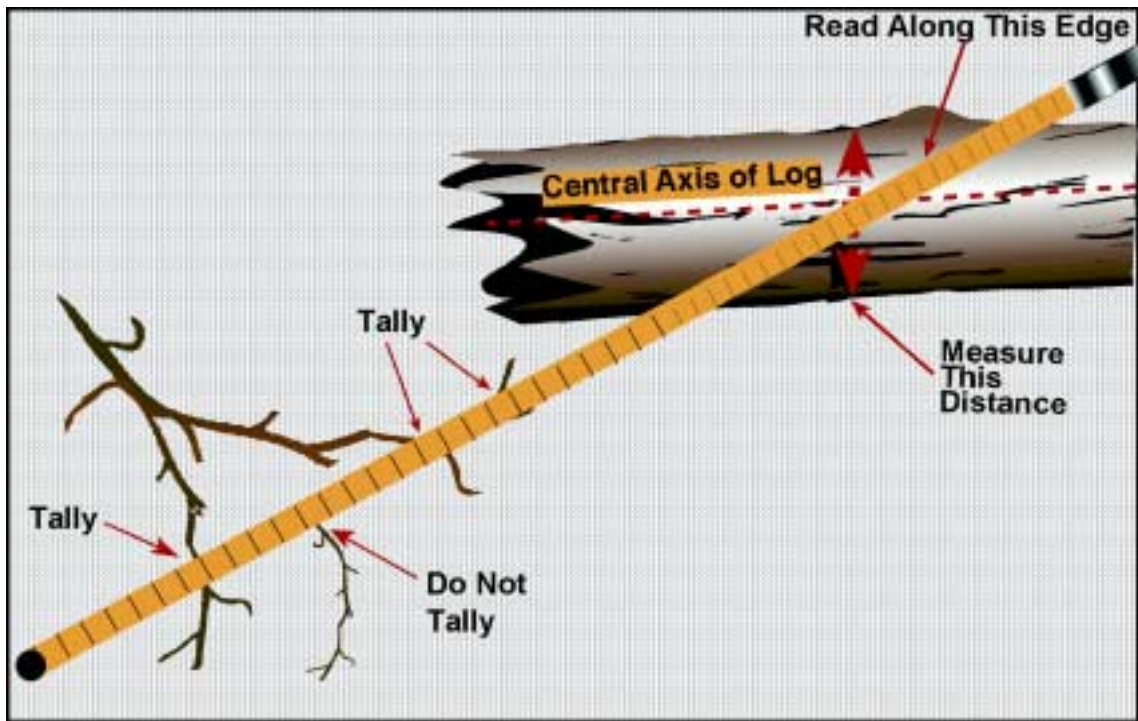

Figure 33. Graphic of a go-no-go gauge.



**Figure 34. Tally rules for dead and down fuel.**

Count all intersections, even curved pieces. All intersections must include the central axis in order to be tallied.

**Table 26. Suggested lengths of transect lines to tally fuels by size class.**

Size Class	Suggested Length
0–0.25" (0–0.62 cm) diameter (1 hour)	tally from 0–6 ft
0.25–1" (0.62–2.54 cm) diameter (10 hour)	tally from 0–6 ft
1–3" (2.54–7.62 cm) diameter (100 hour)	tally from 0–12 ft
>3" (>7.62 cm) diameter (1,000 hour)	measure each log from 0–50 ft

Differentiate between 3 in (or larger) diameter particles that are sound and those that are rotten. Rotten wood is that which is obviously deteriorating or punky. Measure the particle diameter to the nearest 0.5 in with a diameter tape or ruler. Ignore particles buried more than halfway into the duff at the point of intersection. Visually reconstruct rotten logs as a cylinder and estimate the diameter. This reconstructed diameter should reflect the existing wood mass, not the original sound diameter.

Take depth measurements for litter and duff (as defined in the Glossary) at 10 points along each fuel transect—that is at 1, 5, 10, 15, 20, 25, 30, 35, 40, and 45 ft. If the transect is longer than 50 ft, do not take additional litter and duff measurements. Do not take measurements at the stake (0 point); it is an unnatural

structure that traps materials. At each sampling point, gently insert a trowel or knife into the ground until you hit mineral soil, then carefully pull it away exposing the litter/duff profile. Locate the boundary between the litter and duff layers. Vertically measure the litter and duff to the nearest tenth of an inch. Refill holes created by this monitoring technique. Do not include twigs and larger stems in litter depth measurements.

You may choose to install duff pins to measure duff reduction instead of digging and measuring the depth of holes. Duff pins, however, are easy to trip over or pull out, and therefore should be used only where traffic (human or other animal) is limited.

Record the above dead and downed fuel data on the Forest plot fuels inventory data sheet (FMH-19, in Appendix A).

### Measuring Duff and Litter



You can dig and measure in one step if you engrave or etch a ruler in tenths of inches on the back of your trowel. Use paint or nail polish to mark the major graduations.

## DEAL WITH SAMPLING PROBLEMS

Occasionally moss, a tree trunk, stump, log, or large rock will occur at a litter or duff depth data collection point. If moss is present, measure the duff from the base of the green portion of the moss. If a tree, stump or large rock is on the point, record the litter or duff depth as zero, even if there is litter or duff on top of the stump or rock. If a log is in the middle of the litter or duff measuring point, move the data collection point 1 ft over to the right, perpendicular to the sampling plane.

Table 27. Accuracy standards for fuel (RS) variables.

Fuel Load	
% Slope	± 5%
Diameter of $\geq 3$ " logs	± 0.5 in (1.2 cm)
Litter or Duff Depth	± 0.5 in (1.2 cm)

# Monitoring Fire Weather & Behavior Characteristics

## Collecting Fire Behavior and Weather Data



Previous editions of the Fire Monitoring Handbook (USDI NPS 1992) recommended that monitors record fire weather and behavior characteristics at each plot using Fire Behavior Observation Circles (FBOC) or Intervals (FBOI). The revised recommendations follow.

For the monitoring plots to be representative, they must burn under the same conditions and ignition techniques used in the rest of the prescribed fire block. **Fire monitor safety, however, must always be foremost.**

Forest monitoring types may include a dense understory layer, while brush and grassland fuel types are usually flashy; all of them may be unsafe to move through during a fire. The monitoring procedure presented here is an ideal and will be impossible to implement in some situations. The objective of monitoring fire characteristics in forest, brush or grassland types, therefore, is to do whatever is necessary to be safe while simultaneously obtaining representative fire behavior measurements wherever possible.

Take fire weather and behavior observations (rate of spread, flame length, and flame depth (optional), and other level 2 variables described in Chapter 2) in the same monitoring types represented by your plots, in an area where the fire behavior is representative of fire behavior on the plots. Where safe, you can make fire behavior observations near a monitoring plot.

## Fire Behavior Accuracy Standards



Accuracy standards for each variable discussed in this section are listed in Table 29, page 111.

### RATE OF SPREAD

To estimate Rate of Spread (ROS), you can use a Fire Behavior Observation Interval (FBOI). An FBOI consists of two markers placed a known distance apart, perpendicular to the flame front. Five feet is a standard

length for the FBOI; however, you may shorten or lengthen the FBOI to accommodate a slower or faster moving flame front.

If you expect an irregular flaming front, set up another FBOI, perpendicular to the first FBOI. That way you will be prepared to observe fire behavior from several directions. If the fire moves along either FBOI, or diagonally, you can calculate ROS, because several intervals of known length are available. To distribute the FBOIs, use a setup that you think makes sense for your situation.

As the fire burns across each FBOI, monitor the recommended Fire Conditions (level 2) variables, and record observations on the Fire behavior–weather data sheet (FMH-2, in Appendix A). The time required for the fire to travel from one marker to the other divided by the distance (5 ft) is recorded as the observed rate of spread. For further information on ROS, see page 13.

## Rate of Spread



You may use metric intervals to measure ROS. However, a possible problem with using metric ROS intervals is that you may forget to convert the metric into English units to get a standard linear expression for ROS, which is chains per hour or feet per minute. To avoid potential errors, it may be better to pre-measure and mark the ROS intervals in feet.

### FLAME LENGTH AND DEPTH

During the fire, estimate flame length (FL) and flame depth (FD; optional) (see page 13) at 30-second intervals (or more frequently if the fire is moving rapidly), as the flaming front moves across the ROS observation interval. Use the Fire behavior–weather data sheet (FMH-2) to record data. If possible, make five to ten observations of FL and FD per interval. **Note:** Where close observations are not possible, use the height (for FL) or depth (for FD) of a known object between the observer and the fire behavior observation interval to estimate average flame length or flame depth.

Fire weather observations should be recorded at 30-minute intervals. Sample more frequently if you detect a change in wind speed or direction, or if the air temperature or relative humidity seems to be changing significantly, or if directed to do so by the prescribed burn boss.

---

## Fireline Safety



- For safety, inform all burn personnel at the preburn briefing that the unit contains monitoring plots. It is recommended that you provide a brief discussion on the value of these plots, and your role on the burn.
  - Inform all ignition personnel that they are to burn as if the plots do not exist. This will help avoid biased data, e.g., running a backing fire through a plot while using head fires on the rest of the unit.
-

# Monitoring Immediate Postburn Vegetation & Fuel Characteristics

## GRASSLAND AND BRUSH PLOTS

After the burned plot has cooled sufficiently (generally within two to three weeks), remeasure the RS variables (see Tables 5 and 6 on page 57). Record postburn conditions that characterize the amount of heat received in the type on the Brush and grassland plot burn severity data sheet (FMH-22). On each form, circle the postburn status code as “01 Post” (within two months of the burn, see tip box below). The first number represents the number of treatment iterations, e.g., 02 Post would indicate that the plot had been burned (or otherwise treated) twice.

## FOREST PLOTS

After the burned plot has cooled sufficiently (generally within two to three weeks), remeasure the RS variables (see Table 7 on page 57) using the preburn monitoring techniques. Record postburn conditions that characterize the amount of heat received in the type on the Forest plot burn severity data sheet (FMH-21). Remeasure the overstory and record data on the Tree postburn assessment data sheet, FMH-20 (optional for pole-size trees). Do not remeasure the diameter of overstory trees for at least one year postburn, but at every visit record whether each tree is alive or dead. On each form, circle the postburn status code as “01 Post” (within two months of the burn). The first number represents the number of treatment iterations, i.e., 02 Post would indicate that the plot had been burned (or otherwise treated) twice.

### Timing Burn Severity Data Collection



You can lose burn severity data by waiting too long to collect it, and having rain or snow mar the data collection. Collect burn severity data as soon as possible after the plot cools, which can be much less time than the recommended two weeks, especially in grasslands.

### Immediate Postburn Vegetation & Fuel Characteristics Accuracy Standards



Accuracy standards for each variable discussed in this section are listed at the end of this section (Table 29, page 111).

## MONITOR POSTBURN CONDITIONS

### Burn Severity—All Plot Types

Visual assessments of burn severity allow managers to broadly predict fire effects upon the monitoring type, from changes in the organic substrate to plant survival (Ryan and Noste 1985). Burn severity is rated and coded separately for organic substrate and vegetation, distinguished by an S or V, respectively. Rate burn severity according to the coding matrix (Table 28, page 110; adapted from Conrad and Poulton 1966; Ryan and Noste 1985; Bradley and others 1992).

#### Example:

In a plant association dominated by shrubs you observe the following conditions at one of the 4 dm<sup>2</sup> burn severity data collection points: the leaf litter has been consumed, leaving a coarse, light colored ash; the duff is deeply charred, but the underlying mineral soil is not visibly altered; foliage and smaller twigs are completely consumed, while shrub branches are mostly intact (40% of the shrub canopy is consumed). Burn severity would be coded as S2 (substrate impacts) and V3 (vegetation impacts) on the Brush and grassland plot burn severity data sheet (FMH-22), or the Forest plot burn severity data sheet (FMH-21).

Where there was no organic substrate present preburn, enter a 0 to indicate that the severity rating is not applicable. Do the same if there was no vegetation present preburn. You can often determine whether there was vegetation or substrate at a point by examining the preburn data sheets.

### *Grassland and brush plots*

Record burn severity measurements every 5 m, starting at 1 m and ending at the 30P (1 m, 5 m, 10 m, etc.). Record data from a minimum of seven areas per plot. You can choose to rate burn severity at every point sampled (100 data points, optional) along the transect. The additional effort may be minimal since vegetation data may be collected at each of these points anyway. Space has been provided on FMH-22 for this optional data.

---

## Grassland & Brush Plot Burn Severity



In past versions of this handbook, the protocol for collecting burn severity ratings was to collect data every 5 m, starting at the 0P and ending at the 30P. To avoid the influence of the plot rebar, it is now recommended that the first reading be made at 1 m, with all other measurements being the same.

---

At each sample point, evaluate burn severity to the organic substrate and to the above-ground plant parts in a 4 dm<sup>2</sup> area (2 dm × 2 dm) and record the value on FMH-22. Use the burn severity coding matrix for the appropriate plant association (Table 28, page 110) to determine the severity ratings.

### ***Forest plots***

Burn severity ratings are determined at the same points on the forest dead and downed fuel inventory transect lines where duff depth is measured: 1, 5, 10, 15, 20, 25, 30, 35, 40, and 45 ft. Alternatively, if the Q4–30 m (the first 30 m of the Q4–Q1 transect) line is used, you can use the same methods used in grassland and brush plots. See the warning box below for another alternative.

Using the dead and downed fuel inventory transect lines you will have 40 points rated per plot. At each sample point, evaluate burn severity to the organic substrate and to above-ground plants in a 4 dm<sup>2</sup> area (2 dm × 2 dm). Use the burn severity code matrix (Table 28, page 110) for the appropriate plant association, and record the value on FMH-21.

---

## Forest Plot Burn Severity



You may now use the herbaceous transects (e.g., Q4–Q1, Q3–Q2) instead of the fuel transects to monitor burn severity in forest plots. The intervals (except for Q4–30 m) are at the 1, 5, 10, 15, 20, 25, 30, 35, 40, and 45 m marks. Only collect this data for the portions of the plot where you have vegetation transects.

---



Table 28. Burn severity coding matrix.

	Forests		Shrublands		Grasslands	
	Substrate (S)	Vegetation (V)	Substrate (S)	Vegetation (V)	Substrate (S)	Vegetation (V)
<b>Unburned (5)</b>	not burned	not burned	not burned	not burned	not burned	not burned
<b>Scorched (4)</b>	litter partially blackened; duff nearly unchanged; wood/leaf structures unchanged	foliage scorched and attached to supporting twigs	litter partially blackened; duff nearly unchanged; wood/leaf structures unchanged	foliage scorched and attached to supporting twigs	litter partially blackened; duff nearly unchanged; leaf structures unchanged	foliage scorched
<b>Lightly Burned (3)</b>	litter charred to partially consumed; upper duff layer may be charred but the duff layer is not altered over the entire depth; surface appears black; woody debris is partially burned; logs are scorched or blackened but not charred; rotten wood is scorched to partially burned	foliage and smaller twigs partially to completely consumed; branches mostly intact	litter charred to partially consumed, some leaf structure undamaged; surface is predominantly black; some gray ash may be present immediately postburn; charring may extend slightly into soil surface where litter is sparse, otherwise soil is not altered	foliage and smaller twigs partially to completely consumed; branches mostly intact; less than 60% of the shrub canopy is commonly consumed	litter charred to partially consumed, but some plant parts are still discernible; charring may extend slightly into soil surface, but soil is not visibly altered; surface appears black (this soon becomes inconspicuous); burns may be spotty to uniform depending on the grass continuity	grasses with approximately two inches of stubble; foliage and smaller twigs of associated species partially to completely consumed; some plant parts may still be standing; bases of plants are not deeply burned and are still recognizable
<b>Moderately Burned (2)</b>	litter mostly to entirely consumed, leaving coarse, light colored ash; duff deeply charred, but underlying mineral soil is not visibly altered; woody debris is mostly consumed; logs are deeply charred, burned-out stump holes are common	foliage, twigs, and small stems consumed; some branches still present	leaf litter consumed, leaving coarse, light colored ash; duff deeply charred, but underlying mineral soil is not visibly altered; woody debris is mostly consumed; logs are deeply charred, burned-out stump holes are common	foliage, twigs, and small stems consumed; some branches (>.6–1 cm in diameter) (0.25–0.50 in) still present; 40–80% of the shrub canopy is commonly consumed.	leaf litter consumed, leaving coarse, light gray or white colored ash immediately after the burn; ash soon disappears leaving bare mineral soil; charring may extend slightly into soil surface	unburned grass stubble usually less than two inches tall, and mostly confined to an outer ring; for other species, foliage completely consumed, plant bases are burned to ground level and obscured in ash immediately after burning; burns tend to be uniform
<b>Heavily Burned (1)</b>	litter and duff completely consumed, leaving fine white ash; mineral soil visibly altered, often reddish; sound logs are deeply charred, and rotten logs are completely consumed. This code generally applies to less than 10% of natural or slash burned areas	all plant parts consumed, leaving some or no major stems or trunks; any left are deeply charred	leaf litter completely consumed, leaving a fluffy fine white ash; all organic material is consumed in mineral soil to a depth of 1–2.5 cm (0.5–1 in), this is underlain by a zone of black organic material; colloidal structure of the surface mineral soil may be altered	all plant parts consumed leaving only stubs greater than 1 cm (0.5 in) in diameter	leaf litter completely consumed, leaving a fluffy fine white ash, this soon disappears leaving bare mineral soil; charring extends to a depth of 1 cm (0.5 in) into the soil; this severity class is usually limited to situations where heavy fuel load on mesic sites has burned under dry conditions and low wind	no unburned grasses above the root crown; for other species, all plant parts consumed leaving some or no major stems or trunks, any left are deeply charred; this severity class is uncommon due to the short burnout time of grasses
<b>Not Applicable (0)</b>	inorganic preburn	none present preburn	inorganic preburn	none present preburn	inorganic preburn	none present preburn

## Scorch Height

Record the tree tag number (Tag), whether the tree is alive (L), dead (D), resprouting (R), consumed/down (C), broken below BH (B) or cut stump (S) (Live Code), maximum scorch height (ScHgt), and the scorched proportion of the crown (ScPer). See Glossary for definitions. Trees that have fallen should be noted, though they will be recorded during the year-1 remeasurement. You may also record char height (Char), an optional variable, on FMH-20.

Estimate the maximum scorch height on each overstory tree two weeks to two months after the fire has burned across the monitoring plot. **Note:** If another time frame (e.g., 3 months or year-1 postburn) exposes scorch patterns more definitively, measure scorch height again at that time and enter the data with the other Post data. Record this information in the Notes section of the FMH-4.

Maximum scorch height is measured from ground level to the highest point in the crown where foliar death is evident (see Figure 35). Some trees will show no signs of scorch, but the surrounding fuels and vegetation will have obviously burned. In this case, you can estimate scorch height by examining adjacent vegetation. It may be useful to produce a graph of scorch heights to show the variation around the average. Managers may want to correlate scorch height with the pre-burn locations of large dead and down fuels; these correlations usually require photographs or maps of fuel pockets.

## Percent Crown Scorched

For each overstory tree, estimate the percent of the entire crown that is scorched. Average percent crown scorched may be calculated, but percent crown scorched is a better indicator of individual tree mortality.

## OPTIONAL MONITORING PROCEDURES

### Char Height

You can often measure char height simultaneously with scorch height. To obtain an average maximum char height, measure the height of the maximum point of char for each overstory tree (see Figure 35). For these data calculate the mean of maximum char heights. It may be useful to note on the data sheet the extent of the cambial damage to the tree and to describe the char on the ground surrounding each tree in the Notes section of FMH-20.

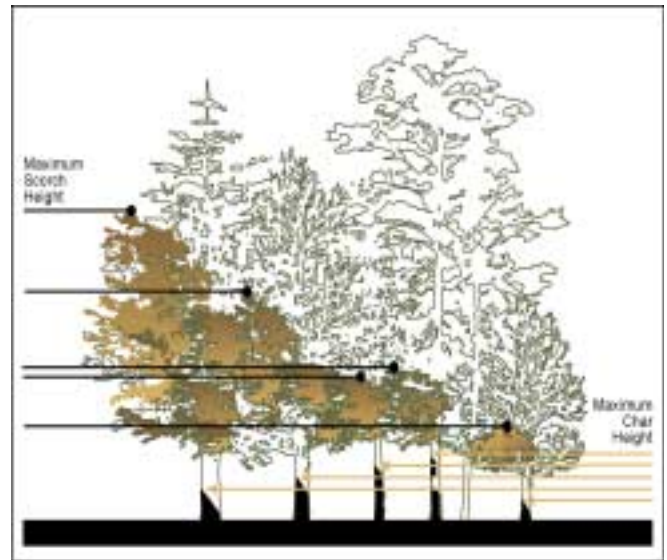

Figure 35. Scorch and char height.

## Scorch and Char for Pole-size Trees (Optional)



You may collect scorch height, percent crown scorch, and char height for pole-size trees if these data are important to resource and/or fire management staff.

Table 29. Accuracy standards for during burn and immediate postburn (RS) variables.

Fire Behavior and Severity		
Flame Length or Depth/ROS	<10 ft	± 1 ft
	>10 ft	± 5 ft
Burn Severity		± 1 Class
Scorch/Char Height	<10 m	± 1 m
	>10 m	± 5 m
Percent Crown Scorch		± 10%

# File Maintenance & Data Storage

## PLOT TRACKING

One of the most important aspects of managing a monitoring program is having a system for tracking the number of plots. One of the most concise methods is to create a Master plot list. Within this list all plot name changes, burn unit locations, burn dates, and

sampling dates are contained within a single document; an example is included below (Table 30). This type of document can easily be created in a spreadsheet program such as Microsoft Excel. Maintain a master list for all plots. It is the responsibility of the lead monitor to maintain this list.

Table 30. Example system for tracking plots.

Former Plot Name & #	Current Plot Name & #	Burn Unit	Burn Date(s)	Pre	01Post	01yr01	01yr02	02Post	Notes
BSAME3T0401	BADSPD0401	Green Meadow	10/93	08/90	11/93	08/94	08/95		Tags not changed
	FUGA4D0921	Coyote Creek	8/92 9/97	7/92	10/92	7/93	8/94	10/97	Did not actually burn in '97

## MONITORING TYPE FOLDERS

For each monitoring type, create a folder to hold all information pertinent to that monitoring type. At minimum each folder should contain the following:

- Monitoring type description sheet
- Master list of all plots within the monitoring type
- Master map(s) with all plots within monitoring type marked
- Minimum plot calculations by monitoring type
- Any burn summaries for burns conducted within the monitoring type
- All data analyses for the monitoring type

## MONITORING PLOT FOLDERS

Establish a raw data file for each monitoring plot. Within the file, store all data sheets and maps for that plot, including the Plot location data sheet (FMH-5). File data sheets in numerical order by data sheet number. All plot folders should then be filed by monitoring type. In some parks, plot folders may be filed by burn unit. If this is the case, all plots should be filed alphabetically by monitoring type and then in numerical order by plot number within each monitoring type.

## SLIDE—PHOTO STORAGE

To protect your originals, make a duplicate set of slides for use in the field. High temperatures and exposure to sunlight, ash, and dirt reduce the lifetime of a slide.

## Offsite Data Backup



It is strongly recommended that you store backup digital or hard copies of all FMH-5 (Plot location data sheets), including the maps illustrating the directions to the plots, with your regional coordinator or in another off-site location. Offsite storage of your data is the only way to protect it in the event your office is burglarized or hit by fire or flood. In the event an original map is lost or destroyed, you will have a copy with which to relocate the plot. **Remember:** a lost plot is lost data.

Place all slides or photos in archival quality slide or photo holders, which in turn should be stored in archival quality binders or a slide file. Store slides in a cool, dry environment away from sunlight. Though it limits ease of access, the optimum storage area is with the archive division of your park. If you have access to a high quality scanner, you may want to scan the slides so that you have digital backups (this will also allow you to print copies to take with you to the plot).

File all photographic materials by monitoring type and then numerically by plot number. File slides for each plot photo (e.g., 0P–30P) sequentially by sample visit: 00 PRE, 01 Burn, 01 Post, 01 yr01, 01 yr02, 01 yr05, 02 Burn, etc.

## FIELD PACKETS

Create field packets to carry copies of monitoring data for field reference. Keep these packets in sturdy fold-

ers. Your field packets should include the following items for each plot:

- Set of print copies of the preburn photos
- Copy of all maps
- Copy of the FMH-4 (Monitoring type description sheet)
- Copy of the FMH-5 (Plot location data sheet)
- Copy of the park's FMH-6 (Species code list)
- Copy of the data from the most recent visit, so that you can consult species codes, check tree diameters, verify protocols, etc.
- Log of problems encountered on the plot, plot name changes, species to be verified, etc. (see Plot maintenance log, FMH-25)

## DATA PROCESSING AND STORAGE

The current National Park Service protocol is to enter all data into the FMH.EXE software (Sydoriak 2001). Data entry screens are designed to mimic the standard data sheets. The addition of pull-down menus, specific help, and extensive error-checking makes FMH.EXE powerful and easy for computer novices to use. Any software that can access xBase files (including Approach, dBASE, Visual FoxPro (or FoxBase), and Paradox) can be used to edit, enter and analyze FMH data, but using FMH.EXE will enhance data integrity by providing validated data entry; in addition, it automates standard data analyses.

Use the Quality control checklist (FMH-24) whenever you enter and quality check your data. Record the date, your initials, and the computer you used. If you find any problems while you are entering data, use the Plot maintenance log (FMH-25) to describe the problem and what you did to correct the problem. Keeping logs such as these serves as a valuable record of data collection and entry problems.

---

### Data Backup



As is recommended with all computer work, **backup often**, particularly after a large data entry session. The FMH software automates data backup onto a floppy diskette. For very large databases the FMH software can zip (compress) your database(s) so that all data can be contained on a single floppy diskette. **It is also important to send copies of your database to your regional coordinator annually (at a minimum) for safe storage.**

---

# Ensuring Data Quality

---

The data you have so painstakingly collected are going to be analyzed, and management decisions will be based on these analyses. One or two errors per data sheet can add up to a significant error, which if not detected can lead to erroneous conclusions about observed changes.

Standards for high data quality begin with accurate field data collection and continue in the office with accurate data entry into the FMH software. Ensure high data quality standards by properly training field staff, and developing a system of data quality checks both in the field and in the office.

Proper training of field staff may involve setting up a practice plot on which each member of the staff has an opportunity to measure and remeasure each of the variables sampled. Comparison of the values will reveal those sampling variables where there can be a high degree of variation in the values obtained. Discuss the variations in values with staff members and clarify proper sampling techniques. Use the accuracy standards at the end of each section in this chapter as a guideline for how close your measurements need to be.

## Example:

Litter and duff depth measurements often have the highest degree of error due to the difficulty of identifying the difference between these two layers. Ask each member of the field staff to measure litter and duff at a series of sample points. Compare the results and discuss the definition of litter and duff and how to identify the two layers. Have staff members sample several more points until each staff member's measurements are within 0.5 in of each other.

---

## QUALITY CHECKS WHEN REMEASURING PLOTS

When remeasuring a plot it is important to review the previous year's data. Refer to the Plot maintenance log (FMH-25) to see if there are any problems that need to be corrected. Use the previous year's data sheets as templates for gathering the subsequent data. It is essential that significant changes seen year to year be true changes and not the result of omission or errors in data collection.

### Monitoring Type

Ensure that previous monitors had a clear understanding of all aspects of the monitoring type description. Has the description changed since the plot was installed? Were the plots established randomly? Did earlier monitors use different sampling areas or methods from one plot to the next? Are these methods different from the methods you currently use? See "Monitoring Type Quality Control" on page 51 for further reference.

### Plot Location Data

Were you able to relocate the plot based on the directions on the FMH-5? Were the directions clear? Was the map easy to follow? Did you find all of the elements of the written directions clearly illustrated on the hand-drawn map?

Some of the important variables to compare year to year are as follows:

### Photo Documentation

Use the previous year's slides (or prints) to take plot photos with the same field of view year to year. Take time to align tree limbs, ridgelines or rock outcrops in the same position as seen in the previous year's photo so that changes in vegetation over time in relation to these features can be seen year to year.

### Herbaceous Cover

Generate a data summary for each plot using the FMH software. Review this summary prior to reading the herbaceous transect, so that you will know what species you may encounter. When you finish reading the transect, check off all the species you encountered on the data summary from the previous year. Look for any species not checked off the list.

### Shrub Density

In some instances individual root crowns can be obscured by grass and other herbaceous plants. Use the previous year's data as a guide to how many individuals were counted within each interval of the brush belt.

### Overstory and Pole-size Trees

Use the previous DBH measurement as a guide to ensure that you are making the current measurement at the same point as the previous measurement. Watch

for large variations in DBH from one year to the next. Confirm that trees marked dead at immediate post are still dead at year-1. If they are not, correct the data for the immediate postburn visit on both the hard copy and in the database. Check each tree along the sampling area perimeter to ensure that >50% of the base of the tree is within the sampling area. Also, check to see if crown or damage codes are fluctuating from one year to the next.

### Downed Fuel Load

Check your data against realistic expectations. The number of 100-hr and 1000-hr logs do not generally fluctuate within a year's time. Rotten 1,000-hr logs do not generally increase in number immediate postburn. 100-hr logs may be consumed immediate postburn (1,000-hr logs rarely are), but between year-1 and year-2 these logs should still be present. Make sure you also check for fluctuations in slope measurement for each fuel transect.

## QUALITY CHECKS IN THE FIELD

Budget a little extra time at the completion of a plot in order to save a repeat trip to a plot to collect data that were overlooked. Before leaving the field, perform the following checks:

### Monitoring Type

Make notes on the quality of the monitoring type description, as your feedback is critical to the authors of that description. Is the description clear to all members of the crew? Does the description contain enough quantitative and qualitative information for your crew to make the decision to accept, or reject a plot? Do the sampling areas seem too large or too small? Do the sampling protocols seem appropriate? Is it clear why managers have asked you to collect data for optional variables? See page 51 for further reference.

### Data Sheets

Are they complete? Is any information missing? For example, has live-dead been indicated on all tree data? Are all species codes identifiable and correct?

### Vouchers

Have voucher specimens been collected for unknowns? If a specimen could not be collected, has the unknown been adequately described, drawn or photographed? Is this information sufficient to distinguish among unknowns? Are collection bags clearly labeled with plot I.D., date and contents? Use the voucher labels on the back of the FMH-6.

The FMH-6 serves as a list of each unknown you encounter in order to help monitors quickly identify which plants need to be collected. Carry this list from plot to plot to ensure that you use the same code until the plant is collected and identified.

### Mapping

Have monitors taken azimuths and distances to and from reference features? Have they drawn a rough map showing the plot location in relation to other prominent features? It is often difficult to recreate the spatial arrangement of features from memory in the office.

---

### Accurate Maps



Accurate mapping of plot locations is one of the most important tasks monitors have to complete. Too often mapping is done hurriedly at the completion of a plot. Allow yourself ample time to take accurate azimuths, measure distances, and write a clear description of how to get to the plot. A plot that cannot be relocated is data lost.

---

## QUALITY CHECKS IN THE OFFICE

If necessary, make a more thorough check of the data sheets when reaching the office. **Check your data sheets as soon as possible after you sample the plot.** Your mind will be fresh, and you can clearly elaborate upon your cryptic notes.

If you cannot identify unknowns within a day or two, press the voucher specimens. Monitors often leave specimens in collection bags for too long and they become moldy and unusable. Keep a running log of voucher specimens collected. Store vouchers properly so they can be used at a future date (see Appendix C for guidelines).

Have a central filing area where you can store original data sheets (organize by task, e.g., to be checked for quality, to be entered, needs discussion, to be filed) until they are filed. Organize the data sheets in a logical order, e.g., alphabetically by monitoring type, then numerically by plot number, then numerically by data sheet number. Use the Quality control checklist (FMH-24) to ensure that all data and supplemental information have been collected, entered, and quality checked for a particular plot.

## QUALITY CHECKS FOR DATA ENTRY

For even the most accurate typist, it is imperative that you check each data sheet entered into the FMH software. Although the FMH software has extensive data-checking capabilities, it cannot detect typographical errors such as entering a DBH of 119.0 instead of 19.0. Once you have entered the data from a data sheet, compare the data on each data sheet with the database, and check those data line by line for accuracy. Generally, it is better that an individual other than the person who entered the data check the data sheet.

When entering data, record any problems on the Plot maintenance log (FMH-25). **Make sure that you resolve each problem and then check it off the log.** The FMH software has a data-checking mechanism for each data sheet. You should use this to check each data sheet after you enter it (optionally, you can check all data sheets at a single time). Make sure that you have error-checked each data sheet before you conduct any data analyses.

---

### Finding Errors in Density Data



Trees, shrubs, or herbs are occasionally missed, or erroneously called dead one year, then found to be alive the next. If you have collected data on your plots for two or three years, one technique for finding these errors is to use the analysis option in the FMH software (multiple burn status graphics), on a single plot basis. Perform this analysis for all visits to a single plot, by choosing the “select plot” option within the analysis menu. Look at the graphical or numerical representation of the data and check for any fluctuations in density that might not be accounted for by death or recruitment, or the absence of change where change is expected.

---

### Finding Errors in Species Cover Data



Shrubs or herbs are occasionally missed, or erroneously called one species name one year and another the next. If you have collected data on your plots for two or three years, use the technique described in the “Finding Errors in Density Data” tip box. Look at the graphical or numerical representation of the data and check for any fluctuations in species within genera or with species that are often mistaken with each other, which might not be accounted for by death or recruitment, or the absence of change where change is expected.

---

### Finding Errors in Fuels Data



Larger diameter size class (>1”) fuels are occasionally missed or placed in the wrong class, or 1,000-hr logs are erroneously called rotten one year and found to be sound the next. Monitoring crews can have varying understandings of the difference between litter and duff from one year to the next. If you have collected data on your plots for two or three years, use the technique described in the “Finding Errors in Density Data” tip box. Look at the graphical or numerical representation of the data and check for any fluctuations in fuel load, within each category of fuel, which might not be accounted for by decomposition or combustion, or look for the absence of change where change is expected.

---

### Data Management



For an in-depth discussion of data management, consult the data management protocols used by the NPS Inventory and Monitoring Program (Tessler and Gregson 1997).



If you follow all of these quality control guidelines, your data generally should have the following characteristics:

- No data are missing from either the data sheets or from FMH.EXE
- No transcription errors exist, i.e., the data sheets match the FMH.EXE screens perfectly
- The data have been error-checked by the software and by an experienced field person
- Data from different visits are at the same level of quality

Plot visits conducted by different field staff or at different times are especially prone to data errors—be sure to confirm species identification and naming consistency, check for fluctuation of individuals between classes (e.g., live and dead, height, crown, age) and ensure that data follow a logical order (e.g., individuals should not decrease in diameter, damage, or maturity).

---





# 6

## Data Analysis & Evaluation

*“Take nothing on its looks; take everything on evidence. There’s no better rule.”*

—Charles Dickens

Analyzing fire monitoring data and using the results to evaluate the prescribed fire management program are the keys to successful adaptive management. The results of a monitoring program are used primarily to determine whether management objectives are being met. The results can verify that the program is on track, or conversely, provide clues as to what may not be working correctly.

Completing the process of data analysis and program evaluation is critical, because the role of monitoring is to gather information to guide the management program. The main purpose of this handbook is to provide valuable feedback for management; if this information is not used as a feedback tool, then the monitoring program will not have served its purpose. Without proper analysis, the monitoring data may at best be useless to managers, and at worst provide misleading information.

The success of a fire monitoring program is strongly dependent on the fulfillment of clearly defined responsibilities at all stages, including analysis and evaluation. The specific duties of management staff have been reviewed in Chapter 1 (page 4). Because the analysis and evaluation process is complex and critical to the monitoring program, the procedures outlined in this chapter should be performed or closely supervised by staff with background and experience in scientific analysis.

The steps involved in data analysis and program evaluation include:

- Document the analysis process
- Examine and quality-check the raw data
- Summarize the monitoring data
- Evaluate whether management objectives were met
- Adjust the fire monitoring program or management actions (if needed)
- Disseminate the results
- Review the monitoring program periodically

Prescribed fire program evaluation is the process by which monitoring becomes more than an exercise in data collection. It requires the coordinated efforts of fire management, resource management, and research expertise. At levels 1 and 2, the data are needed to guide decisions for ongoing fires. At levels 3 and 4, careful and prompt evaluation of short-term and long-term change data will provide information necessary to support and guide the prescribed fire management program by determining whether the program objectives are being met.

### LEVEL 3: SHORT-TERM CHANGE

Summarizing data to assess short-term change (see page 5) involves analysis of the variables specified by short-term change objectives. These objective variables were selected as the attributes measured to evaluate the management objectives. When you summarize short-term data you are essentially comparing the pre-burn and specified postburn conditions to evaluate the achievement of short-term objectives. In addition to summarizing data for each objective variable, you should also analyze all other measured variables to detect changes and identify any unexpected short-term results.

#### Example:

A short-term change objective in the sand pine scrub monitoring type is to reduce mean shrub cover to 30–50% one year postburn. In this case, the one year postburn shrub cover data would be analyzed for all the plots in the sand pine scrub monitoring type to determine whether the mean falls within the 30–50% range. Trend analysis from other measured variables can be examined for desirable or undesirable trends, e.g., an increase in the mean non-native species cover in the understory.

### LEVEL 4: LONG-TERM CHANGE

Evaluating the prescribed fire program’s long-term success is difficult because long-term change (see page 5) objectives often do not exist, or if they do exist, they

often are not specific or measurable. Yet the long-term outcome is the basis for measuring the attainment of broad goals and the success of a prescribed fire management program. For example, where the long-term goal is to restore the natural conditions and processes to an area, knowing that the program met a fuel reduction objective two years postburn is meaningless if the area is never burned again and eventually reverts back to unnaturally heavy fuel load conditions.

Monitoring long-term change is essential for detecting undesired effects of management activities. Therefore, the data analysis, interpretation, and response associated with long-term change requires special attention. Although monitoring plots are designed to quantify the extent of change from preburn conditions, the complex interaction of ecological processes (including fire, succession, herbivory, competition, disease, and climate change) makes the results of long-term change difficult to interpret. In assessing long-term change, data from unburned plots outside this monitoring system, e.g., inventory and monitoring plots, can be especially useful.

**Example:**

A long-term change objective in the mixed-grass prairie monitoring type is to increase the mean native species percent cover by at least 20% after three prescribed fire treatments occurring every 3–8 years. Here, the postburn percent cover data would be analyzed for all the plots in the mixed-grass prairie monitoring type after they were burned three times to determine whether the mean native species percent cover had increased by at least 20%.

Due to the complex nature of non-native species invasion in which many factors may be involved, information on native/non-native species percent cover in similar areas that have not been burned would be useful for comparison, especially if the objective was not met.

Sound management judgment, based on broad review and in-depth knowledge of local ecology, is essential for identifying long-term trends. Trends may be easy to recognize (influx of non-native plants, high mortality of one species) or complex and subtle (changes in stand structure, altered wildlife habitat, or insect or disease infestations). It is essential that managers remain familiar with the character of the monitoring type throughout its range in order to maintain sufficient breadth of context for interpretation of long-term

trends. Joint review of long-term data by fire, research, and resource personnel will help identify and define trends.

# The Analysis Process

## DOCUMENTATION

The analysis process can be complex; therefore, documenting the steps in the process is important so that the reasoning behind the decisions made along the way is clear. Documentation should be clear and thorough enough so that **someone else** can repeat the process used to obtain results, and verify or refine the interpretation of those results. The long-term data will be used for many years. In the future, someone will need to understand how the monitoring results were obtained and how decisions were made based on those results.

### Data Analysis Record (FMH-26)

A form to document the analysis process has been designed to complement the fire monitoring program and provide a link between the management objectives, the raw data, and the results. The Data analysis record (FMH-26) has space for a discussion of the outputs relative to the management and monitoring objectives. This form will help document the analysis process so that the results can be verified and repeated if necessary.

### Data Analysis Record



- Store the Data analysis record (FMH-26) together with all graphs and analysis output sheets and the Monitoring type description sheet (FMH-4).
- Document program changes directly on the Data analysis record or in another format and store in a clearly labeled binder that is easily accessible to managers.

### Program Changes

In addition to documenting the analysis process, you should document any resulting modifications that were made to the monitoring or management program. These modifications may include changes to monitoring protocols, burn prescriptions, treatment strategies, or objectives.

### Program Changes



The historical record of any program changes is critical for understanding the evolution of knowledge and management actions over time. This documentation may be needed at some point in the future to demonstrate that the course of the management program followed a logical progression validated by the monitoring data.

### EXAMINING THE RAW DATA

Before you summarize the data, you will find it helpful to examine the data for each individual plot. Graphs of the objective variable values for each plot can reveal patterns that are not apparent from descriptive statistics such as the mean and the standard deviation. For example, Figure 36 shows four samples each with a sample size of five plots, and each with a mean of 100. Without a graph of the data, one might assume from the means that the data from the four samples were identical.

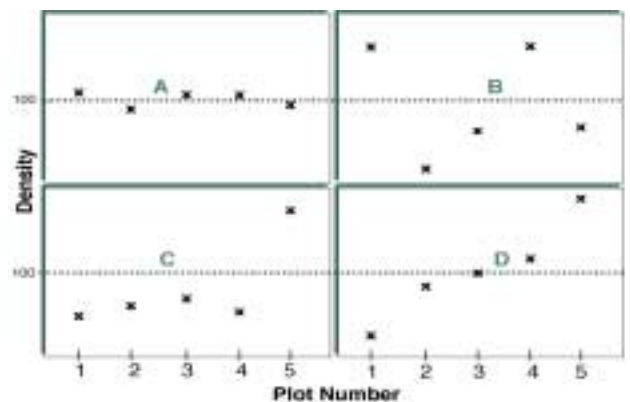

Figure 36. Four samples each with a sample size of five plots, and each with a mean of 100.

Graphically displaying the values for each plot is one way to check data quality. Extreme plot values that might not be apparent from the mean value may be obvious from the graphic display of each plot's values. If you find an extreme value, check the database and raw data sheets for errors.

In addition, some types of inferential statistical tests assume that the data are normally distributed, in what is often referred to as the standard normal distribution

or 'bell-shaped' curve. A graph of the individual plot data will show whether this assumption has been met or whether the data distribution is skewed. For further information regarding the standard normal distribution, see any statistics text (e.g., Norman and Streiner 1997, Zar 1996).

## SUMMARIZING THE DATA

After all plots within a monitoring type burn, and data have been collected for the entire sample, summarize the results so that they can be interpreted. To summarize the data, you can use descriptive statistics to reduce many observations (many plot values) to a single number that describes the sample as a whole. The sample mean is a frequently used statistic that describes the central tendency of the sample, or the average of all plot values for a variable. The sample mean is used as an estimate of the population mean. If the data are not distributed normally, consider using other measures of central tendency, e.g., the median or the mode (see any statistics text for definitions). It is customary to report the sample mean along with some measure of variability.

### Reporting Data Variability

Since the sample mean is only an **estimate** of the true population mean, reporting the sample mean values without saying something about how good the estimate is likely to be is inappropriate (the danger is that people may assume that the sample mean *is* the population mean, when it is really only an estimate).

As stated above in the section on examining raw data, displaying all the individual plot data in a graph is useful to **visually** depict the differences among plots. You should also use one of several measures, either the standard deviation, standard error, or confidence intervals, to **numerically** report the variability in the results.

### ***Standard deviation—variability in the data collected***

To report the variability among plot values in the sample, calculate the standard deviation. This measures how well the average value describes individual observations in the sample. This measure of variability, or dispersion, will tell you whether the observations are very close to the mean or whether many of them are quite different (Figure 37).

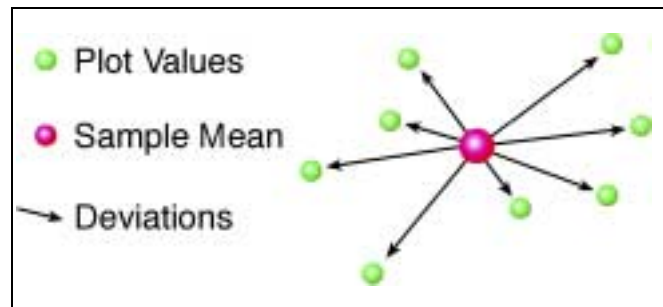

Figure 37. Standard deviation is generally an average of the lengths of all the arrows (distances from the sample mean).

**Standard deviation** is a measure of the distribution (spread) of observations (plot values) in a sample from the sample mean. It is the variability of the data expressed by taking the square root of the variance (which is the sum of squares of the deviations from the mean). If the data are distributed normally (have a shape like the normal distribution), then approximately 68% of the observations will fall within one standard deviation of the sample mean and approximately 95% of the observations will fall within two standard deviations of the sample mean.

A large standard deviation value (high variability) could indicate an error in the data (see page 131), or that the data are truly highly variable. Highly variable data could have one or more implications: more plots may need to be installed, the method used to collect the data may not be the most appropriate, and/or the variable measured is patchy across the area sampled.

To calculate the standard deviation, you need the following inputs:

- Values for each observation (plot)
- Mean of the sample (mean of plot values)
- Number of plots in the sample

The FMH software calculates standard deviation. For the formula to calculate the standard deviation, see page 216 in Appendix D.

### Example:

Three monitoring plots located within a particular burn unit have preburn 1,000-hr fuel loads of 18.5, 4.2, and 6.7 kg/m<sup>2</sup> respectively. Therefore, the mean  $\pm$  one standard deviation is  $9.8 \pm 7.6$  kg/m<sup>2</sup>. The summary results are not used to make generalizations to the burn unit or monitoring type as a whole, but simply to show what the mean and variability is for the 1,000-hr fuels in the three plots. The standard deviation of 7.6 indicates that the variability in 1,000-hr fuel load among the three plots is high (almost equal to the mean of 9.8). In this example, the individual plot values are very different from each other and vary greatly from the mean value of 9.8 kg/m<sup>2</sup>.

### **Standard error—precision of the mean**

Although in the design of the monitoring program the scientific method is used to obtain a random sample, any particular sample (collection of plots in a monitoring type) is just one of many possible samples. One random sample of 10 plots would likely give different results than another random sample of 10 plots; additionally, a sample of three plots would have different results than a sample of 300 plots. Standard error is a measure of the variability related to the fact that only a portion of the entire population is sampled.

If many different samples were taken, each consisting of the same number of plots, the **standard error** is a measure of how close the sample means are likely to be to the true population mean, or what is known as the 'precision of the mean.' Standard error is the variability of the **theoretical** distribution of the sample means for a given sample size. The shape of the distribution of possible sample means changes depending on sample size. The larger the sample size, the closer the sample mean is likely to be to the true population mean; therefore, standard error is directly related to sample size (see Figure 38).

Based on these theoretical distributions of sample means, if many samples of the same size were taken, then approximately 68% of the sample means would fall within one standard error of the true population mean, and approximately 95% of the sample means would fall within two standard errors of the true population mean.

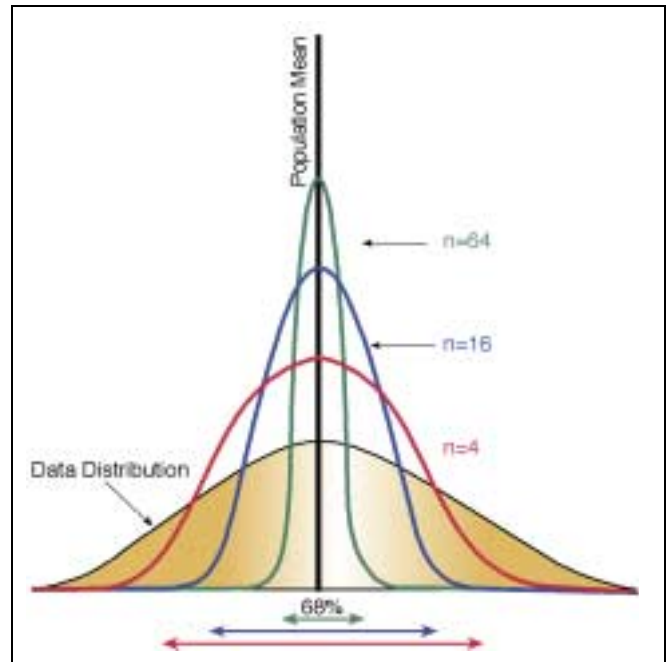

**Figure 38. Three sampling distributions (of different sample sizes) with the same mean.**

This figure illustrates how standard error decreases as sample size increases.

To calculate the standard error, you need the following inputs:

- Standard deviation of the sample
- Number of plots in the sample

The standard error is the default measure of variability calculated by the FMH software. See page 218 in Appendix D for the formula to calculate the standard error.

### Example:

In the tallgrass prairie, 12 monitoring plots were established. The native perennial grass mean relative cover  $\pm$  one standard error is  $48.8 \pm 3.4\%$ . This standard error means that if many samples of 12 plots were taken, approximately 68% of the sample means would fall within  $\pm 3.4\%$  of the true population mean for relative cover (and approximately 95% of the sample means would fall within  $\pm 6.8\%$  of the true population mean).

**When to use standard deviation vs. standard error**  
**Use standard deviation to report the variability of the data itself**—i.e., the variability among plots in the sample.

**Use standard error to express the precision of the mean**—i.e., the closeness with which the sample mean estimates the true population mean.

The decision of which measure of variability to use is not critical, as long as you **report which one you are using**; standard deviation and standard error can be derived from each other as long as you know one of the two as well as the sample size.

### ***Confidence intervals—precision of the mean with stated level of confidence***

While standard error is an estimate of the precision of the sample mean, confidence intervals provide added information about variability by using the standard error along with a stated level of confidence. The **confidence interval** is a range of values for a variable which has a stated probability of including the true population mean.

To calculate the confidence interval, you need the following inputs:

- Mean of the sample
- Standard error
- Desired confidence level (80, 90, or 95%)
- Critical value of the test statistic student's t (two-tailed), based on the selected confidence level (80, 90, or 95%) and the degrees of freedom (number of plots - 1); the values used by the FMH software can be found on page 220 in Appendix D

The FMH software calculates confidence intervals. For the formula to calculate the confidence interval, see page 219 in Appendix D.

#### **Example:**

Three plots show varying values for seedling tree density: 120, 360, and 270 seedlings/ha, with a standard error of 70. The confidence interval is expressed as a range and probability; therefore, there is an 80% probability that the true population mean value for seedling tree density is between 118 and 382 seedlings/ha. Alternatively, you could state that the 80% confidence interval is  $250 \pm 132$  seedlings/ha.

---

## **Summarizing Results**



When summarizing results, always report the mean with some measure of variability (either standard deviation, standard error, or confidence interval), state which measure of variability was used, and be sure to include the sample size (number of plots).

## **RECALCULATING THE MINIMUM SAMPLE SIZE**

Once all of the plots in a monitoring type have burned and monitoring has been conducted throughout the postburn time period of interest (as determined by your objectives), recalculate the minimum sample size needed. Determining the number of plots needed to achieve the desired certainty in the specified postburn results should be done in one of two ways, depending on the type of management objective: change (see page 25) or condition (see page 26).

To assess, as early as possible, whether more plots will be needed, you can perform this calculation after some of the plots (3–5) have reached the postburn time interval rather than waiting for all plots to reach the time interval.

### **Condition Objectives**

To determine whether you have installed the number of plots sufficient to assess the postburn target or threshold objective, you should recalculate the minimum sample size after the plots have burned and reached the appropriate postburn time interval (as determined by your management objectives). Use the same formula (see page 216, Appendix D) used for the preburn plots (see page 49 for discussion) to determine the appropriate number of plots needed. Your chosen confidence and precision levels should remain the same as they were in the initial minimum sample size calculation unless your monitoring objectives have changed for some reason.

If the variability in the postburn data is about the same or lower than the preburn data variability, it is unlikely that more plots will be needed. You may need to install more plots if the postburn data variability is higher than the preburn data variability.

### **Change Objectives**

Once the appropriate number of plots have been installed, burned, and measured at the postburn time interval (specified by your management objectives), a separate calculation will reveal whether you need to install more plots to detect the desired amount of change. For the formula to calculate the minimum sample size for minimum detectable change (MDC) desired, see page 217 in Appendix D.

If the variability in the **differences** between preburn and postburn data is about the same or lower than the preburn data variability, it is unlikely that more plots

will be needed. You may need to install more plots if the variability in the differences is higher than the pre-burn data variability.

---

### Minimum Sample Size for Minimum Detectable Change (MDC)



This formula is a critical new addition to this handbook. For change objectives, calculate the minimum sample size for the minimum detectable change you desire before you fully evaluate whether you have met your objectives.

---

For both condition **and** change objectives, if you determine that more plots are needed after recalculating minimum sample size, install any necessary additional plots in areas of the monitoring type that have not yet burned. If unburned areas no longer exist for the monitoring type, then the current number of plots must suffice and results should be presented with the appropriate level of certainty.



## Additional Statistical Concepts

---

In some cases you may want to perform additional statistical analyses. Several considerations may affect how such analyses are performed, therefore, you should at least be aware of how they might affect the monitoring program results.

### HYPOTHESIS TESTS

In addition to descriptive statistics (e.g., means and measures of variability) and basic inferential statistics (e.g., confidence intervals), hypothesis tests (also known as significance tests) can be performed on monitoring data. These tests are used to assess the actual probability that the sample results were obtained due to chance (as a result of random variation). The concept of hypothesis testing is only briefly and generally discussed here. Examples of hypothesis tests include analysis of variance (ANOVA), chi-square, McNemar's test, paired t-test, repeated measures ANOVA, and Wilcoxin's signed rank test. Review statistical texts (e.g., Norman and Streiner 1997, Zar 1996) for specific information on these tests.

A hypothesis is a proposed statement or theory that provides a basis for investigation. A management objective is like a hypothesis in that it makes a statement that a particular condition or threshold is met, or that some type of change from the current condition occurred. This statement or objective is used as a basis for comparing the data observed. A statement of no difference is called the null hypothesis. In the fire monitoring program, the null hypothesis is usually that a condition or threshold was not met, or that no change in a particular objective variable has occurred over a preselected period of time.

A significance (hypothesis) test is "a procedure for measuring the consistency of data with a null hypothesis" (Cox 1977). The result of a hypothesis test is that the null hypothesis is either rejected or not rejected. If it is likely that the sample results occur reasonably often in the population (based on estimates of variability in the population), then there is no reason to reject the null hypothesis. If only a small probability exists of obtaining the sample results by chance, then the null hypothesis is rejected. A one-sample hypothesis test is one in which the results are compared with a hypothesized value (e.g., comparing a postburn variable mean with a desired mean value); a two-sample test is one in which two sets of results are compared to determine if

there is a difference between them (e.g., comparing preburn and postburn variable means).

In the context of monitoring, hypothesis tests assess the probability that the results indicate a management objective was met (as opposed to the results being due to chance). If the hypothesis test concludes that the observed mean, or change in the mean, of the variable is not due to random variation, then the null hypothesis is rejected in favor of an alternate hypothesis: the mean value is different from the hypothesized condition or a change has occurred in the mean of the variable.

#### Example:

The **management objective** in the ponderosa pine forest monitoring type is to reduce live pole-size tree density to less than 300 trees per hectare within two years postburn. The **null hypothesis** is that the year-2 postburn live pole-size tree density is greater than or equal to 300 trees per hectare. A test to determine whether the null hypothesis is rejected would be performed.

or,

The **management objective** in the sagebrush steppe monitoring type is to increase the mean percent cover of native herbaceous species by at least 20% by 10 years postburn. The **null hypothesis** is that the year-10 postburn mean percent cover of native herbaceous species is less than 20% greater than the preburn percent cover, and a test to determine whether to reject the null hypothesis could be performed.

---

### Significance Level ( $\alpha$ )

Because hypothesis tests assess the **probability** that the results were obtained by chance, we need another criterion to quantify the acceptable probability, thus to indicate whether to reject the null hypothesis. This criterion, called the level of significance, or  $\alpha$  (alpha), is the probability that an apparent difference occurred simply due to random variability.

The significance level ( $\alpha$ ) must be determined before the hypothesis test is performed;  $\alpha$  is equal to one minus the confidence level, which is chosen during the design of the monitoring program before any data are

collected (see page 27). For example, if the confidence level chosen is 90%, then the significance level for a hypothesis test is 10% ( $\alpha = 0.10$ ), and a probability of obtaining the results due to chance less than 10% would result in a rejection of the null hypothesis. It is important to note that the significance level is not the probability that the null hypothesis is true.

### Two Ways To Be Wrong

With a hypothesis test, either of two clear conclusions can result: 1) the test indicates that the results are not likely to be due to chance (hence a real difference exists or a real change has occurred), or 2) the test indicates that the results are likely due to random variation (thus a real difference does not exist or a real change has not occurred). It is also possible that each of these conclusions are either right or wrong (due to insuffi-

cient sample size, poor monitoring design, or inappropriate statistical tests). The combinations of all of these possible conditions yield four potential outcomes of hypothesis testing or monitoring for change. Two of the possibilities are **correct** conclusions: 1) a condition or threshold was not met or no change occurred and it was not detected; and 2) a condition or threshold was met or a real change occurred and it was detected (Figure 39).

Two of the possibilities are **incorrect** conclusions or errors: 1) a condition or threshold was not met or no change occurred but the monitoring detected a change or difference in condition; known as a Type I (or false-change) error; and 2) a condition or threshold was met or a real change occurred but it was not detected; known as a Type II (or missed-change) error.

	Null hypothesis is true: A condition or threshold was not met or no change occurred	Null hypothesis is false: A condition or threshold was met or a real change occurred
Null hypothesis rejected: Monitoring detects a difference or change	Type I Error (false-change)  probability = $\alpha$ (significance level)	Correct (no error)  probability = $1-\alpha$ (confidence level)
Null hypothesis accepted: Monitoring does not detect a difference or change	Correct (no error)  probability = $1-\beta$ (power)	Type II Error (missed-change)  probability = $\beta$

Figure 39. The four possible outcomes of hypothesis testing.

#### Type I error (false-change error)

Type I (false-change) error is comparable to a false alarm. The monitoring program detects a difference in condition or a change in an objective variable but the difference or change that occurred was due to random variability. This type of error can lead to the conclusion that the management objectives were met using prescribed fire, but in fact, the same the results could have been obtained due to chance. Alternatively, an unwanted change or difference might be detected (e.g., an increase in a non-native species) when no real change took place, resulting in an unnecessary adjustment to the prescribed fire program.

The probability of making this type of error is equal to  $\alpha$  (the significance level), which is equal to one minus the confidence level chosen. For example, for a confidence level of 80%,  $\alpha$  is 20%, meaning that a false-change error is likely to occur approximately 20% of the time (or one in five times).

#### Type II error (missed-change error)

Type II (missed-change) error is analogous to an alarm that is not sensitive enough. The monitoring program does not detect a difference in condition or a change in an objective variable, but in fact, a difference or a change has taken place. This type of error may be critical, as it can mean that an unwanted decrease in a favored species, or an unwanted increase in non-native plants, goes undetected following prescribed fire application. Alternatively, the management objective may have been effectively achieved, but the results from the monitoring program would not substantiate the success.

The probability of making this type of error is equal to  $\beta$  (beta), a value that is not often specified but that is related to statistical power.

#### Power

Statistical power is the probability of rejecting the null hypothesis when it is false and should be rejected. In other words, power is the probability of detecting a change when a real change (not due to random vari-

ability) has occurred. Power is equal to one minus power ( $1-\beta$ )—the probability of making a missed-change error. For example, if the power of the statistical test is 90%, then a missed-change error is likely to occur 10% of the time. Conventionally, the minimum level of power should be at least 80% (Cohen 1988), or it should be equal to the confidence level (Peterman 1990).

Power is inversely proportional to the level of significance for a given sample size. To simultaneously increase power, or the probability of detecting a real change ( $1-\beta$ ) while decreasing the probability of committing a false-change error ( $\alpha$ ) you must either increase the sample size or decrease the standard deviation (see Figure 40). For change objectives, you choose the level of power for calculating the minimum sample size needed to detect the minimum amount of change desired. Additionally, if you performed a hypothesis test and it failed to reject the null hypothesis, you can calculate power to determine the monitoring program's ability to detect a real change (and the probability that a Type II (missed-change) error occurred).

## INTERPRETING RESULTS OF HYPOTHESIS TESTS

After you have performed a hypothesis test you can interpret the results by following a series of steps. These steps are summarized in Figure 41. For results that reject the null hypothesis, it is important to calculate the power of the test to determine the monitoring program's ability to detect change. Once again, consult a statistician for advice if you have any questions about the statistical tests and interpretation of the results.

### Pseudoreplication

Pseudoreplication is the use of inferential statistics to test for treatment effects with data where treatments are not replicated (though observations may be) or replicates are not statistically independent (Hurlbert 1984). Pseudoreplication occurs, for example, when all of the plots from a particular monitoring type are located in one burn unit, and inferences about the burn program in general (i.e., a treatment effect), rather than the effects of one particular fire, were made from the data.

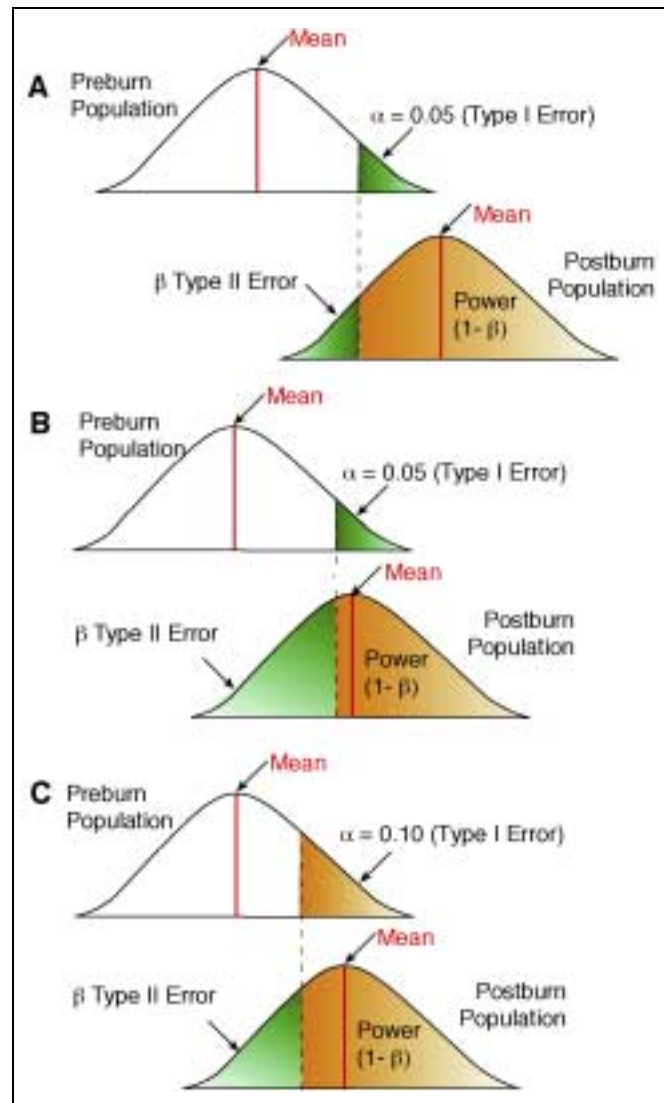

**Figure 40. Influence of significance and power for three normally distributed populations.**  
 A) A large difference in means between the preburn and postburn population results in both a high level of power and a low probability of Type I and Type II errors. This is ideal. B) A smaller difference in means results in low power with a higher probability of Type II error. C) Using a higher level of significance substantially increases the power.

Ideally, plots would first be placed randomly across the entire landscape and then treatments randomly assigned to avoid the problem of pseudoreplication. Within the constraints of a fire management program, however, this type of design is usually not feasible. If pseudoreplication is a serious problem in the sampling design, and is not acknowledged, improper analyses or data misinterpretation can result. See Irwin and Stevens (1996) for a good overview of this often confusing concept. Consult a statistician to determine if pseudoreplication may affect the analysis of a particular monitoring program dataset.

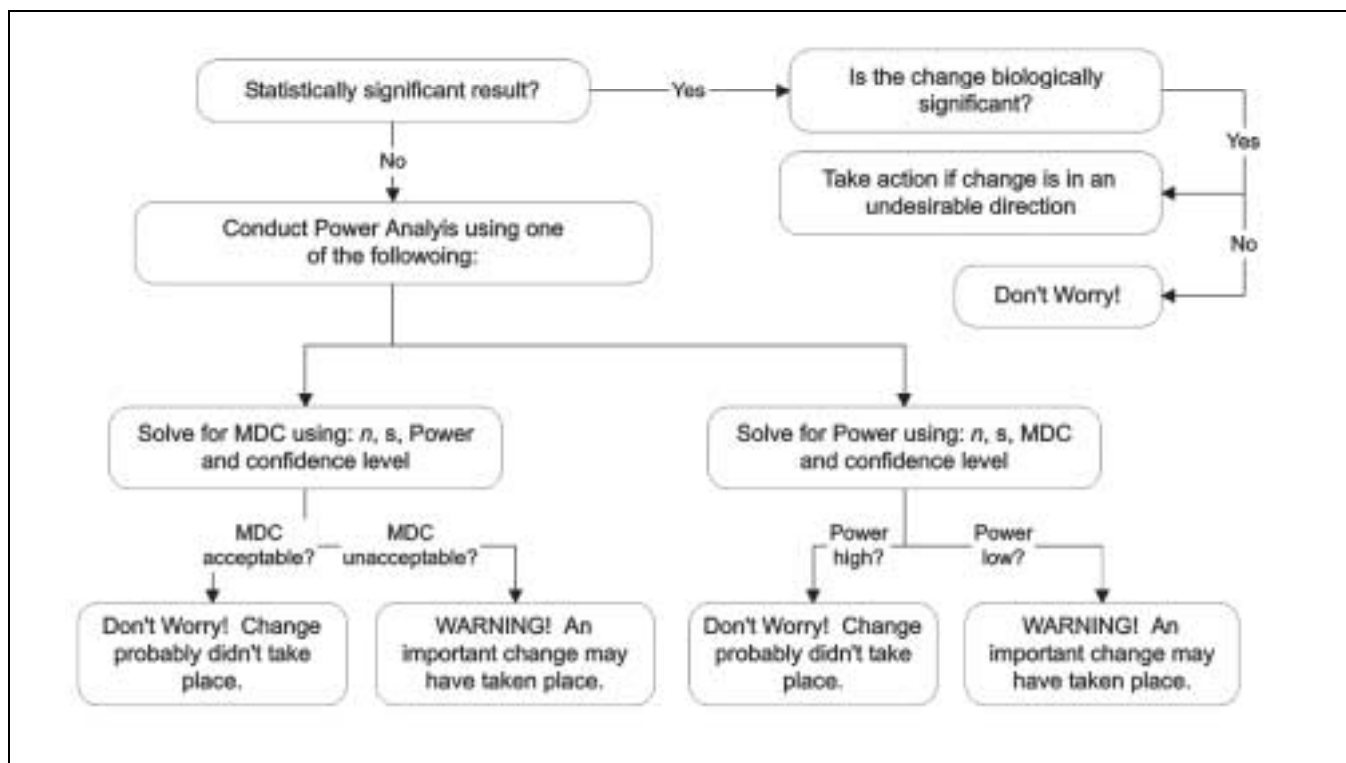

Figure 41. Steps in interpreting the results of a change over time statistical test. Modified from Elzinga and others (1998).

### Autocorrelation

All monitoring programs need to address autocorrelation during the sampling design period. Data that are autocorrelated are not independent over space or time and **therefore are more difficult to analyze**. For example, spatial autocorrelation can occur if plots are placed so close together that the plots tend to record similar information. In this situation, the data may have an artificially low amount of variation. The fire monitoring program addresses spatial autocorrelation by using a restricted random sampling design to minimize the chance that plots will be located in close proximity to each other.

Temporal autocorrelation occurs when the same plots are repeatedly measured over time, such as in the permanent plot methods used in this handbook. The data from one year to the next are not completely independent of the data in preceding years.

### Example:

The preburn density of pole-size trees in one plot is 20 trees per hectare. Year-1 postburn, the pole-size tree density is 5 trees per hectare, a decrease of 15 trees per hectare. The density two years postburn will be limited by the fact that the year-1 postburn density is now only 5 pole-size trees per hectare; a further decline of 15 trees per hectare cannot occur. If the same plot were not remeasured from one year to next, the density would not be constrained by previous years' values. The decrease that occurred between preburn and year-1 postburn is likely to have an influence on the amount of change in future years. For this reason, special types of statistical tests are designed for use in permanent plot situations.

Autocorrelated data require special procedures to perform statistical tests. Consult a statistician for assistance in evaluating the extent of spatial and temporal autocorrelation in the data and the appropriate statistical tests that may be needed.

# The Evaluation Process

## EVALUATING ACHIEVEMENT OF MANAGEMENT OBJECTIVES

After all plots in a monitoring type (the sample) have been installed, burned, and remeasured at the appropriate postburn time interval, use the results to assess whether the management objectives were met using the following steps:

- Compare the results with the target conditions or desired change stated in the management objectives.
- Verify the results.

### Comparing Results with Management Objectives

In order to determine whether the management objectives were met, you must examine the monitoring results for the variable and time period of interest, and compare them to the objectives.

#### *Condition objectives*

If your objective specifies a postburn range of values, or a threshold value, for a variable, calculate the postburn confidence interval and determine whether it falls within the target range (or above or below the threshold).

#### **Example:**

The **management objective** is to maintain a density of live pole-size trees of 80–120 trees per hectare within two years postburn. The **monitoring objective** specified an 80% level of confidence in the results. The monitoring results indicate that the year-2 postburn live pole-size tree mean density  $\pm$  one standard error is  $92 \pm 5$  trees per hectare ( $n=14$  plots). Calculating the 80% confidence interval indicates that there is an 80% probability that the true population mean falls between 85–99 trees per hectare. The objective was met (with 80% confidence) because the confidence interval falls completely within the target range of 80–120 trees per hectare.

If the confidence interval falls completely outside the target range, or completely crosses the threshold value, then you can be certain (with the chosen level of confidence) that the objective was not met. If only part of the confidence interval crosses the threshold, or falls outside the target range, then you must be willing to acknowledge that the objective may not have been met because the true mean population value may fall out-

side the range desired (or may have crossed the threshold), even if the mean value is within the target range.

#### **Example:**

Using the same management and monitoring objectives as in the above example, you find that the year-2 postburn live pole-size mean density is 92 trees per hectare, but the standard error is  $\pm 10$  trees per hectare ( $n=14$  plots). The 80% confidence interval would then be 78–106 trees per hectare. The objective was met on the upper end of the range (less than 120 trees per hectare), but not on the lower end because the true population mean may be between 78–80 trees per hectare. Even though the mean value of 92 falls within the target range of 80–120, in this case, you must decide whether or not you can accept that the true population mean may actually be 78–79 trees per hectare.

The more the confidence interval falls outside the target range or falls above or below the threshold, the greater the possibility that the true population mean may not meet the objective condition. In order to narrow the confidence interval, you must either reduce the variability in the data, increase the sample size, or lower the confidence level (see page 27 for further discussion of this topic).

#### *Change objectives*

If a change from preburn conditions was specified in the management objective, then you must compare the preburn and postburn time interval results. Because the same plots are being measured over time (permanent plots), the pre- and postburn results are not independent and must be treated differently than if they were independent. You should therefore calculate the difference between preburn and postburn values **for each plot** and then calculate a mean of these differences. If the change is specified in terms of a percentage, you must calculate the percent change **for each plot** and then calculate the mean percent change. You can then calculate a confidence interval for the mean of the differences or the mean percent change to see if the confidence interval falls within the range of change desired.

### Example:

The **management objective** is to reduce the mean percent cover of live shrubs by 30–60% within one year postburn. The **monitoring objective** specifies that 80% confidence in detecting a 30% minimum change was desired. The mean of the differences between preburn and year-1 postburn mean live shrub percent cover  $\pm$  one standard error for 11 plots was  $21 \pm 4\%$ . The 80% confidence interval is, therefore, 15–27% cover. The objective was not achieved because the amount of change (15–27%) falls completely outside the target range of 30–60%.

If the confidence interval falls completely within the target range specified in the objective, then the objective was met with that level of confidence. If only part of the confidence interval falls inside the target range, then you must be willing to acknowledge that the objective may not have been met, because the true mean population value may fall outside the range desired even if the mean difference or mean percent change falls within the target range.

### Appropriate Statistical Tests



To determine the probability that the data suggest that your objectives were achieved due to natural variability in the data and not due to real change, you will need to perform a statistical test appropriate for the type of objective and data distribution. Seeking assistance with these statistical analyses is highly recommended; the tests and associated assumptions may be complicated. **Use caution—performing an inappropriate test may cause managers to make misleading conclusions about the results.**

### Verifying Results

Regardless of whether the objectives were met, be sure that the results were not obtained due to errors at some point during the process. To determine if faulty results were obtained, take the following steps:

- Check for data entry or raw data errors (see pages 114–117)
- Verify that the burn or treatment prescription conditions were met on all plots
- Ensure that the data analyses were run properly
- Look for extreme data values, which can contribute to large standard deviations in the summary results

- Review the fire behavior observations for each plot to check that the burn conditions were in prescription
- Step through the analyses to be sure that the appropriate outputs were obtained

If obvious data errors do not exist, the prescription conditions were met for all the plots, and the analyses were run properly, then the results are likely to be valid.

## EVALUATING MONITORING PROGRAM OR MANAGEMENT ACTIONS

### Responding to Desired Results

If the results indicate that your management objectives are being met, it is important to continue the monitoring and burning schedule as planned to be sure that further changes over time do not affect achievement of objectives. If you gain any new knowledge about a species or plant association, reevaluate the relevant objectives to see if the program should be adjusted based on the new information.

Although you may have achieved the current objectives, you should be sure that your management objectives consider the long-term outcome of repeated treatments. After carrying out two or three more prescribed burns in the monitoring type, will your objectives remain the same, or will the long-term target/threshold conditions change after the initial treatment? Well-formulated long-term objectives will help the fire management program progress in a timely, effective, and ecologically sound manner.

Achieving the desired results—and meeting your management objectives—is no simple task. If you have succeeded here, acknowledge the program accomplishment by sharing the results; it is important that you advertise your success by informally recording the results in a widely distributed report or by formally publishing the results (see page 134).

### Responding to Undesired Results

If your verified results indicate that management objectives have not been met, take the following steps to adjust the fire monitoring program or management actions:

- Examine the monitoring program design
- Evaluate the treatment strategy
- Reassess the management objectives
- Seek special assistance from experts

### ***Examining monitoring program design***

Determine whether the monitoring program was properly designed and implemented:

- Verify that the appropriate objective variables were selected to assess the objectives.
- Check to be sure that the data were collected properly for the variables of interest.

#### **Example:**

If the objective was to increase the density of native vs. non-native plants but only percent cover was measured, the data cannot indicate whether the objective was met. Alternatively, if the transect was not long enough to adequately measure percent cover of a sparsely distributed plant species, then it would be difficult to determine whether the objective for increasing the species' percent cover was met.

If you determine that a different objective variable is needed or that the method used to measure an objective variable must be changed, you must install a new set of plots for the monitoring type in areas that have not burned. If all areas in the monitoring type have already been burned, then you will not have the opportunity to attempt to assess objective achievement for the initial prescribed burn. New plots could be installed in the monitoring type, however, to determine whether objectives are met by subsequent burn treatments (repeat burns).

### ***Evaluating treatment strategy***

If the monitoring program design is valid, next determine whether the treatment strategy was adequate by taking the following steps:

- Assess whether the treatment prescription is capable of causing desired results.
- Decide whether the prescription parameters are simultaneously attainable for all objectives.
- Assess whether a change in treatment strategy might produce the desired results.

Tools are available for addressing some of these issues, including developing burn prescriptions that are likely to produce the desired effects. Some examples of predictive tools commonly in use today are RX WINDOWS; BEHAVE; FOFEM; and FARSITE. It is beyond the scope of this handbook to cover the use of these tools; for additional information, talk to your local or regional prescribed fire specialist.

You may be able to refine the treatment prescriptions by comparing the prescriptions you used with successful treatment programs (as described in the literature or by other programs). For example, the majority of the burn treatments may have occurred at the cooler end of the prescription and the burn prescription may be too wide at the cooler end. After you complete the prescription verification process, adjust the treatment prescription and start the monitoring type identification, data collection and analysis process cycle over again using the revised treatment prescription.

Inability to produce the desired results (meeting the objectives) may be due to a number of other treatment factors. After consulting with experts, carefully consider which actions are most likely to yield the desired results.

The treatment may be adjusted in a number of ways; for example:

- Change ignition pattern, intensity of fire application, or ignition technique (e.g., tandem torches vs. single torch, or helitorch vs. drip torch).
- Switch treatment season. **Use caution here.** This strategy can have dramatic consequences because of the sensitivity to disturbance (fire or other disturbance, e.g., mechanical treatment) of plant and animal species at different phenological or reproductive stages and because of large seasonal differences in site moisture regimes.
- Change the frequency of treatments by reducing or increasing the treatment intervals).
- Change the type or intensity of the treatment conducted in conjunction with prescribed fire, e.g., switch from mowing to grazing, or change the mowing height.

### **Treatment Prescription Modification**



Modifying the treatment prescription, e.g., changing the season of the burn, means that you must modify your monitoring type. Remember that the monitoring type is defined by the live vegetation and fuels present as well as the treatment prescription. If either is altered, you must create a new monitoring type to reflect the changes.

### ***Reassessing management objectives***

If the treatment strategy cannot be changed to achieve the desired results, examine the objectives themselves to:

- Decide whether the management objectives are valid.
- Determine whether the management objectives are achievable or whether conflicting objectives exist.

To determine the validity of an objective, make a realistic assessment of the current and target conditions. Decide whether the target conditions have ever existed in the treatment area or whether some of the objectives are unrealistic.

#### **Example:**

Increasing biomass productivity in a severely depressed natural system, or restoring native grasslands where the seed source is no longer available or the topsoil has been removed, may not be realistic objectives.

Perhaps the objective is not reasonable given current management constraints, or one objective may conflict with achieving another objective.

#### **Example:**

A burn prescription calls for spring burns to maximize smoke dispersal. The primary ecological objective is to achieve a mean 30-70% mortality of the pole-size trees within two years of treatment. It may not be possible to generate the level of mortality desired by burning in the spring. In this case, either the burn season may need to be changed (if the mortality objective is critical) or the mortality objective needs to be reassessed (if smoke dispersal in the fall would not be acceptable). Alternatively, methods other than fire may need to be considered to achieve the objectives given these and other constraints.

If an objective is not achievable, you have good reason to refine the objective(s). Upon review and consultation with appropriate specialists, you may revise the management objectives and you should then re-analyze the results to determine whether they meet the revised objectives.

### ***Seeking special assistance***

Subject-matter specialist assistance is advisable when:

- Results are questionable

- Controversial issues arise
- Unanticipated changes occur
- A special investigation (research) is necessary

Prescribed fire programs are based upon the precept that treatment by fire to meet management objectives is generally defensible as a result of prior investigations. If the monitoring data suggest otherwise, the foundation of the prescribed fire management program is in question. The purpose of the monitoring program is to recognize success **and** to discover and learn from errors at the earliest point in time. If the current management strategies are causing unexpected and undesired results, it is important to suspend burning in the affected monitoring type until you can determine a different approach.

#### **Example:**

Winter prescribed burning was carried out to reduce fuel and maintain the overstory for 20 years, without monitoring, before a gradual and irreparable change in the species composition and structure of the understory was noticed (an increase in a noxious non-native). If a monitoring program had been in place, this type of change may have been detected earlier and the burn prescription could have been changed before irreparable harm had occurred.

Expert advice can help you thoroughly explore all possibilities and suggest reasons for the results. Document any such exploration and the logic behind each reason. Seek input from subject-matter experts, especially those who understand fire or disturbance ecology, have knowledge about the particular species or plant association, and/or have knowledge about fire behavior and effects. Places to find special assistance include:

- The Fire Effects Information System (FEIS) (USDA Forest Service 2001)
- Other staff members, especially resource managers, botanists, fire and/or plant ecologists
- USDA research and experiment stations
- USGS scientists
- Subject-matter experts from universities and the private sector
- Library reference or Internet searches

If monitoring results are confusing or equivocal, initiating a more specific research project may be the best management alternative. When monitoring results suggest a fundamental problem, follow-up research projects must be initiated; these studies should be



designed by professionals and may take time to generate defensible and reliable results.

### ***Undesired long-term change***

As with undesired short-term results, management response to undesired long-term change must be based on informed projections and evaluation of trends. You must determine whether the change will affect untreated areas or shift balances in ways that may threaten the integrity of the system. Most importantly, you must determine the ecosystem and management trade-offs of ignoring the change.

#### **Example:**

- Is it acceptable to convert shrubland to grassland?
- Is it acceptable to lose a fire-adapted plant community type such as pitch pine-scrub oak barrens or pinon-juniper forest because the natural fire regime threatens human values?

---

Fire-induced ecosystem alterations can have far-reaching implications; therefore, scientific input from the broadest possible spectrum is strongly recommended. Once you have recognized undesired long-term change, take the following steps:

- Determine the mechanism by which the change is manifested. Trends may be quite subtle and may require research to determine 1) whether the change is real, i.e., not likely to be due to random variability in the system, and 2) if the change is caused by prescribed fire.
- Identify the appropriate modifications to the management program. Proper action may include research or modification of program protocols. Continued burning must be informed. If unacceptable trends are occurring, the burn program should be suspended until research provides mitigating management options.

### **DISSEMINATING RESULTS**

A critical step in the adaptive management feedback loop is distributing the results of a monitoring program in a timely and useful manner. These results are the primary indicator of the success of the prescribed fire management program and must be shared widely. Avenues for dissemination include written reports, staff meetings, and external publication.

### **Annual Report**

Results should be reported each year data are collected as part of a park's annual report. The benefits of analyzing the data every year are:

- The field work was done recently. Analysis tends to reveal sampling-related problems, therefore, any problems can be addressed in the subsequent field season rather than after collecting data for many years.
- The monitoring program can be assessed periodically. Problems that did not come up during the pilot study period can be examined.
- Managers get feedback on a regular basis (a critical part of the adaptive management process) to help assess the progress of the prescribed fire program.

To facilitate the use and sharing of this information, this report may have a standardized format that is used from year to year and from park to park. In addition to the written report, conducting a meeting with all appropriate resource and fire management staff on an annual basis is very helpful for discussing monitoring results and future plans.

### **Formal Monitoring Report**

Once all the plots within a monitoring type have been burned and data have been collected for the time period specified in the management and monitoring objectives, summarize the results in a formal monitoring report. At a minimum, this report should contain:

- A summary of the results, including tables and graphs (with error bars), as well as any interesting trends
- Interpretation of the results, with a list of potential causes for the observed results, implications of these results, and sources of uncertainty in the data
- Assessment of the monitoring study, with a discussion of the efficiency of the methodology, and any recommended changes in methodology
- Recommended changes in the monitoring or management programs

Combined with an executive summary of the monitoring plan, such a report provides a complete picture of the monitoring program. The creation of this document is important for use in the management feedback loop. The formal report may also include more in-depth investigation, analysis, and synthesis of information, including integration with other ongoing research and resource management programs in the park and surrounding lands.

## **External Publication**

In addition to internal reports, you should consider sharing your results with a wider audience through symposium or conference proceedings, poster presentations, or technical publications. Such venues expand the audience for the information, and can assist others doing similar work by sharing protocols, results, and lessons learned. Publication also contributes to personal and professional growth and increases the credibility of the park and the agency.

## **REVIEWING THE MONITORING PROGRAM**

To ensure program integrity, the effectiveness of a park's fire monitoring program must be periodically reviewed at all levels (park, region, service-wide) and by various people (including field technicians, park staff, regional staff, and non-agency scientists). A written evaluation resulting from the review will be distributed to all interested persons. A review should be scheduled if questions have been raised about the effectiveness of the monitoring program, personnel have changed, the management program changes (e.g., changes in treatment prescriptions or the addition of new monitoring types), a particularly sensitive issue must be addressed by monitoring, or a review is requested by program staff.

The purpose of the program review is to:

- Evaluate progress to date
- Review and revise, if necessary, the goals and objectives of the management program
- Determine whether the level of certainty in the results is appropriate
- Review field methods, data processing procedures, reports and publications

An independent review of the national fire monitoring program (by interagency and other scientists, resource managers, and fire ecologists) may also occur as determined by NPS-NIFC or the regional office.



# A

# Monitoring Data Sheets

*"What we observe is not nature itself, but nature exposed to our method of questioning."*

—Werner Heisenberg

FMH-1	Onsite Weather Data Sheet
FMH-1A	Alternate Onsite Weather Data Sheet
FMH-2	Fire Behavior–Weather Data Sheet
FMH-2A	Alternate Fire Behavior–Weather Data Sheet
FMH-3	Smoke Monitoring Data Sheet
FMH-3A	Alternate Smoke Monitoring Data Sheet
FMH-4	Monitoring Type Description Sheet
FMH-5	Plot Location Data Sheet
FMH-6	Species Code List
FMH-7	Forest Plot Data Sheet
FMH-8	Overstory Tagged Tree Data Sheet
FMH-9	Pole-size Tree Data Sheet
FMH-10	Seedling Tree Data Sheet
FMH-10A	Alternate Seedling Tree Data Sheet
FMH-11	Full Plot Tree Map
FMH-12	Quarter Plot Tree Map
FMH-13	Alternate Tree Map
FMH-14	50 m <sup>2</sup> Tree Map
FMH-15	50 m Transect Data Sheet
FMH-16	30 m Transect Data Sheet
FMH-17	Shrub Density Data Sheet
FMH-17A	Alternate Shrub Density Data Sheet
FMH-18	Herbaceous Density Data Sheet
FMH-19	Forest Plot Fuels Inventory Data Sheet
FMH-20	Tree Postburn Assessment Data Sheet
FMH-21	Forest Plot Burn Severity Data Sheet
FMH-22	Brush and Grassland Plot Burn Severity Data Sheet
FMH-23	Photographic Record Sheet
FMH-24	Quality Control Checklist
FMH-25	Plot Maintenance Log
FMH-26	Data Analysis Record



FMH-1

ONSITE WEATHER DATA SHEET

Page \_\_\_ of \_\_\_

Plot ID: \_\_\_\_\_

Burn Status (Indicate number of times treated, e.g., 01 Burn, 02 Burn, etc.): \_\_\_\_\_-Burn

Burn Unit/Fire Name-Number: \_\_\_\_\_

Recorder(s): \_\_\_\_\_

Circle Units for: Wind Speed (mph, m/s) Dry Bulb Temperature (°F, °C)

Obs. Date	Obs. Time	Wind Speed	Wind Dir.	D. B. (°)	R. H. (%)	Location / Comments

Date Entered: \_\_\_ / \_\_\_ / \_\_\_

Park/Unit 4-Character Alpha Code: \_\_\_\_\_

**FMH-1A**

**ALTERNATE ONSITE WEATHER DATA SHEET**

Page \_\_\_\_ of \_\_\_\_

Plot ID: \_\_\_\_\_

Burn Status (Indicate number of times treated, e.g., 01 Burn, 02 Burn, etc.): \_\_\_\_\_-Burn

Burn Unit/Fire Name-Number: \_\_\_\_\_

Recorder(s): \_\_\_\_\_

Circle Units for: Wind Speed (mph, m/s) Dry Bulb Temperature (°F, °C)

Date	Time	Location	Elevation	Aspect	*State of WX	Temperature		RH	Wind Speed	Wind Direction	**Comments
						Dry Bulb	Wet Bulb				
*Codes State of the Weather:		0-clear, <10% cloud cover	1-10–50% cloud cover						**Comments include:		
2-broken clouds, 60–90% cloud cover		4-fog	6-rain		8-showers				- ppt amount/duration		
3-overcast, 100% cloud cover		5-drizzle or mist	7-snow or sleet		9-thunder-storm				- erratic winds		

**FMH-2 FIRE BEHAVIOR-WEATHER DATA SHEET**

Page \_\_\_\_ of \_\_\_\_

Plot ID: \_\_\_\_\_

Date: \_\_\_\_ / \_\_\_\_ / \_\_\_\_

Burn Status (Indicate number of times treated, e.g., 01 Burn, 02 Burn, etc.): \_\_\_\_\_-Burn

Burn Unit/Fire Name-Number: \_\_\_\_\_ Recorder(s): \_\_\_\_\_

Circle Units (below) for: Temperature, Wind Speed, ROS, Flame Length and Flame Depth

Location								
Photo Number(s)								
Fuel Model								
Observation Time								
Elevation								
Aspect (azimuth)*								
Air Temperature (°F, °C)								
Relative Humidity (%)								
Wind Speed (mph, m/s)								
Wind Direction								
1-hr TLFM*								
10-hr TLFM								
Duff Moisture								
Shading/Cloud Cover (%)								
Slope of Hill (%)*								
Fire Spread Direction (B/H/F)								
ROS interval (ft, in, m)								
ROS time (min, sec, hr)								
ROS (ch/hr, m/s)								
Flame Length (ft, in, m)								
Flame Depth (ft, in, m)								

\* These can be measured postburn or calculated.



FMH-2A

**ALTERNATE BEHAVIOR-WEATHER DATA SHEET**

Plot ID: \_\_\_\_\_

Burn Status (Indicate number of times treated, e.g., 01 Burn, 02 Burn, etc.): \_\_\_\_\_-Burn

Burn Unit/Fire Name-Number: \_\_\_\_\_

Recorder(s): \_\_\_\_\_

Date	Time	Location	*Spread Direction	*ROS	*FL	*FD	Fuel Model	% Shading	% Slope	1-hr TLFM	*Comments

\*Spread direction: H-heading; B-backing; F-flanking

\*Rate of Spread (ROS): (ch/hr, m/s) (Circle one)

\*Flame Length (FL): (ft, in, m) (Circle one)

\*Flame Depth (FD): (ft, in, m) (Circle one)

\*Comments include:

- unusual fire behavior
- 10-hr TLFM, duff moisture
- photo #

**FMH-3**

**SMOKE MONITORING DATA SHEET**

Plot ID: \_\_\_\_\_

Date: \_\_\_\_/\_\_\_\_/\_\_\_\_

Burn Status (Indicate number of times treated, e.g., 01 Burn, 02 Burn, etc.): \_\_\_\_\_-Burn

Burn Unit/Fire Name-Number: \_\_\_\_\_

Recorder(s): \_\_\_\_\_

Monitoring Variable (RS)	Each box on the data sheet is divided in two; place the time of your observation in the top portion of the box, and the observation value in the lower portion of the box.												Recommended Thresholds	
Fireline Visibility/CO (ft, m)														Visibility <100' Exposure NTE 2 h
Highway Visibility (ft, m)														
Visibility Downwind (mi, km)														Pop. <u>Min. Dist.</u> 0-5 K            3-5 miles 5 K-50 K        5-7 miles >50 K            7-9 miles
Mixing Height (ft, m)														Maintain 1500'. Do not violate for more than 3 h or past 3:00 PM.
Transport Wind Speed (mph, m/s)														5-7 mph at mixing height. Do not violate for more than 3 h or past 3:00 PM.
Surface Wind Speed (mph, m/s)														1-3 mph-Day 3-5 mph-Night No violations over 1 h
Complaints (Number)														Consult local Air Quality Control District Regs. Do not exceed 5/treatment
CO Exposure (ppm or duration)														Discretion of PBB. Refer to park FMP or PBP.

- OTHER
1. Total Emissions Production (Tons/Acre or kg/ha): \_\_\_\_\_ Fuel Load Reduction (Total): \_\_\_\_\_
  2. Preburn Fuel Load Estimate (See PBP): \_\_\_\_\_ Postburn Fuel Load Calculation
  3. Particulates (Amount/duration)—If Applicable:  $\bar{x}$  = \_\_\_\_\_ (Specify Cycle)
  4. Other Monitor Observations:

Date Entered: \_\_\_\_/\_\_\_\_/\_\_\_\_

**FMH-3**

**PREDICTING EMISSIONS FROM PRESCRIBED FIRES**

1. List all FUEL COMPONENTS.
2. Estimate preburn FUEL LOAD of each component.
3. Estimate PERCENT CONSUMPTION of each component.
4. Multiply FUEL LOAD by PERCENT CONSUMPTION to get CONSUMPTION.
5. Find EMISSION FACTOR in table below for PM10 (or other pollutant of choice). Place result under EMISSION FACTOR.
6. Multiply CONSUMPTION by the EMISSION FACTOR to get EMISSION.
7. Add EMISSION to get TOTAL. Multiply TOTAL by acres burned to get TOTAL EMISSIONS.

Fuel Components	Fuel Load (Tons/Acre)	×	Percent Consumption	=	Consumption (Tons/Acre)	×	Emission Factor	=	Emission
									+
									+
									+
									+
									+
									+

Fuel Component	Emission Factors (Pounds/Ton)*							
	PM2.5	PM10	PM	CO				
Hardwood	22	24	36	224				
Chaparral	16	18	30	124				
Sagebrush		18	30	124				
Long-needled conifers		60	70	326				
Short-needled conifers		26	34	350				
Grassland		20	20	150				
					Total =			
					Acres Burned ×			
					Total Emissions =			

Park/Unit 4-Character Alpha Code: \_\_\_\_\_

**FMH-3A**

**ALTERNATE SMOKE MONITORING DATA SHEET**

Page \_\_\_\_ of \_\_\_\_

Plot ID: \_\_\_\_\_

Date: \_\_\_\_ / \_\_\_\_ / \_\_\_\_

Burn Status (Indicate number of times treated, e.g., 01 Burn, 02 Burn, etc.): \_\_\_\_\_ -Burn

Burn Unit/Fire Name-Number: \_\_\_\_\_

Recorder(s): \_\_\_\_\_

Date	Time	Observer Location and Elevation	Elevation of Smoke Column Above Ground	Smoke Column Direction	Approx. Elevation Smoke Inversion Layer Above Ground	Fireline Visibility	Roadway Visibility	Which Illustration (See Back) Best Describes the Smoke Column (Circle One)
								1 - 2 - 3
								1 - 2 - 3
								1 - 2 - 3
								1 - 2 - 3
								1 - 2 - 3
								1 - 2 - 3
								1 - 2 - 3
								1 - 2 - 3
								1 - 2 - 3
								1 - 2 - 3
								1 - 2 - 3
								1 - 2 - 3
								1 - 2 - 3
								1 - 2 - 3
								1 - 2 - 3
								1 - 2 - 3
								1 - 2 - 3
								1 - 2 - 3
								1 - 2 - 3
								1 - 2 - 3
								1 - 2 - 3
								1 - 2 - 3

Date Entered: \_\_\_\_ / \_\_\_\_ / \_\_\_\_

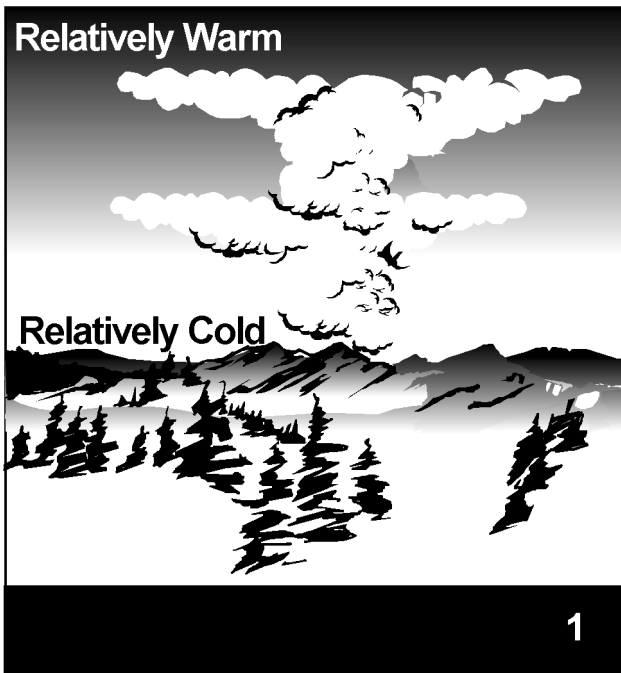

- Clouds in layers, no vertical motion
- Stratus type clouds
- Smoke column drifts apart after limited rise
- Poor visibility in lower levels due to accumulation of haze and smoke
- Fog layers
- Steady winds

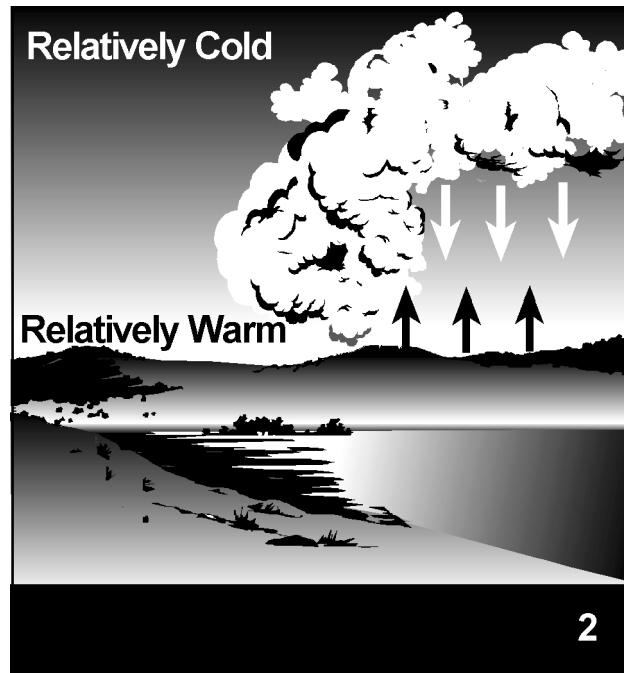

- Clouds grow vertically and smoke rises to great heights
- Cumulus type clouds
- Upward and downward currents of gusty winds
- Good visibility
- Dust whirls

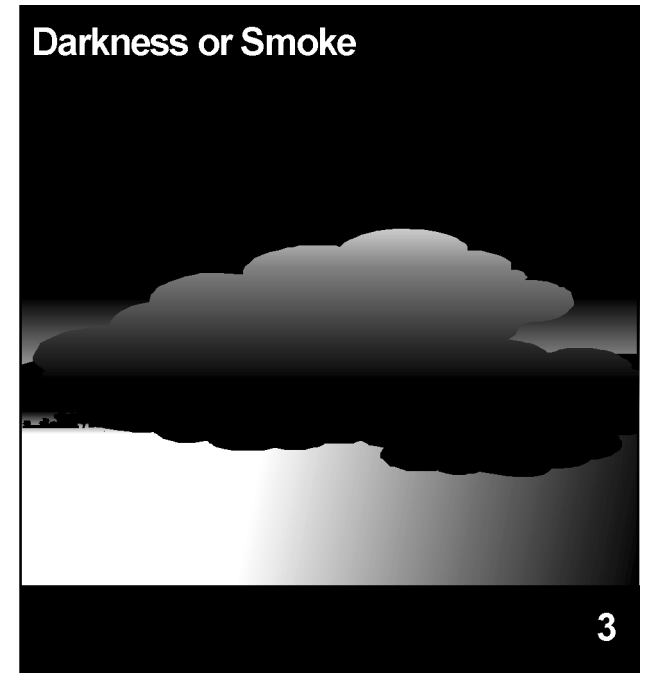

- Smoke column is not observable because of nighttime conditions or observer's location is in smoke

**FMH-4**

**MONITORING TYPE DESCRIPTION SHEET**

Monitoring Type Code: \_\_\_\_\_

Date Described: \_\_\_ / \_\_\_ / \_\_\_

Monitoring Type Name: \_\_\_\_\_

FGDC Association(s): \_\_\_\_\_

Preparer(s) (FEMO/RMS/FMO): \_\_\_\_\_

Burn Prescription (including other treatments: \_\_\_\_\_

\_\_\_\_\_  
\_\_\_\_\_  
\_\_\_\_\_

Management Objective(s): \_\_\_\_\_

\_\_\_\_\_  
\_\_\_\_\_  
\_\_\_\_\_

Monitoring Objective(s): \_\_\_\_\_

\_\_\_\_\_  
\_\_\_\_\_  
\_\_\_\_\_

Objective Variable(s): \_\_\_\_\_

\_\_\_\_\_  
\_\_\_\_\_  
\_\_\_\_\_

Physical Description: \_\_\_\_\_

\_\_\_\_\_  
\_\_\_\_\_  
\_\_\_\_\_

Biological Description: \_\_\_\_\_

\_\_\_\_\_  
\_\_\_\_\_  
\_\_\_\_\_  
\_\_\_\_\_  
\_\_\_\_\_

Rejection Criteria: \_\_\_\_\_

\_\_\_\_\_  
\_\_\_\_\_  
\_\_\_\_\_

Notes: \_\_\_\_\_

\_\_\_\_\_  
\_\_\_\_\_  
\_\_\_\_\_  
\_\_\_\_\_

Date Entered: \_\_\_ / \_\_\_ / \_\_\_

GENERAL PROTOCOLS		(Circle One)		(Circle One)	
<b>Preburn</b>	Control Treatment Plots (Opt)	Y	N	Herb Height (Opt)	Y N
	Herbaceous Density (Opt)	Y	N	Abbreviated Tags (Opt)	Y N
	OP/Origin Buried (Opt)	Y	N	Herb. Fuel Load (Opt)	Y N
	Voucher Specimens (Opt)	Y	N	Brush Fuel Load (Opt)	Y N
	Count Dead Branches of Living Plants as Dead (Opt)				Y N
Width Sample Area Species Not Intercepted But Seen in Vicinity of Herbaceous Transect(s):					
Length/Width Sample Area for Shrubs:			Stakes Installed:		
Herbaceous Frame Dimensions:					
Herbaceous Density Data Collected At:					
<b>Burn</b>	Duff Moisture (Opt)	Y	N	Flame Depth (Opt)	Y N
	100 Pt. Burn Severity (Opt)	Y	N	Herb. Fuel Load (Opt)	Y N
<b>Postburn</b>	Herbaceous/Shrub Data (Opt): FMH- 15/16/17/18				

FOREST PLOT PROTOCOLS		(Circle One)		(Circle One)	
<b>Overstory (&gt;15 cm)</b>	Live Tree Damage (Opt)	Y	N	Live Crown Position (Opt)	Y N
	Dead Tree Damage (Opt)	Y	N	Dead Crown Position (Opt)	Y N
	Record DBH Year-1 (Opt)	Y	N		
Length/Width of Sample Area:		Quarters Sampled: Subset w Q1 w Q2 w Q3 w Q4			
<b>Pole-size (≥2.5≤15)</b>	Height (Opt)	Y	N	Poles Tagged (Opt)	Y N
	Record DBH Year-1 (Opt)	Y	N	Dead Pole Height (Opt)	Y N
	Length/Width of Sample Area:		Quarters Sampled: Subset w Q1 w Q2 w Q3 w Q4		
<b>Seedling (&lt;2.5 cm)</b>	Height (Opt)	Y	N	Seedlings Mapped (Opt)	Y N
	Dead Seedlings (Opt)	Y	N	Dead Seedling Height (Opt)	Y N
	Length/Width of Sample Area:		Quarters Sampled: Subset w Q1 w Q2 w Q3 w Q4		
<b>Fuel Load</b>	Sampling Plane Lengths: ___ 1 hr w ___ 10 hr w ___ 100 hr w ___ 1,000 hr-s w ___ 1,000 hr-r				
<b>Herbaceous</b>	Cover Data Collected at: Q4–Q1 w Q3–Q2 w 0P–50P w Q4–30 m				
<b>Postburn</b>	Char Height (Opt)	Y	N	Poles in Assessment (Opt)	Y N
	Collect Severity Along: Fuel Transects w Herbaceous Transects				

(Opt) = Optional

**FMH-5****PLOT LOCATION DATA SHEET**

Plot ID: \_\_\_\_\_ B / C (Circle One) Date: \_\_\_\_ / \_\_\_\_ / \_\_\_\_

Burn Unit: \_\_\_\_\_ Recorder(s): \_\_\_\_\_

Topo Quad: \_\_\_\_\_ Transect Azimuth: \_\_\_\_\_ Declination: \_\_\_\_\_

UTM ZONE: _____	Lat: _____	Section: _____	Slope (%) along Transect Azimuth: _____
UTMN: _____	Long: _____	Township: _____	Slope (%) of Hillside: _____
UTME: _____		Range: _____	Aspect: _____ Elevation: _____

Location Information Determined by (Circle One): Map &amp; Compass / GPS

If determined by GPS: Datum used: \_\_\_\_\_ (Circle One) PDOP/EHE: \_\_\_\_\_

Fire History of the Plot (including the date of the last known fire): \_\_\_\_\_

1. Road and trail used to travel to the plot: \_\_\_\_\_

2. True compass bearing at point where road/trail is left to hike to plot: \_\_\_\_\_°

3. Describe the route to the plot; include or attach a hand-drawn map illustrating these directions, including the plot layout, plot reference stake and other significant features. In addition, attach a topo, orthophoto, and/or trail map.

4. Describe reference feature: \_\_\_\_\_

5. True compass bearing from plot reference feature to plot reference stake: \_\_\_\_\_°

6. Distance from reference feature to reference stake: \_\_\_\_\_m

7. Problems, comments, notes: \_\_\_\_\_

Date Entered: \_\_\_\_ / \_\_\_\_ / \_\_\_\_

FMH-5





FMH-6

**SPECIES CODE LIST**

Use this form to record unknowns and official species codes. **Tip:** Place an asterisk next to each species you voucher.

Species Code	Life Form	Genus/Species (spell out full name)	Native (Circle One)	Annual/ Biennial/ Perennial
_____	_____	_____	Y N	_____
_____	_____	_____	Y N	_____
_____	_____	_____	Y N	_____
_____	_____	_____	Y N	_____
_____	_____	_____	Y N	_____
_____	_____	_____	Y N	_____
_____	_____	_____	Y N	_____
_____	_____	_____	Y N	_____
_____	_____	_____	Y N	_____
_____	_____	_____	Y N	_____
_____	_____	_____	Y N	_____
_____	_____	_____	Y N	_____
_____	_____	_____	Y N	_____
_____	_____	_____	Y N	_____
_____	_____	_____	Y N	_____
_____	_____	_____	Y N	_____
_____	_____	_____	Y N	_____
_____	_____	_____	Y N	_____
_____	_____	_____	Y N	_____
_____	_____	_____	Y N	_____
_____	_____	_____	Y N	_____
_____	_____	_____	Y N	_____
_____	_____	_____	Y N	_____
_____	_____	_____	Y N	_____
_____	_____	_____	Y N	_____

**Life Forms Codes:**

<b>A</b>	Fern or Fern Ally	<b>G</b>	Grass	<b>R</b>	Grass-like	<b>T</b>	Tree	<b>*</b>	Substrate
<b>F</b>	Forb	<b>N</b>	Non-vascular	<b>S</b>	Shrub	<b>U</b>	Subshrub	<b>V</b>	Vine

Date Entered: \_\_\_\_ / \_\_\_\_ / \_\_\_\_

**VOUCHER SPECIMEN DATA COLLECTION FORMS**

---

Date:	Plot ID:	Collected by:	Coll. #
Latin Name:		Family:	
Common Name:			
Description: ann/bien/per fl. color: fruit type:	Life form: other:	ht.:	Habitat:
Topo Quad:		Assoc. spp.:	
Location (UTM, lat/long):		Elev.:	Slope: Aspect:
Comments:			

---

---

Date:	Plot ID:	Collected by:	Coll. #
Latin Name:		Family:	
Common Name:			
Description: ann/bien/per fl. color: fruit type:	Life form: other:	ht.:	Habitat:
Topo Quad:		Assoc. spp.:	
Location (UTM, lat/long):		Elev.:	Slope: Aspect:
Comments:			

---

---

Date:	Plot ID:	Collected by:	Coll. #
Latin Name:		Family:	
Common Name:			
Description: ann/bien/per fl. color: fruit type:	Life form: other:	ht.:	Habitat:
Topo Quad:		Assoc. spp.:	
Location (UTM, lat/long):		Elev.:	Slope: Aspect:
Comments:			

---

---

Date:	Plot ID:	Collected by:	Coll. #
Latin Name:		Family:	
Common Name:			
Description: ann/bien/per fl. color: fruit type:	Life form: other:	ht.:	Habitat:
Topo Quad:		Assoc. spp.:	
Location (UTM, lat/long):		Elev.:	Slope: Aspect:
Comments:			

---

**FMH-7**

**FOREST PLOT DATA SHEET**

Plot ID: \_\_\_\_\_

B / C (Circle One)

Date: \_\_\_\_ / \_\_\_\_ / \_\_\_\_

Burn Unit: \_\_\_\_\_

Recorders: \_\_\_\_\_

Burn Status: Circle one and indicate number of times treated, e.g., 01-yr01, 02-yr01

00-PRE \_\_\_\_ Post \_\_\_\_-yr01 \_\_\_\_-yr02 \_\_\_\_-yr05 \_\_\_\_-yr10 \_\_\_\_-yr20 Other: \_\_\_\_-yr \_\_\_\_; \_\_\_\_-mo \_\_\_\_

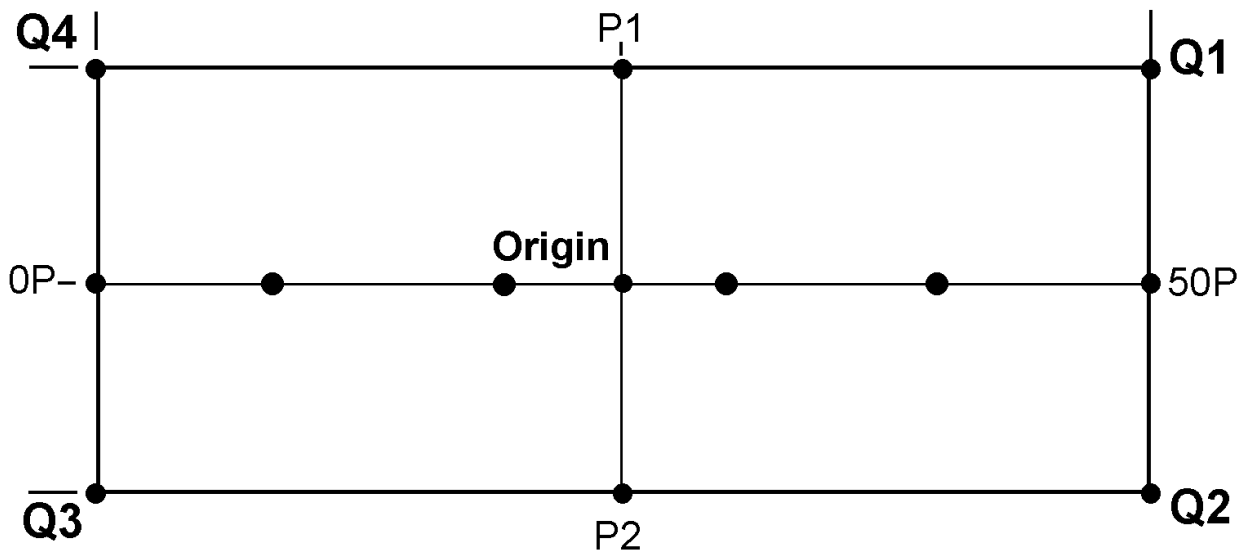

Overstory: \_\_\_\_m<sup>2</sup> in Q \_\_\_\_ Pole: \_\_\_\_m<sup>2</sup> in Q \_\_\_\_ Seedling: \_\_\_\_m<sup>2</sup> in Q \_\_\_\_

**Sampling Areas:**

Shrub: \_\_\_\_m<sup>2</sup> along Q4-Q1 w Q3-Q2 w 0P-50P w Q4-30 m

Shade in the sampling areas for each tree class and for the shrub sampling area(s) on the plot layout above.

**Photo Subject Order**

**Fuel Load Transects**

- |                 |                  |
|-----------------|------------------|
| 1. 0P ⊥ Origin  | 6. Q2 ⊥ Q3       |
| 2. Q4 ⊥ Q1      | 7. P2 ⊥ Origin   |
| 3. P1 ⊥ Origin  | 8. Q3 ⊥ Q2       |
| 4. Q1 ⊥ Q4      | 9. Origin ⊥ REF  |
| 5. 50P ⊥ Origin | 10. REF ⊥ Origin |

	Azimuth	Slope
1	_____	_____
2	_____	_____
3	_____	_____
4	_____	_____

Record photo documentation data for each visit on FMH-23, Photographic record sheet

Draw in fuel load transect lines on the plot layout above.

Date Entered: \_\_\_\_ / \_\_\_\_ / \_\_\_\_



**FMH-8**

**OVERSTORY TAGGED TREE DATA SHEET**

Page     of    

Plot ID: \_\_\_\_\_

B / C (Circle One)

Date:     /     /    

Burn Unit: \_\_\_\_\_

Recorders: \_\_\_\_\_

Burn Status: Circle one and indicate number of times treated, e.g., 01-yr01, 02-yr01

00-PRE     Post    -yr01    -yr02    -yr05    -yr10    -yr20 Other:    -yr   ;    -mo   

Record: quarter (Qtr), tag #, species by code (Spp), DBH in centimeters, live/dead, crown position code (CPC, Optional), damage code (Damage, Optional), and provide any helpful comments for data analysts or future monitors (Comments).

Qtr	Tag	Spp	DBH (cm)	Live	CPC	Damage (codes below)	Comments
_____	_____	_____	_____	Y N	_____	_____	_____
_____	_____	_____	_____	Y N	_____	_____	_____
_____	_____	_____	_____	Y N	_____	_____	_____
_____	_____	_____	_____	Y N	_____	_____	_____
_____	_____	_____	_____	Y N	_____	_____	_____
_____	_____	_____	_____	Y N	_____	_____	_____
_____	_____	_____	_____	Y N	_____	_____	_____
_____	_____	_____	_____	Y N	_____	_____	_____
_____	_____	_____	_____	Y N	_____	_____	_____
_____	_____	_____	_____	Y N	_____	_____	_____
_____	_____	_____	_____	Y N	_____	_____	_____
_____	_____	_____	_____	Y N	_____	_____	_____
_____	_____	_____	_____	Y N	_____	_____	_____
_____	_____	_____	_____	Y N	_____	_____	_____
_____	_____	_____	_____	Y N	_____	_____	_____
_____	_____	_____	_____	Y N	_____	_____	_____
_____	_____	_____	_____	Y N	_____	_____	_____
_____	_____	_____	_____	Y N	_____	_____	_____
_____	_____	_____	_____	Y N	_____	_____	_____
_____	_____	_____	_____	Y N	_____	_____	_____
_____	_____	_____	_____	Y N	_____	_____	_____
_____	_____	_____	_____	Y N	_____	_____	_____

Crown Position Codes (CPC) **Note:** Codes 10–12 are only used postburn, e.g., 01-yr01, 01-yr02, etc., and only used once:

<b>1</b>	Dominant	<b>2</b>	Co-dominant	<b>3</b>	Intermediate	<b>4</b>	Subcanopy
<b>5</b>	Open Growth / Isolated	<b>6</b>	Recent Snag	<b>7</b>	Loose Bark Snag	<b>8</b>	Clean Snag
<b>9</b>	Broken above BH	<b>10</b>	Broken below BH	<b>11</b>	Dead and down	<b>12</b>	Cut Stump

**Damage Codes:**

ABGR—Abnormal Growth	CONK—Large Shelf Fungus	FIRE—Fire Scar / Cambial Damage	INSE—Insects / Their Sign	MISL—Mistletoe	SPAR—Unusually Sparse Foliage
BIRD—e.g., Sapsucker	CROK—Crooked Bole	FORK—Forked Top	LEAN—Leaning Tree	MOSS—Moss	SPRT—Sprouts at Base
BLIG—Blight	DTOP—Dead Top	FRST—Frost Crack	LICH—Lichen	OZON—Ozone	TWIN—Twin—below DBH
BROK—Broken Top	EPIC—Sprouts from Bole / Limbs	GALL—Galls	LIGT—Lightning Scar	ROOT—Large Exposed Roots	UMAN—Human-caused Damage
BROM—Witches' Broom	EPIP—Epiphytes	HOLW—Hollowed-out	MAMM—Mammal Damage	ROTT—Rot / Fungus Other than Conk	WOND—Wound—cracks
BURL—Burl					

Date Entered:     /     /

Qtr	Tag	Spp	DBH (cm)	Live	CPC	Damage	Comments
				Y	N		
				Y	N		
				Y	N		
				Y	N		
				Y	N		
				Y	N		
				Y	N		
				Y	N		
				Y	N		
				Y	N		
				Y	N		
				Y	N		
				Y	N		
				Y	N		
				Y	N		
				Y	N		
				Y	N		
				Y	N		
				Y	N		
				Y	N		
				Y	N		
				Y	N		
				Y	N		
				Y	N		
				Y	N		
				Y	N		
				Y	N		
				Y	N		
				Y	N		
				Y	N		
				Y	N		
				Y	N		
				Y	N		

FMH-9

## POLE-SIZE TREE DATA SHEET

Page \_\_\_ of \_\_\_

Plot ID: \_\_\_\_\_

B / C (Circle One)

Date: \_\_\_ / \_\_\_ / \_\_\_

Burn Unit: \_\_\_\_\_ Recorders: \_\_\_\_\_

Burn Status: Circle one and indicate number of times treated, e.g., 01-yr01, 02-yr01

00-PRE \_\_\_ Post \_\_\_-yr01 \_\_\_-yr02 \_\_\_-yr05 \_\_\_-yr10 \_\_\_-yr20 Other: \_\_\_-yr\_\_\_; \_\_\_-mo\_\_\_

Record: quarter (if other than Q1), tag # (Optional), species by code (Spp), DBH in centimeters, live/dead, and height by code (Hgt, Optional).

Qtr	Tag or Map#	Spp	DBH (cm)	Live	Hgt Code	Qtr	Tag or Map#	Spp	DBH (cm)	Live	Hgt Code
_____	_____	_____	_____	Y	N	_____	_____	_____	_____	Y	N
_____	_____	_____	_____	Y	N	_____	_____	_____	_____	Y	N
_____	_____	_____	_____	Y	N	_____	_____	_____	_____	Y	N
_____	_____	_____	_____	Y	N	_____	_____	_____	_____	Y	N
_____	_____	_____	_____	Y	N	_____	_____	_____	_____	Y	N
_____	_____	_____	_____	Y	N	_____	_____	_____	_____	Y	N
_____	_____	_____	_____	Y	N	_____	_____	_____	_____	Y	N
_____	_____	_____	_____	Y	N	_____	_____	_____	_____	Y	N
_____	_____	_____	_____	Y	N	_____	_____	_____	_____	Y	N
_____	_____	_____	_____	Y	N	_____	_____	_____	_____	Y	N
_____	_____	_____	_____	Y	N	_____	_____	_____	_____	Y	N
_____	_____	_____	_____	Y	N	_____	_____	_____	_____	Y	N
_____	_____	_____	_____	Y	N	_____	_____	_____	_____	Y	N
_____	_____	_____	_____	Y	N	_____	_____	_____	_____	Y	N
_____	_____	_____	_____	Y	N	_____	_____	_____	_____	Y	N
_____	_____	_____	_____	Y	N	_____	_____	_____	_____	Y	N
_____	_____	_____	_____	Y	N	_____	_____	_____	_____	Y	N
_____	_____	_____	_____	Y	N	_____	_____	_____	_____	Y	N
_____	_____	_____	_____	Y	N	_____	_____	_____	_____	Y	N
_____	_____	_____	_____	Y	N	_____	_____	_____	_____	Y	N
_____	_____	_____	_____	Y	N	_____	_____	_____	_____	Y	N
_____	_____	_____	_____	Y	N	_____	_____	_____	_____	Y	N
_____	_____	_____	_____	Y	N	_____	_____	_____	_____	Y	N

Height Class Codes (height in centimeters):

<b>1</b>	0–15	<b>5</b>	100.1–200	<b>9</b>	500.1–600		
<b>2</b>	15.1–30	<b>6</b>	200.1–300	<b>10</b>	600.1–700	<b>13</b>	900.1+
<b>3</b>	30.1–60	<b>7</b>	300.1–400	<b>11</b>	700.1–800		
<b>4</b>	60.1–100	<b>8</b>	400.1–500	<b>12</b>	800.1–900		

**Note:** Measure height from ground level to the highest point of growth on the tree. The highest point on a bent tree would be down the trunk of the tree instead of at the growing apex. Only use height codes 1-4 for leaning trees.

Date Entered: \_\_\_ / \_\_\_ / \_\_\_

FMH-9





**FMH-10**

**SEEDLING TREE DATA SHEET**

Page    of   

Plot ID: \_\_\_\_\_

B / C (Circle One)

Date:    /    /   

Burn Unit: \_\_\_\_\_

Recorders: \_\_\_\_\_

Burn Status: Circle one and indicate number of times treated, e.g., 01-yr01, 02-yr01

00-PRE    Post   -yr01   -yr02   -yr05   -yr10   -yr20 Other:   -yr  ;   -mo  

Record: map number (Map#, Optional), species code (Spp), live/dead, height by class (Hgt Code, Optional), resprout (Rsprt), and # by species and height class (Num/Tally).

Area Sampled: \_\_\_\_\_ in Quarter(s): \_\_\_\_\_

Map#	Spp	Live	Hgt Code	Rsprt	Num/Tally	Map#	Spp	Live	Hgt Code	Rsprt	Num/Tally
		Y N		Y N				Y N		Y N	
		Y N		Y N				Y N		Y N	
		Y N		Y N				Y N		Y N	
		Y N		Y N				Y N		Y N	
		Y N		Y N				Y N		Y N	
		Y N		Y N				Y N		Y N	
		Y N		Y N				Y N		Y N	
		Y N		Y N				Y N		Y N	
		Y N		Y N				Y N		Y N	
		Y N		Y N				Y N		Y N	
		Y N		Y N				Y N		Y N	
		Y N		Y N				Y N		Y N	
		Y N		Y N				Y N		Y N	
		Y N		Y N				Y N		Y N	
		Y N		Y N				Y N		Y N	
		Y N		Y N				Y N		Y N	
		Y N		Y N				Y N		Y N	
		Y N		Y N				Y N		Y N	
		Y N		Y N				Y N		Y N	
		Y N		Y N				Y N		Y N	
		Y N		Y N				Y N		Y N	
		Y N		Y N				Y N		Y N	
		Y N		Y N				Y N		Y N	
		Y N		Y N				Y N		Y N	
		Y N		Y N				Y N		Y N	
		Y N		Y N				Y N		Y N	
		Y N		Y N				Y N		Y N	
		Y N		Y N				Y N		Y N	
		Y N		Y N				Y N		Y N	
		Y N		Y N				Y N		Y N	
		Y N		Y N				Y N		Y N	
		Y N		Y N				Y N		Y N	
		Y N		Y N				Y N		Y N	
		Y N		Y N				Y N		Y N	
		Y N		Y N				Y N		Y N	
		Y N		Y N				Y N		Y N	
		Y N		Y N				Y N		Y N	
		Y N		Y N				Y N		Y N	
		Y N		Y N				Y N		Y N	
		Y N		Y N				Y N		Y N	
		Y N		Y N				Y N		Y N	
		Y N		Y N				Y N		Y N	

Height Class Codes (height in centimeters)

<b>1</b>	0–15	<b>5</b>	100.1–200	<b>9</b>	500.1–600
<b>2</b>	15.1–30	<b>6</b>	200.1–300	<b>10</b>	600.1–700
<b>3</b>	30.1–60	<b>7</b>	300.1–400	<b>11</b>	700.1–800
<b>4</b>	60.1–100	<b>8</b>	400.1–500	<b>12</b>	800.1–900
				<b>13</b>	900.1+

**Note:** Measure height from ground level to the highest point of growth on the tree. The highest point on a bent tree would be down the trunk of the tree instead of at the growing apex.

Date Entered:    /    /

FMH-10A

**ALTERNATE SEEDLING TREE DATA SHEET**

Page \_\_\_ of \_\_\_

Plot ID: \_\_\_\_\_

B / C (Circle One)

Date: \_\_\_ / \_\_\_ / \_\_\_

Burn Unit: \_\_\_\_\_

Recorders: \_\_\_\_\_

Burn Status: Circle one and indicate number of times treated, e.g., 01-yr01, 02-yr01

00-PRE \_\_\_ Post \_\_\_ -yr01 \_\_\_ -yr02 \_\_\_ -yr05 \_\_\_ -yr10 \_\_\_ -yr20 Other: \_\_\_ -yr \_\_\_; \_\_\_ -mo \_\_\_

Record: map number (Map#, Optional), species code (Spp), live/dead, height by class (Hgt, Optional), resprout (Rsprt), and # by species and height class (Num/Tally).

Area Sampled: \_\_\_\_\_ in Quarter(s): \_\_\_\_\_

Map#	Spp	Live	Hgt Code	Rsprt	Num	Tally
_____	_____	Y N	_____	Y N	_____	_____
_____	_____	Y N	_____	Y N	_____	_____
_____	_____	Y N	_____	Y N	_____	_____
_____	_____	Y N	_____	Y N	_____	_____
_____	_____	Y N	_____	Y N	_____	_____
_____	_____	Y N	_____	Y N	_____	_____
_____	_____	Y N	_____	Y N	_____	_____
_____	_____	Y N	_____	Y N	_____	_____
_____	_____	Y N	_____	Y N	_____	_____
_____	_____	Y N	_____	Y N	_____	_____
_____	_____	Y N	_____	Y N	_____	_____
_____	_____	Y N	_____	Y N	_____	_____
_____	_____	Y N	_____	Y N	_____	_____
_____	_____	Y N	_____	Y N	_____	_____
_____	_____	Y N	_____	Y N	_____	_____
_____	_____	Y N	_____	Y N	_____	_____
_____	_____	Y N	_____	Y N	_____	_____
_____	_____	Y N	_____	Y N	_____	_____
_____	_____	Y N	_____	Y N	_____	_____
_____	_____	Y N	_____	Y N	_____	_____
_____	_____	Y N	_____	Y N	_____	_____
_____	_____	Y N	_____	Y N	_____	_____

Height Class Codes (height in centimeters)

<b>1</b>	0–15	<b>5</b>	100.1–200	<b>9</b>	500.1–600	<b>13</b>	900.1+
<b>2</b>	15.1–30	<b>6</b>	200.1–300	<b>10</b>	600.1–700		
<b>3</b>	30.1–60	<b>7</b>	300.1–400	<b>11</b>	700.1–800		
<b>4</b>	60.1–100	<b>8</b>	400.1–500	<b>12</b>	800.1–900		

**Note:** Measure height from ground level to the highest point of growth on the tree. The highest point on a bent tree would be down the trunk of the tree instead of at the growing apex.

**FMH-11**

**FULL PLOT TREE MAP**

Plot ID: \_\_\_\_\_

B/C (Circle One)

Date: \_\_\_\_ / \_\_\_\_ / \_\_\_\_

Burn Unit: \_\_\_\_\_

Recorders: \_\_\_\_\_

Burn Status: Circle one and indicate number of times treated, e.g., 01-yr01, 02-yr01

00-PRE \_\_\_\_ Post \_\_\_\_-yr01 \_\_\_\_-yr02 \_\_\_\_-yr05 \_\_\_\_-yr10 \_\_\_\_-yr20 Other: \_\_\_\_-yr\_\_\_\_; \_\_\_\_-mo\_\_\_\_

**Tree Class**

**(Circle One)**

**Overstory**

**Pole**

**Seedling**

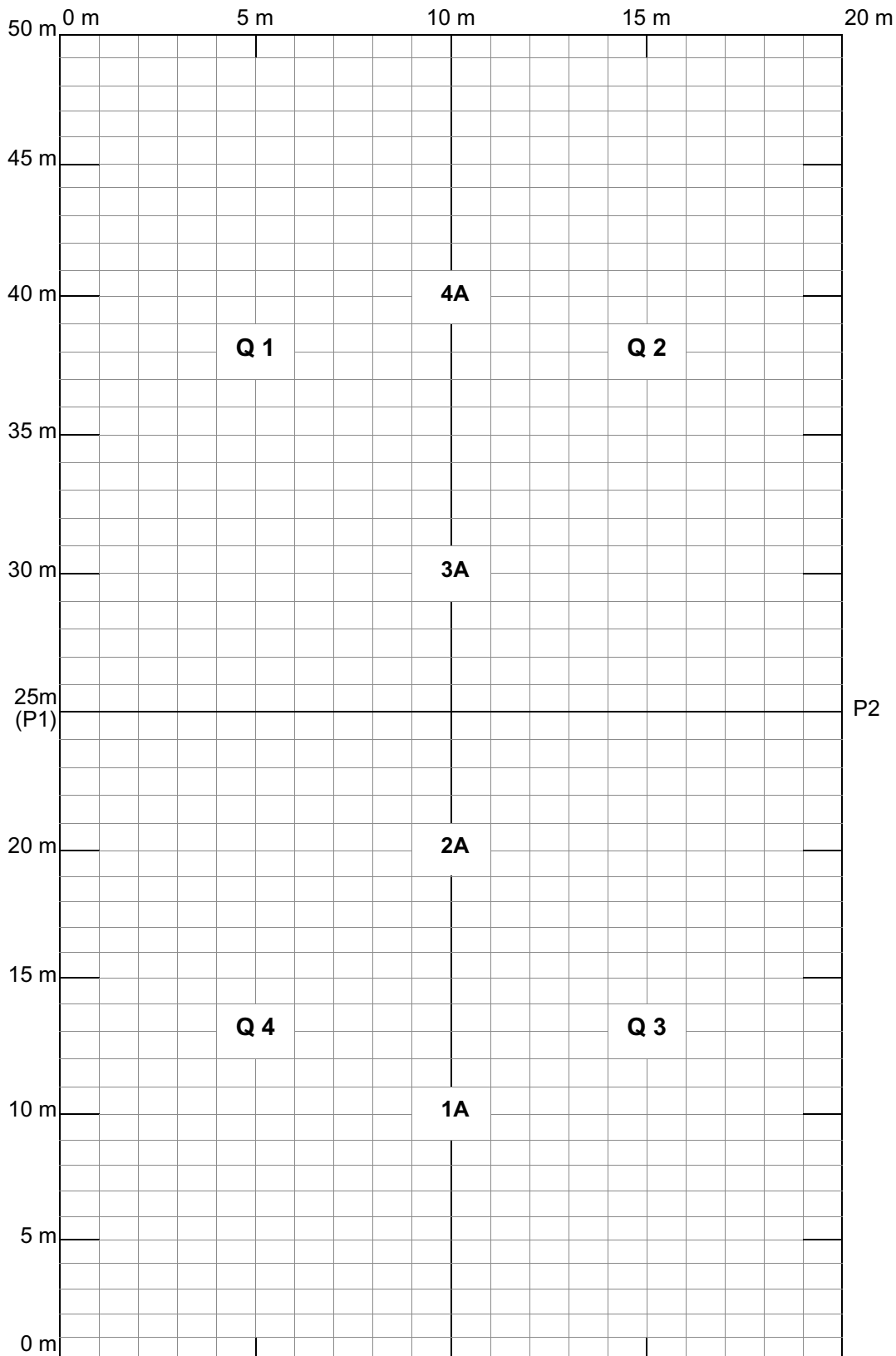

**FMH-12**

**QUARTER PLOT TREE MAP**

Plot ID: \_\_\_\_\_

B/C (Circle One)

Date: \_\_\_\_ / \_\_\_\_ / \_\_\_\_

Burn Unit: \_\_\_\_\_

Recorders: \_\_\_\_\_

Burn Status: Circle one and indicate number of times treated, e.g., 01-yr01, 02-yr01

00-PRE \_\_\_\_ Post \_\_\_\_-yr01 \_\_\_\_-yr02 \_\_\_\_-yr05 \_\_\_\_-yr10 \_\_\_\_-yr20 Other: \_\_\_\_-yr\_\_\_\_; \_\_\_\_-mo\_\_\_\_

**Tree Class**



**(Circle One)**

**Overstory**

**Pole**

**Seedling**

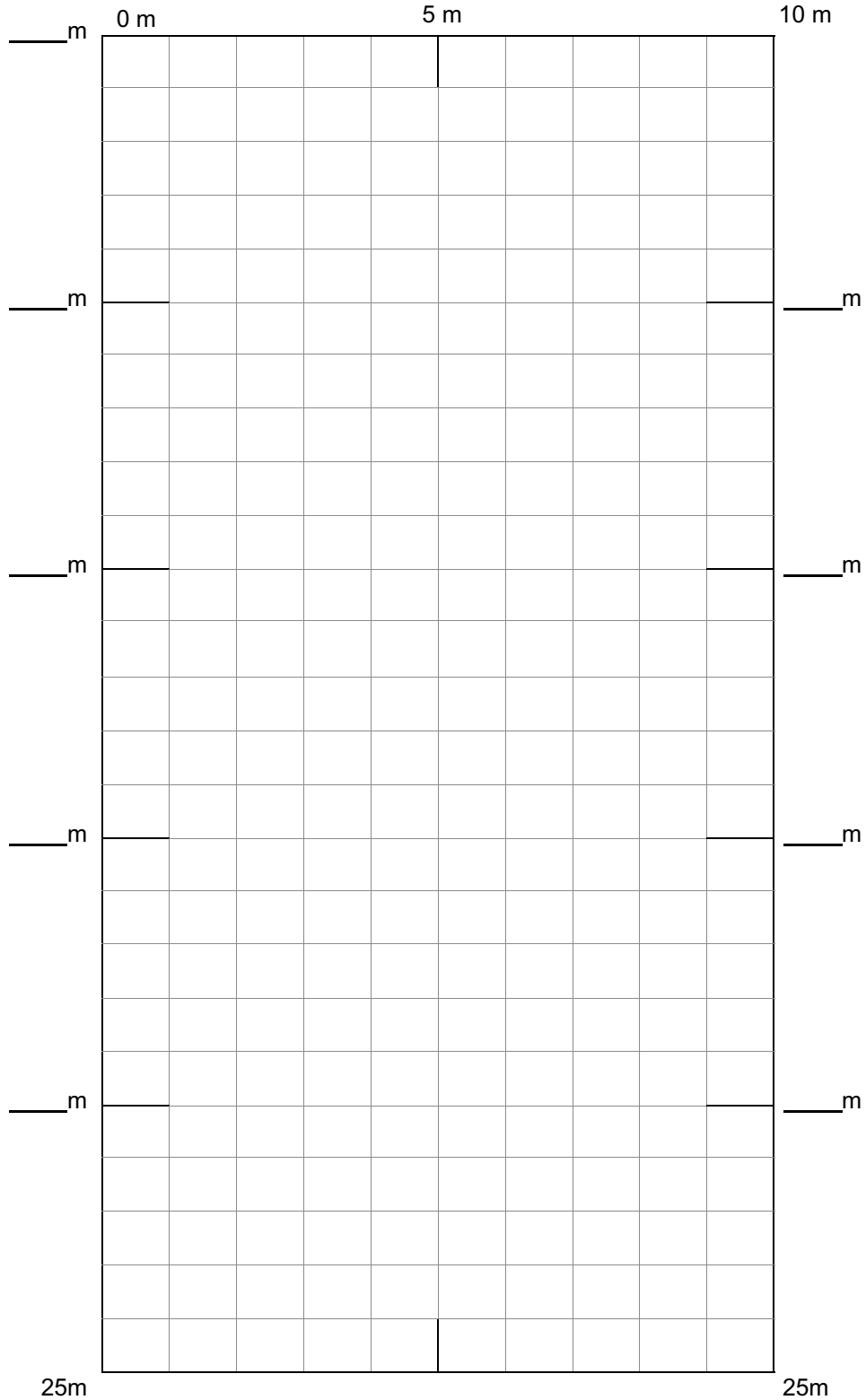

**FMH-13**

**ALTERNATE TREE MAP**

Plot ID: \_\_\_\_\_

B/C (Circle One)

Date: \_\_\_\_ / \_\_\_\_ / \_\_\_\_

Burn Unit: \_\_\_\_\_

Recorders: \_\_\_\_\_

Burn Status: Circle one and indicate number of times treated, e.g., 01-yr01, 02-yr01

00-PRE \_\_\_\_ Post \_\_\_\_-yr01 \_\_\_\_-yr02 \_\_\_\_-yr05 \_\_\_\_-yr10 \_\_\_\_-yr20 Other: \_\_\_\_-yr\_\_\_\_; \_\_\_\_-mo\_\_\_\_

<b>Tree Class</b>	____m	____m	____m	____m
<hr style="border: 2px solid black;"/>				
<b>(Circle One)</b>				
<b>Overstory</b>	____m			
<b>Pole</b>				
<b>Seedling</b>	____m			
	____m			
	____m			
	____m			

**FMH-14**

**50 m<sup>2</sup> TREE MAP**

Plot ID: \_\_\_\_\_

B/C (Circle One)

Date: \_\_\_\_ / \_\_\_\_ / \_\_\_\_

Burn Unit: \_\_\_\_\_ Recorders: \_\_\_\_\_

Burn Status: Circle one and indicate number of times treated, e.g., 01-yr01, 02-yr01

00-PRE \_\_\_\_ Post \_\_\_\_ -yr01 \_\_\_\_ -yr02 \_\_\_\_ -yr05 \_\_\_\_ -yr10 \_\_\_\_ -yr20 Other: \_\_\_\_ -yr \_\_\_\_; \_\_\_\_ -mo \_\_\_\_

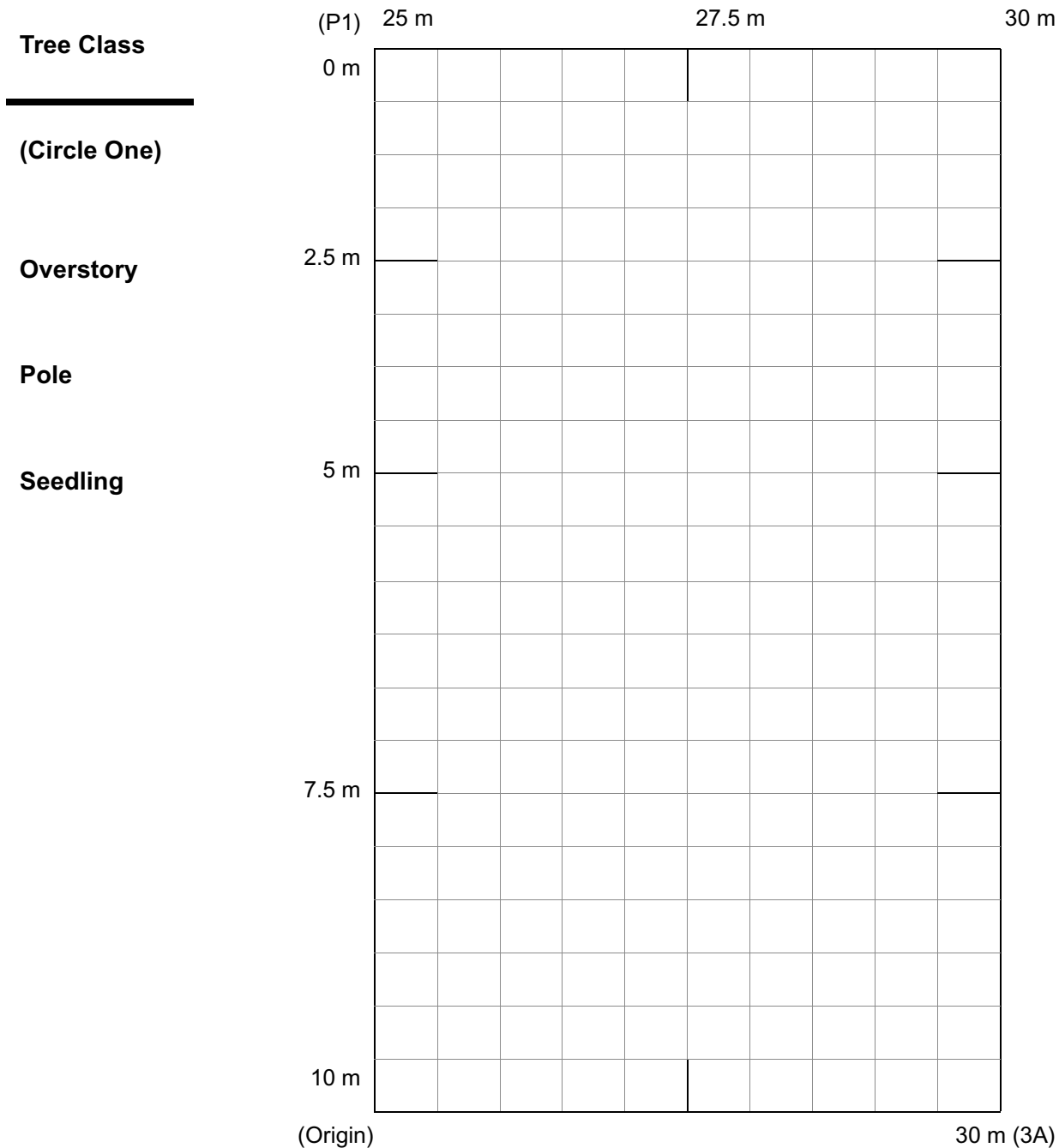

**FMH-15**

**50 m TRANSECT DATA SHEET**

Plot ID: \_\_\_\_\_

B/C (Circle One)

Date: \_\_\_\_ / \_\_\_\_ / \_\_\_\_

Burn Unit: \_\_\_\_\_

Recorders: \_\_\_\_\_

Burn Status: Circle one and indicate number of times treated, e.g., 01-yr01, 02-yr01

00-PRE \_\_\_\_ Post \_\_\_\_ -yr01 \_\_\_\_ -yr02 \_\_\_\_ -yr05 \_\_\_\_ -yr10 \_\_\_\_ -yr20 Other: \_\_\_\_ -yr \_\_\_\_; \_\_\_\_ -mo \_\_\_\_

Phenological Stage: \_\_\_\_\_ (Circle One) Q4-Q1 w Q3-Q2 w 0P-50P

Pnt	Tape	Hgt (m)	Spp; Species or Substrate Codes (tallest to lowest)					
1	0.3							
2	0.6							
3	0.9							
4	1.2							
5	1.5							
6	1.8							
7	2.1							
8	2.4							
9	2.7							
10	3.0							
11	3.3							
12	3.6							
13	3.9							
14	4.2							
15	4.5							
16	4.8							
17	5.1							
18	5.4							
19	5.7							
20	6.0							
21	6.3							
22	6.6							
23	6.9							
24	7.2							
25	7.5							
26	7.8							
27	8.1							
28	8.4							
29	8.7							
30	9.0							
31	9.3							
32	9.6							
33	9.9							
34	10.2							
35	10.5							
36	10.8							
37	11.1							

Date Entered: \_\_\_\_ / \_\_\_\_ / \_\_\_\_



Pnt	Tape	Hgt (m)	Spp; Species or Substrate Codes (tallest to lowest)					
38	11.4							
39	11.7							
40	12.0							
41	12.3							
42	12.6							
43	12.9							
44	13.2							
45	13.5							
46	13.8							
47	14.1							
48	14.4							
49	14.7							
50	15.0							
51	15.3							
52	15.6							
53	15.9							
54	16.2							
55	16.5							
56	16.8							
57	17.1							
58	17.4							
59	17.7							
60	18.0							
61	18.3							
62	18.6							
63	18.9							
64	19.2							
65	19.5							
66	19.8							
67	20.1							
68	20.4							
69	20.7							
70	21.0							
71	21.3							
72	21.6							
73	21.9							
74	22.2							
75	22.5							
76	22.8							
77	23.1							
78	23.4							
79	23.7							
80	24.0							
81	24.3							

Pnt	Tape	Hgt (m)	Spp; Species or Substrate Codes (tallest to lowest)					
82	24.6							
83	24.9							
84	25.2							
85	25.5							
86	25.8							
87	26.1							
88	26.4							
89	26.7							
90	27.0							
91	27.3							
92	27.6							
93	27.9							
94	28.2							
95	28.5							
96	28.8							
97	29.1							
98	29.4							
99	29.7							
100	30.0							
101	30.3							
102	30.6							
103	30.9							
104	31.2							
105	31.5							
106	31.8							
107	32.1							
108	32.4							
109	32.7							
110	33.0							
111	33.3							
112	33.6							
113	33.9							
114	34.2							
115	34.5							
116	34.8							
117	35.1							
118	35.4							
119	35.7							
120	36.0							
121	36.3							
122	36.6							
123	36.9							
124	37.2							
125	37.5							

Pnt	Tape	Hgt (m)	Spp; Species or Substrate Codes (tallest to lowest)					
126	37.8							
127	38.1							
128	38.4							
129	38.7							
130	39.0							
131	39.3							
132	39.6							
133	39.9							
134	40.2							
135	40.5							
136	40.8							
137	41.1							
138	41.4							
139	41.7							
140	42.0							
141	42.3							
142	42.6							
143	42.9							
144	43.2							
145	43.5							
146	43.8							
147	44.1							
148	44.4							
149	44.7							
150	45.0							
151	45.3							
152	45.6							
153	45.9							
154	46.2							
155	46.5							
156	46.8							
157	47.1							
158	47.4							
159	47.7							
160	48.0							
161	48.3							
162	48.6							
163	48.9							
164	49.2							
165	49.5							
166	49.8							

Species observed within \_\_\_\_ m of either side of the transect but not intercepted: \_\_\_\_\_

**FMH-16**

**30 m TRANSECT DATA SHEET**

Plot ID: \_\_\_\_\_

B/C (Circle One)

Date: \_\_\_\_ / \_\_\_\_ / \_\_\_\_

Burn Unit: \_\_\_\_\_

Recorders: \_\_\_\_\_

Burn Status: Circle one and indicate number of times treated, e.g., 01-yr01, 02-yr01

00-PRE \_\_\_\_ Post \_\_\_\_-yr01 \_\_\_\_-yr02 \_\_\_\_-yr05 \_\_\_\_-yr10 \_\_\_\_-yr20 Other: \_\_\_\_-yr\_\_\_\_; \_\_\_\_-mo\_\_\_\_

Phenological Stage: \_\_\_\_\_ (Circle One) Q4-30 m w 0P-30P

Pnt	Tape	Hgt (m)	Spp; Species or Substrate Codes (tallest to lowest)					
1	0.3	_____	_____	_____	_____	_____	_____	
2	0.6	_____	_____	_____	_____	_____	_____	
3	0.9	_____	_____	_____	_____	_____	_____	
4	1.2	_____	_____	_____	_____	_____	_____	
5	1.5	_____	_____	_____	_____	_____	_____	
6	1.8	_____	_____	_____	_____	_____	_____	
7	2.1	_____	_____	_____	_____	_____	_____	
8	2.4	_____	_____	_____	_____	_____	_____	
9	2.7	_____	_____	_____	_____	_____	_____	
10	3.0	_____	_____	_____	_____	_____	_____	
11	3.3	_____	_____	_____	_____	_____	_____	
12	3.6	_____	_____	_____	_____	_____	_____	
13	3.9	_____	_____	_____	_____	_____	_____	
14	4.2	_____	_____	_____	_____	_____	_____	
15	4.5	_____	_____	_____	_____	_____	_____	
16	4.8	_____	_____	_____	_____	_____	_____	
17	5.1	_____	_____	_____	_____	_____	_____	
18	5.4	_____	_____	_____	_____	_____	_____	
19	5.7	_____	_____	_____	_____	_____	_____	
20	6.0	_____	_____	_____	_____	_____	_____	
21	6.3	_____	_____	_____	_____	_____	_____	
22	6.6	_____	_____	_____	_____	_____	_____	
23	6.9	_____	_____	_____	_____	_____	_____	
24	7.2	_____	_____	_____	_____	_____	_____	
25	7.5	_____	_____	_____	_____	_____	_____	
26	7.8	_____	_____	_____	_____	_____	_____	
27	8.1	_____	_____	_____	_____	_____	_____	
28	8.4	_____	_____	_____	_____	_____	_____	
29	8.7	_____	_____	_____	_____	_____	_____	
30	9.0	_____	_____	_____	_____	_____	_____	
31	9.3	_____	_____	_____	_____	_____	_____	
32	9.6	_____	_____	_____	_____	_____	_____	
33	9.9	_____	_____	_____	_____	_____	_____	
34	10.2	_____	_____	_____	_____	_____	_____	
35	10.5	_____	_____	_____	_____	_____	_____	
36	10.8	_____	_____	_____	_____	_____	_____	
37	11.1	_____	_____	_____	_____	_____	_____	
38	11.4	_____	_____	_____	_____	_____	_____	
39	11.7	_____	_____	_____	_____	_____	_____	
40	12.0	_____	_____	_____	_____	_____	_____	
41	12.3	_____	_____	_____	_____	_____	_____	
42	12.6	_____	_____	_____	_____	_____	_____	
43	12.9	_____	_____	_____	_____	_____	_____	
44	13.2	_____	_____	_____	_____	_____	_____	
45	13.5	_____	_____	_____	_____	_____	_____	
46	13.8	_____	_____	_____	_____	_____	_____	
47	14.1	_____	_____	_____	_____	_____	_____	

Date Entered: \_\_\_\_ / \_\_\_\_ / \_\_\_\_

Pnt	Tape	Hgt (m)	Spp; Species or Substrate Codes (tallest to lowest)					
48	14.4							
49	14.7							
50	15.0							
51	15.3							
52	15.6							
53	15.9							
54	16.2							
55	16.5							
56	16.8							
57	17.1							
58	17.4							
59	17.7							
60	18.0							
61	18.3							
62	18.6							
63	18.9							
64	19.2							
65	19.5							
66	19.8							
67	20.1							
68	20.4							
69	20.7							
70	21.0							
71	21.3							
72	21.6							
73	21.9							
74	22.2							
75	22.5							
76	22.8							
77	23.1							
78	23.4							
79	23.7							
80	24.0							
81	24.3							
82	24.6							
83	24.9							
84	25.2							
85	25.5							
86	25.8							
87	26.1							
88	26.4							
89	26.7							
90	27.0							
91	27.3							
92	27.6							
93	27.9							
94	28.2							
95	28.5							
96	28.8							
97	29.1							
98	29.4							
99	29.7							
100	30.0							

Species observed within \_\_\_ m of either side of the transect but not intercepted: \_\_\_\_\_

\_\_\_\_\_

\_\_\_\_\_

\_\_\_\_\_

FMH-17

**SHRUB DENSITY DATA SHEET**

Page \_\_\_\_ of \_\_\_\_

Plot ID: \_\_\_\_\_

B / C (Circle One)

Date: \_\_\_\_ / \_\_\_\_ / \_\_\_\_

Burn Unit: \_\_\_\_\_

Recorders: \_\_\_\_\_

Burn Status: Circle one and indicate number of times treated, e.g., 01-yr01, 02-yr01

00-PRE \_\_\_\_ Post \_\_\_\_-yr01 \_\_\_\_-yr02 \_\_\_\_-yr05 \_\_\_\_-yr10 \_\_\_\_-yr20 Other: \_\_\_\_-yr\_\_\_\_; \_\_\_\_-mo\_\_\_\_

Transect: Q4-Q1 w Q3-Q2 w 0P-50P w Q4-30 m w 0P-30P (Circle One)

For living and dead plants within the transect, count each individual having >50% of its rooted base in the belt. The optional interval field (Int) can be used to divide the belt into subunits to facilitate species counts. Record Age Class (Age) code (see below).

Belt Width: \_\_\_\_m Length: \_\_\_\_m Side of transect monitored facing 30P (Brush Plots Only): \_\_\_\_\_

Int	Spp	Age	Live	Num / Tally	Int	Spp	Age	Live	Num / Tally
			Y N					Y N	
			Y N					Y N	
			Y N					Y N	
			Y N					Y N	
			Y N					Y N	
			Y N					Y N	
			Y N					Y N	
			Y N					Y N	
			Y N					Y N	
			Y N					Y N	
			Y N					Y N	
			Y N					Y N	
			Y N					Y N	
			Y N					Y N	
			Y N					Y N	
			Y N					Y N	
			Y N					Y N	
			Y N					Y N	
			Y N					Y N	
			Y N					Y N	
			Y N					Y N	
			Y N					Y N	
			Y N					Y N	
			Y N					Y N	
			Y N					Y N	

Age Class Codes: I Immature-Seedling R Resprout M Mature-Adult

**FMH-17A**

**ALTERNATE SHRUB DENSITY DATA SHEET**

Page    of   

Plot ID: \_\_\_\_\_

B / C (Circle One)

Date:    /    /   

Burn Unit: \_\_\_\_\_

Recorders: \_\_\_\_\_

Burn Status: Circle one and indicate number of times treated, e.g., 01-yr01, 02-yr01

00-PRE    Post   -yr01   -yr02   -yr05   -yr10   -yr20 Other:   -yr   ;   -mo   

Transect: Q4–Q1 <sub>w</sub> Q3–Q2 <sub>w</sub> 0P–50P <sub>w</sub> Q4–30 m <sub>w</sub> 0P–30P (Circle One)

For living and dead plants within the transect, count each individual having >50% of its rooted base in the belt. The optional interval field (Int) can be used to divide the belt into subunits to facilitate species counts. Record Age Class (Age) code (see below).

Belt Width:    m Length:    m Side of transect monitored facing 30P (Brush Plots Only): \_\_\_\_\_

Int	Spp	Age	Live	Num	Tally
_____	_____	_____	Y N	_____	_____
_____	_____	_____	Y N	_____	_____
_____	_____	_____	Y N	_____	_____
_____	_____	_____	Y N	_____	_____
_____	_____	_____	Y N	_____	_____
_____	_____	_____	Y N	_____	_____
_____	_____	_____	Y N	_____	_____
_____	_____	_____	Y N	_____	_____
_____	_____	_____	Y N	_____	_____
_____	_____	_____	Y N	_____	_____
_____	_____	_____	Y N	_____	_____
_____	_____	_____	Y N	_____	_____
_____	_____	_____	Y N	_____	_____
_____	_____	_____	Y N	_____	_____
_____	_____	_____	Y N	_____	_____
_____	_____	_____	Y N	_____	_____
_____	_____	_____	Y N	_____	_____
_____	_____	_____	Y N	_____	_____
_____	_____	_____	Y N	_____	_____
_____	_____	_____	Y N	_____	_____
_____	_____	_____	Y N	_____	_____
_____	_____	_____	Y N	_____	_____
_____	_____	_____	Y N	_____	_____
_____	_____	_____	Y N	_____	_____
_____	_____	_____	Y N	_____	_____

AgeClassCodes: **I** Immature–Seedling **R** Resprout **M** Mature–Adult

FMH-18

HERBACEOUS DENSITY DATA SHEET

Page \_\_\_ of \_\_\_

Plot ID: \_\_\_\_\_

B / C (Circle One)

Date: \_\_\_ / \_\_\_ / \_\_\_

Burn Unit: \_\_\_\_\_

Recorders: \_\_\_\_\_

Burn Status: Circle one and indicate number of times treated, e.g., 01-yr01, 02-yr01

00-PRE \_\_\_ Post \_\_\_-yr01 \_\_\_-yr02 \_\_\_-yr05 \_\_\_-yr10 \_\_\_-yr20 Other: \_\_\_-yr \_\_\_; \_\_\_-mo \_\_\_

Transect: Q4-Q1 w Q3-Q2 w 0P-50P w Q4-30 m w 0P-30P (Circle One)

For living and dead plants within the transect, count each individual having >50% of its rooted base in the sampling area.

Frame Size: \_\_\_\_\_ m<sup>2</sup>

Side of transect monitored facing 30P (Brush Plots Only): \_\_\_\_\_

Frame #	Spp	Live	Num	Frame #	Spp	Live	Num
_____	_____	Y N	_____	_____	_____	Y N	_____
_____	_____	Y N	_____	_____	_____	Y N	_____
_____	_____	Y N	_____	_____	_____	Y N	_____
_____	_____	Y N	_____	_____	_____	Y N	_____
_____	_____	Y N	_____	_____	_____	Y N	_____
_____	_____	Y N	_____	_____	_____	Y N	_____
_____	_____	Y N	_____	_____	_____	Y N	_____
_____	_____	Y N	_____	_____	_____	Y N	_____
_____	_____	Y N	_____	_____	_____	Y N	_____
_____	_____	Y N	_____	_____	_____	Y N	_____
_____	_____	Y N	_____	_____	_____	Y N	_____
_____	_____	Y N	_____	_____	_____	Y N	_____
_____	_____	Y N	_____	_____	_____	Y N	_____
_____	_____	Y N	_____	_____	_____	Y N	_____
_____	_____	Y N	_____	_____	_____	Y N	_____
_____	_____	Y N	_____	_____	_____	Y N	_____
_____	_____	Y N	_____	_____	_____	Y N	_____
_____	_____	Y N	_____	_____	_____	Y N	_____
_____	_____	Y N	_____	_____	_____	Y N	_____
_____	_____	Y N	_____	_____	_____	Y N	_____
_____	_____	Y N	_____	_____	_____	Y N	_____

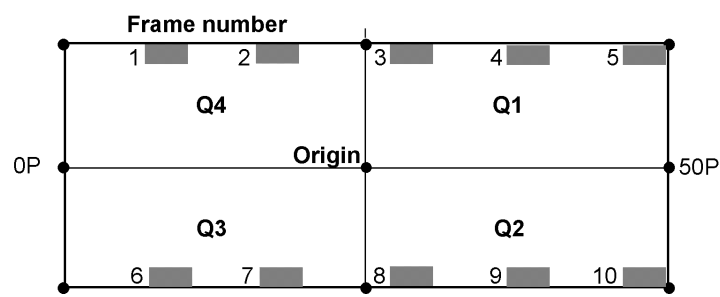

Date Entered: \_\_\_ / \_\_\_ / \_\_\_



Frame #	Spp	Live	Num	Frame #	Spp	Live	Num
		YN				YN	
		YN				YN	
		YN				YN	
		YN				YN	
		YN				YN	
		YN				YN	
		YN				YN	
		YN				YN	
		YN				YN	
		YN				YN	
		YN				YN	
		YN				YN	
		YN				YN	
		YN				YN	
		YN				YN	
		YN				YN	
		YN				YN	
		YN				YN	
		YN				YN	
		YN				YN	
		YN				YN	
		YN				YN	
		YN				YN	
		YN				YN	
		YN				YN	
		YN				YN	
		YN				YN	
		YN				YN	
		YN				YN	
		YN				YN	
		YN				YN	
		YN				YN	
		YN				YN	
		YN				YN	
		YN				YN	
		YN				YN	
		YN				YN	
		YN				YN	
		YN				YN	
		YN				YN	
		YN				YN	

FMH-19

**FOREST PLOT FUELS INVENTORY DATA SHEET**

Page \_\_\_ of \_\_\_

Plot ID: \_\_\_\_\_

B / C (Circle One)

Date: \_\_\_ / \_\_\_ / \_\_\_

Burn Unit: \_\_\_\_\_

Recorders: \_\_\_\_\_

Burn Status: Circle one and indicate number of times treated, e.g., 01-yr01, 02-yr01

00-PRE \_\_\_ Post \_\_\_-yr01 \_\_\_-yr02 \_\_\_-yr05 \_\_\_-yr10 \_\_\_-yr20 Other: \_\_\_-yr\_\_\_; \_\_\_-mo\_\_\_

Transect lengths, in feet: 0-0.25: \_\_\_\_\_ 0.25-1: \_\_\_\_\_ 1-3: \_\_\_\_\_ 3+s: \_\_\_\_\_ 3+r: \_\_\_\_\_

	# of intercepts			Diameter (in)		Litter and Duff Depths (in)					
	0-.25"	.25-1"	1-3"	3+s	3+r	L	D	L	D		
	(1-hr)	(10-hr)	(100-hr)	(1,000-hr)							
<b>Transect 1</b>						1			25		
Compass						5			30		
Dir. _____°						10			35		
Slope ___%						15			40		
Tag 1A						20			45		
& 1B											
<b>Transect 2</b>						1			25		
Compass						5			30		
Dir. _____°						10			35		
Slope ___%						15			40		
Tag 2A						20			45		
& 2B											
<b>Transect 3</b>						1			25		
Compass						5			30		
Dir. _____°						10			35		
Slope ___%						15			40		
Tag 3A						20			45		
& 3B											
<b>Transect 4</b>						1			25		
Compass						5			30		
Dir. _____°						10			35		
Slope ___%						15			40		
Tag 4A						20			45		
& 4B											

**Note:** See reverse for definitions and tally rules

## Definitions

**Litter**—Includes freshly fallen leaves, needles, bark, flakes, fruits (e.g., acorns, cones), cone scales, dead matted grass, and a variety of miscellaneous vegetative parts. Does not include twigs and larger stems.

**Duff**—The fermentation and humus layers; does not include the freshly cast material in the litter layer, nor in the postburn environment, ash. The top of the duff is where needles, leaves, fruits and other cast-off vegetative material have noticeably begun to decompose. Individual particles usually are bound by fungal mycelia. The bottom of the duff is mineral soil.

**Downed Woody Material**—Dead twigs, branches, stems and boles of trees and shrubs that have fallen and lie on or above the ground.

**Obstructions Encountered Along Fuel Transects**—If the fuel transect azimuth goes directly through a rock or stump, in most cases you can run the tape up and over it. If the obstruction is a tree, go around it and pick up the correct azimuth on the other side. Be sure to note on the FMH-19 on which side of the bole the tape deviated so that it will be strung the same way in the future.

## Litter and Duff Measurement Rules

- If the transect is longer than 50 ft, do not take additional litter and duff measurements.
- Do not take measurements at the stake (0 point); it is an unnatural structure that traps materials.
- At each sampling point, gently insert a trowel or knife into the ground, until you hit mineral soil, then carefully pull it away exposing the litter/duff profile. Locate the boundary between the litter and duff layers. Vertically measure the litter and duff to the nearest tenth of an inch.
- Refill holes created by this monitoring technique.
- Do not include twigs and larger stems in litter depth measurements.
- Occasionally moss, a tree trunk, stump, log, or large rock will occur at a litter or duff depth data collection point. If moss is present, measure the duff from the base of the green portion of the moss. If a tree, stump or large rock is on the point, record the litter or duff depth as zero, even if there is litter or duff on top of the stump or rock.
- If a log is in the middle of the litter or duff measuring point, move the data collection point one foot over to the right, perpendicular to the sampling plane.

## Tally Rules for Downed Woody Material

- Measure woody material first to avoid disturbing it and biasing your estimates.
- Do not count dead woody stems and branches still attached to standing shrubs and trees.
- Do not count twigs and branches when the intersection between the central axis of the particle and the sampling plane lies in the duff.
- If the sampling plane intersects the end of a piece, tally only if the central axis is crossed.
- Do not tally any particle having a central axis that coincides perfectly with the sampling plane.
- If the sampling plane intersects a curved piece more than once, tally each intersection.
- Tally uprooted stumps and roots not encased in dirt. Do not tally undisturbed stumps.
- For rotten logs that have fallen apart, visually construct a cylinder containing the rotten material and estimate its diameter.
- When stumps, logs, and trees occur at the point of measurement, offset 1 ft (0.3 m) perpendicular to the right side of the sampling plane.
- Measure through rotten logs whose central axis is in the duff layer.

FMH-20

TREE POSTBURN ASSESSMENT DATA SHEET

Page \_\_\_ of \_\_\_

Plot ID: \_\_\_\_\_

B / C (Circle One)

Date: \_\_\_ / \_\_\_ / \_\_\_

Burn Unit: \_\_\_\_\_

Recorders: \_\_\_\_\_

Burn Status: Circle one and indicate number of times treated, e.g., 01-Post, 02-Post) \_\_\_\_\_ Post

For each tagged tree record: Tag #, tree status (Live Code) (see below), **maximum** scorch height (ScHgt), percent crown scorched (ScPer), and char height (Char) (Optional).

**Overstory w Pole** (Circle One)

Tag	Live Code	ScHgt (m)	ScPer	Char (m)	Tag	Live Code	ScHgt (m)	ScPer	Char (m)

Live Codes:

L	Live	D	Dead	R	Resprouting	C	Consumed/Down	B	Broken below DBH	S	Cut Stump
---	------	---	------	---	-------------	---	---------------	---	------------------	---	-----------

Notes: \_\_\_\_\_ :



**FMH-21**

**FOREST PLOT BURN SEVERITY DATA SHEET**

Page \_\_\_ of \_\_\_

Plot ID: \_\_\_\_\_

B / C (Circle One)

Date: \_\_\_ / \_\_\_ / \_\_\_

Burn Unit: \_\_\_\_\_

Recorders: \_\_\_\_\_

Burn Status: Circle one and indicate number of times treated, e.g., 01-Post, 02-Post) \_\_\_\_\_ Post

When collecting burn severity on fuel transects, rate each fuel load transect at the duff measurement points using the Coding Matrix below. When collecting burn severity on herbaceous transects, rate each herbaceous transect (Q4–Q1—transect 1, Q3–Q2—transect 2, 0P–50P—transect 3) at the meter measurement points on the tape listed in the tables below (1, 5, 10, etc.) using the same matrix. Collect data only along the transects where you collected preburn data. Note: If you read only herbaceous transect Q4–30 m, use FMH-22.

Each observation is from a 4 dm<sup>2</sup> area.

Transect 1	1	5	10	15	20	25	30	35	40	45
Vegetation										
Substrate										

Transect 2	1	5	10	15	20	25	30	35	40	45
Vegetation										
Substrate										

Transect 3	1	5	10	15	20	25	30	35	40	45
Vegetation										
Substrate										

Transect 4	1	5	10	15	20	25	30	35	40	45
Vegetation										
Substrate										

**Coding Matrix:**

5 Unburned	4 Scorched	3 Lightly Burned	2 Moderately Burned	1 Heavily Burned	0 Not Applicable
------------	------------	------------------	---------------------	------------------	------------------

Note: See reverse for detailed definitions.

Date Entered: \_\_\_ / \_\_\_ / \_\_\_

	Unburned (5)	Scorched (4)	Lightly Burned (3)	Moderately Burned (2)	Heavily Burned (1)	Not Applicable (0)
<b>Substrate (S)</b>	not burned	litter partially blackened; duff nearly unchanged; wood/leaf structures unchanged	litter charred to partially consumed; upper duff layer may be charred but the duff layer is not altered over the entire depth; surface appears black; woody debris is partially burned; logs are scorched or blackened but not charred; rotten wood is scorched to partially burned	litter mostly to entirely consumed, leaving coarse, light colored ash; duff deeply charred, but underlying mineral soil is not visibly altered; woody debris is mostly consumed; logs are deeply charred, burned-out stump holes are common	litter and duff completely consumed, leaving fine white ash; mineral soil visibly altered, often reddish; sound logs are deeply charred, and rotten logs are completely consumed. This code generally applies to less than 10% of natural or slash burned areas	inorganic preburn
<b>Vegetation (V)</b>	not burned	foliage scorched and attached to supporting twigs	foliage and smaller twigs partially to completely consumed; branches mostly intact	foliage, twigs, and small stems consumed; some branches still present	all plant parts consumed, leaving some or no major stems/trunks; any left are deeply charred	none present preburn

**FMH-22 BRUSH AND GRASSLAND PLOT BURN SEVERITY DATA SHEET** Page \_\_\_ of \_\_\_

Plot ID: \_\_\_\_\_ B / C (Circle One) Date: \_\_\_ / \_\_\_ / \_\_\_

Burn Unit: \_\_\_\_\_ Recorders: \_\_\_\_\_

Burn Status: Circle one and indicate number of times treated, e.g., 01-Post, 02-Post) \_\_\_\_\_ Post

Burn severity ratings are made every 5 m using the Coding Matrix below. Each observation is from a 4 dm<sup>2</sup> area (top form). Optionally, you can use the lower form, which will allow you to rate severity at all 100 points. Note: If your herbaceous transect(s) are longer than 30 m, use FMH-21.

(Circle One) Q4-30 m w 0P-30P

	1 m	5 m	10 m	15 m	20 m	25 m	30 m
<b>Vegetation</b>							
<b>Substrate</b>							

OR

Substrate and Vegetation Burn Severity at Every Point (Optional)

0.3 S___ V___	6.3 S___ V___	12.3 S___ V___	18.3 S___ V___	24.3 S___ V___
0.6 S___ V___	6.6 S___ V___	12.6 S___ V___	18.6 S___ V___	24.6 S___ V___
0.9 S___ V___	6.9 S___ V___	12.9 S___ V___	18.9 S___ V___	24.9 S___ V___
1.2 S___ V___	7.2 S___ V___	13.2 S___ V___	19.2 S___ V___	25.2 S___ V___
1.5 S___ V___	7.5 S___ V___	13.5 S___ V___	19.5 S___ V___	25.5 S___ V___
1.8 S___ V___	7.8 S___ V___	13.8 S___ V___	19.8 S___ V___	25.8 S___ V___
2.1 S___ V___	8.1 S___ V___	14.1 S___ V___	20.1 S___ V___	26.1 S___ V___
2.4 S___ V___	8.4 S___ V___	14.4 S___ V___	20.4 S___ V___	26.4 S___ V___
2.7 S___ V___	8.7 S___ V___	14.7 S___ V___	20.7 S___ V___	26.7 S___ V___
3.0 S___ V___	9.0 S___ V___	15.0 S___ V___	21.0 S___ V___	27.0 S___ V___
3.3 S___ V___	9.3 S___ V___	15.3 S___ V___	21.3 S___ V___	27.3 S___ V___
3.6 S___ V___	9.6 S___ V___	15.6 S___ V___	21.6 S___ V___	27.6 S___ V___
3.9 S___ V___	9.9 S___ V___	15.9 S___ V___	21.9 S___ V___	28.9 S___ V___
4.2 S___ V___	10.2 S___ V___	16.2 S___ V___	22.2 S___ V___	28.2 S___ V___
4.5 S___ V___	10.5 S___ V___	16.5 S___ V___	22.5 S___ V___	28.5 S___ V___
4.8 S___ V___	10.8 S___ V___	16.8 S___ V___	22.8 S___ V___	29.8 S___ V___
5.1 S___ V___	11.1 S___ V___	17.1 S___ V___	23.1 S___ V___	29.1 S___ V___
5.4 S___ V___	11.4 S___ V___	17.4 S___ V___	23.4 S___ V___	29.4 S___ V___
5.7 S___ V___	11.7 S___ V___	17.7 S___ V___	23.7 S___ V___	29.7 S___ V___
6.0 S___ V___	12.0 S___ V___	18.0 S___ V___	24.0 S___ V___	30.0 S___ V___

**Coding Matrix:**

5 Unburned	4 Scorched	3 Lightly Burned	2 Moderately Burned	1 Heavily Burned	0 Not Applicable
------------	------------	------------------	---------------------	------------------	------------------

**Note:** See reverse for detailed definitions.

Date Entered: \_\_\_ / \_\_\_ / \_\_\_



	Shrublands		Grasslands	
	Substrate (S)	Vegetation (V)	Substrate (S)	Vegetation (V)
<b>Unburned (5)</b>	not burned	not burned	not burned	not burned
<b>Scorched (4)</b>	litter partially blackened; duff nearly unchanged; wood/leaf structures unchanged	foliage scorched and attached to supporting twigs	litter partially blackened; duff nearly unchanged; leaf structures unchanged	foliage scorched
<b>Lightly Burned (3)</b>	litter charred to partially consumed, some leaf structure undamaged; surface is predominately black; some gray ash may be present immediately postburn; charring may extend slightly into soil surface where litter is sparse, otherwise soil is not altered	foliage and smaller twigs partially to completely consumed; branches mostly intact; less than 60% of the shrub canopy is commonly consumed	litter charred to partially consumed, but some plant parts are still discernible; charring may extend slightly into soil surface, but soil is not visibly altered; surface appears black (this soon becomes inconspicuous); burns may be spotty to uniform depending on the grass continuity	grasses with approximately two inches of stubble; foliage and smaller twigs of associated species partially to completely consumed; some plant parts may still be standing; bases of plants are not deeply burned and are still recognizable
<b>Moderately Burned (2)</b>	leaf litter consumed, leaving coarse, light colored ash; duff deeply charred, but underlying mineral soil is not visibly altered; woody debris is mostly consumed; logs are deeply charred, burned-out stump holes are common	foliage, twigs, and small stems consumed; some branches (>.6–1 cm in diameter) (0.25–0.50 in) still present; 40–80% of the shrub canopy is commonly consumed	leaf litter consumed, leaving coarse, light gray or white colored ash immediately after the burn; ash soon disappears leaving bare mineral soil; charring may extend slightly into soil surface	unburned grass stubble usually less than 2 in tall, and mostly confined to an outer ring; for other species, foliage completely consumed, plant bases are burned to ground level and obscured in ash immediately after burning; burns tend to be uniform
<b>Heavily Burned (1)</b>	leaf litter completely consumed, leaving a fluffy fine white ash; all organic material is consumed in mineral soil to a depth of 1–2.5 cm (0.5–1 in), this is underlain by a zone of black organic material; colloidal structure of the surface mineral soil may be altered	all plant parts consumed leaving only stubs greater than 1 cm (0.5 in) in diameter	leaf litter completely consumed, leaving a fluffy fine white ash, this soon disappears leaving bare mineral soil; charring extends to a depth of 1 cm (0.5 in) into the soil; this severity class is usually limited to situations where heavy fuel load on mesic sites has burned under dry conditions and low wind	no unburned grasses above the root crown; for other species, all plant parts consumed, leaving some or no major stems or trunks, any left are deeply charred; this severity class is uncommon due to the short burnout time of grasses
<b>Not Applicable (0)</b>	inorganic preburn	none present preburn	inorganic preburn	none present preburn

**FMH-23**

**PHOTOGRAPHIC RECORD SHEET**

Roll ID: \_\_\_\_\_ Brand and Type of Film: \_\_\_\_\_

Camera Type: \_\_\_\_\_ Lens: \_\_\_\_\_ mm ASA: \_\_\_\_\_

#	Fire Name/ Number	Plot ID	Subject (e.g., Q3-Q2)	Azmth	Date	Time	F-Stop	S- Speed
1								
2								
3								
4								
5								
6								
7								
8								
9								
10								
11								
12								
13								
14								
15								
16								
17								
18								
19								
20								
21								
22								
23								
24								
25								
26								
27								
28								
29								
30								
31								
32								
33								
34								
35								
36								
37								
38								



**FMH-24**

**QUALITY CONTROL CHECKLIST**

Plot ID: \_\_\_\_\_

Burn Status, e.g., 01-yr01, 02-yr01:      -                      -                      -                      -                      -                      -

		Initials/ Date	Initials/ Date	Initials/ Date	Initials/ Date	Initials/ Date	Initials/ Date
<b>30/50 m Transect</b>	Data Collected						
	Quality Checked						
	Data Entered						
	Quality Checked						
<b>Overstory Trees</b>	Data Collected						
	Quality Checked						
	Data Entered						
	Quality Checked						
<b>Pole-size Trees</b>	Data Collected						
	Quality Checked						
	Data Entered						
	Quality Checked						
<b>Seedling Trees</b>	Data Collected						
	Quality Checked						
	Data Entered						
	Quality Checked						
<b>Fuel Transects</b>	Data Collected						
	Quality Checked						
	Data Entered						
	Quality Checked						
<b>Shrub Density</b>	Data Collected						
	Quality Checked						
	Data Entered						
	Quality Checked						
<b>Photographs</b>	Taken						
	Developed						
	Labeled						
<b>Data Entry</b>	Computer(s) Used						
<b>Plot Location Data Sheet</b>		Completed?				Quality Checked?	
<b>Plot Location Map</b>		Completed?				Quality Checked?	
<b>Tags</b>		Attached?				Offsite Data Storage? Location:	

**Comments:**

FMH-25

### PLOT MAINTENANCE LOG

Plot ID: \_\_\_\_\_

Date Log Initiated: \_\_\_\_\_

<b>Date/ Initials</b>	<b>Problem Description</b>	<b>Corrective Action</b>	<b>Date Completed/ Initials</b>	<b>Comments</b>

FMH-26

**DATA ANALYSIS RECORD**

Date: \_\_\_\_ / \_\_\_\_ / \_\_\_\_

Monitoring Type Information (One type per data analysis worksheet)

B / C (Circle One)

Monitoring Type Code	Monitoring Type Name	# Plots in this Analysis
----------------------	----------------------	--------------------------

**Resource Management Goal(s) for this Monitoring Type; e.g., restore and then maintain naturally functioning oak savannas:**

---



---



---

**Target/Threshold Condition(s) for this Monitoring Type:**

---



---



---

**Management Objectives for this Monitoring Type; e.g., reduce total fuel load by 20-80% immediately postburn:**

---



---



---

**Monitoring Objectives for this Monitoring Type; e.g., 80% confident of being within 25% of the true mean fuel load:**

---



---



---

Objective Variables	Other Variables of Interest
---------------------	-----------------------------

Calculated Minimum Number of Plots (Attach computer-generated printouts from which data results were obtained.)

Objective Variable	Minimum Detectable Change	Precision (R) or Power (β)	Confidence Interval (%)	Minimum # Plots	Mean	Standard Deviation
1.						
2.						
3.						

Reaction/Planned Actions Based on Calculated Minimum Number of Plots

Objective Variable	Accept # plots calculated?	Add plots & recalculate?	Number of plots needed is prohibitive	the following actions will be taken instead
1.	Yes No	Yes No		
2.	Yes No	Yes No		
3.	Yes No	Yes No		

Change Over Any Amount of Time (Attach computer generated printouts and graphics from which results/conclusions were drawn.)

Objective Variable	Time Period: _____			Time Period: _____			% Change (+ or )		Objective Met?	Objective Not Met Will Be Taken	These Actions Will Be Taken
	Actual Value	CI (%)	SE/SD (circle one)	Actual Value	CI (%)	SE/SD (circle one)	Actual Value	CI (%)			
1.		_____ to _____ 80/90/95			_____ to _____ 80/90/95			_____ to _____ 80/90/95			
2.		_____ to _____ 80/90/95			_____ to _____ 80/90/95			_____ to _____ 80/90/95			
3.		_____ to _____ 80/90/95			_____ to _____ 80/90/95			_____ to _____ 80/90/95			

**Discussion (add additional sheets, as necessary):**

---



---



---



---



---

# B

# Random Number Generators

*“The generation of random numbers is too important to be left to chance.”*

—Robert Coveyou

Random numbers are used to select truly random samples in monitoring plots and for other purposes. They can be obtained from a table or by using a computer. Note that many calculators also include random number generators.

## USING A TABLE

For each use of the random number table (Table 31, page 190) choose an arbitrary starting point within the table, a reading direction, and a rule for continuing the reading of numbers if the edge of the table is reached. Number sequences may be read in any arbitrary direction (forwards horizontal, downwards vertical, diagonal, etc.) from the starting point, as long as this direction is chosen without reference to placement of numbers in the table. Various rules for continuation of reading can be used; the easiest rules use the initial reading direction, but give a new starting point for further reading. The continuation rule should indicate a new starting position relative to the table edge which has been reached and should change that portion of the table used for continuation reading. Suggested continuation rules follow:

- Start at the opposite end of the table and move to the next line (up or down)
- Start at the center of the next row above and move in the opposite direction

Mark sequences of numbers as you read them, and choose a unique starting point for each new use of the table. If the chosen starting point and reading direction have been previously used, select another point-direction combination.

To generate short sequences, such as groups of three digits to obtain azimuths, divide long sequences into groups of three segments. Reject values that are out of range ( $>359^\circ$  for an azimuth) and continue the process until you have an adequate number of valid values.

### Example:

Say you need four random azimuths. You choose without reference to the table to use the 4<sup>th</sup> digit of the 10<sup>th</sup> row as a starting point. You also choose to read digits horizontally to the right from the starting point. You also decide in advance that you will move down one line when you reach the end of the 10<sup>th</sup> row. You check to ensure that this group of numbers has not been previously used. If this starting point and reading direction have been used previously, you choose another reading direction and starting point; otherwise, you proceed. Starting at the 10<sup>th</sup> row, 4<sup>th</sup> column of our table for our example:

---27	07043	74192	48202
68548	74131	76272	56927
22476	97041	78466	62578

From your starting point, group the digits into threes (as required for an azimuth), rejecting each group of three greater than 359 (out of bounds for an azimuth measurement).

This means that our 3-digit values for an azimuth will be: **270** 704 374 **192** 482 **026** 854 874 **131** 762 725 692 722 476 970 417 846 662 578. . . After rejecting those random numbers that do not provide valid azimuths, our four azimuths will be 270, 192, 26, and 131.



**Table 31. Random number table.**

	<b>12345</b>	<b>67890</b>	<b>12345</b>	<b>67890</b>	<b>12345</b>	<b>67890</b>	<b>12345</b>	<b>67890</b>	<b>12345</b>	<b>67890</b>	<b>12345</b>	<b>67890</b>
<b>1</b>	43420	17861	27541	93247	30645	58654	22765	79767	79506	11802	89126	28268
<b>2</b>	75384	23716	92241	89857	56180	73441	91722	70441	02346	96199	64682	52857
<b>3</b>	84635	97805	51941	02346	31448	46943	60803	31937	99144	99445	61523	80094
<b>4</b>	35577	33639	65961	33222	07508	50196	44245	39508	90236	22251	92363	27309
<b>5</b>	67327	06835	28539	36493	12186	30192	09663	64532	38836	42944	18308	22898
<b>6</b>	63978	14332	01203	70540	41428	85812	00262	57857	50984	67619	48422	57640
<b>7</b>	19004	31174	92411	09206	76051	67576	85574	47613	32144	10358	49050	06722
<b>8</b>	90681	94254	56333	95457	70753	60606	62576	85834	97304	12912	34783	06834
<b>9</b>	70397	47379	07639	46995	87271	35161	54082	03295	56480	38204	37946	97723
<b>10</b>	10727	07043	74192	48202	68548	74131	76272	56927	22476	97041	78466	62578
<b>11</b>	85149	33276	34494	87791	75795	11849	72237	79179	12789	92396	81012	26608
<b>12</b>	76280	14948	11781	26523	35319	43618	33411	63710	42533	90653	11275	98207
<b>13</b>	14497	03898	21628	04392	66984	90309	55778	46791	30241	54176	28265	62071
<b>14</b>	13825	57269	94949	21625	91201	27411	02711	68774	63451	94574	74490	58637
<b>15</b>	76967	72422	23259	52894	36296	12917	71327	25022	95914	31058	50915	09233
<b>16</b>	66349	23796	98079	79106	93148	73404	84240	40666	73334	63239	48548	71302
<b>17</b>	63054	36107	41357	46135	88972	32696	53570	28563	09485	92762	33551	33079
<b>18</b>	60529	53243	48777	84898	77113	92479	89100	14831	59604	53137	07735	82096
<b>19</b>	64917	87234	92835	52124	64729	99247	47446	41344	62916	32154	91327	06893
<b>20</b>	98923	56687	57559	76203	25245	56945	44116	79544	51183	96245	99872	16304
<b>21</b>	31059	49038	01736	17488	67443	69694	75337	14969	45140	51180	12153	85698
<b>22</b>	77156	66008	72540	77427	58070	23973	21523	86849	85689	98464	51003	64546
<b>23</b>	46020	36649	16417	15900	19837	44617	29255	92158	71752	71808	23880	04694
<b>24</b>	26104	07323	59118	61125	51681	84035	93654	88498	01617	63060	95082	93711
<b>25</b>	35063	43030	51741	21526	43169	28991	88024	55180	39694	71960	86485	02693
<b>26</b>	79087	99424	04666	33929	79923	34344	12627	96887	55527	39098	28660	82894
<b>27</b>	93861	49914	56260	07455	61921	18120	59478	99291	06944	46454	09266	70558
<b>28</b>	64053	77217	48215	47495	81584	77284	15032	70994	64234	94885	90574	84334
<b>29</b>	43183	63739	04408	69139	33484	08583	47637	31176	97202	92942	93021	24639
<b>30</b>	20766	40159	35146	34433	52582	43855	51621	27318	71996	16398	66634	09354
<b>31</b>	08585	76590	13683	72833	02847	34160	44903	92382	29577	22842	97241	05215
<b>32</b>	42994	25695	96872	69248	63149	42109	41990	75813	42698	30733	19308	39295
<b>33</b>	25096	52132	86838	29028	82285	26781	49243	07754	73278	97282	32297	99926
<b>34</b>	45698	07696	55532	54280	00023	30584	54275	80829	77042	54533	42414	61456
<b>35</b>	66903	36550	79066	90892	56043	02454	06379	58880	27298	88032	76624	92212
<b>36</b>	57215	19897	53673	30634	33632	16745	09832	47046	54733	67432	40804	30031
<b>37</b>	2042	94487	90192	77706	10029	72209	76974	82521	25101	63445	18913	34753
<b>38</b>	36452	04331	08940	14125	10283	80419	12925	30416	01669	10486	35054	52043
<b>39</b>	72084	69980	81853	23302	86499	78031	28819	94052	64314	99395	25296	47905
<b>40</b>	15066	84772	93764	56211	69351	22236	05421	74096	82126	09619	91147	98289
<b>41</b>	96824	72397	19695	49500	63740	53801	54022	35897	61410	15212	31533	43136
<b>42</b>	64659	65169	40047	29934	85462	37061	46467	69390	15946	24052	75168	39268
<b>43</b>	03964	87377	40550	64545	60767	11232	11196	50971	31397	34620	60200	71465
<b>44</b>	88959	53085	68853	40854	35686	12438	17186	41682	20726	19746	32984	06129
<b>45</b>	83807	12766	44634	86548	67001	50807	92645	81114	92507	71674	62879	96900
<b>46</b>	41011	08132	45094	62988	91721	52023	50359	61376	79004	67837	94935	76599
<b>47</b>	68939	19553	12725	91917	96963	97713	16549	90527	95882	41702	87342	94874
<b>48</b>	65367	15412	57214	99747	37082	24023	85117	79832	30446	68076	05522	85926

## USING SPREADSHEET PROGRAMS TO GENERATE RANDOM NUMBERS

A number of computer spreadsheet programs can calculate series of random numbers. Here are steps for using some of the most popular programs.

### Microsoft Excel

Random numbers can be generated in Microsoft Excel using the `RANDBETWEEN` function. This function allows you to specify the range of values you want generated. For example, if you want to generate a series of random azimuths you can specify generating numbers between 0 and 359. The function syntax is: `=RANDBETWEEN (bottom, top)`. **Note:** This feature is located under Data Analysis, in the “Tools” menu. This is supplied with Excel, but not installed automatically. If it is installed it will be at the bottom of the “Tools” menu. If it is not, you will have to go to the “Add Ins” options on the “Tools” menu and add in the Analysis ToolPak.

Then the steps are:

- Open a new Excel file
- Type the following into any cell: `=RANDBETWEEN(0,359)`. In this formula, zero is the bottom value and 359 is the top value. Press enter, and a single random number between 0 and 359 will then be generated within that cell

To generate additional numbers, do the following:

- Highlight the cell that contains the `RANDBETWEEN` function
- Press `CTRL + C` to copy the function
- Highlight the range of cells you would like the `RANDBETWEEN` function copied to
- Press `CTRL + V` to paste the function into each of the highlighted cells
- New numbers are generated each time the file is closed and reopened

### Corel Quattro Pro and Lotus 1-2-3

The steps are identical to those for Microsoft Excel, except you need to use the `@` symbol instead of the `=` sign, e.g., `@RANDBETWEEN (bottom, top)`.



*“Chance favors the prepared mind.”*

—Louis Pasteur

## Collecting & Processing Voucher Specimens

The creation of a good voucher collection allows you to track unknown species and provides a reference for identified species. Unknowns that you voucher and carefully track can be identified later, and the species name and code can be added retroactively throughout the database. In addition, the collection can be useful for new monitors to review commonly encountered plant species before going into the field.

Collecting herbarium-quality plant specimens requires some art and some craft. The following guidelines have been adapted from those used by experienced botanists and the Missouri Botanical Garden (Liesner 1997). They will help you produce high quality specimens that will be used by future monitors, park staff and researchers alike for many years to come.

### COLLECTING

#### General Guidelines

- Familiarize yourself with the plants that are, or are suspected to be, rare, threatened, or endangered species and **do not collect these species**. Sketch or photograph them instead, and take pictures as vouchers.
- Never collect material inside of or within five meters of plot boundaries. If a plant does not occur locally outside of the plot, write down a very detailed description of it, photograph or sketch it, and continue to look for it elsewhere in the monitoring type.
- When material is abundant outside of the plot, collect enough to make pressing worthwhile. There should be sufficient material to key and to fill a standard herbarium sheet as well as a field specimen binder page.
- “Since the objective of a good specimen is to provide in a convenient form an adequate representation of a plant, one should always include the full range of characters exhibited by the plant, including such things as the largest and smallest leaves, young leaves to show pubescence, stipules, etc. Specimens should always be improved by adding extra flowers

or fruits and inflorescences” (Liesner 1997).

- Collect as much of the individual plant as possible, including roots (or a portion if rhizomatous), bulbs, vegetative, and flowering or fruiting matter. **Do not “top snatch!”** At times there may be justification for allowing the main plant to survive while taking flowers, leaves and only a small portion of root, or no root, for identification (such as with an uncommon perennial species).

#### Preserving Collected Material

Preserving freshly collected material while still in the field can be a challenge. The following hints may help keep plant material in good shape.

#### *Herbaceous plants*

**Tiny plants with fragile flowers, fruits or foliage (ephemerals and other tiny species)**—Beware! Tiny flowered plants are difficult to key when wilted or pressed. Do your best to key them in the field. If that is not possible, or is unsuccessful, carefully press some in a pocket or field press. Place others in a small, sealable plastic food storage container (or a sealable plastic bag, filled with air), pad carefully with a damp cloth (e.g., paper towel or bandana), and try to keep them cool until you are ready to key them. Placing the plants in a refrigerator or a cooler will help keep them fresh.

**Sturdier plants**—Place the plant material in a bag that is large enough to accommodate a plant the size of a standard herbarium sheet (29 × 42 cm) without damaging the plant. Include a damp cloth (e.g., paper towel or bandana) if necessary to keep the sample fresh, and fill the bag with air. Large trash bags are good for dry plants such as grasses. When you collect something that is larger than an herbarium sheet, it is acceptable to bend it to fit into a bag. If the plant is fragile, any bending done to get it into a bag may result in a permanent kink, so bend it to the right size the first time. Alternatively, it may be possible to bend it broadly, without kinking the stem at all. Cutting at the bend

may also be acceptable; see section on “Pressing and Drying” (page 195).

### ***Woody plants***

If the plant is a shrub or tree, snip an appropriate, representative amount (include any fruits and flowers) and note its habit and dimensions along with the other information you collect.

### ***Cumbersome structures***

Cones, cactus pads and fruits, and other awkward structures should be put in paper bags and allowed to dry. It may be appropriate to slice them in half.

## **TOOLS AND SUPPLIES**

### **Plant Identification**

Carry floral references and plant lists to help you identify plants in the field, or at least determine which characteristics will be needed to distinguish species under a dissecting microscope.

You should keep in your office or lab a dissecting kit that includes, at minimum: a box of single-edged razor blades, two pairs of high quality, fine-tipped forceps, several dissecting pins or sharp probes, and a small plastic ruler (metric and English). A small pair of scissors can be useful for cutting large flower parts. As well, make sure to have a lighted dissecting microscope readily available in the office during the field season for the accurate identification of plant species. When using a dissecting scope, keep handy a few index cards with a portion of each side colored in with black marker and a roll of double sided tape—these will help you hold and see tiny, translucent structures that tend to dry up and jump around, such as composite and grass flowers and fruits.

### **Clipping and Digging**

In many cases, a good pocketknife is adequate for cutting branches and digging up roots. Having a set of garden clippers and a small trowel in the field is even better.

### **Storing Freshly Collected Material**

Monitors should carry an assortment of sealable plastic bags in various sizes, a couple of ten-gallon plastic trash bags, and a small (sandwich-size) sealable plastic food storage container—for fragile structures—in the field at all times. As well, keep a few pieces of cloth (e.g., paper towel or bandana) available to moisten and keep the specimens hydrated.

Alternately, you can fashion a 3 in × 5 in pocket press from two pieces of board (Masonite works) and several index cards with blotter paper cut to size, bound with a strong rubber band. Label each specimen as you press it with self-adhesive notes so you can correlate specimens with your field notebook.

### **Collection Notes in the Field**

Take meticulous, legible notes in the field. You can use a small notebook, or make a pronged folder of collection forms such as the one shown in Figure 42. The collection form includes all the information that will be needed for the herbarium labels. **Note:** Copies of this data sheet are on the back of the Species code list (FMH-6). At minimum, your field notes should include the following information:

- Date
- The plot identification code of the monitoring plot near which the sample was taken (the location info for sample plots is in their folders); if the sample was not taken near a plot, then note the specific location (and elevation) on a USGS topographic map
- Collector's name
- Collection number
- Plant name or five character “unknown” code
- Plant family, if known
- Description of the plant, including its habit (annual, biennial, perennial; nonvascular or vascular, fern, vine, herbaceous, shrub, subshrub, tree, etc.; plant dimensions, flower color, and any other items of note)
- Habitat description
- Associated species—list other plants commonly found with your sample

It is important to have a way to correlate your collected material with notes in your field notebook or form. Labels in permanent ink or pencil can be included in the bags with the specimens (note the date, collection number, plant name, etc.).

Date:	Plot ID:	Collected by:	Coll. #
Latin Name:		Family:	
Common Name:			
Description: ann/bien/per fl. color: fruit type:	Life form: other:	ht.:	Habitat:
Topo Quad:		Assoc. spp.:	
Location (UTM, lat/long):		Elev.:	Slope: Aspect:
Comments:			

Figure 42. Voucher specimen data collection form.

## PRESSING AND DRYING

Press your collected specimens as soon as possible; fresh samples are far more flexible and will allow you to position them well on the page. Keeping a standard plant press in your vehicle will allow you to press specimens promptly.

### Use of the Press

It is important to place the end pieces of the press right-side-up or the pressure from securing the straps may break the wooden strips. Between the end pieces, create sets of layers as follows: a sheet of corrugated cardboard, then a sheet of blotter paper, then several pages of newspaper, then another sheet of blotter paper and another sheet of corrugated cardboard. Place each specimen inside the folds of the newspaper. The tabloid-size pages of weekly and monthly newspaper publications (university newspapers, entertainment circulars, etc.) are often just the right size for standard presses.

As each specimen is pressed, note on the top side of the newspaper the collection number, plant name and any other information needed to correlate the specimen with the field notebook entry. Print the species name on the top side of each sheet so you do not have to open the sheets to see what is inside.

Face each sheet of newspaper in the same direction relative to the top side of the specimen and the fold. The samples will require less handling this way. Indicate the top side of the press and always open it right-side-up. Never turn press sheets like pages in a book; pieces will surely fall out with each turning. Instead, open the press, carefully lift each sheet, face up and with the open edge held slightly higher than the folded end so loose material will not escape, and place it aside.

## Arrangement of Specimens on the Page

### Size

Do not allow plant material to extend beyond the press edges; this will allow your specimens to be damaged when they are dry and fragile. Instead, arrange large specimens to fit in the press (see Figure 43).



Figure 43. Pressing an oversized specimen. (Shown mounted in an 8.5 × 11" field book.)

### Trimming the specimen

It may be necessary to trim off some leaves or other vegetative material to make a useful, uncluttered specimen. Do this carefully and with forethought; leaf position is often an important feature. If you do remove a leaf, leave part of the petiole to show the leaf position. Never remove the petiole base and stem attachment or



Figure 44. A nicely trimmed, tall specimen.

leaflets of a compound leaf, and don't mistake a compound leaf for a branch with individual leaves. Leave twigs whole—do not split them (see Figure 44).

### Arrangement

Once pressed, a single plant may not be rearranged, so arrange it artfully at the first pressing. Of course, multiple plants to be included on a single herbarium sheet may be rearranged around each other upon mounting (see Figure 45). Note that specimens of turgid plants may be more easily arranged if you first allow the samples to wilt slightly. You may use a small piece of glass (such as from a picture frame) so you can see the critical structures as you press them.

### Flowers

If the flowers are large enough (e.g., *Mimulus* or *Viola* or larger, most composites) cut one or two open and press them flat so the internal structures are visible (you can use your thumb to press open a flower, then pop it into the press, or press it under a small piece of glass). This is especially important in working with the Polemoniaceae and monocots. Floral structures of the composites are very important in identification, especially the phyllaries (bracts). Always include whole flowers as well (see Figure 46).

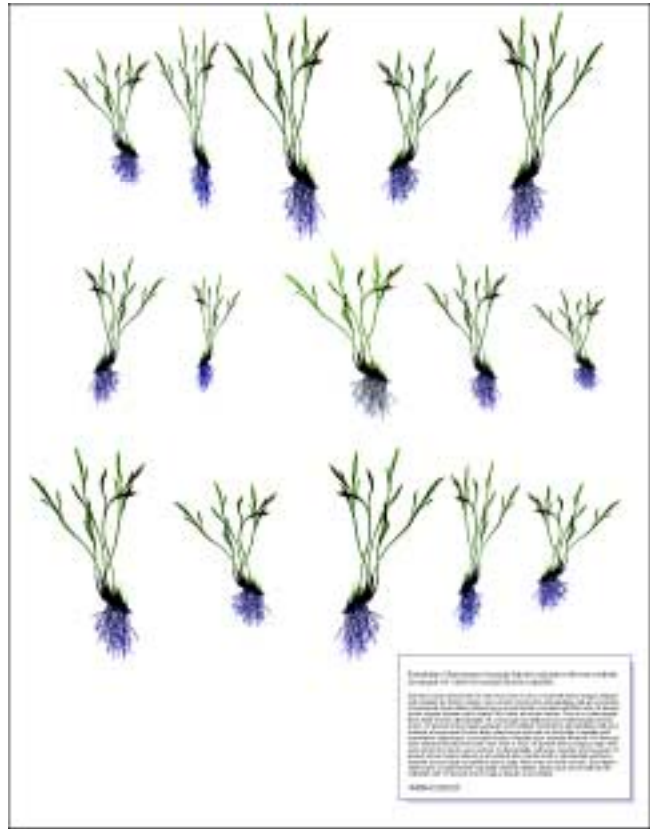

Figure 45. Arranging small plants on a single herbarium sheet.

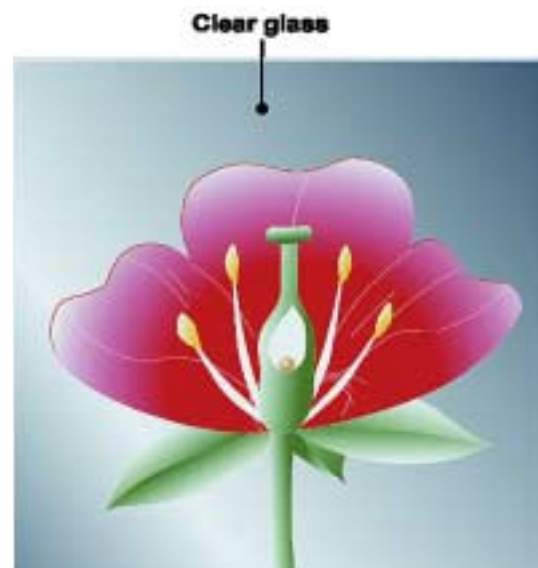

Figure 46. Pressing flowers in an open state.

### Vegetative parts

Press these in such a way that all important, or potentially important, diagnostic features are visible. Show both dorsal and ventral leaf surfaces, flatten out stipules, expose the nodes, and clean off the roots. If you must fold a leaf, keep the base and apex exposed (see Figure 47).

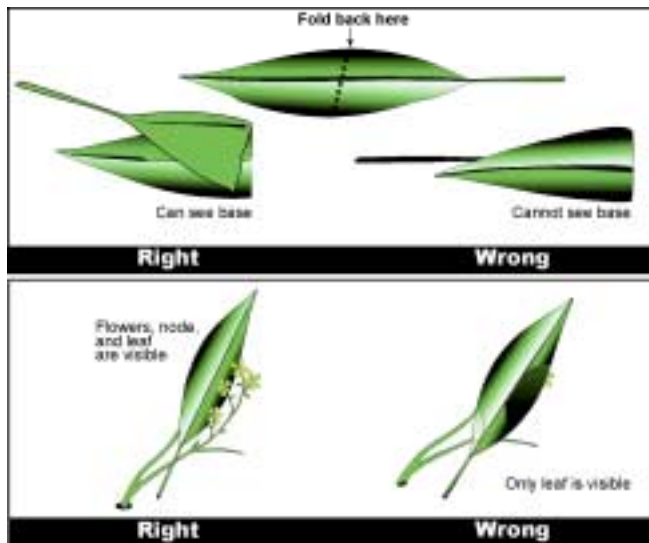

Figure 47. The right and wrong ways to press a large leaf.

### ***Loose fruits, seeds and other structures***

Store loose structures in envelopes or packets made out of newspaper. Make sure each packet is labeled.

### **Drying and Freezing**

Back in the office or lab, finish keying the specimens and compare them with any existing herbarium specimens. Once your identification is complete, you are ready to mount specimens. To prevent molding, first dry the specimens thoroughly. To prevent the introduction of insects to the collection, treat your specimens before moving them into an herbarium.

Commonly such treatment is done by wrapping plants in plastic and freezing them for a week or two. If you mount specimens in the office, freeze them after mounting. If you mount specimens in the herbarium, freeze them before mounting.

## **MOUNTING, LABELING AND STORING**

### **Choosing a Voucher Style**

The best system for vouchering the specimens collected on monitoring plots includes the preparation of a set of official herbarium sheets to be accessioned into the park collection, and the concurrent preparation of a set of smaller sheets for inclusion in a binder that can be easily and quickly accessed by monitors and taken into the field when necessary. Alternatively, you can establish a “working herbarium” for more casual use. See the section on “Storing” below for a detailed discussion of the various options.

### **Herbarium Specimens**

Properly prepared and stored herbarium specimens have an almost indefinite life span. Use only archival quality mounting materials (acid-free mounting and

label paper, glue, etc.), which will not deteriorate over time. The collection curator may have these on hand, or they can be purchased from standard curatorial sources. Never mount specimens with ordinary tape, staples or contact paper.

Create an aesthetically pleasing herbarium specimen by carefully considering the placement of plant material on the sheet.

### **Labeling**

The herbarium curator may require the use of a standard labeling form. In any case, the following information should be included on the label as shown in Figure 48:

- Genus, specific epithet and author
- Family name
- Exact location (including county, topographic quad name, township, range, section, elevation, burn unit, place name, access road, approximate mileage, etc.)
- Habitat description (e.g., wet meadow, oak woodland, dry coniferous forest understory, dry pinyon-juniper woodland)
- Associated species (especially the most common or dominant)
- Collector’s name
- Collection date

REDWOOD NATIONAL AND STATE PARKS HUMBOLDT AND DEL NORTE COUNTIES, CALIFORNIA HERBARIUM COLLECTION	
Latin Name: <i>Agrostis capillaris</i> L.	Cat. No.: 4149
Family: Poaceae	Acc. No.: 00153
Locality: FQUGA4D09-04, Dolason Prairie, see FMH-5 for further information	Elev.: 2320'
Habitat: Coastal Prairie	
Assoc. Spp.: <i>Arrhenatherum elatius</i> , <i>Elymus glaucus</i> , <i>Danthonia californica</i> , <i>Trifolium dubium</i> , <i>Rumex acetosella</i> , <i>Anthoxanthum aristatum</i> .	
Collected by: T. LaBanca and D. Brown	Date: 6/12/01
Adapted from USDI NPS form 10-512 (USDI NPS 2001c).	

Figure 48. Example of an herbarium label.

### **Storing**

Herbarium specimens should be stored according to NPS curatorial guidelines. If you choose to set up an additional, more accessible “working herbarium,” purchase an herbarium cabinet and specimen folders for this use, and keep your specimens under the best climatic conditions possible with regard to humidity and temperature. Herbarium Supply recommends 20–25°C and 40–60% (or lower) RH. Consult with your park curator for more information.



## Field Specimen Books

Your field specimen books will be an invaluable resource in the field and the office. When preparing the herbarium specimens, reserve some good examples of each specimen for the field book. Labeling in a field book is less formal than that of an herbarium, and can be abbreviated (as long as there is a corresponding herbarium specimen to which you can refer). At a minimum it must include the plant name (botanical and common, if desired) and family, the plot near which it was found, the collection date, the initials of the collector, and characteristics important in distinguishing between similar species (length of petals, number of leaflets, size of auricles, etc.). Make sure to also include the number of the herbarium specimen to which it corresponds. Arrange the pages by family, then genus and species. You can create separate books for different habitats as the collection grows. Compilation pages can be included, comparing easily confused species such as some ephemerals, or conifer seedlings.

paper. Taping the specimens directly to paper is not recommended as the specimens tend to get easily damaged with use. If the book is for office use only, you can use plastic sheet protectors; however, these may not be protective enough if the books are to be used in the field (see Figure 43, page 195).

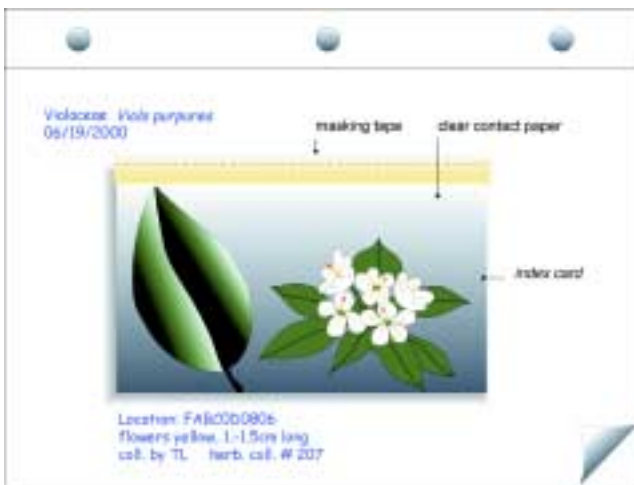

Figure 49. Example of a page from a field specimen book.

Two common styles of field specimen books are:

- **5 × 7 in three-ring binders:** Label an index card with the appropriate information. Encase the specimen between two layers of 3–4 in-wide packing tape or clear contact paper so that both sides of the specimen are visible. If the specimen is too big, include just the critical features, or split the specimen onto two cards. Then tape the encased specimen onto the index card at the top so that it can be flipped up for viewing the underside of the specimen (see Figure 49).
- **8½ × 11 in three-ring binders:** Mount specimens to labeled sheets of acid-free paper with clear contact paper. The contact paper tends to separate; take care that the contact paper is securely adhered to the

# Identifying Dead & Dormant Plants

Vegetation monitoring and sampling is best done during the “height of the bloom,” when most plants are flowering and thus most easily identified. In areas with a bimodal rainfall pattern, or otherwise weak seasonality (such as the southwest or the southeast), it may be best to regularly sample more than once per cycle. This allows you to catch entire suites of plants that you may otherwise miss.

Regardless, you will invariably encounter a few early bloomers that have already gone to seed, or some late blooming perennials that are still dormant. With careful observation and a few additional resources you can still identify dead and dormant plants.

## Identifying Species Using Only Vegetative Characters



Consider any determination that you make using only vegetative characters as tentative until you can make a comparison with a flowering specimen.

## RESOURCES

Always carry a species list and data sheets from previous visits or similar locations. In addition, be familiar with locally represented plant families and their characteristics. Here are some resources you will want to use:

- A species list for the area of concern and data sheets from previous visits, if available
- Your favorite flora
- Your field herbarium
- A locally oriented vegetative plant identification guide if available. **Note:** There are numerous vegetative keys to plant species and their seedlings (e.g., trees, shrubs, grasses, weeds, etc.) available for many locations (see the bibliography in Appendix G, page 240)

## OBSERVATIONS

The key to good science is good observation. One of the best techniques for identifying a cured, dehisced, or dormant plant is to gain familiarity with the plant during its flowering or fruiting stage. Go out in the field earlier than usual in the season and look around for the early bloomers, then go out again for late or off-season bloomers.

Another technique is careful observation of the clues at hand. Spend some time with the plant in question, and really look at it. Carefully examine the following characteristics (refer to a botanical glossary for definitions of these terms) and take notes on any available field clues:

- **Leaves, stipules and leaf scars:** arrangement (alternate, basal, opposite, whorled), attachment (clasping, petiolate, sessile), color, form (compound, simple, pinnate, needle-like), margin (e.g., entire, lobed, serrate), odor, shape (e.g., broad, narrow), size, stipules (presence and characteristics), texture (e.g., durability, smoothness, pubescence (including type, e.g., glandular, stellate, scales))
- **Buds:** arrangement (e.g., appressed, clustered), color, scales (i.e., arrangement, number, shape, texture), size, shape, texture (e.g., smooth, scaly, pubescent (including type, e.g., glandular, stellate, scales)), type (leaf vs. flower)
- **Stems and Twigs:** branching (e.g., extensive or limited, form), color, flexibility, texture (e.g., durability, smoothness, pubescence (including type, e.g., glandular, stellate, scales)), thorns (number, length, shape), odor, pith (color, composition), amount of woody tissue
- **Flowers:** if there is any evidence of flowers, you may be able to determine: arrangement (e.g., catkin, panicle, cyme, umbel), color, dehiscence, fragrance, location (terminal, lateral, new or old wood), filaments (fused, free), stamens (presence, number), number of stigmas/styles/pistils, ovary (superior, inferior or partly), sepals (characteristics, e.g., length, number, texture), presence of a floral bracts, presence of a hypanthium, size, type (e.g., radial, bilateral)
- **Fruit** (look on plant and beneath it): color, location (e.g., old or new wood, terminal or lateral), number of carpels, placenta (axile, parietal, free-central), seed characteristics (e.g., attachment, number), shape (e.g., flat, round, winged), texture (e.g., dry, fleshy), type of fruit (e.g., achene, berry, capsule, follicle, legume, utricle)
- **Bark:** color, texture (e.g., checkered, flaky, lined, smoothness, lenticles, pubescence (including type, e.g., glandular, stellate, scales)), thickness
- **Form:** ascending, columnar, conical, decumbent, erect, globular, oval, prostrate, spreading, vase-like, or weeping
- **Sap:** color, odor, texture

- **Habit:** annual, biennial, perennial, vascular, non-vascular, aquatic, terrestrial, parasitic, fern, shrub, tree, vine, etc.
- **Height**
- **Underground parts:** branching, color, flexibility, texture, type (e.g., bulb, stolons, rhizomes)
- **Habitat:** microclimate where it grew (e.g., dry, open areas, crevices, moist clay, rocky)

Some families or genera have elements that are very characteristic, even in the dried state; for example, composites have receptacles, lilies have woody pods, and umbels have grooved seeds and feathery inflorescences. You may also want to try smelling the plant to see if it is familiar.

If you find that you are somewhat certain as to the identification of the species at hand, compare your specimen with previously identified specimens in a herbarium or voucher collection. Compare the leaves, stems, fruits, and other parts to identified specimens. **Note:** Don't take your specimen into the herbarium without following the herbarium's procedures for killing pests (usually, freezing). However, if you can't identify your specimen, make a voucher, note its exact location, and then visit it again when it is blooming.

## Navigation Aids

As field personnel, monitors must be able to navigate over open terrain, determine distances traveled and plot transect locations on a map. The following sections discuss the correct use of two of the basic tools used by monitors in the field—a compass and a clinometer—as well as some basic mapping techniques for locating and mapping transect locations in the field.

### COMPASS

The compass is probably the instrument most frequently used by field personnel. Accurate compass bearings are essential for navigating over open terrain and for finding and mapping plot locations.

#### Parts of a Compass

A multitude of compass models exist with different features; however, all compasses have at minimum the following:

**Magnetic needle**—The magnetic needle, drawn by the pull of the magnetic north pole, always points to magnetic north. The north end of the needle is usually marked by an arrow, or painted red.

**Revolving 360° dial**—The dial is marked with the cardinal points, N, E, S, W and is graduated into degrees. Within the dial is a transparent plate with parallel orienting lines and an orienting arrow.

**Transparent base plate**—Has a line of travel arrow and ruled edges.

#### Setting a Bearing

If you know the bearing in degrees (and your declination, see page 202) from your current position to an object, turn the dial until the degree is aligned with the index point and line of travel arrow. In Figure 50, the bearing is set at 356°.

#### Obtaining Accurate Compass Bearings



Always hold the compass level, so the magnetic needle can swing freely. Hold the compass away from magnetic objects such as rebar, watches, mechanical pencils, cameras, and belt buckles that can draw the magnetic needle off line.

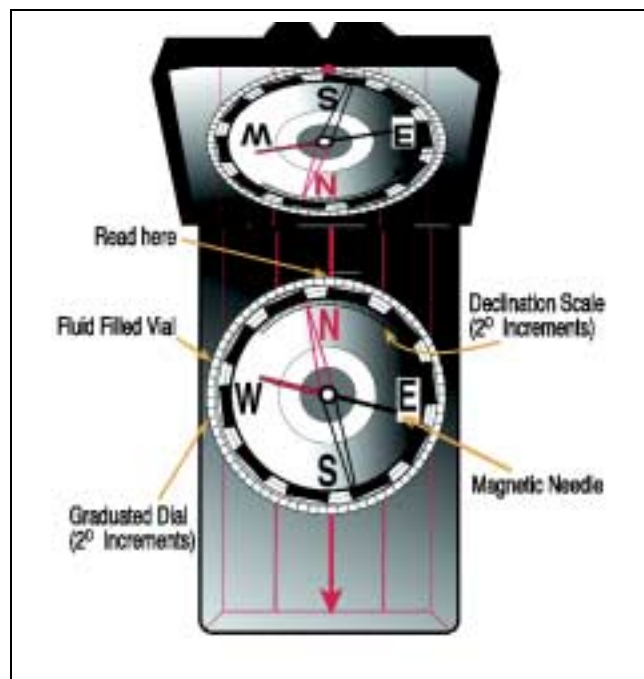

Figure 50. Graphic of a compass.

#### Taking a Bearing

- Aim the line of travel arrow on the compass towards the object.
- Turn the revolving dial until the magnetic needle is aligned within the orienting arrow in the compass dial.
- Read the bearing on the compass dial at the index point.

#### Facing a Bearing (Direction of Travel)

Hold compass with the base plate level and line of travel arrow pointing forward. Turn your body with the compass until the red north end of the magnetic needle point is aligned within the orienting arrow in the compass dial. You are now facing in the direction of the bearing.

#### Walking a Bearing

Look straight ahead in the direction of travel. Choose a landmark that lies in line with the direction of travel. Walk to the landmark. Continue in this manner until you reach your destination.

#### USING A COMPASS IN CONJUNCTION WITH A MAP

You may use a compass in conjunction with a map in either of two ways:

- Determine a bearing from a map and then travel that direction in the field (map to terrain), or
- Take a bearing in the field and plot that bearing on a map (terrain to map).

Whenever combining compass (field) bearings with map (true) bearings, you must account for declination.

### Declination

Declination is the degree of difference between true north and magnetic north. True north is where all lines of longitude meet on a map. Magnetic north is the location of the world's magnetic region (in the upper Hudson Bay region of Canada).

Declination is east or west, depending upon where magnetic north lies in relation to your position. If magnetic north lies to the east of your position, declination is east. If magnetic north lies to the west of your position, declination is west. In North America, zero declination runs roughly from west of Hudson Bay down along Lake Michigan to the gulf in western Florida.

Declination diagrams are located in the bottom margin of USGS topographic maps. Keep in mind that declination changes slightly over time as magnetic north moves slowly west; therefore, the current declination in your area may be slightly different than the declination at the time the map was printed. Declination maps are re-mapped every five years by the USGS; the most recent declination map is for 1995 (see Figure 51).

On some maps the annual rate of change may be printed and thus you can calculate the current declination. USGS also produces a Magnetic Declination Map of the United States. This map shows the rate of change throughout the US so that the current declination in any area can be calculated. You may also obtain the current declination in your area from your county surveyor.

If you need to be more precise, try using a geomagnetic calculator (e.g., NOAA 2000) that will calculate the declination for any year (1900–2005) given the latitude/longitude or UTM coordinates.

#### ***Setting declination on your compass***

Some compass models have a declination adjustment screw. The set screw key is usually attached to a nylon cord that hangs from the compass. Using the key, turn the set screw to the appropriate declination. Once you have set the proper declination you do not need to change it until you move to a different area. If you

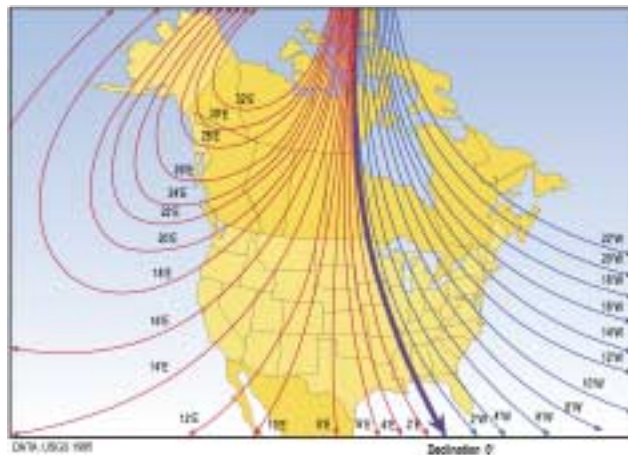

**Figure 51. Map showing declination in North America.** East of the zero line, declination is “west.” West of the zero line, declination is “east.”

move to a new area, remember to reset the declination on your compass. If you do not have a compass with a declination adjustment screw, you must add or subtract declination to determine the correct bearing. Whether you add or subtract declination depends on whether you are working from map to terrain or terrain to map.

#### ***Map to terrain***

If you have determined a bearing between two positions from a map, and you are going to walk the bearing, you must convert that bearing to a magnetic bearing. The rules for converting from map to field bearings are as follows:

- For declination west, turn dial west (add number of degrees of declination)
- For declination east, turn dial east (subtract number of degrees of declination)

#### ***Terrain to map***

If you have taken a field bearing and want to plot the position on a map, you must convert the bearing from a magnetic bearing to a map (true) bearing. The rules are simply the reverse of the map to terrain rules:

- For declination west, turn dial east (subtract)
- For declination east, turn dial west (add)

### CLINOMETER

A second important field tool is a clinometer, which measures slope in degrees and/or percent. Slope is one of the most important topographic influences on fire behavior. In addition, recording the slope along the plot azimuth is another aid in defining (and thus relocating) plots.

## Measuring Slope Using a Clinometer

The model of clinometer most commonly used in fire effects monitoring has both a degree scale and a percent scale. When you look through the lens, you will see the percent slope scale on the right side and the degree scale on the left (see Figure 52).

Slope can be measured in degrees or as a percent. For our purposes, measurements are made in percent slope rather than in degrees; degrees slope is not used in this handbook. Percent slope measures the degree of incline over a horizontal distance; a +1% slope indicates the rise is very gradual over a given distance. A +60% slope indicates the rise is very rapid over a given distance.

The degree scale gives the angle of slope in degrees from the horizontal plane at eye level. The percent scale measures the height of the point of sight from the same horizontal eye level and expresses it as a percent of the horizontal distance (i.e., % slope); percent slope is used throughout this handbook. For a conversion table between degrees slope and percent slope, see Table 34, page 211.

To use a clinometer:

- Hold the clinometer so that the round side-window faces to the left.
- Hold the clinometer up to your right eye but keep both eyes open (you can hold the instrument up to your left eye, if that is more comfortable).
- Aim the clinometer in the direction of the slope you want to measure.
- Fix the hair line of the clinometer on an object in your line of sight and **at the same height as your eye level**, a rangepole may be useful.
- Look into the viewing case, and read where the hair line intersects the percent scale (on the right).

## DETERMINING DISTANCES IN THE FIELD

Distances along the ground can be measured by various means. You can measure distances along a road in a vehicle with an odometer. In the field you can use a meter tape, though over long distances this method is often impractical. Pacing is a common means of measuring distance in the field. By knowing the length of your pace you can measure the distance over ground simply by walking. A pace is defined as the distance between the heel of one foot and the heel of the same foot in the next stride. Therefore, one pace **equals** two steps—one step of each leg.

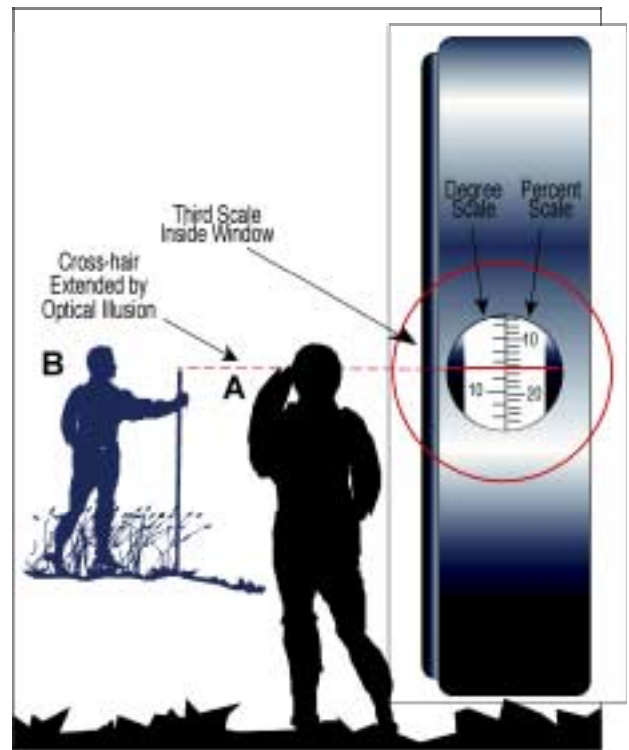

Figure 52. Graphic of a clinometer.

**Note:** The rangepole at B is the same height as the viewer's (A) eye level. Also note that you can find clinometers with percent on either the right or left side; percent being the larger number.

## Determining Your Pace on Level Ground

- On level ground, lay out a course of known distance (e.g., 50 m or 1 chain).
- Walk the length of the course counting each pace (two steps). Take the first step with your left foot, then count each time your right foot touches the ground.
- Repeat the process several times to obtain an average number of paces per length.
- Divide the number of paces into the measured distance to arrive at the length of your pace.

### Example:

$$50 \text{ m} / 32 \text{ pace} = 1.6 \text{ m/pace}$$

$$66 \text{ ft} / 20 \text{ pace} = 3.3 \text{ ft/pace}$$

To determine the distance you have paced in the field, multiply the number of paces by your distance per pace.

### Example:

The distance between the reference feature and OP is 30 paces. Your pace distance is 1.6 m.

$$30 \text{ paces} \times 1.6 \text{ m/p} = 48 \text{ m}$$

## Determining Your Pace on Sloping Ground

Walking on a slope, either uphill or downhill, your paces will be shorter; consequently you will take more paces to cover the same distance on a slope as on level ground. To determine your pace on sloping ground:

- Lay out a course of the same distance used on level ground with moderately steep slope.
- Walk upward on this course, counting the number of paces as before.
- Divide the total distance by the total number of paces.
- This is the length of one pace on a slope.

### Example:

On level ground: 50 m = 32 paces = 1.60 m/pace

On sloping ground: 50 m = 40 paces = 1.25 m/pace

Walk the course several times both uphill and downhill until you have an average length of a pace on sloping ground. Your upslope pace may be different than your downslope pace.

## SOME BASIC MAP TECHNIQUES

### Working with Scale

You will inevitably use maps with many different scales during your monitoring work. A table of scales and equivalents is located on page 212 (Table 35). If you enlarge or reduce a map, the scale of the map will change and you must determine the new scale. Scale on a map is determined by the formula:

$$\text{Scale} = \frac{\text{Map Distance}(MD)}{\text{Ground Distance}(GD)}$$

Map distance equals the distance measured between two points on a map. Ground distance equals the distance on the ground between the same two points.

To determine the new scale of a map that was enlarged or reduced, follow these steps:

- On the original map of known scale, measure the map distance between two points that are separated horizontally and two points that are separated vertically. (The reason to measure two distances is that copy machines are not precision instruments and may skew the map.)

- Compare the distances to the original map scale to determine the four ground distances.
- On the enlarged (or reduced) map, measure the distances between the same four points. (Although the map distance has changed, the ground distances between the four points are still the same.)
- Calculate the scale of the enlarged (or reduced) map with the scale formula, using each of the four distances.
- Average all four scales, and use this for determining ground distances on the enlarged (or reduced) map.

### Example:

You calculate the scale of a map from an original map at the scale of 1:24,000. On the original map, you measure two separate horizontal distances, 5.6 and 11.1 cm, and two vertical distances 4.15 and 6.5 cm. For a 1:24,000 map, 1 cm = 240 m (see Table 35, page 212), so the corresponding ground distances are 1,344, 2,644, 996, and 1,560 m respectively.

Using the enlarged map, now measure the same four distances. Using the first map distance-ground distance combination, we get the following scale:

$$\text{Scale} = \frac{MD}{GD} = \frac{13.2\text{cm}}{1344\text{m}} = \frac{1\text{cm}}{101.82\text{m}}$$

Continuing on for the three remaining distances, the four resulting scales would be 1:10,182; 1:10,129; 1:10,163; and 1:10,163. Taking the average of these four numbers, the scale of the enlarged map is determined to be 1 cm = 101.59 m, or 1:10,159.

### Determining the Direction and Distance Between Two Map Points

You will have to determine the direction and distance between two map points when you use a map to get to your Plot Location Points (PLP).

#### *Determining the direction between two map points*

To determine the direction between two points on a map, follow these steps:

- Draw a line connecting the two points (A B).
- Place your compass with the edge of the base plate along the line.
- Orient the compass with the line of travel arrow pointing towards point B.
- Turn the revolving dial of the compass until the orienting lines within the compass dial are parallel with the north-south meridian lines on the map, and the North (N) arrow points to north on the map.

- Read the bearing at the index point on the compass.

**Note:** The direction of the magnetic needle is irrelevant in this procedure.

If you are going to **set a field bearing** using this map bearing, remember to **add or subtract the declination** according to the rules in the previous section (page 202). If your compass has the declination set, you do not need to make any adjustments.

## Map Direction



You can use a protractor in place of a compass in this procedure. Simply place the black etched line on the center of the protractor cross bar on point A and make sure that 0° or 360° points towards North on the map. Read the number of degrees where the line drawn between points A and B intersects the protractor's outer edge.

### ***Determining the distance between two map points***

- Align the edge of a piece of paper with the line drawn between the two points.
- Make a mark on the paper at points A and B.
- Hold the paper against the scale on the bottom of the map.
- Measure the distance against the map scale.

### **Determining a Plot Location in the Field**

You can determine plot locations with either of two instruments: a compass or a Global Positioning System (GPS) unit. All plot locations, especially the origin (forest plots), or 0P (grassland and brush plots), should be defined at some time with a GPS unit so they can be included in your park GIS database.

You can use a compass to plot a location on a topographic map in the field using a method known as resection. You must first identify two landmarks (e.g., buildings, lakes, ridgetops) on the terrain that you can pinpoint on a map. Once you have identified your two landmarks, follow these steps (see Figure 53):

- Take a field bearing from your location to one of the landmarks, adjusting for declination if necessary.
- Place compass on the map with one edge of the base plate intersecting the landmark point.

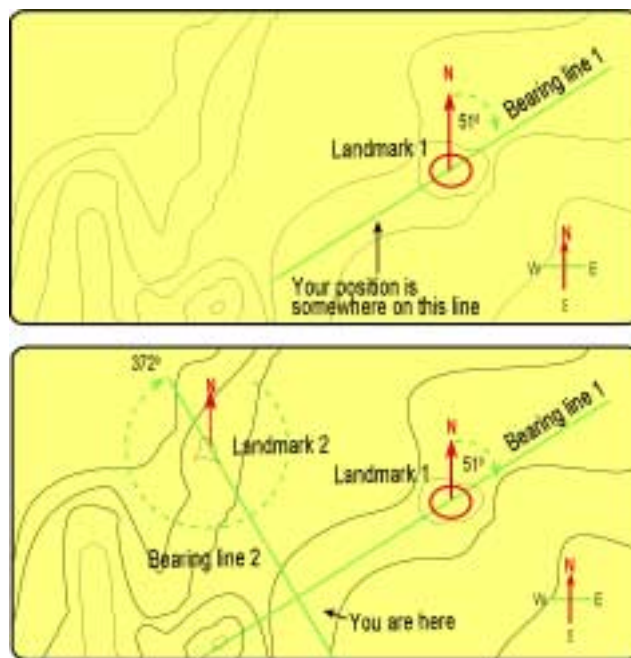

Figure 53. Illustration of the resection method to determine a plot location in the field.

- Keeping the compass edge against this point, turn the entire compass, not the dial, until the compass orienting lines are parallel with the north-south meridian lines on the map and the N points to the direction of north on the map.
- Draw a line along the edge of the compass intersecting the point; your location lies somewhere along this line.
- Repeat the process with the second point to draw a second line on the map. The intersection of the two lines is your location.

### **Determining Plot Location Using UTM Coordinates on a USGS Topographic Map**

Locate the UTM grid line markings along the edge of a USGS topographic map. You can purchase clear Mylar overlays that indicate the increments between the map lines. To use them, simply find the closest UTM markings on the map edge, follow those out to the plot (or other location) you wish to map, place the overlay on the map and count the increments.

## **GLOBAL POSITIONING SYSTEM INFORMATION**

Many NPS units have access to PLGR units, a type of GPS unit. This summary is intended to provide a quick reference for some basic tasks that are commonly performed in fire effects monitoring work (for further information, see USDI NPS 1997).



This section is not intended to replace training on the use of PLGR or any other GPS units. In general, enter and change information on the PLGR by using the right and left arrow keys to highlight a field (make it blink), then use the up and down arrow button to select the field.

### Displaying Your Current UTM Coordinate Position

Turn on the PLGR. The position screen will appear. In the upper right corner of the screen the word OLD will appear indicating that the information displayed on the rest of the screen is from a previous or old location. After the PLGR obtains signals from four or five satellites the word OLD is replaced by the PDOP (see Glossary), which is the amount of error for the displayed position (this calculation might take a few minutes). Enter this error information into the FMH-5. If the level of error is acceptable for your GIS specialist, store your location as a waypoint (see below).

For the best accuracy, go to MENU, then SETUP and change the SETUP MODE to AVG. This will allow the PLGR to average points together to give you a more accurate reading of your location. The number of points averaged is shown in the upper part of the screen ( $\geq 180$  points is desirable). It is important not to move the location of the PLGR while in averaging mode, as this prevents the unit from obtaining an accurate reading.

### Store a Position as an Individual Point Called a Waypoint

To store the UTM coordinates of your current position as a waypoint, press the MARK button twice. The position will be stored as WP001, WP002, WP003, etc. It is useful to include a small notebook with the PLGR for tracking waypoint numbers to assist with their definition at a later date, e.g., “WP01 = Oak Flat trail-head.”

To clear a waypoint, press WP, select CLEAR, type in the waypoints you wish to delete, then select ACTIVATE/CONFIRM.

### Navigate to a Known Waypoint from Your Current Location

To navigate to a known waypoint, press NAV, and then choose “2D Fast and DIRECT” on the top line. On the second line, press NUMLOCK to activate the numeric keypad (“N” will be displayed in the lower right corner instead of “P”) and enter the number of

the desired waypoint, or simply scroll to the desired waypoint number. Page down to the next screen, which lists the selected waypoint, and the distance (RNG) and direction (AZ) you should travel from your current location.

### Obtain Distance and Direction Between Two Waypoints

Use this feature to calculate the distance and azimuth between two remote locations once they have been marked as waypoints. You can then transfer this information to your plot location maps, e.g., distance from reference point to a plot point (Ref-0P), or use it to navigate from plot to plot without returning to a starting point.

Press the WP key, then select DIST. The next screen will allow you enter two waypoints; it will then display the range (distance) and azimuth from the first waypoint to the second waypoint.

### Geodetic Datums



The reference systems that define Geodetic datums describe the earth’s size and shape. Various datums are used by different countries and agencies, and the use of the wrong datum can result in tremendous position errors of hundreds of meters. GPS units use WGS84 for all data capture, but can output data in a variety of datums. Select the datum that matches the GIS data of your park unit, or tell your GIS specialist which datum you used so the data can be converted. The following datums are used in the US and its territories:

Abbreviation	Full Title
NAD27 (Conus)	North American Datum-1927, Continental US
NAD83 (Conus)	North American Datum-1983, Continental US
NAD83 (Hawaii)	North American Datum-1983, Hawaii
WGS84	World Geodetic System-1984
OHD26	Old Hawaiian Datum (Mean)-1926
ASD62	American Samoa-1962
GD63	Guam Datum-1963

## Basic Photography Guidelines

---

When photographing outdoors, you should strive to strike a balance between the quality of the film image, ambient light levels and depth of field (how much of the view is in focus). The three ways to control these factors are 1) film speed, 2) shutter speed and 3) aperture size (how wide the shutter opens).

The following procedure may be followed to obtain high quality photos:

- **Film Speed:** Use the slowest film possible while still maximizing the depth-of-field (64 or 200 ASA Kodachrome, 100–400 ASA Fujichrome or Ektachrome).

Film speed should be carefully selected to represent the slowest speed (lowest ASA) acceptable for the ambient light conditions. For example, photography in a dark forest understory requires a faster speed such as 200 ASA or even 400 ASA, but in a bright, open prairie 64 ASA may be the best choice. In this case, the faster speed films (higher ASA) would also work in the prairie, but will not produce as sharp an image as the slower speed film.

It is advisable to purchase a range of film speeds reflective of the lighting conditions likely to be encountered at your unit, and to switch film (mid-roll if necessary) when drastic changes in lighting occur (such as a switch from dark forest plots to light brush plots). You may want to consider having a second camera to help manage films of different speeds.

Remember that although higher speed film can be used in higher light conditions, to avoid blurry photos do not use lower speed film in lower light conditions. If you desire one all-purpose film speed, choose 64 ASA for open areas and use 200 ASA for darker conditions.

- **Exposure:** Once you have selected the subject, set the exposure, a combination of aperture (also called f/stop) and shutter speed.

Try to obtain f/16 and still have a shutter speed of 1/60 second or faster if the camera is handheld (slower speed is fine if the camera is mounted on a monopod or tripod). If the light meter indicates

that more light is needed, then back off to f/12 or f/8 (try to get the smallest aperture possible, which is indicated by the highest number). The light meter will indicate when an acceptable setting has been reached. Be sure that the light meter reading has not included any sky.

Keep your shutter speed as fast as possible to avoid blurry photos. Under the same conditions, a slower film speed will require a slower shutter speed and a faster film speed will allow for a faster shutter speed. If the camera is hand-held, the shutter speed should be kept at or above 1/60 (one-sixtieth of a second), although some very steady hands can push this to 1/30. If a monopod or tripod is used with a cable release, any shutter speed will work.

- **Depth of Field:** Set the depth of field (the focus mechanism on the lens) to include the farthest object visible in the shot (usually infinity).

Aperture, or f-stop, dictates the depth-of-field (the distance to which the photo will be in focus). For plot photography it is usually desirable to have a depth-of-field of infinity, with a corresponding f-stop of f/11 or f/16 (or occasionally f/8, if the view is not deep anyway, due to tall vegetation). The aperture setting interacts with the shutter speed; as the shutter speed increases, the aperture must widen (indicated by a smaller number), reducing the depth-of-field.

You are now ready to take the shot. Don't change the lens setting or focus, even if the view seems out of focus; it will give an excellent, clear shot with the entire field of view in focus if set from the above instructions.

Note the nearest distance that will be in focus (shown on the depth-of-field indicator).

- **Set up the Shot:** Look through the viewfinder and place the bottom of the view at the nearest distance that will be in focus. Select an object in the center of the view that is easy to find (e.g., the tape or rangepole) and center the shot on it, using the "cross hairs" as a reference.
- **Shoot:** Be sure that the camera is level, and shoot.

The following table (Table 32) demonstrates a few examples of different environmental conditions, film speeds, camera settings and the results you may expect.

**Table 32. Results you may expect from different environmental conditions, film speeds, and camera settings.**

Environmental Setting	Film Speed	Shutter Speed	Aperture Setting	Results
Open Prairie—Sunny Day	64 ASA	1/250	f/16	Highest quality, clear image
Open Prairie—Sunny Day	200 ASA	1/500	f/16	High quality, clear image
Shaded Woodland—Sunny Day	200 ASA	1/60	f/11	High quality, clear image
Shaded Woodland—Sunny Day	64 ASA	1/60	f/5.6	Light OK, but only the foreground is in focus due to small aperture setting. Use higher speed film to enable higher aperture.
Dark Forest—Sunny Day	200 ASA	1/15	f/11	Good depth of field, light OK, but blurry due to slow shutter speed. Try changing the aperture to 8, or using a monopod or tripod.
Dark Forest—Sunny Day with Monopod or Tripod	200 ASA	1/30	f/16	Good quality image
Dark Forest—Cloudy Day, Late Afternoon in Autumn	200 ASA	1/15	f/5.6	Don't bother. Return earlier on another day with better light conditions. Bring a monopod or tripod. Consider higher speed film if conditions are always very dark.

# Conversion Tables

Table 33. Conversion factors.

IF YOU HAVE	MULTIPLY BY	TO GET
Acres	0.4047	Hectare or sq. hectometer
Acres	43,560.0	Square feet
Acres	4,446.86	Square meters
Acres	$1.563 \times 10^{-3}$	Square miles
Centimeters	0.03281	Feet
Centimeters	0.3937	Inches
Centimeters	0.1	Decimeters
Centimeters	$10^{-5}$	Kilometers
Centimeters	0.01	Meters
Centimeters	$6.214 \times 10^{-6}$	Miles
Centimeters	10.0	Millimeters
Centimeters	0.01094	Yards
Chains	66.0	Feet
Chains	792.0	Inches
Chains	20.12	Meters
Chains/hour	3,600	Inches/sec
Chains/hour	0.01833	Feet/sec
Circumference of a tree	0.3183	DBH
Decimeter	0.1	Meters
Degrees (Celsius)	$(1.8 \text{ C}^\circ) + 32^\circ$	Degrees (Fahrenheit)
Degrees (Fahrenheit)	$(5.5 \text{ F}^\circ) - 32^\circ$	Degrees (Celsius)
DBH	3.1416	Circumference of a tree
Feet	0.01515	Chains
Feet	30.48	Centimeters
Feet	$3.048 \times 10^{-4}$	Kilometers
Feet	0.3048	Meters
Feet	304.8	Millimeters
Feet/sec	0.8333	Inches/sec
Feet/sec	54.54	Chains/hour
Feet/sec	0.305	Meters/sec

Table 33. Conversion factors. (Continued)

IF YOU HAVE	MULTIPLY BY	TO GET
Grams	0.03527	Ounces
Grams	$2.205 \times 10^{-3}$	Pounds
Hectares	2.471	Acres
Hectares	107,600	Square feet
Hectares	10,000	Square meters
Hours	0.041672	Days
Hours	$5.952 \times 10^{-3}$	Weeks
Inches	2.54	Centimeters
Inches	0.0254	Meters
Inches	$1.578 \times 10^{-5}$	Miles
Inches	25.4	Millimeters
Inches/sec	5.0	Feet/min
Inches/sec	$1.2626 \times 10^{-3}$	Chains/hour
Inches	0.02778	Yards
Kilograms	1,000.0	Grams
Kilograms	2.205	Pounds
Kilograms	$9.842 \times 10^{-4}$	Tons [Long]
Kilograms	$1.102 \times 10^{-3}$	Tons [Short]
Kilograms/square meter	4.462	Tons [Short]/acre
Kilometers	100,000	Centimeters
Kilometers	3,281.0	Feet
Kilometers	39370.0	Inches
Kilometers	1,000.0	Meters
Kilometers	0.6214	Miles
Kilometers	1,093.6	Yards
Kilometers/hour	27.78	Centimeters/sec
Kilometers/hour	54.68	Feet/min
Kilometers/hour	0.9113	Feet/sec
Kilometers/hour	16.67	Meters/min
Kilometers/hour	0.278	Meters/sec
Kilometers/hour	0.6214	Miles/hour
Meters	100.0	Centimeters

**Table 33. Conversion factors. (Continued)**

<b>IF YOU HAVE</b>	<b>MULTIPLY BY</b>	<b>TO GET</b>
Meters	0.04971	Chains
Meters	3.281	Feet
Meters	39.37	Inches
Meters	$1.0 \times 10^{-3}$	Kilometers
Meters	$6.214 \times 10^{-4}$	Miles
Meters	1,000.0	Millimeters
Meters	1.094	Yards
Meters/sec	178.9	Chains/hour
Meters/sec	196.9	Feet/min
Meters/sec	3.281	Feet/sec
Meters/sec	3.6	Kilometers/hour
Meters/sec	0.06	Kilometers/min
Meters/sec	1.943	Knots
Meters/sec	2.237	Miles/hour
Miles	160,900	Centimeters
Miles	5,280.0	Feet
Miles	$6.336 \times 10^4$	Inches
Miles	1.609	Kilometers
Miles	1,609.0	Meters
Miles	1,760.0	Yards
Miles/hour	44.7	Centimeters/sec
Miles/hour	88.0	Feet/min
Miles/hour	1.467	Feet/sec
Miles/hour	1.609	Kilometers/hour
Miles/hour	0.45	Meters/sec
Millimeters	$3.281 \times 10^{-3}$	Feet
Millimeters	0.03937	Inches
Millimeters	$1.0 \times 10^{-6}$	Kilometers
Millimeters	$1.0 \times 10^{-3}$	Meters
Millimeters	$6.214 \times 10^{-7}$	Miles
Millimeters	$1.094 \times 10^{-3}$	Yards
Ounces	28.35	Grams
Ounces	0.0625	Pounds
Ounces	$2.79 \times 10^{-5}$	Tons [Long]
Ounces	$3.125 \times 10^{-5}$	Tons [Short]

**Table 33. Conversion factors. (Continued)**

<b>IF YOU HAVE</b>	<b>MULTIPLY BY</b>	<b>TO GET</b>
Pounds	453.6	Grams
Pounds	0.4536	Kilograms
Pounds	16.0	Ounces
Pounds	$5.0 \times 10^{-4}$	Tons [Short]
Pounds	$4.464 \times 10^{-4}$	Tons [Long]
Slope (Degrees)	see table below	Slope (Percent)
Slope (Percent)	see table below	Slope (Degrees)
Square Feet	$2.296 \times 10^{-5}$	Acres
Square Feet	0.0929	Square Meters
Square Feet	$3.587 \times 10^{-8}$	Square Miles
Square Meters	$2.471 \times 10^{-4}$	Acres
Square Miles	640.0	Acres
Square Miles	$27.88 \times 10^6$	Square Feet
Tons [Long]	1,016.05	Kilograms
Tons [Long]	2,240.0	Pounds
Tons [Short]/Acre	0.2241	Kilograms/square meter
Tons [Short]	907.2	Kilograms
Tons [Short]	2,000.0	Pounds
Tons (Metric)	1,000.0	Kilograms
Tons (Metric)	2,204.6	Pounds
Yards	91.44	Centimeters
Yards	$9.144 \times 10^{-4}$	Kilometers
Yards	0.9144	Meters
Yards	$5.682 \times 10^{-4}$	Miles
Yards	914.4	Millimeters

**Table 34. Slope Conversions (Between degrees and percent).**

Degrees	Percent Slope	Degrees	Percent Slope	Degrees	Percent Slope	Degrees	Percent Slope
1	1.7	24	44.5	47	107.2	70	274.7
2	3.5	25	46.6	48	111.1	71	290.4
3	5.2	26	48.8	49	115.0	72	307.8
4	7.0	27	51.0	50	119.2	73	327.1
5	8.7	28	53.2	51	123.5	74	348.7
6	10.5	29	55.4	52	128.0	75	373.2
7	12.3	30	57.7	53	132.7	76	401.1
8	14.1	31	60.1	54	137.6	77	433.1
9	15.8	32	62.5	55	142.8	78	470.5
10	17.6	33	64.9	56	148.3	79	514.5
11	19.4	34	67.5	57	154.0	80	567.1
12	21.3	35	70.0	58	160.0	81	631.4
13	23.1	36	72.7	59	166.4	82	711.5
14	24.9	37	75.4	60	173.2	83	814.4
15	26.8	38	78.1	61	180.4	84	951.4
16	28.7	39	81.0	62	188.1	85	1143.0
17	30.6	40	83.9	63	196.3	86	1430.1
18	32.5	41	86.9	64	205.0	87	1908.1
19	34.4	42	90.0	65	214.5	88	2863.6
20	36.4	43	93.3	66	224.6	89	5729.0
21	38.4	44	96.6	67	235.6	90	∞
22	40.4	45	100.0	68	247.5		
23	42.4	46	103.6	69	260.5		

**% Slope = 100 × Tan [Slope] = 100 × Vertical Rise/Horizontal Distance**

**Table 35. Map scales and their equivalents in feet, meters, and acres.**

Scale (1" on a map=)	Feet per Inch	Meters per Inch	Acres per Sq. Inch
1:500	41.67	12.70	0.04
1:600	50.00	15.24	0.06
1:1,000	83.33	25.40	0.16
1:1,200	100.00	30.48	0.23
1:1,500	125.00	38.10	0.36
1:2,000	166.67	50.80	0.64
1:2,400	200.00	60.96	0.92
1:2,500	208.33	63.50	1.00
1:3,000	250.00	76.20	1.43
1:3,600	300.00	91.44	2.07
1:4,000	333.33	101.60	2.55
1:4,800	400.00	121.92	3.67
1:5,000	416.67	127.00	3.99
1:6,000	500.00	152.40	5.74
1:7,000	583.33	177.80	7.81
1:7,200	600.00	182.88	8.26
1:7,920	660.00	201.17	10.00
1:8,000	666.67	203.20	10.20
1:8,400	700.00	213.36	11.25
1:9,000	750.00	228.60	12.91
1:9,600	800.00	243.84	14.69
1:10,000	833.33	254.00	15.94
1:10,800	900.00	274.32	18.60
1:12,000	1,000.00	304.80	22.96
1:12,500	1,041.66	317.51	24.91
1:13,200	1,100.00	335.28	27.78
1:14,400	1,200.00	365.76	33.06
1:15,000	1,250.00	381.00	35.89
1:15,600	1,300.00	396.24	38.80
1:15,840	1,320.00	402.34	40.00
1:16,000	1,333.33	406.40	40.81
1:16,800	1,400.00	426.72	45.00
1:18,000	1,500.00	457.20	51.65
1:19,200	1,600.00	487.68	58.77
1:20,000	1,666.67	508.00	63.77

**Table 35. Map scales and their equivalents in feet, meters, and acres. (Continued)**

Scale (1" on a map=)	Feet per Inch	Meters per Inch	Acres per Sq. Inch
1:20,400	1,700.00	518.16	66.35
1:21,120	1,760.00	536.45	71.11
1:21,600	1,800.00	548.64	74.38
1:22,800	1,900.00	579.12	82.87
1:24,000	2,000.00	609.60	91.83
1:25,000	2,083.33	635.00	99.64
1:31,680	2,640.00	804.67	160.00
1:33,333	2,777.78	846.68	177.14
1:48,000	4,000.00	1,219.20	367.31
1:50,000	4,166.67	1,270.03	398.56
1:62,500	5,208.33	1,587.50	622.74
1:63,360	5,280.00	1,609.35	640.00
1:75,000	6,250.00	1,905.04	896.75
1:96,000	8,000.00	2,438.41	1,469.24
1:100,000	8,333.33	2,540.05	1,594.23
1:125,000	10,416.67	3,175.01	2,490.98
1:126,720	10,560.00	3,218.69	2,560.00
1:250,000	208,333.33	6,350.01	9,963.91
1:253,440	21,120.00	6,437.39	10,244.20
1:300,000	25,000.00	7,620.02	14,348.03
1:500,000	41,666.67	12,700.03	39,855.63
1:760,320	63,360.00	19,312.17	92,160.00
1:1,000,000	83,333.33	25,400.05	159,422.51
Chains/Inch = Scale/792.08		Meters/Inch = Scale/39.37	
Miles/Inch = Scale/63,291.14		Feet/Inch = Scale/12	
Meters/Centimeter = Scale/100			

# D

## Data Analysis Formulae

*“It is always better to give an approximate answer to the right question than a precise answer to the wrong question.”*

—Golden Rule of Applied Mathematics

Most of the analysis calculations mentioned in this handbook are performed by the FMH software. They are also included here in case you need to calculate results manually. Those calculations that will require additional software are so noted.

### COVER

#### Percent Cover

Percent cover is the number of points at which a species occurs on a transect divided by the total number of transect points, multiplied by 100. Each species is counted only once at a point; however, more than one species can be counted at each point. Percent cover may be greater than 100%.

$$\text{percent cover}_{sp} = \frac{\text{hits}_{sp} \times 100}{\text{points}}$$

where:

$\text{percent cover}_{sp}$  = percent cover of a transect species

$sp$  = index for species

$\text{hits}_{sp}$  = number of points on which a species occurs

$\text{points}$  = total number of points on transect

#### Relative Cover

Relative cover is the percent cover of a species divided by the sum of the percent cover of all species, multiplied by 100. Relative cover is only calculated for live perennials and live or dead annuals. Therefore, the sum of percent cover ignores dead perennials and non-plant materials. The total of all relative cover calculations is always equal to approximately 100%.

$$\text{relative cover}_{sp} = \frac{\text{percent cover}_{sp} \times 100}{\text{percent cover}_{total}}$$

where:

$\text{relative cover}_{sp}$  = relative cover of a species

$sp$  = index for species

$\text{percent cover}_{sp}$  = percent cover of a species

$\text{percent cover}_{total}$  = total percent cover for all species

### TREE, HERB, AND SHRUB DENSITY

Density per hectare can be calculated for tree, herb and shrub species using the following calculation:

$$\text{density}_{sp} = \frac{\text{count}_{sp} \times \text{ha}}{\text{area}}$$

where:

$\text{density}$  = individuals per hectare by species

$sp$  = index for species

$\text{count}$  = number counted from database

$\text{ha}$  = hectare, 10,000m<sup>2</sup>

$\text{area}$  = area sampled, m<sup>2</sup>

To convert density measurements from individuals per hectare to individuals per acre, divide individuals per hectare by 2.47.

#### Basal Area

Basal area is the area outline of a plant near the ground. In this handbook, this measurement is used to express the total stump surface of trees. Total basal area is calculated using the following formula:

$$\text{basal area}_{sp} = \sum_{i=1}^n 3.14 \times \left(\frac{d_i}{2}\right)^2$$

where:

$d_j$  = individual stem diameter (DBH)

$sp$  = index for species



## Diameter at Root Crown (DRC)

For a single-stemmed woodland tree species, the computed DRC is equal to the single diameter measured. For multi-stemmed tree species, DRC is computed as the square root of the sum of  $n$  squared stem diameters.

$$DRC_{sp} = \sqrt{\sum_{i=1}^n d_i^2}$$

where:

$d_i$  = individual stem diameter

$sp$  = index for species

### Example:

A tree has four stems that fork below ground level. Their diameters (cm) at ground level are 3.5, 6.7, 2.1 and 3.7. The stem that measured 2.1 is excluded from the calculation because it is too small (because it is in the seedling tree size class).

$$DRC = \sqrt{3.5^2 + 6.7^2 + 3.7^2}$$

$$DRC = 8.42\text{ cm}$$

## FUEL LOAD

### Dead and Down Fuel Load

Fuel calculations are based on Brown and others 1982, and Brown 1974. Downed fuel constants required by the formula are weighted by a sum of overstory tree diameters by species on the plot. Weight the fuel constants only for those overstory tree species that are found in the fuel constant database. If there are no overstory trees for that plot, you can choose one of the following:

- Use the fuel model embedded in the monitoring type code.
- Use the average fuel constants contained in the FMH software (Sydoriak 2001), which contains constants from throughout North America, or use an average fuel constant from another source.
- Enter a species code or fuel model to use.
- Exclude the plot from calculations.
- Quit calculations.

The weighted fuel constant ( $w_{sp}$ ) is calculated as follows:

$$w_{sp} = \frac{\text{constant}_{sp} \times \sum ba_{sp}}{\text{total } ba}$$

where:

$w$  = individual stem diameter

$sp$  = index for species

$\text{constant}_{sp}$  = fuel constant for a single species

$ba_{sp}$  = basal area for a single species

$\text{total } ba$  = basal area for all species

For each species, each calculation constant is multiplied by the summed basal area for that species, then divided by the total basal area for all the species in the plot.

### Example:

For three species—a, b, and c—the summed basal area for each is 10, 10, 20 respectively. The total basal area is therefore 40. If the fuel constants are (a) 0.2, (b) 0.1, and (c) 0.4, then the weighted constant is  $((0.2 \times 10) + (0.1 \times 10) + (0.4 \times 20)) / 40 = 0.275$ .

The slope correction is calculated for each transect using the following formula:

$$\text{slopecorr}_t = \sqrt{1 + (\text{slope}_t \times 0.01)^2}$$

where:

$\text{slopecorr}$  = slope correction factor

$t$  = index for transects

$\text{slope}$  = % slope of the transect

Particle observations for the 1-hr, 10-hr, and 100-hr time lag fuel classes are multiplied by the slope correction factor and summed for each transect using the formula (once for each time lag class):

$$\text{obscorr} = \sum_{t=1}^n (\text{obs}_t \times \text{slopecorr}_t)$$

where:

*obs* = fuel particle observations corrected for slope

*n* = number of transects

*t* = index for transects

*obs* = fuel particle count from database

*slopecorr* = slope correction factor

Tons per acre fuel load (*ta*) for the 1-hr, 10-hr, and 100-hr time lag fuel classes are calculated using the formula (once for each time lag class):

$$ta = \frac{(11.64 \times obscorr \times w_d \times w_s \times w_a)}{tranlength}$$

where:

*ta* = tons per acre

11.64 = constant

*w<sub>d</sub>* = weighted average squared diameter

*w<sub>s</sub>* = weighted average specific gravity

*w<sub>a</sub>* = weighted average angle to horizontal

*tranlength* = sum of the length of all transects

Observations of sound and rotten fuels greater than three inches in diameter (1000-hr) are corrected for slope with the formula:

$$obscorr = \sum_{t=1}^n \left( \left( \sum_{i=1}^{obs} diameter_i \right) \times slopecorr_t \right)$$

where:

*obs* = fuel particle observations corrected for slope

*t* = index for transects

*n* = number of transects

*i* = index of observations

*obs* = number of observations

*diameter* = particle diameter from database

*slopecorr* = slope correction factor

Bulk density values for duff and/or litter are entered in the database as pounds per cubic foot. Duff and litter pounds per acre can be calculated using the following formula (Brown and others 1982):

$$ta = 1.815 \times B \times d$$

where:

*ta* = tons per acre

1.815 = constant

*B* = bulk density, lbs/ft<sup>3</sup>

*d* = average duff/litter depth over all transects

### Fuel Moisture

The moisture content of many important fuels (e.g., duff moisture, 100-hr) and soils cannot be readily calculated, but must be determined from samples collected from the site to be burned. Moisture content is expressed as a percent. It is simply a measure of how much water is on and in a sample of material. For consistency it is expressed as a percent of the dry weight of the sample. You will need to make two measurements: first weigh the fuel sample just as it was taken from the field, then dry it out in an oven and weigh it again. Use the following formula to calculate the moisture content (at the time of this writing the FMH software does not perform this calculation):

$$moisture\ content(\%) = \frac{wet\ weight - dry\ weight}{dry\ weight} \times 100$$

## Biomass

Calculate the kilograms/hectare or tons/acre for each biomass sample using this formula (at the time of this

writing the FMH software does not perform this calculation):

$$\text{biomass}(\text{kg/ha}) = \frac{\text{dry weight}(\text{g}) - \text{container}(\text{g})}{\text{area of quadrat}(\text{m}^2)} \times \frac{10,000\text{m}^2}{1\text{ha}} \times \frac{1\text{kg}}{1,000\text{g}}$$

where:

*dry weight* = dry weight of sample with container (g)

*container* = weight of empty container (g)

*area of quadrat* = area from which biomass was sampled (m<sup>2</sup>)

## DATA ANALYSIS CALCULATIONS

## Confidence Interval Width

### Standard Deviation

$$d = \frac{\bar{x} \times R}{100}$$

$$s = \sqrt{\frac{\sum_{i=1}^n (x_i - \bar{x})^2}{n - 1}}$$

where:

*s* = standard deviation

*n* = number of observations within the sample

*x<sub>i</sub>* = the *i*<sup>th</sup> sample observation

$\bar{x}$  = sample mean

where:

*d* = desired precision level (confidence interval width expressed as a percentage of the mean), derived below

$\bar{x}$  = the sample mean (from initial ten plots)

*R* = desired precision level as a percentage of the mean

### Minimum Sample Size

***Minimum sample size for condition or threshold desired***

$$n = \frac{t^2 \times s^2}{d^2}$$

where:

*n* = minimum number of plots needed

*t* = critical value of the test statistic Student's *t* based on the selected confidence level (95, 90, or 80%) and the degrees of freedom (number of plots - 1); see Table 36, page 220

*s* = standard deviation of the sample (from initial 10, or current number of plots)

*d* = desired precision level (confidence interval width expressed as a percentage of the mean), derived below

**Example:**

**Management Objective:** Increase the mean density of overstory aspen trees to 125 stems per hectare within five years of the initial prescribed fire (a condition objective).

**Monitoring Objective:** Estimate the mean density of overstory aspen trees with 80% confidence that you are within 25% of the estimated true value of the mean.

You have data from 10 monitoring plots, and the **mean** and **standard deviation** are:

$$\bar{x} = 135, s = 70$$

You have chosen a **desired precision level** (R) of 25. Therefore:

$$d = 135 \times 25/100 = 33.75$$

You chose a **confidence level** of 80, so your **t value** would be 1.383 (see Table 36, page 220). Therefore, your minimum sample size would be:

$$n = (1.383)^2 \times 70^2/33.75^2 = 8$$

This result indicates that, with eight plots, we can be 80% confident that our estimated value of 135 is within 25% of the true mean value.

***Minimum sample size for minimum detectable change desired***

To calculate the minimum sample size needed to detect the minimum amount of change, the following inputs are needed:

- **Standard deviation for the differences between paired samples**—see the example below
- **Chosen level of significance ( $\alpha$ )**—(20, 10, or 5%) from monitoring objectives (see page 126 for discussion), see the example below
- **Chosen level of power ( $\beta$ )**—(80, 90, or 95%) from monitoring objectives (see page 26 for discussion), see the example below
- **Minimum detectable amount of change**—from management objectives (see page 26 for discussion), see the example

$$n = \frac{s^2(t_\alpha + t_\beta)^2}{(MDC)^2}$$

where:

- $n$  = minimum number of plots needed
- $s$  = the sample standard deviation for the differences among paired samples
- $t_\alpha$  = the critical value of  $t$  based on the level of significance and the number of plots in the sample (see Table 36, page 220)
- $t_\beta$  = the critical value of  $t$  based on the selected level of power and the number of plots in the sample (see Table 36, page 220)

$MDC$  = minimum detectable amount of change

**Note:** Minimum detectable amount of change is expressed in absolute terms rather than as a percentage. For example, if you want to detect a minimum of 40% change in the sample mean of tree density from one year to the next, and your first year sample mean = 10 trees/ha, then your  $MDC = (0.40 \times 10) = 4$  trees/ha.

**Example:**

**Management Objective:** Increase the mean percent cover of *Bouteloua eriopoda* by at least 30% within three years of the initial prescribed burn.

**Monitoring Objective:** To be 80% certain of detecting a 30% increase in the mean percent cover of *Bouteloua eriopoda* three years after the initial prescribed burn. We are willing to accept a 20% chance of saying that at least a 30% increase took place, when it did not.

You have percent cover data from 10 monitoring plots that burned three or more years ago. The results are:

$$\text{Preburn: } \bar{x} = 15, s = 9$$

$$\text{Year-3 postburn: } \bar{x} = 38, s = 16$$

$$\text{Difference (among plots): } \bar{x} = 17, s = 11$$

### Example: (Continued)

You have chosen a **minimum detectable change** of 30%, which you multiply by the preburn mean (as this is the variable that you are attempting to change):

$$15 \times 0.30 = 4.5$$

Then you would use the **standard deviation** of the mean difference (among plots) between the preburn and the postburn—11. The  $t_{\alpha}$  based on the 20% significance level and the number of plots=0.883, (**Note:** We are using the one-tailed value as we seek to be confident only about detecting a unidirectional change—an increase) and the  $t_{\beta}$ =0.883 based on the selected level of power (80%) and the number of plots (10 plots). **Note:**  $t_{\beta}$  is always one-tailed. See Table 36, page 220 for a  $t$  table. Therefore, your minimum sample size would be:

$$\frac{11^2(0.883 + 0.883)^2}{(4.5)^2} = 18.6$$

Rounding up 18.6 to 19, this result indicates that you need to install nine more plots, for a total of 19, in order to be 80% confident of detecting a 30% increase in percent cover.

### Standard Error

$$se = \frac{s}{\sqrt{n}}$$

where:

$se$  = standard error

$s$  = standard deviation

$n$  = number of plots

### Example:

For a three-plot sample with a mean total fuel load of 25.0 tons per acre and a standard deviation of 12.1, the standard error is:

$$se = \frac{12.1}{\sqrt{3}} = 7.0$$

This means that with an infinite number of samples of three plots, approximately 68% of the sample means obtained will be within 7.0 units (above or below) of the true population mean.

### Coefficient of Variation

$$CV = \frac{s}{\bar{x}}$$

where:

$CV$  = coefficient of variation

$s$  = standard deviation

$\bar{x}$  = sample mean

To calculate the coefficient of variation, use the FMH software to run a minimum sample size equation for the variable of interest; the output will contain the sample mean and standard deviation. Then simply divide the standard deviation by the mean (at the time of this writing the FMH software does not perform the coefficient of variation calculation).

Use the coefficient of variation to compare two or more sampling designs to determine which is more efficient. The lower the coefficient of variation, the more efficient the sampling design. If two or more designs have similar coefficients of variation, pick the design that will be the easiest to use.

### Example:

Installing ten pilot forest plots in a slash pine flatwoods forest monitoring type using the pilot sampling scenario in Figure 11, page 45 resulted in the following data:

$$5 \times 20 \text{ m: } \bar{x} = 9.1, s = 14.3, CV = 1.57$$

$$20 \times 10 \text{ m: } \bar{x} = 15.5, s = 22.5, CV = 1.45$$

$$20 \times 20 \text{ m: } \bar{x} = 30.1, s = 41.67, CV = 1.38$$

$$25 \times 20 \text{ m: } \bar{x} = 43.2, s = 60.83, CV = 1.41$$

$$25 \times 5 \text{ m: } \bar{x} = 12.2, s = 19.2, CV = 1.57$$

$$50 \times 5 \text{ m: } \bar{x} = 26.2, s = 43.94, CV = 1.68$$

$$50 \times 10 \text{ m: } \bar{x} = 56.0, s = 96.04, CV = 1.72$$

$$50 \times 20 \text{ m: } \bar{x} = 110.5, s = 183.12, CV = 1.66$$

**Example: (Continued)**

The combination that resulted in the lowest coefficient of variation was 20 × 20 m (CV = 1.38), which was calculated as follows:

$$\frac{41.67}{30.1} = 1.38$$

As a 20 × 20 m area is also reasonably efficient to sample, managers felt comfortable choosing this size-shape combination for sampling seedlings throughout the slash pine monitoring type.

**Confidence Interval of the Mean**

$$CI = \bar{x} \pm (t \times se)$$

where:

- CI* = confidence interval
- $\bar{x}$  = sample mean
- se* = standard error
- t* = critical *t* value for selected confidence level and degrees of freedom (number of plots-1)

Using the table of critical values (Table 36, page 220), look up the value of *t* that corresponds to the chosen confidence level and the degrees of freedom, which is *n*-1 (in our case, the number of plots minus 1). Use the confidence level chosen in the monitoring objectives.

**Example:**

For the three-plot fuel load example, the 80% confidence interval is calculated as follows:

$$25.0 \pm (1.886 \times 7.0) = 25.0 \pm 13.2$$

$$25.0 - 13.2 = 11.8$$

$$25.0 + 13.2 = 38.2$$

Therefore, there is an 80% probability that the true population mean total fuel load falls between 11.8 and 38.2 tons per acre. (Alternatively, you could say that the mean ± 80% confidence interval is 25.0 ± 13.2.)

Note that the interval is quite large (spans over 25 tons per acre), but remember that our sample size was only three. The standard error, and therefore the confidence interval, gets smaller as the sample size gets bigger. Your results more closely represent the true population as you increase your sample size.

Table 36. Student's t table, showing 80, 90, and 95% confidence levels.

n - 1	One-tailed			Two-tailed		
	95%	90%	80%	95%	90%	80%
1	6.314	3.078	1.376	12.706	6.314	3.078
2	2.920	1.886	1.061	4.303	2.920	1.886
3	2.353	1.638	0.978	3.182	2.353	1.638
4	2.132	1.533	0.941	2.776	2.132	1.533
5	2.015	1.476	0.920	2.571	2.015	1.476
6	1.943	1.440	0.906	2.447	1.943	1.440
7	1.895	1.415	0.896	2.365	1.895	1.415
8	1.860	1.397	0.889	2.306	1.860	1.397
9	1.833	1.383	0.883	2.262	1.833	1.383
10	1.812	1.372	0.879	2.228	1.812	1.372
11	1.796	1.363	0.876	2.201	1.796	1.363
12	1.782	1.356	0.873	2.179	1.782	1.356
13	1.771	1.350	0.870	2.160	1.771	1.350
14	1.761	1.345	0.868	2.145	1.761	1.345
15	1.753	1.341	0.866	2.131	1.753	1.341
16	1.746	1.337	0.865	2.120	1.746	1.337
17	1.740	1.333	0.863	2.110	1.740	1.333
18	1.734	1.330	0.862	2.101	1.734	1.330
19	1.729	1.328	0.861	2.093	1.729	1.328
20	1.725	1.325	0.860	2.086	1.725	1.325
21	1.721	1.323	0.859	2.080	1.721	1.323
22	1.717	1.321	0.858	2.074	1.717	1.321
23	1.714	1.319	0.858	2.069	1.714	1.319
24	1.711	1.318	0.857	2.064	1.711	1.318
25	1.708	1.316	0.856	2.060	1.708	1.316
26	1.706	1.315	0.856	2.056	1.706	1.315
27	1.703	1.314	0.855	2.052	1.703	1.314
28	1.701	1.313	0.855	2.048	1.701	1.313
29	1.699	1.311	0.854	2.045	1.699	1.311
30	1.697	1.310	0.854	2.042	1.697	1.310
40	1.684	1.303	0.851	2.021	1.684	1.303
60	1.671	1.296	0.848	2.000	1.671	1.296
120	1.658	1.289	0.845	1.980	1.658	1.289

**Note:** You can run two types of *t*-tests, a two-tailed test, and a one-tailed test. Two-tailed tests are used for detecting a difference in either possible direction (increase or decrease). One-tailed tests are only for detecting either an increase or a decrease.

# E

# Equipment Checklist

*“Experience is directly proportional to the amount of equipment ruined.”*

—Harrisberger's Fourth Law of the Lab

## LOCATING, MARKING, AND INSTALLING A MONITORING PLOT

ITEM	NUMBER
• Topographic maps for locating random points (PLPs)	variable
• Orthophoto quads or aerial photos for locating random points	variable
• Databack camera with 35 mm lens	1
• High ASA film (64–400) Ektachrome or Fujichrome (a variety of film speeds should be available if varying light and canopy conditions are likely to be encountered—see pages 72 and 207).	1 roll + spare (± 20 exposures/plot)
• Monopod or tripod	1
• Photo board (e.g., laminated paper, dry erase board, Glacier National Park magnetic board)	1
• Photographic record sheet (FMH-23)	1 per roll of film
• Compass (declination preset)	1
• GPS unit	1
• Clinometer	1
• Cyberstakes (optional, see page 224)	variable
• Flagging	1 roll
• Rangepole (contrasting colors; used for sighting, photos, etc.)	1
• Stakes (use rebar, rolled steel or PVC, depending on your situation; 0.5 in diameter rebar works well)	2 (grassland/brush plot); 4 to 17 (forest plot)
• Orange and blue paint to mark stakes (engine paint works well)	1 can per color
• Metal detector or magnetic locator (to locate buried rebar, see page 224) (optional)	1
• Cordless drill or “rock drill” (for installing rebar in rock) (optional)	1
• Hammers	2
• Plot identification tags (see page 224)	2 (grassland/brush plot); 17 (forest plot)
• Hand stamp steel dies to mint plot ID tags	1
• Wire for attaching tags to stakes (brass, 16 gauge or thicker)	variable
• Clipboard and pencils	2+ (1 per monitor)
• Small plant press with blotter paper	1
• Large plant press (in vehicle)	1
• Pruner for collecting woody plants	1
• Containers for plant samples	variable

ITEM	NUMBER
• Voucher specimen data collection forms	variable
• Plant identification guides/flora	1+
• Plant identification tools and supplies (see page 194)	variable
• Field specimen book or field voucher collection	1
• Fire Monitoring Handbook	1
• FMH-4 Monitoring type description sheet	1 per monitoring type
• FMH-5 Plot location data sheet	1 per plot
• FMH-6 Species code list	1 per park
• Random number list (or random number generator)	1
• Field packet, see page 112	1 per plot

## MONITORING FOREST PLOTS

ITEM	NUMBER
• 50 m tape—or longer if needed	3–4
• 50 ft tape—or longer if needed—for downed fuel inventories	1
• 20 m or 30 m tape—or longer if needed	3
• 10 m diameter tape (DBH tape)	1–2
• 1–2 m sampling rod, ¼ in diameter; marked in decimeters (see Table 12, page 82 for sources)	1
• Sequentially numbered brass tree tags	150+ per plot
• Aluminum nails, 2 <sup>7/8</sup> in length	150+ per plot
• Hammer	1
• Go-no-go gauge	1–2
• 12 in metal ruler graduated in tenths of inches for litter/duff depth	1
• 1 yd (1 m) metal rule graduated in tenths of inches to estimate log diameters	1
• Calipers or 24 in ruler for log diameters	variable
• Small gardening trowel for digging duff holes or collecting underground plant parts	1
• Tally meter or counter (for counting shrub individuals)	1
• Clipboard and pencils	2+ (1 per monitor)
• Small plant press with blotter paper	1
• Large plant press (in vehicle)	1
• Pruner for collecting woody plants	1
• Small gardening trowel for collecting underground plant parts	1
• Containers for plant samples	variable



ITEM	NUMBER
• Voucher specimen data collection forms	variable
• Plant identification guides/flora	1+
• Plant identification tools and supplies (see page 194)	variable
• Field specimen book or field voucher collection	1
• Munsell plant tissue color chart (for describing plant & flower color)	1
• Field packet, see page 112	1 per plot
• Recommended single forms:	
FMH-7 Forest plot data sheet	1 per plot
FMH-11 Full plot tree map	1 per plot
FMH-14 50 m <sup>2</sup> tree map	1 per plot
FMH-17 Shrub density data sheet	1 per plot
FMH-19 Forest plot fuels inventory data sheet	1 per plot
FMH-21 Forest plot burn severity data sheet (immediate postburn only)	1 per plot
FMH-23 Photographic record sheet	1 per roll of film
FMH-24 Quality control data sheet	1 per plot
FMH-25 Plot maintenance log	1 per plot
• Recommended multiple forms:	
FMH-8 Overstory tagged tree data sheet	2+ per plot
FMH-9 Pole-size tree data sheet	2+ per plot
FMH-10 Seedling tree data sheet	2+ per plot
FMH-12 Quarter plot tree map	4+ per plot
FMH-15 50 m transect data sheet	1+ per plot
FMH-20 Tree postburn assessment data sheet (immediate postburn only)	2+ per plot
• Optional forms:	
FMH-10A Alternate seedling tree data sheet	2+ per plot
FMH-13 Alternate tree map	1 per plot
FMH-16 30 m transect data sheet	1 per plot
FMH-17A Alternate shrub density data sheet	1+ per plot
FMH-18 Herbaceous density data sheet	1+ per plot
FMH-22 Brush and grassland plot burn severity data sheet (immediate postburn only)	1 per plot

## MONITORING BRUSH AND GRASSLAND PLOTS

ITEM	NUMBER
• 2 m tall, ¼ in wide sampling rod (see Table 12, page 82 for sources)	1
• 30 m tape	2
• Tally meter or counter (for counting shrub individuals)	1
• Clipboard and pencils	2+ (1 per monitor)
• Small plant press with blotter paper	1
• Large plant press (in vehicle)	1
• Pruner for collecting woody plants	1

ITEM	NUMBER
• Small gardening trowel for collecting underground plant parts	1
• Containers for plant samples	variable
• Voucher specimen data collection forms	variable
• Plant identification guides/flora	1+
• Field specimen book or field voucher collection	1
• Plant identification tools and supplies (see page 194)	variable
• Munsell plant tissue color chart (for describing plant & flower color)	1
• Field packet, see page 112	1 per plot
• Recommended forms:	
FMH-16 30 m transect data sheet	1 per plot
FMH-17 Shrub density data sheet	1+ per plot
FMH-22 Brush and grassland plot burn severity data sheet (immediate postburn only)	1 per plot
FMH-23 Photographic record sheet	1 per roll of film
FMH-24 Quality control data sheet	1 per plot
FMH-25 Plot maintenance log	1 per plot
• Optional forms:	
FMH-17A Alternate shrub density data sheet	1+ per plot
FMH-18 Herbaceous density data sheet	1+ per plot

## Determining Brush Biomass

ITEM	NUMBER
• Go-no-go gauge	2
• Airtight containers	25+
• Pruners for brush	1
• Calipers	1
• Drying oven and scale	1

## Determining Grass Biomass

ITEM	NUMBER
• 1 pint airtight containers	10
• Clippers for grass	1
• 13.3 in hoop for grass	1
• Drying oven and scale	1

## MONITORING DURING A PRESCRIBED FIRE

ITEM	NUMBER
• 2 ft pieces of wire or short metal stakes	32
• Belt weather kit	1
sling psychrometer (with extra wick)	2
water bottle (filled with distilled water)	1
anemometer	1
compass, with adjustable declination	1
notebook	1
RH tables	variable
pencils, mechanical	variable

ITEM	NUMBER
• 10 m or 20 m tape—or longer if needed	1
• 10-hr fuel sticks *	1
• Fuel stick scale	1
• Airtight containers for collecting fuels (fuel moisture)	10
• 24 in ruler graduated in tenths of inches	2
• Chronograph watch with sweep second hand	2
• Recommended forms:	
FMH-1 Onsite weather data sheet	variable
FMH-2 Fire behavior–weather data sheet	variable
FMH-3 Smoke monitoring data sheet	variable
• Optional forms:	
FMH-1A Alternate onsite weather data sheet	variable
FMH-2A Alternate fire behavior–weather data sheet	variable
FMH-3A Alternate smoke monitoring data sheet	variable

**\* Set out at least three days prior to planned burning**

## MONITORING DURING A WILDLAND FIRE

ITEM	NUMBER
• Park briefing package (including maps of fire area, fire management zone, important telephone numbers, radio call numbers, significant portions of fire management plan, and all necessary forms, e.g., WFIP).	1
• Fire behavior field reference guide (NFES 2224)	1
• Clipboard, notebook, pencil	1
• NWCG fireline handbook (NFES 0065)	1
• Fireline handbook fire behavior supplement (NFES 2165)	1
• Belt weather kit	1
sling psychrometer (with extra wick)	2
water bottle (filled with distilled water)	1
anemometer	1
compass, with adjustable declination	1
notebook	1
RH tables	variable
pencils, mechanical	variable
• First aid kit	1
• 12 in ruler (graduated in tenths of inches)	2
• File folders	variable
• Long envelopes	variable
• Protractor	variable
• Chronograph watch with sweep second hand or digital timer	1
• Portable radio with extra batteries	1
• Personal protective equipment	variable
• Hand tool	1
• Food and water for 24 hours	variable
• FMH-1 Onsite weather data sheet	variable
• FMH-2 Fire behavior–weather data sheet	variable

ITEM	NUMBER
• FMH-3 Smoke monitoring data sheet	variable
<b>OPTIONAL ITEMS</b>	<b>NUMBER</b>
• Batteries (AA)	variable
• Dot grids for acreage	variable
• Mini binoculars	1
• Altimeter	1
• Clinometer	1
• Pocket stereoscope	1
• Camcorder	1
• Camera (35 mm with yellow filter for smoke)	1
• Extra film	variable
• Flagging	variable
• Portable radio with weather band (190–400 KC)	1
• Alarm clock	1
• HP-71B or laptop, printer and paper	optional
• Tape recorder and tapes	1
• Fuel type guides (photo series if available)	variable
• Other maps	
state or county	variable
park districts	variable
topographic	variable
weather zone	variable
• Recently prepared WFIP's (for same area or ecotype)	variable
• Conversion charts	variable
• 2 ft pieces of wire or short metal stakes	variable
• 10 m or 20 m tape—or longer if needed	1
• 10-hr fuel sticks *	1
• Fuel stick scale	1
• Airtight containers for collecting fuels (fuel moisture)	10
• Flares	variable
• Range finder	1
• Fire Effects Monitor (FEMO)/Field Observer (FOBS) job task book	1
• Fire Monitoring Handbook	1
• FMH-1A Alternate onsite weather data sheet	variable
• FMH-2A Alternate fire behavior–weather data sheet	variable
• FMH-3A Alternate smoke monitoring data sheet	variable
• FMH-19 Forest monitoring plot fuels inventory data sheet	1 per plot

**\* Set out at least three days prior to use**

## OPTIONAL EQUIPMENT

### Electronic Marker System

If you need to bury your plot stakes completely, consider using an Electronic Marker System that uses “cyberstakes.” For further information and recommendations see Whitlam (1998). For ordering info:

3M Telecom Systems Division  
6801 River Place Blvd.  
Austin, TX 78726-9000  
1-800-426-8688  
<[www.3M.com/telecom](http://www.3M.com/telecom)>

Choose “product literature,” then indicate ScotchMark Electronic Marker System.

If you find it difficult to relocate rebar, consider purchasing a metal detector or a magnetic locator; both items are available from a number of manufacturers. Magnetic detectors are more expensive than metal detectors, but are more sensitive, lightweight, rugged, and waterproof tools. For ordering info, conduct an Internet search for either item.

### Suggested Equipment Suppliers:

Forestry Suppliers, Inc.  
205 West Rankin Street  
P.O. Box 8397  
Jackson, MS 39204-0397  
1-800-647-5368  
<[www.forestry-suppliers.com/](http://www.forestry-suppliers.com/)>

Ben Meadows Company  
2601-B West Fifth Ave  
P.O. Box 2781  
Eugene, OR 97402  
1-800-241-6401  
<[www.benmeadows.com/](http://www.benmeadows.com/)>

#### For Brass Tags:

National Band and Tag Company  
721 York Street  
P.O. Box 430  
Newport, KY 41072  
(606) 261-2035  
[tags@nationalband.com](mailto:tags@nationalband.com)  
<[www.nationalband.com](http://www.nationalband.com)>

Salt Lake Stamp Company  
380 West 2<sup>nd</sup> St.  
P.O. Box 2399  
Salt Lake City, UT 84110  
(801) 364-3200

#### For Herbarium Supplies:

Herbarium Supply Company  
3483 Edison Way  
Menlo Park, CA 94025  
(800) 348-2338  
[info@herbariumsupply.com](mailto:info@herbariumsupply.com)  
<[www.herbariumsupply.com/](http://www.herbariumsupply.com/)>

#### For Archival Supplies:

See the Northeast Document Conservation Center technical leaflet regarding preservation suppliers and services (NDCC 2000).

#### For Glacier NP Magnetic Board:

Contact the Lead Fire Effects Monitor at:  
Glacier National Park  
West Glacier MT 59936-0128  
(406) 888-7812  
[glac\\_fire\\_monitors@nps.gov](mailto:glac_fire_monitors@nps.gov)

### Recommended Equipment Specifications:

#### Stake Tags

brass racetrack tags (special order)  
standard size: 1 × 2 ¾ in  
standard hole size: 3/16 in  
unnumbered

#### Tree Tags

brass round tags (special order)  
standard size: 1.25 in  
numbered sequentially  
hole size: 3/16 in (not standard) [**Note:** Make sure the hole size is big enough for the nails you use.]

#### Hand Stamp Steel Dies

0.25 in combination letter and figure set

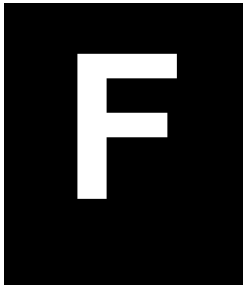

# Monitoring Plan Outline

*“Planning without action is futile. Action without planning is fatal.”*

—Alan Spiegel

## INTRODUCTION (GENERAL)

This the place to discuss:

- The need for study, or the “why” of the management program
- The species (plant associations, flora, fauna) that you will monitor

## DESCRIPTION OF ECOLOGICAL MODEL

Here you provide the following information regarding the species (plant associations, flora, fauna) that you will monitor:

- Life history
- Phenology
- Reproductive biology
- Distribution, range and influences
- Habitat characteristics
- Management conflicts in your area
- Effects of other resource uses on the species (e.g., herbivory of flower heads by elk)

The model should summarize what you know about the ecology of a species, and should describe known biology (based on natural history research or observations) and assumed relationships and functions; be sure to identify your references. Also, identify the gaps in knowledge with regard to the species.

Utilize this section to identify the sensitive attribute(s) (population size; presence/absence; percent of habitat affected; cover, density, production, etc.) and to describe some of the relationships between species biology and potential management activities. Remember that this section will serve as the biological basis for the development of objectives. This should be a conceptual construct, which summarizes how you think the world works, and it can be as simple or as complex as you wish. See Elzinga and others (1998) for examples of ecological models as they relate to monitoring.

## MANAGEMENT OBJECTIVE(S)

In order to develop an effective monitoring program you need to create clear, concise, measurable objectives. Keep in mind that the process of setting objectives is a dynamic process, and must include the ability to respond to new information. It may be difficult to establish measurable objectives due to the lack of knowledge about a portion or portions of the population, community or ecosystem in question. Managers should use the best of available information, and focus on creating knowledge-based measurable objectives.

This section of the monitoring plan includes the rationale that you used to choose the attribute to measure and the amount of change or target population size. See page 23 for some examples of management objectives.

## MONITORING DESIGN

### Monitoring Objective(s)

In this section you state the chosen levels of accuracy and power for all your critical variables, as well as the rationale you used to determine these levels of accuracy and power. See page 26 for examples of a monitoring objective.

A monitoring objective must contain the level of accuracy and power that you desire (80% is suitable for power and accuracy in most monitoring situations), the minimum amount change you want to be able to detect, and what variable is to be measured.

The “80% sure” (power, or  $\beta$ ) refers to how willing you are to have your monitoring program miss an actual change that takes place in your park (Type II Error). This is critical for land managers—if there’s a change going on out there, you want to know about it.

The “20% chance” (accuracy, or  $\alpha$ ) refers to how willing you are to have your monitoring program indicate that the variables you are measuring are changing, when in fact they are not (Type I Error).

## **Sampling Design**

Describe your sampling design clearly. Include any additional materials that are relevant, e.g., changes that you made to a referenced sampling design, and why you made those changes. Also include here your completed Monitoring type description sheets (FMH-4) for each monitoring type.

What sizes and shapes will your sampling units be? How will you define the vegetation–fuel complex within which you are sampling? How will sampling units be placed in the field? Use restricted random sampling for sample sizes of less than 30.

As a part of your sampling design, you should consider pilot sampling. This entails establishing a small number (ten) of plots and/or transects, and then analyzing this information to determine if the sampling design is adequate to measure the variables that you have chosen.

Once you have determined your minimum sample size requirements, document how many sampling units you have installed per vegetation association–treatment. Reference any associated or related studies that might expand the scale of the monitoring project. Studies worth mentioning include other inventory and monitoring projects, as well as research projects that are occurring in your park or in a nearby area.

## **Field Measurements**

Here you reference the Fire Monitoring Handbook and discuss deviations to protocol, or any additional protocols that you will use, e.g., sampling of faunal populations.

## **Timing of Monitoring**

What time of year, both calendar and phenologically, will you monitor your plots? How often will your plots be monitored? Provide this information if you are using a timing system that is different from what is stated in the Fire Monitoring Handbook.

## **Monitoring Plot Relocation**

Describe how to relocate plots. Include clear directions, maps and aerial photographs describing how to get to the study location, and how to find individual sampling units (if permanent). Attach copies of your Plot location data sheets (FMH-5) here.

## **Intended Data Analysis Approach**

Describe how you intend to analyze your data; record which statistical tests you will use. Will you blend and/or contrast your results with other studies? If so, with

which studies will you compare and/or combine your data?

## **Data Sheet Examples**

Include examples of your data sheets here, if they have been modified from those included in the Fire Monitoring Handbook. Otherwise, reference the Fire Monitoring Handbook.

## **Information Management**

It has been estimated that 25–40% of time spent on any monitoring project is spent managing data.

- How will you manage this time?
- How long will it take to do data entry?
- When do you have access to the computer?
- When is the best time to enter data?
- Who is going to enter data?
- How much time do you need for error-checking?
- Where will you archive your data on a regular basis?
- Who's going manage and maintain the data?

## **Quality Control**

- How will you ensure data quality?
- How will you institute data quality checks?
- How often will these checks be performed?
- Who will conduct these checks?
- How often will you request a program evaluation?

## **Sources of data errors**

How will you minimize the following common data errors?

- Errors in recording
- Transcription errors
- Incorrect identification of species
- Species that are overlooked or not seen
- Data collected at the wrong time of year
- Incomplete or uncollected data
- Misinterpretation of monitoring design
- Impacts of monitoring
  - Voucher Specimen Collection
  - Trampling
    - fuels
    - vegetation

Some ideas on how to minimize these errors include:

- Fill out all forms completely
- Maintain accurate documentation of plot locations for ease of relocation
- Correct unknown species identifications
- Clearly label all plot folders
- Provide quality training
- Listen to your field technicians
- Periodically review your protocols
- GPS your plot locations
- Schedule error-checking of:
  - field data
  - computer data

Addressing proper procedures in your monitoring plan establishes expectations up-front and can help ensure the collection of accurate data.

### **Responsible Parties**

- Name the authors of this monitoring plan
- Who will review your program for design or statistical problems?
- Who is responsible for the various administrative tasks required for this monitoring program?

### **Funding**

- What funding sources will you use?
- How will you insure long-term funding?

### **Management Implications of Monitoring Results**

- In what setting will you present results of this monitoring program for discussion? Regular staff meetings? Public meetings? Conferences? Publications?
- How will management use this data? What action will management take if your monitoring data shows desirable trends or undesirable trends?
- What are the potential trigger points that will cause you to reexamine either the monitoring program and/or the management activity?

### **References**

Include gray literature and personal communications.

### **Reviewers**

List those who have reviewed drafts of the monitoring plan.



# G

## Additional Reading

*“The books that help you the most are the ones that make you think the most.”*

—Theodore Parker

### References for Nonstandard Variables

This handbook addresses Recommended Standard variables, but in many cases, it may be appropriate to monitor nonstandard variables. To develop monitoring methods for nonstandard variables, always consult subject-matter experts. The techniques used to monitor these nonstandard variables must be accurate, defensible, and have a high level of certainty. This section contains a list of references to help you develop techniques for monitoring optional parameters. Included are bibliographies dealing with fire conditions, air, soil, water, forest pests, amphibians, reptiles, birds, mammals, vegetation, and fuels. These and/or other nonstandard variables may be considered Recommended Standards for your park, depending on its fire management program. Also included here are references for assistance with adaptive management and sampling design.

Additional informational sources include NPS regional libraries, USGS Biological Resources Division Research Centers, USFS Research Stations, USFS Pest Management Offices, and local universities. Many universities can conduct computerized literature searches quite rapidly at low cost. Literature computer searches also can be conducted through the Department of Interior by writing to: Department of Interior, Computerized Literature Search, Natural Resources Library, 18th and C Streets, N. W., Washington, DC 20240.

#### GENERAL

Bonham CD, Bousquin SG, Tazik D. 2001. Protocols and models for inventory, monitoring, and management of threatened and endangered plants. Fort Collins (CO): Colorado State University Department of Rangeland Ecosystem Science. <[www.cnr.colostate.edu/frws/research/rc/tesintro.htm](http://www.cnr.colostate.edu/frws/research/rc/tesintro.htm)>. Accessed 2003 July 22.

Cochran WG. 1977. Sampling techniques. 3<sup>rd</sup> ed. New York: J Wiley. 428 p.

Drost CA, Stohlgren TJ. 1993. Natural resource inventory and monitoring bibliography. Davis (CA): Cooperative National

Park Resources Studies Unit, University of California. Technical Report No NPS/WRUC/NRTR93-04.

*Emphasizes references on: inventory and monitoring design considerations; field methods for biological and physical survey and monitoring (particularly evaluation of particular methods, or comparison of two or more methods); examples of planned, ongoing, or completed inventories and monitoring programs; data analysis and interpretation, including analysis of census data, plant community measurement, diversity measures, and application of remote imaging; and application of inventory and monitoring information. Available in electronic format as either a database or word processing document.*

Elzinga CL, Salzer DW, Willoughby JW. 1998. Measuring and monitoring plant populations. Denver: USDI Bureau of Land Management. 492 p.

Elzinga CL, Salzer DW, Willoughby JW, Gibbs JP. 2001a. Monitoring plant and animal populations. Malden (MA): Blackwell Science. 368 p.

Elzinga CL, Salzer DW, Willoughby JW, Gibbs JP. 2001b. Internet resources to accompany: Monitoring Plant and Animal Populations: A Handbook for Field Biologists. <[www.esf.edu/efb/gibbs/monitor/popmonroot.html](http://www.esf.edu/efb/gibbs/monitor/popmonroot.html)>. Accessed 2003 July 22.

Environment Canada, Ecological Monitoring and Assessment Network Coordinating Office. 1998. Protocols for monitoring organisms of terrestrial ecosystems. <[www.eman-rese.ca/eman/ecotools/protocols/terrestrial/](http://www.eman-rese.ca/eman/ecotools/protocols/terrestrial/)>. Accessed 2003 July 22.

*Includes references for measuring trees, ground vegetation, shrubs and saplings, grasslands, tundra, wetlands/bogs, amphibians, arthropods (see Finnermore and others 1999), earthworms, non-native and invasive plants, fleshy fungi in forest ecosystems, and mosses and lichens; phenology of flowering plants, decomposition, necromass; and making plant collections.*

Fancy S. 1999. Monitoring natural resources in our National Parks. <[www.nature.nps.gov/im/monitor/](http://www.nature.nps.gov/im/monitor/)>. Accessed 2003 July 22.

*An excellent compilation of information from a number of sources on designing and implementing long-term monitoring of natural resources.*



Fish and Wildlife Service. 2000. Fire effects monitoring reference guide. <fire.r9.fws.gov/ifcc/monitor/RefGuide/default.htm>. Accessed 2003 July 22.

Gegoire TG, Brillinger DR, Diggle PJ, Russek-Cohen E, Warren WG, Wolfinger RD, editors. 1997. Modeling longitudinal and spatially correlated data. New York: Springer-Verlag. 402 p.

Goldsmith B, editor. 1991. Monitoring for conservation. New York: Chapman and Hall. 275 p.

GreatPlains.org. 1999. Annotated bibliography of ecological indicators. <www.greatplains.org/resource/ecobib/ecobib.htm>. Accessed 2003 July 22.

*A searchable bibliography that contains citations on various indicator species, e.g., indicators for biodiversity and contaminants.*

Hall FC. 2001. Ground-based photographic monitoring. Portland (OR): USDA Forest Service, Pacific Northwest Research Station. Gen Tech Report PNW-GTR-503. 340 p. Available online at: <www.fs.fed.us/pnw/pubs/gtr503/>. Accessed 2003 July 22.

*A comprehensive overview of photomonitoring.*

Hawaii Natural Resources Monitoring Working Group. 1998. Monitoring references. <www.hear.org/hinrmwg/monrefs.htm>. Accessed 2003 July 22.

*An annotated monitoring bibliography with an emphasis on monitoring in the tropics.*

Krebs CJ. 1989. Ecological methodology. New York: Harper and Row. 654 p.

Littel RC, Milliken GA, Stroup WW, Wolfinger RD. 1996. SAS System for mixed models. Cary (NC): SAS Institute. 633 p.

Ludwig JA, Reynolds JR. 1988. Statistical ecology: a primer on methods and computing. New York: J Wiley. 337 p.

Mueller-Dombois D, Ellenberg H. 1974. Aims and methods of vegetation ecology. New York: J Wiley. 547 p.

National Park Service. 1999a. Colorado Plateau natural resource bibliography. <www.usgs.nau.edu/searchnr-bib.htm>. Accessed 2001 May 29.

*This site is currently accessible only to National Park Service employees.*

National Park Service. 1999b. Natural resource bibliography for the National Park Service inventory and monitoring program. Seattle (WA): Natural Resource Information Division, NPS Columbia Cascades Support Office Library - Pacific West Region. <www.nature.nps.gov/nrbib/>. Accessed 2001 May 29.

*A searchable database of references to sources of natural resource information including reports, maps, journal articles and videotapes.*

Scheaffer RL, Mendenhall W, Ott L. 1996. Elementary survey sampling. 5<sup>th</sup> ed. Belmont (CA): Duxbury Press. 501 p.

Spellerberg IF. 1991. Monitoring ecological change. New York: Cambridge University Press. 334 p.

Sutherland WJ, editor. 1996. Ecological census techniques. Great Britain (UK): Cambridge University Press. 336 p.

Thompson SK. 1992. Sampling. New York: J Wiley. 343 p.

USGS Patuxent Wildlife Research Center. 1999. Monitoring program. <www.im.nbs.gov/>. Accessed 2003 July 22.

*Information on monitoring protocols for birds, butterflies, amphibians, and other species. Also information on biological software and designing a monitoring program, and an extensive list of biological links.*

## **FIRE CONDITIONS AND OBSERVATIONS**

Alexander ME. 1982. Calculating and interpreting forest fire intensities. Canadian Journal of Botany 60:349–57.

Boudreau S, Maus P. 1996. An ecological approach to assess vegetation changes after large scale fires on the Payette National Forest. *In*: Greer JD, editor. Remote sensing: people in partnership with technology. Proceedings of the Sixth Forest Service Remote Sensing Applications Conference; 1996 April 29–May 3; Denver, CO. Bethesda (MD): American Society for Photogrammetry and Remote Sensing. p 330–9.

Burgan RE, Rothermel RC. 1984. BEHAVE: fire behavior prediction and fuel modeling system, fuel subsystem. Ogden (UT): USDA Forest Service, Intermountain Forest and Range Experiment Station. Gen Tech Report INT-167. 126 p.

Cole KL, Klick KF, Pavlovic NB. 1992. Fire temperature monitoring during experimental burns at Indiana Dunes National Lakeshore. Natural Areas Journal 12(4):177–83.

Engle DM., Bidwell TG, Ewing AL, Williams JR. 1989. A technique for quantifying fire behavior in grassland fire ecology studies. The Southwest Naturalist 34(1):79–84.

Fischer WC, Hardy CE. 1976. Fire-weather observers' handbook. Ogden (UT): USDA Forest Service, Intermountain Forest and Range Experiment Station. Agriculture Handbook No 494. 152 p.

Fosberg MA. 1977. Forecasting the 10-hour timelag fuel moisture. Fort Collins (CO): USDA Forest Service, Rocky Mountain Forest and Range Experiment Station. Research Paper RM-187. 10 p.

- Gill AM, Knight IK. 1991. Fire measurement. *In*: Cheney NP, Gill AM, editors. Conference on bushfire modeling and fire danger rating system: proceedings; 1988 July; Canberra, ACT. Yarralumla (ACT): CSIRO, Division of Forestry. p 137–46.
- Glenn SM, Collins SL, Gibson DJ. 1992. Disturbances in tallgrass prairie: local and regional effects on community heterogeneity. *Landscape Ecology* 7(4):243–51.
- Glenn SM, Collins SL, Gibson DJ. 1995. Experimental analysis of intermediate disturbance and initial floristic composition: decoupling cause and effect. *Ecology* 76(2):486–92.
- Gwynfor DR, Bryce RW. 1995. A computer algorithm for simulating the spread of wildland fire perimeters for heterogeneous fuel and meteorological conditions. *International Journal of Wildland Fire* 5(2):73–9.
- Hardy CC. 1996. Guidelines for estimating volume, biomass and smoke production for piled slash. Portland (OR): USDA Forest Service, Pacific Northwest Forest and Range Experiment Station. PNW-GTR-364. 21 p.
- Hulbert LC. 1988. Causes of fire effects in tallgrass prairie. *Ecology* 69(1):46–58.
- McKenzie D, Peterson DL, Alvarado E. 1996. Predicting the effect of fire on large-scale vegetation patterns in North America. Portland (OR): USDA Forest Service, Pacific Northwest Forest and Range Experiment Station. PNW-RP-489. 38 p.
- McMahon CK, Adkins CW, Rodgers SL. 1987. A video image analysis system for measuring fire behavior. *Fire Management Notes* 47(1):10–15.
- McRae DJ, Alexander ME, Stocks BJ. 1979. Measurement and description of fuels and fire behavior on prescribed burns: a handbook. Sault Sainte Marie (ON): Canadian Forest Service. Report O-X-287. 59 p.
- Moore PHR, Gill AM, Kohnert R. 1995. Quantifying bushfires for ecology using two electronic devices and biological indicators. *CALM Science Supplement* 4:83–8.
- Nelson RM Jr, Adkins CW. 1986. Flame characteristics of wind-driven surface fires. *Canadian Journal of Forest Research* 16:293–300.
- Norum RA, Fischer WC. 1980. Determining the moisture content of some dead forest fuels using a microwave oven. Ogden (UT): USDA Forest Service, Intermountain Forest and Range Experiment Station. INT-277. 7 p.
- O’Keefe MA. 1995. Fitting in fire: a statistical approach to scheduling prescribed burns. *Restoration and Management Notes* 13(2):198–202.
- Reinhardt TE, Ottmar RD, Hallett MJ. 1999. Guide to monitoring smoke exposure of wildland firefighters. Portland (OR): USDA Forest Service, Pacific Northwest Research Station. Gen Tech Report PNW-GTR-448. 34 p.
- Rothermel RC. 1983. How to predict the spread and intensity of forest fires. Ogden (UT): USDA Forest Service, Intermountain Forest and Range Experiment Station. Gen Tech Report INT-143. 161 p.
- Rothermel RC, Deeming JE. 1980. Measuring and interpreting fire behavior for correlation with fire effects. Ogden (UT): USDA Forest Service, Intermountain Forest and Range Experiment Station. Gen Tech Report INT-93. 4 p.
- Rothermel RC, Rinehart GC. 1983. Field procedures for verification and adjustment of fire behavior predictions. Ogden (UT): USDA Forest Service, Intermountain Forest and Range Experiment Station. Gen Tech Report INT-142. 25 p.
- Ryan KC, Noste NV. 1985. Evaluating prescribed fires. *In*: Lotan JE, Kilgore BM, Fischer WC, Mutch RW, technical coordinators. Symposium and workshop on wilderness fire: proceedings; 1983 November 15–18; Missoula, MO. Ogden (UT): USDA Forest Service, Intermountain Forest and Range Experiment Station. Gen Tech Report INT-182. p 230–8.
- Sampson RN, Atkinson RD, Lewis JW, editors. 2000. Mapping wildfire hazards and risks. Binghamton (NY): Haworth Press Inc. 343 p.
- Compiles a number of perspectives on using a geographical information system to help determine the risks of wildfires and the benefits of controlled burns.*
- USDA Forest Service. 1995. Burned area emergency rehabilitation handbook. Washington (DC): GPO. FSH 2509.13. 106 p.

## AIR, SOIL AND WATER

- Denison WC, Carpenter SM. 1973. A guide to air quality monitoring with lichens. Corvallis (OR): Lichen Technology. 39 p.
- A simplified approach for laypersons including ID and surveying techniques.*
- Campbell S, Smith G, Temple P, Pronos J, Rochefort R, Andersen C. 2000. Monitoring for ozone injury in West Coast (Oregon, Washington, California) forests in 1998. Portland (OR): USDA, Forest Service, Pacific Northwest Research Station. Gen Tech Report PNW-GTR-495. 19 p.
- Dunne T. 1977. Evaluation of erosion conditions and trends. *In*: Guidelines for Watershed Management. Kunkle SK, editor. Rome: United Nations Food and Agriculture Organization. FAO Conservation Guide 1. p 53–83.

*Describes a range of field techniques for assessing rates of erosion by various processes, and emphasizes methods that are relatively low in cost.*

Dunne T, Leopold L. 1978. Water in environmental planning. San Francisco: WH Freeman and Company. 818 p.

*A textbook with general information on measuring soil erosion, river processes, sediment production and water quality.*

Geiser LH, Derr CC, Dillman KL. 1994. Air quality monitoring on the Tongass National Forest: methods and baselines using lichens. Petersburg (AK): USDA Forest Service, Alaska Region. Technical Bulletin R10-TB-46. 85 p.

Hawsworth DL, Rose F. 1976. Lichens as pollution monitors. London: Edward Arnold. The Institute of Biology's Studies in Biology No 66. 60 p.

Pearson L. 1993. Active monitoring. *In*: Stolte K, Mangis D, Doty R, Tonnessen K, Huckaby LS, editors. Lichens as bio-indicators of air quality. Fort Collins (CO): USDA Forest Service, Rocky Mountain Forest and Range Experiment Station. Gen Tech Report RM-224. p 89–95.

Richardson D. 1997. Methodology for volunteer/school monitoring projects using lichens. Ecological Monitoring and Assessment Network. <[www.cciw.ca/eman-temp/research/protocols/lichen/part1.html](http://www.cciw.ca/eman-temp/research/protocols/lichen/part1.html)>. Accessed 2001 May 29.

Richardson DHS. 1992. Pollution monitoring with lichens. Slough (UK): Richmond Publishing. Naturalists' Handbooks 19. 76 p.

## **FOREST PESTS (MISTLETOE, FUNGI, and INSECTS)**

While most commercial foresters consider native mistletoe and many native fungi and insects to be forest pests, the National Park Service recognizes that the occurrence, even in large numbers, of these organisms is a part of a natural process. Non-native forest pests, however, may be removed or increased by management fires; if this is a concern the park manager should develop and implement a pest monitoring program. Suggested pest identification sources and monitoring method references are listed below.

Amman GD, Pesky JE. 1987. Mountain pine beetle in ponderosa pine: effects of phloem thickness and egg gallery density. Ogden (UT): USDA Forest Service, Intermountain Research Station. Research Paper INT-367. 7 p.

Bloomberg WJ. 1983. A ground survey method for estimating loss caused by *Phellinus weirii* root rot. III. Simulation of disease spread and impact. Victoria (BC): Canadian Forest Service, Pacific Forestry Centre. BC-R-7. 24 p.

Brace S, Peterson DL, and Bowers D. 1999. A guide to ozone injury in vascular plants of the Pacific Northwest. Portland (OR): USDA Forest Service, Pacific Northwest Forest and Range Experiment Station. PNW-GTR-446. 63 p. <[www.fs.fed.us/pnw/pubs/gtr\\_446.pdf](http://www.fs.fed.us/pnw/pubs/gtr_446.pdf)>. Accessed 2001 May 29.

Brewer JW, Hantsbarger WM, Taylor S. 1980. Insect pests of Colorado trees and shrubs. Fort Collins (CO): Department of Zoology and Entomology, Colorado State University. Bulletin 506A. 93 p.

Brooks MH, Colbert JJ, Mitchell RG, Stark RW, coordinators. 1985. Managing trees and stands susceptible to western spruce budworm. Washington (DC): USDA Forest Service, Cooperative State Research Service. Tech. Bulletin No 1695. 111 p.

*Chapter 5 contains information on survey and sampling methods. Chapter 6 contains information on rating stand hazards for western spruce budworm. Chapters 7 and 8 discuss management schemes.*

Brooks MH, Colbert JJ, Mitchell RG, Stark RW. 1985. Western spruce budworm and forest management planning. Washington (DC): USDA Forest Service, Cooperative State Research Service. Tech. Bulletin No 1696. 88 p.

Carolyn VM Jr, Coulter WK. 1972. Sampling populations of western spruce budworm and predicting defoliation on Douglas-fir in Eastern Oregon. Portland (OR): USDA Forest Service, Pacific Northwest Forest and Range Experiment Station. Research Paper PNW-149. 38 p.

Felt EP, Rankin WH. 1924. Insects and diseases of ornamental trees and shrubs. New York: The Macmillan Company. 507 p.

Furniss RL, Carolyn VM. 1977. Western forest insects. Washington (DC): U.S. Department of Agriculture, Forest Service. Miscellaneous Publication No 1339. 654 p.

Hepting GH. 1971. Diseases of forest and shade trees of the United States. Washington (DC): U.S. Department of Agriculture. Agricultural Handbook 386. 658 p.

Ives WGH. 1988. Tree and shrub insects of the prairie provinces. Edmonton: Northern Forestry Centre, Canadian Forestry Service. 327 p.

Johnson DW. 1982. Forest pest management training manual. Lakewood (CO): USDA Forest Service, Rocky Mountain Region (Region 2), Forest Pest Management. 138 p. *General reference that helps identify forest pests and provides life history information, symptoms, importance, and control strategies for forest pests.*

Johnson, WT, Lyon HH. 1991. Insects that feed on trees and shrubs. 2<sup>nd</sup> ed. Ithaca (NY): Comstock Publishing Associates, Cornell University Press. 560 p.

- Knight FB. 1967. Evaluation of forest insect infestations. *Annual Review of Entomology* 12:207–28.
- Mason RR. 1970. Development of sampling methods of the Douglas-fir tussock moth, *Hemerocampa pseudotsugata* (Lepidoptera: Lymantriidae). *Canadian Entomologist* 102(7):836–45.
- Scharpf RF, technical coordinator. 1993. Diseases of Pacific Coast conifers. Washington (DC): USDA Forest Service. Agricultural Handbook 521. 199 p.
- General reference that helps identify conifer diseases and provides basic biological information and treatments for numerous types of rots, blights, mistletoe, rusts, etc.*
- Scharpf RF, Parmeter JR Jr, technical coordinators. 1978. Proceedings of the symposium on dwarf mistletoe control through forest management; 1978 April 11–13; Berkeley, CA. Albany (CA): USDA Forest Service, Pacific Southwest Forest and Range Experiment Station. Gen Tech Report PSW-31. 190 p.
- Sinclair WA, Lyon HH, Johnson WT. 1987. Diseases of trees and shrubs. Ithaca (NY): Comstock Publishing Associates, Cornell University Press. 574 p.
- Solomon JD. 1995. Guide to insect borers in North American broadleaf trees and shrubs. Washington (DC): U.S. Department of Agriculture, Forest Service. Agriculture Handbook 706. 205 p.
- Stevens RE, Stark RW. 1962. Sequential sampling of the lodgepole needle miner, *Evagora milleri*. *Journal of Economic Entomology* 55(4):491–4.
- Torgersen TR, McKnight ME, Cimon N. 2000. The Hopkins U.S. System Index—HUSI. La Grande (OR): USDA Forest Service, Pacific Northwest Research Station. [Database] <www.fs.fed.us/pnw/hussi>. Accessed 2001 May 29.
- A database consisting of a collection of notes on thousands of insect and damage specimens taken mainly in the United States.*
- USDA Forest Service. 1985. Field instructions for stand examination. *In*: USDA Forest Service. Timber Management Data Handbook, Chapter 400. Missoula (MT): USDA Forest Service. FSH No 2409.21h. 223 p.
- USDA Forest Service. 1994. How to identify ozone injury on eastern forest bioindicator plants. Atlanta (GA): USDA Forest Service, Southern Region. R8-PR-25. 10 p.
- USDA Forest Service. 1997. Forest health monitoring: field methods guide. Research Triangle Park (NC): USDA Forest Service, National Forest Health Monitoring Program. 353 p.
- USDA Forest Service. 1998. Forest disease management notes. <www.fs.fed.us/r6/nr/fid/mgmtnote/index.htm>. Accessed 2001 May 29.
- USDA Forest Service. 1999a. Forest insect and disease leaflets. <www.fs.fed.us/r6/nr/fid/fidpage.htm>. Accessed 2001 May 29.
- A series of leaflets each of which deals with the identification and control of a specific insect or disease. More than 160 leaflets are available for North America. Most of these publications are out of print, and available only via the Internet.*
- USDA Forest Service. 1999b. Common pest alerts in the United States. <www.fs.fed.us/na/morgantown/fhp/palerts/palerts.htm>. Accessed 2001 May 29.
- A series of one-page fact sheets about new or unusual tree pests. They are intended to alert land managers and the public about important tree pests.*
- USDA Forest Service. 1999c. “How to” publications. <willow.ncfes.umn.edu/fth\_pubs/howto.htm>. Accessed 2001 May 29.
- Publications written for homeowners, land managers and others who want to know more about how to care for trees. Most are descriptions of specific pests that affect trees.*
- Williams RE, Leapheart CD. 1978. A system using aerial photography to estimate area of root disease centers in forests. *Canadian Journal of Forest Research* 8:213–9.
- Wilson LF. 1977. A guide to insect injury of conifers in the Lake States. Washington (DC): USDA Forest Service. 218 p.

## AMPHIBIANS AND REPTILES

- Amand WB. 1982. Chemical restraint of reptiles. *In*: Nielson L, Haigh JC, Fowler ME, editors. Chemical immobilization of North American wildlife: proceedings; 1982; Milwaukee, WI. Milwaukee (WI): Wisconsin Humane Society. p 194–8.
- Anderka FW, Weatherhead PJ. 1983. A radio transmitter and implantation technique for snakes. Proceedings of the Fourth International Conference Wildlife Biotelemetry; 1983; Halifax, NS. Laramie (WY): The Conference. p 47–53.
- Anderson DR, Burnham KP, Otis DL, White GC. 1982. Capture-recapture and removal methods for sampling closed populations. Los Alamos (NM): Los Alamos National Laboratory. 235 p.
- Bouskila A. 1985. A trapping technique for capturing large active lizards. *Journal of the Herpetological Association of Africa* 31:2–4.
- Bury RB, Lukenbach RA. 1977. Censusing desert tortoise populations using a quadrat and grid location system. *In*: Desert Tortoise Council. The Second Annual Symposium

- of the Desert Tortoise Council; Proceedings; 1977 March 24–26; Las Vegas, NV. San Diego (CA): The Council. p 169–73.
- Bury RB, Raphael MG. 1983. Inventory methods for amphibians and reptiles. *In*: Bell JF, Atterbury T, editors. Renewable resource inventories for monitoring changes and trends; proceedings; 1983 August 15–19; Corvallis, OR. Corvallis (OR): Oregon State University. p 416–9.
- Caughley G. 1977. Analysis of vertebrate populations. New York: J Wiley. 234 p.
- Cochran WG. 1977. Sampling techniques. 3<sup>rd</sup> ed. New York: J Wiley. 428 p.
- Davis DE, editor. 1982. Handbook of census method for terrestrial vertebrates. Boca Raton (FL): CRC Press. 397 p.
- Heyer WR, Donnelly MA, McDiarmid RW, Hayek LC, Foster MS. 1994. Measuring and monitoring biological diversity: standard methods for amphibians. Washington (DC): Smithsonian Institution Press. 364 p.
- Part of a series that details standard qualitative and quantitative methods for sampling biological diversity for several groups of plants and animals.*
- Larson MA. 1984. A simple method for transmitter attachment in Chelonians. Bulletin of the Maryland Herpetological Society 20(2):54–7.
- Legler WK. 1979. Telemetry. *In*: Harless M, Morlock H, editors. Turtles: Perspectives and research. New York: J Wiley. p 61–72.
- Marais J. 1984. Probing and marking snakes. Journal of the Herpetological Association of Africa 30:15–16.
- Medica PA, Lyons CL, Turner FB. 1986. “Tapping”: a technique for capturing tortoises. Herpetological Review 17(1):15–16.
- Mulder JB, Hauser JJ. 1984. A device for anesthesia and restraint of snakes. veterinary medicine—small animal clinician 79(7):936–7.
- Pacala S, Rummel J, Roughgarden J. 1983. A technique for enclosing *Anolis* lizard populations under field conditions. Journal of Herpetology 17(1):94–7.
- Paulissen MA. 1986. A technique for marking teiid lizards in the field. Herpetological Review 17(1):16–17.
- Plummer MV. 1979. Collecting and marking. *In*: Harless M, Morlock H, editors. Turtles: perspectives and research. New York: J Wiley. p 45–60.
- Semenov DV, Shenbrot GI. 1985. An estimate of absolute density of lizard populations taking into account the marginal effect. Zoologicheskii Zhurnal 64(8):1246–53.
- Simon CA, Bissinger BE. 1983. Paint marking lizards: does the color affect survivorship? Journal of Herpetology 17(2):184–6.
- Stark MA. 1984. A quick, easy and permanent tagging technique for rattlesnakes. Herpetological Review 15(4):110.
- Stark MA. 1985. A simple technique for trapping prairie rattlesnakes during spring emergence. Herpetological Review 16(3):75–7.
- Stark MA. 1986. Implanting long-range transmitters in prairie rattlesnakes, *Crotalus v. viridis* Herpetological Review 17(1):17–18.
- Zwinker FC, Allison A. 1983. A back marker for individual identification of small lizards. Herpetological Review 14(3):82.

## BIRDS

Generally three census methods have been used to assess the effect of fire on bird populations: spot mapping, plot, and transect techniques. These will be briefly explained below. Other methods have been successfully used to estimate bird numbers, but were not found in the literature that relates to fire. These are the variable circular-plot, variable distance transect, and mark-recapture methods, which are described and evaluated in Ralph and Scott (1981).

In all methods, individuals flying overhead, such as raptors, are not counted; censuses are made in the early morning; and censuses are not conducted in bad weather.

Potential pitfalls common to all techniques:

- An inexperienced observer biases results
- Observation conditions are related to weather, time of day, etc.
- Habitat has a screening effect
- Different species of birds are not equally conspicuous (relative to noise, movement behavior patterns, size, and color)

The choice of research method depends upon availability of money and observers. The spot mapping technique is best for assessing density, but it is the most labor-intensive technique, and “floaters” are lost using this technique. No method is really good for monitoring density; only consider measuring for den-

sity if you have plenty of funding. The variable-circular-plot method is currently gaining in popularity. Spending a specified time at one spot is thought to be more controlled than walking a transect, because different observers walk at different rates and therefore will record differing results. The variable-strip is actually the same method as the variable-circular plot; both show promise.

### Census Techniques

Brewer R. 1978. A comparison of three methods of estimation winter bird populations. *Bird-Banding* 49(3):253–61.

Burnham KP, Crain BR, Laake JL, Anderson DR. 1979. Guidelines for line transect sampling of biological populations. *Journal of Wildlife Management* 43(1):70–8.

Emlen JT. 1977. Estimating breeding season bird densities from transect counts. *The Auk* 94:455–68.

Van Velzen WT. 1972. Breeding-bird census instructions. *American Birds* 26(6):927–31.

### Spot mapping

Bock CE, Lynch JF. 1970. Breeding bird populations of burned and unburned conifer forest in the Sierra Nevada. *Condor* 72:182–9.

*The spot mapping technique calls for determining the distribution of number of birds on a grid. The census technique requires slow walking along grid lines, and recording bird positions and movements on maps of the grids.*

Pielou EC. 1984. The interpretation of ecological data: a primer on classification and ordination. New York: J Wiley. 263 p.

Raphael MG, Morrison M, Yoder-Williams MP. 1987. Breeding bird populations during twenty-five years of postburn succession in the Sierra Nevada. *Condor* 89:614–26.

*Ruzicka's Index (RI) was used to compute the similarity of birds between plots and among years (Pielou 1984). The long-term nature of this study permits discussion of overall predictability of bird population changes in response to habitat change in the study area.*

### Plot

Kilgore BM. 1970. Response of breeding bird populations to habitat changes in a giant sequoia forest. *The American Midland Naturalist* 85(1):135–52.

*Using maps, workers recorded bird observations on a route including a series of U-turns that ran back and forth between a burned and unburned plot. The route passes within 30.5 m of every point in each plot. All bird activities were noted; however, considerable effort was taken to record simultaneously singing males. At least ten census trips were made each year between April and July. Concentrated groups indicated an activity area. The basic results of feeding height and spe-*

*cies were used as an index to food intake and converted to consuming biomass (Salt 1957).*

Lawrence GE. 1966. Ecology of vertebrate animals in relation to chaparral fire in the Sierra Nevada foothills. *Ecology* 47(2):279–91.

*Breeding bird population data consisted of recording activity of the resident bird species on 20 acre burned and unburned plots of chaparral and grassland. The route included two U-turns so that each point in the area came within 32 m of the view or hearing of the observer. All activities of each bird species were recorded on maps. Censusing occurred from 7:30–11:00 am, and from late March through June. Each gridded 20 acre plot was traversed five or six times during this period. Where activity records for a given species revealed a pair was repeatedly present, they were considered a resident pair.*

Salt GW. 1957. An analysis of avifaunas in the Teton Mountains and Jackson Hole, Wyoming. *Condor* 59:373–93.

### Transect

Beals E. 1960. Forest bird communities in the Apostle Islands of Wisconsin. *Wilson Bulletin* 72(2):156–81.

Beedy EC. 1981. Bird communities and forest structure in the Sierra Nevada of California. *Condor* 83:97–105.

*Censusing occurred from June to September 1974. On each of four transects, 12 censuses were conducted, six each in the nesting and post-nesting seasons. A strip-transect method was used (Kendeigh 1944, Salt 1957). Fixed width transects were used in preference to the variable-strip method (Emlen 1971) because it was difficult to estimate accurately the lateral distances to vocalizing birds in these forests. More than 85% of the bird detections were based on vocalizations alone.*

*All birds noted within a 15 m band on either side of a measured trail were noted. Also noted were the foraging substrate, location, and behavior for each bird. Individuals flying overhead, such as raptors, were not noted. Since transects varied in size, a conversion factor was used to determine relative numbers per hectare.*

Emlen JT. 1971. Population densities of birds derived from transect counts. *Auk* 88:323–42.

Kendeigh SC. 1944. Measurements of bird populations. *Ecological Monographs* 14:67–106.

Taylor DL, Barmore WJ Jr. 1980. Postburn succession of avifauna in coniferous forests of Yellowstone and Grand Teton National Parks, Wyoming. In: DeGraff RM, technical coordinator. Management of western forests and grasslands for nongame birds; proceedings; 1980 February 11–14; Salt Lake City, UT. Ogden (UT): USDA Forest Service, Intermountain Forest and Range Experiment Station and Rocky Mountain Forest and Range Experiment Station. p 130–45. *A transect survey method was used to estimate breeding bird density. One person made all bird counts. Authors recommend using transect counts when large areas must be sampled in a short time. A 75 ft-wide belt on each side of a 1,000 yd transect was used. Classification of*

birds into feeding categories according to foraging level and food type follows Salt (1957).

Theberge JB. 1976. Bird populations in the Kluane Mountains, Southwest Yukon, with special reference to vegetation and fire. *Canadian Journal of Zoology* 54:1356.

*A wide geographical area was divided into eight communities according to major vegetation. In each community, plots 4 ha (671 m long and 63 m wide) were established. Each plot was studied by walking the mid longitudinal line slowly, noting all birds heard or seen within 31 m on each side. Each plot was walked at least twice, usually on consecutive days. Elongated plots were used to fit narrow vegetational zones. The typical census plot entails many days of observation for each plot and was unsuitable in this study.*

*For each plot, the number of species recorded was the sum of all different species found on the three surveys. The number of individuals was the maximum number recorded for each species on any of the surveys.*

*Coefficients of similarity based on densities of each species were calculated for each community to compare various bird populations (Beals 1960).*

## Estimating Bird Numbers

Buckland ST, Anderson DR, Burnham KP, Laake JL. 1993. Distance sampling: estimating abundance of biological populations. New York: Chapman and Hall. 446 p.

Howe RW, Niemi GJ, Lewis SJ, Welsh DA. 1997. A standard method for monitoring songbird populations in the Great Lakes Region. *Passenger Pigeon* 59(3):183–94.

*This paper describes a very specific, standardized protocol for counting songbirds and other small diurnal bird species in the Great Lakes Region of northeastern North America and adjacent Canada. The authors made several modifications to the recommendations of Ralph and others (1995), in order to provide explicit directions for biologists in this region.*

Ralph CJ, Scott JM, editors. 1981. Estimating numbers of terrestrial birds. *Studies in Avian Biology* No 6. Lawrence (KS): Allen Press. 630 p.

*This book critically evaluates methods and assumptions used in data gathering and analysis. The authors suggest ways to increase the sophistication and accuracy of analytical and sampling methods. Diverse points of view are brought together in these proceedings. Topics include:*

- *Estimating relative abundance*
- *Estimating birds per unit area*
- *Comparison of methods*
- *Species variability*
- *Environmental influences*
- *Observer variability*
- *Sampling design*
- *Data analysis*

*The **Mark-Recapture** method has rarely been used by ornithologists for estimating population size. There are theoretical and practical problems in this technique.*

*The **Variable-Circular-Plot** method has been fully described by Buckland and others (1993). Basically, stations are established within a habitat at intervals along a transect or are scattered in such a manner as to minimize the probability of encountering the same bird at several stations. Each bird heard or seen during a fixed time period from each station is counted and the horizontal distance to its location estimated. The basal radius for each species is then determined as the distance from the stations where the density of birds first begins to decline. Finally the density of each species is determined from the total number of birds encountered within the circle radius,  $r$ , which is determined from the data.*

Ralph CJ, Geupel GR, Pyle P, Martin TE, DeSante DF. 1993. Handbook of field methods for monitoring landbirds. Albany (CA): USDA Forest Service, Pacific Southwest Research Station. Gen Tech Report PSW-GTR-144. 41 p.

Ralph CJ, Sauer JR, Droege S, eds. 1995. Monitoring bird populations by point counts. Albany (CA): USDA Forest Service, Pacific Southwest Research Station. Gen Tech Report PSW-GTR-149. 187 p.

USGS Patuxent Wildlife Research Center. 1999. Bird monitoring in North America. <[www.im.nbs.gov/birds.html](http://www.im.nbs.gov/birds.html)>. Accessed 2001 May 29.

## MAMMALS

Beacham TD, Krebs CJ. 1980. Pitfall versus live-trap enumeration of fluctuating populations in *Microtus townsendii*. *Journal of Mammalogy* 61:489–99.

Bell JT, Atterbury T. 1983. Renewable resources inventories for monitoring changes and trends. Corvallis (OR): College of Forestry, Oregon State University. 737 p.

*Authors review papers on monitoring a wide range of animals, including statistical methods for data analysis.*

Bookhout TA, editor. 1994. Research and management techniques for wildlife and habitats. 5<sup>th</sup> ed. Bethesda (MD): The Wildlife Society. 740 p.

*A general reference on a wide variety of techniques and analytical methods.*

Caughley G. 1977. Analysis of vertebrate populations. London: Wiley-Interscience. 234 p.

*Includes discussion on relative measures (indices), absolute abundance, and dispersal and mark-recapture methods.*

Davis DE, editor. 1982. Handbook of census method for terrestrial vertebrates. Boca Raton (FL): CRC Press. 397 p.

Tanner JT. 1978. Guide to the study of animal populations. Knoxville (TN): University of Tennessee Press. 186 p.

*An excellent guide to methods used for density and abundance measures, particularly mark-recapture methods.*

Williams DF, Braun SE. 1983. Comparison of pitfall and conventional traps for sampling small mammal populations. *Journal of Wildlife Management* 47:841–5.

Wilson DE, Cole FR, Nichols JD, Rudran R, Foster MS. 1996. *Measuring and monitoring biological diversity: standard methods for mammals*. Washington (DC): Smithsonian Institution Press. 409 p.

*Part of a series that details standard qualitative and quantitative methods for sampling biological diversity for several groups of plants and animals.*

## VEGETATION

Avery TE, Burkhardt HE. 1963. *Forest measurements*. 3<sup>rd</sup> ed. New York: McGraw-Hill. 331 p.

Barbour MG, Burk JH, Pitts WD. 1980. *Terrestrial plant ecology*. Menlo Park (CA): Benjamin-Cummings. 604 p.

Bonham CD. 1989. *Measurements for terrestrial vegetation*. New York: J Wiley. 338 p.

Canfield RH. 1941. Application of the line interception method in sampling range vegetation. *Journal of Forestry* 39:388–94.

Elzinga CL, Evenden AG, compilers. 1997. *Vegetation monitoring: an annotated bibliography*. Ogden (UT): USDA Forest Service, Intermountain Research Station. Gen Tech Report INT-GTR-352. 184 p.

Elzinga CL, Salzer DW, Willoughby JW. 1998. *Measuring and monitoring plant populations*. Denver: USDI Bureau of Land Management. 492 p.

Floyd DA, Anderson JE. 1987. A comparison of three methods for estimating plant cover. *Journal of Ecology* 75:221–8.

Goodall, DW. 1952. Some considerations in the use of point quadrats for the analysis of vegetation. *Australian Journal of Scientific Research* 5:1–41.

Grieg-Smith P. 1983. *Quantitative plant ecology*. Berkeley (CA): University of California Press. 256 p.

Max TA, Schreuder HT, Hans T, Hazard JW, Oswald DD, Teply J, Alegria J. 1996. *The Pacific Northwest region—vegetation and inventory monitoring system*. Portland (OR): USDA Forest Service, Pacific Northwest Research Station. Research Paper PNW-RP-493. 22 p.

Stohlgren TJ, Bull KA, Otsuki Y. 1998. Comparison of rangeland vegetation sampling techniques in the central grasslands. *Journal of Range Management* 51(2):164–72.

Storm GL, Ross AS. 1992. 1<sup>st</sup> ed. *Manual for monitoring vegetation on public lands in Mid-Atlantic United States*. University Park (PA): Pennsylvania Cooperative Fish and Wildlife Research Unit. 87 p.

USDI Bureau of Land Management. 1996. *Sampling vegetation attributes: interagency technical reference*. Denver: National Applied Resource Sciences Center. 172 p.

Van Horn M, Van Horn K. 1996. *Quantitative photomonitoring for restoration projects*. *Restoration and Management Notes* 14:30–4.

Wouters MA. 1992. *Monitoring vegetation for fire effects*. Australia: Department of Conservation and Natural Resources, Fire Management Branch. Research Report No 34. 71 p.

## FUELS

Agee JK. 1973. *Prescribed fire effects on physical and hydrological properties of mixed conifer forest floor and soil*. Davis (CA): Water Resources Center, University of California, Davis. Contribution Report 143. 57 p.

Anderson HE. 1978. *Graphic aids for field calculation of dead, down forest fuels*. Ogden (UT): USDA Forest Service, Intermountain Forest and Range Experiment Station. Gen Tech Report INT-45. 19 p.

Anderson HE. 1982. *Aids to determining fuel models for estimating fire behavior*. Ogden (UT): USDA Forest Service, Intermountain Forest and Range Experiment Station. Gen Tech Report INT-122. 22 p.

Brown JK. 1974. *Handbook for inventorying downed material*. Ogden (UT): USDA Forest Service, Intermountain Forest and Range Experiment Station. Gen Tech Report INT-16. 23 p.

Brown JK, Marsden MA. 1976. *Estimating fuel weights of grasses, forbs, and small woody plants*. Ogden (UT): USDA Forest Service, Intermountain Forest and Range Experiment Station. Research Note INT-210. 11 p.

Brown JK, Oberhue RD, Johnston CM. 1982. *Handbook for inventorying surface fuels and biomass in the Interior West*. Ogden (UT): USDA Forest Service, Intermountain Forest and Range Experiment Station. Gen Tech Report INT-129. 48 p.

Catchpole WR, Wheeler CJ. 1992. *Estimating plant biomass: a review of techniques*. *Australian Journal of Ecology* 17:121–31.

*An excellent overview of the various methods of estimating biomass.*

Chambers JC, Brown RW. 1983. *Methods for vegetation sampling and analysis on revegetated mined lands*. Ogden (UT):



- USDA Forest Service, Intermountain Forest and Range Experiment Station. Gen Tech Report INT-151. 37 p.
- Evans RA, Jones MB. 1958. Plant height times ground cover versus clipped samples for estimating forage production. *Agronomy Journal* 50:504–6.
- Green LR. 1981. Burning by prescription in chaparral. Albany (CA): USDA Forest Service, Pacific Southwest Forest and Range Experiment Station. Gen Tech Report PSW-51. 36 p.
- Hutchings SS, Schmautz JE. 1969. A field test of the relative-weight estimate method for determining herbage production. *Journal of Range Management* 22(6):408–11.
- Martin RE, Frewing DW, McClanhan JL. 1981. Average biomass of four Northwest shrubs by fuel size class and crown cover. Portland (OR): USDA Forest Service, Pacific Northwest Forest and Range Experiment Station. Research Note PNW-374. 6 p.
- Means JE, Hansen HA, Koerper GJ, Alaback PB, Klopsch MW. 1994. Software for computing plant biomass—BIOPAK user's guide. Portland (OR): USDA Forest Service, Pacific Northwest Forest and Range Experiment Station. Gen Tech Report PNW-GTR-374. 184 p.
- BIOPAK is a menu-driven package of computer programs for IBM PC family or fully compatible computers that calculates the biomass, area, height, length or volume of plant components, e.g., leaves, branches, crown.*
- Meeuwig RO. 1981. Point sampling for shrub biomass. *In*: Lund HG, Caballero RH, Hamre RH, Driscoll RS, Bonner W, technical coordinators. Arid land resource inventories: developing cost effective methods: proceedings; 1980 November 30–December 6; La Paz, Mexico. Washington (DC): USDA Forest Service. Gen Tech Report WO-28. p 323–6.
- The author compares estimates of shrub production using point intercept transects and variable plots with estimates using 1 m<sup>2</sup> plots.*
- Mitchell JE, Bartling PNS, O'Brien R. 1982. Understory cover-biomass relationships in the front range ponderosa pine zone. Fort Collins (CO): USDA Forest Service, Rocky Mountain Forest and Range Experiment Station. Research Note RM-471. 5 p.
- Ohmann LF, Grigal DF, Rogers LL. 1981. Estimating plant biomass for undergrowth species of northeastern Minnesota. St. Paul (MN): USDA Forest Service, North Central Forest Experiment Station. Gen Tech Report NC-61. 10 p.
- Olson CM, Martin RE. 1981. Estimating biomass of shrubs and forbs in central Washington Douglas fir stands. Portland (OR): USDA Forest Service, Pacific Northwest Forest and Range Experiment Station. Research Note PNW-380. 6 p.
- Parsons DJ, Stohlgren TJ. 1986. Long-term chaparral research conference in sequoia national park. *In*: DeVries JJ, editor.; chaparral ecosystems research conference: proceedings; 1985 May 16–17; Santa Barbara, CA. Davis (CA): California Water Resources Center Report No 62. p 107–14.
- Pechanec JF, Pickford GD. 1937. Weight estimate method for the determination of range or pasture production. *Journal of the American Society of Agronomy* 29:894–904.
- Schlesinger WH, Gill DS. 1978. Demographic studies of the chaparral shrub, *Ceanothus megacarpus*, in the Santa Ynez Mountains, California. *Ecology* 59:1256–63.
- Stahl G. 1998. Transect relascope sampling—a method for the quantification of coarse woody debris. *Forest Science* 44:58–63.
- Stohlgren TJ, Stephenson NL, Parsons DJ, Rundel RW. 1982. Using stem basal area to determine biomass and stand structure in chamise chaparral. *In*: USDA Forest Service. symposium on dynamics and management of Mediterranean-type ecosystems: proceedings; 1981 June 22–26; San Diego, CA. Berkeley (CA): USDA Forest Service, Pacific Southwest Forest and Range Experiment Station. Gen Tech Report PSW-58. p 634.
- Tucker CJ. 1980. A critical review of remote sensing and other methods for non-destructive estimation of standing crop biomass. *Grass and Forage Science* 35:177–82.
- van Wagtenonk JW, Benedict JM, Sydoriak WM. 1996. Physical properties of woody fuel particles of Sierra Nevada conifers. *International Journal of Wildland Fire* 6(3):117–123.
- van Wagtenonk JW, Benedict JM, Sydoriak WM. 1998a. Fuel bed characteristics of Sierra Nevada conifers. *Western Journal of Applied Forestry* 13(3):73–84.
- van Wagtenonk JW, Sydoriak WM, Benedict JM. 1998b. Heat content variation of Sierra Nevada conifers. *International Journal Wildland Fire* 8(3):147–158.
- van Wagtenonk JW, Sydoriak WM. 1985. Correlation of woody and duff moisture contents. *In*: Donoghue LR, Martin RE, editors. Weather—the drive train connecting the solar engine to forest ecosystems. The Eighth Conference on Fire and Forest Meteorology: proceedings; 1985 April 29–May 2; Detroit, MI. Bethesda (MD): Society of American Foresters. p 186–91.
- Wakimoto RH. 1977. Chaparral growth and fuel assessment in Southern California. *In*: Mooney HA, Conrad CE, technical coordinators. Symposium on the environmental consequences of fire and fuel management in Mediterranean ecosystems: proceedings; 1977 August 1–5; Palo Alto, CA. Washington (DC): USDA Forest Service. Gen Tech Report WO-3. p 412–8.

## ADAPTIVE MANAGEMENT

- Brunner RD, Clark TW. 1997. A practice-based approach to ecosystem management. *Conservation Biology* 11:48–58.
- Gunderson LH, Holling CS, Light SS, editors. 1995. *Barriers and bridges to the renewal of ecosystems and institutions*. New York: Columbia University Press. 593 p.
- Holling CS. 1978. *Adaptive environmental assessment and management*. London: John Wiley. 377 p.
- Johnson BL. 1999. The role of adaptive management as an operational approach for resource management agencies. *Conservation Ecology* 13(2):8. <[www.consecol.org/vol3/iss2/art8](http://www.consecol.org/vol3/iss2/art8)>. Accessed 2001 May 29.
- Lee KN. 1999. Appraising adaptive management. *Conservation Ecology* 3(2):3. <[www.consecol.org/vol3/iss2/art3](http://www.consecol.org/vol3/iss2/art3)>. Accessed 2001 May 29.
- Margoluis R, Salafsky N. 1998. *Measures of success: designing, managing, and monitoring conservation and development projects*. Washington (DC): Island Press. 362 p.
- McLain RJ, Lee RG. 1996. Adaptive management: promises and pitfalls. *Environmental Management* 20:437–48.
- Ringold PL, Alegria J, Czaplewski RL, Mulder BS, Tolle T, Burnett K. 1996. Adaptive monitoring design for ecosystem management. *Ecological Applications* 6:745–7.
- Schindler DW. 1990. Experimental perturbations of whole lake ecosystems as tests of hypotheses concerning ecosystem structure and function. *Oikos* 57:25–41.
- Schindler B, Cheek KA, Stankey G. 1999. *Monitoring and evaluating citizen-agency interactions: a framework developed for adaptive management*. Portland (OR): U.S. Department of Agriculture, Forest Service, Pacific Northwest Research Station. Gen Tech Report PNW-GTR-452. 38 p.
- Schroeder RL, Keller ME. 1990. Setting objectives—a prerequisite of ecosystem management. *Ecosystem Management: Rare Species and Significant Habitats*, New York State Museum Bulletin 471:1–4.
- Sit V, Taylor B, editors. 1998. *Statistical methods for adaptive management studies*. Lands Management Handbook No 42. Victoria (BC): Ministry of Forests, Research Branch. <[www.for.gov.bc.ca/hfd/pubs/docs/lmh/lmh42.htm](http://www.for.gov.bc.ca/hfd/pubs/docs/lmh/lmh42.htm)>. Accessed 2001 May 29.
- Taylor B, Kremsater L, Ellis R. 1997. *Adaptive management of forests in British Columbia*. Victoria (BC): Ministry of Forests, Forests Practices Branch. 103 p. <[www.for.gov.bc.ca/hfd/pubs/docs/Sil/Sil426.htm](http://www.for.gov.bc.ca/hfd/pubs/docs/Sil/Sil426.htm)>. Accessed 2001 May 29.
- USDI, Glen Canyon adaptive management program. 2000. *Glen Canyon Adaptive Management Program*. <[www.uc.usbr.gov/amp](http://www.uc.usbr.gov/amp)>. Accessed 2001 May 29.
- Walters CJ. 1986. *Adaptive management of renewable resources*. New York: McGraw-Hill. 374 p.
- Walters CJ, Holling CS. 1990. Large-scale management experiments and learning by doing. *Ecology* 71:2060–8.

## Vegetative Keys

---

Most traditional floras require users to have the flowers of the plant in order to use their dichotomous keys. However, you will often encounter plants without flowers and need some way to identify them. The following list has been generated to help you in these situations. In addition, there are many Internet sites that contain images of plants and other information useful during plant identification. Visit Lampinen (1998a) for a list of flora information on the Internet, and Lampinen (1998b) for a list of Internet sites with plant images.

When you collect non-flowering plants for identification, keep in mind that the ultimate identification of that plant may require information on when and where you collected it, the microclimate in which it grew, whether the plant is annual, biennial or perennial, its height, and/or the structure of its underground parts (e.g., does it have stolons or rhizomes? Is there a bulb?). In other words, take careful notes on any available field clues. **Note: Consider any determination that you make using only vegetative characters as tentative until you can make a comparison with a flowering specimen.**

Aiken SG, Dallwitz MJ, McJannet CL, Consaul LL. 1998. 2<sup>nd</sup> version. *Festuca of North America: descriptions, illustrations, identification, and information retrieval*. <[biodiversity.uno.edu/delta/festuca/index.htm](http://biodiversity.uno.edu/delta/festuca/index.htm)>. Accessed 2001 May 29.

*Requires downloading INTKEY version 5, available at: <[www.rbghkew.org.uk/herbarium/gramineae/wrldgr.htm](http://www.rbghkew.org.uk/herbarium/gramineae/wrldgr.htm)>. Accessed 2001 May 29.*

Aikman JM, Hayden A. 1938. *Iowa trees in winter*. Ames (IA): Iowa State College, Extension Service. Extension Circular 246. 72 p.

Allen CM. 1992. 2<sup>nd</sup> ed. *Grasses of Louisiana*. Eunice (LA): Cajun Prairie Habitat Preservation Society. 320 p.

Barfield T, Soden D. 1993. *A key to aid identification of a selection of grasses, including the majority of grassland species, by vegetative characters*. Peterborough (UK): English Nature. 7 p.

*Useful for identifying non-native grassland species from Europe.*

Barnard CM, Potter LD. 1984. 1<sup>st</sup> ed. *New Mexico grasses: a vegetative key*. Albuquerque: University of New Mexico Press. 157 p.

Bell CR, Lindsey AH. 1990. *Fall color and woodland harvests: a guide to the more colorful fall leaves and fruits of the eastern forests*. Chapel Hill (NC): Laurel Hill Press. 184 p.

Bell CR, Lindsey AH. 1991. *Fall color finder: a pocket guide to autumn leaves*. Chapel Hill (NC): Laurel Hill Press. 63 p.

Bennett HW, Hammons RO, Weissinger WR. 1950. The identification of 76 grasses by vegetative morphology. *Mississippi State College Agricultural Experiment Station Technical Bulletin* 31:1–108.

*Covers Mississippi grasses.*

Best KF, Budd AC. 1964. *Common weeds of the Canadian prairies: aids to identification by vegetative characters*. Ottawa: Department of Agriculture, Research Branch. Publication 1136. 71 p.

Blakeslee AF, Jarvis CD, Harrar ES. 1972. Rev. ed. *New England trees in winter*. New York: Dover. 264 p.

Bradley K, Hagood S. 2001. *Weed identification guide*. Blacksburg (VA): Virginia Polytechnic Institute and State University; Department of Plant Pathology, Physiology and Weed Science. <[www.ppws.vt.edu/weedindex.htm](http://www.ppws.vt.edu/weedindex.htm)>. Accessed 2001 May 22.

*For common weeds and weed seedlings found throughout Virginia and the Southeastern U.S. Contains a non-native grass identification key.*

British Columbia Ministry of Forests. 1998. *Knowing grasses and grasslike plants in British Columbia: self-study guide to identification of selected species mostly by vegetative characteristics*. Victoria (BC): Ministry of Forests Forest Practices Branch, Range Section. 127 p.

Brown CL, Kirkman LK. 1990. *Trees of Georgia and adjacent states*. Portland (OR): Timber Press. 292 p.

Brown L. 1997. *Reissue. Wildflowers and winter weeds*. New York: Norton. 252 p.

*Reissue of the excellent book "Weeds in Winter."*

Buell MF, Cain RL, Ownbey GB. 1968. 2<sup>nd</sup> ed. *Vegetative key to the woody plants of Itasca State Park, Minnesota*. Minneapolis: Dept. of Botany, University of Minnesota. 32 p.

Campbell CS, Hyland F, Campbell MLF. 1978. Rev. ed. *Winter keys to woody plants of Maine*. Orono (ME): University of Maine Press. 52 p.

- Carrier L. 1917. The identification of grasses by their vegetative characters. Washington (DC): Government Printing Office. 30 p.
- Carter JL, Leggitt M. 1988. Trees and shrubs of Colorado. Boulder (CO): Johnson Books. 144 p.
- Carter JL, Leggitt M, Dennis B, Underwood B. 1997. Trees and shrubs of New Mexico. Boulder (CO): Mimbres. 520 p.
- These two titles by Carter are not strictly vegetative keys, but use vegetative characteristics primarily and floral characteristics only when necessary.*
- Chancellor RJ. 1966. The identification of weed seedlings of farm and garden. Oxford: Blackwell Scientific Publications. 88 p.
- Cistone JN. 1963. Vegetative key to the vascular plants of Waldo E. Steidtmann Wildlife Sanctuary [thesis]. Bowling Green (OH): Bowling Green State University. 61 p.
- Clark GT, Clark TP. 1981. Winter twigs of Arkansas: a field guide to deciduous woody plants. Little Rock (AR): Rose Publishing. 93 p.
- Clarke SE, Campbell JA, Shevkenek W. 1950. The identification of certain native and naturalized grasses by their vegetative characters. Ottawa: Canadian Department of Agriculture. Technical Bulletin No 50. 129 p.
- Cope EA. 2001. Muenscher's keys to woody plants: an expanded guide to native and cultivated species. Ithaca (NY): Cornell University Press. 368 p.
- A major expansion and revision of W. C. Muenscher's popular reference work.*
- Copple RF, Aldous AE. 1932. The identification of certain native and naturalized grasses by their vegetative characters. Manhattan (KA): Agricultural Experiment Station, Kansas State College of Agriculture and Applied Science. Technical bulletin 32. 73 p.
- Copple, RF, Pase CP. 1978. A vegetative key to some common Arizona range grasses. Fort Collins (CO): USDA Forest Service, Rocky Mountain Forest and Range Experiment Station. Gen Tech Report RM-53. 105 p.
- Core EL, Ammons NP. 1946. Woody plants of West Virginia in winter condition. Morgantown (WV): West Virginia University. 124 p.
- Core EL, Ammons NP. 1958. Woody plants in winter; a manual of common trees and shrubs in winter in the northeastern United States and southeastern Canada. Pittsburgh: Boxwood Press. 218 p.
- Damman AWH. 1963. Key to the Carex species of Newfoundland by vegetative characteristics. Ottawa: Department of Forestry. Publication No 1017. 39 p.
- Davis KC. 1895. Key to the woody plants of Mower County, in Southern Minnesota, in their winter condition. Austin (MN). 5 p.
- Dierker WW. 1978. Grasses and grasslike plants of cultivated fields and pastures in Missouri: identification by vegetative characters. Columbia (MO): University of Missouri, College of Agriculture. 56 p.
- Dole JW, Rose BB. 1996. An amateur botanist's identification manual for the shrubs and trees of the southern California coastal region and mountains. North Hills (CA): Foot-loose Press. 184 p.
- Dutton BE. 1996. Key to the genera of woody plants. <[www.bbg.org/research/nymf/key/index.html](http://www.bbg.org/research/nymf/key/index.html)>. Accessed 2001 May 29.
- Written to accommodate the variation found in those species occurring only in the New York Metropolitan region.*
- Farrar JL. 1995. Trees of the northern United States and Canada. Ames (IA): Iowa State University Press. 512 p.
- Covers upper United States (Virginia to northern California) and Canada.*
- Franklin JF. 1961. A guide to seedling identification for 25 conifers of the Pacific Northwest. Portland (OR): USDA Forest Service, Pacific Northwest Forest and Range Experiment Station. 31 p.
- Gates FC. 1940. Winter twigs: the identification of Kansas woody plants by their twigs. Manhattan (KA): Kansas Academy of Science. 31 p.
- Gilkey HM, Packard PL. 1962. Winter twigs; a wintertime key to deciduous trees and shrubs of northwestern Oregon and western Washington. Corvallis (OR): Oregon State University Press. Oregon State monographs. Studies in Botany: No 12. 109 p.
- Graves AH. 1955. Winter key to the woody plants of the northeastern United States and adjacent Canada (native and exotic species). (CT): Wallingford. 33 p.
- Graves AH. 1992. Rev. ed. Illustrated guide to trees and shrubs: a guide to the woody plants of the northeastern United States, native, naturalized, and commonly cultivated exotic kinds, including both summer and winter characters. Mineola (NY): Dover. 282 p.
- Gresham-Barlow School District. 1999. Leaves of native vines, shrubs and trees: Willamette Valley, Cascade Mts, Columbia River Gorge. <[ghs.gresham.k12.or.us/science/ps/nature/leaves/lvs.htm](http://ghs.gresham.k12.or.us/science/ps/nature/leaves/lvs.htm)>. Accessed 2001 May 29.

- Grimm WC, Kartesz J. 1998. The illustrated book of trees: with keys for summer and winter identification. Harrisburg (PA): Stackpole. 544 p.
- Grimm WC, Kartesz JT. 1993. Rev. ed. The illustrated book of wildflowers and shrubs: the comprehensive field guide to more than 1,300 plants of eastern North America. Harrisburg (PA): Stackpole Books. 672 p.
- Contains a shrub vegetative key.*
- Hallsten GP. 1984. A vegetative key to the grasses of Wyoming [thesis]. Laramie (WY): University of Wyoming. 638 p.
- Harlow WM. 1959. Fruit key and twig key to trees and shrubs: fruit key to northeastern trees; twig key to the deciduous woody plants of eastern North America. New York: Dover Publications. 56 p.
- Harrington HD. 1940. Keys to the woody plants of Iowa in vegetative condition. University of Iowa Studies in Natural History 17(9): 375–489.
- Harrington HD, Durrell LW. 1944. Key to some Colorado grasses in vegetative condition: containing drawings and descriptions of 119 species, including almost all the common ones and those of economic importance. Fort Collins (CO): Colorado Agricultural Experiment Station, Colorado State College. Technical Bulletin 33. 86 p.
- Hayes DW, Garrison GA. 1960. Key to important woody plants of eastern Oregon and Washington. Washington (DC): USDA Forest Service. Agricultural Handbook No 148. 227 p.
- Hitchcock AS. 1893. Key to Kansas trees in their winter condition. Manhattan (KA): State Board of Agriculture. Reprinted from the Biennial Report of the Kansas State Board of Agriculture, 1893. Bound with Opuscula botanica (12). 6 p.
- Hitchcock CL. 1937. A key to the grasses of Montana, based upon vegetative characters. St. Louis: Swift. 30 p.
- Hitchcock CL. 1969. Key to the grasses of the Pacific Northwest based upon vegetative characters. *In*: Hitchcock CL, Cronquist A, Ownbey M, Thompson JW. Vascular Plants of the Pacific Northwest. Seattle: University of Washington Press. 1:384–438.
- Hunter CG. 1995. Autumn leaves and winter berries in Arkansas. Little Rock (AR): Ozark Society Foundation. 52 p.
- Huntington AO. 1910. Studies of trees in winter; a description of the deciduous trees of northeastern America. Boston: D Estes. 198 p.
- Jensen E, Ross CR. 1994. Trees to know in Oregon. Corvallis (OR): Oregon State University Extension Service; Salem (OR): Oregon Dept. of Forestry. EC-1450. 128 p.
- Keim FD, Beadle GW, Frolik AL. 1932. The identification of the more important prairie hay grasses of Nebraska by their vegetative characters. Nebraska Agricultural Experiment Station Research Bulletin 65.
- Khodayari K, Oliver LR. 1983. A vegetative seedling key for common monocots. Weed identification for purposes of control, Arkansas. Arkansas Farm Research - Arkansas Agricultural Experiment Station 32(4):9.
- Knobel E. 1973. Identify trees and shrubs by their leaves: a guide to trees and shrubs native to the Northeast. New York: Dover Publications. 47 p.
- Kummer AP. 1951. Weed seedlings. Chicago: University of Chicago Press. 321 p.
- Leopold DJ, McComb WC, Muller RN. Trees of the central hardwood forests of North America: an identification and cultivation guide. Portland (OR): Timber Press. 509 p.
- Encompassing part or all of 28 eastern U.S. states and two Canadian provinces.*
- Levine C. 1995. A guide to wildflowers in winter: herbaceous plants of northeastern North America. New Haven: Yale University Press. 329 p.
- Lewis JF. 1931. A key for the identification of twenty-one selected genera of trees and shrubs in winter. 24 p.
- Deals with Pennsylvania genera.*
- Littlefield B, Jensen E. 1996. Trees of the Pacific Northwest. Oregon State University. <[www.orst.edu/instruction/for241/index.html](http://www.orst.edu/instruction/for241/index.html)>. Accessed 2001 May 29.
- Looman J. 1982. Repr and enl. Prairie grasses identified and described by vegetative characters. Ottawa: Department of Agriculture. Canadian Department of Agriculture Publication 1413. 244 p.
- Maisenhelder LC. 1969. Identifying juvenile seedlings in southern hardwood forests. New Orleans (LA): USDA Forest Service Southern Forest Experiment Station. Research Paper SO-47. 77 p.
- Manitoba Agriculture and the Crop Protection Section of Saskatchewan Agriculture. 1986. Rev. ed. Weed seedling identification guide. Saskatchewan: Manitoba Agriculture. 25 p.
- May M. 1960. Key to the major grasses of the Big Horn Mountains, based on vegetative characters. Laramie (WY): University of Wyoming, Agricultural Experiment Station. Bulletin 371. 44 p.
- McKean WT (editor). 1976. Winter guide to central Rocky Mountain shrubs, with summer key. Denver: State of Colorado, Game and Fish Department. 273 p.

- Meacham CA. 1999. MEKA version 3.0. <www.mip.berkeley.edu/meka/meka.html>. Accessed 2001 May 29.
- An electronic key that allows the user to select plant characteristics present in the specimen from a list of possibilities. As the character states are scored, MEKA eliminates taxa that no longer match the list of scored character states. The download includes the following databases: Key to Wetland Woody Plants of North America; Key to Angiosperm (Flowering Plant) Families of the World; and Key to Woody Plant Families of the Neotropics.*
- Miller D. 1989. Winter weed finder: a guide to dry plants in winter. Rochester (NY): Nature Study Guild. 62 p.
- Montgomery JD, Fairbrothers DE. 1992. New Jersey ferns and fern allies. New Brunswick (NJ): Rutgers University Press. 293 p.
- Immature ferns may be identified in this book using vegetative parts.*
- Morden C, Caraway V. No date. Vegetative key to the common grasses of Hawaii. Unpublished. 22 p.
- Morris MS, Schmaltz JE, Stickney PF. 1962. Winter field key to the native shrubs of Montana. Washington (DC): Montana Forest and Conservation Experiment Station and Intermountain Forest and Range Experiment Station. 70 p.
- Moyle JB. 1953. 5<sup>th</sup> ed. A field key to the common non-woody flowering plants and ferns of Minnesota, based largely upon vegetative characters. Minneapolis (MN): Burgess. 72 p.
- Munson RH. 1973. Vegetative key to selected dwarf and slow-growing conifers [thesis]. Ithaca (NY): Cornell University Press.
- Musil AF. 1950. Identification of Brassicas by seedling growth or later vegetative stages. Washington (DC): United States Department of Agriculture. Series Circular No 857. 26 p.
- Norton JBS. 1930. Maryland grasses. Maryland Agricultural Experiment Station Bulletin 323: 314-323.
- Nowosad FS, Newton Swales DE, Dore WG. 1936. The identification of certain native and naturalized hay and pasture grasses by their vegetative characters. Quebec (Canada): Macdonald College. Technical Bulletin No 16. 74 p.
- Ogden EC. 1981. Field guide to northeastern ferns. Albany (NY): University of the State of New York, State Education Department. New York State Museum Bulletin No 444. 122 p.
- Includes random-access keys.*
- Parks CG, Bull EL, Torgersen TR. 1997. Field guide for the identification of snags and logs in the Interior Columbia River Basin. Portland (OR): USDA Forest Service, Pacific Northwest Research Station. Gen Tech Report PNW-GTR-390. 40 p.
- Patterson J, Stevenson G. 1977. Native trees of the Bahamas. Hope Town, Abaco, Bahamas: J. Patterson. 128 p.
- Pechanec JF. 1936. The identification of grasses on the upper Snake River Plains by their vegetative characters. Ecology 17:479-90.
- Petrides GA. 1998. 2<sup>nd</sup> ed. A field guide to trees and shrubs: northeastern and north-central United States and southeastern and south-central Canada. Boston: Houghton Mifflin. 428 p.
- Petrides GA, Petrides O. 1996. Trees of the California Sierra Nevada: a new and simple way to identify and enjoy some of the world's most beautiful and impressive forest trees in a mountain setting of incomparable majesty. Williamston (MI): Explorer Press. 79 p.
- Petrides GA, Petrides O. 1998a. Trees of the Pacific Northwest: including all trees that grow wild in Oregon, Washington, Idaho, Montana, British Columbia, W. Alberta, Yukon, and Alaska: a new and simple way to identify and enjoy some of the world's most beautiful and impressive forest trees. Williamston (MI): Explorer Press. 103 p.
- Petrides GA, Petrides O. 1998b. 1<sup>st</sup> ed., exp. A field guide to western trees: western United States and Canada. Boston: Houghton Mifflin. 428 p.
- Petrides GA, Petrides O. 1999. 1<sup>st</sup> ed., exp. Trees of the Rocky Mountains: including all trees growing wild from Alaska and Yukon to Arizona and west Texas. Williamston (MI): Explorer Press. 104 p.
- Petrides GA, Petrides O. 2000. Trees of the American Southwest and adjacent Mexico: including all the trees that grow wild in Southeast California, South Nevada, Arizona, New Mexico, West Texas and adjacent Mexico. Williamston (MI): Explorer Press. 111 p.
- Petrides GA, Wehr J, Peterson RT. 1998. 1<sup>st</sup> ed., exp. A field guide to eastern trees: eastern United States and Canada, including the Midwest. Boston: Houghton Mifflin. 424 p.
- Phillips CE. 1962. Some grasses of the Northeast: a key to their identification by vegetative characters. Newark (DE): University of Delaware, Agricultural Experiment Station. Field Manual No 2. 77 p.
- Phillips CE. 1975. Trees of Delaware and the Eastern Shore: a guide to their identification in winter. Newark (DE): CE Phillips. 31 p.
- Popham RA. 1941. A key to the genera of the Compositales of northeastern North America (based on vegetative and floral characters). Columbus (OH): The Ohio State University. 129 p.

- Preston RJ, Jr, Wright VG. 1981. Identification of southeastern trees in winter. Raleigh (NC): North Carolina Agricultural Extension Service. 113 p.
- Randall WR, Keniston RF, Bever DN, Jensen EC. 1994. Rev ed. Manual of Oregon trees and shrubs. Corvallis (OR): Oregon State University Books. 305 p.
- Roberts JC. 1993. Season of promise: wild plants in winter, northeastern United States. Athens (OH): Ohio State University Press. 308 p.
- Royal Botanic Gardens, Kew. 1999. World grasses database. <[www.rbgekew.org.uk/herbarium/gramineae/wrldgr.htm](http://www.rbgekew.org.uk/herbarium/gramineae/wrldgr.htm)>. Accessed 2001 May 29.
- Requires downloading INTKEY version 5, available at the above website. North American species are incomplete; however, work is being done to add to them.*
- Sargent FL. 1903. Key to common deciduous trees in winter: and key to common woods. Cambridge (MA): FL Sargent. 11 p.
- Scotfield D. 1998. Ferns: of fern forest and south Florida. <[www.cassiakeyensis.com/sofl\\_plants/fern\\_index.html](http://www.cassiakeyensis.com/sofl_plants/fern_index.html)>. Accessed 2001 May 29.
- Scurlock JP. 1987. Native trees and shrubs of the Florida Keys: A Field Guide. Pittsburg: Laurel Press. 220 p.
- Seiler JR, John A. Peterson. 2001. Dendrology at Virginia Tech. Blacksburg (VA): Virginia Polytechnic Institute and State University, Department of Forestry. <[www.cnr.vt.edu/dendro/dendrology/dendrohome.htm](http://www.cnr.vt.edu/dendro/dendrology/dendrohome.htm)>. Accessed 2001 May 29.
- This website contains twig and leaf keys as well as identification fact sheets on 470 species of woody plants.*
- Severin C. 1980. A key to the woody plants of southeastern Minnesota: based on vegetative structures. Winona (MN): St. Mary's College Press. 143 p.
- Shaw RB, Dodd JD. 1976. Vegetative key to the Compositae of the Rio Grande Plain of Texas. College Station (TX): Texas Agricultural Experiment Station, Texas A & M University. 31 p.
- Smith HV. 1973. Winter wildflowers. Ann Arbor (MI): Michigan Botanical Club. Special Publication No 2. 64 p.
- Southern Weed Science Society. 2000. Weeds of the United States and Canada [CD-ROM]. Champaign (IL): Southern Weed Science Society. <[www.thundersnow.com/weedid-frameset.htm](http://www.thundersnow.com/weedid-frameset.htm)>. Accessed 2001 May 29.
- Steward AN, Dennis LJ, Gilkey HM. 1960. Aquatic plants of the Pacific Northwest, with vegetative keys. Corvallis (OR): Oregon State College. Oregon State Monographs. Studies in Botany No 11. 184 p.
- Storey A. 1935. A key to the genera of vines, wild or cultivated, out of doors in the northeastern United States based on vegetative characters [thesis]. Washington (DC): George Washington University. 13 p.
- Stuart JD, Sawyer JO. 2001. Trees and shrubs of California. Berkeley (CA): University of California Press. California Natural History Guides No 62. 479 p.
- Stucky JM, Monaco TJ, Worsham AD. 1980. Identifying seedling and mature weeds common in the southeastern United States. Raleigh (NC): North Carolina Agricultural Research Service, North Carolina Agricultural Extension Service. 197 p.
- Sutherland DM. 1975. A vegetative key to Nebraska grasses. *In*: Wali MK, editor. Prairie: a multiple view. Grand Forks (ND): University of North Dakota Press. p 283–316.
- Sutherland DM. 1984. Vegetative key to grasses of the Sand Hills region of Nebraska. Transactions of the Nebraska Academy of Sciences and Affiliated Societies 12:23-60.
- Swink F, Wilhelm G. 1994. Plants of the Chicago region. 4<sup>th</sup> ed. Indianapolis: Indiana Academy of Sciences. 921 p.
- Includes mostly vegetative keys in the family keys.*
- Symonds GWD. 1973a. The tree identification book: a new method for the practical identification and recognition of trees. New York: William Morrow. 272 p.
- Symonds GWD. 1973b. The shrub identification book: the visual method for the practical identification of shrubs, including woody vines and ground covers. New York: William Morrow. 379 p.
- Taylor CA. 1955. Trees and shrubs of Brookings, SD: a key based on vegetative characters. Brookings (SD): South Dakota State College. 37 p.
- Thomas WW. 1982. Identification of the species of Carex in Michigan's upland deciduous forests; a key stressing vegetative features. The Michigan Botanist 21:131–9.
- Trelease W. 1967. 3<sup>rd</sup> ed. Winter botany. New York: Dover. 396 p.
- Turner RM, Busman CL. 1984. Vegetative key for identification of the woody legumes of the Sonoran Desert region. Desert Plants 6(4):189-202.
- Uva RH, Neal JC, DiTomaso JM. 1997. Weeds of the Northeast. Ithaca (NY): Comstock Publishing Associates, Cornell University Press. 416 p.

- Viereck LA, Elbert LL Jr. 1986. Alaska trees and shrubs. Fairbanks (AK): University of Alaska Press. Agriculture Handbook No 410. 265 p.
- Watts MT. 1991. Tree finder: a manual for the identification of trees by their leaves. Rochester (NY): Nature Study Guild. 62 p.
- Watts MT, Watts T. 1970. Winter tree finder. Rochester (NY): Nature Study Guild. 62 p.
- Watts MT, Watts T. 1974. Desert tree finder: a manual for identifying desert trees of Arizona, California, New Mexico. Rochester (NY): Nature Study Guild. 62 p.
- Watts T. 1972. Rocky Mountain tree finder: a manual for identifying Rocky Mountain trees. Rochester (NY): Nature Study Guild. 62 p.
- Watts T. 1973. Pacific Coast tree finder: a manual for identifying Pacific Coast trees. Rochester (NY): Nature Study Guild. 62 p.
- Weishaupt CG. 1985. A descriptive key to the grasses of Ohio based on vegetative characters. Columbus (OH): College of Biological Sciences, Ohio State University. Bulletin of the Ohio Biological Survey 7:1. 99 p.
- Whitson T. 1996. 5<sup>th</sup> ed. Weeds of the west. Laramie (WY): University of Wyoming. 630 p.
- Wiegand KM, Foxworthy FW. 1908. 3<sup>rd</sup> ed. A key to the genera of woody plants in winter: including those with representatives found growing wild or in cultivation within New York State. Ithaca (NY): New York State. 33 p.
- Wray P, Vitosh M, Iles J, Quinn T. 1998. Identification of common trees of Iowa—an interactive key.  
<[www.exnet.iastate.edu/Pages/tree/](http://www.exnet.iastate.edu/Pages/tree/)>. Accessed 2001 May 29.
- XID Services. 1967–1992. Various titles of electronic keys.  
<[www.xidservices.com/](http://www.xidservices.com/)>. Accessed 2001 May 29.

*The various titles include: A guide to selected weeds of Oregon (1985) and supplement (1989); An illustrated guide to Arizona weeds (1990); California growers weed identification handbook (1992); Common weeds of the United States (1971); Field guide to the common weeds of Kansas (1983); Nebraska weeds (1979); Northwest weeds (1990); Ontario weeds (1992); South Dakota weeds (1967); Southern Weed Science Society weed ID guide (1993); Weeds and poisonous plants of Wyoming and Utah (1987); Weeds of Alberta (1983); Weeds of Colorado (1983); Weeds of Eastern Washington and adjacent areas (1972); Weeds of Kentucky and adjacent states (1991); Weeds of the north central states (1981); Weeds of the west (1992); California (682 species); Colorado (468 species); Iowa (370 species); Kansas (480 species); New Mexico (508 species); Pacific Northwest (396 species).*





# Glossary of Terms

---

**Abundance.** The relative number of individuals of a species in a given area.

**Accuracy.** The closeness of a measurement to the true value. An accurate estimator will have a small amount of bias. See **Bias**.

**Adult.** See **Mature**.

**Aerial Cover.** The area covered by a vertical projection of all aboveground plant parts, living or dead, onto the ground; also called foliar cover. This is the type of cover measured by the default FMH point intercept method. See **Basal Cover**, **Cover**.

**Alien Species.** See **Non-native Species**.

**Anemometer.** An instrument for measuring the force or velocity of the wind; a wind gauge.

**Annual.** Plant species that complete their life cycle within a single growing season. Compare to **Perennial**, **Biennial**.

**Aspect.** The direction toward which a slope faces, in relation to the points of the compass.

**Association, FGDC.** The finest level of the NSDI classification standard. An association is a uniform group of vegetation that shares one or more diagnostic (dominant, differential, indicator, or character) overstory and understory species. These elements occur as repeatable patterns of assemblages across the landscape, and are generally found under similar habitat conditions. (An association refers to existing vegetation, not a potential vegetation type.) See **FGDC**, **NSDI**.

**Autocorrelation.** The correlation or relationship between two or more members of a series of observations, and the same values at a second time interval (temporal autocorrelation) or location (spatial autocorrelation).

**Azimuth.** A horizontal angle, measured clockwise from north and expressed in degrees; also called a bearing.

**Back Azimuth.** Refers to an azimuth 180° opposite another azimuth. For example, if OP to 30P equals 35°; the back azimuth of 30P to 0P equals 215° (35° + 180° = 215°).

**Backing Fire.** A prescribed fire or wildland fire burning into or against the wind or downslope without the aid of wind. Compare to **Head Fire**.

**Barrier.** Any physical obstruction to the spread of fire; typically an area or strip without flammable fuel. See **Fire Line**.

**Basal Area.** The cross-sectional area of a tree trunk (measured in square inches, square centimeters, etc.); or the total area of stump surface of trees at breast height; or an area of ground covered by basal parts of grasses or tussock vegetation. Basal area is calculated from DBH and is used as a measure of dominance. Compare to **Basal Cover**.

**Basal Cover.** Within a given area, the percentage of the ground surface occupied by the plants right at ground level. This cover measurement is often used to monitor changes in bunch-grasses. See **Aerial Cover**, **Cover**; compare to **Basal Cover**.

**Bearing.** See **Azimuth**.

**Belt Transect.** A sample area used for collecting density information.

**BEHAVE.** A system of interactive computer programs for modeling fuel and fire behavior (Burgan and Rothermel 1984).

**Bias.** A systematic distortion of data arising from a consistent flaw in measurement, e.g., using a ruler that is incorrectly calibrated, or an incorrect method of sampling, e.g., all plots in a sample are non-randomly located in easily accessible areas. See **Accuracy**.

**Biennial.** Plant species that complete their life cycle within two years or growing seasons (generally flowering only in the second). Compare to **Perennial**, **Annual**.

**Biomass.** Total dry weight of living matter in a given unit area.

**Bole.** The trunk of a tree. When the sampling rod intersects the bole of a tree that is over 2 m tall, record "2BOLE," or "2SDED" if the tree is dead.

**Burn Severity.** A qualitative assessment of the heat pulse directed toward the ground during a fire. Burn severity relates to soil heating, large fuel and duff consumption, consumption of the litter and organic layer and mortality of buried plant parts.

**Canadian Forest Fire Danger Rating System (CFFDRS).** A fire danger rating system that predicts fire potential from point-source weather measurements (e.g., a single fire weather network station). The system deals primarily with day-to-day variations in the weather, but will accommodate variations through the day as well.

**Canopy.** Stratum containing the crowns of the tallest vegetation (living or dead); usually above 20 ft.

**Cardinal Points.** North, East, South, or West.

**Certainty.** A measurement, expressed in percent, of the quality of being certain on the basis of evidence.

**CCFDRS.** See **Canadian Forest Fire Danger Rating System.**

**Char Height.** The maximum height of charred bark on each overstory tree. Note that the maximum height is measured even if the char is patchy.

**Clonal.** Plants derived vegetatively from one parent plant, so that each is genetically identical to each other and to the parent. Clonal shrub species are generally excluded from belt density transects. When an indicator of density for clonal species is desired, stem density is often used.

**Club Fungi.** A group of fungi, also known as the basidiomycetes. This division includes about 25,000 different fungi, including mushrooms and rusts. Many mushrooms in this group look like umbrellas (growing from the ground) or like shelves (growing on wood). See **Sac Fungi, Zygote Fungi.**

**Co-dominant.** Overstory trees with crowns forming the general level of crown cover, and receiving full light from above but comparatively little from the sides. Compare to **Dominant.**

**Complex Fire Management Program.** A defined strategy for using prescribed fires and/or wildland fire for resource benefit, in addition to wildland fire suppression.

**Confidence Interval.** An estimated range of values likely to include an unknown population parameter and calculated from a given set of sample data. The width of the confidence interval gives us some idea about how uncertain we are about the unknown parameter (see **Precision**). A very wide interval may indicate that more data should be collected before anything very definite can be said about the parameter. In the case of a 80% interval, we expect 80% of the confidence intervals obtained by repeated sampling to include the true population mean.

**Confidence Interval of the Mean.** A range of values within which the unknown population mean may lie. The width of the confidence interval indicates how uncertain you are about the unknown population mean. This interval is expressed mathematically as follows:

$$CI = \bar{x} \pm (t \times se)$$

Where,  $\bar{x}$  is the sample mean,  $se$  is the standard error, and  $t$  is the critical “t” value for the selected confidence interval (80, 90, or 95%).

**Confidence Interval Width.** The distance between the mean and the upper or lower limit of the confidence interval.

**Confidence Level.** The probability value (1 -  $\alpha$ ) associated with a confidence interval. It is often expressed as a percentage. For example, if  $\alpha = 0.05 = 5\%$ , then the confidence level is equal to (1 - 0.05) = 0.95, i.e., a 95% confidence level.

**Confidence Limit.** The lower and upper boundaries or values of a confidence interval; the values which define the range of a confidence interval.

**Consumed.** For the purposes of this handbook, an overstory or pole-size tree that has been completely burned by a prescribed fire.

**Control Plots.** For the purpose of this handbook, plots that are not burned by prescribed fire; e.g., plots where all fires are suppressed, or plots in wildland fire use zones. These plots can be used in the same way as classic control plots. This definition differs from classic control plots in the acknowledgment that even “no treatment” is a treatment in itself.

**Cool Season Species.** Plants whose major growth occurs during the late fall, winter, or early spring. See **Warm Season Species.**

**Cover.** The proportion of the ground covered by plant material (including woody stems and foliage); usually expressed as a percent. See **Aerial Cover, Basal Cover, Percent Cover, Relative Cover.**

**Creeping Fire.** A fire that burns with a low flame and spreads slowly.

**Crown Fire.** A fire that burns primarily in the leaves and needles of trees, spreading from tree to tree above the ground.

**Crown Position Code.** An assessment of the canopy position of live overstory trees. See **Dominant, Co-dominant, Intermediate, Subcanopy, Open Growth.** Also, a snag classification for dead overstory trees.

**Crown Scorch.** Browning of needles or leaves in the crown of a tree, caused by heat from a fire.

**Crustose Lichen.** One of three major types of lichens, defined by their shape and form. Crustose lichens are flaky or crust-like. They grow tightly appressed to the substrate, like paint, and are generally attached by all of the lower surface. They can be found covering rocks, soil, bark, etc.—often forming brilliantly colored streaks. See **Fruticose Lichen, Foliose Lichen.**

**Cryptobiotic Soil.** A community of mosses, lichens, fungi, and algae that form a crust along on the ground; commonly found in the Colorado Plateau area. Also known as cryptogamic soil or crust, and Cyanobacteria, microbiotic or microphytic crust.

**Cyberstakes.** See **Electronic Marker Systems.**

**Dead Tree.** A dead tree, standing or down, that has no living tissue above DBH.

**DBH.** See **Diameter Breast Height.**

**Declination.** The angle formed between true north and magnetic north at a given location. Declination east means magnetic north is east of true north.

**Density.** The number of individuals, usually by species, per unit area. Individuals are generally considered dense at  $\geq 50$ /unit area, and sparse at  $\leq 20$ /unit area.

**Descriptive Statistics.** Numerical measures or graphs used to summarize properties of data. In general, descriptive statistics summarize the variability in a data set (i.e., the spread of the numbers) and the center of the data (e.g., mean, median). Compare to **Inferential Statistics**.

**Destructive Sampling.** Sampling activities that are (or are potentially) damaging to the vegetation from which the samples are taken.

**Diameter at Root Crown (DRC).** The equivalent of DBH for multi-stemmed species; all stems of a woodland species are measured at their bases, and aggregated into a single value.

**Diameter Breast Height (DBH).** The diameter of a tree 1.37 m (4.5 ft) up the trunk from the tree's base, when measured at midslope, and used to calculate basal area. The DBH of a leaning tree is measured by leaning with the tree. Adjustments are made for bole irregularities (see page 92). In regions outside the U.S., DBH is usually measured at 1.3 m.

**Diversity Index.** Any of a number of indices describing the relationship of the number of taxa (richness) to the number of individuals per taxon (abundance) for a given community. Commonly-used indices include Simpson's and Shannon-Weiner's.

**Dominant.** 1) Overstory trees with a canopy extending above the general level of the crown cover, receiving full light from all sides; 2) The most abundant or numerous species. Compare to **Co-dominant**.

**DRC.** See **Diameter at Root Crown**.

**Dry-bulb Temperature.** Air temperature as measured by an ordinary thermometer. Compare to **Wet-bulb Temperature**.

**Duff.** The fermentation and humus layer of the forest floor material lying below the litter and above mineral soil; consisting of partially decomposed organic matter whose origins can still be visually determined, as well as the fully decomposed humus layer. Does not include the freshly cast material in the litter layer, nor in the postburn environment, ash. See **Litter**.

**Ecotone.** A narrow, well-defined transition zone between two or more different plant associations.

**EHE.** See **Estimated Horizontal Error**.

**Electronic Marker Systems (EMS).** Small, durable, passive antennas that can be buried to serve as stake markers with no visible surface presence. They are used in conjunction with a portable locator that transmits a pulse at a frequency to which the buried marker is tuned. Also called "cyberstakes" or "radio balls."

**Emissions.** Elements resulting from burning, including smoke, carbon monoxide, lead, particulate matter, and sulfur oxides.

**Energy Release Component (ERC).** The total computed heat release per unit area (British thermal units per square foot) within the flaming front at the head of a moving fire.

**Environmental Monitoring (Level 1).** This level provides a basic overview of the baseline data to be collected prior to a burn event. Information at this level includes historical data such as weather, socio-political factors, natural barriers, and other factors useful in a fire management program.

**Epiphyte.** A nonparasitic plant that grows on another plant for mechanical support, but not nutrients; sometimes called "air plants."

**ERC.** See **Energy Release Component**.

**Estimate.** An indication of the value of an unknown quantity based on observed data. It is the particular value of an estimator that is obtained from a particular sample of data and used to indicate the value of a parameter.

**Estimated Horizontal Error (EHE).** A measurement of the horizontal position error of a GPS unit (in feet or meters), based on a variety of factors including Position Dilution of Precision and satellite signal quality. See **Position Dilution of Precision**.

**Exotic Species.** See **Non-native Species**.

**FARSITE.** A software modeling tool that uses spatial information on topography and fuels along with weather and wind files to simulate fire growth.

**FBOC.** See **Fire Behavior Observation Circles**.

**FBOI.** See **Fire Behavior Observation Intervals**.

**Federal Geographic Data Committee (FGDC).** The inter-agency committee that coordinates the development of the National Spatial Data Infrastructure (NSDI). The NSDI encompasses policies, standards, and procedures for organizations to cooperatively produce and share geographic data. Representatives of the 16 federal agencies comprising the FGDC work in cooperation with organizations from state, local and tribal governments, the academic community, and the private sector.

**Fern or Fern Ally.** The life form used for any pteridophyte; i.e., ferns, horsetails, and club mosses.

**FGDC.** See **Federal Geographic Data Committee.**

**Fine Fuels.** Fuels such as grass, leaves, draped pine needles, fern, tree moss, and some kinds of slash which, when dry, ignite readily and are consumed rapidly. Also called “flash” or “one-hour fuels.”

**Fire Behavior.** The response of fire to its environment of fuel, weather, and terrain; includes ignition, spread, and development.

**Fire Behavior Monitoring.** A process by which variables are measured to describe and characterize fire behavior, permit fire behavior prediction, and relate fire effects to burning conditions.

**Fire Behavior Observation Circles (FBOC).** Circles used to define an area in which to monitor fire behavior in forest monitoring plots. Their diameter is determined by the anticipated rate of spread the fire being studied.

**Fire Behavior Observation Intervals (FBOI).** Intervals (length) used to define an area in which to monitor fire behavior in grassland and brush monitoring plots. Their length is determined by the anticipated rate of spread of the fire being studied.

**Fire Behavior Prediction System.** A system for predicting flame length, rate of spread, fireline intensity, and other fire behavior values. This system was developed by Albini (1976) at the USFS Northern Forest Fire Laboratory.

**Fire Conditions Monitoring.** Observations and data collection for fires that have the potential to threaten resource values at risk, or that are being managed under specific constraints, such as a prescribed fire. Fire conditions monitoring generally calls for data to be collected on ambient conditions and fire and smoke characteristics. These data are coupled with information gathered during environmental monitoring to predict fire behavior and to identify potential problems.

**Fire Effects.** The physical, biological, and ecological impacts of fire on the environment.

**Fire Effects Monitoring.** Observations and data collection procedures that allow managers to evaluate whether fire is meeting management objectives, and to adjust treatment prescriptions accordingly. Fire effects monitoring does not prove cause-and-effect associations; rather, it can help management assess long-term change in managed areas.

**Fire Front.** The part of a fire within which continuous flaming combustion is taking place. Unless otherwise specified, the fire front is assumed to be the leading edge of the fire perimeter. In ground fires, the fire front may be mainly smoldering.

**Fire History.** The chronological record of the occurrence and scope of fire in an ecosystem.

**Fire Line.** A strip of land cleared of vegetation to stop the spread of a fire; a type of barrier.

**Fire Management Plan (FMP).** A strategic document that defines a long-term program to manage wildland and prescribed fires within a park unit, and that documents how fire will be managed according to the park’s general management plan. The FMP is supplemented by operational plans such as preparedness plans, prescribed fire plans, and prevention plans.

**Fire Monitoring.** The systematic process of collecting and recording fire-related data, particularly with regard to fuels, topography, weather, fire behavior, fire effects, smoke, and fire location.

**Fire Observation Monitoring (Level 2).** A monitoring level which includes two stages, reconnaissance monitoring, which is the basic assessment and overview of the fire; and fire conditions monitoring, which is the monitoring of the dynamic aspects of the fire.

**Fire Perimeter.** The outer edge or boundary of a fire. Also **Perimeter.**

**Fire Regime.** The pattern of fire in an area as determined by its systematic interaction with the biotic and physical environment. It includes the timing, number, spatial distribution, size, duration, behavior, return interval, and effects of natural fires.

**Fire Scar.** Scar tissue that develops if a tree or shrub is burned by a fire but is not killed. The fire leaves a record of that particular burn on the plant. Scientists can examine fire scars and determine when and how many fires occurred during the plant’s lifetime.

**Fire Season.** The period or periods of the year during which wildland fires are likely to occur, spread and do sufficient damage to warrant organized fire control; a period of the year with beginning and ending dates that is established by some agencies.

**Flame Depth.** The average depth of the zone of a moving fire that is primarily flaming; measured on a horizontal axis.

**Flame Length.** The distance measured from the tip of the flame to the middle of the fire front at the base of the fire. It is measured on a slant when the flames are tilted due to effects of wind and slope.

**Flare-up.** Any sudden acceleration in rate of spread (ROS) or intensification of a fire.

**Flanking Fire.** A fire moving across a slope or across the direction of the wind.

**FMH.EXE (FMH).** A software program used to enter and analyze data collected in this monitoring program.

**FMP.** See **Fire Management Plan**.

**Foliose Lichen.** One of three major types of lichens, defined by their shape and form. Foliose (leaf-like) lichens can be papery thin or, in more advanced forms, netted and branch-like. Branched foliose lichens have a distinct top and bottom surface, thus easily differentiating them from most fruticose lichens. See **Crustose Lichen**, **Fruticose Lichen**.

**Forb.** An annual, biennial, or perennial plant lacking significant woody growth, or any multi-stemmed woody plant that typically grows no taller than 0.5 m due either to genetic or environmental constraints.

**Frequency.** A quantitative expression of the presence or absence of individuals of a species within a population. Frequency is defined as the percentage of occurrence of a species in a series of samples of uniform size.

**Fruticose Lichen.** One of three major types of lichens, defined by their shape and form. Fruticose lichens are the most highly developed lichens. Their branches are much closer in form to “true” branches, although the lichens lack specialized vascular systems for transporting fluids. Growth forms include: stringy, upright, or shrub-like. See **Crustose Lichen**, **Foliose Lichen**.

**Fuel.** All dead and living material that will burn. This includes grasses, dead branches and pine needles on the ground, as well as standing live and dead trees. Also included are flammable minerals near the surface (such as coal) and human-built structures.

**Fuel Load.** The amount of fuel present, expressed quantitatively in terms of weight of fuel per unit area.

**Fuel Model.** A simulated fuel complex, which consists of all the fuel descriptors required to calculate a fire’s potential rate of spread.

**Fuel Type.** An identifiable association of fuel elements of distinctive species, form, size, arrangement, or other characteristics that will cause a predictable rate of spread under specified weather conditions.

**Geographic Information System (GIS).** A computer system for capturing, storing, checking, integrating, manipulating, analyzing and displaying data related to specific positions on the Earth’s surface. Typically, a GIS is used for handling maps and other spatial data. These might be represented as several different layers, each layer of which holds data about a particular feature. Each feature is linked to a position, or set of positions, on the graphical image of a map. Layers of data are organized for study and statistical analysis.

**Goal.** The desired state or target/threshold condition that a resource management policy or program is designed to achieve. A goal is usually not quantifiable and may not have a specific due date. Goals form the basis from which objectives are developed. Compare to **Objective**.

**Global Positioning System (GPS).** A constellation of satellites orbiting the earth transmitting signals that allow accurate determination of GPS unit locations.

**GPS Unit.** A handheld device using triangulating satellite signals to record precise UTM coordinates of its location. Also called a GPS receiver or Global Position Device (GPD). See **PLGR**.

**Grass.** The life form used for species in the grass family (Poaceae).

**Grass-like.** The life form used for any grass-like plant not in the grass family (Poaceae), e.g., any sedge (member of the Cyperaceae) or rush (member of the Juncaceae).

**Green-up.** The time period during which seeds typically germinate and perennial species experience renewed growth. While this is typically in the spring for most species, in some regions, some species of grasses and forbs produce new growth in the fall, after an inactive summer.

**Ground Cover.** Material other than bare ground that covers the land surface; expressed as a percent. Ground cover includes live and standing dead vegetation, litter, gravel, and bedrock. Ground cover plus bare ground equals 100 percent.

**Harvesting.** A sampling technique in which the aboveground parts of the study species are cut at a certain height, usually at or close to ground level, and used for calculation of above-ground biomass.

**Hazardous Fuels.** Fuels that, if ignited, could threaten park developments, human life and safety, or natural resources, or carry fire across park boundaries.

**Head Fire.** A fire spreading, or set to spread, with the wind or upslope. Compare to **Backing Fire**.

**Herbaceous Layer.** Generally the lowest structural layer in a vegetation complex; usually composed of non-woody plants. See **Vegetative Layer**.

**Horizontal Distance.** The measurement of distance on a true level plane. See **Slope Distance**.

**Humus.** The organic portion of the soil; a brown or black complex and varying material formed by the partial decomposition of vegetable or animal matter.

**Hygrothermograph.** A simple, accurate and reliable instrument that continuously measures and records temperature and relative humidity.

**Hypothesis.** A proposition tentatively assumed in order to draw out its logical consequences and so test its accord after data are collected.

**Immature/Seedling (Shrubs).** For the purposes of this handbook, an age class for shrubs without burls that have emerged since the time of the last disturbance, or a shrub (with or without a burl) too immature to flower. This definition will vary by shrub, by ecosystem and by the time since the last disturbance.

**Immediate Postburn.** The period just after a burn during which sampling takes place; generally within two months of a wildland or prescribed fire.

**Inferential Statistics.** Numerical measures used to draw inferences about a population from a sample. There are two main types of inferential statistics: estimation and hypothesis testing. In estimation, the sample is used to estimate a parameter and provide a confidence interval around the estimate. In the most common use of hypothesis testing, a null hypothesis is tested (and possibly rejected) by data. See **Null Hypothesis**; compare to **Descriptive Statistics**.

**Intercardinal Points.** Northeast, Southeast, Southwest, or Northwest. See **Cardinal Points**.

**Intermediate.** An overstory tree crown position class, which includes trees shorter than the main canopy level of the forest and receiving little direct light from above and none from the sides; this usually includes smaller, sublevel trees that are relatively dense.

**Inventory.** The systematic acquisition and analysis of information needed to describe, characterize, or quantify resources for land use planning and management. This is often the first step in a monitoring program.

**Keetch-Byram Drought Index (KBDI).** A commonly used drought index adapted for fire management applications, with a numerical range from 0 (no moisture deficiency) to 800 (maximum drought).

**Key Variable.** A fundamental environmental component (frequently vegetation, sometimes fuel) that identifies a monitoring type.

**Level 1 Monitoring.** See **Environmental Monitoring**.

**Level 2 Monitoring.** See **Fire Observation Monitoring**.

**Level 3 Monitoring.** See **Short-term Monitoring**.

**Level 4 Monitoring.** See **Long-term Monitoring**.

**Lichen.** An organism, generally recognized as a single plant, consisting of a fungus and an alga or cyanobacterium living in symbiotic association.

**Life Form.** A classification of plants based upon their size, morphology, habit, life span, and woodiness.

**Line Transects.** A sampling method consisting of horizontal, linear measurements of plant intercepts along the course of a line. Transect data are typically used to measure foliar and basal cover. Also called line-intercept transects.

**Litter.** The top layer of the forest, shrubland, or grassland floor, directly above the duff layer, including freshly fallen leaves, needles, bark flakes, cone scales, fruits (including acorns and cones), dead matted grass and other vegetative parts that are little altered in structure by decomposition. Does not include twigs and larger stems. See **Duff**.

**Live Fuel Moisture.** Water content of a living fuel, expressed as a percentage of the oven-dry weight of the fuel.

**Long-term Monitoring (Level 4).** Any type of monitoring that extends over a period of two or more years.

**Magnetic North.** The direction towards which the magnetic needle of a compass points. Compare to **True North**.

**Marking and Mapping.** A method of mapping and/or marking plant populations so that they can be recognized at a future date. This usually involves studies of single species; also called demographic studies.

**Mature.** For the purposes of this handbook, an age class for shrubs able to produce flowers and seeds. Also called **Adult**.

**Mean.** The arithmetic average of a set of numbers. Compare to **Median**.

**Median.** The numerical value that divides a data distribution in half. Numerically, half of the numbers in a population will be equal to or larger than the median and half will be equal to or smaller than the median. Compare to **Mean**.

**Minimum Sample Size.** The smallest number of plots needed to gather data to measure whether monitoring objectives are being met.

**Mixing Height.** The maximum altitude at which ground and upper air mix; smoke would rise to this height. An 'inversion' means that the mixing height is very low.

**Mode.** The numerical value in a given population that occurs most frequently. Note that the mode of a data set is not the frequency of the most common value; it is the value itself.

**Monitoring.** The orderly collection, analysis, and interpretation of environmental data to evaluate management's progress toward meeting objectives, and to identify changes in natural systems. Compare to **Research**.

**Monitoring Plot.** A sample unit (transect or plot) established to monitor fire behavior and fire effects in a monitoring type. Plots size, shape, number and arrangement vary from one monitoring type to another. As described in this handbook, monitoring plots are to be established in each monitoring type. See **Sample**.

**Monitoring Type.** A major fuel-vegetation complex or vegetation association subject to a particular burn prescription; for example, a white fir-dominated (basal area >50%) mixed conifer forest that is burned in the fall when plants are dormant.

**National Environmental Policy Act (NEPA).** Passed by Congress in 1969 to establish a national policy for the environment, to provide for the establishment of a Council of Environmental Quality, and for other purposes.

**National Fire Danger Rating System (NFDRS).** A uniform fire danger rating system based on the environmental factors that control fuel moisture content.

**National Interagency Fire Center (NIFC).** The nation's support center for wildland and prescribed fire. Seven federal agencies work together to support wildland and prescribed fire operations. These agencies include the Bureau of Indian Affairs, Bureau of Land Management, Forest Service, Fish and Wildlife Service, National Park Service, National Weather Service, and Office of Aircraft Services.

**National Interagency Fire Management Integrated Database (NIFMID).** Stores historical data about wildland fire occurrence and weather; automatically archives fire weather observations from the Weather Information Management System (WIMS).

**National Spatial Data Infrastructure (NSDI).** As per an executive order, "the technologies, policies, and people necessary to promote sharing of geospatial data throughout all levels of government, the private and non-profit sectors, and the academic community." Coordinated by the FGDC.

**NEPA.** See **National Environmental Policy Act**.

**Next Burning Period.** The next anticipated period of greatest fire activity, usually between 10:00 to 18:00 the next day.

**NFDRS.** See **National Fire Danger Rating System**.

**NIFC.** See **National Interagency Fire Center**.

**NIFMID.** See **National Interagency Fire Management Integrated Database**.

**Non-native Species.** Plants or animals living in a part of the world other than that in which they originated. Also called **Alien** or **Exotic Species**.

**Non-Parametric Tests.** Statistical tests that may be used in place of their parametric counterparts when certain assumptions about the underlying population are questionable. Non-Parametric tests often are more powerful in detecting population differences when certain assumptions are not satisfied. All tests involving ranked data are non-parametric. Compare to **Parametric Tests**.

**Non-vascular Plant.** The life form used for any plant without specialized water or fluid conductive tissue (xylem and phloem); this category includes mosses, lichens, and algae. Compare to **Vascular Plant**.

**NPS Branch of Fire Management.** A branch of the Ranger Activities Division of the WASO directorate of the National Park Service. Stationed in Boise, Idaho, this branch functions in close cooperation with the National Interagency Fire Center, operated by the Bureau of Land Management.

**NSDI.** See **National Spatial Data Infrastructure**.

**Null Hypothesis.** A statement put forward either because it is believed to be true or because it is to be used as a basis for argument, but has not been proven. For example, in a test of a new burn prescription, the null hypothesis might be that the new prescription is no better, on average, than the current prescription. This is expressed as  $H_0$ : there is no difference between the two prescriptions on average.

**Objective.** Specific results to be achieved within a stated time period. Objectives are subordinate to goals, are narrower in scope and shorter in range, and have an increased possibility of attainment. An objective specifies the time periods for completion and measurable, quantifiable outputs or achievements. See **Goal**.

**Objective Variable.** A key element of an ecosystem, sensitive to fire-induced change, and linked to the accomplishment of fire program objectives and as such is chosen for use in minimum sample size analysis.

**Open Growth.** A description of crown position in which an overstory tree canopy is not evident because the tree crowns are not fully closed. When this crown position code is used, it is normally assigned to all trees within a plot.

**Origin.** The randomly derived origin point for all monitoring plots. In grassland and brush plots it is called 0P; in forest plots it is called the plot center or the Origin.

**Overstory Tree.** For the purpose of this handbook, generally a living or dead tree with a diameter >15.0 cm at diameter breast height (DBH).



**Pace.** A unit of linear measure equal to the length of a given person's stride (two steps). The pace is measured from the heel of one foot to the heel of the same foot in the next stride.

**Paired Sample t-test.** A statistical test used to determine whether there is a significant difference between the average values of the same measurement made under two different conditions. Both measurements are made on each unit in a sample, and the test is based on the paired differences between these two values. The usual null hypothesis is that the difference in the mean values is zero.

**Palmer Drought Severity Index (PDSI).** A long-term meteorological drought severity index with a numerical range from +6.0 (extremely wet) to -6.0 (extremely dry).

**Parametric Tests.** Statistics used to estimate population parameters (e.g., means, totals) of the population being studied. Compare to **Non-parametric Tests**.

**PBB.** See **Prescribed Burn Boss**.

**PDOP.** See **Position Dilution of Precision**.

**PDSI.** See **Palmer Drought Severity Index**.

**FFP.** See **Prescribed Fire Plan**.

**Percent Cover.** A measure, in percentage, of the proportion of ground or water covered by vegetation. Note that total percent cover may exceed 100% due to the layering of different vegetative strata. This is the typical expression of cover; compare to **Relative Cover**.

**Perennial.** Plant species with a life cycle that characteristically lasts more than two growing seasons and persists for several years. Compare to **Annual**, **Biennial**.

**Perimeter.** See **Fire Perimeter**.

**Periodic Fire Assessment.** A process that validates the level of implementation actions on a wildland fire.

**Periphyton.** Microscopic plants and animals (e.g., algae, fungi, and bacteria) that are firmly attached to solid surfaces under water such as rocks, logs, and pilings.

**Phenology.** The stage of plant development, e.g., flowering, fruiting, dormant.

**Pilot Sample Plots.** The first ten monitoring plots established within a monitoring type used to assess the suitability of a sampling design.

**PLGR (Precision, Light-weight, GPS Receiver).** A specific type of GPS unit provided by the Department of Defense to some land management agencies; used to determine UTM

coordinates of a given location, which provides users an accuracy of  $\leq 16$  m. See **GPS Unit**.

**Plotless Sampling.** A sampling method using sampling units with imaginary and variable boundaries.

**PM-10.** An air quality standard established by the Environmental Protection Agency for measuring suspended atmospheric particulates less than or equal to  $10 \mu$  in diameter.

**PM-2.5.** An air quality standard established by the Environmental Protection Agency for measuring suspended atmospheric particulates less than or equal to  $2.5 \mu$  in diameter.

**Point Intercept.** A sampling method for estimating cover by lowering a "pin" through the vegetation at objectively established sampling points. The "pin" may be a visual siting device (e.g., cross hairs), a rod or a series of rods. This handbook uses a 0.25 in diameter sampling rod for point intercept sampling.

**Pole-size Tree.** For the purpose of this handbook, a standing living or dead tree generally with a DBH  $\geq 2.5$  cm and  $\leq 15$  cm.

**Population.** Any entire collection of people, animals, plants or things from which we may collect data. A population is typically described through the study of a representative sample. For each population there are many possible samples. A sample statistic gives information about a corresponding population parameter. For example, the sample mean for shrub density from a particular monitoring type would give information about the overall population mean of shrub density for that monitoring type.

**Position Dilution of Precision (PDOP).** A measurement of the accuracy of a GPS unit reading taking into account each satellite's location in relation to other GPS satellites. Smaller values indicate more accurate readings (four is good, and seven or more is poor).

**Power.** The ability of a statistical hypothesis test to reject the null hypothesis when it is actually false—that is, to make a correct decision. Power, the probability of not committing a type II error, is calculated by subtracting the probability of a type II error from 1, usually expressed as: Power =  $1 - \beta$ .

**Precision.** A measure of how close an estimator is expected to be to the true value of a parameter; standard error is also called the "precision of the mean." See **Confidence Interval**.

**Prescribed Burn Boss (PBB).** The person responsible for all decisions related to tactics and strategy on a prescribed fire, including organization, implementation, communication, and evaluation.

**Prescribed Fire.** A fire ignited by management actions to meet specific objectives. Prior to ignition, a written, prescribed fire plan must be approved and meet NEPA requirements.

**Prescribed Fire Plan (PFP).** A document that must be completed each time a fire is ignited by park managers. A PFP must be prepared by a prescribed burn boss and approved by the park superintendent prior to ignition. The PFP is one of the operational plans that document specific execution of a park's fire management plan.

**Prescription Weather Station.** A shelter at a field site containing instruments such as a hygrothermograph, fuel moisture sticks, a rain gauge, and an anemometer.

**Qualitative Variable.** A variable for which an attribute or classification is assigned, e.g., height class, age class.

**Quantitative Variable.** A variable for which a numeric value representing an amount is measured, e.g., cover, density.

**Random Sampling.** A technique involving the selection of a group of plots (a sample) for study from a larger group (a population). Sampled individuals are chosen entirely by chance; each member of the population has a known, but possibly non-equal, chance of being included in the sample. The use of random sampling generates credible results without introducing significant bias. See **Restricted Random Sampling**, **Stratified Random Sampling**.

**Range.** A measure of the spread or dispersion of observations within a sample or a data set. The range is the difference between the largest and the smallest observed values of some measurement such as DBH or plant height.

**Rate of Spread (ROS).** The time it takes the leading edge of the flaming front to travel a known distance; in this handbook, measured in chains/hour or meters/second.

**RAWS.** See **Remote Automatic Weather Station**.

**Real-time.** Live; current, present time.

**Recommended Response Action.** The documented assessment of whether a situation warrants continued implementation of wildland fire use or a suppression-oriented action of initial or extended attack.

**Recommended Standard (RS).** The minimum level of fire monitoring recommended in this Fire Monitoring Handbook. Special circumstances (such as serious non-native species problems or undetermined "natural state") will dictate monitoring at a different level or the addition of a research program.

**Reconnaissance Monitoring.** A type of monitoring that provides a basic overview of the physical aspects of a fire event.

**Rejection Criteria.** Pre-defined criteria used to establish whether a plot can be included within a particular monitoring type.

**Relative Cover.** The percent contribution of a particular species to the total plant cover, such that the sum of the relative cover values for all species totals 100%. Compare to **Percent Cover**.

**Relative Humidity.** The ratio of the amount of water in the air at a given temperature to the maximum amount it could hold at that temperature; expressed as a percentage.

**Remeasurement.** Any plot visit after the initial plot establishment conducted for the purpose of gathering comparative data to previous visits.

**Remote Automatic Weather Station (RAWS).** A solar-powered weather station that measures temperature, humidity, wind speed and direction, barometric pressure, fuel moisture, and precipitation. The data can be transmitted via satellite or fire radio, or recorded on-site for later collection.

**Replication.** The systematic or random repetition of an experiment or procedure to reduce error.

**Representativeness.** The ability of a given sample to represent the total population from which it was taken.

**Research.** Systematic investigation to establish principles and facts. Research usually has clearly defined objectives, which are often based on hypotheses. Research also includes the process of investigating and proving a potential application of established scientific knowledge. Compare to **Monitoring**.

**Resource Value at Risk.** A natural, cultural, or developed feature subject to threat by fire or smoke. Resource values at risk are classified as high or low.

**Resprout.** For the purposes of this handbook, a shrub or seedling tree age class of shrubs or seedling trees that have resprouted after being top-killed by a fire or any other disturbance. Sprouting can be epicormic (from the stem) or basal (from the base of the plant).

**Restoration Burn.** A prescribed fire used to bring fuels and/or vegetation into a state similar to that which would be found naturally or as part of a historic scene.

**Restricted Random Sampling.** A variant of stratified random sampling, in which the number,  $n$ , of sampling units needed to meet a monitoring objective determines the number of segments in the monitoring type. Within each of these  $n$  segments a monitoring plot is randomly established. This method ensures the random distribution of plots throughout the monitoring type.

**ROS.** See **Rate of Spread**.

**RS.** See **Recommended Standard**.

**Running.** Behavior of a rapidly-spreading fire with a well-defined head.

**Sac Fungi.** A group of fungi known as ascomycetes. The defining feature of these fungi is their production of special pods or sac-like structures called asci. Examples include morels, truffles, cup fungi, and flask fungi. See **Club Fungi**, **Zygoter Fungi**.

**Sample.** A representative group of units selected from a larger group (the population), often selected by random sampling. Study of the sample helps to draw valid conclusions about the larger group. Generally a sample is selected for study because the population is too large to study in its entirety. In this handbook a sample is the aggregation of all monitoring plots with the same prescription for a particular monitoring type (fuel-vegetation type).

**Sample Size.** The number of monitoring plots included in a study and intended to represent a population.

**Sample Standard Deviation.** A measure of the spread or dispersion of a sample of measurements within a population. It is equal to the square root of the variance and symbolized by *sd*, or *s*.

**Sampling Rod.** A tall, thin (0.25 in diameter), lightweight pole used for point intercept sampling.

**Sampling Unit.** The area or domain used for data collection; this can be an individual, linear transect, area, volume, etc. A 50 m × 20 m forest plot and a 30 m grassland plot are sampling units.

**Scorch Height.** The maximum height at which leaf mortality occurs due to radiant or convective heat generated by a fire. Below this height, all needles are brown and dead; above it, they are live and green.

**Seed Bank.** The body of ungerminated but viable seed that lies in the soil. Also called the soil seed bank.

**Seed Bank Soil Cores.** Soil cores of known depth and area taken at sample points throughout the study area so that the vertical distribution of seeds in the soil can be determined through germination tests and seed counts.

**Seed Traps.** Traps placed on the soil surface to estimate the seed density per unit time of seed arriving on that surface.

**Seedling Tree.** For the purposes of this handbook, a living or dead tree with a diameter <2.5 cm at diameter breast height.

**Short-term Change Monitoring (Level 3).** A level of monitoring that provides information on fuel reduction and vegetative change within a specific vegetation and fuel complex (monitoring type), as well as on other variables, according to manage-

ment objectives. Vegetation and fuels monitoring data are collected primarily through sampling of permanent monitoring plots, and include such items as density, fuel load, and relative cover by species.

**Shrub.** The life form used for woody plant species that typically grow taller than 0.5 m in height, generally exhibit several erect, spreading, or prostrate stems, and have a bushy appearance. In instances where the life form cannot be determined, woody plant species that typically grow taller than 0.5 m in height, but are less than 5 m in height, are considered shrubs.

**Sling Psychrometer.** A portable instrument for obtaining wet- and dry-bulb thermometer readings for the measurement of relative humidity.

**Slope.** The natural incline of the ground, measured in percent of rise (vertical rise or drop divided by horizontal distance). A 1% slope would be equal to a rise of one meter over a distance of 100 m.

**Slope Distance.** The inclined distance (as opposed to true horizontal or vertical distance) between two points. See **Horizontal Distance**.

**Smoldering.** The behavior of a fire burning without a flame and barely spreading.

**Snag.** A free-standing dead overstory tree.

**Species Composition.** The relative numbers of different species.

**Species Diversity.** The number of different species occurring in an area.

**SPI.** See **Standardized Precipitation Index**.

**Spotting.** Behavior of a fire that is producing sparks or embers that are carried by the wind and start new fires beyond the zone of direct ignition by the main fire.

**Standard Deviation.** A measure of the spread of observations from the sample mean, represented by *s*

**Standard Error.** The standard deviation of the values of a given function of the data (parameter), over all possible samples of the same size, represented by *se*. Also called “precision of the mean.”

**Standardized Precipitation Index (SPI).** A versatile drought index used by drought planners and based on the probability of precipitation for any time scale with a numerical range from +4 (extremely wet) to -4 (extremely dry).

**Statistic.** A quantity calculated from a sample of data and used to describe unknown values in the corresponding population. For example, the average of the data in a sample is used to esti-

mate the overall average in the population from which that sample was drawn.

**Statistics.** A branch of mathematics dealing with the collection, analysis and interpretation of numerical data.

**Statistical Inference.** The use of information from a sample to draw conclusions (inferences) about the population from which the sample was taken.

**Stratified Random Sampling.** A means of reducing uncertainty (variance) in sampling by dividing the area under study into blocks with common features. For example, combining forest and shrublands into a common sampling area produces more variation than stratifying them into vegetation types first, then sampling within each. Stratification is a fine tool if you understand how the variable used to stratify (in this example, vegetation type) affects the elements you are measuring (such as growth or density).

**Subcanopy.** In reference to tree crown position, a tree far below the main canopy level of the forest and receiving no direct light.

**Subshrub.** Multi-stemmed woody plant species with a height of less than 0.5 m due either to genetic or environmental constraints. Also called dwarf shrubs.

**Substrate.** The life form used for dead and inorganic materials found lying on the ground within a plot or transect.

**Suppression.** Actions intended to extinguish or limit the growth of fires.

**Surface Fire.** A fire that burns leaf litter, fallen branches and other fuels on the forest floor.

**Surface Winds.** Air speed measured 20 ft above the average top of the vegetation. Surface winds often are a combination of local and general winds.

**t-Test.** The use of the statistic ( $t$ ) to test a given statistical hypothesis about the mean of a population (one-tailed) or about the means of two populations (two-tailed).

**Timelag.** An indication of the rate at which a dead fuel gains or loses moisture due to changes in its environment; the time necessary, under specified conditions, for a fuel particle to gain or lose approximately 63% of the difference between its initial moisture content and its equilibrium moisture content. Given unchanged conditions, a fuel will reach 95% of its equilibrium moisture content after four timelag periods. Fuels are grouped into 1 hour, 10 hour, 100 hour, and 1,000 hour timelag categories.

**Torching.** The ignition and subsequent flare-up, usually from bottom to top, of a tree or small group of trees.

**Total Counts.** The number of individuals of a species or the number of species.

**Transect.** A specific area of pre-determined size used for sampling; for example, a narrow strip (measuring tape) used for point-intercept sampling, or a belt used for collecting density information.

**Tree.** The life form used for any woody plant species that typically grows with a single main stem and has more or less definite crowns. In instances where life form cannot be determined, woody plant species that typically grow taller than 5 m in height are considered trees.

**True North.** The direction of north on a map. Compare to **Magnetic North**.

**Type I Error.** The rejection of a true null hypothesis. For example, if the null hypothesis is that there is no difference, on average, between preburn and year-2 postburn shrub densities, a type I error would occur with the conclusion that the two densities are different when in fact there was no difference between them.

**Type II Error.** The lack of rejection of a false null hypothesis. For example, if the null hypothesis is that there is no difference, on average, between preburn and year-2 postburn shrub densities, a type II error would occur with the conclusion that there is no difference between the two densities on average, when in fact they were different.

**Universal Transverse Mercator (UTM).** A map grid that divides the world into 60 north-south zones, each covering a longitudinal strip 6 ° wide. Midway along each longitudinal strip is a longitudinal central meridian, with an easting value of 500,000. Values west of the meridian are less than 500,000 and values to the east of the meridian are greater than 500,000. Coordinates are measured within each zone in meters. Coordinate values are measured from zero at the equator in a northerly or southerly direction.

**UTM.** See **Universal Transverse Mercator**.

**Variability.** The degree of difference among the scores on given characteristics. If every score on the characteristic is about equal, the variability is low. Also known as dispersion or spread.

**Variable.** The characteristic of interest being measured. For example, pole-size tree height, relative cover of non-native grasses, etc.

**Vascular Plant.** Any plant with water and fluid conductive tissue (xylem and phloem), e.g., seed plants, ferns, and fern allies. Compare to **Nonvascular Plant**.

**Vegetation Association.** For the purpose of this handbook, an aggregate of similar vegetation such as lower mixed conifer forest.

**Vegetation Composition.** The identity and mixture of plant species in a given vegetation unit; this term may be applied to any of a number of scales, from the regional to the very local.

**Vegetation Mapping.** A method of estimating the cover of vegetation associations over a large area.

**Vegetative Layer.** A structural position within a vegetation complex. Generally, a forest plot consists of dead and downed fuel, herbaceous, shrub, understory tree, and overstory tree layers.

**Vine.** The life form used for any plant having a long, slender stem that trails or creeps on the ground, or that climbs by winding itself about a support or holding fast with tendrils or claspers.

**Visual Estimates.** A method of quantifying a variable; species cover is visually estimated either in the entire study area, or within sample plots, such as in quadrats. See **Frequency**.

**Voucher Specimen.** A pressed and dried plant, usually cataloged, mounted on herbarium paper, stored in a herbarium and used to confirm the identity of a species present in a particular plot.

**Warm Season Species.** Plants whose major growth occurs during the spring, summer or fall; usually dormant in winter. See **Cool Season Species**.

**Weather Information and Management System (WIMS).** An interactive computer system designed to accommodate the weather information needs of all federal and state natural resource management agencies. The system provides timely access to weather forecasts, current and historical weather data, the National Fire Danger Rating System (NFDRS), and the National Interagency Fire Management Integrated Database (NIFMID).

**Wet-bulb Temperature.** A measurement used to calculate relative humidity, usually with a sling psychrometer. Wet-bulb temperature is the lowest temperature to which air can be cooled by evaporating water into air at a constant pressure when the heat required for evaporation is supplied by the cooling of the air. This is measured by a wet-bulb thermometer, which usually employs a wetted wick on the bulb as an evaporative cooling device. Compare to **Dry-bulb Temperature**.

**WFIP.** See **Wildland Fire Implementation Plan**.

**Wildland Fire.** Any non-structure fire, other than prescribed fire that occurs in wildlands. This term encompasses fires previously called wildfire or prescribed natural fire.

**Wildland Fire Implementation Plan (WFIP).** A progressively developed assessment and operational management plan that documents the analysis and selection of strategies and describes the appropriate management response for a wildland fire. A full WFIP consists of three stages. Different levels of completion may be appropriate for differing management strategies (i.e., fires managed for resource benefits will have two-three stages of the WFIP completed while some fires that receive a suppression response may only have a portion of Stage I completed).

**WIMS.** See **Weather Information and Management System**.

**Zygoter Fungi.** A group known as the zygomycetes or conjugation fungi. The best-known member of this group is black bread mold. Zygoter fungi inhabit the soil or grow on decaying plant and animal material. See **Club Fungi**, **Sac Fungi**.

## CITED REFERENCES

- Albini FA. 1976. Estimating wildfire behavior and effects. Ogden (UT): USDA Forest Service, Intermountain Forest and Range Experiment Station. Gen Tech Report INT-30. 92 p.
- Anderson HE. 1982. Aids to determining fuel models for estimating fire behavior. Ogden (UT): USDA Forest Service, Intermountain Forest and Range Experiment Station. Gen Tech Report INT-122. 22 p.
- Avery TE, Burkhardt HE. 1963. Forest measurements. 3<sup>rd</sup> ed. New York: McGraw-Hill. 331 p.
- Beals E. 1960. Forest bird communities in the Apostle Islands of Wisconsin. *Wilson Bulletin* 72(2):156–81.
- Bonham CD. 1989. Measurements for terrestrial vegetation. New York: J Wiley. 338 p.
- Bradley AF, Noste NV, Fischer WC. 1992. Fire ecology of forests and woodlands in Utah. Ogden (UT): USDA Forest Service, Intermountain Research Station. Gen Tech Report INT-287. 128 p.
- Brown JK. 1974. Handbook for inventorying downed material. Ogden (UT): USDA Forest Service, Intermountain Forest and Range Experiment Station. Gen Tech Report INT-16. 23 p.
- Brown JK. 1996. Personal communication.
- Brown JK, Oberhue RD, Johnston CM. 1982. Inventorying surface fuels and biomass in the Interior West. Ogden (UT): USDA Forest Service, Intermountain Forest and Range Experiment Station. Gen Tech Report INT-129. 48 p.
- Buckland ST, Anderson DR, Burnham KP, Laake JL. 1993. Distance sampling: estimating abundance of biological populations. New York: Chapman and Hall. 446 p.
- Burgan RE, Rothermel RC. 1984. BEHAVE: fire behavior prediction and fuel modeling system, fuel subsystem. Ogden (UT): USDA Forest Service, Intermountain Forest and Range Experiment Station. Gen Tech Report INT-167. 126 p.
- Chambers JC, Brown RW. 1983. Methods for vegetation sampling and analysis on revegetated mined lands. Ogden (UT): USDA Forest Service, Intermountain Forest and Range Experiment Station. Gen Tech Report INT-151. 57 p.
- Cohen J. 1988. Statistical power analysis for the behavioral sciences. 2<sup>nd</sup> ed. Hillsdale (NJ): Lawrence Erlbaum Associates. 567 p.
- Conrad CE, Poulton CE. 1966. Effect of a wildfire on Idaho fescue and bluebunch wheatgrass. *Journal of Range Management* 19:138–41.
- Countryman CM, Dean WM. 1979. Measuring moisture content in living chaparral: a field user's manual. Berkeley (CA): USDA Forest Service, Pacific Southwest Forest and Range Experiment Station. Gen Tech Report PSW-36. 16 p.
- Cox DR. 1977. The role of significance tests. *Scandinavian Journal of Statistics* 4:49–70.
- Elzinga CL, Evenden AG, compilers. 1997. Vegetation monitoring: an annotated bibliography. Ogden (UT): USDA Forest Service, Intermountain Research Station. Gen Tech Report INT-GTR-352. 184 p.
- Elzinga CL, Salzer DW, Willoughby JW. 1998. Measuring and monitoring plant populations. Denver: USDI Bureau of Land Management. 492 p.
- Elzinga CL, Salzer DW, Willoughby JW, Gibbs JP. 2001. Monitoring plant and animal populations. Malden (MA): Blackwell Science. 368 p.
- Emlen JT. 1971. Population densities of birds derived from transect counts. *Auk* 88:323–42.
- [FGDC] Federal Geographic Data Committee, Vegetation Subcommittee. 1996. FGDC vegetation classification and information standards. Reston (VA): USGS MS 590 National Center. 35 p.
- Finklin AI, Fischer WC. 1990. Weather station handbook—an interagency guide for wildland managers. Boise (ID): National Wildfire Coordinating Group, National Interagency Fire Center. NFES No 1140. PMS No 426-2. 237 p.
- Finnamore AT, Winchester NN, Behan-Pelletier VM. 1999. Protocols for measuring biodiversity: arthropod monitoring in terrestrial ecosystems. <[www.eman-rese.ca/eman/ecotools/protocols/terrestrial/arthropods/intro.html](http://www.eman-rese.ca/eman/ecotools/protocols/terrestrial/arthropods/intro.html)>. Accessed 2003 July 25.
- Fischer WC, Hardy CE. 1976. Fire-weather observers' handbook. Ogden (UT): USDA Forest Service, Intermountain Forest and Range Experiment Station. Agriculture Handbook No 494. 152 p.
- Hardwick P, Lachowski H, Maus P, Griffith R, Parsons A, Warbington R. 1997. Burned area emergency rehabilitation (BAER): use of remote sensing and GIS. Salt Lake City: USDA Forest Service, Remote Sensing Applications Center. RSAC-7140-1. 4 p.
- Hurlbert SH. 1984. Pseudoreplication and the design of ecological field experiments. *Ecological Monographs* 54(2):187–211.
- Irwin I, Stevens L. 1996. Pseudoreplication issues versus hypothe-

- sis testing and field study designs: alternative study designs and statistical analyses help prevent data misinterpretation. *Park Science* 16(2):28–31.
- Kendeigh SC. 1944. Measurements of bird populations. *Ecological Monographs* 14:67–106.
- Lampinen R. 1998a. Internet directory for botany: checklists, floras, taxonomic databases, vegetation. Finnish Museum of Natural History. <[www.botany.net/IDB/subject/botflor.html](http://www.botany.net/IDB/subject/botflor.html)>. Accessed 2003 May 29.
- Lampinen R. 1998b. Internet directory for botany: images. Finnish Museum of Natural History. <[www.botany.net/IDB/subject/botpics.html](http://www.botany.net/IDB/subject/botpics.html)>. Accessed 2003 May 29.
- Liesner R. 1997. Field techniques used by Missouri Botanical Garden; collecting. <[www.mobot.org/MOBOT/research/library/fieldtechbook/collect.html](http://www.mobot.org/MOBOT/research/library/fieldtechbook/collect.html)>. Accessed 2003 May 29.
- McMahon CK, Adkins CW, Rodgers SL. 1987. A video image analysis system for measuring fire behavior. *Fire Management Notes* 47(1):10–15.
- Mueller-Dombois D, Ellenberg H. 1974. Aims and methods of vegetation ecology. New York: J Wiley. 547 p.
- Nature Conservancy, The. 1998. Terrestrial vegetation of the United States: the national vegetation classification system. <<http://www.natureserve.org/publications/library.jsp>>. Accessed 2003 July 25.
- [NDCC] Northeast Document Conservation Center. 2000. Preservation suppliers and services. Andover (MA): Northeast Document Conservation Center. <[www.nedcc.org](http://www.nedcc.org)>. Accessed 2003 July 25.
- [NEPA] National Environmental Policy Act of 1969, § 102, 42 U.S.C. § 4332 (1982)
- [NOAA] National Oceanic and Atmospheric Administration. 2000. Geomagnetic models and software available from National Geophysical Data Center (NGDC). <[www.ngdc.noaa.gov/seg/potfld/magmodel.shtml](http://www.ngdc.noaa.gov/seg/potfld/magmodel.shtml)>. Accessed 2003 July 25.
- Norman GR, Streiner DL. 1997. PDQ statistics. 2<sup>nd</sup> ed. St Louis: Mosby-Year Book.
- Norum RA, Miller M. 1984. Measuring fuel moisture content in Alaska: standard methods and procedures. Portland (OR): USDA Forest Service, Pacific Northwest Forest and Range Experiment Station. Gen Tech Report PNW-171. 34 p.
- [NWCG] National Wildfire Coordinating Group. 1997. Smoke management techniques, RX-450. Boise (ID): Publications Management System, National Interagency Fire Center. 450 p.
- Peterman RM. 1990. Statistical power analysis can improve fisheries research and management. *Canadian Journal of Fisheries and Aquatic Science* 47:2–15.
- Pielou EC. 1984. The interpretation of ecological data: a primer on classification and ordination. New York: J Wiley. 263 p.
- Ralph CJ, Sauer JR, Droege S, editors. 1995. Monitoring bird populations by point counts. Albany (CA): USDA Forest Service, Pacific Southwest Research Station. Gen Tech Report PSW-GTR-149. 187 p.
- Ralph CJ, Scott JM, editors. 1981. Estimating numbers of terrestrial birds. *Studies in Avian Biology* No 6. Lawrence (KS): Allen Press. 630 p.
- Reinhardt TE, Ottmar RD, Hanneman AJS. 2000. Smoke exposure among firefighters at prescribed burns in the Pacific Northwest. Portland (OR): USDA Forest Service, Pacific Northwest Research Station. Research Paper PNW-RP-526. 45 p. <[www.fs.fed.us/pnw/pubs/rp526.pdf](http://www.fs.fed.us/pnw/pubs/rp526.pdf)>. Accessed 2003 July 25.
- Rothermel RC. 1983. How to predict the spread and intensity of forest fires. Ogden (UT): USDA Forest Service, Intermountain Forest and Range Experiment Station. Gen Tech Report INT-143. 161 p.
- Ryan KC, Noste NV. 1985. Evaluating prescribed fires. *In*: Lotan JE, Kilgore BM, Fischer WC, Mutch RW, technical coordinators. Symposium and workshop on wilderness fire: proceedings; 1983 November 15–18; Missoula, MO. Ogden (UT): USDA Forest Service, Intermountain Forest and Range Experiment Station. Gen Tech Report INT-182. p 230–8.
- Salt GW. 1957. An analysis of avifaunas in the Teton Mountains and Jackson Hole, Wyoming. *Condor* 59:373–93.
- Sydoriak WM. 2001. FMH.EXE [Computer Program]. Version 3.1x. Boise (ID): National Park Service. Accompanied by: one manual. System requirements: IBM PC family or fully compatible computer; DOS 5.0 or higher; hard disk with a minimum of 7 to 10 MB free space strongly recommended. Available from: <[www.nps.gov/fire/fmh/index.htm](http://www.nps.gov/fire/fmh/index.htm)>. Accessed 2003 May 1.
- Tessler S, Gregson J. 1997. Data management protocol. [Draft] National Park Service, Natural Resource Information Division, Inventory and Monitoring Program. Available from: <[www.nature.nps.gov/im/dmproto/joe40001.htm](http://www.nature.nps.gov/im/dmproto/joe40001.htm)>. Accessed 2003 May 29.
- Thomas JW, Anderson RG, Maser C, Bull EL. 1979. Snags. *In*: Thomas JW, technical editor. Wildlife habitats in managed forest: the Blue Mountains of Oregon and Washington. Washington (DC): USDA Forest Service, in cooperation with Wildlife Management Institute and USDI Bureau of Land Management. Agricultural Handbook No 553. p 60–77.
- USDA Forest Service. 1995. Burned area emergency rehabilitation handbook. FSH 2509.13. Washington (DC): GPO. 102 p.
- USDA Forest Service. 1997. Forest health monitoring 1997 field methods guide. Research Triangle Park (NC): USDA Forest Service, National Forest Health Monitoring Program. 353 p.
- USDA Forest Service. 2001. Fire effects information system. Mis-

- soula (MT): USDA Forest Service, Rocky Mountain Research Station, Fire Sciences Laboratory. <[www.fs.fed.us/database/feis/](http://www.fs.fed.us/database/feis/)>. Accessed 2003 May 29.
- [USDA NRCS] USDA National Resources Conservation Service. 2001. The PLANTS database. <[plants.usda.gov/plants](http://plants.usda.gov/plants)>. Accessed 2003 May 29.
- [USDI NPS] USDI National Park Service. 1992. Western Region fire monitoring handbook. San Francisco: Western Region Prescribed and Natural Fire Monitoring Task Force, National Park Service. 287 p.
- [USDI NPS] USDI National Park Service, Alaska Support Office, Geospatial Data Clearinghouse. 1997. Global positioning system (GPS) awareness briefing and hands-on PLGR+96 training including mission planning software (MPS). Kearneysville (WV): National Conservation Training Center. 193 p. <[165.83.119.44/npsgps/npsgps.htm](http://165.83.119.44/npsgps/npsgps.htm)>. Accessed 2003 May 29.
- [USDI NPS] USDI National Park Service. 1998. Wildland fire management guideline (DO-18). Boise (ID): National Interagency Fire Center. 10 p.
- [USDI NPS] USDI National Park Service. Modification to be published in 2001a. Reference Manual-18: wildland fire management. Boise (ID): National Interagency Fire Center. 310 p.
- [USDI NPS] USDI National Park Service, Alaska Support Office, Geospatial Data Clearinghouse. 2001b. AlaskaPak: functions pack extension for ArcView 3.1. <[www.nps.gov/akso/gis/av31/akpak.htm](http://www.nps.gov/akso/gis/av31/akpak.htm)>. Accessed 2003 July 25.
- [USDI NPS] USDI National Park Service, Museum Management. 2001c. Herbarium collection label. NPS Form 10-512. [Generated by ANCS+.]
- White JD, Ryan KC, Key CC, Running SW. 1996. Remote sensing of forest fire severity and vegetation recovery. *International Journal of Wildland Fire* 6:125–36.
- Whitlam RG. 1998. Cyberstaking archaeological sites: using electronic marker systems (EMS) for a site datum and monitoring station. *Society for American Archaeology* 16(2): 12–15. <<http://www.saa.org/publications/sabulletin/16-2/SAA11.html>>. Accessed 2003 July 25.
- Wilhelm H, Brower C. 1993. The permanence and care of color photographs: traditional and digital color prints, color negatives, slides, and motion pictures. Grinnell (IA): Preservation Publishing Company. 744 p.
- Zar JH. 1996. Biostatistical analysis. 3<sup>rd</sup> ed. Upper Saddle River (NJ): Prentice Hall. 918 p.
- ADDITIONAL REFERENCES**
- Agee JK. 1973. Prescribed fire effects on physical and hydrological properties of mixed conifer forest floor and soil. Davis (CA): Water Resources Center, University of California, Davis. Contribution Report 143. 57 p.
- Anderson HE. 1978. Graphic aids for field calculation of dead, down forest fuels. Ogden (UT): USDA Forest Service, Intermountain Forest and Range Experiment Station. Gen Tech Report INT-45. 19 p.
- Barbour MG, Burk JH, Pitts WD. 1980. Terrestrial plant ecology. Menlo Park (CA): Benjamin-Cummings. 604 p.
- Brown L. 1997. Reissue. Wildflowers and winter weeds. New York: Norton. 252 p.
- Bullock J. 1996. Plants. *In*: Sutherland WJ, editor. Ecological census techniques. Great Britain (UK): Cambridge University Press. p 111–37.
- California Highway Patrol. 1984. Letter in response to NPS-WR foresters inquiry relative to acceptable highway visibility reduction caused by smoke. Located at Pacific West Regional Office, San Francisco. File code: Y14 (WR-RN)
- Canfield RH. 1941. Application of the line interception method in sampling range vegetation. *Journal of Forestry* 39:388–94.
- Case JL, Toops PL, Shabica SV. 1982. Reference marker-photo-point resources management system. Atlanta: USDI National Park Service Southeast Regional Office, Natural Science and Research Division. Research-Resources Management Report SER-62. 30 p.
- Christensen NL, Cotton L, Harvey T, Martin R, McBride J, Rundel P, Wakimoto R. 1987. Review of fire management program for sequoia-mixed conifer forests of Yosemite, Sequoia and Kings Canyon National Parks. Final Report to the National Park Service. 8 p.
- Cochran WG. 1977. Sampling techniques. 3<sup>rd</sup> ed. New York: J Wiley. 428 p.
- Floyd DA, Anderson JE. 1987. A comparison of three methods for estimating plant cover. *Journal of Ecology* 75:221–8.
- Goldsmith B, editor. 1991. Monitoring for conservation. New York: Chapman and Hall. 275 p.
- Gonick L, Smith W. 1993. The cartoon guide to statistics. New York: Harper Perennial. 231 p.
- Goodall DW. 1952. Some considerations in the use of point quadrats for the analysis of vegetation. *Australian Journal of Scientific Research* 5:1–41.
- Green LR. 1981. Burning by prescription in chaparral. Berkeley (CA): USDA Forest Service, Pacific Southwest Forest and Range Experiment Station. Gen Tech Report PSW-51. 36 p.
- Grieg-Smith P. 1983. Quantitative plant ecology. Berkeley (CA): University of California Press. 256 p.
- Hicks AJ, Hicks PH. 1978. A selected bibliography of plant collection and herbarium curation. *Taxon* 27(1):63–99.
- Interagency Technical Team. 1996. Sampling vegetation attributes.



- Denver: USDI Bureau of Land Management. 172 p.
- Jain SK. 1977. A handbook of field and herbarium methods. New Delhi: Today and Tomorrow. 157 p.
- Leopold AS, Cain SA, Cottam CM, Gabrielson JN, Kimball TL. 1963. Wildland management in the national parks. *Am Forest* 69:32–5, 61–3.
- Martin RE, Frewing DW, McClanhan JL. 1981. Average biomass of four northwest shrubs by fuel size class and crown cover. Portland (OR): USDA Forest Service, Pacific Northwest Forest and Range Experiment Station. Research Note PNW-374. 6 p.
- Maxwell WG, Ward FR. 1980. Guidelines for developing or supplementing natural photoseries. Portland (OR): USDA Forest Service, Pacific Northwest Forest and Range Experiment Station. Research Notes PNW-358. 16 p.
- National Wildfire Coordinating Group. 1995a. Task book for the position of prescribed fire behavior specialist (RXFM). Boise (ID): National Interagency Fire Center. 16 p.
- National Wildfire Coordinating Group. 1995b. Task book for the position of prescribed fire behavior analyst (RXFA). Boise (ID): National Interagency Fire Center. 18 p.
- National Wildfire Coordinating Group, Incident Operations Standards Working Team. 1996. Glossary of wildland fire terminology. Boise (ID): National Interagency Fire Center. 162 p.
- Nature Conservancy, The. 1996. Vegetation monitoring in a management context. Student text from class taught at Crossnore (NC). Located at: The Nature Conservancy, International Headquarters, Arlington VA.
- Nuss JR. 1998. Plant identification, top to bottom. University Park (A): Penn State College of Agricultural Sciences. <[www.penpages.psu.edu/penpages\\_reference/29401/29401135.html](http://www.penpages.psu.edu/penpages_reference/29401/29401135.html)>. Accessed 2003 May 29.
- Parks CG, Bull EL, Torgersen TR. 1997. Field guide for the identification of snags and logs in the interior Columbia River basin. Portland (OR): USDA Forest Service, Pacific Northwest Research Station. Gen Tech Report PNW-GTR-390. 40 p.
- Parsons DJ, Stohlgren TJ. 1986. Long term chaparral research in Sequoia National Park. *In*: DeVries JJ, editor. Proceedings of the chaparral ecosystems research conference, 1985 May 16–17; Santa Barbara, CA. Davis (CA): California Water Resources Center Report No 62. p 107–14.
- Scheaffer RL, Mendenhall W, Ott L. 1996. Elementary survey sampling. 5<sup>th</sup> ed. Belmont (CA): Duxbury Press. 501 p.
- Schlesinger WH, Gill DS. 1978. Demographic studies of the chaparral shrub, *Ceanothus megacarpus*, in the Santa Ynez Mountains, California. *Ecology* 59:1256–63.
- Schroeder MJ, Buck CC. 1970. Fire Weather—A guide for application of meteorological information to forest fire control operations. USDA Forest Service Agriculture Handbook No 360. Washington (DC): United States Government Printing Office. 229 p.
- Silva. 1983. Instruction manual, Ranger compass type 15. Sturtevant (WI): Silva. 8 p.
- Silva. No date. How to find your way with the Silva compass. Sturtevant (WI): Silva. 32 p.
- Stohlgren TJ. 1998. Personal communication.
- Stohlgren TJ, Bull KA, Otsuki Y. 1998. Comparison of rangeland vegetation sampling techniques in the central grasslands. *Journal of Range Management* 51(2):164–72.
- Suunto. No date. Instruction pamphlet, optical reading clinometer, PM-5. Carlsbad (CA): Suunto USA. 19 p.
- USDI, U. S. Geological Survey. 1999. The Universal Transverse Mercator (UTM) grid. Reston (VA): U. S. Department of the Interior, U. S. Geological Survey. USGS Fact Sheet 142-97.
- Veirs SD Jr, Goforth D. 1988. A line point transect method for long term monitoring of shrub and grassland or forest understory vegetation and a personal computer program for data analysis. Unpublished draft. Davis (CA): CPSU Davis, University of California. 24 p.
- Wakimoto RH. 1977. Chaparral growth and fuel assessment in southern California. *In*: Mooney HA, Conrad CE, technical coordinators. Symposium on the environmental consequences of fire and fuel management in Mediterranean ecosystems: proceedings; 1977 August 1–5; Palo Alto, CA. Washington (DC): USDA Forest Service. Gen Tech Report WO-3. p 412–8.
- Werth J. 2000. National fire danger rating system. National Oceanic and Atmospheric Administration. <[www.seawfo.noaa.gov/fire/olm/nfdrs.htm](http://www.seawfo.noaa.gov/fire/olm/nfdrs.htm)>. Accessed 2003 May 29.
- West NE. 1983. Choice of vegetation variables to monitor range condition and trend. *In*: Bell JF, Atterbury T, editors. Renewable resource inventories for monitoring changes and trends: Proceedings; 1983 August 15–19; Corvallis, OR. Corvallis (OR): Oregon State University. p 636–9.

## A

- Abundance 247
- Accuracy 247
  - See also Bias*
- Accuracy Standards 114
  - Burn & Immediate Postburn Variables 111
  - Fuel Load Variables 105
  - Herbaceous Variables 90
  - Overstory Tree Variables 99
  - Plot Dimensions 67, 69
  - Plot Layout 67
  - Plot Location Description 76
  - Pole-size Tree Variables 101
  - Seedling Tree Variables 102
  - Warning 80
- Adaptive Management 1–2, 20–21, 119, 134
  - References 239
- Adult
  - See Mature*
- Aerial Cover 247
  - See also Basal Cover, Cover*
- Alien Species
  - See Non-native Species*
- Anemometer 247
- Annual 44, 50, 82–83, 85–86, 194, 200, 247, 251
- Annual Report 134
- ArcInfo 61
- ArcView 60–61
- Area Growth 13
- Aspect 247
  - in Monitoring Type 35, 37, 39
  - Plot Location Description 75
  - Procedures and Techniques 11
- Association, FGDC 36
  - Example 39
- Autocorrelation 129, 247
  - Example 129
- Azimuth 247
  - Determining Using a GPS Unit 206
  - Fuel Transects 68, 76, 103, 176
  - Generating Random 189, 191
  - Plot Location 62
  - Randomizing in Narrow Monitoring Types 63
  - Reference Features 75, 115
  - Transect 67–68, 75
  - Wind Direction 12

## B

- Back Azimuth 247
- Backing Fire 247
- Barrier 247
  - See also Fire Line*
- Basal Area 31, 214, 247
  - Equation 213

- Basal Cover 247
  - See also Aerial Cover, Cover*
- Bearing
  - See Azimuth*
- BEHAVE 10–11, 13, 132, 247
  - Custom Fuel Models 47
- Belt Transect 24, 37–38, 89, 247
  - See also Shrub Density*
- Bias 247
- Biennial 82–83, 85, 194, 200, 247, 251
- Biological Description 37
  - Example 39
- Biological Diversity 21, 29
- Biomass 247
  - Brush Fuel Load 89
  - Equation 216
  - Grass Fuel Load 90
  - Pilot Sampling 47
- Blight 96
- Bole 247
  - Measuring DBH 91, 93, 96, 100
  - Obstructing Photographs 72
  - on Fuel Transect 103, 176
  - on Herbaceous Transect 68, 81–82
- Brown's Transect
  - See Dead and Downed Fuels*
- Brush Fuel Load 40, 89
- Brush Plots 60, 64–65, 71, 75, 80–81, 87, 89, 108–109, 205, 207, 253
  - See also Grassland and Brush Methods*
- Burn Prescription 34–35, 39, 53, 121, 132–133, 253
  - Modification 132
- Burn Severity 42, 57, 108–109, 247
  - Accuracy Standards 111
  - and Duff Moisture 12
  - Example 108
  - Forest Plots 108
  - Grassland and Brush Plots 108–109
  - Mapping 15
- Burn Status
  - Codes 80
  - Immediate Postburn 108
- Burning Problems 53
  - Partially Burned Plots 53
  - Plot Burned Out-of-Prescription 54
  - Plot Burning Off-Schedule 53
  - Plot Burns at Different Time Than the Burn Unit 53
  - Short Fire Intervals 53
  - Unplanned Ignitions 53

## C

- Canadian Forest Fire Danger Rating System (CFFDRS) 7, 247–248
- Canopy 247

- Carbon Monoxide
    - Monitoring 14
  - Cardinal Points 247
  - Certainty 248
  - CFFDRS
    - See Canadian Forest Fire Danger Rating System*
  - Change Objectives 23
    - Comparing Results with Objectives 130
    - Example 23, 119–120, 131
    - Minimum Sample Size 124
    - Monitoring Objectives 25
    - Power 128
  - Char Height 57, 111, 248
    - Accuracy Standards 111
  - Clinometer 11, 62, 201
  - Clonal Species 248
    - See also Overstory Trees, Shrub Density*
  - Cloud Cover 12–13
  - Codes
    - Burn Severity 108
    - Burn Status 80
    - Crown Position 93–95
    - Dead or Inorganic Material 86
    - Height Class for Pole-size Trees 101
    - Height Class for Seedling Trees 102
    - Live 111
    - Monitoring Type 36
    - Park Unit 4-Character Alpha 36
    - Photograph 71
    - Species 83
      - Non-vascular Plants 86
      - Unknown Vascular Plants 85–86
    - Stake Location 70
    - Substrate 86
    - Tree Damage 96–97
  - Co-dominant 94, 248
  - Coefficient of Variation 43, 218–219
    - Equation 218
  - Compass 62, 75–76, 201
    - Creating Random Numbers 62
    - Declination 202
    - Determining a Plot Location in the Field 205
    - Determining the Direction Between Two Map Points 204
    - Obtaining Accurate Bearings 201
  - Complex Fire Management Program 248
  - Concerns and Values to be Protected
    - Procedures and Techniques 8
  - Condition Objectives 23
    - Comparing Results with Objectives 130
    - Example 23, 130, 217
    - Minimum Sample Size 124
    - Monitoring Objectives 26
  - Confidence Interval 26–28, 122, 124, 130, 216, 219, 248
    - Equation 219
    - Example 26, 124
    - See also Precision*
  - Confidence Level 26, 49, 124, 126–128, 130, 216–217, 219–220, 248
  - Confidence Limit 248
  - Consumed 248
  - Control Plots 2, 52, 248
    - Immediate Postburn Effects 52
    - Long-term Change 52
    - Short-term Change 52
    - Warning 2
  - Conversion Table
    - Conversion Factors 209
    - Map Scales 212
    - Slope 211
  - Cool Season Species 248
  - Cover 248
    - Advantages vs. Limitations 30
    - See also Aerial Cover, Basal Cover, Percent Cover, Relative Cover*
  - Creeping Fire 248
  - Crown Fire 248
  - Crown Position 93, 95, 97
    - Accuracy Standards 99
    - Code
      - See Overstory Trees*
      - See also Dominant, Co-dominant, Intermediate, Subcanopy, Open Growth*
  - Crown Scorch 42, 57, 248
    - Accuracy Standards 111
    - Percent 111
  - Cryptobiotic Soil 86, 248
  - Cyanobacteria
    - See Cryptobiotic Soil*
  - Cyberstakes 64, 68, 224, 248–249
- ## D
- Data Analysis 119
    - Appropriate Statistical Tests 131
    - Data Analysis Record 121
    - Disseminating Results 134
    - Documentation 121
    - Evaluating Monitoring Program or Management Actions 131–135
    - Examining the Raw Data 121
    - Intended Approach 226
    - Short-term Change 119
    - Steps Involved 119
    - Summarizing Results 122, 124
    - The Analysis Process 121
    - Verifying Results 131
  - Data Entry
    - Data Management 116
    - FMH.EXE 113
    - Quality Control 116, 226
  - Data Quality 114
    - Data Entry 116
    - in the Field 115
    - in the Office 115
    - When Remeasuring Plots 114
  - Data Storage 112
    - Data Management 116
  - DBH
    - See Diameter Breast Height*
  - Dead and Downed Fuels
    - Equation 214
    - Pilot Sampling 45

- RS Procedures 103
- Sampling Problems 103, 105, 176
- Suggested Plot Specifications 44
- Declination 202, 249
  - Plot Location Description 75
- Defining Monitoring Types 22, 34–40
- Density 249
  - Advantages vs. Limitations 30
  - Equation 213
- Describing Monitoring Types 36–38
- Descriptive Statistics 121–122, 126, 249
  - See also Inferential Statistics*
- Design
  - Monitoring 19
- Destructive Sampling 249
- Diameter at Root Crown (DRC) 57, 97, 249
  - Diameter Groupings 98
  - Equation 214
  - Pilot Sampling 47
  - Pole-size Trees 100
- Diameter Breast Height (DBH) 57, 249
  - Accuracy Standards 102
  - Correlation with Canopy Cover 31
  - Measuring on a Slope 91
  - Overstory Trees 91
  - Pole-size Trees 100
  - Quality Control 114
  - Remeasuring 58
  - Seedling Trees 102
  - Size Classes 44
  - Tagging at 91, 100
  - Tagging Small Trees 100
  - vs. DRC 47, 97, 100
- Disease
  - Blight 96
  - Damage Codes 96
  - Witches Broom 96
- Diversity Index 249
- DO-18
  - Guidelines 1
- Documentation
  - Data Analysis 121
  - Monitoring Design 51
  - Photographs 72, 114
  - Plot Location 227
  - Program Changes 121
  - Voucher 84
- Dominant 94, 249
- DRC
  - See Diameter at Root Crown*
- Drought Index 12, 16
- Dry-bulb Temperature 249
- Duff 249
  - Burn Severity 108–110
  - Depth 42
  - Fuel Characteristics 35
  - Measuring Depth 104
  - Moisture 12, 215
  - Quality Control 114
  - See also Litter*

**E**

- Ecotone 37, 50, 249
- EHE
  - See Estimated Horizontal Error*
- Electronic Marker Systems (EMS) 64, 224, 249
- Elevation
  - Accuracy Standards 76
  - in Monitoring Type 35, 37, 39
  - Inversion Layer 15
  - Metadata 7
  - Mixing Height 14
  - Observer 14
  - Plot Location Description 75
  - Procedures and Techniques 11
  - Smoke Column 15
- Emissions 249
- EMS
  - See Electronic Marker Systems*
- Energy Release Component (ERC) 12, 16, 249
- Environmental Monitoring 5, 7–8, 249
  - Monitoring Schedule 7
  - Procedures and Techniques 7
- Epiphyte 249
- Equations 89, 213–219
  - Basal Area 213
  - Biomass 216
  - Coefficient of Variation 218
  - Confidence Interval of the Mean 219
  - Cover 213
  - Density 213
  - Fuel Load 214
  - Fuel Moisture 215
  - Minimum Sample Size 216–217
  - Slope Correction 214
  - Standard Deviation 216
  - Standard Error 218
- Equipment Checklist 221–222, 224
- Equipment Suppliers 224
- ERC
  - See Energy Release Component*
- Estimate 249
- Estimated Horizontal Error (EHE) 75, 249
  - See also Position Dilution of Precision*
- Evaluation
  - Achievement of Management Objectives 130
  - Management Actions 131
  - Monitoring Program 131, 226
  - Postburn 9, 15
  - Potential Concerns, Threats, and Constraints 8
  - Process 119
  - Short-term Change 119
  - Treatment Strategy 132
- Exotic Species
  - See Non-native Species*

**F**

- False-Change Error 127–128
- FARSITE 132, 249
- FBOC
  - See Fire Behavior Observation Circle*

- FBOI
  - See Fire Behavior Observation Interval*
- Federal Geographic Data Committee (FGDC) 35–36, 39, 247, 249, 253
- Fern 250
  - Life Form Category 83
- FGDC
  - See Federal Geographic Data Committee*
- Field Aids 193
- Field Packets 112
- File Maintenance 112
- Fine Fuels 250
- Fire Behavior 16, 250
  - Accuracy Standards 111
  - Monitoring 250
  - Monitoring Schedule 56
  - Prediction System 250
  - Procedures and Techniques 10, 106
- Fire Behavior Observation Circle (FBOC) 106, 249–250
- Fire Behavior Observation Interval 106
- Fire Behavior Observation Interval (FBOI) 106, 249–250
- Fire Cause 3, 9
- Fire Characteristics 11, 13, 106
- Fire Conditions Monitoring 250
  - Monitoring Schedule 11
  - Procedures and Techniques 11
- Fire Danger Rating
  - Procedures and Techniques 7
- Fire Effects 250
  - Monitoring 250
- Fire Front 250
- Fire History 75, 77, 250
- Fire Line 250
- Fire Management
  - Goals 5, 41
  - Plan 1, 4, 12, 14, 21, 29, 223, 250
  - Strategies ii, 3, 7, 41
- Fire Monitoring 250
  - Level 1 (Environmental) 5, 7
  - Level 2 (Fire Observation) 5, 9–10
  - Level 3 (Short-term Change) 5, 119
  - Level 4 (Long-term Change) 5, 119
  - Levels 4
  - Plan 21, 225–227
  - Policy 1
  - Program Steps 18
- Fire Monitoring Plan 21, 225–227
- Fire Observation Monitoring 5, 9–15, 250
- Fire Perimeter 13, 250
- Fire Regime 250
- Fire Scar 250
- Fire Season 250
- Fire Severity Map 15–16
- Fire Size
  - Procedures and Techniques 9
- Fire Spread Direction 14
- Fire Weather Forecast 9–10
- Flame Depth 250
  - Accuracy Standards 111
  - Measuring 14, 106
- Flame Length 250
  - Accuracy Standards 111
  - Measuring 13, 106
- Flanking Fire 250
- Flare-up 250
- FMH.EXE 5, 67, 83, 113, 117, 251
- FOFEM 132
- Forb 251
  - Life Form Category 83
- Forest Methods
  - Burn Severity 108
  - Burn Severity Codes 110
  - Char Height 111
  - Cover 81
  - Crown Position 93
  - Crown Scorch 111
  - Dead and Downed Fuel Load 103
  - Diameter at Root Crown (DRC) 97, 100
  - Duff and Litter Depth 104
  - Fire Behavior 106
  - Herbaceous Density 89
  - Immediate Postburn Monitoring 108
  - Laying out and Installing 67
  - Marking the Plot 67
  - Overstory Trees 91
  - Photographing the Plot 71
  - Plot Specifications 44
  - Plot Variables 42
  - Pole-size Trees 100
  - Scorch Height 111
  - Seedling Trees 102
  - Shrub and Herbaceous Layer 80
  - Shrub Density 87
  - Tree Damage 96–97
  - Tree Height 100, 102
- Forest Pests 229, 232–233
- Frequency 251
  - Advantages vs. Limitations 31
- Fuel 251
  - Type 251
- Fuel and Vegetation Description
  - Procedures and Techniques 10
- Fuel Characteristics 19, 35, 108
- Fuel Conditions 7
  - Procedures and Techniques 7
  - Quality Control 115
- Fuel Load 42, 57, 251
  - See also Dead and Downed Fuels*
- Fuel Model 13, 251
  - Developing a Custom 47
  - Fire Behavior Prediction System 8, 13
  - in Monitoring Type 35
- Fuel Moisture 8, 10–12, 16
  - Equation 215
- Funding 227
  - Additional 48
  - Control Plots 52
  - Monitoring of Suppression Fires 3
- Fungi
  - See Mushroom*

## G

- Geographic Information System 60–61, 251
- Geomagnetic Calculator 202
- Global Positioning System 61–62, 65, 75–76, 205–206, 227, 251
- Goals 251
  - Fire Management 5, 41
  - Goal vs. Objective 20
- GPS Unit 251
  - See also Precision, Light-weight, GPS Receiver*
- Grass 251
  - Biomass 90
  - Life Form Category 83
- Grassland and Brush Methods
  - Brush Biomass 89
  - Burn Severity 108
    - Codes 108, 110
  - Cover 80–81
  - Fire Behavior 106
  - Grass Biomass 90
  - Height 83
  - Herbaceous and Shrub Layers 80
  - Herbaceous Density 89
  - Immediate Postburn Monitoring 108
  - Laying out and Installing 64
  - Marking the Plot 64
  - Percent Dead Brush 89
  - Photographing the Plot 71
  - Plot Variables 42
  - Shrub Density 87
- Grass-like 251
  - Life Form Category 83
- Ground Cover 251

## H

- Handbook
  - How to use xii
  - Software 5
- Harvesting 251
- Hazardous Fuels 251
- Head Fire 251
- Height
  - Camera 72
  - Char 111, 248
  - Herbaceous Layer 83
  - Mixing 14
  - Mowing 132
  - Pole-size Trees 100–101
  - Quality Control 117
  - Scorch 111, 256
  - Seedling Trees 102
  - Stake 64, 68
  - Wind Speed 11
    - See also Diameter Breast Height*
- Herbaceous Cover 35, 38, 41, 47, 57, 114
- Herbaceous Density 88–89
  - Accuracy Standards 90
  - Forest Plots 89
  - Grassland and Brush Plots 89
  - Pilot Sampling 47

- Herbaceous Layer 251
  - Height 83
- Herbaceous Transect 80
  - Quality Control 114
- Holding Options 11, 15
- Horizontal Distance 251
  - See also Slope Distance*
- Humidity, Relative 11–12, 107
- Humus 251
- Hygrothermograph 252
- Hypothesis 252
- Hypothesis Tests 126, 128
  - Example 126
  - Interpreting Results 128

## I

- Identifying Dead and Dormant Plants 199
- Ignition Point
  - Procedures and Techniques 9
- Immature 252
- Immediate Postburn 252
  - Effects 4, 24
- Immediate Postburn Monitoring
  - Monitoring Schedule 53, 56
- Inferential Statistics 25, 126, 128, 249, 252
  - See also Descriptive Statistics, Null Hypothesis*
- Insects 29, 96–97, 197, 232–233
- Intercardinal Points 252
- Intermediate 94, 252
- Internet ii, 5, 7, 10, 84, 133, 224, 233, 240, 260
- Inventory 252

## K

- Keetch-Byram Drought Index (KBDI) 12, 252
- Key Variable 252

## L

- LANDSAT 15
- Level 1 Monitoring
  - See Environmental Monitoring*
- Level 2 Monitoring
  - See Fire Observation Monitoring*
- Level 3 Monitoring
  - See Short-term Monitoring*
- Level 4 Monitoring
  - See Long-term Monitoring*
- Lichen 86, 97, 229, 231–232, 248, 251–253
- Life Form 30, 83, 250–253, 256–258
- Line Transect 252
- Litter 252
  - as Substrate 81
  - Burn Severity 110
  - Depth 42
  - Measuring Depth 104
  - Quality Control 114
    - See also Duff*
- Live Fuel Moisture 12, 252
- Logistical Information
  - Procedures and Techniques 9
- Long-term Change ii, xii, 4–5, 24, 29, 41, 53, 119–120, 250

- Control Plots 52
- Data 4–5
- Undesired 134
- Long-term Change Monitoring 5
  - Example 120
  - Monitoring Schedule 55
  - Procedures and Techniques 5
- M**
- Magnetic Declination 202
- Magnetic North 201–202, 249, 252, 257
- Management Objectives ii, 1–3, 5, 7, 19–23, 25–26, 29, 33–34, 41, 50, 52, 119, 121, 124, 127, 130–131, 133, 217, 225, 250, 256
  - Change Objectives 23
  - Components 22
  - Condition Objectives 23
  - Examples 23, 39, 217
  - Reassess 133
    - Example 133
  - Types 23
- Management Strategy 1, 3, 11
- Maps
  - Fire Severity 15
  - Gridding 61
  - Monitoring Plot 75–76, 114–115
  - Navigation Aids 201–202
  - Overstory Trees 92
  - Pilot Sampling 43
  - Pole-size Trees 100
  - Scale 204, 212
  - Seedling Trees 102
  - Some Basic Techniques 204
- Marking and Mapping 252
- Mature 88, 252
- Mean 25–26, 28, 121–124, 126, 128, 216–219, 248–249, 252, 254, 256–257
- Median 122, 252
- Metadata 7
- Microbiotic Soil
  - See Cryptobiotic Soil*
- Microphytic Soil
  - See Cryptobiotic Soil*
- Minimum Detectable Change 25–26, 48, 50, 124–125, 217–218
- Minimum Sample Size
  - Calculating 49
  - Change Objectives 124
  - Condition Objectives 124
  - Equation 216
  - Recalculating 50, 124
  - Reducing 44
- Missed-Change Error 127–128
- Mixing Height 14, 17
- Mode 122, 252
- Monitoring 108, 253
  - Data Sheets 137
  - Design ii, 34, 43, 48, 50, 55, 127, 225–226
  - Environmental 5, 7–8
  - Fire Conditions 11–12, 14–15, 17
  - Fire Observation 5, 9
  - Frequency 5, 15, 55–57
  - Levels 3–4
  - Long-term Change 5, 41
  - Monitoring vs. Research 2
  - Reconnaissance 9–10
  - Short-term Change 5, 41
- Monitoring Design Problems
  - Gradient Monitoring 50
  - Small Areas 50
  - Species Difficult to Monitor 50
- Monitoring Objectives 23–27
  - Change Objectives 25
  - Components 23
  - Condition Objectives 26
  - Examples 26, 39, 217
- Monitoring Plan 16, 21–22, 225, 227, 229, 237, 259
  - Outline 225–227
- Monitoring Plot 24, 253
  - Calculating the Minimum Number of 49
  - Field Packets 112
  - Folders 112
  - Installation 64
  - Labeling Stakes 70
  - Mapping 75
  - Photographing 71
  - Plot Location 62
  - Randomization 59
  - Rejection Criteria 37
  - Tracking 112
  - See also Sample*
- Monitoring Results 1, 27, 121, 130, 133–134
  - Annual Report 134
  - External Publication 135
  - Formal Report 134
  - Management Implications 227
  - Postburn Report 15
- Monitoring Schedule xii, 7, 9, 11, 55–56
  - During Burn 56
  - Environmental Monitoring 7
  - Fire Conditions Monitoring 11
  - Immediate Postburn 53, 56
  - Long-term Change 55
  - Postburn 56
  - Preburn 56
  - Reconnaissance Monitoring 9
  - Short-term Change Monitoring 55
  - Smoke Monitoring 17
- Monitoring Type
  - Additional Headers 37
  - Alternative Methods 2
  - Burn Prescription 35, 37
  - Code 36
    - Examples 36
  - Consistency Among Plots 43, 47
  - Defining 34–36
    - Example 34
  - Describing 36
  - Establishing Selection Criteria 35
  - Example 38

- FGDC Association(s) 36
  - Five-Year Burn Plan 22
  - Folders 112
  - Fuel Characteristics 35
  - Level 3 & 4 Variables 41
  - Management Objectives 37
  - Monitoring Objectives 37
  - Name 36
  - Notes 37
  - Objective Variables 29, 37
  - Other Treatments 36
  - Physiography 35
  - Pilot Sampling 38, 43
  - Plot Protocols 38
  - Plot Specifications 44
  - Plot Type 36
  - Recommended Standard (RS) Variables 41
  - Rejection Criteria 37
  - Sample 24
  - Selecting 34, 36
  - Sensitive Species 35
  - Small Areas 50
  - Target Population 22
  - Treatment Prescription Modification 132
  - Vegetation Composition 35
  - Vegetation Structure 35
  - Monitoring vs. Research 2
  - Moss 86, 97, 105, 176
  - Mushroom 86, 96–97, 232, 248, 254, 256, 258
- N**
- National Interagency Fire Center iv–v, 4, 253, 259–262
  - National Interagency Fire Management Integrated Database (NIFMID) 253, 258
  - National Spatial Data Infrastructure (NSDI) 253
  - Navigation Aids 201–206
  - NEPA (National Environmental Policy Act) 1, 21, 253
    - Provisions of 1
  - NFDRS (National Fire Danger Rating System) 7, 13, 253
  - NHPA (National Historic Preservation Act) 21
  - NOAA (National Oceanic and Atmospheric Administration) 7, 10
  - Non-native Species 8, 22, 35–36, 42, 50, 52, 83, 120, 127, 132–133, 232, 253
  - Non-parametric Tests 253
  - Non-vascular 253
    - Life Form Category 83
    - Species Codes for 85–86
  - Notes 37
    - Example 39
  - Null Hypothesis 126–128, 252–254, 257
- O**
- Objective 253
    - Change 23
    - Condition 23
    - Management 20
    - Monitoring 23
    - See also Goals*
  - Objective Variable 29, 33, 253
    - Certainty 25–26
    - Comparing Vegetation Attributes 30
    - Desired Precision Level 28
    - Example 29, 39
    - in Monitoring Type 37
    - Short-term Change 41
    - Variability 25, 35
  - Objectivity 24
  - Open Growth 94, 253
  - Origin 253
  - Overstory Trees 91, 253
    - Accuracy Standards 99
    - Clonal or Rhizomatous Species 91
    - Crown Position Codes (CPC) 93, 95–96, 248
    - Damage Codes 96–97
    - Diameter at Root Crown 97
    - Pilot Sampling 44
    - Quality Control 114
    - RS Procedures 91
    - Size Classes 44
    - Suggested Plot Specifications 44
- P**
- Pace 203–204, 254
    - Determining 203
    - Example 203
  - Paired Sample t-test 254
  - Palmer Drought Severity Index (PDSI) 12, 254
  - Parametric Tests 254
  - PDOP
    - See Position Dilution of Precision*
  - Percent Cover 23, 25–26, 29–30, 42, 80, 88, 213, 217–218, 248, 254–255
    - Equation 213
  - Percent Dead Brush 89
    - Pilot Sampling 47
  - Perennial 82–83, 85–86, 194, 200, 251, 254
  - Perimeter 254
    - Growth 13
  - Periodic Fire Assessment 254
  - Periphyton 254
  - Phenology 254
    - Ecological Model 225
    - Fuel 8
    - in Monitoring Type Code 36
    - in Photographs 71, 74
    - Sampling 55–56, 226
    - Treatment Season 132
  - Photo Documentation 73, 79, 114
  - Photographs 57
    - Aerial 60
    - Basic Guidelines 207–208
    - Equipment and Film 72
    - Film 73
    - Quality Control 114
    - RS Procedures 71
    - Scorch Height 111
    - Storage 112
    - Taking into the Field 72
  - Physical Description 37, 59



- Example 39
  - Pilot Sampling 2, 33–34, 37–38, 43–48, 55, 59, 89, 218, 226, 254
  - Plant Association
    - See Vegetation Association*
  - Plant Identification 84, 87, 193, 196, 226–227
    - Dead and Dormant Plants 199–200, 240–245
    - Resources 199–200
    - Tools and Supplies 194
  - Plant Mortality 15, 30
  - PLGR
    - See Precision, Light-weight, GPS Receiver*
  - Plot Location Points (PLPs) 59, 63
    - Assessing Suitability 62
    - Random Assignment of 59–60
  - Plot Protocols 36, 38
    - Example 38, 40
  - Plot Specifications 44
  - Plot Type xii, 29, 36, 55, 61, 64, 80, 87, 108
  - Plotless Sampling 254
  - PM-10 14, 17, 254
  - PM-2.5 14, 17, 254
  - Point Intercept Method 81, 254
    - Advantages vs. Limitations 31
  - Pole-size Trees 100, 254
    - Accuracy Standards 101
    - Diameter at Root Crown 100
    - Height 100
    - Pilot Sampling 45
    - Quality Control 114
    - RS Procedures 100
    - Suggested Plot Specifications 44
  - Policy, Fire Monitoring 1
  - Population 254
  - Position Dilution of Precision (PDOP) 75, 206, 254
  - Postburn Report 15
  - Potential for Further Spread
    - Procedures and Techniques 10
  - Power 26, 127, 254
  - Precision 26–28, 30, 44, 48–49, 55, 124, 216–217, 254
    - Example 28
    - See also Confidence Interval*
  - Precision, Light-weight, GPS Receiver 75, 205–206, 254
    - See also GPS Unit*
  - Prescribed Burn Boss 254
  - Prescribed Fire 254
    - Burning the Units 53
    - Monitoring Policy 1
    - Plan 255
    - Recommended Standard (RS) 4
    - Smoke Monitoring 15
  - Prescription Weather Station 255
  - Pressing Voucher Specimens 194–195
  - Problems
    - Burning 53
    - Clonal or Rhizomatous Species 88
    - Dead Branches of Living Plants 82
    - Dead Herbaceous and Shrub Species 82
    - Dramatic Increases in Postburn Seedling Density 51, 102
    - Dramatic Increases in Postburn Shrub Density 88
    - Gradient Monitoring 50
    - Large Obstructions Encountered on the Transect 68
    - Obstruction Along the Fuel Transect 103
    - Partially Burned Plots 53
    - Plot Burned Out-of-Prescription 54
    - Plot Burning Off-Schedule 53
    - Plot Burns at Different Time Than the Burn Unit 53
    - Rebar Won't Go In 69
    - Sampling DBH 92
    - Short Fire Intervals 53
    - Small Areas 50
    - Species Difficult to Monitor 50
    - Sprouting Dead Trees 82
    - Tall Vegetation 82
    - Toxic Plants at DBH 93
    - Unplanned Ignitions 53
    - Void at BH 92
    - Working on Steep Slopes 63
  - Procedures and Techniques
    - Environmental Monitoring 7
    - Long-term Change Monitoring 5
    - Reconnaissance Monitoring 9
    - Short-term Change Monitoring 59
  - Program
    - Evaluation 119, 131, 135, 226
    - Example 132
    - Responsibilities of Personnel 4
  - Pseudoreplication 128, 259
- Q**
- Qualitative Variable 255
  - Quality Control 4, 17, 113–115, 117, 226
    - Data Entry 116
    - Example 114
    - in the Field 115
    - in the Office 115
    - Monitoring Types 51
    - While Remeasuring Plots 114
  - Quantitative Variable 255
- R**
- Random Number Table 190
  - Random Numbers
    - Using Spreadsheet Programs to Generate 191
  - Random Sampling 255
    - See also Restricted Random Sampling, Stratified Random Sampling*
  - Range 255
  - Rate of Spread (ROS) 255
    - Measuring 13, 106
  - Real-time 255
  - Recommended Response Action 255
  - Recommended Standards (RS) 2
    - Brush or Shrubland Plot Variables 42
    - Cover 81
    - Fire Conditions Monitoring 11
    - Forest or Woodland Plot Variables 42
    - Fuel Load 103
    - Grassland Plot Variables 42
    - Herbaceous and Shrub Layers 80
    - Herbaceous Density 89

- Immediate Postburn Vegetation & Fuel Characteristics 108
- Long-term Change Monitoring 41, 55
- Modifying 2, 29, 41, 55
- Overstory Trees 91
- PM-2.5 and PM-10 14, 17
- Pole-size Trees 100
- Prescribed Fire 3
- Reconnaissance Monitoring 9
- Required by Management Strategy 3
- Seedling Trees 102
- Short-term Change Monitoring 41, 55
- Smoke Characteristics 14
- Suppression 3
- Wildland Fire Use 3
- Reconnaissance Monitoring 9–10, 255
  - Monitoring Schedule 9
  - Procedures and Techniques 9
- References
  - Adaptive Management 239
  - Air, Soil and Water 231
  - Amphibians and Reptiles 233
  - Fire Conditions and Observations 230
  - Fuels 237
  - General Monitoring 229
  - Mammals 236
  - Methods for Nonstandard Variables 229
  - Mistletoe, Fungi, and Insects 232
  - Vegetation 237
  - Vegetative Keys 240
- Rejection Criteria 34, 255
  - Defining 37
  - Example 37, 39
  - Initial Plot Rejection 59
  - Use of 61–62
- Relative Cover 30–31, 42, 213, 248, 254–257
  - Equation 213
- Relative Humidity 11–12, 16, 107, 255
- Remeasurement 255
- Reminder
  - Accurate Maps 115
  - Be Kind to the Fragile Herbage, Fine Fuels and Soils Beneath You 81
  - Clean Data 117
  - Consistent Sampling Areas 47
  - Fire Behavior Accuracy Standards 106
  - Fuel Load Accuracy Standards 103
  - Herbaceous and Shrub Layer Accuracy Standards 81
  - Immediate Postburn Vegetation and Fuel Characteristics Accuracy 108
  - Management Objectives and Adaptive Management 21
  - Map Direction 205
  - Mapping 75
  - Obtaining Accurate Compass Bearings 201
  - Overstory Tree Accuracy Standards 91
  - Plot Location and Burn Units 56
  - Pole-size Tree Accuracy Standards 100
  - Program Changes 121
  - Rephotographing Plots 72
  - Resource Management Plan 21
  - Subshrubs in Shrub Density 88
  - Summarizing Results 124
  - Symbol Definition xiii
  - Remote Automatic Weather Stations (RAWS) 7, 11–12, 255
  - Replication 24, 255
  - Representativeness 24–25, 255
  - Research 255
    - Monitoring vs. Research 2
    - Required 4
  - Resource Advisor 11, 15
  - Resource Availability
    - Procedures and Techniques 8
  - Resource Management Plan 1, 4, 7, 21
  - Resource Value at Risk 255
  - Resprout 255
    - Immediate Postburn Tree Class 111
    - Seedling Tree Class 91, 100, 102
    - Shrub Age Class 88
    - Tree Bole 91, 100
  - Restoration Burn 255
  - Restricted Random Sampling 43, 56, 59, 129, 226, 255
    - See also Stratified Random Sampling*
  - Rhizomatous Species
    - See Shrub Density* 61
  - Root Crown 47, 97–98, 100, 110, 114, 214, 249
  - ROS
    - See Rate of Spread*
  - RS
    - See Recommended Standard*
  - Rules
    - Burning 53
  - Running Fire 256
  - RX WINDOWS 132
- S**
  - Sample 256
    - Burning 53
    - Burning Problems 53
    - Data Variability 24–25, 34, 122–123
    - Representative 25
    - Small Areas 50
  - Sample Size 24–27, 29–30, 32, 59, 216–219, 226, 252–253, 256
  - Sampling Design Alternatives 27
  - Sampling Problems 82, 92, 105
  - Sampling Rod 65, 81–83, 256
  - Sampling Techniques 114, 229, 234, 237, 261–262
  - Sampling Unit 24, 31, 59, 226, 254–256
  - Scale
    - Calculating From a Map 204
      - Example 204
    - Equivalents in Feet, Meters and Acres 212
  - Scorch Height 42, 57, 111, 256
    - Accuracy Standards 111
  - Seed Bank 256
  - Seed Traps 256
  - Seedling Trees 102, 256
    - Accuracy Standards 102
    - Dramatic Increases in Postburn Density 51, 102
    - Height 102

- Pilot Sampling 45
- Resprout Class 102
- RS Procedures 102
- Suggested Plot Specifications 44
- Shading and Cloud Cover 12
- Short Fire Intervals 53
- Short-term Change ii, xii, 2–5, 29, 41, 119
  - Data 4–5
  - Example 119
- Short-term Change Monitoring 5, 256
  - Monitoring Schedule 55
  - Procedures and Techniques 59
- Shrub 256
  - Age Class 42, 88, 252, 255
  - Biomass 89
  - Immature/Seedling 88, 252
  - Life Form Category 83
  - Mature 88, 252
  - Resprout 88, 255
  - See also Grassland and Brush Methods*
- Shrub and Herbaceous Layer
  - Pilot Sampling 45
  - Suggested Forest Plot Specifications 44
- Shrub Density 42, 57, 87
  - Accuracy Standards 90
  - Age Classes 88
  - Anticipated Dramatic Increases in 88
  - Clonal or Rhizomatous Species 37, 46, 88
    - Examples 88
  - Dead Burls 88
  - Pilot Sampling 46
  - Quality Control 114
  - Resprouts 88
  - Subshrubs 88
  - Suggested Forest Plot Specifications 44
- Significance Level 25–26, 126–127, 218
- Slides
  - Labeling 72
  - Stable Film 73
  - Storage 112
  - Taking into the Field 72
- Sling Psychrometer 256
- Slope 256
  - Accuracy Standards 76
  - Advice for Installing Brush Plots 65
  - Converting Between Degrees and Percent 211
  - Determining Your Pace on Sloping Ground 204
  - Fuel Transects 76
    - in Measuring Cover 81
    - in Measuring DBH 91
    - in Monitoring Type 35, 39
  - Measuring Using a Clinometer 203
  - Photographic Protocols 72
  - Plot Location Description 75
  - Procedures and Techniques 11
  - Slope Distance 67, 256
    - See also Horizontal Distance*
  - Transect 75
  - Variable 67
  - Working on Steep Slopes 63
- Smoke
  - Carbon Monoxide 14
  - Characteristics 14
  - Documented Complaints 14
  - Mixing Height 14
  - Monitoring Data Sheet 15
  - Monitoring Variables 17
  - Particulates 14
  - Total Production 14
  - Transport Winds 14
  - Visibility 14
  - Volume and Movement 10
- Smoldering 256
- Snag 93, 95–96, 256
- Soil Type
  - in Monitoring Type 37, 39
- Species Codes
  - Examples 83
  - for Dead or Inorganic Material 86
  - for Non-vascular Plants 86
  - for Unknown Plants 84–86
    - Guidelines 83
- Species Composition 256
- Species Diversity 256
- Spotting 256
- Stake
  - Absolute Minimum Number Needed 68
  - Burial of 64, 67–68
  - Height 64–65, 68
  - in Photographs 72, 74
  - Installing 63
    - Forest Plots 67–68
    - Grassland and Brush Plots 64
  - Labeling 70
  - Painting 64
  - Reference 76
  - Tag Specifications 224
- Standard Deviation 27, 48–49, 121–124, 128, 131, 216–218, 256
  - Equation 216
  - Example 123
- Standard Error 122–124, 218–219, 248, 254, 256
  - Equation 218
  - Example 123
- Standardized Precipitation Index (SPI) 12, 256
- Statistic 256
- Statistical Inference 257
- Statistics 4, 23, 25, 249, 252, 257, 259–261
- Strategies, Fire Management 4
- Stratified Random Sampling 59, 257
  - See also Restricted Random Sampling*
- Subcanopy 94, 257
- Subshrub 257
  - Life Form Category 83
- Substrate 257
  - Aerial 83
    - at Each “Point Intercept” 81
  - Burn Severity 108–110
  - Codes for Dead or Inorganic Material 86
  - Life Form Category 83

Suppression 3, 9, 248, 255, 257–258  
  Recommended Standards (RS) 3  
Surface Fire 257  
Surface Winds 257

## T

### Tags

  Monitoring Plot 70, 103  
  Sources 224  
  Stamping 70  
  Tree 91–93, 98, 100, 111

### Temperature 16

  Procedures and Techniques 11

### Timelag 257

  Fuel Moisture 12

### Tip from the Field

  Advice for Installing Brush Plots 65  
  Before You Visit a Previously Established Plot 80  
  Carrying Rebar 67  
  Control Plots 52  
  Damage Codes 97  
  Data Analysis Record 121  
  Data Management 116  
  Defining the Brush Belt 64  
  Different Sizes and Shapes of Sampling Areas 47  
  Duff Moisture 12  
  Field Handbook xii  
  Finding Errors in Density Data 116  
  Finding Errors in Fuels Data 116  
  Finding Errors in Species Cover Data 116  
  Fireline Safety 13, 107  
  Geodetic Datums 206  
  Grid or XY Coordinates Method 61  
  Importance of Good Preburn Photos 72  
  Increase Your Chances of Accepting a Plot Location Point 63  
  Large Obstructions Encountered on the Transect 68  
  Locating Your First Plots 59  
  Measuring DBH without a Diameter Tape 92  
  Measuring Duff and Litter 104  
  Monitoring Types 35  
  Navigation Aids 62  
  Nonstandard Stamp Additions 70  
  Pilot Sampling 43  
  Plot Squaring Priorities 67  
  Randomization 62  
  Redesigning an Existing Sampling Design 43  
  Reference Features 75  
  Sampling Rods 81  
  Save Time Stamping 70  
  Streamlining the Form Filling Process 80  
  Successful Photos 74  
  Symbol Definition xiii  
  Tall Vegetation Sampling Problems 82  
  Timing Burn Severity Data Collection 108  
  Toxic Plants at DBH 93  
  When an Obstruction is Encountered Along the Fuel  
    Transect 103  
  When The Rebar Won't Go In 69

Topographic Variables 11

Torching 257

Transect 257

Tree 257

  Density 42, 57

  Life Form Category 83

*See also Overstory, Pole-size, Seedling Tress*

Tree Damage 93, 96–97, 99

  Accuracy Standards 99

Trends 23, 30, 35, 41, 120, 134

  Responding to 41–42, 120, 134, 227

  Useful 5

True North 202, 249, 257

Type I Error 127–128, 225, 257

Type II Error 127–128, 225, 254, 257

## U

Universal Transverse Mercator (UTM) 257

  Determining Using a GPS Unit 206

  Fire Location 9

  Mapping 75

  Plot Location 205

  Plot Location Points (PLPs) 60, 62

Unknown Plants 84, 87, 115, 193

  Example of Description 84

  Species Code Examples 85

Unplanned Ignitions 53

## V

Variability 25, 257

Variables 257

  Examples 23

  Nonstandard 29, 229

  Objective 29–30

    Examples 29

*See also Objective Variable*

  Recommended Standard (RS) 13, 42

Vascular Plant 257

Vegetation

  Burn Severity 108–110

Vegetation Association 13, 22, 33–37, 109, 131, 225–226,  
247, 249, 253, 258

  Federal Standard 35–36

Vegetation Attributes

  Compared 30

Vegetative Layer 258

Vine 86, 258

  Life Form Category 83

Visibility 8, 13–14, 17, 68, 261

Visual Estimates 258

*See also Frequency*

Voucher Specimen 258

  Collecting 87, 193

  Quality Control 115

  Voucher Label 87

  Voucher Style 197

## W

Warm Season Species 258

Warning

  Accuracy Standards 80

Alternative Methods 2  
 Appropriate Statistical Tests 131  
 Assigning Species Codes 83  
 Change Over Time 50  
 Collecting Fire Behavior and Weather Data 106  
 Confidence Level and Precision 49  
 Control Plots 2  
 Counting Dead Branches of Living Plants as Dead 82  
 Crown Position Codes (CPC) 96  
 Data Backup 113  
 Data Collection on Trees with a CPC of 10–12 96  
 DBH Remeasurement 58  
 Dead Herbaceous and Shrub Species Sampling Problems  
     82  
 Diameter at Root Crown 98  
 Documenting Rare Plants 87  
 Forest Plot Burn Severity 109  
 Forest Plot Data Sheet (FMH-7) 76  
 Fuel Load Measurements 103  
 Grassland and Brush Plot Burn Severity 109  
 Identifying Species Using Only Vegetative Characters 199  
 Life Form 83  
 Limited Amount of the Monitoring Type Available for  
     Burning 56  
 Minimum Detectable Change 25  
 Minimum Sample Size 49  
 Minimum Sample Size for Minimum Detectable Change  
     50, 125  
 Objective Variables Not Covered by this Handbook 29  
 Offsite Data Backup 112  
 Photographic Protocols 72  
 Precision 28  
 Professional Input and Quality Control 51  
 Rate of Spread 106  
 Required Research 3  
 Restricted Random Sampling 59  
 Sampling Area Consistency 43  
 Sampling Problems with DBH 92  
 Scorch and Char for Pole-size Trees 111  
 Seedling Resprout Class 102  
 Sprouting Dead Trees 82  
 Symbol Definition xiii  
 Taking Slides into the Field 72  
 Toxic Plants at DBH 93  
 Treatment Prescription Modification 132  
 Void at BH 92  
 Voucher Label 87  
 Working on Steep Slopes 63  
 Weather  
     Automatic Stations 7, 11  
     Procedures and Techniques 7, 10, 107  
 Wet-bulb Temperature 258  
 Wildland Fire 1, 3, 9, 11, 77, 223, 247–248, 250, 253–255,  
 258, 261–262  
     Immediate Postburn Monitoring 41  
     Monitoring Policy 1  
     Smoke Monitoring 15  
 Wildland Fire Implementation Plan 3–4, 9, 11, 258  
 Wildland Fire Use 1, 3, 56, 248, 255  
     Recommended Standards (RS) 3

WIMS 253, 258

Wind

Direction 12

Speed 11