

Opel GT Paint Project Notes: Table of Contents



(Page 1) Table of Contents

(Page 2) Making Your Commitment
A think-piece on "how" and "why" you can translate your intentions to a finished project

(Pgs 3-4) Getting Yours Started/Planning and Action
A breakdown of some initial steps

(Page 5) Paint Prep "Top 10 Checklist"
Simplified presentation of the basics for a GT paint project

(Page 6-7) Paint Prep Considerations
Details regarding color selection and body prep

(Pgs 8-9) Original Opel GT Paint Mixture Notes & Chip Chart
For original-color repaint jobs, a handy reference guide with notes

(Pgs 10-11) Paint Shop Preparation Checklist/Part Preparation Checklist
Notes on the next step of the process

(Pgs 12-16) Opel GT Source Body & Door Parts
Selections from OGTSource part catalogs for your paint project. Includes: New window rubbers, door rebuild and body parts

(Page 17) Floor Pans
Presents the popular "Mustang option" for quality and savings

(Page 18) Windshield Notes and Wiper Notes
Includes windshield supplier reference and related notes

(Page 19) Important Reminders
Smaller thoughts, including not to let slip-ups and frustration distract you from completing your final goals

(Page 20) Diagrams
Enable improved communication with your body/paint shop, by using these outlines as a visual reference for professionals you choose to hire

(Pgs 21-22) Post-Paint Tips
Be Happy (by taking action proactively, to avoid a few well-known post-paint heart-breakers)

(Page 23) Opel GT Source (About Us)

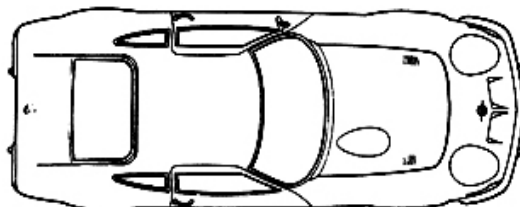
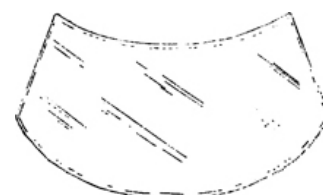
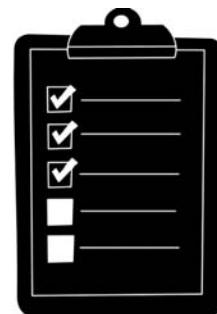

Opel GT Paint Project Notes

Opel GT owners (and future GT owners) all agree:
They had to see an Opel GT, to want it.

Once they saw a nice Opel GT, they all wanted to own it

From there, owners recognized they had a cool car and a timeless classic, but many got stuck at just promising themselves that they would restore it “someday.”

We want all Opel GT owners to share this journey and the rewards, of fulfilling their visions for this beautiful vehicle, with their choice of color and options, as their desires see fit.



(Above Illustration, by GT Designer Erhard Schnell)

Making Your Commitment

Motivations can vary. Some find “quiet garage time” a sanctuary from work and domestic issues. Others do it for the kids. Some fix a GT up, to allow the car to be seen as it was meant to be seen (so many parked GT’s survived these 30+ years, because so few had the heart to depart from a car with such contagious charm). Other GT owners have been encouraged by results of initial mechanical repairs, and feel empowered and ambitious to take on greater tasks. In more advanced cases of “Opelitis,” it’s not unprecedented that several so-so backyard “donor” cars are combined to make up one very nice GT.

It’s a checklist and a challenge. An important first step, is evaluating realistically, whether you have a suitable restoration candidate GT or need to search for another restorable GT. Deciding whether to strictly retain the original body contours and color scheme, or which modifications to adopt and install, is the next step. Another is performing an inventory of parts necessary or desired, to be acquired, replaced, or improved. Stockpiling needed parts, setting aside a budget, planning a realistic (and seasonable) time schedule for the work, locating trustworthy paint/body professionals, disassembling and paint-prep, then transporting and ultimately re-assembling the GT, are all part of this process.

Good news is, more new replacement parts are available now from Opel GT Source than there were 25 years ago. Many exclusive reproductions and upgraded parts are now in our inventory and appear in our part catalogs, plus we have a warehouse full of common used parts that are also available (on request). To help encourage additional Opel restorations using higher-quality Opel GT Source parts, some hard-won lessons from our clients’ prior projects, are described here.

The results, ultimately, are very rewarding. Although quality GT restorations do appreciate faster than less ambitious projects, it’s best to think of the process as an investment for yourself. A beautiful GT is something you can possess, take pride in, and view again and again (typically at a cost of thousands of dollars less than other vintage sports cars — and certainly for less than the most comparable new roadsters). Driver’s of restored GT’s already know, just driving down the road or stopping at a filling station, provokes all manner of neck-craning, looks, waves, and impromptu conversation.

It’s also a tribute to the original design accomplishment of the GT. You can observe the way light reflections glow on a fresh coat of wax, cascading to shadows sweeping off a sensuously curvy fender, wrapping with the chiseled crease of a silvery chromed bumper, as testimony to the inspiration of automotive artists who let imagination sculpt their passions. The details; Pivoting hideaway headlights, real & functional hood louvers, standout taillights, are even more ingenious. At the peak of the muscle-car era, the Opel GT won Style Auto’s prestigious “best styled production car” award in 1969. We don’t see anything new on the road approaching classic GT’s, and modern restrictions mean we probably won’t again.



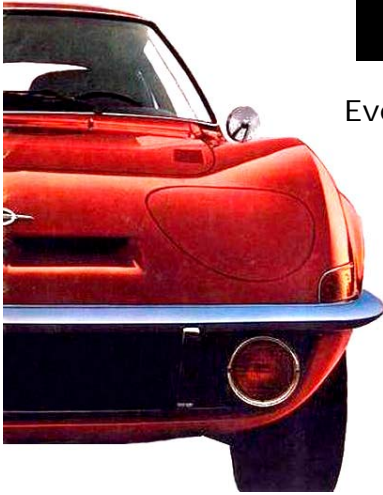

Opel GT Paint Project: Getting Yours Started

Every Opel GT owner knows, that they have a beautifully styled “cool car” Often all that’s needed to realize its beauty, is completing a paint job.

You can choose to restore your Opel GT to its original condition and color (paint code is on the firewall plate, exterior hardware is shown on following pages), or you can modify your Opel GT (in another color, with other parts and accessories).

When planning your paint job, in order to avoid unwanted delays, we suggest purchasing all necessary parts before you start, so that the progress on your project will not be interrupted or stopped. This is because vendors produce critical Opel GT parts in batches, and sometimes delays occur in-between production runs. Having parts in hand, also allows you or your shop to proceed at a pace that is best for your car—which is especially important if you have a deadline (like an appearance at a car show or a “gift” delivery) planned.

Pivoting headlights, sharp lines on rounded fenders, are unique GT features

When planning a paint job, also consider the condition of some of your interior parts.

In particular, it’s the best time to perform a headliner replacement and/or service of the heater system, dashboard, or some interior wire looms (because access to these components is much easier, when the glass and mouldings are already removed from the body—as typically happens during preparation for paint).

Not sure, of what you want your repainted GT to look like?

Fortunately, excellent images of Opel GT’s (painted in every color of the rainbow), are now on the internet—just a click away.

A well-done restored GT, is something you can look upon with pride, again and again, for years to come. Parts and advice from Opel GT Source can help you realize the GT of your dreams.

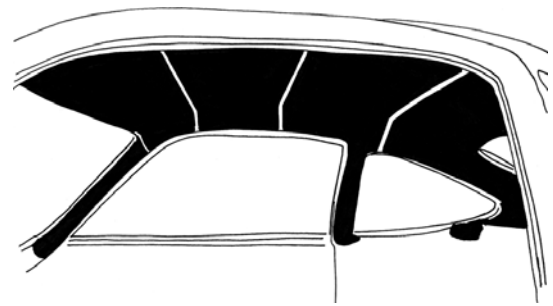

Is your headliner intact?

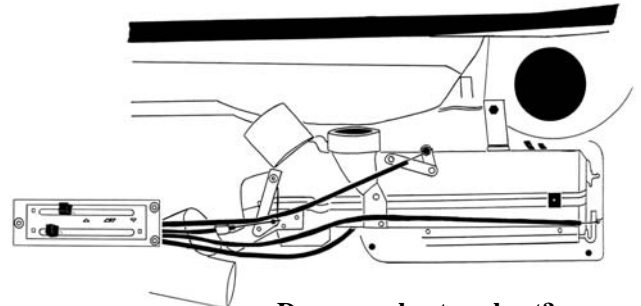

Does your heater - heat?

Recommended: Seals, Bumpers, Gaskets

Don't overlook these small but important parts:

- #2014 Door Top Bumpers (2 required)
- #2018 Side “Popout” window grommets (if on 1971-73 GT)
- #2030 Floor Plugs
- #2031 Door Handle Gasket Set
- #5555 Exterior Lens Gasket Set
- #6038 Hood Bumpers (4 required)
- #9007 Fuel Line Boot
- #9014 Gas Tank Filler Neck Gasket
- #12010 Rear Underbody Drain Boots
- #12094 or #12095 Grommet Sets for Body Emblems

All parts can be found online at: <http://www.opelgtsource.com>

For best results, we suggest approaching your Opel GT Paint Project in 2 phases:

(1) Planning

Start by evaluating the condition of the car body, make styling decisions and then make an inventory of parts to acquire.

— Note areas of repair of body damage or rust on diagrams showing the front, rear, sides and top areas of the Opel GT.

— Research and note your styling preferences: Will this be a restoration with original model-year-accurate GT parts and color, or a modification with the solid-rubber European “GT/J” style window mouldings, or will this be another style?

— Make a list of exterior hardware and other items you need to either replace or upgrade, based on your choices and the parts available in this guide.

Also research and make important decisions, like whether to remove the headlight buckets (or to rotate them in position while painting the car), whether to paint the under-hood and door jamb areas, and whether to retrofit with “opening” side quarter windows. Available reference materials include paint job “tech tips” offered with related parts from Opel GT Source.

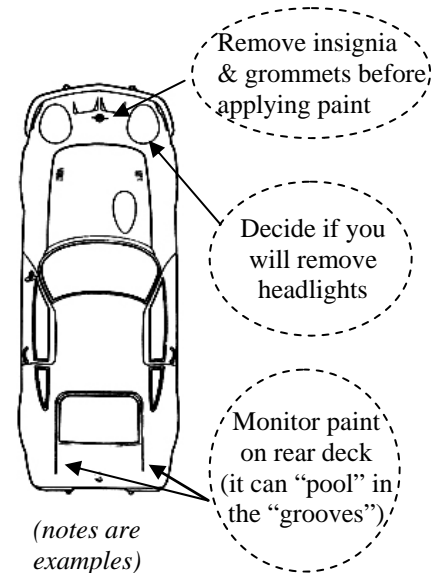

Above: “GT Body Diagram”

Marking diagrams and providing copies, will assist successful communications with your paint/body service providers.,

(2) Action

Disassembly and storage choices help ensure your success - especially with tricky “GT-unique” hardware pieces. Printed instructions are available that detail the safe removal of headlights, approaches to door disassembly, unbolting of the rear trim strip and wiring schematics of exterior lights - (copies of these can be requested with part orders).

“Bagging and Tagging” parts as you remove them (especially small screws, bolts and unique connector pieces) and storing removed parts safely (in clearly-labeled, sturdy boxes in a designated corner of your garage) pays off when it’s time to reassemble a freshly-painted Opel. Also apply tape and baggies on all wire ends (to avoid overspray).

Preparation can include sanding metal surfaces that are to be painted (some prefer to re-apply paint on the sturdy original factory primer layer, others choose to strip the car to the bare metal) and masking off other areas (that will not be painted). Priorities at this stage of the project include maintaining good communication with your paint/body shop (put all instructions in writing, and use body diagrams to indicate repair areas).

Another important activity is cleaning, prepping and lubricating removed parts while the car is being painted, so you are “ready to go” for the (fun) reassembly stage - after the paint has had time to fully “cure”.

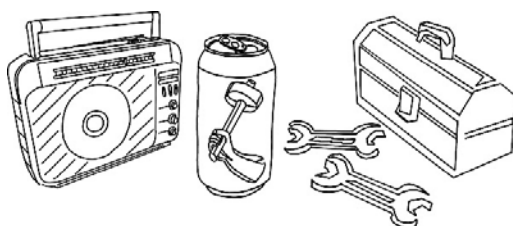
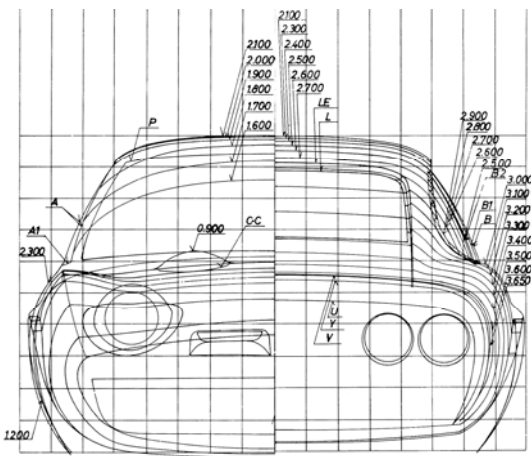

We also suggest maintaining a pleasant working atmosphere, by clearing a “project area” dedicated to your GT, and stocking it with your choice of tools, supplies, books, lighting, heating/cooling elements, music and energizing beverages.

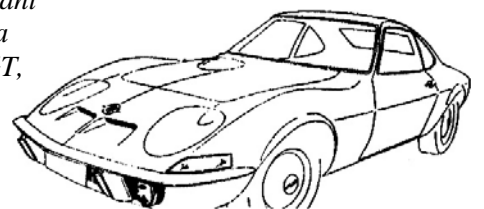

Paint Prep “Top 10” Checklist:

Following these notes, will help you make the most of your investment

(1) Inspect and Evaluate Condition of your GT

As you do this, make notes on xerox of car “body diagram” (on a following page). Scrutinize typical GT rust areas (behind the wheels, below the floor pan and inside the rocker panels). Also use a magnet to locate where “bondo” body-filler was used (where a magnet doesn’t “stick”), and also note missing or misadjusted parts. When there’s a choice, also consider acquiring a better GT body (if one costs less than repair labor).

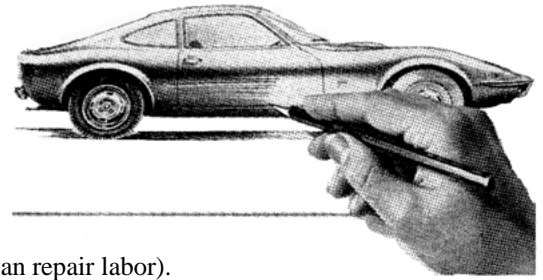

(2) Do some research

Spend some time in particular, on subjects covered on the following pages such as “paint prep considerations” (like selection of a paint color, aspects of GT body repairs, and “hands-on” paint preparation procedures). You can also consult Opel GT Source tech tips (supplied with our parts) too.

(3) Make Your Choices: (Original GT Style or Modified? GT A/L or GT/J Exterior Mouldings?)

Write your decisions on car diagrams and in a notebook, and place all papers and photos in a folder or binder (so nothing gets lost)

(4) Secure a comfortable and safe working environment

Also plan how to trailer your car body to repair shop (s), and where to park (for a 30-day paint curing period and when you are doing part reassembly jobs)

(5) Acquire needed (new) parts, BEFORE you begin your paint job!

Your checklist should consider or include:

- Front, Side and Rear Window Rubber Mouldings
- Chrome Insert and Chrome Corners (if GT A/L style exterior is chosen)
- Hood Bumpers and Door Top Bumpers
- Door Weatherstripping: External Body and Internal Door Rubber
- Door Handle Gasket Set, and Exterior Lens Gasket Set
- Grommet Sets for Emblems, and Side “Popout” windows (if on 1971-73 GT)
- Gas Tank Filler Neck Gasket, Body Emblems
- (Round) Floor Plugs and Rear Underbody Drain Boots
- Exterior Body Hardware (Chrome Bumpers, Mirrors, Lights, and other parts)

The reason for this, is that vendors produce critical Opel GT parts in batches, and *you don’t want to have to wait for the next production run* (if they are sold out) !

This list could also include critical body items like fiberglass body panels, and optional items like a new headliner, heater plate and dash cover (if you decide to combine projects).

(6) Acquire desired (used) parts

Give us a call, or email/fax a list of what you want or need to Opel GT Source.

(7) Acquire needed materials and supplies

Gather supply of gallon-size & sandwich-size plastic baggies, & boxes to safely store parts. Also consider special auto body abrasives, adhesives, masking tape, tools, and cleaners.

(8) Make a preliminary schedule

Don’t promise anyone (or yourself) a specific completion date, as unplanned complications (like dealing with rust discoveries or broken bolts) can occur. Include time for outside service jobs (like re-chroming, headliner installation, or dash recovering work)

(9) Consult with body and paint shops, for prices and best times to bring car in

Supply them your “body diagram” and notes, ask for their ideas, ask for a vial of “touch up” paint, and get estimates in writing.

(10) Important Additional Things (to do and to know)

Run your gas tank low, then drain as much as gas out as is possible, before beginning prep work.

Do NOT disassemble the front suspension, unless the drivetrain is in the car (you need engine weight to compress the GT spring)

- Organize your parts: Bag your parts with their original attaching hardware (and place identification notes in each bag)
- Keep unused “extra” parts secure (away from pets/kids) in sturdy boxes at home (so a shop can’t lose them), and mark the boxes
- Many GT parts are side-specific: Note their origin and mark them Driver’s/Left or Passenger/Right side when they’re removed
- Keep your old rubber after it’s removed, as you may want to reuse it on the car (if it’s parked outside before fresh paint is “cured”)
- Take digital photos, and make notes throughout the process (these really come in handy, during reassembly)

opelgtsource.com ©2016

Enjoy “energy drinks” while working, and be happy! (We learned these the hard way—You don’t have to repeat our mistakes!)

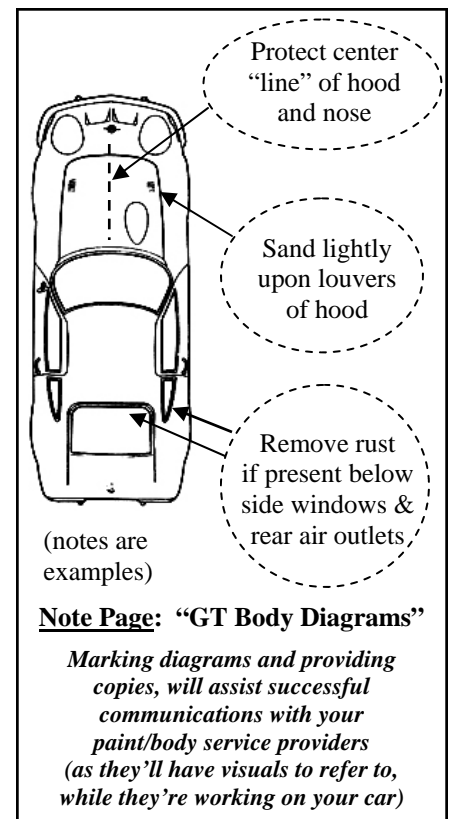

Paint Prep Considerations

(1) Color Selection:

It's a matter of "individual preference" as well as intention.

Ask yourself:

Are you repainting a GT in an original color for show-quality "concours" judging and higher resale value, or changing its color for your own personal enjoyment?

See the firewall VIN plate to identify the GT's original color. Original US-export Opels received enamel paint, with mixtures by Dupont & Ditzler.

Non-original colors, run the gamut of the rainbow.

Considerations include

Your typical driving weather (dark colors draw interior heat from the sun)

View impressions (light colors make a GT look larger, dark colors it appear smaller)

Risk factors (red cars are said to receive more attention from traffic officers)

Body condition (light colors like white are more forgiving to repairs, while very dark colors like black reveal every imperfection on the GT body).

A process for deciding what color you want can include

Looking at photos of Opels online to seek out what you like

Looking at other car models (it's said, if a color looks good on a BMW or a Porsche, it'll look better on a GT)

Looking at paint chips online (at www.autocolorlibrary.com), or "chip books" at a local auto paint shop.

Understanding that there is no one source that is completely color-accurate (computer screens and even paint books do not reproduce pigments consistently). Other factors (age of a paint sample, time of day, indoor vs. outdoor lighting, direct sunlight or shadows, how paint will fade) all affect perceptions of the look of a color. You've found it, when you like a color you see, on another car on the street.

Other variables include color differences between manufacturers and paint mixtures (per EPA regulations). You can choose among tougher urethane enamels, apply multiple stages of a lacquer and/or a clear coat, or adopt other formulas.

(2) Body Repair:

Start by visiting the library or bookstores and consulting articles and books devoted to just this subject, then talk to experienced professionals to learn more. *(Be aware, that some providers of opinions, such as used car re-sellers or social media on the Internet, are not as reliable as a source)!*

Then you should inspect your vehicle.

Where cosmetic work is needed, you can consider options like available new replacement panels (such as a fiberglass belly pan, nose panel or taillight panel). Damaged wheel openings can be masked with wheel flares.

Rusted out floor panels can be replaced, by welding in reproduction sheet metal pieces (which are now remanufactured for the classic Ford Mustang).

If you require other panels, you can seek out a fellow Opel owner who will cut those for you from their spare "parts car" (or consider purchasing a "parts car" of your own), to receive the best economic value.



Paint
"chip"
samples

opelgtsource.com ©2016



"Extreme" Body
Repair at Home

Because the GT is a vintage 1960's all-steel body, you need to treat all rust before applying paint.

Look carefully for rust in corners and even in obscure areas (like the lower windshield and lower side window grooves). Minor surface rust areas can be sanded down, treated with POR-15 or similar chemicals, then covered with spray-primer. A common rust area behind the rear wheels, can be repaired by replacement with generic new sheet metal curved to fit.

But when rust is extensive, rather than replace metal panels, we advise you to reconsider the idea of a complete restoration. Consider a temporary "re-spray" paint job using primer (or even spray-paint, per instructions available online), so you can seek out a better GT body—but still enjoy your car in the meantime.

Dealing with "bondo" (body filler) is another matter. Use a magnet to locate bondo (where the magnet won't "stick"). Generally it's a good idea to remove old body filler down to the old metal, then treat any underlying rust. Ask your auto paint store or body shop in advance to identify combinations of bondo and primer (that are compatible with the paint type you'll use), then reapply a fresh coat of bondo, so the new paint won't "crack" during the drying process or from exposure to sunlight in the future.



Rust Protection at Home

Sand and treat rusted areas, then spray with metal primer

(3) Hands-On Body Metal Prep:

Small tricks like careful part disassembly and masking can make the difference between a show-winner, and a pretty job filled with small regrets. The option of doing paint removal and careful surface preparation at your home will help paint to adhere to the GT's delicate curves, and can also save shop labor expenses.

Research various tools and supplies required, at stores or on the internet.

Sandpaper: Grit sizes vary (lower numbers are coarse, higher numbers fine)

Orbital Sanders: Dual-action "DA" sanders strip wide areas

Respirators: Face masks with filters, worn where fine dust is present

Block Sanders: Hand-held blocks used for more precise sanding

Tarps: Ground and work area covers catch flying particles.

Consult our notes and follow instructions regarding removal of exterior trim pieces (in advance of starting work), so you don't accidentally "wander" into fragile areas and accessories that you don't want sanded.

Schedule your work project to include numerous work interruptions for rest breaks and "days off".

Sand down only to the original factory primer, which is a tough rust-protectant layer that helps "grab" any new paint that's applied. Going down to the metal requires a new layer of primer, which also has to be sanded prior to paint application. (Be aware that processes like sand- or media- blasting can leave residue, and chemical strips and dips work nice but can be hazardous to your skin as well as expensive).

Whichever method you use, clean the body exterior thoroughly, let dry, then mask off areas on the body with tape (like stickers, remaining trim, etc.). If you're just doing a "quickie" re-spray job but also plan to replace the rubber, you can just trim the edges of old rubber around the windows -- to expose the metal with-out getting paint dust in the car. All this careful preparation gives you better control of the results, which is now necessary because most body shop workers won't be as meticulous when working on your GT, due to its unfamiliar seams and body curves (compared to more typical "collision repair" type jobs).



Tools & Supplies

Original Opel GT Paint Mixture Notes

All US export Opel GT's received a color code stamped on the VIN plate. These corresponded with enamel paint mixtures produced by the Dupont and Ditzler firms as original Opel GT paint colors. Below, is available information sourced from Opel's Service Bulletins.

(*Some paint mixture data was substituted from a PPG/Ditzler chip chart combined with 1969 Kadett, and needs verification to be correct for a GT).

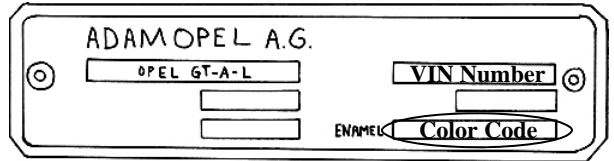

Above:
Opel GT Firewall VIN Plate (for US export models)
Color Code Information is stamped in lower right box

1969 Paint Codes:

Applied to GT's starting with VIN code 94-1535504

<u>VIN Code</u> (Sales Code)	<u>Paint Color</u>	<u>Dupont Enamel</u>	<u>Ditzler Enamel</u>
DD	Aztec Gold		23200*
UU or 16	Metallic Silver		32797*
GT or 15 or 336	Metallic "Forest" Green		44034
HH (DD)	Strato Blue	8474D	DAR13829
JJ (RR)	Flame Red	8547DH	DAR71841

1970 Paint Codes:

Applied to GT's starting with VIN code 94-1888188

<u>VIN Code</u> (Sales Code)	<u>Paint Color</u>	<u>Dupont Enamel</u>	<u>Ditzler Enamel</u>
16 (ZZ)	GT Chartreuse	8548D	DAR44226
JJ (RR)	Flame Red	8547DH	DAR71841
HH (DD)	Strato Blue	8474D	DAR13829
SS (TT)	Sunburst Yellow	8552DH	DAR81804
RR (CC)	Brilliant White	8480D	DAR8779
WW (BB)	Rallye Orange	8553DH	DAR60593



Above:
Sample page, from a "color chip" book by Ditzler (a.k.a. PPG)

1971 Paint Codes:

Applied to GT's starting with VIN code 77-2265862

<u>VIN Code</u> (Sales Code)	<u>Paint Color</u>	<u>Dupont Enamel</u>	<u>Ditzler Enamel</u>
235 (DD)	Strato Blue	8474D	14172
508 (RR)	Flame Red	8547DH	71891
446 (YY)	Chrome Yellow	8550DH	81876
304 (HH)	Jade Green	33007D	44378
529 (XX)	Fireglow (Orange)	33012DH	60620
135 (PP)	Astro Silver	8473D	32905
411 (QQ)	Rallye Gold	33008D	81875

1972 Paint Codes:

Applied to GT's starting with VIN code 77-2560567

<u>VIN Code</u> (Sales Code)	<u>Paint Color</u>	<u>Dupont Enamel</u>	<u>Ditzler Enamel</u>
235 (DD)	Strato Blue	8474D	14172
446 (YY)	Chrome Yellow	8550DH	81876
529 (XX)	Fireglow (Orange)	33012DH	60620
411 (QQ)	Rallye Gold	33008D	81875

1973 Paint Codes:

Applied to GT's starting with VIN code OY07NC-2944586

<u>VIN Code</u> (Sales Code)	<u>Paint Color</u>	<u>Dupont Enamel</u>	<u>Ditzler Enamel</u>
235 (DD)	Strato Blue	8474D	14172
508 (RR)	Flame Red	8547DH	71891
446 (YY)	Chrome Yellow	8550DH	81876
416 (CC)	Alpine White	33010D	8859
303 (HH)	Jade Mist	33032D	44548
529 (XX)	Fireglow (Orange)	33012DH	60620
411 (QQ)	Rallye Gold	33008D	81875

These references may be incomplete, as the service bulletins didn't reflect all the sales manual data (and didn't reflect any mid-year changes)

Note:

Opel GT's originally sold in the European market also received additional color choices in paint mixtures of acrylic lacquer. These "alternate" mixtures (along with a few additional color shades) sometimes also appear in "color chip" books from US paint suppliers, and some GT's in these colors were imported to the US (as "gray market" vehicles) by individual owners in the 1970's.

Original GT Colors

Original Opel GT “North America Export” Colors, Codes, and Interior Combinations:
(Disclaimer: Color “chips” shown here are approximate, due to print ink and computer screen variations, and reflected light. View a GT, or consult a paint shop, for actual colors)

Code Exterior Color, Year(s), Interior Color(s)

- 15 = Forest Green (1969, darker tan interior)
- BB = Rallye Orange (1970, black interior)
- CC = Brilliant White (1970, red interior)
- CC = Alpine White (1973, black interior)
- DD = Aztec Gold (1969, black interior)
- DD = Strato Blue (1970, 1971, 1973, off-white int.)
- DD = Strato Blue (1972, black interior- optional)
- HH = Strato Blue (1969, black interior)
- HH = Jade Green (1971, 1973, black interior)
- JJ = Rallye Red (1969, black interior)
- PP = Astro Silver (1971, black interior)
- QQ = Rallye Gold (1971, 1972, off-white interior)
- QQ = Rallye Gold (1973, light tan interior)
- RR = Flame Red (1970, 1971, 1972, 1973 black int)
- TT = Sunburst Yellow (1970, black interior)
- UU = Metallic Silver (1969, red interior)
- XX = Fireglow Orange (1971, 1972, 1973 black int.)
- YY = Chrome Yellow (1971, black interior)
- YY = Chrome Yellow (1972, 1973, off- white int.)
- ZZ = GT Chartreuse (1970, black interior)

15	HH	TT
BB	JJ	UU
CC	PP	XX
DD	QQ	YY
DD/HH	RR	ZZ

Note: Above colors also available on Kadetts, Mantas & 1900's, except for the “ZZ” color code (which was unique to 1970 GT's)

GT Interior Colors

opelgtsource.com ©2016



Black: Most US Opel GT's came equipped with the black interior. All interiors had black instrument panel facia, vents, ashtray, shift knob, and door pull inserts.



Off-White: Some Opel GT's came with an “off-white” interior. This retained the black dashboard, black center consoles, and black carpet, but featured off-white-colored headliner, sun visors, door panels and armrests, rear quarter panel covers, spare tire area cover and off-white seat covers. This color is sometimes also called “buckskin.”

GT “Special” Interior Colors



Red: 1969 Silver and 1970 White Opel GT's came equipped with a red interior. This included a red dashboard, center consoles, carpet, headliner, sun visors, door panels and armrests, rear quarter panel covers, spare tire area cover and red seat covers. Some pieces are now hard to find.

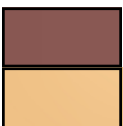

Tan Dark: 1969 “Forest Green” GT's featured a darker tan “almost brown” interior color. Very Rare!

Tan Light: 1973 “Rallye Gold” GT's featured a lighter tan “beige” interior color. Also Rare. These included tan dashboard, center consoles, carpet, headliner, sun visors, door panels and armrests, rear quarter panel covers, spare tire area cover and tan seat covers. Some pieces are now hard to find.



(Shown: 1969 Ad, 1970 Silver/Red, 1973 Tan Interior)

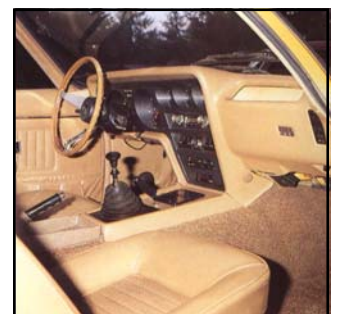

Paint Shop Preparation Checklist

Bring your written paint instructions (on a visual diagram) to your shop.

Include areas of particular attention, such as where body repair is required, or where alterations are to be added.

You should also present any notes to protect delicate body areas, such as suggesting that the painter spray lightly in areas to not “fill in” body “grooves” (like the rear deck lines), and to not to excessively sand off body metal “peaks” (like the center line of the hood and the front nose panel, the louvers on the hood and the top edges of front fenders).

This helps the paint shop managers and hands-on employees, to better communicate and understand your intentions for your project.

An important question to answer:

Is this a same color re-paint, or a color change?

If the job includes a color change, you need to also discuss painting door jambs, the underside of the hood (and possibly also the engine compartment).

Another consideration is the headlight buckets (will you remove them, or arrange to have them rotated during the painting?) and the rear trim ring.

Arrange for critical parts that may be off the car (headlight lids and buckets, rear trim ring, hood, hood prod holder, maybe even the doors) to be also painted and dried at the same time as your car, by your painter. This will help ensure the best possible color match.

An important decision, that can save money and increase quality, is if you will do your own preparation, such as paint masking. To do this, you will have to acquire special auto painter’s tape (sold by auto body supply stores, it’s not as sticky as common masking tape). The advantage is, you can take more time and care, to protect some critical hard-to-reach areas.

This will require some careful attention when it comes time to remove the tape, as dried paint can stick to the tape (it’s recommended to cut with a razor blade or exacto-knife & pull it back very slowly).

Consider "shortcut" options:

(These are best used when car is repainted in the same color).

Instead of a thorough disassembly, you can just very carefully mask exterior hardware like door handles, the antenna, and the lower horizontal exterior door chrome trim. If you plan to replace windshield and rear rubber on a same-color re-paint job, you can trim the edges of the old rubber around the glass (a fraction of an inch) to expose more metal (but keep paint overspray and dust out of the interior of the car).

Final Check:

Pull chrome caps and trim rings from wheels. If you can, put on a set of “spare” tires and rims for just the paint job (from a “parts car” if you have one). Make sure any body holes (like door handle and antenna) are taped from the inside and all wire ends are taped too.

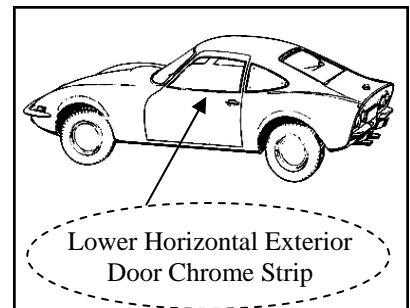
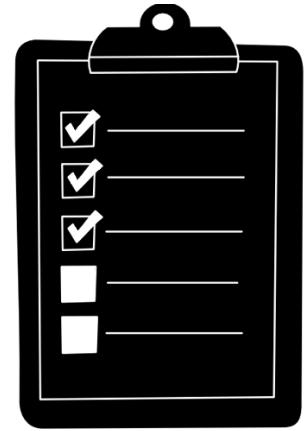

Lower Horizontal Exterior
Door Chrome Strip

Communicate about this part !

Disassembly of door panel, internal parts and glass, is required prior to removal of this chrome trim strip, because trim attachment is to an internal groove (*damage will occur from attempts at external prying*).

In some cases, tape masking is preferable to removal.

Note Page: “GT Body Diagrams”

Marking diagrams and providing copies, will assist successful communications with your paint/body service providers (as they’ll have visuals to refer to, while they’re working on your car)

Opel GT Source Body Parts

The stares and questions you get (every time you stop for gas) are confirmation: forty years after its introduction, the GT has remained "forever young" as one of the most uniquely attractive classic cars you can drive.

Restoring the body exterior (including a paint job, in the color you've always wanted) is your opportunity to return it to its original beauty. To help, Opel GT Source offers reproduction window moldings and body trim.

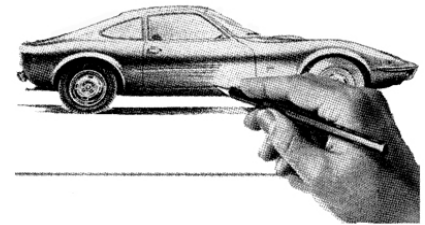

Windshield Rubber Moulding

- 2001 GT/A-L Window Channel, Front (grooved for chrome insert) reproduction



An important tip, is to never try to "pry" the windshield out of its rubber moulding. The curved glass is brittle and easily cracks! Instead, cut the old rubber (then gently lift out glass).

Rear Window Rubber Moulding

- 2002 GT/A-L Window Channel, Rear (grooved for chrome insert) reproduction

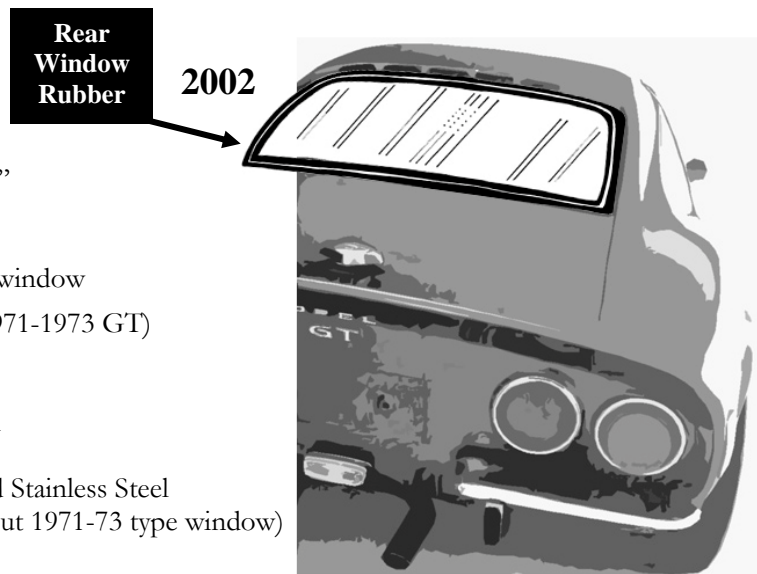

Side "Quarter" Window

- 2003 GT/A-L Quarter Window Rubber Channel (grooved for decorative metal insert) for "fixed" (non-opening) 1968-1970 side quarter window
- 2004 Quarter Window Rubber Channel, for 1971-1973 "pop-out" opening side quarter window
- 2018 Grommet Set, "Pop-Out" Quarter Window (1971-1973 GT)
- 2055 Rear Mount "Button", Polished Stainless Steel (sold individually, 2 are required per car)
- 2056 Front Mount "Button", Polished Stainless Steel (sold as a pair, 4 are required per car)
- 2057 "Button" set, does 1 Pop-out window, Polished Stainless Steel
- 2058 Exterior Metal Trim w/Corners (does 1 Pop-Out 1971-73 type window)

Side Window Rubber

2003 OR 2004

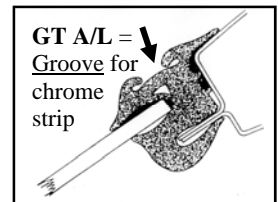
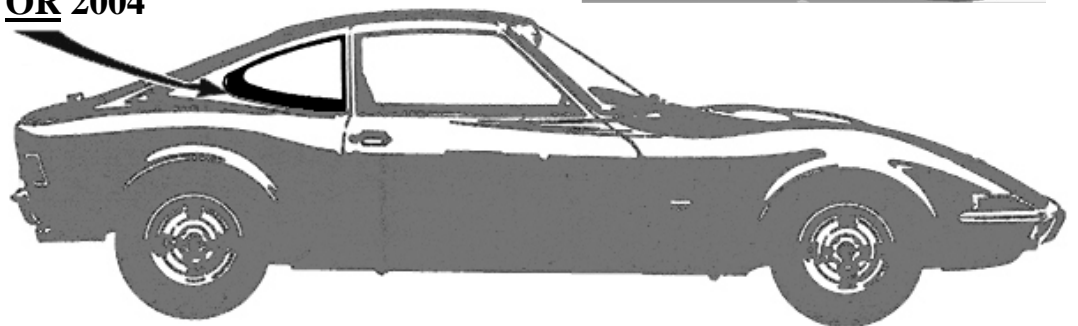
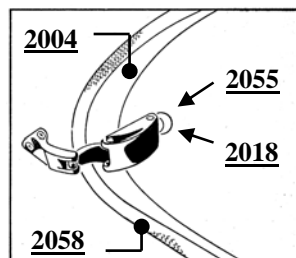

Above: "Pop-Out type" 1971-1973 side glass (Identifiable by the hinge assembly and related hardware)

Original "Opel GT A/L" Style Body Exterior

Above rubber mouldings have a "groove" (for installation of "chrome appearance" trim)

Original "GT A/L" Style Chrome Insert

2010 Chrome Insert, 22 feet: For GT/A-L window rubber mouldings for part numbers 2001 & 2002

Note: One set of insert will fit one Opel GT (front & rear)

Note: A non-original option is #2040 black plastic insert, below

2019 Chrome Insert Tool (Recommended for installation of #2010)

12005 Corner, reproduction: For part number 2001 & 2002.
(2 per front window, 2 per rear window, 4 per car required)



2001 & 2002 Window Rubber Mouldings w/Groove (GT A/L style)

2010 Chrome Insert Strip

2019 (Tool)

Chrome Strip Insertion

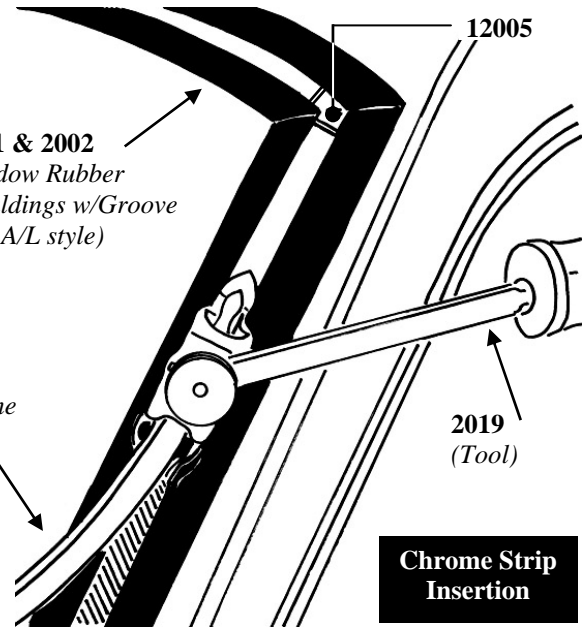

Design Option: "GT/J" Exterior Trim

This rubber can offer you a uniquely "European" trim style, featuring the black-out monochromatic look (which originally became popular in the 1970's-80's).

The main difference in the front windshield and rear window rubber gaskets, is that the surface is solid rubber with no groove in the middle.

(There are also GT/J style quarter window gaskets, for "fixed" non-opening 1968-70 side quarter windows).

This option works best as a design choice, or when the vehicle is to be parked outdoors for extended amounts of time. It is also an option, when some of the other original chrome trim on the sides of the vehicle have faded or are missing.

To more fully copy the GT/J style, you can also custom-paint chrome strips around the doors and quarter windows black to match, as well as paint or powder-coating the front and rear bumpers (and other exterior hardware like the door mirror, rear license lenses and gas cap) black..

Body Exterior: "GT/J Style" Reproduction Parts

- 2011 GT/J Front Window Channel (solid rubber, no groove)
- 2012 GT/J Rear Window Channel, (solid rubber, no groove)
- 2013 GT/J Side Window Channel, (solid rubber, no insert)
Quarter Window, for fixed 1968-1970 side glass
(For opening "pop-out" 1971-1973 side glass, use #2004)
- 2040 Black Plastic Insert, 22 ft.
(Replaces Chrome Insert number 2010, when front & rear GT A/L rubber has been installed)

Other original GT/J features, require parts installed in Europe-only Opel GT's: Amp/oil warning lights (instead of gauges), dash switch operation of headlights, rubber floor mats (instead of carpets), and an added GT/J side stripe.

Option:

"Original" ("GT A/L") rubber, is grooved for chrome strip
"European" ("GT/J") rubber, has no groove and is solid

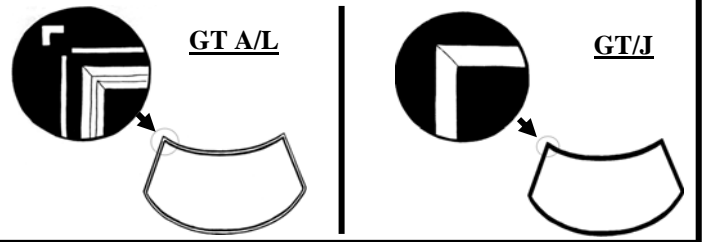

Euro Style

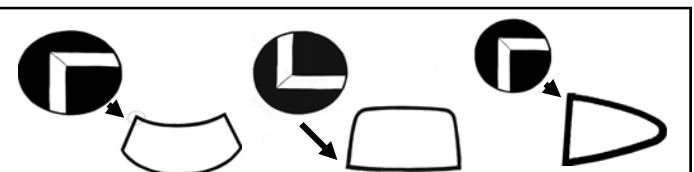

GT/J Parts

- Front Windshield Rubber Moulding
- Rear Window Rubber Moulding
- 2 Side Window Rubber Mouldings ("fixed" 1968-70 GT's)

Opel GT Door Parts

Want window glass that slides up and down smoothly?
 Want a quieter, rattle-free door? Opel GT Source provides parts
 and solutions to allow you to rebuild your GT's doors, from the inside out.

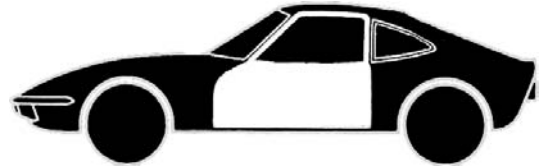

GT Door Interior Hardware

- 1040 Nylon Slider Bushings: Set of 4 w/rivets, does one door.
Helps door glass slide up/down evenly, requires some assembly (installation instructions available)
- 1041 Door Panel Plastic Plugs (set of 10, for 1 door)
- 1042 Knob, Door Lock Button (in Aluminum)
- 1043 Felt Weatherstrip, for Inner GT Door Panel
This is clipped to the inside top of the door panel.
Helps seal inside edge of door window glass
- 1045 Door Panel Clips (set of 10, does one door)
- 1050 Door Panel (Set of 4, includes quarter panels)
- 2041 Ring, Door lock on door panel, plastic. (2 per car)
- 2041A Ring, Door lock on door panel, aluminum. Pair
- 2051 Window Crank Handle (Opel service replacement style)
- 13009 Window Regulator Repair Service
See description in "part rebuilding" section, for more information and details

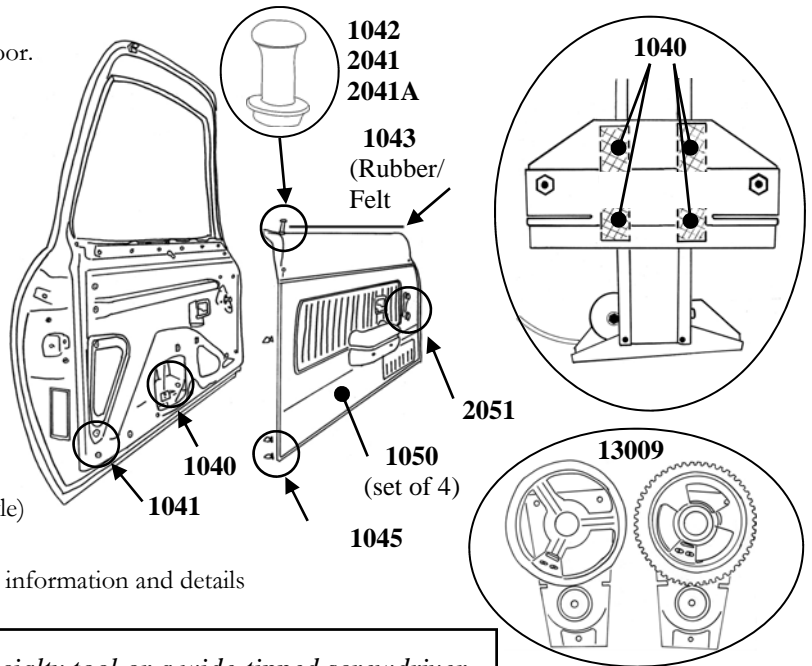

When removing the door panel, use a specialty tool or a wide-tipped screwdriver on each attaching clip (to avoid damaging its soft cardboard backing board). "Door Rebuild" tech tips are available (with a related part purchase)

GT Door Weatherstripping

- 2005 Door Window Track
(This is the felt-lined rubber track that fits inside the door, which has an inner "groove" for glass to slide within. Sold as one roll for both doors, you cut it to fit).
- 2036 Window track clips for #2005 (set of 20)
- 2014 Upper Door Bumper, Opel GT
- 2222 Body Weatherstripping, 24 Foot Roll: Seals door to body.
Cut to fit, does both doors top&bottom. Black color (white or tan backing also available)
- 2038 GT Door Weatherstripping, Top: Single piece for one door. 8'-6"
- 2039 GT Lower Door Weatherstripping, Bottom: Single piece for one door. 3'-6"
- 2044 Trim Screw, Door Sill Plate (sold individually, 7 required per sill plate)
- 2054 Sill Plate, Stainless Steel, New Reproduction (Requires drilling for screw holes)

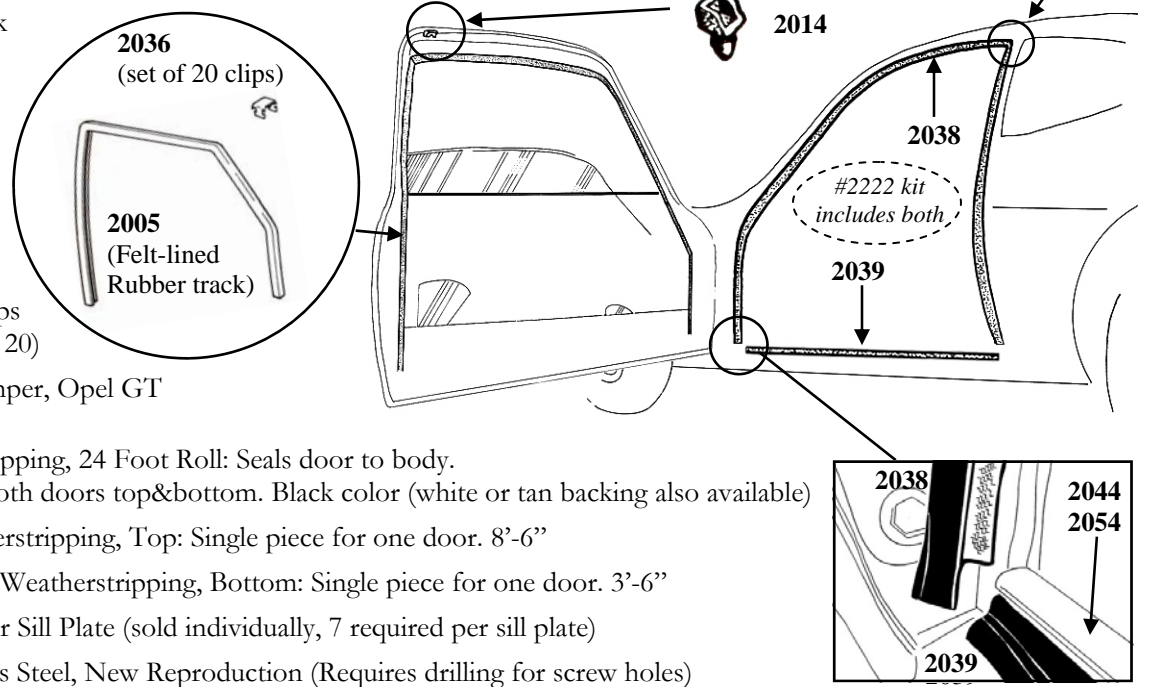

Check your GT Door Weatherstrip to make sure it isn't dried out and has a "gap" on the upper body (where the door closes into it). Fresh replacement rubbers help to quiet road noise and seal out rain.

Opel GT Body Parts

From exterior door rubbers to body panels, parts are available from Opel GT Source for your project, to help you when you choose to repaint your GT or complete its restoration.

GT Body Parts & Related Hardware

- 2025 Opel GT Fiberglass Belly Pan
Replaces this often rusted and damaged original panel. Unlike steel, will not corrode from battery acid!
- 2027 Opel GT Fiberglass Nose Panel
Wraps around side lights and replaces the often damaged center vent area.
- 2045 Center Grill GT,
European reproduction
- 2046 Side Grill GT,
European reproduction
- 12001 Front Blitz Emblem
Reproduction, in chromed plastic.
- 12001B Front Blitz Emblem
Reproduction, in Black

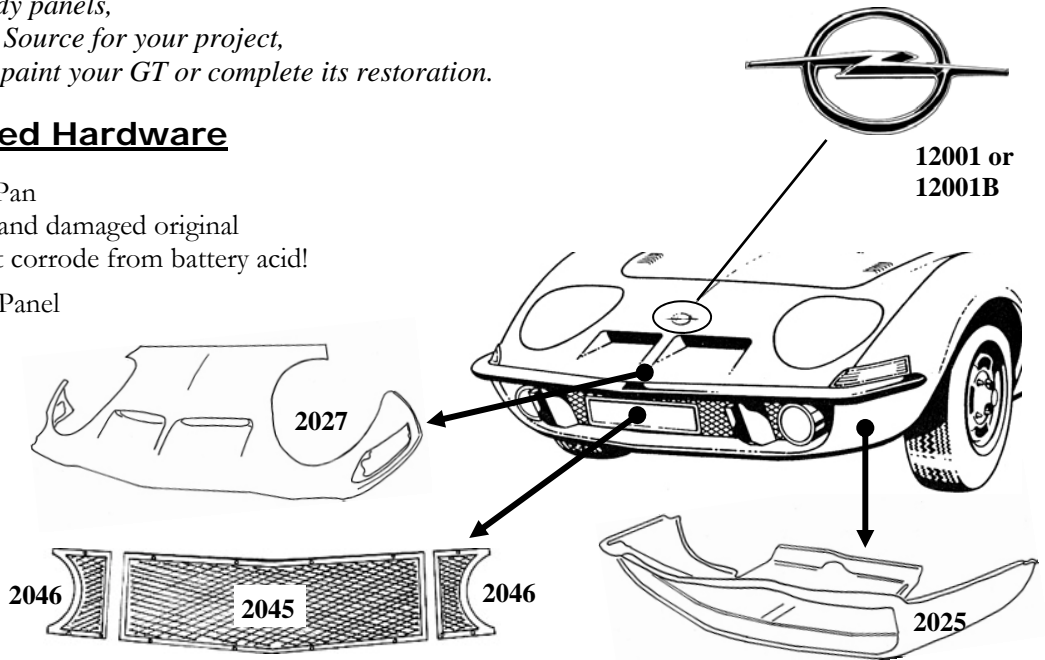

 For best results, allow fiberglass body panels to warm prior to installation, and install in a warm area, to allow expansion (to match configuration of the original body).

GT Door Exterior Hardware

- 2006 Lower Door Window Rubber Scraper
(This is the rubber piece that slides into the lower horizontal chrome trim on the exterior of the car door, which helps seal the door from rain & water)
- 2031 Door handle gaskets, set of 4, Opel GT
(one set does both doors)
- 2034 Mirror gasket, plastic, for Opel GT
- 2035L Opel GT Chrome Mirror, Original Style,
Driver's Side w/Gasket, Reproduction
- 2035R Opel GT Chrome Mirror, Original Style,
Passenger Side w/Gasket, Reproduction
- 2059 Door Chrome Corner (Special Order)
- 12025 Aftermarket Sport Mirror: Reproduction of
classic Opel Mirror (see "accessories" section)
- 12037 Key Blank: See "accessories section"
for style descriptions.

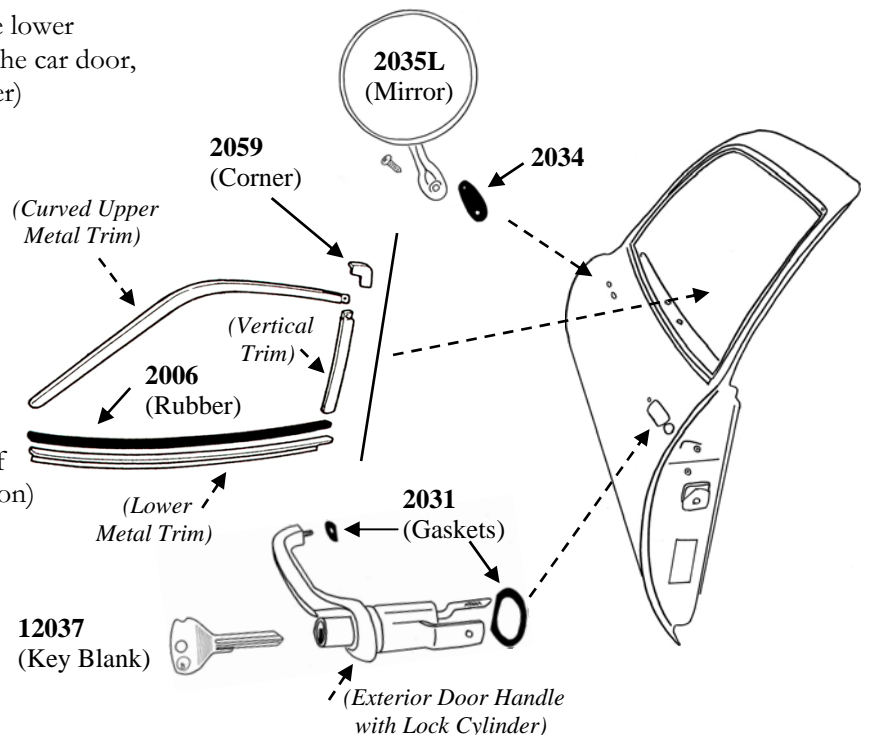

L	Door Mirrors	R
Original-style (Chrome) Reproductions		
#2035L (driver's side)		
#2035R (passenger side)		

 Door Hinges and locks require periodic lubrication; Consult a service manual for procedures.

NOTE: Many Good Used Opel GT door and body parts are also available, Contact Opel GT Source and ask!

Opel GT Body Parts

GT Rear Body

Panels and trim to improve the appearance of your GT

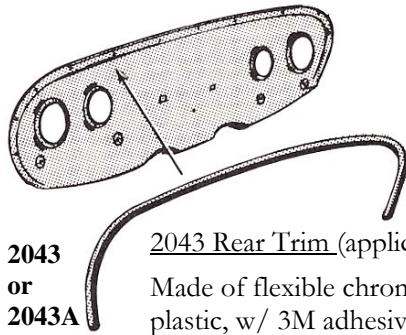

2043 or 2043A 2043 Rear Trim (appliqué):
Made of flexible chromed plastic, w/ 3M adhesive back.

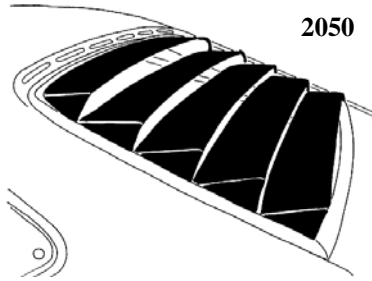

2050 GT Rear Window Louvers:
Classic style, helps shade and cool car interior

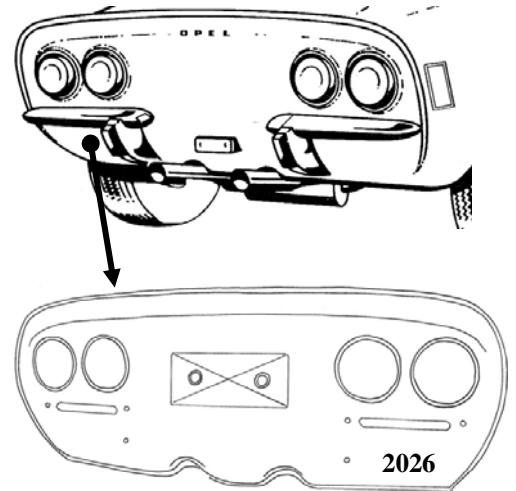

2026 Opel GT Fiberglass Rear Panel

2043A Rear Trim Strip
Made of formed aluminum
Special Order item.

2049 Rear Trim Strip Mounting Studs:
Used to install a metal trim strip.
(set of 10 studs with nuts)

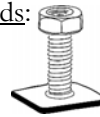

GT Bumper Hardware

- 2020 Opel GT Bumper Gasket Set
Fits between the bumper and bumperette. Set of 4
- 2021 Bumperette Rubber Pad, Front
One required per chrome bumperette. Comes with nuts.

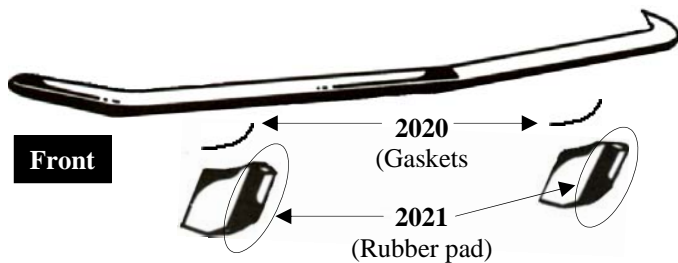

Front

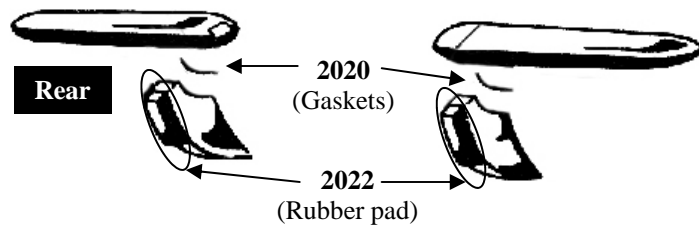

Rear

- 2022 Bumperette Rubber Pad, Rear
One required per chrome bumperette. Comes with nuts.

NOTE:

To help complete your restoration, many Good Used Opel GT Body & Door-related parts are also available in our inventory.

To inquire about used GT parts, contact Opel GT Source and ask

- 2048 Rear Bumper Spacer w/Sleeve
Fits between the tail lamp panel & the rear bumpers of the Opel GT.
(6 required)



The Finishing Touch: "Bumper Set"

A beautiful reproduction, of the GT front and rear bumper assemblies, manufactured in rust-proof stainless steel. Includes front and rear bumperettes, bumperette rubbers, bumper gaskets and rear bumper spacers/sleeves. #Bumper Set

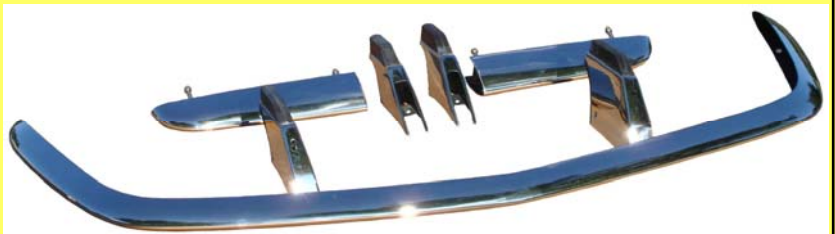

Floor Pans (Notes)

As a California-based business, we're nowhere near as experienced as owners in other areas, when it comes to dealing with chassis rust. However we do want to pass along what others have informed us is a valuable cost-saving technique when it comes to replacing the vulnerable Opel GT floor pans.

When rust holes are limited to the floor areas (beneath the seats and foot-wells), instead of importing large and expensive replacement reproduction panels from European suppliers, owners have sourced brand new metal from suppliers who make floor pans for the early Ford Mustangs (1964-1966) and cut them to fit the GT.

To us, this would seem to be possible, as the widest dimensions of the GT floor are within 20"W x 50"L, and some "full floor" panels now being manufactured for the Mustang are 23"W x 60"L. You also have the option of cutting 1 1/2" diameter holes for adding floor plugs where you want to locate them.

Additional advantages include that you receive new metal (which can be undercoated and insulated for protection) and that these pieces are of a uniform size that is relatively thin, easily boxed and shipped via common domestic carriers like UPS very affordably.

This compares particularly well to original panels that are over 40 years old of variable quality, have prices inclusive of the labor required for them to be cut from a body, and require custom-packaging for freight, when sourced from a wrecking yard.

Specific References include:

www.GoodmarkIndustries.com

Phone 877-477-3577

Part # 3020-500-64R and/or Part #3020-500-64L

Verify dimensions and fit prior to confirming order

Price varies from \$50-\$80 each for full-length floors

www.ShermanParts.com

Phone 800-345-9487

Part #46546BR & #46546BL

Verify dimensions and fit prior to confirming order

Price varies from \$50 to \$80 each for

full-length floors

There may be additional suppliers like Dynacorn or others. Retail resellers include Summit, Jegs, and many local Mustang shops.

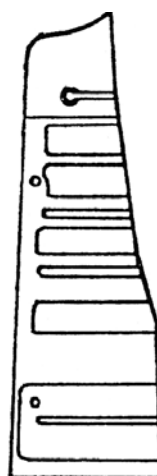
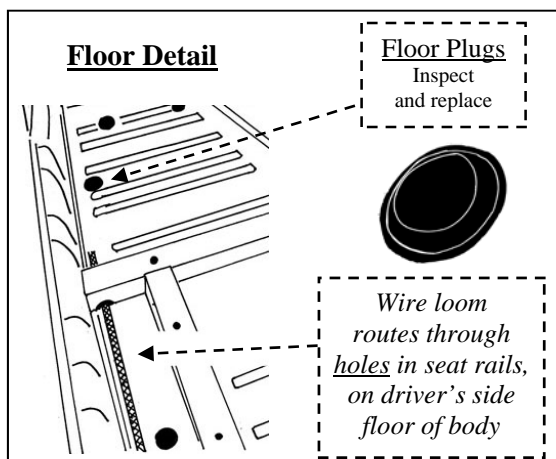

Floor Pans
Available for hundreds of dollars from Europe, suitable replacement pans can also be cut to fit the GT from stock sold inexpensively in the US for the 1964-66 Ford Mustang.

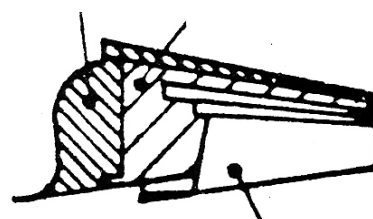

Rocker Panel

A key chassis support member, it composes 3 pieces including an outer edge, an middle panel an edge of the inner floor pan. If replacing, weld in a parallel rod for body support before cutting into any metal.

We also suggest consulting with an experienced auto body professional, or someone who has performed this procedure, before starting.

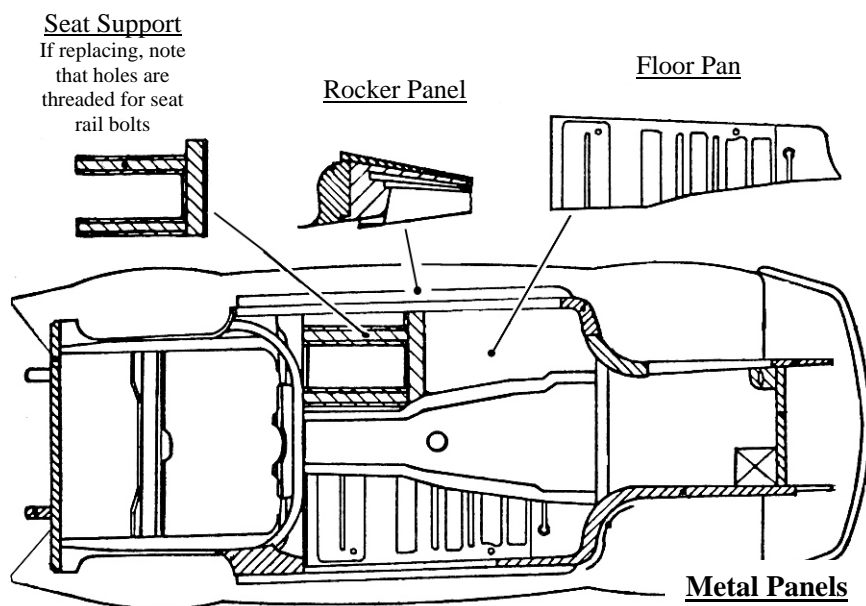

Windshields (Notes)

Options for replacing a GT windshield include locating an old-stock piece from a glass shop in your state, finding and installing a good used glass, or buying a new GT windshield from www.pilkingtonclassics.com of Ohio (phone 800-848-1351, solid for about \$400 plus extra costs for crating and shipping to your location).

When removing an existing windshield, we strongly recommend cutting the rubber moulding then carefully lifting the glass out safely. (Trying to grab or pry a windshield out almost always cracks the pricey glass).

We also suggest having a local glass shop install new glass, as some batches vary slightly in curvature and size at the edges, and professionals have specialty tools sometimes required during installation for a secure fit.

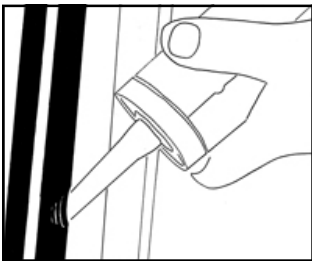
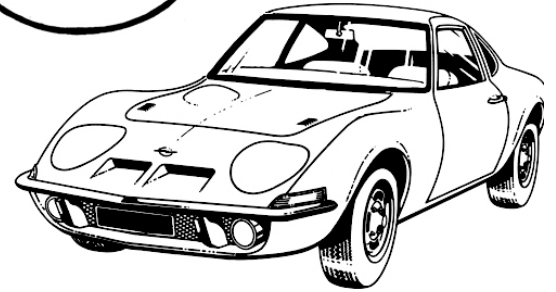
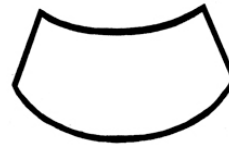

Installation notes are provided with new rubber moldings (sold as #2001 or #2011 depending upon your choice of style), and we recommend use of a non-hardening tar-based sealer to prevent rain or water leaks (avoid hard-drying silicone sealer).

GT Original –Style Chrome Insert #2010

Supplied in a roll, cut lengths to fit.
Use special tool #2019 & WD-40,
to help install chrome strip insert.



Wipers (Notes)

Although interesting to watch, original Opel GT windshield wipers now often suffer from exposure at critical connection and pivot points.

Wiper blades were originally about 17 1/2" long, and replacement hardware with blades of varying lengths is now available in any auto part store.

The linkage is tricky and sometimes difficult to re-install or adjust.

Even in optimal condition these wipers aren't very effective and often leave streak paths that remain visible across the windshield glass.

To avoid this, we instead recommend carrying and using a water-repellant spray such as "Formula 1" "RainX" or "Dafna Krystal Kleer" When you are planning local travel or a road trip.

Wiper Blades

OEM Bosch #0-508 were 445mm (17.5")
Modern equivalents can now be found
in any well-stocked auto part store.

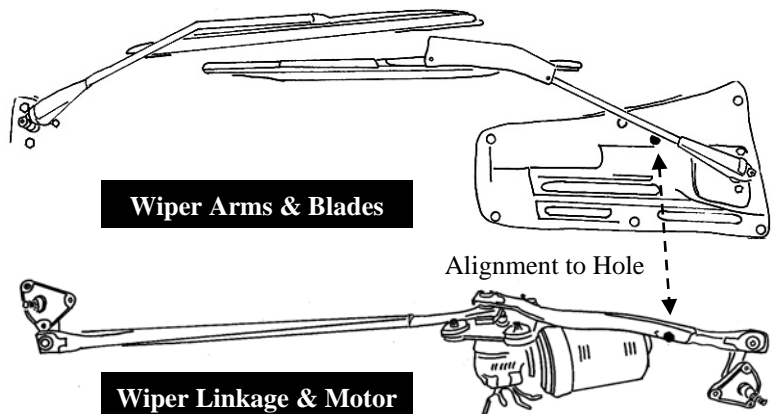

Important Reminders:

Motivation to take on a GT project, is generally visual (from seeing your own car, from photos of other GT's or from looking at other GT's at car shows). To get the job done, you need to convert the energy of seeing in your mind the results of an Opel GT project to a commitment to seeing the goal all the way through to a successful completion. Some hopefully helpful reminders to deal with this challenge are listed below (as they have appeared throughout the individual tech sections). The phrase "Do it right, or do it over" certainly applies to Opels, but by keeping these approaches in mind as you work through the preceding pages, you're much more likely to accomplish your goals.

(1) **Preparation:** Adequate preparation is the key to minimizing frustration. As mentioned, this includes acquiring needed parts and supplies before you actually need them. It also means clearing out a convenient area to work on the car. (Some have even used plastic sheeting to "wall off" a paint area in their garage. We don't advocate that, however if that's your approach we emphasize all surfaces must be cleaned of all dust before any paint is sprayed)

(2) **Organization:** This includes taking notes, following checklists, and making sure to "bag and tag" all removed parts (including noting where they came from, on driver/passenger side-specific parts). Don't leave parts at the shop longer than necessary: That's how they can get lost (especially on long-term projects).

(3) **Dealing with Frustration:** It's going to happen, but don't let it stop you. When energy levels get low, or a difficult repair just doesn't "work," it's a good idea to periodically "back off" for a break from the project. At other times having energy drinks available (something like coffee, Pepsi, Red Bull, or whatever works for you) and music you like, can make a big difference.

(4) **Approaches:** Variables affecting parts can include past damage, rust, improper part substitutions and/or part loss by prior owners. Unless you're fortunate enough to have a GT that's a true untampered survivor, it's likely you will encounter some challenges. It's not enough to just consider these situations as learning experiences, but to deal with them successfully.

A) **Critical connectors:** Use a conservative approach to these

Bolt Loosening: Where possible, spray bolt threads with some PB Blaster or Aerokroil, then loosen them with a back-and-forth motion (counterclockwise, then clockwise), to reduce the chances of the bolts snapping apart.

Bolt Tightening: "Start" bolts by rotating them counterclockwise (to help "find" the thread), then tighten them clockwise. Just try to "snug" a bolt in position at first (to avoid overtightening), especially on the brittle plastic lenses and housings. It's not possible to use a torque wrench on every bolt (even where factory specifications are stated, they are probably wrong when applied to worn parts), so if it's a critical piece consider also using a dab of low-strength "threadlocker" on the threads.

B) **Part Cleaning:** Do this as you go along, so the small tasks don't stack up to a big one. This is the best use of time, when your car is at shop or when the fresh paint is curing. Use Metric taps to clean bolt holes, and dies to clean bolt threads.

C) **Paint Overspray and Paint Dust:**

Many of the part-by-part tips repeat reminders to prevent exposure to paint overspray and dust (particularly in places you don't ordinarily think about, which are more important if you don't completely disassemble the car).

Insulate: All exposed power wires, and especially protect all ground wire connections to the chassis.

Masking: Tape should be applied carefully, especially in tight areas (using a fingernail or thin screwdriver tip). When removing tape, be careful to note that it doesn't also remove some paint from the body itself too. (Careful use of an exacto-knife can help prevent excessive tape lift).

(5) **Communication**

Take time to prepare and organize your requests by outside services. Use of visual diagrams will help your instructions to be understood (especially by workers who were hired for their lower labor rates, rather than their formal education).



A "Headache", is strictly optional

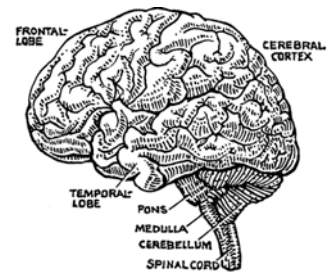

CONTROL SYSTEM

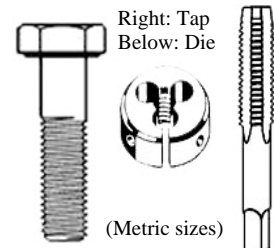
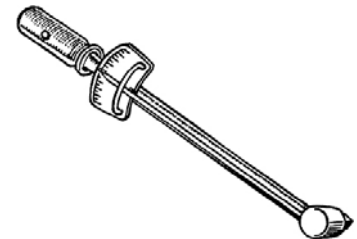

Front

Body Work Repair Sheet
(add your own notes)

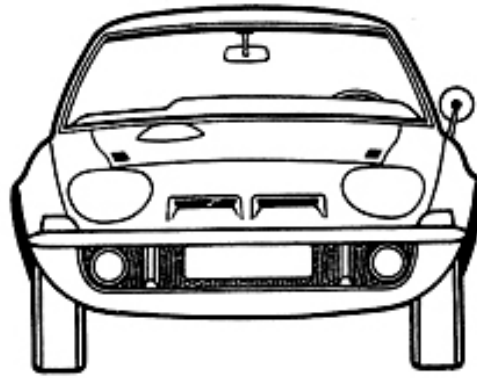

Rear

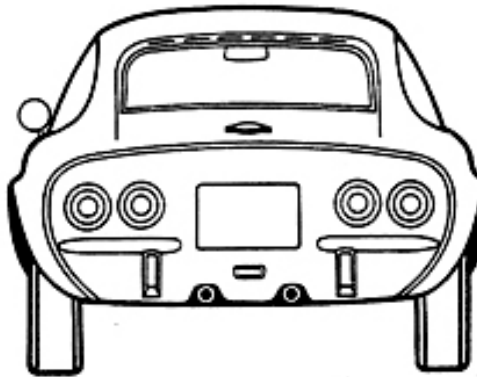

Driver's Side

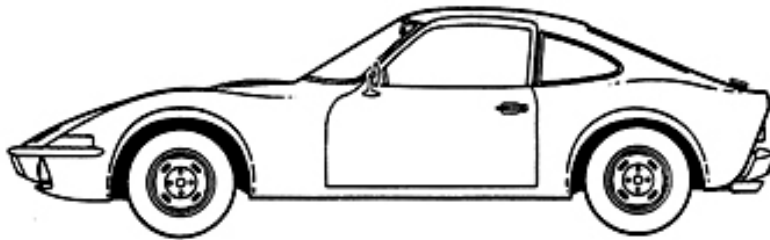

Passenger Side

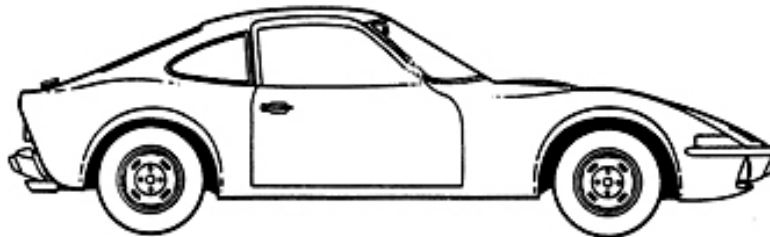

Overall/Top View

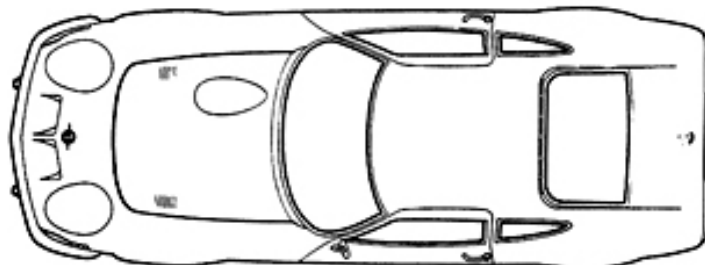

Part Preparation Checklist

Don't wait for the paint to be done, before you start prepping parts!

The enthusiasm you may feel when your car has returned, may lead you to rush through and "cut corners" on some important related projects.

Before the car is sent off to the shop, and while it's there:

Start cleaning, servicing and lubricating important internal parts:

Headlight mechanisms and related parts
Door Window sliders and tracks
Door Handles and lock components
Dashboard Gauges and Panel
Heater Box components

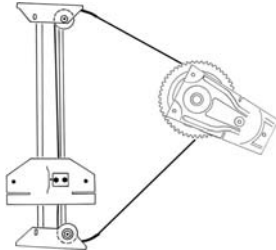

Bolts & Screws:

Wire-wheel the threads, to remove rust and for easier re-assembly.
Sanding at ground screws and electrical connectors, will greatly assist the GT electrical system.

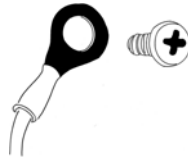

Interior Vinyl:

If off the car, use Castrol Super Clean on door panels, console, side panels and kick panel pieces.

Be careful to protect the critical horizontal "chrome strips" that are present across the original door and interior side panels.

Clean interior vinyl panels

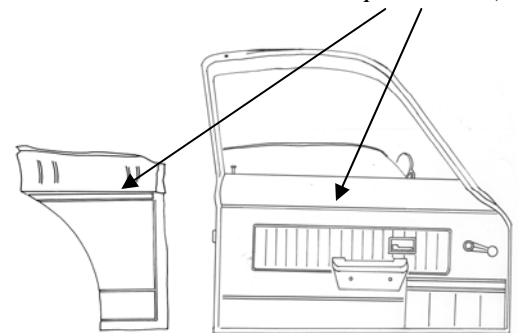

Chrome:

Clean with SOS pads and finish with fine-grade steel wool.

Front turn signal housings,
Front marker light housings,
Bumpers and bumperettes
Door handles, and original-type door mirrors
Consider re-chroming or replacing if required.

Clean Exterior Chrome and Housings

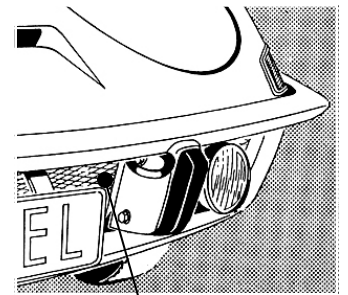

Door or side window exterior chrome trim strips:

Use a light approach and polish formula
(Do not use steel wool on these, to avoid dulling the aluminized finish)

Wiper Arms and Front Grilles

Remove, mask where appropriate, and apply fresh black paint

Repaint Front Grilles and Wiper Arms

The goal of this approach is to be able to just pull your parts from boxes and baggies, in a condition where they are ready to install (when you are motivated to get that done)

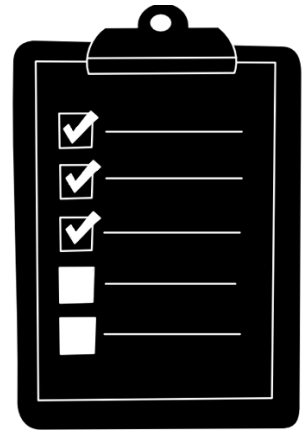
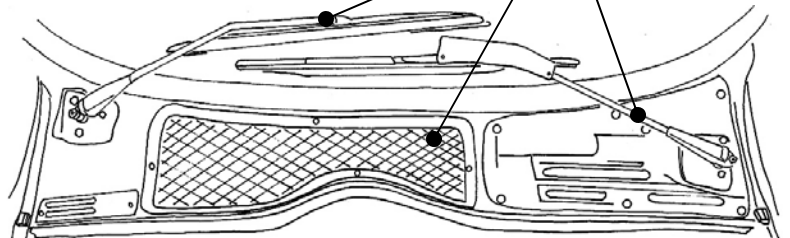

Lubricate mechanisms

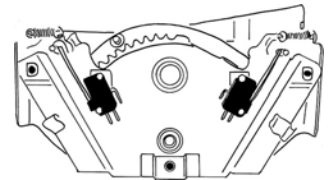

opelgtsource.com ©2016

Post-Paint Tips

Transportation:

Arrange a trailer or tow vehicle to home (or to an interior shop)

Documents:

Bring papers, including the original work invoice and your instructions

Protection:

Bring boxes (lined with old blankets) to carry all loose painted parts

Leftovers:

Don't forget acquire a bottle of "touch up" paint (from your painter)

Inspection:

Examine entire car and note outstanding problems, before signing it off

It's quite normal that you will be excited at your first sight of new gleaming paint on your car, but it's also very important at that time to keep a business perspective.

Don't sign a release form (which might be "pushed" at you), until fully inspecting the car & noting in writing remaining work or follow-up repairs you want them to do. (Be aware that some unscrupulous shops will lie to you, or even cover imperfections with dust, to get you to sign).

If paying under protest, use a credit card (to reserve a chargeback option).

Critical parts to install immediately

Do this before moving the body, to avoid chipping the soft fresh new paint

4 new hood bumpers (OGTS part #6038),

2 new doortop bumpers (OGTS part #2014),

Door Weatherstrip (re-use your old pieces for 30 days until paint is cured, replace with OGTS part #2222),

Underhood rubber strips (re-use your old pieces for 30 days, replace with OGTS part #6037)

New filler neck gasket (OGTS part #9014)

New Door Handle Gasket set (OGTS part #2031)

If you install the exterior door handles (to open/close a car that has the door glass in and which will be parked outside): Remove tape in hole, then add new gaskets on door handle prior to installation. Approach insertion of the door handle carefully (don't chip the hole edge), rotate the handle upside-down to insert it then rotate it right-side up and align tip of "prong end" so that it goes into the slot on the internal lock mechanism. Lightly snug attaching nut and bolt, double-check to assure the handle gaskets are properly aligned, then test operation of handle (before tightening it in place).

Handling:

Only move car by grabbing door pillars (don't press on rear panel or front nose panel between headlights).

Interior Work:

If you ever plan to have a headliner installed by an interior shop, now is the time. Once the headliner is in, use many office-supply type binder clips around the edges of the window openings, to keep the fabric in place. (Before permanently installing window mouldings and door weatherstrip on a body you need to install the headliner, interior kick panels, then the interior side 1/4 panel vinyl pieces).

Curing Area:

Establish a "buffer zone," so nothing affects fresh paint during the 30-day curing period.

This includes rain (quickly wipe off any drops, as sunlight will "etch" them into the paint), yard debris like leaves, dirt or dust, and pets (avoid claws of cats and dogs). Generally this is an indoor or a shaded area.

But if you have no choice but to store the car outdoors, you might temporarily lay the glass (along with the used window mouldings) back on the car loosely. Don't polish or wax the car, until at least 30-days are up.

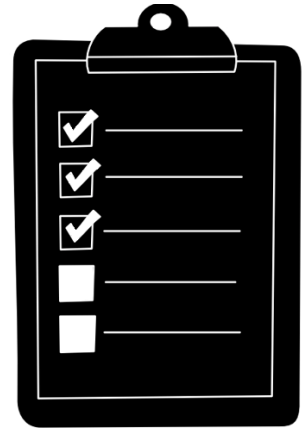

**Use of a credit card
(not cash) reserves to you
post-transaction options**

Repairing Overspray Areas:

After the paint has dried, but just prior to reassembly, inspect areas of typical overspray: Within the fenderwells (consider re-spraying with cans of undercoating), on the exhaust (repaint it) and the suspension. Sand paint off small accessible electrical grounds areas, including headlights, rear lights, and ground cable connections.

Reassembly:

This is the opportunity all your preparation leads up to. In retrospect, owners agree that one of the peak moments of owning a GT, is when they started to bolt on new, long-stored, and ready-to-go exterior pieces (especially the chrome and lenses), onto a shiny newly-painted surface (in the color of their choice). Anticipation grows here, as you build your long-planned vision of the car. This writer often found himself standing back again and again and really liking what there was to see. It's the payoff, of all the careful pre-paint preparation that was invested, in achieving a long-sought view of the GT, as it was envisioned to look. We truly hope that you too can share this experience.

Final Assembly:

When installing emblems or insignia on the body, install new grommets first, then the emblems themselves. Only after masking sure, that all parts related to the dashboard/dash gauge panel/heater are correctly installed (and fully working), should you re-install the windshield with a new rubber moulding. The last step is to seal the windshield (with a tar-based, non-hardening sealer — NOT silicone). Drape with a car cover, if kept outdoors.

Congratulate Yourself — and Enjoy the feeling you have (every time you look at your shiny GT!)

Re-Appraise:

Consider protecting your investment, by gathering receipts and having your car insurance coverage raised. Consider savings of “classic car” type insurance, and registering your Opel as a “historic vehicle”.

Keep Your Distance:

The first paint chip or scratch can be a heart-breaker. So avoid it instead.

Change your parking habits:

Instead of jockeying for a position nearest a store, park a few cars away from other vehicles in lots. (This minimizes chances of idiots rolling loose shopping carts, or swinging their heavy SUV doors, right into yours).

On the road drive pro-actively, and be aware of what other cars might do.

To enhance your ability to avoid collisions (before they happen) consider for future projects: Modern brake upgrades (to avoid other cars) or a more powerful “2.0 conversion” engine (to power away from them).

At the very least, this will continue your ascent into what is recognized as the affliction of “Opelitis”.

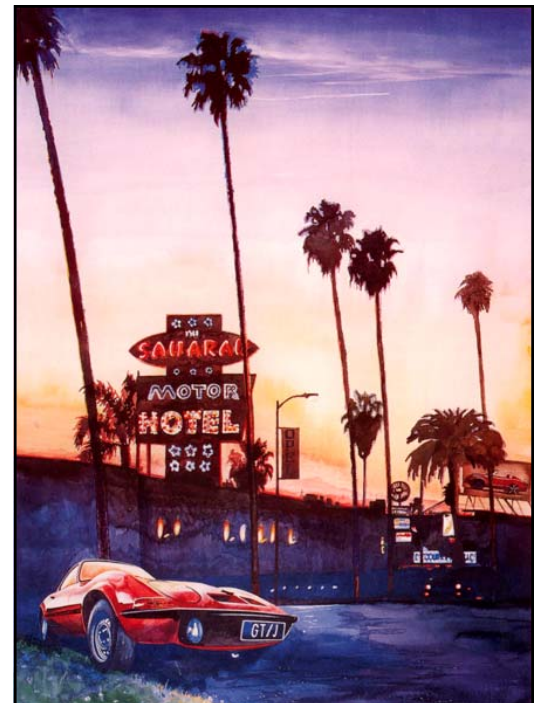

OPEL GT SOURCE

Who we are, What we do

Opel GT Source was established in 1987, to provide parts for "restoration, maintenance and enhancement of the Opel GT".

Since then, "OGTS" (as we have become known) has earned its "best in the industry" reputation for quality products and responsive customer service (by answering the needs of many thousands of Opel owners).

If there is an Opel part you need (that you don't see in our listings), Contact us and ask!
(We also have a warehouse full of many good used Opel parts).

Why Buy from "OGTS"?

Convenience, Confidence, Pricing.

We stock thousands of parts, so that you can get the parts you need for your Opel fast. You can also rest assured you're dealing with a company that's been in business for over 25 years, and knows Opels! Our prices are kept low because many parts are custom-manufactured and because we control our own overhead.

Shop Policies:

Payment: We accept Visa, M/C, Discover or American Express credit cards (and can arrange for Money Orders, or PayPal.)

Charge Policy: Your credit card will only be charged, when items are ready to be shipped**

Data Security: Our order systems are secure, as our internal data is not connected to, or accessible via, the Internet.

Shipping: We ship via UPS, US Priority Mail, or Truck Freight, and strive to achieve a "same day" shipping policy.

Back Orders: When an unavailable item returns to stock, we will contact you (we do not charge, until its ready to ship).

(**An exception is "special orders", when we are required to provide advance payment to arrange a special imported part).

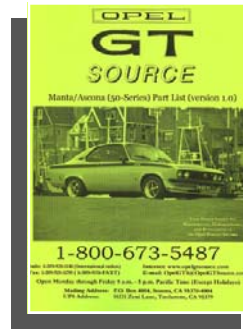
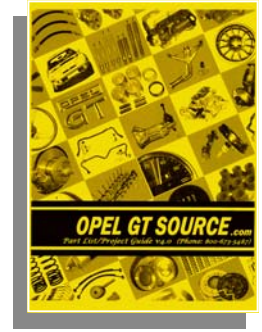

See our part catalogs (in print and online), to view our inventory of new Opel parts, and for technical information (that is commonly needed to order particular Opel parts).

Our goal continues to be to supply higher-quality Opel-specific parts for your car



Contact Information:

Internet Orders use <http://www.opelgtsource.com>

Order Line: Phone 800-673-5487 (800-OPEL-GTS), during our business hours (Mon-Fri 8am-5pm California, USA time zone)

Canada/International Calls: Phone 209-928-1110

FAX us at 209-928-3298

Email us at opelgts@opelgtsource.com

Facebook: "Like" us, at "Opel GT Source"

FAX



Opel GT Source has re-invested our proceeds, into remanufacture of many previously "obsolete" parts for Opel models.

Our customer's purchases allow us to do this (other shops typically restock for other non-Opel inventory).

When you patronize Opel GT Source, you are also investing in your own ability, to be able to drive your Opel for many more years to come!

