



**The Audi A5 and S5 Cabriolet**

Pricing and Specification Guide  
Valid from October 2010



# Personalising your Audi A5 Cabriolet

This guide has been designed to help you tailor and price your chosen Audi A5 Cabriolet quickly and logically. At the back, you will also find information on CO2 emissions-based taxation and the other services offered by Audi, including Finance and Insurance. Alternatively, you can go to [audi.co.uk](http://audi.co.uk) and configure your Audi A5 Cabriolet online.

## The Audi A5 Cabriolet

|               |    |
|---------------|----|
| Efficiency    | 8  |
| Engines       | 10 |
| Transmissions | 11 |
| quattro®      | 12 |

## Model details and prices

|                              |    |
|------------------------------|----|
| Standard model equipment     | 14 |
| SE model equipment           | 15 |
| S line model equipment       | 16 |
| S5 Cabriolet model equipment | 18 |
| Model prices                 | 20 |

|                       |    |
|-----------------------|----|
| <b>Audi exclusive</b> | 22 |
|-----------------------|----|

## Colour and upholstery

|                       |    |
|-----------------------|----|
| Paint                 | 26 |
| Upholstery            | 28 |
| Colour and trim guide | 32 |
| Inlays                | 36 |

## Options

|                              |    |
|------------------------------|----|
| Wheels, tyres and suspension | 38 |
| Packages                     | 40 |
| Audio and communication      | 42 |
| Interior equipment           | 44 |
| Seats                        | 46 |
| Exterior equipment           | 47 |
| Safety and security          | 48 |
| Steering wheels              | 49 |
| Service Plan and warranty    | 50 |
| Merchandise                  | 51 |
| Accessories                  | 52 |

## Technical details

|                        |    |
|------------------------|----|
| Technical data         | 53 |
| Dimensions             | 55 |
| Additional information | 57 |
| Pricing information    | 59 |





## Vorsprung durch Technik

Three words that express the very essence of Audi. Vorsprung durch Technik isn't a slogan. It's our way of seeing the world. It is the driving force behind our history of innovation that continues into the 21st century. Indeed, many technologies that Audi pioneered remain in our cars today. Some are milestones in the history of the motorcar.

From our beginnings in 1899 to the Auto Union team's Grand Prix successes in the 1930s and our more recent wins at Le Mans, we have always been at the forefront of the motor industry.

Vorsprung durch Technik makes us who we are. To see more of its influence, just read on.

## **The Audi A5 Cabriolet: with technology that makes it ideal for all conditions**

Great design tends to get noticed. The shape of the Audi A5 Cabriolet, for example, has probably already caught your attention. But there's another kind of beautiful design in this car that's just as significant: the technology. We've included a fully automatic hood as standard, enabling you to make the most of the sun. There's also optional head-level heating for when it's cold and heat-resistant upholstery for when it's hot. So now there really is no bad weather.





## Efficiency

At Audi, doing less is something we're trying to do more of. We're working to use less fuel, release less CO<sub>2</sub> and waste less energy. It's why we've incorporated a number of more efficient technologies into the Audi A5 Cabriolet.

### **Automatic Start-Stop function**

In heavy traffic, your car still uses fuel and releases CO<sub>2</sub>, even when it's stationary. The automatic Start-Stop function counteracts this problem by switching off the engine when your car comes to a standstill. As soon as you touch the clutch, the car restarts. In conjunction with TDI® and FSI®, it helps save up to 0.4 litres of fuel every 100km.

### **TDI® and FSI®**

Inside the engine of the Audi A5 Cabriolet you'll find the same advanced fuel-injection technology that's driven us to win after win at Le Mans. With TDI® and FSI®, fuel is injected directly into the engine's chambers so that combustion is timed right down to the millisecond. As a result, waste is minimised and you get the most from every last drop of fuel.







### **Recuperation**

When a vehicle brakes, the discs convert the kinetic energy into thermal energy, which is wasted as it cannot be used. With a recuperation system like the one in the Audi A5 Cabriolet, the kinetic energy is converted into useful electrical energy. The way it works is simple. While the car is coasting or braking, the alternator voltage is raised above the level of the basic electrical system, which enables the alternator to generate electrical energy and store it temporarily in the battery. When the vehicle accelerates, this energy is used to relieve the load on the alternator, resulting in a fuel saving of up to 3%.

## Engines

### Petrol

FSI® direct-injection technology is a unique Audi innovation that was originally developed for the Le Mans 24-hour endurance race to deliver more power and torque, as well as enhanced fuel efficiency. Precisely the right amount of fuel and air are injected into the combustion chambers, enabling the engine to 'breathe' more easily. It results in reduced heat loss and increased output, with around a 15% reduction in fuel consumption and significantly lower exhaust emissions. We've also developed TFSI®, with either turbocharging or supercharging, which combines FSI® technology with forced induction – giving cars an extra injection of power.

### Diesel

We introduced TDI® to the roads in 1989, marking a departure from the noisy, fuel-thirsty diesel engines of the past. And since then, we've continuously refined it, recently developing common-rail technology. Under this system, a series of piezo injectors use electrical charge to precisely control the amount of fuel injected into the engine. As well as reducing noise, this allows combustion to happen at a lower temperature and with less oxygen, which lowers emissions.





## Transmissions

### **multitronic®**

Translating a driver's preferences and intentions into road performance, the multitronic® transmission system entertains no compromises – whether in terms of dynamism, convenience or economy. multitronic® automatic transmission is available on models without quattro® permanent all-wheel-drive. A continuously variable transmission, multitronic® can transmit up to 400 Nm of torque and permits an exceptionally wide range of gear ratios. The result is smooth, powerful acceleration and a high level of driving comfort. And thanks to its lightweight design and a number of advanced electronic control systems that monitor gradient, road conditions and the way the driver is using the accelerator pedal, multitronic® also plays an instrumental role in reducing fuel consumption.

### **S tronic®**

Driving is all about thinking ahead, which is just what the S tronic® dual-clutch transmission does. It works almost as two separate systems, one engaging the odd-numbered and the other the even-numbered gears. So when you're accelerating in second, it has third gear waiting for you. And once you make the switch, it's already thinking about fourth. With two clutches working together, you can change gears almost instantly while experiencing smooth, uninterrupted power.

## quattro®

It's the technology that has given Audi the edge on the racetrack ever since it was first introduced 30 years ago – a technology that delivers ultimate control whilst enhancing the sporty characteristics which make the Audi A5 Cabriolet so thrilling to drive. It's called quattro® permanent all-wheel-drive. The principle is simple: in the same way that four brakes ensure better deceleration, four permanently-driven wheels deliver better acceleration and road-holding, pushing or pulling the car as needed, for a driving experience that's both dynamic and safe.

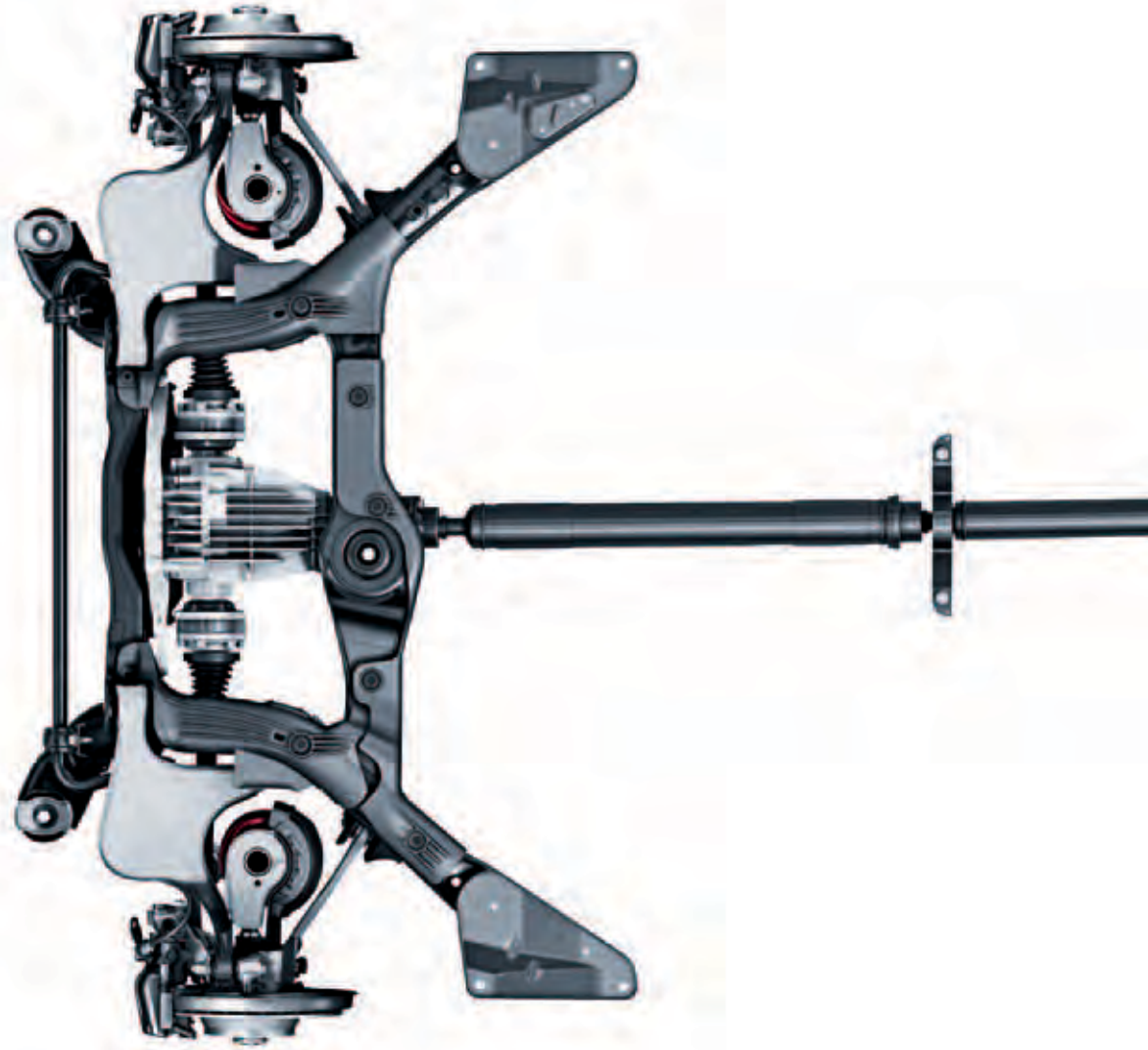

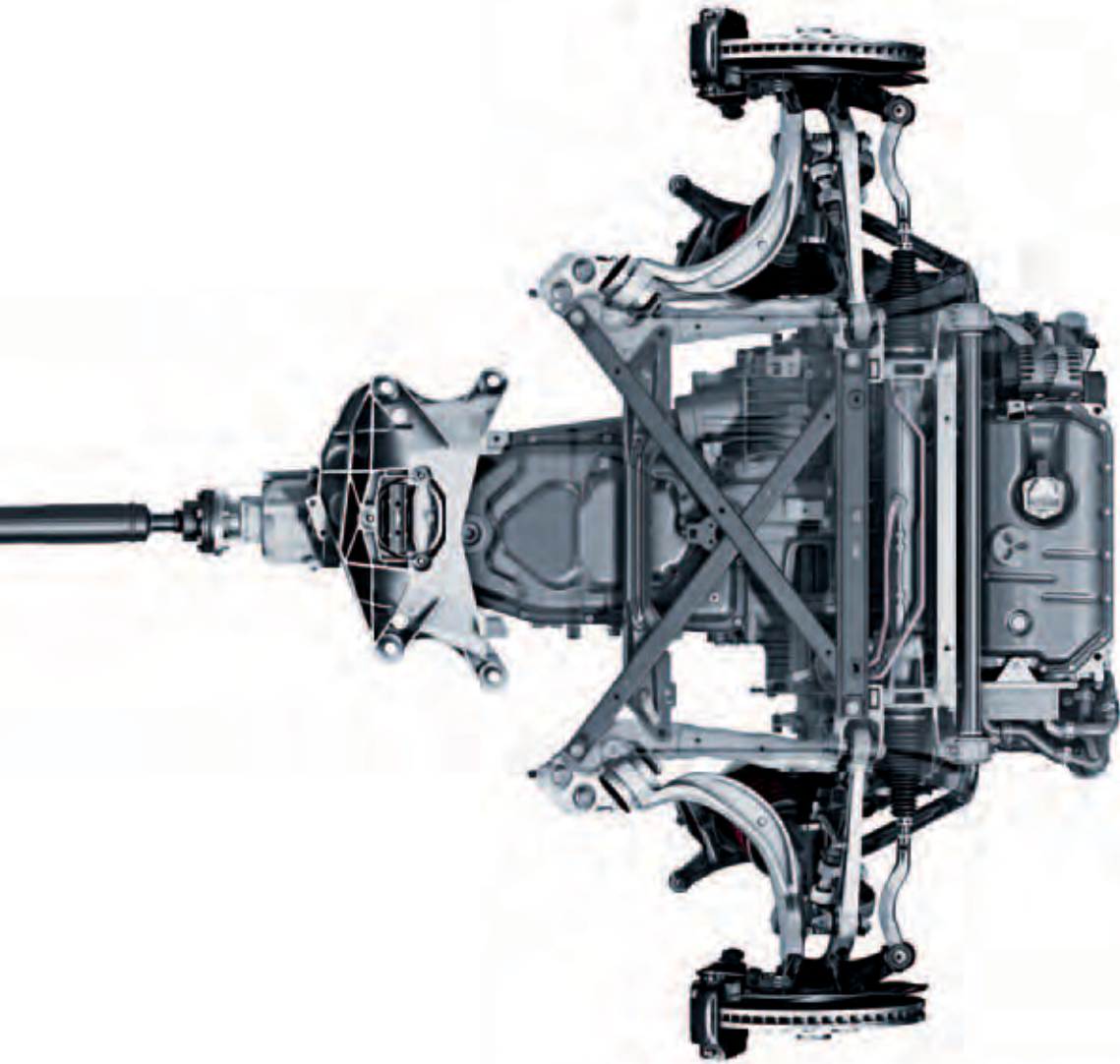

In the Audi A5 Cabriolet, asymmetric dynamic torque distribution continuously distributes drive power between the front and rear axles, depending on weather conditions, road surface and gradient. This leads to greater flexibility and an enhanced, sportier drive.

# Standard model equipment

All Audi A5 Cabriolet models have the following items of standard equipment

## Engines

Automatic Start-Stop function for greater fuel and CO<sub>2</sub> efficiency (only available on the 2.0 TDI and 2.0 TFSI manual engines)  
Recuperation for optimal energy utilisation  
Misfuelling inhibition for diesel engines

## Wheels, tyres and suspension

17" x 7.5J '6-arm' design alloy wheels with 225/45 R17 Y tyres and locking wheel bolts  
Space-saver spare wheel

## Interior equipment

1-zone climate control  
3-spoke leather steering wheel  
Driver's Information System (DIS) with energy saving tips feature, including gearshift indicator  
Electric front and rear windows  
Electromechanical parking brake  
Front and rear floor mats

Intelligent key

Interior chrome package

Micrometallic inlays

Steering column adjustment for rake and reach

Servotronic speed-related power-assisted steering (on 190PS models and above)

## Safety and security

ESP (including limited-slip differential on FWD models)

First aid kit

Front and rear fog lights

Front and rear ISOFIX preparation with front passenger airbag de-activation switch

Front side airbags

Halogen daytime-running lights

Headlight range adjustment

Thatcham category 1 alarm and immobiliser

Toolkit and car jack

Warning triangle

## Exterior equipment

Fully automatic hood (can be operated at speeds up to 31mph)

Exterior mirrors – electrically operated and heated

Front grille – black gloss on 3.0 TDI® and 3.2 FSI® models, stone grey on all others

Exhaust pipes – 4-cylinder models have two exhaust pipes on the left-hand side. 2.0 TFSI® and 6-cylinder models have one exhaust pipe on either side

Exterior aluminium package

## Audio and communication

Audi Concert audio system. Single CD with MP3 compatibility, colour centre console screen, SD memory-card reader and AUX-IN socket in centre console

6 loudspeakers (80 Watts)

## Seats

Arcade cloth seats

Automatic seat-belt feeder

Split-folding rear seat – one-touch operation



17" x 7.5J '6-arm' design alloy wheels



Fully automatic hood

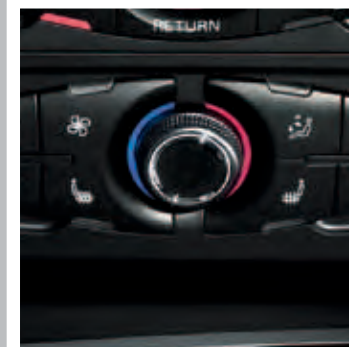

1-zone climate control



Exterior mirrors – electrically operated and heated

# SE model equipment

## In addition to Standard model equipment

**Basic RRP**  
£1,608.33

**Total RRP inc VAT**  
£1,930.00

### Wheels, tyres and suspension

17" x 7.5J '7-arm' design alloy wheels with 225/50 R17 tyres and locking wheel bolts

### Audio and communication

Audi sound system speaker package, 10 speakers including subwoofer (180 Watts)

### Seats

Milano leather seats

### Safety and security

Automatic headlight operation  
Automatic windscreen wipers  
Rear acoustic parking system

### Interior equipment

3-spoke leather multi-function steering wheel

Deluxe 3-zone climate control with separate air distribution and digital display for driver and front passenger. System includes air-conditioning controls in rear centre console for rear passenger compartment

Driver's Information System (DIS) in colour with energy saving tips feature, including gearshift indicator

Front centre armrest including 12V power socket

Wind deflector



17" x 7.5J '7-arm' design alloy wheels



Rear acoustic parking system



Driver's Information System (DIS)



Milano leather seats

# S line model equipment

## In addition to SE model equipment

**Basic RRP**  
£2,133.33

---

**Total RRP inc VAT**  
£2,560.00

### Wheels, tyres and suspension

18" x 8J '5-spoke' S line design alloy wheels with 245/40 R18 tyres and locking wheel bolts

Sports suspension with stiffer spring settings and dampers than Standard models

### Interior equipment

3-spoke S line multi-function steering wheel (paddle shift for automatic models)

Black headlining

Matt-brushed aluminium inlays

Perforated leather gear knob

S line embossed Sport seats in Milano leather

S line sill plates

### Exterior equipment

Acoustic hood with LED rear passenger reading lights

Bumper 'blade' in Platinum optic

Chrome fog light surround

Chrome rolled exhaust

S line exterior styling package including:

- S line side skirts

- S line front bumper

- S line rear diffuser

- S line badges on wings

Xenon headlights with LED daytime-running lights

LED rear lights



18" x 8J '5-spoke' design alloy wheels



Xenon headlights with LED daytime-running lights



Matt-brushed aluminium inlays



3-spoke S line multi-function steering wheel (paddle shift for automatic models)







## S5 quattro® Cabriolet model equipment – in addition to SE model equipment

The Audi S5 Cabriolet features a powerful 3-litre V6 engine as standard, which uses supercharging to take you from 0 to 62 mph in just 5.6 seconds. From the comfort and stability of an S5-embossed Silk Nappa leather Super Sports seat, you can sit back and enjoy every unit of this engine's 333PS capability, not to mention the safety and security of quattro® permanent-all-wheel-drive.

### Wheels, tyres and suspension

19" x 8.5J '5-parallel-spoke' design alloy wheels with 255/35 R19 tyres  
'S' Sports suspension

### Interior equipment

3-spoke S5 Sports multi-function leather steering wheel with silver stitching  
Aluminium scuff plates with S5 logo  
Interior lighting package  
Inlays in matt-brushed aluminium  
'S' instrument dials

### Safety and security

'S' model enhanced braking system

### Seats

S5 Super Sports seats with electric adjustment and lumbar support  
Silk Nappa leather upholstery  
Through-load facility

### Exterior equipment

Acoustic hood with LED rear passenger reading lights  
Aluminium-effect door mirror housings  
Exhaust pipes – twin on left- and right-hand side in chrome rolled finish  
Platinum grey matt grille, with vertical bars and chrome inserts  
Painted brake callipers with S5 logo  
'S' body styling  
Xenon headlights with LED daytime-running lights and LED rear lights



S5 Super Sports seats with electric adjustment and lumbar support



'S' instrument dials



19" x 8.5J '5-parallel-spoke' design alloy wheels

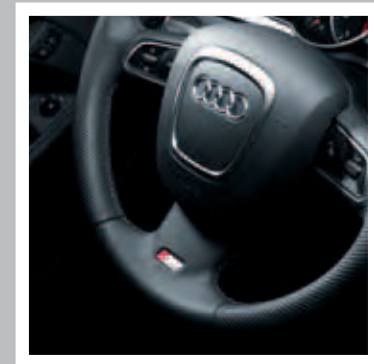

3-spoke S5 Sports multi-function leather steering wheel with silver stitching



## A5 Cabriolet Standard

| Engines          | Power | Transmissions    | Basic RRP  | Total RRP inc VAT | Recommended OTR |
|------------------|-------|------------------|------------|-------------------|-----------------|
| 1.8 TFSI         | 160PS | 6-speed manual   | £23,337.50 | £28,005.00        | £28,900.00      |
| 2.0 TFSI         | 211PS | 6-speed manual   | £25,837.50 | £31,005.00        | £31,805.00      |
| 2.0 TFSI quattro | 211PS | 7-speed S tronic | £28,341.67 | £34,010.00        | £34,955.00      |
| 2.0 TDI          | 170PS | 6-speed manual   | £25,625.00 | £30,750.00        | £31,520.00      |

## A5 Cabriolet SE

| Engines          | Power | Transmissions       | Basic RRP  | Total RRP inc VAT | Recommended OTR |
|------------------|-------|---------------------|------------|-------------------|-----------------|
| 1.8 TFSI         | 160PS | 6-speed manual      | £24,945.83 | £29,935.00        | £30,830.00      |
| 2.0 TFSI         | 211PS | 6-speed manual      | £27,445.83 | £32,935.00        | £33,735.00      |
| 2.0 TFSI quattro | 211PS | 7-speed S tronic    | £29,950.00 | £35,940.00        | £36,885.00      |
| 3.2 FSI          | 265PS | 8-speed multitronic | £31,487.50 | £37,785.00        | £38,855.00      |
| 3.2 FSI quattro  | 265PS | 7-speed S tronic    | £32,762.50 | £39,315.00        | £40,510.00      |
| 2.0 TDI          | 170PS | 6-speed manual      | £27,233.33 | £32,680.00        | £33,450.00      |
| 2.7 TDI          | 190PS | 8-speed multitronic | £30,170.83 | £36,205.00        | £37,100.00      |
| 3.0 TDI quattro  | 240PS | 7-speed S tronic    | £32,891.67 | £39,470.00        | £40,415.00      |

**Please note:** The maximum power output figures are quoted in PS (or Pferdestärke, which is the metric equivalent of brake horsepower). To convert to brake horsepower, divide the PS figure by 1.0139.

**Recommended On-The-Road (OTR) retail prices include:** delivery charge, half a tank of fuel, number plates at £590.00 (inc. VAT), Road Fund Licence (which may vary depending on model/transmission – see page 57 for details) and first registration fee at £55.00. Vehicle Excise Duty correct at time of going to print, but this may alter to reflect any change in the applicable VED rate.

RRP – Recommended Retail Price. All prices are subject to VAT at 20% reflecting the VAT rate most likely to be in force at the time of delivery. The VAT rate may change if the vehicle is delivered before 4 January 2011 or if the VAT rate subsequently changes.

## A5 Cabriolet S line

| Engines          | Power | Transmissions       | Basic RRP  | Total RRP inc VAT | Recommended OTR |
|------------------|-------|---------------------|------------|-------------------|-----------------|
| 1.8 TFSI         | 160PS | 6-speed manual      | £27,079.17 | £32,495.00        | £33,390.00      |
| 2.0 TFSI         | 211PS | 6-speed manual      | £29,579.17 | £35,495.00        | £36,295.00      |
| 2.0 TFSI quattro | 211PS | 7-speed S tronic    | £32,083.33 | £38,500.00        | £39,445.00      |
| 3.2 FSI          | 265PS | 8-speed multitronic | £33,620.83 | £40,345.00        | £41,415.00      |
| 3.2 FSI quattro  | 265PS | 7-speed S tronic    | £34,895.83 | £41,875.00        | £43,070.00      |
| 2.0 TDI          | 170PS | 6-speed manual      | £29,366.67 | £35,240.00        | £36,010.00      |
| 2.7 TDI          | 190PS | 8-speed multitronic | £32,304.17 | £38,765.00        | £39,660.00      |
| 3.0 TDI quattro  | 240PS | 7-speed S tronic    | £35,025.00 | £42,030.00        | £42,975.00      |

## S5 Cabriolet

| Engine           | Power | Transmission     | Basic RRP  | Total RRP inc VAT | Recommended OTR |
|------------------|-------|------------------|------------|-------------------|-----------------|
| 3.0 TFSI quattro | 333PS | 7-speed S tronic | £36,604.17 | £43,925.00        | £45,120.00      |

## Transmissions

|                          | 8-speed multitronic | 7-speed S tronic |
|--------------------------|---------------------|------------------|
| 1.8 TFSI                 | ●                   | –                |
| 2.0 TFSI                 | ●                   | –                |
| 2.0 TFSI quattro         | –                   | S                |
| 3.2 FSI                  | S                   | –                |
| 3.2 FSI quattro          | –                   | S                |
| 2.0 TDI                  | –                   | –                |
| 2.7 TDI                  | S                   | –                |
| 3.0 TDI quattro          | –                   | S                |
| S5 quattro               | –                   | S                |
| <b>Basic RRP</b>         | <b>£1,233.33</b>    | <b>£1,233.33</b> |
| <b>Total RRP inc VAT</b> | <b>£1,480.00</b>    | <b>£1,480.00</b> |

– = Not available

● = Available

S = Standard



## Audi exclusive



## Audi exclusive

Every Audi is intrinsically exclusive. It's the breathtaking design, the exceptional engineering, the Vorsprung durch Technik. But for that special touch you can specify your A5 Cabriolet with options from Audi exclusive. Whether you want a unique, custom-mixed paint colour or seats in a combination of complementary shades, Audi exclusive will enable you to drive the car you've always imagined.

Both the exclusive and standard options can be found on the following pages.

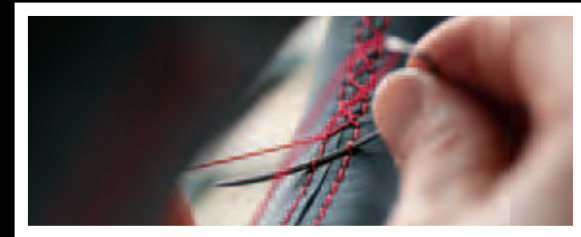
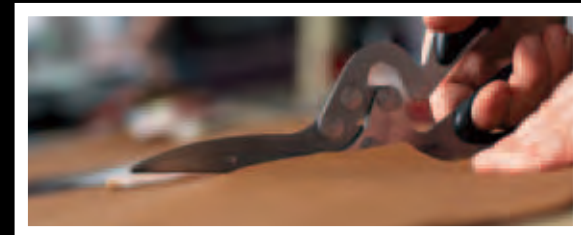
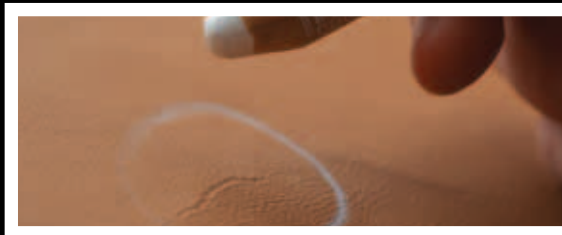

## Audi exclusive line





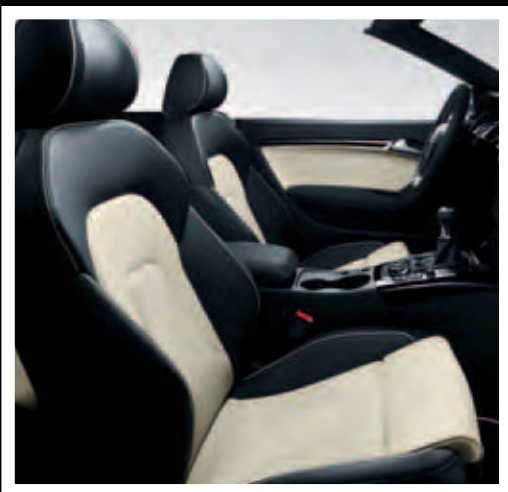

# Paint

You can select one of the Standard colours shown opposite or, for a different look, choose from a range of optional finishes.

## Standard colours



Ibis white – T9

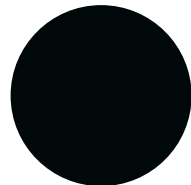

Brilliant black – A2

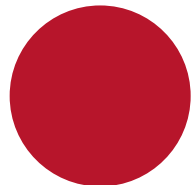

Brilliant red – C8

## Optional colours

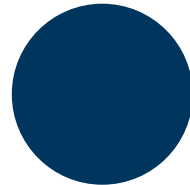

Aruba blue, pearl effect\* – Q9

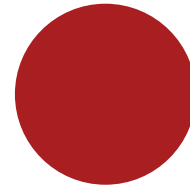

Garnet red, pearl effect – 9C

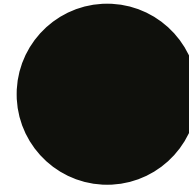

Phantom black, pearl effect – L8

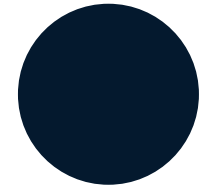

Deep sea blue, pearl effect – 8A

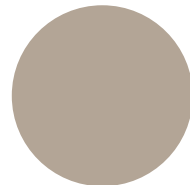

Sahara silver, metallic\* – 9T

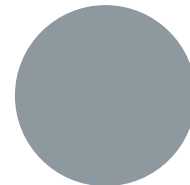

Quartz grey, metallic – Q4

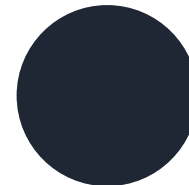

Meteor grey, pearl effect – X5

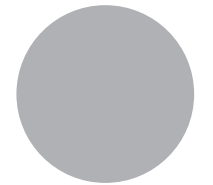

Ice silver, metallic – P5

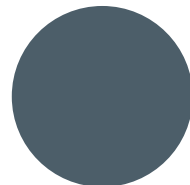

Sphere blue, metallic\* – 9F

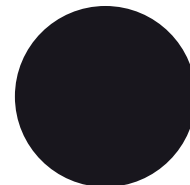

Tungsten grey, pearl effect\* – 1J

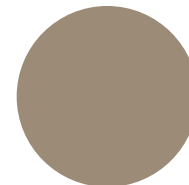

Aurum beige, metallic\* – C6

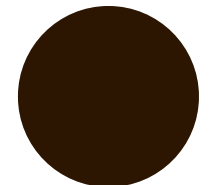

Teak brown, metallic\* – 4U

Options are subject to availability and may extend delivery.

All the colour swatches on this page are matched as accurately as possible to the actual paint colours used. However, due to print processes, Audi UK cannot guarantee that colours shown are 100% accurate.

Visit your local Audi Centre for a more accurate colour swatch.

\*Not available on S5 quattro

RRP – Recommended Retail Price.

All prices are subject to VAT at 20% reflecting the VAT rate most likely to be in force at the time of delivery. The VAT rate may change if the vehicle is delivered before 4 January 2011 or if the VAT rate subsequently changes.

### Optional colours

**Basic RRP**  
£512.50

---

**Total RRP inc VAT**  
£615.00

## S line colours

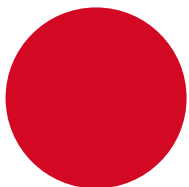

Misano red, pearl effect\* - N9

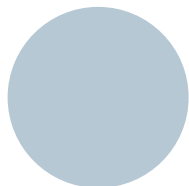

Monza silver metallic\* - U7

## S5 colour

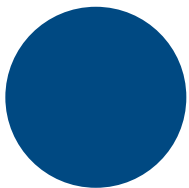

Sprint blue, pearl effect - 5N  
(only available on S5 quattro®)

## Hood colours



Red - SF

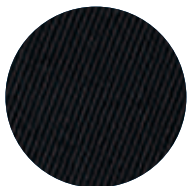

Black - PA

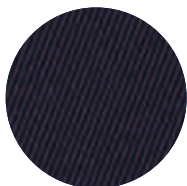

Blue - PB\*\*



Brown - PW

# Paint

## Audi exclusive

Everyone has a favourite colour. No matter what yours is, Audi exclusive provides a range of unique colours that have been designed to set your car apart. Choose from the swatches here, or specify any other paint colour in the Audi range – whether it's Jet blue from the Audi R8 or Alpine white from the original Audi quattro®. The choice is yours.

## Customised

If you have a particular colour in mind, we'll mix the exact metallic or pearl-effect shade you want.\*\*

\*\*Acoustic hood only

\*Visit your local Audi Centre for colour samples

\*\*Custom paint is subject to factory approval, and is available for metallic and pearl-effect water-based paints only. Three-colour process colours and two-tone schemes are not available.

All the colour swatches on this page are matched as accurately as possible to the actual paint colours used. However, due to print processes, Audi UK cannot guarantee that colours shown are 100% accurate.

Visit your local Audi Centre for a more accurate colour swatch.

RRP - Recommended Retail Price.

All prices are subject to VAT at 20% reflecting the VAT rate most likely to be in force at the time of delivery. The VAT rate may change if the vehicle is delivered before 4 January 2011 or if the VAT rate subsequently changes.

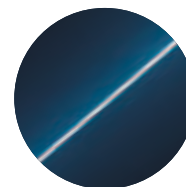

Palace blue, pearl effect

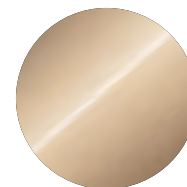

Sand beige, pearl effect

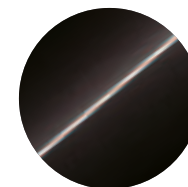

Saddle brown, pearl effect

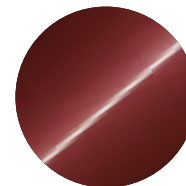

Classic red, pearl effect

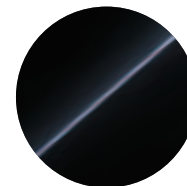

Mamba black, metallic

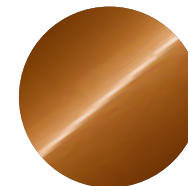

Ipanema brown, metallic



Any colour in the Audi range



100 Audi exclusive colours to choose from\*



Customised paint

## Audi exclusive

Basic RRP  
£1,445.83

Total RRP inc VAT  
£1,735.00

## Customised

Basic RRP  
£2,041.67

Total RRP inc VAT  
£2,450.00

# Upholstery

## Standard seats

Choose your favourite upholstery from the swatches shown opposite to give your car's interior the look and feel you want.

Arcade cloth



Black - GD/JN



Light grey - GE/AD

Milano leather



Black - GD/JN



Light grey - GE/AD

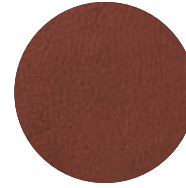

Cinnamon brown - CN/GJ

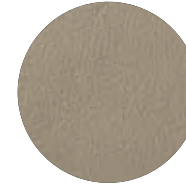

Cardamom beige - AN

|                | Standard | SE | S line | S5 quattro® | Basic RRP | Total RRP inc VAT |
|----------------|----------|----|--------|-------------|-----------|-------------------|
| Arcade cloth   | S        | -  | -      | -           | No charge | No charge         |
| Milano leather | •        | S  | -      | -           | £1,095.83 | £1,315.00         |

Options are subject to availability and may extend delivery.

- = Not available
- = Available
- S = Standard

All leather upholstery choices include seats, head restraints, door inserts and front centre armrest in leather. Leather/Alcantara choices include head restraints, seat side bolsters and front centre armrest in leather with the seat centres and door inserts in Alcantara.

RRP - Recommended Retail Price.

All prices are subject to VAT at 20% reflecting the VAT rate most likely to be in force at the time of delivery. The VAT rate may change if the vehicle is delivered before 4 January 2011 or if the VAT rate subsequently changes.



# Upholstery

## Sports seats

Front Sports seats with 4-way electrical lumbar adjustment and manual height adjustment.













Options are subject to availability and may extend delivery.

- = Not available  
• = Available  
S = Standard

All leather upholstery choices include seats, head restraints, door inserts and front centre armrest in leather. Leather/Alcantara choices include head restraints, seat side bolsters and front centre armrest in leather with the seat centres and door inserts in Alcantara.

RRP – Recommended Retail Price.

All prices are subject to VAT at 20% reflecting the VAT rate most likely to be in force at the time of delivery. The VAT rate may change if the vehicle is delivered before 4 January 2011 or if the VAT rate subsequently changes.

|                    |  |   |   |   | Standard | SE | S line | S5 quattro® | Basic RRP | Total RRP inc VAT |
|--------------------|--|---|---|---|----------|----|--------|-------------|-----------|-------------------|
| Leather/Alcantara  |   |   |  |   | -        | •  | -      | -           | £404.17   | £485.00           |
|                    | Black – GD/JN  | Light grey – GE/AD  | Cardamom beige – AN   |   |          |    |        |             |           |                   |
|                    |  |   |   |   |          |    |        |             |           |                   |
| Milano leather     |   |   |  |  | -        | •  | -      | -           | £404.17   | £485.00           |
|                    | Black – GD/JN  | Light grey – GE/AD  | Cardamom beige – AN   | Cinnamon brown – GN/GJ  |          |    |        |             |           |                   |
| Fine Nappa leather |   |   |  |  | -        | •  | -      | -           | £704.17   | £845.00           |
|                    | Black – GD/JN  | Light grey – GE/AD  | Cardamom beige – AN   | Red – AA/BF   |          |    |        |             |           |                   |
|                    |  |  |   |   |          |    |        |             |           |                   |
|                    | Luxor beige – AC/GM  | Cinnamon brown – GN/GJ  |   |   |          |    |        |             |           |                   |

# Upholstery

## S line Sports seats

Front S line Sports seats with 4-way electrical lumbar adjustment and manual height adjustment. Front seats with 'S line' logo available with black stitching on all upholsteries and silver stitching on leather/cloth and leather/Alcantara upholsteries.



Options are subject to availability and may extend delivery.

- = Not available
- = Available
- S = Standard

All leather upholstery choices include seats, head restraints, door inserts and front centre armrest (if fitted) in leather. Leather/Alcantara choices include head restraints, seat side bolsters and front centre armrest in leather with the seat centres and door inserts in Alcantara.

RRP – Recommended Retail Price.

All prices are subject to VAT at 20% reflecting the VAT rate most likely to be in force at the time of delivery. The VAT rate may change if the vehicle is delivered before 4 January 2011 or if the VAT rate subsequently changes.

|  | Standard | SE | S line | S5 quattro® | Basic RRP | Total RRP inc VAT |
|--|----------|----|--------|-------------|-----------|-------------------|
| <b>Milano leather</b><br><br>Black – QE   | -        | -  | S      | -           | No charge | No charge         |
| <b>Leather/Alcantara</b><br> <br>Black – QE      Black with Silver stitching – QF | -        | -  | •      | -           | No charge | No charge         |
| <b>Fine Nappa leather</b><br><br>Black – QE   | -        | -  | •      | -           | £304.17   | £365.00           |

# Upholstery

## Climate-controlled seats

Climate-controlled front seats can be heated or cooled according to the driver's and passenger's requirements. Includes electrically-adjustable front seats and memory function for driver's seat. Also included: door mirrors – electrically folding and auto-dimming with memory function, and auto-dimming rear-view mirror (only available in Milano leather and must be combined with head-level heating).

## S5 Cabriolet quattro® Super Sports seats

S5 embossed seats with electric height adjustment, forwards and backwards position, backrest angle and lumbar support for driver and front-passenger seats.

Options are subject to availability and may extend delivery.

- = Not available
- = Available
- S = Standard

All leather upholstery choices include seats, head restraints, door inserts and front centre armrest in leather.

RRP – Recommended Retail Price.

All prices are subject to VAT at 20% reflecting the VAT rate most likely to be in force at the time of delivery. The VAT rate may change if the vehicle is delivered before 4 January 2011 or if the VAT rate subsequently changes.

Milano leather



Black – GD/JN



Light grey – GE/AD

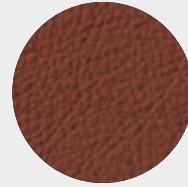

Cinnamon brown – GN/GJ

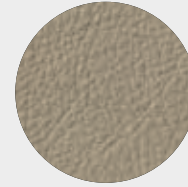

Cardamom beige – AN

| Standard | SE | S line | S5 quattro® | Basic RRP | Total RRP inc VAT |
|----------|----|--------|-------------|-----------|-------------------|
| –        | •  | –      | –           | £2,254.17 | £2,705.00         |

Silk Nappa leather



Black/Black – ZM/SC

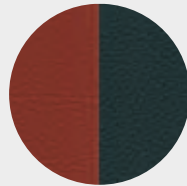

Magma red/Black – FA/SJ

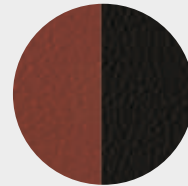

Mustang brown/Black – SH/SK

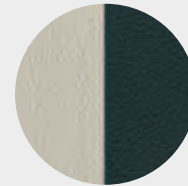

Spectral silver/Black – SP/SQ

| Standard | SE | S line | S5 quattro® | Basic RRP | Total RRP inc VAT |
|----------|----|--------|-------------|-----------|-------------------|
| –        | –  | –      | S           | No charge | No charge         |

# Colour and trim guide

## Interior trim colours

### Standard seats

To help you choose the right interior for your Audi A5 Cabriolet, please use this guide, showing the carpet, dashboard and headlining colours that have been matched to your chosen upholstery.

| Order Code   | Upholstery     | Carpet          | Dashboard (upper/lower) | Headlining   | Arcade cloth (N0B) | Milano leather (N5W) |
|--------------|----------------|-----------------|-------------------------|--------------|--------------------|----------------------|
| <b>GD/JN</b> | Black          | Black           | Black/Black             | Silver/Black | ●                  | ●                    |
| <b>GE/AD</b> | Light grey     | Quartz grey     | Black/Graphite grey     | Silver/Black | ●                  | ●                    |
| <b>GN/GJ</b> | Cinnamon       | Black           | Black/Black             | Silver/Black | —                  | ●                    |
| <b>AN</b>    | Cardamom beige | Coriander beige | Taupe beige/Tan beige   | Linen beige  | —                  | ●                    |

### Sports seats

| Order Code   | Upholstery     | Carpet          | Dashboard (upper/lower) | Headlining   | Leather/Alcantara (N7U) | Milano leather (N5W) | Fine Nappa leather (N3Q) |
|--------------|----------------|-----------------|-------------------------|--------------|-------------------------|----------------------|--------------------------|
| <b>GD/JN</b> | Black          | Black           | Black/Black             | Silver/Black | ●                       | ●                    | ●                        |
| <b>GE/AD</b> | Light grey     | Quartz grey     | Black/Graphite grey     | Silver/Black | ●                       | ●                    | ●                        |
| <b>AN</b>    | Cardamom beige | Coriander beige | Taupe beige/Tan beige   | Linen beige  | ●                       | ●                    | ●                        |
| <b>AA/BF</b> | Red            | Black           | Black/Black             | Silver/Black | —                       | —                    | ●                        |
| <b>AC/GM</b> | Luxor beige    | Black           | Black/Black             | Silver/Black | —                       | —                    | ●                        |
| <b>GN/GJ</b> | Cinnamon       | Black           | Black/Black             | Silver/Black | —                       | ●                    | ●                        |

### S line Sports seats

| Order Code                   | Upholstery | Carpet | Dashboard (upper/lower) | Headlining | Leather/Alcantara (N7K) | Milano leather (N1Y) | Fine Nappa leather (N2R) |
|------------------------------|------------|--------|-------------------------|------------|-------------------------|----------------------|--------------------------|
| <b>QE (Black stitching)</b>  | Black      | Black  | Black/Black             | Black      | ●                       | ●                    | ●                        |
| <b>QF (Silver stitching)</b> | Black      | Black  | Black/Black             | Black      | ●                       | —                    | —                        |

Options are subject to availability and may extend delivery.

- = Not available
- = Available
- S = Standard



# Colour and trim guide

## Interior trim colours

### Climate-controlled seats

| Order Code   | Upholstery     | Carpet          | Dashboard (upper/lower) | Headlining   | Milano leather (N5W) |
|--------------|----------------|-----------------|-------------------------|--------------|----------------------|
| <b>GD/JN</b> | Black          | Black           | Black/Black             | Silver/Black | ●                    |
| <b>GE/AD</b> | Light grey     | Quartz grey     | Black/Graphite grey     | Silver/Black | ●                    |
| <b>GN/GJ</b> | Cinnamon       | Black           | Black/Black             | Silver/Black | ●                    |
| <b>AN</b>    | Cardamom beige | Coriander beige | Taupe beige/Tan beige   | Linen beige  | ●                    |

### S5 Cabriolet Super Sports seats

| Order Code   | Upholstery            | Carpet | Dashboard (upper/lower) | Headlining   | Silk Nappa leather (N1U) |
|--------------|-----------------------|--------|-------------------------|--------------|--------------------------|
| <b>SH/SK</b> | Mustang brown/Black   | Black  | Black/Black             | Black/Silver | ●                        |
| <b>SP/SQ</b> | Spectral silver/Black | Black  | Black/Black             | Black/Silver | ●                        |
| <b>FA/SJ</b> | Magma red/Black       | Black  | Black/Black             | Black/Silver | ●                        |
| <b>ZM/SC</b> | Black/Black           | Black  | Black/Black             | Black/Silver | ●                        |

Options are subject to availability and may extend delivery.

- = Not available
- = Available
- S = Standard

\*Acoustic hood only.

# Upholstery

## Audi exclusive

With Audi exclusive, you can specify your seats in Fine Nappa leather or Fine Nappa leather/Alcantara, in an array of different colours shown to the right.

Select just one all-over shade for each seat, or customise each panel in two or more complementary colours from the distinctive Audi exclusive palette. You can even choose the colour of the decorative stitching – to match or contrast with your chosen upholstery – from this varied collection. Whatever combination you decide upon, we think you'll be extremely comfortable with the result.

Options are subject to availability and may extend delivery.

-- = Not available  
 • = Available  
 S = Standard

\*Leather and stitching (where applicable) can be specified in a variety of colours from the Audi exclusive range.

RRP – Recommended Retail Price.

All prices are subject to VAT at 20% reflecting the VAT rate most likely to be in force at the time of delivery. The VAT rate may change if the vehicle is delivered before 4 January 2011 or if the VAT rate subsequently changes.

| Order Code         |  | Standard | SE | S line | S5 quattro® | Basic RRP | Total RRP inc VAT |
|--------------------|--|----------|----|--------|-------------|-----------|-------------------|
| <b>PYD/PYJ S3G</b> | <b>Audi exclusive leather package 2 in Fine Nappa leather.</b> Includes leather-covered seat upholstery, door trim inserts, front centre armrest, backrest covers and door armrests and handles. Add-on parts and seat side trims come in the interior trim colour. (Not available in conjunction with climate comfort seats)*                           | –        | •  | •      | •           | £2,608.33 | £3,130.00         |
| <b>PYF S3G</b>     | <b>Audi exclusive leather package 2 in Fine Nappa leather/Alcantara.</b> Includes leather-covered seat side trims and backrest covers, front centre armrest, door armrests and Alcantara seat centre sections and door trim inserts. Seat side trims and add-on parts are colour coordinated. (Not available in conjunction with climate comfort seats)* | –        | •  | •      | –           | £2,608.33 | £3,130.00         |



Chestnut brown

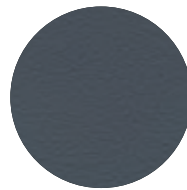

Jet grey

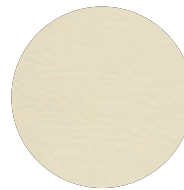

Alabaster white

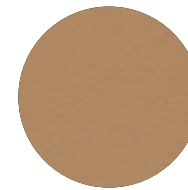

Sand beige

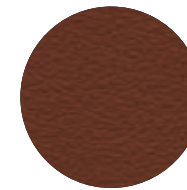

Saddle brown

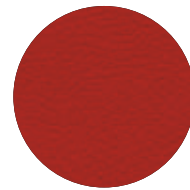

Crimson red

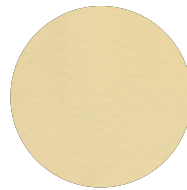

Magnolia white



Havana brown



Cognac brown

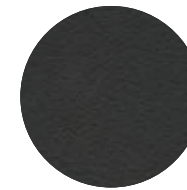

Night blue

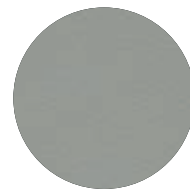

Cloudy grey

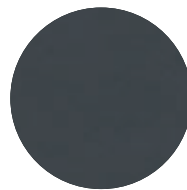

Smoky blue

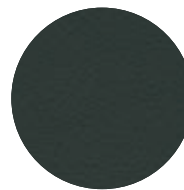

Iceland green

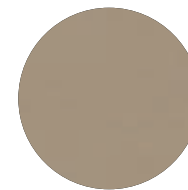

Powder beige

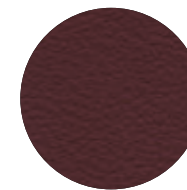

Classic red

### Also available:

**Alcantara colours:** available in all the Audi exclusive colours shown, except for Crimson red, Jet grey and Sand beige. Alcantara equivalents are Chilli red, Amethyst grey, and Sesame beige respectively.

**Carpet colours:** available in all the Audi exclusive colours shown, except for Crimson red and Saddle brown.

Please consult your Audi Centre for examples of Alcantara and carpet colours.

# Upholstery

## Audi exclusive line

Audi exclusive is ultimately about choice – but if you'd rather leave some of the decisions in the capable hands of our designers, the expert team at quattro® GmbH have compiled Audi exclusive line, combining some of the most popular elements of the exclusive range in one, beautifully coordinated package.

Options are subject to availability and may extend delivery.

– = Not available  
 • = Available  
 S = Standard

RRP – Recommended Retail Price.

All prices are subject to VAT at 20% reflecting the VAT rate most likely to be in force at the time of delivery. The VAT rate may change if the vehicle is delivered before 4 January 2011 or if the VAT rate subsequently changes.

| Order Code |                     | Standard | SE | S line | S5 quattro® | Basic RRP | Total RRP inc VAT |
|------------|---------------------|----------|----|--------|-------------|-----------|-------------------|
| WQK        | Audi exclusive line | –        | •  | –      | –           | £1,741.67 | £2,090.00         |



Crimson red – QY

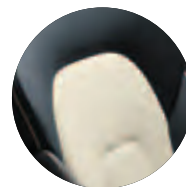

Alabaster white – UA

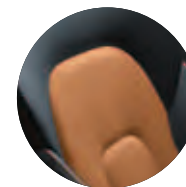

Cognac brown – QX

### This package includes

- ▶ Sports seats in two-tone Fine Nappa leather, with black seat-side sections with coloured stitching and coloured seat-centre section in Crimson red, Alabaster white or Cognac brown
- ▶ Door-trim inserts in black to match seat-centre section
- ▶ Black dashboard and carpets
- ▶ Black cloth headlining
- ▶ Audi exclusive door sill trims
- ▶ Matt-brushed aluminium inlays
- ▶ Floor mats in black with coloured piping (to match seat-centre section)
- ▶ 3-spoke leather steering wheel (S tronic® with shift paddles)
- ▶ Steering wheel rim and gear lever gaiter with coloured stitching in matching colour to seat-centre section
- ▶ Head restraints with coloured stitching in matching colour to seat-centre section

# Inlays

Inlays are the all-important finishing touch that add flair and interest to your car's interior.

| Order Code |  | Standard | SE | S line | S5 quattro® | Basic RRP | Total RRP inc VAT |
|------------|--|----------|----|--------|-------------|-----------|-------------------|
| 5MA        | Micrometallic platinum   | S        | S  | -      | -           | No charge | No charge         |
| 5TG        | Matt-brushed aluminium   | -        | -  | S      | S           | No charge | No charge         |
| 5TE        | Aluminium hologram   | ●        | ●  | -      | -           | £129.17   | £155.00           |
| 5TZ        | Fine grain birch wood, grey  | -        | -  | ●      | ●           | £150.00   | £180.00           |
| 5TK        | Fine grain ash, almond beige                                       | ●        | ●  | -      | -           | £275.00   | £330.00           |
| 5MG        | Walnut, brown  | ●        | ●  | -      | -           | £275.00   | £330.00           |
| 5MZ        | Stainless steel mesh (centre console comes in Piano finish, black) | -        | -  | -      | ●           | £304.17   | £365.00           |
| 5MK        | Carbon atlas   | -        | -  | -      | ●           | £212.50   | £255.00           |
| 7TD        | Laurel, nutmeg   | ●        | ●  | -      | -           | £275.00   | £330.00           |
| 5TL        | Piano finish, black  | -        | -  | ●      | -           | No charge | No charge         |

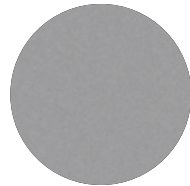

Micrometallic platinum – 5MA

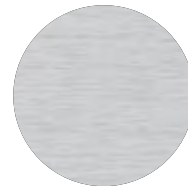

Matt-brushed aluminium – 5TG

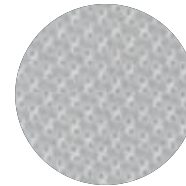

Aluminium hologram – 5TE



Fine grain birch wood, grey – 5TZ



Fine grain ash, almond beige – 5TK

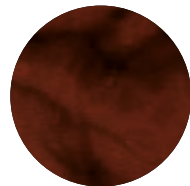

Walnut, brown – 5MG

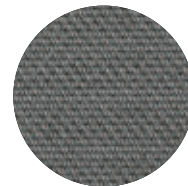

Stainless steel mesh (centre console comes in Piano finish, black) – 5MZ

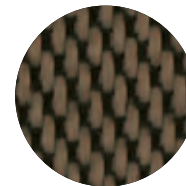

Carbon atlas – 5MK

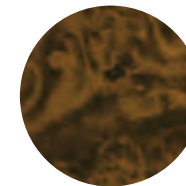

Laurel, nutmeg – 7TD

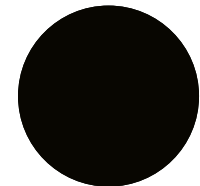

Piano finish, black – 5TL

Options are subject to availability and may extend delivery.

- = Not available
- = Available
- S = Standard

RRP – Recommended Retail Price.

All prices are subject to VAT at 20% reflecting the VAT rate most likely to be in force at the time of delivery. The VAT rate may change if the vehicle is delivered before 4 January 2011 or if the VAT rate subsequently changes.

# Inlays

## Audi exclusive

Audi exclusive has sourced a wide range of materials which you can select for your inlays, from Sepia oak to warm Saffron poplar.

| Order Code |   | Standard | SE | S line | S5 quattro® | Basic RRP | Total RRP inc VAT |
|------------|---|----------|----|--------|-------------|-----------|-------------------|
| YTA S3G    | Audi exclusive inlays (cannot be combined with the inlays shown on page 36) | –        | •  | •      | •           | £675.00   | £810.00           |



Fine grain ash, nougat



Fine grain myrtle, nutmeg

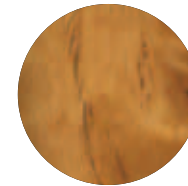

Poplar, saffron



Oak, sepia

Options are subject to availability and may extend delivery.

- = Not available
- = Available
- S = Standard

RRP – Recommended Retail Price.

All prices are subject to VAT at 20% reflecting the VAT rate most likely to be in force at the time of delivery. The VAT rate may change if the vehicle is delivered before 4 January 2011 or if the VAT rate subsequently changes.

## Wheels, tyres and suspension

Choose a set of specially-selected alloy wheels to subtly enhance the way your car looks and drives. And you can also specify Audi drive select, which allows you to change suspension and steering settings according to your driving style.



18" x 8.5J '10-spoke' design  
alloy wheels – PQ5



18" x 8.5J '15-spoke star' design  
alloy wheels – PRR



19" x 8.5J '5-spoke Y' design  
alloy wheels – PRV



19" x 9J '20-spoke' design,  
2-piece alloy wheels – PQS



19" x 9J '5-segment-spoke' design  
alloy wheels with tyres – PQ6



20" x 9J '7-arm double-spoke' design  
alloy wheels – PQF

Options are subject to availability and may extend delivery.

-- = Not available  
• = Available  
S = Standard

RRP – Recommended Retail Price.

All prices are subject to VAT at 20% reflecting the VAT rate most likely to be in force at the time of delivery. The VAT rate may change if the vehicle is delivered before 4 January 2011 or if the VAT rate subsequently changes.

# Wheels, tyres and suspension

## Audi drive select

Audi drive select changes your car's handling and responses at the touch of a button to suit the way you want to drive. There are four modes: comfort, dynamic, auto and individual. Please note that you can only choose the 'individual' mode and customise your settings if you also have Satellite Navigation installed.

## Dynamic steering

With this new technology, driving is significantly more agile under everyday conditions, while directional stability and precision are increased at high speeds and in demanding driving situations.

## Damper control

Formed on the basis of lowered Sports suspension, the optional damper control system fine tunes suspension settings according to road conditions and driver needs.

Options are subject to availability and may extend delivery.

- = Not available
- = Available
- S = Standard

RRP - Recommended Retail Price.

All prices are subject to VAT at 20% reflecting the VAT rate most likely to be in force at the time of delivery. The VAT rate may change if the vehicle is delivered before 4 January 2011 or if the VAT rate subsequently changes.

| Order Code |  | Standard | SE | S line | S5 quattro® | Basic RRP | Total RRP inc VAT |
|------------|--|----------|----|--------|-------------|-----------|-------------------|
| CH5        | 17" x 7.5J '7-arm' design alloy wheels with 225/50 R17 tyres   | •        | S  | -      | -           | £166.67   | £200.00           |
| PQ5        | 18" x 8.5J '10-spoke' design alloy wheels with 245/40 R18 tyres  | -        | -  | •      | -           | No charge | No charge         |
| PRR        | 18" x 8.5J '15-spoke star' design alloy wheels with 245/40 R18 Y tyres   | -        | •  | -      | -           | £516.67   | £620.00           |
| PRV        | 19" x 8.5J '5-spoke Y' design alloy wheels with 255/35 R19 Y tyres   | -        | •  | -      | -           | £1,108.33 | £1,330.00         |
| PQ5        | 19" x 9J '20-spoke' design, 2-piece alloy wheels with 255/35 R19 Y tyres (only available in combination with quattro®)                                 | -        | -  | •      | •           | £383.33   | £460.00           |
| PQ6        | 19" x 9J '5-segment-spoke' design alloy wheels with 255/35 R19 tyres   | -        | •  | -      | -           | £1,191.67 | £1,430.00         |
|            |  | -        | -  | •      | •           | £383.33   | £460.00           |
| PQF        | 20" x 9J '7-arm double-spoke' design alloy wheels with 255/30 R20 tyres (only available in combination with quattro®)                                  | -        | -  | •      | -           | £937.50   | £1,125.00         |
|            |  | -        | -  | -      | •           | £825.00   | £990.00           |
| 2H1        | Audi drive select - must be combined with Dynamic Steering and/or Damper Control and/or quattro® Sports differential                                   | -        | •  | •      | •           | £183.33   | £220.00           |
| 1N7        | Dynamic Steering - must be combined with Audi drive select   | -        | •  | •      | •           | £604.17   | £725.00           |
| 1BL        | Damper Control - must be combined with Audi drive select   | -        | •  | -      | -           | £566.67   | £680.00           |
|            |  | -        | -  | •      | •           | £250.00   | £300.00           |
| GH2        | Audi quattro® Sports differential - must be combined with Audi drive select, only available on 3.0 TDI, 3.2 FSI quattro® and 3.0 TFSI quattro® engines | -        | •  | •      | •           | £516.67   | £620.00           |
| 1N3        | Servotronic power steering (standard on 190PS and above models)  | •        | •  | •      | S           | £154.17   | £185.00           |
| 1BE        | Sports suspension, with stiffer springs, stiffer shock absorbers and a 20mm lower ride height  | •        | •  | S      | -           | £212.50   | £255.00           |
| 1BV        | S line Sports suspension, with stiffer springs and shock absorbers and 30mm lower ride height  | -        | -  | •      | -           | No charge | No charge         |

# Packages

Some items work well together, which is why we've created these special packages. They provide increased convenience and value by combining several of our most popular options.

| Order Code                             |  | Standard | SE | S line | S5 quattro® | Basic RRP | Total RRP inc VAT |
|--|--|----------|----|--------|-------------|-----------|-------------------|
| <b>PV3</b>                             | <b>Convenience package.</b> Comprising electric front seats with memory function on driver's side and lumbar support. Also includes folding and auto-dimming door mirrors with memory function and auto-dimming rear-view mirror | -        | ●  | -      | -           | £1,191.67 | £1,430.00         |
| <b>6XL</b>                             |  | -        | -  | ●      | -           | £933.33   | £1,120.00         |
| <b>4L6</b>                             |  | -        | -  | -      | ●           | £512.50   | £615.00           |
| <b>WB1</b>                             | <b>Comfort package.</b> Audi Parking system plus, cruise control and Bluetooth interface<br><br>In combination with Technology package – High  | -        | ●  | ●      | ●           | £425.00   | £510.00           |
| <b>7X4</b><br><b>8T1</b><br><b>9ZX</b> |  | -        | ●  | ●      | ●           | £295.83   | £355.00           |
| <b>WB3</b>                             | <b>Sound package.</b> Bang & Olufsen Sound system and DAB Radio  | -        | ●  | ●      | ●           | £500.00   | £600.00           |
| <b>WB7</b><br><b>8T1</b><br><b>001</b> | <b>Technology package – HDD</b> Satellite Navigation system with MMI 3G – High, Audi Music Interface and cruise control (AMI deletes AUX-IN input)   | -        | ●  | ●      | ●           | £1,662.50 | £1,995.00         |

Options are subject to availability and may extend delivery.

- = Not available
- = Available
- S = Standard

RRP – Recommended Retail Price.

All prices are subject to VAT at 20% reflecting the VAT rate most likely to be in force at the time of delivery. The VAT rate may change if the vehicle is delivered before 4 January 2011 or if the VAT rate subsequently changes.

**Satellite Navigation – HDD-based with MMI 3G.** 3rd generation MMI system including single CD/DVD player, 2 FM tuners, high-resolution (800 x 400) 7" colour TFT display, 2 SD card readers and 40GB hard drive, 10GB of which can be used to store up to 4,000 songs. HDD Navigation functionality includes 3D and topographical mapping display and advanced 3D building display.



Advanced 3D building display (part of HDD Navigation)

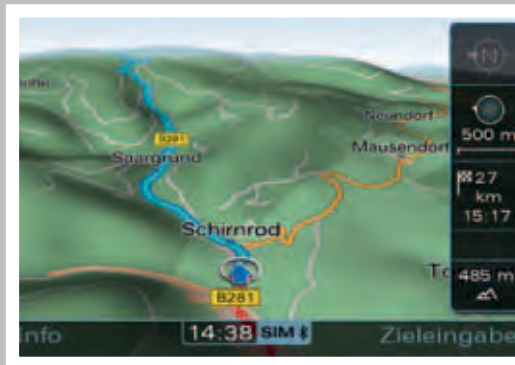

3D topographical mapping display (part of HDD Navigation)



MMI 3G Control – High, part of HDD Navigation





# Audio and communication

Stay in touch using our range of communication functions, and give each journey its own soundtrack with our advanced audio equipment.

Options are subject to availability and may extend delivery.

- = Not available  
 • = Available  
 S = Standard

RRP – Recommended Retail Price.

All prices are subject to VAT at 20% reflecting the VAT rate most likely to be in force at the time of delivery. The VAT rate may change if the vehicle is delivered before 4 January 2011 or if the VAT rate subsequently changes.

| Order Code |   | Standard | SE | S line | S5 quattro® | Basic RRP | Total RRP inc VAT |
|------------|---|----------|----|--------|-------------|-----------|-------------------|
| <b>BUM</b> | <b>Audi Symphony radio.</b> AM/FM twin tuner with TP memo function. Front-loading 6-CD changer with MP3 compatibility and active front and rear speakers. Includes colour centre console screen, SD memory-card reader and AUX-IN socket. Cannot be combined with Satellite Navigation  | •        | •  | •      | •           | £233.33   | £280.00           |
| <b>QV3</b> | <b>DAB digital radio.</b> Integrated into MMI, receives digitally-transmitted radio stations in addition to the range of analogue stations. Displays music track, artist and radio program. Capable of 'DAB Slideshow' where transmitted. Reception dependent on local digital network. Automatic switch from DAB to FM reception if the network signal is not strong enough  | -        | •  | •      | •           | £254.17   | £305.00           |
| <b>9VK</b> | <b>Bang &amp; Olufsen sound system.</b> Designed specifically for the Audi A5 Cabriolet, providing 5.1 surround sound reproduction with dynamic compensation for road noise, 10-channel amplifier and 14 high-performance loudspeakers (total output 505 Watts)   | -        | •  | •      | •           | £445.83   | £535.00           |
| <b>PNW</b> | <b>Satellite Navigation system – DVD-based.</b> Includes MMI High and colour Driver's Information System (DIS). Integrated into the MMI is a clear map display with special destinations indicated by symbols, high-speed map loading, zoom function, bird's-eye view function, selection of address book destinations, target memory, dynamic route guidance with TMC (with vehicle life subscription), including Europe DVD (where digitised). CD changer is recommended with this option | -        | •  | •      | •           | £1,350.00 | £1,620.00         |



Bang & Olufsen sound system



Mobile telephone preparation – High with privacy handset



DVD Satellite Navigation display



Colour Driver's Information System

# Audio and communication

| Order Code |  | Standard | SE | S line | S5 quattro® | Basic RRP | Total RRP inc VAT |
|------------|--|----------|----|--------|-------------|-----------|-------------------|
| 9ZX        | <b>Mobile telephone preparation – Bluetooth interface.</b> Provides handsfree connection via Bluetooth using mobile phone aerial. Please contact your Audi Centre for phone compatibility. Only in combination with multi-function steering wheel  | ●        | ●  | ●      | ●           | £216.67   | £260.00           |
| PT5        | <b>Mobile telephone preparation – Low with Bluetooth.</b> Provides handsfree connection via Bluetooth using the mobile phone aerial. Alternatively, it can use a cradle with charging facility for optimal reception via external aerial. Located in front centre armrest. Cradle available at extra cost – please contact your Audi Centre for phone compatibility. Only in combination with Concert or Symphony radio and multi-function steering wheel  | ●        | -  | -      | -           | £445.83   | £535.00           |
|            |  | -        | ●  | ●      | ●           | £320.83   | £385.00           |
| 9ZW        | <b>Mobile telephone preparation – High with Bluetooth.</b> Provides handsfree connection using an external aerial for optimal reception via a Bluetooth interface. Please note that your mobile phone must have SIM-Access Profile facility for full functionality. Only in combination with a technology package  | -        | ●  | ●      | ●           | £554.17   | £665.00           |
| PT4        | <b>Mobile telephone preparation – High with Bluetooth privacy handset located in front centre armrest.</b> The cordless handset allows passengers to make private calls, providing remote control of the telephone functions as well as convenient SMS text message function. The handset is charged from a docking station integrated into the front centre armrest. The SIM card can be integrated directly into the handset if the mobile phone does not have SIM-Access Profile (SAP). The handset is charged from a docking station integrated in the front centre armrest. Only in combination with a technology package | -        | ●  | ●      | ●           | £808.33   | £970.00           |
| UF7 001    | <b>Audi Music Interface (AMI).</b> Universal connection for use with stereo audio sources, USB and MP3 devices including Apple iPod generation 4 onwards (iPod, iPod classic, iPod mini, iPod nano, iPod photo, iPod video, iPod touch). Provides intuitive control through the audio system and multi-function steering wheel (where fitted). It also replicates the iPod display on the audio screen and DIS, including track titles. The interface provides charging function (dependent on device). (Includes 2 cables to connect your iPod or USB MP3 device). AUX-IN is deleted with this option                         | -        | ●  | ●      | ●           | £212.50   | £255.00           |
| 7A6        | <b>CD changer.</b> For six CDs with MP3 compatibility. Operated via MMI system. Only in combination with Satellite Navigation – DVD-based  | -        | ●  | ●      | ●           | £254.17   | £305.00           |
| 7D1        | <b>CD changer and DVD player.</b> Only in combination with technology package  | -        | ●  | ●      | ●           | £254.17   | £305.00           |
| QV9        | <b>TV reception – analogue and digital.</b> TV tuner for reception of 'free-to-air' TV channels. Picture display only possible on MMI screen when vehicle is stationary, audio available at all times. Reception dependent upon local digital network availability. Only in combination with technology package  | -        | ●  | ●      | ●           | £725.00   | £870.00           |

Options are subject to availability and may extend delivery.

- = Not available
- = Available
- S = Standard

RRP – Recommended Retail Price.

All prices are subject to VAT at 20% reflecting the VAT rate most likely to be in force at the time of delivery. The VAT rate may change if the vehicle is delivered before 4 January 2011 or if the VAT rate subsequently changes.

# Interior equipment

Specify every detail of your car's interior with this range of options.

Options are subject to availability and may extend delivery.

- = Not available
- = Available
- S = Standard

\*HomeLink® is a registered trademark of Johnson Controls. For information on compatibility, visit [www.homelink.com](http://www.homelink.com)

RRP – Recommended Retail Price.

All prices are subject to VAT at 20% reflecting the VAT rate most likely to be in force at the time of delivery. The VAT rate may change if the vehicle is delivered before 4 January 2011 or if the VAT rate subsequently changes.

| Order Code |  | Standard | SE | S line | S5 quattro® | Basic RRP | Total RRP inc VAT |
|------------|--|----------|----|--------|-------------|-----------|-------------------|
| <b>4F2</b> | <b>Advanced key.</b> Access and authorisation system which automatically exchanges data between key and vehicle, allowing the driver to keep the key in their pocket or bag at all times. To unlock and open, simply lift the exterior door handle. To lock, press the button on the handle. Pressing the start/stop button integrated in the centre console starts and stops the engine | -        | •  | •      | •           | £420.83   | £505.00           |
| <b>8T1</b> | <b>Cruise control.</b> For holding any speed above 25mph   | •        | •  | •      | •           | £187.50   | £225.00           |
| <b>8T4</b> | <b>Adaptive cruise control (ACC).</b> Automatic distance regulation, using radar sensors to maintain required distance by braking and accelerating. Four programs (distance 1 to distance 4) set via steering column controls of the cruise control system   | -        | •  | •      | •           | £937.50   | £1,125.00         |
| <b>VC1</b> | <b>Garage door opener (Homelink®*).</b> Programmable radio-operated remote control for compatible doors/gates. Control buttons integrated in the front roof module   | •        | •  | •      | •           | £150.00   | £180.00           |
| <b>QQ1</b> | <b>Interior light package.</b> Includes front and rear footwell lighting, active door reflectors, illuminated vanity mirrors, entrance lights and illuminated glove compartment, vents and internal door controls  | •        | •  | •      | S           | £83.33    | £100.00           |



MMI 3G Control – High, part of the HDD Satellite Navigation



Audi exclusive carpets

# Interior equipment

Options are subject to availability and may extend delivery.

- = Not available  
 ● = Available  
 S = Standard

\*The leather, stitching and piping (where applicable) can be selected from any of the exclusive colours shown on page 34. The carpet colour can also be selected from any of the exclusive colours shown on page 34, except for Crimson red and Saddle brown.

RRP – Recommended Retail Price.

All prices are subject to VAT at 20% reflecting the VAT rate most likely to be in force at the time of delivery. The VAT rate may change if the vehicle is delivered before 4 January 2011 or if the VAT rate subsequently changes.

| Order Code     |  | Standard | SE | S line | S5 quattro® | Basic RRP | Total RRP inc VAT |
|----------------|--|----------|----|--------|-------------|-----------|-------------------|
| <b>9K1</b>     | <b>Head-level heating system.</b> Includes vents in the front seat backrest that blow hot air onto your neck as you drive. Can be adjusted in three stages. Only in combination with heated front seats, sports seats or climate comfort seats | -        | ●  | ●      | -           | £291.67   | £350.00           |
| <b>7HB</b>     | <b>Leather armrests.</b> Includes leather covered armrest on door panels for front and rear  | -        | ●  | ●      | ●           | £170.83   | £205.00           |
| <b>7S1</b>     | <b>Wind deflector.</b> To reduce draughts and wind noise. Manually attached to mounting in rear seating area. Can be folded for compact stowage  | ●        | S  | S      | S           | £225.00   | £270.00           |
| <b>YSR S3G</b> | <b>Audi exclusive floor mats with leather piping.</b> Includes 4 floor mats for front and rear (cannot be combined with option YSQ/S3G – Audi exclusive carpets)*  | -        | ●  | ●      | ●           | £254.17   | £305.00           |
| <b>YSQ S3G</b> | <b>Audi exclusive carpets.</b> Includes 4 Audi exclusive floor mats with leather piping (cannot be combined with option YSR/S3G – Audi exclusive floor mats)*  | -        | ●  | ●      | ●           | £725.00   | £870.00           |



Head-level heating

# Seats

Choose from a variety of different seat options so you can maintain the right driving posture at all times.

| Order Code |  | Standard | SE | S line | S5 quattro® | Basic RRP | Total RRP inc VAT |
|------------|--|----------|----|--------|-------------|-----------|-------------------|
| 4A3        | <b>Heated front seats.</b> Individually controlled variable temperature adjustment   | ●        | ●  | ●      | ●           | £233.33   | £280.00           |
| 4A4        | <b>Heated front and outer rear seats.</b> Individually controlled variable temperature adjustment  | -        | ●  | ●      | ●           | £383.33   | £460.00           |
| PV1        | <b>Electrically adjustable front seats.</b> Includes adjustment for height, forwards and backwards position, backrest angle and lumbar support | -        | ●  | -      | -           | £637.50   | £765.00           |
|            |  | -        | -  | ●      | S           | £379.17   | £455.00           |
| 3X2        | <b>Ski/snowboard bag</b>   | ●        | ●  | ●      | ●           | £58.33    | £70.00            |
| 7P1        | <b>Electric lumbar support</b> for front seats with horizontal and vertical adjustment   | ●        | ●  | S      | S           | £195.83   | £235.00           |

Options are subject to availability and may extend delivery.

- = Not available
- = Available
- S = Standard

RRP – Recommended Retail Price.

All prices are subject to VAT at 20% reflecting the VAT rate most likely to be in force at the time of delivery. The VAT rate may change if the vehicle is delivered before 4 January 2011 or if the VAT rate subsequently changes.



Electric front seats

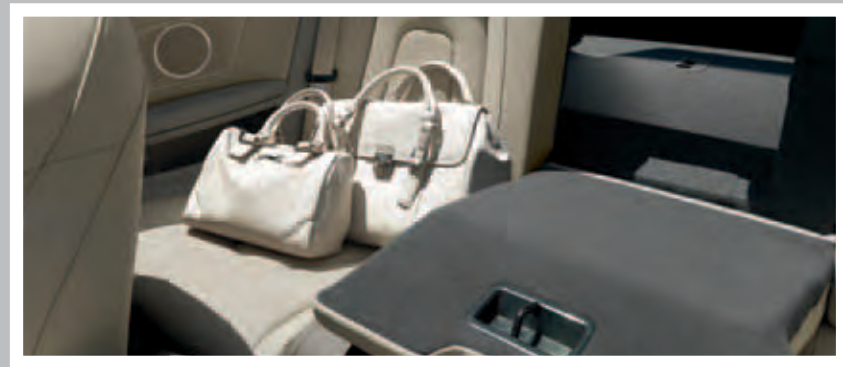

Through-load facility

# Exterior equipment

Make sure your car looks exactly as you want it to by selecting some of our striking options.

| Order Code |   | Standard | SE | S line | S5 quattro® | Basic RRP | Total RRP inc VAT |
|------------|---|----------|----|--------|-------------|-----------|-------------------|
| 8N7        | <b>High-beam assist.</b> Automatically adjusts headlights from high-beam to dipped-beam when another vehicle is approaching. Only in combination with Xenon Plus headlights and auto-dimming rear-view mirror | ●        | ●  | ●      | ●           | £91.67    | £110.00           |
| 8Q5        | <b>Adaptive lights.</b> Swivelling headlights for improved illumination of a winding road   | -        | -  | ●      | ●           | £275.00   | £330.00           |
| PX1<br>8Q5 | <b>Adaptive headlights.</b> Swivelling headlights for improved illumination of a winding road. Includes Xenon Plus headlights with LED daytime-running lights and headlight washers                           | ●        | ●  | -      | -           | £941.67   | £1,130.00         |
| 3FT        | <b>Acoustic hood – fully automatic.</b> Additional foam layer within hood reduces wind noise further. Includes rear LED reading lights  | ●        | ●  | S      | S           | £183.33   | £220.00           |
| 2Z0        | <b>Deletion of model and engine technology designation at rear</b>  | ●        | ●  | ●      | -           | No charge | No charge         |
| 2Z7        | <b>Deletion of engine technology designation at rear</b>  | ●        | ●  | ●      | -           | No charge | No charge         |
| 6XE        | <b>Door mirrors – electrically adjustable, folding and heated</b>   | -        | ●  | ●      | ●           | £150.00   | £180.00           |
| 6XK<br>4L6 | <b>Door mirrors – electrically folding and auto-dimming.</b> Includes auto-dimming rear-view mirror   | -        | ●  | ●      | ●           | £404.17   | £485.00           |
| 1D2        | <b>Towing equipment – removable.</b> Factory-fitted and removable. Usually requires a 13 to 7-pin adaptor. Please consult your Audi Centre for details  | ●        | ●  | ●      | ●           | £554.17   | £665.00           |

Options are subject to availability and may extend delivery.

- = Not available
- = Available
- S = Standard

RRP – Recommended Retail Price.

All prices are subject to VAT at 20% reflecting the VAT rate most likely to be in force at the time of delivery. The VAT rate may change if the vehicle is delivered before 4 January 2011 or if the VAT rate subsequently changes.

# Safety and security

Intelligent technology designed to give you better all-round awareness and safety on the road.

Options are subject to availability and may extend delivery.

- = Not available  
 ● = Available  
 S = Standard

RRP – Recommended Retail Price.

All prices are subject to VAT at 20% reflecting the VAT rate most likely to be in force at the time of delivery. The VAT rate may change if the vehicle is delivered before 4 January 2011 or if the VAT rate subsequently changes.

| Order Code |  | Standard | SE | S line | S5 quattro® | Basic RRP | Total RRP inc VAT |
|------------|--|----------|----|--------|-------------|-----------|-------------------|
| 7X1        | <b>Acoustic parking system (rear only).</b> Aids parking by acoustically indicating distances to obstacles   | ●        | S  | S      | S           | £279.17   | £335.00           |
| 7X4        | <b>Audi parking system plus.</b> Aids parking by acoustically and visually indicating distances to obstacles   | -        | ●  | ●      | ●           | £270.83   | £325.00           |
| 7X8        | <b>Audi parking system advanced.</b> Aids parking by acoustically and visually indicating distances to obstacles with guiding lines. Measured by sensors and reversing camera. Only in combination with technology package   | -        | ●  | ●      | ●           | £554.17   | £665.00           |
| UH2        | <b>Audi hill-hold assist.</b> Uses either the ESP system or electromechanical parking brake to hold the vehicle stationary (not available with 2.0TDI/2.0TFSI engines with manual gearboxes)   | ●        | ●  | ●      | ●           | £54.17    | £65.00            |
| PU1        | <b>Audi lane assist.</b> Uses a discreet camera mounted at the top of the windscreen to monitor the road ahead. The driver is warned via a vibration of the steering wheel if the vehicle is about to exit the lane unintentionally. Only in combination with 4-spoke multi-function steering wheel  | -        | ●  | ●      | -           | £383.33   | £460.00           |
| 7Y1        | <b>Audi side assist.</b> Aids the driver when changing lane. Audi side assist monitors the area behind the car using radar sensors located discreetly in the rear bumper, informing the driver with a visual warning signal in the door mirror if there is a vehicle in their blind spot or approaching quickly from behind. The system is activated using a button in the driver's door | -        | ●  | ●      | ●           | £383.33   | £460.00           |
| 4L6        | <b>Auto-dimming rear view-mirror.</b> Including acoustic windscreen  | -        | ●  | ●      | ●           | £187.50   | £225.00           |
| 7K6        | <b>Tyre pressure loss indicator.</b> A visual and acoustic warning when the system detects a potential loss of tyre pressure   | ●        | ●  | ●      | ●           | £62.50    | £75.00            |



Audi parking system plus



Door mirror – electrically folding



Audi lane assist



# Steering wheels

You can choose from a selection of advanced leather multi-function steering wheels, allowing you to control your audio system at the touch of a button.

Options are subject to availability and may extend delivery.

- = Not available
- = Available
- S = Standard

\*The leather and stitching (where applicable) can be selected from any of the exclusive colours shown on page 34.

RRP – Recommended Retail Price.

All prices are subject to VAT at 20% reflecting the VAT rate most likely to be in force at the time of delivery. The VAT rate may change if the vehicle is delivered before 4 January 2011 or if the VAT rate subsequently changes.

| Order Code |   | Standard | SE | S line | S5 quattro® | Basic RRP | Total RRP inc VAT |
|------------|---|----------|----|--------|-------------|-----------|-------------------|
| 1XW        | 3-spoke multi-function steering wheel. Manual models only   | •        | S  | S      | S           | £212.50   | £255.00           |
| 1XX        | 3-spoke multi-function steering wheel with gear-shift paddles. S tronic® models only  | •        | S  | S      | S           | £329.17   | £395.00           |
| 2ZQ        | 4-spoke multi-function steering wheel. Manual models only. Only in combination with Audi lane assist                            | -        | •  | •      | -           | No charge | No charge         |
| 2ZS        | 4-spoke multi-function steering wheel with gear-shift paddles. S tronic® models only. Only in combination with Audi lane assist | -        | •  | •      | -           | No charge | No charge         |
| YRH S3G    | Audi exclusive leather-covered steering wheel*  | -        | •  | •      | •           | £304.17   | £365.00           |
| YRB S3G    | Audi exclusive controls package – includes leather-covered steering wheel and gear-shift gaiter*                                | -        | •  | •      | •           | £600.00   | £720.00           |



## Service Plan

Choosing an Audi Service Plan provides an easy way to cover all your car's scheduled servicing with a convenient monthly payment plan. It can take care of everything from fluid and filter changes to your full service, ensuring you retain a full Audi service history. There are no servicing bills to plan for and you'll continue to benefit from today's prices for the length of your agreement.

## Warranty

Options are subject to availability and may extend delivery.

- = Not available  
• = Available  
S = Standard

\*Prices are based on the Audi Fixed Inspection Service Schedule and 10,000 miles per annum or less. For more information on the Service Schedule, please see page 56.

\*\*Only available when ordering your new A5 Cabriolet. Please speak to your Audi Centre for full details.

RRP - Recommended Retail Price.

All prices are subject to VAT at 20% reflecting the VAT rate most likely to be in force at the time of delivery. The VAT rate may change if the vehicle is delivered before 4 January 2011 or if the VAT rate subsequently changes.

| Order Code |  | Standard | SE | S line | S5 quattro® | Basic RRP | Total RRP inc VAT |
|------------|--|----------|----|--------|-------------|-----------|-------------------|
| -          | <b>3-Service Plan.</b> Comprehensive package covering servicing costs for 3 services or 30,000 miles (whichever occurs sooner). Visit <a href="http://audi.co.uk/serviceplans">audi.co.uk/serviceplans</a> for full details including terms and conditions | •        | •  | •      | -           | £25.00    | £30.00            |
|            |  | -        | -  | -      | •           | £33.33    | £40.00            |
| -          | <b>5-Service Plan.</b> Comprehensive package covering servicing costs for 5 services or 50,000 miles (whichever occurs sooner). Visit <a href="http://audi.co.uk/serviceplans">audi.co.uk/serviceplans</a> for full details including terms and conditions | •        | •  | •      | -           | £33.33    | £40.00            |
|            |  | -        | -  | -      | •           | £41.67    | £50.00            |

| Order Code |   | Standard | SE | S line | S5 quattro® | Basic RRP | Total RRP inc VAT |
|------------|---|----------|----|--------|-------------|-----------|-------------------|
| -          | <b>Audi Warranty,</b> covering you for unlimited mileage in the first two years of ownership, and up to 60,000 miles in the third year. Transferable between owners**   | S        | S  | S      | S           | No charge | No charge         |
| EA6        | <b>Audi Warranty,</b> covering you for up to 4 years or 75,000 miles, whichever comes soonest. Cover includes a two-year unlimited mileage warranty, and up to 75,000 miles in the third and fourth years. Transferable between owners**        | •        | •  | •      | •           | £445.83   | £535.00           |
| EA9        | <b>Audi Warranty,</b> covering you for up to 5 years or 90,000 miles, whichever comes soonest. Cover includes a two-year unlimited mileage warranty, and up to 90,000 miles in the third, fourth and fifth years. Transferable between owners** | •        | •  | •      | •           | £1,045.83 | £1,255.00         |

# Merchandise

From the enthusiasts' motorsport collection to the sophisticated Audi collection, there's a wide variety of adults' and children's clothing, lifestyle accessories and collectables, all of which bear the Audi name.

Please speak to a member of our team at your local Audi Centre to see the full Audi collection and to place an order. A selection of Audi merchandise is also available to buy from [audi.co.uk/merchandise](http://audi.co.uk/merchandise).



Audi kids



Bags and leather goods



Clothing



Motorsports



Sport and travel



Model cars

# Accessories

Choosing an Audi isn't just a matter of deciding on the model you want; it's about creating a car that suits your needs perfectly. And that's why we've developed a whole range of accessories to enhance your A5 Cabriolet, enabling you to customise it down to the last detail. Like your Audi, all these accessories are developed to the highest possible standards. And they're all available exclusively from Audi.

To find out more, just visit [audi.co.uk/accessories](http://audi.co.uk/accessories) or contact your local Audi Centre.

## Warranty

All of the accessories available on the A5 Cabriolet are covered by a three-year warranty\* if they are ordered and included in the purchase price of the car at date of delivery. Any accessories ordered and installed after delivery include a two-year warranty.\*



Sport and design



Transport and touring

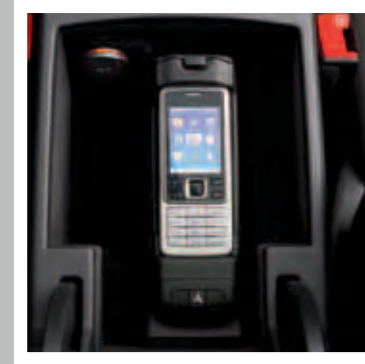

Entertainment and communication



Comfort and protection

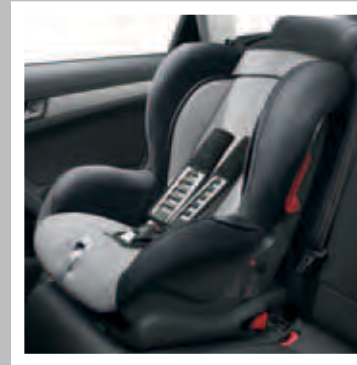

Family



Safety and security

\*Excluding Road Angel products.  
Audi Accessories warranty terms and conditions can be found at [audi.co.uk](http://audi.co.uk)

# A5 Cabriolet Petrol technical data

| Engine   | 1.8 TFSI       | 1.8 TFSI             | 2.0 TFSI       | 2.0 TFSI             | 2.0 TFSI quattro® | 3.2 FSI              | 3.2 FSI quattro®  | S5 quattro®       |
|--|----------------|----------------------|----------------|----------------------|-------------------|----------------------|-------------------|-------------------|
| Transmission   | 6-speed manual | 8-speed multitronic® | 6-speed manual | 8-speed multitronic® | 7-speed S tronic® | 8-speed multitronic® | 7-speed S tronic® | 7-speed S tronic® |
| Cylinder   | 4-cylinder     | 4-cylinder           | 4-cylinder     | 4-cylinder           | 4-cylinder        | V6                   | V6                | V6                |
| Displacement, cubic cm (valves per cylinder)             | 1798           | 1798                 | 1984           | 1984                 | 1984              | 3197                 | 3197              | 2995              |
| Max. power <sup>1</sup> , PS at rpm                      | 160            | 160                  | 211            | 211                  | 211               | 265                  | 265               | 333               |
| Max. torque, Nm at rpm                                   | 250/1500-4500  | 250/1500-4500        | 350/1500-4200  | 350/1500-4200        | 350/1500-4200     | 330/3000-5000        | 330/3000-5000     | 440/2900-5300     |
| 0-62mph acceleration, seconds                            | 9.9            | 9.5                  | 7.5            | 7.9                  | 7.3               | 6.9                  | 6.9               | 5.6               |
| Top speed, mph   | 135            | 131                  | 150            | 145                  | 148               | 153                  | 155               | 155               |
| CO <sub>2</sub> emissions <sup>2</sup> , g/km            | 172            | 174                  | 159            | 174                  | 179               | 199                  | 219               | 224               |
| Benefit in kind (BIK)%                                   | 23%            | 22%                  | 20%            | 23%                  | 24%               | 28%                  | 32%               | 33%               |
| Fuel consumption, mpg (l/100km) Urban                    | 28.2 (10.0)    | 29.7 (9.5)           | 31.0 (9.1)     | 28.5 (9.9)           | 29.7 (9.5)        | 23.3 (12.1)          | 20.5 (13.8)       | 20.5 (13.8)       |
| Fuel consumption, mpg (l/100km) Extra Urban              | 47.9 (5.9)     | 44.1 (6.4)           | 52.3 (5.4)     | 47.1 (6.0)           | 42.8 (6.6)        | 43.5 (6.5)           | 40.4 (7.0)        | 38.7 (7.3)        |
| Fuel consumption, mpg (l/100km) Combined                 | 38.2 (7.4)     | 37.7 (7.5)           | 41.5 (6.8)     | 38.2 (7.4)           | 36.7 (7.7)        | 32.8 (8.6)           | 29.7 (9.5)        | 29.1 (9.7)        |
| ABI insurance group 1-20/1-50*                           | TBC            | TBC                  | 17/33 E        | 17/33 E              | 17/34 E           | 17/33 E              | 17/39 E           | 19/42 E           |
| Unladen weight <sup>3</sup> , kg                         | 1610           | 1645                 | 1630           | 1655                 | 1735              | 1710                 | 1785              | 1875              |
| Gross weight limit, kg                                   | 2110           | 2145                 | 2130           | 2155                 | 2235              | 2210                 | 2285              | 2375              |
| Nose weight, kg  | 80             | 80                   | 80             | 80                   | 80                | 80                   | 80                | 80                |
| Max trailer load <sup>4</sup> unbraked, kg               | 750            | 750                  | 750            | 750                  | 750               | 750                  | 750               | 750               |
| Max trailer load <sup>4</sup> with 12% gradient          | 1300           | 1300                 | 1500           | 1500                 | 1700              | 1700                 | 1900              | 1900              |
| Max trailer load <sup>4</sup> with 8% gradient, kg       | 1500           | 1500                 | 1700           | 1700                 | 1900              | 1800                 | 2100              | 2100              |
| Luggage compartment capacity, rear seats upright, litres | 320            | 320                  | 320            | 320                  | 320               | 320                  | 320               | 320               |
| Luggage compartment capacity, rear seats folded, litres  | 750            | 750                  | 750            | 750                  | 750               | 750                  | 750               | 750               |
| Fuel tank capacity approx, litres                        | 65             | 65                   | 65             | 65                   | 64                | 65                   | 64                | 64                |

\*Highest insurance group rating shown. Group may be lower dependent on trim level. Please visit [www.thatcham.org/abigrouprating](http://www.thatcham.org/abigrouprating) for details.

<sup>1</sup>The given value was obtained in accordance with the specified measurement procedure (the respective current version of the Directive 80/1269/EEC).

<sup>2</sup>The given values were calculated in accordance with the specified measurement procedure (the respective current version of Directive 80/1268/EEC). This information does not relate to a single vehicle and does not comprise part of the offer but is merely intended for the purpose of comparison between the different vehicle types.

<sup>3</sup>Vehicle's unladen weight without driver (calculated in accordance with the current version of Directive 80/1268/EEC). The fitting of additional equipment may increase the vehicle's unladen weight and drag coefficient, whereupon the potential carrying capacity and top speed will be correspondingly reduced.

<sup>4</sup>The engine's power output always goes down with increasing altitude. At 1,000m above sea level, and for every additional 1,000m, deduct 10% from the weight of the outfit (trailer load limit + gross weight of the towing vehicle).

**Please note:** The maximum power output figures are quoted in PS (or Pferdestärke, which is the metric equivalent of brake horsepower). To convert to brake horsepower, divide the PS figure by 1.0139.

# A5 Cabriolet Diesel technical data

| Engine   | 2.0 TDI        | 2.7 TDI              | 3.0 TDI quattro®  |
|--|----------------|----------------------|-------------------|
| Transmission   | 6-speed manual | 8-speed multitronic® | 7-speed S tronic® |
| Cylinder   | 4-cylinder     | V6                   | V6                |
| Displacement, cubic cm (valves per cylinder)             | 1968           | 2698                 | 2967              |
| Max. power <sup>1</sup> , PS at rpm                      | 170            | 190                  | 240               |
| Max. torque, Nm at rpm                                   | 350/1750-2500  | 400/1400-3250        | 500/1500-3000     |
| 0-62mph acceleration, seconds                            | 9.3            | 8.6                  | 6.4               |
| Top speed, mph   | 138            | 138                  | 154               |
| CO <sub>2</sub> emissions <sup>2</sup> , g/km            | 144            | 169                  | 179               |
| Benefit in kind (BIK)%                                   | 20%            | 25%                  | 27%               |
| Fuel consumption, mpg (l/100km) Urban                    | 42.2 (6.7)     | 36.7 (7.7)           | 33.2 (8.5)        |
| Fuel consumption, mpg (l/100km) Extra Urban              | 60.1 (4.7)     | 48.7 (5.8)           | 48.7 (5.8)        |
| Fuel consumption, mpg (l/100km) Combined                 | 51.4 (5.5)     | 43.5 (6.5)           | 41.5 (6.8)        |
| ABI insurance group 1-20/1-50**                          | TBC            | 16/33 E              | 18/39 E           |
| Unladen weight <sup>3</sup> , kg                         | 1655           | 1785                 | 1860              |
| Gross weight limit, kg                                   | 2155           | 2285                 | 2360              |
| Nose weight, kg  | 80             | 80                   | 80                |
| Max trailer load <sup>4</sup> unbraked, kg               | 750            | 750                  | 750               |
| Max trailer load <sup>4</sup> with 12% gradient          | 1600           | 1700                 | 1900              |
| Max trailer load <sup>4</sup> with 8% gradient, kg       | 1800           | 1900                 | 2100              |
| Luggage compartment capacity, rear seats upright, litres | 320            | 320                  | 320               |
| Luggage compartment capacity, rear seats folded, litres  | 750            | 750                  | 750               |
| Fuel tank capacity approx, litres                        | 65             | 65                   | 64                |

\*\*Highest insurance group rating shown. Group may be lower dependent on trim level. Please visit [www.thatcham.org/abigrouprating](http://www.thatcham.org/abigrouprating) for details.

All diesel engines are fitted with a Diesel Particulate Filter.

<sup>1</sup>The given value was obtained in accordance with the specified measurement procedure (the respective current version of the Directive 80/1269/EEC).

<sup>2</sup>The given values were calculated in accordance with the specified measurement procedure (the respective current version of Directive 80/1268/EEC). This information does not relate to a single vehicle and does not comprise part of the offer but is merely intended for the purpose of comparison between the different vehicle types.

<sup>3</sup>Vehicle's unladen weight without driver (calculated in accordance with the current version of Directive 80/1268/EEC). The fitting of additional equipment may increase the vehicle's unladen weight and drag coefficient, whereupon the potential carrying capacity and top speed will be correspondingly reduced.

<sup>4</sup>The engine's power output always goes down with increasing altitude. At 1,000m above sea level, and for every additional 1,000m, deduct 10% from the weight of the outfit (trailer load limit + gross weight of the towing vehicle).

**Please note:** The maximum power output figures are quoted in PS (or Pferdestärke, which is the metric equivalent of brake horsepower). To convert to brake horsepower, divide the PS figure by 1.0139.

# A5 Cabriolet dimensions

The technical drawings opposite show the exact dimensions of the Audi A5 Cabriolet, so you can check everything – from whether the car will fit in your garage to whether your luggage will fit in the boot.

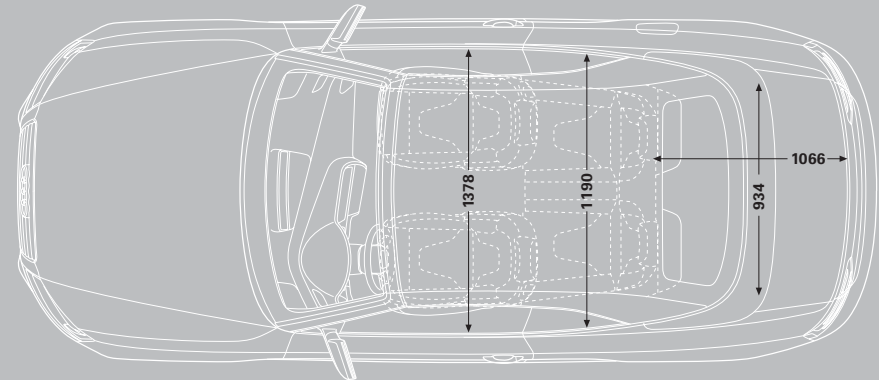
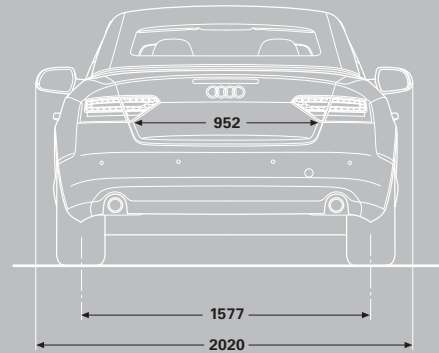
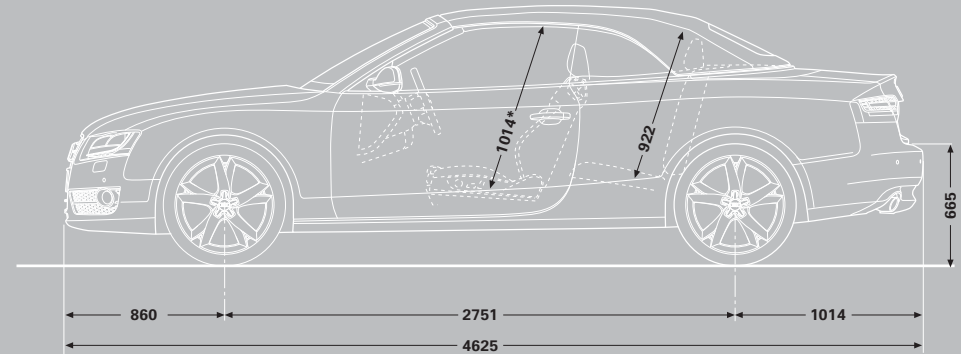
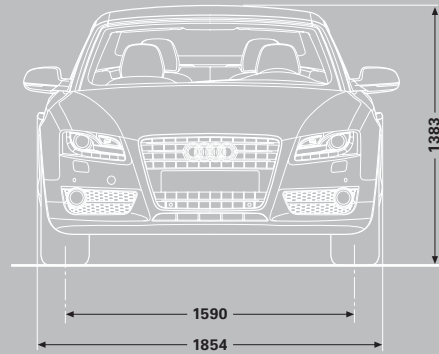

\*Maximum headroom.

Dimensions were measured with vehicle at unladen weight, ground clearance measured with vehicle carrying its maximum load.

Luggage compartment volume in litres: 320 with hood open, 360 with hood closed, 750 with rear seats folded (measured by the VDA standard test method using 200 x 100 x 50 mm blocks; second value: with rear seat folded down).

Turning circle approx 11.4m.

Dimensions in millimetres.

# S5 Cabriolet dimensions

The technical drawings opposite show the exact dimensions of the Audi S5 Cabriolet, so you can check everything – from whether the car will fit in your garage to whether your luggage will fit in the boot.

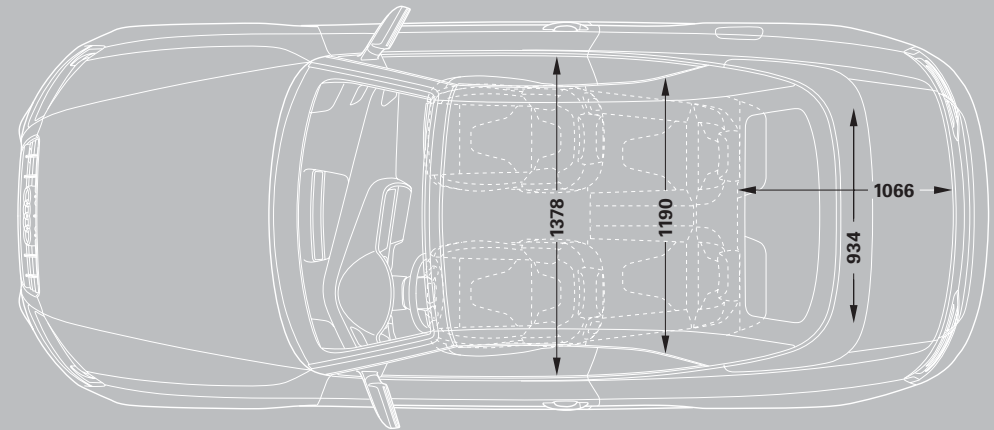
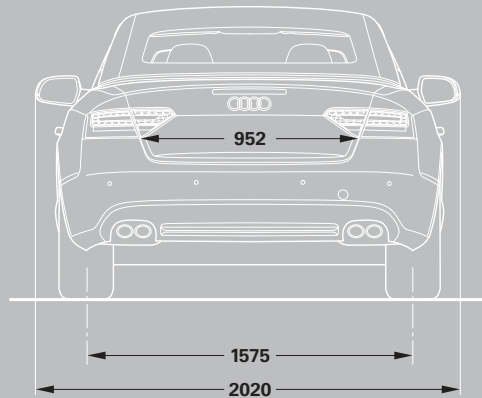
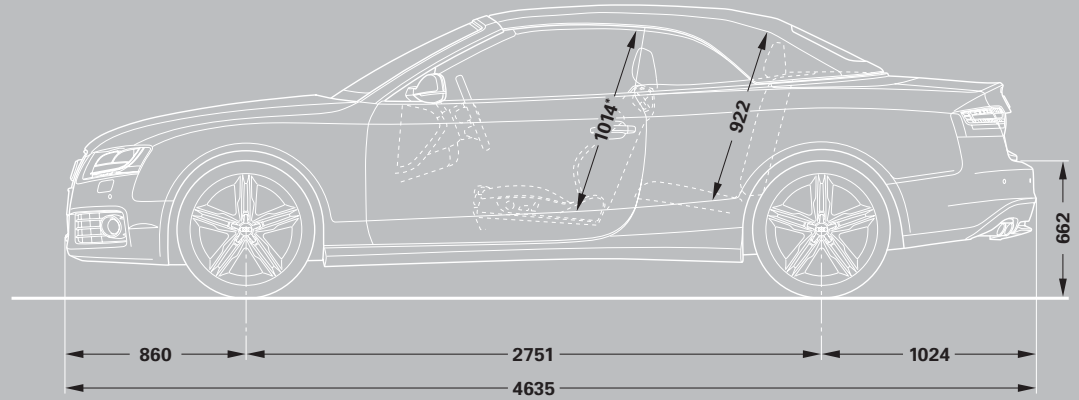
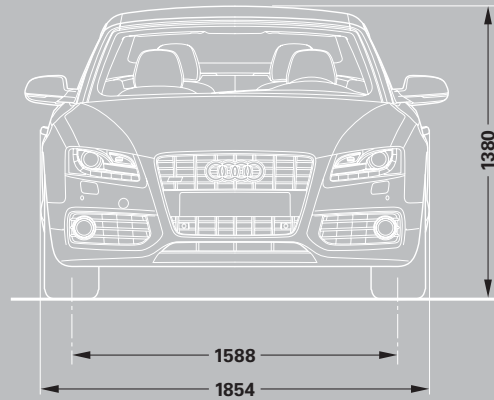

\*Maximum headroom.

Dimensions were measured with vehicle at unladen weight, ground clearance measured with vehicle carrying its maximum load.

Luggage compartment volume in litres: 320 with hood open, 360 with hood closed, 750 with rear seats folded (measured by the VDA standard test method using 200 x 100 x 50 mm blocks; second value: with rear seat folded down).

Turning circle approx 11.4m.

Dimensions in millimetres.



# Additional information

## CO<sub>2</sub> data and information

### CO<sub>2</sub> emissions-based Vehicle Excise Duty

Vehicle Excise Duty (Road Fund Licence) is based upon the amount of Carbon Dioxide (CO<sub>2</sub>) a vehicle emits, measured in grams per kilometre (g/km). The DVLA has created thirteen categories:

#### Petrol and Diesel engines

|                    |         |
|--------------------|---------|
| A - up to 100g/km  | £0.00   |
| B - 101 to 110g/km | £0.00   |
| C - 111 to 120g/km | £0.00   |
| D - 121 to 130g/km | £0.00   |
| E - 131 to 140g/km | £110.00 |
| F - 141 to 150g/km | £125.00 |
| G - 151 to 165g/km | £155.00 |
| H - 166 to 175g/km | £250.00 |
| I - 176 to 185g/km | £300.00 |
| J - 186 to 200g/km | £425.00 |
| K - 201 to 225g/km | £550.00 |
| L - 226 to 255g/km | £750.00 |
| M - over 255g/km   | £950.00 |

Vehicle Excise Duty (VED) rates correct at time of going to print, but these may alter to reflect any change in the applicable VED rate.

### Servicing tailored to your needs

Regular servicing is key to safeguarding your Audi's performance and a full Audi service history could help you preserve the future re-sale value. To make servicing easy, the Audi Service Schedules have been designed to work with your individual driving style and vehicle.

There are two schedules available and your Audi Centre will advise which schedule is most suited to your needs. The conventional fixed Audi Inspection Service schedule has fixed intervals for the Oil-change and Inspection Service that are based on time

and distance, whichever comes first. With the Audi LongLife Service schedule, sensors take account of driving style and conditions in which the vehicle is used to indicate when the Oil-change Service is required. Oil-change Service intervals are therefore variable and are conveniently indicated via the on-board service interval display.

#### Fixed Inspection Service Schedule

|                    | Vehicle usage:  |
|--------------------|---|
| Mileage            | Less than 10,000 miles per annum  |
| Type of journey    | Mainly city/town centre driving. Short journeys   |
| Conditions         | Frequent cold starts. High engine loading – e.g. frequent hill climbs, vehicle fully loaded, towing                           |
| Driving style      | Uneconomical – e.g. heavy acceleration, heavy braking, constant changes in speed, constant use of high revs, 'sporty' driving |
|                    | Service Intervals:  |
| Oil-change Service | Fixed to every 9,000* miles/1 year  |
| Inspection Service | Fixed to every 19,000* miles/2 years  |

#### Variable LongLife Service Schedule

|                    | Vehicle usage:   |
|--------------------|--|
| Mileage            | More than 10,000 miles per annum   |
| Type of journey    | Motorway and main road driving. Mainly longer distance journeys. Constant speeds                             |
| Conditions         | Normal engine loading – e.g. with little or no towing, with little or no hill climbs. Normal vehicle loading |
| Driving style      | Moderate acceleration, moderate braking, engine revs mainly below 3,000                                      |
|                    | Service Intervals:   |
| Oil-change Service | Variable to a maximum of every 19,000* miles/2 years   |
| Inspection Service | Fixed to every 19,000* miles/2 years   |

\*As indicated by the service interval display. Mileages are approximate as the Service Indicator system uses kilometres as its distance measurement.

# Additional information

## Welcome to Audi

By placing an order for your Audi, you're choosing to get behind the wheel of one of the most sophisticated cars on the road. And because we believe the service we offer should be just as advanced, we wanted to let you know exactly what you can expect from us, now and in the future.

We've agreed a set of standards with all our Centres, which governs the way we do business with you. It outlines the kind of service we promise to deliver for every customer, right down to filling each new Audi we sell with half a tank of fuel.

So whether you're interested in the date your car will arrive in the UK or the way we'll dispose of non-biodegradable materials after we service your Audi, you can have total confidence in us.

## Audi Promise

### Audi Centres

We guarantee that all of our Centres will be open as follows:

Sales: Monday to Friday 9am–6pm  
Saturday 9am–5pm  
Service: Monday to Friday 8am–6pm  
Saturday 8.30am–1pm

Sunday opening is at local discretion.

### New car delivery

Once we've confirmed a delivery date for your car, we'll keep you informed of progress. Subject to reasonable notice, we'll then deliver it to a place of your choice, whether that's your home or place of work. In the unlikely event of a delay, we'll provide a courtesy car to minimise inconvenience and keep you mobile.

### The experts in Vorsprung durch Technik

Would you entrust your Audi to anyone who hasn't been regularly trained to Audi standards? Our network of Audi Approved Master Technicians have undergone an impressive 100,000 hours of training over a 10-year programme to ensure they have the latest technical expertise for maintaining and servicing your Audi. All of our Service Advisors undergo a specialist induction and training to ensure they are Audi professionals and able to talk to you about any issues you may have with your Audi vehicle. What's more, we have so much expertise and experience in looking after Audi vehicles that we are able to make a note of your mileage and the state of your vehicle as and when we see it and predict when certain key events may occur. As part of our commitment to you, we will notify you in plenty of time so you can make an appointment with us.

### Your convenience comes first

At Audi you can choose from a range of convenient services that suit your needs. Why not book a 'service while you wait' appointment\* and enjoy our complimentary refreshments while your car is with us? Or, if you need to be mobile, take advantage of one of our courtesy cars which we can even collect and deliver to you.\* We guarantee we can service your Audi within 5 days without a courtesy car, or within 10 days if you need transport. We will also ensure your car is returned to you with a full valet.

### Audi Genuine Parts

Would you put a part into your Audi that wasn't the same quality as the factory fitted original? You can rest assured that only Audi Genuine Parts will be used on your vehicle. What's more, Audi parts and labour come with a 2-year guarantee.\*\* We stock a wide variety of parts, so we are well covered. However, if we don't have a part in stock at our Centre we have the back-up of parts at other Audi Centres, at our national warehouse and our factory and can usually source the relevant part very quickly.

### We don't like surprises either

We believe strongly in transparency and there will be no hidden costs. For added peace of mind, we will give you a quotation over the phone for the work you have requested and email you the price confirmation. We'll consult you if any additional work on your car is needed when it is with us. We won't carry out any extra work without asking your permission first.

### The Audi Stamp

Regular servicing is key to safeguarding your Audi's performance and a full Audi service history could help you preserve the future re-sale value of your car. Only the Audi Stamp will prove your approved Audi service history.

### Getting better every time

We continually gather feedback from our Audi Trained Technicians, as well as our customers, to ensure our vehicles are running as they should. Whenever we see an Audi for a service, we connect it directly to our headquarters in Ingolstadt which enables us to check your car's software and make sure it's as up-to-date as possible. If the factory has released a software upgrade for your model, it can be applied immediately – improving anything from your car's efficiency to the precision of its parking system.

### Environmental commitment

We promise to dispose of all non-biodegradable materials from your vehicle in a responsible manner.

\*Subject to availability.

\*\*Excludes wear and tear.

# Pricing information

## Pricing

Prices and specifications given are correct at the time of printing. Always check details with your Audi Centre, as Audi policies are continually developing. We reserve the right to change prices or specifications at any time.

All prices are subject to VAT, currently charged at 20% but this may alter to reflect any change in the applicable VAT rate.

Delivery charges and number plates are not included in the vehicle price.

|                 |         |
|-----------------|---------|
| Delivery charge | £471.66 |
| Number plate    | £20.00  |
| VAT             | £98.34  |
| Total           | £590.00 |

## Audi Roadside Assistance

Your new car comes complete with 3 years' complimentary roadside assistance and recovery across the UK provided by RAC Motoring Services. Also included is roadside assistance throughout Europe, managed by RAC Motoring Services.

For further information and terms and conditions please visit [audi.co.uk](http://audi.co.uk)

## Audi Customer Care

Every new Audi benefits from the comprehensive Audi Customer Care Package, which comprises:

- ▶ A 3-year Audi warranty, which covers you for unlimited mileage in the first 2 years of ownership, with a full mechanical and electrical warranty which covers you for up to 60,000 miles in the 3rd year

- ▶ A 3-year paint warranty
- ▶ A 12-year anti-corrosion warranty
- ▶ 3 years' UK roadside assistance and recovery

You also have the option when ordering your new car of choosing a 4-year or 5-year Audi warranty. Speak to a member of the sales team for more information.

## Audi Tax-Free Sales

If you are entitled to purchase a vehicle free of VAT, normally through Military or Diplomatic privilege, please contact your local Audi Centre for full details.

Should you have any difficulty obtaining the information you require, please call Freephone 0800 585878.

## Audi Finance

Audi Finance specialise in providing funding solutions for Audi drivers. Whether your Audi is for private or business use, there are a range of funding options to choose from.

Below is the full range of finance products.

- ▶ Solutions – a Personal Contract Plan
- ▶ Hire purchase
- ▶ Lease purchase
- ▶ Finance lease
- ▶ Contract hire

With all products, you can choose a fixed-cost maintenance plan designed to help you budget accurately.

No matter what Audi model you choose, your local Audi Centre can provide you with a personalised quote which could fit your budget and motoring needs.

Audi Finance is a trading name of Volkswagen Financial Services (UK) Limited. An offer of finance depends on certain conditions. Available to people over 18 in the UK only.

## Audi Insurance

We want you to start enjoying your new car from day one and thanks to Audi Insurance complimentary seven day cover, you can. Call free on 0800 316 7893 (lines are open Monday to Friday 8am - 9pm, and Saturday 9am - 5pm), provide a few details and a cover note will be sent to your Audi Centre. They will then tax your car and you can drive it away.



**Audi UK**

Customer Services  
Selectapost 29  
Sheffield  
S97 3FG  
0800 699888  
audi.co.uk

Specifications and prices subject  
to change without notice.

© Audi UK

Printed in the UK  
Edition 4.0 10/10  
2011 model year

Images are for illustrative purposes only.