

2007 Fifth Wheel

Montana

"Built by people who know RVing"



North America's #1 Selling Fifth Wheel for 5 Consecutive Years!

Montana

2007

The Montana product team is focused on providing every customer with the best overall features, value and construction making it the #1 selling fifth wheel for six consecutive years.* We focus on all of the details so our customers can rest and enjoy Montana's excellent product design in four critical areas

Residential styling, amenities, and four season living ability, creates a home-away-from-home atmosphere like no other.

Excellent towability with better aerodynamics, suspension, and weight distribution, insures that your drive is as comfortable as your stay.

Superior construction to provide long lasting durability means you'll enjoy your Montana for years to come.

Tremendous interior and exterior storage space adds the crowning touch, adding convenience in every area of your vacation home.

For many years, Montana customers have rested comfortably knowing their Montana provides everything they need to enjoy living the RV lifestyle to the fullest!

*Stat Survey - Independent research data 2006.



The Montana's master bedroom suite features abundant storage, cedar-lined front closets, ample drawer space and pull-out full extension drawer guides.

In addition, Montana provides 6'5" of head room, with a full length mirror. The optional king bed and padded head board maximize comfort. Shown here in Sapphire décor.





The 3400 RL rear lounge, shown here in the Sapphire décor, features an amazing kitchen with wrap-around bar area for the ultimate in storage and function. Whether you are resting in matching high-back dinette chairs or the deluxe hide-a-bed sofa, you will have a spectacular view of the great outdoors.

The bedroom suite of this 3400 RL features a TV that swivels out for the perfect viewing image with unsurpassed drawer space. The bath sink and vanity light make preparing for the day a true pleasure.



The main living area of this 3585SA, shown in Venetian decor, provides a spacious interior with excellent visibility of the 27" LCD HD TV from all seating areas. The new side aisle bath, angled entertainment center with full closet and ample rear kitchen are sure to soon become a customer favorite for this new addition to the Montana line-up.

Quality.

A Montana's appearance speaks of class-leading style and comfort. But we are not satisfied with mere good looks. So, we build the Montana as tough and durable as it is beautiful. Realizing that the final quality of the Montana is a direct result of the quality of everything that goes into it, Montana's engineers analyze every component to ensure years of trouble-free enjoyment.

Montana's standard quality features like the Total Surround Aluminum Plus™ framing, full-extension steel drawer guides, solid hardwood cabinet doors and drawers as well as deluxe furnishings provide long lasting durability. Other manufacturers find it easier to talk about quality than to create it. Montana's Old World craftsmen are the finest in the industry and continually strive to provide a level of "fit-and-finish" second to none. Your peace of mind is assured because you are purchasing an RV worthy of its established reputation for quality.



Towability.

The Montana comes equipped with the Mor/Ryde™ suspension system. This unique suspension upgrade replaces the steel leaf spring equalizer with a heavy duty rubber shear spring designed to increase the dampening effects of road shock by as much as 30%.

In addition, with Mor/Ryde™ the amount of travel in each axle is increased by 100%, from 2" to 4", providing a much smoother and more comfortable ride for you and your cargo.

The Mor/Ryde™ suspension system will better protect personal belongings minimizing road shock and preventing cabinets and drawers from accidentally opening during travel on uneven road surfaces.



For additional information on MOR/ryde systems please visit www.morryde.com or call 574-293-1581



The innovative Hitch Vision™ mirror mounted on the center of the Montana front end makes it much easier to align the hitch pin of the fifth wheel to your truck.



Montana's newly designed front fiberglass cap dramatically improves the overall turning radius by 30%, even while towed by short bed trucks! The top to bottom and side to side curvature of the front cap aerodynamically cuts through the air more efficiently, improves the tow vehicle's fuel economy and stabilizes the trailer.

Montana

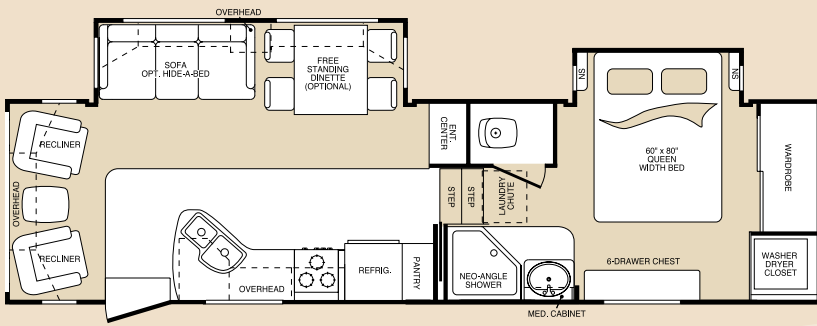

2955RL

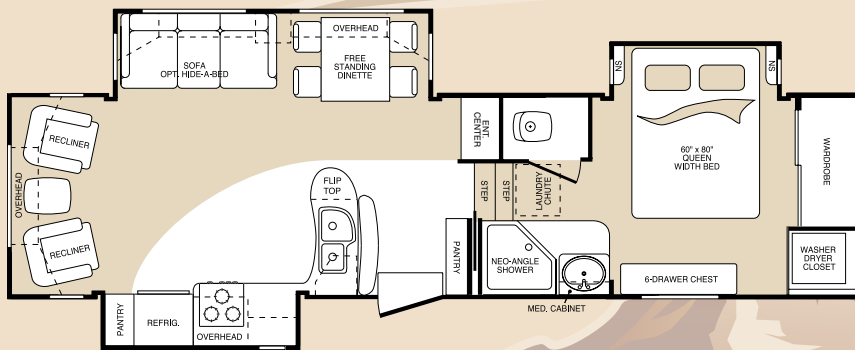
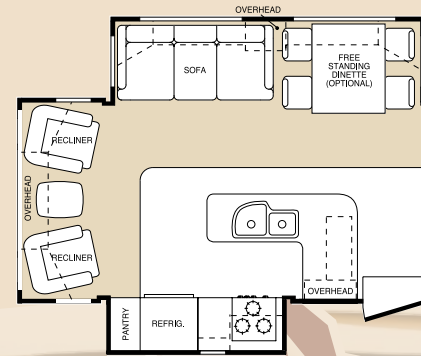

3075RL

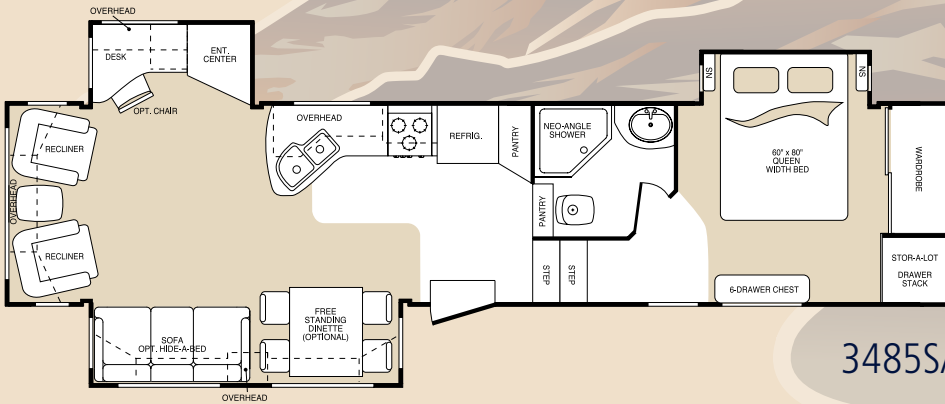
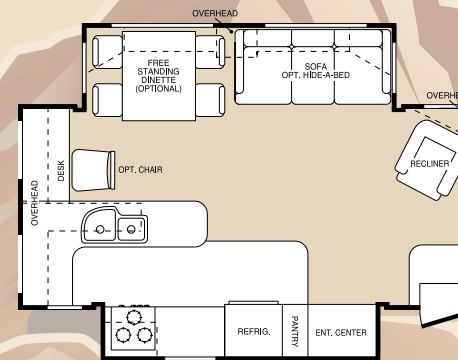

3485SA

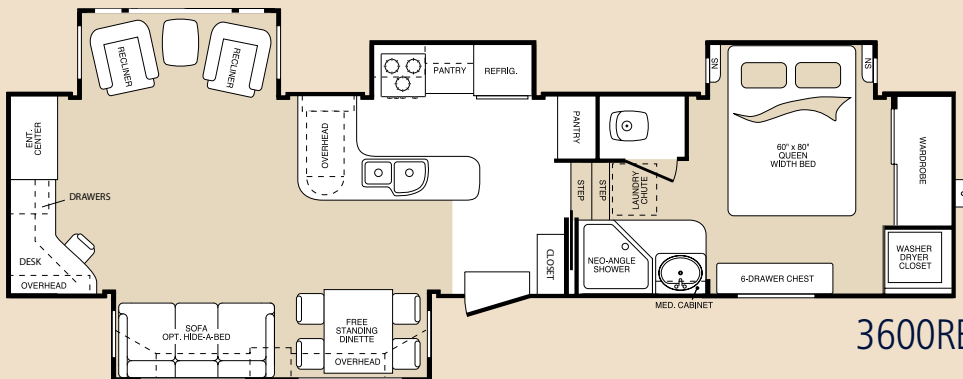
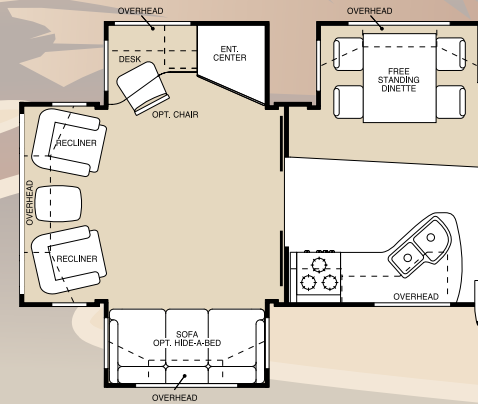

3600RE

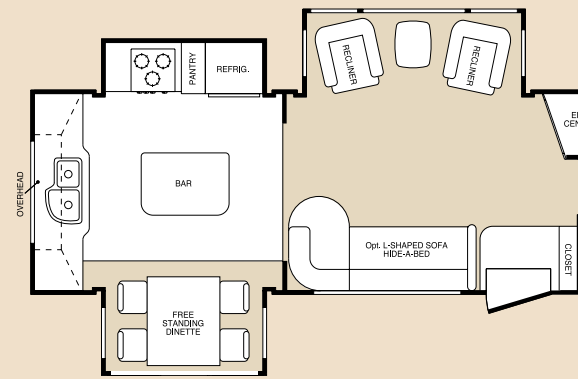

Comfort.

Your level of joy is directly proportional to your level of comfort. That's why Montana pays so much attention to providing comfort. Extra tall slide rooms and 6'5" of height entering the bedroom / bathroom suite allow ample head room. Full-size designer sofas invite you to relax during the day and an optional king size bed promises to make your nights full of peaceful bliss.

More examples of comfort-focused amenities include large, fully vented windows, residential-grade carpeting, and large glass enclosed shower stalls. The result—your sanctuary from the cares of the world is created.

The Spacemaker™ free-standing dinette features a tabletop which slides forward and back on either side so it is easier to enter and leave the dining area. The elegant, single pedestal design allows ample leg room under the table. You'll find plenty of additional storage under the hinged seat cushions.



Imagine the pleasure of this 5,100 BTU electric fireplace whenever you want to enjoy a touch of cozy warmth.



Style.

Three fashionable color schemes form the foundation for Montana's carefully coordinated room décors. Beautiful drapery and upholstery fabrics, designer hardware, fashionable window treatments, walls and counter tops in the latest colors and materials — all contribute to Montana's legendary style, setting your fifth wheel home apart from all others in a quiet but dramatic statement that says you've "arrived."

Our larger shower with glass enclosure, skylight, built-in shelves and spray head make preparing for the day a wonderful experience.





The galley area of this 3585SA provides unmatched storage space and convenience with its wrap around solid surface countertop, large double door refrigerator, convection / microwave oven, 22" LP gas oven, sink covers, abundant cabinets and drawer space. The full linoleum kitchen makes cleaning up easy.

Convenience.

At Montana, brilliant ergonomics are a trademark to be found literally at every turn. Veteran travelers instantly recognize RV-friendly features such as a computer work station with data port, Freezeguard™ winterizing system, E-Z Lube wheels and a central exterior convenience center. An abundance of more subtle conveniences like plate-depth overhead cabinets and a rechargeable flashlight exist to improve your ownership experience.

Our designers have also examined every detail to offer maximum storage and utilization of space. Pull-out pantry baskets, a lazy Susan, the Spacemaker™ dinette group and a sliding waste container are just a few examples of an excellent use of space that is synonymous with most Montana fifth wheels.



The high arching single-level kitchen faucet, deep solid surface sinks and dual tiered sink covers with cutting boards and dish rack provide conveniences not found in other brands.

Durability.

Roof (R-14)‡

1. One-Piece EPDM Rubber Roof Membrane
2. Aluminum Radius Roof Transition Molding
3. 3/8" Roof Decking
4. 5" Fabricated galvanized Steel

- Truss Rafters on 16" Centers
5. Fiberglass Insulation
6. Ceiling Decking with Vinyl
7. Aluminum wrapped AC duct
8. Vented attic
9. 15,000 BTU A/C
10. Wire Harness
11. Rear Ladder

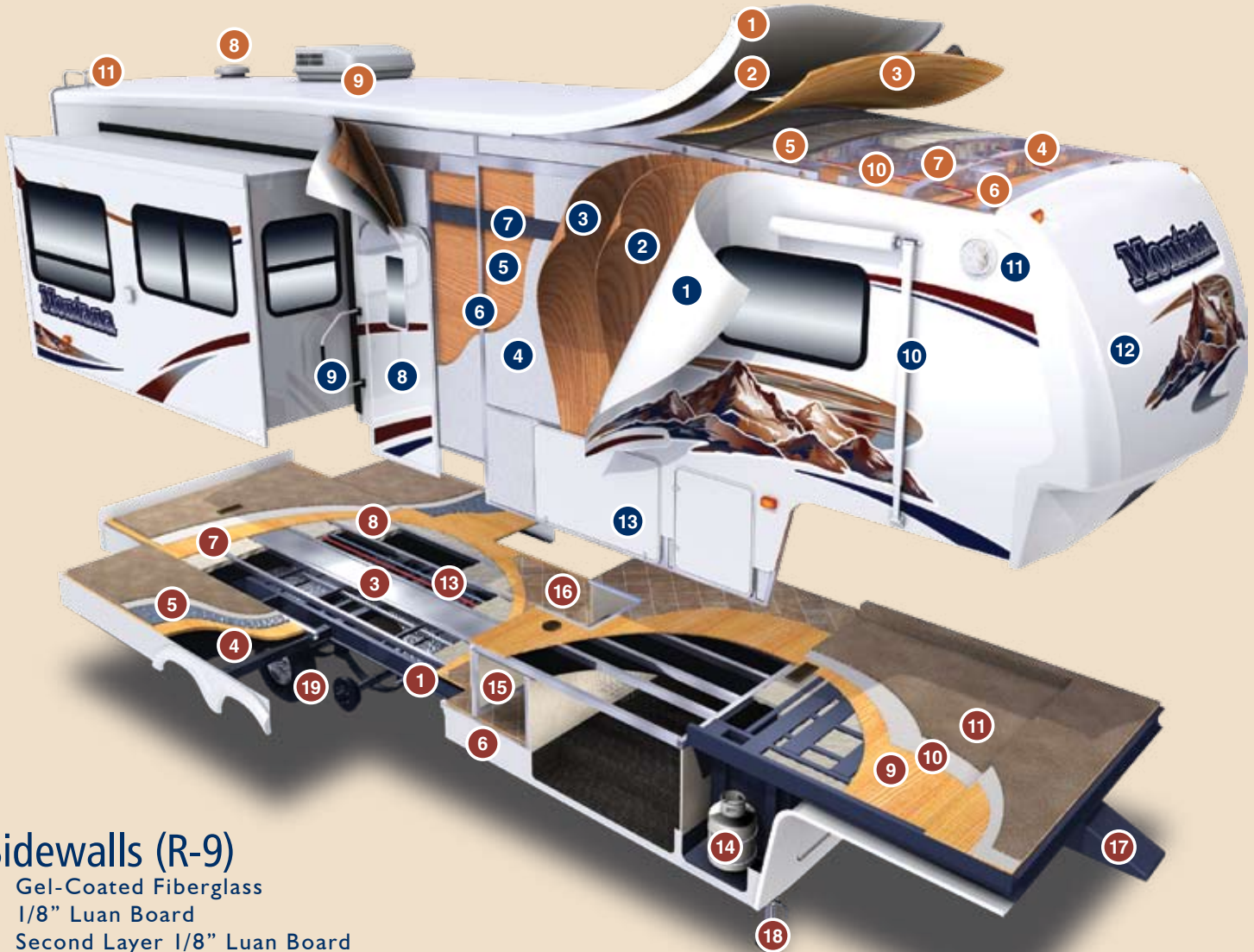

Sidewalls (R-9)

1. Gel-Coated Fiberglass
2. 1/8" Luan Board
3. Second Layer 1/8" Luan Board with Seams Staggered
4. Solid Block Insulating Foam
5. Interior Decorator Board
6. 2" Welded Aluminum Wall Studs
7. Electro-Galvanized Sheet (EGS) Metal Backing Strips
8. 30"x74" Entry Door with Window
9. Fold-Away Grab Handle
10. Patio Awning
11. Scare Light
12. Fiberglass front cap with improved turning radius and hitch vision
13. Heavy duty insulated baggage doors

Floor (R-21)‡

1. Powder-coated 10" Steel "Rolled" I-Beam
2. 3" Welded Aluminum Floor
3. 3" Large-Capacity Heat Duct
4. 1/4" ABS Underbelly
5. Astro-Foil Insulation (97% Heat Reflection)‡
6. Full Radius-wrap Aluminum Enclosure
7. Moisture Barrier
8. Fiberglass Insulation
9. 5/8" Seamless Floor Decking
10. Carpet Pad

11. Residential-Grade Carpeting with Stain Protectant
12. 2" Heat Duct from Furnace into underbelly
13. Enclosed and Insulated Water Lines
14. LP Bottle
15. Service Bag
16. Linoleum
17. Hitch Pin
18. Easy Access Adjustable Snap Jack Pins
19. Heavy Duty 8-Lug Wheels

Exterior Details.

- A. Easy-lube axles can be lubricated without removing the wheel.
- B. Attic vents provide vital escape routes for unwanted moisture that can accumulate with extended use.
- C. "Tailgate Compatibility" means there's no need for a special tailgate; just drop it down and hitch up the Montana.
- D. The detachable marine power cord is safe, easy to use and completely sealed.
- E. Easy-pull snap jacks are mounted toward the front for convenient access.
- F. The convenience center provides access to all major exterior plumbing functions and enclosed dump valves.

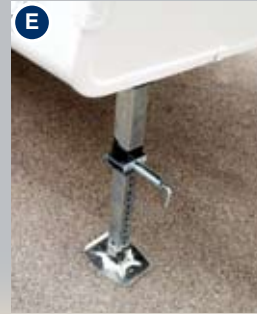
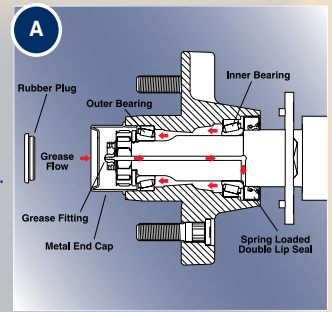

Interior Details.

- G. Easy to connect central vacuum system makes cleaning a snap.
- H. Hidden storage is great for keys or jewelry.
- I. Montana's heated stool room includes a high-rise porcelain toilet with a residential size lid.
- J. The strategically placed bedroom lamp casts light downward into your drawer areas.
- K. The versatile pantry area has loads of storage potential and a pull-out waste basket.
- L. Pull-out pantry baskets are convenient lightweight carriers for your outdoor dining.
- M. Under-bed storage area for bulkier, larger items includes a hidden and secured safe.
- N. The hidden laundry chute enables you to keep your RV home organized and clean.
- O. The full length bedroom mirror with lovely trim detail reflects our careful craftsmanship.
- P. The lighted cedar-lined front closet provides residential storage for essential wardrobe items.

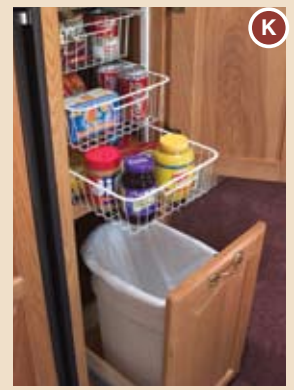

Standard Features.

Exterior

- Welded, totally aluminum-framed walls and floor • 2" laminated, gel-coated Filon exterior walls (R-9) • 5" fabricated steel truss rafters • Aerodynamic front and rear fiberglass caps
- Outstanding exterior pass-thru storage • Insulated radius baggage doors with inside fasteners • Radius wrap lower walls • Heated, enclosed holding tanks • Sectional ABS, fully enclosed underbelly • 16" radial tires • Heavy duty 8-lug wheels • Seamless, one-piece 5/8" Dynaspan floor decking • Flip-up front storage shelf • "Wide Stance" front jack legs with adjustable snap jack pins • In-floor heated and enclosed water lines • Outside Shower

Interior

- High-density residential carpeting and upholstery with fabric protector • Solid hardwood cabinet doors with radius tops • Deluxe entertainment center with TV cabinet • Residential full extension steel drawer glides • 6'3" extra tall slide room with overhead cabinets • (1 or 2) glider/recliner(s) w/footrest • Computer work station with data port (most models) • Flush floor slide room in living room • Day/night shades • Oil-rubbed bronze hardware and lighting package • Jiffy Bed Sofa

Kitchen

- Large, 8 cubic foot double door refrigerator • Solid surface countertop • 1-piece molded kitchen sink with deep bowls • Lighted range hood with fan
- Wide, deep drawers – real wood • Residential-size overhead cabinets
- Linoleum kitchen floor and entryway • Crown molding trim

Bathroom

- 36" garden tub with glass enclosure (3295, 3400, 3075, 3485, 3600) • Neo-angle shower with glass enclosure (2955, 2980, 3000, 3500, 3650) • Adult height vanity • Larger residential-size bath sink • Decorative vanity light • Residential-style medicine cabinet • Linen shelf with towel bar • Porcelain toilet with foot pedal flush.

Bedroom

- Single level bedroom/bath suite • Quilted bedspread and 2 pillow shams • Residential-sized chest of drawers • 19" TV with built-in cabinet and cable and satellite outlets • Deluxe inner-spring mattress • "Shoe closet" storage area in wardrobe • Night stand shelves
- Wood window valance with hidden storage • Enlarged residential size front closet

Utilities

- 35,000 BTU furnace • No-fuss, "Freezeguard"™ winterizing kit • Systems monitor panel
- 55-amp convertor • 50-amp detachable, marine power cord • Automatic ignition furnace with in-floor ducting • Phone jack / data port • Cable TV hook-up • Fresh water system – 62 gal.; Grey water – 76 gal.; Black water – 38 gal. • Carbon monoxide detector

Montana Fifth Wheel is a product of:



**Keystone RV
Company**

2642 Hackberry Drive Goshen, IN 46526
(574) 535-2100 www.keystone-montana.com

Your Montana Dealer:



Product information is as accurate as possible as of the date of publication of this brochure. Features, floor plans, and specifications are subject to change without notice. Please also consult Keystone's web site at keystonerv.com for more current product information and specifications. **Tow Vehicle Disclaimer: CAUTION:** Owners of Keystone recreational vehicles are solely responsible for the selection and proper use of tow vehicles. All customers should consult with a motor vehicle manufacturer or their dealer concerning the purchase and use of suitable tow vehicles for Keystone products. Keystone disclaims any liability or damages suffered as a result of the selection, operation, use or misuse of a tow vehicle. **KEYSTONE'S LIMITED WARRANTY DOES NOT COVER DAMAGE TO THE RECREATIONAL VEHICLE OR THE TOW VEHICLE AS A RESULT OF THE SELECTION, OPERATION, USE OR MISUSE OF THE TOW VEHICLE.** 12/06

ZERO DEGREE

Tested and approved features
enhance four-season living.

- Vented attic
- Enclosed heated dump valves
- Enclosed heated holding tanks
- Insulated water lines along furnace duct
 - Digital thermostat
 - Heated stool room
- Arctic insulation package with higher R-values
 - Enclosed low point drain shut-off valves
 - Fully enclosed underbelly ABS

Optional Features.

Moving To Montana Package:

- 15,000 BTU A/C with quick cool • Convection microwave
- Deluxe Patio Awning • 27" LCD/HD TV in living area

Customer Convenience Group

Easy lube axles / Deep tint windows / Safety glass windows / Vented attic / 12 v. rechargeable flashlight near exit / Cabinet toe kicks / Laundry chute to basement with wire basket / Reading lights over bed / TV antenna and booster / High output range with automatic ignitor and 22" oven / Water heater by-pass kit / easy-Access™ double 30-lb. LP bottles with auto change-over / Two kitchen sink-covers with dish drain rack, cutting board, and composite counter-tops / Lighted, cedar-lined front closet / Central convenience center / Deluxe inner-spring mattress / Aerodynamic front cap with 30° improved turing radius and Hitch Vision™ Mirror

Value Package:

- Fold-away entry/exit handle • Patio scare light: door and roadside • Crank-down stabilizer jacks • Electric front jacks • Raised-oak refrigerator front • Flush mount range cover • Roof ladder • DVD/CD/FM receiver with 5.1 surround sound • Skydome over tub • Mor/Ryde Suspension • Brinks® hidden safe • RG6 Satellite prep • 19" bedroom TV • Deluxe porcelain toilet upgrade • Black tank flush • Spare tire and carrier

Exterior Options

- Slide-room awning(s) • Aluminum wheels • Dual pane safety glass windows • Hi-gloss gel-coated fiberglass exterior • Basement slide tray

Interior Options

- Spacemaker free-standing dinette w/4 storage chairs • Neo-angle shower w/glass enclosure IPO garden tub • King size bed • End table and lamp • Sofa table • High-back desk chair • Air Mattress Hide-a-Bed Sofa

Equipment Options

- Second 13,500 BTU A/C in bedroom • Wire and frame for second A/C • Ceiling fan • Power vent fan w/rain sensor • Generator prep • 10 cubic foot double-door refrigerator • Washer/Dryer prep • Arctic insulation package • Hydraulic selector valves • Central vacuum • 5.5 KW Onan Generator • Electric fireplace

IPO=In Place Of

Visit the Montana Owners' Club website, independently created and maintained by Montana fifth wheel owners, at www.montanaowners.com