



From Westminister, Massachusetts, Curt & Cheryl Barnard's 1953 Starlight Coupe

ELECTRICAL SECTION GLOSSARY

Headlight Rims, Retainers & Parts 202-203

Taillight Housings, Bezels & Parts..... 204 -205

Backup Light & Parking Parts..... 205

License Lamp Assemblies & Parts 206

Lens.....206-207

Bulbs..... 207

Lens Gaskets & Seals.....208-209

Ignition Related Parts..... 210-211

Distributors & Related Parts..... 212-213

Starters & Related Parts 214-215

Generators & Related Parts216

Alternators & Related Parts.....217

Switches..... 218-219

Windshield Wiper Related Parts.....220-221

Power Window.....221

Wiring Harnesses222-223

Battery Related Parts 223

Horn Related Parts 224

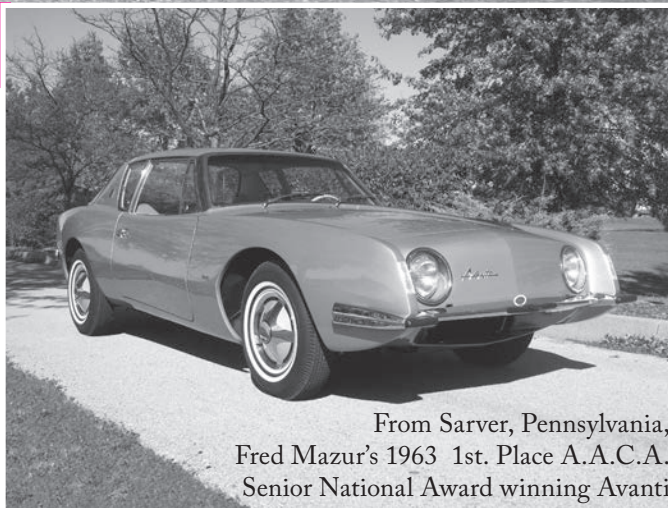

From Sarver, Pennsylvania, Fred Mazur's 1963 1st. Place A.A.C.A. Senior National Award winning Avanti



From Conchas Dam, New Mexico, C.E. Longfellow's 1962 G.T. Hawk



649030 Headlight ring, 1942-48 M-series truck. Chrome. Includes parking lens gasket and retainer. Pictured, left. **\$99.95 ea.**



1312088W
1953-55 car, all models & 1956-62 Hawk. Retainer bracket included. **\$99.00 ea.**



1314322
Right, headlight upper moulding. 1956 President. **\$95.00 ea.**



1312089P
Painted headlight rim. 1956-57 Champion & Commander, 1958 Scotsman. Not Pictured. **\$75.00 ea.**
NEW Listing - 1312089W
Headlight rim. 1956-57 Champion & Commander, 1958 Scotsman. Chrome. **\$135.00 ea.**

1957 Packard Chrome. **1323075W** Left side. **\$120.00 ea.**

HEADLIGHT RIM KITS



285155X Head light rim kit. 1947-49 Champion. Kit includes (2) 285177 h/l rims, (2) 285197 glass p/l lens & (2) 285181 gaskets. **\$219.00 kit.**

285177 1947-49 Champion H/L rim ONLY. **\$99.95 ea.**

652780X Head light rim kit. 1949-53 Truck. Kit includes (2) 652780 h/l rims, (2) 285197 glass p/l lens & (2) 285181 gaskets. **\$219.00 kit**

652780 H/L rim ONLY. **\$99.95 ea.**



1326172WP Facing, 1958 sedan with single headlight. Chrome. NOS. .. **\$75.00 ea.**



1330120P
H/L Filler ring 1958 sedan. **\$35.00 ea.**

1331415P
1959-60 Lark. Truck: 1960-64 Champ. Painted. NOS. .. **\$45.00 ea.**

1331415W
1959-60 Lark. Truck: 1960-64 Champ. Chrome. Pictured. **\$95.00 ea.**



1338484 1961 Lark with dual headlight. NOS. **\$38.00 ea.**

1339214 1961 Lark with single headlight. NOS. **\$35.00 ea.**

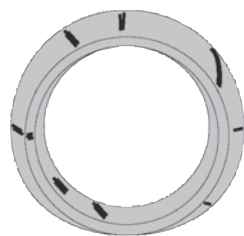

1342465 Right or Left. 1962-63 Lark. NOS. **\$38.00 ea.**

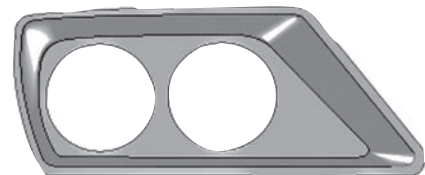

1356202 Right. 1964-65 Lark with dual headlight. NOS. **\$44.00 ea.**

1356203 Left. 1964-65 Lark with dual headlight. NOS. **\$44.00 ea.**

HEADLIGHT RETAINING RINGS

NEW Listing - 285187

1947-49 Champion, 1951-54 Champion & Commander. Truck: 2R-2E all & 3E - 4E 1, 2, 3. **\$12.00 ea.**

1326837 1958-66 with dual headlight. Hall. Pictured. **\$8.00 ea.**

NEW Listing - 1342945 1961-65 with dual headlight. Hall - Canada. **\$8.00 ea.**

NEW Listing - 1351891 1961-66 with dual headlight. Hobbs. **\$8.00 ea.**



1356216 Right. 1964 or 66 Lark with single headlight equipment. NOS. **\$32.00 ea.**

1356217 Left. 1964 or 1966 Lark with single headlight equipment. NOS. **\$32.00 ea.**



HEADLIGHT ASSEMBLIES



273760 This headlight assembly is available in limited quantities. 1939 car with sealed beam headlights & 1940 car all models. Complete housing with bucket, bulb & chrome rim. NOS. **\$250.00 ea.**



- 1326292** Right. 1958 sedan with dual headlight. **\$75.00 ea.**
- 1326293** Left. 1958 sedan with dual headlights. **\$75.00 ea.**
- 1339736** Right. 1961-63 Lark with dual Hall headlight. **\$75.00 ea.**
- 1339737** Left. 1961-63 Lark with dual Hall headlight. **\$75.00 ea.**
- 1351880** Right. 1963 & 1965 Lark with dual Hobb headlight. **\$65.00 ea.**
- 1351881** Left. 1963 & 1965 Lark with dual Hobbs headlight. **\$65.00 ea.**
- 1358650** Right or left. 1964 & 1966 Lark with single headlight. **\$88.00 ea.**
- 1360180** Right 1964-65 Lark with dual Hall headlight. **\$65.00 ea.**
- 1360181** Left. 1964-65 with dual Hall headlights. **\$65.00 ea.**
- 1360190** Right. 1964-65 Lark with dual Hobbs headlight. **\$65.00 ea.**
- 1360191** Left. 1964-65 Lark with dual Hobbs headlight. **\$65.00 ea.**
- 1655392** Truck: 5E-8E, models 13, 14, 16, 28, 40, 35, 45 except "96 BBC". **\$100.00 ea.**
- 1656262** Truck: 7E & 8E, models 28, 35, 40, 45 "96 BBC" **\$91.00 ea.**

HEADLIGHT

- 263528** Headlight bulb, 6-volt, (#2331). All 1936-39 car without sealed beam headlight. **\$12.50 ea.**
- 272586** 6-volt. 1946-55, all models with sealed beam. **\$19.50 ea.**
- 1326844** Outer, headlight sealed beam. 1958-65 sedan & wagon with D/L. . **\$9.00 ea.**
- 1326845** Inner, headlight sealed beam. 1958-65 sedan & wagon with D/L. **\$9.00 ea.**

ROUND HEADLIGHT PARTS 1963 AVANTI



- 1578X34** Speed nut securing ring. Takes 8. **35¢ ea.**
- 1350397** Headlight lens cover gasket. **\$15.00 ea.**
- NEW Listing - 1350398** Right, replacement round front headlight lens. Plastic. **\$48.50 ea.**
- NEW Listing - 1350399** Left, replacement round front headlight lens. Plastic. **\$48.50 ea.**
- 1350533W** Left outer retainer ring. Chrome. **\$145.00 ea.**
- 1350534W** Right outer retainer ring. Chrome. **\$145.00 ea.**

SQUARE HEADLIGHT PARTS 1964-85 AVANTI

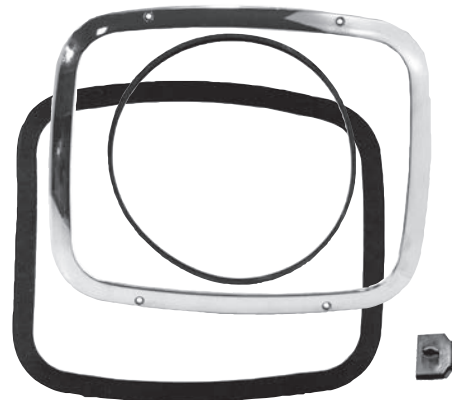

- 1578X34** Speed nut, securing ring. Takes 8. **35¢ ea.**
- 1358786** Headlight lens cover gasket. **\$12.50 ea.**
- 1358787** Headlight housing to body seal. **\$12.50 ea.**
- 1358849W** Outer retainer ring. Chrome. **\$150.00 ea.**
- NEW Listing - 1750591** Rectangular front headlight lens replacement. Plastic. **\$48.50 ea.**

HEADLIGHT BEZELS



- 1750663** Left. **\$65.00 ea.**
- 1750664** Right **\$65.00 ea.**

Rectangular headlight bezel for 1984-89 Avanti. Fiberglass.

HEADLIGHT RELATED PARTS

- 1523X39** Screw, headlight rim to body. 1963-64 Hawk. **\$2.50 ea.**
- 3305X3** Gasket, headlight rim to body. 1964 Hawk. **\$3.00 ea.**
- 276526** Nut, headlight focusing. 1941-57 car. Truck: 1941-59. Takes 4. **\$4.50 ea.**
- 285187** Sealed beam retainer ring, stainless. 1947-49 Champion, Truck: 1949-59 with standard metal grille. **\$22.00 ea.**
- 285974** Headlight focusing screw. 1947-57 car. **\$6.00 ea.**
- 801653** Retainer bracket kit for 1312088W headlight rim. Includes (1) early, (1) late style bracket and screws. Also fits 1963-64 Hawk. **\$5.50 ea.**

- 131026** Grommet for headlight cable. 1934-42 car. **\$3.50 ea.**
- 1326832** Focusing nut & bracket. 1961-63 car with Hall dual headlight equipment. **\$4.00 ea.**
- 1326833** Focusing screw. 1961-63 car with Hall dual headlight equipment. **\$2.25 ea.**
- 1326834** Cable. 1958 car with dual headlight equipment. **\$26.00 ea.**
- 1331432** Cable. 1959-60 Lark. Truck: 1960-64 Champ. **\$20.00 ea.**
- 1338678** Cable. 1961 Lark with single headlight. **\$20.00 ea.**
- 1339735** Cable. 1961-63 Lark with dual headlight. **\$24.00 ea.**
- 1351891** Sealed beam retainer ring, stainless. 1963-66 with Hobbs dual headlight. **\$18.00 ea.**
- 1360198** Cable. 1964-65 car with dual headlight. **\$24.00 ea.**

HEADLIGHT BUCKETS & BASES

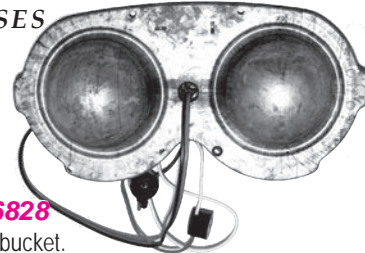

- 1326828** Right bucket. 1958 car with dual headlights. **\$52.00 ea.**
- 1326829** Left bucket. 1958 car with dual headlight. **\$52.00 ea.**
- 1338674** Right or left bucket. 1961 Lark with single headlights. **\$52.00 ea.**
- 1339774** Right bucket. 1962-63 Lark with dual Hall headlight. **\$41.00 ea.**
- 1339775** Left bucket. 1962-63 Lark with dual Hall headlights. **\$41.00 ea.**
- 1351885** Inner, left base. 1963-66 Lark with dual Hobbs headlight. **\$16.00 ea.**
- 1351886** Outer, right base. 1963-66 Lark with dual Hobbs headlight. **\$16.00 ea.**
- 1351887** Outer, left base. 1963-66 Lark with dual Hobbs headlight. **\$16.00 ea.**
- 1351888** Right or left bucket. 1963 Lark with dual Hobbs headlight. **\$41.00 ea.**
- 1360195** Right or left bucket. 1964-65 car with dual Hobbs headlight. **\$41.00 ea.**

TAIL LIGHT RIMS



289760
Tail light ring, chrome. 1950 Champion.
.....**\$129.95 ea.**

289939
Tail light bezel, chrome. 1950 Commander, Includes reflector.
.....**\$139.95 ea.**



293778X2
Tail light ring, chrome. 1951 Champion and Commander. Includes reflector.
.....**\$139.95 ea.**



TAIL LIGHT HOUSING

(Lens sold Separately)

308225 for 1955-56 C & K except 1956 Golden Hawk. Beautiful chrome finish! Includes socket, cable and lens gasket.
.....**\$210.00 ea.**

308958 Tail light lens for 1955 C & K.
.....**\$29.95 ea.**

1312694 Tail light lens for 1956 Hawk.
.....**\$60.00 ea.**

TAIL LIGHT HOUSINGS & BEZELS

NEW Listing - 296291W
Tail light bezel. 1952 car. Chrome.
.....**\$160.00 ea.**



298968X2 Right, tail light housing. 1953 sedan. Chrome.
.....**\$145.00 ea.**
298969X2 Left, tail light housing. 1953 sedan. Chrome.
.....**\$145.00 ea.**



Bulbs not included.

308227X1 Left, tail light housing. 1955 sedan. Painted.
.....**\$135.00 ea.**



308226X2 Right, tail light housing. 1955 sedan. Chrome.**\$195.00 ea.**
308227X2 Left, tail light housing. 1955 sedan. Chrome.**\$195.00 ea.**

300965 Clip, lens retainer for 641311. Takes 3.**\$3.00 ea.**

641311 tail light assembly complete with lens and license light, left side. 1937-55 Truck. Pictured right.**\$65.00 ea.**

641311X1 tail light assembly with lens but without license light, right side.**\$55.00 ea.**

641311W Same as above (641311) with chrome bezel.**\$80.00 ea.**

641311X2 Same as above (641311X1) with chrome bezel.**\$70.00 ea.**

1312378 1956 sedan.**\$210.00 ea.**

1312676 Right, tail light housing. 1956 station wagon.**\$145.00 ea.**

1312677 Left, tail light housing. 1956 station wagon. Pictured left.**\$145.00 ea.**

1323576
Tail light housing. 1957 Scotsman.
.....**\$95.00 ea.**



1326520 Tail light housing base. 1958 Scotsman.**\$25.00 ea.**

NEW Listing - 306076X2 Right, tail light assembly. 1954 sedan & 1954-55 wagon. Chrome.**\$195.00 ea.**

NEW Listing - 306077X2 Left, tail light assembly. 1954 sedan & 1954-55 wagon. Chrome.**\$195.00 ea.**

1338884 Right, tail light housing. 1961 Lark.**\$45.00 ea.**

1338885 Left, tail light housing. 1961 Lark.**\$45.00 ea.**

1343060 Right, tail light housing. 1962 Lark station wagon.**\$150.00 ea.**



1353005 Left, tail light assembly. 1963-66 Wagonaire.**\$160.00 ea.**

1356250 Right, tail light housing. 1964-65. Painted.**\$65.00 ea.**

1356251 Left, tail light housing. 1964-65. Painted.**\$65.00 ea.**

NEW Listing - 1356256 Right bezel, chrome. 1964-65 Lark.**\$95.00 ea.**

1361800 Right, tail light housing. 1966. Painted.**\$65.00 ea.**

1361801 Left, tail light housing. 1966. Painted.**\$65.00 ea.**

1362116 Right painted and chrome bezel. 1966 Lark.**\$45.00 ea.**

1362117 Left painted and chrome bezel. 1966 Lark.**\$45.00 ea.**

1362118P Right painted bezel. 1966 Lark.**\$25.00 ea.**

1362118W Right chrome bezel. 1966 Lark.**\$45.00 ea.**

1362119P Left painted bezel. 1966 Lark.**\$25.00 ea.**

1362119W Left chrome bezel. 1966 Lark.**\$45.00 ea.**

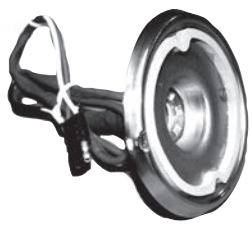

TAIL LIGHT BODIES

1320902

1957-59 Hawk. Complete with socket & cable, & lens gasket.

.....**\$65.00 ea.**

1337115 1960-61 Hawk. Complete with socket & cable, & lens gasket.**\$65.00 ea.**

1952 TAIL LIGHT BODY AND CABLE KIT

Kit Includes

- 1 - 296363 Body
- 1 - 296365 Cable & socket
- 1 - 293764 Turn signal and stop light bulb



801837**\$82.50/kit**

TAIL LIGHT BRACKET

1685848P Right or left. 1949-62 truck.**\$29.95 ea.**

SAFETY RUNNING LIGHTS

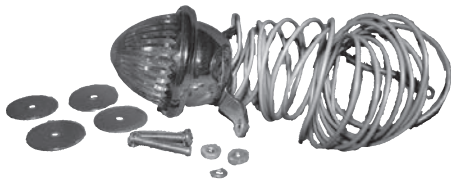

AC-3522 New cars have it today. Studebaker had it in the sixties. Mounts in center of grille and stays on whenever car is running. NOS.**\$25.00 ea.**

BACK-UP LIGHT KITS



AC-2957 Less lens. 1959-61 Lark wagon.**\$85.00 pr.**

AC-3199 Socket & cables. 1962-63 Lark, all.**\$12.00 pr.**

AC-3218 Less lens, 1962 Lark wagon**\$90.00 pr.**

AC-3488 Socket & cables. 1964 Lark**\$15.00 pr.**

BACK-UP BODIES

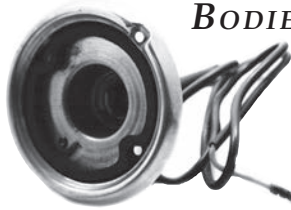

1320917

1957-61 Hawk. Complete with socket, cable, & lens gasket.

.....**\$60.00 ea.**

1326522 1958 sedan. Complete with socket & cable.**\$24.50 ea.**

BACK-UP RETAINERS & BEZELS



1350258 Right, chrome. 1963-89 Avanti.

.....**\$35.00 ea.**

1350259 Left, chrome. 1963-89 Avanti.**\$35.00 ea.**



1958 sedan. Chrome.

1326502W Right.

.....**\$75.00 ea.**

1326503W Left.

.....**\$75.00 ea.**



AVANTI CHROME PARKING HOUSING

1358720 1964-83 Avanti. Beautiful chrome reproduction with electrical connector. Includes lens and gasket.**\$175.00 ea.**

1959-61 HAWK PARKING LIGHT

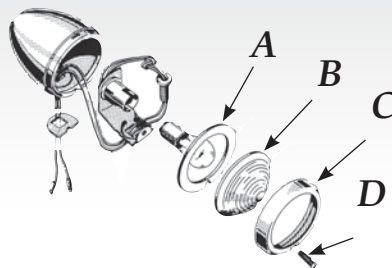

A) 1332602 Lens gasket.**\$2.00 ea.**

B) 1332601 Lens. No Stock

C) 1332600 Chrome ring.**\$20.00 ea.**

D) 1332603 Chrome screw for ring.**\$1.00 ea.**

LAMP SOCKETS & CABLES

290242 Parking light. 1950 Commander.

.....**\$15.00 ea.**

295929 Parking & turn signal light. Late 1952 car.**\$14.00 ea.**

296580 Parking & turn signal light. Early 1952 car.**\$12.00 ea.**

519810 In dash, directional tell-tale light. 1947-49 cars, all.**\$20.00 ea.**

526215 Map light. 1950-52, all models.

.....**\$12.00 ea.**

526341 Instrument light. 1950 Champion.**\$10.00 ea.**

526543 In dash, signal light flasher. 1951-52 car, all.**\$22.00 ea.**

526549 Directions tell-tale. 1950, all models.

.....**\$16.50 ea.**

526551 Rear turn signal. 1950 car, all.

.....**\$16.00 ea.**

530586 Cable with fuse, flasher to ignition switch. 1951-52 car, all.**\$18.00 ea.**

1312869 Parking light. 1956-57 Hawk.

.....**\$22.50 ea.**

1326617 Parking light. 1958 Hawk.

.....**\$22.50 ea.**

NEW Listing - 1350504

Parking light

socket & cable. 1963 Avanti.**\$45.00 ea.**

.....**\$45.00 ea.**

PARKING/TURN SIGNAL LAMP HOUSINGS & CABLES

1312966 Right, parking housing. 1956 sedan, not Hawk.**\$45.00 ea.**

1312967 Left, parking housing. 1956 sedan, not Hawk.**\$45.00 ea.**

1327965 Left, parking & turn light housing. 1958 Packard.**\$75.00 ea.**

1338681 Left, parking & turn light housing.

1961 Lark with dual headlight.**\$26.00 ea.**

1338690 Parking & turn light housing. 1961 Lark with single headlight.**\$26.00 ea.**

1353543 Parking & turn light bezel. 1963 Hawk before V11587 US, VX2295 Canada. Stainless steel.**\$15.00 ea.**

1355026 Right, parking housing & cable. 1962-63 Lark.**\$26.00 ea.**

1355027 Left, parking housing and cable. 1962-63 Lark.**\$26.00 ea.**

Note: 1964-65 Lark parking light housings originally were die-cast with chrome plating. In 1966 they were aluminum sand-cast and were not plated. These were also used as replacements by the factory for 1964-65 models. We have the following available.

1356220 Right. 1964-66. Sand-cast with new chrome plating.**\$95.00 ea.**

1356220X Right. 1964-66. NOS with original chrome plating.**\$120.00 ea.**

1356221 Left. 1964-66. Sand-cast with new chrome plating.**\$95.00 ea.**

1356221X Left. 1964-66. NOS with original chrome plating. No Stock

LICENSE LAMP ASSEMBLIES & RELATED PARTS



536458 License lens & gasket. 1955 car all models except station wagon, 1956-64 Hawk.

..... **\$15.00 ea.**

NEW Listing - 1331722 Retainer for 1331728 lens. **\$12.50 ea.**

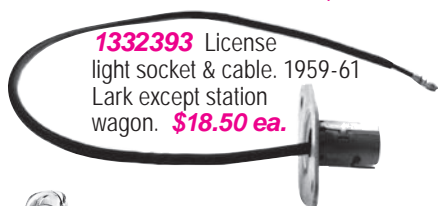

1332393 License light socket & cable. 1959-61 Lark except station wagon. **\$18.50 ea.**



1539168 1955 car, all models except station wagon. 1956-64 Hawk. Assembly includes bracket, socket, bulb, lens, gasket and mounting screws. **\$45.00 ea.**

1539169 1956 2-door station wagon. NOS **\$60.00 ea.**

1559770 1962-66 Lark. 1955-56 station wagon. 1959-61 station wagon. 1953-54 all models. 1963-83 Avanti. **\$15.00 ea.**



ACCESSORY GLOVE BOX LIGHTS



AC-1051 1941-42 Champion & Commander. Truck: M-series. . **\$45.00 ea.**

AC-1433 1947 Champion. **\$40.00 ea.**

NEW Listing - AC-2831 1959-60 Lark. Truck: 1960-64 Champ. **\$20.00 ea.**

NEW Listing - AC-3090 1961-62 Lark. **\$22.50 ea.**

AC-3417 1963 Lark. **\$25.00 ea.**

AC-3514 1964-66 Lark. **\$25.00 ea.**



Is time running out on your Renovation?

Give us a call!

Lens



LICENSE LENS

285439 1947-49 car, all models. **\$8.00 ea.**

289829 1950 car, all models. .. **\$16.50 ea.**

293050 1951-52 Champion & Commander. **\$16.50 ea.**

..... **\$16.50 ea.**

293237 1951-52 Champion W1, F1, C1, Q4. **\$12.50 ea.**

..... **\$12.50 ea.**

536458 1955 all, 1956-64 C & K. **\$15.00 ea.**

..... **\$15.00 ea.**

1312315 1956 sedan. **\$12.50 ea.**

1331676 Early 1959 Lark. **\$12.50 ea.**

NEW Listing - 1331728 Late 1959 -61 Lark. **\$12.50 ea.**

..... **\$12.50 ea.**

1686080 1956-64 C-cab. **\$15.00 ea.**



BACK-UP LENS

526284 1951-52 car, all. **\$65.00 ea.**

..... **\$65.00 ea.**

535299 1954-55 station wagon. **\$45.00 ea.**

..... **\$45.00 ea.**

1312389 1956 sedan **\$18.00 ea.**

1320363 1957 sedan **\$25.00 ea.**

1320924 1957-61 Hawk & 1959-61 Lark. **\$30.00 ea.**

..... **\$30.00 ea.**

1326515 1958 sedan. **\$20.00 ea.**

1342625 1962 Lark. **\$30.00 ea.**

1343541 1962-64 Hawk. **\$24.00 ea.**

1343541X1 Amber. 1962-64 Hawk. Export. **\$24.00 ea.**

..... **\$24.00 ea.**

1350256 Right. 1963-83 Avanti. **\$35.00 ea.**

..... **\$35.00 ea.**

1350257 Left. 1963-83 Avanti. **\$35.00 ea.**

1353524 Right. 1963-65 wagon. 1966 all. **\$30.00 ea.**

..... **\$30.00 ea.**

1356258 Right. 1964-65 Lark. **\$15.00 ea.**

1356259 Left. 1964-65 Lark. .. **\$15.00 ea.**

1541582 1956 Hawk **\$20.00 ea.**

6484471 1957-58 Packard. **\$95.00 ea.**

TURN SIGNAL LENS



285314 Front, right. 1947-49 Champion. **\$25.00 ea.**

..... **\$25.00 ea.**

285315 Front, left. 1947-49 Champion. **\$25.00 ea.**

..... **\$25.00 ea.**

285394 Rear. 1947-49 Champion. **\$12.00 ea.**

..... **\$12.00 ea.**

684584 Front or rear, pedestal mounted. 1955-64 C-cab No Stock

6484470 1957-58 Packard. **\$85.00 ea.**

..... **\$85.00 ea.**

TAIL LIGHT LENS

269907 Right, 1939 Commander & President. **\$48.00 ea.**

269908 Left, 1939 Commander & President. **\$48.00 ea.**

..... **\$48.00 ea.**

273537 1940 Commander & President. **\$48.00 ea.**

..... **\$48.00 ea.**

282172 Right. 1942-46 Champion. **\$38.00 ea.**

282173 Left. 1942-46 Champion. **\$20.00 ea.**

..... **\$20.00 ea.**

283170 1942 Commander & President **\$22.00 ea.**

..... **\$22.00 ea.**

285393 1947-49 Champion. **\$12.00 ea.**

285901 1947-49 Commander. **\$28.00 ea.**

..... **\$28.00 ea.**

289838 1950 Champion. **\$60.00 ea.**

289859 1950 Commander. **\$60.00 ea.**

293228 1951 car, all models. Used. **\$60.00 ea.**

..... **\$60.00 ea.**

296313 1952 car, all models. **\$60.00 ea.**

298960 1953 sedan **\$15.50 ea.**

299169 1953 C & K. **\$30.00 ea.**

300964 Truck: 1937-55. **\$22.00 ea.**

306715 1954 sedan & 1954-55 station wagon. **\$22.00 ea.**

..... **\$22.00 ea.**

306717 1954 C & K. Note: Some 1954 Coupes used '53 tail lights - call if you're uncertain if this pertains to you and we'll check your serial number. **\$48.00 ea.**

..... **\$48.00 ea.**

308958 1955 C & K. **\$39.95 ea.**

308960 1955 sedan **\$56.00 ea.**

1312387 1956 sedan. **\$60.00 ea.**

1312681 1956 wagon **\$25.00 ea.**

1312694 1956 Hawk **\$60.00 ea.**

1320362 1957 sedan **\$35.00 ea.**

1320915 1957-61 Hawk. **\$30.00 ea.**

1326507 1958 Champion. **\$30.00 ea.**

1326508 1958 Commander. **\$35.00 ea.**

1326529 1958 President. **\$50.00 ea.**

1331774 1959 Lark. **\$45.00 ea.**

Available again - 1336251

1960 Lark. **\$45.00 ea.**

1342630 1962 4-door wagon. **\$22.00 ea.**

..... **\$22.00 ea.**

1342662 1962 Lark **\$65.00 ea.**

1343540 1962-64 Hawk. **\$40.00 ea.**

NEW Listing - 1350256X1 Right center. 1983-88 Avanti. **\$32.00 ea.**

NEW Listing - 1350257X1 Left center. 1983-88 Avanti. **\$32.00 ea.**

1350294 Right 1963-91 Avanti. **\$58.00 ea.**

..... **\$58.00 ea.**

1350295 Left 1963-91 Avanti. .. **\$58.00 ea.**

1352436 Right. 1963-66 wagon. **\$20.00 ea.**

..... **\$20.00 ea.**

1352437 Left. 1963-66 wagon. **\$20.00 ea.**

1353620 1963 Lark, except station wagon. **\$65.00 ea.**

..... **\$65.00 ea.**

1356264 Right. 1964 Lark. **\$15.00 ea.**

1356265 Left. 1964 Lark. **\$15.00 ea.**

1361050 Right. 1965 Lark. **\$15.00 ea.**

1361051 Left. 1965 Lark. **\$15.00 ea.**

1361806 Right. 1966 Lark. **\$15.00 ea.**

1361807 Left. 1966 Lark. **\$15.00 ea.**

1656113 Truck: 1961-64 Champ with wide box. **\$40.00 ea.**

1686084 Truck: 1956-62 all except wide bed truck. **\$15.00 ea.**

6484470 1956-58 Packard. **\$45.00 ea.**

Bulbs



6-VOLT

- 110527** Parking light, without directional signals. 1934 Dictator, Commander, President. 1950-55 all models. License light. 1938-55 all models. **\$1.60 ea.**
- 185368** Parking light, without directional signals. 1935-46 all models. 1937-55 all models. 1947-49 Champion. Truck: M-series. Dashboard light. Clear. **\$1.75 ea.**
- 186547** Tail light. 1934-50 all models. Parking light, with directional signals. 1951-55 all models. Truck: M-series 2R-E, all models #1158. **\$3.90 ea.**
- 188659** 1934-55 Instrument turn signal and high beam dash indicator. **\$1.25 ea.**
- 281149** Dome light. 1947-55 all models. Truck: 2R-E. #88 **\$2.00 ea.**
- 282012** Backup, 1947-52 All. **\$3.50 ea.**
- 293764** Tail light. 1951-55 all models #1154. **\$2.85 ea.**
- 523439** Accessory spotlight, back-up. All models, without sealed beam. 1953-55. **\$9.90 ea.**

12-VOLT

- 1557882** Dashboard light, red. #57, large. All models with red bulb & 1963-85 Avanti. **\$1.05 ea.**
- 1557883** Dashboard light, red. #53, small. All models with red bulb & 1963-85 Avanti. **\$1.05 ea.**
- 1358200** Front amber parking bulb for Avanti with clear lens equipment. **\$2.00 ea.**
- G127934** Dashboard light, clear. #57 **\$1.05 ea.**
- G142450** License light. 1956-66 car & 1963-85 Avanti. **\$2.00 ea.**
- G142456** Back-up light. 1956-66 car & 1963-85 Avanti. **\$2.00 ea.**
- G454645** Tail light. 1956-66 car & 1963-85 Avanti. Parking light. 1956-66 car & 1963-85 Avanti **\$1.50 ea.**
- NEW Listing - G454646** Backup. 1956 - 1957 car all except 1957 C & K. Also used on 1958 Scotsman. **\$2.00 ea.**
- G455136** Dome light. 1956-66 car & 1963-85 Avanti. **\$2.00 ea.**
- G131282** Dashboard light, clear. #53 **\$1.25 ea.**

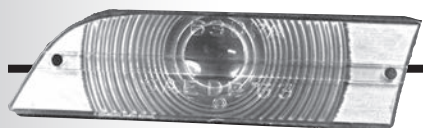

FRONT PARKING LIGHT LENS

- 272610** 1939 with sealed beam head lights & 1940 all. **\$25.00 ea.**
- 281618** 1941 Commander & President fender light. **\$45.00 ea.**
- 285197** 1947-49 Champion. Truck: 1949-53 2R. **\$22.00 ea.**
- 285914** 1947-49 Commander. . **\$22.00 ea.**
- 289739** 1950 Commander. **\$30.00 ea.**
- 295930** Early 1952 car, all models. **\$20.00 ea.**
- 296175** Late 1952 Champion & Commander. **\$20.00 ea.**
- 297572** Right. 1953-54 car, all models. **\$48.00 ea.**
- 297573** Left. 1953-54 car, all models. NOS. **\$48.00 ea.**
- 308098** Right. 1955 car, all models. **\$35.00 ea.**
- 308099** Left. 1955 car, all models. **\$35.00 ea.**
- 1312666** 1956 sedan. **\$18.00 ea.**
- 1312867** 1956-58 Hawk. **\$15.00 ea.**
- 1323138** 1957 Packard. **\$48.50 ea.**
- 1327968** 1958 Packard, all except Hawk. **\$24.00 ea.**
- 1332328** Right. 1959 Lark. **\$12.00 ea.**
- 1332329** Left. 1959 Lark. **\$12.00 ea.**
- 1336222** Right. 1960 Lark. **\$12.00 ea.**
- 1336223** Left. 1960 Lark. **\$12.00 ea.**
- 1338684** Right. 1961-62 Lark. **\$20.00 ea.**
- 1338685** Left. 1961-62 Lark. **\$45.00 ea.**
- 1338692** 1961 Lark with single headlights. **\$15.00 ea.**
- 1350106** Outer without chrome ring. 1963 Avanti. **\$36.00 ea.**

- 1350106X1** Outer with chrome ring. 1963 Avanti. **\$46.00 ea.**
- 1350108** Amber inner P/L 1963 Avanti. **\$30.00 ea.**
- 1353388** Right. 1963 Lark. **\$20.00 ea.**
- 1353389** Left. 1963 Lark. **\$20.00 ea.**
- 1353542** Amber. Early 1963 Hawk. **\$18.00 ea.**
- 1356226** Right, clear. 1964-66 Lark. **\$40.00 ea.**
- 1356227** Left, clear. 1964-66 Lark. **\$40.00 ea.**
- 1356762** Clear. Late 1963-64 Hawk. **\$25.00 ea.**
- 1358722** Clear. 1964 Avanti. ... **\$40.00 ea.**
- 1360694** Right, amber. 1964-66 Lark. **\$40.00 ea.**
- 1360695** Left, amber. 1964-66 Lark. **\$40.00 ea.**
- 1360697** Amber. 1964-83 Avanti. **\$35.00 ea.**
- 1654081** Truck: 1956 2-E. **\$42.00 ea.**
- 1655024** Truck: 1958-64 Transtar. **\$40.00 ea.**
- 1656356** Right, amber. Truck: 1960-64 Champ. **\$15.00 ea.**
- 1656357** Left, amber. Truck: 1960-64 Champ. Pictured. **\$15.00 ea.**
- 1657751** Zip van. **\$15.00 ea.**

REFLECTOR

-  **289886** 1951-52 tail light bezel. **\$3.95 ea.**
- 1320364** Jewel tail light reflector 1957 sedan. **\$5.00 ea.**

FRONT FENDER SPEAR ASSEMBLY PARTS FOR 1962-64 HAWK



- 1355125W** Hawk front moulding. 1962-64 Hawk, top of front fender retainer for plastic spear. Chrome. **\$40.00 ea.**
- 1353851** Seal, spear to moulding **\$2.00 ea.**
- 1343590** Front fender plastic spear insert 1962 Hawk. ... **\$20.00 ea.**
- 1353324** Front fender plastic spear insert. 1963-64 Hawk. **\$20.00 ea.**
- 1353741** 1963-64 Hawk socket cable and bulb. **\$18.00 ea.**
- 1353850** Seal. 1962-64 Hawk. Moulding to body. **\$3.00 ea.**



- 1353655** Lower metal cover. 1963-64 Hawk. ... **\$16.50 ea.**
- 1353661** Seal, under fender light assembly. **\$3.00 ea.**

FRONT SPEAR ASSEMBLY KIT

- Kit for 1963-64 Hawk. Includes:
- 2 1355125W Chrome spear
 - 2 1353850..... Moulding to body seal
 - 2 1353851 Lens seal
 - 2 1353324 Plastic spear
 - 2 1353741 Socket cable and bulb
 - 2 1353655..... Lower cover
 - 2 1353661..... Housing seal
- Total if parts were purchased separately. **\$205.00**
- 801857**
Special Kit Price \$184.50 pr.

Lens Gaskets & Housing Seals

PARKING LENS GASKETS & SEALS

- 274472** Parking light lens gasket. 1942-48 M-series truck. **\$2.00 ea.**
285181 Parking light lens gasket. 1947-49 Champion. Truck: 2R. **\$2.00 ea.**
289731 Parking light lens gasket. 1950 Champion & 1951 Champion & Commander. **\$7.50 ea.**
297774 Parking light lens gasket. 1953-54 car, all models. **\$2.00 ea.**
309349 Parking light lens gasket. 1955 car, all models. **\$2.00 ea.**
NEW Listing - 1312797 Parking light lens gasket. 1956 sedan. **\$2.00 ea.**
1312868 Parking light lens gasket. 1956-58 Hawk. **\$1.50 ea.**
1320089 Parking light lens gasket. 1957-58 sedan. **\$1.50 ea.**
1323137 Parking light lens gasket. 1957 Packard. **\$2.00 ea.**
1331554 Parking light lens gasket. 1959-60 Lark. Truck 1960-64 Champ. **\$2.00 ea.**
1332602 Parking light lens gasket. 1959-61 Hawk. **\$2.00 ea.**
1338686 Parking light lens gasket. 1961-63 Lark and 1962 Hawk. **\$2.00 ea.**
1338693 Parking light lens gasket. 1961 Lark with single head lights. **\$2.00 ea.**
1350107 Parking light lens gasket. 1963 Avanti. **\$2.00 ea.**
1353544 Parking light lens gasket. Early 1963 Hawk. **\$2.00 ea.**
NEW Listing - 1353545 Parking light bezel seal. Early 1963 Hawk. **\$3.00 ea.**
1355021 Parking light lens gasket. Late 1963-64 Hawk. **\$2.00 ea.**
1356228 Parking light lens gasket. 1964-66 Lark. **\$2.00 ea.**
1358715 Parking light housing to body seal. 1964-83 Avanti. **\$2.50 ea.**
1358716 Parking light lens gasket. 1964-83 Avanti. **\$2.00 ea.**

LENS SCREW KITS

- 800287** 1963-85 Avanti. Chrome screws for headlight ring, parking light & back-up light. **\$5.00 set**
800288 1962-64 Hawk. Includes parking, tail and back up. 12 chrome plated screws. **\$5.00 set**
801349 1953 car. Parking light & tail light. **\$3.50 set**
801350 1954 car. Parking light & tail light. **\$3.50 set**
801351 1955 car. Parking light & tail light. **\$3.50 set**



TAIL LIGHT LENS & BODY GASKETS & SEALS

- 3096X2** Tail light housing to body gasket. 1959-60 Lark. **\$3.50 ea.**
3096X5 Tail light housing to body gasket. 1962 wagon. **\$3.00 ea.**
3096X7 Tail light housing to body gasket. 1962-64 Hawk. **\$8.00 set/4**
271284 Tail light lens seal. 1939-40 Champion. **\$5.00 ea.**
287022 Tail light to fender seal. 1947-49 Champion. **\$4.50 ea.**
287068 Tail light to fender seal. 1947-49 Commander. **\$4.50 ea.**
289885 Tail light to fender. 1950 car. all models. **\$4.00 ea.**
293338 Tail light lens seal. 1951 **\$10.50 ea.**
299170 Tail light. lens seal. 1953 C & K. **\$2.00 ea.**
306055 Tail light lens seal. 1954 C & K. Note: Some 1954 Coupes used 53 tail lights - call if you're uncertain if this pertains to you and we'll check your serial number. **\$2.00 ea.**
308957 Tail light lens seal. 1955-56 C & K. **\$2.00 ea.**
NEW Listing - 802234 Tail light lens seal. 1950 and 1952 Champion & Commander. **\$4.50 ea.**
NEW Listing - 1312391 Tail light lens seal. 1956 sedan. **\$2.00 ea.**
1320361 Tail light body to housing gasket. 1957 sedan. **\$9.50 ea.**
1320916 Tail light lens seal. 1957-61 Hawk. **\$2.00 ea.**
1326518 Tail light lens. 1958 sedan. **\$2.00 ea.**
1331426 Round tail light cable seal to body. 1959-60 Lark. **\$2.00 ea.**
1331429 Tail light lens. 1959-60 Lark. **\$2.00 ea.**
1338883 Tail light housing and lens to body. 1961 Lark. **\$4.00 ea.**
1342665 Tail light lens seal, 1962-63 Lark. **\$3.00 ea.**
1343064 Tail light lens seal. 1962 4-door station wagon. **\$2.00 ea.**
NEW Listing - 1343065 Seal, tail light cable to body. 1962 wagon. **\$2.00 ea.**
1343456 Tail light housing to body gasket. 1962-63 Lark. **\$3.50 ea.**
1343543 Tail light lens seal. 1962-64 Hawk. **\$2.00 ea.**
1350296 Tail light lens seal. 1963-88 Avanti. **\$2.00 ea.**
1350768 Tail light housing seal. Avanti. **\$4.50 ea.**
1352438 Tail light lens seal. 1963-66 station wagon. **\$2.00 ea.**
1355041 Tail light housing gasket. 1963-66 station wagon. **\$4.50 ea.**
1356262 Tail light lens seal. 1964-65 Lark. **\$5.50 ea.**
1356263 Tail light housing gasket. 1964-65 Lark. **\$4.00 ea.**
NEW Listing - 1361804 Tail light housing gasket. 1966 Lark. **\$4.00 ea.**



HEADLIGHT BODY GASKETS & SEALS

- 3305X3** Headlight rim to body. 1964 Hawk. **\$3.00 ea.**
272617 Headlight to rim. 1939-41 car with sealed beam. Truck: early M-series. **\$12.00 ea.**
285196 Headlight to fender. 1947-49 Champion. Truck: 1949-54 **\$6.00 ea.**
285968 Headlight to fender. 1947-49 Commander 1953-66 car, with single Headlight equipment. Truck: 1960-64 Champ. **\$6.00 ea.**
289638 Headlight to fender. 1950 Champion. 1951 car, all models. **\$6.00 ea.**
289639 Headlight to fender. 1950 Commander. **\$6.00 ea.**
296275 Headlight to fender. 1952 car, all models. **\$6.00 ea.**
648761 Headlight to fender. 1941-46 car, all models. Truck: M-series. **\$12.50 ea.**

BACK-UP LENS & BODY GASKETS & SEALS

- 3096X4** Backup housing to body seal. 1959-61 Lark. 1962 Lark 2-dr. wagon. **\$2.00 ea.**
3096X6 Backup housing to body seal. 1962 Lark 4-dr. wagon **\$2.00 ea.**
3161X3 Backup housing to body & lens seal. 1962 Lark. **\$3.50 ea.**
3161X5 Backup housing to body & lens seal. 1966 all models & 1963-65 wagon. **\$3.50 ea.**
535071X2 Backup housing to body seal. 1953-55. **\$3.00 ea.**
NEW Listing - 1312390 Backup lens seal. 1956 sedan. **\$2.00 ea.**
1320775 Backup lens seal. 1957-61 Hawk, 1959-61 Lark. **\$2.00 ea.**
NEW Listing - 1326516 Backup lens seal. 1958 sedan. **\$2.00 ea.**
1342627 Backup light housing to body seal. 1962 Lark. **\$2.00 ea.**
1343542 Backup lens seal. 1962-64 Hawk. **\$2.00 ea.**
1350260 Backup lens seal. 1963-90 Avanti. **\$2.00 ea.**
1353170 Backup lens seal. 1963 Lark. **\$2.00 ea.**
1353275 Backup housing to body seal. 1963 Lark. **\$3.00 ea.**

LICENSE LENS SEALS

- 534195** License lens seal. 1953-54 car, all models. 1962-66 Lark. 1963-83 Avanti. **15¢ ea.**
1331677 1959-61 Lark. **\$3.00 ea.**

Lens Kits

1956 HAWK

- 308957** Tail light lens gasket (2).\$2.00
- 536458** License lens.\$15.00
- 1312694** Tail light lens (2).\$60.00
- 1312867** Parking light lens (2).\$15.00
- 1312868** Parking light lens gasket (2).
.....\$1.50

Total of all parts if purchased separately\$172.00

801617
Special package price....\$155.00 ea.

1962 HAWK

- 536458** License lens\$15.00
- 800288** Lens screw kit\$5.00
- 1338686** Parking light lens gasket (2).
.....\$2.00
- 1343540** Tail light lens (2).\$40.00
- 1343541** Back up lens (2).\$24.00
- 1343542** Back up lens gasket (2).\$2.00
- 1343543** Tail light lens gasket (2). ...\$2.00

Total of all parts if purchased separately \$160.00

801620
Special package price....\$145.00 ea.

1953 COUPE & HARDTOP

- 297572** Parking light lens, right.\$48.00
- 297573** Parking light lens, left.\$48.00
- 297774** Parking light lens gasket (2).
.....\$2.00
- 299169** Tail light lens (2).\$30.00
- 299170** Tail light lens gasket (2).\$2.00
- 801349** Lens screw kit.\$3.50
- 1559770** License light assembly, (2).
.....\$15.00

Total of all parts if purchased separately..\$197.50

801614
Special package price\$180.00 ea.

1957-58 HAWK

- 536458** License lens.\$15.00
- 1312867** Parking light lens (2).\$15.00
- 1312868** Parking light lens gasket (2).
.....\$1.50
- 1320775** Back up lens gasket (2). ...\$2.00
- 1320915** Tail light lens (2).\$30.00
- 1320916** Tail light lens gasket (2). ...\$2.00
- 1320924** Back up lens (2).\$30.00

Total of all parts if purchased separately \$176.00

801618
Special package price....\$167.00 ea.

EARLY 1963 HAWK

- 536458** License lens.\$15.00
- 800288** Lens screw kit.\$5.00
- 1343540** Tail light lens (2).\$40.00
- 1343541** Back up lens (2).\$24.00
- 1343542** Back up lens gasket (2).\$2.00
- 1343543** Tail light lens gasket (2). ...\$2.00
- 1353542** Parking light lens (2).\$18.00
- 1353544** Parking light lens gasket (2).
.....\$2.00

Total of all parts if purchased separately..\$196.00

801621
Special package price\$174.00 ea.

1954 COUPE & HARDTOP

- 297572** Parking light lens, right.....\$48.00
- 297573** Parking light lens, left.....\$48.00
- 297774** Parking light lens gasket (2)\$2.00
- 306055** Tail light lens gasket (2)\$2.00
- 306717** Tail light lens (2)\$48.00
- 801350** Lens screw kit\$3.50
- 1559770** License light assembly (2).
.....\$15.00

Total of all parts if purchased separately \$233.50

801615
Special package price....\$212.00 ea.

Note: Some 1954 Coupes used 1953 tail lights - call if you're uncertain if this pertains to you and we'll check your serial number. Plus, we'll adjust this price if it does.

LATE 1963 HAWK

- 536458** License lens\$15.00
- 800288** Lens screw kit\$5.00
- 1343540** Tail light lens (2)\$40.00
- 1343541** Back up lens (2).....\$24.00
- 1343542** Back up lens gasket (2)\$2.00
- 1343543** Tail light lens gasket (2)\$2.00
- 1356762** Parking light lens, clear (2).
.....\$25.00
- 1355021** Parking light lens gasket (2). ...\$2.00 ea.

Total of all parts if purchased separately..\$210.00

801622
Special package price\$190.00 ea.

1959-61 HAWK

- 536458** License lens\$15.00
- 1332601** Parking light lens (2).....**NLA**
- 1332602** Parking light lens gasket (2)\$2.00
- 1320775** Back up lens gasket (2)\$2.00
- 1320915** Tail light lens (2)\$30.00
- 1320916** Tail light lens gasket (2)\$2.00
- 1320924** Back up lens (2).....\$30.00

Total of all parts if purchased separately...\$147.00

801619
Special package price\$135.00 ea.

1955 COUPE & HARDTOP

- 308098** Parking light lens, right.....\$35.00
- 308099** Parking light lens, left.....\$35.00
- 308957** Tail light lens gasket (2)\$2.00
- 308958** Tail light lens (2)\$39.95
- 309349** Parking light lens gasket (2)\$2.00
- 536458** License lens\$15.00
- 801351** Lens screw kit\$3.50

Total of all parts if purchased separately.\$176.40

801616
Special package price ...\$162.00 ea.

1964 HAWK

- 536458** License lens.\$15.00
- 800288** Lens screw kit.\$5.00
- 1343540** Tail light lens (2).\$40.00
- 1343541** Back up lens (2).\$24.00
- 1343542** Back up lens gasket (2). ...\$2.00
- 1343543** Tail light lens gasket (2). ...\$2.00
- 1356762** Parking light lens (2).\$25.00
- 1355021** Parking light lens gasket (2).
.....\$2.00 ea.

Total of all parts if purchased separately..\$210.00

801623
Special package price\$190.00 ea.



Ignition

COILS for 6-cylinder Engines



- 519977** 1942 with IGC distributor. 1946-55 car. Truck: M5, M15, M15A, M17 & 2R-E- 5, 10, 11, 15, 16, 17 **\$46.50 ea.***
533064 1933-42 car, except 1942 with IGC distributor. Not used with original ignition switch & setup. **\$46.50 ea.**
1549377 1956-61 car. Truck: 2E-6E 1, 5, 10. **\$43.65 ea.**
1553539 1961-64 except 1961 Lark with IGNO42 distributor. Truck: 2E 6, 11, 14 & 4E 1, 5 & 3E-4E 3, 6, 11, 14, 16, 17 & 6E 5, 10. NOS. **\$30.90 ea.**
1553636 1965-66 car without trans ignition. New production. **\$30.90 ea.**
 *Note: not for vehicles with old style ignition switch and cable.

COILS for 8-Cylinder Engines

- 533064** 1951-55 car. Truck: 3R-E 7, 12, 13, 28, 40. **\$46.50 ea.**
1553539 1962-64 car & 1963-64 Avanti. 1956 Golden Hawk. Truck: 7E-8E 7, 12, 13, 28, 40. NOS. **\$30.90 ea.**
1553636 1956-61 car except 1956 Golden Hawk. 1965-66 car. Truck: 2E-5E 2, 7, 12, 13, 28, 38, 40 & 6E 7, 12, 13, 28, 40. New production. **\$30.90 ea.**
1565264 1964-66 car, with Trans Igniter ignition. **\$25.50 ea.**



COIL RESISTORS & RELATED PARTS

NEW Listing - 439553

- Resistor, primary coil, 1956-57 V-8 all except Packard. **\$35.00 ea.**
NEW Listing - 1540269 Cable, coil to primary resistor, 1963-64 Lark & Hawk with R-1 or R-2 engines also 1963-64 Avanti. .. **\$15.50 ea.**
NEW Listing - 1550327 Resistor wire, ignition to coil. 1960 Lark and Hawk. **\$15.50 ea.**
1550556 Resistor, R-2 Avanti after serial #5280. Also 1961 6-cylinder Lark & 1961-62 6-cylinder truck. NOS. **\$10.50 ea.**
NEW Listing - 1558482 Resistor. 1963-64 R-2 Lark and Hawk before engine #V-6760. 1963-64 Avanti before serial number 5280. **\$35.00 ea.**
NEW Listing - 1559977 Cable, ignition switch to coil primary resistor. 1963 Lark and Hawk with R-1 or R-2. **\$15.50 ea.**
NEW Listing - 1561493 Cable, ignition switch to coil primary resistor. 1964 Lark and Hawk with R-1 or R-2. **\$15.50 ea.**
6484685 Resistor used with coil 1553636. **\$19.50 ea.**

IGNITION SHIELDING 1963-64 Avanti

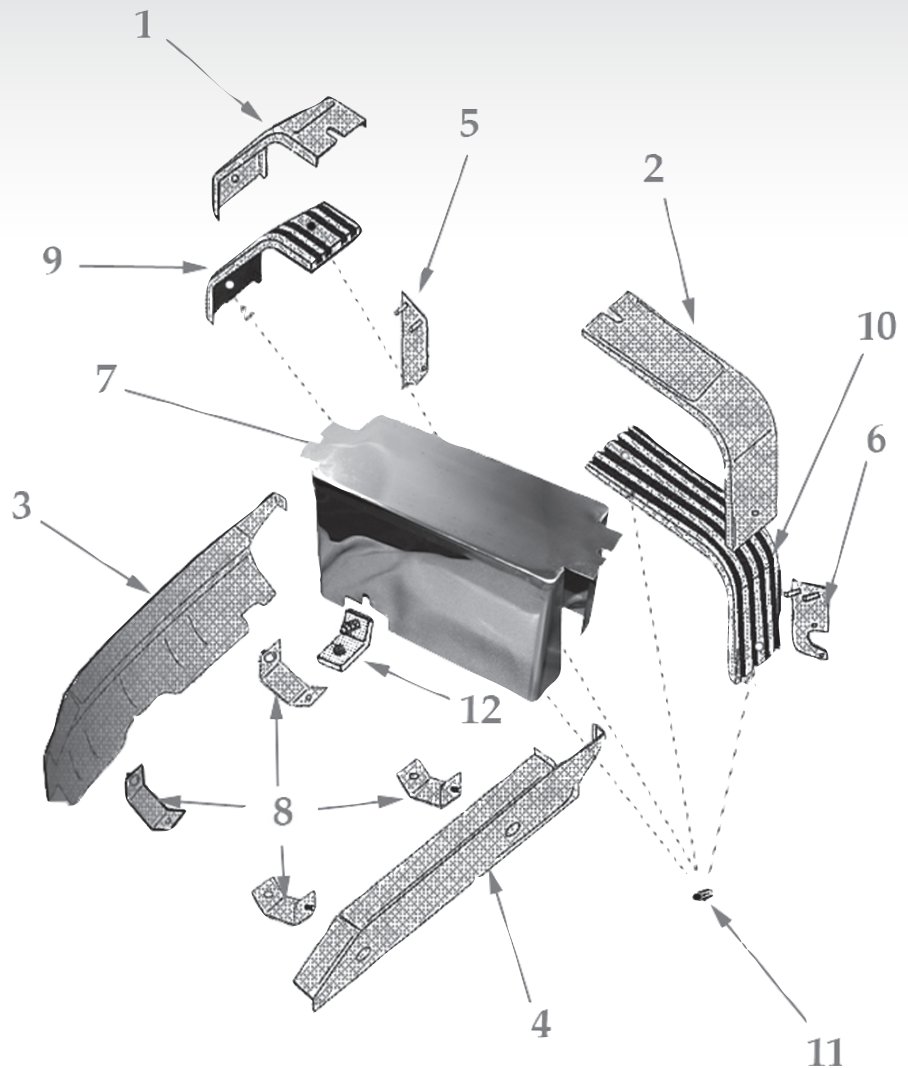

All stainless ignition shielding except for the center distributor cover are NOS. Many years of shelf wear have left some pieces in less than show worthy condition. You can polish the stainless to return its bright and scratch free appearance.

- | | |
|---|---|
| (1) 1557227 Right, plug wire cover. \$30.00 ea. | (7) 1556936 Distributor cover. \$119. 95 ea. |
| (2) 1557226 Left, plug wire cover. \$30.00 ea. | (8) 1556947 Plug cover bracket. \$18.00 ea. |
| (3) 1556944 Right, spark plug cover. \$30.00 ea. | (9) 1557569 Right, plug wire insulator. No Stock |
| (4) 1556941 Left, spark plug cover. \$35.00 ea. | (10) 1557568 Left, plug wire insulator. No Stock |
| (5) 1557723 Right, bracket to head. \$22.50 ea. | (11) 1557658 Spacer. Takes 4. \$1.50 ea. |
| (6) 1557730 Left, bracket to head. \$22.50 ea. | (12) 1557660 Bracket for distributor cover. \$8.50 ea. |

Chrome MOUNTING NUT



- 519987** 1947-50 Champion. Chrome mounting nut for ignition switch. **\$20.00 ea.**

IGNITION SHIELDING ACORN NUTS



- 1-102** Ignition shielding acorn nuts. 1963-64 Avanti. 8 nuts, 8 washers. **\$10.50 set**

IGNITION SWITCH ASSEMBLY

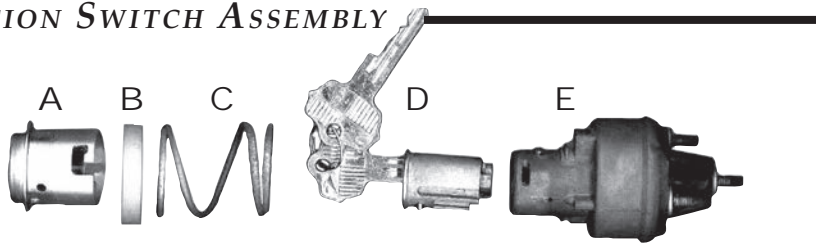

- A) 532501W** Bezel. 1953-54 car, all models NOS.\$18.50 ea.
***A) 1544684W** Bezel, does not have "start" imprinted.*1955-59 car, all models. Truck: 1955-59.\$22.50 ea.*
***A) 1549685W** Bezel, used with 1549705 switch. 1960-66 car, all models & 1963-70 Avanti. Truck: 1960-64, all models.\$22.50 ea.*
B) 1544987 Ignition lock spacer. 1956-64, all models & 1963-70 Avanti.\$12.00 ea.
C) 532502 Spring. 1953-54 car, all models.\$5.50 ea.
C) 536125 Spring, ignition switch tension. 1958 Scotsman.\$5.00 ea.
C) 1546371 Spring, ignition switch tension. 1955-64 car, all models & 1963-70 Avanti.\$5.50 ea.
D) 1555547 Ignition lock & keys. 1947-66 car, all models with Yale switch & 1963-70 Avanti. Truck: 1955-64, all models. This lock fits inside 1549705 switch. Includes 2 keys. . \$22.50 ea.
E) 1549705 Ignition switch with 1555547 lock. 1955-66 car & truck. Lock comes with 2 1960-63 style keys. Lock is removable and can be replaced with your original lock and keys or can be re-keyed (by your locksmith) to match your doors. Switch is identical to original and accommodates twist-on style bezel.\$75.00 ea.
 *NOTE: This reproduction bezel is made of aluminum and is much stronger than the original. This is an important safety item as the original bezels frequently broke, allowing the switch to become loose and short circuit. Replace your bezel before this happens!

REPLACEMENT IGNITION SWITCH

800840 1955-66 car, all models & 1963-70 Avanti. Truck: 1955-64 all models. Includes switch, lock, bezel & 2 keys. Your old keys will not work with this lock. Use your old spring (1546371). Looks just like original when installed.\$62.00 ea.

SWITCHES WITHOUT CYLINDER & KEYS (Switch only)

- 521050** 1951-52 Commander & 2R series truck. Switch only. Hurd lock\$50.00 ea.
526396 1950 Commander & Land Cruiser with standard trans. Ignition switch only. Hurd lock.\$50.00 ea.

NOTE: We have a limited quantity of additional ignition switches, please inquire. (317) 462-3124

IGNITION KEYS



525810 1947-59 models with Yale lock. Same key should operate both ignition & doors.\$6.00 pr.



525931 1947-60 models with Hurd lock. Same key should operate both ignition & doors.\$6.00 pr.

NOTE: This key is easily identified because the shaft is quite short.



1555550 1960-63 all models including Avanti. Same key should operate both ignition & doors.\$6.00 pr.



1561741 1964-66 all models & 1964-70 Avanti. Same key should operate both ignition and doors.\$6.00 pr.



801542 Deluxe ignition & door key blank for all 1947-63 models with Yale locks. Beautiful gold finish with crest logo.\$6.95 ea.



801543 Deluxe ignition & door key. All 1947-60 models with Hurd locks. Hurd keys have a very small shaft. Beautiful gold finish with crest logo.\$6.95 ea.

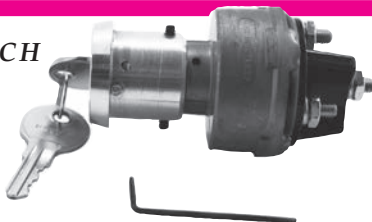

IGNITION SWITCH TUMBLER WITH KEYS

- NEW Listing - 196900** Yale ignition switch tumbler with keys. 1939-46 Champion and some M-series truck.\$45.00 ea.
NEW Listing - 520460 Hurd switch tumbler with keys for some M-series trucks.\$45.00 ea.

Trunk keys can be found on page 155.
 Glove box keys can be found on page 63.

IGNITION CABLE SETS COPPER CORE WIRE

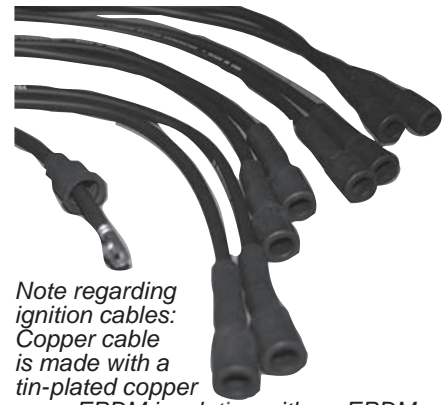

Note regarding ignition cables:
 Copper cable is made with a tin-plated copper core, EPDM insulation with an EPDM jacket. This is very similar to what was in the car when new.
 Silicone cable is made with a CHT core (Aramid fiber with a conductive latex covering with a conductive silicone cover), EDPM insulation, with a silicone jacket. Silicone cable will not be as easily damaged by exhaust manifold or engine heat and also reduces radio static.

- 531123** 1951-54 V-8 car, all models\$57.00 set
681445 1955-58 V-8 car, all models except 1956 Golden Hawk. Truck: 1955-58 V-8.\$57.00 set
1547452 1939-60 Champion. Truck: M5, M15, M15A & 2R-5E 5, 10, 15\$44.00 set
1555534 1961-64 Lark 6-cylinder. Truck: 6E-8E 5, 10\$44.00 set
1557780 1963-64 Avanti\$62.00 set
1559516 1959-64 V-8 car, all models. Truck: 4E-8E 2, 7, 12,13, 28, 38, 40\$57.00 set
1687137 1934-50 Commander. Truck*: 2E-3E 6, 11, 14, 16, 17\$44.00 set
 *Note: Except coil wire on pre-war car.

SILICONE WIRE black Packard cable
800854 1939-60 Champion. Truck: M5, M15, M15A & 2R-5E 5, 10, 15.\$56.00 set
800855 1961-64 Lark 6-cylinder. Truck: 6E-8E, 5, 10.\$57.00 ea.
800856 1951-54 V-8 car, all models.\$72.00 ea.
800857 1955-58 V-8 car, all models except 1956 Golden Hawk Truck: 1955-58 V-8.\$72.00 ea.

- 800858** 1959-64 V-8 car, all models. Truck: 4E-8E 2, 7, 12,13, 28, 38, 40.\$71.00 ea.
800867 1963-64 Avanti.\$79.50 ea.
800954 1947-50 Commander. Truck: 2E-3E 6, 11, 14, 16,17. May work on earlier vehicles except for distributor to coil wire. . \$54.00 ea.

IGNITION CABLE CLIP

- NEW Listing 1549752** 1959-64 V-8.\$4.50 ea.



IGNITION CABLE BRACKET

- 1539892** 1956-64 V-8, all models.\$20.00 ea.
NEW Listing - 1564741 Rear upper left. 1965-66 V-8.\$12.00 ea.



Distributor

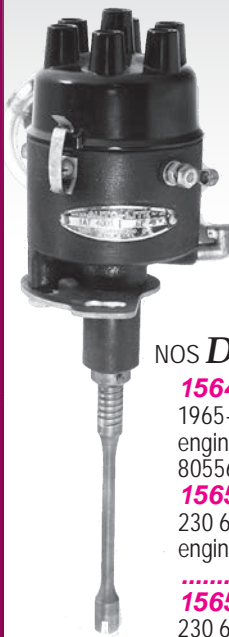



REBUILT
802189 Most models available. Must have rebuildable old Distributor first. Call (317) 462-3124 for availability and price.

NOS DISTRIBUTORS

1564269 Distributor. 1965-66 V-8. Used before engine numbers 20556913 & 805566913. ... **\$230.00 ea.**
1565703 Distributor. 1966 230 6-cylinder. Used before engine number 715214668. **\$195.00 ea.**
1565731 Distributor. 1966 230 6-cylinder. Used after engine number 715214668. **\$195.00 ea.**
1565732 Distributor. 1966 V-8. Used after engine numbers 20556913 & 805566913. **\$230.00 ea.**

DISTRIBUTOR SEALS (to Block)

 **510131** Distributor seal. 1934-64 6-cylinder. **\$1.25 ea.**
527214 Distributor seal. 1951-52 V-8. **\$1.00 ea.** 
 **533010** Distributor seal. 1953-64 V-8 & 1963-64 Avanti. ... **\$1.00 ea.**
NEW Listing - 1564114 Distributor. 1965-66 6-cylinder. **.50¢ ea.**
NEW Listing - 1564271 Distributor. 1965-66 V-8. **.50¢ ea.**

CAPS FOR 6 CYLINDER ENGINES

125917 With Delco distributor. 1950 Commander & 1959 Lark. Truck: 2R-2E, 6, 11, 14, 16, 17 & 4E 1, 5 & 3E-5E 3, 6, 11, 14, 16, 17, 28 & 29 Dictator & Commander 6-cylinder (see note T-4). **\$16.00 ea.**
173254 1929-34 Studebaker & Dictator 6 with Delco Remy distributor. **\$30.00 ea.**
182271 With Autolite IGW distributor. 1934-41 Dictator, Commander, Coupe Express. 1939-41 Champion. Truck: M5, 15, 15A, 16, 17. (see note T-5). **\$35.20 ea.**
527340 With Autolite IAT distributor. Late 1950 Champion. Truck: 2R 5, 10, 15. (see note 2 & T-2). **\$35.00 ea.**
530225 With Autolite distributor 1951-64 Champion & Lark. Truck: 2R-2E 5, 10, 15 & 3E-8E 1, 5, 10. (see note T-1). ... **\$15.00 ea.**
667658 With Autolite IGC distributor 1942-49 Commander. 1942-early 1950 Champion. Truck: M5, 15A 16, 17 & 2R 5, 10, 15, 16, 17. (see note 1 & T-3). **\$26.00 ea.**
1565154 1965-66 Lark with Delco distributor **\$13.50 ea.**

CAPS FOR 8-CYLINDER ENGINES

458563 1956 Golden Hawk. Autolite distributor **\$28.90 ea.**
530937 1951-59 car, all models. 1960-61 Hawk. Truck: 3R-2E, 7, 12, 13, 28, 38 & 3E-5E 2, 7, 12, 13, 28, 38, 40. With Delco distributor (see note T-7) **\$21.00 ea.**
1550272 1960-61 Lark & 1965-66 Lark. Truck: 4E-6E 2, 7, 12, 13, 28, 40. With Delco window type distributor (see note T-6) **\$14.50 ea.**
1555503 1962-64 car, all models & 1963-64 Avanti. Truck: 7E-8E 7, 12, 13, 28, 40. With Prestolite distributor. **\$25.00 ea.**



NOTE 1: Type with spark modifier mounted under base. Used on model 1950 Champion before engine #531,285.

NOTE 2: Type with spark modifier mounted on side of base. Used on & after engine numbers in note 1.

NOTE T-1: Type with spark modifier mounted in side of base. Used on & after 2R5-2R10: 1R-94,733; 2R15; 2R-12,058.

NOTE T-2: Type with spark modifier mounted on side of base. Used on engine numbers 2R5-2R10: 1R-51,666 to 1R-84,733; 2R15; 2R- 0,371 to 2R-12,058.

NOTE T-3: Type with spark modified mounted under base. Used before engine number 2R5-2R10: 1R-51,666; 2R15: 2R-10,371. Used on M5-M17 on and after engine numbers in T-5.

NOTE T-4: Delco Remy equipment. Used on and after engine 2R16A-2R17A: R-20,907.

NOTE T-5: Used before engine number M5: 1M-8, 566; M5-M15A: 2M-7,795; M16-M17: 3M-13,488.

NOTE T-6: Used on and after trucks listed in note T-7.

NOTE T-7: Used before truck serial 4E2: E2-674; 4E7: E7-12,136; 4E12-4,167; 4E13-3,093.

TUNE-UP KITS

Kit Includes

- Ignition cable set (Black silicone Packard cable)
- Distributor cap
- Points
- Rotor
- Condenser
- Spark plugs

1951-64 CHAMPION

6-cylinder with Autolite Distributor

Total of all parts if purchased separately \$122.00 ea
801030R Special Package Price **\$115.00/kit**

1951-59 V-8

all models except 1956 Golden Hawk

& 1960-61 HAWK

Delco

Total of all parts if purchased separately \$170.10 ea.
801031R Special Package Price **\$161.50/kit**

1960-61 LARK V-8

all models with Delco window type

Total of all parts if purchased separately \$153.00 ea
801032R Special Package Price **\$145.00/kit**

1962-64 V-8

all models, except Avanti. Prestolite

Total of all parts if purchased separately \$153.90 ea.
801033R Special Package Price **\$146.00/kit**

1963-64 AVANTI

R-1 or R-2. Prestolite

Total of all parts if purchased separately \$165.90 ea.
801034R Special Package Price **\$157.50/kit**

1965-66 6-cylinder

Kit Includes: points, rotor & condenser only.
1565290 **\$14.95/kit**

Note: When ordering specify year and model of car, No substitutions or deletions.

Tune-Up with Kits to Save Money!

Spark Plugs



FOR 6-CYLINDER ENGINES

AC-88 1933-40 car. Truck: M16. **\$3.60 ea.**
419918 1941-60 car. Truck: 1948-60. **\$3.60 ea.**
1550554 1961-64 car. Truck: 1961-64. **\$3.60 ea.**

FOR 8 CYLINDER ENGINES

AC-88 1933-40 car, straight 8. ... **\$3.60 ea.**
439771 1956 Golden Hawk **\$3.60 ea.**
1550554 1951-64 car except 1956 Golden Hawk. Truck: 1955-64. **\$3.60 ea.**
1559195 1963-64, all models including Avanti with jet thrust engine. 1965-66 Lark. **\$3.60 ea.**

DISTRIBUTOR PARTS



516196 Distributor weights. 1947-64, all with Prestolite or Autolite distributor. Set of 2 with brass bushings. **\$46.00 pr.**

526893 Vacuum advance. 1950 Commander. Truck: Late 2R-6E 3, 6, 11, 14, 16, 17. **\$45.00 ea.**

NEW Listing - 527341 Vacuum advance. Late 1950-60 Champion 6-cylinder. **\$95.00 ea.**

527351 Cable, distributor contact arm, with modifier on side of base. Late 1950-54 Champion & 2R-2E 5 & 10 truck. .. **\$7.50 ea.**

527352 Cable, distributor contact arm, with modifier below base. Late 1950-54 Champion & 2R-2E 5 & 10 truck. **\$5.30 ea.**

531759 Spring set. Late 1951- all 1952 car and 1959-61 V-8. **\$12.00 pr. 801970**



Prestolite/ Autolite small parts kit. Includes bushings, roll pin, shims, washers, spacers, springs, etc. 1962-64 V-8 & 1959-64

6-cylinder. **\$22.50 ea.**

1549387 1960-64 6-cylinder. Cable to coil. **\$12.00 ea.**

1555504 1962-64 V-8. Cable to coil. **\$16.00 ea.**

1555505 Vacuum advance. 1962-64 V-8 with single point distributor. **\$125.00 ea.**

1564652 Vacuum advance. 1966 6-cylinder. **\$32.00 ea.**

1564653 Distributor vacuum advance. 1965-66 V-8. **\$45.00 ea.**

1565135 Distributor vacuum advance. 1965 6-cylinder. **\$32.00 ea.**

1558290 Distributor vacuum advance 1963-64 Lark, Hawk, and Avanti with R1- R2 engines Prestolite, Nors. **\$125.00 ea.**

6484249 Autolite distributor vacuum advance. 1956 Golden Hawk. NOS. **\$125.00 ea.**

Condensers

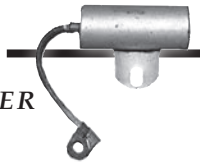

FOR 6-CYLINDER ENGINES

175967 1934-41 car. Truck: M5, M15, M15A, M16, M17. With Autolite IGW distributor (see note T-3). **\$14.80 ea.**

193804 1934 & 1936 Dictator and 1934-40 Straight 8's. With Delco distributor. **\$9.80 ea.**

661926 1950 Commander. 1959 Lark or 1965-66 Lark. Truck: 2R-5E all except 5, 10, 15. 1928-29 Dictator & Commander. With Delco distributor (see note T1). **\$10.10 ea.**

1555506 With Autolite distributor, 1942-64 car. Truck: M5, M15A, 16, 17 & 2R-8E. (see note T-2)..... **\$7.90 ea.**

FOR 8 CYLINDER ENGINES

513655 1941 President. **\$12.00 ea.**

516206 1942 President. **\$12.00 ea.**

661926 1951-59 car, all models; 1960-61 Hawk and 2R-5E truck with Delco distributor. **\$10.10 ea.**

513655 1941 President. **\$12.00 ea.**

516206 1942 President. **\$12.00 ea.**

661926 1951-59 car, all models; 1960-61 Hawk and 2R-5E truck with Delco distributor. **\$10.10 ea.**

CONDENSERS

For 8 Cylinder Engines (Continued)

1550279 1960-61 and 1965-66 Lark. Truck: 4E-6E 2, 7, 12, 13, 28, 40. With Delco window type distributor. **\$10.50 ea.**

1555506 1962-64 Lark or Hawk with single pointed distributor, 1956 Golden Hawk (458578). Truck: 7E 4 12, 13, 28, 40. With Prestolite distributor. **\$7.90 ea.**

1560358 1963-64 Avanti or Larks & Hawks with R-1 or R-2 engines. NOS **\$12.50 ea.**

NOTE T-1: Delco Remy Equipment.

Used on and after engine #: 2R16A-2R17A: 4R20,907.

NOTE T-2: Used on and after engine #:

M5: 1M-8,566 and M15-M15A: 2M-7,795 and M16-M17: 3M-13,488.

NOTE T-3: Used before engine

numbers in note T-2.

Points

FOR 6-CYLINDER ENGINES



194031 1934 & 1936 Dictator with Delco distributor **\$32.00 ea.**

194035 1934-35 Dictator with Autolite distributor. **\$16.00 ea.**

194036 With Autolite IGW distributor 1936-41 car and M5-M17 truck. (see note T-1). **\$16.00 ea.**

526985 With Delco distributor. 1950 Commander. 1959 Lark or Hawk. Truck: 4E 1, 5 & 2R-5E 3, 6, 11, 14, 16, 17. **\$17.50 ea.**

1548446 1959-64 car and 4E-6E 1, 5, 10 & 7E-8E 1, 5,10 truck with Autolite distributor. **\$12.50 ea.**

1550501 With Autolite distributor. 1942-59 car. Truck: M5, M15A-M17 & 2R-3E 5,10, 15, 16, 17 & 3E 1, 5, 10. (see note T-2) **\$10.50 ea.**

1564676 1965-66 car with Delco distributor. **\$10.50 ea.**

FOR 8 CYLINDER ENGINES

513653 1941-42 Presidents (dual points) **\$22.00 pr.**



1544167 With Delco distributor 1951-59 car, 1960-61 Hawk. Truck: 2R-4E 2, 7, 12, 13, 28, 38, 40. **\$17.50 ea.**

1548446 With Prestolite distributor 1962-64 car. Truck: 7E-8E 7, 12, 13, 28, 40 **\$12.50 ea.**

1550286 With Delco window type distributor 1960-61 Lark. 1965-66 Lark. **\$21.50 ea.**

1560473 With Prestolite dual point distributor, 1963-64 with Avanti jet thrust R1 or R-2 engine; 1956 Golden Hawk. **\$16.50 pr.**

NOTE T-1: Used before engine

numbers: M5 1M-8,566. M15-M15A: 2M-7,795. M16-M17: 3M-13,488.

NOTE T-2: Used on and after engine

numbers in note T-1.

Rotors



FOR 6 CYLINDER ENGINES

131569 1929-36 car with Delco distributor. **\$25.50 ea.**

189113 1934-41 car. Truck: M5, 15, 15A, 16, 17. With Autolite IGW distributor (see note T-4). **\$15.50 ea.**

527328 Late 1950 Champion. With Autolite IAT distributor. Truck: 2R 5, 10, 15 (see note 1 & T-2). **\$12.00 ea.**

530226 1951-64 Champion and Lark. Truck: 2R-2E 5, 10, 15 & 3E-6E 1, 5, 10, & 4E-5E 1, 5 & 7E-8E 5, 10. With Autolite distributor (see note T-1). **\$8.00 ea.**

635267 1950 Commander, 1959 Lark or Hawk. Truck: 2R-5E 3, 6, 11, 14, 16, 17 & 4E 1, 5. With Delco distributor. **\$8.00 ea.**

905826 1942-49 Commander. 1942-early 50 Champion. Truck: Late M5, 15A, 16, 17, & 2R 5, 10, 15, 16, 17 (see note 2 & T-3). With Autolite IGC Distributor. **\$11.00 ea.**

1565138 1965-66 Lark. With Delco distributor **\$3.75 ea.**

FOR 8 CYLINDER ENGINES

371245 1956 Golden Hawk with Autolite distributor. **\$12.50 ea.**

533942 1951-59 car, all models & 1960-61 Hawk. Truck: 3R-3E & 4E 2, 7, 12, 13, 28, 38, 40. With Delco distributor. (see note T-6) **\$21.50 ea.**

1555502 1962-64 V-8 car, all models & 1963-64 Avanti. Truck: 7E-8E 7, 12, 13, 28, 40. With Prestolite distributor. **\$9.00 ea.**

1564662 1960-61 Lark & 1965-66 Lark. Truck: 4E-6E 2, 7, 12, 13, 28, 40. With Delco window type distributor (see T-5). .. **\$7.50 ea.**

NOTE 1: Used on 1950 Champion with Autolite IAT distributor (spark modifier on side of base) on & after engine #531, 285.

NOTE 2: Used on 1950 Champion with Autolite IGC distributor (spark modifier under base) before engine #531,285.

NOTE T-1: Type with spark modifier mounted on side of base.

Used on trucks after engine #2R5-2R10: 1R-94,732, 2R15: 2R-10,371.

NOTE T-2: Use with Autolite distributor with spark modified mounted on side of base. Engine # 2R5-2R10:

1R-51,666 to 1R-94,732, 2R15: 2R10,371 to 2R-10,371 to 2R-12058.

NOTE T-3: For M5, M15, M15A, M16, M17. Used on and after engine numbers:

M5: 1M-8566; M15-M15A: 2M-7795; M16-M17: 3M-13,488. For 2R5, 2R10, 2R15, 2R16, 2R17. Type with spark modifier mounted under base. Used on models with engine numbers before 2R5-2R10: 1R-51,666; 2R15: 2R-10,371; 2R16A-2R17A;4R-20907 with Autolite.

NOTE T-4: Used on M5, M15, M15A, M16, M17 before engine number: M5: 1M-8566; M15-M15A: 2M-7795; M16-M17: 3M-13488.

NOTE T-5: Used on and after truck serials: 4E2: E2-674; 4E7: E7-12,136; 4E12-4,167; 4E13: E13-3,093; 4E28: E28-6,659; 4E40: E40-3,120.

NOTE T-6: Used on trucks before serial in note T-5.

Starter

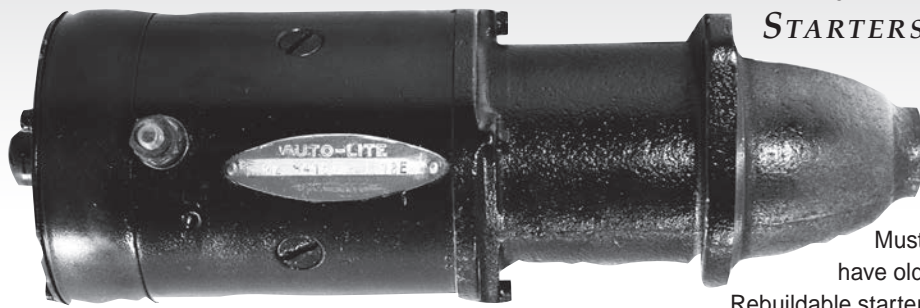

REBUILT STARTERS

Must have old Rebuildable starter first.

801206R Professionally rebuilt to operate as new **\$210.00 ea.**

STARTER MOTOR ARMATURES



188620 Autolite armature. 1936 Dictator, late 1937 Dictator and 1938-42 Commander. **\$90.00 ea.**

188626 Autolite armature. 1936 Dictator with and late 1937-42 Dictator, Commander & Coupe Express. Also early M16 & 17 truck. **\$90.00 ea.**

190461 Armature, early 1937 Dictator & 1941-42 President 8. **\$110.00 ea.**

197310 Armature, starter. 1939 Champion early- M2 4066. **\$75.00 ea.**

197526 Armature. 1939-46 Champion, except 39's with motor #MZ-4066. Also fits 1941-48 M5 & M15 all models & 1949-55 truck with champion 6-cylinder engine. No Stock

521885 Armature. 1947-55 cars with Champion 6-cylinder engine. **\$90.00 ea.**

522067 Armature. 1947-49 Commander 6-cylinder cars & early 2R16 & 17 truck. **\$90.00 ea.**

526875 Armature. 1950 Commander cars, late 2R-series trucks and all 3R (1954) and E-series (1955) truck. All with Commander 6-cylinder engine. Also used on 1951-55 V-8 car & truck with V-8 engine. **\$90.00 ea.**

1540776 Armature, 1956-60 6-cylinder. **\$75.00 ea.**

1540826 Armature, 1956-58 V-8. **\$75.00 ea.**

1550795 Armature. Late 1960 and all 1961-64 170 6-cyl cars and 1962-64 Champ 6-cylinder truck with automatic transmission. **\$95.00 ea.**

1552709 Armature, Delco. 1961 V-8. **\$75.00 ea.**

Note: We have access to additional armatures not featured here. Please inquire.

STARTER BENDIX DRIVE SPRING

521889 1950-55 Champion **\$3.95 ea.**

STARTER SOLENOIDS

191939 1938-50 Commander, 1947-54 Champion. **\$75.00 ea.**

530039 Dash mounted. 1951-54 Commander. **\$28.00 ea.**

536124 Dash mounted. 1955 Commander & President. **\$29.50 ea.**

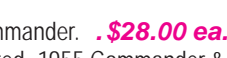

1539452 Starter mounted. 1956-58 Champion. Truck: 2E 5, 6, 10, 11, 14 & 3E 5, 6, 11, 14, 16. Pictured, left. **\$79.00 ea.**



1539716 1956-58 Commander & President. 1959-64 car, all models & 1963-64 Avanti. Truck: 3E-6E all models & 7E-8E 5, 7, 10, 12, 13, 28, 40. **\$16.50 ea.**

1564897 1965-66 car, all models & 1966-85 Avanti. **\$24.00 ea.**

STARTER SWITCHES

195948 Aftermarket, 1939-46 Champion & 1941-42 Commander. Truck: M5-M17 all models & 2R, 3R, E. Floor mounted. **\$29.00 ea.**

513183 1953-54 Champion with auto transmission on dash. **\$28.00 ea.**

527663 1950-51 car with automatic transmission on dash. **\$25.00 ea.**

531716 1952 with automatic transmission on dash. **\$28.00 ea.**

532135 1953 Commander with auto transmission on dash. **\$28.00 ea.**

NEW Listing - 665190 1941-55 truck. NOS. **\$29.00 ea.**



BRUSHES & SPRINGS



123577 Brush set. 1928-33 car, 1934-36 Dictator. 1934-35 Commander. 1934-40 President & 1951-55 V-8. Truck: All with Delco starter. **\$10.25 set/4**

176203 Spring for Autolite brushes. 1934-64 all 6-cylinder, 1962-64 V-8 car, all models & 1963-64 Avanti. Truck: 3E, 5E-8E 5, 10 & 7E-8E 7, 12, 13, 28, 40. No Stock

176226 & 524262 (2 ea.) Autolite brush set. 1934-35 Dictator & 1939-46 Champion. **\$22.00 set/4**

188622 & 524262 (2 ea.) Brush set. 1936-42 Commander Coupe Express & 1941-42 President 8. **\$18.50 set/4**

197307 Brush set for Autolite starter. 1939-55 Champion. Truck: M5, M15, M15A & 2R-E 5, 10, 15 Includes 4 - **524262**. **\$24.00 set/4**

458873 Brush set. 1956-61 V-8 & 1965-66 car. Truck: 2E-6E all except 5, 10 & 4E 1, 5. With Delco starter. **\$9.00 set/4**

458874 Spring for brushes. 1956-61 V-8. 1959 6-cylinder, 1965-66 car, all models. Truck: 2E-6E, all models except 5, 10. With Delco starter. **\$12.25 set/2**

801358 Brush set. 1936-42 Commander, Dictator, Coupe Express & 1941-42 President 8. 2 each - **188622 & 188623**. **\$22.00 set/4**

1540774 Brush set, Autolite starter. 1956-59 6-cylinder car. **\$24.00 set/4**

1550789 Brush set, Prestolite starter. 1960-64 6-cylinder, 1962-64 V-8 car, all models & 1963-64 Avanti. Truck: 5E-6E 5, 10, & 7E-8E 5, 7, 10, 12, 13, 28, 40. **\$13.50 set/4**

STARTER DRIVES Remanufactured



Note: Due to a limited supply of cores, your old one must be received first, or a \$100.00 deposit will be charged.

197313 1939-46 Champion with Autolite starter. Truck: M5, M15, M15A, & 2R-2E 5, 10, 15, 3R & 3E-7E 1, 5, 10. **\$85.00 Ex.**

6484191 1956 Golden Hawk. **\$35.00 Ex.**

STARTER DRIVES - New

188628 1936-42 Dictator, Commander, Coupe Express & 1936 President. **\$105.00 ea.**

190426 1937-40 President. **\$55.25 ea.**

511488 1934-35 all models. **\$105.00 ea.**

521888 1947-55 all models. Truck: M16, M17 & 2R-E except 5, 10, 15. **\$94.50 ea.**

1540831 1956-60 6-cylinder & 1956-61 V-8 car with Delco starter. Truck: 4E 1, 5 & 2E-5E 3, 6, 11, 14, 16, 17 & 2E-6E 2, 7, 12, 13, 28, 38. **\$94.50 ea.**

1550373 1960-64 6-cylinder & 1961-64 V-8 car & 1963-64 Avanti. Truck: 7E-8E 5, 7, 10, 12, 13, 28, 40. **\$94.50 ea.**

1564648 1965-66 car & 1966-77 Avanti. **\$25.00 ea.**

Starter Motor Rebuild Kits

Kit Includes:

- Commutator end plate & bushing
- Brush set
- Springs
- Intermediate bearing
- Nose bushing. Where applicable.

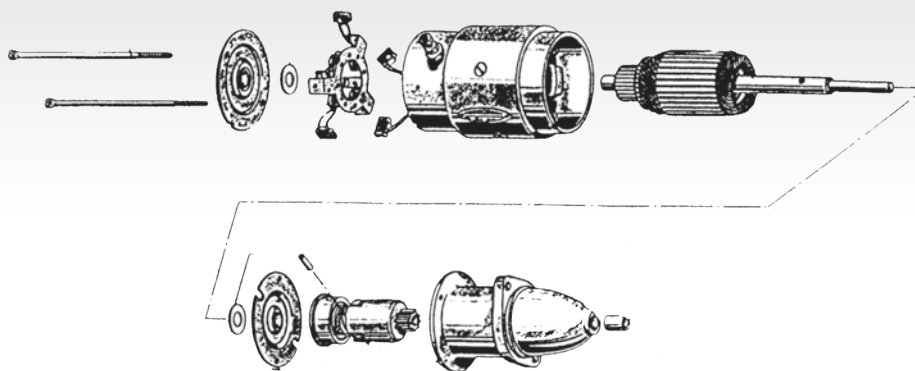

1938 COMMANDER

tag #AL-MAW-4015

191929X1.....\$80.00/kit

1941-42 COMMANDER & EARLY M16 & M17

TRUCK tag #AL-MAW-4020

199954X1.....\$80.00/kit

Late 1939 & all 1940-46 CHAMPION & CHAMPION TRUCKS 1941-55

tag #AL-MZ-4074 or 4090 - excludes front plate

512863X1.....\$60.00/kit

1947 CHAMPION tag #4136

519135X1.....\$60.00/kit

1948-55 CHAMPION

tag #MZ-4151 or 4157

excludes commutator end plate & brush springs

526214X1.....\$55.00/kit

1950-55 COMMANDER, 1949-55

COMMANDER 6 TRUCK,
Late 2R16 & 17's, all 3R &
E 16 & 17 TRUCK &
1954-55 V-8 TRUCK

531608X1.....\$80.00/kit

1947-49 COMMANDER, Late M16 & M17 TRUCK,

Early 2R16 & 17 TRUCKS
vehicles with 226 engine and tag #MCH-4001

676714X1.....\$80.00/kit

1956-61 COMMANDER 6 & V-8 TRUCK, 4E

CHAMPION TRUCK with Delco
Remy equipment, & ALL 1956-
61 V-8 CARS ALSO 1959
6-CYL CARS with Delco Remy
equipment

1539580X1.....\$80.00/kit

1956-58 CHAMPION car

1539582X1.....\$80.00/kit

1959 & Early 1960 6-cylinder car (Autolite)

1549019X1.....\$80.00/kit

STARTER BUSHINGS, PINIONS & BEARINGS

131971 Bushing, Bendix drive housing.
1936 Dictator. 1936-40 President. 1951-55 V-8.
Truck: 2R-E. With Delco starter..... **\$6.25 ea.**

171777 Center bearing. All 1934 cars with
Delco Remy starter. **\$22.00 ea.**

171780 Bushing, Bendix drive housing.
1928-35. With Delco starter. **\$6.00 ea.**

176208 Bushing, Bendix drive housing. 1947-
55 Champion. With Autolite starter. .. **\$5.50 ea.**

197320 Pinion & barrel, Bendix. 1939-46
Champion. **\$22.00 ea.**

511728 Bushing, Bendix drive housing. 1934-
37 Dictator. 1938-49 Commander. 1941-42
President. 1937-39 Coupe Express. Truck: M16,
M17 & 2R 16, 17. With Autolite starter. . **\$7.75 ea.**

1540779 Bushing, Bendix drive housing.
1956 Golden Hawk. 1956-64 6-cylinder, 1962-
64 V-8 car, all models & 1963-64 Avanti. Truck:
7E-8E 5, 7, 10, 12, 13, 28, 40 with Autolite
starter. **\$4.50 ea.**

1540830 Bushing, Bendix drive housing. 1956-61 V-8, 1959 6-cylinder, 1965-66 car, all mod-
els. Truck: 2E-6E with Delco starter..... **\$5.50 ea.**

From Fontana, California, David Sears' 1962 Champ Truck



Generator

REBUILT

801207R Professionally rebuilt to operate as new. **\$165.00 Ex.**

NOTE: We must have your old rebuildable generator first.

ADJUSTING ARMS with Generators



529369 1951-57 V-8. **\$15.00 ea.**

1539782P 1956-64 6-cylinder. **\$12.50 ea.**

1545940 1958-64 V-8 without air conditioning. **\$25.00 ea.**

1546014 1959-64 V-8 with air conditioning. **\$35.00 ea.**

GENERATOR BRUSH SETS

(Standard Equipment only)

191921 1934 Dictator 6 AL- GAR-4609A & 1935-36 Dictator with Autolite. 1937 Dictator & Coupe Express with AL-GBM-4604A OR 4607A. **\$25.00 pr.**

191922 1937 Dictator or Coupe Express with Autolite AL-GCM-480ZA generator. Also 1939-40 Champion. **\$12.10 pr.**

195058 1934 Dictator 6 with Delco Remy generator. **\$25.00 pr.**

195059 1936 Dictator & 1934-36 President with Delco Remy equipment. **\$31.00 pr.**

199035 1940 President. **\$31.00 pr.**

526812 1950 Commander. 1951-61 V-8. 1959 6-cylinder. Truck: 2R-2E all except 1, 5, 15. With Delco Remy generator. Takes 2. **\$8.00 pr.**



527487 Brushes. 1939-51 Champion & 1939-49 Commander with Autolite generator. **\$15.00 pr.**

531647 Brush spring. 1952-61 V-8 with Delco generator. **\$6.00 pr.**

537829 1939-40 Commander, Coupe Express & 1941-42 President 8. **\$12.00 pr.**

1550801 For Autolite generator. 1951-62 6-cylinder, 1956 Golden Hawk, & 1962 V-8 car, all models. Truck: 3E-6E 1, 5, 10 & 7E-8E 5, 7, 10, 12, 13, 28, 40. **\$18.00 pr.**



Generator Overhaul Kits

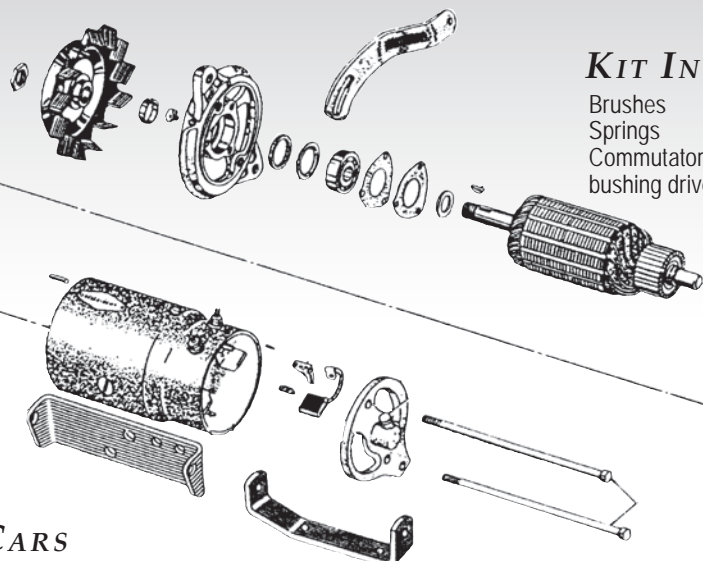

KIT INCLUDES:

Brushes
Springs
Commutator end plate with bushing
drive end plate bearing

CARS

512574X1 1941-50 Champion. GDZ 4804A. **\$80.00 kit**

512575X1 1941-49 Commander 6 GDZ 4805A. **\$80.00 kit**

526682X1 Late 1950 Champion. GDZ 6001A. **\$80.00 kit**

526683X1 1950 Commander. **\$80.00 kit**

531385X1 1951 Commander. **\$80.00 kit**

531635X1 1952-54 Commander. Includes insulated brush holder kits. **\$80.00 kit**

531705X1 1951-55 Champion. **\$80.00 kit**

1540825X1 Autolite. 1956-58 Champion & 1959-early 60's 6-cylinder. **\$80.00 kit**

1541275X1 1955-58 V-8 except with air conditioning & power steering, 1959 6-cylinder & V-8 with Delco Remy generator. **\$80.00 kit**

1550351X1 All 1960 V-8 & early 1961 V-8. **\$80.00 kit**

1550372X1 Late 1960 & all 1961 6-cylinder. Autolite. **\$80.00 kit**

1553181X1 Late 1961 V-8. **\$80.00 kit**

1555236X1 1962 car, all models. **\$80.00 kit**

TRUCKS

512574X1 1941-48 M5 & M15 & early 2R5-10-15 GDZ4804A. **\$80.00 kit**

512575X1 1941-48 M16 & M17 & early 2R16 & 17 GDZ4805A. **\$80.00 kit**

531635X1 All 1949-55 Commander 6 truck, V-8 & late 2R16 & 17 truck. **\$80.00 kit**

531705X1 Late 2R5 thru 1955 Champion truck GDZ6001 A/6001S. **\$80.00 kit**

1540825X1 Autolite. 1956 Champion 6-cyl P.U. also 1957-59. **\$80.00 kit**

1541275X1 All 1956 trucks except Champion 6 & 1959 Champion 6 with Delco Remy, 1957-59 Commander V-8. **\$80.00 kit**

1550351X1 1960 Champion 1/2 ton 6-cylinder. **\$80.00 kit**

1550372X1 1960-61 Champion 6-cylinder. **\$80.00 kit**

1553181X1 1961 Commander 6 & V-8. **\$80.00 kit**

1555236X1 Autolite. 1962-64 all with single belt equipment. **\$80.00 kit**

1695105X1 1962-64 trucks models 7-12-13-28-40 with dual belt equipment. **\$80.00 kit**

1695129X1 1962-64 trucks models 15-25-35-45. Excludes commutator end plate. **\$80.00 kit**

..... **\$80.00 kit**

GENERATOR DRIVE END BEARING

526868 Drive end bearing. 1934-62 car, all models. Truck: All models with generator.....**\$20.00 ea.**



GENERATOR ARMATURES

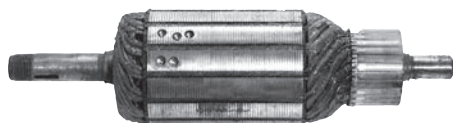

NEW Listing - 458828 1956-58 V-8 except car with power steering and air conditioning.**\$130.00 ea.**
530934 Armature, 1951 V-8.**\$136.00 ea.**
531641 Armature, 1953-55 V-8.**\$115.00 ea.**
531760 1952-55 Champion. **\$125.00 ea.**
680896 Truck: 2R 6, 11, 14, 16, 17.**\$125.00 ea.**
1540762 1956 Golden Hawk. 1956-62 6-cylinder, 1961-62 V-8.**\$135.00 ea.**
1546798 1958 Champion. ...**\$115.00 ea.**
1552759 1960-63 Auto-Lite 40 AMP.**\$235.00 ea.**

VOLTAGE REGULATORS



513615 Early 1941-50 Champion with Autolite generator. 1940-49 Commander. Truck: M5, 2R, 3R 5, 10, 15.**\$94.00 ea.**
530227 1950 Commander. 1951-55 V-8 car with Delco generator. Truck: 2R 6, 11, 14, 16, 17 & 3R-E all except 5, 10, 15.**\$94.00 ea.**
NEW Listing - 530272 1951 Champion. NOS.**\$94.00 ea.**
531703 1952-55 6-cylinder car with Autolite generator. Truck: 2R & E 5, 10, 15 with 45 amp generator.**\$94.00 ea.**
1539451 1956-early 60 6-cylinder & 1956 Golden Hawk with Autolite generator. Truck: 1957-59 3E, 4E 1, 5, 10.**\$94.00 ea.**
1539579 1956-61 V-8 car with Delco generator. Truck: 4E 1, 5 & 3E, 4E all except 1, 5, 10 & 5E all except 5. NOS.**\$96.00 ea.**
1550091 1960-61 6-cylinder Lark with GJP7102C generator. Truck: 5E, 6E 5, 10. NOS.**\$96.00 ea.**
1555237 1962 6-cyl and V-8 car with Autolite generator. Truck: 7E, 8E 5, 7, 10, 12, 13, 28, 40 NOS.**\$64.00 ea.**
1556952 1963-64 Avanti. (Replacement).**\$106.00 ea.**
***1558528** 1963-66 car, all models except Avanti, with alternator.**\$23.50 ea.**

***Note: These regulators are electronic replacements that look similar to original manufactured ones.**

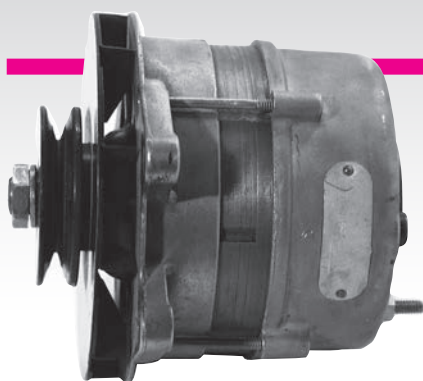

ALTERNATOR PARTS

(35-AMP) 1963-65 Car & Truck: 8E

1558002 Brush set, all models.**\$25.00 ea.**
1558009 Drive end bearing. All models.**\$10.90 ea.**
1558014 Bearing, slip ring end head. All models.**\$12.50 ea.**
1558015 Rectifier, positive. Takes 3.**\$16.00 ea.**
1558016 Rectifier, negative. Takes 3.**\$16.00 ea.**
1559795 Rotor and slip ring. All models.**\$180.00 ea.**
1559797 Head, drive end.**\$60.00 ea.**
1559798 Stator. All models. ...**\$115.00 ea.**
1559799 Head slip ring end. ...**\$90.00 ea.**

AVANTI R1-R2 &

1963-65 CARS With 40-AMP Alternator

Everything same as 35 amp alternator except as follows:

1558006 Rotor. All.**\$170.00 ea.**
1558008 Head, alternator drive end. All.**\$135.00 ea.**
1558010 Stator. All.**\$138.00 ea.**

PRESTOLITE & DELCO TAGS



800206 Prestolite tag for alternator, distributor, starter. 1962-64 all models including Avanti.**\$12.00 ea.**

Alternator

REBUILT

801208R Professionally rebuilt to operate as new. To order we must have the number from the manufactures tag on your old alternator & the year, model & engine of your car.**\$165.00 ea.**

NOTE: Because of a shortage of cores we must have your old rebuildable alternator first.

ALTERNATOR

MOUNTING BRACKETS

1558221 1963-64 6-cylinder without power steering.**\$35.00 ea.**
1560438 1963-64 V-8.**\$20.00 ea.**
NEW Listing - 1563541 1965 6-cylinder.**\$25.00 ea.**
NEW Listing - 1563591 1965 V-8.**\$25.00 ea.**
NEW Listing - 1565193 1966 6-cylinder.**\$25.00 ea.**
NEW Listing - 1565288 1966 V-8.**\$25.00 ea.**

ADJUSTING ARMS with Alternators



1539782 1965-66 6-cylinder without air conditioning.**\$15.00 ea.**
1552529 1961-63 V-8 with air conditioning.**\$40.00 ea.**
1558222 1963-64 6-cylinder without power steering.**\$20.00 ea.**
1558337 Adjusting arm. 1963-64 V-8 without air conditioning.**\$20.00 ea.**
1558939 Adjusting arm. 1963 V-8 with air conditioning. No Stock

801109 Delco tag for generator, starter & distributor. 6-volt. Black.**\$12.00 ea.**
801110 Delco tag for generator, starter & distributor. 12-volt. Red.**\$12.00 ea.**

From Sorrento, Florida, Frank Ambrogio's 1956 Golden Hawk



TURN SIGNAL SWITCHES & RELATED PARTS

526544 6-volt flasher, 1950-54 car, all models. Truck: 1951-55..... **\$12.00 ea.**
Available Again - 533519 Switch & cables. All 1953- early 1960 car except 1956 Golden Hawk with automatic transmission. Truck: 1956 V-8 with class-B turn signals & automatic trans. Some 1961 & all 1962-64 truck with 4-speed transmission. Also, 1-ton & larger 1962-64 truck. **\$60.00 ea.**
533522 Spring shift coil tension. 1953-54 car. **\$1.50 ea.**
533627 Switch plate. 1955-59 truck with auto trans. 1953-55 car with field installed switch ("4HD-B" stamped on plate). **\$25.00 ea.**
NEW Listing - 535371 Lever, Loma Gray with tan knob, 1953-55 car. Truck: various models 1949-64. See chassis manual to determine your application. **\$30.00 ea.**
NEW Listing - 681729 Lever, chrome. Truck: 25 3E, 4E, various applications. Please see your chassis manual to determine application. **\$26.00 ea.**
684548 Switch. Truck: E-2E with auto trans **\$26.00 ea.**

800478 Cancel. 1961-66 car all models except Avanti. Truck: 6E-8E 5, 7, 10, 12. Note: If your turn switch does not cancel after you turn, this is probably what is broken. **\$11.00 ea.**
801095 Cancel. 1963-70 Avanti. If your turn switch does not cancel after you turn, this is probably what is broken. **\$11.00 ea.**
NEW Listing - 1550921 Lever, chrome with black knob. 1956 - 60 car, all models. **\$35.00 ea.**
Available Fall 2014 - 1551930 Switch and cables. 1961-66 cars all except Avanti. Truck: Some 1961-62 and all 1963-64 without 4-speed. **75.00 ea.**
NEW Listing - 1552456 lever, chrome handle with black knob. 1961 car, all models and 1966 Lark. Truck: 1961-64 Champ. **\$35.00 ea.**
NEW Listing - 155280 Lever, chrome with white knob, 1962 - 65 car, all models including Avanti. **\$35.00 ea.**



Available Again!

1551930

1556137 Switch & cables. 1963-70 Avanti without tilt wheel. **\$175.00 ea.**

1558203 Flasher. 1956-66 car, all models & 1963-85 Avanti. Truck: 5E-7E all. **\$4.00 ea.**



New!



BACK UP & NEUTRAL SAFETY SWITCHES

AC-2973 Back-up, 1960 car with standard transmission. **\$40.00 ea.**
522966 Back-up. 1947-50 car, all models. **\$30.50 ea.**
527294 Neutral safety/backup. 1950 car, all models with automatic trans. **\$32.00 ea.**
530440 Neutral safety/backup light. 1951-52 car with auto trans **\$29.00 ea.**
533321 1953-54 without power steering. **\$69.00 ea.**
534389 Backup light, standard transmission, only. 1955-59 car with Saginaw power steering except 1959 Hawks. **\$40.00 ea.**
1540309 Neutral safety/backup light. 1956 Golden Hawk. **\$63.50 ea.**
1549583 Back-up. 1960-61 Lark & Hawk with standard transmission. **\$38.50 ea.**
1549665 Back-up & starter cut out. 1960 Lark. & 1960-61 Hawk with automatic transmission. **\$40.00 ea.**
1552190 Back-up. 1962-66 with column standard transmission. **\$26.50 ea.**
1552780 Back-up & starter cut out. With automatic transmission, 1961-66 Lark & 1962-64 Hawk (on column). **\$36.50 ea.**
1553052 Back-up. 1961-64 Lark or Hawk with 4-speed trans. & 1963-64 Avanti. **\$88.00 ea.**
1557538 Back-up. 1963-64 Avanti with 3-speed transmission. **\$88.00 ea.**
1557359 Back-up light. 1963-64, all models & 1963-85 Avanti with floor mounted automatic transmission. **\$88.00 ea.**
1558650 Starter cut-out. 1963-64, all models & 1963-85 Avanti with floor mounted automatic transmission. **\$88.00 ea.**

BACK UP SWITCH BRACKET

1553199 Bracket. Back-up switch to 4-speed trans. 1961-64 Lark or Hawk & 1963-64 Avanti **\$19.95 ea.**

BRAKE LIGHT SWITCHES

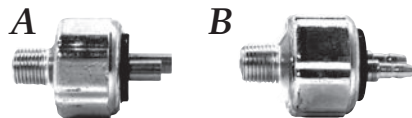

(A) 191078 1942-50 car, all models with screw terminal. **\$29.50 ea.**
(B) 666858 All models with push type terminal. 1942-46 Champion & Commander. 1947-66 car & 1963-70 Avanti. Truck: 1942-64. **\$14.50 ea.**

EMERGENCY BRAKE WARNING LIGHT & SWITCH

1360022 Warning light switch. 1964-66 Lark. **\$20.00 ea.**
1564499 Warning light. 1963-66 Lark. Mounts on dash. **\$25.00 ea.**

TRUNK & TAILGATE SWITCHES

801788 Avanti II trunk release switch. **\$15.00 ea.**



1350475 Trunk light switch. 1963-85 Avanti. **\$35.00 ea.**

1352460 Rear window switch. 1963-66 station wagon with electric rear window on dash. **\$45.00 ea.**

HEADLIGHT SWITCHES

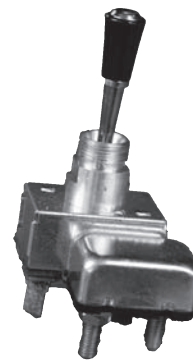

519798 1947-49 car, all models. **\$48.00 ea.**
526350 1950 car, all models. **\$62.00 ea.**
532134 1953 car, all models. **\$32.00 ea.**
536217 1955 C & K. **\$45.00 ea.**

536725 1955 sedan with wrap around windshield. **\$46.00 ea.**
680908 All 1941 cars. Truck: 2R, 3R, E, 2E, M-series **\$45.00 ea.**
1540063 1956 sedan. **\$52.00 ea.**
1540135 1956 Hawk, black. Will also fit 1957 Hawk but knob is a different style. **\$48.00 ea.**
NEW Listing - 1542263 1957 car. Includes (1) 1544272 switch and instructions on how to convert it to 1957 specifications. **\$35.00 ea.**
NEW Listing - 1544272 Black. 1958 sedan. 1958-62 Hawk. **\$35.00 ea.**
1547332 1959 Lark. **\$28.00 ea.**
1549564 1960 Lark. **\$70.00 ea.**
1551530 1961-62 Lark. Truck: 1963-64. **\$40.00 ea.**
1558720 White, 1963-64 Hawk. **\$48.00 ea.**
1561930 White, 1963-83 Avanti. **\$55.00 set/2**
NEW Listing - 1565148 White. 1964-65 Lark. Smooth and without ridges. .. **\$90.00 ea.**
1565577 Black. 1966 Lark. **\$48.00 ea.**

HEADLIGHT DIMMER SWITCHES

519246

1940-59 car, all models.

Truck: M5-M15, 2R-4E, 5E-8E 13-16, 25-45

.....**\$31.50 ea.**

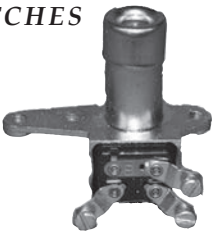

1547356 1960-66

car, all models & 1963-74 Avanti. Truck: 5E-8E 5, 6, 7, 10, 11, 12.**\$12.50 ea.**

FOG LIGHT SWITCHES

519145 Fog light switch, includes knob. 1947-48 Champion.**\$34.00 ea.**

525475 Fog light switch, includes knob. 1949 Champion.**\$26.50 ea.**

530143 Fog light. 1951-52 car, all models**\$24.00 ea.**

536292 1955 without curved windshield. (Includes C & K).**\$32.00 ea.**

HEATER SWITCHES



522360

Truck: 2R-4E.

.....**\$45.00 ea.**

532133 1953-54 car, all models. Pictured above.**\$35.00 ea.**

534957 1954 Commander.**\$35.00 ea.**

535229 1954 Champion.**\$37.00 ea.**

536219 1955 All without wraparound windshield. Includes C & K.**\$35.00 ea.**

536723 1955 All with wraparound windshield.**\$45.00 ea.**

1540283 1956 Hawk.**\$32.00 ea.**

1542245 1957 sedan.**\$37.00 ea.**

1547064 1956 sedan.**\$37.00 ea.**

1547334 1959 Lark.**\$27.00 ea.**

1547689 Heater control. 1959 Lark**\$25.00 ea.**

1549346 Heater control. 1960-62 Lark**\$25.00 ea.**

1549565 1960-61 Lark.**\$35.00 ea.**

1550616 Auxiliary heater. 1960-62 Lark.**\$37.00 ea.**

1554978 1962 Hawk.**\$36.00 ea.**

1555074 1962 Lark.**\$41.00 ea.**

1558719 1963-64 Hawk.**\$67.50 ea.**

NEW Listing - 1561930 1963-83

Avanti.**\$48.00 set/2**

1565576 1966 Lark.**\$35.00 ea.**

1691701 For motor blower. Late 1959 & all 1960-64 C-cab trucks.**\$35.00 ea.**

1692931 Truck: 1960-64 Champ.**\$25.00 ea.**

HEAT SYNC

1565194 Heat sync. For Trans ignitor Ignition.**\$96.00 ea.**

AIR CONDITIONER SWITCH

1552649 Switch, fan air control. 1961-62 Lark & Hawk.**\$45.00 ea.**

Additional Air Conditioning parts are on page 200



DEFROSTER SWITCHES

522360 1947-48 car, all models.

.....**\$45.00 ea.**
NEW Listing - 536219 1955 car without wraparound windshield including C & K.

.....**\$45.00 ea.**
536723 1955 with wrap around windshield.

.....**\$45.00 ea.**

1542247 1957 all models.**\$65.00 ea.**

1544278 Defroster. 1959-61 Hawk

.....**\$38.00 ea.**

1554978 1962 Hawk.**\$36.00 ea.**

SWITCH LABEL SETS

801931 1956 Hawk, all models. Includes lights, instrument lights, defrost, air, wiper and heat.**\$52.00 set/6**

801932 1957-62 Hawk, all models. Includes lights, instrument lights, defrost and air.**\$36.00 set/4**

801933 1963-64 Hawk, all models. Includes lights, instrument lights, air and wiper.**\$36.00 set/4**

.....**\$36.00 set/4**

NOTE: Dash Labels are sold in kits only and are not available individually.

INSTRUMENT LIGHT SWITCHES

532132 1953 car, all models.**\$36.00 ea.**

534956 1954 Commander.**\$30.00 ea.**

535228 1954 Champion.**\$32.00 ea.**

536218 1955 car.**\$28.00 ea.**

1542265 1957 Hawk. No Stock

1544273 1958 sedan.**\$30.00 ea.**

1559409 for rheostat. 1963-66 Lark.

.....**\$25.00 ea.**

NEW Listing - 1561930 1963-83

Avanti.**\$48.00 set/2**

1565576 Rheostat, 1966 Lark.**\$25.00 ea.**

1685892 1956 truck, all models.

.....**\$28.00 ea.**

INTERIOR LAMP SWITCHES

281130X3 1947-52 Champion and Commander except convertible. Also used on some pre-war model sedans. Mounts on door pillar. Tan.**\$24.95 ea.**



285641 1942-46 Champion & 1947-66 all models. Truck: 1949-64 all, replacement.**\$12.00 ea.**

801279 Same as 285641 but used original.**\$25.00 ea.**

1351043 1963-87 Avanti Replacement.**\$13.00 ea.**



From Arlington Heights, Illinois, William Janowiak's 1964 G.T. Hawk

HORN BUTTON SWITCHES

1543008 Horn button contact switch. 1959-66 cars without horn ring. ...**\$22.00 ea.**

ELECTRIC DOOR LOCK SWITCH

800503 Electric door lock switch. 1976-83 Avanti.**\$15.00 ea.**

OIL PRESSURE LIGHT SWITCH

1539898 1956-62 car, all models with warning light. Truck: 3E-4E & 5E-6E 5, 6, 7, 10, 11, 12 & 7E-8E 5, 7, 10, 12.**\$9.00 ea.**



ANTI-CREEP SWITCHES

527260 Anti-creep solenoid valve control switch, on accelerator linkage. 1951-55 car.**\$16.00 ea.**

527394 Solenoid valve pressure switch. 1950-64 car with automatic transmission.**\$42.00 ea.**



NEW Listing - 527804 Solenoid. 1950-52 car.**\$85.00 ea.**

NEW Listing - 532958 Solenoid. All 1953 and early 1954 Canadian built car.**\$85.00 ea.**

NEW Listing - 535546 Solenoid. All 1954 U.S. car and late 1954 Canadian built car.**\$85.00 ea.**

1548797 Anti-creep solenoid. 1959-66 car, all models.**\$78.00 ea.**

MISC. SWITCHES

If you don't see the switch you need listed in our catalog, please call

(317) 462-3124

Additional Switches are available in limited quantities

Windshield Wiper

ELECTRIC SWITCHES

*Parking switch - located on motor and returns arms to down position when wipers are turned off

- 307049** 1951-55 car & truck; 1949-55 with Redmond motor. **\$24.00 ea**
307543 1953-55 car with American Bosch motor **\$55.00 ea**

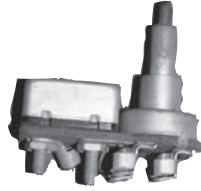

- 309018** 1955 C-5 and K-5 body styles. **\$28.00 ea.**

- 311087** 1955 Autolite motors. **\$28.00 ea.**

- 311467** 1953-54 car, all models & 1955 sedan. **\$42.00 ea.**

- 512814** 1941 Commander & President. **\$28.00 ea.**

- ***1312459** Parking switch. 1956-62 car & truck with Autolite motor **\$26.00 ea.**

- 1312861** Control switch. 1956 Champion with vacuum type motor. **\$28.00 ea**



- 1338055** 1956-62 car, all models. American Bosch. **\$42.00 ea.**

- 1549566** 1960-62 Lark. Truck: 1962. Used. **\$45.00 ea.**

- ***1351851** Parking switch. 1963-66 Lark. **\$25.00 ea.**

- 1558843** 1963-64 Hawk. **\$35.00 ea.**

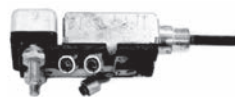

- 1540134** 1956 sedan. **\$40.00 ea.**

- 1540137** 1956 C & K. **\$45.00 ea.**

- 1542261** 1957 sedan & Hawk. Can be used through 1962 by changing the connectors. **\$55.00 ea.**

- 1547333** 1959 Lark. **\$25.00 ea.**

- 1561520** Switch with grooves. 1963-64 Lark. **\$40.00 ea.**

- 1565152** Switch without grooves. 1965 Lark. **\$35.00 ea.**

- 1565578** 1966 Lark. **\$35.00 ea.**

- 1654080** 1956 car & truck & some 1957-59 truck. **\$40.00 ea.**

- 1654663** Some 1957-59 truck. .. **\$35.00 ea.**

WIPER SWITCH RETAINER

NUTS (Chrome)

- 284969W** 1947-55 car, all models, 1957-62 sedan & Lark. Truck: 1949-64 all. **\$4.50 ea.**

- 536350W** 1957-64 many models including Hawk. 9/16". **\$5.50 ea.**

WIPER SWITCH ESCUTCHEON

- 1557358** 1963 - 1964 Avanti. .. **\$20.00 ea.**

DRIVE ARMS, PIVOTS & RELATED PARTS



- 293665** Left driver & connecting arm. 1951-52 Champion with electric wipers. **\$30.00 ea.**

- 293685** Left driver & connecting arm. 1951-52 Champion with vacuum wipers. **\$30.00 ea.**

- 298231** Left driver & connecting arm. 1953-58 sedan & wagon with electric wipers. **\$52.00 ea.**

- 298232** Right driver & connecting arm. 1953-58 sedan & wagon with vacuum or electric wipers. **\$34.00 ea.**

- 298233** Left driver & connecting arm. 1953 sedan & wagon with vacuum wipers. **\$32.00 ea.**

- 298300** Wiper pivot gasket. 1947-66 car, all models except Avanti. Also used on 1960-64 truck. Takes 2. **\$3.50 ea.**

- 298301W** Wiper pivot chrome spacer. 1953-66 all models except Avanti. Truck: 1960-64 Champ. **\$18.00 ea.**

- 303840** Right driver & connecting arm. 1953-61 K-body coupe & hardtop with vacuum or electric wipers. **\$48.00 ea.**

- 303841** Left driver & connecting arm. 1953-58 K-body coupe & hardtop with vacuum wipers. **\$48.00 ea.**

- 303925** Left driver & connecting arm. 1953-64 C & K bodies with electric wipers. **\$52.00 ea.**

- 652728** Right driver & connecting arm. Truck: early 2R with type-A vacuum wipers. **\$40.00 ea.**

- 652729** Left driver & connecting arm. Truck: early 2R with type-A vacuum wipers. **\$40.00 ea.**

- 652730** Wiper pivot spacer. 1949-64 C-cab truck. Chrome. **\$20.00 ea.**

- 1332438** Right, driver & electric connecting arm. 1959-60 Lark. **\$50.00 ea.**

- 1332475** Left, driver & electric connecting arm. 1959-60 Lark. **\$50.00 ea.**

- 1339044** Right, driver & electric connecting arm. 1961-62 Lark. **\$45.00 ea.**

- 1339045** Left, driver & electric connecting arm. 1961-62 Lark. **\$50.00 ea.**

- 1343550** Right, driver connecting arm. 1962-64 GT Hawk. **\$40.00 ea.**

- NEW Listing - 1351380** Right, driver & arm. 1963-66 Lark. **\$40.00 ea.**

- 1351023** Wiper pivot gasket Avanti. Truck: 1949-64 C-cab. Takes 2. **\$3.50 ea.**

- 1351024W** Chrome washer, wiper pivot. 1963-91 Avanti. **\$8.00 ea.**

- 262609** Retainer & spring for wiper arms on 1936-39 car except Champion & all 1941-46 Champion cars with vacuum motors only. Truck: Early 2R. **\$10.00 ea.**



- 271842** Right wiper arm pivot. 1939 Commander & President with electric wipers. **\$60.00 ea.**

- 271843** Left wiper arm pivot. 1939 Commander & President with electric wipers. **\$60.00 ea.**

- 272534** Right or left wiper arm pivot. 1940 car, all except Champion. Takes 2. **\$60.00 ea.**

- 274180** Right or left wiper arm pivot. 1941-42 car, all except Champion. **\$60.00 ea.**

- 278428** Wiper arm, spring with rod. 1941-42 Champion with vacuum wiper. **\$10.00 ea.**

- 284967W** Wiper pivot spacer. 1947-52 car. Chrome. **\$20.00 ea.**

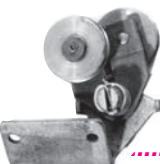

- 1947-48 car. **285117** Right tensioner. **\$18.00 ea.**

- 285118** Left tensioner. **\$15.00 ea.**

- 286072** Right driver & cable. 1947-48 car. **\$35.00 ea.**

- 286073** Left driver & cable. 1947-48 car. **\$36.00 ea.**



- 287693W** Wiper pivot nut. Chrome. 1947-66 car, all models & all Avanti. Truck: 1949-64, all. Takes 2. **\$4.95 ea.**

- 290158** Right driver & cable. 1949-50 car. **\$35.00 ea.**

- 290159** Left driver & cable. 1949-50 car. **\$32.00 ea.**

- 290160** Right tensioner. 1949-50 car. **\$22.00 ea.**

- 290161** Left tensioner. 1949-50 car. **\$22.00 ea.**



- NEW Listing - 293663** Clip, wiper arm to pivot. 1951-66 most models. Limited Supply. . **\$12.50 ea.**

Kit Includes:

- (2) 287693W retainer nuts
 (2) 298300 leather washers
 (2) 298301W chrome spacers

- Total of all parts if purchased separately **\$52.90**
801698 **\$48.50/kit**

WIPER PIVOT KIT

- 1953-66 car all models excluding Avanti
 Truck:
 1960-64 Champ.



WINDSHIELD WIPER RELATED PARTS

291188 Control cable for wiper motor. 1950 car. **\$25.00 ea.**

293687 Control cable. Truck: 2R & all 1954-59 with vacuum wipers & 1951-52 Champion. **\$26.00 ea.**

293749 Rubber gasket, wiper motor bracket to cowl. 1951-60 car with electric wiper motor & 1961-62 Hawk. **\$4.50 ea.**

310844 Rubber gasket, windshield wiper motor to cowl. 1963-70 Avanti. **\$2.00 ea.**



800345 Avanti Wiper motor cover, the factory may have left it off but here it is. Keeps dirt out and gives a more finished appearance under the hood. 1963-70 Avanti. **\$12.95 ea.**

1339055 Rubber gasket, wiper motor bracket to cowl. 1961-62 Lark. **\$2.50 ea.**

WINDSHIELD VACUUM WIPER MOTORS

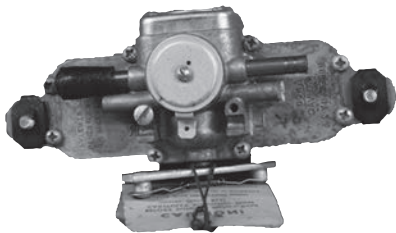

269939 Vacuum motor, new or good used one. 1939 Commander or President. **\$120.00 ea.**

293684 Vacuum motor, new or good used one. 1951-52 car, all models. **\$95.00 ea.**

298128 Vacuum. 1953-58 Champion. **\$95.00 ea.**

303832 Vacuum. 1953-55 Champion C & K and 1959 Lark. **\$110.00 ea.**

NOTE: We have limited quantities of Unlisted vacuum motors, please inquire!

POWER WINDOW AND/OR TAILGATE MOTORS



310075 Motor, 6-volt power window motor. 1955 car. **\$175.00 ea.**

1351263 Motor. 1963-75 Avanti windows & 1963-66 station wagon tailgate with electric window. **\$195.00 ea.**

1312250 Motor. 1956-58 car all models with power windows. **\$165.00 ea.**

ELECTRIC WIPER MOTORS

1. All wiper motors, whether rebuilt or new/old stock, are sold by exchange only.

2. Motors marked with * are available "new" as of this printing and are priced accordingly.

3. All rebuilt motors are dependent on core availability.

4. 1953-61 motors were made by American Bosch, Autolite, and Redmond. We cannot guarantee that the manufacturer of purchased motors will be the same as original.

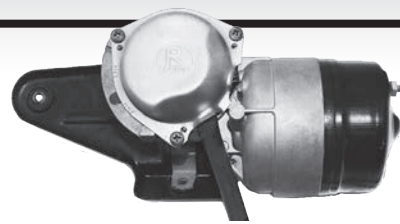

NOS - ELECTRIC WIPER MOTORS

NEW Listing - 1351452 1963-64 Hawk. Truck: 1963 - 1964 Champ less mounting bracket. **\$175.00 ea.**

NEW Listing - 1657096 Postal Zip Van. **\$145.00 ea.**

REBUILT - ELECTRIC WIPER MOTORS

NEW Listing - 293662 1951-52 car. **\$225.00 Ex.**

NEW Listing - 311168 1953-55 car. **\$225.00 Ex.**

NEW Listing - 653277 1949-55 truck. **\$225.00 Ex.**

NEW Listing - 1312320 1956-57 car. **\$225.00 Ex.**

NEW Listing - 1323466* 1958-59 car. American Bosch 1959-60. **\$225.00 Ex.**

NEW Listing - 1339330 1961-62 car. Truck: 1961-62 C-cab. (Autolite) **\$225.00 Ex.**

NEW Listing - 1339332 1961-62 car. American Bosch. **\$225.00 Ex.**

NEW Listing - 1339396 1961-62 Hawk. Truck: 1961 - 1962 Champ. **\$225.00 Ex.**

NEW Listing - 1351040 1963-1970 Avanti. **\$395.00 Ex.**

NEW Listing - 1351450 1963-64 Lark. **\$225.00 Ex.**

NEW Listing - 1654075 Truck: 1956 all & some 1957-58. **\$225.00 Ex.**

NEW Listing - 1654662* 1957-60 Truck C-cab with ark-less terminals. **\$225.00 Ex.**

NEW Listing - 1656319 Truck: 1963-64 C-cab. **\$225.00 Ex.**

WIPER DRIVE ELECTRIC MOTOR REPAIR PARTS

295838 Brush & holder kit. 1951-55 car & truck: 1949-55 with "Redmond" motor. **\$15.00 ea.**

307043 Spring for brush. 1951-55 car with "Redmond" wiper motor & truck: 1949-55. **\$3.00 ea.**

307542 Armature. 1953-55 with American Bosch. **\$75.00 ea.**

311079 Spring for brushes. 1955 Autolite motors. Takes 2. **\$2.50 ea.**

311084 Armature. 1955 car & truck with Autolite motor **\$70.00 ea.**

311085 Commutator head for Autolite motor. 1955 car & truck. Includes brushes. **\$45.00 ea.**

311088 Commutator head for Autolite motor. 1955 car & truck. Includes brushes. **\$45.00 ea.**

311089 Motor gear. 1955-62 car & truck with Autolite motor **\$15.00 ea.**

1312210 Armature. 1956-62 Autolite. **\$80.00 ea.**

1312838 Commutator end head, includes brushes. 1959-62 car & truck with Autolite motor. **\$30.00 ea.**

1314983 Armature. American Bosch. 1956-62 car, 1960-61 Truck. **\$80.00 ea.**

1351857 Motor drive gear. 1963-66 car **\$16.00 ea.**

131026 Rubber grommet on door, wires pass through. 1963-64 Avanti, before #5168. **\$3.50 ea.**

308456W Chrome housing for power window switches on 1955-58 4-door car. 4-button. **\$35.00 ea.**

310216 Relay, to ignition switch. 1955 car. **\$52.00 ea.**

310217 Lift motor relay. 1955. **\$85.00 ea.**

310425X1 Switch with chrome knob. 1-button. 1955-58 car. **\$45.00 ea.**

310425X2 Switch with gold knob. 1-button. 1955-58 car. **\$45.00 ea.**

311008 Circuit breaker, window lift. 1955 with power windows **\$22.50 ea.**

1312210 Armature. 1956-62 Autolite. **\$80.00 ea.**

1312838 Commutator end head, includes brushes. 1959-62 car & truck with Autolite motor. **\$30.00 ea.**

1314983 Armature. American Bosch. 1956-62 car, 1960-61 Truck. **\$80.00 ea.**

1351857 Motor drive gear. 1963-66 car **\$16.00 ea.**

311089 Motor gear. 1955-62 car & truck with Autolite motor **\$15.00 ea.**

1312210 Armature. 1956-62 Autolite. **\$80.00 ea.**

1312838 Commutator end head, includes brushes. 1959-62 car & truck with Autolite motor. **\$30.00 ea.**

1314983 Armature. American Bosch. 1956-62 car, 1960-61 Truck. **\$80.00 ea.**

1351857 Motor drive gear. 1963-66 car **\$16.00 ea.**

311089 Motor gear. 1955-62 car & truck with Autolite motor **\$15.00 ea.**

1312210 Armature. 1956-62 Autolite. **\$80.00 ea.**

1312838 Commutator end head, includes brushes. 1959-62 car & truck with Autolite motor. **\$30.00 ea.**

1314983 Armature. American Bosch. 1956-62 car, 1960-61 Truck. **\$80.00 ea.**

1351857 Motor drive gear. 1963-66 car **\$16.00 ea.**

311089 Motor gear. 1955-62 car & truck with Autolite motor **\$15.00 ea.**

1312210 Armature. 1956-62 Autolite. **\$80.00 ea.**

1312838 Commutator end head, includes brushes. 1959-62 car & truck with Autolite motor. **\$30.00 ea.**

1314983 Armature. American Bosch. 1956-62 car, 1960-61 Truck. **\$80.00 ea.**

POWER WINDOW RELATED PARTS

131026 Rubber grommet on door, wires pass through. 1963-64 Avanti, before #5168. **\$3.50 ea.**

308456W Chrome housing for power window switches on 1955-58 4-door car. 4-button. **\$35.00 ea.**

310216 Relay, to ignition switch. 1955 car. **\$52.00 ea.**

310217 Lift motor relay. 1955. **\$85.00 ea.**

310425X1 Switch with chrome knob. 1-button. 1955-58 car. **\$45.00 ea.**

310425X2 Switch with gold knob. 1-button. 1955-58 car. **\$45.00 ea.**

311008 Circuit breaker, window lift. 1955 with power windows **\$22.50 ea.**

311347 Drive end head for power window motor. 1955 car **\$35.00 ea.**

311351 Commutator end head for 6-volt window motor. 1955 car. Includes brushes. **\$50.00 ea.**

311352 Armature for window motor. 1955 car **\$70.00 ea.**

1312959 Armature for window motor. 1956-58, 12-volt. **\$60.00 ea.**

1355430 Motor sacrifice gear, brass. 1963-75 Avanti. **\$39.00 ea.**

Windshield wiper arms & blades on page 76

Window glass, frames, regulators & hardware pages 69-70

NOTE: All harnesses are made with plastic coated wire & are color coded as original. Unless the harness is NOS, they are made to order and require 2-6 weeks for shipping. Please inquire about anticipated delivery time frame when ordering harnesses marked with an asterisk before the part number. These harnesses have special foreseen circumstances that will require more than 6 weeks

CHASSIS FRONT WIRING HARNESSES Dashboard & Forward

- 181844-5** 1934 Commander. Dash & engine. **\$215.00 ea.**
196741 1939 Champion. **\$135.00 ea.**
513160 1940 Champion. **\$155.00 ea.**
519823 1947-49 Champion. **\$205.00 ea.**
520350 1947-49 Commander. **\$205.00 ea.**
526361 1950 Commander. **\$225.00 ea.**
526362 1950 Champion. **\$225.00 ea.**
530297 1951 Champion. **\$195.00 ea.**
530298 1951 Commander. **\$195.00 ea.**
531670 1952 Champion. **\$210.00 ea.**
531671 1952 Commander. **\$210.00 ea.**
534383 1953-54 Champion & C & K body car after serial # 1, 235, 258. **\$260.00 ea.**
535404 1953-54 Commander C & K. **\$270.00 ea.**
536539 1955 Champion C & K **\$175.00 ea.**
536540 1955 Commander & President V-8 sedan without wraparound windshield. **\$290.00 ea.**
536541 1955 Commander & President C & K. **\$300.00 ea.**
537085 1955 Champion sedan with wrap-around windshield. **\$280.00 ea.**
537086 1955 Commander & President sedan with wraparound windshield. **\$330.00 ea.**
537423 1955 Speedster. **\$375.00 ea.**
675149 Truck: M5, 15, 15A, M16. **\$210.00 ea.**
682891 Truck: 1949-53 2R, 1954 3R, 1955 E. 6-cylinder. **\$210.00 ea.**
684030 Truck: 1955 E V-8. **\$240.00 ea.**
1540233 1956 Commander & President. **\$305.00 ea.**
1540234 1956 Champion. NOS. **\$200.00 ea.**
1540235 1956 Hawk V-8. **\$305.00 ea.**
1540839 1956 Golden Hawk. **\$375.00 ea.**
1542270 1957 Hawk 6-cylinder. **\$325.00 ea.**
1542271 1957 Hawk V-8. **\$385.00 ea.**
1542282 1957 Champion 6-cylinder. NOS. **\$250.00 ea.**
1542283 1957 Commander & President. **\$385.00 ea.**
1545041 1958 Hawk V-8. **\$385.00 ea.**
1545043 1958 Champion. NOS. **\$250.00 ea.**
1545197 1958 Commander & President. **\$300.00 ea.**
1547442 1959 Lark 6-cylinder. **\$87.00 ea.**
1548411 1959 Hawk 6-cylinder or V-8. **\$220.00 ea.**
1549100 1959 Lark front chassis 6-cylinder & V-8. NOS. **\$85.00 ea.**
1549443 1960 Lark 6-cylinder. NOS. **\$280.00 ea.**

Wiring Harnesses

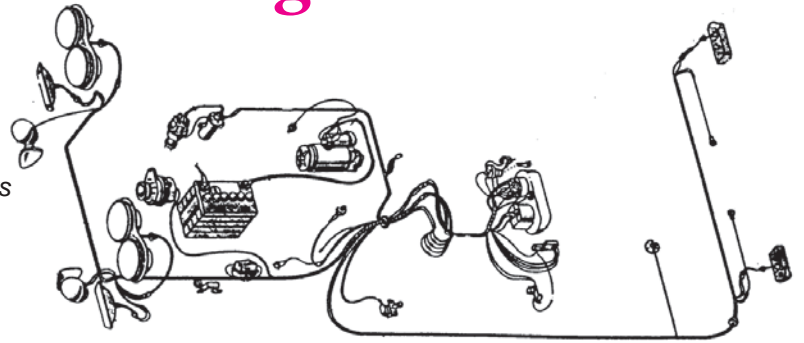

CHASSIS FRONT WIRING HARNESSES Dashboard & Forward (Continued)

- *1549444** 1960 Lark V-8. **\$385.00 ea.**
***1550079** 1960 Hawk. **\$320.00 ea.**
1550080 1960 Hawk 6-cylinder. **\$300.00 ea.**
1552125 1961 Lark 6-cylinder. NOS. **\$250.00 ea.**
***1552721** 1961 Hawk V-8. **\$390.00 ea.**
***1554878** 1962 Lark V-8. **\$390.00 ea.**
1554880 1962 Lark 6-cylinder. NOS. **\$250.00 ea.**
***1554950** 1962 Hawk V-8. **\$390.00 ea.**
1558777 1963 Hawk 6-cylinder. **\$275.00 ea.**
1558995 1963 Lark 6-cylinder. NOS. **\$275.00 ea.**
1560091 1963-64 Hawk V-8. **\$390.00 ea.**
1561445 1964 Lark V-8. NOS. **\$290.00 ea.**
1561446 1964 Lark 6-cylinder. NOS. **\$275.00 ea.**
1563476 1965-66 Lark V-8. NOS. **\$290.00 ea.**
1563506 1965-66 Lark 6-cylinder. NOS. **\$275.00 ea.**
1685379 Truck: 2E V-8. **\$190.00 ea.**
1689567 Truck: 3E & 4E 6-cylinder. **\$175.00 ea.**
1689569 Truck: 3E & 4E V-8. **\$210.00 ea.**
1693350 Truck: 6E 5. **\$310.00 ea.**
1694264 Truck: 7E-8E 15, 25, 35, 45. **\$320.00 ea.**
1696306 Truck: 8E 5, 10. NOS. **\$280.00 ea.**
1696307 Truck: 1963-64 8E 7, 12. NOS. **\$280.00 ea.**
1696572 Truck: 8E diesel. **\$290.00 ea.**

CHASSIS REAR WIRING HARNESSES

- 519817** 1947-48 all except Land Cruiser. **\$80.00 ea.**
520810 1947-49 Land Cruiser. **\$80.00 ea.**
526364 1950 Land Cruiser. **\$85.00 ea.**
526366 1950 Champion & Commander with turn signals. **\$85.00 ea.**
530177 1951-52 all except Land Cruiser. **\$85.00 ea.**
530178 1951-52 Land Cruiser. **\$85.00 ea.**
534367 1953-54 C & K. **\$90.00 ea.**
536542 1955 sedan. **\$90.00 ea.**
536543 1955 C & K. **\$90.00 ea.**
665624 Truck: M-5. **\$90.00 ea.**
680000X1 Truck: 2R 5, 6 without turn signals. **\$80.00 ea.**
683136X1 Truck: 2R 3R, E 5, 6 with turn signals. **\$90.00 ea.**
683136X2 Truck: 2R 10, 11, 14, 15 with turn signals. **\$90.00 ea.**
1540181 1956-59 C & K & 1956-58 sedan. **\$90.00 ea.**
1548277 1959 Lark. **\$85.00 ea.**
1549445 1960-61 Lark. **\$85.00 ea.**
1549446 1960-61 station wagon. **\$85.00 ea.**
1550081 1960-64 C & K. NOS. **\$100.00 ea.**
1554678 1962-63 Lark. NOS. **\$90.00 ea.**
1559299 1963 Lark station wagon with manual tailgate. NOS. **\$100.00 ea.**
1561543 1964-66 Lark station wagon with manual tailgate. NOS. **\$95.00 ea.**
1561544 1964-66 Lark. NOS. **\$90.00 ea.**
1565053 1964-66 Lark station wagon with electric tailgate. NOS. **\$120.00 ea.**
1692317 Truck: 5E-6E 13, 14, 16, 28, 40. NOS. **\$80.00 ea.**
1692318 Truck: 5E-6E 16, 28, 40. 7E 5, 7, 10, 12 with narrow box. NOS. **\$80.00 ea.**
1692335 Truck: 5E-6E 5, 6, 7, 10, 11, 12 with narrow box. NOS. **\$85.00 ea.**
1693847 Truck: 7E 5, 7, 10, 12 with wide box. NOS. **\$90.00 ea.**
1694266 Truck: 7E - 8E 15, 25, 35, 45, 131", 143", 155" with wide box. NOS. **\$90.00 ea.**
1694267 Truck: 7E - 8E 15, 25, 35, 45, 195" with wide box. NOS. **\$90.00 ea.**

WIRING HARNESS CLIP



NEW Listing - 536795 Clip, wiring to cowl brace, most models. **\$4.50 ea.**

WIRING DIAGRAMS

800976R Copied from original shop manuals. These diagrams include color codes. Please specify year, model & engine when ordering. **\$3.50 ea.**

OVERDRIVE WIRING HARNESSES

- 196937** 1939-40 Champion. **\$38.00 ea.**
519822 1947- early 1950 Champion. 1947-50
 Commander. **\$60.00 ea.**
527426 Late 1950-52 Champion. Late 1950
 Commander. **\$60.00 ea.**
530355 1951 Commander. **\$55.00 ea.**
531727 1952 Commander. **\$60.00 ea.**
532636 1953-54 Champion C & K. 1955
 Champion with lockout switch. **\$58.00 ea.**
534004 1953-55 Champion sedan. NOS.
 **\$55.00 ea.**
534399 1953-54 Commander C & K. 1955
 Commander with lockout switch. **\$58.00 ea.**
537410 1955 Champion sedan without
 lockout switch. **\$58.00 ea.**
679754 Truck: 1949-53 2R, 1954 3-R, 1955
 E. **\$58.00 ea.**
684836 Truck: 1955 E without lockout
 switch. **\$60.00 ea.**
1540182 1956 Golden Hawk before
 6.031.808. NOS. **\$65.00 ea.**
1540299 1956-57 Champion. NOS.
 **\$58.00 ea.**
1540300 1956-57 C & K 6-cyl. **\$35.00 ea.**
1540305 1956-57 C & K V-8. **\$58.00 ea.**
1540310 1956-57 sedan V-8. **\$58.00 ea.**
1548251 1959-60 all models. NOS.
 **\$26.00 ea.**
1552343 1961-63 all models. NOS.
 **\$20.00 ea.**
1562249 1964 all models. NOS.
 **\$38.00 ea.**
1685847 Truck: 1956-59 2E-4E with relay.
 **\$58.00 ea.**

MISC. WIRING HARNESSES

- 288694** 1947-50 convertible top motor.
 **\$100.00 ea.**
288955 1947-50 convertible. Switch to
 breaker. **\$18.00 ea.**
288956 1947-50 convertible. Breaker to
 solenoid. **\$20.00 ea.**
529211 1950 Champion & Commander.
 Front turn signals. **\$46.00 ea.**
529341 1950-51 Champion. Anti-creep
 **\$52.00 ea.**
530524 1951 Commander. Anti-creep.
 **\$55.00 ea.**
530575 1951 Champion & Commander.
 Front turn signals. **\$38.00 ea.**
531783 1952 Champion & Commander.
 Front turn signals. **\$38.00 ea.**
532982 1953-55 V-8. Generator to regulator.
 **\$18.00 ea.**
533095 1953-54 sedan. Anti-creep.
 **\$56.00 ea.**
533230 1953-54 all models. Front turn
 signals. **\$38.00 ea.**
536150 1955 all models. Front turn signals.
 **\$58.00 ea.**
536545 1955 sedan. Anti-creep.
 **\$58.00 ea.**
536546 1955 C & K. Anti-creep. **\$58.00 ea.**
1540837 1956 Golden Hawk. Starter switch
 to junction. **\$18.00 ea.**
1552256 harness, air conditioning, ignition
 switch to a/c switch, 1961 Lark. **\$15.00 ea.**

BATTERY BRACKETS & SUPPORTS

- 285758**
 6-volt. 1947-55
 car, all models.
 Truck: 1949-55.
\$36.50 ea.

770031 1963 Avanti **\$34.00 set/2**

800024 10 7/8 inch long "J" bolt retainer
 with washer & wing nut. **\$4.50 ea.**

1312971P
 12 volt.
 1956-58 car,
 all models.
 1959-64
 Hawk.
 Truck: 1956-64 C-cab. **\$30.00 ea.**

New!
NEW Listing - 1312973P bracket, battery
 to fender. 1956-64 C & K body. **\$15.50 ea.**

NEW Listing - 1314745 9 3/4 inch long
 "J" bolt retainer with washer & wing nut. 1956-
 64 C & K body, except 1958 Packard Hawk.
 Takes 2 **\$9.50 ea.**

1323655 12 volt. 1956-58 car, all models.
 1959-64 Hawk. Truck: 1956-64 C-cab
 **\$24.00 ea.**

1339477 12 volt. 1959-66 Lark.
 1964-85 Avanti. Truck: 1960-64 Champ.
 **\$22.00 ea.**
1350251 Battery hold down bolt &
 bracket. Rivets to inner fender. 1963
 Avanti (before 4892). **\$24.50 ea.**

1350251X1 Reinforcement
 for 1350251. **\$15.00 ea.**

BATTERY TRAY

Reinforcement
 1964-85 Avanti

- 800076** Metal panel
 fits under battery.
 Bracket bolts to
 radiator support &
 front sway bar bolt.
 Standard on later
 models. Good addition
 on earlier models. **\$59.95 ea.**



BATTERY BOX Reinforcement

- 800077** A factory addition on some 1963
 Avanti. This fiberglass reinforcement fits
 under the fender well, adding strength to hold
 battery. **\$45.00 ea.**



BATTERY MAT

This battery mat offers every car around-the-
 clock protection from an ever-present threat:
 its own battery. A battery can leak undetected
 for months, causing rust on any metal surface
 the acid encounters. This rust, of course,
 can cause irreversible damage to body parts
 resulting in costly repairs or even accidents.

The battery mat (which is slightly larger than
 a standard size battery) is inserted underneath
 the battery, which is then clamped down as
 usual. It can be installed easily at any time,
 either under an existing battery or when
 replacing an old one.

Once installed, this battery mat will trap
 and neutralize battery acid that leaks from
 the terminals or top side of the battery, thus
 preventing corrosion and expensive damage.
 Because of the latex sealant, this battery mat
 can repel water and keep the acid neutralizers
 sealed in and potent. Because the latex sealant
 is not impervious to battery acid, however,
 the acid will seep into the battery mat's highly
 porous fabric, where it will be absorbed and
 harmlessly neutralized.

Everyone who owns a car should install one to
 prevent damage from a leaking battery. It is
 usable in Brand "X" cars as well as Studebakers,
 in recreational vehicles such as motor homes
 and motor boats.

- 800804** **\$6.00 ea.**

JUNCTION BLOCKS

Headlight Cables

- 198061** Three
 terminals. 1940-
 51 car, most
 models & 1956
 Golden Hawk.
 Various applications. Truck: 1941-48 M-series,
 1949-59 C-cab. **\$42.00 ea.**



- 519186** Five terminals. 1947-57 car, most
 models. **\$42.00 ea.**

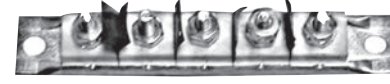

Horn

196673 Cup, push button spring contact. 1940-42 Commander, 1947-50 Champion & Commander **\$4.50 ea.**

NEW Listing - 192245 cap, push button contact. Various models of cars & trucks. **\$25.50 ea.**

192247 Horn plate, various models of cars & trucks.....**\$35.00 ea.**



519180 Spacer, horn. 1947-56 car & 1957 Champion. Also substitutes for various early cars and trucks. Takes 3. **\$3.00 ea.**

520411 Horn ring push back, sponge. 1947-56 car, all models with horn bar or ring. **\$20.00 ea.**

522198P Horn bar. Painted. 1947- 48 Commander. **\$50.00 ea.**



522198W Horn bar. Chrome. Pictured above. 1947- 48 Commander **\$75.00 ea.**

533467
Cable.
1953-56 sedan,
all models with power
steering. **\$16.50 ea.**

533468 Cable. 1953-56 C & K with Saginaw power steering **\$25.00 ea.**

HORNS - Replacement

800927
Sold in pairs only —
1 high and 1 low tone.
Comes with universal type
mounting bracket for all
model cars and trucks.
12-volt. **\$140.00 pr.**

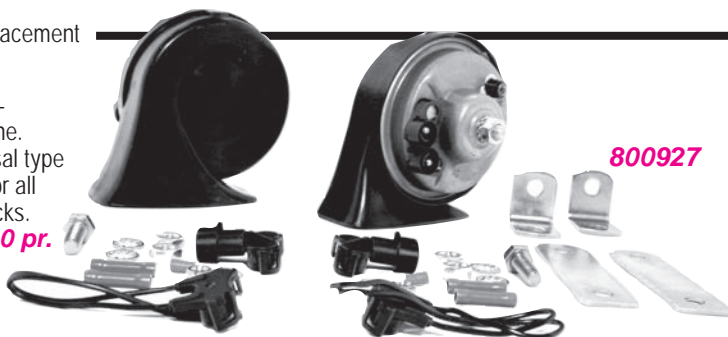

1544080 Horn, Autolite Hi. 1957-58 car. NOS. **\$95.00 ea.**
1562522 Horn, Delco Lo. 1964-66 car. NOS. **\$95.00 ea.**

1539065 Horn cable, 1938-56 all car plus 1957 Champion 6-cylinder with 3-spoke wheel and without power steering. Truck: 1941-48 M-series and 1949-64 C-cab. **\$15.00 ea.**

1541949
Switch. 1957-66
car with type
A & B steering
wheels. See
Chassis Parts
Manual. **\$20.00 ea.**

NEW Listing - 1541950
Spacer. 1957-60 and 1963 - 66, all
with horn ring. 1957 - 66 all with horn
button. **\$4.00 ea.**

1541961W Center ring,
chrome. 1957-66 car, all
models without horn ring.
..... **\$18.00 ea.**

1541991 Contact plate.
1957-66 car, all models.
..... **\$18.00 ea.**



1542007 Horn cable with brushes, 1957-59 Hawk with Saginaw power steering. .. **\$18.00 ea.**
NEW Listing - 1542795 Cable extension. 1962-64 Hawk with power or disc brakes. **\$4.00 ea.**

1543008
Switch. 1957-66
car with center
button.
\$25.00 ea.



1551595 Spacer for horn bar. 1961-62. Substitutes for many cars & trucks back through the 1940's. **\$4.50 ea.**



1552237 Roller & bracket assembly. 1961 Lark. **\$25.00 ea.**
1555303 Roller & bracket Assembly. 1962-66 car, all models except Avanti... **\$28.00 ea.**

Please see page 56 for horn buttons.

Can't find the part you're looking for?

Call & we'll be glad to look for a part just for you!

(317) 462-3124

We welcome overseas customers!

HORN RELAYS

190085 1937 Dictator & Coupe Express. 1947-55 car, all models. Truck: M5-M17 & 2R-E. .. **\$30.50 ea.**

1539596 1956-58 car, all models. Truck: 2E-4E. **\$27.00 ea.**

1547377 Pictured 1959-62 car, all models. Truck: 5E-8E **\$36.50 ea.**

1557365 1963-66 car, all models & 1963-85 Avanti. Truck: 8E. **\$18.00 ea.**

