

VOL 17 2017-2018

PUMP & POWER SERVICES CATALOG

sunbeltrentals.com

800-736-2504



SUNBELT
RENTALS®

PUMP & POWER
SERVICES



PUMPS ■ GENERATORS & POWER DISTRIBUTION ■ AIR COMPRESSORS
LOAD BANKS ■ TEMPERATURE CONTROL & DEHUMIDIFICATION ■ TRENCH SHORING



PUMPS
GENERATORS & POWER DISTRIBUTION
AIR COMPRESSORS
LOAD BANKS
TEMPERATURE CONTROL & DEHUMIDIFICATION
TRENCH SHORING



SUNBELT RENTALS PUMP & POWER SERVICES OVERVIEW

Sunbelt Rentals provides innovative rental solutions for everyone from contractors to weekend do-it-yourselfers. We operate more than 600 locations throughout the U.S. and Canada, and offer a broad and modern rental fleet of \$5 billion.

Sunbelt's specialty divisions provide a high level of technical expertise to specific market segments. Our Pump & Power Services specialty division tackles projects ranging from large scale sewer bypasses to job site power generation. Pump & Power Services offers a wide range of equipment including generators, pumps, compressed air, temperature control, dehumidification, ground protection and trench safety.

Sunbelt's custom designed, state-of-the-art equipment provides efficient, dependable performance and quiet, environmentally friendly operation.

Our highly trained specialists and technicians have the knowledge and experience to respond quickly to customer needs and provide an effective rental solution for any application, no matter how challenging. And, we offer 24/7 emergency service that is second to none.

Pumps

Sunbelt's extensive pump fleet includes diesel and electric driven trash pumps from 3" to 24", with flow rates up to 16,000 GPM and heads up to 360'. We also offer a wide selection of specialized pumps including air diaphragm, wellpoint, electric submersible, hydraulic submersible, double diaphragm and sound attenuated. Our pump specialists design and install complex bypass installations that meet and exceed customer expectations.

Generators & Power Distribution

Sunbelt's power generation equipment ranges from 20 kW to 2,000 kW, with custom features to meet specific customer requirements such as ultra-quiet operation and extended periods of continuous running. We also offer a wide range of generator accessories including transformers, load banks, distribution panels, cable, and everything else needed to complete custom installations.

Air Compressors

A wide range of diesel and electric air compressors are offered including standard, electric, high-pressure, and Instrument-Quality models. We also offer an extensive line of air treatment equipment to meet the needs of any application—from construction to industrial to food preparation.

Temperature Control & Dehumidification

Sunbelt provides temperature control solutions for any application including special events, industrial shutdowns and construction. We offer cooling solutions from 1 ton to 400 tons, heaters up to 4.2 million BTU, ducting and accessories, plus years of professional design and installation experience. We also offer large desiccant dehumidifiers from 600 CFM to 15,000 CFM including electric, gas and combination models. This equipment is ideal for large dehumidification applications such as water damage restoration and industrial condensation prevention.

Trench Shoring

Our extensive trench shoring equipment includes steel and aluminum trench boxes, steel manhole and bedding boxes, hydraulic shoring shields, hydraulic vertical shores, aluminum Lite-Shields and steel road plates. Our trained shoring professionals are also experienced in pit-box configurations and slide rail systems.

With Pump & Power Services locations from coast to coast, Sunbelt Rentals is your one-stop source for all of your equipment needs.



GENERAL INFORMATION

OPERATING HOURS

Standard business hours at most Sunbelt Rentals locations are from 6:30 am to 5:30 pm Monday through Friday (check for local weekend operating hours). We also offer a 24-hour emergency hotline to accommodate both after-hours service and rental needs. Our **"No Sweat" Guarantee** promises that customers calling after hours will receive a response from a Sunbelt Rentals representative within 1 hour, or 1 day's rental is free. To see how quickly we respond, call our after-hours emergency number: **888-828-4049**. In 2016, our team responded to 99.2% of all after-hours calls in under 30 minutes, and 96.1% in under one hour.

RENTAL TERMS

Most equipment featured in this catalog is offered for rent on a daily, weekly or monthly basis. However, some items may require a minimum rental term of 1 week or more. All rentals and purchases are subject to any applicable taxes. Customers not holding a credit account will be required to pay in advance for the rental and any supply items purchased. Additional deposits may also be required, depending on the type of equipment rented. Two forms of identification are required from all non-credit account customers, preferably a current driver's license and a major credit card. Acceptable forms of payment are cash, check or major credit card. We accept MasterCard, Visa, American Express and Discover. Customers who rent on a frequent basis may be eligible for a credit account. To apply, complete the credit application at the back of this catalog and fax it to your nearest Sunbelt Rentals location or toll-free at **888-886-7820**. The credit application is also available online.

FUEL PAYMENT OPTIONS

Sunbelt Rentals allows you to choose how you want to replace the fuel before returning your equipment. For fuel replacement, Sunbelt Rentals provides three options: "No Sweat" Fuel Option (Prepay), Pay on Return and Return Full.

"NO SWEAT" FUEL OPTION (prepay)

For your convenience, Sunbelt Rentals offers a "No Sweat" Fuel Option. The "No Sweat" Fuel Option is a prepay option that permits you to purchase at the time of rental a full tank of fuel at a competitive, self-service per gallon price (posted fuel charge at Sunbelt Rentals location). The charge is based on the average fuel tank size for the equipment class. There is no hassle and this option saves time and money. As an added convenience, you can purchase the "No Sweat" Fuel Option at the time of the rental, however, if you decide to return the equipment full of fuel, you will be refunded the cost of the "No Sweat" Fuel Option. This way, you can either decide to fill it up or let Sunbelt Rentals do it when you return the equipment—it's your choice.

PAY ON RETURN OPTION

With this option, you can pay the full-service fuel price (posted fuel charge at Sunbelt Rentals location) per gallon of fuel used. This is another easy, timesaving option where you only pay for the fuel you use.

RETURN FULL OPTION

The final option is returning the equipment full of fuel. You will be charged the "No Sweat" Fuel Option cost at the time of the rental, but you will receive a refund when you return the equipment full of fuel. FOC-713R

DELIVERY & PICK-UP

Sunbelt Rentals maintains an extensive fleet of delivery vehicles to provide responsive transport of equipment for our customers at competitive rates. We also offer trailers for rent, specially designed for hauling the types of equipment we offer.

THE "NO SWEAT" GUARANTEE.®

Satisfaction . Delivery . Service . Availability . After-Hours Response

We supply the right equipment, on time, serviced and ready to do the job at hand, or the rental that day is free.

We deliver within 45 minutes of the quoted delivery time, or the rental that day is free.

We repair or replace down equipment within 4 hours of the call for service, or the rental that day is free.

If you visit a Sunbelt Rentals location to rent a guaranteed stocked item that is unavailable, we will provide free delivery from another location directly to your job site.

Quick response for emergency after-hours delivery or service calls is important. A local operational representative will respond to your after-hours call within 1 hour, or 1 day's rental is free.



SPECIALTY DIVISIONS

Climate Control Services
800-892-8677 24/7

Facility Maintenance
800-508-4760 24/7

Flooring Solutions
844-723-4778

GSA Services
800-667-9328 24/7

Industrial Services
855-260-6726

Oil & Gas Services
877-687-1146 24/7

Pile Driving Services
800-223-8427

Pump & Power Services
800-736-2504 24/7

Remediation & Restoration
800-508-4760 24/7

Scaffold Services
866-784-1785

SAFETY

It is important that you wear all the manufacturer's recommended safety equipment, review all safe operation manuals and decals and observe all safety precautions when utilizing tools and operating equipment. Operator/User assumes all responsibility for the use, care and inspection of PPE (Personal Protective Equipment).

Note: The equipment listed in this catalog reflects the most current models and specifications available at the time of print. Equipment may vary at Sunbelt Rentals locations but with no compromise in performance or reliability.



INDEX BY PRODUCT CATEGORY

Air Compressors (Large)	45-49	Ground Protection	44	Temperature Control & Dehumidification	56-69
Dust Collectors		Ground Protection Mats		Air Conditioners, Portable	
Diesel Air Compressors, Standard		Containment Berms		Air Conditioners, Industrial	
Diesel Air Compressors, High-Pressure				Air Handlers	
Diesel Air Compressors, Instrument-Quality		Load Banks	42-43	Chillers	
Electric Air Compressors		Resistive Load Banks		Desiccant Dehumidifiers	
Reference Data, Compressed Air		Rack Load Banks		Heat Pumps, Portable	
Air Compressor Accessories	50-55	Pumps	6-20	Heaters, Electric	
Aftercooler/Dryer/Filter Packages		Air Diaphragm Pumps		Heaters, Hydronic Ground	
Aftercooler/Filter Packages		Diesel Trash Pumps, Silenced		Heaters, Indirect-Fired Oil & Gas	
Aftercooler/Separators		Diesel Trash Pumps, Standard		Heaters, Specialty	
Air Hose		Double Diaphragm Pumps, Diesel		High Static Blowers	
Air Manifolds		Electric Submersible Pumps		Hybrid Cooling Units	
Custom Filter Packages		Electric Trash Pumps		Reference Data, Dehumidification	
Desiccant Dryer Packages		High Head Pumps, Diesel		Reference Data, Heaters	
Membrane Dryer/Aftercoolers		Hydraulic Power Packs		Sunbelt Air Monitoring System (SAMS)	
Refrigerated Dryer Packages		Hydraulic Submersible Pumps			
Safety Whipchecks		Performance Testing & Pump Services		Trench Shoring Equipment	70-78
Generators	28-34	Reference Data, Pumps		Aluminum Lite-Shields	
Diesel Generators, Industrial		Wellpoint Pumps		Hydraulic Shoring Shields	
Diesel Generators, Movie Set				Hydraulic Vertical Shores	
Diesel Generators, Towable		Pump Accessories	21-27	Reference Data, Trench Shoring	
Natural Gas Generators		Auto-Start Systems		Road Plates, Steel	
Reference Data, Generators		Auxiliary Fuel Tanks		Steel Bedding/Rock Boxes	
Generator Accessories	35-41	Butterfly Valves & Gate Valves		Steel Manhole Boxes	
Auxiliary Fuel Tanks		Bauer Pipe & Fittings		Trench Boxes, Aluminum	
Cable Ramps		Flange Adapters		Trench Boxes, Steel	
Cam-Lock Connectors		HDPE Pipe & Fittings		Water Tap Boxes	
Distribution Panels		Hose & Fittings			
Extension Cables		LOFA Panels			
Fuseable Disconnect Switches		Pipe Plugs			
I-Line Multi-Panels		Remote Monitoring Systems			
Load Banks, Resistive		Road Ramps			
Mill Panels		Swing Check Valves			
Pigtail Adapters		Transducers			
Power Cables					
Quad Box Strings					
Remote Monitoring Systems					
Spider Boxes					
Step-Down Transformers					
Three Gang Boxes					
Transfer Switches, Double Throw					



PUMP & POWER
SERVICES

Sunbelt Rentals
Pump & Power Services

800-736-2504

Available 24/7

Location Directory

82-83

Application For Credit & Rental Agreement 79-80



PUMPS

SILENCED DIESEL TRASH PUMPS

PUMPS

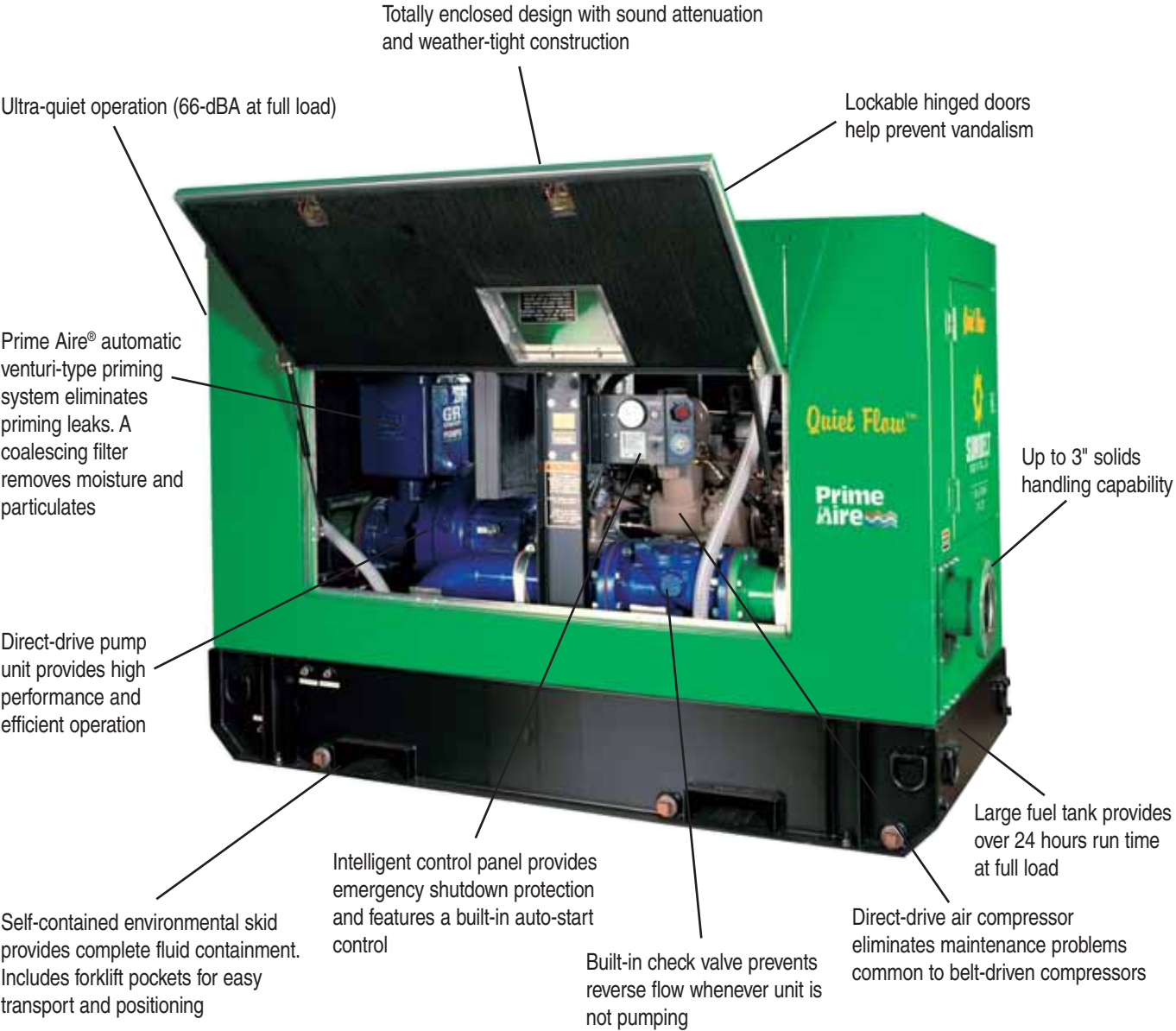

Quiet Flow™ Silenced Diesel Trash Pumps

Offered exclusively by
Sunbelt Rentals Pump & Power Services



PUMPS

SILENCED DIESEL TRASH PUMPS

QUIET FLOW™ SILENCED DIESEL TRASH PUMPS are available in 4", 6", 10", 12" and 18" models, offered exclusively by Sunbelt Rentals Pump & Power Services locations. These state-of-the-art pumps have set a new industry standard for both pump performance and environmental protection. They feature a totally enclosed design with outstanding sound attenuation and a self-contained environmental skid that captures any possible leaks of engine oil, fuel, or coolant.

- Ultra-quiet operation (66 dBA at full load)
- Prime Aire® automatic priming system (see illustration below)
- Up to 3" solids handling capability
- Built-in auto-start capability
- Large fuel tanks provide over 24 hours run time at full load
- Auxiliary fuel tanks are also available (see page 22)
- Direct-drive pump units provide reduced maintenance



(3) Quiet Flow 12" Silenced Diesel Trash Pumps

Working on a sewer bypass project

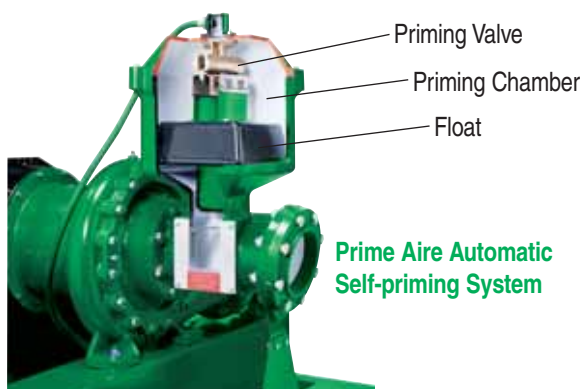

Prime Aire Automatic Self-priming System



Solids Handling Impeller
Heavy-duty impellers handle up to 3" diameter solids for fewer clogs on tough jobs.



Direct-Drive Air Compressor
Eliminates maintenance problems common to belt-driven compressors

Type	Suction x Discharge	Max GPM	Max Head	Engine	Onboard Fuel Cap	Consump Full Load	Run Time Full Load	Overall Dimensions	Dry Weight	Cat-Class
4" QF ¹	4" x 4"	1,400	118'	Yanmar 35 HP	60 gal.	1.75 GPH	34 hrs.	128"L x 64"W x 59"H	3,020 lbs.	041-0137
6" QF	6" x 6"	2,280	158'	John Deere 76 HP	87 gal.	3.1 GPH	28.1 hrs.	108"L x 48"W x 74"H	4,212 lbs.	041-0160
10" QF ²	10" x 8"	4,100	158'	John Deere 150 HP	135 gal.	5.8 GPH	28.4 hrs.	145"L x 60"W x 89"H	7,000 lbs.	041-0240
12" QF ²	12" x 12" Std.	6,320	104'	John Deere 150 HP	174 gal.	7.4 GPH	23.6 hrs.	151"L x 77"W x 87"H	9,200 lbs.	041-0330
12" HV QF ²	12" x 12" HV	8,500	200'	John Deere 250 HP	300 gal.	10.5 GPH	28.6 hrs.	154"L x 70"W x 80"H	11,000 lbs.	041-0340
18" HV QF	18" x 18" HV	12,500	175'	John Deere 315 HP	300 gal.	15 GPH	20.7 hrs.	160"L x 80"W x 95"H	13,000 lbs.	041-0408

¹Trailer-mounted model ²Skid-mounted models

Note: 6" x 6" and 10" x 8" models are also available trailer-mounted.

PUMPS

PUMPS

STANDARD DIESEL TRASH PUMPS

STANDARD DIESEL TRASH PUMPS are available in 4", 6", 10", 12" and 24" models. We offer an extensive fleet of large, diesel-driven trash pumps for performing sewer bypass, plant shutdowns, dewatering flooded areas and drought relief pumping applications. All models feature continuously operating priming systems designed for extended periods of dry running.

- 4" to 24" models available
- Up to 4" solids handling capability
- All pumps feature continuously operating priming systems
- Emergency engine shutdown protection
- Automatic start/stop capability is available
- Large fuel tanks provide over 24 hours run time at full load
- Auxiliary fuel tanks are also available (see page 22)
- Both skid- and trailer-mounted pumps are available

PUMPS



Gorman-Rupp 4" x 4" Diesel Trash Pumps



Gorman-Rupp 6" x 4" Diesel Trash Pump
Working on a construction dewatering project



(3) Gorman-Rupp 12" x 12" Diesel Trash Pumps
Working on a municipal bypass project



Premier 24" x 24" Diesel Trash Pump
Working on an emergency dewatering project

Type	Suction x Discharge	Max GPM	Max Head	Engine	Onboard Fuel Cap	Consump Full Load	Run Time Full Load	Overall Dimensions	Dry Weight	Cat-Class
4" NS ²	4" x 4"	1,050	153'	John Deere 72 HP	88 gal.	3.1 GPH	28.4 hrs.	122"L x 71"W x 91"H	3,260 lbs.	041-0130
6" NS ²	6" x 6"	2,600	160'	John Deere 76 HP	120 gal.	3.3 GPH	36.4 hrs.	135"L x 66"W x 83"H	3,417 lbs.	041-0150
10" NS ¹	10" x 10"	4,100	160'	John Deere 153 HP	171 gal.	7.8 GPH	21.9 hrs.	108"L x 60"W x 83"H	4,365 lbs.	041-0230
12" NS ¹	12" x 12"	6,320	104'	John Deere 153 HP	171 gal.	7.8 GPH	21.9 hrs.	120"L x 55"W x 85"H	4,510 lbs.	041-0320
24" NS ²	24" x 24"	16,000	200'	John Deere 425 HP	100 gal.	22.2 GPH	4.5 hrs.	192"L x 92"W x 94"H	16,000 lbs.	041-0400

¹Skid-mounted models ²Trailer-mounted models

PUMPS

ELECTRIC-DRIVEN TRASH PUMPS, DIESEL HIGH HEAD PUMPS

ELECTRIC-DRIVEN TRASH PUMPS are ideal for bypass, plant shutdowns and other applications where 460V 3-phase electric power is available, providing quiet, dependable, unattended operation. They also save considerable time and expense by not having to be refueled.

- 4", 6", 8" and 12" skid-mounted models
- Operate on 460V 3-phase electric power
- NEMA 3R weather resistant control panel
- Automatic self-priming systems
- Up to 3" solids handling capability
- Built-in auto-start capability



(2) Gorman-Rupp 12" x 12" Electric Drive Trash Pumps

Type	Suction x Discharge	Max GPM	Max Head	Max Solids	HP	Voltage	Amp Rating	Overall Dimensions	Weight	Cat-Class
4"E	4" x 4"	1,000	82'	3"	30	460V, 3ø	34	48"L x 36"W x 33"H	2,000 lbs.	041-0120
6"E	6" x 6"	2,200	120'	3"	50	460V, 3ø	57	72"L x 49"W x 67"H	3,310 lbs.	041-0140
8" E	8" x 8"	3,100	130'	3"	100	460V, 3ø	113	118"L x 60"W x 61"H	5,690 lbs.	041-0210
12" E	12" x 12"	6,000	96'	3"	125	460V, 3ø	155	118"L x 61"W x 64"H	6,515 lbs.	041-0310
8" E HH	8" x 6" HH	3,200	300'	3"	125	460V, 3ø	155	90"L x 49"W x 58"H	1,200 lbs.	041-0445

DIESEL HIGH HEAD (HIGH-PRESSURE) PUMPS are capable of handling flows at significantly higher total dynamic head (TDH) ratings than standard trash pumps. They utilize a closed design impeller and a compact volute called a diffuser to generate high discharge pressure. However, they cannot handle large solids. Applications include quarries, forced mains and other high head applications where the TDH requirement is greater than 75'.

- 3" to 10" models available
- Sound-attenuated models (Premier 6" x 4" and 10" x 8")
- All pumps feature continuously operating priming systems
- Automatic start/stop capability
- Both skid- and trailer-mounted pumps
- Large fuel tanks provide extended run times at full load
- Auxiliary fuel tanks are also available (see page 22)



(2) Gorman-Rupp Diesel High Head Pumps

Type	Suction x Discharge	Max GPM	Max Head	Engine	Onboard Fuel Cap	Consump Full Load	Run Time Full Load	Overall Dimensions	Dry Weight	Cat-Class
3" HH NS ¹	3" x 3"	450	300'	John Deere 75 HP	120 gal.	3.6 GPH	33.3 hrs.	135"L x 66"W x 83"H	3,150 lbs.	041-0410
6" HH NS ¹	6" x 4"	1,220	296'	John Deere 103 HP	88 gal.	4.2 GPH	21.0 hrs.	104"L x 53"W x 75"H	3,750 lbs.	041-0420
6" HH QF ^{1,3}	6" x 4"	1,500	330'	John Deere 103 HP	130 gal.	5.4 GPH	24.0 hrs.	159"L x 76"W x 79"H	4,900 lbs.	041-0425
8" HH NS ²	8" x 6"	2,250	320'	John Deere 210 HP	250 gal.	11.0 GPH	22.7 hrs.	144"L x 72"W x 85"H	8,000 lbs.	041-0440
10" HH NS ²	10" x 6"	4,300	260'	John Deere 203 HP	130 gal.	9.8 GPH	13.2 hrs.	124"L x 62"W x 84"H	5,495 lbs.	041-0455
10" HH QF ^{2,3}	10" x 8"	4,000	360'	John Deere 201 HP	120 gal.	10.0 GPH	12.0 hrs.	188"L x 85"W x 79"H	9,600 lbs.	041-0457

¹Trailer-mounted models ²Skid-mounted models ³Sound-attenuated models

PUMPS

PUMPS

SPECIFICATION TABLES, PERFORMANCE CURVES



SILENCED DIESEL TRASH PUMPS

Type	Suction x Discharge	Mounting Type	Max GPM	Max Head	Max Solids	Diesel Engine	HP	Onboard Fuel Cap	Consump Full Load
4" QF	4" x 4"	Trailer	1,400	118'	3"	Yanmar	35	60 gal.	1.75 GPH
6" QF	6" x 6"	Skid ¹	2,280	158'	3"	John Deere 4045D	76	87 gal.	3.1 GPH
10" QF	10" x 8"	Skid ¹	4,100	158'	3"	John Deere 4045H	185	135 gal.	5.8 GPH
12" QF	12" x 12" Std.	Skid	6,500	112'	3"	John Deere 6081H	185	175 gal.	6.2 GPH
12" HV QF	12" x 12" HV	Skid	8,500	200'	3"	John Deere 6081H	250	300 gal.	10.5 GPH
18" HV QF	18" x 18" HV	Skid	12,500	175'	4"	John Deere 6091H	315	300 gal.	14.5 GPH

¹Trailer-mounted models are also available.



STANDARD DIESEL TRASH PUMPS

Type	Suction x Discharge	Mounting Type	Max GPM	Max Head	Max Solids	Diesel Engine	HP	Onboard Fuel Cap	Consump Full Load
4" NS	4" x 4"	Trailer ¹	1,050	153'	3"	John Deere 4045D	72	88 gal.	3.1 GPH
6" NS	6" x 6"	Trailer ¹	2,600	160'	3"	John Deere 4045D	76	120 gal.	3.3 GPH
10" NS	10" x 10"	Skid	4,100	160'	3.25"	John Deere 6068T	153	171 gal.	7.8 GPH
12" NS	12" x 12"	Skid	6,320	104'	3"	John Deere 6068T	153	171 gal.	7.8 GPH
24" NS	24" x 24"	Skid	16,000	200'	4.5"	John Deere 6125H	400	100 gal.	22.5 GPH

¹Skid-mounted models are also available.



DIESEL HIGH HEAD PUMPS

Type	Suction x Discharge	Mounting Type	Max GPM	Max Head	Max Solids	Diesel Engine	HP	Onboard Fuel Cap	Consump Full Load
3" HH NS	3" x 3"	Trailer	450	300'	1"	John Deere 4045D	75	120 gal.	3.6 GPH
6" HH NS	6" x 4"	Skid	1,220	296'	3"	John Deere 4045T	103	88 gal.	4.2 GPH
6" HH QF ¹	6" x 4"	Trailer	1,500	330'	3"	John Deere 4045T	103	130 gal.	5.4 GPH
8" HH NS	8" x 6"	Skid	2,250	320'	1.5"	John Deere 6081T	210	250 gal.	11.0 GPH
10" HH NS	10" x 6"	Skid	4,300	360'	3"	John Deere 6068H	203	130 gal.	9.8 GPH
10" HH QF ¹	10" x 8"	Skid	4,000	330'	3"	John Deere 6068H	201	120 gal.	10.0 GPH

¹Sound-attenuated models (Quiet Flow)



ELECTRIC-DRIVEN TRASH PUMPS

Make	Suction x Discharge	Mounting Type	Max GPM	Max Head	Max Solids	HP	Voltage
4" E	4" x 4"	Skid	1,000	82'	3"	30	460V, 3-phase
6" E	6" x 6"	Skid	2,200	124'	3"	50	460V, 3-phase
8" E	8" x 8"	Skid	3,100	130'	3"	100	460V, 3-phase
12" E	12" x 12"	Skid	6,000	98'	3"	125	460V, 3-phase
8" E HH	8" x 6" HH	Skid	3,200	300'	3"	125	460V, 3-phase



Data Sheets with detailed specifications and individual performance curves are available for pumps listed on this page. For more information, call 800-736-2504.

Run Time Full Load	Overall Dimensions	Weight Wet/Dry	Cat-Class
34 hrs.	128"L x 64"W x 59"H	3,020/3,391 lbs.	041-0137
28.1 hrs.	108"L x 48"W x 74"H	4,876/4,212 lbs.	041-0160
28.4 hrs.	145"L x 60"W x 89"H	8,166/7,000 lbs.	041-0240
28.2 hrs.	156"L x 71"W x 103"H	10,215/9,000 lbs.	041-0330
28.6 hrs.	154"L x 70"W x 80"H	13,100/11,000 lbs.	041-0330
20.0 hrs.	160"L x 80"W x 95"H	15,000/13,000 lbs.	041-0408

Run Time Full Load	Overall Dimensions	Weight Wet/Dry	Cat-Class
28.4 hrs.	122"L x 71"W x 91"H	3,924/3,260 lbs.	041-0130
36.4 hrs.	135"L x 66"W x 83"H	4,080/3,239 lbs.	041-0150
21.9 hrs.	108"L x 60"W x 83"H	5,562/4,365 lbs.	041-0230
21.9 hrs.	120"L x 55"W x 85"H	5,717/4,510 lbs.	041-0320
4.5 hrs.	192"L x 92"W x 94"H	16,700/16,000 lbs.	041-0350

Run Time Full Load	Overall Dimensions	Weight Wet/Dry	Cat-Class
33.3 hrs.	135"L x 66"W x 83"H	3,990/3,150 lbs.	041-0410
21.0 hrs.	104"L x 53"W x 75"H	4,366/3,750 lbs.	041-0420
24.0 hrs.	159"L x 76"W x 79"H	5,810/4,900 lbs.	041-0425
22.7 hrs.	144"L x 72"W x 85"H	9,750/8,000 lbs.	041-0440
13.2 hrs.	124"L x 62"W x 84"H	6,405/5,495 lbs.	041-0455
12.0 hrs.	188"L x 85"W x 79"H	10,440/9,600 lbs.	041-0457

Amp Rating	Overall Dimensions	Weight	Cat-Class
34	48"L x 36"W x 33"H	2,000 lbs.	041-0120
57	72"L x 49"W x 67"H	3,310 lbs.	041-0140
113	118"L x 60"W x 61"H	5,690 lbs.	041-0210
155	118"L x 61"W x 64"H	6,515 lbs.	041-0310
155	90"L x 49"W x 58"H	1,200 lbs.	041-0445

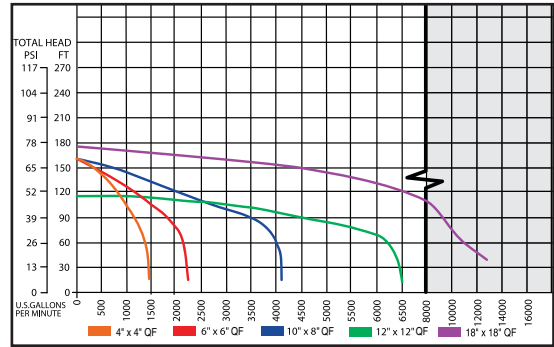

Silenced Diesel Trash Performance Curves

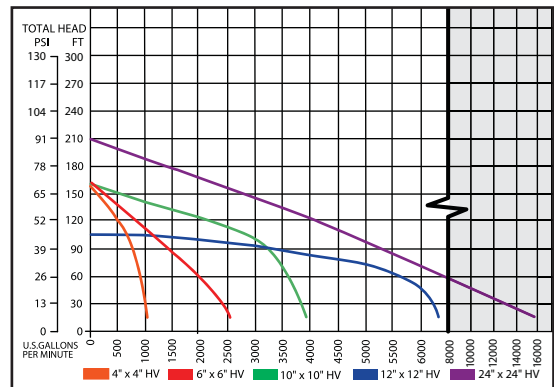

Standard Diesel Trash Performance Curves

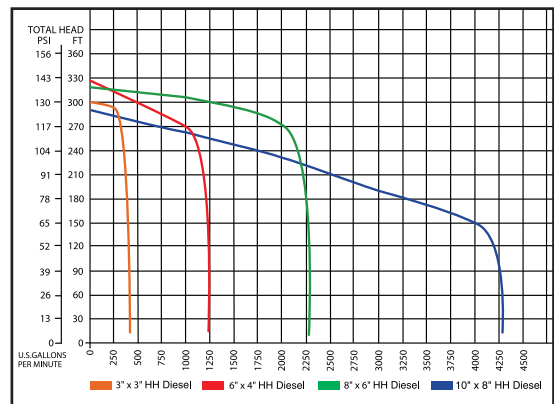

Diesel High-Head Performance Curves

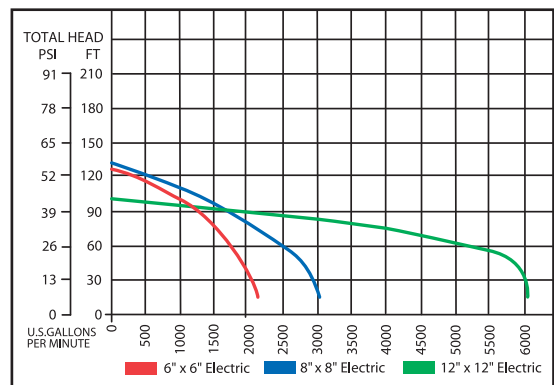

Electric-Driven Trash Performance Curves

PUMPS

PUMPS

460V ELECTRIC SUBMERSIBLE PUMPS

460V ELECTRIC SUBMERSIBLE PUMPS are designed for high-volume dewatering and bypass applications where 460V 3-phase electric power is available. Dewatering, high head and trash types are available.

- 2" to 12" pumps available, with flows up to 11,000 GPM
- Smaller pumps feature a slim design that allows placing them inside narrow casings
- All 3-phase pumps include a 50' or 100' power cable and a weather resistant control panel



Mody 4" 10 HP Dewatering Pump
Operating in a dewatering application.



2" Dewatering pump being lowered inside a narrow casing



Gorman-Rupp 8" 70 HP Trash Pump
One of four 8" trash pumps utilized on a wastewater treatment plant bypass job being lowered into a wet well

Make	Type	Discharge	Max GPM	Max Head	Max Solids	HP	Voltage	Amp Rating	Max Pump Diameter	Weight	Cat-Class
Mody	Dewatering	2"	175	72'	.25"	2	460V, 3ø	3.9	6.25"	39 lbs.	047-0110
Tsurumi	Dewatering	3"	291	72'	.25"	4	460V, 3ø	6.0	7.3"	93 lbs.	047-0130
Mody	Dewatering	3"	400	78'	.25"	5	460V, 3ø	7.1	7.50"	88 lbs.	047-0130
Mody	Dewatering	4"	830	98'	.25"	10	460V, 3ø	14.0	10.75"	142 lbs.	047-0140
Mody	High Head	4"	300	265'	.38"	16	460V, 3ø	22.0	14.20"	310 lbs.	047-0150
Gorman-Rupp	Trash	4"	600	140'	3"	19	460V, 3ø	24.4	22.41"	620 lbs.	047-0160
Gorman-Rupp	Dewatering	4"	900	128'	1"	25	460V, 3ø	30.0	23.25"	602 lbs.	047-0170
Gorman-Rupp	Dewatering	6"	1,900	98'	1"	35	460V, 3ø	40.0	23.25"	595 lbs.	047-0210
Mody	High Head	6"	650	265'	.38"	35	460V, 3ø	44.0	15.75"	525 lbs.	047-0210
Gorman-Rupp	Trash	6"	2,500	111'	4"	43	460V, 3ø	53.3	37.60"	996 lbs.	047-0230
Gorman-Rupp	Trash	8"	5,000	111'	4"	70	460V, 3ø	91.0	56.50"	1,594 lbs.	047-0240
Gorman-Rupp	Dewatering	8"	2,700	159'	1"	95	460V, 3ø	105.0	28.00"	1,100 lbs.	047-0250
Gorman-Rupp	Trash	12"	11,000	115'	5"	147	460V, 3ø	173.5	69.88"	3,377 lbs.	047-0310

PUMPS

PUMPS

HYDRAULIC SUBMERSIBLE PUMPS, HYDRAULIC POWER PACKS

HYDRAULIC SUBMERSIBLE PUMPS are ideal for applications requiring a suction lift greater than 25' and with high solids concentration. A wide selection of hydraulic pump heads, plus matching diesel-driven hydraulic power packs are available.

- **Trash Pumps** are ideal for pumping water containing solids such as mud, sticks and other foreign materials, utilizing a semi-open impeller design
- **Sludge Pumps** can handle heavy concentrations of viscous material, due to a specially designed impeller that spins the material in the top of the volute
- **Slurry/Digester Pumps** (Slurry Gate) are sludge pumps equipped with a hydraulic activated gate which, when opened, produces a mixing action. This allows heavier materials to be introduced to lighter ones, which produces a more uniform material to be pumped once the gate is closed



Trash/Sludge Pump Head

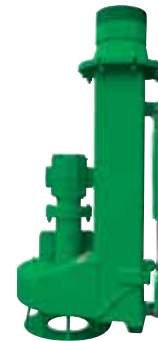

Slurry Gate Pump Head

PUMPS

Make	Model	Type	Discharge	Max GPM	Max Head	Max Solids	Matching Power Unit	Hydraulic Flow	Weight	Cat-Class
Gulf Atlantic	2-32 x 4-30	Trash/Sludge	4"	1,000	85'	3"	30 HP	21 GPM	135 lbs.	045-0210
Gulf Atlantic	3-32 x 4-60	Slurry Gate	4"	1,100	115'	3"	60 HP	41 GPM	175 lbs.	045-0210
Gulf Atlantic	2-32 x 4-60	Trash/Sludge	4"	1,100	115'	3"	60 HP	41 GPM	135 lbs.	045-0230
Gulf Atlantic	2-37 x 6-30	Trash/Sludge	6"	1,500	50'	3.5"	30 HP	20 GPM	205 lbs.	045-0310
Gulf Atlantic	2-37 x 6-60	Trash/Sludge	6"	1,900	82'	3.5"	60 HP	45 GPM	205 lbs.	045-0330
Gulf Atlantic	3-37 x 4-60	Slurry Gate	6"	2,200	95'	3.5"	100 HP	54 GPM	265 lbs.	045-0350
Gulf Atlantic	2-50 x 8-100	Trash/Sludge	8"	4,000	58'	4.5"	100 HP	62 GPM	730 lbs.	045-0420
Gulf Atlantic	2-50 x 10-100	Trash/Sludge	10"	5,000	58'	4.5"	100 HP	62 GPM	740 lbs.	045-0510
Gulf Atlantic	2-67 x 12-150	Trash/Sludge	12"	6,000	72'	5.5"	150 HP	80 GPM	915 lbs.	045-0610

Note: Stainless steel models are also available for pumping corrosive liquids.

DIESEL-DRIVEN HYDRAULIC POWER PACKS

are trailer-mounted for portability and designed for extended periods of continuous operation.

- 30 HP to 150 HP models
- Large fuel tanks provide over 24 hours run time at full load
- Auxiliary fuel tanks are available for longer run times (see page 22)
- All models utilize biodegradable hydraulic fluid to help protect the environment



Gulf Atlantic ZU-100JT 100 HP Hydraulic Power Pack

Make	Model	HP	Hydraulic Flow	Supply*	Return*	Onboard Fuel Cap	Consump Full Load	Run Time Full Load	Overall Dimensions	Weight	Cat-Class
Gulf Atlantic	ZU-35JT	35	31 GPM	3/4"	1"	53 gal.	1.9 GPH	27.9 hrs.	72"L x 72"W x 68"H	2,000 lbs.	042-0135
E & E	4045D ¹	60	44 GPM	1-1/4"	1-1/2"	97 gal.	3.7 GPH	26.2 hrs.	160"L x 75"W x 78"H	6,100 lbs.	042-0150
Gulf Atlantic	ZU-60JT	60	42 GPM	1"	1-1/4"	96 gal.	2.6 GPH	36.9 hrs.	96"L x 72"W x 68"H	2,500 lbs.	042-0160
Gulf Atlantic	ZU-85JT	85	62 GPM	1"	1-1/4"	112 gal.	3.4 GPH	32.9 hrs.	138"L x 72"W x 68"H	3,100 lbs.	042-0170
Gulf Atlantic	ZU-100JT	100	71 GPM	1-1/4"	1-1/2"	112 gal.	3.9 GPH	28.7 hrs.	138"L x 72"W x 68"H	3,100 lbs.	042-0180
Gulf Atlantic	ZU-150JT	150	106 GPM	1-1/2"	1-1/2"	121 gal.	5.3 GPH	22.8 hrs.	149"L x 72"W x 68"H	3,500 lbs.	042-0190

*Supply and return connections shown accommodate runs up to 50' from the power unit. For longer runs, increase hose diameter by 1/4" in each direction.

¹Environmental model with sound-attenuation and complete fluid containment

PUMPS

AIR DIAPHRAGM PUMPS, WELLPOINT PUMPS, DOUBLE DIAPHRAGM PUMPS

AIR DIAPHRAGM PUMPS provide pumping solutions for applications where compressed air is available as a power source. Output is variable, dependent upon the air supply pressure, which should not exceed 125 PSI (100 PSI maximum for polypropylene models).

- All models are self-priming, can be run dry and handle suction lifts of 10' to 20'
- Submersible—pumps can be dropped to the bottom of a tank
- Suitable for hazardous location applications
- Variable flow rates, determined by the inlet air pressure
- All models feature a 1:1 ratio (inlet air pressure vs. discharge outlet pressure)

Note: Air diaphragm pumps provide a variety of application options. Please contact Sunbelt Rentals Pump & Power Services for technical assistance: 800-736-2504



2" Stainless Steel Pump

3" Aluminum Pump

Make	Model	Suction/Discharge	Housing	Diaphragm	Flow Range	Max Head	Max Solids	Max Temp	Applications	Weight	Cat-Class
Ingersoll-Rand	6661AF-344-C	1"	Polypropylene	Teflon	0-35 GPM	240'	.125"	175°	Chemical transfer	24 lbs.	047-0010
Ingersoll-Rand	PD20A-AAP-GGG	2"	Aluminum	Buna	0-170 GPM	240'	.430"	212°	Neutral (6-8 pH)	64 lbs.	047-0020
Versa-Matic	E2PA5B5T9	2"	Polypropylene	Teflon	0-165 GPM	240'	.250"	175°	Chemical transfer	72 lbs.	047-0030
Ingersoll-Rand	PD2A-ASP-STT	2"	Stainless Steel	Teflon	0-170 GPM	240'	.250"	212°	Acid (0-3 pH), caustic (11-14 pH)	154 lbs.	047-0040
Ingersoll-Rand	PD30A-AAP-GGG-B	3"	Aluminum	Buna	0-275 GPM	240'	.375"	212°	Neutral (6-8 pH)	113 lbs.	047-0050
Ingersoll-Rand	PD30A-ACP-GGG-B	3"	Cast Iron	Buna	0-275 GPM	240'	.375"	212°	Acid (4-5 pH), caustic (9-10 pH)	197 lbs.	047-0060
Versa-Matic	E3PQ5T559	3"	Polypropylene	Teflon	0-150 GPM	231'	.710"	150°	Chemical transfer	237 lbs.	047-0070
Ingersoll-Rand	PD30A-ASP-STT-B	3"	Stainless Steel	Teflon	0-275 GPM	240'	.375"	212°	Acid (0-3 pH), caustic (11-14 pH)	203 lbs.	047-0080

DIESEL WELLPOINT PUMPS are specifically designed for underground dewatering applications, used with PVC headers and points to dewater construction sites prior to excavation. A high-efficiency air separation tank allows the pump to handle large volumes of air and water. A dry prime system automatically primes and reprimers the pump while it is running.

Croy 6RH 6" Standard Pump; 3,350 lbs. dry weight (Cat-Class 041-0520)

Croy 6RHSA 6" Sound-attenuated Pump; 3,650 lbs. dry weight (Cat-Class 041-0525)

Note: Wellpoint pumps are available in select markets only.



Croy 6RHSA 6" Sound-attenuated Diesel Wellpoint Pump



Myers-Seth DD-4/HA/T 4" Diesel Double Diaphragm Pump

DIESEL DOUBLE DIAPHRAGM PUMPS are positive displacement pumps that are ideal for handling the mud and slurries often found at construction sites, as well as for pumping abrasive materials. They feature a double plunger design with dual diaphragm pump chambers and heavy-duty cushion rods for rugged, dependable performance. Pumps are self-priming and can run dry continuously.

Myers-Seth DD-4/HA/T (Cat-Class 041-0010)

- 4" pump mounted on towable trailer, 1,350 lbs. dry weight
- Hatz diesel engine
- 300 max GPM, 65' max head, 3.5" max solids

PUMPS

PUMP SERVICES



Sewer bypass completed in Baltimore, MD., with 16 18" Quiet Flow™ pumps, all designed and installed by Sunbelt Rentals Pump & Power Services.

PUMPS

PUMP SERVICES include the complete design of temporary pump and pipeline systems, from suction to discharge. We can help you determine the most productive and cost efficient pump solution for all your fluid handling needs.

Note: See pages 16–20 for reference information including pump basics, determining pump requirements and performance calculations.

Sunbelt Rentals technicians servicing a 24" diesel trash pump on a multi-pump municipal sewer bypass project



For more information about large pumps and custom installations, call Sunbelt Rentals Pump & Power Services at 800-736-2504. 24-Hour Service



PUMPS

LARGE PUMP BASICS

GLOSSARY

Atmospheric Pressure—the force exerted by the atmosphere on the earth's surface, which allows a centrifugal pump to operate. At sea level, the atmospheric pressure equals 14.7 PSI.

Brake Horsepower (HP)—pump performance can be expressed in horsepower using the following formula:

$$\text{Brake HP} = \text{GPM} \times \text{Ft./Head} \div 3940$$

Capacity—the water handling capability (volume) of a pump expressed as gallons per minute (GPM).

Cavitation—status in which the pump impeller is not receiving a full supply of material. This can be due to reduced flow or over rotation. Excessive pump RPM can cause a vortex in the eye of the impeller. Air bubbles attach to the metal surfaces and, under extreme pressure, implode, taking tiny bits of metal away with each implosion, pitting the impeller and volute surfaces.

Centrifugal Force—the action that causes something to move away from its center of rotation.

Centrifugal Pump—uses centrifugal force to move water or other liquids. Centrifugal pumps use an impeller and a volute to create the partial vacuum and discharge pressure necessary to move water through the casing. The impeller and volute form the heart of a pump—their design determines its flow, pressure and solid handling characteristics. As the impeller rotates and churns the water, it purges air from the casing, creating an area of low pressure, or partial vacuum, at the eye (center) of the impeller. The weight of the atmosphere on the external body of water pushes water rapidly through the hose and pump casing toward the eye of the impeller. Centrifugal force created by the rotating impeller pushes water away from the eye, where pressure is lowest, to the vane tips where pressure is the highest. The velocity of the rotating vanes pressurizes the water, forcing it through the volute and discharging it from the pump.

Check Valve—(swing check valve) a device used in a suction or discharge line that allows flow in only one direction, isolating the material being pumped.

Critical Lifts—suction lifts greater than 25'

Dewatering Pump—designed for clear water applications (agricultural, industrial and residential). As a general rule, dewatering pumps are limited to a 10% solids concentration and a solids size of one-fourth the diameter of the suction inlet.

Diaphragm Pump—uses a positive displacement design rather than centrifugal force to move water through the casing, delivering a specific amount of flow per stroke, revolution or cycle. Diaphragm pumps are ideal for applications with slow seepage at the point of suction, due to their great air handling capabilities.

Duty Point—The point on a performance curve that plots flow (GPM) and head (feet).

Dynamic Discharge Head—the sum of the static discharge head and the discharge friction loss in the discharge line. Also referred to as Total Discharge Head.

Dynamic Suction Head—the sum of the static suction lift and the suction friction loss in the suction line. Also referred to as Total Suction Head.

Flow Rate—how many gallons per minute (GPM) of pump flow are required. Flow can also be expressed in gallons per hour (GPH) and in million gallons per day (MGD).

$$1 \text{ MGD} = 700 \text{ GPM.}$$

Float Switch—a device used to start and stop a pump based on preset water levels.

Fluid Type—whether the fluid being pumped is clean or dirty, contains any solids or abrasives or is a hazardous material.

Friction Loss—reductions in flow due to turbulence as water passes through hoses, pipes, valves and fittings. This includes both suction and discharge friction losses.

Head—gains or losses in pressure caused by gravity and friction as water moves through a system. It can be measured in lbs. per square inch (PSI) or feet of water. A pump must produce 1 PSI to push a column of water vertically 2.31 feet. Use the following formulas to convert:

$$\begin{aligned} \text{Max pressure} \times 2.31 &= \text{Max Head Rating} \\ \text{Max Head Rating} \div 2.31 &= \text{Max Pressure} \end{aligned}$$

High Head (high-pressure) Pump—capable of handling flows at significantly higher total dynamic head ratings (TDH). They utilize a closed design impeller and a compact volute called a *diffuser* to generate the high dis-

charge pressure needed and cannot handle large solids.

Hose Length (or Pipe)—the suction and discharge hose or pipe lengths required for a given application. Longer hoses increase friction loss, reducing pump performance. Hose lengths should be kept as short as possible.

Impeller—a rotating disk with a set of vanes coupled to the engine or drive shaft that produces centrifugal force within the pump casing of a centrifugal pump.

Maximum Suction Lift—the height (approximately 25') that water can be lifted by a centrifugal pump in actual conditions, taking into consideration altitude, friction loss, temperature, suspended particles and the inability to create a perfect vacuum. The 25' suction lift is attainable for cold water (60°F) at sea level.

Mechanical Seal—a spring-loaded pump component that forms a seal between the pump and the engine or motor. Pumps designed for working in harsh environments require a more abrasive resistant seal.

Net Positive Suction Head (NPSH)—the amount of energy in the liquid at the pump inlet. It must be defined to have meaning, as either available or required.

Performance Curve—a chart or graph that illustrates pump performance by plotting the total head and flow rate at various suction lifts. Performance curves for diesel-driven pumps also show pump performance at various engine RPMs.

Prime—the creation of a partial vacuum inside the pump casing, which allows water to flow into the pump.

Seepage—the rate at which the fluid being pumped accumulates at the point of suction. Slow seepage allows air into the pump suction, which causes some types of pump to lose their prime.

Self-priming—the ability of a pump to purge air from its casing and suction hose, creating a partial vacuum and allowing water to flow freely into the pump.

Solids Concentration—ratio of solids to liquid in the overall volume of the material being pumped, which is helpful in determining the proper pump for the application.

continued on next page

PUMPS

LARGE PUMP BASICS

Solids Size—average diameter of individual particles in the material being pumped, which is important to know when specifying a pump. Large solids can be filtered with strainers or rock guards.

Static Discharge Head—the vertical distance from the centerline of the pump impeller to the point of discharge. (see dynamic discharge head)

Static Suction Lift—the vertical distance from the lowest suction point to the centerline of the pump impeller. This distance should be kept to a minimum for maximum pump performance. (see theoretical and maximum suction lift)

Submersible Pump—a centrifugal pump designed to operate within the water source being pumped, thereby eliminating the suction lift limitations common to other types.

Theoretical Suction Lift—the maximum height (33.9') that water can be lifted inside a tube under perfect conditions (perfect vacuum) at sea level. At this point, the water inside exerts a pressure equal to the weight of the atmosphere pushing down on the ocean's surface. Theoretical suction lift is calculated by dividing the atmospheric pressure at sea level (14.7 lbs. per square inch) by the weight of one cubic inch of water (.0361 lbs.). This equals 407.2" or 33.9'.

Total Dynamic Head (TDH)—the sum of the dynamic suction head and the dynamic discharge head. Also referred to as Total Head.

Trash Pump—designed to handle large amounts of debris, with a solid handling capability of 25% by volume. As a rule of thumb, trash pumps can handle spherical solids up to one-half the diameter of the suction inlet. Larger, diesel-driven trash pumps (4" to 12" diameter) are designed to handle 3" diameter solids.

Viscosity—the resistance to flow of a liquid at a given temperature. Highly viscous liquids are thick and tend to flow slower than liquids of low viscosity.

Volute—the casing surrounding the impeller in a centrifugal pump that collects the liquid discharged from the impeller.

DETERMINING PUMP REQUIREMENTS

To select the most suitable pump(s) for your application, follow the steps below.

1. Establish the following factors: fluid type, flow rate required, hose (or pipe) lengths required, static suction lift, static discharge head and seepage.

2. Calculate the dynamic suction head, which equals the sum of the static suction lift and the friction loss added by suction pipe, valves and fittings needed for the installation. To begin, select a pipe or hose diameter based on the flow rate required, referring to a reference chart that plots flow, velocity and friction loss per 100' of length for various diameters of hose or pipe. Friction loss for valves and fittings is expressed in equivalent feet of straight pipe of the same diameter, which is obtained using reference conversion charts. The sum of the friction losses for suction pipe, valves and fittings is divided by 100 to calculate the friction loss in feet, which is added to the static suction lift to determine the dynamic suction head. To utilize centrifugal pumps, the dynamic suction head must be less than 25'. Submersible pumps must be used if the dynamic suction head is greater than 25'.

Tip: Using larger diameter suction pipe may reduce friction loss enough to lower the dynamic suction head to a workable range in applications with a high static suction lift (15' or larger).

3. Calculate the dynamic discharge head, which equals the sum of the static discharge head and the friction loss for discharge pipe, valves and fittings needed for the installation. The friction loss for the discharge line is calculated in the same manner as the suction side. Add this number to the static discharge head to determine the dynamic discharge head.

Tip: Long discharge lines add significant friction losses to a pump system. To reduce friction loss, use larger diameter pipe for all (or part) of the discharge line.

4. Calculate the total dynamic head, which equals the sum of the dynamic suction head and the dynamic discharge head.

5. Match a pump (or pumps) to the application by referring to the performance curve for a given pump, which plots total dynamic head and flow rates at various static suction lifts. Performance curves for diesel-driven pumps also plot pump performance at various engine RPMs.

Notes:

- 1. See the Total Dynamic Head Worksheet on page 18.*
- 2. Large pump installations, such as sewer bypass jobs, may require multiple pumps, along with custom manifolds and extensive pipeline fabrication.*

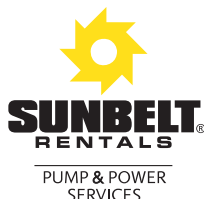

For more information about large pumps and custom installations, call Sunbelt Rentals Pump & Power Services at 800-736-2504. 24-Hour Service

PUMPS

LARGE PUMP BASICS



PUMPS

TOTAL DYNAMIC HEAD WORKSHEET

Project _____ Flow Rate Required _____

Static Suction Lift _____
(Vertical distance from lowest suction point to the centerline of the impeller)

Static Discharge Head _____
(Vertical distance from the centerline of the pump impeller to the point of discharge)

1. Calculate the Friction Loss on the Suction Piping

Total Suction Pipe Length _____ Diameter _____

Fittings (from equivalent feet of pipe chart) _____

Total (equivalent) Feet of Suction Pipe _____

Friction Loss Factor (from pipe friction loss chart) _____

Friction Loss = Total (equivalent) Feet of Suction Pipe x Friction Loss Factor ÷ 100
= _____ x _____ ÷ 100 = _____

2. Calculate the Total Dynamic Suction Head

Total Dynamic Suction Head = Static Suction Lift + Friction Loss
= _____ + _____ = _____

3. Calculate the Friction Loss on the Discharge Piping

Total Discharge Pipe Length _____ Diameter _____

Fittings (from equivalent feet of pipe chart) _____

Total (equivalent) Feet of Discharge Pipe _____

Friction Loss Factor (from pipe friction loss chart) _____

Friction Loss = Total (equivalent) Feet of Discharge Pipe x Friction Loss Factor ÷ 100
= _____ x _____ ÷ 100 = _____

4. Calculate the Equivalent Discharge Head for PSI Reading

Equivalent Discharge Head = PSI x 2.31 = _____

5. Calculate the Total Dynamic Discharge Head

Total Dynamic Discharge Head = Static Discharge Head + Friction Loss + Equivalent Discharge Head
= _____ + _____ + _____ = _____

6. Calculate the Total Dynamic Head (TDH)

Total Dynamic Head (TDH) = Dynamic Suction Head + Dynamic Discharge Head
= _____ + _____ = _____



For more information about large pumps and custom installations, call Sunbelt Rentals Pump & Power Services at 800-736-2504. 24-Hour Service

PUMPS

LARGE PUMP BASICS

VELOCITY AND FRICTION LOSS OF WATER IN FEET PER 100' OF PIPE

(Based on Williams & Hazen Formula Using Constant 100 C Factor)

GPM	3" Pipe		4" Pipe		6" Pipe		8" Pipe		10" Pipe		12" Pipe		14" Pipe		16" Pipe		18" Pipe		24" Pipe		GPM
	ft./sec.	in ft.	ft./sec.	in ft.	ft./sec.	in ft.	ft./sec.	in ft.	ft./sec.	in ft.	ft./sec.	in ft.	ft./sec.	in ft.	ft./sec.	in ft.	ft./sec.	in ft.	ft./sec.	in ft.	
100	4.54	4.96	2.55	1.22	1.13	0.17															100
110	5.00	6.00	2.81	1.46	1.25	0.21															110
120	5.45	7.00	3.06	1.17	1.36	0.24															120
130	5.91	8.10	3.31	1.97	1.47	0.27															130
140	6.35	9.20	3.57	2.28	1.59	0.32	0.90	0.08													140
150	6.82	10.60	3.82	2.62	1.70	0.36	0.96	0.09													150
160	7.26	11.80	4.08	2.91	1.82	0.40	1.02	0.10													160
170	7.71	13.30	4.33	3.26	1.92	0.45	1.08	0.11													170
180	8.17	14.00	4.60	3.61	2.04	0.50	1.15	0.13													180
190	8.63	15.50	4.84	4.01	2.16	0.55	1.21	0.14													190
200	9.08	17.08	5.11	4.40	2.27	0.62	1.28	0.15													200
220	9.99	21.30	5.62	5.20	2.50	0.73	1.40	0.18													220
240	10.89	25.10	6.13	6.20	2.72	0.87	1.53	0.22	0.98	0.07											240
260	11.80	29.10	6.64	7.20	2.95	1.00	1.66	0.26	1.06	0.08											260
280	12.71	33.80	7.15	8.20	3.18	1.14	1.79	0.28	1.15	0.09											280
300	13.62	38.00	7.66	9.30	3.40	1.32	1.91	0.32	1.22	0.11											300
320	14.52	42.80	8.17	10.50	3.64	1.47	2.05	0.37	1.31	0.12											320
340	15.43	47.90	8.68	11.70	3.84	1.62	2.18	0.41	1.39	0.14											340
360	16.34	53.00	9.19	13.10	4.08	1.83	2.30	0.45	1.47	0.16											360
380	17.29	59.00	9.69	14.00	4.31	2.00	2.43	0.50	1.55	0.17	1.06	0.07									380
400	18.16	65.00	10.21	16.00	4.55	2.20	2.60	0.54	1.63	0.19	1.14	0.08									400
450	20.00	78.00	11.49	19.80	5.11	2.74	2.92	0.68	1.84	0.23	1.38	0.09									450
500	22.70	98.00	12.77	24.00	5.68	2.90	3.15	0.82	2.04	0.28	1.42	0.11	1.04	0.06							500
550			14.04	28.70	6.25	3.96	3.62	0.97	2.24	0.33	1.56	0.14	1.15	0.07							550
600			15.32	33.70	6.81	4.65	3.84	1.14	2.45	0.39	1.70	0.16	1.25	0.08							600
650			16.59	39.80	7.38	5.40	4.16	1.34	2.65	0.45	1.84	0.19	1.37	0.09							650
700			17.87	44.90	7.95	6.21	4.46	1.54	2.86	0.52	1.99	0.22	1.46	0.10							700
750			19.15	51.00	8.50	7.12	4.80	1.74	3.06	0.59	2.13	0.24	1.58	0.11							750
800			20.42	57.00	9.08	7.96	5.10	1.90	3.25	0.66	2.27	0.27	1.67	0.13							800
850			21.70	64.00	9.65	8.95	5.48	2.20	3.47	0.76	2.41	0.31	1.79	0.14	1.36	0.06					850
900			22.98	71.60	10.20	10.11	5.78	2.46	3.67	0.83	2.66	0.34	1.88	0.16	1.44	0.08					900
950					10.77	11.20	6.06	2.87	3.88	0.92	2.70	0.38	2.00	0.18	1.52	0.10					950
1,000					11.34	12.04	6.38	2.97	4.08	1.03	2.84	0.41	2.10	0.19	1.60	0.10	1.26	0.03			1,000
1,100					12.48	14.55	7.03	3.52	4.49	1.19	3.13	0.49	2.31	0.23	1.76	0.12	1.38	0.03			1,100
1,200					13.61	17.10	7.66	4.17	4.90	1.40	3.41	0.58	2.52	0.27	1.92	0.14	1.50	0.04			1,200
1,300					14.72	18.40	8.30	4.86	5.31	1.62	3.69	0.67	2.71	0.32	2.08	0.17	1.64	0.05			1,300
1,400					15.90	22.68	8.95	5.50	5.71	1.87	3.98	0.78	2.92	0.36	2.24	0.19	1.77	0.06			1,400
1,500					17.02	25.60	9.58	6.24	6.12	2.13	4.26	0.89	3.15	0.41	2.39	0.21	1.90	0.06			1,500
1,600					18.10	26.90	10.21	7.00	6.53	2.39	4.55	0.98	3.34	0.47	2.56	0.24	2.02	0.07			1,600
1,800							11.50	8.78	7.35	2.96	5.11	1.21	3.75	0.58	2.87	0.30	2.27	0.09			1,800
2,000							12.78	10.71	8.16	3.59	5.68	1.49	4.17	0.71	3.19	0.37	2.52	0.11	1.28	0.04	2,000
2,200							14.06	12.78	8.98	4.24	6.25	1.81	4.59	0.84	3.61	0.44	2.85	0.14	1.42	0.05	2,200
2,400							15.32	14.20	9.80	6.04	6.81	2.08	5.00	0.99	3.83	0.52	3.15	0.17	1.70	0.07	2,400
2,600									10.61	6.81	7.58	2.43	5.47	1.17	4.15	0.60	3.36	0.19	1.84	0.08	2,600
2,800									11.41	6.70	7.95	2.76	5.84	1.32	4.47	0.68	3.57	0.21	1.96	0.09	2,800
3,000									12.24	7.62	8.52	3.15	6.01	1.49	4.79	0.78	3.78	0.24	2.13	0.10	3,000
3,200									13.05	7.80	9.10	3.51	6.68	1.67	5.12	0.88	4.10	0.28	2.26	0.12	3,200
3,500									14.30	10.08	9.95	4.16	7.30	1.97	5.59	1.04	4.41	0.32	2.49	0.14	3,500
3,800									15.51	13.40	10.80	4.90	7.98	2.36	6.07	1.20	4.88	0.40	2.69	0.17	3,800
4,200											11.92	6.88	8.76	2.77	6.70	1.44	5.35	0.48	2.99	0.20	4,200
4,600											12.78	6.90	9.45	3.22	7.18	1.64	5.82	0.56	3.20	0.22	4,600
5,000											14.20	8.40	10.56	3.92	8.01	2.03	6.30	0.65	3.64	0.27	5,000
5,500													11.65	4.65	8.78	2.39	6.93	0.79	3.90	0.33	5,500
6,000													12.60	5.50	9.58	2.79	7.57	0.92	4.25	0.38	6,000
6,500													13.65	6.45	10.39	3.52	8.20	1.09	4.61	0.45	6,500
7,000													14.60	7.08	11.18	3.70	8.83	1.25	4.97	0.52	7,000
8,000															12.78	4.74	10.10	1.63	6.68	0.66	8,000
9,000															14.37	5.90	11.03	2.05	6.35	0.81	9,000
10,000															15.96	7.19	12.60	2.52	7.07	0.98	10,000
12,000																	15.10	3.62	8.50	1.40	12,000
14,000																	17.70	4.91	9.95	1.87	14,000
16,000																	20.20	6.40	11.38	2.40	16,000
18,000																	22.70	8.08	12.76	2.97	18,000
20,000																	25.20	9.96	14.20	3.60	20,000

C Factor Values of typical hose and pipe:

Layflat Discharge Hose = 130 HDPE Pipe = 150
 Bauer Discharge Pipe = 120

C Factor Value	150	140	130	120	110	100	90	80	70	60
Multiplier	.47	.54	.62	.71	.84	1	1.22	1.50	1.93	2.57



PUMPS

LARGE PUMP BASICS

PUMPS

FRICITION LOSS—VALVES & FITTINGS

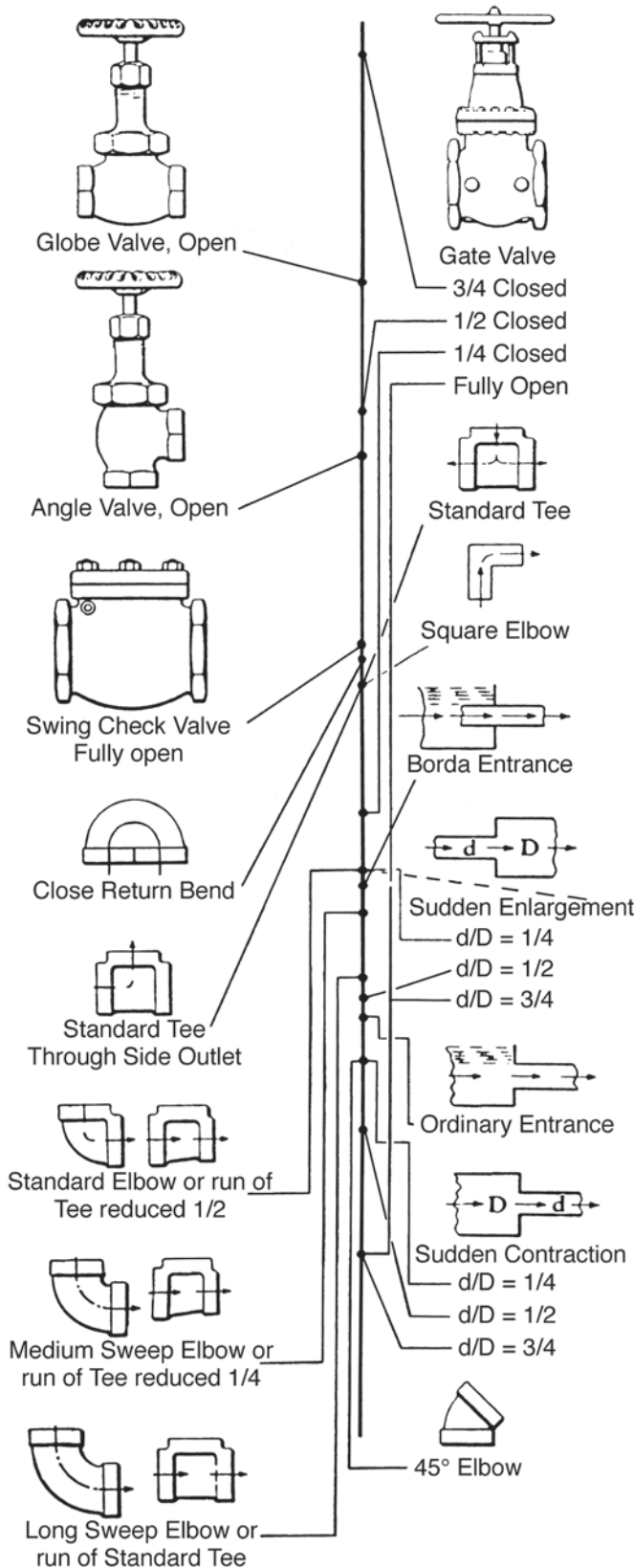

Example: The dotted line shows that the resistance of a 6-inch Standard Elbow is equivalent to approximately 16 feet of 6-inch Standard Pipe.

Note: For sudden enlargements or sudden contractions, use the smaller diameter, *d*, on the pipe size scale.

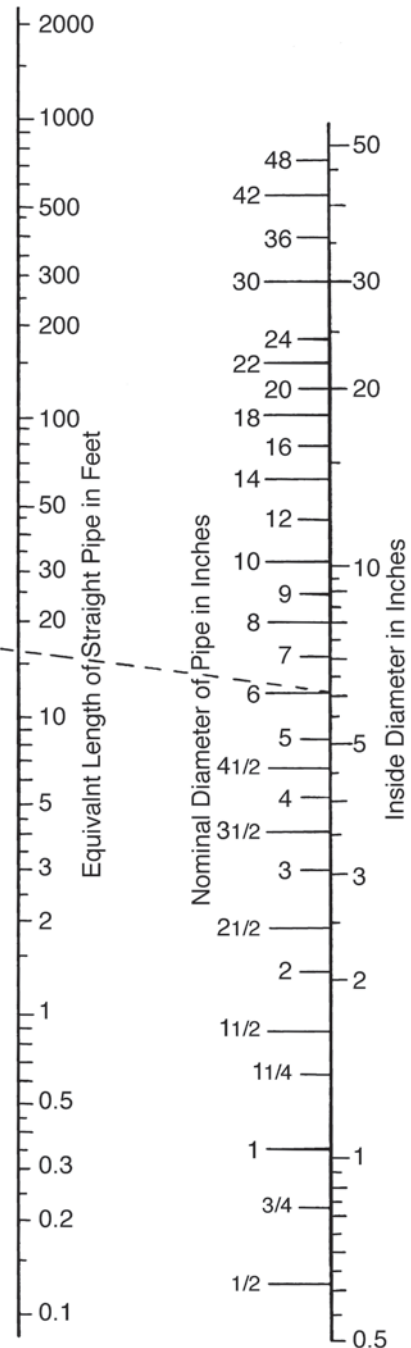

PUMP ACCESSORIES

AUTO-START SYSTEMS, LOFA PANELS, TRANSDUCERS

AUTO-START SYSTEMS allow pumps to start up or shut down automatically when the fluid level reaches a preset level. Quiet Flow™ diesel-driven trash pumps include built-in auto-start capability, integrated into the main control panel. Float switches, which are placed at preset levels in the intake area, are connected to the control panel by a twist-lock cable.

Auto-Start control (Cat-Class 046-0901)

Float switch (Cat-Class 155-1070)

Float switch, double (Cat-Class 155-1071)

25' Float switch cable: (Cat-Class 155-1080)

Quiet Flow diesel-driven trash pumps include built-in Auto-Start capability, as shown in the this control panel



Sunbelt Rentals is always looking for tools that will help our customers increase process efficiencies. The LOFA panel is just that – a universal platform to monitor, control and automatically start/stop both electronically and mechanically governed diesel engines. The panel displays diagnostic messages from the engine ECU as well as performs the ECU function by monitoring oil pressure, RPM, engine temperature, diagnostic codes and fuel level. For automated pump applications, the panel can easily be configured in the field for a wide variety of pumping applications utilizing float switches or transducers for level, pressure or flow. (Cat-Class 006-0100)

- Universal engine support for both electronically and mechanically governed engines
- Super-bright LEDs for Preheat, Autostart, Warning and Stop indication
- Alarm output to signal start warning or shutdown conditions
- Engine monitoring and diagnostics via First-Fault Diagnostics (FFD)

TRANSDUCERS were designed for difficult level sensing applications where sludge, slurry or turbulence may be present. They provide excellent durability and service life in difficult environments; they may be used to monitor extremely low liquid levels or when the assembly is buried in a layer of sludge. Common applications include lift stations, wet wells and other level sensitive applications. When coupled with a LOFA 750 controller, transducers allow a diesel engine to become an automatic variable speed unit. Sensing the flow level as it rises, transducers gradually increase the engine speed and decrease it as the flow level drops. (Cat-Class 006-0105)



PUMP ACCESSORIES

REMOTE MONITORING SYSTEMS, AUXILIARY FUEL TANKS

REMOTE MONITORING SYSTEMS are available for tracking the status and performance of pumps and other equipment utilized in critical applications. Systems available range from simple auto-dialers, which dial multiple phone numbers when the equipment shuts down or starts up, to sophisticated, web-based tracking systems that monitor multiple functions on a continuous basis. Typical functions monitored include the following:

- Machine status—whether or not the unit is running
- Engine hours—monitors usage and helps schedule preventive maintenance
- Location (global positioning)—for dispatch purposes and theft protection
- GeoFencing—notification when equipment leaves a designated area
- Remote management—ability to monitor single or multi-unit status, including monitoring multiple machine functions and controlling start-up and shutdown of units without a machine operator present

ENVIRONMENTAL AUXILIARY FUEL TANKS provide extended run times for all types of diesel-driven equipment. Several sizes are available, each featuring an environment-friendly design and rugged, steel construction that provides excellent spill control and complete fluid containment.

- 275, 500, 1,000 and 2,300 gallon tanks available
- Double wall construction (except 275 gallon tank), with UL listed interior tanks and exterior rupture basins
- Southwest Research Fire Code rated
- Galvanized steel frames provide protection from accidental damage and also allow stacking of tanks
- Forklift pockets and 4-point lifting eyes for easy loading
- Fuel gauge with lockable fill and overflow shutoff valve
- Quick-connect hoses and fittings allow fast, easy hookup
- Each tank accommodates two supply and two return lines



Two containment berms holding auxiliary fuel tanks at a dewatering project in Seattle, WA



Transcube 30TCG

Model	Capacity	Dimensions	Dry Weight	Cat-Class
10TCG	264 gal.	46"L x 46"W x 52"H	1,118 lbs.	110-0110
275GT ¹	275 gal.	56"L x 44"W x 55"H	1,431 lbs.	110-0110
500ET	500 gal.	84"L x 48"W x 80"H	3,750 lbs.	110-0210
20TCG	528 gal.	87"L x 46"W x 52"H	1,825 lbs.	110-0210
30TCG	792 gal.	91"L x 59"W x 52"H	2,153 lbs.	110-0310
40TCG	1,000 gal.	91"L x 87"W x 48"H	2,724 lbs.	110-0310
1000ET	1,000 gal.	102"L x 66"W x 80"H	4,850 lbs.	110-0310
50TCG	1,240 gal.	91"L x 91"W x 52"H	3,576 lbs.	110-0410
2300ET	2,300 gal.	144"L x 96"W x 84"H	8,100 lbs.	110-0410

¹275 gallon tank does not include double-wall construction or UL and Southwest Research ratings. Accommodates only one supply and one return line.

CONTAINMENT BERMS offer an ideal solution for secondary containment. Extremely durable, the berm's outside support straps allow the use of the full footprint of the berm for containment purposes. (see page 44)

GROUND PROTECTION MATS create effective temporary roadways and working platforms to ensure the safe transport and operation of workers and equipment. Made of High-Density Polyethylene, the mats provide superior protection and outperform plywood, timber mats and steel road plates in performance, safety and efficiency. (see page 44)

- Composite rig matting system, temporary road and drill staging system
- Easy installation
- Anti-slip traction pattern
- Easy-to-use cast aluminum cam lock system

PUMP ACCESSORIES

PIPE PLUGS

PIPE PLUGS are used to block off pipelines during bypass, rehabilitation and maintenance applications. The plug is positioned inside the pipeline and then expanded to fit using compressed air from an outside source. A selection of multi-size pipe plugs is available to accommodate pipelines from 6" to 96" diameter, plus rope and hose kits.

- Domehead plugs feature controlled expansion: as the plug inflates, it gets larger in diameter and shorter in length
- Flow-Thru plugs include a large bypass within the plug, which allows bypassing line fluids or injecting chemicals into the line

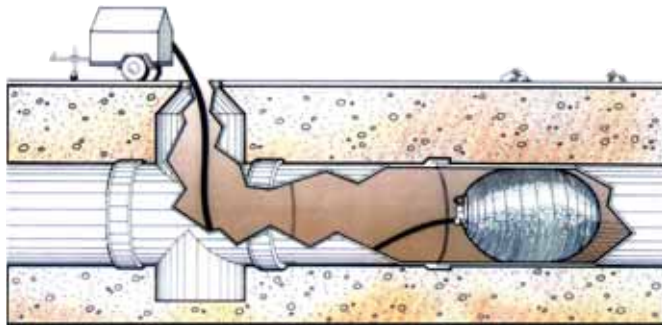

Domehead Pipe Plug



Flow-Thru Pipe Plug

Rope and Hose Kits
Available in 20' & 30' kits with and without pressure gauge (Cat-Class 155-1085)



CAUTION!
Block plugs to prevent moving.

Make	Model	Type	Pipe Range	Min Pipe Dia	Max Pipe Dia	Required Inflation	Max Back/Test	Bypass Flow-Thru	Length	Diameter	Weight	Cat-Class
Lansas	060-610-0	Domehead	6"-10"	5.25"	10.25"	30 PSI	15 PSI	N/A	19"	5.0"	5 lbs.	155-1115
Lansas	070-610-1	Flow-Thru	6"-10"	5.70"	10.25"	30 PSI	15 PSI	3"	20"	5.0"	11 lbs.	155-1120
Lansas	060-812-0	Domehead	8"-12"	7.25"	12.25"	25 PSI	15 PSI	N/A	20"	7.0"	8 lbs.	155-1125
Lansas	070-812-1	Flow-Thru	8"-12"	7.00"	12.25"	30 PSI	15 PSI	4"	20"	6.0"	18 lbs.	155-1130
Lansas	060-1218-0	Domehead	12"-18"	11.50"	18.25"	25 PSI	15 PSI	N/A	30"	11.0"	29 lbs.	155-1135
Lansas	072-1218-1	Flow-Thru	12"-18"	11.00"	18.25"	25 PSI	15 PSI	8"	32"	10.5"	50 lbs.	155-1142
Lansas	060-1530-1	Domehead	15"-30"	14.00"	30.25"	20 PSI	8 PSI	N/A	55"	13.7"	49 lbs.	155-1145
Lansas	072-1530-1	Flow-Thru	15"-30"	14.30"	30.25"	20 PSI	8 PSI	8"	52"	14.0"	120 lbs.	155-1152
Lansas	060-2036-0	Domehead	20"-36"	19.00"	36.25"	20 PSI	8 PSI	N/A	64"	18.5"	85 lbs.	155-1155
Lansas	072-2036-1	Flow-Thru	20"-36"	19.00"	36.25"	20 PSI	8 PSI	8"	56"	18.5"	163 lbs.	155-1162
Lansas	060-2448-0	Domehead	24"-48"	22.00"	48.25"	15 PSI	8 PSI	N/A	84"	21.5"	98 lbs.	155-1165
Lansas	072-2448-1	Flow-Thru	24"-48"	22.00"	48.25"	15 PSI	8 PSI	8"	94"	21.5"	174 lbs.	155-1172
Lansas	060-3660-0	Domehead	36"-60"	34.50"	60.25"	10 PSI	6 PSI	N/A	84"	29.5"	150 lbs.	155-1175
Lansas	072-3660-1	Flow-Thru	36"-60"	34.50"	60.25"	10 PSI	6 PSI	8"	98"	29.5"	210 lbs.	155-1182
Lansas	060-4872-0	Domehead	48"-72"	46.00"	72.25"	10 PSI	6 PSI	N/A	84"	43.5"	340 lbs.	155-1185

PIPE PLUG SAFETY INSTRUCTIONS

1. Pipe plugs are intended for use in piping systems only. Do not inflate a pipe plug unless it is totally confined within the proper size pipe.
2. Each pipe plug is specifically rated for certain pressures under specific conditions. Do not exceed these pressures, as specified for each plug. If in doubt, contact a Sunbelt Rentals representative.
3. All pipe plugs must be used with proper blocking or restraints that meet or exceed the standards of the industry—consult a registered engineer.
4. Pipe plugs are designed for inflation in piping only. Plugs must conform in rated size(s) to piping size.
5. Through misuse, abuse, improper storage, age, or component failure or malfunction, a device may fail. The user is warned to consider the failure mode of all parts (components) to be used in the system and to provide adequate safeguards to prevent personal injury, death, or property damage in the event of a failure mode occurrence.

6. All end users must be thoroughly instructed in all safety aspects when using these products, including how to provide for personal protection in the event of a failure mode.
7. It is the responsibility of the user to check all components for both accuracy and integrity immediately prior to use. All gauges and pressure components must be checked and certified for function and accuracy.
8. All end users are cautioned to review specific warnings, ratings, pressures and other information immediately prior to use. This information may be found in instruction sheets, product specification sheets, catalogs/brochures on the device and/or on attached hang tags.
9. If such information cannot be located, the user is requested to call the Lansas factory at (800) 452-4902 for specific information. Such information will be supplied in written form by FAX or mail upon request. Lansas safety information can also be found on the Lansas web site: www.lansas.com
10. Do not operate or attempt to use any pipe plugs without proper training and complete information regarding the pipe plug to be used.

PUMP ACCESSORIES

HOSE & FITTINGS

PUMP ACCESSORIES

KANAFLEX SUCTION HOSE is ideal for heavy-duty fluid handling applications. It is very durable and lightweight, constructed of corrugated PVC hose with smooth bore coupled galvanized Bauer-type fittings (male x female) and two spiral bolt clamps at each end. Each hose includes closure, ball, socket and ring. Hose strainers are also available for each size.



Kanaflex Suction Hose				
ID	Length	Max PSI	Weight	Cat-Class
2"	10'	50	11 lbs.	155-0875
2"	20'	50	18 lbs.	155-0880
3"	10'	50	19 lbs.	155-0885
3"	20'	50	31 lbs.	155-0890
4"	10'	40	33 lbs.	155-0895
4"	20'	40	50 lbs.	155-0900
6"	10'	35	71 lbs.	155-0905
6"	20'	35	89 lbs.	155-0910
8"	10'	30	99 lbs.	155-0915
8"	20'	30	155 lbs.	155-0920
10"	10'	20	151 lbs.	155-0925
12" ¹	10'	20	294 lbs.	155-0930

¹12" suction hose is vacuum rubber, not corrugated PVC.



Hose Strainers		
Diameter	Weight	Cat-Class
2"	2 lbs.	155-0935
3"	2 lbs.	155-0940
4"	3 lbs.	155-0945
6"	7 lbs.	155-0950
8"	9 lbs.	155-0955
10"	31 lbs.	155-0960
12"	42 lbs.	155-0965



Bauer-Type Fittings



Camlock Fittings

SNAP-TITE DISCHARGE HOSE features a "lay-flat" design and includes a Nitrile tube and cover coupled with Bauer-type fittings at each end (male x female), with two stainless steel band clamps and one T-Bolt clamp at each end (2" and 3" I.D. hose has only one band clamp at each end).



Snap-Tite Discharge Hose				
ID*	Length	Max PSI	Weight	Cat-Class
2"	50'	100	21 lbs.	155-0975
3"	50'	100	39 lbs.	155-0980
4"	25'	100	35 lbs.	155-0985
4"	50'	100	55 lbs.	155-0990
6"	25'	75	58 lbs.	155-0995
6"	50'	75	90 lbs.	155-1000
8"	25'	50	98 lbs.	155-1005
8"	50'	50	168 lbs.	155-1010

*Lay-Flat discharge hose is not suitable for high-pressure applications such as forcemain sewer bypasses.

WILCOX COMPOSITE HOSE is designed for high-pressure applications such as forcemain sewer bypasses. It is also chemical resistant, flexible and lightweight. Each hose is coupled with steel, full-face flanges.



Wilcox Composite Hose				
ID	Length	Max PSI	Weight	Cat-Class
4"	10'	250	105 lbs.	155-1030
4"	20'	250	160 lbs.	155-1035
6"	10'	250	145 lbs.	155-1040
6"	20'	250	220 lbs.	155-1045
8"	10'	250	227 lbs.	155-1050
8"	20'	250	346 lbs.	155-1055
12" ¹	10'	150	525 lbs.	155-1060

¹12" hose is high-pressure rubber (not Wilcox).

PUMP ACCESSORIES

BAUER PIPE & FITTINGS

BAUER PIPE is heavy-duty galvanized steel piping that has gained worldwide acceptance as the preferred choice in a wide range of fluid handling applications. An extensive inventory of Bauer pipe and fittings are available to accommodate any size pump installation.

- **Strong and Durable**—Produced from high-grade, high-tensile steel with abrasion resistant, hot-dip galvanization. Resists high heat (110° C). Designed to maintain high-tensile strength under pressure or suction. Unique welded hinge and pin design provides excellent durability
- **Fast Assembly**—No loose parts. Hook-and-latch design allows you to quickly attach pipe and fittings without tools
- **Flexible**—The unique ball and socket design allows up to a 30° articulation at the pipe joint, making it easy to align pipe on uneven terrain
- **Safe**—The Bauer HK coupler provides a tight seal for suction and discharge applications up to 80 PSI

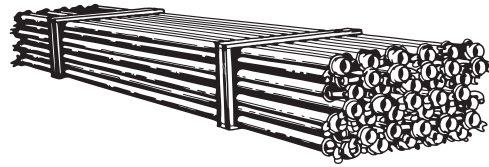

Bauer Pipe					
Diameter	Length	Max PSI	Artic	Weight	Cat-Class
4"	3'	174	30°	12 lbs.	155-0260
4"	6'	174	30°	19 lbs.	155-0265
4"	10'	174	30°	25 lbs.	155-0270
4"	20'	174	30°	41 lbs.	155-0275
6"	3'	174	15°	23 lbs.	155-0280
6"	6'	174	15°	33 lbs.	155-0285
6"	10'	174	15°	44 lbs.	155-0290
6"	20'	174	15°	75 lbs.	155-0295
8"	3'	174	15°	37 lbs.	155-0300
8"	6'	174	15°	50 lbs.	155-0305
8"	10'	174	15°	64 lbs.	155-0310
8"	20'	174	15°	100 lbs.	155-0315
12"	3'	174	20°	100 lbs.	155-0320
12"	10'	174	20°	183 lbs.	155-0325

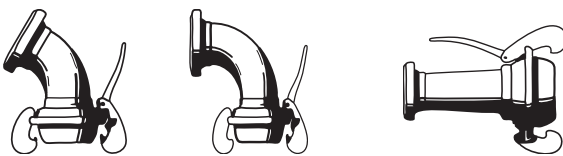

60° & 90° Bends			
Size	Angle	Weight	Cat-Class
4"	60°	11 lbs.	155-0330
4"	90°	11 lbs.	155-0335
6"	60°	23 lbs.	155-0340
6"	90°	18 lbs.	155-0345
8"	60°	28 lbs.	155-0350
8"	90°	28 lbs.	155-0355
10"	60°	54 lbs.	155-0360
10"	90°	60 lbs.	155-0365
12"	60°	84 lbs.	155-0370
12"	90°	87 lbs.	155-0375

Increasers		
Size	Weight	Cat-Class
3" x 4"	7 lbs.	155-0415
4" x 6"	13 lbs.	155-0420
6" x 8"	24 lbs.	155-0425
8" x 10"	37 lbs.	155-0430
8" x 12"	59 lbs.	155-0435
10" x 12"	72 lbs.	155-0440

Balls with Pipe Thread or Flange			
Size	Thread/Flange	Weight	Cat-Class
3"	FPT	7 lbs.	155-0495
3"	MPT	4 lbs.	155-0500
3"	Flange	14 lbs.	155-0505
4"	FPT	13 lbs.	155-0510
4"	MPT	5 lbs.	155-0515
4"	Flange	16 lbs.	155-0520
6"	FPT	26 lbs.	155-0525
6"	MPT	11 lbs.	155-0530
6"	Flange	27 lbs.	155-0535
8"	FPT	41 lbs.	155-0540
8"	MPT	24 lbs.	155-0545
8"	Flange	35 lbs.	155-0550
10"	Flange	57 lbs.	155-0555
12"	Flange	87 lbs.	155-0560

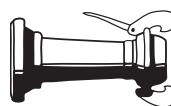

Step Bows		
Size	Weight	Cat-Class
4"	28 lbs.	155-0380
6"	62 lbs.	155-0385

Reducers		
Size	Weight	Cat-Class
4" x 3"	6 lbs.	155-0445
6" x 4"	12 lbs.	155-0450
8" x 6"	23 lbs.	155-0455
10" x 8"	46 lbs.	155-0460
12" x 8"	58 lbs.	155-0465
12" x 10"	64 lbs.	155-0470

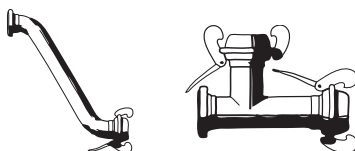

Cross Tees		
Size	Weight	Cat-Class
4"	17 lbs.	155-0390
6"	32 lbs.	155-0395
8"	54 lbs.	155-0400
10"	82 lbs.	155-0405
12"	130 lbs.	155-0410

Wyes		
Size	Weight	Cat-Class
4"	21 lbs.	155-0475
6"	41 lbs.	155-0480
8"	66 lbs.	155-0485
12"	155 lbs.	155-0490



Sockets with Pipe Thread or Flange			
Size	Thread/Flange	Weight	Cat-Class
3"	FPT	5 lbs.	155-0565
3"	MPT	11 lbs.	155-0570
3"	Flange	9 lbs.	155-0575
4"	FPT	11 lbs.	155-0580
4"	MPT	11 lbs.	155-0585
4"	Flange	11 lbs.	155-0590
6"	FPT	16 lbs.	155-0595
6"	MPT	11 lbs.	155-0600
6"	Flange	18 lbs.	155-0605
8"	FPT	28 lbs.	155-0610
8"	MPT	11 lbs.	155-0615
8"	Flange	22 lbs.	155-0620
10"	Flange	53 lbs.	155-0625
12"	Flange	74 lbs.	155-0630

PUMP ACCESSORIES

VALVES & FLANGES, ROAD RAMPS

SWING CHECK VALVES are used in a suction or discharge line to allow flow in only one direction. This prevents reverse flow in the pipeline, isolating the material being pumped. Valves also include a built-in tap for a backflow actuator, which allows backflushing, draining and testing pipelines. Val-Matic

Swing Check Valves		
Diameter*	Weight	Cat-Class
4"	63 lbs.	155-1210
6"	100 lbs.	155-1215
8"	200 lbs.	155-1220
12"	525 lbs.	155-1225

*Rubber-lined valves are available that are suitable for abrasive and corrosive materials.



Swing Check Valves

Cutaway view of valve in the closed position
The mechanical indicators show whether the valve is open or closed
Note: Mechanical indicators and backflow actuators are not recommended on rubber-lined valves.

BUTTERFLY VALVES are used to isolate suction/discharge piping and provide false head. They are adjusted very quickly compared to other types of valves.

Butterfly Valves		
Diameter	Weight	Cat-Class
4"	65 lbs.	155-1190
6"	85 lbs.	155-1195
8"	120 lbs.	155-1200
12"	270 lbs.	155-1205



Butterfly Valve

Available in 4" to 12" diameters



Gate Valve

Available in 4" to 18" diameters

GATE VALVES (also called knife valves) are used to isolate suction/discharge flow and provide false head. They are useful in bypass applications where there is a lot of debris present since the valve mechanism is located outside of the stream flow, helping to prevent clogging.

Gate Valves		
Diameter	Weight	Cat-Class
4"	40 lbs.	155-1230
6"	65 lbs.	155-1235
8"	110 lbs.	155-1240
12"	255 lbs.	155-1245
18"	600 lbs.	155-1247

STEEL FLANGE ADAPTERS are used to connect two different sizes of hose or pipe that are equipped with full-face flanges.



Steel Flange Adapter

Steel Flange Adapters		
Size	Weight	Cat-Class
8" x 12"	30 lbs.	155-1250
12" x 18"	115 lbs.	155-1255
18" x 24"	197 lbs.	155-1260
24" x 36"	400 lbs.	155-1265

ROAD RAMPS are used to transfer pumped fluids across a street or roadway without blocking traffic. They utilize square steel tubing and include ASA flanges on each end.



An 8" x 12' road ramp in operation on a golf course drought relief pump project

Road Ramps		
Size*	Weight	Cat-Class
8" x 12'	1,150 lbs.	155-1090
12" x 12'	2,270 lbs.	155-1093

*Additional sizes of road ramps may also be available.

PUMP ACCESSORIES

HDPE PIPE & FITTINGS

HDPE PIPE (High Density Polyethylene) is very reliable for pump and pipeline installations. It is well-suited for long pipelines, such as sewer bypass projects, combining a lightweight design with high flow capabilities. HDPE pipe is available in 8", 12", 16", 18" and 24" diameters in any length required to accommodate large installations. Pipe is delivered to the job site in 40' to 50' sections, which are joined together using a portable fusion machine. At the completion of a project, the pipeline is cut into sections and reused on other jobs.

- Heat fuseable—allows fabrication of long pipelines on-site
- Extremely reliable, with a zero leak rate
- Hydraulically smooth, with superior flow capabilities
- Durable—excellent resistance to fatigue, surges, weather, abrasion, corrosion and chemicals
- Reusable—cut pipe into sections and use on other jobs



HDPE pipe is ideal for large pump installations requiring high flow rates and long discharge lines

Above: A 36" diameter HDPE manifold combining the flows of (6) 18" discharge lines on a sewer bypass project

Below: A portable fusion machine joining two 24" diameter HDPE pipe sections



HDPE elbows, tees, reducers, wyes and flange adapters are available



A 24" diameter HDPE manifold combining the flows of (4) 12" discharge lines on a sewer bypass project



McElroy T630 Fusion Machine 8" IPS – 24" pipe

HDPE SDR26 Pipe		
Diameter	Weight (per foot)	Cat-Class (per foot)
8"	3.78 lbs.	155-1735
12"	8.27 lbs.	155-0830
16"	13.02 lbs.	155-0835
18"	16.48 lbs.	155-0840
24"	29.29 lbs.	155-0845

GENERATORS

TOWABLE DIESEL GENERATORS

TOWABLE DIESEL GENERATORS provide ideal power solutions for temporary, standby and emergency power requirements ranging from 20 kW to 640 kW. Tandem-axle trailers allow easy towing at highway speeds. All models feature quiet operation (69 dBA or lower at full load) and onboard fuel capacity for 24-hour minimum run times. Multiple voltages are easily configured, with simultaneous single and 3-phase power output.

- Excellent voltage regulation: $\pm 1.5\%$ from no load to full load
- Simultaneous single and 3-phase power output
- Complete analog instrumentation, with an easy-to-read, illuminated instrument panel
- Silenced, weather-resistant steel housings
- Tandem-axle trailers equipped with surge brakes, designed for easy towing at highway speeds (except 640 kW)
- Large fuel tanks provide extended run times at full load
- Auxiliary fuel tanks are available for longer run times without refueling (see page 35)
- Environmental package with complete fluid containment is available for most models (see illustration below)
- Ultra-Silent generators are available in 20 kW, 36 kW, 56 kW, and 100 kW models (see illustration below)



MQ Power 100 kW Towable Generator
Temporary power for a construction site



MQ Power 320 kW Industrial Generators
Temporary power for a construction site

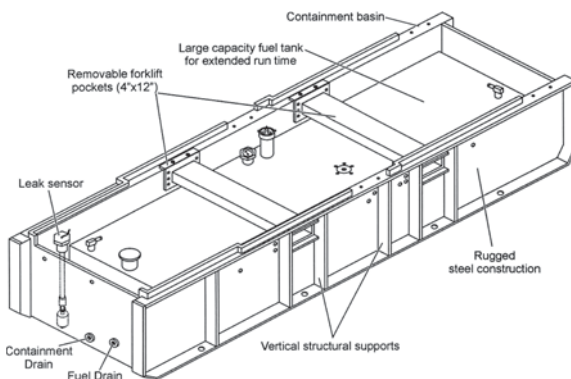

Environmental Package
Available for all models except the 640 kW. Features an integrated environmental skid that provides complete fluid containment to protect the environment



Ultra-Silent Generators
Available in 20 kW, 36 kW, 56 kW and 100 kW models. They feature a patented airflow design and sound attenuation yielding a decibel rating of 62 dBA (or lower) at 23 feet

Make	Prime Rating	Engine	Onboard Fuel Cap	Consump Full Load	Run Time Full Load	Overall Dimensions	Operating Weight	Hertz	120V	240V	208V	480V	Cat-Class
MQ Power	20 kW	Isuzu 31 HP	42 gal.	1.6 GPH	27 hrs.	110"L x 57"W x 77"H	2,517 lbs.	60	✓	✓	✓	✓	009-0030
MQ Power	36 kW	Isuzu 55 HP	79 gal.	3.0 GPH	26 hrs.	143"L x 65"W x 84"H	4,342 lbs.	60	✓	✓	✓	✓	009-0040
MQ Power	56 kW	Isuzu 90 HP	103 gal.	4.5 GPH	23 hrs.	174"L x 73"W x 99"H	6,061 lbs.	60	✓	✓	✓	✓	009-0070
MQ Power	100 kW	Isuzu 152 HP	169 gal.	7.3 GPH	23 hrs.	184"L x 80"W x 97"H	8,849 lbs.	60	✓	✓	✓	✓	009-0100
MQ Power	120 kW	John Deere 180 HP	269 gal.	9.0 GPH	30 hrs.	202"L x 83"W x 89"H	9,784 lbs.	60	✓	✓	✓	✓	009-0105
MQ Power	150 kW	John Deere 286 HP	310 gal.	11.4 GPH	30 hrs.	204"L x 87"W x 93"H	11,438 lbs.	60	✓	✓	✓	✓	009-0120
MQ Power	175 kW	John Deere 286 HP	350 gal.	13.6 GPH	26 hrs.	209"L x 88"W x 94"H	12,850 lbs.	60	✓	✓	✓	✓	009-0130
MQ Power	240 kW	Komatsu 347 HP	329 gal.	16.7 GPH	20 hrs.	227"L x 95"W x 103"H	17,412 lbs.	60	✓	✓	✓	✓	009-0170
MQ Power	320 kW ¹	Volvo 468 HP	479 gal.	20.6 GPH	23 hrs.	241"L x 94"W x 115"H	19,719 lbs.	60	✓	✓	✓	✓	009-0210
MQ Power	640 kW ²	Komatsu 1,008 HP	129 gal.	41.3 GPH	3 hrs.	217"L x 77"W x 99"H	25,961 lbs.	60	✓	✓	✓	✓	009-0330

¹320 kW models are also available with Isuzu and Komatsu diesel engines.

²640 kW specifications reflect skid-mounted units.

Note: Above specifications reflect the most recent designs—specifications may vary for specific units rented.

GENERATORS

INDUSTRIAL DIESEL GENERATORS

INDUSTRIAL DIESEL GENERATORS provide efficient, continuous-duty solutions for temporary, standby and emergency power requirements up to 2,000 kW. To meet larger capacity requirements, all units are parallelable. Generators are enclosed in a self-contained, 20' or 40' ISO container, mounted on a tandem-axle trailer chassis for over-the-road transport. All models feature sound attenuation, with noise levels rated at 69 dBA or lower at full operating load.

- Paralleling system allows combining multiple units
- Programmable engine starting and shutdown, accommodates auto-dialers for remote operation and control
- Isolated, interior control room provides security and weather protection
- Triple-stage engine oil filtration system includes a refined 2-micron filter, an oil centrifuge system and an oil level regulating system, allowing up to 1,000 hours continuous operation
- Walk-through engine compartment provides access to all major components
- Large fuel tanks provide over 24 hours run time at full load
Auxiliary fuel tanks are also available (see page 35)
- Ladder and platform provide convenient access for refueling



Left: Generators include a digital control panel located in an isolated control room for security and weather protection. Right: Walk-through engine compartment provides convenient access to all major components. Includes a 24V DC battery lighting system



Cummins 500 and 1,000 kW Industrial Generators
Power provided for an outdoor event



Two paralleled MQ Power 500 kW Generator
Emergency power for disaster relief

Make	Prime Rating	Standby Rating	Engine	Onboard Fuel Cap	Consump Full Load	Run Time Full Load	Overall Dimensions	Operating Weight	Hertz	208V	480V	Cat-Class
MQ Power	315 kW	350 kW	Volvo 533 HP	800 gal.	22.9 GPH	35 hrs.	24'L x 8'W x 12' 8"H	25,000 lbs.	60	✓	✓	009-0230
Cummins	455 kW	500 kW	Cummins 755 HP	849 gal.	34.4 GPH	25 hrs.	20'L x 8'W x 12' 6"H	27,940 lbs.	60	✓	✓	009-0310
MQ Power	450 kW	500 kW	Volvo 796 HP	800 gal.	37.7 GPH	21 hrs.	24'L x 8'W x 12' 8"H	26,920 lbs.	60	✓	✓	009-0310
MQ Power	730 kW	750 kW	Cummins 1,340 HP	1,000 gal.	60.0 GPH	17 hrs.	40'L x 8'W x 12' 8"H	44,500 lbs.	60	✓	✓	009-0340
Cummins	725 kW	800 kW	Cummins 1,220 HP	1,614 gal.	53.0 GPH	30 hrs.	30'L x 8'W x 12' 6"H	44,951 lbs.	60	✓	✓	009-0340
Cummins	900 kW	1,000 kW	Cummins 1,490 HP	1,614 gal.	72.2 GPH	22 hrs.	30'L x 8'W x 12' 6"H	48,059 lbs.	60	✓	✓	009-0350
MQ Power	900 kW	1,000 kW	Cummins 1,380 HP	1,000 gal.	69.3 GPH	14 hrs.	40'L x 8'W x 12' 8"H	45,200 lbs.	60	✓	✓	009-0350
Cummins	1,350 kW	1,500 kW	Cummins 2,220 HP	1,631 gal.	104.0 GPH	16 hrs.	48'L x 8'W x 12'6"H	71,960 lbs.	60	✓	✓	009-0370
MQ Power	1,250 kW	1,500 kW	Cummins 2,220 HP	1,000 gal.	88.0 GPH	11 hrs.	40'L x 8'W x 12' 8"H	53,220 lbs.	60	✓	✓	009-0370
Kohler	1,800 kW	2,000 kW	Detroit	1,000 gal.	127.0 GPH	7.2 hrs.	45'L x 8'W x 13' 6"H	76,380 lbs.	60	✓	✓	009-0390

Note: Some MQ Power units may be powered by Detroit Diesel engines. Note: 120V & 240V available with a transformer.

GENERATORS

GENERATORS

MOVIE SET DIESEL GENERATORS

MOVIE SET DIESEL GENERATORS are the preferred choice for quiet, dependable power throughout the entertainment industry. They provide ultra-quiet operation and extremely clean power for motion picture production, TV broadcasting and outdoor music concerts.

- Sound-attenuated design provides “movie quiet” operation. Includes automatic overhead doors with sound baffles, a critical grade exhaust silencer, two layers of acoustic insulation and engine-mounted isolators
- Dual redundant voltage regulators ensure voltage stability, with $\pm 1\%$ variance from no load to full load
- Totally enclosed design provides weather protection
- Mounted on rugged, single or tandem-axle trailers with surge brakes for easy towing at highway speeds
- Digital control panel monitors all engine and generator functions and helps ensure peak operating efficiency
- Emergency shutdown protection
- Stainless steel water lines, exhaust piping, hinges and outer hardware
- Auxiliary fuel tanks are available for longer run times without refueling (see page 35)



Crawford 1,400 amp Movie Set Generator
Powering sound stages at an outdoor concert



Crawford 1,400 amp Movie Set Generator
Powering video screens at an outdoor rally

Make	Prime Rating	Engine	Onboard Fuel Cap	Consump Full Load	Run Time Full Load	Overall Dimensions	Operating Weight	Hertz	120V	240V	208V	480V	Cat-Class
MQ Power	500 amp	Cummins 93 HP	95 gal.	4.8 GPH	33 hrs.	14'L x 6'W x 6' 6"H	4,272 lbs.	60	✓		✓		009-0420
MQ Power	1,400 amp	Volvo 250 HP	160 gal.	11.7 GPH	14 hrs.	15'L x 6'W x 9'H	7,715 lbs.	60	✓		✓		009-0410

GENERATORS

NATURAL GAS GENERATORS

NATURAL GAS GENERATORS provide cost effective and sustainable gas, and with the decrease in flaring, they also satisfy the need for a more environmentally conscious power source on oil and gas well sites. Ranging in size from 20 kW to 360 kW, natural gas generators allow you to dispose of unwanted oil by-products and cut down on fuel transportation costs while simultaneously generating electricity to service on-site needs.

- User friendly features such as analog control panel displaying AC voltage, AC frequency, ammeter, hour meter, fuel level, battery volt meter and an off/manual/auto toggle switch ensure ease of operation
- Bumper pull or gooseneck trailer-mounted
- Heavy duty 12 gauge galvaneal steel enclosure provides weather protection
- Exhaust silencer offers quiet operation



Taylor Power TGR250
235 kW Natural Gas Generator

Make	Model	Prime Rating	Engine	Controller	Dual Fuel (NG/LP)	Overall Dimensions*	Weight	Trailer Type	Hertz	480V	Cat-Class
Taylor Power	TGR30	20 kW	GM 3.0L	DEIF AGC-4	✓	120" x 59.5" x 268"	3,500 lbs.	Bumper Pull	60	✓	009-0500
Taylor Power	TGR60	50 kW	GM 5.7L	DEIF AGC-4	✓	120" x 59.5" x 268"	4,000 lbs.	Bumper Pull	60	✓	009-0510
Taylor Power	TGR70	70 kW	GM 8.1L	DEIF AGC-4	✓	102" x 117" x 240"	10,341 lbs.	Bumper Pull	60	✓	009-0520
Taylor Power	TGR200	176 kW	Doosan 11.1L	DEIF AGC-4	✓	109" x 122" x 300"	11,615 lbs.	Gooseneck	60	✓	009-0530
Taylor Power	TGR250	235 kW	Doosan 14.6L	DEIF AGC-4	✓	109" x 113" x 300"	14,612 lbs.	Gooseneck	60	✓	009-0540
Taylor Power	TGR400	360 kW	Doosan 21.9L	DEIF AGC-4	✓	102" x 142" x 323"	18,720 lbs.	Gooseneck	60	✓	009-0560

*Dimensions of individual units may vary from the above specs—check with your Sunbelt Rentals location to confirm dimensions.

GENERATORS

POWER GENERATION BASICS

GLOSSARY

Alternating Current (AC)—a current which reverses in regularly recurring intervals of time, has alternative positive and negative values and occurs a specified number of times per second (see frequency).

Ampere (Amp)—the unit of electric current flow. One ampere will flow when one volt is applied across a resistance of one ohm.

Capacitance—the property of a circuit or body that permits it to store an electrical charge equal to the accumulated charge divided by the voltage. Expressed in farads.

Circuit—a complete or partial path over which electric current may flow.

Circuit Breaker—a mechanical switching device capable of making, carrying and breaking currents under normal conditions. Also capable of making, carrying for a specific time and automatically breaking currents under specified abnormal circuit conditions, such as a short circuit. Circuit breakers have an ampere trip rating for normal overload protection and a maximum magnetic ampere interrupting capacity (AIC) for short circuit protection.

Commercial Power—the term applied to power furnished by an electric power utility.

Conductor—a wire, cable or bus bar designed for the passage of electrical current.

Contact—an electro-mechanical device that is operated by an electric coil and allows automatic or remote operation to repeatedly establish or interrupt an electrical power circuit.

Contacts—devices for making and breaking electrical circuits, which are a part of all electrical switching devices.

Current (I)—the amount of electricity flowing in a circuit, measured in amperes.

Cycle—a given length of time (see alternating current). In the U.S. most electric current is 60 cycle (60 Hz).

Delta Connection—a common three-phase connection shaped schematically like the Greek delta (Δ). The end of one phase is connected to the beginning of the next phase, or vice versa.

Dielectric—insulating material, such as air or glass, that has a high resistance to the conductance of electric current; a non-conductor.

Direct Current (DC)—an electric current flowing in one direction.

Distribution Panel—a device that provides multiple power outlets from a 208V 3-phase or 240V single-phase power source for operating power tools, work lights and other equipment.

Efficiency Factor (EFF)—the ratio of output

power to input power in an electric motor.

Electric Utilities—all enterprises engaged in the production and/or distribution of electricity for use by the public.

Electromotive Force (E)—the force or electric pressure that causes or tends to cause a current to flow in a circuit, equivalent to the potential difference between the terminals and commonly measured in volts.

Emergency (Stand-by) Power—an independent reserve source of electric power, upon failure or outage of the normal power source, provides stand-by electric power.

Frequency—the number of complete cycles of an alternating voltage or current per unit of time, usually expressed in cycles per second or Hertz (Hz).

Full Load Current (Amps)—the greatest current that a motor or other device is designed to carry under specific conditions: when rated voltage is applied at rated frequency with rated horsepower. Any additional current is an overload.

Fuse—an over-current protective device that consists of a conductor that melts and breaks when current exceeds rated value beyond a predetermined time.

Fuseable Disconnect Switch—a switching device that provides a safe way to distribute power for operating electrical equipment.

Generator—a machine that converts mechanical energy into electrical energy or power.

Generator Receptacle—a contact device installed for the connection of a plug and flexible cord to supply emergency power from a portable generator or other alternate source of power. Receptacles are rated in voltage, amps, number of wires and by enclosure type.

Ground—a connection, either intentional or accidental, between an electric circuit and the earth or some conducting body serving in place of the earth.

Ground Fault Circuit Interrupter (GFCI)—a receptacle with a built in circuit that will detect leakage current to ground on the load side of the device. When the GFCI detects leakage current to ground, it will interrupt power to the load side of the device, preventing a hazardous ground fault condition. GFCI receptacles must conform to UL Standard 943 Class A requirements and their use is required by the National Electric Code NFPA-70 in a variety of indoor and outdoor locations.

Grounded Neutral—the common neutral conductor of an electrical system, which is intentionally connected to ground to provide a current carrying path for the line to neutral load devices.

Grounding Conductor—the conductor that is used to establish a ground and that connects equipment, a device, a wiring system or another conductor (usually the neutral conductor) with the grounding electrode.

Hertz (Hz)—a unit of frequency equal to one cycle per second.

Horsepower (HP)—the amount of energy required to lift 33,000 lbs., one foot, in one minute. The electrical equivalent of one horsepower is 745.6 watts.

Impedance—a characteristic of an electric circuit that determines its hindrance to the flow of electricity. The unit of measure is the same as resistance (ohms).

Inductance—the property of an electric circuit that causes it to store energy in the form of a magnetic field and because of which a varying current in a circuit induces an electromotive force (voltage) in that or a neighboring circuit.

Kilowatt (kW)—a unit of measure of electrical power, equal to 1000 watts. Used where larger units of electrical power are measured.

Kilovolt-Amperes (kVA)—a rating of apparent power before being used, such as the rating of a transformer.

Manual Transfer Switch—a switch designed to disconnect the load from one power source and reconnect it to another source, while at no time allowing both sources to be connected to the load simultaneously.

Megohm—a unit of resistance equal to one million ohms.

NEC—the National Electrical Code, which is the standard of the National Board of Fire Underwriters for electric wiring and apparatus, as recommended by the National Fire Protection Association.

NEMA—National Electrical Manufacturers Association, a non-profit trade association supported by the manufacturers of electrical apparatus and supplies. NEMA promulgates standards to facilitate understanding between the manufacturers and users of electrical products.

Neutral—the point common to all phases of a polyphase circuit, a conductor to that point, or the return conductor in a single phase circuit. The neutral in most systems is grounded at or near the point of service entrance only and becomes the grounded neutral.

Ohm—unit of electrical resistance. One volt will cause a current of one ampere to flow through a resistance of one ohm.

GENERATORS

POWER GENERATION BASICS

GLOSSARY

Ohm's Law—the rate of the flow of the current is equal to the electromotive force divided by the resistance. The three basic Ohm's law formulas are:

- Amperes = Volts ÷ Ohms
- Ohms = Volts ÷ Amperes
- Volts = Amperes x Ohms

Overload Protection—the effect of a device operated on excessive current, but not necessarily on short circuit, to cause and maintain the interruption of current flow to the device being governed.

Parallel Circuit—an electrical circuit that has more than one path through which electrons may flow.

Power Factor (PF)—the ratio of the true power to the volt-amperes in an alternating current circuit. Power factor is expressed in a percent of unity either lagging for inductive loads or leading for capacitive loads.

Reactance—the component of impedance that does not dissipate energy. Inductive reactance stores magnetic energy and hinders the flow of alternating current.

Relay—an electric device that is designed to interpret input conditions in a prescribed manner and, after specified conditions are met, to respond and cause contact operation or similar abrupt changes in associated electric control circuits.

Resistance (R)—the non-reactive opposition that a device or material offers to the flow of direct or alternating current. Usually measured in ohms. The larger the resistance, the lower the current for a given source (driving) voltage.

Resistive Load Bank—a device that provides temporary electrical loads for field testing power sources such as generators and uninterruptible power supplies.

Series Circuit—an electrical circuit with only one path through which electrons may flow.

Single-Phase Circuit—a circuit that differs in phase by 180°. Single-phase circuits have two conductors, one of which may be a neutral, or three conductors, one of which is neutral.

Stand-by Power—see Emergency Power.

Star Connection—a three-phase connection, so called because, schematically, the joint of the "Y" points looks like a star. (Same as a "Y" or "Wye" connection.)

Starting Amps—the maximum current drawn by a motor during the starting period.

Step-Down Transformer—a transformer that provides one or more electrical outlets at reduced voltage and current from the main power source.

Surge Arrestor—a protective device for limiting surge voltages on equipment by discharging or bypassing surge current; it prevents continued flow of current to ground and is capable of repeating these functions as specified.

Switch—a device for making, breaking or changing connections in a circuit.

Terminal Block—an insulating base equipped with terminals for connecting wires.

Three-Phase Circuit—a combination of circuits energized by alternating electromotive sources that differ in phase by one third of a cycle, that is, 120°. A three-phase circuit may be three wire or four wire with the fourth wire being connected to the neutral point of the

circuit that may be grounded.

Transformer—a static electric device consisting of a single winding, or two or more coupled windings, used to transfer power by electromagnetic induction between circuits at the same frequency, usually with changed values of voltage and current.

Underwriters Laboratories (UL)—an independent, non-profit U.S. organization that tests products for safety.

Volt—a unit of measure of electric potential and electromotive force, equal to the difference of electric potential between two points on a conducting wire carrying a constant current of one ampere when the power dissipated between the points is one watt.

Voltage—electromotive force, or difference in electric potential, expressed in volts.

Watt—a unit of measure of electrical power, equal to the power used when one volt causes one ampere to flow in a circuit.

Wye Connection—see Star Connection.

kVA	kW	208V	220V	240V	380V	400V	440V	450V	460V	480V	600V	2400V	3300V	4160V
6.3	5	17.5	16.5	15.2	9.6	9.1	8.3	8.1	7.9	7.6	6.1	1.5	1.09	0.86
9.4	7.5	26.1	24.7	22.6	14.3	13.6	12.3	12	11.8	11.3	9.1	2.25	1.64	1.3
12.5	10	34.7	33	30.1	19.2	18.2	16.6	16.2	15.7	15.1	12	3	2.1	1.7
18.7	15	52	49.5	45	28.8	27.3	24.9	24.4	23.6	22.5	18	4.5	3.2	2.6
25	20	69.5	66	60.2	38.4	36.4	33.2	32.4	31.4	30.1	24	6	4.4	3.5
31.3	25	87	82.5	75.5	48	45.5	41.5	40.5	39.3	37.8	30	7.5	5.5	4.4
37.5	30	104	99	90.3	57.6	54.6	49.8	48.7	47.1	45.2	36	9.1	6.6	5.2
45	36	125	118	108	68	65	59	57	57	54	43	11	8	6
50	40	139	132	120	77	73	66.5	65	63	60	48	12.1	8.8	7
62.5	50	173	165	152	96	91	83	81	79	76	61	15.1	10.9	8.7
70	56	194	183	168	106	101	91	90	88	84	67	17	12	9
75	60	208	198	181	115	109	99.6	97.5	94	91	72	18.1	13.1	10.5
93.8	75	261	247	226	143	136	123	120	118	113	90	22.6	16.4	13
100	80	278	264	240	154	146	133	130	126	120	96	24.1	17.6	13.9
125	100	347	330	301	192	182	166	162	157	150	120	30	21.8	17.5
150	120	417	394	361	228	217	197	193	188	181	136	36	26	20
156	125	433	413	375	240	228	208	204	196	188	150	38	27.3	22
187	150	520	495	450	288	273	249	244	236	225	180	45	33	26
219	175	608	577	527	335	318	289	283	275	264	211	53	38	31
250	200	694	660	601	384	364	332	324	314	301	241	60	44	35
312	250	866	825	751	480	455	415	405	393	376	300	75	55	43
375	300	1040	990	903	576	546	498	487	471	451	361	90	66	52
400	320	1112	1051	962	685	578	525	514	503	481	385	96	70	55
438	350	1220	1155	1053	672	637	581	568	550	527	422	105	77	61
500	400	1390	1320	1203	770	730	665	650	628	602	481	120	88	69
625	500	1735	1650	1504	960	910	830	810	785	752	602	150	109	87
750	600	2080	1980	1803	1150	1090	996	975	942	902	721	180	131	104
800	640	2223	2102	1924	1217	1156	1051	1027	1005	962	771	192	140	111
875	700	2430	2310	2104	1344	1274	1162	1136	1100	1052	842	210	153	121
937.5	750	2605	2475	2254	1442	1367	1246	1218	1178	1128	903	225	164	130
1000	800	2780	2640	2405	1540	1460	1330	1300	1257	1203	962	241	176	139
1125	900	3120	2970	2709	1730	1640	1495	1460	1414	1354	1082	271	197	156
1250	1000	3470	3300	3009	1920	1820	1660	1620	1571	1504	1202	301	218	174
1563	1250	4350	4130	3765	2400	2280	2080	2040	1963	1885	1503	376	273	218
1875	1500	5205	4950	4520	2880	2730	2490	2440	2356	2260	1805	452	327	261
2188	1750	6079	5747	5280	3350	3180	2890	2830	2749	2640	2106	528	380	304
2500	2000	6947	6568	6020	3840	3640	3320	3240	3141	3015	2405	602	436	348
2812	2250	7816	7389	6780	4320	4095	3735	3645	3534	3400	2710	678	491	392
3130	2500	8684	8210	7520	4800	4560	4160	4080	3926	3765	3005	752	546	435
3750	3000	10421	9852	9040	5760	5460	4980	4880	4712	4525	3610	904	654	522
4375	3500	12158	11495	10550	6700	6360	5780	4660	5197	5285	4220	1055	760	610
5000	4000	13895	13137	12040	7680	7280	6640	6480	6282	6035	4810	1204	872	695

GENERATORS

GENERATORS

POWER GENERATION BASICS

Several basic electrical formulas, which are listed below, are related to Ohm's law. (See definition on previous page.)

Variables used in these formulas are as follows:

- I = Intensity of current = Amperes
- E = Electromotive Force = Volts
- R = Resistance = Ohms
- P = Power = Watts

Current (Ampere) Formulas

$$I = \sqrt{\frac{P}{R}} = \sqrt{\frac{\text{Watts}}{\text{Ohms}}} \quad I = \frac{P}{E} = \frac{\text{Watts}}{\text{Volts}} \quad I = \frac{E}{R} = \frac{\text{Volts}}{\text{Ohms}}$$

Voltage Formulas

$$E = \sqrt{P \times R} = \sqrt{\text{Watts} \times \text{Ohms}} \quad E = \frac{P}{I} = \frac{\text{Watts}}{\text{Amps}}$$

$$E = R \times I = \text{Ohms} \times \text{Amps}$$

Power (Watt) Formulas

$$P = E \times I = \text{Volts} \times \text{Amps} \quad P = \frac{E^2}{R} = \frac{\text{Volts}^2}{\text{Ohms}}$$

$$P = R \times I^2 = \text{Ohms} \times \text{Amps}^2$$

Resistance (Ohms) Formulas

$$R = \frac{E}{I} = \frac{\text{Volts}}{\text{Amps}} \quad R = \frac{E^2}{P} = \frac{\text{Volts}^2}{\text{Watts}} \quad R = \frac{P}{I^2} = \frac{\text{Watts}}{\text{Amps}^2}$$

Listed below are several additional electrical formulas, which are useful for calculating amperes, horsepower, kilowatts and kVA for both single-phase and three-phase alternating current when other values are known. Additional variables used in these formulas are as follows:

HP = Horsepower

EFF = Efficiency Factor (use 0.9 unless otherwise indicated)

PF = Power Factor (use 0.8 unless otherwise indicated)

ALTERNATING CURRENT (AC)

To Find:	Single-Phase	Three-Phase
Amperes, when motor HP is known	$\frac{HP \times 746}{E \times \text{EFF} \times \text{PF}}$	$\frac{HP \times 746}{E \times \text{EFF} \times \text{PF} \times 1.73}$
Amperes, when kW is known	$\frac{kW \times 1,000}{E \times \text{PF}}$	$\frac{kW \times 1,000}{E \times \text{PF} \times 1.73}$
Amperes, when kVA is known	$\frac{kVA \times 1,000}{E}$	$\frac{kVA \times 1,000}{E \times 1.73}$
Kilowatts (kW)	$\frac{E \times I \times \text{PF}}{1,000}$	$\frac{E \times I \times \text{PF} \times 1.73}{1,000}$
kW Input, when motor HP is known	$\frac{HP \times 0.746}{\text{EFF}}$	$\frac{HP \times 0.746}{\text{EFF}}$
Kilovolt-Amperes (kVA)	$\frac{E \times I}{1,000}$	$\frac{E \times I \times 1.73}{1,000}$
Horsepower (HP)	$\frac{E \times I \times \text{EFF} \times \text{PF}}{746}$	$\frac{E \times I \times \text{EFF} \times 1.73}{746}$

FULL-LOAD CURRENT IN AMPERES—ALTERNATING CURRENT (AC) MOTORS

HP	Single-Phase		Three-Phase Induction Type				Three-Phase Synchronous		
	115V	230V	208V	230V	460V	575V	230V	460V	575V
1/6	4.4	2.2							
1/4	5.8	2.9							
1/3	7.2	3.6							
1/2	9.8	4.9	2.4	2.2	1.1	0.9			
3/4	13.8	6.9	3.5	3.2	1.6	1.3			
1	16.0	8.0	4.6	4.2	2.1	1.7			
1-1/2	20.0	10.0	6.6	6.0	3.0	2.4			
2	24.0	12.0	7.5	6.8	3.4	2.7			
3	34.0	17.0	10.6	9.6	4.8	3.9			
5	56.0	28.0	16.7	15.2	7.6	6.1			
7-1/2	80.0	40.0	24.2	22.0	11.0	9.0			
10	100.0	50.0	30.8	28.0	14.0	11.0			
15			46.2	42.0	21.0	17.0			
20			59.4	54.0	27.0	22.0			
25			74.8	68.0	34.0	27.0	53.0	26.0	21.0
30			88.0	80.0	40.0	32.0	63.0	32.0	26.0
40			114.0	104.0	52.0	41.0	83.0	41.0	33.0
50			143.0	130.0	65.0	52.0	104.0	52.0	42.0
60			169.0	154.0	77.0	62.0	123.0	61.0	49.0
75			211.0	192.0	96.0	77.0	155.0	78.0	62.0
100			273.0	248.0	124.0	99.0	202.0	101.0	81.0
125			343.0	312.0	156.0	125.0	253.0	126.0	101.0
150			396.0	360.0	180.0	144.0	302.0	151.0	121.0
200			528.0	480.0	240.0	192.0	400.0	201.0	161.0
250					302.0	242.0			
300					361.0	289.0			
350					414.0	336.0			
400					477.0	382.0			
450					515.0	412.0			
500					590.0	472.0			

The chart at the left is useful for finding the full-load current in amperes for common types of electric motors with various horsepower and voltage ratings. To calculate the kW required to run a motor based on these values, use the following formulas:

Single-Phase

$$kW = \frac{\text{Volts} \times \text{Amps} \times \text{PF}^*}{1,000}$$

Three-Phase

$$kW = \frac{\text{Volts} \times \text{Amps} \times \text{PF}^* \times 1.73}{1,000}$$

*Use 0.8 power factor unless otherwise indicated.

Note: As a general rule, to estimate the kW necessary to start a motor, multiply the running kW x 2.5.

GENERATOR ACCESSORIES

REMOTE MONITORING SYSTEMS, AUXILIARY FUEL TANKS

REMOTE MONITORING SYSTEMS are ideal for tracking the status and performance of generators and other equipment utilized in critical applications. Systems available range from simple auto-dialers, which dial multiple phone numbers when the equipment shuts down or starts up, to sophisticated, web-based tracking systems that monitor multiple functions on a continuous basis. Typical functions monitored include:

- Engine hours—monitors usage and helps schedule preventive maintenance
- Location (Global Positioning)—for dispatch purposes and theft protection
- GeoFencing—notification when equipment leaves a designated area
- Remote management—ability to monitor single or multi-unit status, including monitoring multiple machine functions and controlling start-up and shutdown of units without a machine operator present
- Machine status—whether or not the unit is running

ENVIRONMENTAL AUXILIARY FUEL TANKS provide extended run times for all types of diesel-driven equipment. Several sizes are available, each featuring an environment-friendly design and rugged, steel construction that provides excellent spill control and complete fluid containment.

- Fuel tanks from 264-2,300 gallons available
- Double wall construction (except 275 gallon tank), with UL listed interior tanks and exterior rupture basins
- Southwest Research Fire Code rated
- Galvanized steel frames provide protection from accidental damage and also allow stacking of tanks
- Forklift pockets and 4-point lifting eyes for easy loading
- Fuel gauge with lockable fill and overflow shutoff valve
- Quick-connect hoses and fittings allow fast, easy hookup
- Each tank accommodates two supply and two return lines
- Forklift pockets and 4-point lifting eyes for easy loading
- Fuel gauge with lockable fill and overflow shutoff valve



Transcube 30TCG

Model	Capacity	Dimensions	Dry Weight	Cat-Class
10TCG	264 gal.	46"L x 46"W x 52"H	1,118 lbs.	110-0110
275GT ¹	275 gal.	56"L x 44"W x 55"H	1,431 lbs.	110-0110
500ET	500 gal.	84"L x 48"W x 80"H	3,750 lbs.	110-0210
20TCG	528 gal.	87"L x 46"W x 52"H	1,825 lbs.	110-0210
30TCG	792 gal.	91"L x 59"W x 52"H	2,153 lbs.	110-0310
40TCG	1,000 gal.	91"L x 87"W x 48"H	2,724 lbs.	110-0310
1000ET	1,000 gal.	102"L x 66"W x 80"H	4,850 lbs.	110-0310
50TCG	1,240 gal.	91"L x 91"W x 52"H	3,576 lbs.	110-0410
2300ET	2,300 gal.	144"L x 96"W x 84"H	8,100 lbs.	110-0410

¹275 gallon tank does not include double-wall construction or UL and Southwest Research ratings. Accommodates only one supply and one return line.

CONTAINMENT BERMS offer an ideal solution for secondary containment. Extremely durable, the berm's outside support straps allow the use of the full footprint of the berm for containment purposes. (see page 44)

GROUND PROTECTION MATS create effective temporary roadways and working platforms to ensure the safe transport and operation of workers and equipment. Made of High-Density Polyethylene, the mats provide superior protection and outperform plywood, timber mats and steel road plates in performance, safety and efficiency. (see page 44)

- Composite rig matting system, temporary road and drill staging system
- Easy installation
- Anti-slip traction pattern
- Easy-to-use cast aluminum cam lock system

GENERATOR ACCESSORIES

PORTABLE DISTRIBUTION PANELS

PORTABLE DISTRIBUTION PANELS provide multiple power outlets from a 208V 3-phase or 240V single-phase power source for operating power tools, work lights and other equipment. Several types of panels that accommodate various voltage and outlet requirements are available, plus a wide selection of pigtail adapters, extension cables, spider boxes and other accessory items. (see pages 40–41)

- NEMA 4X polycarbonate enclosures
- Input: 208V 3-phase or 240V single-phase
- Output: Multiple 208V 3-phase, 208V single-phase, 250V single-phase and 120V single-phase outlets
- Power on light and main circuit breaker
- Most models include 2-wheel mounting for portability



100A
Duplex Panel w/GFCI



200A
Quad Box Feeder Panel



200A
Spider Box Feeder Panel



400A
Spider Box Feeder Panel

Description	Power Input	Power Outlets	GFCI	Weight	Cat-Class
50A Duplex panel	50A, 240V 1ø	(12) 20A, 120V 1ø	yes	56 lbs.	006-0100
100A Quad Box Feeder Panel	100A, 208V 3ø	(4) 20A, 208V 3ø; (1) 20A, 120V 1ø; (1) 50A, 250V 1ø	no	65 lbs.	006-0120
100A Duplex Panel	100A, 208V 3ø	(12) 20A, 120V 1ø	yes	65 lbs.	006-0130
200A Quad Box Feeder Panel	200A, 208V 3ø	(10) 20A, 208V 3ø	no	130 lbs.	006-0200
200A Spider Box Feeder Panel	200A, 208V 3ø	(6) 50A, 250V 1ø	no	65 lbs.	006-0390
400A Spider Box Feeder Panel	400A, 208V 3ø	(10) 50A, 250V 1ø	no	130 lbs.	006-0400
400A Pin & Sleeve Splitter Panel	400A, 208V 3ø	(4) 100A, 208V 3ø	no	145 lbs.	006-0410

GENERATOR ACCESSORIES

WEATHERPROOF DISTRIBUTION PANELS

WEATHERPROOF DISTRIBUTION PANELS provide multiple power outlets from a 208V 3-phase power source. They are ideal for powering outdoor special events such as concerts, sporting events, conventions and motion picture production.

- Heavy-duty, molded rubber enclosures provide excellent shock, impact, corrosion and weather resistance
- Lightweight designs for easy handling
- Panels are stackable for easy transportation and storage



DB100NP-AFF-S3
100A Quad Feeder Boxes



DBS100DP-A4GFI
100A GFCI Duplex Panel



DB200NP-A6S-S3
200A Spider Box Feeder Panel



DB200NP-FFF-S3
200A Quad Feeder Box



DB400A-F202000
400A 3-phase Splitter Box



DB50NQ-BBB-S3
50A Spider Box
Input: 50A, 125/250V
Output: (6) 20A 125V duplex
16 lbs. (Cat-Class 006-0001)



Spider Box Cables
50' length, 38 lbs.
(Cat-Class 150-0800)
100' length, 75 lbs.
(Cat-Class 150-0805)



20A Quad Box Strings w/GFCI
40' length w/10' spacing, 17 lbs.
(Cat-Class 155-0010)
60' length w/20' spacing, 31 lbs.
(Cat-Class 155-0020)
80' length w/30' spacing, 45 lbs.
(Cat-Class 155-0030)



20A Quad Extension Cables
50' length, 25 lbs.
(Cat-Class 155-0040)
100' length, 45 lbs.
(Cat-Class 155-0045)

Make	Model	Description	Power Input	Power Outlets	Dimensions	Weight	Cat-Class
Lex Products	DB100NP-AFF-S3	100A Quad Feeder Box	100A 3ø 120/208V 5 wire male cam	(5) NEMA L21-20 20A 4P5W 3ø 120/208V locking receptacles	11"L x 11"W x 13"H	32 lbs.	006-0120
Lex Products	DBS100DP-A4GFI	100A GFCI Duplex Panel	100A 3ø 120/208V 5 wire male cam	(12) NEMA 5-20 20A 2P3W 125V GFCI duplex receptacles	11"L x 11"W x 13"H	33 lbs.	006-0130
Lex Products	DB200NP-FFF-S3	200A Quad Feeder Box	200A 3ø 120/208V 5 wire male cam	(10) NEMA L21-20 20A 4P5W 3ø 120/208V locking receptacles	15"L x 18"W x 22"H	75 lbs.	006-0200
Lex Products	DB200A-X016369	200A Spider Box Feeder Panel	200A 3ø 120/208V 5 wire male cam	(8) 50A 125/250V "California-style" locking receptacles	15"L x 15"W x 19"H	60 lbs.	006-0390
Lex Products	DB400A-F202000	400A 3-phase Splitter Box	400A 3ø 120/208V 5 wire male cam	(4) 100A 3ø 120/208V 5 wire female cam; (2) NEMA 5-20 20A 2P3W 125V GFCI duplex	15"L x 18"W x 22"H	75 lbs.	006-0410

GENERATOR ACCESSORIES

MULTI-PANELS, FUSEABLE DISCONNECTS, LOAD BANKS

I-LINE MULTI-PANELS provide extra versatility by adapting to any voltage up to 600V. Applications include distribution panels, portable air handling and temperature control equipment and electric pumps. Circuit breakers can be added or removed as required for multiple electric loads from a single power source.

- Input: 5-wire sets of cam-type receptacles with snap back protective covers
Accommodate any voltage up to 600V
- Output: Hardwire via I-Line circuit breakers, which are added or removed as required

Notes:

1. Circuit breakers are rented separately from multi-panels.
2. Please advise circuit breaker ratings needed, including amperage and number of phases, when placing order.



1,200A
I-Line Multi-Panel

Capacity	Power Input	Power Outlets	Weight	Cat-Class
200A	up to 600V, 3ø	(1) 5-wire set of cam-type receptacles	75 lbs.	006-0470
600A	up to 600V, 3ø	(1) 5-wire set of cam-type receptacles	100 lbs.	006-0490
1,200A	up to 600V, 3ø	(1) 5-wire set of cam-type receptacles	300 lbs.	006-0500

FUSEABLE DISCONNECT SWITCHES provide a safe way to distribute power for operating motors, office trailers and equipment for special events.

- Power Input: up to 600V, 3-phase
- Power Outlets: 5-wire set of cam-type receptacles
- Utilize buss-type fuses



200A Fuseable
Disconnect Switch

Capacity	Power Input	Power Outlets	Weight	Cat-Class
200A	up to 600V, 3ø	(1) 5-wire set of cam-type receptacles	100 lbs.	006-0700
400A	up to 600V, 3ø	(1) 5-wire set of cam-type receptacles	300 lbs.	006-0705

GENERATOR ACCESSORIES

MILL PANELS, STEP-DOWN TRANSFORMERS, TRANSFER SWITCHES

MILL PANELS are ideal for providing multiple 120V outlets from a 480V or 575V 3-phase power source for turn-arounds, plant maintenance, and shutdowns. 10 kVA and 30 kVA step-down transformer type mill panels are available, plus a 225kVA model that is ideal for multi-operator welding applications.

- NEMA 4X polycarbonate enclosures
- Include primary safety switch and power-on light



30 kVA Mill Panel



225 kVA Mill Panel

Capacity	Power Input	Power Output	Power Outlets	Weight	Cat-Class
10 kVA	480/575V, 3ø	208Y/120V, 41.7 amps	(6) 20A 120V GFCI, (2) 30A 240V	175 lbs.	006-0300
30 kVA	600/480V, 3ø	208Y/120V, 83.4 amps	(9) 20A 120V GFCI, (4) 50A 125/250V twist-lock	450 lbs.	006-0310
225 kVA	480/575V, 3ø	480/575V, 3ø	(8) 50A 480/575V, 3ø welder receptacles	221 lbs.	006-0320

STEP-DOWN TRANSFORMERS provide multiple 208V 3-phase power connections from a 480V 3-phase power source, making them ideal for powering portable distribution panels. Several sizes of step-down transformers from 30 kVA to 225 kVA are available, plus a 2,500 kVA step-up transformer.

- Input: 480V 3-phase
- Output: Multiple 208V 3-phase connections using 5-wire sets of cam-type output receptacles (except 2,500 kVA model)



HOW TO CALCULATE KVA REQUIREMENTS FOR 3-PHASE TRANSFORMERS

To calculate the kVA for 3-phase transformers:

1. Determine the required voltage and amperage.
2. Plug these values into the following formula:

$$\frac{\text{Volts} \times \text{Amps} \times 1.732}{1,000} = \text{kVA}$$

Capacity	Power Input	Power Output	Power Outlets	Weight	Cat-Class
30 kVA	36A, 480V 3ø	83A, 208V 3ø	(1) 5-wire set of cam-type receptacles	465 lbs.	006-0800
45 kVA	54A, 480V 3ø	124A, 208V 3ø	(1) 5-wire set of cam-type receptacles	580 lbs.	006-0810
75 kVA	113A, 480V 3ø	208A, 208V 3ø	(1) 5-wire set of cam-type receptacles	1,000 lbs.	006-0815
150 kVA	181A, 480V 3ø	417A, 208V 3ø	(2) 5-wire sets of cam-type receptacles	1,250 lbs.	006-0830
225 kVA	271A, 480V 3ø	625A, 208V 3ø	(4) 5-wire sets of cam-type receptacles	1,425 lbs.	006-0840
2,500 kVA	480Y/277Y	4,160V/13,200V	Multiple series voltage taps	13,600 lbs.	006-0890

DOUBLE THROW TRANSFER SWITCHES provide an economical means of transferring electrical loads between two power sources, such as a utility and an emergency or standby generator.

- Input: 480V 3-phase, 5-wire cam-type receptacles
- Output: 480V 3-phase, 5-wire cam-type receptacles

Notes:

1. Both manual and automatic transfer switches are available for the capacities listed.
2. Dual voltage and low voltage types are also available.

Capacity	Cat-Class
100A	006-0752
200A	006-0758
400A	006-0720
600A	006-0725
800A	006-0768
1,200A	006-0730



600A Double Throw Transfer Switch

GENERATOR ACCESSORIES

DISTRIBUTION ACCESSORIES

SPIDER BOXES are used to provide multiple 20A 120V outlets from a 250V single-phase power source when a 3-phase power source is unavailable. Includes (6) 20A 120V GFCI receptacles and (1) 30A 240V Twist-Lok receptacle. Weight: 28 lbs. (Cat-Class 006-0001)



MOLDED CABLE RAMPS are used to provide protection for many types of cable, up to 1.3" diameter. They eliminate the need for burying, bypassing or stringing cables. Ramps feature five channels and an interlocking design that allows combining units. End caps and protector bridges are also available. Dimensions: 36"L x 20"W x 2"H. Unit weighs 21 lbs. (Cat-Class 155-0245)

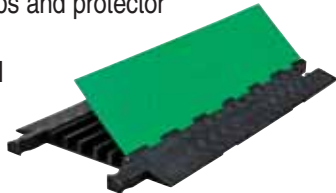

THREE GANG BOXES W/GFCI are used for supplying multiple 120V outlets away from the primary panel. Includes (1) 20A, 3-phase, 120/208V twist-lock plug and (3) 20A 120V GFCI duplex receptacles. Unit weighs 6 lbs. (Cat-Class 155-0035)



QUAD BOX STRINGS W/GFCI are used to distribute 120V services every 10', 20' or 30' from a 20A 208V power source. All sizes include five conductor #10 AWG type SOW-A power cable; (3) molded outlet boxes, each with (2) 20A 120V GFCI duplex receptacles; and a 20A, 3-phase, 120/208V twist-lock plug and connector.



30' length w/10' spacing, 17 lbs. (Cat-Class 155-0010)
 60' length w/20' spacing, 31 lbs. (Cat-Class 155-0020)
 90' length w/30' spacing, 45 lbs. (Cat-Class 155-0030)

CAM-LOCK MULTI-WAY CONNECTORS are used to connect multiple Cam-Type single conductor cables. Accommodate #2-4/0 cables, 600V/400A capacity

- A 3-Fer-Male-Female-Female-Female (Cat-Class 155-1900)
- B Double Female-Female-Female (Cat-Class 155-1910)
- C Tapping Tee-Female-Female-Male (Cat-Class 155-0235)
- D Paralleling Tee-Female-Male-Male (Cat-Class 155-0235)



GENERATOR ACCESSORIES

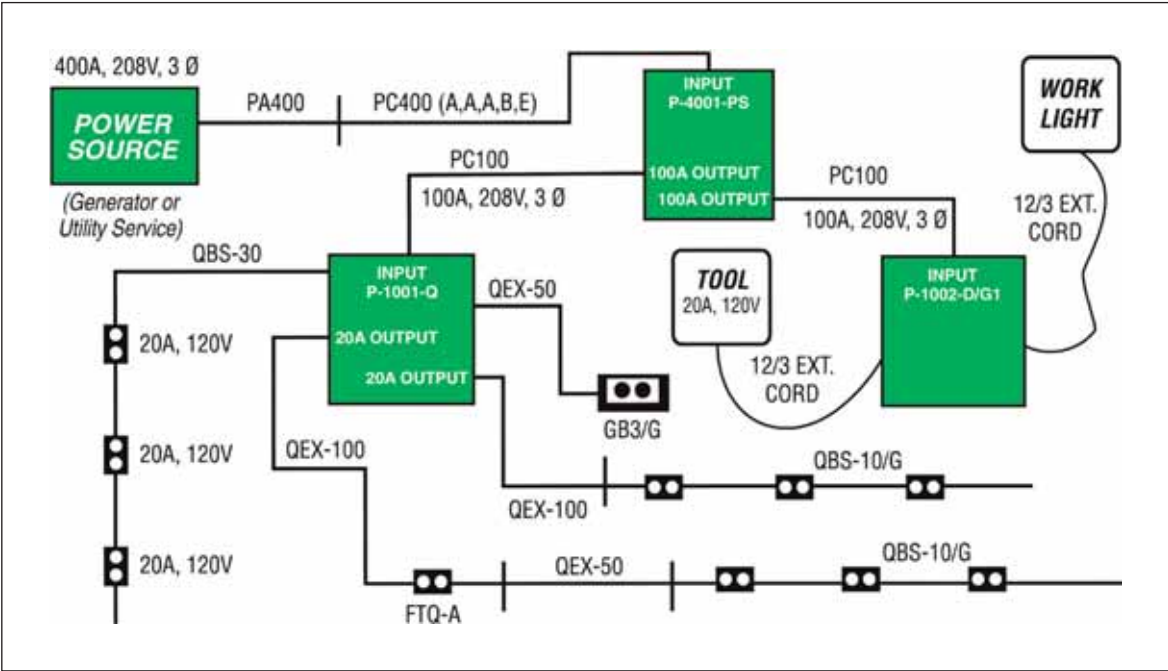

Typical Power Distribution System Layout

GENERATOR ACCESSORIES

POWER CABLE

PIGTAIL ADAPTERS



2/5 Pin & Sleeve **4/0 Cam-Lock** **Appleton Plug**
Used to connect the power source to a distribution panel

Pigtail Adapters					
Connector Type	Cable	Length	Capacity	Weight	Cat-Class
Cam-Lock FM	2/0	10'	600V/200A	8 lbs.	155-0090
Cam-Lock M	2/0	10'	600V/200A	8 lbs.	155-0095
Cam-Lock FM	4/0	10'	600V/400A	11 lbs.	155-0125
Cam-Lock M	4/0	10'	600V/400A	11 lbs.	155-0130
Twist-Lock M	2/5	10'	600V/100A	20 lbs.	155-0155
Twist-Lock FM	2/5	10'	600V/100A	20 lbs.	155-0160
Pin & Sleeve M	2/5	10'	600V/100A	20 lbs.	155-0175
Pin & Sleeve FM	2/5	10'	600V/100A	20 lbs.	155-0180
Twist-Lock FM	6/4	10'	600V/60A	6 lbs.	155-0205
Twist-Lock M	6/4	10'	600V/60A	6 lbs.	155-0210
Quad String FM	10/5	10'	600V/25A	5 lbs.	155-0050
Quad String M	10/5	10'	600V/25A	5 lbs.	155-0055
Appleton Plug	2/4	10'	600V/100A	20 lbs.	155-0243

CAM-LOCK CABLES

Single-conductor cables, each equipped with one male and one female Cam-Type connector. Used for supplying power to 200A and 400A distribution panels.



Cam-Lock Cables				
Cable	Length	Capacity	Weight	Cat-Class
2/0	50'	600V/200A	38 lbs.	155-0065
2/0	100'	600V/200A	75 lbs.	155-0070
4/0	50'	600V/400A	55 lbs.	155-0100
4/0	100'	600V/400A	108 lbs.	155-0105

PIN & SLEEVE CABLES

Five-conductor cables, each equipped with one male and one female Pin & Sleeve connector. Used for supplying power to 100A distribution panels.



Pin & Sleeve Cables				
Cable	Length	Capacity	Weight	Cat-Class
2/5	25'	600V/100A, 3ø	68 lbs.	155-0165
2/5	50'	600V/100A, 3ø	140 lbs.	155-0170

BANDED 5 WIRE CABLES

Highly Flexible Cam Type Extension with (5) #2 AWG SC (Entertainment) conductors banded every 2' with heavy-duty sealant type heat shrink for durability and rated to 600V/220A.



QUAD EXTENSION CABLES

Five-conductor cables, each equipped with one 120/208V twist-lock plug and connector. Used for supplying power to Quad Box Strings and Three Gang Boxes.



Quad Extension Cables				
Cable	Length	Capacity	Weight	Cat-Class
10/5	50'	20A/208Y, 3ø	26 lbs.	155-0040
10/5	100'	20A/208Y, 3ø	45 lbs.	155-0045

SPIDER BOX CABLES

Four-conductor cables, equipped with California plugs. Used for supplying 50A 250V single-phase power to Spider Boxes.



Spider Box Cables				
Cable	Length	Capacity	Weight	Cat-Class
6/4	25'	600V/50A	16 lbs.	155-0795
6/4	50'	600V/50A	37 lbs.	155-0800
6/4	100'	600V/50A	57 lbs.	155-0805

BARE CABLE

Bare cable is rented by the foot in the cable size required.



Bare Cable			
Cable	Capacity	Weight (per foot)	Cat-Class (per foot)
2/0	600V/200A	0.73 lbs.	155-0056
4/0	600V/400A	1.05 lbs.	155-0098
250 MCM	5kV/315A	1.13 lbs.	155-0132
535 MCM	2kV/720A	2.22 lbs.	155-0134
600 MCM	5kV/525A	2.42 lbs.	155-0141
800 MCM	5kV/525A	2.94 lbs.	155-0143
2/5	600V/100A	2.00 lbs.	155-0144
6/4	600V/60A	0.60 lbs.	155-0193
10/5	600V/25A	0.50 lbs.	155-0213
10/3	600V/25A	0.28 lbs.	155-0223

LOAD BANKS

RACK LOAD BANKS

LOAD BANKS are devices that develop an electrical load, apply the load to an electrical power source, and convert or dissipate the resultant power output of the source. A load bank is intended to accurately mimic the operational or real load which a power source will see in actual application. However, unlike the real load, which is likely to be dispersed, unpredictable and random in value, a load bank provides a contained, organized and fully controllable load. Consequently, a load bank can be further defined as a self-contained, systematic device which includes both load elements with control and accessory devices required for operation. Whereas the real load is served by the power source and uses the energy output of the source for some productive purpose, the load bank serves the power source, using its energy output to test, support or protect the power source. Load banks effectively test equipment ranging from batteries to diesel generators to utility feeders.

Markets Served Include:

- Aerospace
- Armed Forces & Government
- Commissioning Companies
- Communications
- Data Centers
- Energy/Power Generation
- Engineering Firms
- Financial
- Generator Service Companies
- Green / Renewable Energy
- Healthcare
- Industrial Manufacturing
- Maritime
- Municipal
- Transportation
- Utility
- Wind Farms

RACK LOAD BANKS are designed to mimic the heat loading of a computer server to test the cooling facilities of temperature-sensitive environments such as data centers. Using Rack Load Banks prior to installation helps to identify and correct potential temperature issues, preventing the escalation of possible heat-related problems.



Avtron Patriot SLS-10
10 kW Server Load Simulator

Make	Model	Capacity*	Overall Dimensions	120V	240V	208V	Cat-Class
Mosebach	SRMLB	5 kW	22"L x 19"W x 10.25"H	✓	✓	✓	115-0005
Avtron	SLS-10 (Server Load Simulator)	10 kW	19"L x 23.3"W x 15.75"H	✓	Single Phase	Single Phase	115-0005

*Load bank capacity may vary according to the voltage applied—contact a Sunbelt Rentals Pump & Power Services representative for details.

LOAD BANKS

RESISTIVE LOAD BANKS

RESISTIVE LOAD BANKS are designed to provide temporary electrical loads for field testing power sources such as generators and uninterruptible power supplies. Reduction of “wet stacking” helps to ensure that your equipment is ready for peak performance. Load banks range from 75 kW to 2,500 kW capacity.



- Convenient Operator Controls with Digital Metering
- Portable for Load Testing at Multiple Site
- Capacities up to 2,500kW
- 1,250kW and larger are Trailer Ready

LOAD BANKS



Mosebach X100S
100 kW Portable



Avtron Patriot 700
700 kW Portable



Avtron K580
1,250 kW Trailer-Mounted

Make	Model	Capacity*	Load Step	Overall Dimensions	Weight	Hertz**	120V	240V	208V	480V	Cat-Class
Mosebach	X60	60 kW	5 kW	20"L x 18"W x 24"H	75 lbs.	60	✓	✓	✓	✓	115-0010
Mosebach	X100	100 kW	5 kW	19"L x 17"W x 32"H	110 lbs.	60	✓	✓	✓	✓	115-0020
Mosebach	X200	200 kW	5 kW	32"L x 19"W x 37"H	250 lbs.	60	✓	✓	✓	✓	115-0070
Mosebach	X400	400 kW	5 kW	40"L x 33"W x 46"H	500 lbs.	60	✓	✓	✓	✓	115-0040
Avtron	Freedom 100	100 kW	5 kW	25"L x 16"W x 29"H	105 lbs.	60	✓	✓	✓	✓	115-0020
Avtron	Millennium 400	400 kW	5 kW	56"L x 34"W x 50"H	785 lbs.	60	✓	✓	✓	✓	115-0040
Avtron	Patriot 700	700 kW	5 kW	61"L x 24"W x 75"H	1,150 lbs.	60	✓	✓	✓	✓	115-0050
Avtron	K580	1,250 kW	5 kW	208"L x 93"W x 84"H	6,000 lbs.	60		✓	✓	✓	115-0060
Avtron	K580	2,000 kW	5 kW	203"L x 93"W x 118"H	7,500 lbs.	60		✓	✓	✓	115-0070
Avtron	K580 HC	2,500 kW	50 kW	203"L x 93"W x 118"H	7,500 lbs.	60				✓	115-0075

*Load bank capacity may vary according to the voltage applied—contact a Sunbelt Rentals Pump & Power Services representative for details.

**Control and blower must operate at 60 Hz.

GROUND PROTECTION

GROUND PROTECTION MATS, BERMS

GROUND PROTECTION MATS offer a safe, stable surface for heavy vehicles and equipment. Available in four convenient sizes, the mats create effective temporary roadways and working platforms to ensure the safe transport and operation of workers and equipment. The mats provide superior protection and outperform plywood, timber mats and gravel in performance, safety and efficiency. DuraDeck® is available in white or beige.

- Composite rig matting system, temporary road and drill staging system
- Easy installation
- Anti-slip traction pattern
- Easy-to-use cast aluminum cam lock system



MegaDeck®

	MegaDeck®	DuraDeck®	ArmorDeck® 1	ArmorDeck® 3	UltraDeck
Size	14'L x 7.5'X x 4"H	4'L x 8'W x .5"H	45" x 45" x 2" (with connection tabs exposed)	45" x 45" x 2.5" (with connection tabs exposed)	12'L x 24'W x 1.125"H
Weight	1,150 lbs.	86 lbs.	31 lbs.	41 lbs.	2.88 lbs.
General Usage	Heavy-Duty Use	Light to Medium Use	Light to Medium Use	Light to Medium Use	Light to Medium Use
Weight-Bearing Ability	Up to 600 PSI	Up to 80 ton	25,000 lbs./sq. ft.* <small>*Static load on a solid and level surface</small>	45,000 lbs./sq. ft.* <small>*Static load on a solid and level surface</small>	Up to 20,000 lbs./sq. ft.
Cat-Class	154-0295	154-0105/0120	154-0005/0007	154-0035/0045	154-0165



	DuraDeck®	MegaDeck®	Plywood/Timber Mats
Average Lifespan	6+ years	12+ years	Maximum of 3 years
Chemical Resistant	Yes	Yes	No
Heavier When Wet	No	No	Yes
Warping Due to Moisture	No	No	Yes
Recyclable	Yes	Yes	No
Environmentally Responsible	Yes	Yes	No
Integrated Connection System	Yes	Yes	No
Safety: Anti-slip Tread	Yes	Yes	No
Splinters	No	No	Yes

CONTAINMENT BERMS

are ideal for spill containment. Constructed of a military grade fabric, the berms are extremely durable, and their outside support straps allow the use of the full footprint of the berm for containment purposes. Perfect for a wide range of applications, containment berms can be used in conjunction with any piece of equipment that houses fuel or oil.

- Mitigates the environmental impact of fuel and oil spills
- Durable construction supports long-term use
- One-piece build allows for easy setup
- Various sizes ensure equipment can be effectively contained



Containment Berm

Make	Size	Containment Capacity	Cat-Class
Basic Concepts, Inc.	4'x4'	120 gal.	155-2040
Basic Concepts, Inc.	6'x6'	269 gal.	155-2045
Basic Concepts, Inc.	6'x10'	449 gal.	155-2050
Basic Concepts, Inc.	6'x14'	628 gal.	155-2052
Basic Concepts, Inc.	8'x8'	479 gal.	155-2053
Basic Concepts, Inc.	8'x10'	598 gal.	155-2054
Basic Concepts, Inc.	8'x12'	718 gal.	155-2056
Basic Concepts, Inc.	8'x14'	838 gal.	155-2057
Basic Concepts, Inc.	8'x16'	957 gal.	155-2058
Basic Concepts, Inc.	10'x10'	748 gal.	155-2059
Basic Concepts, Inc.	10'x12'	898 gal.	155-2061
Basic Concepts, Inc.	10'x14'	1,047 gal.	155-2038
Basic Concepts, Inc.	10'x16'	1,197 gal.	155-2060
Basic Concepts, Inc.	10'x18'	1,346 gal.	155-2062
Basic Concepts, Inc.	10'x20'	1,496 gal.	155-2063
Basic Concepts, Inc.	10'x24'	1,795 gal.	155-0826
Basic Concepts, Inc.	10'x28'	2,094 gal.	155-2074
Basic Concepts, Inc.	10'x30'	2,244 gal.	155-2064
Basic Concepts, Inc.	10'x34'	2,543 gal.	155-2076
Basic Concepts, Inc.	10'x40'	2,992 gal.	155-2065
Basic Concepts, Inc.	10'x44'	3,291 gal.	155-2078
Basic Concepts, Inc.	10'x50'	3,740 gal.	155-2080
Basic Concepts, Inc.	10'x52'	3,890 gal.	155-2082
Basic Concepts, Inc.	12'x6'	539 gal.	155-2067
Basic Concepts, Inc.	12'x12'	1,077 gal.	155-2066
Basic Concepts, Inc.	12'x16'	1,436 gal.	155-2071
Basic Concepts, Inc.	12'x18'	1,616 gal.	155-2069
Basic Concepts, Inc.	12'x24'	2,154 gal.	155-2068
Basic Concepts, Inc.	12'x50'	4,488 gal.	155-2070
Basic Concepts, Inc.	16'x16'	1,915 gal.	155-2090
Basic Concepts, Inc.	20'x20'	2,992 gal.	155-2095

AIR COMPRESSORS

DIESEL STANDARD, HIGH-PRESSURE

STANDARD DIESEL (LUBRICATED AIR END) AIR COMPRESSORS are ideal for meeting emergency and supplemental air requirements at industrial plants and commercial facilities where critical air quality is not required. They are also well-suited for construction applications such as powering large portable drills and multiple smaller air tools. Feature efficient rotary screw compressor units coupled with continuous duty-rated diesel engines for sustained, dependable operation.

- Quiet, dependable operation (less than 76 dBA at 7 meters)
- Automatic safety shutdown protection
- High-speed running gear allows towing at highway speeds
- Auxiliary fuel tanks are available for extended operation without refueling (see page 35)
- Both standard and high-pressure models are available

HIGH-PRESSURE AIR COMPRESSOR APPLICATIONS

- Catalytic regeneration (gasoline and refined oils)
- Soot blowing (utilities with coal fired furnaces)
- Drilling (down-the-hole for rock and oil drilling)
- PET (bottle blowing—used with a booster)
- Nitrogen membrane separation



Doosan HP750WCU
750 CFM Standard Air Compressor, 150 PSI



Doosan XHP1170
1,070 CFM High-pressure Air Compressor, 350 PSI

Make	Model	CFM	Rated Pressure	Pressure Range	HP	Onboard Fuel Cap	Consump Full Load	Run Time Full Load	Overall Dimensions	Weight	Cat-Class
Doosan	XP375	375	125 PSI	80-150 PSI	123	60 gal.	6.3 GPH	11 hrs.	13'L x 78"W x 68"H	4,418 lbs.	001-0050
Sullivan-Palatek	D375P	375	100 PSI	70-125 PSI	140	40 gal.	6.0 GPH	7 hrs.	12'L x 56"W x 80"H	3,395 lbs.	001-0050
Doosan	HP375	375	150 PSI	80-175 PSI	123	60 gal.	6.3 GPH	11 hrs.	13'L x 78"W x 68"H	4,418 lbs.	001-0060
Sullivan-Palatek	D375PH	375	150 PSI	70-170 PSI	140	40 gal.	6.0 GPH	7 hrs.	12'L x 56"W x 80"H	3,395 lbs.	001-0060
Doosan	P600WIR ¹	600	100 PSI	80-125 PSI	170	73 gal.	8.5 GPH	9 hrs.	15'L x 78"W x 76"H	5,133 lbs.	001-0080
Doosan	HP750WCU ¹	750	150 PSI	80-150 PSI	275	100 gal.	12.9 GPH	8 hrs.	16'L x 86"W x 89"H	7,590 lbs.	001-0090
Doosan	HP750WJD	750	150 PSI	80-150 PSI	275	100 gal.	11.4 GPH	9 hrs.	16'L x 86"W x 89"H	7,890 lbs.	001-0095
Sullivan-Palatek	D750PH	750	150 PSI	70-150 PSI	275	100 gal.	12.7 GPH	8 hrs.	16'L x 80"W x 89"H	9,000 lbs.	001-0095
Doosan	XP825WCU ¹	825	125 PSI	80-125 PSI	275	100 gal.	12.9 GPH	8 hrs.	16'L x 86"W x 89"H	7,590 lbs.	001-0100
Doosan	HP915WCU ²	900	150 PSI	80-150 PSI	300	110 gal.	14.5 GPH	8 hrs.	18'L x 79"W x 93"H	10,250 lbs.	001-0110
Sullivan-Palatek	D900PH	900	150 PSI	70-150 PSI	305	100 gal.	14.0 GPH	7 hrs.	16'L x 80"W x 89"H	9,000 lbs.	001-0110
Doosan	XHP1070 ²	1,070	350 PSI	150-375 PSI	475	230 gal.	20.9 GPH	11 hrs.	24'L x 90"W x 100"H	15,950 lbs.	001-0130
Sullivan-Palatek	D1150PVH	1,100	350 PSI	200-350 PSI	540	200 gal.	25.0 GPH	8 hrs.	20'L x 90"W x 94"H	19,000 lbs.	001-0130
Doosan	XHP1170 ²	1,170	350 PSI	150-375 PSI	540	230 gal.	20.9 GPH	11 hrs.	24'L x 90"W x 100"H	16,700 lbs.	001-0150
Sullivan-Palatek	D1600PH	1,600	150 PSI	70-150 PSI	535	200 gal.	24.0 GPH	8 hrs.	20'L x 90"W x 94"H	19,000 lbs.	001-0210

¹Fuel capacities and run times are based on units with Tier 2 certified engines—specs may vary for units with other engines.

²Fuel capacities and run times are based on units with Tier 3 certified engines—specs may vary for units with other engines.

AIR COMPRESSORS

INSTRUMENT-QUALITY

INSTRUMENT-QUALITY (I-Q) AIR COMPRESSORS provide extremely clean, high-quality compressed air on a cost-effective basis for a wide range of industrial and construction applications. This is achieved by combining a rotary screw air compressor with an aftercooler, a moisture separator, dual coalescing filters and a condensate burn-off system in an efficient, self-contained package.

- All models exceed the ISA-S7.0.01-1996 Quality Standard for Instrument Air: Particulate size is less than 0.01 micron; Oil and water aerosol removal down to 0.01 PPM
- Integral aftercooler discharges compressed air at 15° approach temperature to ambient
- Simple valving also allows the versatility of running units in standard mode for non I-Q applications
- Desiccant dryers are available for special applications requiring a lower dew point to eliminate condensation of water vapor in downstream air lines and equipment
- High-speed running gear allows towing units behind a truck at highway speeds
- Auxiliary fuel tanks are available for extended operation without refueling (see page 35)

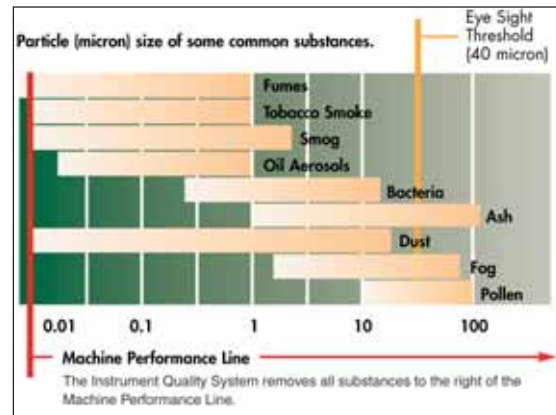
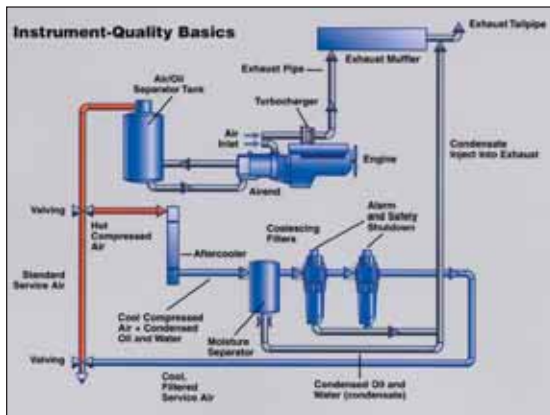

Doosan HP1600WCU
1,600 CFM, 150 PSI
Instrument Quality Air Compressor

Make	Model	CFM	Rated Pressure	Pressure Range	HP	Onboard Fuel Cap*	Consump Full Load	Run Time Full Load*	Tier	Overall Dimensions	Weight	Cat-Class
Doosan	375IQ	425 375	100 PSI 150 PSI	80-125 PSI 80-175 PSI	130	60 gal.	6.1 GPH	9.84 hrs.	4i	1521"L x 78"W x 68"H	4535 lbs.	001-0065
Doosan	750IQ	750	150 PSI	80-175 PSI	270	102 gal.	11 GPH	9.27 hrs.	4i	2041"L x 91"W 79"H	9500 lbs.	001-0095
Doosan	915IQ	915	150 PSI	80-175 PSI	300	110 gal.	14.5 GPH	7.59 hrs.	3 Flex	2151"L x 79"W x 88"H	10250 lbs.	001-0116
Doosan	HP1600WCU IQ	1,600	150 PSI	80-150 PSI	560	230 gal.	22.0 GPH	10 hrs.	3 Flex	24'L x 90"W x 101"H	18,300 lbs.	001-0220
Sullivan	D375DF375	375	150 PSI	70-150 PSI	140	40 gal.	6 GPH	6 hrs.	3 Flex	145"L x 55"W x 80"H	3,400 lbs.	001-0065
Sullivan	DF750PHCU IQ	750	150 PSI	80-150 PSI	305	150 gal.	14 GPH	10 hrs.	3 Flex	17.9"L x 77"W x 88"H	9000 lbs.	001-0095
Sullivan	DF900PH3CU IQ	900	150 PSI	80-150 PSI	305	150 gal.	16 GPH	8 hrs.	3 Flex	17.9"L x 77"W x 88"H	9000 lbs.	001-0115
Sullivan	DF1600PHCU IQ	1600	150 PSI	80-150 PSI	535	200 gal.	24 GPH	8 hrs.	Tier 3	22.9"L x 92.5"W x 100"H	19000 lbs.	001-0220
Sullivan	DF1150PVHCU IQ	1150	350 PSI	250-350 PSI	535	200 gal.	24 GPH	8 hrs.	3 Flex	22.9"L x 92.5"W x 100"H	19000 lbs.	001-0150

*Fuel capacities and run times are based on units with Tier 3 certified engines—specs may vary for units with other engines.

AIR COMPRESSORS

ELECTRIC

ELECTRIC AIR COMPRESSORS deliver outstanding, trouble-free performance in a wide range of industrial and commercial applications. They feature quiet operation and easy, low-cost maintenance. Models ranging from 50 HP to 400 HP are available.

- Weather-resistant, sound-attenuated enclosures—units operate indoors or outdoors
- Units operate on 460V 3-phase power
- Operate in ambient temperatures from -10° to 115°F
- Dryer and filter packages are available to meet special requirements (see pages 51-54)
- Cam Lock Cable Connectors
- Complete fluid containment skid with drains
- Spin on type lube filters mounted strategically for ease of maintenance



Sullivan-Palatek compressors feature easy operation with analog instrumentation.



Sullivan-Palatek 100UD
125 HP Electric Air Compressor



Sullivan-Palatek 50UD
50 HP Electric Air Compressor

Make	Model	HP	CFM	Rated Pressure	Amp Rating	Starting Amp Requirement	Outlet	Overall Dimensions	Weight	Cat-Class
Sullivan-Palatek	50UD*	50	200	150 PSI	58	280	1.25"	87"L x 35"W x 51"H	2,700 lbs.	001-0420
Sullivan-Palatek	100UD*	125	440	150 PSI	112	300	2"	92"L x 45"W x 78"H	3,960 lbs.	001-0425
Sullivan-Palatek	250UD*	250	900	150 PSI	287	690	3"	111"L x 71"W x 92"H	7,900 lbs.	001-0431
Sullivan-Palatek	350UD*	300	1,100	150 PSI	361	850	3"	135"L x 79"W x 88"H	10,000 lbs.	001-0432
Sullivan-Palatek	400UD*	400	1,490	150 PSI	448	1050	3"	135"L x 79"W x 88"H	10,500 lbs.	001-0438

*Units operate on a 460V 3-phase power

AIR COMPRESSORS

COMPRESSED AIR BASICS

AIR TYPES

Standard Compressed Air (Oil-Flooded)

- Hot (Heat of compression is approximately 110°F over ambient)
- Wet (Humidity in ambient air is sent downstream)
- Oily (Oil-flooded compressors will pass oil downstream)

Instrument-Quality (IQ) Compressed Air

- Oil-flooded air with after-treatment
- After-cooled (15–25° of ambient)
- Filtered (.01 micron and .01 PPM remaining oil content)
- 99.99% of all impurities are removed
- Cleanest compressed air available

Oil-Free Compressed Air (Dry Screw)

- No oil utilized in the compression cycle
- After-cooled (25° of ambient)
- Minimal filtration (filtered to 25 microns)
- Not cost effective and not needed for compressing air.

GLOSSARY

Ambient Air—the air surrounding you.

Aftercoolers—heat exchanger that cools discharged air from the compressor (provides the most effective means of removing moisture from compressed air; approximately 70% of water is removed).

Air-Cooled Compressors—atmospheric air is circulated around to cool the unit and/or the compressed air.

Air End—compression chamber where air is compressed.

Approach Temperature—temperature above ambient.

Boosters—increase air pressure (usually four times inlet PSI).

Boss Hose Fitting—threaded fitting to connect hose from compressor or extend the length of hose used to flow gases.

Chicago Fitting—(crows foot) 1/4 turn fitting that can connect hose to the compressor or extend the length of hose used to flow gases.

CFM—cubic feet per minute.

Centrifugal Compressors—compression of air/gas through turning impellers.

Condensate—liquid discharged from compressor and/or air treatment equipment.

Dew Point—temperature that moisture changes from vapor to liquid.

Dew Point Suppression—temperature below ambient.

Dynamic-Type Compressors—air or gas is compressed by rotating vanes or impellers.

Filters—devices that separate and/or remove undesired liquids and particulates from compressed air.

High-Pressure Air—compressed air above 150 PSI.

Instrument-Quality (IQ) Air—treated compressed air from an oil-flooded compressor (after-cooled, filtered).

Low-Pressure Air—compressed air 150 PSI or lower.

Multicasting Compressors—one motor can run two or more compression chambers.

Multistage Compressor—compressor with two or more stages.

Microns—measurement used to define particulates in the air stream (one micron equals one millionth of a meter, about one-eighth the thickness of one human hair).

Oil-Flooded Air—compressed air produced by a lubricated air end.

Oil-Free Air—compressed air produced by a dry air end.

Oil Separator—device used in an oil-flooded system to recycle oil back to the air end.

OSHA Valve—valve used to depressurize a system when pressure drop is noticed.

PSI—pounds per square inch, unit for pressure of compressed air.

Particulates—any solid material, such as dirt, rust, weld fines, pollen, etc., in the air stream.

PPM—parts per million, measurement of the oil present in compressed air.

Receivers—tanks used to store compressed air and help dampen discharge line pulsations.

Reciprocating Compressor—a piston in a cylinder producing compression.

SCFM—standard cubic feet per minute.

Standard Air—air at a temperature of 68°F, 14.70 PSI atmospheric pressure and relative humidity of 36% (per ASME). In the gas industry, temperature is 60°F.

Standard Compressed Air—untreated compressed air from an oil-flooded system (not after-cooled or filtered).

Rotary Compressors—compression is produced by the positive action of rotating elements.

Two-Stage Compressors—two-compression chambers (initial to intermediate) with one air discharge.

Whipcheck—safety cable used to restrain air hoses if an end breaks.

RULES OF THUMB

1. For every 20° that compressed air drops in temperature, half of the water vapor will change to liquid.
2. A 1,000 CFM air compressor can produce 55 gallons of water in 24 hours of straight run time.
3. 1,800 CFM at 100 PSI is approximately the maximum amount of air that can pass through a 3-inch hose.
4. For electric air compressors, multiplying the horsepower times four will give you the approximate CFM.
5. As the pressure increases, the CFM decreases. Conversely, as the pressure decreases, the CFM increases.
6. All electric air compressors have built-in aftercoolers.

QUESTIONS TO ASK

1. What are the CFM and PSI requirements?
2. What type of compressor is needed?
 - a. Diesel (standard, I-Q or oil-free)
 - b. Electric
3. What quality of air is required?
 - a. Particulates (what micron?)
 - b. Moisture (dew point)
 - c. Oil content (PPM)
4. What is the application?
5. What type and size air connections will we pipe to?
 - a. Pipe thread
 - b. Flange
 - c. Boss
 - d. Chicago (crows feet), etc.
6. What type and size connections do we need on the compressor? (match hose fittings with compressors)
 - a. Mpt, fpt
 - b. Boss
 - c. Chicago (crows feet)
 - d. Flange, etc.
7. What is the distance from the compressor to the process connection? (How many hose lengths and whipchecks will be needed?)
8. Do you need low ambient (below 35°F) protection?
9. How much room do you have to place the equipment? (Compare to the overall dimensions of the selected equipment.)
10. Is after treatment (after-cooler separators, dryers or filters) needed?

AIR COMPRESSORS

COMPRESSED AIR BASICS

AIR TREATMENT PACKAGES

Aftercooler/Separators (air or electric driven)

- Reduce compressed air temperature (10-20° approach)
- Remove 70% of the water
- 450 to 3,500 CFM capacity (high pressure available)

Aftercooler/Filter Packages (air driven)

- Reduce compressed air temperature (10-15° approach)
- Remove 80% of the water
- Filter particulates to .01 micro
- Remaining oil content = .01 PPM
- 450 to 1,600 CFM capacity (high pressure available)
- Makes a standard air compressor an IQ compressor

Membrane Dryer/Aftercoolers (air driven)

- Reduce compressed air temperature (10° approach)
- Reduce dew point to 60° suppression
- Filter particulates to .01 micron
- Remaining oil content = .01 PPM
- 185 to 500 CFM capacity

Refrigerated Dryer Packages (230/460V 3-phase electric)

- Remove moisture content to 38° dew point
- Max inlet temperature 120°F
- 150 to 20,000 CFM capacity

Desiccant Dryer Packages (115V)

- Remove moisture content -40° or -100° dew point
- Filter particulates to .01 micron
- Remaining oil content = .01 PPM
- Max inlet temperature 120°F
- 45 to 5,400 CFM capacity (high pressure available)

Aftercooler/Dryer/Filter Packages (115V or 12/24V DC)

- Remove moisture content -40° or -100° point
- Filter particulates to .01 micron
- Remaining oil content .01 PPM
- 260 to 1,550 CFM capacity (high pressure available)
- Connect to a standard air compressor

Custom Filter Packages: Per customer request (ISO)

- Particulate removal (micron)
- Oil removal (PPM), Oil vapor removal (PPM)
- Separator/filters, Air line filters
- Combinations of any of the above filters
- Max temperature 120°F
- High pressure available

ISO 8573.1 QUALITY CLASSES

Quality Classes	Solids (max particle size in microns)	Moisture Dew Point		Oil Liquid & Gas	
		°C	°F	mg/m3	PPM w/w
0		Exceeds Class 1			
1	0.1	-70	-94	0.01	0.008
2	1	-40	-40	0.1	0.08
3	5	-20	-4	1	0.8
4	15	3	38	5	4
5	40	7	45	>5	>4
6	-	10	50	-	-



TYPICAL COMPRESSED AIR APPLICATIONS

Applications	Compressed Air Type			
	Filtered & Dried	Instrument-Quality	Standard	High-Pressure
Chemical Plants	Preferred			
Critical Instrument Air	Preferred			
Electronics	Preferred			
Food and Drug (packaging)	Preferred			
Metalworking Plants	Preferred	Good		
Paper Mills	Preferred	Good		
Pharmaceuticals	Preferred	Good		
Refineries	Preferred			
Snowmaking	Preferred	Good		
Textiles	Preferred	Good		
General Industrial/Manufacturing		Preferred	Good	
Instrument Air	Preferred	Preferred		
Shipyards		Preferred	Good	
Painting & Blasting		Preferred		
Demolition Tools			Preferred	
General Construction			Preferred	
Catalytic Regeneration (gasoline and refined oils)				Preferred
Drilling (down-the-hole rock and oil)				Preferred
Nitrogen Membrane Separation				Preferred
PET (bottle blowing)				Preferred
Soot Blowing (Utilities with coal fired furnaces)				Preferred

AIR COMPRESSORS

AIR COMPRESSOR ACCESSORIES

AIR HOSE, AIR MANIFOLDS

AIR HOSE

To complete your compressed air installation, Sunbelt Rentals offers a wide selection of air hose and accessory items including connectors and fittings, safety whipchecks, OSHA valves, inline water separators, inline oilers, pressure regulators, blow pipes and receiver tanks.

Air Hose	
Description	Cat-Class
3/8" x 25' Air Hose	150-0019
3/8" x 50' Air Hose	150-0020
3/4" x 50' Air Hose	150-0025
1" x 50' Air Hose	150-0030
1-1/2" x 50' Air Hose	150-0032
2" x 25' Air Hose	150-0035
2" x 50' Air Hose	150-0040
3" x 25' Air Hose	150-0045
3" x 50' Air Hose	150-0050
Bull Hose Spud Connector	150-0055
Air Hose Whip Check	150-0060
Air Hose OSHA Valve	150-0065
Inline Water Separator	150-0070
Y Air Hose Fitting	150-0075
Inline Oiler	150-0080
Air Pressure Regulator	150-0085
Blow Pipe	150-0090
660 gal. Air Receiver Tank	150-0053



3/8" Air Hose



3/4" Air Hose



2" Air Hose

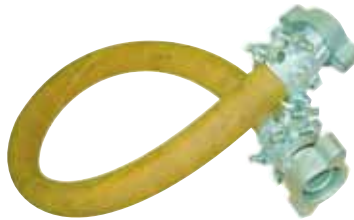

3" Air Hose with Boss Fittings



Air Hose Whip Check

AIR MANIFOLDS provide multiple 3/4" air outlets with ball valve controls from a larger (1-1/2" or 2") air inlet. Both tank-type and cage-type air manifolds are offered, both types with a 200 PSI pressure rating. (Cat-Class 150-0095)

Note: Other types and sizes of air manifolds are available.

Inside Diameter	Free CFM	Pressure Loss in Air Hose (per 50' length)						
		Line Pressure (PSI)						
		60	80	100	120	150	200	300
3/4"	60	3.1	2.4	2.0				
	80	5.3	4.2	3.5	2.9	2.4	1.8	1.2
	100	8.1	6.4	5.2	4.5	3.6	2.8	1.9
	120		9.0	7.4	6.3	5.1	3.9	2.7
	140		12.0	9.9	8.4	6.9	5.3	3.6
	160			12.7	10.8	8.9	6.8	4.6
	180				13.6	11.1	8.5	5.8
	200				16.6	13.5	10.4	7.1
	220					16.2	12.4	8.4
	120	2.7	2.1					
150	4.1	3.2	2.7	2.3				
180	5.8	4.6	3.8	3.2	2.6	2.0	1.3	
210	7.7	6.1	4.0	4.3	3.5	2.7	1.8	
240		7.9	6.5	5.5	4.5	3.4	2.3	
270		9.8	8.1	6.9	5.6	4.3	2.9	
300		12.0	9.9	8.4	6.9	5.3	3.6	
330			11.8	10.0	8.2	6.3	4.3	
360			13.9	11.9	9.7	7.4	5.0	
390				13.8	11.3	8.7	5.9	
420				15.9	13.0	10.0	6.8	
450					14.8	11.4	7.7	
600	1.9							
800	3.2	2.5	2.1					
1,000	5.0	3.9	3.2	2.7	2.2	1.7	1.1	
1,200	7.0	5.5	4.5	3.8	3.1	2.4	1.6	
1,400	9.3	7.4	6.1	5.2	4.2	3.2	2.2	
1,600		9.6	7.9	6.7	5.5	4.2	2.8	
1,800		12.1	9.9	8.4	6.9	5.3	3.6	
2,000			12.2	10.4	8.5	6.5	4.4	
2,200			14.6	12.5	10.2	7.8	5.3	
2,400				14.7	12.0	9.2	6.3	
2,600					14.1	10.8	7.3	
2,800					16.2	12.4	8.5	
2,000	2.5	2.0						
2,500	3.9	3.0	2.5	2.1				
3,000	5.5	4.4	3.6	3.1	2.5	1.9	1.3	
3,500	7.5	5.9	4.9	4.1	3.4	2.6	1.7	
4,000	9.8	7.6	6.3	5.3	4.4	3.3	2.3	
4,500		9.6	7.9	6.7	5.5	4.2	2.8	
5,000		11.7	9.6	8.2	6.7	5.1	3.5	
5,500			11.5	9.8	8.0	6.1	4.2	
6,000			13.6	11.5	9.4	7.2	4.9	
6,500				13.5	11.0	8.4	5.7	
7,000				15.6	12.7	9.8	6.6	
7,500					14.5	11.1	7.6	

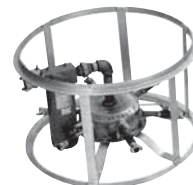

Cage-Type Air Manifold w/Water Filter
(6) ball valve controlled outlets and a 1-1/2" air inlet
Texas Pneumatic TX-1AMF-WF



Tank-Type Air Manifold
(8) ball valve controlled outlets
2" air inlet with 4-prong coupler on one end and flow-through plug on other end allows using multiple units in tandem. Texas Pneumatic TX-2AMF

AIR COMPRESSOR ACCESSORIES

AFTERCOOLER/SEPARATORS, AFTERCOOLER/FILTERS

AFTERCOOLER/SEPARATORS

Reduce compressed air temperatures to within 5°F to 20°F of ambient temperature

Features

- Makes air safe, usable and capable of further filtering and drying
- Eliminates up to 70% of water
- Maximum working pressures to 400 PSIG are available

Choice of

- Electric Drive Fans: include automatic interconnect for 3-phase units—determines if incoming power is 230V or 460V and automatically matches the supply voltage
- Air-driven Fans: include air motor, regulator, lubricator and relief valve



Capacity Selection Chart: Max SCFM @ 5, 10, 15 and 20°F approach temperature to ambient

Inlet Temperature °F	150				200				250			
	5	10	15	20	5	10	15	20	5	10	15	20
Approach Temperature °F												
AACE-1600 & AACA-1600	790	1,440	1,950	2,260	710	1,290	1,720	1,950	660	1,200	1,600	1,860
AACE-2500 & AACA-2500	1,220	2,220	3,000	3,470	1,090	1,980	2,680	3,100	1,035	1,880	2,500	2,870
AACA-3000	1,450	2,650	3,580	4,120	1,295	2,360	3,200	3,710	1,243	2,260	3,000	3,450

Above capacities are based on 80 to 125 PSIG operating pressures. Maximum pressure drop, less than 3 PSI.

Specifications: Electric Drive

Model	Motor	Voltage TEFC	Phase HP	Full Load Amps 110/230V	In/Out Connections	Dimensions			Weight
						H	W	D	
AACE-450	1/2	110/1/60	1	9	2" NPT	66"	36"	60"	400 lbs.
AACE-1000	2	110/1/60	1	18	3" NPT	66"	48"	72"	500 lbs.
AACE-1600	1.5	110/1/60	1	18	3" NPT	66"	48"	72"	650 lbs.
AACE-2500	7.5	230 or 460/3/60	1	22/11	4" NPT	62"	48"	80"	900 lbs.
AACE-3000	10	230 or 460/3/60	1	28/14	4" NPT	62"	60"	80"	1,000 lbs.

Specifications: Air-Driven

Model	Air Motor Usage	In/Out Connections	Dimensions			Weight
			H	W	D	
AACA-450	10 SCFM	2" NPT	46"	48"	60"	400 lbs.
AACA-1000	20 SCFM	2" NPT	46"	48"	60"	600 lbs.
AACA-1600	70 SCFM	3" NPT	73"	48"	72"	800 lbs.
AACA-2500	80 SCFM	4" NPT	66"	48"	90"	1,000 lbs.
AACA-3000	120 SCFM	4" NPT	73"	60"	108"	1,200 lbs.
AACA-3500	120 SCFM	4" NPT	73"	60"	108"	1,400 lbs.

AFTERCOOLER/FILTERS

Obtain oil-free air with lubricated (oil-flooded) compressors

Packages Include

- **Aftercooler with air-driven fan motor**—reduces air temperature leaving the compressor to within 10° to 15°F of ambient temperature. Eliminates 80% of water
- **Separator/filter**—removes bulk liquids. Prefilters the air for finer filtration. Large in depth bed eliminates heavy particulate loads
- **Ultra-high efficiency coalescing oil removal filter**—removes fine oil droplets (aerosols) and solid particles 0.01 microns and larger. Oil content after filtration: 0.001 PPM W/W

Features

- Skid-mounted—pre-piped with in/out connections
- No power required—includes automatic condensate drains
- Gauges on filters indicate need for element replacement

Applications

- Construction, bridge repair, sandblasting and painting
- Manufacturing, refineries, shipyards, paper and chemical



Specifications

Model	Capacity (SCFM)	Dimensions			Weight
		H	W	D	
AFCS450	450	53"	46"	36"	675 lbs.
AFCS750	750	68"	48"	60"	675 lbs.
AFCS1000	1,000	73"	48"	72"	950 lbs.
AFCS1600	1,600	73"	48"	72"	1,000 lbs.

AIR COMPRESSOR ACCESSORIES

MEMBRANE DRYER/AFTERCOOLERS, AFTERCOOLER/DRYER/FILTERS

MEMBRANE DRYER/AFTERCOOLERS

Reduce compressed air temperatures and remove liquids and water vapor

Packages Include

- **Aftercooler**—rated for 10°F approach from ambient temperature. Includes air-driven fan motor, regulator, lubricator and muffler/separator
- **Filtration**—1st: Separator/prefilter to remove liquids to 3 microns
2nd: Two-stage prefilter to remove liquid water and oil to 1 micron
3rd: High-efficiency oil removal to remove solids and aerosols to 0.01 micron
Filters are oversized and staged to increase particulate loading capacity
Drains on prefilter housings are float type
- **Membrane Dryer**—utilizes membrane gas separation technology. Compressed air flows through a bundle of tube-shaped membranes. Compressed air is used to sweep the water vapor out of the dryer. Dry air then exits the tube bundle for use downstream. There are no power requirements, no moving parts and no consumables, such as deliquescent tablets, to replace
- **Frame and Construction**—steel channel construction with forklift slots. Includes 2" NPT Male in and out compressed air connections

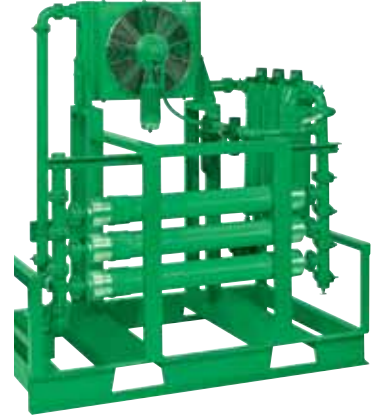

Specifications

Model	Inlet Conditions	Outlet Dew Point	Flow (SCFM)	Max Inlet Pressure	Max Inlet Temp	Utilities Needed	Dimensions			In/Out Connections	Weight
							H	W	D		
RAM185	30°F Ambient & below 50°F Ambient	-30°F Dew Point -5°F Dew Point	185 to 260	300 PSIG	350°F	20 SCFM	50"	36"	70"	2" NPT Male	450 lbs.
RAM260	70°F Ambient	15°F Dew Point	260 to 370			25 SCFM	50"	36"	70"		500 lbs.
RAM375	90°F Ambient 100°F Ambient	35°F Dew Point 50°F Dew Point	370 to 500			30 SCFM	50"	36"	70"		550 lbs.

AFTERCOOLER/DRYER/FILTERS

A complete air treatment system in one package (CFM air loss 15–20%)

Packages Include

- **Aftercooler with air-driven fan motor**—lowers temperature of air leaving the compressor to within 7.5°F of ambient temperature and eliminates 80% of water
- **Prefilter 1: Separator/filter**—removes bulk liquids and prefilters the air
- **Prefilter 2: Ultra-high efficiency coalescing type oil removal filter**—removes fine oil droplets (aerosols) and solid particles 0.01 microns and larger
Oil content after filtration = 0.001 PPM w/w
- **Pressure-swing (heatless) regenerative desiccant dryer**—produces extra dry air (-40°F or -100°F pressure dew point). Efficient design minimizes purge air requirements.
- **Afterfilter**—1 micron particulate filter removes desiccant fines
In-depth media allows long element life

Features

- Mounted on sled-type skid with lifting lugs and forklift channels
Units are pre-piped with convenient in/out connections
- Dryer runs on 12V DC (allows powering with portable air compressor)—115V AC optional
- Includes automatic condensate drains.
Gauges on filters indicate the need for element replacement
- Dryer control panel includes alarms and built-in diagnostic capabilities



Applications

- **Industrial**—spray painting, powder coating, blow molding, pneumatic instrumentation, nitrogen generation, process air
- **Construction** (with portable compressors)—bridge repair, sandblasting, painting, pipeline dehydration

Specifications

Model	Capacity (SCFM) @ 100 PSIG	Max Working Pressure	Dimensions			Weight
			H	W	D	
RDH260GAC	185–260	250 PSI	82"	50"	69"	1,500 lbs.
RDH450GAC	260–500	250 PSI	82"	50"	69"	2,200 lbs.
RDH930GAC	500–1,000	150 PSI	80"	75"	71"	3,800 lbs.
RDH1550AC	1,000–1,600	150 PSI	97"	73"	81"	6,000 lbs.
RDH1550GAC	1,000–1,600	250 PSI	87"	78"	83"	6,000 lbs.

AIR COMPRESSOR ACCESSORIES

DESICCANT DRYERS

DESICCANT DRYERS

For dew points of **-40°F** and **-100°F** (CFM air loss 15–20%)

Features

- Mounted particulate and oil removal prefilters complete with automatic condensate drains and a one micron afterfilter—no field installation of filters is required
- Heavy-duty frame with lifting lugs and forklift channels for easy handling
- NEMA 4, 115/1/60 electrics—suitable for outdoor operation (all pneumatic units are also available)
- Units can be field adjusted for **-40°F** or **-100°F** pressure dew point
- Full instrumentation package provides ready indication of system malfunction
- High-pressure models (350 PSI) are available

Operating Conditions

- Maximum inlet compressed air temperature: 120°F
- Minimum/maximum ambient temperature: 35/120°F standard (-10/120°F with low ambient package installed)

Specifications

Standard Models	Flow (SCFM)*			Max Working Pressure	In/Out Connections	Dimensions			Weight
	Inlet	Outlet				H	W	D	
		@ -40°F PDP	@ -100°F PDP						
RDH115	115	98	97	150 PSI	1" NPT	90"	40"	34"	650 lbs.
RDH165	165	141	140	150 PSI	1-1/2" NPT	90"	40"	34"	825 lbs.
RDH260	260	223	220	150 PSI	2" NPT	90"	42"	47"	1,350 lbs.
RDH370	370	317	312	150 PSI	2" NPT	90"	42"	60"	1,650 lbs.
RDH450	450	385	380	150 PSI	2" NPT	92"	42"	60"	1,800 lbs.
RDH590	590	505	498	150 PSI	2" NPT	95"	50"	70"	2,860 lbs.
RDH750	750	642	634	150 PSI	2-1/2" NPT	97"	58"	72"	3,450 lbs.
RDH930	930	796	786	150 PSI	2-1/2" NPT	105"	58"	72"	3,800 lbs.
RDH930G	930	796	786	150 PSI	2-1/2" NPT	80"	76"	73"	3,500 lbs.
RDH1130	1,130	967	955	150 PSI	3" NPT	105"	58"	72"	4,300 lbs.
RDH1350	1,350	1,156	1,141	150 PSI	3" NPT	109"	58"	72"	4,700 lbs.
RDH1550	1,550	1,327	1,309	150 PSI	3" Boss	100"	78"	96"	5,000 lbs.
RDH1550G	1,550	1,327	1,309	250 PSI	3" Boss	79"	78"	83"	5,500 lbs.
RDH2100	2,100	1,797	1,774	150 PSI	3" Boss	80"	80"	73"	6,900 lbs.
RDH2100G	2,100	1,797	1,774	150 PSI	3" Boss	80"	80"	73"	5,750 lbs.
RDH3000	3,000	2,567	2,534	150 PSI	3" Boss	121"	86"	133"	12,100 lbs.
RDH3000G	3,000	2,567	2,534	150 PSI	2 x 3" Boss	81"	91"	115"	9,200 lbs.
RDH4100	4,100	3,465	3,445	150 PSI	6" FLG	105"	91"	115"	14,000 lbs.
RDH5400	5,400	4,620	4,561	150 PSI	6" FLG	123"	96"	122"	16,000 lbs.
RDH5400G	5,400	4,620	4,561	150 PSI	4 x 3" Boss	81"	91"	153"	14,800 lbs.
High-Pressure Models (350 PSIG)									
RDHHP495	900	828	818	365 PSI	3" NPT	94"	78"	96"	3,800 lbs.
RDHHP715	1,300	1,196	1,186	365 PSI	3" NPT	96"	78"	96"	4,000 lbs.
RDHHP1550G	2,800	2,576	2,550	365 PSI	3" Boss	79"	78"	83"	6,200 lbs.
RDHHP5200G	9,300	8,530	8,400	365 PSI	4 x 3" Boss	81"	91"	153"	19,000 lbs.

*Flow shown is based on inlet compressed air at 100 PSI and 100°F.



Note: Transport desiccant dryers on air-ride trucks only.



Sunbelt Rentals also offers air hose and accessory items including connectors and fittings, safety whipchecks, OSHA valves, inline water separators, inline oilers, pressure regulators, blow pipes and receiver tanks (see page 51)

AIR COMPRESSOR ACCESSORIES

REFRIGERATED DRYERS, CUSTOM FILTERS

REFRIGERATED DRYERS

For dew points from 38°F and 50°F

Features

- Highly efficient, rugged heat exchangers—designed to resist fouling and maintain low pressure drop
- Highly reliable separators and automatic drains ensure condensate is separated from the air system
- Refrigeration system designed for maximum reliability—accumulators, filters and strainers, dryers and a desuperheating system prevent compressor slugging and overheating—keeps dryer operating in a range of conditions



Note: Choice of 230V or 460V 3-phase models is available.

Operating Conditions (Min/max ambient temperatures)

- Air-cooled models—35/110°F standard (-10/110°F with low ambient package installed)
- Maximum inlet air temp 120°F
- Watercooled models—35/130°F standard (-10/130°F with low ambient package installed)

Specifications

Standard Models*	Flow (scfm)**	Max Working Pressure	Inlet/Outlet Connections	Dimensions			Weight
				H	W	D	
RRD150AC	150	200 PSI	2" NPT	42"	38"	42"	500 lbs.
RRD300AC	300	200 PSI	2" NPT	42"	38"	42"	600 lbs.
RRD400AC	400	200 PSI	3" NPT	42"	38"	42"	700 lbs.
RRD500AC	500	200 PSI	3" NPT	69"	40"	46"	950 lbs.
RRD700AC	700	200 PSI	3" NPT	69"	40"	46"	1,100 lbs.
RRD800AC	800	200 PSI	3" NPT	80"	40"	46"	1,300 lbs.
RRD1000AC	1,000	200 PSI	3" NPT	80"	40"	46"	1,465 lbs.
RRD1200AC	1,200	200 PSI	4" FLG	72"	54"	56"	1,500 lbs.
RRD1600AC	1,600	200 PSI	6" FLG	89"	50"	52"	2,200 lbs.
RRD2000AC	2,000	200 PSI	6" FLG	89"	50"	52"	2,400 lbs.
RRD2300AC	2,300	200 PSI	6" FLG	89"	50"	52"	2,800 lbs.
RH33AC	3,000	175 PSI	6" FLG	110"	54"	113"	4,400 lbs.
RH44AC	4,000	175 PSI	6" FLG	110"	54"	113"	4,900 lbs.
RH55AC	5,000	175 PSI	8" FLG	112"	60"	128"	5,200 lbs.
RH66AC	6,000	175 PSI	8" FLG	112"	60"	128"	5,800 lbs.
RH77AC	8,000	175 PSI	10" FLG	123"	60"	128"	6,200 lbs.
RH88AC	10,000	175 PSI	10" FLG	120"	90"	174"	10,500 lbs.
RH1010WC	15,000	175 PSI	12" FLG	128"	81"	160"	14,200 lbs.
RH1111WC	20,000	175 PSI	14" FLG	128"	96"	180"	20,300 lbs.
High-Pressure Models***							
HPRD-1	250	700 PSI	3" NPT	61"	38"	38"	900 lbs.
HPRD-2	550	700 PSI	3" NPT	61"	38"	38"	900 lbs.
HPRD-4	1,200	700 PSI	4" FLG	76"	50"	50"	1,509 lbs.

*AC designates air-cooled; WC designates water-cooled.

**Flow shown is based on inlet compressed air at 100 PSIG and 100°F, operating in an ambient temperature of 100°F.

***Flow (scfm) @ 700 PSIG

CUSTOM FILTER PACKAGES

Compressed air as clean as you need it—we offer custom filter packages tailored to meet your specific requirements. Examples include coalescing type oil removal filters, oil vapor removal filters, separator/filters, air line filters and any combination of these filters. Each filter package includes automatic drains and filter change indicators.



For more information about compressed air solutions, contact a Sunbelt Rentals Pump & Power location at 800-736-2504.

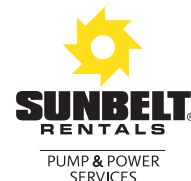

DUST COLLECTORS

DUST COLLECTORS

DUST COLLECTORS are available in 40 HP and 60 HP models. Both are skid-mounted and offer an initial MERV 12 efficiency rating. The units are easy to operate and have both forklift pockets and crane lift points, making them easy to transport.

- In-line air flow between plenum and fan ensures the highest efficiency
- Extremely low air to cloth ratio provides more filter area for high dust conditions
- Unique filter baffle system enhances pulse jet cleaning and extends filter life
- Top loading filters offer superior cleaning and can be changed by a single operator with less risk of hazardous spills
- Hydraulically driven augers for low maintenance and dependable operation
- Greater job site versatility with conveniently located air inlets on three sides
- Solid state, programmable timer board for reverse air pulse filter cleaning system
- Heavy duty construction



En Tech Industries 12DC
12,000 CFM

Make	Model	Mounting	Motor	Fan	Filter	Dimensions	Weight	Cat-Class
EnTech Industries	12DC	Skid	40 HP 130/460 3ø TEFC	12,000 CFM @ 12" wc / non-overloading spark resistant	4,680 sq. ft. of filter area for an air to cloth ratio of 2.56:1	192"L x 72"W x 102"H (in transport)	7,500 lbs	061-2220
EnTech Industries	20DC	Skid	60 HP 230/460 3ø TEFC	20,000 CFM @ 12" wc / non-overloading spark resistant	7,020 sq. ft. of filter area for an air to cloth ratio of 2.85:1	266"L x 72"W x 112"H (in transport)	9,000 lbs.	061-2380

AIR CONDITIONERS

PORTABLE AIR CONDITIONERS, PORTABLE HEAT PUMPS

PORTABLE AIR CONDITIONERS are ideal for small area cooling and spot cooling—the ability to direct cool air to precise locations. These efficient units provide comfort for workers and protection for sensitive equipment in all types of environments. Spot cooling provides substantial energy savings compared to central air conditioning by cooling only the area, people or equipment necessary. Energy-efficient and ultra-quiet, these units can achieve temperature drops of 12°F to 30°F in just minutes.

- Completely self-contained, with caster-mounting for portability
- Classic 1-2 ton models include flexible, built-in ducts to direct airflow (when used indoors, these units must be vented)
- Smaller portable units equipped with condensate bucket
- Provide air filtration and remove humidity for increased comfort
- 5 ton standard units equipped with condensate pump



HSC-14
1.2 Ton



MOB-42HP
3.5 Ton w/heating/dehumidifying

Make	Model	Capacity	Max Airflow	Cooling Area*	Cool Air Duct Dia/Max Length	Warm Air Duct** Dia/Max Length	Voltage	Amp Rating	Weight	Cat-Class
MovinCool	Office Pro 12	1 ton	410 CFM	200/400 sq. ft.	***	12"/60'	115V	11.2	165 lbs.	107-0105
MovinCool	Classic 10	1 ton	270 CFM	200/400 sq. ft.	5"/40'	12"/60'	115V	10.6	145 lbs.	107-0110
MovinCool	Office Pro 18	1.5 ton	540 CFM	300/600 sq. ft.	***	12"/100'	115V	15.6	177 lbs.	107-0110
Airrex	HSC-14	1.2 ton	440 CFM	400 sq. ft.	5"/30'	12"/50'	115V	1.5	176 lbs.	107-0110
MovinCool	Classic Plus 14	1.1 ton	440 CFM	210/420 sq. ft.	5"/30'	12"/60'	115V	12.3	153 lbs.	107-0112
Airrex	HSC-18	1.5 ton	460 CFM	600 sq. ft.	5"/30'	12"/50'	115V	1.95	185 lbs.	107-0114
Airrex	HSC-24A	2 ton	460 CFM	800 sq. ft.	5"/30'	12"/50'	220V	2.74	210 lbs.	107-0120
MovinCool	Classic Plus 26	2 ton	708 CFM	400/800 sq. ft.	6"/60'	12"/45'	208-230V	15.6/14.0	235 lbs.	107-0120
MobileCool	MOB-42HP ¹	3.5 ton	1,400 CFM	700/1,400 sq. ft.	12"/25'	N/A	230V, 1ø	26.0	475 lbs.	107-0130
Airrex	HSC-36B	3 ton	943 CFM	1,200 sq. ft.	7"/65.6'	16"/50'	220V	4.62	396 lbs.	107-0134
MobileCool	MOB-60HP ¹	5 ton	1,950 CFM	1,000/2,000 sq. ft.	2 x 12"/50'	N/A	230V, 1ø	47.0	725 lbs.	107-0140
MovinCool	Classic 60	5 ton	1,580 CFM	1,000/2,000 sq. ft.	12"/60'	N/A	460V, 3ø	10.5	463 lbs.	107-0140
MovinCool	Office Pro 60	5 ton	1,940 CFM	1,000/2,000 sq. ft.	***	16"/100'	208/230V	29.0	623 lbs.	107-0154

*Cooling area is based upon an uninsulated/insulated enclosed area. **Optional warm air flange is required when using warm air discharge duct. ***Cool air duct chutes are optional
¹MOB-series models are combination heating/cooling/dehumidifying units with 12" supply and (2) 12" return ducts—weatherproof for outdoor placement.

PORTABLE WATER-COOLED AIR CONDITIONERS do not discharge large amounts of heat, they do not require exhaust ducting and are used to great effect in enclosed areas.

Make	Model	Capacity	Max Airflow	Cooling Area*	Warm Air Duct** Dia/Max Length	Voltage	Amp Rating	Weight	Cat-Class
Airrex	HSC-60	5 ton	1940 CFM	2,000 sq. ft.	16"/50'	220V/1	10.4	550 lbs.	107-0154
Airrex	HSC-60	5 ton	1940 CFM	2,000 sq. ft.	16"/50'	220V/3	10.4	550 lbs.	107-0155
Airrex	HSC-60	5 ton	1940 CFM	2,000 sq. ft.	16"/50'	480V/3	10.4	550 lbs.	107-0156
Airrex	HSC-70	7 ton	2200 CFM	2,800 sq. ft.	16"/50'	480V	15.4	550 lbs.	108-0158

*Cooling area is based upon an uninsulated/insulated enclosed area. **Optional warm air flange is required when using warm air discharge duct.

PORTABLE HEAT PUMPS combine both cooling and heating capabilities in a single, self-contained unit. The most common type of portable heat pump uses ambient air to heat a space. All that is required is to simply plug the unit in. No outside access is needed to dispel exhaust.

- Great for supplemental and emergency heating, spot heating, and backup heating during HVAC repairs or renovations
- Popular in office buildings, retail spaces, schools, hospitals and special events
- Safer and more efficient than electric space heaters
- Perfect for year-round use



Airrex AHSC-12
1 Ton

Make	Model	Capacity	Max Airflow	Cooling Area*	Warm Air Duct** Dia/Max Length	Voltage	Amp Rating	Weight	Cat-Class
Airrex	AHSC-12	1 ton	272 CFM	400 sq. ft.	10"/25'	115V	1.21	148 lbs.	107-2018
Airrex	AHSC-18	1.5 ton	424 CFM	600 sq. ft.	12"/50'	115V	1.84	210 lbs.	107-2019
MovinCool	Climate Pro 12	1 ton	420 CFM	400 sq. ft.	12"/60'	115V	11.1	196 lbs.	107-2018
MovinCool	Climate Pro 18	1.5 ton	540 CFM	200/400 sq. ft.	12"/60'	115V	14.7	214 lbs.	107-2019

*Cooling area is based upon an uninsulated/insulated enclosed area. **Optional warm air flange is required when using warm air discharge duct.

AIR CONDITIONERS

INDUSTRIAL AIR CONDITIONERS, EVAPORATIVE COOLING FANS

INDUSTRIAL AIR CONDITIONERS provide the cooling power for large area cooling and dehumidifying. Applications include warehouse facilities, aerospace and aviation, industrial plant shutdowns and maintenance, emergency backup cooling and large scale spot cooling. All models include an electrical disconnect switch and utilize 20" flexible duct for supply and return air.

- Multiple compressor units for flexibility and reliability
- 25-ton and 40-ton models are heating/cooling/dehumidifying units with built-in electric heaters and a humidistat
- 20" flexible duct is available in 25' lengths (Cat-Class 150-0115)
- Rugged, weatherproof designs for outdoor installations



MobileCool MOB-250 25-ton Industrial Air Conditioner
Temporary cooling application at a job site



Tent transitions are available with one supply and two return duct (Cat-Class 150-0135)



MobileCool MOB-250 25-ton Industrial Air Conditioner
Cooling a large special events tent—inset shows tent transition



Combined Refrigeration SACP40A-HS
40-ton Industrial Air Conditioner

TEMPERATURE CONTROL & DEHUMIDIFICATION

Make	Model	Capacity	Max Airflow	Cooling Area*	Supply Duct Dia/ Max Length	Return Duct Dia/ Max Length	Voltage	Amp Rating	Overall Dimensions	Skid Weight	Cat-Class
MobileCool	MOB-100	10 ton	4,000 CFM	2,000/4,000 sq. ft.	20"/50'	20"/50'	460V, 3ø	31	59"L x 96"W x 53"H	1,350 lbs.	107-0210
AirPac	PAC120	10 ton	6,000 CFM	2,000/4,000 sq. ft.	20"/50'	20"/50'	460V, 3ø	32	61"L x 30"W x 80"H	1,300 lbs.	107-0210
MobileCool	MOB-200	20 ton	8,000 CFM	4,000/8,000 sq. ft.	2 x 20"/50'	2 x 20"/50'	460V, 3ø	53	92"L x 127"W x 67"H	2,600 lbs.	107-0220
MobileCool	MOB-250 ¹	25 ton	10,000 CFM	5,000/10,000 sq. ft.	2 x 20"/50'	2 x 20"/50'	460V, 3ø	57	92"L x 128"W x 63"H	3,200 lbs.	107-0230
York	DX25 ¹	25 ton	12,000 CFM	5,000/10,000 sq. ft.	2 x 20"/50'	2 x 20"/50'	460V, 3ø	134	61"L x 94"W x 143"H	4,300 lbs.	107-0230
York	40TR ¹	40 ton	18,000 CFM	8,000/16,000 sq. ft.	2 x 20"/50'	2 x 20"/50'	460V, 3ø	215	184"L x 128"W x 63"H	7,970 lbs.	107-0240
Mayer	60TR ¹	60 ton	10,000 CFM	10,000/20,000 sq. ft.	2 x 20"/50'	2 x 20"/50'	460V, 3ø	146	102"L x 74"W x 74"H	8,500 lbs.	107-0260
Combined Refrigeration	SACP40A-HS	40 ton	6,400 CFM	8,000/16,000 sq. ft.	2 x 20"	2 x 20"	460V, 3ø	67.6	78"L x 88"W x 98"H	4,620 lbs.	107-0245
Combined Refrigeration	SACP80A-HS	80 ton	12,800 CFM	16,000/32,000 sq. ft.	2 x 20"	4 x 20"	460V, 3ø	143	130"L x 88"W x 98"H	4,620 lbs.	107-0285

*Cooling area is based upon an uninsulated/insulated enclosed area. (See previous page for additional information about determining cooling requirements.)

¹Combination cooling/heating/dehumidifying units with built-in electric heaters: 72 kW heater (25-ton models); 108 kW heater (40-ton model); 200 kW heater (60-ton model).

¹Amp rating may change based on heating or cooling application.

AIR HANDLERS AND CHILLERS

PORTABLE AIR HANDLING UNITS

AIR HANDLING UNITS are designed and constructed for ease of operation and mobility as well as the rigors of everyday use. Our units are mounted on a structural steel frame that incorporates tube slots for forklift handling. Our units also includes a certified structural lifting/stacking protective cage for optional overhead positioning with an onsite crane for hard to reach site setup locations. The units are ready for operation with minimal setup of (2) 4" hose connections and (4) Camlock power cables.

- Hot dip galvanized structural lifting/stacking skid and integrated tie-downs
- Chilled water temperature and pressure indication inlet & outlet)
- Integrated control panel with Camlock power connections, circuit breaker, magnetic starter, potentiometer for VFD control, OFF/Auto two position switch, Power On indicator light and Phase Incorrect indicator light



50 Ton Portable Air Handling Unit



120 Ton Portable Air Handling Unit

Type	Make	Model	Capacity	CFM	Duct Size	# of Supply Ducts	# of Return Ducts	Voltage	Dimensions	Weight	Cat-Class
50 ton AHU	CAPS	PAHH-50TC	50 ton	6,250	20"	2	4	460V	107.25"L x 83"W x 63.25"H	3250 lbs.	109-1050
120 ton AHU	CAPS	PAHH-120TC	120 ton	15,000*	20"	4	6	460V	151.5"L x 101"W x 63.25"H	5200 lbs.	109-1120

*At 5" WC

TEMPERATURE CONTROL & DEHUMIDIFICATION

AIR HANDLERS AND CHILLERS

PORTABLE AIR COOLED CHILLER PACKAGES

PORTABLE AIR COOLED CHILLER PACKAGES offer flexible temporary fluid cooling solutions using equipment that has been designed and engineered to be self contained systems for Commercial and Industrial air conditioning and process cooling applications. These packages have also been designed and constructed for ease of operation and mobility as well as the rigors of everyday use. Our package is mounted on a structural tubular steel frame that incorporates tube slots for forklift handling. Our package also includes a certified structural lifting/stacking protective cage for optional overhead positioning with an onsite crane for hard to reach site setup locations.

- Freeze protection to -20F with 3/4" foam insulated evaporator & protective aluminum jacketing, chilled water barrel heaters, external thermostat control for heaters and refrigerant isolation valves (discharge valve)
- Dual circuit machine for staging and efficiency
- UL/cUL listed to US and Canadian safety standard
- ASHRAE 90.1 compliance
- ARI Standard 550/590
- ANSI/NFPA Standard 70
- Phase monitor and phase fail indicator light
- Master On/Off switch
- Integrated main power wiring with Cam-Lock electrical connections and associated wiring
- Single point 460V/3PH/60HZ power application power connection for Chiller/Pump package
- Temperature and pressure gauges (Inlet & Outlet)



150 Ton Portable Air Cooled Chiller Package

VOLUME TANKS

are available in 500-gallons. Volume tanks have a maximum operating pressure 125 PSI and are a necessary add-on for some chiller rentals.



Volume Tank For Chillers



Chiller, air handler and generator at a processing plant



Desiccant dehumidifier and air handler at a processing plant

Make	Model	Capacity	Pump Size	Hose Connection	Voltage	Min Circuit Ampacity	VSD	Pump Discharge	FPCC**	Dimensions	Weight	Cat-Class
Smart Family	STAC10D-R	10.6 ton	24 GPM	2"	460V	29 amps	N/A	100'	36"	90"L x 56"W x 66"H	1,600 lbs.	109-1005
CAPS	PCHH-56TD	56 ton	140 GPM	4"	460V	153 amps	N/A	100'	Varies	205"L x 100"W x 77.5"H	6,800 lbs.	109-1056
CAPS	PCHH-70TD	70 ton	200 GPM	4"	460V	181 amps	N/A	100'	54"	177"L x 100"W x 102"H	8,200 lbs.	109-1270
CAPS	PCHH-100TD	100 ton	300 GPM	4"	460V	244 amps	N/A	100'	54"	205"L x 100"W x 102"H	11,000 lbs.	109-1300
CAPS	PCHH-150TD	150 ton	500 GPM	6"	460V	345 amps	N/A	100'	54"	255"L x 101"W x 102"H	14,500 lbs.	109-1350
CAPS	PCHH-200TD	200 ton	600 GPM	6"	460V	379 amps	Installed	100'	54"	292"L x 100"W x 102"H	20,000 lbs.	109-1520
CAPS	PCHH-417TD	400 ton	1,200 GPM	6"	460V	752 amps	Installed	100'	N/A	636"L x 103"W x 158"H	48,000 lbs.	109-1560

*400 ton chiller is complete with air-ride trailer.

**FPCC: Fork pockets center to center. Please check fork pocket sizes. Most are 4" x 10" or 6" x 10" depending on model. 400 ton chillers are trailer mounted with 8 lifting eyes.

HEATERS

ELECTRIC HEATERS

PORTABLE ELECTRIC HEATERS provide fast, clean, odorless heat for contractors, special events and other enclosed spaces, operating virtually maintenance-free. Units are also great for emergency thawing of frozen pipes and a variety of drying applications. Portable electric heaters ranging from 1.5 kW to 60 kW capacity are available.

- All models include a built-in thermostat to regulate operation
- Patron 1.5 kW heater is a compact model ideal for heating one room—unit plugs into a standard 120V outlet
- 10 kW to 30 kW heaters include a 2-wheel dolly for portability and connect to an electric service panel
- 60 kW heaters are ductible and feature a rugged aluminum frame that allows stacking. Units include 4-wheel casters for portability and connect to an electric service panel
- All models include an electric fan that circulates heated air



Fostoria FES-1524-3E 15 kW



Patron E 1.5 1.5 kW



Chromalox DRA-30-43 30 kW



Chromalox SDRA-60-43 RG 60 kW

INDUSTRIAL ELECTRIC HEATERS provide clean, dry electric heat for large capacity industrial and special event applications. They feature environment-friendly operation and rugged, weatherproof enclosures for reliable operation outdoors. Utilizes 20" ducting for both supply and return ducts. Units operate on 480V 3-phase power and utilize a 4-circuit design that can be configured as 150 kW (512,000 BTU), 90 kW (386,000 BTU) and 60 kW (256,000 BTU) capacity to match heating requirements. Chromalox units are stackable for efficient transport and storage.



Mosebach 150 kW Industrial Electric Heater
Units have fixed casters for easy mobility



Chromalox 150 kW Industrial Electric Heaters
Multiple units heating special events tents

STEAM HEATERS mount to a durable, heavy-duty cart with hanging/lifting support brackets and heavy-duty locking wheels, providing on-the-spot heat. This unit comes pre-piped with inlet strainer, pressure line shutoff valve, on/off switch and an electrical pig tail. Plug-through thermostatic control also available. (Cat-Class 010-0900)

Heating Capacity BTU/u	684,000*
Max Airflow	4,000 CFM
Fuel Type	Steam
Power Supply	120V, 1ph
Net Wt./Shipping Wt.	225/400 lbs.
Dimensions	34"L x 66"W x 36"H

* At 75 lbs. PSI of steam



Safe-Heat STM-500

Make	Model	kW	Max BTU	Heating Area*	Max Airflow	Voltage	Amp Rating	Weight	Cat-Class
Patron	Patron E 1.5	1.5	5,100	120 sq. ft.	116 CFM	120V 1ø	15	15 lbs.	010-0510
Fostoria	FES-1024-1CA	10	34,130	790 sq. ft.	800 CFM	240V 3ø	42	60 lbs.	010-0520
Chromalox	DRA-15-23	15	51,180	1,185 sq. ft.	1,070 CFM	240V 3ø	36	65 lbs.	010-0530
Fostoria	FES-1524-3E ¹	15	51,195	1,185 sq. ft.	800 CFM	240V 3ø	36	60 lbs.	010-0530
Chromalox	DRA-30-43	30	102,390	2,370 sq. ft.	1,070 CFM	480V 3ø	36	75 lbs.	010-0540
Fostoria	FES-3048-3A	30	102,360	2,370 sq. ft.	800 CFM	480V 3ø	36	72 lbs.	010-0540
Patron	Patron 40E	40	133,000	3,080 sq. ft.	1,765 CFM	480V 3ø	60	125 lbs.	010-0550
Chromalox	SDRA-60-43 RG	60	204,720	4,740 sq. ft.	2,700 CFM	480V 3ø	73	170 lbs.	010-0560
Patron	Patron 60E	60	205,000	4,740 sq. ft.	1,765 CFM	480V 3ø	75	130 lbs.	010-0560
Chromalox	PN 305481005	150	512,000	11,850 sq. ft.	5,000 CFM	480V 3ø	180	1,740 lbs.	010-0570
Mosebach	HBXISO4803Q	150	512,000	11,850 sq. ft.	4,500 CFM	480V 3ø	181	723 lbs.	010-0570

*Heating area is based upon a 40° temperature rise in a sealed building with an 8' ceiling.

¹Fostoria FES-1524 is also available in 240V 1ø (Cat-Class 010-0525) and 480V 3ø (Cat-Class 010-0535) models.

TEMPERATURE CONTROL & DEHUMIDIFICATION

HEATERS

INDIRECT-FIRED HEATERS

INDIRECT-FIRED HEATERS include heat exchangers that provide clean, dry, odorless heat. They also include air outlets that accommodate flexible ducting, which allows placing the heaters a safe distance from special events tents and other structures.

- Heat exchangers keep fumes and combustion products out of the airflow
- Ideal for drying crawl spaces under water damaged houses
- No open flame—suitable for use in applications with potentially dangerous fumes and dust present
- Oil models burn kerosene or No. 1 fuel oil (onboard tank)
- Gas models burn either propane or natural gas



160,000 BTU Oil Indirect-Fired



(2) ICE OHV 350 320,000 BTU Oil Indirect-Fired
Shown heating a temporary construction building



ICE IDF 500 LP/NG
500,000 BTU Gas Indirect-Fired

Oil Indirect-Fired Models

Make	Model	Max BTU	Heating Area*	CFM	Supply Duct Dia/Max Length	Return Duct Dia/Max Length	Fuel Tank	Fuel Consump	Run Time	Voltage	Weight	Cat-Class
Sunbelt	160-IF	160,000	3,700 sq. ft.	1,060	16"/20'	N/A	17.0 gal.	1.4 gal./hr.	12.0 hrs.	115V	161 lbs.	010-0180
ICE	Mirage 180H	180,900	4,200 sq. ft.	1,475	12"/24'	N/A	13.5 gal.	1.3 gal./hr.	10.4 hrs.	115V	168 lbs.	010-0180
ICE	OHV 350 Oil	320,000	7,400 sq. ft.	2,500	2 x 12"/24'	N/A	40.0 gal.	2.0 gal./hr.	20.0 hrs.	115V	400 lbs.	010-0210
ICE	IDF 350 Oil	350,000	8,100 sq. ft.	2,500	2 x 12"/24'	N/A	40.0 gal.	2.3 gal./hr.	17.4 hrs.	115V	495 lbs.	010-0210
ICE	OHV 500 Oil	420,000	9,700 sq. ft.	3,100	2 x 12"/24'	N/A	40.0 gal.	2.5 gal./hr.	16.0 hrs.	115V	400 lbs.	010-0230
ICE	IDF 500 Oil	500,000	11,600 sq. ft.	3,100	2 x 12"/24'	N/A	40.0 gal.	3.6 gal./hr.	11.1 hrs.	115V	495 lbs.	010-0230
ICE	IHS700 Oil ¹	700,000	16,200 sq. ft.	4,200	2 x 16"/100'	2 x 16"/25'	N/A	5.0 gal./hr.	N/A	230V	1,600 lbs.	010-0250
Allmand	MH-1000 ²	1,000,000	23,000 sq. ft.	11,400	2 x 16"/110'	N/A	191 gal.	7.0 gal./hr.	27.2 hrs.	110V	3,500 lbs.	010-0265
ICE	IHS1.2 Oil ¹	1,200,000	27,800 sq. ft.	8,420	3 x 16"/50'	3 x 16"/25'	N/A	8.9 gal./hr.	N/A	230/480V	4,000 lbs.	010-0270
TOPP	IDF-2000 ¹	2,000,000	46,300 sq. ft.	12,500	2 x 20"/75'	2 x 20"/75'	N/A	20.0 gal./hr.	N/A	240/480V	3,400 lbs.	010-0280

*Heating area is based upon a 40° temperature rise in a sealed building with an 8' ceiling.

¹Skid-mounted models that operate using external fuel tanks. (see tanks available on page 101)

²Trailer-mounted model with twin heaters and an onboard 8 kW diesel generator to power blowers and ignition.



ICE IHS700 LP/NG
700,000 BTU
Propane/Natural Gas

ICE IHS1.2 Oil
1,200,000 BTU
Oil Indirect-Fired



Gas Indirect-Fired Models

Make	Model	Max BTU	Heating Area*	CFM	Supply Duct Dia/Max Length	Return Duct Dia/Max Length	Fuel Consump	Run Time**	Voltage	Weight	Cat-Class
ICE	IDF 350 LP/NG	350,000	8,100 sq. ft.	2,500	2 x 12"/24'	N/A	16.7 lbs./hr.	6.0 hrs.	115V	495 lbs.	010-0220
ICE	OHV 350 LP/NG	350,000	8,100 sq. ft.	2,500	2 x 12"/24'	N/A	16.5 lbs./hr.	6.1 hrs.	115V	400 lbs.	010-0220
ICE	IDF 500 LP/NG	420,000	9,700 sq. ft.	3,100	2 x 12"/24'	N/A	20.1 lbs./hr.	5.0 hrs.	115V	495 lbs.	010-0240
ICE	OHV 500 LP/NG	450,000	10,400 sq. ft.	3,100	2 x 12"/24'	N/A	21.8 lbs./hr.	4.6 hrs.	115V	400 lbs.	010-0240
ICE	IHS700 LP/NG	680,000	16,200 sq. ft.	4,200	2 x 16"/100'	2 x 16"/25'	32.5 lbs./hr.	3.1 hrs.	230V	1,600 lbs.	010-0260
ICE	IHS1.2 LP/NG	1,200,000	27,800 sq. ft.	8,420	3 x 16"/50'	3 x 16"/25'	59.8 lbs./hr.	1.7 hrs.	230/480V	4,000 lbs.	010-0275

* Heating area is based upon a 40° temperature rise in a sealed building with an 8' ceiling.

**Run times are based on using a 100 lb. external propane tank. Use multiple or larger tanks for longer run times. (see page 20)

For natural gas fuel consumption and connection information, contact Sunbelt Rentals.

HEATERS

SPECIALTY HEATERS

INDUSTRIAL HEATERS are available in indirect-fired, flameless and hydronic surface models. Ranging in size from 550,000 to 4.2 million BTUs per hour, all of the units are completely self-contained and add a new versatility to the Pump & Power Services fleet.

- Clean, safe, reliable air flow
- Capable of ducting long distances with minimal loss of air pressure or outlet temperature
- Flameless heaters are extremely efficient and allow for less fuel consumption. Due to zero combustion, flameless heaters eliminate the need for fire-watch.
- Most units offer temperature rise capabilities up to 180 degrees F
- Rugged, heavy duty steel construction



MAC Flameless Heater



MAC Indirect-Fired Heater

Make	Model	Max BTU	CFM	Fuel Type	Fuel Tank	Fuel Consumption	Overall Dimensions	Weight	Cat-Class
MAC	1.2G	1,200,000	6,500	#2 Diesel	270 gal.	30 GPH	252"L x 98"W x 97"H	7,000 lbs	010-0273
MAC	4.2ES	4,200,000	21,000	#2 Diesel	130 gal.	30 GPH	288"L x 101"W x 120"H	14,000 lbs.	010-0290
MAC	550F	550,000	3,500	#2 Diesel	125 gal.	3 GPH	178"L x 72"W x 80"H	3,800 lbs.	010-1650
MAC	750F	750,000	2,650	#2 Diesel	107 gal.	3.55 GPH	178"L x 72"W x 80"H	4,300 lbs.	010-1850
MAC	800G	800,000	3,900	#2 Diesel	175 gal.	5.7 GPH	178"L x 72"W x 88"H	4,620 lbs.	010-0263
MAC	950F	950,000	3,000	#2 Diesel	160 gal.	7.1 GPH	192"L x 72"W x 85"H	5,650 lbs.	010-2050

INLINE HEATERS are available in 30 kW, 60 kW and 150 kW models. Both the 30 kW and 60 kW models have two stages of heat, while the 150 kW unit offers four stages of heat. All units offer a built-in thermostat to control the heat stages for desired operation. Durable steel cabinets make the heaters ideal for rental, and numerous safety features make them a great fit for temporary heating applications.



Make	Model	Capacity	Amps	Voltage	Overall Dimensions	Weight	Cat-Class
United Cool Air	PIH150	150 kW	189	460 V 3ø	42"L x 34"W x 45"H	820 lbs.	010-1075
United Cool Air	PIH60	60 kW	75.3	460 V 3ø	53"L x 34"W x 45"H	520 lbs.	010-1050
United Cool Air	PIH1530	30 kW	37.7	460 V 3ø	65"L x 34"W x 45"H	410 lbs.	010-1000

TEMPERATURE CONTROL & DEHUMIDIFICATION

HEATERS

HEATER BASICS

HEATER TYPES

FLAMELESS HEATERS

are extremely efficient and allow for less fuel consumption. Due to zero combustion, flameless heaters eliminate the need for fire-watch.

FORCED AIR HEATERS

utilize a fan or blower to create artificial air movement, which removes the heat from the heater surface very quickly. Forced air heaters can circulate heated air over very long distances and are usually the choice for heating larger areas. Forced air heaters are available in direct-fired, indirect-fired and electric types.



DIRECT-FIRED HEATERS

are ideal for applications where a great deal of heat is required in non-enclosed areas such as general construction, ventilated warehouses and parking garages. They are highly efficient since all the heat is transferred to the heated airflow. Direct-fired heaters are both compact and economical due to their simple design. They are available in oil, propane and dual fuel (propane and natural gas) types.



INDIRECT-FIRED HEATERS

utilize a heat exchanger that keeps fumes and exhaust products out of the airflow, providing clean, dry, odorless heat. A flue vents excess moisture, carbon monoxide and other products of combustion. Indirect-fired heaters can also accommodate ductwork, which allows distribution of clean heated air to specific target areas. This feature allows placing the unit outside in a remote location from the area being heated. Indirect-fired heaters are available in oil and dual fuel (propane and natural gas) types. (see page 61)



CONVECTION HEATERS

transfer heat to the surrounding air by the natural circulation of air through the heater. Air motion is a result of gravitational forces where the heated air is lighter than the cooler air. Heated air rises from the top of the heater and is replaced by cooler air that enters from the bottom. Individual convection heaters are a common heat source for smaller enclosed areas and multiple units can be combined to heat larger areas.

RADIANT (INFRARED) HEATERS

heat people and objects rather than air or space. Radiant heat is less affected by drafts and large air movements, since it passes through the air to heat floors, walls, machinery and people. This makes radiant heaters ideal for outdoor and high ceiling heating applications. They are also ideal for spot heating areas like shipping docks; for protecting valves, pumps and machinery from freezing; and for thawing frozen pipes. Radiant heaters generate no noise, fumes or flames.



ELECTRIC HEATERS

provide clean, dry heat with none of the combustion by-products common to fossil fuel burning units. They are also very quiet and require almost no routine maintenance. Applications include general construction in enclosed areas, temporary commercial heating, special event tents and moisture control/drying. Electric heaters are available in portable and industrial types. (see page 60)



FUEL TYPES

KEROSENE AND FUEL OIL are by-products of petroleum refining and are comprised of liquid hydrocarbons. They are available in several grades depending upon the range of distillation. Kerosene and No. 1 fuel oil are recommended for oil heaters and have a heat rating as follows:
1 gal. = 126,000 BTUs

PROPANE (LPG) consists of refined natural gases that are extracted in a liquid state during refining, under pressure. It remains in liquid state during storage and transportation. When the pressure is reduced, propane vaporizes and becomes a gaseous fuel. When stored in a tank, propane is in both liquid and gaseous state; one gallon of liquid propane weighs 4.35 lbs. and expands to 36.35 cu. ft. of gas when it is evaporated (at sea level). Heat ratings for propane are as follows:
1 gal. = 91,500 BTUs
1 lb. = 21,030 BTUs
1 cu. ft. = 2,521 BTUs

NATURAL GAS is the lightest of all petroleum products and is lighter than air. It remains in a gaseous state throughout the pressure and temperature changes that occur during distribution. Natural gas is sold by the therm, with one therm equal to 40 cu. ft. Heat ratings for natural gas are as follows:
1 therm = 100,000 BTUs
1 cu. ft. = 2,500 BTUs

ELECTRICITY is sold in kilowatt hours (kWH), with one kWH equivalent to 1,000 watts usage for one hour. Electric heaters utilize resistance heating, which converts electrical energy to heat at the rate of 3,450 BTUs per kilowatt (kW).

CALCULATING HEATING FUEL COSTS

Fuel Type	Unit Price		Units per Therm		Efficiency Factor		Heating Cost
Kerosene/ No. 1 Fuel Oil	\$_____/gal.	x	.79 gal.	÷	.86	=	\$_____/Therm
Propane	\$_____/lb.	x	4.79 lbs.	÷	.90	=	\$_____/Therm
Natural Gas	\$_____/Therm	x	1.00	÷	.90	=	\$_____/Therm
Electric	\$_____/kWH	x	29.3 kWH	÷	.95	=	\$_____/Therm

The chart above is useful for comparing relative heating costs for different fuel types. These formulas allow you to calculate the heating cost per therm (100,000 BTUs), using local market prices. The efficiency factors reflect industry averages and will vary slightly for specific heaters.

TEMPERATURE CONTROL & DEHUMIDIFICATION

HEATERS

HEATER BASICS, HYDRONIC GROUND HEATERS

GLOSSARY

Air Changes/Hour—the number of times per hour that the air in a room or building is changed by mechanical means.

BTU—the basic unit for measuring the output of a heater (acronym for British thermal unit). One BTU equals the amount of heat required to raise the temperature of one pound of water by one degree Fahrenheit.

Combustion—the chemical action of a substance with oxygen resulting in the evolution of heat and some light. The three requirements for combustion are sufficiently high temperatures, oxygen and fuel.

Conduction—the transmission of heat through and by matter.

Convection—the transmission of heat by the circulation of air.

Heat Exchanger—a device used to transfer heat from one medium to another. It allows fumes and the by-products of combustion to be vented away from the heated airflow in an indirect-fired heater.

Heat Rise—the desired rise in temperature in degrees Fahrenheit for a heated area. To determine heat rise, subtract the outside temperature from the desired inside temperature in the area being heated.

Resistance Heating—heat generated by electric current passing through a resistance wire. This is the most common type of electric portable heater.

Static Pressure—the pressure which tends to burst a pipe. It is used to overcome the frictional resistance to flow through the pipe. It is usually expressed in inches of water column.

Therm—a unit of heat equal to 100,000 BTUs. It is also used to measure natural gas and as a basis for comparing different fuel types. One therm equals 40 cu. ft. of natural gas.

Thermostat—a device that automatically responds to temperature changes and activates switches controlling heaters and other HVAC equipment.

CALCULATING HEATING REQUIREMENTS

How many BTUs of heating capacity do you need? The formula below can serve as a rough guide for determining the heat requirements for common building applications:

$$\text{BTU Required} = \text{Square footage} \times \text{Ceiling Height} \times \Delta t \times \text{Building Factor}$$

Where Δt = Temperature Rise (Desired Temp. F inside–Outside Temp F)

Building Factors: .135 (Sealed building) .145 (Unsealed building) .160 (Tent)

Example: A 4000 sq. ft. unsealed building has an 8' ceiling height. The desired temperature is 70°F and the outside temperature is 30°F. Therefore, the desired temperature rise (Δt) is 40°.

$$\text{BTU Required} = 4,000 \times 8 \times 40 \times .145 = 185,600$$

Other factors to consider are insulation, ventilation and the number of rooms being heated. After determining the most suitable type of heater and the BTU requirements for your application, select a heater (or heaters) with a BTU rating equal to (or greater than) your requirements.

HYDRONIC GROUND HEATERS provide high-efficiency solutions for two major challenges contractors face working in cold climates: thawing frozen ground and curing concrete. A diesel-fired burner heats hydronic (water/glycol) transfer fluid, which is pumped through flexible hoses to distribute heat directly to the surface, providing more than six times the specific heat of heated air.

- Ground Thawing—up to 1' of depth per day
- Concrete Curing—raise concrete to the ideal curing temperature of 65° to 75°F reducing costs and delays
- Large capacity fuel tanks provide up to 140 hours run time
- Trailer-mounted for easy highway towing

Note: Operation requires two 120V 20A AC power sources.



DRYAIR 300GTS Greenthaw
301,000 BTU Hydronic Ground Heater

Make	Model	Max BTU	Thawing Capacity	Curing Capacity	Efficiency	Transfer Fluid	Fuel Tank	Run Time	Weight	Cat-Class
DRYAIR	300GTS Greenthaw	301,000	3,000–6,000 sq. ft.	6,000 sq. ft.	85%	66 gal.	150 gal.	Up to 140 hrs.	5,650 lbs.	010-0800
Wacker	E3000	385,000	3,000–6,000 sq. ft.	6,000 sq. ft.	83%	115 gal.	230 gal.	Up to 140 hrs.	7,190 lbs.	010-0800
DRYAIR	600GTS Greenthaw	620,200	6,000–8,000 sq. ft.	8,000 sq. ft.	82%	124 gal.	250 gal.	Up to 113 hrs.	6,600 lbs.	010-0600
MAC	6000	630,000	3,000–6,000 sq. ft.	6,000 sq. ft.	86%	130 gal.	225 gal.	Up to 78 hrs.	9,550 lbs.	010-3600
DRYAIR	900GTS Greenthaw	896,000	6,000–8,000 sq. ft.	8,000 sq. ft.	85%	142 gal.	250 gal.	Up to 78 hrs.	7,100 lbs.	010-0880

Thawing and curing capacities are based on the amount of hose that comes on board each unit.

All machines are capable of thawing and curing larger areas by adding an auxiliary manifold and additional thawing and curing hose.

DEHUMIDIFIERS/REMEDIATION EQUIPMENT

LARGE DESICCANT DEHUMIDIFIERS

Sunbelt Rentals Pump & Power Services locations offer large capacity desiccant dehumidifiers ideal for water damage restoration applications, condensate and humidity control in manufacturing, and corrosion and humidity control for industrial coating and lining applications, as well as moisture mitigation in construction projects. By utilizing advanced desiccant technology to provide a low dew-point airstream and absorbing moisture vapor in the air, Sunbelt's desiccant dehumidifiers lower moisture levels in both the ambient indoor air and moisture content in building materials. This reduces the premature degradation of building materials and lowers the risk of microbial growth due to high moisture levels within a structure. Desiccant dehumidifiers are the most efficient option for humidity control, are suitable for use in nearly all environmental conditions, and can be operated as a stand-alone strategy or as a component of a more complex environmental control system with other air treatment components such as air conditioners, heaters and HEPA filtration units.



Above: Four 5,000 CFM Electric Desiccant Dehumidifiers in operation at a construction project in CA.

Above Right: Four 5,000 CFM Electric Desiccant Dehumidifiers utilizing extensive ducting operating on a new construction.

Above Right: Technician checking performance on a 5,000 CFM desiccant dehumidifier using a digital thermo hygrometer.



LARGE DESICCANT DEHUMIDIFIER APPLICATIONS

Water Damage Restoration—Provide a low-dew point air stream to quickly pull moisture from building materials that have come in contact with water due to storms, floods, fires and piping failures. Quickly dry out wet buildings and structures to prevent growth of mold and fungus.

New Construction Dehumidification—Speed drying and curing of construction materials; also helps prevent odors and mold contamination.

Humidity Control in Buildings—Use alone or with other air-treatment components, such as air conditioners, heaters and HEPA filters.

Industrial Preparation and Surface Coatings—Prevent condensation inside tanks prior to painting or industrial coating to ensure proper bonding.

Industrial Condensation Prevention—Eliminate condensation in industrial and manufacturing processes to ensure high quality.

Power Plant & Marine Lay-up—Prevent corrosion in utility and industrial piping idled for long periods by lowering the ambient dew point.



Pharmaceutical
Food Supplement



Maritime
Power Plant



Surface Preparation
Protective Coating Application



Food Production
Cold Storage

TEMPERATURE CONTROL & DEHUMIDIFICATION

DEHUMIDIFIERS/REMEDICATION EQUIPMENT

LARGE DESICCANT DEHUMIDIFIERS

LARGE DESICCANT DEHUMIDIFIERS utilize a solid desiccant rotor that is slowly rotated by a drive motor. As the rotor turns, this produces very dry discharge air with extremely low relative humidity, which is ducted to the area being treated to facilitate drying or other moisture control applications. Many advanced features are included to provide precision control and maximum operating efficiency. Electric, gas and propane reactivation types are available. All models require electric power to energize the controllers and blower motors.

- 600 CFM models come in two options. Single phase 230 Volt comes in a portable unit that will run off a spider box and is ideal for residential or construction applications. 460 Volt / 3 Phase unit comes mounted in a lifting cage with fork pockets and is built for industrial projects.
- 1000/2000 CFM combination unit is 460 Volt / 3 Phase and has an option for either 1,000 or 2,000 CFM. This allows you to run the unit at a lower setting, decreasing energy use and cost. Unit is mounted in a lifting cage with fork pockets and casters.
- 5,000 CFM Tri-Fuel models can utilize electric, natural gas or propane gas for the reactivation energy, allowing you to choose the most efficient energy method. Unit electrical operation is 460 Volt / 3 Phase with single point hookup for either natural gas or propane. Unit comes in a lifting cage with fork-pockets and is less than 48" wide allowing for units to be shipped side-by-side.
- 15,000 CFM Tri-Fuel units utilize the same technologies found in our 5,000 CFM units. Ideal for outside use, the units are mounted on a galvanized steel skid, surrounded by a lifting cage. Units require 460 Volt / 3 Phase and can utilize natural gas or propane.

Note: Ducting is available in 25' lengths.



5,000 CFM Electric Desiccant Dehumidifier & 175 kW Generator



5,000 CFM Desiccant Dehumidifier, 320 kW Generator & 150 kW Heater



15,000 CFM Electric Desiccant Dehumidifier

Performance Specifications (Gas = Natural Gas or Propane)

Model	Type Reactivation	Air Volume	Static Pressure	Moisture Removal			Overall Dimensions*	Weight	Cat-Class
				80°F / 60% RH	55°F / 80% RH	40°F / 80% RH			
GC-150	Electric	150	2"	5.75-11.5 gal./day	N/A	N/A	24"L x 22"W x 38.5"H	170 lbs.	105-0001
MS-600	Electric	600	0.5"	23 gal./day	18 gal./day	N/A	32"L x 26"W x 43"H	140 lbs.	105-0005
MS1000	Electric	1,000	2"	58 gal./day	43 gal./day	29 gal./day	81"L x 29"W x 40"H	525 lbs.	105-0010
MS2000	Electric	2,000	2"	143 gal./day	120 gal./day	71 gal./day	92"L x 29"W x 50"H	800 lbs.	105-0110
MS2400/1000	Electric	1000-2400 Hi (2000)	2"	158 gal./day	121 gal./day	72gal./day	92"L x 35"W x 63"H	1,100 lbs.	105-0050
		Low (1000)	2"	79 gal./day	69 gal./day	36gal./day			
MS2000G	Gas	2,000	2"	143 gal./day	120 gal./day	71 gal./day	92"L x 29"W x 50"H	800 lbs.	105-0120
MS5000	Electric	5,000	5"	392 gal./day	331 gal./day	216 gal./day	170"L x 49"W x 79"H	4,800 lbs.	105-0410
MS5000TRI	Tri-Fuel	5,000-6,000	5"	392 gal./day	331 gal./day	216 gal./day	170"L x 49"W x 79"H	5,000 lbs.	105-0420
MS10000TRI	Tri-Fuel	10,000-12,000	5"	866 gal./day	754 gal./day	458 gal./day	193"L x 96"W x 72"H	8,000 lbs.	105-0440
MS15000	Electric	15,000	5"	1,221 gal./day	1,022 gal./day	697 gal./day	211"L x 88"W x 104"H	8,800 lbs.	105-0810
MS15000TRI	Tri-Fuel	15,000-17,000	5"	1,221 gal./day	1,022 gal./day	697 gal./day	211"L x 88"W x 104"H	13,500 lbs.	105-0820

*Dimensions of individual units may vary from the above specs—check with your Sunbelt Rentals location to confirm dimensions.

Air ducts—600 CFM: (4) 10" ducts; 1,000 CFM: (6) 10" ducts; 2,000 CFM: (2) 20" & (2) 10" ducts; 5,000 CFM: (2) 20" ducts; 15,000 CFM: (6) 20" ducts

DEHUMIDIFIERS

LARGE DESICCANT DEHUMIDIFIERS, HYBRID COOLING UNITS SUNBELT AIR MONITORING SYSTEM (SAMS)

Electric/Fuel Requirements (Gas = Natural Gas or Propane)

Model	Type Reactivation	Electric Load (Electric Reactivation) 230V, 1ø	Electric Load (Electric Reactivation) 460V, 3ø	Electric Load (Gas Reactivation) 460V, 3ø	Fuel Consumption (Natural Gas) Max Usage	Fuel Consumption (Propane) Max Usage
GC-150	Electric	N/A	5A/3 kW ¹	N/A	N/A	N/A
MS-600	Electric	24A/20 kW ¹	18A/20 kW ¹	N/A	N/A	N/A
MS1000	Electric	80A/56 kW ¹	28A/36 kW ¹	N/A	N/A	N/A
MS2000	Electric	N/A	56A/56 kW ¹	N/A	N/A	N/A
MS2400/1000	Electric (2400)	N/A	60A/56 kW ¹	N/A	N/A	N/A
	Electric (1000)	N/A	30A/36 kW ¹	N/A	N/A	N/A
MS2000G	Gas	N/A	N/A	15A/20 kW ¹	120 cu. ft./hr.	.975 gal./hr.
MS5000	Electric	N/A	138A/120 kW ¹	N/A	N/A	N/A
MS5000TRI	Tri-Fuel	N/A	138A/120 kW ¹	13A/20 kW ¹	400 cu. ft./hr.	4.4 gal./hr.
MS10000TRI	Tri-Fuel	N/A	292A/250 kW ¹	26A/20 kW ¹	718 cu. ft./hr.	7.6 gal./hr.
MS15000	Electric	N/A	335A/300 kW ¹	N/A	N/A	N/A
MS15000TRI	Tri-Fuel	N/A	335A/300 kW ¹	44A/56 kW ¹	1,200 cu. ft./hr.	12.7 gal./hr.

¹Recommended generator size for portable operation

HYBRID COOLING UNITS are designed to provide practical moisture control in hot and humid environments. The Sunbelt HCU units bring makeup air into a space by using a cooling coil to control temperature while a desiccant rotor wheel controls ambient humidity.

The Sunbelt HCU units are very energy efficient, reducing the overall cost of operation by lowering the amount of power and fuel necessary for operation. The HCU design combines practical cooling and desiccant dehumidification technologies into one energy efficient package. The Sunbelt HCU units are often utilized in construction drying projects, protective coating application projects, and in seasonal applications within the power generation, manufacturing and entertainment industries.



- 4,000-6,000 CFM
- Humidity or temperature demand control
- High energy efficiency
- Variable frequency drive for capacity control
- Digital control with optional remote monitoring
- Optimizes refrigeration-based A/C and desiccant-based dehumidification performance

Model	Dimensions	Weight	Full Load Amps (FLA)	Static Pressure	Airflow	Cat-Class
HCUb-6000	126"L x 84"W x 57"H	5200 lbs.	78 at 460V, 3ø	5" wc	4000-6000 SCFM	105-0430

SUNBELT AIR MONITORING SYSTEM (SAMS) offers a wireless solution for monitoring job site conditions. Originally designed to meet stringent military specifications for tank lining, SAMS successfully monitors the conditions of nearly any critical dehumidification project and is the only logging system able to continuously collect conditions in the event power and/or internet connectivity is lost.

- Perfect for use on industrial coating and painting projects and construction sites
- Invaluable project documentation of job site conditions
- Optional sensors available to measure air pressure differential, CO₂ and other gases, and porous materials such as wood, concrete and plaster



Sunbelt Air Monitoring System (SAMS)

TEMPERATURE CONTROL & DEHUMIDIFICATION

HIGH STATIC BLOWERS

HIGH STATIC BLOWERS, INLINE ELECTRIC BLOWERS

TEMPERATURE CONTROL & DEHUMIDIFICATION



HIGH STATIC BLOWERS move low to medium volumes of air at high static pressures. Skid-mounted, the fans in our High Static Blowers are rated at 14,000 CFM at 14" Wc., giving you the capacity you need to get the job done. Typical applications include material conveying, product drying, scrubber exhaust, combustion air and more.

EnTech Industries VNT1400
High Static Blower

Make	Model	Mounting	Motor	Fan	Dimensions	Weight	Cat-Class
EnTech Industries	VNT1400	Skid	50 HP 460V/3ø	14,000 CFM @ 14" wc /spark resistant	64"L x 67"W x 60"H	2,415 lbs.	036-0650



United Cool Air PILB5G4
Inline Electric Blower

INLINE ELECTRIC BLOWERS are designed especially for ducted applications up to 20" with up to 5" External Static Pressure. Mounted on casters, our Inline Electric Blowers offer a horizontal cabinet and are capable of producing 5,000 CFM.



Make	Model	Mounting	Power Requirements	Blower Capacity	Motor	Motor FLA	Motor Speed	Dimensions	Weight	Cat-Class
United Cool Air	PILB5G4	Skid	460V/3ø/60	5,000 CFM	10 HP 460V 3ø	11.5 amps	3,525 RPM	52"L x 38"W x 51.5"H	582 lbs.	010-1090

DEHUMIDIFIERS/REMEDICATION EQUIPMENT

DEHUMIDIFICATION BASICS

GLOSSARY

Actual Vapor Pressure—the partial pressure exerted by the water vapor present in a parcel, measured in millibars. Water in a gaseous state (i.e. water vapor) exerts a pressure just like the atmospheric air.

Dehumidification—the process of removing moisture from the air or other materials.

Desiccant—a substance such as calcium oxide or silica gel that is used as a drying agent.

Dew Point—the temperature air must be cooled to in order for saturation to occur, producing water in the form of dew or condensation.

Dry Bulb Temperature—the actual air temp.

Evaporation—the change of liquid water into water vapor. Moisture evaporates due to differential vapor pressure—the larger the vapor pressure differential, the faster the drying.

Humidistat—an instrument that indicates or controls the relative humidity of the air.

Hygrometer—an instrument that measures atmospheric humidity.

Relative Humidity—the ratio of the amount of water vapor in the air at a specific temperature to the maximum capacity of the air at that temperature. Relative humidity is expressed as a percentage: divide the actual vapor pressure by the saturation vapor pressure and then convert to a percent.

Saturation of Air—the condition under which the amount of water vapor in the air is the maximum possible at the existing temperature and pressure. Condensation or sublimation will begin if the temperature falls or water vapor is added to the air.

Saturation Vapor Pressure—the maximum partial pressure that water vapor molecules would exert if the air were saturated with vapor at a given temperature. Saturation vapor pressure is directly proportional to the temperature.

Wet Bulb Temperature—the lowest temperature that can be obtained by evaporating water into the air at constant pressure. Wet bulb temperatures can be used along with the dry bulb temperature to calculate dew point or relative humidity.

CALCULATING REQUIREMENTS

WATER DAMAGE RESTORATION

Normally two to five air changes per hour (ACH) are recommended for water damage restoration applications.

1. Calculate the volume of the structure in cubic feet (L x W x H).
2. Calculate the SCFM for one air change (volume ÷ 60).
3. Calculate the dehumidification capacity required (SCFM x ACH).

Example: A multi-story building measuring 100'L x 50'W x 50'H has received water damage due to flooding. Provide dehumidification capacity for three air changes per hour (ACH).

1. Volume = 100 x 50 x 50 = 250,000 cu. ft.
2. SCFM = 250,000 ÷ 60 = 4,167 SCFM
3. Dehumidification capacity = 4,167 SCFM x 3 ACH = 12,501 SCFM

This capacity could be provided using three 5,000-CFM dehumidifiers or one 15,000-CFM dehumidifier.

INDUSTRIAL CONDENSATION PREVENTION

Use desiccant dehumidifiers in combination with air conditioning units. Size dehumidifier flow for approximately one-half the air conditioner flow. Use 400 SCFM per ton of A/C capacity. If large amounts of outside air (above 10% of total flow) are required, use an air conditioner to pre-cool the dehumidifier inlet.

Example: Provide temporary dehumidification for a commercial building with a rooftop 20-ton air conditioner.

$$\text{Dehumidification capacity} = 400 \text{ SCFM} \times 20 \text{ tons} \div 2 = 4,000 \text{ SCFM}$$

INDUSTRIAL PREPARATION AND SURFACE COATINGS

Temporary dehumidification inside tanks being prepared for painting or industrial coating eliminates the potential for condensation.

Procedure: Purge the tank with 100% dehumidified air. Return air is not used due to the heavy dirt loading, usually 2 to 4 ACH is sufficient.

Example: Provide temporary dehumidification for a 100' diameter tank 30' high. The tank has (3) 3' diameter manholes and (8) 1' diameter vents.

Sizing Method #1 (Volume)

1. Calculate the volume of the tank in cu. ft. (3.14 x Radius² x H).
2. Calculate the SCFM for one air change (volume ÷ 60).
3. Calculate the dehumidification capacity required (SCFM x ACH).
Dehumidification capacity = 235,500 cu. ft. ÷ 60 = 3,925 SCFM @ 1 ACH
This computes to 7,850 SCFM @ 2 ACH or 15,700 SCFM @ 4 ACH.

Sizing Method #2: (Leakage)

1. Calculate the leakage in square feet from manholes and vents.
2. Calculate the dehumidification capacity required (Leakage x 250 FPM).
Leakage = 21.13 sq. ft. (manholes) + 9.42 sq. ft. (Vents) = 30.60 sq. ft. total
Dehumidification capacity = 30.60 sq. ft. x 250 FPM = 7,650 SCFM

Note: The above calculations are for estimating purposes only. The actual dehumidification requirements for specific applications may vary.

TRENCH SHORING EQUIPMENT

TRENCH BOXES—STEEL

STEEL TRENCH BOXES provide heavy-duty trench protection. 4" and 6" doublewall boxes are available. In addition, we offer several "job-matched" options for custom installations including spreader sets, height adapters, end panels and stacking tubes.

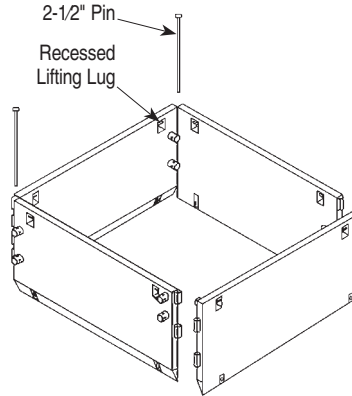

4-Sided Pit Kit

For square or rectangular pit shields. Ideal for well drilling/ shafts, tank, vault or junction box installations

4" Doublewall Steel Trench Boxes

4M Series Shield Sidewalls: sets of two Doublewall										
Model	Size		Pipe Clearance	Weight	Shield Cap (PSF)	Max Depth Per Soil Type*				Cat-Class
	H	L				A	B	C-60	C-80	
4M412NKE ¹	4'	12'	16"	3,265 lbs.	2,522	99'	58'	44'	34'	014-0215
4M416NKE ¹	4'	16'	16"	3,964 lbs.	1,334	55'	32'	24'	19'	014-0220
4M420NKE ¹	4'	20'	16"	4,718 lbs.	823	35'	20'	16'	12'	014-0228
4M812	8'	12'	64"	5,449 lbs.	1,702	72'	42'	32'	25'	014-0140
4M816	8'	16'	64"	6,870 lbs.	1,277	55'	32'	25'	20'	014-0150
4M1016	10'	16'	76"	8,419 lbs.	933	42'	26'	21'	17'	014-0190
4M1020	10'	20'	76"	10,221 lbs.	746	35'	22'	17'	14'	014-0195

¹NKE models are stacking trench boxes without knife edges.

6" Doublewall Steel Trench Boxes

6M Series Shield Sidewalls: sets of two Doublewall										
Model	Size		Pipe Clearance	Weight	Shield Cap (PSF)	Max Depth Per Soil Type*				Cat-Class
	H	L				A	B	C-60	C-80	
6M416NKE ¹	4'	16'	16"	4,575 lbs.	2,164	89'	50'	38'	29'	014-0225
6M420NKE ¹	4'	20'	16"	5,468 lbs.	1,336	55'	32'	24'	19'	014-0230
6M424NKE ¹	4'	24'	16"	6,362 lbs.	906	38'	22'	17'	13'	014-0240
6M816	8'	16'	64"	7,695 lbs.	2,064	87'	50'	38'	30'	014-0160
6M816NKE ¹	8'	16'	64"	7,695 lbs.	2,064	87'	50'	38'	30'	014-0270
6M820	8'	20'	64"	9,339 lbs.	1,328	57'	34'	26'	21'	014-0170
6M820NKE ¹	8'	20'	64"	9,339 lbs.	1,328	57'	34'	26'	21'	014-0280
6M824	8'	24'	64"	10,982 lbs.	900	40'	24'	19'	15'	014-0180
6M824NKE ¹	8'	24'	64"	10,982 lbs.	900	40'	24'	19'	15'	014-0290
6M1016	10'	16'	76"	9,448 lbs.	1,464	64'	38'	29'	23'	014-0192
6M1020	10'	20'	76"	11,443 lbs.	1,171	52'	31'	25'	20'	014-0197
6M1024NKE ¹	10'	24'	76"	13,456 lbs.	898	41'	25'	20'	16'	014-0202

¹NKE models are stacking trench boxes without knife edges.

*Depths are based on A,B,C-60 and C-80 soil types as described in OSHA's 29 CFR Part 1926 Subpart P, October 31, 1989 and publications of the Trench Shoring & Shielding Association (TSSA), with Type A not exceeding 25 PSF per foot of depth, Type B not exceeding 45 PSF per foot of depth, Type C-60 not exceeding 60 PSF per foot of depth, Type C-80 not exceeding 80 PSF per foot of depth. Determine actual soil pressures and consult Manufacturer's Tabulated Data prior to each use.



4" Doublewall Steel Trench Box



6" Doublewall Steel Trench Box

Spreader Sets

*8DS Spreader Sets: For use on 4M & 6M Shields; 8" Schedule 80 Pipe										
Model	8DS24	8DS36	8DS48	8DS60	8DS72	8DS84	8DS96	8DS108	8DS120	8DS144
Inside Width	24"	36"	48"	60"	72"	84"	96"	108"	120"	144"
Weight	441 lbs.	621 lbs.	802 lbs.	982 lbs.	1,163 lbs.	1,343 lbs.	1,524 lbs.	1,704 lbs.	1,885 lbs.	2,246 lbs.
Cat-Class	155-1625	155-1630	155-1635	155-1640	155-1645	155-1650	155-1655	155-1660	155-1665	155-1670

*8DS Spreaders include a 2" diameter pin.

TRENCH SHORING EQUIPMENT

TRENCH BOXES—STEEL, STEEL ROAD PLATES



Left: This application required the 76" pipe clearance of a 10' tall trench box. A 10' x 20' 6" wall steel trench box, with an 8' x 20' 6" wall box stacked on top, provided the necessary 18' of protection while reducing weight for easier movement.



Right: This installation was designed combining pit box configurations with height adaptors. Eight 8' x 12' steel trench boxes and four 120" vertical clearance height adaptors were utilized. This provided four-side protection while straddling the existing 96" pipe.

STEEL ROAD PLATES provide a secure covering over open areas, allowing pedestrians and vehicles to pass over safely. Applications include trench covering and temporary road surfacing. Available road plates range from 4' x 8' to 8' x 20'. Most plates are 1" thick and include lifting eyes for easy lifting and placement.

Steel Road Plates		
Plate Size*	Weight	Cat-Class
4' x 8'	1,307 lbs.	155-1570
6' x 12'	2,948 lbs.	155-1600
8' x 12'	3,921 lbs.	155-1610
8' x 16'	5,228 lbs.	155-1615
8' x 20'	6,534 lbs.	155-1620

*Additional sizes are also available to meet specific customer requirements.



Pump & Power locations are equipped with boom trucks that can deliver road plates and other trench shoring equipment



Swivel lifting rings are available to facilitate easy lifting, loading and placing of steel road plates. Rings swivel 360° and pivot 180° (Cat-Class 155-1623)



For more information about trench shoring solutions, contact a Sunbelt Rentals Pump & Power location at 800-736-2504.



TRENCH SHORING EQUIPMENT

TRENCH SHORING EQUIPMENT

TRENCH BOXES—ALUMINUM

ALUMINUM TRENCH BOXES feature an outstanding weight-to-strength ratio, which makes them easy to transport and set up on the job site. They can be lifted easily using backhoe loaders and mini excavators. Some systems can even be installed by hand. Both 2" wall and 4" wall aluminum trench boxes are available, each equipped with a tough T-6 knife edge and a rugged top cap. Optional accessories include pull bars and custom spreader sets.



A custom engineered shoring installation on a natural gas transmission line project. Two 8' x 16' 4" wall aluminum trench boxes with 20' steel spreaders were utilized



2" Wall Aluminum Trench Box

2" Wall Aluminum Trench Boxes

2AEX—2" Aluminum Extruded Wall										
Model	Size			Weight	Pipe Clearance	Max Depth Per Soil Type				Cat-Class
	H	L	W			A	B	C-60	C-80	
2AEX-86	8'	6'	2'	943 lbs.	36"	45'	26'	20'	14'	014-0310
2AEX-88	8'	8'	2'	1,177 lbs.	36"	34'	20'	15'	11'	014-0320
2AEX-810	8'	10'	2'	1,412 lbs.	36"	23'	14'	11'	8'	014-0330
2AEX-812	8'	12'	2'	1,647 lbs.	36"	15'	9'	8'	5'	014-0340

2AEX Spreaders: Pinned in place adjustable, box steel tube, 3.5" x 3.5"					
Model	2AEX-2640	2AEX-3250	2AEX-3859	2AEX-4468	2AEX-5692
Range	26"–40"	32"–50"	38"–59"	44"–68"	56"–92"
Weight	28 lbs.	34 lbs.	41 lbs.	47 lbs.	62 lbs.
Cat-Class	155-3000	155-3010	155-3020	155-3030	155-3040

Note: Four spreaders are required per box. Pull Bars are available to assist with installation. (Cat-Class 155-3140)

4" Wall Aluminum Trench Boxes

4AEX—2" Aluminum Extruded Wall										
Model	Size			Weight	Pipe Clearance	Max Depth Per Soil Type				Cat-Class
	H	L	W			A	B	C-60	C-80	
4AEX-812	8'	12'	4'	2,631 lbs.	48"	45'	26'	20'	15'	014-0345
4AEX-816	8'	16'	4'	3,197 lbs.	48"	26'	15'	12'	9'	014-0350

4AEX Spreaders: Loose 5" Schedule 80 Pipe										
Model	5DS24	5DS36	5DS48	5DS60	5DS72	5DS84	5DS96	5DS108	5DS120	
Inside Width	24"	36"	48"	60"	72"	84"	96"	108"	120"	
Weight	186 lbs.	269 lbs.	352 lbs.	436 lbs.	519 lbs.	602 lbs.	685 lbs.	768 lbs.	851 lbs.	
Cat-Class	155-3050	155-3060	155-3070	155-3080	155-3090	155-3100	155-3110	155-3120	155-3130	

Note: Four spreaders are required per box. Pull Bars are available to assist with installation. (Cat-Class 155-3140)



4" Wall Aluminum Trench Box

TRENCH SHORING EQUIPMENT

HYDRAULIC SHORING SHIELDS

HYDRAULIC SHORING SHIELDS consist of lightweight, aluminum sidewalls, coupled with heavy-duty, adjustable hydraulic spreaders. The spreader contains a hydraulic cylinder and return spring and is protected by steel box tubing. A uniquely designed manifold allows the user to precisely control the flow of fluid to each cylinder, while safely outside the trench.

- Lightweight sheeting sidewalls with sturdy lifting eyes
- Heavy-duty skid plates and sheeting caps
- Heavy-duty, steel box tubing protects cylinder and features end-loading capability for 3- and 4-sided use
- Multiple pinning locations permit a wide range of settings in static mode
- Fold-down steel cover protects manifold when shield is in use, yet permits quick access to hydraulic hook-ups
- Cut-outs are available for working around crossing utility lines and to simplify lateral connections
- Certified by a registered professional engineer to meet OSHA standards



Hydraulic shoring shields with end panel assemblies

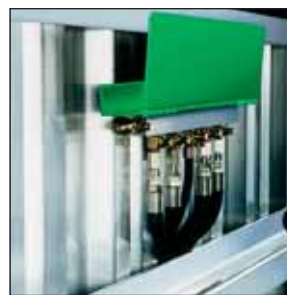

Manifold Sidewall Panel



Cut-Out Side Panel

Note: Hydraulic shoring shields are assembled from individual components, matched to each specific application. Select two aluminum sidewall panels and four hydraulic spreaders to form the basic shield. To form an end panel, select the appropriate length end panel tube and two or more aluminum end panel sheets.

Aluminum Sidewall Panels															
Model	Type	Size		Weight	Clearance*		Max Depth** Per Soil Type								Cat-Class
		H	L		A	B	A		B		C-60		C-80		
					Hyd	Stat	Hyd	Stat	Hyd	Stat	Hyd	Stat	Hyd	Stat	
HS-5x5 A	Manifold	5'	5'	239 lbs.	22"	45"	22'	45'	25'	25'	25'	21'	16'	16'	155-1800
HS-5x5 B	Cut-Out	5'	5'	233 lbs.	22"	45"	25'	25'	25'	25'	25'	21'	16'	16'	155-1802
HS-6x6 A	Manifold	6'	6'	308 lbs.	22"	57"	25'	25'	25'	25'	25'	21'	16'	16'	155-1804
HS-6x6 B	Cut-Out	6'	6'	304 lbs.	22"	57"	25'	25'	25'	25'	25'	21'	16'	16'	155-1806
HS-6x8 A	Manifold	6'	8'	406 lbs.	22"	81"	25'	25'	25'	25'	25'	21'	16'	16'	155-1808
HS-6x8 B	Cut-Out	6'	8'	399 lbs.	22"	81"	25'	25'	25'	25'	25'	21'	16'	16'	155-1810
HS-6x10 A	Manifold	6'	10'	487 lbs.	22"	105"	25'	25'	25'	25'	25'	21'	16'	16'	155-1812
HS-6x10 B	Cut-Out	6'	10'	481 lbs.	22"	105"	25'	25'	25'	25'	25'	21'	16'	16'	155-1814
HS-6x12 A	Manifold	6'	12'	575 lbs.	22"	129"	25'	25'	25'	21'	21'	16'	12'	12'	155-1816
HS-6x12 B	Cut-Out	6'	12'	569 lbs.	22"	129"	25'	25'	25'	21'	21'	16'	12'	12'	155-1820
HS-8x8 A	Manifold	8'	8'	460 lbs.	22"	105"	25'	25'	25'	25'	21'	19'	15'	15'	155-1822
HS-8x8 B	Cut-Out	8'	8'	454 lbs.	22"	105"	25'	25'	25'	25'	21'	19'	15'	15'	155-1824
HS-8x10 A	Manifold	8'	10'	561 lbs.	22"	105"	25'	25'	25'	25'	25'	21'	16'	16'	155-1826
HS-8x10 B	Cut-Out	8'	10'	555 lbs.	22"	105"	25'	25'	25'	25'	25'	21'	16'	16'	155-1828
HS-8x12 A	Manifold	8'	12'	668 lbs.	22"	129"	25'	25'	23'	16'	17'	12'	9'	9'	155-1830
HS-8x12 B	Cut-Out	8'	12'	662 lbs.	22"	129"	25'	25'	23'	16'	17'	12'	9'	9'	155-1832
HS-10x10 A	Manifold	10'	10'	720 lbs.	22"	105"	25'	25'	25'	25'	25'	21'	16'	16'	155-1840
HS-10x10 B	Cut-Out	10'	10'	710 lbs.	22"	105"	25'	25'	25'	25'	25'	21'	16'	16'	155-1842

Adjustable Hydraulic Spreaders			
Model	Range	Weight	Cat-Class
HS-2640	26"-40"	62 lbs.	155-1435
HS-3250	32"-50"	76 lbs.	155-1436
HS-3859	38"-59"	95 lbs.	155-1437
HS-4468	44"-68"	115 lbs.	155-1438
HS-5692	56"-92"	137 lbs.	155-1439

Adjustable End Panel Tubes			
Model	Range	Weight	Cat-Class
HS-EPT-3250	32"-50"	17 lbs.	155-1440
HS-EPT-3859	38"-59"	21 lbs.	155-1441
HS-EPT-4468	44"-68"	24 lbs.	155-1442
HS-EPT-5692	56"-92"	29 lbs.	155-1443

Adjustable End Panel Sheets			
Model	Size	Weight	Cat-Class
ALS-6	6' x 12"	19 lbs.	155-1444
ALS-8	8' x 12"	25 lbs.	155-1445

*Clearance: A = Pipe Clearance, B = Open Work Area (See illustrations at the bottom of the page.)

**Depth: Hyd = Hydraulic Application, Stat = Static Application

Depths are based on A, B, C soil types as described in OSHA's 29 CFR Part 1926 Subpart P, October 31, 1989 with type A not exceeding 25 PSF per foot at depth, Type B not exceeding 45 PSF per foot of depth and Type C not exceeding 60 PSF per foot of depth. Determine actual soil pressures and consult Manufacturer's Tabulated Data prior to each use.

TRENCH SHORING EQUIPMENT

TRENCH SHORING EQUIPMENT

HYDRAULIC VERTICAL SHORES

HYDRAULIC VERTICAL SHORES are designed to prevent cave-ins in all but the most unstable soil conditions by supporting the side walls of the trench through the use of hydraulic pressure. Shores can be used as spot bracing for repair situations, or they can be used for production trenching.

- Quick set-up and safe, simple operation
- Lightweight, high-strength aluminum alloy construction provides exceptional durability and portability
- Shores can be used with, or without sheeting according to soil conditions.
- Standard rail sets range from 1.5' to 7' length
- Standard hydraulic cylinders range from 17" to 88" widths. (one-piece, slip-on cylinder extensions are available for adding up to 56" in width)
- Cylinders feature oversleeve protection and a security bleed-off port
- Interchangeable components and compact storage
- OSHA-approved 4' x 8' fin form is available when soil conditions require greater stability (Cat-Class 155-1555)
- Molded plastic pump buckets, which deliver 50% more volume per stroke than a comparable steel pump bucket, are available
- Certified by a registered professional engineer to meet OSHA standards
- Complete manufacturer's tabulated data and installation/removal procedures are provided



Aluminum Rail Fin Form Hydraulic Cylinders

Note: Hydraulic vertical shores are assembled from individual components, matched to each application. Select two aluminum rails sized to accommodate the trench depth. Then select two hydraulic cylinders (only one cylinder with 1.5' length rails) to accommodate the trench width. One-piece, slip-on cylinder extensions are available for wider trenches.



Vertical end shores are available for shoring the end of the trench.



Installation and removal are performed from the top of the trench.

Aluminum Rail Sets				
Model	Rail Length	Weight	Cylinders Required	Cat-Class
HVR-1.5	1.5'	10 lbs.	1	155-1535
HVR-3.5	3.5'	22 lbs.	2	155-1540
HVR-5	5'	32 lbs.	2	155-1545
HVR-7	7'	42 lbs.	2	155-1550

Cylinder Extensions				
Model	Ext. Length	Matching Cylinder	Weight	Cat-Class
2-EXT-1727-11	11"	2-CYL-1727	6 lbs.	155-1458
2-EXT-1727-22	22"	2-CYL-1727	8 lbs.	155-1461
2-EXT-1727-33	33"	2-CYL-1727	10 lbs.	155-1464
2-EXT-2236-11	11"	2-CYL-2236	6 lbs.	155-1470
2-EXT-2236-22	22"	2-CYL-2236	8 lbs.	155-1473
2-EXT-2236-33	33"	2-CYL-2236	11 lbs.	155-1476
2-EXT-2846-15	15"	2-CYL-2846	8 lbs.	155-1482
2-EXT-2846-30	30"	2-CYL-2846	11 lbs.	155-1485
2-EXT-2846-45	45"	2-CYL-2846	15 lbs.	155-1488
2-EXT-3455-18	18"	2-CYL-3455	9 lbs.	155-1494
2-EXT-3455-36	36"	2-CYL-3455	14 lbs.	155-1497
2-EXT-3455-54	54"	2-CYL-3455	18 lbs.	155-1500
2-EXT-4064-21	21"	2-CYL-4064	12 lbs.	155-1506
2-EXT-4064-42	42"	2-CYL-4064	17 lbs.	155-1509
2-EXT-4064-56	56"	2-CYL-4064	21 lbs.	155-1512
2-EXT-5288-24	24"	2-CYL-5288	14 lbs.	155-1518
2-EXT-5288-42	42"	2-CYL-5288	19 lbs.	155-1521
2-EXT-5288-56	56"	2-CYL-5288	21 lbs.	155-1524



5-gallon molded plastic pump bucket (Cat-Class 155-1560)

Hydraulic Cylinders			
Model	Range	Weight	Cat-Class
2-CYL-1727	17"-27"	11 lbs.	155-1455
2-CYL-2236	22"-36"	13 lbs.	155-1467
2-CYL-2846	28"-46"	16 lbs.	155-1479
2-CYL-3455	34"-55"	18 lbs.	155-1491
2-CYL-4064	40"-64"	21 lbs.	155-1503
2-CYL-5288	52"-88"	26 lbs.	155-1515



Installation/Removal Tools
Upper tool shown is an install hook. (Cat-Class 155-1566)
Lower tool shown is a release tool. (Cat-Class 155-1565)

Note: One extension is required per cylinder.

TRENCH SHORING EQUIPMENT

ALUMINUM LITE SHIELD SYSTEMS

ALUMINUM LITE SHIELD SYSTEMS are modular systems that provide maximum flexibility and ease of use. The lightweight 24-inch height panels can be transported easily and are available in panel lengths ranging from 2 to 8 feet. These versatile systems assemble in just minutes at the job site. Tongue-in-groove panels are easily aligned eliminating pinch points and the mechanical screw-jack struts provide fast, variable adjustment. The screw jack struts feature a shallow square thread design and are coated with a special rust inhibitor that wipes clean with a rag for smoother performance. For maximum versatility, the system can be used as a 2-, 3- or 4-sided configuration.

- Strong yet lightweight 6061-T6 aluminum construction
- 2-inch wall thickness
- Foam filling available as an option
- Certified by a professional engineer to meet OSHA standards
- Versatile in allowing for 2-, 3- or 4-sided protection
- Excellent depth rating in all soil types
- Designed for use with backhoe loaders and today's smaller excavators



2-sided aluminum lite shield working in a pipeline application



Aluminum lite shields are extremely versatile and adaptable to a wide range of applications



Lite Shield Panel Connector

If more depth is required, simply add panels, connectors and struts from the top of the trench. Then place the assembly in the deeper excavation.

- 16" Panel Connector (Cat-Class 155-3420)
- 48" Panel Connector (Cat-Class 155-3440)
- Connection Pin (Cat-Class 155-3500)

Aluminum Lite Shield Panels									
Model	Size			Weight	Max Depth Per Soil Type				Cat-Class
	L	W	H		A	B	C-60	C-80	
24SLP-2	2'	2'	2'	31 lbs.	24'	24'	22'	16'	155-3300
24SLP-3	3'	2'	2'	45 lbs.	24'	24'	22'	16'	155-3305
24SLP-4	4'	2'	2'	63 lbs.	24'	24'	22'	16'	155-3310
24SLP-5	5'	2'	2'	75 lbs.	24'	24'	22'	16'	155-3315
24SLP-6	6'	2'	2'	86 lbs.	24'	24'	22'	16'	155-3320
24SLP-8	8'	6'	2'	114 lbs.	24'	23'	17'	13'	155-3330
24SLP-10	10'	2'	2'	140 lbs.	24'	14'	10'	8'	155-3333



Lite Shield Strut
With keyed locking pins

Aluminum Lite Shield Struts				
Model	Weight	Adjustment Range (Inside Panel Dimension)		Cat-Class
		w/Connector	w/o Connector	
24LSS-1	12 lbs.	24"-32"	20"-28"	155-3340
24LSS-2	16 lbs.	32"-48"	28"-44"	155-3360
24LSS-2.5	21 lbs.	40"-64"	30"-60"	155-3380
24LSS-3	25 lbs.	51"-86"	47"-82"	155-3400



Lite Shield Corner Connector

Corner (manhole) connectors are used in the same way as the panel connectors, except they accept a panel instead of a strut. They are used instead of panel connectors to construct a 3- or 4-sided closed end box (Manhole, inlet, repair pit)

- Corner Connector, 2 panel (steel) (Cat-Class 155-3480)
- Corner Connector, 3 panel (aluminum) (Cat-Class 155-3480)
- Corner Connector, 4 panel (aluminum) (Cat-Class 155-3480)
- Connection Pin, (Cat-Class 155-3500)

TRENCH SHORING EQUIPMENT

STEEL MANHOLE BOXES, STEEL BEDDING/ROCK BOXES

SQUARE MANHOLE BOXES provide the needed inside clearspan, while reducing the amount of excavation and restoration required. Standard models include two walls and two spreader assemblies. All are certified by a professional engineer to meet OSHA standards.

MH-series Doublewall Manhole Boxes (w/spreaders and attaching hardware)											
Model	Size			Pipe Clearance	Weight	Shield Cap (PSF)	Max depth Per Soil Type				Cat-Class
	H	W	L				A	B	C-60	C-80	
MH48DW ¹	4'	8'	8'	N/A	2,803 lbs.	2,221 lbs.	91'	51'	39'	30'	014-0640
MH410DW ¹	4'	10'	10'	N/A	3,316 lbs.	1,444 lbs.	60'	34'	26'	20'	014-0650
MH412DW ¹	4'	12'	12'	N/A	3,829 lbs.	1,014 lbs.	43'	25'	19'	15'	014-0660
MH8DW	8'	8'	8'	45"	4,104 lbs.	1,764 lbs.	75'	43'	33'	26'	014-0610
MH10DW	8'	10'	10'	45"	4,787 lbs.	1,147 lbs.	50'	29'	23'	18'	014-0620
MH12DW	8'	12'	12'	45"	6,244 lbs.	805 lbs.	36'	22'	17'	14'	014-0630

¹4' high boxes feature a stackable design.



ROUND MANHOLE BOXES are specially designed for personal protection during manhole installations and repair work. High-strength steel walls, welded securely to rigid steel top and bottom framing. Optional replaceable cut-outs allow for clearance of utility lines.

RMH-series Round Manhole Boxes									
Model	Size		Weight	Shield Cap (PSF)	Max Depth Per Soil Type				Cat-Class
	Diameter	Height			A	B	C-60	C-80	
RMH 8.5x4	8.5'	4'	920 lbs.	1,920 lbs.	32	32	32	21	014-0680
RMH 8.5x8	8.5'	8'	1,609 lbs.	1,920 lbs.	32	32	32	21	014-0670



WATER TAP BOXES are ideal for contractors, municipal water and sewer departments, plumbers and contractors engaged in routine water main repairs and maintenance. They feature steel walls and one-piece welded construction. All are certified by a professional engineer to meet OSHA standards.

WTB-series Water Tap Boxes										
Model	Size			Weight	Type	Max Depth Per Soil Type				Cat-Class
	H	W	L			A	B	C-60	C-80	
WTB488	4'	8'	8'	3,465 lbs.	Stacking	69'	39'	30'	23'	014-0808
WTB41010	4'	10'	10'	4,725 lbs.	Stacking	60'	34'	26'	20'	014-0809
WTB888	8'	8'	8'	6,300 lbs.	Cutout	71'	41'	32'	25'	014-0810
WTB61010	6'	10'	10'	6,454 lbs.	Cutout	61'	35'	27'	21'	014-0812
WTB81010	8'	10'	10'	7,875 lbs.	Cutout	62'	36'	28'	22'	014-0813



STEEL BEDDING BOXES feature rugged welded construction, fully reinforced at all points of stress. The top frame is further strengthened by an inner core of hardwood. The sides and ends are constructed of 1/4" steel plate. The bottom surface is smooth, fabricated of 1/2" steel plate, with wear strips on the inside to guard against damage by bucket teeth. Low 44" profile allows dump trucks to fill the box from either the ends or the sides.

BS-series Steel Bedding/Rock Boxes						
Model	Capacity	Size			Weight	Cat-Class
		W	L	H		
BS-7	7 cu. yds.	60"	16'	44"	5,023 lbs.	014-0710
BS-9	9 cu. yds.	72"	16'	44"	5,614 lbs.	014-0720



TRENCH SHORING EQUIPMENT

TRENCH SHORING ESSENTIALS

Competent Person is defined as capable of identifying existing and potential hazards in the surroundings or working conditions that are unsanitary, hazardous or dangerous to workers and who is authorized to take prompt corrective measures to eliminate them.

Responsibilities of the Competent Person:

- Understanding the Excavation Standard for excavations
- Conducting soil classifications, recognizing changing conditions and reclassifying
- Determining the proper protective system according to soil classification
- Conducting air tests for hazardous atmospheres
- Providing safe access and egress from the trench or excavation
- Locating any existing utilities prior to beginning excavation
- Monitoring any water removal equipment
- Performing daily inspections and maintaining records
- Providing protection from vehicular traffic
- Providing protection from overhead falling objects

Rules for a Safer Trench:

1. OSHA Sub-Part P standards are the minimum standards.
2. Trenches deeper than 4' require a ladder that extends 36" above ground level.
3. No worker can be more than 25' from a safe means of access.
4. Manufacturer's Tabulated Data supersedes any tables or charts within the standard.
5. Watch for signs of soil failure such as cracks, local raveling or small pieces of material falling from the sides of the trench.
6. Keep excavated material at least 2' from the edge of trench.
7. Shoring or shielding not only provides worker protection, but also decreases the amount of material excavated, reducing labor and fuel costs.
8. Trained workers, using manufactured shoring systems correctly, reduces the possibility of injury or death.



For more information about trench shoring solutions, contact a Sunbelt Rentals Pump & Power location at 800-736-2504.

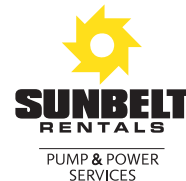

**Know what's below.
Call before you dig.**

One free, easy call gets your utility lines marked AND helps protect you from injury and expense.

Safe Digging is No Accident—Always Call 811 Before You Dig

Visit www.call811.com for more information

Logo and message printed courtesy of the Common Ground Alliance (CGA)

TRENCH SHORING EQUIPMENT

TRENCH SHORING BASICS

GLOSSARY

Definitions from the Excavation Standard Sub-Part P 1926.650 (b)

Aluminum Hydraulic Shoring—a pre-engineered shoring system comprised of aluminum hydraulic cylinders (cross braces) used in conjunction with vertical rails (uprights) or horizontal rails (walers). This system is designed to support the sidewalls of an excavation and prevent cave-ins.

Benching—a method of protecting workers from cave-ins by excavating the sides of an excavation to form one or a series of horizontal levels. This method of protection may only be used in cohesive soils.

Cave-in—the separation of a mass of soil or rock from the side of an excavation, or the loss of soil from under a trench shield or support system and its sudden movement into an excavation.

Competent Person—one who is capable of identifying existing and potential hazards in the surroundings or working conditions that are unsanitary, hazardous, or dangerous to workers and who has the authorization to take prompt corrective measures to eliminate them.

Excavation—any man-made cut, cavity, trench or depression in the earth's surface.

Failure—the breakage, displacement or permanent deformation of a structural member or connection point, as to reduce its structural integrity and supportive capabilities.

Kick-out—the accidental release or failure of a cross brace.

Protective System—a method of protecting workers from cave-ins, from material that could fall or roll from an excavation face or into an excavation, or from the collapse of adjacent structures. Protective systems include support systems, shield systems, benching systems and other systems that provide the necessary protection.

Ramp (or Ramping)—an inclined walking or working surface that is used to gain access to one point from another.

Shield (or Shield System, generally referred to as a Trench Box)—a structure that is able to withstand the forces imposed on it by a cave-in and thereby protects workers within the structure. Shields can be permanent structures or can be designed to be portable and

moved along as work progresses. Additionally, shields can be either pre-manufactured or job-built in accordance with Federal Requirements 1926.652 (Federal Requirements for Protective System under 29 CFR Part 1925).

Shoring (or Shoring System)—a structure such as a hydraulic or timber shoring system that supports the sides of an excavation and is designed to prevent cave-ins.

Sloping (or Sloping System)—a method of protecting workers from cave-ins by excavating to form sides of an excavation that are inclined away from the excavation. The angle of incline required to prevent a cave-in varies with differences in such factors as the soil type, environmental conditions of exposure and application of surcharge loads.

Support System—a structure such as underpinning, bracing or shoring that provides support to an adjacent structure or the sides of an excavation.

Tabulated Data—tables and charts approved by a registered professional engineer, which are used to design and construct a protective system.

Trench—a narrow excavation (in relation to its length) made below the surface of the ground. In general, the depth is greater than the width, but the width of a trench (measured at the bottom) is not greater than 15 feet.

Uprights—the vertical members of a trench shoring system placed in contact with the earth and usually positioned so that individual members do not contact each other.

APPLICATIONS

Aluminum Shoring Products

Aluminum shoring products provide lightweight solutions that are compatible with the limited lifting capacities of today's smaller excavators. Hydraulic trench shields with end panels, hydraulic vertical shores with extensions and fin form, Lite-Shields and 4" wall aluminum trench boxes are available.

Steel Shoring Products

Our Steel trench shields (trench boxes) rental fleet provides contractors the maximum in flexibility and protection while performing both deep and shallow cuts. Our standardized fleet makes stacking applications, three or four sided pits and adding height adaptors for increased pipe clearance simple and consistent.

Manhole Shields and Bedding/Rock Boxes

Designed to provide a safer workplace and to boost efficiency. Manhole shields assemble in minutes in the field, are stackable and are available in multiple sizes for various applications. Bedding/rock boxes reduce the spillage of materials on the job site, reducing material costs.

Please see your Sunbelt Sales Representative for assistance in site-specific or more detailed trench shoring applications.

RULES OF THUMB

1. Any job site where an excavation or trench is created that job-site is required by OSHA to have a Competent Person on-site.
2. Any excavation 5 feet or less with a potential for a cave-in requires the use of a shoring or shielding system. Many die needlessly each year in shallow excavations. It is the Competent Persons responsibility to prevent any exposer to cave-in dangers.
3. A ladder, ramp or other safe means of egress shall be located in trench excavations that are 4 feet or more in depth so as to require no more than 25 feet of lateral travel for workers.
4. No one should work in excavations with accumulated water or where water is accumulating unless adequate precautions are taken, such as a wellpoint system and shoring system.
5. Dirt spoil piles or other materials shall be located a minimum of 2 feet from the edge of an excavation.
6. No one shall be allowed in shields when they are being installed, removed or moved vertically. They may however remain in the protective system while it is being moved horizontally in the trench
7. A shield may be up to 2 feet above the bottom of the trench, but only if the shield is rated for the full depth of the trench and there is no loss of soil from behind or below the bottom of the shield.
8. Soil that remains in clumps when excavated is cohesive. Soil that breaks easily and does not stay in clumps is granular.
9. One cubic foot of saturated soil weighs approximately 114 pounds.
10. One cubic yard of saturated soil weighs approximately 3,078 pounds or 1-1/2 tons.



SUNBELT
RENTALS

sunbeltrentals.com

Account No. _____ PC # _____ Rep # _____

APPLICATION FOR CREDIT & RENTAL AGREEMENT
Confidential Credit Information

Phone: 800-508-4756 Fax: 888-886-7820 E-mail: sunbeltcredit@sunbeltrentals.com

You can also apply online—go to: www.sunbeltrentals.com/credit

In order to process your request, this agreement must be signed. Please attach a company credit profile if available.

AC 3/17c

Customer Name (Individual or Company)		Physical Address	Mailing Address
(d/b/a) Trade Name		City	City
Phone Number	Fax Number	State, Zip Code	State, Zip Code

BUSINESS INFORMATION Corporation LLC Partnership Proprietorship Length of Time in Business _____

Previous Business Name _____ D & B# _____ (If less than 2 years, please provide INDIVIDUAL PERSONAL GUARANTY information below and sign guaranty on reverse side.)

Have you ever filed bankruptcy? _____ Federal Tax ID# _____

Bonding Agent Name and Address _____

SIGNATORY INFORMATION (Authorized Agent)

Name	(Please Print)	Title / Relationship to Customer
Address		
City	State	Zip
Phone Number	Social Security Number	
Email Address		

BANKING INFORMATION

Bank Name		
Contact Name	Phone	
Address		
City	State	Zip
Checking Account Number	Loan Account Number	

ACCOUNTING INFORMATION

Purchase Order Number Required? <input type="checkbox"/>	Insurance Co. _____
Job #s Required <input type="checkbox"/>	Insurance Contact Person _____
Tax Exempt? <input type="checkbox"/>	Insurance Co. Phone No. _____
<small>If checked, attach proper forms.</small>	Certificate of Insurance being forwarded <input type="checkbox"/>
Interested in online access to Account Information? <input type="checkbox"/>	<small>Insurance Certificate required prior to rental.</small>

Accounts Payable (A/P) Contact	A/P E-Mail Address	A/P Phone Number	A/P Fax Number
--------------------------------	--------------------	------------------	----------------

TRADE REFERENCES	City, State	Phone Number

Rental Companies Previously Used? United/RSC Herc/Hertz Other _____

APPLICATION FOR CREDIT & RENTAL AGREEMENT
Confidential Credit Information

TERMS & AGREEMENT *(Must be signed for account processing)*

The undersigned ("Customer") in consideration of Sunbelt Rentals, Inc. or any of its subsidiaries and affiliated entities, successors or assigns ("Sunbelt") extending commercial credit based upon the information furnished herein, warrants and agrees that by executing this Agreement: (a) all purchases/rentals made by Customer from Sunbelt are subject to the terms and conditions contained herein; (b) Customer has received, read, understands and accepts all of the terms and conditions of Sunbelt's rental contract, which are on the reverse side of each and every rental contract, found at www.sunbeltrentals.com/About/pdf/SunbeltContract.pdf and available in writing, upon request, including the release, indemnification and insurance provisions in sections 8 and 9 ("Rental Contract"); (c) the Rental Contract terms are deemed incorporated into and made a part of this Agreement and each and every rental/sale of equipment and/or provision of labor furnished to Customer, whether or not Customer executes each Rental Contract; and (d) any terms in the Customer's acceptance, purchase order or other documentation that are inconsistent with or in addition to this Agreement (except such additional terms which are required by law) shall be void and of no effect (any use or reference to Customer's purchase order or purchase order number in any Rental Contract is for Customer's convenience only). Sunbelt shall deliver equipment in consideration for Customer's agreement to be bound by the Rental Contract. Customer also confirms that they and/or the persons or companies who will have access to the equipment purchased and/or rented are not listed on the Specially Designated Nationals ("SDN") List maintained by the Office of Foreign Assets Control, nor any other denied persons list maintained by a U.S. government agency, and agrees to notify Sunbelt should they become listed in the future. Refer to www.treas.gov/offices/enforcement/ofac/ for information regarding the SDN list and to www.bis.doc.gov for information on other denied parties lists and other U.S. export restrictions.

In making this Agreement upon which Sunbelt will rely to extend commercial credit, I/We agree to Sunbelt's terms of payment as follows: NET DUE UPON RECEIPT on all accounts and service charges of 1.5% per month on all invoices/contracts not paid when due or the maximum rate permitted by law, whichever is less. Any disputed invoices must be brought to the attention of the Sunbelt within fifteen (15) days of the receipt or the invoices/contracts are deemed correct and undisputed. At Sunbelt's discretion, any account with a delinquent balance may be placed on a cash basis, deposits may be required and the rental equipment picked up without notice. If collection of amounts due requires the assistance of a collection agency or attorneys, suit is brought hereon, or it is enforced through any judicial proceeding whatsoever, I/We agree (a) that Sunbelt reserves the right to bring legal action in whatever jurisdiction Sunbelt deems necessary, whose laws, at the option of Sunbelt, shall govern this Agreement, and (b) to pay all costs and expenses of collection, including but not limited to, reasonable attorney's fees, not exceeding a sum equal to fifteen percent (15%) of the outstanding balance owing, plus all other reasonable expenses incurred by Sunbelt in exercising any of Sunbelt's rights and remedies.

The individual executing this Agreement below warrants that (i) s/he is authorized to do so; (ii) the information contained in this Agreement is a true and correct statement of the financial condition of Customer; and (iii) a photo or facsimile copy of this Agreement shall be valid as the original. If any part of this Agreement is held unenforceable, the remainder of this Agreement shall not be affected thereby. Customer waives the right to a jury trial of any or all claims or disputes which may arise from this Agreement. **I/We authorize Sunbelt to make whatever credit inquiries it deems necessary in connection with this Agreement.** Bank and trade reference(s) can accept this authorization to disclose to Sunbelt and/or their respective designees (and any assignee or potential assignee thereof), Customer information normally released to a prospective creditor including: length of time account has been active, average monthly balances, how the account has been handled, and details of any lending relationship. I/We authorize Sunbelt to contact our insurance company and authorize the insurance company to issue insurance certificate(s) when Sunbelt's calls from time to time showing the insurance required in the Rental Contract to be maintained by Customer.

Print Customer Name: _____

Print Authorized Officer's Name: _____

Authorized Officer's Signature: _____

Print Authorized Officer's Title: _____

Date: _____

INDIVIDUAL PERSONAL GUARANTY

The undersigned guarantor(s), for and in consideration of Sunbelt extending credit at my/our request to the Customer named above, in which I/we have a financial interest, jointly, severally and unconditionally personally guarantee prompt payment and performance of any obligations Customer to Sunbelt whether now existing or hereinafter made, and further agree to bind myself/ourselves to pay on demand any sum which is due by Customer to Sunbelt whenever Customer fails to pay the same. It is understood that this guaranty shall be absolute, continuing and irrevocable for such indebtedness of Customer. I/We expressly waive presentment, demand, protest, my/our homestead exemption as to this debt, notice of protest, dishonor, diligence, maturity, default or nonpayment, acceptance of this guaranty, extending of any guaranteed indebtedness already or hereafter contracted for by Customer, any modifications or renewals of any credit agreement evidencing the indebtedness hereby guaranteed and all setoffs and counterclaims.

If collection of amounts due requires the assistance of a collection agency or attorneys, suit is brought hereon, or it is enforced through any judicial proceeding whatsoever, I/We agree (a) that Sunbelt reserves the right to bring legal action in whatever jurisdiction Sunbelt deems necessary, whose laws, at the option of Sunbelt, shall govern this Agreement, and (b) to pay all costs and expenses of collection, including reasonable attorney's fees not exceeding a sum equal to fifteen percent (15%) of the outstanding balance owing, plus all other reasonable expenses incurred by Sunbelt in exercising any of Sunbelt's rights and remedies.

The Undersigned recognizes the obligation of the Applicant and the undersigned and agrees to hold the portion of all payments received by Applicant which include payment to Applicant for the rent and/or purchase of equipment and supplies furnished by Sunbelt pursuant to this agreement to be held in a separate trust account for payment to Sunbelt. The undersigned agrees to act as fiduciary for payment to Sunbelt and agrees that Applicant shall not use said payments for any other purpose, in exchange for the Applicant's ability to rent and/or purchase equipment and supplies on a credit account. The undersigned agrees that any failure to hold payments in trust for Sunbelt shall create a debt which is not dischargeable in bankruptcy and which shall be an exception to discharge pursuant to the terms of 11 USC 523 (a)(4) and (6). The undersigned represent that (i) the information contained in this Agreement is a true and correct statement of the financial condition of Customer; and (ii) a photo or facsimile copy of this Agreement shall be valid as the original. If any part of this Agreement is held unenforceable, the remainder of this Agreement shall not be affected thereby. The undersigned hereby waives the right to a jury trial of any or all claims or disputes which may arise from this Agreement. Sunbelt shall not be required to exhaust all remedies against Customer prior to exercising its rights against Guarantor(s). **I/We authorize Sunbelt to make whatever credit inquiries it deems necessary in connection with this Agreement.** Bank and trade reference(s) can accept this authorization to disclose to Sunbelt and/or their respective designees (and any assignee or potential assignee thereof), Guarantor(s) information normally released to a prospective creditor including: length of time account has been active, average monthly balances, how the account has been handled, and details of any lending relationship

Guarantor's Signature: _____

Guarantor's Signature: _____

Print Guarantor's Name: _____

Print Guarantor's Name: _____

Address: _____

Address: _____

SSN: _____

SSN: _____

Witness Signature: _____

Witness Signature: _____

Print Witness Name: _____

Print Witness Name: _____

Date: _____

Date: _____

In order to process your request, this agreement must be signed. Please attach a company credit profile if available.

Fax to your nearest Sunbelt Rentals Location —or— 888-886-7820

Mail: Sunbelt Rentals, Inc. • 1004 Hickory Hill Lane, Unit 1 • Hermitage, TN 37076 • 800-508-4756

RENT RETURN MANAGE & MORE



In this age of information, Command Center serves as your digital ecosystem, providing insight into all aspects of the rental cycle — easily guiding you through a world of vast functionality. Our suite of tools puts power, speed, and ease of use literally in your hands, at your fingertips.

Download our mobile app for iOS devices (iPhone and iPad) and Android smartphones.

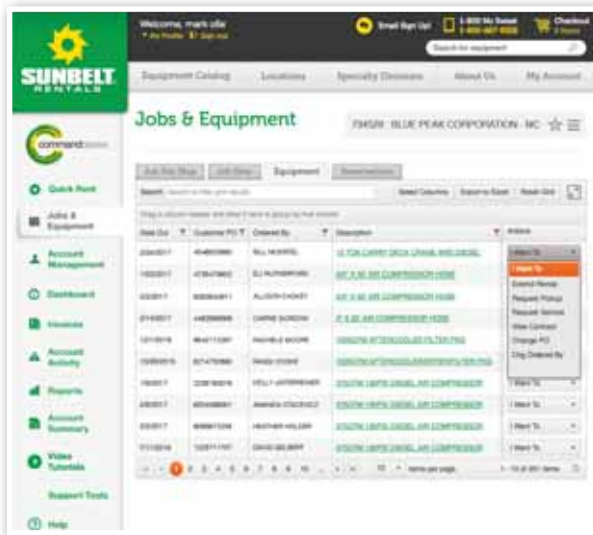

- Eliminate wasted time
- Reserve – Rent – Release
- Schedule service
- Track deliveries
- Fleet mapped to job sites
- Real time custom reporting
- Schedule alerts
- Manage payables



®

Manage your equipment rental needs anytime from anywhere.

PUMP & POWER LOCATION DIRECTORY

Specialty Key:

P&P=Pump & Power Services **GP**=Ground Protection **IH**=Industrial Heat **IPCC**=Industrial Power & Climate Control **CT**=Cooling Tower Services **LB**=Load Banks Services

ALABAMA

Alabama Pump & Power **P&P**
Branch #95
3000 B Pinson Valley Parkway
Birmingham, AL 35217
Phone: 205-251-2563
Fax: 205-251-2503

Mobile Pump & Power **P&P**
Branch #107
3465 Hurricane Bay Drive
Theodore, AL 36582
Phone: 251-443-7248
Fax: 251-443-7338

ARIZONA

Phoenix Pump & Power **P&P**
Branch #786
5714 51st Avenue
Glendale, AZ 85301
Phone: 623-888-3838
Fax: 623-888-3839

CALIFORNIA

Bakersfield Pump & Power **P&P**
Branch # 656
4000 Saco Road
Bakersfield, CA 93308
Phone: 800-736-2504

OPENING SOON

Los Angeles Pump & Power **P&P**
Branch #388
14861 Artesia Boulevard
La Mirada, CA 90638
Phone: 714-923-1890
Fax: 714-923-1891

Northern California Pump & Power **P&P**
Branch #577
2800 Goodrick Avenue
Richmond, CA 94801
Phone: 510-621-0015
Fax: 510-621-0016

Sacramento Pump & Power **P&P**
Branch #216
4635 Power Inn Road
Sacramento, CA 95826
Phone: 916-210-8282
Fax: 916-210-8280

San Diego Pump & Power **P&P**
Branch #146
3860 Sherman Street
San Diego, CA 92110
Phone: 619-574-1908
Fax: 619-298-9732

COLORADO

Denver Pump & Power **P&P**
Branch #580
12055 North Perry Street
Broomfield, CO 80020
Phone: 720-887-7473
Fax: 720-887-6035

Denver Pump & Power **GP**
Branch #688
13109 US Highway 85N
Littleton, CO 80125
Phone: 720-835-9054

CONNECTICUT

Hartford Pump & Power **P&P**
Branch #775
2258 Berlin Turnpike
Newington, CT 06111
Phone: 860-656-0752
Fax: 860-656-0748

FLORIDA

Tampa Pump & Power **P&P**
Branch #48
8417 Palm River Road
Tampa, FL 33619
Phone: 813-247-4800
Fax: 813-247-5988

North Florida Pump & Power **P&P**
Branch #53
11000 Blasius Road
Jacksonville, FL 32226
Phone: 904-696-9000
Fax: 904-696-9051

Orlando Pump & Power **GP**
Branch #550
9101 B Parkers Landing
Orlando, FL 32824
Phone: 407-701-1666
Fax: 407-816-9643

Orlando Pump & Power **P&P**
Branch #96
9101 B Parkers Landing
Orlando, FL 32824
Phone: 407-816-8188
Fax: 407-816-9643

South Florida Pump & Power **P&P**
Branch #91
3701 NW 120th Avenue
Coral Springs, FL 33065
Phone: 954-577-9429
Fax: 954-703-3260

GEORGIA

Atlanta Pump & Power **P&P**
Branch #30
1540 Iris Drive SW
Conyers, GA 30094
Phone: 678-342-9869
Fax: 678-342-9871

ILLINOIS

Chicago Pump & Power **P&P**
Branch #313
23322 S. Frontage Road West
Channahon, IL 60410
Phone: 815-521-9895
Fax: 815-521-9896

St. Louis Pump & Power **P&P**
Branch #371
1081 Geil Drive
Granite City, IL 62040
Phone: 618-219-3224
Fax: 618-931-1731

INDIANA

Indianapolis Pump & Power **P&P**
Branch #387
11220 Allisonville Road
Fishers, IN 46038
Phone: 317-572-1180
Fax: 317-572-1181

KANSAS

Kansas City Pump & Power **P&P**
Branch #787
9101 Rosehill Road
Lenexa, KS 66215
Phone: 816-673-7970
Fax: 816-673-7971

KENTUCKY

Cincinnati Pump & Power **P&P**
Branch #190
10060 Toebben Drive
Independence, KY 41051
Phone: 859-283-5544
Fax: 859-283-9263

LOUISIANA

Baton Rouge Pump & Power **P&P**
Branch #572
300 Wooddale Boulevard
Baton Rouge, LA 70806
Phone: 225-610-1293
Fax: 225-610-1299

Baton Rouge Pump & Power **IPCC**
Branch #534
16125 Florida Boulevard
Baton Rouge, LA 70819
Phone: 225-242-2083

Fort Polk Pump & Power **P&P**
Branch #583
135 Highway 121
Leesville, LA 71446
Phone: 337-239-6003
Fax: 337-239-6002

MARYLAND

Maryland Pump & Power **GP**
Branch #683
7430 Montevideo Road
Jessup, MD 20794
Phone: 667-701-5050

Maryland Pump & Power **P&P**
Branch #163
7430 Montevideo Road
Jessup, MD 20794
Phone: 301-470-2595
Fax: 301-470-9926

MASSACHUSETTS

Boston Pump & Power **P&P**
Branch #784
149 Providence Street
Hyde Park, MA 02136
Phone: 877-658-1968
Fax: 617-333-9522

New England Pump & Power **P&P**
Branch #571
800 Hartford Turnpike
Shrewsbury, MA 01545
Phone: 508-925-1630
Fax: 508-719-0046

MINNESOTA

Minneapolis Pump & Power **P&P**
Branch #600
15125 South Robert Trail
Rosemount, MN 55068
Phone: 952-229-6699
Fax: 952-229-6698

PUMP & POWER LOCATION DIRECTORY

Specialty Key:

P&P=Pump & Power Services **GP**=Ground Protection **IH**=Industrial Heat **IPCC**=Industrial Power & Climate Control **CT**=Cooling Tower Services **LB**=Load Banks Services

MISSOURI

Missouri Pump & Power **GP**
Branch #689
905 Stadium Boulevard
Jefferson City, MO 65101
Phone: 573-469-0060
Phone: 573-469-0061

NEW JERSEY

New Jersey Pump & Power **P&P**
Branch #172
3090 Route 73 North
Maple Shade Township, NJ 08052
Phone: 856-779-2772
Fax: 856-779-8571

NEW YORK

New York Pump & Power **P&P**
Branch #104
40 Charlotte Avenue
Hicksville, NY 11802
Phone: 516-937-1500
Fax: 516-937-1516

NORTH CAROLINA

Charlotte Pump & Power **P&P**
Branch #22
7205 Statesville Road
Charlotte, NC 28269
Phone: 704-335-0204
Fax: 704-335-0722

Raleigh Pump & Power **P&P**
Branch #93
2708 Connector Drive
Wake Forest, NC 27587
Phone: 919-570-7050
Fax: 919-570-0479

OHIO

Carroll Pump & Power **IH**
Branch #793
4045 Coonpath Road
Carroll, OH 43112
Phone: 740-756-7270
Fax: 740-756-7247

Cincinnati Pump & Power **P&P**
Branch #190
10060 Toebben Drive
Independence, KY 41051
Phone: 859-283-5544
Fax: 859-283-9263

NE Ohio Pump & Power **P&P**
Branch #579
5162 Akron Cleveland Road
Peninsula, OH 44264
Phone: 330-650-1874
Fax: 330-650-0608

OKLAHOMA

Oklahoma City Cooling Tower Services **CT**
Branch #266
Phone: 405-979-2179
Fax: 803-578-6865

Oklahoma City Pump & Power **P&P**
Branch #588
11201 Northwest 10th Street
Yukon, OK 73099
Phone: 405-350-0254
Fax: 405-350-5629

PENNSYLVANIA

Central PA Pump & Power **IH**
Branch #773
2050 South Main Street
Mansfield, PA 16933
Phone: 570-721-0446

Pittsburgh Pump & Power **P&P**
Branch #629
639 Rochester Road
Pittsburgh, PA 15237
Phone: 412-837-5727
Fax: 412-837-5726

SOUTH CAROLINA

Charleston Pump & Power **P&P**
Branch #23
3430 Ashley Phosphate Road
Charleston, SC 29418
Phone: 843-971-6450
Fax: 843-308-9195

Spartanburg Pump & Power **GP**
Branch #452
2771 Fairforest Clevedale Road
Spartanburg, SC 29301
Phone: 800-736-2504

TENNESSEE

Nashville Pump & Power **P&P**
Branch #127
1327 Foster Avenue
Nashville, TN 37210
Phone: 615-259-2080
Fax: 615-259-9950

Memphis Pump & Power **P&P**
Branch #261
3681 Old Getwell Road
Memphis, TN 38118
Phone: 901-333-2690
Fax: 901-333-2691

TEXAS

Angleton Pump & Power **IPCC**
Branch #531
23898 North Highway 288
Angleton, TX 77515
Phone: 979-848-1255
Fax: 979-265-6909

Austin Load Banks Services **LB**
Branch #386
1912 Bench Mark Drive
Austin, TX 78728
Phone: 512-251-2496

Beaumont Pump & Power **IPCC**
Branch #532
2705 Cardinal W Drive
Beaumont, TX 77705
Phone: 409-842-2048
Fax: 409-842-1888

Corpus Christi Pump & Power **IPCC**
Branch #533
961 Savage Lane
Corpus Christi, TX 78407
Phone: 361-225-1111
Fax: 361-883-8688

Dallas/Ft. Worth Pump & Power **P&P**
Branch #184
711 N Beach Street
Fort Worth, TX 76111
Phone: 817-759-0413
Fax: 817-834-0524

Fairfield Pump & Power **GP**
Branch #433
493 US Highway 84
Teague, TX 75860
Phone: 903-389-5655
Fax: 254-739-5740

Houston Pump & Power **P&P**
Branch #147
330 Richey Street
Pasadena, TX 77506
Phone: 713-672-7895
Fax: 713-672-7853

San Antonio Pump & Power **P&P**
Branch #578
16825 IH 35 North
Selma, TX 78154
Phone: 210-662-7743
Fax: 210-662-7932

UTAH

Salt Lake City Pump & Power **P&P**
Branch #581
48 North 1330 West
Orem, UT 84057
Phone: 801-224-7342
Fax: 801-224-7345

Salt Lake City Pump & Power **IH**
Branch #772
2006 West 1500 South
Salt Lake City, UT 84104
Phone: 801-401-9025
Fax: 801-401-9026

VIRGINIA

Northern Virginia Pump & Power **P&P**
Branch #790
8250 Chatsworth Drive
Manassas, VA 20109
Phone: 703-334-4070
Fax: 703-334-4071

Richmond Pump & Power **P&P**
Branch #455
9400 Burge Avenue
Richmond, VA 23237
Phone: 800-736-2504

Virginia Beach Pump & Power **P&P**
Branch #173
4750 Baxter Road
Virginia Beach, VA 23462
Phone: 757-499-1338
Fax: 757-499-1533

WASHINGTON

Seattle Pump & Power **P&P**
Branch #348
2257 Lincoln Avenue
Tacoma, WA 98421
Phone: 253-922-6995
Fax: 253-922-6973

WISCONSIN

Milwaukee Pump & Power **P&P**
Branch #788
W231 N1125 County Highway F
Waukesha, WI 53186
Phone: 262-832-9626
Fax: 262-832-9627

SUNBELT RENTALS LOCATIONS

U.S. AND CANADA

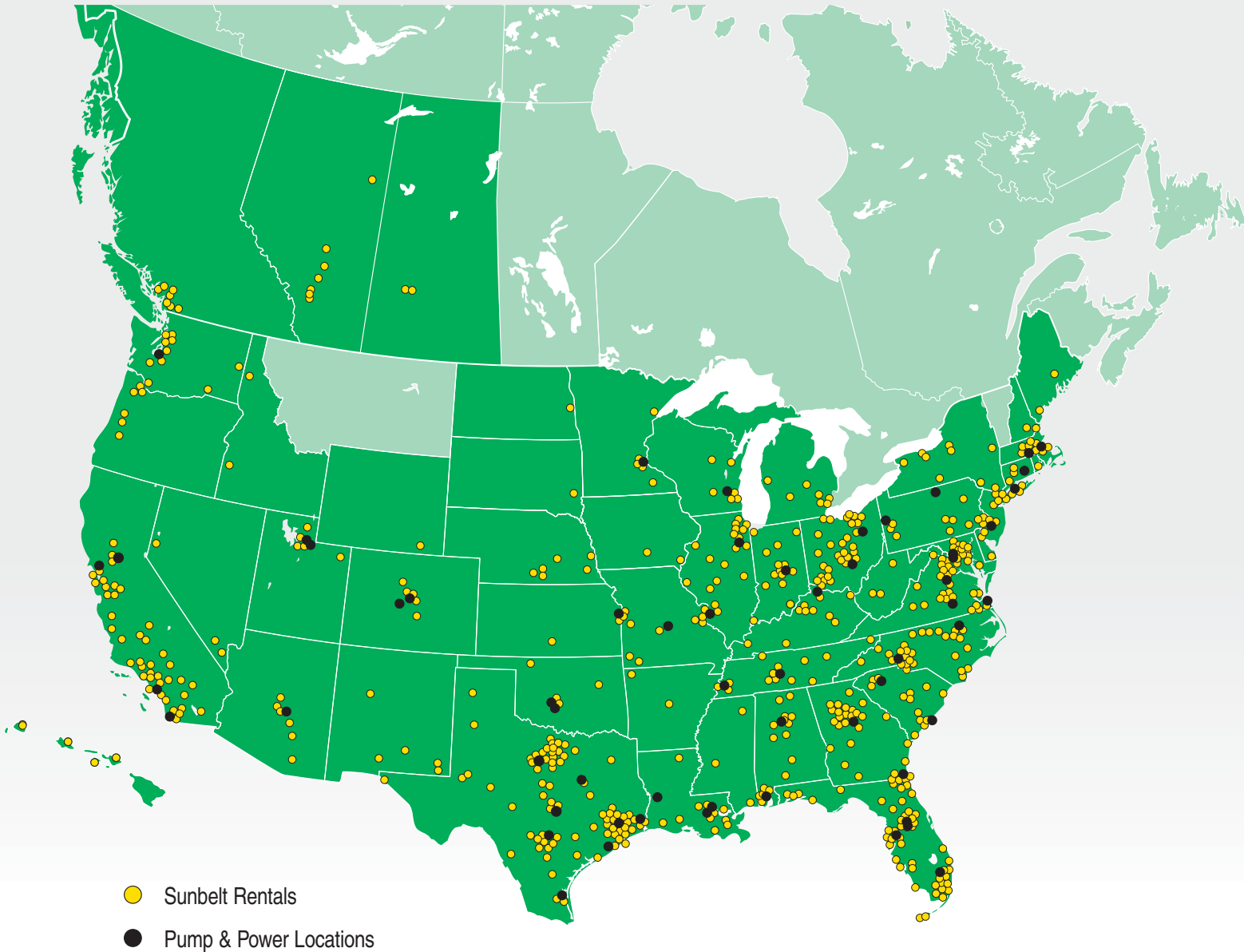

Sunbelt Rentals is one of the largest equipment rental companies in North America. Backed by an ever expanding network, Sunbelt successfully services a variety of customers — from those in construction, commercial, residential, industrial, municipal and specialized service industries, to weekend do-it-yourselfers.

Designed to serve distinct customer segments requiring a high level of technical expertise, our specialty divisions offer a highly diversified product mix, as well as trained experts.