



Legendary
AUTO INTERIORS LTD.®

American Motors

1968-74 Javelin, AMX & Rebel
1971-74 Gremlin, Hornet,
Ambassador & Matador

2020
1ST QUARTER

THE FINEST COLLECTION OF INTERIOR AND EXTERIOR PRODUCTS



WE'RE NOT JUST CHRYSLER ANYMORE!

1964-72 CHEVELLE/EL CAMINO, GTO/LEMANS, CUTLASS/442 & SKYLARK/GS
1970-72 MONTE CARLO, 1970-72 NOVA & 1967-81 CAMARO & FIREBIRD



WWW.LEGENDARYAUTOINTERIORS.COM

A Special Message from the President...

For over 3 decades, Legendary Auto Interiors, Ltd has been committed to providing the automotive restoration industry and enthusiast with the world's highest quality soft trim products and services. Available from the most authentic "As Original" interiors to the most extreme "One of a Kind" Custom Resto-Mod interiors, Legendary has been relied upon and Legendary has delivered!

This past decade has been extremely exciting! We continue to set the bar and truly lead by example, establishing industry expectations and standards. Introducing innovative tools such as our exclusive "Custom Design Center", "LegendImagery™" and "Sample Request Center". Whether your preference is "As Original" or a creation of your own vision, we have created a destination where you can let your imagination lead the way! Our commitment to developing and maintaining innovative solutions is a dedicated process that will continue to provide you with great products, service and help grow our restoration industry.

We are looking forward to a very productive future. As owner and President and from all of our proud team here at Legendary Auto Interiors LTD, we would like to thank you for allowing us the opportunity and the privilege of being your automotive soft trim supplier.

Thank you once again for your business, interest and support!

Sincerely yours,



Martin J. Beckenbach
President

PRODUCT DISCLAIMER: Products listed in this catalog have been reproduced and/or remanufactured to resemble original products. All manufacturers names and descriptions are used for reference purposes only. It is therefore understood that the products listed in this catalog are in fact REPRODUCTIONS unless specified otherwise. All parts described and offered for sale in this publication as NOS (New Old Stock) are new parts/materials manufactured by or for Chrysler LLC and General Motors Corporation.

All literature produced by and directly related to Legendary Auto Interiors Ltd., is protected under copyright laws.
All literature cannot be reproduced for any reason unless prior permission is obtained.





Legendary Auto Interiors is providing
the automotive industry with the world's
highest quality soft trim products and services
RIGHT HERE AT HOME

Most products are 100% made in the U.S.A. and
all are 100% assembled and designed in the U.S.A.



THERE REALLY IS A DIFFERENCE!!™

Legendary
AUTO INTERIORS LTD.®

www.legendaryautointeriors.com



INTRODUCING THE BEST WARRANTY COVERAGE IN THE INDUSTRY!!

Limited Lifetime Warranty

Limited Warranty - Legendary Auto Interiors Ltd. (called "we") warrants that the products it manufactures will be free of defects in materials and workmanship from the date it is first purchased by the retail purchaser. A retail purchaser is any person or any entity who or which purchases the product but does not do so for resale.

Obligation - If a product is not as warranted, we will either repair or, at our option, replace the defective product. If repair or replacement is not possible within a reasonable time, we will refund the purchase price.

Exclusions from Warranty - This Warranty does not apply to:

1. Conditions resulting from the product being altered, abused, misused, damaged by accident or negligence; being repaired without our authorization; or not being maintained properly in accordance with written instructions provided with the product.
2. Conditions resulting from ordinary wear and tear or including, without limitation, exposure to ultraviolet light.
3. Conditions resulting from the use of Specialty Run Materials (SRM) supplied by the purchaser.
4. Conditions resulting from improper installation by the purchaser or anyone else outside of our control.

Disclaimer - EXCEPT FOR THE LIMITED WARRANTY DESCRIBED ABOVE, WE OFFER NO WARRANTIES, EXPRESSED OR IMPLIED, AND OTHER THAN THE LIMITED WARRANTY EXPRESSLY CONTAINED HEREIN, WE HEREBY DISCLAIM ANY AND ALL WARRANTIES, INCLUDING WITHOUT LIMITATION ANY IMPLIED WARRANTIES OF MERCHANTABILITY, SUITABILITY OR FITNESS FOR A PARTICULAR PURPOSE. Some states do not allow limitations on how long an implied warranty lasts, so the above limitation may not apply to you.

Exclusion of Incidental and Consequential Damages - WE ARE NOT RESPONSIBLE FOR ANY INCIDENTAL OR CONSEQUENTIAL DAMAGES RESULTING FROM BREACH OF THE LIMITED WARRANTY DESCRIBED ABOVE. Some states do not allow the exclusion or limitation of incidental or consequential damages, so the above limitation or exclusion may not apply to you.

Other Legal Rights - This Warranty gives you specific legal rights, and you may also have other rights which vary from state to state.

What To Do If You Have A Warranty Claim - If you have a warranty claim, you must call our sales office for further assistance. Once given a return authorization number please indicate the number on the box and return the product to our facility; Legendary Auto Interiors 121 West Shore Blvd, Newark, NY 14513. We will perform our warranty obligation within a reasonable amount of time after the returned product arrives at our facility.









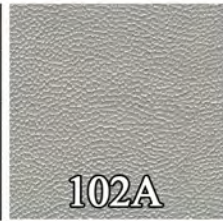
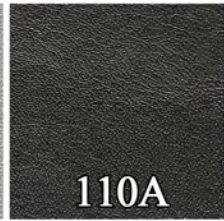
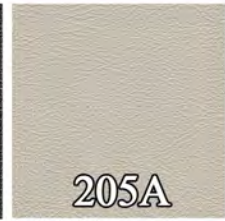

PRODUCT DISCLAIMER: Products listed in this catalog have been reproduced and/or remanufactured to resemble original products. All manufacturers names and descriptions are used for reference purposes only. It is therefore understood that the products listed in this catalog are in fact REPRODUCTIONS unless specified otherwise. All parts described and offered for sale in this publication as NOS (New Old Stock) are new parts/materials manufactured by or for Chrysler Group LLC and General Motors Corporation.

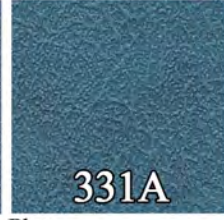
LEGENDARY AUTO INTERIORS LTD., COPYRIGHT 2015

All literature produced by and directly related to Legendary Auto Interiors Ltd., is protected under copyright laws. All literature cannot be reproduced for any reason unless prior permission is obtained.

Vinyl Color Chart

 100A	 102A	 110A	 205A	 206A	 250A	 270A
Black	Platinum	Charcoal	Dark White	White Knit	Parchment	Beige
 310A	 329A	 331A	 332A	 333A	 344A	 366A
Metallic Blue	Blue	Blue	Blue Knit	Blue	Blue	Blue
 432A	 438A	 440A	 441A	 453A	 463A	 503A
Light Met Olive Green	Green	Green	Green Knit	Green	Green	Red
 512A	 535A	 640A	 646A	 647A	 649A	 655A
Dark Red	Dark Red	Saddle	Brown	Brown	Cinnamon Knit	Brown
 656A	 668A					
Brown	Tan					

Vinyl Grain Chart

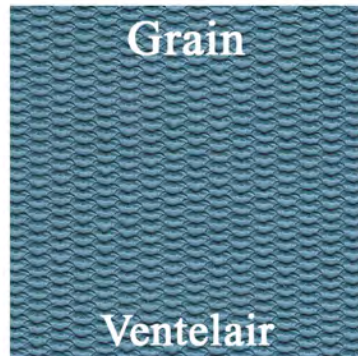
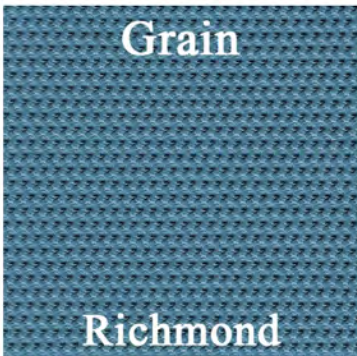
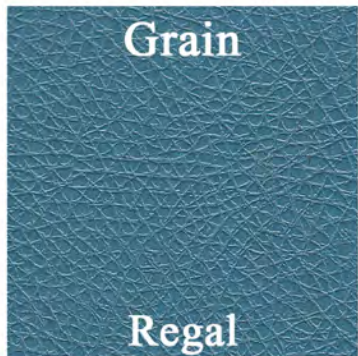
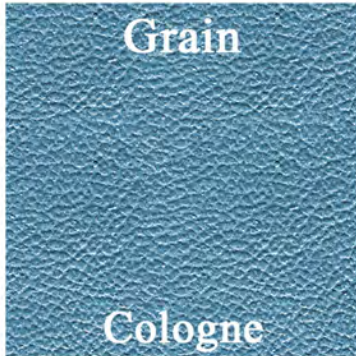
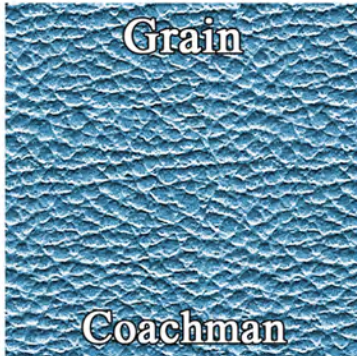
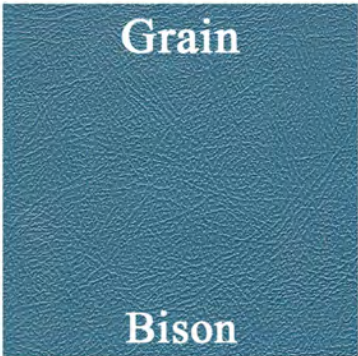

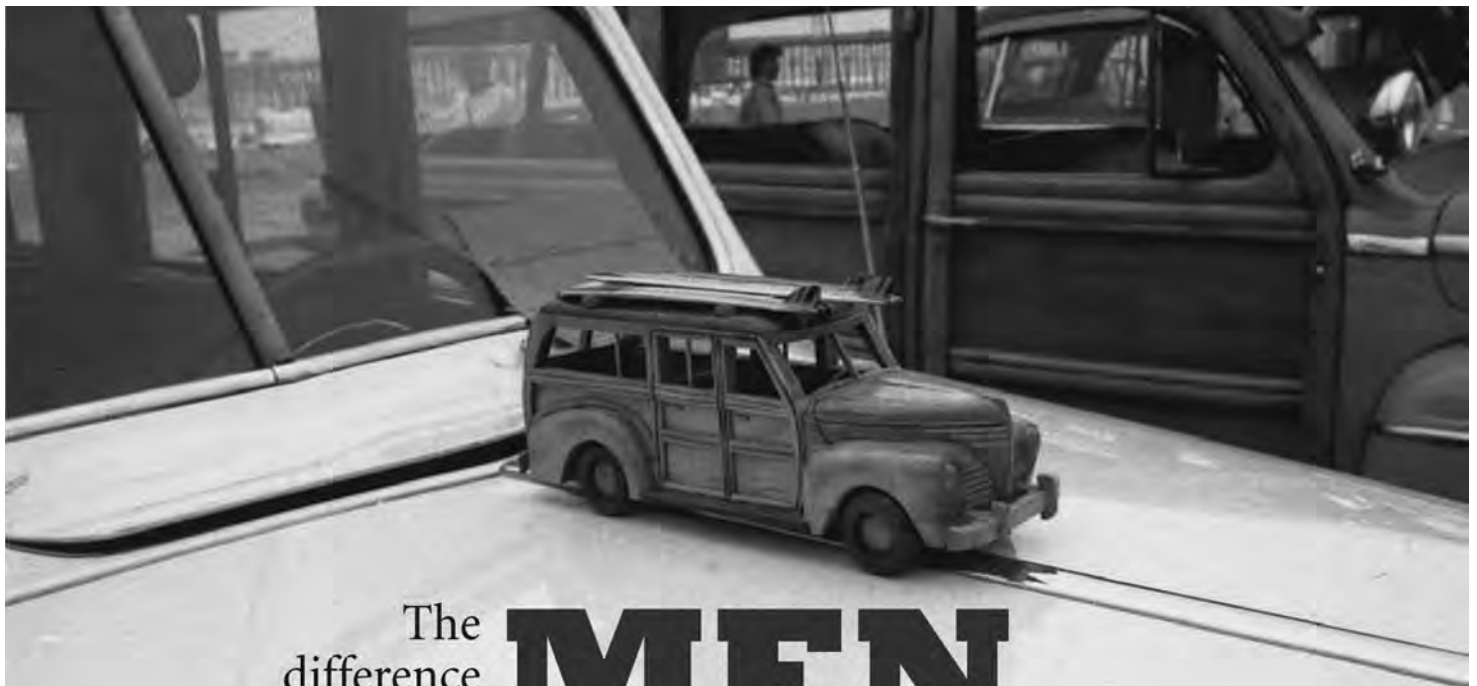

The
difference
between

MEN

& Boys

*is the size of
their toys!*

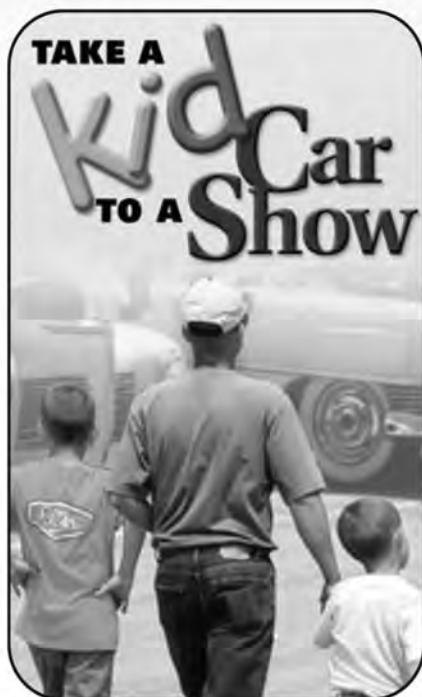

Even if there is a generation or two between you and a child, collector cars can be a terrific common ground. Your enthusiasm and knowledge could be the spark of a new lifelong passion. Bring kids to *your* playground...a car show...and have fun.

Life is full of choices for kids. You can help them make the right ones by sharing your appreciation for cool old cars. (And a kid might even call you “cool” too!)





For more information and a list of upcoming automotive events, visit our website:
www.TakeAKidToACarShow.com



909/396-0289 • tkcs@sema.org

Take a Kid to a Car Show is a program of ARMO, the Automotive Restoration Market Organization, a SEMA Council.



UPHOLSTERY AND TRIM ACCESORIES

 facebook.com/legendaryautointeriors
 twitter.com/legendaryautoin

 www.legendaryautointeriors.com
 instagram.com/legendaryautointeriorsltd
 youtube.com/user/legendaryauto

1968 AMX, JAVELIN & JAVELIN SST

This Legendary product features as-original heat sealed Ventilair grain inserts with Regal grain skirts.

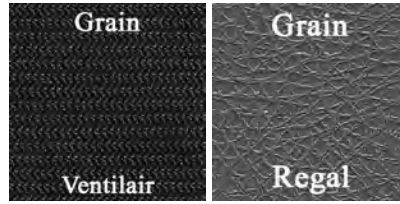

(C) COLOR CODES:

- (100A) Black
- (512A) Dark Red
- (668A) Tan



Front Buckets **AA68AAJ0010(C)**
 (All colors)..... \$495/pr.
 ☞ Will only fit models with reclining bucket seats

Front Bucket Seatback Panels
 (All vinyl panels with new boards)
 **SK68AAJ0018(C)**
 (All colors)..... \$130/pr.

Headrest Covers
 (with zipper & 12.5" base)
 **HC68AAJ0014(C)**
 (without zipper & 10" base)
 **HC68AAJN014(C)**
 (All colors)..... \$87/pr.
 ☞ Please specify zippered or non-zippered headrest style at time of order.

Rear Bench..... **AA68AJ00040(C)**
 (All colors)..... \$307/ea.
 ☞ Javelin & Javelin SST models only

1969 AMX

This Legendary product features as-original heat sealed Ventilair grain collars and inserts with Cologne or Regal grain skirts.

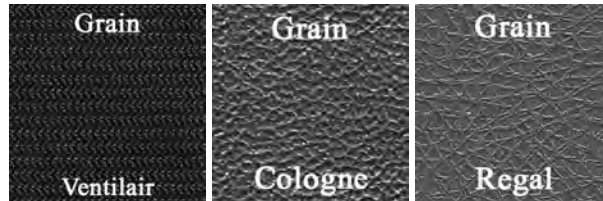

(C) COLOR CODES:

- (102A) Platinum (Regal)
- (110A) Charcoal (Cologne)
- (512A) Dark Red (Regal)
- (640A) Saddle (Cologne) (Requires Sample Approval)



Front Buckets
 (Cologne)..... **AA69AAC0010(C)**
 (Regal) **AA69AAR0010(C)**
 (All colors)..... \$495/pr.
 ☞ Will only fit models w/ reclining bucket seats

Front Bucket Seatback Panels
 (All vinyl panels with new boards)
 **SK68AAJ0018(C)**
 (All colors)..... \$130/pr.

Headrest Covers
 (with zipper & 12.5" base)
 **HC68AAJ0014(C)**
 (without zipper & 10" base)
 **HC68AAJN014(C)**
 (All colors)..... \$87/pr.

Center Cushion/Armrest
 (Cologne)..... **CR69AAJC013(C)**
 (Regal)..... **CR69AAJR013(C)**
 (All colors)..... \$82/ea.

1969 AMX "LEATHER STYLE"

This Legendary product features as-original heat sealed Leather inserts with Leather skirts.

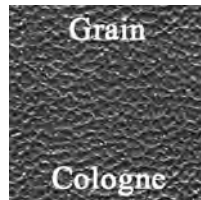

(Seatback Panels and Center Armrest only)

(C) COLOR CODES:

- (110A) Charcoal
- (640A) Saddle (Requires Sample Approval)



Front Buckets **AA69AAL0010(C)**
 (All colors)..... \$1414/pr. (L3)
 ☞ Will only fit models with reclining bucket seats

Front Bucket Seatback Panels
 (All vinyl panels with new boards)
 **SK68AAJ0018(C)**
 (All colors)..... \$130/pr.

Headrest Covers
 (without zipper & 10" base)
 **HC69AAL0014(C)**
 (All colors)..... \$165/pr. (L3)

Center Cushion/Armrest
 (All vinyl) **CR69AAJC013(C)**
 (All colors)..... \$82/ea. (L3)



1969 JAVELIN & JAVELIN SST



This Legendary product features as-original heat sealed Ventilair grain collars and inserts with Cologne or Regal grain skirts.

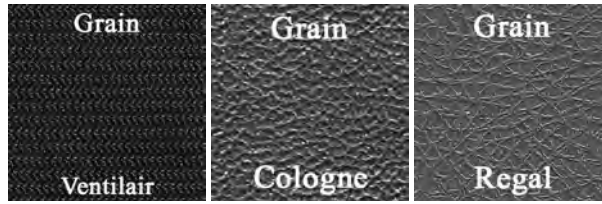

(C) COLOR CODES:
 (102A) Platinum (Regal)
 (110A) Charcoal (Cologne)
 (270A) Beige (Regal)
 (366A) Metallic Blue (Regal)
 ☞ 366A Metallic Blue uses Special Run Material.
 (512A) Dark Red (Regal)

Front Buckets (Cologne).....	AA69AJC0010(C)
(Regal).....	AA69AJR0010(C)
102A, 110A, 270A, 512A ..	\$495/pr.
366A	\$1126/pr. (L1)
☞ Will only fit models with reclining bucket seats	
Front Bucket Seatback Panels (All vinyl panels with new boards)	
.....	SK68AAJ0018(C)
102A, 110A, 270A, 512A ..	\$130/pr.
366A	\$237/pr. (L1)
Headrest Covers (w/ zipper & 12.5" base).....	HC68AAJ0014(C)
(w/o zipper & 10" base).....	HC68AAJN014(C)
102A, 110A, 270A, 512A ..	\$ 87/pr.
366A	\$185/pr. (L1)
Center Cushion/Armrest (Cologne).....	CR69AAJC013(C)
(Regal).....	CR69AAJR013(C)
102A, 110A, 270A, 512A ..	\$ 82/ea.
366A	\$204/ea. (L1)
Rear Bench (Cologne).....	AA69AJC0040(C)
(Regal).....	AA69AJR0040(C)
102A, 110A, 270A, 512A ..	\$307/ea.
366A	\$1126/ea. (L1)

1970 AMX, JAVELIN & JAVELIN SST



This Legendary product features as-original heat sealed Ventilair grain collars and inserts with Cologne or Regal grain skirts.

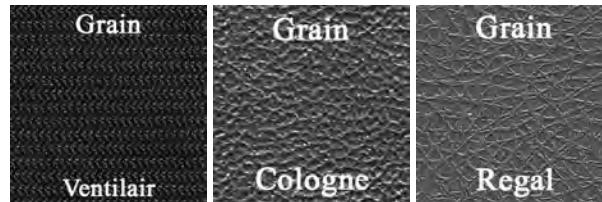

(C) COLOR CODES:
 (100A) Black (Cologne)
 (310A) Metallic Blue (Regal) (Requires Sample Approval)
 (432A) Light Metallic Olive Green (Regal)
 (512A) Dark Red (Cologne)
 (655A) Brown (Cologne)

Front Buckets	AA70AAJ0010(C)
100A, 310A, 432A,	
512A	\$495/pr.
655A	\$1212/pr. (L1)
☞ 655A Brown uses Special Run Material.	
Center Cushion/Armrest (Cologne).....	CR70AAJC013(C)
(Regal).....	CR70AAJR013(C)
100A, 310A, 432A,	
512A	\$ 82/ea.
655A	\$204/ea. (L1)
☞ 655A Brown uses Special Run Material.	
Rear Bench	AA70AJ00040(C)
100A, 310A, 432A,	
512A	\$307/ea.
655A	\$908/ea. (L1)
☞ Javelin & Javelin SST models only.	
☞ 655A Brown uses Special Run Material.	

**1970 JAVELIN SST
"CLOTH STYLE"**

This Legendary product features as-original heat sealed Corduroy cloth inserts and collars with Coachman grain skirts.

PHOTO N/A
AT TIME OF
PRINTING

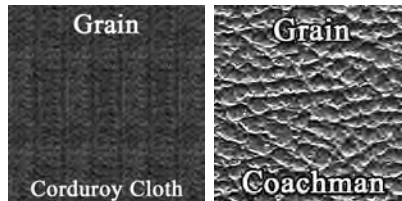

(C) COLOR CODES:
 (834A) Black Corduroy Cloth / Black
 (835A) Blue Corduroy Cloth / Metallic Blue
 (836A) Green Corduroy Cloth / Light Metallic Green
 (837A) Red Corduroy Cloth / Dark Red
 (838A) Brown Corduroy Cloth / Brown

(C) CENTER ARMREST COLOR CODES:
 (100A) Black
 (432A) Lt Met Olive Green
 (655A) Brown
 (310A) Met Blue
 (512A) Dark Red

Front Buckets	AA70AAJC010(C)
834A, 835A, 836A	
837A, 838A.....	\$1212/pr. (L1)
Center Cushion/Armrest (Cologne).....	CR70AAJC013(C)
(Regal).....	CR70AAJR013(C)
100A, 310A, 432A,	
512A	\$ 82/ea.
655A	\$204/ea. (L1)
☞ 655A Brown uses Special Run Material.	
Rear Bench.....	AA70AAJC040(C)
834A, 835A, 836A	
837A, 838A.....	\$908/ea. (L1)

1970 REBEL "MACHINE" & REBEL SST



This Legendary product features as-original heat sealed Ventilair grain collars and inserts with Cologne or Regal grain skirts.

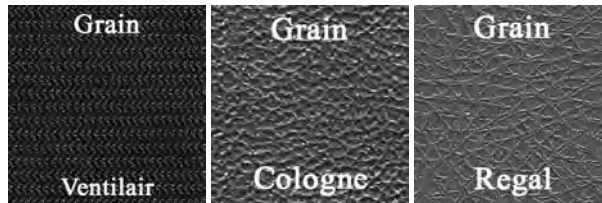

(C) COLOR CODES:

- (100A) Black (Cologne)
- (123A) Red, White, Blue / Black (Center Armrest Only)
- (310A) Metallic Blue (Regal) (Requires Sample Approval)
- (512A) Dark Red (Cologne)
- (655A) Brown (Cologne)

Front Buckets **AA70AR00010(C)**
 100A, 310A, 512A.....\$513/pr.
 655A.....\$1332/pr. (L1)
 ☞ 655A Brown uses Special Run Material.

Center Cushion/Armrest
 (Single color) **CR70AR00013(C)**
 (Red, White, Blue) **CR70ARM0013(C)**
 100A, 310A, 512A.....\$110/ea.
 123A.....\$139/ea.
 655A.....\$262/ea. (L1)
 ☞ 655A Brown uses Special Run Material.

Rear Bench..... **AA70AR00040(C)**
 100A, 310A, 512A.....\$321/ea.
 655A.....\$1004/ea. (L1)
 ☞ 655A Brown uses Special Run Material.

1970-71 AMX, JAVELIN & JAVELIN SST "LEATHER STLE"



This Legendary product features as-original heat sealed Leather inserts with Leather skirts.

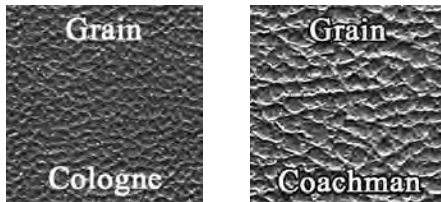

(1970 Seatback Panels and Center Armrest only)

(1971 Seatback Panels and Center Armrest only)

(C) COLOR CODES:

- (100A) Black ('70-'71)
- (512A) Dark Red ('70)
- (535A) Dark Red ('71)
- (655A) Brown ('70)

Front Buckets
 (1970) **AA70AAJL010(C)**
 100A \$967/pr. (L3)
 512A, 655A \$1319/pr. (L3)
 (1971) **AA71AAJL010(C)**
 100A \$967/pr. (L3)
 535A \$1319/pr. (L3)

Center Cushion/Armrest (All Vinyl)
 (1970) **CR70AAJC013(C)**
 (All colors) \$82/ea. (L3)
 (1971) (One-piece) .. **CR71AAJ0013(C)**
 (All colors) \$47/ea. (L3)

Rear Bench
 (1970) (Leather)..... **AA70AJL0040(C)**
 100A \$745/ea. (L3)
 512A, 655A \$1055/ea. (L3)
 (1970) (Vinyl) **AA70AJC0040(C)**
 100A, 512A \$298/ea. (L3)
 655A \$908/ea. (L3)
 ☞ Javelin & Javelin SST models only.
 ☞ 655A Brown uses Special Run Material.
 ☞ Rear seats were originally all vinyl from the factory but all leather has been verified. Please specify at time of order.

(1971) (Leather)..... **AA71AJL0040(C)**
 100A \$745/ea. (L3)
 535A \$1055/ea. (L3)
 (1971) (Vinyl) **AA71AJC0040(C)**
 100A, 535A \$298/ea. (L3)
 ☞ Rear seats were originally all vinyl from the factory but all leather has been verified. Please specify at time of order.



1970 AMX



1971 AMX, JAVELIN & JAVELIN SST



This Legendary product features as-original heat sealed Coachman, Regal or Ventilair grain collars and inserts with Coachman grain skirts.

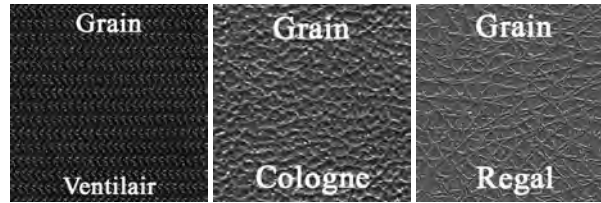

- (C) COLOR CODES:**
 (100A) Black
 (205A) Dark White
 (344A) Blue
 (463A) Green (Requires Sample Approval)
 (535A) Dark Red

Front Buckets
 (Coachman).....**AA71AAGJ010(C)**
 (Ventilair)**AA71AJ00010(C)**
 (All colors).....\$495/pr.
 ☞ Specify Coachman grain or Ventilair grain insert for 100A Black at time of order.
 ☞ 205A Dark White comes as original with Regal grain skirts and Regal grain inserts.

Center Cushion/Armrest
 (One-piece).....**CR71AAJ0013(C)**
 (All colors).....\$47/ea.

Rear Bench
 (Coachman)**AA71AAJ0040(C)**
 (Ventilair)**AA71AJ00040(C)**
 (All colors).....\$307/ea.
 ☞ Specify Coachman grain or Ventilair grain insert for 100A Black at time of order.
 ☞ 205A Dark White comes as original with Regal grain skirts and Regal grain inserts.

**1971 AMX, JAVELIN & JAVELIN SST
 "CLOTH STYLE"**

This Legendary product features as-original heat sealed Corduroy cloth inserts and collars with Coachman grain skirts.

PHOTO N/A
 AT TIME OF
 PRINTING

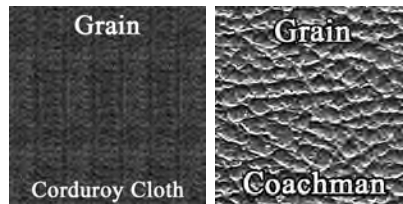

- (C) COLOR CODES:**
 (824A) Black Corduroy Cloth / Black
 (828A) Blue Corduroy Cloth / Blue
 (832A) Red Corduroy Cloth / Dark Red
 (833A) Green Corduroy Cloth / Green
 (Requires Sample Approval)

- (C) CENTER ARMREST COLOR CODES:**
 (100A) Black (463A) Green
 (344A) Blue (535A) Dark Red

Front Buckets **AA71AAJC010(C)**
 824A, 828A,
 832A, 833A..... \$1212/pr. (L1)

Center Cushion/Armrest
 (One-piece, all vinyl)... **CR71AAJ0013(C)**
 (All colors)..... \$47/ea.

Rear Bench..... **AA71AAJC040(C)**
 824A, 828A,
 832A, 833A..... \$908/ea. (L1)

1972 AMX & JAVELIN

This Legendary product features as-original heat sealed Coachman grain inserts with Coachman grain skirts.



- (C) COLOR CODES:**
 (100A) Black
 (205A) Dark White
 (333A) NOS Blue
 (453A) Green
 (504A) Red / Black
 (657A) Parchment / Brown
- (C) CENTER ARMREST COLOR CODES:**
 (100A) Black
 (205A) Dark White
 (333A) NOS Blue
 (453A) Green
 (656A) Brown

Front Buckets **AA72AAGHJ10(C)**
 100A, 205A, 453A, 504A, 657A..\$495/pr.
 333A\$1212/pr. (L1)

Center Cushion/Armrest
 (One-piece)..... **CR71AAJ0013(C)**
 100A, 205A, 453A, 657A\$47/ea.
 333A\$204/ea. (L1)

Rear Bench..... **AA72AAJ0040(C)**
 100A, 205A, 453A, 504A, 657A..\$307/ea.
 333A\$908/ea. (L1)

1972 AMX & JAVELIN "CLOTH STYLE"

This Legendary product features as-original heat sealed Corduroy cloth inserts and collars with Coachman grain skirts.



(C) COLOR CODES:

- (824A) Black Corduroy Cloth / Black
- (825A) Blue Corduroy Cloth / Blue
- (826A) Green Corduroy Cloth / Green
- (827A) Brown Corduroy Cloth / Brown

(C) CENTER ARMREST COLOR CODES:

- (100A) Black
- (333A) Blue
- (453A) Green
- (656A) Brown

Front Buckets **AA72AAJC010(C)**
824A, 825A,
826A, 827A..... \$1212/pr. (L1)

Center Cushion/Armrest
(One-piece, all vinyl) ... **CR71AAJ0013(C)**
(All colors)..... \$47/ea.

Rear Bench..... **AA72AAJC040(C)**
824A, 825A,
826A, 827A..... \$908/ea. (L1)



1973 AMX & JAVELIN

This Legendary product features as-original heat sealed Uganda grain inserts and collars with Coachman grain skirts.

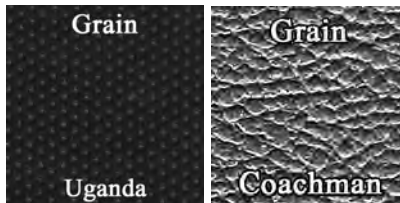

(C) COLOR CODES:

- (100A) Black
- (205A) Dark White
- (331A) Blue
- (440A) Green
- (648A) Parchment / Brown (Requires Sample Approval)
- (651A) Parchment / Brown

(C) CENTER ARMREST COLOR CODES:

- (100A) Black
- (205A) Dark White
- (331A) Blue
- (440A) Green
- (646A) Brown
- (647A) Brown (Requires Sample Approval)

Front Buckets **AA73AAJM010(C)**
100A, 205A, 331A,
440A, 648A..... \$495/pr.
651A..... \$908/pr. (L1)

Center Cushion/Armrest
..... **CR73AAJ0013(C)**
100A, 205A, 331A,
440A, 647A..... \$ 82/ea.
646A..... \$204/ea.

Rear Bench..... **AA73AAJ0040(C)**
100A, 205A, 331A,
440A, 648A..... \$307/ea.
651A..... \$691/ea. (L1)



1973 AMX & JAVELIN "CLOTH STYLE"

This Legendary product features as-original heat sealed Domino cloth inserts and Ribbed cloth bolsters with Coachman grain skirts.

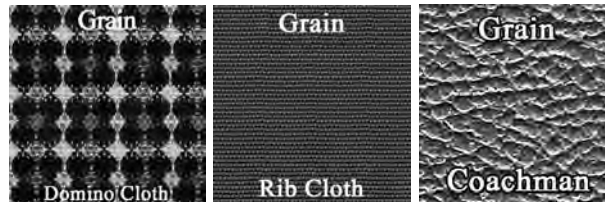

(C) COLOR CODES:

- (802A) Black & White Domino Cloth / Black Ribbed Cloth / Black
- (805A) Blue & White Domino Cloth / Blue Ribbed Cloth / Blue
- (808A) Green & White Domino Cloth / Green Ribbed Cloth / Green
- (812A) Cinnamon & White Domino Cloth / Cinnamon Ribbed Cloth / NOS Brown

(C) CENTER ARMREST COLOR CODES:

- (100A) Black
- (331A) Blue
- (440A) Green
- (646A) Brown

Front Buckets **AA73AAHJC010(C)**
802A, 805A, 808A,
812A..... \$1212/pr. (L1)

Center Cushion/Armrest
..... **CR73AAJ0013(C)**
100A, 331A, 440A,
647A..... \$ 82/ea.
646A..... \$204/ea. (L1)

Rear Bench..... **AA73AAJC040(C)**
802A, 805A, 808A,
812A..... \$908/ea. (L1)



1974 AMX & JAVELIN

This Legendary product features as-original heat sealed Knitted vinyl inserts with Coachman grain skirts.

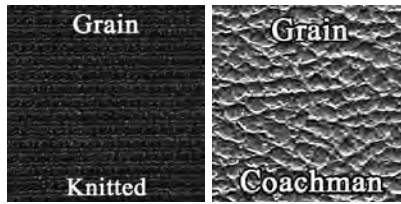

(C) COLOR CODES:

- (100A) Black
- (120A) Black / Black
- (205A) Dark White
- (207A) Dark White / Dark White
- (331A) Blue
- (334A) Blue / Blue
- (440A) Green
- (442A) Green / Green
- (648A) Parchment / Brown *(Requires Sample Approval)*
- (652A) Cinnamon / Brown

(C) CENTER ARMREST COLOR CODES:

- (100A) Black
- (331A) Blue
- (646A) Brown
- (205A) Dark White
- (440A) Green
- (647A) Brown *(Requires Sample Approval)*

Front Buckets	AA74AAJM010(C)
100A, 205A, 331A, 440A, 648A.....	\$495/pr.
207A, 334A, 442A....	\$892/pr. (L1)
652A	\$1290/pr. (L1)
<i>Customer must reuse original medallions</i>	

Center Cushion/Armrest	CR73AAJ0013(C)
100A, 205A, 331A, 440A, 647A.....	\$ 82/ea.
646A	\$204/ea. (L1)

Rear Bench.....	AA74AAJ0040(C)
100A, 205A, 331A, 440A, 648A.....	\$307/ea.
207A, 334A, 442A....	\$644/ea. (L1)
652A.....	\$1000/ea. (L1)

1974 AMX & JAVELIN "CLOTH STYLE"

This Legendary product features as-original heat sealed Domino cloth inserts and Ribbed cloth bolsters with Coachman grain skirts

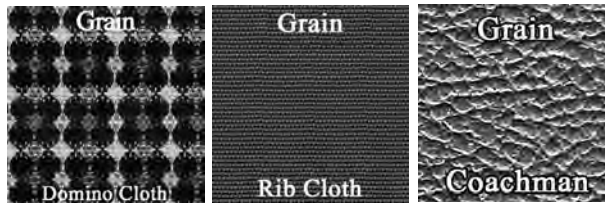

(C) COLOR CODES:

- (802A) Black & White Domino Cloth / Black Ribbed Cloth / Black
- (805A) Blue & White Domino Cloth / Blue Ribbed Cloth / Blue
- (808A) Green & White Domino Cloth / Green Ribbed Cloth / Green
- (812A) Cinnamon & White Domino Cloth / Cinnamon Ribbed Cloth / Brown

(C) CENTER ARMREST COLOR CODES:

- (100A) Black
- (331A) Blue
- (440A) Green
- (646A) Brown

Front Buckets	AA74AAJC010(C)
802A, 805A, 808A, 812A.....	\$1212/pr. (L1)

Center Cushion/Armrest	CR73AAJ0013(C)
100A, 331A, 440A, 647A.....	\$ 82/ea.
646A	\$204/ea. (L1)

Rear Bench.....	AA74AAJC040(C)
802A, 805A, 808A, 812A.....	\$908/ea. (L1)

1971 GREMLIN

This Legendary product features as-original heat sealed Coachman vinyl inserts with Coachman grain skirts.



(C) COLOR CODES:

- (100A) Black
- (344A) Blue
- (463A) Green *(Requires Sample Approval)*
- (535A) Dark Red

Front Buckets	AA71AAGJ010(C)
<i>(All colors)</i>	\$495/pr.

Rear Bench	PATTERN NEEDED
<i>(All colors)</i>	\$ N/A

1972 GREMLIN & HORNET



This Legendary product features as-original heat sealed Coachman vinyl inserts with Coachman grain skirts.



Front Buckets	AA72AAGHJ10(C)
100A, 504A, 657A	\$495/pr.
333A	\$1212/pr. (L1)
Rear Bench	
(Gremlin)	AA72AG00040(C)
(Hornet)	PATTERN NEEDED
100A, 504A, 657A	\$253/ea.
333A	\$908/ea. (L1)

(C) COLOR CODES:

- (100A) Black
- (333A) NOS Blue
- (504A) Red / Black
- (657A) Parchment / Brown

1973 GREMLIN & HORNET



This Legendary product features as-original heat sealed Coachman vinyl inserts with Coachman grain skirts.



Front Buckets	AA73AGH0010(C)
100A, 205A, 504A, 648A	\$495/pr.
330A, 439A, 651A	\$935/pr. (L1)
Rear Bench	
(Gremlin)	AA73AG00040(C)
(Hornet)	PATTERN NEEDED
100A, 205A, 504A, 648A	\$307/ea.
330A, 439A, 651A	\$691/ea. (L1)

(C) COLOR CODES:

- (100A) Black
- (205A) Dark White
- (330A) Light Blue / Blue
- (439A) Light Green / Green
- (504A) Red / Black
- (648A) Parchment / Brown (Requires Sample Approval)
- (651A) Parchment / Brown

(C) CENTER ARMREST COLOR CODES:

- (100A) Black
- (331A) Blue
- (440A) Green
- (646A) Brown
- (647A) Brown (Requires Sample Approval)

1973 HORNET "CLOTH STYLE"



This Legendary product features as-original heat sealed Domino cloth inserts and Ribbed cloth bolsters with Coachman grain skirts.

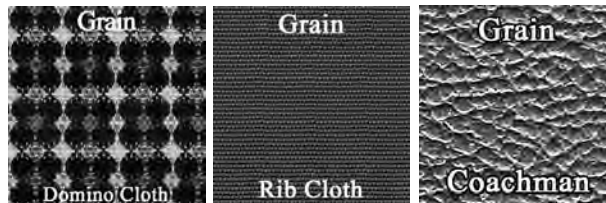

Front Buckets	AA73AAHJC10(C)
802A, 805A, 808A, 812A	\$1212/pr. (L1)
Rear Bench	
	PATTERN NEEDED
(All colors)	\$ N/A

(C) COLOR CODES:

- (802A) Black & White Domino Cloth / Black Ribbed Cloth / Black
- (805A) Blue & White Domino Cloth / Blue Ribbed Cloth / Blue
- (808A) Green & White Domino Cloth / Green Ribbed Cloth / Green
- (812A) Cinnamon & White Domino Cloth / Cinnamon Ribbed Cloth / Brown



1974 GREMLIN & HORNET

This Legendary product features as-original heat sealed Richmond vinyl inserts with Coachman grain skirts.

PHOTO N/A
AT TIME OF
PRINTING

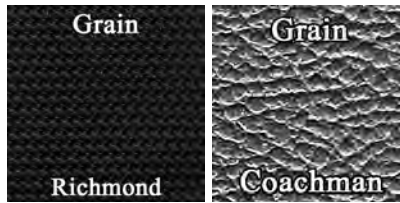

Front Buckets	AA74AGH0010(C)
100A, 205A, 504A, 648A.....	\$513/pr.
330A, 439A, 651A.....	\$935/pr. (L1)
Rear Bench (Gremlin).....	AA74AG00040(C)
(Hornet)	PATTERN NEEDED
100A, 205A, 504A, 648A.....	\$307/ea.
330A, 439A, 651A.....	\$691/ea. (L1)

(C) COLOR CODES:

- (100A) Black
- (205A) Dark White
- (330A) Light Blue / Blue
- (439A) Light Green / Green
- (504A) Red / Black
- (648A) Parchment / Brown *(Requires Sample Approval)*
- (651A) Parchment / Brown

1973 MATADOR & AMBASSADOR

This Legendary product features as-original heat sealed Uganda grain inserts and collars with Coachman grain skirts.

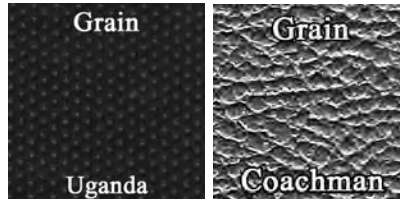

Front Buckets	AA73AAJM010(C)
100A, 205A, 504A, 648A.....	\$495/pr.
330A, 439A, 651A.....	\$908/pr. (L1)
Rear Bench	PATTERN NEEDED
(All colors).....	\$ N/A

(C) COLOR CODES:

- (100A) Black
- (331A) Blue
- (440A) Green
- (648A) Parchment / Brown *(Requires Sample Approval)*
- (651A) Parchment / Brown

1974 MATADOR

This Legendary product features as-original heat sealed Knitted vinyl inserts with Coachman grain skirts.

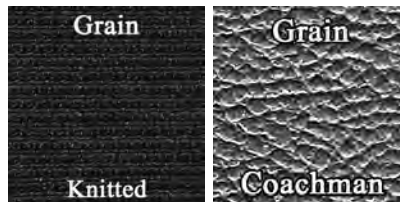

Front Buckets	AA74AAJM010(C)
100A, 205A, 331A, 440A, 648A.....	\$495/pr.
207A, 334A, 442A....	\$892/pr. (L1)
652A	\$1290/pr. (L1)
Rear Bench.....	AA74AM00040(C)
100A, 205A, 331A, 440A, 648A.....	\$307/ea.
207A, 334A, 442A....	\$644/ea. (L1)
652A	\$1000/ea. (L1)

(C) COLOR CODES:

- (100A) Black
- (205A) Dark White
- (207A) Dark White / Dark White
- (331A) Blue
- (334A) Blue / Blue
- (440A) Green
- (442A) Green / Green
- (648A) Parchment / Brown *(Requires Sample Approval)*
- (652A) Cinnamon / Brown

This Legendary product features as-original heat sealed Basketweave vinyl inserts with Regal grain skirts.

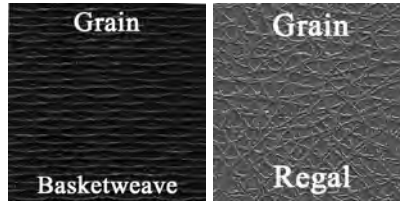

(C) COLOR CODES:

- (110A) Charcoal
- (366A) Metallic Blue (*Rambler only*)
- (512A) Red (*Rambler only*)

(C) HEADREST COLOR CODES:

- (110A) Charcoal (*Rambler only*)
- (111A) Red, White and Blue (*SC/Rambler only*)
- (366A) Metallic Blue (*Rambler only*)
- (512A) Red (*Rambler only*)

Front Buckets **AA69AS00010(C)**
 110A, 512A \$513/pr.
 366A \$1126/pr. (L1)

Rear Bench..... **AA69AS00048(C)**
 110A, 512A \$321/ea.
 366A \$867/ea. (L1)

Headrest Covers **HC69AS00014(C)**
 110A (*Rambler only*)... \$87/pr.
 111A (*SC/Rambler only*).. \$117/pr.
 366A (*Rambler only*)... \$185/pr. (L1)
 512A (*Rambler only*)... \$87/pr.

HOG RING PLIER KITS



Standard Hog Ring Plier Kit
TAHOG\$ 7.00/ea.
 ⚡ Kit contains pliers and enough hog rings for a front or rear installation only.

Deluxe Hog Ring Plier Kit
TAHOGHVV (*shown*).....\$32.00/ea.
 ⚡ Kit contains heavy duty pliers and enough hog rings for a complete front and rear installation.

Hog Rings (*Pkg/200*)
TAHOGRING200\$ 5.00/pk.

FOAM & COTTON ACCESSORIES

Cotton Batting (*1 Roll*)
TACOTTONROLL ^{OS2} \$48.00/ea.
 ⚡ 1 Roll averages 10-12 lbs.

Muslin (*1 yard*)
TAYDMUSLIN..... \$3.00/yd.

High Density Foam
TAFOAM1 (*2" thick x 12" x 12"*) \$20.00/ea.
TAFOAM2 (*2" thick x 24" x 24"*)\$38.00/ea.
TAFOAM3 (*2" thick x 24" x 66"*) ^{OS1}\$82.00/ea.



Burlap (*36" wide*)
TABURLAP \$ 3.00/yd.



Paper Coated Wire
TAPAPERWIRE..... \$ 2.50/ft.





MOLDED FOAM AND FOAM ACCESORIES

 facebook.com/legendaryautointeriors
 twitter.com/legendaryautoin

 www.legendaryautointeriors.com
 instagram.com/legendaryautointeriorsltd
 youtube.com/user/legendaryauto

MOLDED FOAM

1968-69 BUCKET SEAT FOAM

1968-69 molded foam for AMX & Javelin models. Sets consist of a pair of (2) front seat tops and (2) front seat bottoms.



MF68AAJSET \$297.00/set
 ☞ Requires minimal to moderate modification on some models during installation.
 ☞ Professional installation is highly recommended. Please see our installation services in the back of this catalog.

1970-72 BUCKET SEAT FOAM

Molded foam for 70-72 AMX/Javelin w/ vinyl & cloth buckets, 70-71 AMX/Javelin w/ leather buckets, 70 Rebel/Rebel Machine, 70-72 Gremlin/Ambassador, 71-72 Matador & 72 Hornet. Sets consist of a pair of (2) front seat tops and (2) front seat bottoms.



MF70AAJSET \$399.00/set
 ☞ Requires minimal to moderate modification on some models during installation.
 ☞ Professional installation is highly recommended. Please see our installation services in the back of this catalog.

SEAT INSTALLATION KITS

FRONT BUCKET SEATS

All 1968-74 AMC



INSTALLATION-KIT1 \$26.00/ea.
 ☞ Kit includes: 2 yards of burlap, 30 feet of paper coated listing wire, 2.5 yards of 2 inch wide felt & a dust mask.

HARDTOP AND CONVERTIBLE REAR SEATS

All 1968-74 AMC





INSTALLATION-KIT2 \$236.00/ea.
 ☞ Kit includes: (1) 30"x70" 1 1/2" thick foam, (1) 10lb. roll of cotton, 4 yards of burlap, 12 feet of paper coated listing wire, 2 yards of muslin, (1) 3 1/2" x 64" Wire Edge Reinforced Burlap Cotton Support Band & a dust mask.





DOOR PANEL AND TRIM ACCESORIES

 facebook.com/legendaryautointeriors
 twitter.com/legendaryautoin

 www.legendaryautointeriors.com
 instagram.com/legendaryautointeriorsltd
 youtube.com/user/legendaryauto

1968 JAVELIN

This Legendary product features as-original Die-electrically heat sealed Regal grain vinyl. Special cutout area in filler board to accommodate armrest base. Padded Multi-Level Construction 3-Dimensional Panel.



(C) COLOR CODES:

- (100A) Black
- (205A) Dark White
- (512A) Dark Red
- (668A) Tan

Front Door Panels (Unassembled) **DO68AJ00010(C)**

100A, 205A, 512A, 668A \$433/pr.

- ☞ Will also fit AMX models.
- ☞ Requires 12 clips.

(Pre-assembled) **DO68AJ00010(C)-PA**

100A, 205A, 512A, 668A \$647/pr. ^{OS1}

- ☞ Window sweeps included.
- ☞ Customer must provide upper metal rails
- ☞ Will also fit AMX models.
- ☞ Requires 12 clips.

Rear "Kick" Panels (AMX models only) (Regal grain) **DO68AAR0040(C)**
100A, 205A, 512A, 668A \$87/pr.

1969 JAVELIN & JAVELIN SST

This Legendary product features as-original Die-electrically heat sealed Cologne or Regal grain vinyl. Special cutout area in filler board to accommodate armrest base. Padded Multi-Level Construction 3-Dimensional Panel.

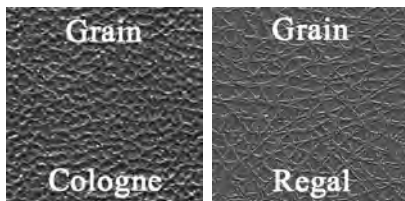
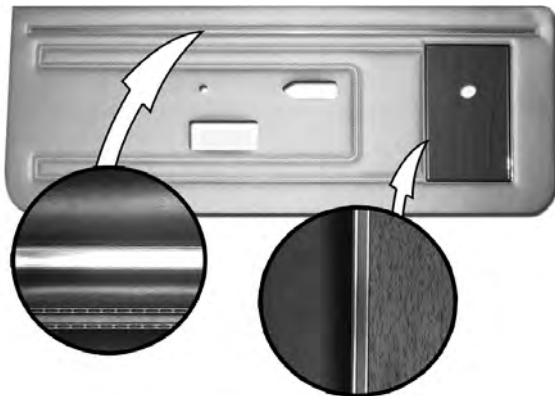

(C) COLOR CODES:

- (102A) Platinum (Regal)
- (110A) Charcoal (Cologne)
- (270A) Beige (Regal)
- (366A) Metallic Blue (Regal)
- (512A) Dark Red (Regal)

Front Door Panels (Unassembled) **DO69AAJ0010(C)**

102A, 110A, 270A, 512A \$480/pr.

366A \$793/pr. (L1)

- ☞ 366A Metallic Blue uses special run material.
- ☞ Requires 12 clips.

(Pre-assembled) ^{OS1} **DO69AAJ0010(C)-PA**

102A, 110A, 270A, 512A \$695/pr.

366A \$1009/pr. (L1)

- ☞ 366A Metallic Blue uses special run material.
- ☞ Window sweeps included.
- ☞ Customer must provide upper metal rails.
- ☞ Requires 12 clips.

Rear Panels (Unassembled) **DO69AJ00040(C)**

102A, 110A, 270A, 512A \$275/pr.

366A \$450/pr. (L1)

- ☞ 366A Metallic Blue uses special run material.

(Pre-assembled) ^{OS1} **DO69AJ00040(C)-PA**

102A, 110A, 270A, 512A \$464/pr.

366A \$626/pr. (L1)

- ☞ 366A Metallic Blue uses special run material.
- ☞ Window sweeps included.
- ☞ Customer must provide upper metal rails.

1970 JAVELIN & JAVELIN SST

This Legendary product features as-original Die-electrically heat sealed Cologne or Regal grain vinyl. Special cutout area in filler board to accommodate armrest base. Padded Multi-Level Construction 3-Dimensional Panel.

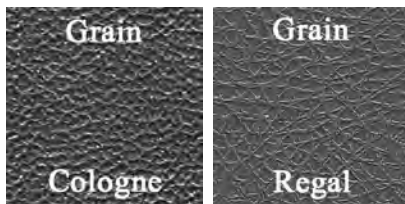

(C) COLOR CODES:

- (100A) Black (Cologne)
- (310A) Metallic Blue (Regal)
- (432A) Light Metallic Olive Green (Regal)
- (512A) Dark Red (Cologne)
- (655A) Brown (Cologne)

Front Door Panels (Unassembled) **DO70AAJ0010(C)**

100A, 512A... \$433/pr.

655A \$739/pr. (L1)

310A, 432A... \$420/pr.

- ☞ 655A Brown uses special run material.
- ☞ Requires 12 clips.

Front Door Panels (Pre-assembled) ^{OS1} **DO70AAJ0010(C)-PA**

100A, 512A... \$647/pr.

655A \$954/pr. (L1)

310A, 432A... \$628/pr.

- ☞ Customer must provide upper metal rails.
- ☞ 655A Brown uses special run material.
- ☞ Requires 12 clips.

Rear Panels (Unassembled) **DO70AJ00040(C)**

100A, 512A... \$275/pr.

655A \$424/pr. (L1)

310A, 432A... \$267/pr.

- ☞ 655A Brown uses special run material.

Rear Panels (Pre-assembled) ^{OS1} **DO70AJ00040(C)-PA**

100A, 512A... \$464/pr.

655A \$626/pr. (L1)

310A, 432A... \$450/pr.

- ☞ Customer must provide upper metal rails.



1970 REBEL & REBEL "MACHINE"

This Legendary product features as-original Die-electrically heat sealed Cologne or Regal grain vinyl. Special cutout area in filler board to accommodate armrest base. Padded Multi-Level Construction 3-Dimensional Panel.

PHOTO N/A
AT TIME OF
PRINTING

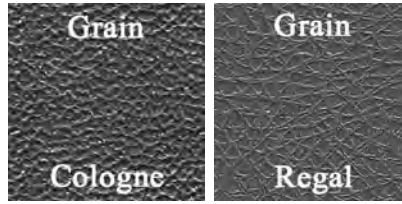

(C) COLOR CODES:

- (100A) Black (Cologne)
- (310A) Metallic Blue (Regal)
- (432A) Light Met. Green (Regal)
- (655A) Brown (Cologne)



Front Door Panels
(Unassembled) **DO70AR00010(C)**
100A, 310A, 432A.....\$536/pr.
655A\$809/pr. (L1)
☞ Rebel Machine originally available in black only.
☞ 655A Brown uses special run material.
☞ Requires 12 clips.

Front Door Panels
(Pre-assembled) ⁰⁵¹..... **DO70AR00010(C)-PA**
100A, 310A, 432A.....\$822/pr.
655A\$1096/pr. (L1)
☞ Rebel Machine originally available in black only.
☞ Customer must provide upper rails.
☞ 655A Brown uses special run material.
☞ Requires 12 clips.

Rear Panels
(Unassembled) **DO70AR00040(C)**
100A, 310A, 432A.....\$275/pr.
655A\$413/pr. (L1)
☞ Rebel Machine originally available in black only.
☞ 655A Brown uses special run material.

Rear Panels ⁰⁵¹
(Pre-assembled) **DO70AR00040(C)-PA**
100A, 310A, 432A.....\$464/pr.
655A\$608/pr. (L1)
☞ Rebel Machine originally available in black only.
☞ Customer must provide upper rails.
☞ 655A Brown uses special run material.

**1970 JAVELIN & JAVELIN SST
"CLOTH STYLE"**

This Legendary product features as-original Die-electrically heat sealed Cologne or Regal grain vinyl. Special cutout area in filler board to accommodate armrest base. Padded Multi-Level Construction 3-Dimensional Panel.

PHOTO N/A
AT TIME OF
PRINTING

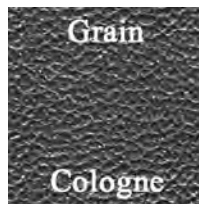

(C) COLOR CODES:

- (834A) Black Corduroy Cloth / Black
- (835A) Blue Corduroy Cloth / Metallic Blue
- (836A) Green Corduroy Cloth / Light Metallic Green
- (837A) Red Corduroy Cloth / Dark Red
- (838A) Brown Corduroy Cloth / Brown

Front Door Panels
(Unassembled) **DO70AJC0010(C)**
.....\$651/pr.
☞ Requires 12 clips.

Front Door Panels ⁰⁵¹
(Pre-assembled) **DO70AJC0010(C)-PA**
.....\$869/pr.
☞ Customer must provide upper rails.
☞ Requires 12 clips.

Rear Panels
(Unassembled) **DO70AJC0040(C)**
.....\$413/pr.

Rear Panels ⁰⁵¹
(Pre-assembled) **DO70AJC0040(C)-PA**
.....\$608/pr.
☞ Customer must provide upper rails.

1969 AMX

This Legendary product features as-original Die-electrically heat sealed Cologne or Regal grain vinyl. Special cutout area in filler board to accommodate armrest base. Padded Multi-Level Construction 3-Dimensional Panel.

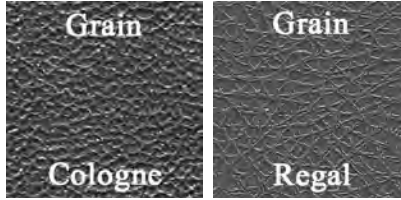
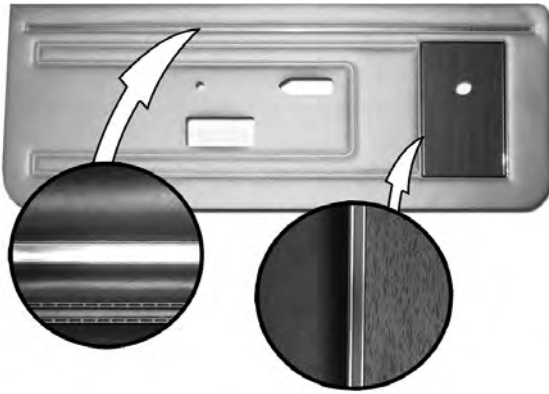

(C) COLOR CODES:

- (102A) Platinum (Regal)
 - (110A) Charcoal (Cologne)
 - (512A) Dark Red (Regal)
 - (640A) Saddle (Cologne)
- (Requires Sample Approval)*

Front Door Panels	
(Unassembled)	DO69AAJ0010(C)
102A, 110A, 512A,	
640A	\$480/pr.
☞ Requires 12 clips.	
<i>(Pre-assembled) ^{OS1}</i>	
DO69AAJ0010(C)-PA	
102A, 110A, 512A,	
640A	\$695/pr.
☞ Window sweeps included.	
☞ Customer must provide upper metal rails	
☞ Requires 12 clips.	
Rear "Kick" Panels	
(Cologne grain)	DO68AAC0040(C)
110A, 640A	\$87/pr.
(Regal grain)	DO68AAR0040(C)
102A, 512A	\$87/pr.

1970 AMX

This Legendary product features as-original Die-electrically heat sealed Cologne or Regal grain vinyl. Special cutout area in filler board to accommodate armrest base. Padded Multi-Level Construction 3-Dimensional Panel.

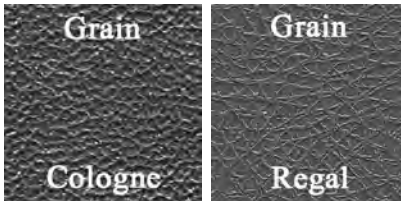

(C) COLOR CODES:

- (100A) Black (Cologne)
- (310A) Metallic Blue (Regal)
- (512A) Dark Red (Cologne)
- (655A) Brown (Cologne)

Front Door Panels	
(Unassembled)	DO70AAJ0010(C)
(Cologne grain)	
100A, 512A	\$433/pr.
655A	\$739/pr. (L1)
☞ 655A Brown uses special run material.	
☞ Requires 12 clips.	
(Regal grain)	
310A	\$420/pr.
Front Door Panels ^{OS1}	
<i>(Pre-assembled)</i>	
DO70AAJ0010(C)-PA	
(Cologne grain)	
100A, 512A	\$647/pr.
655A	\$954/pr. (L1)
☞ Customer must provide upper rails.	
☞ 655A Brown uses special run material.	
☞ Requires 12 clips.	
(Regal grain)	
310A	\$628/pr.
Rear "Kick" Panels (AMX models only)	
(Cologne grain)	DO70AAC0040(C)
100A, 512A	\$87/pr.
655A	\$185/pr. (L1)
☞ 655A Brown uses special run material.	
(Regal grain)	
DO70AAR0040(C)	
310A	\$87/pr.

DOOR PANEL CLIPS

Door panel clips for all models.

1968-70 AMX & Javelin

DOCLIP\$1.00/ea.



DOOR PANEL WATERSHIELDS

Die-cut watershields are designed to protect your door panels from moisture.

1968-70 AMX & Javelin

DO68AAJWATERH (Fronts only) \$30.00/set



1970 AMX & Javelin

DO70AAJWATERH.....\$23.00/pr.





CARPETS, FLOORMATS AND ACCESORIES

 facebook.com/legendaryautointeriors
 twitter.com/legendaryautoin

 www.legendaryautointeriors.com
 instagram.com/legendaryautointeriorsltd
 youtube.com/user/legendaryauto



MODEL SPECIFIC CARPET

THE MOST ACCURATE CARPET IN THE INDUSTRY!!

Legendary brand molded carpets utilize the heaviest face weight cutpile and loop carpet combined with an extra heavy poly coated backing that provides for an accurate and sharply detailed mold formed area. Legendary carpets have correctly matched heel pad shapes including colors, grains and thickness. Surged edges and accurately die cut and applied 40oz. felt underlayment is the finishing touch to our vehicle specific carpets.



SELECT FEATURES

LEGENDARY MADE CORRECT FACTORY STYLE AND COLOR HEEL PADS FOR

1967-76 Chrysler/Dodge/Plymouth A-Body, 1962-65 Chrysler/Dodge/Plymouth B-Body
1966-70 Chrysler/Dodge/Plymouth B-Body, 1965-79 Chrysler/Dodge/Plymouth C-Body
1970-74 Chrysler/Dodge/Plymouth E-Body, 1968-72 GM A-Body & 1967-79 GM F-Body & Nova

Correct Color & Thickness Heel Pad

Our heel pads are designed and manufactured in house to a minimum thickness of 90 mil. and are color matched to each specific carpet color. Grain and surface features are also model specific. Our molded carpets are the most authentic product in the market.



Bound and Surged Edges

Both Legendary cutpile and loop molded carpets have a heavy duty bound and surged edge that provides for an easy installation and clean appearance.



Underlayment Padding

Legendary molded carpets are made with a 40 oz. felt underlayment padding. All padding is trimmed around seat track mounts, seat belt holes and covers the most area than any carpet in the industry!



80/20 LOOP CARPET COLOR SELECTOR (c)

01 BLACK	03 RED	04 AQUA	05 DARK TEAL	06 FORD BLUE	07 DARK BLUE	08 TEAL	09 SHADE 13 BLUE
10 BRIGHT BLUE	11 MEDIUM BLUE	12 GREEN	13 DARK GREEN	14 DARK OLIVE GREEN	15 BLUE GREEN	16 MOSS GREEN	21 MEDIUM RED
22 BURNT ORANGE	24 ROSE BEIGE	25 DARK BROWN	26 SADDLE	27 LT/MEDIUM SADDLE	28 DARK COPPER	29 DARK SADDLE	31 MAROON
32 GOLD	33 DARK GOLD	34 FAWN	35 RED TUXEDO	36 BLUE TUXEDO	37 AQUA TUXEDO	38 LIGHT GREEN	39 ORANGE
40 PLUM	41 SUNSET GLOW	42 SILVER MINK	44 CORAL	45 EMBER GLOW	46 IVY GOLD	47 FAWN TUXEDO	48 SILVER
49 GUNMETAL GRAY	50 PARCHMENT	51 MIDNIGHT BLUE	53 GOLD TUXEDO	54 COPPER TUXEDO	55 OLIVE TUXEDO	81 CHARCOAL	

****36oz. JUTE PADDING INCLUDED WHERE PADDING WAS ORIGINAL.**

****VINYL BOUND EDGE WHERE THE FRONT AND REAR SECTIONS OF THE CARPET OVERLAP.**

****COLOR MATCHED ORIGINAL HEEL PAD ACCURATELY APPLIED USING THE SAME METHOD AS OEM.**

****MEETS OR EXCEEDS OEM SPECIFICATIONS.**

****DIMMER SWITCH GROMMET INCLUDED.**

****COLOR SAMPLES ARE AVAILABLE FOR COLORS OTHER THAN BLACK.**

****DYE LOTS WILL VARY +/- 10%. THIS IS COMMON IN THE CARPET INDUSTRY. CUSTOMERS ARE ENCOURAGED TO ORDER ALL CARPETED PRODUCTS AT THE SAME TIME TO ENSURE MATCHING DYE LOT.**

****FOR YEARS AND MODELS NOT LISTED PLEASE CALL OUR SALES DEPARTMENT AT 800-363-8804**

CUTPILE

CARPET COLOR SELECTOR (c)

801 BLACK	802 BLUE	807 DK. GRAY	808 TURQUOISE	810 BROWN	812 ROYAL BLUE	815 RED	818 OCEAN BLUE
819 DK. BLUE	820 SADDLE	821 TAUPE	825 MAROON	830 BUCKSKIN	835 FIRETHORNE	839 FED. BLUE	840 NAVY
849 JADE GREEN	850 CHAMOIS	852 SILVER	854 CAMEL	857 MED. GRAY	869 WILLOW GREEN	871 SANDALWOOD	875 OXBLOOD
877 DOVE GRAY	885 LT. MAROON	897 CHARCOAL	1251 ALMOND	1804 SILVER	4033 MIDNIGHT BLUE	4305 OXBLOOD	4640 SADDLE
4643 POWDER BLUE	4666 SMOKE	4880 SAGE GREEN	7037 CAMEL TAN	7039 CARMINE	7075 OYSTER	7099 ANTELOPE	7130 DK. BLUE
7140 MED. SADDLE	7295 MEDIUM DOESKIN	7298 MAPLE	7500 BRIAR BROWN	7623 MEDIUM SAND GRAY	7701 GRAPHITE	7766 BLUE	8046 SILVER
8075 MED. GRAY	8082 LT. CRYSTAL BLUE	8384 DESERT TAN	8801 FLAME RED	8991 FORD SANDALWOOD	9006 LIGHT MOCHA	9196 MED. OPAL	9197 MEDIUM MOCHA
9199 SMOKE	9229 STEEL BLUE	9304 REGATTA BLUE	9577 MEDIUM DARK OAK	9777 BEIGE	9779 MED. GRAY	9779 TORCH RED	2000 CHROME YELLOW
2947-A RED	2005 HUGGER ORANGE	1998 ROYAL PURPLE	2003 LIMELIGHT GREEN	2004 ELECTRIC BLUE	8500 WHITE	1999 POWER PUMPKIN	2001 FUCHSIA

*For colors other than BLACK, a clean, non-faded sample may be helpful to assure a correct color match when ordering. Samples are available upon request. Dye lots will vary +/- 10%. This is common to industry standards and must be understood by the customer on all colors with or without sample approval. Customers are encouraged to order all carpeted products at one time to ensure the best dye lot matching. Carpeted items include: Seat back panels, Console carpet kits and certain model door panel carpet trim.

LOOP & CUT-PILE CARPET

The finest available today. Pre-molded shapes made of 100% Nylon Loop or Cut-Pile. All carpets include 36oz. jute padding on the backside, dimmer switch grommet, color matched original style heel pad and vinyl bound edge where the front and rear sections overlap. Carpet kits are not shipped with pre-cut holes and must be done during installation of carpet. Some other minor trimming may be needed.

1968 AMX

CA68AAA(C) (Automatic) (5 pc. Loop) \$445.00/ea.
CA68AAS(C) (Manual) (5 pc. Loop) \$445.00/ea.

1969-70 AMX

CA69AAA(C)P (Automatic) (5 pc. Cut-pile) \$445.00/ea.
CA68AAS(C)P ("Borg-Warner" Manual) (5 pc. Cut-pile) \$445.00/ea.
CA69AAS(C)P ("Hurst" Manual) (5 pc. Cut-pile) \$445.00/ea.
For 1969 4-speed models, please specify if your car has a "T-10 Borg Warner" or "Hurst" transmission. All 1970-1974 4-speed models came equipped with a "Hurst" transmission.

1968 Javelin & Javelin SST

CA68AJA(C) (Automatic) (2 pc. Loop) \$211.00/ea.
CA68AJS(C) (Manual) (2 pc. Loop) \$211.00/ea.

1969-74 Javelin & Javelin SST

1971-74 AMX
CA69AJA(C)P (Automatic) (2 pc. Cut-pile) \$211.00/ea.
CA68AJS(C)P ("Borg-Warner" Manual) (2 pc. Cut-pile) \$211.00/ea.
CA69AJS(C)P ("Hurst" Manual) (2 pc. Cut-pile) \$211.00/ea.
For 1969 4-speed models, please specify if your car has a "T-10 Borg Warner" or "Hurst" transmission. All 1970-1974 4-speed models came equipped with a "Hurst" transmission.

1969-70 Rebel, Rebel Machine & Ambassador

CA69ARA(C)P (Automatic) (2 pc. Cut-pile) \$211.00/ea.
CA69ARS(C)P (Manual) (2 pc. Cut-pile) \$211.00/ea.

CARPET YARDAGE

Loop Carpet

CAYD(XX) (1 yard) \$75.00/yd.
*for colors other than black please refer to color code list

Cut-pile Carpet

CAYD(XX) (1 yard) \$75.00/yd.

SEAT BELTS



COLORS

(01) Black	(21) Medium Red
(03) Red	(25) Dark Brown
(07) Dark Blue	(26) Saddle
(13) Dark Green	(31) Maroon
(18) Light Blue	

Universal aftermarket non-retractable replacement seat belts for all models. These belts feature a "flip" release and are available in 60" & 74" lengths. Mounting hardware included. Sold individually, one belt per passenger.

1968-74 AMX & Javelin

TNSEATBELT60(C) (60") \$32.00/ea.
TNSEATBELT74(C) (74") \$32.00/ea.

Please specify color at time of order.

JAVELIN LOGO FLOOR MATS

Retain that fresh look of your new carpet with a set of color coordinated floor mats. Universal fit, heavy duty floor mats made of nylon loop or cut-pile carpet feature an embroidered Javelin logo on the front mats, non-slip backing and vinyl bound edges.



4-piece logo floor mats

FM01ZLOGO(XX) \$173.00/set

(XX) Numbers



107 (Javelin script only) \$173.00/set



235 (Javelin script w/ target emblem) \$173.00/set

229 \$173.00/set



ORIGINAL-STYLE FLOOR MATS

Want to keep that stock appearance in your AMX/ Javelin? Legendary Auto Interiors, Ltd. has the solution. We manufacture original-style reproduction floor mats for 1968-70 AMX and Javelin models.

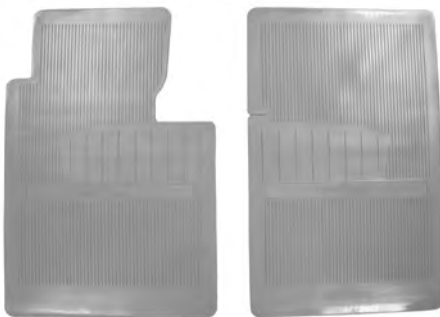

FMOR68AAJ(C) \$257.00/set

(C) COLOR CODES

(001) Black	(023) Tan
(007) Dk. Blue	(057) Dk. Green
(011) Med. Blue	(079) Gray
(020) Red	

SOUND DEADENER

This rubber/tar material installs under the carpet to reduce heat and noise. Pre-cut to correct shape and size.

1968-74 AMX & Javelin

SD68AAJ \$124.00/ea.

JUTE PADDING

This insulating material when placed between the floorpan and molded carpet enhances sound barrier protection from road noise and adds cushion to your carpet. Also helpful for insulating headliners, trunk areas and more.



36"x36" cut

TA20OZFELT (20 oz.) \$10.00/yd.
TA40OZFELT (40 oz.) \$15.00/yd.

FIREWALL INSULATION



Die-cut to original specifications, this jute padding with black backing properly fits the firewall. Clips included.

1968-70 AMX & Javelin

FI68AAJ (shown) \$70.00/kit

1970 Rebel, Rebel Machine NEW!!!

1970-72 Matador

FI70AR \$75.00/kit



1971-74 AMX & Javelin

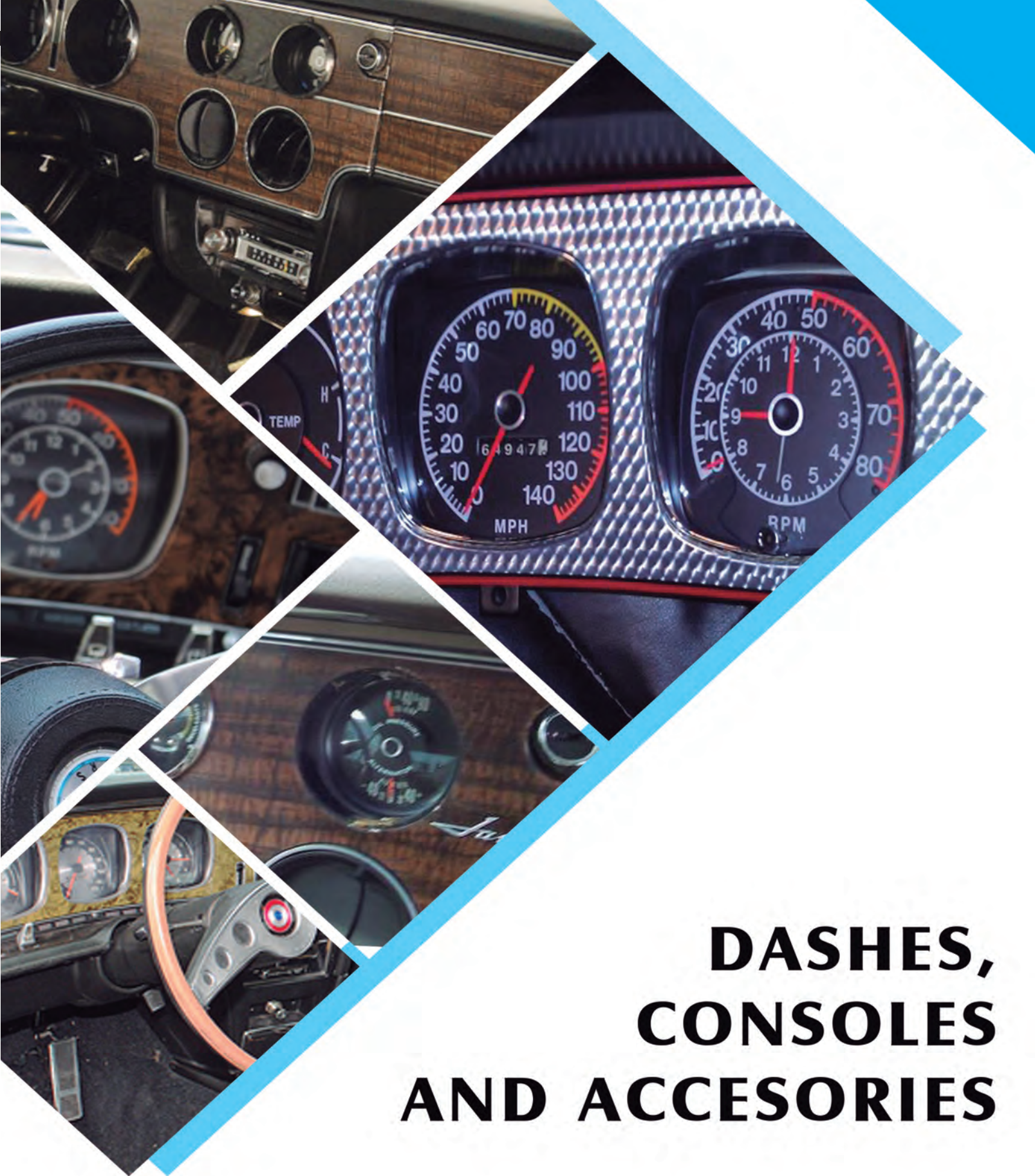

FI71AAJ \$70.00/kit





DASHES, CONSOLES AND ACCESORIES

 facebook.com/legendaryautointeriors
 twitter.com/legendaryautoin

 www.legendaryautointeriors.com
 instagram.com/legendaryautointeriorsltd
 youtube.com/user/legendaryauto

STEERING COLUMN SEAL



Precision die-cut gasket seals the steering column at the firewall.

- 1968-69 AMC (all models) NEW!!!**
GK68A.....\$13.00/ea.
- 1970 Rebel Machine NEW!!!**
GK70AR.....\$13.00/ea.
- 1970-74 AMC (all models) NEW!!!**
GK70A.....\$13.00/ea.

UNDERDASH INSULATION

Die-cut to original specifications, this insulation eliminates underdash noise and vibration.

- 1968-70 AMX & Javelin**
UD68AAJ.....\$19.00/kit
- 1970 Rebel & Rebel Machine NEW!!!**
UD70AR.....\$14.00/kit

GLOVEBOX LINERS



Glovebox liners are die-cut and pre-stapled with all the mounting hardware attached for easy installation.

- 1970 AMX & Javelin**
GB70AAJ.....\$21.00/ea.

DASH INSERTS

These factory correct, die-stamped vinyl woodgrain or "engine-turned" overlays fit perfectly over your existing dash panel fascia.

- 1970 AMX & Javelin**
WC70AAJ (2-pc.) (Woodgrain).....\$61.00/kit
- 1971-74 AMX & Javelin**
WC71AAJ (2-pc. w/o air) (Woodgrain).....\$52.00/kit
WC71AAJ-A (2-pc. w/air) (Woodgrain).....\$52.00/kit
WC71AAJ-ET (2-pc. w/o air) ("Engine-turned") \$52.00/kit
WC71AAJ-ETA (2-pc. w/air) ("Engine-turned") \$52.00/kit

WOODGRAIN CONSOLE INSERTS

Die-cut vinyl woodgrain inserts for automatic models. Adhesive backing makes them easy to install.

- 1969 AMX & Javelin**
WC69AAJ-A (Automatic).....\$23.00/kit
- 1970 AMX & Javelin**
WC70AAJ-A (Automatic).....\$23.00/kit



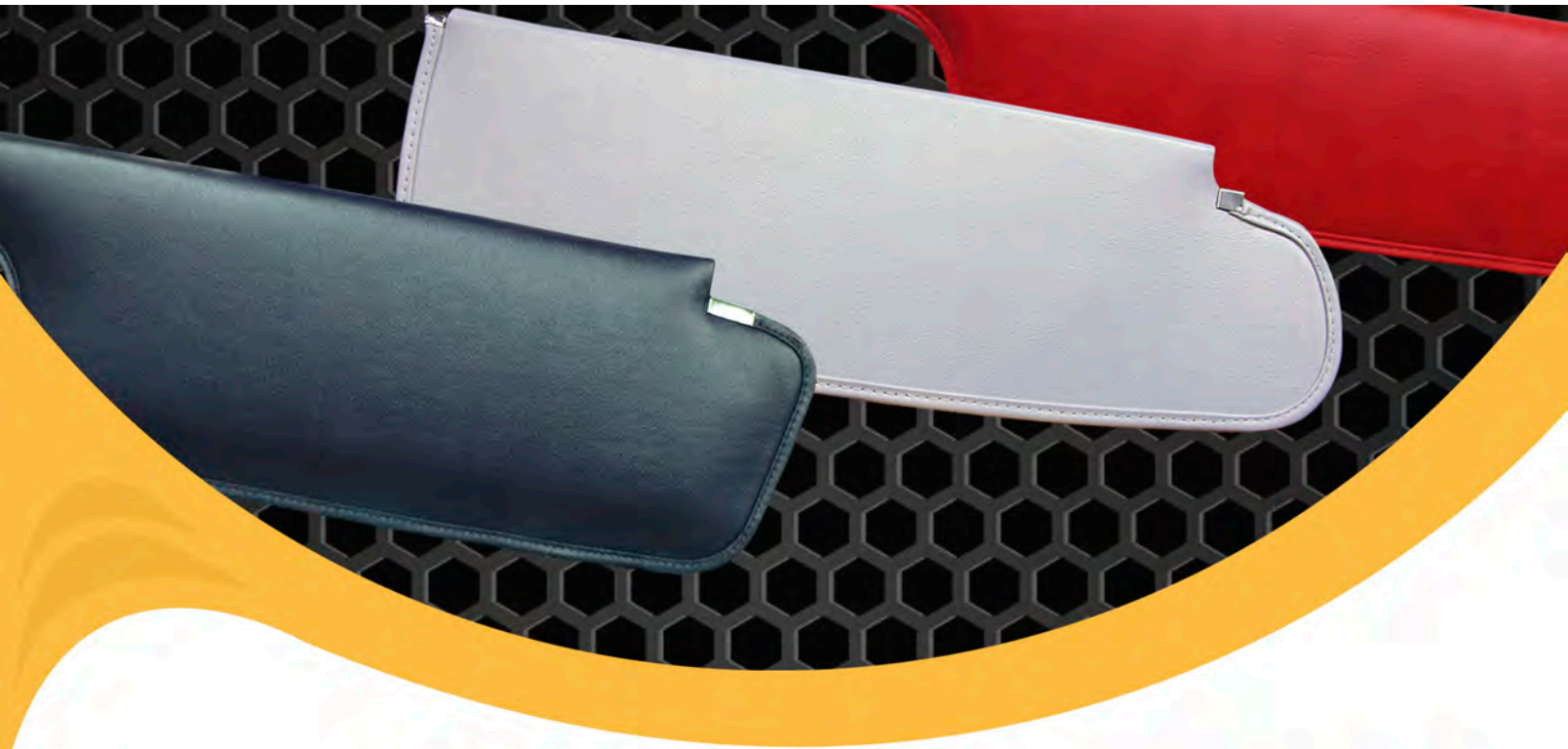

SUNVISORS

Original reproduction sunvisors are made with the correct grains and vinyl colors as applicable by year/make/model to compliment and match your Legendary interior. Superior materials and technology with World Class craftsmanship create the highest quality sunvisors available. Original mounting hardware and metal rod must be reused. Please specify hardtop or convertible and color at time of order.

- Factory correct size, shape, colors and grains by year, make and model
- Original fit and appearance
- Custom colors and grains available
- Limited Lifetime Warranty (*First and only in the industry!!!*)
- Correct multi layer construction applicable by year, make and model
- Available with or without cut-outs for driver and passenger mirror options



Correct multi layer construction & shape applicable by year, make, model & body style



SUNVISORS

1968-69 AMX & Javelin

SV68AAJ100A-PA (black)	\$145.00/pr.
SV68AAJ102A-PA (platinum)	\$145.00/pr.
SV68AAJ110A-PA (charcoal)	\$145.00/pr.
SV68AAJ270A-PA (beige)	\$145.00/pr.
SV68AAJ366A-PA (metallic blue)	\$145.00/pr.
SV68AAJ512A-PA (dark red)	\$145.00/pr.
SV68AAJ640A-PA (saddle)	\$145.00/pr.
SV68AAJ668A-PA (tan)	\$145.00/pr.

1970 AMX & Javelin

SV70AAJ100A-PA (black)	\$145.00/pr.
SV70AAJ310A-PA (metallic blue)	\$145.00/pr.
SV70AAJ432A-PA (light met olive)	\$145.00/pr.
SV70AAJ512A-PA (dark red)	\$145.00/pr.
SV70AAJ655A-PA (brown)	\$145.00/pr.

1971 AMX & Javelin

SV71AAJ100A-PA (black)	\$145.00/pr.
SV71AAJ205A-PA (dark white)	\$145.00/pr.
SV71AAJ344A-PA (blue)	\$145.00/pr.
SV71AAJ463A-PA (green)	\$145.00/pr.
SV71AAJ535A-PA (dark red)	\$145.00/pr.

1972 AMX & Javelin

SV71AAJ100A-PA (black)	\$145.00/pr.
SV71AAJ205A-PA (dark white)	\$145.00/pr.
SV71AAJ333A-PA (blue)	\$145.00/pr.
SV71AAJ453A-PA (green)	\$145.00/pr.
SV71AAJ656A-PA (brown)	\$145.00/pr.

1973-74 AMX & Javelin

SV71AAJ100A-PA (black)	\$145.00/pr.
SV71AAJ205A-PA (dark white)	\$145.00/pr.
SV71AAJ331A-PA (blue)	\$145.00/pr.
SV71AAJ440A-PA (green)	\$145.00/pr.
SV71AAJ646A-PA (brown)	\$145.00/pr.
SV71AAJ647A-PA (brown)	\$145.00/pr.

1970 Rebel & Rebel Machine

SV70AR100A-PA (black)	\$145.00/pr.
SV70AR310A-PA (metallic blue)	\$145.00/pr.
SV70AR512A-PA (dark red)	\$145.00/pr.
SV70AR655A-PA (brown)	\$145.00/pr.



1971-74 Gremlin



SV71AG100A-PA (black)	\$145.00/pr.
SV71AG205A-PA (white)	\$145.00/pr.
SV71AG331A-PA (blue)	\$145.00/pr.
SV71AG333A-PA (blue)	\$145.00/pr.
SV71AG344A-PA (blue)	\$145.00/pr.
SV71AG440A-PA (green)	\$145.00/pr.
SV71AG463A-PA (green)	\$145.00/pr.
SV71AG535A-PA (dark red)	\$145.00/pr.
SV71AG647A-PA (brown)	\$145.00/pr.
SV71AG656A-PA (brown)	\$145.00/pr.





PACKAGE TRAY AND TRUNK ACCESORIES

 facebook.com/legendaryautointeriors
 twitter.com/legendaryautoin

 www.legendaryautointeriors.com
 instagram.com/legendaryautointeriorsltd
 youtube.com/user/legendaryauto

PACKAGE TRAY & JUTE INSULATION

1968 Javelin 

(Without Cuts)

PT68AJ100AN (black)	\$61.00/ea.
PT68AJ512AN (red)	\$61.00/ea.
PT68AJ668AN (tan)	\$61.00/ea.

(With Cuts)

PT68AJ100A (black)	\$97.00/ea.
PT68AJ512A (red)	\$97.00/ea.
PT68AJ668A (tan)	\$97.00/ea.
PT68AJJ (jute insulation)	\$24.00/ea.

1969 Javelin 

(Without Cuts)

PT68AJ100AN (black)	\$61.00/ea.
PT68AJ110AN (charcoal)	\$61.00/ea.
PT68AJ366AN (blue)	\$61.00/ea.
PT68AJ512AN (red)	\$61.00/ea.
PT68AJ640AN (saddle)	\$61.00/ea.

(With Cuts)

PT68AJ100A (black)	\$97.00/ea.
PT68AJ110A (charcoal)	\$97.00/ea.
PT68AJ366A (blue)	\$97.00/ea.
PT68AJ512A (red)	\$97.00/ea.
PT68AJ640A (saddle)	\$97.00/ea.
PT68AJJ (jute insulation)	\$24.00/ea.

1970 Javelin 

(Without Cuts)

PT68AJ100AN (black)	\$61.00/ea.
PT68AJ310AN (blue)	\$61.00/ea.
PT68AJ432AN (light green)	\$61.00/ea.
PT68AJ512AN (red)	\$61.00/ea.
PT68AJ655AN (brown)	\$61.00/ea.

(With Cuts)

PT68AJ100A (black)	\$97.00/ea.
PT68AJ310A (blue)	\$97.00/ea.
PT68AJ432A (light green)	\$97.00/ea.
PT68AJ512A (red)	\$97.00/ea.
PT68AJ655A (brown)	\$97.00/ea.
PT68AJJ (jute insulation)	\$24.00/ea.

1967-68 Rebel 

(Without Cuts)

PT67AR100AN (black)	\$61.00/ea.
PT67AR512AN (red)	\$61.00/ea.

(With Cuts)

PT67AR100A (black)	\$97.00/ea.
PT67AR512A (red)	\$97.00/ea.
PT67ARJ (jute insulation)	\$24.00/ea.

1969 Rebel 

(Without Cuts)

PT67AR110AN (charcoal)	\$61.00/ea.
PT67AR366AN (blue)	\$61.00/ea.
PT67AR512AN (red)	\$61.00/ea.
PT67AR640AN (saddle)	\$61.00/ea.

(With Cuts)

PT67AR110A (charcoal)	\$97.00/ea.
PT67AR366A (blue)	\$97.00/ea.
PT67AR512A (red)	\$97.00/ea.
PT67AR640A (saddle)	\$97.00/ea.
PT67ARJ (jute insulation)	\$24.00/ea.

1970 Rebel & Rebel Machine 

(Without Cuts)

PT70AR100AN (black)	\$61.00/ea.
PT70AR310AN (blue)	\$61.00/ea.
PT70AR432AN (light green)	\$61.00/ea.
PT70AR512AN (red)	\$61.00/ea.
PT70AR655AN (brown)	\$61.00/ea.

(With Cuts)

PT70AR100A (black)	\$97.00/ea.
PT70AR310A (blue)	\$97.00/ea.
PT70AR432A (light green)	\$97.00/ea.
PT70AR512A (red)	\$97.00/ea.
PT70AR655A (brown)	\$97.00/ea.
PT70ARJ (jute insulation)	\$24.00/ea.

1971 Javelin 

(With Cuts)

PT71AJ100A (black)	\$97.00/ea.
PT71AJ344A (blue)	\$97.00/ea.
PT71AJ463A (green)	\$97.00/ea.
PT71AJ535A (red)	\$97.00/ea.
PT71AJJ (jute insulation)	\$24.00/ea.

1972 Javelin 

(With Cuts)

PT71AJ100A (black)	\$97.00/ea.
PT71AJ333A (blue)	\$97.00/ea.
PT71AJ453A (green)	\$97.00/ea.
PT71AJ656A (brown)	\$97.00/ea.
PT71AJJ (jute insulation)	\$24.00/ea.

1973-74 Javelin 

(With Cuts)

PT71AJ100A (black)	\$97.00/ea.
PT71AJ331A (blue)	\$97.00/ea.
PT71AJ440A (green)	\$97.00/ea.
PT71AJ647A (brown)	\$97.00/ea.
PT71AJJ (jute insulation)	\$24.00/ea.

SAIL PANEL BOARDS

Die-cut to original size and shape, these reproduction sail panel boards replace warped or water damaged originals.

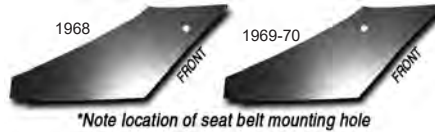

1968 AMX NEW!!!

SB68AA	\$30.00/pr.
--------	-------------

 Fits some early production 1969 AMX models.

1969-70 AMX NEW!!!

SB69AA	\$30.00/pr.
--------	-------------

 Some early production 1969 AMX models use 1968 sail panel boards. Use part #SB68AA for these early models.

SPARE TIRE COVER

Add the finishing touch to your trunk with a spare tire cover to match your trunk mat. These covers will fit any vehicle with a floor mounted spare tire.

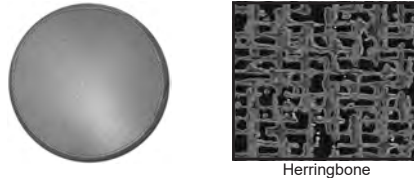

1968-74 Javelin

ST68AJHB (Herringbone) (shown)	\$50.00/ea.
--------------------------------	-------------

1968-70 Rebel & Rebel Machine

ST68ARHB (Herringbone)	\$50.00/ea.
------------------------	-------------

1968-74 AMX & Javelin (with Space Saver)

ST68AAJHB (Herringbone)	\$41.00/ea.
-------------------------	-------------

1970-78 Gremlin (Full Size)

ST70AG100A	\$70.00/ea.
------------	-------------

1971-78 Gremlin (Space Saver)

ST71AG100A	\$58.00/ea.
------------	-------------

TRUNK DIVIDERS

Die-cut reproduction of the black fiberboard panel that separates the rear seat from the trunk compartment.



1968-74 Javelin

TD68AJ (shown) 	\$30.00/ea.
--	-------------

1968-70 AMX (Rear Panel)

TD68AA (board only) 	\$27.00/ea.
---	-------------

 This back panel board fits between the wheel wells and goes up to the lower rear window trim molding.

 Originally covered with carpet and is offered like this in our carpet kits only.

1969-70 AMX

TD69AA 	\$30.00/ea.
--	-------------

TRUNK MAT MATERIAL

Legendary Auto Interiors offers an uncut roll of trunk mat material in Herringbone for American Motors Corporation models not offered. You cut to size this 52" x 80" roll.

TMROLLHB (Herringbone)	\$59.00/ea.
------------------------	-------------

TRUNK FLOOR FILLER BOARDS

Die-cut reproduction trunk boards fill in the area between the trunk floor outer edges and inner quarter panels.

1968-70 AMX

TB68AA	\$7.00/kit
--------	------------



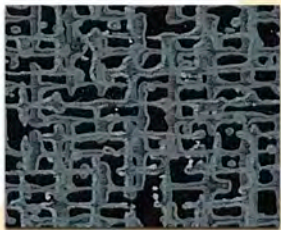

Herringbone

TRUNK MATS

Original style rubber trunk mats die-cut to factory specifications to assure a correct fit. Please specify material pattern at time of order.

TRUNK MATS

Original style rubber trunk mats die-cut to factory specifications to assure a correct fit.



Early 1971 Javelin

Late 1971 & all 1972-74 Javelins

1968-69 AMX & Javelin

TM68AAJHB (Herringbone)..... \$39.00/ea.

1970 AMX & Javelin

TM70AAJHB (Herringbone)..... \$39.00/ea.

1970 Rebel & Rebel Machine

TM70ARHB (Herringbone)..... \$39.00/ea.

1971 AMX & Javelin

TM71AAJEHB (Herringbone) \$39.00/ea.

Fits early production models only.

1971-74 AMX & Javelin

TM71AAJHB (Herringbone)..... \$34.00/ea.

Fits late production 1971 models.



VINYL TOPS

Legendary Auto Interiors, Ltd. "fitted" vinyl tops are manufactured to original specifications with the correct 100% cotton drill backing that gives trouble free installation and long term durability. All seams are double stitched and die-electrically heat-sealed insuring accurate deck width and seam durability. Each top is individually cut and fit for each specific year, make and model to give that perfect Legendary fit. Every Legendary vinyl top carries a (5) year factory warranty, the best in the industry!!

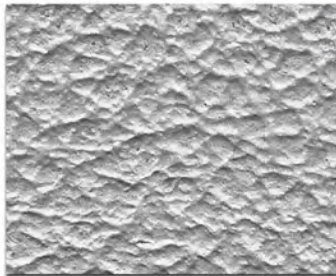

Levant Grain
(1966-67)

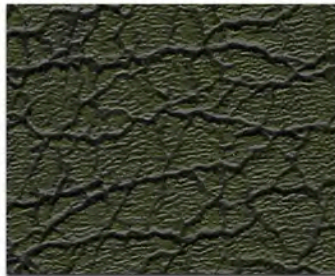

Boar Grain
(1967-74)

VINYL TOPS

1968-69 Javelin (Full top)

VTL24A01L (Black)\$279.00/ea.
VTL24A02L (White)\$279.00/ea.

☞ 1968-69 vinyl top models use Levant grain.

1970 Javelin (Full top)

VTL24A01 (Black)\$279.00/ea.
VTL24A02 (White)\$279.00/ea.

☞ 1970 vinyl top models use Boar grain.

1970 Rebel, Rebel SST, Rebel Machine

VTL26AR01 (Black)\$307.00/ea.
VTL26AR02 (White)\$307.00/ea.

1970 Javelin (1/2 top)

VTL25A01 (Black)\$224.00/ea.
VTL25A02 (White)\$224.00/ea.

☞ 1970 vinyl top models use Boar grain.

1971-72 AMX & Javelin (2-Piece)

VTL21A01 (Black)\$224.00/ea.
VTL21A02 (White) (shown)\$224.00/ea.

☞ 1971-72 vinyl top models use Boar grain.



1973-74 AMX & Javelin (Full top)



VTL20A01L (Black)\$279.00/ea.
VTL20A02L (White)\$279.00/ea.

☞ 1973-74 vinyl top models use Levant grain.



WEATHERSTRIPING AND ACCESORIES

 facebook.com/legendaryautointeriors
 twitter.com/legendaryautoin

 www.legendaryautointeriors.com
 instagram.com/legendaryautointeriorsltd
 youtube.com/user/legendaryauto

American Motors

DOOR WEATHERSTRIPPING



Thick molded rubber weatherstrip includes the necessary clips and correct molded endpads for an excellent fit. These pieces wrap around the bottom and sides of each door.

1968-74 AMX & Javelin
WS68A-AJDOOR.....\$135.00/pr.

1967-73 Rebel & Matador
WS67A-ARDOOR.....\$135.00/pr.

ROOF RAIL WEATHERSTRIPPING



Thick molded rubber with correct molded endpads. These start at the base of the windshield pillar post and follow along the outer edge of the roofline to the rear of the quarter window.

1968-70 AMX
WS68A-AROOF.....\$245.00/pr.

1968-70 Javelin
WS68A-JROOF.....\$ 99.00/pr.

1971-74 AMX & Javelin
WS71A-JROOF.....\$ 99.00/pr.

⚠ This weatherstripping is a replacement and is not exact to the original in shape or appearance.

TRUNK SEALS



Correct original profile extruded foam seals the trunk lid preventing water leaks.

1968-74 AMX & Javelin
TS68AAJ.....\$25.00/ea.

HOOD PAD INSULATION

Die-cut reproductions of the original hood insulation pads ready to install. Clips not included.

1968-70 AMX & Javelin
HP68AAJ (requires 14 clips).....\$27.00/ea.

1970 AMX & Javelin (with ram air hood)
HP70AAJ (requires 11 clips).....\$27.00/ea.

1971-74 AMX & Javelin NEW!!!
HP71AAJ (NO cowl induction).....\$27.00/ea.

HP71AAJ-CI (with cowl induction hood) . \$27.00/ea.

⚠ Both styles require 11 clips.

HOOD PAD CLIPS

Reproductions plastic hood pad clips for 1968-1974 models.



HPCLIP-P.....\$1.00/ea.

WINDOW SWEEP KITS

Reproduction window sweep kits consist of felt-lined pieces for sealing the side glass to the door or quarter panel. Reproduced as close to original as possible, each kit is model specific and includes the chrome or black metal backing strip. Available in 2 piece(outers only) and 4 piece complete kits for AMX models. 4 piece (outers only) and 8 piece complete kits for Javelin models.



1968-70 AMX
WS68WW50102 (2 pc.).....\$ 73.00/kit
WS68WW50604 (4 pc.).....\$116.00/kit
1968-70 Javelin
WS68WW50504 (4 pc.).....\$109.00/kit
WS68WW50008 (8 pc.).....\$154.00/kit

1971-74 AMX & Javelin
WS71WW51102 (2 pc.) (doors only)....\$ 73.00/kit
WS71WW51604 (4 pc.) (doors only)....\$116.00/kit
WS71WW51504 (4 pc.).....\$109.00/kit
WS71WW51008 (8 pc.).....\$154.00/kit

AMX/JAVELIN WEATHERSTRIPPING

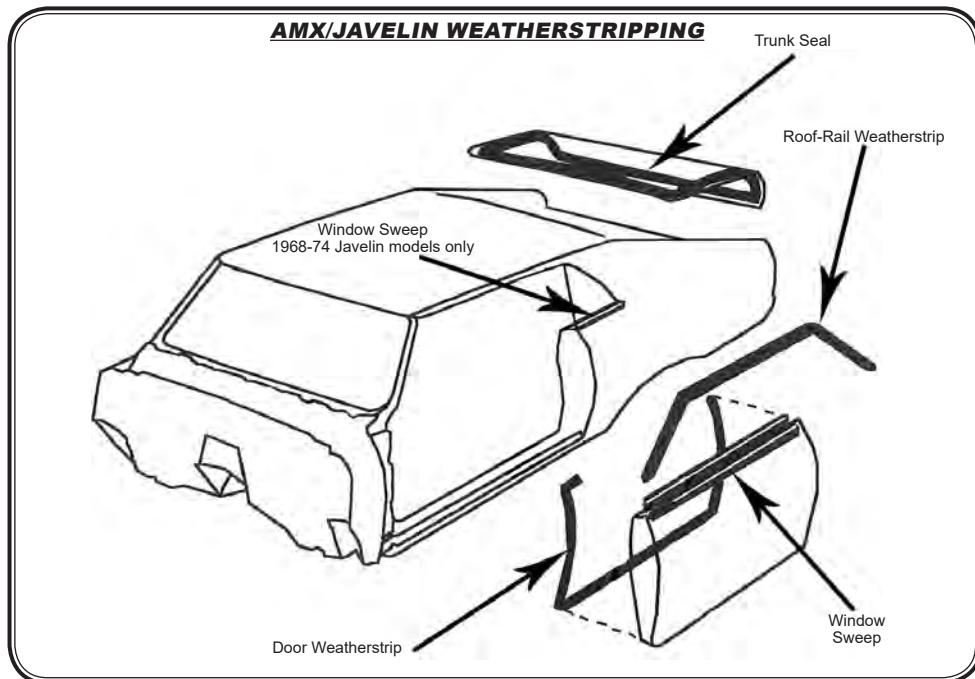

ORDERING INFORMATION

HOW TO ORDER

MAIL, PHONE OR FAXES – When ordering by mail, please fill in all information on the order form that pertains to your vehicle. Print all information and include a telephone number where you can be reached during the day and evening. When ordering for more than one vehicle, please use separate order forms for each vehicle (see order forms in your Legendary Auto Interiors catalog). When ordering by phone, please have your customer number and a list of items ready. You may order conveniently by phone 8:00AM to 6:00PM EST Monday-Friday. Orders may also be sent in by fax 24 hours a day, 7 days a week. Please note that orders faxed in on Saturday or Sunday will not be received and processed until Monday. FAX: 1-800-732-8874

ON-LINE ORDERING – Legendary Auto Interiors, Ltd also offers convenient and easy on-line ordering 24 hours a day, 7 days a week at www.legendaryautointeriors.com. Click on the “Shop Online” tab in the options menu and follow the ordering procedures. Upon completion, Legendary Auto Interiors, Ltd will follow up with an email confirmation so you can verify that your order has been received correctly and is being processed. You may also choose to email your orders by contacting our sales department at sales@legendaryautointeriors.com.

METHODS OF PAYMENT

CREDIT CARDS – Legendary Auto Interiors, Ltd accepts Visa, MasterCard, American Express and Discover for your convenience. Please include the cardholder’s name, billing address, home and business phone, credit card number, expiration date and the 3 or 4 digit security code when placing your orders. Without this information it may slow the processing of your order.

CHECKS AND MONEY ORDERS – Personal Checks will be held 5 business days. To expedite your orders, we suggest paying by Certified Bank Check or Money Order. COD orders are no longer accepted. All payments MUST be in U.S. funds.

SHIPPING SERVICES

DOMESTIC SHIPPING - Legendary Auto Interiors Ltd utilizes both UPS and FedEx Ground for most U.S. parcel shipments which provides our customers the most efficient and cost effective shipping services available. We will ship by the best method for your geographic area unless otherwise specified. We also offer specialized shipping services such as 3 day Select, 2nd day air and Next Day Air for your convenience.

INTERNATIONAL SERVICES – We use the most current and most cost effective international parcel shipping companies available to provide both “Door to Airport” and “Door to Door” services to our overseas customers. We utilize UPS Canadian and FedEx International for Canadian shipments. This provides us with the best possible shipping and brokerage fees for our international customers.

DAMAGES AND SHORTAGES

The carrier is responsible for any merchandise lost or damaged in transit. **Should a package appear to be damaged, OPEN the package while the carrier’s driver is present and note all damages and/or shortages.** If this is not possible and you discover damaged goods or shortages, contact our Customer Service Department immediately! Damages and/or shortage claims must be made within 5 days of receipt of merchandise to ensure our ability to file a claim with the carrier. Please be sure to check all merchandise when you receive it and again before attempting installation.

Legendary Auto Interiors, Ltd. is committed to providing the highest possible level of customer service, however on rare occasions circumstances beyond our control can result in lost or damaged packages. To protect our customers against delays and having to make time consuming phone calls to the carrier, orders will incur a modest \$2.50 insurance fee on each shipment. In the event any products become lost or damaged we will then send replacement parts as quickly as possible, subject to material availability. We will also file the claims and deal with the carrier.

Carriers allow a short period of time to file claims. To take advantage of this service you must notify Legendary Auto Interiors, Ltd. of any damages within 5 days of receiving your delivery. Failure to contact us within this 5 day window will negate Legendary Auto Interiors further involvement.

RETURN POLICY

Legendary Auto Interiors Ltd. will accept the return of products for a full refund or exchange up to 30 days from the original invoice date with no re-stocking fee. Returns after a 30 day period, but before 60 days will be subject to a 25% restocking fee. No returns will be accepted after 60 days. Custom, Special Orders, Specialty Run Materials, Leather and NOS are not eligible for return under any circumstances other than a manufacturing defect. If any product is modified, altered, painted, installed or disassembled in any way without Legendary’s expressed written permission, the item is non-returnable. Legendary always recommends professional installation on all products. Any item which has been altered, painted, installed or deemed non-resalable by Legendary will be returned to the customer at the customer’s expense. Legendary is not responsible or liable for labor fees associated with the installation, modification or repair of any product purchased regardless of the circumstances.

RETURN GOOD INFORMATION

All returns must receive prior approval and an RMA (Return Merchandise Authorization) number prior to return shipping. Packages received by Legendary Auto Interiors Ltd. without prior approval and RMA number will be refused. Return shipping and insurance are the customers responsibility. All returned items must be received in as new condition. Examples that render a product non-returnable include, but are not limited to: evidence of attempted installation, parts that have been bent, broken, creased, scratched, soiled, melted or discolored. Also, we will not accept returns for any items that have been altered, painted, repaired or for any reason that has rendered the product non-returnable. Warning: Legendary is not responsible for damaged or lost packages returned by the customer.

CANADIAN CUSTOMER RETURNS

Warranty returns must be clearly marked as follows: **“U.S. GOODS BEING RETURNED FOR REPAIR OR REPLACEMENT UNDER WARRANTY COMMODITY CODE 9801:00V0”.**

PRICES

All prices effective December 1st, 2015 and are subject to change without notice.

HOURS

Monday – Friday 8:00AM to 6:00PM (Eastern Standard Time)

Saturday - By appointment only please

IMPORTANT ADDITIONAL INFORMATION

WARRANTY INFORMATION

Legendary Auto Interiors, Ltd proudly stands behind all of the products and services we offer. All Legendary manufactured interior soft trim products are backed by an exclusive **Limited Lifetime Warranty** for as long as you own your car. In addition, we offer a 5-year warranty on all of our molded and exterior soft trim products. Legendary Auto Interiors, Ltd also offers a huge selection of interior components, which we warranty for a minimum of 1 year in accordance with the original manufacturers product warranty. **Product Disclaimer: Normal wear from use or problems due to improper installation are excluded from any warranty.**

LEGENDARY GUARANTEE

All Legendary Auto Interiors, Ltd manufactured products are made to original specifications and are guaranteed to fit. In the event that you experience a problem with any of our products or are dissatisfied with our service, we will make every effort to resolve and correct your issue promptly and do our best to make sure that you are completely satisfied.

INTERIOR COLORS/GRAINS

Legendary Auto Interiors, Ltd offers one of the most diverse product lines available in the marketplace. We feature the correct "color matched" and "grain matching" materials for nearly all models and styles. Due to the extensive number of colors produced by Chrysler, AMC and General Motors, there are some colors, which are simply not available in reproduction form. As the demand for colors increases, we are constantly having previously unavailable colors reproduced. In the event that a vinyl or cloth is not available in reproduction form, the use of NOS material may be required. Please inquire for a current quote, as the price and availability of these NOS materials will vary. To ensure a correct color and grain match, your interior trim code may be required for verification. As color dye lots will vary, we recommend purchasing all your soft trim components at the same time to ensure an exact color match of all components throughout your interior. **Color and grain samples are available upon request at no charge.**

LEATHER INTERIORS

Legendary Auto Interiors, Ltd produces a large number of "as original" leather interiors that are color matched to the original. Special order custom leather interiors are also available upon request. Some applications may require a clean, non-faded sample to ensure the closest possible color match. Leather interior orders may require additional lead-time as well as additional costs, which will be quoted at time of your order. **Note: Due to the variable nature of real leather, minor marks and features are normal and add to the character & individuality of leather products.**

CUSTOM ORDERS

In addition to "As Original" reproduction interiors, Legendary Auto Interiors, Ltd specializes in and is proud to feature "CUSTOM" interiors servicing the Resto-Mod enthusiast. With the introduction of our new & exclusive *Legendary* product, custom orders have taken on an entirely new look and have given enthusiasts almost limitless options to create a one of a kind interior. Special Order and Custom interiors require approval for all designated materials being used and a signature approval on a "Custom Order" form is also required. Once the Custom work has been approved these orders must be prepaid and are Non-Returnable, Non-Refundable and Non-Cancelable.

INSTALLATION NOTES

Since age deteriorates certain areas of seats due to wear patterns and foam breakdown, certain adjustments and foam repair may be required to complete a perfect fit installation. For this reason, we recommend having a professional automotive interior trim/upholstery shop install your new Legendary Auto Interiors, Ltd soft trim products. As the manufacturer, we know how to install our products better than anyone and we offer complete installation services for both seat upholstery and door panels. For further information, see the **INSTALLATION GUIDE** included with your seat upholstery and door panels or the installation page of this catalog.

PRODUCT DEVELOPMENT & PATTERNS NEEDED

In an effort to develop new upholstery kits, door panels and other soft trim products we work hand in hand with many of our customers who provide their original parts for product development. These items must be ORIGINAL, in fair to good condition and have not been previously repaired or replaced in any way. Our Sales Department must be contacted directly before sending your old upholstery or other soft trim products to us. Since we have no idea about the usability of your parts until we receive them in, you may initially be asked to send photos in an effort to identify the condition of your original parts. Please remember that even if you send in your parts for inspection, we may not be able to use them. **PLEASE NOTE THAT OLD UPHOLSTERY AND OTHER SOFT TRIM ITEMS CANNOT BE RETURNED TO YOU, AS THEY WILL BE DISMANTLED FOR DEVELOPMENT USE.**

MAINTENANCE

All Legendary Auto Interiors, Ltd products may be cleaned with a mild soap and warm water solution. Never scrub or use any kind of harsh pads, brushes or detergents. After cleaning with mild soap and water, lightly clean again with an industrial grade wax and grease remover. (Contact your local auto parts store) Allow surface to dry. LIGHTLY mist with the vinyl protectant of your choice. Install your new parts into your cruising machine. Sit back, enjoy the ride and drive safely!! Note: On leather upholstery applications we recommend using a high-quality mink oil, neatsfoot oil and/or wax. Hand apply, let stand 30-60 minutes and then wipe /buff clean. LIGHTLY rub your soft trim product with oil and wipe excess oil from the surface. **DO NOT USE SILICONE BASED PRODUCTS** as they will deteriorate the thread and dry out leather.

INSTALLATION SERVICES

GM, CHRYSLER & AMC SEAT UPHOLSTERY

(Includes tear down of original upholstery and installation of new upholstery)



Front Buckets Install - \$400.00/pr.
(No Headrest Covers)



Front Buckets w/ Headrest Covers Install - \$500.00/pr.



Front Split Bench Install - \$475.00/ea.



Front Split Bench w/ Headrest Covers Install - \$575.00/ea.



Rear Bench Seat Install - \$300.00/ea.



Headrest Covers Install - \$150.00/pr.

Center Armrest Install - \$150.00/ea.
(for models w/ buckets and no console)



SAVE ON COMPLETE FRONT & REAR INSTALLS!!

Front Buckets & Rear Bench Seat Install - \$650.00/set

Front Buckets w/ Headrest Covers & Rear Bench Seat Install - \$750.00/set

Front Split Bench & Rear Bench Seat Install - \$725.00/set

Front Split Bench w/ Headrest Covers & Rear Bench Seat Install - \$825.00/set

**NOTE* Basic installations DO NOT include new foam and cotton replacement or reconstruction, media blasting, painting, welding, frame straightening, polishing or trim detailing. These services are additional and available at an hourly rate. Please call for more details. 1-800-363-8804*

INSTALLATION SERVICES

GM, CHRYSLER & AMC DOOR PANELS

Basic Door Panel Installation

(Includes installation of metal rails and window weatherstrip)

**Convertible rear panel installation DOES NOT include ashtray/well covers*

**Ashtray/well covers for General Motors models are available. Call for details*



Front Panels (Pair Only) - \$200.00/pr.



Hardtop/Convertible Rear Panels (Pair Only) - \$200.00/pr.

Complete Front & Rear Panels (Pairs Only) - \$350.00/pr.

Deluxe Door Panel Installation

(Includes installation of metal rails, window weatherstrip, metal trim and decorative emblems)

**Convertible rear panel installation DOES NOT include ashtray/well covers*

**Ashtray/well covers for General Motors models are available. Call for details*



Front Panels (Pair Only) - \$350.00/pr.



Hardtop/Convertible Rear Panels (Pair Only) - \$250.00/pr.

Complete Front & Rear Panels (Pairs Only) - \$550.00/pr.

DOOR PANEL REFURBISHMENT

If we do not list your particular year/make/model vehicle, Legendary Auto Interiors, Ltd. can refurbish your panels back to original for you. The following refurbishing rates include installation of new panels (on your original metal rails), inner window weatherstripping, metal trim and decorative emblems. Please call for instructions before shipping your door panels.

Front Panels (Pair Only) - \$635.00/pr.

Hardtop/Convertible Rear Panels (Pair Only) - \$423.00/pr.

Complete 2-Door Front & Rear Panels (Pairs Only) - \$1055.00/set

Complete 4-Door Front & Rear Panels (Pairs Only) - \$1055.00/set

**NOTE* Custom refurbishing does not include the refinishing of metal trim and decorative emblems. We highly recommend this work is done before sending the panels.*

SHIPPING/HANDLING RATE CHART

Order Value \$	Flat Rate	Oversize Charges	Rate
.01-40	\$8	OS1	\$20
41-100	\$17	OS2	\$39
101-200	*\$32	OS3	\$56
201-400	*\$37	Insurance	*\$3.50
401-600	*\$59		
601-800	*\$86		
801-1000	*\$104		
1001-1250	*\$130		
1251-1500	*\$164		
1501-1850	*\$196		
1851-2100	*\$224		
2101-2500	*\$252		
2501-3000 up	*\$279		

*Includes \$3.50 for insurance

*On all orders over \$100

*NYS Customers - Sales tax will be added

*AK, HI, PR & International customers call for shipping

*Next Day, 2nd Day & 3 Day Select shipping, please call for rates

Oversize Items	Classification
Package Tray	OS1
Trunk Divider	OS1
Plastic Door Panels	OS1
Pre-Assembled Door Panels	OS1
2nd Gen F-Body Door Panels	OS1 
Consoles	OS1
Bucket Molded Foam	OS1
Install Kits 2-5	OS1

Oversize Items	Classification
Molded Headliners	OS3
Molded Hood Pads	OS3
Pick Up Seat Back Kits	OS3 
GM Bench Seat Foam	OS3
E-Body Dash Pads/Caps	OS3
Trunk Packages	OS3

Oversize Items	Classification
C-Body Carpet Kits	OS2
Fastback Carpet Kits	OS2
Carpet Yardage	OS2 
Sound Dampeners	OS2
Firewall Insulation	OS2
Convertible Glass	OS2

2020 TENTATIVE SHOWS AND DATES

*Indy Cylinder Head
Charlotte Auto Fair
Spring Carlisle
Mopars in the Park
Chryslers @ Carlisle
Tri Power Nationals
Mopar Nationals
Mopar Fest
Pure Stock Drags
Fall Carlisle
SEMA*

*Indianapolis, IN
Concord, NC
Carlisle, PA
Stillwater, MN
Carlisle, PA
Norwalk, OH
Columbus, OH
New Hamburg, ON
Stanton, MI
Carlisle, PA
Las Vegas, NV*

*March 7 - 8, 2020
April 2 - 5, 2020
April 22 - 26, 2020
May 29 -31, 2020
July 10 - 12, 2020
July 31 - August 2, 2020
August 7 - 9, 2020
August 15 - 16, 2020
September 18 - 19, 2020
September 30 - 4, 2020
Nov. 3 - 6, 2020*

Legendary Auto Interiors Ltd. welcomes the opportunity to support the smaller clubs' and organizations' car shows and swap meets. A variety of flyers, catalogs and gift certificates are available to clubs and organizations who sponsor shows nationwide. Please call or write for additional information. The list above is a tentative schedule subject to change without notice. Come visit us at many car shows/swap meets and see what makes a Legendary interior... truly Legendary.



Legendary
AUTO INTERIORS LTD.

Table of Contents

SEAT UPHOLSTERY & TRIM ACCESORIES B1-B12

Bucket Seat Foam	B11
Installation Kits	B12
Molded Foam	B11
Upholstery	B2-B10

DOOR PANELS & TRIM ACCESORIES B13-B16

Door Panels	B14-B16
Door Panel Clips	B16
Door Panel Watershields	B16

CARPETS, FLOORMATS & ACCESORIES B17-B22

Carpet	B22
Carpet Color Selector	B20-B21
Carpet Yardage	B22
Firewall Insulation	B22
Floormats (Carpet)	B22
Floormats (Original)	B22
Jute Paddding	B22
Sound Deadener	B22

DASHES, CONSOLES, SHIFTERS & ACCESORIES B23

Dash Inserts	B23
Glovebox Liners	B23
Steering Column Seal	B23
Underdash Insulation	B23
Woodgrain Console Inserts	B23

SUNVISORS B24

PACKAGE TRAY & TRUNK ACCESORIES B25-B27

Package Trays & Insulation	B26
Sail Panel Boards	B26
Spare Tire Cover	B27
Trunk Divders	B27
Trunk Floor Filler Boards	B27
Trunk Mats	B27
Trun Mat Material	B27

VINYL TOPS B28

WEATHERSTRIPPING & ACCESORIES B29-B30

Door Weatherstripping	B30
Hood Pad Clips	B30
Hood Pad Insulation	B30
Roof Rail Weatherstripping	B30
Trunk Seals	B30
Window Sweep Kits	B30

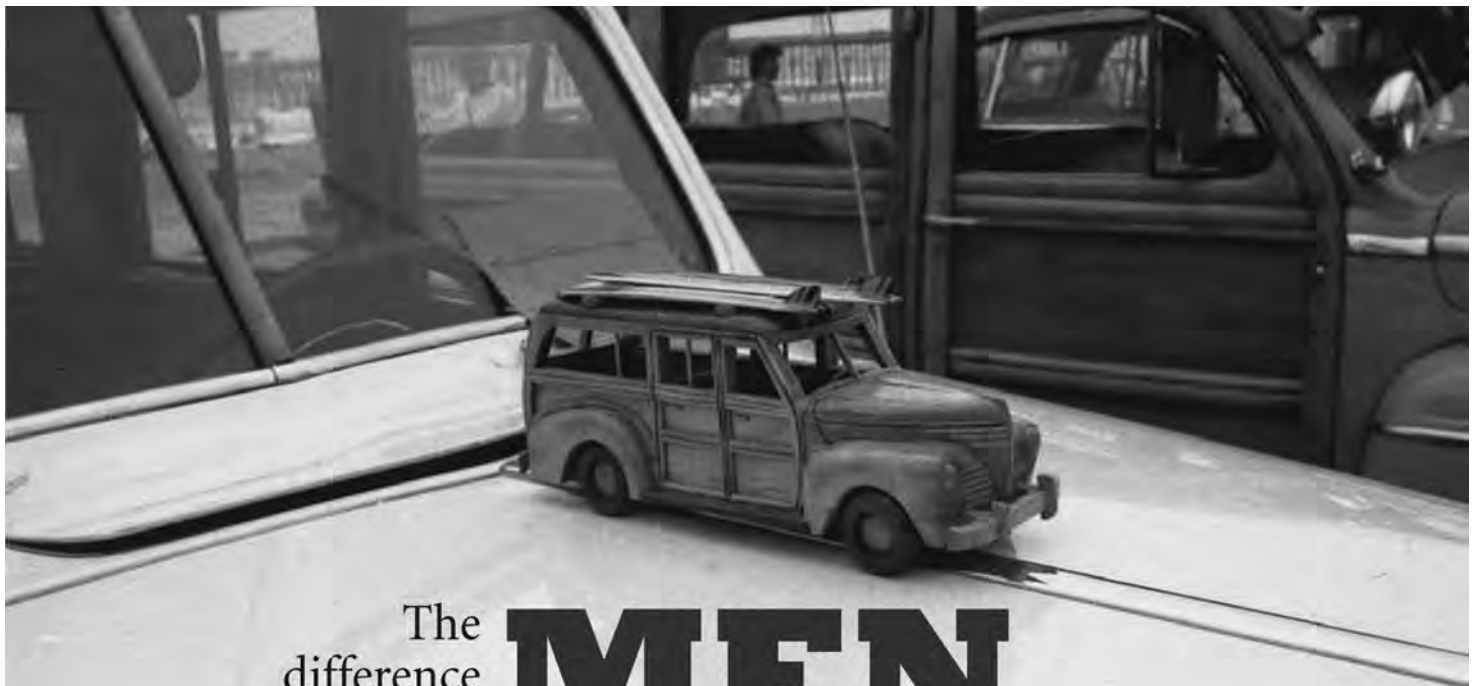

The
difference
between

MEN

& Boys

*is the size of
their toys!*

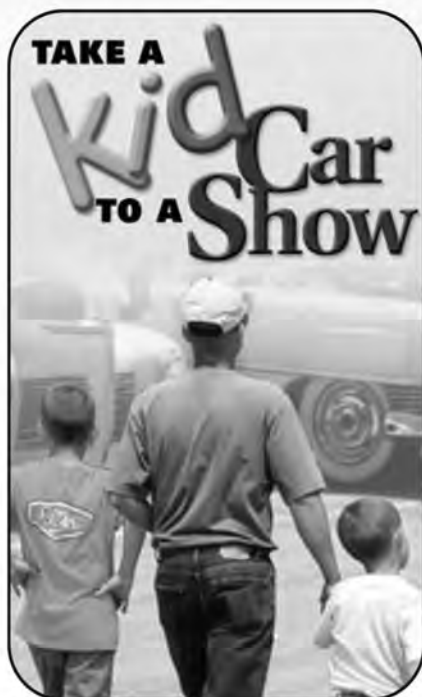

Even if there is a generation or two between you and a child, collector cars can be a terrific common ground. Your enthusiasm and knowledge could be the spark of a new lifelong passion. Bring kids to *your* playground...a car show...and have fun.

Life is full of choices for kids. You can help them make the right ones by sharing your appreciation for cool old cars. (And a kid might even call you “cool” too!)



For more information and a list of upcoming automotive events, visit our website:
www.TakeAKidToACarShow.com

909/396-0289 • tkcs@sema.org

Take a Kid to a Car Show is a program of ARMO, the Automotive Restoration Market Organization, a SEMA Council.



OVER 225 DIFFERENT INTERIOR STYLES OFFERED FOR CHRYSLER & AMC

1957-76 MOPAR A,B,C,E & F-BODY, 1963-68 DODGE A-100 VAN
1973-79 DODGE TRUCK & 1968-74 AMC JAVELIN/AMX

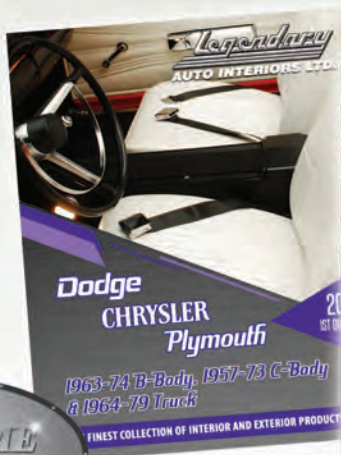

WWW.LEGENDARYAUTOINTERIORS.COM





LEGENDARY AUTO INTERIORS

WWW.LEGENDARYAUTOINTERIORS.COM

1-800-363-8804

 facebook.com/legendaryautointeriors

 instagram.com/legendaryautointeriorsltd

 twitter.com/legendaryautoin

 youtube.com/user/legendaryauto

PREFERRED CHOICE OF RESTORERS WORLDWIDE