

**STANDARDS MANUAL FOR DRAINAGE DESIGN  
AND FLOODPLAIN MANAGEMENT  
IN TUCSON, ARIZONA**

**DECEMBER, 1989**  
*(REVISED JULY, 1998)*



*Prepared for*  
*City of Tucson*  
*Department of Transportation*  
*Engineering Division*

*Prepared by*  
*Simons, Li & Associates, Inc.*

**STANDARDS MANUAL FOR DRAINAGE DESIGN  
AND FLOODPLAIN MANAGEMENT  
IN TUCSON, ARIZONA**

**PREPARED FOR  
CITY OF TUCSON  
DEPARTMENT OF TRANSPORTATION,  
ENGINEERING DIVISION**

**PREPARED BY  
SIMONS, LI & ASSOCIATES, INC.**

**DECEMBER, 1989**  
*REVISED JULY, 1998*

## ACKNOWLEDGEMENTS

This Manual was prepared for the City of Tucson Department of Transportation, Engineering Division, by Simons, Li & Associates, Inc. (SLA). The contract was under the direction of Mr. Benny J. Young, P.E., City Engineer, and Mr. James A. Turner, P.E., R.L.S., Deputy Chief Engineer. The Project Manager for the City of Tucson was Mr. Ray A. Brown, P.E. The Project Principal for SLA was Mr. Michael E. Zeller, P.E., P.H., and the Project Manager was Mr. Robert J. Smolinsky, P.E. Other contributing authors at SLA were Mr. Philip O. Lowe, P.E., Mr. Justin M. Turner, P.E., and Mr. Robert L. Shand, P.E.

The Authors would like to extend their appreciation to the City of Tucson staff, who provided input and thoughtful review of the Manual throughout its development. Among those who contributed were Mr. Yash D. Desai, P.E., Mr. H.P. Shiao, P.E., Mr. Charles Chung, P.E., Mr. Joe Hatch, P.E., and Mr. Rob Emmett.

A special thanks is also given to Sally Adams of SLA for her tireless efforts in the editing, word processing, and formatting of this Manual, and to Jan Smolinsky of SLA for her technical support with the word-processing software.

December, 1989

October 24, 1997

**Attention:** All Users of the "Standards Manual for Drainage Design and Floodplain Management in Tucson, Arizona" (Standards Manual)

**Subject:** (1) New and Revised Hydrologic Procedures for Estimating Flood Peaks within the City of Tucson  
(2) New Balanced and Critical Basin Map for the City of Tucson  
(3) Threshold Retention Requirements and Stormwater Harvesting

Dear Manual Users:

Chapter IV ("City of Tucson Method for Estimating Flood Peaks and Flood Hydrographs") and Chapter XIV ("Detention/Retention Basins") of the Standards Manual have been revised. In addition, the "Table of Contents," "List of Tables," "Glossary," "List of Symbols," "References and Selected Bibliographies," and "Index" sections of the Standards Manual have been updated to reflect the revisions to Chapters IV and XIV. Please replace the appropriate pages of your Standards Manual with the enclosed revisions.

The revisions to Chapter IV were necessary in order to bring the existing procedures in conformance with the City of Tucson's recent adoption of new hydrologic procedures which are the result of the regional hydrologic modeling that was completed during the formulation of the Tucson Stormwater Management Study (TSMS), Phase II, Stormwater Master Plan. The City-wide hydrologic modeling has produced peak flow rates and flood hydrographs which can be utilized for purposes of drainage design and floodplain management at many locations throughout the City. Please check with the City's Stormwater Section (791-4372) for information regarding the hydrologic modeling. Specific guidelines have been enclosed that describe the conditions under which the TSMS hydrologic data can be used. Additional information is available on the TSMS web site at [www.ci.tucson.az.us/transport/stormwater/index.html](http://www.ci.tucson.az.us/transport/stormwater/index.html).

It is the preference of the City of Tucson that TSMS hydrologic data be used, where practicable, in lieu of the procedures presented within Chapter IV of the Standards Manual. For areas where the hydrologic modeling is not available, or not appropriate for site-specific applications, the revised procedures within Chapter IV can be used to calculate peak flow rates which will be consistent with TSMS hydrologic modeling results.

The TSMS hydrologic modeling was approved by the Federal Emergency Management Agency (FEMA) on May 12, 1996, for use with all watersheds within the City except for the largest two—the Airport Wash and Julian Wash watersheds. The TSMS hydrologic modeling for the Airport Wash and Julian Wash watersheds was approved by FEMA on October 10, 1997.



The new "Balanced and Critical Basin" map (enclosed) shows the watersheds which have been designated as Balanced or Critical Basins within the City limits. For those watersheds which have not been designated as either balanced or critical, detention/retention requirements may be waived for new development provided new or existing local stormwater-conveyance facilities can safely release and convey the increased onsite runoff without increasing flood hazards to adjacent properties. Chapter XIV of the Standards Manual has been updated to reflect these changes. For site-specific applications, check with the City Engineering Division (791-4914).

Requirements for retention were included within the Floodplain and Erosion Hazard Regulations Ordinance adopted by Mayor and Council in 1990. However, compliance with the Threshold Retention requirements has previously been waived, since reliable maps were not available which showed Balanced and Critical Basins. Compliance with these Threshold Retention requirements, which are described in the Stormwater Detention/Retention Manual, is now required.

In addition, Mayor and Council has directed the City Engineer's office to require new developments to utilize stormwater harvesting to the maximum extent reasonably possible. The volume utilized for stormwater harvesting may be used to offset the volume required for Threshold Retention. Stormwater harvesting has been added as Design Policy #10 in Chapter XIV of the Standards Manual. For site-specific requirements, check with the City Engineering Division (791-4914).

For those watersheds designated as Critical Basins, a 15% reduction in the 2-, 10-, and 100-year flow events will be required as a fair and equitable apportioning increment. The 15% reduction is consistent with requirements currently being imposed by Pima County.

Very truly yours,

G. Dewayne Tripp, P.E.  
City Engineer

Enclosures: Revised portions of Standards Manual  
Conditions of Use, TSMS Hydrologic Data  
Balanced and Critical Basin Map for City



# CITY OF TUCSON

The Sunshine City

P.O. BOX 27210  
TUCSON, ARIZONA 85726-7210

DEPARTMENT OF TRANSPORTATION  
ENGINEERING DIVISION  
(520) 791-4251  
FAX: (520) 791-4238

July 29, 1998

**Attention:** All Users of the "Standards Manual for Drainage Design and Floodplain Management in Tucson, Arizona" (Standards Manual)

**Subject:** (1) New and Revised Hydrologic Procedures for Estimating Flood Peaks within the City of Tucson  
(2) New Balanced and Critical Basin Map for the City of Tucson  
(3) Threshold Retention Requirements and Stormwater Harvesting

Dear Manual Users:

Chapter IV ("City of Tucson Method for Estimating Flood Peaks and Flood Hydrographs") and Chapter XIV ("Detention/Retention Basins") of the Standards Manual have been revised. In addition, the "Table of Contents," "List of Tables," "Glossary," "List of Symbols," "References and Selected Bibliographies," and "Index" sections of the Standards Manual have been updated to reflect the revisions to Chapters IV and XIV. Please replace the appropriate pages of your Standards Manual with the enclosed revisions.

The revisions to Chapter IV were necessary in order to bring the existing procedures in conformance with the City of Tucson's recent adoption of new hydrologic procedures which are the result of the regional hydrologic modeling that was completed during the formulation of the Tucson Stormwater Management Study (TSMS), Phase II, Stormwater Master Plan.

The City-wide hydrologic modeling has produced peak flow rates and flood hydrographs which can be utilized for purposes of drainage design and floodplain management at many locations throughout the City. Please check with the City's Stormwater Section (791-4372) for information regarding the hydrologic modeling. Specific guidelines have been enclosed that describe the conditions under which the TSMS hydrologic data can be used. Additional information is available on the City of Tucson's TSMS web site at [www.ci.tucson.az.us/transport/stormwater/index.html](http://www.ci.tucson.az.us/transport/stormwater/index.html).

It is the preference of the City of Tucson that TSMS hydrologic data be used, where practicable, in lieu of the procedures presented within Chapter IV of the Standards Manual.

For areas where the hydrologic modeling is not available, or not appropriate for site-specific applications, the revised procedures within Chapter IV can be used to calculate peak flow rates which will be consistent with TSMS hydrologic modeling results.

The TSMS hydrologic modeling was approved by the Federal Emergency Management Agency (FEMA) on May 12, 1996, for use with all watersheds within the City except for the largest two—the Airport Wash and Julian Wash watersheds. The TSMS hydrologic modeling for the Airport Wash and Julian Wash watersheds was approved by FEMA on October 10, 1997.

July 29, 1998

The new "Balanced and Critical Basin" map (enclosed) shows the watersheds which have been designated as Balanced or Critical Basins within the City limits. For those watersheds which have not been designated as either balanced or critical, detention/retention requirements may be waived for new development provided new or existing local stormwater-conveyance facilities can safely release and convey the increased onsite runoff without increasing flood hazards to adjacent properties. Chapter XIV of the Standards Manual has been updated to reflect these changes. For site-specific applications, check with the City Engineering Division (791-4914).

Requirements for retention were included within the Floodplain and Erosion Hazard Regulations Ordinance adopted by Mayor and Council in 1990. However, compliance with the Threshold Retention requirements had previously been waived, since reliable maps were not available which showed Balanced and Critical Basins. Compliance with these Threshold Retention requirements, which are described in the Stormwater Detention/Retention Manual, is now required.

In addition, Mayor and Council has directed the City Engineer's office to require new developments to utilize stormwater harvesting to the maximum extent reasonably possible. The volume utilized for stormwater harvesting may be used to offset the volume required for Threshold Retention. Stormwater harvesting has been added as Design Policy #10 in Chapter XIV of the Standards Manual. For site-specific requirements, check with the City Engineering Division (791-4914).

For those watersheds designated as Critical Basins, a 15% reduction in the 2-, 10-, and 100-year flow events will be required as a fair and equitable apportioning increment. The 15% reduction is consistent with requirements currently being imposed by Pima County.

Very truly yours,

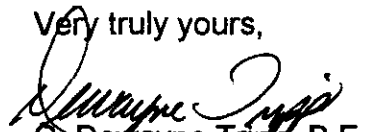

G. Dewayne Tripp, P.E.  
City Engineer

Enclosures: Revised portions of Standards Manual  
Conditions of Use, TSMS Hydrologic Data  
Balanced and Critical Basin Map for City

**Tucson Stormwater Management Study (TSMS)  
Hydrologic Data**

**CONDITIONS OF USE**

Regional hydrologic modeling has been performed for the City of Tucson for the purpose of developing the TSMS Stormwater Master Plan. The TSMS hydrologic modeling was accomplished using the Stormwater System Planner, a software package which includes a database manager, the HEC-1 hydrologic model, and an AutoCAD mapping component. The Stormwater System Planner allows the user to create a customized HEC-1 input file for hundreds of locations throughout the City based upon the hydrologic data that are stored within the database. These HEC-1 input files, along with summary information related to the hydrologic modeling, are available from the Stormwater Section by calling 791-4372.

The TSMS hydrologic modeling was performed for the purpose of regional stormwater planning, and not for site-specific applications involving flood-control design or floodplain mapping. Neither the City of Tucson nor the consultants who developed the software package warrant the accuracy of the input data or the HEC-1 modeling results. It is the sole responsibility of the users of the TSMS hydrologic data to confirm that the TSMS input and output data are reasonable for use with more detailed, site-specific applications. This can be accomplished using the following general step-by-step procedure:

- Step 1: Collect the basic data, including HEC-1 input files, 200-scale watershed maps, watershed summary report, and routing-reach modeling report.
- Step 2: Review the watershed summary report and 200-scale watershed maps for each individual subwatershed to determine if estimated land uses are appropriate. During formulation of the Stormwater Master Plan, land uses were determined using 1983, 200-scale aerial topographic maps and 1990, 400-scale aerial photos.
- Step 3: Review the watershed summary report and 200-scale watershed maps to determine if the standard values for noncontributing area are appropriate for each individual land use (see Standards Manual, Chapter IV). The City Engineer will require sufficient supporting data, in the form of an analysis of aerial photos and field verification (as necessary), for the values of the noncontributing areas.
- Step 4: Review the routing-reach modeling report. Each routing reach utilizes one typical cross-section. Compare the geometry of the cross-section versus more recent or more detailed topographic information. The TSMS cross-sections were based on the 1983, 200-scale aerial topographic maps.
- Step 5: Determine if the regulatory (100-year) peak flow rates are reasonable. This can be accomplished by comparing the results to regional regression equations and gauge data, if available.

## TABLE OF CONTENTS

	<u>Page</u>
LIST OF FIGURES .....	xi
LIST OF TABLES .....	xv
GLOSSARY .....	xvii
LIST OF SYMBOLS .....	xxvii
CHAPTER I.           INTRODUCTION	
1.1   Objectives .....	1.01
1.2   Applicability .....	1.02
1.3   General Policies .....	1.02
1.4   Implementation .....	1.05
1.4.1   Subdivision Assurances .....	1.05
1.4.2   Private Improvement Agreement .....	1.05
1.4.3   Public Improvement District .....	1.06
1.4.4   Private Drainage Improvements .....	1.06
1.5   Maintenance of Drainage Improvements .....	1.06
1.5.1   Maintenance of Drainageways .....	1.07
1.5.2   Maintenance of Detention/Retention Basins .....	1.08
CHAPTER II.           POLICIES, PROCEDURES, AND FORMATS FOR DRAINAGE REPORTS, HYDROLOGY REPORTS, AND DRAINAGE STATEMENTS	
2.1   Introduction .....	2.01
2.1.1   Drainage Report .....	2.01
2.1.2   Hydrology Report .....	2.01
2.1.3   Drainage Statement .....	2.01
2.2   Conditions Requiring Report or Data Submittal .....	2.02
2.2.1   Rezoning Applications .....	2.02
2.2.2   Subdivision Plats and Development Plans .....	2.02
2.2.3   Application for a Building Permit or a Grading Permit .....	2.03
2.2.4   Condominium Conversions .....	2.03
2.2.5   Floodplain Use Permits .....	2.04
2.2.6   Request for Map Revision .....	2.04
2.3   Report Content and Format .....	2.05
2.3.1   Drainage Reports and Hydrology Reports .....	2.05
2.3.1.1   Cover Sheet .....	2.05
2.3.1.2   Introduction .....	2.06
2.3.1.3   Hydrology .....	2.07
2.3.1.4   Floodplain Analyses and Results .....	2.09
2.3.1.5   Hydraulic Improvements and Hydraulic Structures .....	2.11
2.3.1.6   Detention Basins and/or Retention Basins .....	2.12

## TABLE OF CONTENTS--Continued

		<u>Page</u>
	2.3.1.7 Summary and Conclusions . . . . .	2.14
	2.3.1.8 References . . . . .	2.15
	2.3.1.9 Appendices . . . . .	2.15
	2.3.2 Drainage Statement . . . . .	2.15
2.4	Quality of Submittals . . . . .	2.15
<b>CHAPTER III. PLANNING</b>		
3.1	Drainage Sub-System . . . . .	3.01
3.2	Drainage Master Planning . . . . .	3.01
3.3	Balanced and Critical Basins . . . . .	3.02
3.4	Flood Plains and Floodways . . . . .	3.03
3.5	Transportation . . . . .	3.04
<b>CHAPTER IV. CITY OF TUCSON METHOD FOR ESTIMATING FLOOD PEAKS AND FLOOD HYDROGRAPHS</b>		
4.1	Purpose . . . . .	4.01
4.2	Flood Peak Estimator Procedure . . . . .	4.01
	4.2.1 Step-by-Step Procedure for Estimating Flood Peaks . . . . .	4.02
4.3	Selection of Basin Factors ( $n_{b100}$ 's) . . . . .	4.10
	4.3.1 Procedure for Determination of Weighted Basin Factors ( $n_{bw100}$ 's) . . . . .	4.11
	4.3.2 Guidelines for Determination of Dispersed-Flow Watersheds and Underfit Channels When Computing a 100-Year Flood . . . . .	4.14
4.4	Calculating Times of Concentration for Frequent Floods . . . . .	4.16
4.5	Development of a Flood Hydrograph . . . . .	4.16
<b>CHAPTER V. FLOODPLAIN DELINEATION</b>		
5.1	Purpose . . . . .	5.01
5.2	Policies . . . . .	5.01
5.3	Analytical Procedures for Evaluating Floodplain Widths and Depths in Channels with Uniform Hydraulic Roughness . . . . .	5.02
	5.3.1 Normal Flow Depth . . . . .	5.02
	5.3.2 Backwater Flow Depth . . . . .	5.03
5.4	Analytical Procedures for Evaluating Floodplain Widths and Depths in Channels with Composite Hydraulic Roughness . . . . .	5.03
	5.4.1 Composite Channels . . . . .	5.03
	5.4.2 Manning Roughness Coefficients . . . . .	5.04
5.5	City of Tucson Requirements for Evaluating Flood Plains and Floodways Subject to Agency Review . . . . .	5.05
	5.5.1 Floodplain Delineations . . . . .	5.05
	5.5.2 Floodway Delineations . . . . .	5.07

## TABLE OF CONTENTS--Continued

	<u>Page</u>
5.6 Administrative Procedures for Revising Effective Flood Insurance Rate Maps . . . . .	5.08
5.6.1 Federal Flood Insurance Rate Maps . . . . .	5.08
5.6.2 Map Amendments and Revisions . . . . .	5.08
 CHAPTER VI.       EROSION AND SEDIMENTATION	
6.1 Introduction . . . . .	6.01
6.2 Purpose . . . . .	6.01
6.3 Fluvial Geomorphology . . . . .	6.01
6.3.1 Channel Morphology . . . . .	6.02
6.3.1.1 Hydraulic Geometry of Alluvial Channels . . . . .	6.02
6.3.1.2 Influence of Sediment Load . . . . .	6.02
6.4 Sediment-Transport Theory . . . . .	6.03
6.5 Sediment Routing . . . . .	6.04
6.5.1 Simplified Sediment Modeling . . . . .	6.04
6.5.2 Quasi-Dynamic Sediment Modeling . . . . .	6.06
6.5.3 Dynamic Mathematical Modeling . . . . .	6.07
6.6 Depth of Scour . . . . .	6.07
6.6.1 General Scour . . . . .	6.08
6.6.2 Anti-Dune Trough Depth . . . . .	6.09
6.6.3 Low-Flow Thalweg . . . . .	6.09
6.6.4 Bend Scour . . . . .	6.11
6.6.5 Local Scour . . . . .	6.13
6.6.6 Scour Below Channel Drops . . . . .	6.18
6.7 Scour-Hole Geometry at Culvert Outlets . . . . .	6.20
6.8 Design of Sediment Basins . . . . .	6.28
6.9 Equilibrium Slopes within Constructed Channels . . . . .	6.31
6.10 Spacing and Depth of Grade-Control Structures . . . . .	6.34
 CHAPTER VII.      EROSION-HAZARD/BUILDING-SETBACK CRITERIA	
7.1 Introduction . . . . .	7.01
7.2 Purpose . . . . .	7.01
7.3 Applicability . . . . .	7.01
7.4 Policies . . . . .	7.02
7.5 Erosion Resistance of Unlined Channels . . . . .	7.02
7.5.1 Allowable-Velocity Approach . . . . .	7.02
7.5.2 Tractive-Stress Approach . . . . .	7.04
7.5.3 Tractive-Power Approach . . . . .	7.15
7.5.4 Effect of Vegetation upon Channel Stability . . . . .	7.18
7.6 Setbacks . . . . .	7.18
7.6.1 Equations to Compute Setbacks . . . . .	7.18
7.6.2 Sediment Supply Rates/Transport Capacity . . . . .	7.21

## TABLE OF CONTENTS--Continued

	<u>Page</u>
7.6.3 Bank Sloughing/Slope Stability .....	7.22
7.6.4 Detailed Sediment-Transport Analysis .....	7.23
7.6.5 Drainage Swales, Roads, and P.A.A.L.'s .....	7.23
CHAPTER VIII. OPEN-CHANNEL DESIGN	
8.1 Purpose .....	8.01
8.2 Introduction .....	8.01
8.3 Requirements for Natural Channels .....	8.01
8.4 Floodplain Encroachments .....	8.02
8.5 Constructed Channels .....	8.03
8.5.1 Channel Geometry .....	8.03
8.5.1.1 Side-Slopes .....	8.04
8.5.1.2 Width .....	8.04
8.5.1.3 Depth .....	8.05
8.5.1.4 Freeboard .....	8.07
8.5.2 Safety Considerations .....	8.08
8.5.3 Right-of-Way .....	8.08
8.5.4 Bank-Protection Key-Ins and Minor Side Drainage .....	8.09
8.5.5 Bank-Protection Toe-Downs .....	8.11
8.5.6 Low-Flow and Compound Channels .....	8.11
8.5.6.1 Low-Flow Channels .....	8.11
8.5.6.2 Compound Channels .....	8.11
8.5.7 Upstream and Downstream Controls .....	8.12
8.5.8 Channel Slope .....	8.14
8.5.9 Hydraulic Jump .....	8.14
8.5.9.1 Height of a Hydraulic Jump .....	8.15
8.5.9.2 Length of a Hydraulic Jump .....	8.16
8.5.9.3 Surface Profile of a Hydraulic Jump .....	8.16
8.5.9.4 Location of a Hydraulic Jump .....	8.16
8.5.9.5 Undular Hydraulic Jumps .....	8.16
8.5.10 Flow in a Curved Channel .....	8.22
8.5.10.1 Superelevation .....	8.22
8.5.10.2 Easement Curves .....	8.25
8.5.10.3 Banking .....	8.25
8.5.10.4 Limiting Curvature .....	8.26
8.5.11 Transitions .....	8.26
8.5.11.1 Entrance Transitions .....	8.26
8.5.11.2 Exit Transitions .....	8.31
8.5.11.3 Internal Channel Transitions .....	8.31
8.5.12 Channel Confluences .....	8.33
8.5.12.1 General Design Guidelines .....	8.33
8.5.12.2 Momentum Equation .....	8.35
8.5.12.3 Design Procedure: Supercritical Flow .....	8.40



## TABLE OF CONTENTS--Continued

		<u>Page</u>
8.5.13	Collector Channels .....	8.43
	8.5.13.1 Cross Section and Slope .....	8.43
	8.5.13.2 Depth .....	8.43
	8.5.13.3 Erosion Protection .....	8.44
	8.5.13.4 Sediment .....	8.46
	8.5.13.5 Additional Design Considerations .....	8.46
<b>CHAPTER IX. CHANNEL STABILIZATION AND HYDRAULIC STRUCTURES</b>		
9.1	Introduction .....	9.01
9.2	Purpose .....	9.01
9.3	Stabilization Methods .....	9.01
	9.3.1 Soil Cement .....	9.02
	9.3.2 Concrete or Shotcrete .....	9.02
	9.3.3 Rock Riprap .....	9.02
	9.3.3.1 Riprap Sizing .....	9.02
	9.3.3.2 Riprap Gradation, Blanket Thickness, and Stone Shape ..	9.04
	9.3.3.3 Riprap Filters .....	9.05
	9.3.4 Gabion Baskets and Mattresses .....	9.05
	9.3.5 Articulated Revetment Units .....	9.05
	9.3.6 Other Forms of Channel Stabilization .....	9.06
9.4	Energy Dissipators .....	9.06
	9.4.1 Culvert Outlets .....	9.06
	9.4.2 Channel Outlets .....	9.06
	9.4.3 Channel Drops .....	9.06
	9.4.4 Seepage Forces .....	9.07
9.5	Bridges .....	9.08
	9.5.1 Hydraulic Analysis .....	9.09
	9.5.2 Scour .....	9.09
	9.5.3 Freeboard .....	9.09
9.6	Structure Aesthetics .....	9.09
<b>CHAPTER X. STORM DRAINS</b>		
10.1	Purpose .....	10.01
10.2	Introduction .....	10.01
10.3	Policies .....	10.01
10.4	Design Discharge and Hydrology .....	10.02
10.5	Street and Gutter Flow .....	10.03
10.6	Pavement Inlets .....	10.08
	10.6.1 Capacity of a Grate Inlet in a Sag .....	10.10
	10.6.2 Capacity of a Curb Inlet in a Sag .....	10.11
	10.6.3 Capacity of a Combination Inlet in a Sag .....	10.12
	10.6.4 Capacity of a Slotted Inlet in a Sag .....	10.12

## TABLE OF CONTENTS--Continued

	<u>Page</u>
10.6.5 Capacity of a Grate Inlet on a Continuous Grade . . . . .	10.14
10.6.6 Capacity of a Curb Inlet on a Continuous Grade . . . . .	10.17
10.6.7 Capacity of a Combination Inlet on a Continuous Grade . . . . .	10.22
10.6.8 Capacity of a Slotted Inlet on a Continuous Grade . . . . .	10.22
10.6.9 Clogging . . . . .	10.24
10.7 Inlet Design Procedure . . . . .	10.25
10.8 Storm-Drain Calculations . . . . .	10.26
10.8.1 Normal-Depth Calculations . . . . .	10.28
10.8.2 Pressure-Flow Calculations: Computation of Hydraulic Grade Line . . . . .	10.28
10.8.3 Friction Losses . . . . .	10.30
10.8.4 Minor Losses . . . . .	10.30
10.8.5 Bend Losses . . . . .	10.30
10.8.6 Junction Losses . . . . .	10.32
10.8.7 Transition Losses . . . . .	10.34
10.8.8 Manhole Losses . . . . .	10.35
10.8.9 Entrance and Outlet Losses . . . . .	10.35
10.9 Storm-Drain Design Procedure . . . . .	10.37
10.9.1 Preliminary Design . . . . .	10.37
10.9.2 Final Pipe Sizing: Hydraulic Grade-Line Calculations . . . . .	10.40
10.10 Suggested Design Practices . . . . .	10.41
10.11 Check List for Design Submittals . . . . .	10.43

### CHAPTER XI. CULVERTS

11.1 Purpose . . . . .	11.01
11.2 Design Criteria and Policies . . . . .	11.01
11.3 Procedure for Culvert Design . . . . .	11.01
11.3.1 Step-by-Step Procedure for Sizing Culverts . . . . .	11.02
11.4 Guidelines for Culvert Design . . . . .	11.12
11.4.1 Hydraulics of Culverts and Dip Sections . . . . .	11.12
11.4.2 Culvert Inlets and Outlets . . . . .	11.15
11.4.2.1 Inlets . . . . .	11.15
11.4.2.2 Outlets . . . . .	11.15
11.4.3 Debris Grates . . . . .	11.16
11.4.4 Sedimentation and Erosion . . . . .	11.16
11.4.4.1 Inlet Recommendations . . . . .	11.16
11.4.4.2 Outlet Recommendations . . . . .	11.16
11.5 Culvert vs. Bridge Crossings . . . . .	11.17
11.6 At-Grade (Dip) Crossings . . . . .	11.18

## TABLE OF CONTENTS—Continued

	<u>Page</u>
CHAPTER XII. STREET AND PARKING LOT DRAINAGE	
12.1 Purpose . . . . .	12.01
12.2 Street Drainage Design Criteria . . . . .	12.01
12.2.1 Local, Collector, and Arterial Streets . . . . .	12.01
12.2.2 Collector and Arterial Streets . . . . .	12.02
12.3 P.A.A.L. Drainage Design Criteria . . . . .	12.02
12.4 Alley Drainage Design Criteria . . . . .	12.03
12.5 Flow-Through Openings in Perimeter Walls . . . . .	12.03
12.6 Computation of Flow Splits at Intersections . . . . .	12.05
CHAPTER XIII. FLOODPROOFING	
13.1 Purpose . . . . .	13.01
13.2 Policies . . . . .	13.01
13.3 When to Floodproof . . . . .	13.02
13.4 Types of Floodproofing . . . . .	13.07
13.5 Engineering Aspects . . . . .	13.10
13.5.1 Flooding Characteristics . . . . .	13.10
13.5.2 Floodproofing Methods . . . . .	13.10
13.5.2.1 Sealants . . . . .	13.10
13.5.2.2 Closures . . . . .	13.11
13.5.2.3 Floodwalls and Levees . . . . .	13.11
13.5.2.4 Protection of Utilities . . . . .	13.13
13.5.2.5 Elevation . . . . .	13.13
CHAPTER XIV. DETENTION/RETENTION BASINS	
14.1 Purpose . . . . .	14.01
14.2 Design Policies . . . . .	14.01
14.3 Inspection and Maintenance Policies . . . . .	14.03
14.4 Fees in Lieu of Detention/Retention Requirements . . . . .	14.04
14.5 Stormwater-Infiltration Systems . . . . .	14.05
REFERENCES AND SELECTED BIBLIOGRAPHIES . . . . .	R.01
INDEX . . . . .	I.01

### APPENDIX

#### EVALUATION OF ALTERNATIVE FLOOD-CONTROL AND EROSION-CONTROL TECHNIQUES FOR WATERCOURSES IN TUCSON, ARIZONA

This page intentionally left blank.

## LIST OF FIGURES

<u>Figure</u>	<u>Page</u>
4.1 Hydrologic Data Sheet . . . . .	4.09
4.2 Arcadia Wash Watershed . . . . .	4.13
5.1 Diagram of Idealized Urban Flood Plain . . . . .	5.06
6.1 Definition of Sediment-Load Components . . . . .	6.05
6.2 Definition Sketch for Anti-Dune Trough Depth . . . . .	6.10
6.3 Illustration of Terminology for Bend-Scour Calculations . . . . .	6.12
6.4 Common Pier Shapes . . . . .	6.15
6.5 Definition Sketch of Embankment Length " $a_c$ " . . . . .	6.17
6.6 Depth of Scour Below a Free Overfall . . . . .	6.19
6.7 Relationship of Variables in Equation for Scour Below a Submerged Grade-Control Structure . . . . .	6.21
6.8 Dimensionless Scour-Hole Geometry for Maximum Tailwater . . . . .	6.29
6.9 Dimensionless Scour-Hole Geometry for Minimum Tailwater . . . . .	6.30
7.1 Basic Allowable Velocity for Earthen Channels . . . . .	7.03
7.2 Correction Factor $C_a$ for Channel Alignment . . . . .	7.05
7.3 Correction Factor $C_b$ for Bank Slope . . . . .	7.05
7.4 Correction Factor $C_d$ for Depth Of Flow . . . . .	7.06
7.5 Actual Maximum Tractive Stress, $\tau_s$ , on Sides of Straight Trapezoidal Channels . . . . .	7.08
7.6 Actual Maximum Tractive Stress, $\tau_{sc}$ , on Sides of Trapezoidal Channels within a Curved Reach . . . . .	7.09
7.7 Actual Maximum Tractive Stress, $\tau_{st}$ , on Sides of Trapezoidal Channels in Straight Reaches Immediately Downstream from Curved Reaches . . . . .	7.10
7.8 Angle of Repose, $\phi_R$ , for Non-Cohesive Materials . . . . .	7.12
7.9 Graphic Solution of Reference Tractive Stress . . . . .	7.13

## LIST OF FIGURES--Continued

<u>Figure</u>		<u>Page</u>
7.10	Graphic Solution of Reference Tractive Stress (Continued) . . . . .	7.14
7.11	Applied Maximum Tractive Stresses, $\tau_s$ , on Sides of Straight Trapezoidal Channels . . .	7.16
7.12	Maximum Allowable Tractive Stress for Non-Cohesive Soils, $D_{75} < 0.25"$ . . . . .	7.17
7.13	Unconfined Compressive Strength and Tractive Power as Related to Channel Stability .	7.19
8.1	Typical Bank-Protection Key-Ins . . . . .	8.10
8.2	Typical Low-Flow and Compound Channels . . . . .	8.13
8.3	Height of a Hydraulic Jump for a Horizontal, Rectangular Channel . . . . .	8.17
8.4	Height of a Hydraulic Jump for a Horizontal, Trapezoidal Channel . . . . .	8.18
8.5	Length of a Hydraulic Jump for a Rectangular Channel . . . . .	8.19
8.6	Length of a Hydraulic Jump for Nonrectangular Channels . . . . .	8.20
8.7	Surface Profile of a Hydraulic Jump . . . . .	8.21
8.8	Cross-Wave Pattern for Supercritical Flow in a Curved Channel . . . . .	8.23
8.9	Transition for Channel Contractions in Supercritical Flow . . . . .	8.28
8.10	Transition Distance Required to Allow Flow to Return to Natural Conditions . . . . .	8.32
8.11	Maximum Wave Height at a Channel Junction . . . . .	8.34
8.12	Rectangular Channel Junction . . . . .	8.37
8.13	Trapezoidal Channel Junction . . . . .	8.38
8.14	Typical Confluence Layouts . . . . .	8.41
8.15	Typical Collector-Channel Cross Section . . . . .	8.45
9.1	Riprap Design Chart . . . . .	9.03
10.1	Nomograph for Flow in a Wide, Shallow Triangular Channel . . . . .	10.05
10.2	Composite Gutter Sections . . . . .	10.07

## LIST OF FIGURES--Continued

<u>Figure</u>	<u>Page</u>
10.3	Curb-Opening Inlets .....10.13
10.4	Ratio of Frontal Flow to Total Gutter Flow .....10.15
10.5	Frontal-Flow Interception Efficiency for Grate Inlets .....10.16
10.6	Side-Flow Interception Efficiency for Grate Inlets. ....10.18
10.7	Inlet Length for Total Interception by Curb Openings and Slotted Drains .....10.20
10.8	Inlet Interception Efficiency for Curb Openings and Slotted Drains .....10.21
10.9	Compound Gutter Section .....10.23
10.10	Pavement Drainage Worksheet .....10.27
10.11	Hydraulic Parameters of a Circular Cross Section .....10.29
10.12	Head-Loss Diagram for Pipes .....10.29
10.13	Head-Loss Coefficient for 90° Pipe Bend .....10.31
10.14	Junction and Transition Configurations .....10.33
10.15	Manhole Head Loss .....10.36
10.16	Hydraulic Grade-Line Calculation Sheet for Pressure Flow .....10.42
10.17	Parabolic Street Section for Example 10.1 .....10.46
10.18	Watershed Boundaries and Inlet Spacing for Example 10.2 .....10.48
10.19	Assumed Street Cross Section for Example 10.2 .....10.50
10.20	Plan View of Storm Drain for Example 10.3 .....10.59
10.21	Profile of Storm Drain for Example 10.3 .....10.60
10.22	Station 4 + 60: Junction for Example 10.3 .....10.62
10.23	Station 5 + 70: Junction for Example 10.3 .....10.62
10.24	Hydraulic Grade-Line Calculations for Example 10.3 .....10.64

## LIST OF FIGURES--Continued

<u>Figure</u>		<u>Page</u>
11.1	Worksheet for Culvert Capacity Calculations . . . . .	11.03
11.2	Nomograph for Computing Headwater Depth for Concrete Pipe Culverts with Inlet Control . . . . .	11.04
11.3	Nomograph for Computing Headwater Depth for Box Culverts with Inlet Control . . . . .	11.05
11.4	Graph for Determining Critical Depth in Circular Pipes . . . . .	11.07
11.5	Graph for Determining Critical Depth in Rectangular Sections . . . . .	11.08
11.6	Worksheet for Roadway-Embankment Overflow Computations . . . . .	11.14
12.1	Definition Sketch for Computing $Q_m$ in an Inverted-Crown Street . . . . .	12.06
12.2	Example of Flow Split at a Street Intersection . . . . .	12.08
13.1	Computation of Expected Annual Damages for Example 13.1 . . . . .	13.15



## LIST OF TABLES

<u>Table</u>	<u>Page</u>
4.1	Areally Reduced One-Hour Rainfall Depths, in Inches, for Watershed Areas of Up to Ten Square Miles in Size Located in and around Tucson, Arizona . . . . . 4.05
4.2	Standard Basin Factors ( $n_{b100}$ 's) to Use When Computing the Regulatory (100-Year) For Various Land Uses and Channel Types Located Within the City of Tucson . . . . . 4.06
4.3	Runoff Coefficients vs. One-Hour Rainfall Depths for Applicable Soil Types and Intensity of Land Use in the Greater Tucson Area . . . . . 4.07
4.4	Contributing Area Factors . . . . . 4.08
4.5	Ratios of More Frequent Floods to the 100-Year Flood . . . . . 4.08
4.6	Slope Breaks and Basin-Factor Reach Lengths for the Arcadia Wash at Pima Street . . 4.12
4.7	Curvilinear, Dimensionless Hydrograph . . . . . 4.18
4.8	Hydrograph Rise Times for $T_c \leq 60$ Minutes . . . . . 4.19
6.1	Reduction Factors to Be Used When Applying Scour Formulas for Square-Nosed Piers to Other Shapes . . . . . 6.14
6.2A	Experimental Coefficients for Scour Depth, $Z_{sc}$ , at Culvert Outlets . . . . . 6.23
6.2B	Experimental Coefficients for Scour Width, $W_{sc}$ , at Culvert Outlets . . . . . 6.24
6.2C	Experimental Coefficients for Scour Length, $L_{sc}$ , at Culvert Outlets . . . . . 6.25
6.2D	Experimental Coefficients for Scour Volume, $V_{sc}$ , at Culvert Outlets . . . . . 6.26
8.1	Manning's Roughness Coefficients . . . . . 8.06
8.2	Types of Hydraulic Jumps . . . . . 8.15
8.3	Coefficients for Use in Super-Elevation Formula . . . . . 8.24
8.4	Head-Loss Coefficients for Use with Transitions in Open Channels . . . . . 8.29
8.5	Recommended Convergence Rates for Entrance Transitions with Supercritical Flow . . 8.30
9.1	Weighted-Creep Ratios . . . . . 9.08
10.1	Manning's Roughness Coefficient (" $n$ ") for Streets and Gutters . . . . . 10.04

LIST OF TABLES—Continued

<u>Table</u>		<u>Page</u>
11.1	Entrance Loss Coefficients for Outlet Control: Full, or Partly Full, Entrance HeadLoss . . . . .	11.10
13.1	Flood Damages as a Percentage of Value for Residential Structures . . . . .	13.04
13.2	Cost of Damage . . . . .	13.05
13.3	Expected Annual Damages . . . . .	13.06
13.4	Retrofitting Methods . . . . .	13.08

## GLOSSARY

The following technical terms are used in this Manual.

**ALLEY** is a secondary point of access to property, and is used typically for utility and sanitary services.

**ALL-WEATHER ACCESS** is a safe vehicular route which either ordinary or emergency vehicles require for the purpose of unimpeded access. This standard applies to public or private streets, or to a designated route connecting a street and the development or building in question. Storm runoff flowing either across or in the direction of an all-weather access route shall not exceed one foot in depth during the 10-year flood. In addition, the depth of flow,  $y$ , in feet, plus the velocity head,  $V^2/2g$ , in feet, shall not exceed the numerical value of 1.30 for a duration in excess of thirty minutes during the 100-YEAR FLOOD.

**ALTERNATE DEPTHS** are the two depths of flow possible--one lower than critical and one higher than critical--for a given rate of flow and a given SPECIFIC HEAD. Also refer to the definition of CRITICAL DEPTH.

**ARTERIAL STREET** is a street that carries high levels of traffic, typically serving over 12,000 vehicles per day.

**AT-GRADE CROSSING** is a depression or vertical sag in the roadway designed to allow drainage to cross "at-grade" without using CULVERTS (also see DIP).

**BACKWATER** is the effect tailwater has upon upstream flow. Backwater can also refer to the calculations that are performed to compute water-surface profiles in an open channel.

**BALANCED BASIN/WATERSHED** means a drainage basin which contains floodwater channels, natural or manmade, and/or flood-control structures that are adequate to contain existing runoff from a BASE FLOOD produced by the basin; but in which additional runoff cannot be safely contained by said channels or structures.

**BANK PROTECTION** is a form of channel lining wherein only the banks of the WATERCOURSE are protected against flowing waters.

**BANKING** is the lowering or tilting of the inside of the floor around a bend in a totally lined drainage channel in order to counteract the effects of superelevation of the water surface along the outer bank.

**BASE FLOOD** is a flood stage or height that, statistically, has a one percent chance of being equaled or exceeded in any given year. The Base Flood is often referred to as the ONE-HUNDRED-YEAR (100-YEAR) FLOOD.

**CARRYOVER FLOW** is GUTTER flow that is not intercepted by a pavement inlet on a continuous grade.

**CATCH BASIN** refers to an appurtenance to STORM-DRAIN inlets which is used primarily to capture runoff and secondarily to trap solid, waterborne debris.

## GLOSSARY--Continued

**CHANNEL** refers to a drainageway which has been created or extensively modified by man for the purpose of conveying floodwaters, and is no longer a WASH or a WATERCOURSE in its natural condition.

**CHANNEL LINING** is erosion-resistant armoring or protection that is placed along the bottom and/or sides of drainage channels.

**CLOSURE**, when used in the context of FLOODPROOFING, refers to a structural alteration made to a window, door, or other opening of a building in order to keep floodwaters from entering.

**COLLECTOR CHANNELS** are drainage channels normally designed to capture dispersed surface flow (sheet flow) so that it can be concentrated for conveyance to a desired point using a CONVEYOR CHANNEL.

**COMBINATION INLET** is a pavement inlet consisting of a combined GUTTER inlet and CURB inlet.

**CONVEYOR CHANNELS** are drainage channels which generally receive flow from upstream COLLECTOR CHANNELS for conveyance to some downstream location.

**CRITICAL BASIN/WATERSHED** means a drainage basin which contains floodwater channels, natural or man-made, and/or flood-control structures that cannot contain existing runoff produced by a BASE FLOOD within the basin; and which has a documented history of severe flooding hazards.

**CRITICAL DEPTH** is the particular depth of flow in an open channel with a given discharge at which the specific energy is at a minimum. The given discharge may flow at an ALTERNATE DEPTH above or below CRITICAL DEPTH in a given channel, but the specific energy of the flow at either ALTERNATE DEPTH will be greater than that for flow at CRITICAL DEPTH.

**CRITICAL FLOW** occurs when flow is at CRITICAL DEPTH, and it is the state at which the specific energy of flow is at a minimum for a given unit discharge. This state occurs when the inertial and gravitational forces are balanced.

**CROSS-SLOPE** is the transverse slope of the pavement of a street, measured at a 90° angle to the direction of traffic flow.

**CULVERT** is a short, closed conduit employed for the purpose of passing surface runoff under an embankment. A rectangular or square concrete structure for passing such runoff is referred to as a BOX CULVERT.

**CURB** is a concrete barrier, usually six to eight inches high, found at the edge of street pavement.

**CURB INLET** is a STORM-DRAIN inlet consisting of an opening in a vertical curb, in combination with an underground CATCH BASIN, which allows the entrance of stormwater runoff into the STORM-DRAIN SYSTEM.

## GLOSSARY--Continued

**DETENTION BASIN** is a type of flood-control system which employs a reservoir as a means of delaying the downstream progress of floodwaters in a controlled manner. This is generally accomplished through the combined use of temporary storage areas and a metered outlet device (such as a WEIR or orifice) which reduces downstream flood peaks, and thereby causes a lengthening of the duration of flow.

**DEVELOPMENT** means any man-made change to improved or unimproved real estate, including but not limited to buildings or other STRUCTURES, mining, dredging, filling, grading, paving, excavation, or drilling.

**DIP** is a depression or vertical sag in the roadway designed to allow drainage to cross "at-grade" without using CULVERTS (also see AT-GRADE CROSSING).

**DISPERSED FLOW** is characterized by wide, shallow, "sheet-flow" runoff conditions, usually found in areas where no CHANNELS or well-defined drainageways exist to serve as the primary runoff-conveyance systems.

**DRAINAGE BASIN** means any watershed or runoff catchment area.

**DRAINAGE REVIEW ZONE** is an area delineated on a base map prepared and periodically updated by City Floodplain Section staff. Any building permit application within a "drainage review zone" will be marked by the City Building Safety Division with a note stating that a Drainage Report, Grading Permit, and/or Floodplain Use Permit will be required prior to the issuance of a Building Permit.

**DRAINAGEWAY** is a route or WATERCOURSE along which storm runoff moves, or may move, to drain a catchment area.

**DRY FLOODPROOFING** is a form of FLOODPROOFING that is intended to keep all floodwaters out of the STRUCTURE, and is used whenever it is important to protect the entire interior of a building from flooding.

**DRY WELL** is an engineered hole with a grated inlet designed to dispose of floodwaters through a process of passive infiltration of floodwaters into the vadose zone (i.e., the unsaturated sediments commonly found above the water table).

**DWELLING UNIT** means a place of residence which may be located in a single or multiple dwelling building, or a manufactured home.

**EASEMENT CURVES**, when used in the context of open-channel design, refer to the alignment transition curves that have a relatively large radius of curvature, and are located between a straight reach of a channel and a circular curve having a smaller radius of curvature.

**ENCROACHMENT, EQUAL DEGREE OF** means the advancement or infringement of land uses, fill, or structures onto the FLOOD PLAIN in a manner which reduces the flow capacity of the CHANNEL and/or FLOOD PLAIN of a WATERCOURSE. An equal degree of encroachment is a standard applied to the evaluation of the effects of development upon increases in flood heights. This standard assumes

## GLOSSARY--Continued

that if a development is permitted to encroach onto a FLOOD PLAIN, the approval to do so confers upon all property owners on both sides of the WATERCOURSE an equal right to encroach to the same hydraulic degree within that reach. Since the factors affecting hydraulic efficiency are usually not uniform within a reach, this will usually not result in equal distances between the FLOODWAY limits and the sides of the WATERCOURSE.

**ENERGY GRADE LINE (EGL)** is the elevation line which represents the total unit energy of flowing water. Points on the EGL are located above the water-surface elevation a distance equal to the VELOCITY HEAD plus the PRESSURE HEAD.

**ENGINEER** means a person who, by reason of special knowledge of the mathematical and physical sciences and the principles and methods on engineering analysis and design acquired by professional education and practical experience, is qualified to practice engineering as attested by his or her registration in the State of Arizona as a Professional Engineer.

**ENGINEERED BASIN FLOOR** or **ENGINEERED BOTTOM** is a rock-filled hole or volume within the bottom of a larger stormwater storage facility which is designed for the purpose of temporarily storing runoff and subsequently disposing of same within the sub-surface through the process of infiltration.

**EROSION** refers to the removal and transport of soil particles by flowing water.

**FEMA** is an abbreviation for Federal Emergency Management Agency.

**FIRM** is an abbreviation for Flood Insurance Rate Map.

**FLOOD** means a temporary rise in flow or stage of any CHANNEL, stream, WASH, or WATERCOURSE that results in water overtopping the banks and inundating adjacent areas.

**FLOOD PLAIN** means areas of land adjoining or near the CHANNEL of a WATERCOURSE which have been, or may be, covered by floodwaters.

**FLOODPROOFING** refers to the combination of structural changes to buildings or the external adjustments to properties subject to flooding, primarily for the purpose of reducing flood hazards. As used in this Manual, FLOODPROOFING is primarily intended to mean improvements made to protect existing buildings which have their lowest finished floors below BASE (100-YEAR) FLOOD ELEVATIONS.

**FLOODWALL** is a form of floodproofing consisting of an artificial barrier located between the structure and the source of flooding.

**FLOODWAY** is an area along a WATERCOURSE which will allow passage of the REGULATORY FLOOD without increasing flood elevations by more than one foot after a hypothetical encroachment has been made into the FLOODWAY FRINGE.

**FLOODWAY FRINGE** is that portion of the REGULATORY FLOOD PLAIN that lies outside of the FLOODWAY.

## GLOSSARY--Continued

**FLOW-THROUGH WALL OPENING** (also referred to as a **WEEP HOLE**) is a relatively small wall opening placed at the bottom, or base, of perimeter walls. These openings are used both to accept runoff onto and/or release runoff out of developments enclosed by solid walls. **FLOW-THROUGH WALL OPENINGS** are normally located in surface depressions such that the existing drainage patterns, both entering and leaving the developed parcel, can be maintained without significant ponding and/or without concentrating runoff.

**FREEBOARD** is the extra vertical distance between the calculated maximum level of the water surface in a conduit, **CULVERT**, reservoir, tank, **DETENTION/RETENTION BASIN**, **CHANNEL**, or canal and the top of the confining structure, which is provided so that waves or other movements of the water surface will not overtop such confining structures. The term is also used when referring to the vertical distance from the calculated, maximum water level in a **DETENTION/RETENTION BASIN**, **CHANNEL**, or **WASH**, to the base of any man-made **STRUCTURE**, such as the minimum finished floor of a building.

**FRICITION (HEAD) LOSSES** are losses in the unit energy of flowing water attributable to friction between the water and the perimeter of the conduit.

**FRICITION SLOPE** is the slope of the **ENERGY GRADE LINE**, if minor losses are ignored.

**FROUDE NUMBER** is a dimensionless ratio used in hydraulic design which defines the relationship between inertial forces and gravitational forces of flowing water. Typically, a Froude number greater than one indicates **SUPERCritical FLOW** conditions in which flow depths are controlled by upstream hydraulic conditions. Similarly, when the Froude number is less than one, the flow conditions are said to be **SUBCRITICAL**, and are controlled by downstream hydraulic conditions.

**GRATE INLET** is a pavement inlet, normally consisting of an iron or steel grate set flush with the pavement or **GUTTER**, in combination with an underground **CATCH BASIN** which allows the entrance of stormwater runoff into the **STORM-DRAIN SYSTEM**.

**GUTTER** is the low area adjacent to the **CURB** of a crowned street, and is used for conveying stormwater runoff.

**HEADCUTS** are vertical drops in the profile of earthen channels. Headcuts normally move in an upstream direction as a result of **EROSION**.

**HYDRAULIC GRADE LINE (HGL)** is a line which represents the static head plus **PRESSURE HEAD** of flowing water.

**HYDRAULIC JUMP** is an abrupt rise in the water surface which occurs in an open **CHANNEL** when water flowing at a supercritical flow state is forced to flow at a subcritical flow state.

## GLOSSARY--Continued

**INFILTRATION TRENCH** is a rock-filled trench, possibly containing a perforated pipe, designed for the purpose of temporarily storing runoff, and then subsequently disposing of same within the sub-surface through the process of infiltration. (An **INFILTRATION TRENCH** is similar to, yet narrower than, an **ENGINEERED BASIN FLOOR**.)

**INVERT** is the floor, bottom, or lowest portion of the internal cross section of a conduit.

**KEY-INS** refer to the extensions of **BANK PROTECTION** either (1) below the surface of the ground at the top of the constructed or existing bank; or (2) at the upstream and downstream limits of a bank-protected reach.

**LETTER OF MAP AMENDMENT (LOMA)** is a document from FEMA describing approved changes to the regulatory flood plain. Approval is based on prescribed administrative procedures in which FEMA reviews the scientific or technical submissions of an owner or lessee of property who believes his property has been inadvertently included in designated A, A0, A1-A99, V0, and V1-V30 Zones as a result of the transposition of the curvilinear flood water surface to either street or other readily identifiable features shown on FIRMs. The necessity for a LOMA procedure in order to make map corrections is due in part to the technical difficulty of accurately delineating the curvilinear line or floodwater surface on a FIRM. Where there has been a final determination of a **BASE FLOOD ELEVATION**, any alteration of the topography shall not be subject to this procedure. The Federal requirement for flood insurance does not apply to unimproved land, because flood insurance is available only for **STRUCTURES** and their contents. However, if construction is proposed on land within a Special Flood Hazard Area (SFHA), a **CONDITIONAL LOMA** can be issued provided that the proposed structural information meets the established criteria for a standard LOMA. After construction is completed, certified as-built information must be submitted to FEMA for the purpose of obtaining a LOMA. The information required for a **CONDITIONAL LOMA** is basically the same information that is required for a LOMA. Property owners and developers should note that a **CONDITIONAL LOMA** merely provides a comment on the proposed plan, and does not amend the map or waive the requirement to purchase flood insurance.

**LETTER OF MAP REVISION (LOMR)** is a document from FEMA which describes changes to effective FIRMs. The LOMR gives a detailed description of the **BASE FLOOD ELEVATION (BFE)** and graphic changes that will be made to the SFHA currently delineated on the effective FIRM and/or Flood Hazard Boundary Map (FHBM). FEMA will then revise the effective Flood Insurance Study (FIS) to reflect the new information which shows the original FIS to be incorrect, such as physical changes which invalidate the original FIS analyses or presentation of data. Updated or corrected topographic mapping, hydrologic data, or hydraulic data constitutes new information which may warrant a revision. Flood-protection projects and any form of topographic alterations (e.g., cut and fill) constitute physical changes which may also warrant a map revision. The map-revision process cannot be initiated without the community's endorsement, since it is the community that adopts the effective FIS. Therefore, any individuals requesting a



## GLOSSARY--Continued

change to the FIS must do so through the community. The community, in turn, may support the request and forward the information to FEMA for evaluation.

**LEVEE** is an embankment of compacted soil, often covered with an impermeable veneer, which is built to redirect or impede the flow of floodwaters.

**LOCAL DETENTION/RETENTION BASIN** is a relatively small-scale stormwater storage facility which is owned, built, and maintained by developers, or their assigns, for the purpose of satisfying Section 23-469 of the Tucson Floodplain Regulations.

**MAJOR WATERCOURSE** or **MAJOR WASH** is any **WATERCOURSE** which has a contributing drainage area of less than 30 square miles and a 100-year peak discharge of 2,500 cubic feet per second (cfs), or greater. Examples of Major Washes include, but are not necessarily limited to, the West Branch of the Santa Cruz River at Valencia Road; Pima Wash at its confluence with the Rillito Creek; Rodeo Wash at its confluence with the Santa Cruz River; Silvercroft Wash at its confluence with the Santa Cruz River; Alamo Wash at its confluence with Rillito Creek; Tucson Arroyo at its confluence with the Santa Cruz River; and the Cholla Wash at its confluence with the West Branch of the Santa Cruz River.

**MANHOLE** is an opening into a storm-drain system from the ground surface through which access to the drain is obtained for the purpose of routine and/or emergency inspection and maintenance.

**MINOR (HEAD) LOSSES** are losses in energy of flowing water not attributable to friction losses (e.g., expansion losses, contraction losses, bend losses, etc.)

**MINOR WATERCOURSE** or **MINOR WASH** is a **WATERCOURSE** which has a 100-year peak discharge of less than 2,500 cfs, but more than 100 cfs.

**NORMAL FLOW** is open-channel flow under uniform conditions of depth, discharge, slope, and channel cross section. Under normal flow, the **ENERGY GRADE LINE** is parallel to the slope of the **CHANNEL** or conduit.

**OBSTRUCTION** is any physical alteration in, along, across, or projecting into any **CHANNEL**, **WATERCOURSE**, stream, lake, or **REGULATORY FLOOD PLAIN** which may impede or divert floodwaters, either in itself or by catching or collecting debris carried by such floodwaters, or that is placed where a flow of water might carry the same downstream to the damage of life or property. Examples include, but are not limited to, the following: any dam, wall, wharf, embankment, levee, dike, pile, abutment, projection, excavation, channel rectification, bridge, conduit, **CULVERT**, building, wire, fence, rock, gravel, refuse, fill, **STRUCTURE** or vegetation.

**ONE-HUNDRED-YEAR (100-YEAR) FLOOD** is a flood stage or height that, statistically, has a one percent chance of being equaled or exceeded in any given year. The **ONE-HUNDRED-YEAR FLOOD** is often referred to as the **BASE FLOOD**.

## GLOSSARY--Continued

**ONE-HUNDRED-YEAR FLOOD ELEVATION** is the water-surface elevation of the 100-YEAR FLOOD. For watercourses where supercritical flow velocities are encountered, the critical depth of flow shall be used in conjunction with establishing a BASE FLOOD ELEVATION, rather than the lower, supercritical water-surface elevation.

**OVERBANK FLOODING** is floodwaters which overtop the banks of an existing or improved channel section.

**OVERNIGHT PARKING** shall exist when a motor vehicle is left unattended during the hours from sunset to sunrise.

**PARKING AREA ACCESS LANE** is the area providing access to vehicular parking spaces. Sometimes this term is abbreviated as P.A.A.L., or PAAL.

**PARKING LOT** is an area devoted to more than four off-street parking spaces, as defined in Tucson Development Standard 3-01.1.4. Parking lot is synonymous with the term PARKING AREA.

**PAVEMENT INLET** is an opening in the street, GUTTER, or CURB made for the purpose of removing water from the street cross section.

**PRESSURE FLOW** is the flow of water within a closed conduit without a free surface open to atmospheric pressure.

**PRESSURE HEAD** is equal to water pressure, at a specific point, divided by the specific weight of water. **PRESSURE HEAD** is usually expressed in units of length.

**REGIONAL DETENTION/RETENTION BASIN** collects runoff from a relatively large area, and has been designed to use storage as a means of reducing downstream flood peaks, reducing possible flood damage, or reducing downstream channel construction costs. Regional facilities are usually multi-purpose, and normally are the responsibility of either the City of Tucson or the Pima County Department of Transportation and Flood Control District.

**REGIONAL WATERCOURSE** is a large, intermittent stream which has a contributing drainage area of 30 square miles, or greater. Examples of Regional Watercourses include, but are not necessarily limited to, the Santa Cruz River; Rillito Creek; Pantano Wash; Tanque Verde Creek; and the Cañada del Oro Wash.

**REGULATORY FLOOD** is a 100-YEAR FLOOD with a peak discharge of 100 cubic feet per second (cfs), or greater, and which has a one percent (1%) chance of being equaled or exceeded in any given year.

**REGULATORY FLOOD PLAIN** is any portion of a flood plain, as well as any areas which are subject to sheet flooding, that would be inundated by a REGULATORY FLOOD.

## GLOSSARY--Continued

**RETENTION BASIN** is a facility which stores surface runoff, but is not provided with a positive outlet. No flow is discharged directly into a downstream watercourse from a RETENTION BASIN, but may be drained into the subsurface by infiltration.

**RETROFITTING**, when used in reference to FLOODPROOFING, refers to those structural improvements made to a building after its construction.

**RILL EROSION** is a pattern of narrow, vertical troughs formed in relatively steep earthen embankments by floodwaters cascading down the embankment.

**SAG** is a specified low point sometimes found within a street profile where stormwater runoff water is expected to collect.

**SEALANTS** are materials that can be applied or attached to the walls of a building to prevent floodwaters from entering.

**SETBACK** is the minimum horizontal distance between a STRUCTURE and a CHANNEL, stream, WASH, WATERCOURSE, or DETENTION BASIN. A channel setback is measured from the top edge of the highest channel bank or from the edge of the 100-year water-surface elevation, whichever is closer to the channel centerline.

**SHEET FLOODING** is a condition which occurs within those areas which are subject to flooding of about one foot in depth, more or less, during the REGULATORY FLOOD; and where a clearly-defined CHANNEL does not exist so that the path of the flooding is often unpredictable and indeterminate.

**SHEET FLOW** is shallow, diffuse runoff such as would be produced from rainfall on a large, flat surface. It is characterized by an approximately equal depth of runoff across a broad width of flow.

**SIGNIFICANT WATERCOURSE** is any WATERCOURSE with a contributing drainage area equal to or greater than one standard acre (i.e., 43,560 square feet) in size.

**SLOTTED INLET** is a pavement inlet consisting of a long, narrow slot, typically two to four inches in width, and usually welded to the soffit of a corrugated metal pipe.

**SOFFIT** is the highest point within the cross section of a closed conduit.

**SPECIFIC ENERGY (SPECIFIC HEAD)** is the energy per pound of water at any section of a CHANNEL measured with respect to the channel bottom.

**STORM DRAIN (or STORM-DRAIN SYSTEM)** is a combination of underground conduits and surface-inlet structures constructed for the purpose of removing runoff from the ground surface, usually from street pavement, and conveying it to some downstream discharge point.

**STORMWATER-INFILTRATION SYSTEM** is a term used to refer to DRY WELLS, ENGINEERED BASIN FLOORS, INFILTRATION TRENCHES, or any combination thereof.

## GLOSSARY--Continued

**STRUCTURE** is anything constructed or erected, the use of which requires either its location on the ground or its attachment to some foundation having a location on the ground.

**SUBCRITICAL FLOW** is tranquil flow (i.e., the FROUDE NUMBER is less than 1.0) in which gravitational forces are dominant over inertial forces. **SUBCRITICAL FLOW** is controlled by downstream conditions.

**SUMP** is synonymous with sag.

**SUPERCritical FLOW** is rapid flow (i.e., the FROUDE NUMBER is greater than 1.0) in which inertial forces are dominant over gravitational forces. **SUPERCritical FLOW** is controlled by upstream conditions.

**TAILWATER** is the flow condition encountered at the downstream end of any hydraulic structure, or hydraulic condition, under investigation.

**TIME OF CONCENTRATION** is the time required for storm runoff to flow from the hydraulically most remote point of a catchment or drainage area to the outlet or point under consideration.

**TOE-DOWN** is the vertical extension of **BANK PROTECTION** below the channel bed to prevent scour from undermining the protection on the channel sides.

**TRANSITIONS** are longitudinal sections of a channel within which the flow width is expanded or contracted in a predetermined manner.

**UNATTENDED VEHICLE** shall mean a vehicle which the owner or authorized driver cannot reasonably remove before flooding occurs.

**VELOCITY HEAD** is the kinetic energy per pound of flowing water.

**WASH** refers to a natural **WATERCOURSE** that has not been significantly disturbed by development, and the native vegetation is therefore still present.

**WATERCOURSE** is any naturally occurring lake, river, stream, creek, **WASH**, arroyo, or other body of water or channel having banks and bed through which waters flow at least periodically and any depression serving to give direction to a current of storm water, provided that, it shall, upon rule or order of the City of Tucson, also include other designated, naturally occurring areas where substantial flood damage may occur.

**WEIR (BROAD-CRESTED)** is an open-channel control section, with a horizontal crest above which fluid pressure may be considered hydrostatic.

**WET FLOODPROOFING** is the **FLOODPROOFING** of a portion of a building, while allowing the rest of the building to be flooded.

## LIST OF SYMBOLS

Following is a list of the majority of symbols used within the text of this Manual. Some symbols appear only in a figure, where they are defined; these symbols are not included within this list.

- $A$  = Area, usually cross-sectional area of flow, in square feet, or surface area, in acres.
- $a$  = Gutter depression, in inches.
- $a_e$  = Embankment or encroachment length measured normal to the edge of the floodplain or channel bank, in feet.
- $B, b$  = Bottom width of a channel or box culvert, in feet.
- $BF$  = Bulking factor.
- $b_n$  = Bottom width of channel under natural conditions, in feet.
- $B_p$  = Horizontal distance from the base of curb to the crown in a pavement cross section, in feet.
- $b_p$  = Pier width normal to the flow direction, in feet.
- $b_{pe}$  = Effective pier width, in feet.
- $b_u$  = Bottom width of channel under urbanized conditions, in feet.
- $C$  = Coefficient, as identified by its use within this Manual.
- $C_a$  = Correction factor for channel alignment.
- $C_b$  = Correction factor for bank slope.
- $C_c$  = Coefficient of contraction.
- $C_d$  = Correction factor for flow depth.
- $C_e$  = Coefficient of expansion.
- $C_{rw}$  = Weighted creep ratio.
- $C_w$  = Weighted runoff coefficient.
- $C_{w100}$  = Weighted runoff coefficient for a 100-year flood.
- $D$  = Diameter of a pipe or culvert, height of a box culvert, or height of a flow-through wall opening, in feet.

## LIST OF SYMBOLS--Continued

- $d_c$  = Critical depth in a culvert or storm drain, in feet.
- $D_{cw}$  = Total height of a cut-off wall or grade-control structure, from top to toe, including the drop height drop,  $h$ , in feet.
- $D_{hg}$  = Difference between hydraulic grade-line elevation and invert of a storm drain, in feet.
- $D_{xx}$  = The grain-size diameter for which  $xx\%$  of the material consists of smaller particles, where  $xx$  represents a number from 0 to 100 (for example,  $D_{50}$ ).
- $DSG$  = Dimensionless scour-hole geometry.
- $EGL$  = Energy grade line.
- $E_i$  = Efficiency of a curb or grate inlet.
- $EL_{hd}$  = Design headwater elevation, in feet.
- $EL_{ho}$  = Outlet-control headwater elevation for a culvert, in feet.
- $EL_i$  = Upstream invert elevation of a culvert, in feet.
- $EL_o$  = Outlet invert elevation of a culvert, in feet.
- $EL_{sf}$  = Streambed elevation at the culvert face, in feet.
- $E_o$  = Ratio of frontal flow at a grate to total pavement flow, or ratio of flow in the depressed section to total gutter flow.
- $F$  = Froude number.
- $F_{Ac}$  = Contributing area factor.
- $F_{Acw}$  = Weighted contributing area factor.
- $FB$  = Freeboard in a constructed channel, in feet.
- $F_t$  = Transition Froude number.
- $F_u$  = Upstream Froude number.
- $F_1$  = Froude number upstream of hydraulic jump.
- $G$  = Weighting parameter used for mean-slope determination, in feet.

## LIST OF SYMBOLS—Continued

- $g$  = Gravitational constant = 32.2 ft/sec<sup>2</sup>.
- $H$  = Specific head (energy), head on structure, or culvert head loss, as identified by its use within this Manual, in feet.
- $h$  = Height, drop height, wave height, or curb opening depth, as identified by its use within this Manual, in feet.
- $h'$  = Vertical drop in water surface through an open-channel junction, in feet.
- $h_b$  = Bend head loss, in feet.
- $H_c$  = Crown height of pavement cross section, in feet.
- $H_d$  = Specific (energy) head downstream of a channel drop, in feet.
- $h_d$  = Vertical drop in channel bottom through an open-channel junction, in feet.
- $h_e$  = Entrance head loss, in feet.
- $h_f$  = Friction (barrel) head loss, in feet.
- $HG$  = Elevation of hydraulic gradient, in feet.
- $HGL$  = Hydraulic grade line.
- $h_i$  = Culvert headwater under inlet control, in feet.
- $h_j$  = Junction head loss, or height of a hydraulic jump, in feet, as identified by its use within this Manual.
- $H_l$  = Head loss through a culvert, in feet.
- $H_m$  = Minor head losses, in feet.
- $h_{mh}$  = Manhole head loss, in feet.
- $h_o$  = Outlet head loss, culvert headwater under outlet control, or difference in height between a culvert outlet invert and the hydraulic grade line, as identified by its use within this Manual, in feet.
- $H_t$  = Total drop in head over a grade-control structure, measured from the upstream energy grade line to the downstream energy grade line, in feet.
- $h_t$  = Transition head loss, in feet.

## LIST OF SYMBOLS—Continued

- $h_{tc}$  = Transition head loss at a contraction, in feet.
- $h_{te}$  = Transition head loss at an expansion, in feet.
- $H_u$  = Specific (energy) head upstream of a channel drop, in feet.
- $h_v$  = Velocity head of flowing water, in feet.
- $h_{vd}$  = Velocity head downstream of a channel drop, in feet.
- $h_{vu}$  = Velocity head upstream of a channel drop, in feet.
- $HW$  = Total headwater for a culvert, weir, or flow-through wall opening, in feet.
- $HW_d$  = Design headwater depth for a culvert, in feet.
- $HW_i$  = Required headwater depth at a culvert, in feet.
- $i$  = Rainfall intensity, in inches per hour.
- $I_w$  = Weighted impervious cover of a watershed, in percent.
- $i_{100}$  = 100-year rainfall intensity, in inches per hour.
- $K$  = Flow conveyance factor. (Also used to represent a coefficient, as identified by its use within this Manual.)
- $k$  = Normal size of  $D_{50}$  rock to be used in riprap design, in feet, or a coefficient, as identified by its use within this Manual.
- $k_b$  = Bend-loss coefficient.
- $K_e$  = Entrance head-loss coefficient.
- $k_{mh}$  = Manhole head-loss coefficient.
- $k_r$  = Adjusted size of  $D_{50}$  rock to be used in riprap design, in feet.
- $k_s$  = Equivalent roughness height, in feet.
- $L$  = Length, in feet, as identified by its use within this Manual.
- $L'$  = Distance of maximum superelevation downstream of a curve in a channel conveying supercritical flow, in feet.



## LIST OF SYMBOLS--Continued

- $L_c$  = Confluence length of a channel junction, in feet; length of a curve, in feet; or length of hydraulically longest watercourse within a watershed, in feet, as identified by its use within this Manual.
- $L_{ca}$  = Length along the hydraulically longest watercourse of a watershed, measured from the watershed outlet to the geographical center of the watershed area, in feet.
- $L_{ct}$  = Total length of a curve connecting two channels at a junction, in feet.
- $L_e$  = Length of easement curve, in feet.
- $L_H$  = Horizontal, or flat, contact distance used to determine the weighted-creep ratio, in feet.
- $L_i$  = Length of curb-opening inlet, or length of the  $i^{\text{th}}$  reach of a watercourse in weighted basin-factor determination, in feet.
- $L_o$  = The individual distance between rows of buildings in the floodplain, or distance between Point of Tangency,  $PT$ , and a junction apex, in feet, as identified by its use within this Manual.
- $L_r$  = Length of a reach along a flood profile or channel parallel to the direction of flow, or reach length between adjacent grade-control structures, in feet, as identified by its use within this Manual.
- $L_s$  = Length of scour hole, in feet.
- $L_{sc}$  = Length of scour hole below culvert, in feet.
- $L_T$  = Reach length used in computing a composite roughness coefficient for overbank flooding, in feet.
- $L_t$  = Curb-opening length required to intercept 100 percent of gutter flow, in feet.
- $L_{TR}$  = Length of expanding transition section, in feet.
- $L_V$  = Vertical, or steep, contact distance used to determine the weighted-creep ratio, in feet.
- $M$  = Momentum of a moving mass of water.
- $N$  = An unspecified number, or number of reaches along a watercourse.
- $n$  = Manning's roughness coefficient.
- $n_{ac}$  = Manning's roughness coefficient for an approach channel (used in computing sedimentation at culvert crossings).

## LIST OF SYMBOLS—Continued

- $n_{b100}$  = Basin factor for use in peak-discharge determination.
- $n_{bc100}$  = "Composite" basin factor.
- $n_{bn100}$  = "Normal" basin factor.
- $n_{bu100}$  = "Underfit" basin factor.
- $n_{bw100}$  = Weighted basin factor.
- $n_c$  = Manning's channel roughness coefficient.
- $n_{i100}$  = 100-year basin factor for the  $i^{\text{th}}$  reach of a watercourse in weighted basin-factor determination.
- $n_n$  = Manning's roughness coefficient for a natural or existing channel.
- $n_o$  = Manning's roughness coefficient for area between buildings in a floodplain.
- $n_p$  = Manning's roughness coefficient for a culvert (used in computing sedimentation at culvert crossings).
- $n_u$  = Manning's roughness coefficient for urban conditions.
- $P$  = Wetted perimeter, in feet, or rainfall depth, in inches, as identified by its use within this Manual.
- $PC$  = The beginning point of curvature of a circular curve, or upstream point of curvature at the centerline radius of curvature, as identified by its use within this Manual.
- $P_g$  = Perimeter of a grate inlet, in feet.
- $P_h$  = Hydrostatic pressure.
- $P_{hi}$  = Horizontal component of hydrostatic pressure on the channel invert.
- $P_{hf}$  = Retardation force of friction.
- $P_{hw}$  = Axial component of hydrostatic pressure on the channel walls.
- $PI$  = The point of intersection of two lines tangent to a circular curve, or plasticity index of a soil, as identified by its use within this Manual.
- $P_n$  = n-hour precipitation depth, in inches.

## LIST OF SYMBOLS—Continued

- $PT$  = Point of tangency of a circular curve, or downstream point of tangency to the centerline radius of curvature, as identified by its use within this Manual.
- $P_{Tc}$  = Precipitation depth at time of concentration, in inches.
- $P_1$  = One-hour rainfall depth, in inches.
- $P_{1,100}$  = Areally reduced 100-year, one-hour rainfall depth, in inches.
- $Q$  = Flow rate, or discharge, in cubic feet per second.
- $Q_a$  = Mean-annual discharge, in cubic feet per second.
- $Q_{ac}$  = Discharge in approach channel (used in computing sedimentation at culvert crossings), in cubic feet per second.
- $Q_{bf}$  = Bank-full channel capacity, in cubic feet per second.
- $Q_{cap}$  = Discharge capacity, in cubic feet per second.
- $Q_{co}$  = Carry-over flow past a pavement inlet, in cubic feet per second.
- $Q_d$  = Design, or maximum allowable discharge, in cubic feet per second.
- $Q_e$  = Rate of discharge over the end of a grate opening, in cubic feet per second.
- $Q_f$  = Frontal flow passing over a grate, in cubic feet per second.
- $Q_{fi}$  = Frontal flow intercepted by a grate, in cubic feet per second.
- $Q_i$  = Discharge into a pavement inlet or grate opening, in cubic feet per second.
- $Q_L$  = Lateral flow into a side street, in cubic feet per second.
- $Q_{LOB}$  = Discharge in the left overbank of a channel or street, in cubic feet per second.
- $Q_m$  = For a normally crowned street, the discharge measured between the curbs of a main, water-carrying street, in cubic feet per second; and for an inverted crowned street, only that portion of the total discharge above the elevation of the crest of a side street.
- $Q_n$  = Peak-discharge rate under natural conditions, in cubic feet per second.
- $Q_o$  = Overbank flow intercepted by a side street, in cubic feet per second.
- $Q_p$  = Peak flow rate (discharge), or total culvert discharge, in cubic feet per second.

## LIST OF SYMBOLS--Continued

- $Q_{pc}$  = Percent of peak discharge that is contained within the banks of the channel.
- $Q_{pn}$  = Peak discharge for the n-year flood, in cubic feet per second.
- $Q_{po}$  = Percent of peak discharge that is outside of the channel.
- $Q_{p100}$  = Peak discharge for the 100-year flood, in cubic feet per second.
- $Q_r$  = Representative discharge, in cubic feet per second.
- $Q_{ROB}$  = Discharge in the right overbank of a channel or street, in cubic feet per second.
- $Q_s$  = Side flow at a grate inlet, in cubic feet per second, or sediment discharge, in cubic feet per second, as identified by its use within this Manual.
- $Q_{si}$  = Side flow intercepted by a grate inlet, in cubic feet per second.
- $Q_T$  = Total flow reaching a pavement inlet, or total gutter flow, in cubic feet per second.
- $Q_u$  = Peak-discharge rate under urbanized conditions, in cubic feet per second.
- $Q'$  = Only that portion of the total discharge below the elevation of the crest of a side street, in cubic feet per second.
- $Q_{100}$  = The 100-year peak discharge, in cubic feet per second.
- $q$  = Unit discharge, in cubic feet per second per foot.
- $R$  = Hydraulic radius, in feet.
- $r$  = Radius of curvature, or radius of a circular conduit, in feet.
- $R_{ac}$  = Hydraulic radius of flow in approach channel (used in computing sedimentation at culvert crossings), in feet.
- $r_c$  = Radius of curvature of channel centerline, in feet.
- $R_f$  = Ratio of frontal flow intercepted by a grate to total frontal flow.
- $R_p$  = Hydraulic radius of flow within a culvert (used in computing sedimentation at culvert crossings), in feet.
- $R_s$  = Sediment-transport ratio (channel to culvert).
- $R_s$  = Reduction factor for sediment supply.

## LIST OF SYMBOLS—Continued

- $R_{sf}$  = Ratio of side flow intercepted by a grate to total side flow.
- $S$  = Channel slope or culvert slope, in feet per foot.
- $S_{ac}$  = Longitudinal slope of approach channel (used in computing sedimentation at culvert crossings), in feet per foot.
- $SB$  = Minimum setback distance from the top edge of the highest channel bank or from the edge of the 100-year water-surface elevation, whichever is closer to the channel centerline, in feet.
- $S_c$  = Critical slope, in feet per foot, or mean basin slope, in feet per foot, as identified by its use within this Manual.
- $S_e$  = Energy slope, or equivalent cross-slope of a depressed or composite gutter, in feet per foot.
- $S_{eq}$  = Equilibrium slope of a channel, in feet per foot, as identified by its use within this Manual.
- $S_f$  = Friction slope, in feet per foot.
- $S_i$  = Channel slope for the  $i^{\text{th}}$  reach of a watercourse in weighted basin-factor determination, in feet per foot.
- $S_{ib}$  = Initial channel bed slope, in feet per foot.
- $S_m$  = Longitudinal slope of a main, water-carrying street, in feet per foot.
- $S_n$  = Natural or existing channel slope, in feet per foot.
- $S_o$  = Outlet slope of a culvert, slope of ground surface, street, culvert, or storm drain in the direction of flow, in feet per foot.
- $S_p$  = Longitudinal slope of a culvert, in feet per foot.
- $S_s$  = Longitudinal slope of side street, in feet per foot.
- $S_v$  = Saturated shear strength, in pounds per square inch.
- $S'_w$  = Cross-slope of a gutter, measured from the cross-slope of the pavement,  $S_x$ , in feet per foot.
- $S_x$  = Pavement cross-slope normal to the direction of traffic flow, in feet per foot.
- $T$  = Top width of water surface or channel, in feet, or a unit of time, as identified by its use within this Manual.

## LIST OF SYMBOLS--Continued

- $t$  = Cumulative time from beginning of runoff in a runoff event, in minutes, or a coefficient as identified by its use within this Manual.
- $T_c$  = Time of concentration, in minutes.
- $T_{cn}$  = Time of concentration for the  $n$ -year flood ( $T_{cn} < T_{c100}$ ), in minutes.
- $T_{c100}$  = Time of concentration for the 100-year flood, in minutes.
- $T_r$  = Rise time of a hydrograph, in minutes.
- $T_w$  = Channel top width, in feet.
- $TW$  = Tailwater elevation, in feet.
- $V$  = Flow velocity, in feet per second, or total runoff volume in acre-feet, as identified by its use within this Manual.
- $V_a$  = Maximum allowable flow velocity in an unlined channel, in feet per second.
- $V_b$  = Basic maximum allowable flow velocity in an unlined channel, in feet per second.
- $V_d$  = Channel velocity downstream of a culvert, in feet per second.
- $V_i$  = Approach flow velocity for a culvert, in feet per second.
- $V_m$  = Mean channel velocity, average velocity of flow, or flow velocity, in feet per second, as identified by its use within this Manual.
- $V_o$  = Gutter velocity at which splash-over first occurs at a grate inlet, in feet per second.
- $V_{p100}$  = Average velocity of flow at the peak of a 100-year flood, in feet per second.
- $V_s$  = Sediment volume, in cubic feet.
- $V_{sc}$  = Volume of scour hole below culvert, in cubic feet.
- $v$  = Accumulated runoff volume of a hydrograph at time  $t$ , in acre-feet.
- $W$  = Width, in feet.
- $W_m$  = Width of a main, water-carrying street, in feet.
- $W_o$  = The individual widths between buildings in the floodplain measured perpendicular to the direction of flow, in feet.

## LIST OF SYMBOLS—Continued

- $W_{sc}$  = Width of scour hole below culvert, in feet;
- $W_{ss}$  = Width of a side street, in feet.
- $W_T$  = Total width of floodplain, in feet.
- $X, x$  = Horizontal distance, in feet.
- $x_{sce}$  = Horizontal distance from the downstream face of a grade-control structure to the point of maximum scour downstream of the structure, in feet.
- $Y$  = Depth of flow, or channel depth, in feet, as identified by its use within this Manual.
- $y$  = Depth of flow, in feet.
- $Y_c$  = Critical depth of channel flow, in feet.
- $Y_{cf}$  = Depth of flow at the curb face, in feet.
- $Y_{cs}$  = Critical depth of side inflow to a channel, in feet.
- $Y_e$  = Equivalent depth of flow at a culvert outlet, in feet.
- $Y_{gb}$  = Depth of flow at the grade break between gutter and pavement, in feet.
- $Y_h$  = Hydraulic (mean) depth of flow, in feet.
- $Y_i$  = Depth of water at lip of curb opening, in feet.
- $Y_{max}$  = Maximum depth of flow, in feet.
- $Y_n$  = Normal depth of flow, in feet.
- $Y_o$  = Effective head on the center of a curb-opening orifice throat, in feet.
- $y_o$  = Average depth of overbank flow intercepted by a side street, in feet.
- $Y_{p100}$  = Maximum depth of flow at the peak of a 100-year flood, in feet.
- $Z$  = Vertical elevation, in feet; channel side-slope (horizontal/vertical), in feet per foot; or invert of pavement cross-slope, in feet per foot; as identified by its use within this Manual.
- $Z_a$  = Anti-dune trough depth, in feet.
- $Z_{bs}$  = Bend scour depth, in feet.

## LIST OF SYMBOLS--Continued

- $Z_{gs}$  = General scour depth, in feet.
- $Z_{1ft}$  = Low-flow thalweg depth, in feet.
- $Z_{1s}$  = Depth of local scour, in feet.
- $Z_{1sc}$  = Depth of scour hole below a culvert, in feet.
- $Z_{1sc}$  = Depth of local scour due to an embankment, in feet.
- $Z_{1sf}$  = Depth of local scour due to a free-overfall drop, in feet.
- $Z_{1sp}$  = Depth of local scour due to a pier, in feet.
- $Z_{1ss}$  = Depth of local scour due to a submerged drop, in feet.
- $Z_p$  = Vertical rise of the pavement elevation along distance  $x$  of a parabolic curve, in feet.
- $Z_t$  = Design scour depth, in feet.
- $\alpha$  = Angle, or empirically derived coefficient, as identified by its use within this Manual.
- $\alpha_e$  = Empirically derived coefficient.
- $\beta$  = Angle, or empirically derived coefficient, as identified by its use within this Manual.
- $\gamma_r$  = Unit weight of rock, in pounds per cubic foot.
- $\gamma_w$  = Unit weight of water, in pounds per cubic foot.
- $\Delta H$  = Change in watercourse elevation, used for mean-slope determination, in feet.
- $\Delta L$  = Change in watercourse length, used for mean-slope determination, in feet.
- $\Delta Y$  = Rise in water-surface elevation (superelevation) around the outside of a channel bend, in feet.
- $\theta$  = Angle, or empirically derived coefficient, as identified by its use within this Manual.
- $\theta_a$  = Slope angle of abutment face, measured from the horizontal, in degrees.
- $\nu$  = Kinematic viscosity, in  $\text{ft}^2/\text{sec}$ .
- $\pi$  = Mathematical constant  $\approx 3.1416$ .
- $\rho$  = Density of water, or fluid density, in slugs per cubic foot.



## LIST OF SYMBOLS--Continued

- $\sigma$  = Statistical standard deviation.
- $\tau$  = Tractive stress, in pounds per square foot.
- $\tau_c$  = Critical tractive shear stress, in pounds per square foot.
- $\tau_\infty$  = Tractive stress for an infinitely wide channel, in pounds per square foot.
- $\tau_{ls}$  = Allowable tractive stress on an unlined channel bank, in pounds per square foot.
- $\tau_s$  = Actual maximum tractive stress on sides of straight trapezoidal channels, in pounds per square foot.
- $\tau_{sc}$  = Actual maximum tractive stress on sides of trapezoidal channels within a curved reach, in pounds per square foot.
- $\tau_{st}$  = Actual maximum tractive stress on sides of trapezoidal channels in straight reaches immediately downstream from curved reaches, in pounds per square foot.
- $\phi_p$  = Angle of approach flow in relationship to pier wall, in degrees.
- $\phi_R$  = Angle of repose of soil, in degrees.
- $\nabla$  = A symbol which indicates the vertical location of the water-surface elevation.

## CHAPTER I: INTRODUCTION

### 1.1 Objectives

This Manual is intended to serve as a multi-purpose document which addresses the issues associated with drainage policies, drainage design, and floodplain management within the City of Tucson. It is the overall and primary objective of the City of Tucson to promulgate Floodplain and Drainage Standards which protect the general health, safety, and welfare of the citizens of the community. This is best accomplished by providing a comprehensive set of policies and analytical procedures for evaluating and designing both public and private improvements which are located within or near areas of flood hazard.

Step-by-step analytical procedures are provided herein which are intended to standardize the methodologies by which routine drainage engineering problems are approached and solved. Besides providing simplified, step-by-step analysis and design procedures, this Manual also provides performance criteria which allows for non-standard designs to be submitted and approved.

This approach is intended to allow the engineer the flexibility either to apply innovative concepts or to minimize engineering effort by utilizing a conservative, simpler approach to drainage projects. Secondary benefits which are intended to be gained from this Manual include: (1) minimizing review time for drainage report submittals, (2) minimizing public expenditures on flood-control projects, and (3) maintaining eligibility in the National Flood Insurance Program by simplifying procedures for compliance with Flood Plain Ordinance requirements.

A summary of general drainage policies is provided within Section 1.3 of this chapter. It is important that this section be read and understood prior to applying the step-by-step procedures presented within the body of this Manual. By reading Section 1.3, a greater understanding of the purpose and philosophy of drainage regulation within the City of Tucson can be gained by the interested reader, as well as by the experienced engineer.

Chapter II and Chapter III of this Manual address the policies, procedures, and planning principles associated with drainage design and floodplain management within the City of Tucson. Chapter IV through Chapter XIV of this Manual address the technical engineering details associated with the analyses of the various drainage-related facilities which are or may be located within the City of Tucson. The material contained within these chapters is targeted for use by practicing engineers in drainage and flood-control related fields, or other individuals with equivalent knowledge or training. Consequently, an understanding of the basic concepts of hydrology and hydraulics has been assumed throughout this Manual.

Little attempt has been made to discuss theory or derivations of the methods presented herein, rather step-by-step approaches are presented. Should additional information be desired, the user is encouraged to consult the "References and Selected Bibliographies" section at the end of this Manual. In some cases where a methodology has been adequately documented within a easily obtained reference, the reader has been directed to the reference in order to obtain the procedure. Copies of most of these sources are available, for viewing, in a reference library at the Office of the City Engineer. Additionally, a Recommendations Report (Simons, Li & Associates, Inc., 1987)

## I. INTRODUCTION

which presents much of the background work that went into the preparation of this Manual is also on file at the office of the City Engineer for review by the interested reader.

### 1.2 Applicability

The methods, procedures, criteria and policies presented within Manual are applicable to the planning, analysis, and design of both public and private drainage facilities within the incorporated limits of the City of Tucson. Many of the specific items contained within this Manual have limited ranges of applicability. An attempt has been made to specify these ranges, whenever and wherever possible. However, it is the responsibility of the practicing engineering to utilize good engineering judgement when applying any procedure found in this Manual to a particular site condition.

### 1.3 General Policies

This section provides a summary of the general policies relating to drainage and flood-control within the corporate limits of the City of Tucson. This section does not reiterate all of the provisions and requirements contained within the City of Tucson Floodplain Ordinance, nor does it provide specific engineering criteria for drainage design and analysis.

The general policies contained herein are numbered by chapter and policy number. Since policies are periodically modified or amended, the user of this Manual should contact the City of Tucson prior to commencing on a new project to insure awareness of any new policies, as well as design criteria and ordinance provisions.

The drainage policies of the City of Tucson, as explained within the appropriate chapters of this Manual, are as follows:

#### ***Chapter II: Policies and Procedures for Submittals of Drainage Reports***

1. **The City Engineer shall require, for review and approval, the submittal of a drainage report, drainage statement, or an application for a Floodplain Use Permit whenever development and/or grading is proposed in areas that either (1) are within a regulatory flood plain; (2) are within an erosion/building-setback zone; or (3) are within a watercourse that might otherwise be obstructed by the proposed development/grading.**
2. **All drainage submittals given to the City Engineer or his staff for review shall be prepared by an Arizona Registered Professional Civil Engineer, or his/her bona-fide employee, and stamped by same.**

#### ***Chapter III: Planning***

See Chapter III of this Manual for an in-depth presentation of planning policies and concepts.

## I. INTRODUCTION

### **Chapter IV: City of Tucson Method for Estimating Flood Peaks and Flood Hydrographs**

1. The City of Tucson Flood Peak Estimator Procedure shall be used to determine the design 100-year flood peak for drainage basins less than ten square miles in size. Because of the current City policy which requires detention/retention within all new developments, flood peaks are to be estimated assuming both existing and future hydrological conditions for on-site watersheds.

### **Chapter V: Floodplain Delineation**

1. All Tentative/Final Plats, Site Plans, and Development Plans (when requested) that are submitted to the City of Tucson for review and approval shall clearly show the floodplain limits for all 100-year floods with peak discharges equal to or greater than 100 cubic feet per second (cfs).
2. For those proposed developments that are to be located within areas designated as regulatory flood plains by FEMA, as well as those proposed developments that are to be located within other flood plains identified by the City Engineer, the owner/developer shall provide (1) a certificate of finished-floor elevation, prepared by an Arizona Registered Professional Civil Engineer or Land Surveyor, once the foundation and floor have been placed (i.e., following the issuance of a foundation-only permit and before the issuance of a building permit); and (2) an application for, and obtaining of, an approved Floodplain Use Permit prior to the issuance of any grading or building permits.

### *Chapter VI: Erosion and Sedimentation*

See Chapter VI of this Manual for an in-depth presentation of erosion and sedimentation policies and concepts.

### *Chapter VII: Erosion-Hazard/Building-Setback Criteria*

See Chapter VII of this Manual for an in-depth presentation of erosion-hazard/building-setback policies and criteria.

### **Chapter VIII: Open-Channel Design**

1. Open channels shall be designed to convey at least the 100-year peak discharge within the main channel and its adjoining overbank flow areas, as needed.
2. All constructed channels shall have a parallel access and maintenance easement on one or both sides of the channel. These easements shall form an interconnected network of limited-access, multi-purpose rights-of-way.

## I. INTRODUCTION

- Development within these rights-of-way shall not interfere with either vehicular or pedestrian movement.
3. Lined and unlined open channels shall be designed to minimize overall costs to the City of Tucson, including costs for rights-of-way, construction, operation/ maintenance, and possible liability.
  4. All open channels shall include an appropriate degree of visual-impact mitigation, such as landscaping, adding color and texture to bank-protection materials, and placement of screen walls, where applicable.
  5. Whenever feasible, open channels shall be designed to accommodate pedestrian and bicycle access.

### *Chapter IX: Channel Stabilization and Hydraulic Structures*

See Chapter IX of this Manual for an in-depth presentation of channel stabilization policies and techniques, and policies regarding the use of hydraulic structures.

### *Chapter X: Storm Drains*

See Chapter X of this Manual for an in-depth presentation of storm-drain policies and design.

### **Chapter XI: Culverts**

1. To minimize backwater effects, the rise in headwater elevation on the upstream side of a culvert shall not exceed one foot above the existing water-surface elevation. In addition, any increase in floodplain width caused by the roadway and/or the culvert shall remain within a public or private right-of-way, drainage easement, or a flowage easement; and, in all cases, the increased flow depth shall not reduce the one-foot freeboard criterion established as the minimum difference allowable between the 100-year water-surface elevation and the finished-floor elevations of any existing or proposed residential, commercial, and/or industrial buildings, as stipulated in Section 23-464.2 of the Tucson Zoning Code.

### **Chapter XII: Street and Parking Lot Drainage**

1. Runoff from a 10-year storm must be contained between the curbs of the street. On arterial streets or multi-laned roadways, at least one travel lane in each direction shall be free from flooding during a 10-year flood. Otherwise, storm drains, drainage channels, or other acceptable methods shall be required where all-weather access cannot be achieved.

## I. INTRODUCTION

2. The primary purpose of streets shall be to serve as conveyors for vehicular traffic and to permit access to all lots and properties served by any given street. Although it is realized that streets will convey a certain amount of drainage, such as stormwaters draining from adjacent lots and stormwaters resulting from rainfall directly upon the streets themselves, new streets shall not be designed to convey flows other than those of local origin.
3. The conveyance of stormwater runoff in streets shall be limited, and controlled to the extent that interference with vehicles and pedestrian traffic is minimized.
4. Street flows shall be controlled to prevent damage to the street surface by limiting the flow velocity. Street flow shall be contained within the street right-of-way, or within the right-of-way plus drainage easement, in order to prevent damage to adjacent properties.

### *Chapter XIII: Floodproofing*

See Chapter XIII of this Manual for an in-depth presentation of floodproofing policies and techniques.

### *Chapter XIV: Detention/Retention Basins*

1. Except for large-scale, regional detention/retention basins, the City of Tucson shall not accept small-scale, local detention/retention basins for operation, maintenance, or liability.

#### 1.4 Implementation

Several alternatives exist for the implementation or execution of agreements to provide drainage improvements during the development process. These alternatives include posting of assurances for subdivisions, the execution of a Private Improvement Agreement for private construction within public right-of-way, the formation of an Improvement District, and the construction of private improvements on private property.

##### *1.4.1 Subdivision Assurances*

Under State Statutes and the City Code, all subdivision improvements, including drainage and flood-control improvements, require assurances for securing adequate completion by the developer. For more information, refer to Tucson Development Standard 1-04.0, which describes subdivision assurance procedures and policies.

##### *1.4.2 Private Improvement Agreement*

A Private Improvement Agreement (PIA) is made in order to allow for the expeditious design, construction, and inspection of drainage improvements by private

## I. INTRODUCTION

parties within public rights-of-way. Typically, once the PIA has been finalized, and the improvement plans have been approved, construction and construction inspection becomes the responsibility of the developer. Upon satisfactory completion of the project, and upon engineering certification of substantial completion, the City will accept the long-term maintenance of the drainage improvement. The Subdivision Engineer in the City Engineer's Office should be contacted for current PIA policies and procedures.

### 1.4.3 *Public Improvement District*

Upon the demonstration of public need and upon the concurrence of the majority of affected property owners, the City of Tucson will form a Public Improvement District, often simply called an Improvement District, to provide public improvements, including drainage improvements. The design, construction, and construction inspection of these drainage improvements are coordinated by either the City Engineer or a duly authorized representative. Partial repayment for the improvements by the affected property owners is typically in accordance with the assessment formulas described in an intra-departmental memorandum between the City Engineer and the Assistant Director of Transportation dated July 10, 1986, and entitled "Administrative Policy on Establishment of Improvement Districts by Petition of the Property Owners". The Improvement District Coordinator in the City Engineer's Office should be contacted for current Improvement District policies and procedures.

### 1.4.4 *Private Drainage Improvements*

Drainage improvements on private property are subject to review by either the City Engineer or a duly authorized representative. Depending upon the size of the proposed drainage improvement, approval by the City may be in conjunction with the review of a Development Plan, a Building Permit Application, a Floodplain Use Permit Application, or a Grading Permit Application. The City Floodplain Engineer, the Subdivision Engineer with the City Engineer's Office, and the Plans Examiner with the Building Safety Division should be contacted for their current policies and procedures relating to private drainage improvements.

## 1.5 Maintenance of Drainage Improvements

Maintenance of drainage improvements within Public rights-of-way or within a public drainage easement is the responsibility of the Operations Division of the City of Tucson. Except for the enforcement of floodplain regulations by the City of Tucson, maintenance of, and liability for, watercourses outside of public rights-of-way or public drainage easements is the responsibility of the private property owner.

However, all watercourses must be dedicated to the City as either drainage rights-of-way or drainage easements for maintenance purposes, unless certain requirements are met. These requirements are:

1. A mechanism must be provided by which some person, private party, or association is responsible for maintenance of the drainageway. The responsible entity must have sufficient financial resources to adequately

## I. INTRODUCTION

maintain the drainageway in the future. For instance, a certain portion of the revenues of a homeowners' association must go for maintenance, and this must be clearly stated in the covenants, conditions, and restrictions of the association.

2. The responsible entity must have a visible interest in adequately maintaining the drainageway. In other words, should the drainageway fail through lack of maintenance, the responsible entity must be the one to suffer the consequences.
3. Inadequate maintenance of the drainageway must not result in conditions that could cause loss of life or damage to other property.

If the City Engineer is satisfied that the above conditions are met, the drainageway may be owned and maintained privately, and there are no requirements as to maintenance access lanes or minimum bottom width. However, a flowage easement, granted to the City, is still required over the drainageway. The flowage easement shall not give the City maintenance responsibility, but shall give the City the right to allow drainage water to flow freely (i.e., unobstructed) through the drainageway. Therefore, if necessary, the City shall have the right, by easement, to order the drainageway cleaned or repaired by the responsible entity. The flowage easement shall also give the City the right, should the required maintenance not be performed in a timely manner, to perform the maintenance and be reimbursed by the responsible entity.

In addition, privately owned and maintained drainageways that are not built to minimum City standards for maintenance access may not be dedicated to the City, unless they are first modified to conform to City standards at private expense.

### *1.5.1 Maintenance of Drainageways*

As a condition of approval of Subdivision Plats and Development Plans, the City of Tucson will require that all drainageways be encumbered by either a drainage easement or a flowage easement, depending upon whether or not public maintenance is desired or required.

Whenever private maintenance is required or needed, a Homeowners' or Business-Owners' Association shall be established for all subdivisions in order to create the authority and responsibility for maintaining all small washes and small, constructed channels within the subdivision. All major washes going through a subdivision shall be maintained by the City of Tucson, after the recordation of appropriate easements. For the smaller washes and constructed channels, Covenants, Conditions, and Restrictions shall be written and recorded stating that both scheduled and unscheduled maintenance of drainageways will be performed by, or for, the Homeowners'/Business-Owners' Association or the Owner(s) of the non-residential development; and that a Professional Civil Engineer, registered in the State of Arizona, shall be retained by the Association/Owner(s) at least once a year, and also following any damaging floods, in order to inspect and to certify compliance with the drainageway and detention/retention basin maintenance-inspection criteria contained in the approved drainage report for the development or subdivision. A copy of the Engineer's annual inspection reports and certifications of compliance shall be kept on file by the Association/



## I. INTRODUCTION

Owner(s), and be made available to the City of Tucson upon request. In addition, a note shall be placed on the Final Plat or Development Plan granting the City of Tucson easements and rights of access to assure that an adequate level of maintenance is being performed.

All large washes and large, constructed channels forming the main stem of a major watercourse will be maintained by the City of Tucson upon receipt of appropriate easements. As a condition of Development Plan or Subdivision Plat approval, the individual reaches of major watercourses passing through the development shall be covered by recorded access/maintenance and drainage easements dedicated to the City of Tucson.

All drainageways, whether or not they are maintained by the City of Tucson, including natural washes and constructed channels, require unobstructed access/maintenance easements beside the channel or wash. Normally, these access/maintenance easements shall be at least 16 to 20 feet wide, free of any structures, and be located on *both* sides of the City-maintained channel or wash; unless the City of Tucson specifically accepts either a wider or narrower easement, or accepts an access/maintenance easement on only one side of the wash/channel.

All drainageways that are intended for maintenance by the City of Tucson shall be designed for low maintenance, using approved design and construction procedures. Natural washes may require periodic grade-control structures in order to prevent gradual channel degradation. An approved engineering study may be required to confirm otherwise. Unlined channels must be hydraulically designed by assuming that natural vegetation becomes re-established, and is not removed by periodic City maintenance. Constructed channels that are to be maintained by the City of Tucson shall have a minimum bottom width of ten feet, and shall have frequent access ramps into the bottom of the channel in order to provide adequate vehicular access.

### *1.5.2 Maintenance of Detention/Retention Basins*

Small, local detention basins constructed in compliance with Section 23-469 of the Tucson Zoning Code will *not* be accepted by the City of Tucson for maintenance or liability. All local detention/retention basins shall be constructed according to current design standards, and they must include appropriate access and maintenance easements, including an unobstructed access route into the basin.

As part of the drainage report submitted in conjunction with the Development Plan, Tentative Plat, or Site Plan, a detailed inspection list and basin-performance criteria shall be included for subsequent reference by the Engineer responsible for annual and as-needed maintenance inspections of the basins and drainageways.

Refer to Tucson Development Standard 10-01.0 (i.e., the "Stormwater Detention/Retention Manual") for design and maintenance criteria for small detention/retention basins. Also, the Floodplain Engineer and the Subdivision Engineer in the City Engineer's Office should be contacted for current policies and procedures concerning private maintenance of detention/retention basins and their attendant drainageways.

## CHAPTER II: POLICIES, PROCEDURES, AND FORMATS FOR DRAINAGE REPORTS, HYDROLOGY REPORTS, AND DRAINAGE STATEMENTS

### 2.1 Introduction

The purpose of this chapter is to present criteria for submittals of drainage reports, hydrology reports, and drainage statements to the City of Tucson, including the necessary information that should be included as part of such submittals. The basic purpose for preparing and submitting any of these studies is to adequately determine the finished floor elevations (FFE) of proposed structures. In addition to this purpose, a hydrology study should specifically identify existing runoff patterns and floodplain areas, identify existing flood hazards, and determine the effect of proposed construction upon existing flows and water-surface elevations. In addition, drainage reports should specify stormwater detention/retention requirements, as well as identify required drainage improvements and structures.

Before preparing a drainage report, hydrology report, or drainage statement, the consulting engineer is strongly encouraged to discuss the proposed drainage design with the Floodplain Engineer, or his designated representative, and obtain specific hydrologic, hydraulic, and design requirements for developing the subject parcel. Additional planning information can also be obtained as a result of this meeting, including City drainage policies found in documents with limited distribution, such as the Tucson Comprehensive Plan, Basin-Management Plans, Neighborhood Plans, and Specific Plans.

#### 2.1.1 *Drainage Report*

A drainage report is a report which is required for any site greater than one acre in size or for any site subject to detention requirements. The drainage report shall contain all elements of a hydrology report, as well as the appropriate components for the required detention facility design. In addition, a drainage report shall be required for any site where extensive structural improvements for mitigating drainage impacts are required.

#### 2.1.2 *Hydrology Report*

A hydrology report is a report required for developments which are not subject to detention requirements, nor which require extensive structural improvements for handling drainage; but which are impacted by flows from significant watercourses and/or affected by 100-year flows of 100 cfs, or more. The objective of a hydrology report is to establish finished-floor elevations which assure that all structures are free from flooding during a regulatory flood. Additional objectives of a hydrology report are to establish the size and configuration of flow-through wall openings and other minor drainage features; and, if required, to develop a grading plan which demonstrates adequate site drainage.

#### 2.1.3 *Drainage Statement*

A drainage statement is a brief description of drainage conditions applicable for a site which is not affected by 100-year flows of 100 cfs, or more, and is neither subject to detention requirements nor impacted by flows from a significant watercourse. The objective is to demonstrate adequate site drainage, and to establish finished-floor elevations which assure that all structures are free from flooding during a 100-year flood.

## II. REPORT FORMATS

### 2.2 Conditions Requiring Report or Data Submittal

The review and approval of drainage reports, hydrology reports, and drainage statements by staff in the Floodplain Section of the City Engineer's Office are typically in response to reports and statements submitted in order to satisfy one of the following: (1) a requirement of rezoning; (2) a specific requirement for approval of a subdivision plat or a development plan; (3) approval of a disclosure statement prepared in conjunction with a condominium conversion; (4) the request for a floodplain, building, or grading permit for a parcel located within either a regulatory floodplain (sometimes called a drainage-review zone), an erosion/building-setback zone, or an identified flood-hazard area; or (5) application for a Letter of Map Amendment (LOMA) or a Letter of Map Revision (LOMR) from the Federal Emergency Management Agency (FEMA).

The complexities of drainage reports, hydrology reports, and drainage statements depend upon many factors, such as development size, severity of existing drainage problems, extent of drainage improvements needed to satisfy Floodplain Regulations and development standards, and the need to provide detention/retention basins. A brief description of the amount of drainage information that will be required for various development settings is provided below.

#### 2.2.1 *Rezoning Applications*

In addition to architectural elevations and a generalized site plan, the Preliminary Concept Plan submitted to the Planning Director, in conjunction with an application for a Building Zone Map amendment, must show the approximate size and location of all proposed, major, drainage improvements. For the benefit of the City Engineer's staff, who will be reviewing the application, it must be shown how the drainageways and detention/retention basins, if required, will satisfy Floodplain Regulations and Drainage Standards. It must also be shown that these drainage features will serve as appropriately landscaped, and visually appealing, multi-use elements of the site design, so that they will be perceived as amenities by the community. Therefore, before the applicant formulates a Preliminary Concept Plan for a particular parcel, they are encouraged to be familiar with and be able to incorporate the planning and design concepts contained in the following City of Tucson documents: (1) Section 3 (Character and Appearance) of the Comprehensive Plan Amendment (Resolution Number 14047, June 8, 1987); (2) the "Stormwater Detention/Retention Manual," adopted as Tucson Development Standard 10-01.0; and (3) the "Interim Watercourse Improvement Policy," adopted June 27, 1988. Those applicants wishing technical and/or drainage-planning assistance are urged to contact the Floodplain Engineer, or his designated representative. Typically, no drainage report, hydrology report, drainage statement, or computations will be needed at a preliminary stage, unless the drainage information appears severely inadequate and/or the Floodplain Engineer considers site drainage to be an important and limiting factor in the successful development of the site.

#### 2.2.2 *Subdivision Plats and Development Plans*

In accordance with Sections 23-409, 23-433, and 23-439 of the Tucson Zoning Code, approval of some Development Plans and all Tentative/Final Subdivision Plats submitted to the Planning Director for review and approval will be withheld until an

## II. REPORT FORMATS

appropriate drainage plan has been approved by the City Engineer. *Unless specifically requested* by the City Engineer, a drainage report, hydrology report, or drainage statement shall *not* be required for a Development Plan. The City Engineer should be consulted to determine if such information is required. However, *unless specifically waived* by the City Engineer or his representative, all Tentative/Final Subdivision Plats shall be accompanied by a drainage report, hydrology report, or drainage statement which technically describes how the proposed development will be in compliance with City Floodplain Regulations and City Drainage Standards.

### 2.2.3 *Application for a Building Permit or a Grading Permit*

Typically, whenever a future building site is located within a "drainage-review zone" shown on base maps prepared and periodically updated by the Floodplain Section staff, or involves an area of one acre or more, staff reviewing Building-Permit applications in the City's Building Safety Division will mark the Building-Permit application with a note stating that a drainage report, hydrology report, drainage statement, and/or a Floodplain Use Permit will be required prior to issuance of a Building Permit. If this happens, or if the consulting engineer or the architect recognizes that drainage may be a problem in developing a site, they are encouraged to meet with the Floodplain Engineer to discuss whether or not a formal drainage submittal will be required. In rendering his decision, the Floodplain Engineer will apply the same general criteria used to decide whether or not a drainage report, hydrology report, or a drainage statement will be needed (e.g., will detention/retention be required; will significant drainage improvements and/or hydraulic analyses be needed to satisfy the Floodplain Regulations; or, is the site in a Flood Hazard Zone, as shown on Flood Insurance Rate Maps or City-generated flood-prone maps?).

### 2.2.4 *Condominium Conversions*

Any subdivider who submits a Disclosure Statement and Final Plat to the Planning Director for review and approval for the purpose of converting residential or non-residential rental buildings into condominium ownership shall submit a hydrology report, as required by Section 23-543 of the Tucson Zoning Code, which describes the physical condition or relationship of the existing structures to onsite and offsite drainage conditions. The hydrology report shall specify, by name or number, those units or spaces which:

- A. Do not have all-weather access; and/or,
- B. Have their finished-floor elevations less than one foot above the surrounding 100-year water-surface elevations; and/or,
- C. Are located in a flood-prone area as shown on the effective FIRM.

Unless the City Engineer, or his designated representative, waives the drainage-information requirement, the drainage portion of the disclosure statement shall be prepared and certified by an Arizona Registered Professional Civil Engineer. The purpose of requiring that drainage information be supplied as a part of condominium conversion projects is to provide all perspective purchasers, mortgage lending groups, or flood-insurance agents with relevant information with which to make their

## II. REPORT FORMATS

respective financial decisions concerning the project. This report requirement does not generally imply, nor do the Floodplain Regulations generally imply, that structures converted to condominium ownership shall be required to be brought into compliance with current drainage regulations. However condominium conversions made concurrently with a rezoning request *will* be subject to certain performance requirements, including drainage-related requirements specifically imposed by the Mayor and Council of the City of Tucson.

### 2.2.5 *Floodplain Use Permits*

In accordance with Section 23-470 of the Tucson Zoning Code, Floodplain Use Permits are required under the following circumstances:

- A. Whenever a parcel, lot, building pad, or development is within or affected by:
  1. A Regulatory Floodplain shown on an effective Flood Insurance Rate Map;
  2. A Regulatory Floodplain which has not been shown on a Flood Insurance Rate Map, but which is the result of a 100-year flood peak equal to or greater than 100 cfs, except for those locations where the Floodplain Engineer chooses to waive this requirement; and,
  3. An erosion setback zone, or a building setback zone, as defined in Sections 23-466.1 and 23-466.2 of the Tucson Zoning Code.
- B. Whenever a parcel, lot, building pad, or development is located within a specific portion of an approved Final Plat, Development Plan, or Site Plan which has been identified as requiring a Floodplain Use Permit.
- C. Parcels, or portions of parcels, within the Regulatory Floodplain upon which aggregate, sand, gravel, or soils are removed by excavation, or are stockpiled for storage as per Section 23-466 of the Tucson Zoning Code.
- D. Whenever fill is proposed in a regulatory floodplain.

Whenever there is insufficient technical information upon which to evaluate the permit application, either the City Engineer or the Floodplain Engineer may require the owner to have a technical study prepared by an Arizona Registered Professional Civil Engineer; the scope and content of which shall be determined by appropriate City staff on a case-by-case basis.

### 2.2.6 *Request for Map Revision*

Whenever a development is to be located within the Regulatory Floodplain, as shown on effective Flood Insurance Rate Maps, the owner/developer may obtain a Conditional Letter of Map Revision by submitting sufficient technical information. All such information must be in accordance with Section 23-463.5 of the Tucson Zoning Code. In addition, this technical information shall be submitted to the City separately

## II. REPORT FORMATS

from the Drainage Report so that it may first be reviewed and approved, and then submitted by the City to the Federal Emergency Management Agency (FEMA), on behalf of the applicant, for their review and approval. However, this does not imply that there is a requirement to apply for, or obtain, a LOMA/LOMR in order to develop within the regulatory floodplain.

The Federal Emergency Management Agency has very specific requirements for making a submittal, most of which are described in a brief document entitled, "Appeals, Revisions, And Amendments To Flood Insurance Maps: A Guide For Community Officials", published in 1985 by FEMA. Before assembling the technical information, the consulting engineer and the owner/developer are advised to discuss their plans with the Floodplain Engineer, who will be able offer assistance and guidance.

### 2.3 Report Content and Format

#### 2.3.1 *Drainage Reports and Hydrology Reports*

Whenever a drainage report or a hydrology report is required, its presentation and format should be as brief and as succinct as possible. Unless otherwise noted herein, they should contain the following engineering information, at a minimum, presented in approximately the specified format indicated below:

##### 2.3.1.1 *Cover Sheet*

- A. Submittal number (i.e., first submittal, second submittal, first addendum, etc.).
- B. Name and address of the parcel, project, or development for which the report is being submitted; the Proposed Zoning of the development (i.e., R-1, B-2A, etc.); the Planning Case Number (i.e., C9-, Cd9-, C12-); the Approximate location of the project site relative to Township, Range, and Section; and the Floodplain Section's Record Number, R-#. (Note that the Record Number is normally assigned after receipt of the first submittal. Therefore, this number would usually be found on the second, and all subsequent, submittals).
- C. Name, address, and telephone number of the client for whom the report was prepared.
- D. Name, address and telephone number of the engineering firm responsible for the report.
- E. Submittal date.
- F. Seal and signature of the Arizona Registered Professional Civil Engineer responsible for preparation of the report.
- G. Table of Contents. All report pages shall be numbered sequentially, including any appendices.

## II. REPORT FORMATS

### 2.3.1.2 Introduction

#### A. Site Location and Project Description

1. When writing the report introduction, very briefly describe the general location of the parcel relative to nearby streets, drainageways, and washes.
2. Submit a site-location map, at a minimum scale of three inches equal to one mile, which shows the geographical relationship of the project to nearby properties, streets, and watercourses.
3. Provide a legal description of the specific parcel or parcels in question (if the description is lengthy, the information may be placed in an Appendix).
4. Briefly describe the type, and approximate size, of the project to be constructed. It must be clear to the reviewer, for detention/retention considerations, whether or not the parcel or parcels being developed is greater than, or less than, one standard acre (i.e., 43,560 square feet) in size. Any lot subdivided from a parcel greater than or equal to one standard acre in size on or after September 4, 1984, is subject to stormwater detention requirements, regardless of lot size. A drainage report will be required under such conditions.
5. In order for the reviewer to understand whether or not additional information will be forthcoming, identify those drainageways and roadways for which improvement plans will be prepared.

#### B. Purpose and Objectives for Submitting a Drainage Report or Hydrology Report

1. Give the purpose for submitting the report (i.e., Tentative Plat/ Development Plan approval, Building Permit application, Floodplain Use Permit application, condition of rezoning, etc.).
2. Briefly enumerate the report objectives.

#### C. Known Development Requirements

1. Repeat, for the benefit of the reviewer, those drainage and land-use policies given in the Tucson Comprehensive Plan, Basin-Management Plans, Neighborhood Plans, or Specific Plans that apply to the project site, or its immediate vicinity. Specify how these policies have been satisfactorily addressed during the design of the development. (NOTE: For many projects, this information will not be required.)

## II. REPORT FORMATS

2. As appropriate, list any rezoning requirements that relate to drainage and grading, and describe how these specific requirements have been satisfied.
3. Summarize the preliminary requirements given by the City Floodplain Section staff during any Pre-Submittal Conference. Include a dated copy of the Pre-Submittal Conference Summary, if required, as prepared by the Consulting Engineer.

### D. Previous Studies

1. Identify all known drainage studies for the subject parcel, and for *adjacent* parcels which share drainageways and/or storm runoff. Mention previous submittals of the subject report, if any; and reference earlier staff correspondence, as appropriate.

### E. Long-Term Maintenance Responsibility

1. Specify the name, address, and telephone number of the person(s), firm(s), agency or agencies responsible for the ownership, operation, scheduled and unscheduled maintenance, and liability of drainage improvements (i.e., roads, parking areas, washes, drainageways, detention/retention basins, common areas, etc.) described in the drainage report. List other documents where these responsibilities are documented (i.e., CC&Rs, Final Plats, Development Plans, etc.).

### F. Required Permits

1. Submit a comprehensive list of Permits which either have been or will shortly be obtained from those governmental agencies whereby approval is required by Federal or State Law; including, but not necessarily limited to, a Section 404 Permit as required under the Federal Pollution Control Act Amendments of 1972, 33 U.S.C. 1334. Submit copies of appropriate correspondence, and/or written documentation, which describe whether or not permits are needed. Note that, according to current Floodplain Regulations, it is the City's responsibility to make sure that the owner/developer *obtains* all necessary permits from other agencies *prior* to granting approval of the project.

### 2.3.1.3 *Hydrology*

#### A. Offsite Drainage

1. In order to help staff locate the development relative to future drainage improvements, give the name of the Major or Minor Wash, or the Regional Watercourse *into* which the project site drains.



## II. REPORT FORMATS

2. Describe the size, location, and hydrologic characteristics of upstream and adjoining watersheds which may potentially affect the site.
3. Provide either a topographic map at a scale of one inch equal to 200 feet, or larger, or (preferably) a photo-topo which shows:
  - a) The parcel boundaries, major streets, drainageways, and nearby storm-drain systems (if they are considered in the analyses);
  - b) Boundaries of the offsite watersheds affecting the site;
  - c) Principal points of drainage concentration; and,
  - d) Flowlines and grade breaks used to compute basin lengths and average watercourse slopes.

Note that U.S. Geological Survey 7.5-minute or 15-minute Topographic Quadrangle Maps, as well as City of Tucson Drainage Base Maps, are generally *not* acceptable for delineating offsite and onsite watershed boundaries, but may be used to show large drainage basins, if the actual basin boundaries are determined from larger-scale maps. These larger-scale maps should also be included within the report.

4. Identify and describe both the existing natural and/or man-made impacts and the proposed major developments to be located within the contributing watershed which may impact the subject development, relative to flooding and erosion or sedimentation.
5. Identify and describe, as appropriate, the effects that nearby impending City/County drainageway and/or roadway-improvement projects may have upon site drainage or site design. Also, specify the time frame within which these improvements are planned.
6. Submit Hydrologic Data Sheets for each principal point of drainage concentration. Calculations are to be presented for both pre-development and post-development conditions. If there are many sheets, put them in an Appendix, and summarize the watershed characteristics and flood peaks in a table placed within the text of the report. Indicate whether the flood-peak estimates are for existing or future watershed conditions, or both.

### B. Onsite Drainage

1. Describe the size, location, and hydrologic characteristics of the onsite watersheds.
2. Unless an alternative size has been approved, beforehand, by the Floodplain Engineer, show onsite drainage conditions on topo maps

## II. REPORT FORMATS

having a minimum scale of one inch equal to 40 feet with one-foot contour intervals, as stipulated in Tucson Development Standard 2-03.2.1. A Grading Plan, Tentative Plat, Development Plan, or Site Plan may be modified for this purpose. Show on this map:

- a) Watershed boundaries;
  - b) All points of drainage concentration; and,
  - c) Flowlines and grade breaks used to compute basin lengths and average watercourse slopes.
3. Submit Hydrologic Data Sheets for each significant point of drainage concentration. If they are different, calculations are to be presented for both pre-development and post-development conditions. If there are many sheets, put them in an Appendix, and summarize the watershed characteristics and flood peaks in a table placed within the text of the report. Indicate, as appropriate, whether the flood-peak estimates are for existing or future watershed conditions, or both.

### *2.3.1.4 Floodplain Analyses and Results*

It is intended that the particular chapter of a drainage report or a hydrology report which addresses Floodplain Analyses be reserved for describing the existing and future flood plains affecting the proposed development. Either normal-depth computations or backwater computations should be used to describe both the existing (pre-development) and the future (post-development) flow depths, widths, and velocities.

The format of this chapter will vary, depending upon the complexity of the prevalent drainage patterns. Therefore, the consulting engineer may exercise his or her own judgement in writing this portion of the report. Understandably, however, the analyses and results must be clearly presented and organized; and calculations and design elements should be clearly cross-referenced to other appropriate sections of the report.

The following list contains the major technical items that must be included, or considered:

- A. Describe the hydraulic analyses used to evaluate flood plains and floodways located in, and adjacent to, the proposed development. This description shall include a brief discussion of the theory and/or the numerical/computer model used, the source of input data, and any simplifying assumptions made.
- B. Describe the results of the hydraulic analyses in terms of site design.
- C. The following items should be shown by appropriate symbols and labels on the Site Plan, Tentative Plat, or Development Plan, if located either inside of or within at least 200 feet of the subject development, as required by

## II. REPORT FORMATS

Tucson Development Standards 2-03.2, 2-03.3, and 2-03.4, and by Sections 23-409, and 23-535 of the Tucson Zoning Code.

1. Unless entirely contained within a street section or constructed drainageway, all 100-year floodplain limits and areas of sheet flooding resulting from 100-year flood peaks of 100 cfs or greater shall be clearly shown and labeled, and shall also include spot water-surface elevations.
  2. Those areas subject to flooding from flows smaller than 100 cfs shall also be identified and labeled with flow arrows.
  3. Plans and Plats shall be of a scale no smaller than one inch equal to 40 feet; and shall have ground contours, referenced to City Datum, plotted at intervals of one foot, unless unusual physical features or project size dictates otherwise.
  4. Each significant concentration point, along with its 100-year peak discharge and contributing drainage area, shall be labeled.
  5. All floodplain limits and erosion/building setback lines shall be shown in a surveyable manner on the final plat.
  6. Any Regulatory Flood Plain shall be clearly labeled as "Regulatory Flood Plain".
  7. All flood plains shall be labeled in one of the following ways: "To be left natural," "To be channelized," "Public or Private Flowage Easement," "Public or Private Drainage Easement," or "Public or Private Right-Of-Way." Prior approval from the City Engineer shall be required for the dedication of any public easement.
  8. 100-year floodplain limits which are entirely contained within a street section or constructed drainageway shall be labeled as such on the plan/plat, or a general note shall be included on the plan/plat which states same.
- D. The Hydraulic Calculation Sheets used in conjunction with the delineation of offsite and onsite flood plains, as well as those used for evaluating flow depths, velocities and flow durations, should be presented in a clearly understandable manner. Note that if computer input and output are submitted, they must be well documented and described.
- E. All hydraulic cross sections are to be clearly identified on a map of suitable scale so that they may be easily cross-referenced to the Hydraulic Calculation Sheets used by the consulting engineer. The cross sections are to be plotted to scale, and accompanied by pertinent hydraulic information, such as the ground profile, design discharge and return period, computed water-surface elevation and depth of flow, channel and overbank velocities, effective and ineffective flow areas, Manning's roughness coefficient(s),

## II. REPORT FORMATS

wetted perimeter, energy slope and/or ground slope, Froude number, and critical depth.

- F. The calculations used to assess the hydraulic effects that existing and future structures may have upon the flood plain and floodway should be presented and be clearly described. Encroachment analyses will be needed whenever significant development is planned within FEMA-recognized flood plains, major washes, or other washes or floodplains, as designated by the City Floodplain Engineer.
- G. The floodplain analyses presented in the report being submitted should be compared with those presented in previous reports for the same geographical area. Special emphasis should be given to comparing the current results with those given in Flood Insurance Studies and Flood Insurance Rate Maps, Basin-Management Studies, and studies accompanying drainage or roadway-Improvement Plans. Unless a LOMR is to be requested, the floodplain delineation should essentially coincide with the FIRM limits.

### *2.3.1.5 Hydraulic Improvements and Hydraulic Structures (Drainage Report Only)*

It is intended that the particular chapter of a drainage report which addresses Hydraulic Improvements and Hydraulic Structures be reserved for describing the design of any drainage improvements which are needed in order to satisfy either the wishes of the owner/developer or governmental regulations and standards, whether Local, State, or Federal.

The format of this chapter of the drainage report will vary, depending upon the complexity of the prevalent drainage patterns. Therefore, the consulting engineer may exercise his or her own judgement in writing this portion of the report, subject to specific requirements imposed by the City Floodplain Engineer.

The following list contains the major technical items that shall be included, or considered:

- A. Provide a general description of the proposed drainage design for the entire project. Indicate which portions will be constructed in phases, in conjunction with other major structures.
- B. Describe and present Hydraulic Calculation Sheets for each of the hydraulic systems used to collect offsite flow. Examples of these kinds of systems include collector channels, existing drainageways, and flow-through openings in perimeter screen walls. Demonstrate that the collector systems to be employed do not unnecessarily obstruct offsite flows. Encroachment analyses shall be provided, as needed.
- C. Describe and present detailed and easily understandable Hydraulic Calculation Sheets for each of the stormwater conveyance systems to be constructed as part of the overall project. These systems include, but are not necessarily

## II. REPORT FORMATS

limited to, lined and unlined channels, drainage swales, streets and alleys, storm drains, and roadway culverts;

- D. If any of the proposed drainage structures and roadways are to be dedicated to the City for ownership and operation/maintenance, Improvement Plans, prepared to City Standards, must be submitted for approval prior to the issuance of a Grading Permit or a Building Permit. When applicable, place a note on the Final Plat, Development Plan, Site Plan, and Grading Plan which indicates same.
- E. If computer input and output are submitted in conjunction with Hydraulic Computation Sheets, they must be well documented and explained.
- F. Describe and present Hydraulic Calculation Sheets for each of the hydraulic systems used to return the flow to either its natural or existing location and magnitude along the downstream property line.
- G. If flows are to be concentrated, or ponded, on the upstream or downstream side of the subject property, either a recorded drainage easement or written permission must be obtained from the appropriate property owner(s) prior to issuance of Grading Permits and Building Permits. When applicable, place a note on the Development Plan, Final Plat, Site Plan, or Grading Plan, as appropriate, which indicates same. If drainage improvements are proposed for offsite areas, written approval from the offsite property owner(s) will be required.

### 2.3.1.6 *Detention Basins and/or Retention Basins (Drainage Report Only)*

#### A. Basin Location and Description

1. State whether the project watershed has been designated as a Balanced Basin or Critical Basin by either the City or County, and describe how this designation affects the site design (i.e., standard detention/retention, threshold retention, etc.).
2. Provide any calculations needed to demonstrate that detention/retention can be waived in accordance with criteria given in Tucson Development Standard 10-01.0 (i.e., the "Stormwater Detention/Retention Manual").
3. Give a general description of the proposed detention/retention scheme for the entire project. Indicate which basins and appurtenant drainage structures will be constructed in phases.
4. Submit a detailed site plan which clearly shows the dimensions and locations of all proposed detention/retention systems, including:

## II. REPORT FORMATS

- a) The location, size, and type of inflow and outflow structures to be employed. Include dimensions and elevations of critical portions of those structures;
  - b) The location and size of access and maintenance access ramps and roadways;
  - c) Boundaries of Common Areas and Private Drainage Easements which cover the basin, inlet and outlet structures, inflow and outflow drainage channels, and maintenance routes;
  - d) Clearly marked dimensions of all building and/or erosion-setback zones (i.e., additional space provided for structural safety considerations). Be sure to show the dimensions or distances between structures and any proposed basins or drainageways;
  - e) Maximum water-surface elevations, and the limits of ponding; and,
  - f) Identified locations and types of all security barriers to be installed around the basins, as appropriate.
5. Provide details and discussions of how the proposed detention/retention scheme will comply with landscaping and grading guidelines given in Tucson Development Standard 10-01.0.

### B. Basin Design

1. Provide and describe Reservoir-Routing Calculation Sheets for each basin for the 2-year, 10-year, and 100-year design floods, at a minimum. The Reservoir-Routing Calculation Sheets shall, at a minimum, consist of a working-table for each basin, and a routing-table for each flow event. Note that the final basin design must be approved prior to approving Grading Plans, Site Plans, Development Plans, and Tentative/Final Plats.
2. Provide and describe any other Hydraulic Calculation Sheets prepared while evaluating stage-storage and stage-discharge relationships, or any other pertinent data used in the basin analysis and design.
3. Submit plotted inflow and outflow hydrographs (preferably superimposed). Include any lag-time calculations.

### C. Basin and Drainageway Maintenance

1. A very detailed Drainageway and Detention/Retention Basin Maintenance Checklist and Schedule shall be provided by an Arizona Registered Professional Civil Engineer, which will be

## II. REPORT FORMATS

followed by anyone performing scheduled and unscheduled maintenance on behalf of the owner(s) referenced in the Introduction to the Drainage Report. Certification of such maintenance shall be undertaken by an Arizona Registered Professional Civil Engineer. Each of the privately owned drainage structures and detention/retention basins to be regularly inspected shall be identified, and the final design shall be indicated by referencing specific portions of construction drawings, noting the minimum frequency of inspection and identifying the expected range of acceptable performance (i.e., sedimentation levels, scour-hole dimensions, etc.).

If private drainageways or other water-conveyance structures are proposed, but detention/retention basins are not, a maintenance checklist and schedule shall still be prepared as part of the drainage report. In these cases, the engineer may exercise his or her own judgement as to the location within the report where he or she wishes to place the discussion of maintenance.

2. As part of the checklist, state that the annual inspection report shall contain the following summaries:
  - a) A statement saying that either no maintenance work is needed at that time, or a list of repairs and work to be done to correct deficiencies, to avoid potential problems, and/or to restore the aesthetics. Also state that this work shall be followed by a Letter of Certification from an Arizona Registered Professional Civil Engineer verifying that the recommended work has been satisfactorily completed. The Engineer shall notify the City Engineer, in writing, should safety-related maintenance not be completed within a reasonable period of time.
  - b) A statement either indicating that watershed conditions have not changed since the previous inspection report, or stating that specific changes have occurred which alter or eliminate some of the design features--thereby affecting the level of service of the drainage and detention/retention systems. In addition, the City Engineer is to be immediately notified, in writing, if watershed conditions have changed to the extent that drainage and detention/retention systems no longer satisfy the requirements of the City Floodplain Regulations.

### 2.3.1.7 *Summary and Conclusions*

- A. Provide a brief summary of the important analyses and conclusions presented in the report

## II. REPORT FORMATS

- B. Certify that the proposed drainage plan, once properly constructed, will adhere to applicable Local, State, and Federal Floodplain Regulations.

### 2.3.1.8 *References*

Alphabetically list all of the sources of information and design procedures used in developing the drainage analysis and design.

### 2.3.1.9 *Appendices*

Place Hydrologic, Hydraulic, and Reservoir-Routing Calculation Sheets, and other relevant documents, in one or more referenced appendices.

### 2.3.2 *Drainage Statement*

A drainage statement may be submitted in lieu of a drainage report or hydrology report. Because site conditions vary considerably within the Tucson area, each drainage statement may be different in content and format. The Arizona Registered Professional Civil Engineer preparing the report may exercise his or her own judgement in presenting the technical information for review. In all cases, the drainage statement must be clearly written, sealed, and signed by the Engineer; and may contain the following information concerning the proposed project:

- A. A brief description of the type and size of the proposed development, including a legal description of the parcel or parcels being developed.
- B. A brief description of the amount of runoff expected on, or near, the site.
- C. A 200-scale aerial photo-topo, or other acceptable map, showing the subject parcel, the contributing drainage areas and their principal points of drainage concentration, and any other pertinent information related to the site design.
- D. Hydrologic Calculation Sheets for each principal point of drainage concentration.
- E. The appropriate Hydraulic Calculation Sheets used in designing the proposed method of drainage disposal.
- F. A 40-scale Site Plan, for review and approval.
- G. Where significant changes to hydraulic structures, detention basins, grades, FFEs, or other development conditions occur on the grading plan submitted for the purpose of a grading permit, a drainage-report addendum, justifying the proposed changes, must be included with the plan.

### 2.4 Quality of Submittals

The Arizona Registered Professional Civil Engineer shall be held solely responsible for the correctness and adequacy of all data, drawings, calculations, and reports



## II. REPORT FORMATS

submitted to the City of Tucson for review and approval. In addition, the Engineer shall comply with all Local, State, and Federal Floodplain Regulations in the design of the development.

Staff in the City Engineer's Floodplain Section will review the technical submittals for completeness and general compliance with all applicable Floodplain Regulations and Drainage Standards. Approval by the City does not necessarily imply that the design is appropriate, nor that the development is in strict compliance with all applicable regulations and standards. Review and approval of drainage submittals shall not create liability on the part of the City or its employees for any flood damages that may result from reliance upon any administrative decision made by the City or its employees.

## CHAPTER III: PLANNING

The purpose of this chapter is to briefly present drainage concepts that should be understood and considered during the initial planning of urban drainage projects. Understandably, because many of the ideas contained in this chapter are basic principles or general guidelines, they are to be treated as recommendations; and therefore not to be rigidly enforced by the City Engineer or his staff. Nevertheless, it is advisable that all civil engineers practicing drainage engineering be aware of and understand the concepts presented in this chapter of the Manual.

### 3.1 Drainage Sub-System

One of the prominent features of suburban and metropolitan Tucson is the network of coalescing urban watercourses and drainageways extending throughout the basin. In fact, these urban watercourses and drainage systems are just as significant a part of the total fabric of our community as are the roadways, linear parks, and the residential and non-residential neighborhoods which serve as vital, interconnected components of the overall urban environment of the City of Tucson. Unfortunately, the overall importance of an urban watercourse is often overlooked, and the full potential for utilizing this important land resource is often not fully realized by land planners and civil engineers.

Urban watercourses serve numerous complementary purposes, such as providing a primary pathway for the conveyance of stormwater runoff; reducing downstream flood peaks by temporarily detaining floodwaters in the shallow flood plains or overbank storage areas naturally found along the unchannelized and/or underfit portions of watercourses; providing open space within the otherwise possibly congested urban environment; providing areas for the either the preservation or the re-establishment of natural, riparian vegetation, thereby preserving wildlife habitat and movement corridors for native and introduced animal species; and providing a suitable location to accommodate future trail systems adjoining the watercourses for the enjoyment of pedestrians and bicyclists.

In an effort to improve the appearance and to encourage multi-purpose uses of important urban watercourses in our community, the design of drainageways and channels should be done in the context of the entire urban environment, and not just as a single-purpose project.

### 3.2 Drainage Master Planning

As of April, 1988, under a project entitled the Tucson Stormwater Management Study, the City of Tucson is actively formulating a city-wide stormwater master plan which, when completed, will identify optimum drainage solutions for our community from the perspective of technical feasibility, social acceptability, economic viability, environmental compatibility, and the minimization of liability leading to litigation. In addition to planning the optimum drainage system for our community by employing a multi-disciplinary design team, one of the other significant benefits will be the establishment of an equitable and defensible method for financing the construction, regulation, and maintenance of the required drainage infrastructure within the City of Tucson.

### III. PLANNING

In addition to the Tucson Stormwater Management Study, which is being conducted under the direction of the City Engineer and his staff, basin-management plans for individual watersheds have been prepared, are currently being prepared, and will continue to be prepared for a number of basins in our community. These individual basin-management plans cover relatively small geographical areas, and they are intended to serve as interim drainage plans for specific areas prior to the completion of the long-range, and more comprehensive, Tucson Stormwater Management Study.

It is the responsibility of all civil engineers designing drainage structures or residential/non-residential developments in our community to be aware of drainage master plans, basin-management studies, neighborhood plans, and City drainage policies that encompass or affect the drainage work being undertaken by the engineer. For those engineers, architects, and planners unfamiliar with the existence of drainage master plans or drainage policies, it is recommended that they contact staff either in the City Engineer's Office or in the City of Tucson Planning Department for proper advice and direction.

#### 3.3 Balanced and Critical Basins

According to the current Floodplain Regulations found in Division 32, Section 23, of the Tucson Zoning Code, as well as Tucson Development Standard 10-01.0, all watersheds within the incorporated limits of the City of Tucson have been designated by the City Engineer as being either Balanced Basins or Critical Basins. This designation is dependant upon whether or not the basins have previously been identified by either the City Engineer or his staff as having the potential for severe increases in flood hazards, or whether they already have severe flooding problems as a direct result of increased urbanization within those particular basins. In addition, the City Engineer reserves the right to identify additional Critical Basins on a case-by-case basis, whenever new hydrologic information becomes available.

A basin designation (i.e., Balanced or Critical) must be known by the design engineer prior to the preparation of concept plans for both detention/retention basins and improved channels. Planning of residential and non-residential development within designated Balanced Basins requires the identification of specific areas within the development for the future construction of detention/retention basins. These basins are required so that the theoretical post-development flood peaks do not increase and exceed those found prior to development. The approximate detention-basin volume can be quickly computed using simple equations found in Section 3.3 of the Pima County/City of Tucson Stormwater Detention/Retention Manual (1987), also referred to within this Manual as Tucson Development Standard 10-01.0.

Within designated critical basins, all proposed developments may be required to provide additional retention volumes, referred to as "threshold retention." This additional storage volume is added to the detention/retention basins in order to further reduce future runoff, and thereby help to improve an already poor drainage condition within the area. Prior to planning any retention facility, the City Engineer should be contacted to determine specific requirements and limitations.

### III. PLANNING

In order to provide design flexibility, and to also reduce overall construction and maintenance costs for local detention/retention basins, it is generally acceptable for relatively large developments with several small sub-basins within its boundaries to over-mitigate in one or more of the sub-basins, and correspondingly under-mitigate in other sub-basins, as long as the cumulative flood peaks and flood volumes at the property line have been appropriately reduced to satisfy current detention/retention requirements, and no adverse downstream effects occur.

Because of the limited land resources in our community, it is strongly recommended that detention basins serve more than one purpose, and that they be appropriately landscaped to improve their otherwise barren appearance. The use of parking-lot detention basins is discouraged. Guidelines for the design of multi-purpose and aesthetically pleasing detention/retention basins are presented in Chapter IV of the Stormwater Detention/Retention Manual mentioned previously herein.

The encroachment and filling of broad, shallow flood plains bordering both natural washes and underfit channels usually reduces the volume of overbank storage, and this typically results in a small, yet sometimes detectable increase in downstream flood peaks. Downstream flood peaks can be further increased by improving the hydraulic efficiency of designed channels, or by the addition of a storm-drain system that delivers runoff to a downstream point faster than normal overland flow processes. Planning of drainage projects along major watercourses, as well as along some of the larger minor watercourses within the City of Tucson, should include extensive consideration of either mitigating the increased downstream flood peak by use of regional detention facilities, or by increasing the size of the channel to accommodate the resulting larger, post-construction flood peak.

#### 3.4 Flood Plains and Floodways

The construction of new developments within the regulatory flood plains of major and minor watercourses is generally acceptable as long as it is done within the limitations as set forth in the current City of Tucson Floodplain Regulations found in Section 23-464 of the Tucson Zoning Code. These limitations include providing all-weather access; setting the minimum finished-floor elevations of all new structures at least one foot above applicable 100-year flood elevations; and providing technical assurances that any new developments within the flood plain will not measurably obstruct flood flows.

However, improvements within a floodway are not always acceptable, and they are also subject to the much more stringent requirements found in the City of Tucson Floodplain Regulations. These stringent requirements include, among others, not adversely affecting upstream or downstream developments by increasing flooding or erosion, and not creating or exacerbating flood damage to public facilities.

All regional watercourses located within the City of Tucson shall have, as a minimum, a fifty-foot-wide linear park adjoining each riverbank. Linear parks of appropriate width shall also be located along natural washes, and along minor washes having trail systems which are already established.

### III. PLANNING

All constructed channels that are to be maintained by the City of Tucson should be designed for low maintenance, and they must have access and maintenance easements sufficient to permit unobstructed entry of City personnel and vehicles into or along the washes, as is appropriate. Typically, access/maintenance easements are a minimum of 16 to 20 feet wide along at least one side of the wash. The unobstructed channel must be at least ten feet wide, at its base, to allow for vehicular movement, if needed. Access ramps must be installed which lead into and out of the wash at frequent intervals; and they must be placed so that culverts, bridges, or grade-control structures do not form barriers to vehicles or maintenance personnel. Also, the access/maintenance easement itself must be connected to a nearby street or alley having public access.

Prior to initiating drainage planning, it is advisable that the responsible engineer be familiar with the guidelines contained in the "Interim Watercourse Improvement Policy," adopted by the Mayor and Council on June 27, 1988.

Flowage easements and/or drainage easements are to be dedicated whenever new developments are located within a regulatory flood plain or an erosion-hazard zone.

Public drainage improvements planned for previously developed floodplain areas must be designed as if the contributing watershed were designated as a Critical Basin; and in such a manner that any new improvements, at a minimum, shall not worsen the poor existing drainage conditions. Preferably, the drainage improvement should make some improvement according to the amount of available funds for the project, and according to the extent of benefits that may be accrued as a direct result of the proposed drainage project. If the benefits are significant, then a Drainage Improvement District may be a viable consideration.

The advance planning of developments within either a regulatory floodplain or floodway normally requires a thorough understanding of floodplain regulations and drainage standards, as well as an engineering background in open-channel hydraulics, river mechanics, and sediment transport. Therefore, for technical and administrative assistance, the City Floodplain Engineer, or members of his staff, should be contacted prior to initiating large-scale drainage projects.

#### 3.5 Transportation

Standards have been developed to provide uniform design of drainage improvements along roadways in order to maintain the primary vehicular-movement function of roadways. Many of these drainage standards are contained in this Manual, and still others can be found within the Tucson Development Standards.

Planning of roadway drainage must include primary consideration for vehicular safety, as well as a secondary consideration of pedestrian safety along those areas adjacent to the roadway. Areas of heavy traffic usage may not always coincide with areas of heavy pedestrian traffic, as for example an urban park or public school located along a collector street. Therefore, the primary and secondary users of the street and adjoining sidewalk should also be considered when initially designing any new drainage infrastructure within the City of Tucson.

## FOREWORD TO CHAPTER IV

### “STANDARDS MANUAL FOR DRAINAGE DESIGN AND FLOODPLAIN MANAGEMENT IN TUCSON, ARIZONA”

Chapter IV of the Standards Manual, “City of Tucson Method for Estimating Flood Peaks and Flood Hydrographs,” has been revised. The revisions to Chapter IV were necessary in order to bring the existing procedures in conformance with the regional hydrologic modeling that was completed as part of the Tucson Stormwater Management Study (TSMS). It is the preference of the City of Tucson that TSMS hydrologic data be used for purposes of drainage design and floodplain management, where practicable, in lieu of the procedures presented within Chapter IV of the Standards Manual. For areas where the hydrologic modeling is not available, or not appropriate for site-specific applications, the revised procedures within Chapter IV can be used to calculate peak flow rates which will be consistent with the results of the TSMS hydrologic modeling.

Chapter IV contains a revised step-by-step procedure for calculating flood peaks. One of the more significant changes to the procedure is the use of a Contributing Area Factor to account for implicit detention/retention effects of specific urban land uses (see Step 15). The City Engineer will require sufficient supporting data, in the form of an analysis of aerial photographs and field verification, as a condition of approval for watershed-specific values of the Contributing Area Factors.

Other changes to the step-by-step procedure include minor adjustments to (1) the 100-year basin factors listed in Table 4.2; (2) the values for percent impervious listed in Table 4.3; and (3) the ratios of more frequent floods listed in Table 4.5. These changes make the calculated peak flow rates consistent with the TSMS hydrologic modeling.

Another significant change in computing flood peaks is related to the adoption of the new “Balanced and Critical Basin” map for the City of Tucson. For those watersheds which are no longer classified as balanced or critical basins, flood peaks for future conditions must be computed. Future land uses in the watershed can be estimated using land-use plans, area plans, or adjacent, existing land uses in the area.

## CHAPTER IV: CITY OF TUCSON METHOD FOR ESTIMATING FLOOD PEAKS AND FLOOD HYDROGRAPHS (REVISED APRIL, 1998)

### 4.1 Purpose

The purpose of this chapter is to present a simple, step-by-step procedure for estimating 2-year, 5-year, 10-year, 25-year, 50-year, and 100-year flood peaks and flood hydrographs for watershed areas located within the City of Tucson which are less than or equal to 10 square miles in size. Prior to applying the procedure presented within this chapter, however, the user should be aware of the fact that flood peaks and flood hydrographs for the previously listed flood-recurrence intervals have already been determined for most watersheds located within the corporate limits of the City of Tucson during formulation of the Tucson Stormwater Management Study (TSMS), Phase II, Stormwater Master Plan. The TSMS, Phase II, Stormwater Master Plan was completed in December of 1995, and was subsequently approved by the Mayor and Council of the City of Tucson in February of 1996. The TSMS hydrologic modeling for all City watersheds that are less than or equal to 10 square miles in size was also approved by the Federal Emergency Management Agency (FEMA) on May 12, 1996. Therefore, before proceeding with the estimation of flood peaks for a particular project utilizing the procedures described within this chapter of the Manual, the user should first check with the City Engineer to see if TSMS flood peaks and flood hydrographs are already available for the affected watercourse/watershed. In fact, *it is the strong preference of the City of Tucson that TSMS peak discharges be used in lieu of the procedures presented herein*, whenever and wherever it is practicable to do so.

### 4.2 Flood Peak Estimator Procedure

When TSMS hydrology is nonexistent, or when its application is not practicable, the following step-by-step procedure for estimating flood peaks shall be applied within the incorporated limits of the City of Tucson when designing structures or developments along watercourses whose contributing watershed areas are less than or equal to 10 square miles in size. The Flood Peak Estimator Procedure contained within this chapter is a simplification of, and is compatible with, the Pima County Flood Control District's "Hydrology Manual" (Zeller, 1979), and has been modified to produce results which are in general agreement with TSMS hydrology. For watershed areas larger than 10 square miles in size, the engineer shall first meet with either the City Engineer or his designated staff to obtain TSMS hydrology, if available, or to discuss and receive approval for the procedure proposed to be used by the engineer for estimating flood peaks within the particular watershed under investigation which exceeds 10 square miles in size.

It should also be noted that the Flood Peak Estimator Procedure contained within this chapter should only be applied to areas where "normal" runoff characteristics predominate. For areas wherein significant man-made controls exist (e.g., regional stormwater detention/retention

#### IV. FLOOD PEAK/HYDROGRAPH METHODS (REV. 4/98)

facilities), TSMS hydrology should be used, if applicable, or a City-approved hydrologic methodology (e.g., HEC-1) should be used to properly model the effects of any such controls.

##### 4.2.1 Step-by-Step Procedure for Estimating Flood Peaks

Steps required in estimating the 100-year flood peak,  $Q_{p100}$ , are given below, and correspond to the numbers shown on the blank Hydrologic Data Sheet found on Figure 4.1.

Step 1: Enter the project name and location.

Step 2: Briefly describe or identify the concentration point at which the flood peak is being estimated. To the right of this line, check the appropriate box to indicate whether computations are for existing or future hydrologic conditions within the watershed.

Step 3: Enter the watershed area,  $A$ , in acres. Depending on flood depth or frequency, careful attention must be given to the topographic maps in order to satisfactorily identify "underfit" channels and other flow areas where possible breakouts or flow splits may significantly affect the boundaries and/or physical size of the contributing watershed.

NOTE: The most recent photo-topographic maps (preferably 200-scale, with 2-foot contour intervals) are to be used in determining the size of the contributing drainage area, the watershed length, and the watershed slope. Whenever possible, drainage areas should be field checked to verify their accuracy.

Step 4: Enter the length, in feet, of the hydraulically longest watercourse within the subject watershed. This length, designated as  $L_c$ , is normally measured from the concentration point under consideration to the watershed divide—including the distance across the area subject to overland flow found upstream of the longest defined channel.

Step 5: Enter the length, in feet, of that portion of the hydraulically longest watercourse found downstream of the geographical center of the watershed area. This length is designated as  $L_{ca}$ . Within a watershed which possesses an unusually shaped area, such that it is difficult to precisely determine its geographical center,  $L_{ca}$  may be approximated as  $L_c/2$ .

Step 6: On lines a, b, c, and d, enter the lengths,  $\Delta L$ , of at least four segments of the hydraulically longest watercourse located within the watershed. Also, enter the corresponding change in elevation,  $\Delta H$ , for each of these segments on the adjacent line. The channel slope along each of these segments should be approximately constant. Also, the sum of the lengths of all these segments must exactly equal the length of  $L_c$ .



#### IV. FLOOD PEAK/HYDROGRAPH METHODS (REV. 4/98)

- Step 7: Additional space has been provided for computing " $G$ " in a checkable form.
- Step 8: Compute the mean channel slope of the watershed,  $S_c$ , in the space provided.
- Step 9: Enter the areally reduced 100-year, one-hour rainfall depth,  $P_{1,100}$ , from Table 4.1.
- Step 10: Enter the watershed type that is, or that will be, typical of existing or future land use (i.e., highly urban, commercial/industrial, etc.). If more than one watershed type or land use predominates within the watershed, then note the approximate proportion of each (e.g., natural, 25%; suburban, 75%; etc.) under the additional subarea headings.
- Step 11: From Table 4.2, enter a basin factor,  $n_{b100}$ , for the appropriate land use. If necessary, compute a weighted basin factor,  $n_{bw100}$ , using the proportion of each watershed type previously given or, preferably, the procedure described within Section 4.3. (Note that the basin factors shown in Table 4.2 reflect watershed-wide hydraulic conditions for a 100-year flood, and produce flows generally consistent with TSMS hydrology).
- Step 12: From the most recent NRCS (SCS) Soil Maps of the Tucson metropolitan area, enter the hydrologic soil types (i.e., soil types "B", "C", or "D"), and the percent of each soil type found within the watershed. Substitute soil type "B" whenever soil type "A" appears on the maps. If detailed map coverage does not yet exist for portions of watersheds located within the urban valley of the City of Tucson, use the default values of 80% "B" and 20% "D" as appropriate hydrologic soil types for these areas.
- Step 13: Using recent photo-topographic maps, in conjunction with current Neighborhood/Area Plans or other approved Land-Use Plans, estimate either the existing percentage of the watershed that is impervious or the percent that will be impervious under future conditions. These percentages, whether future or existing, should be approximately equal to the percentages provided within Table 4.3, which are representative of each watershed type (note: Table 4.3 percentages are compatible with TSMS hydrology).
- Step 14: Calculate a weighted runoff coefficient,  $C_{w100}$ , using the applicable values for the one-hour rainfall depth, the hydrologic soil types, and the weighted percentage of impervious cover,  $I_w$ , that are listed in Table 4.3. The coefficients shown in Table 4.3, compatible with TSMS hydrology, may be used when hydrologic characteristics match the land-use breakdown for the watershed under investigation.
- Step 15: Select the appropriate Contributing Area Factor,  $F_{Ac}$ , from Table 4.4. This factor accounts for the implicit detention/retention effects that specific urban land uses have upon the contribution of drainage subareas to the maximum flood peak and flood volume of the total watershed. If more than one land use predominates within the

#### IV. FLOOD PEAK/HYDROGRAPH METHODS (REV. 4/98)

watershed, the Contributing Area Factor for each type of land use should be listed (e.g., "Natural" conditions  $F_{Ac} = 1.0$ ; "Moderately Urban" conditions  $F_{Ac} = 0.7$ ) under the additional subarea headings provided; then compute a weighted Contributing Area Factor,  $F_{Acw}$ , based upon the areal extent of each  $F_{Ac}$  representing a specific land use located within the watershed. These factors are compatible with TSMS hydrology, and are described in detail in the TSMS, Phase II, report titled: "Existing Conditions Hydrologic Modeling" (SLA, 1995). Note, however, that when applying the Flood Peak Estimator Procedure, it is the responsibility of the engineer to verify the appropriateness of using the factors listed in Table 4.4 in conjunction with the land-use characteristics of the contributing watershed associated with a site-specific project. Consequently, the engineer shall provide the City Engineer with sufficient supporting data (e.g., aerial-photographic analysis and field verification), as required, to justify use of the Contributing Area Factors which have been chosen.

**Step 16:** Calculate the time of concentration for the 100-year flood,  $T_{c100}$ , using the following equation, and insert the result in the space provided:

$$T_{c100} = \left( \frac{0.23n_{bw100}(L_c L_{ca})^{0.3}}{(S_c P_{1,100} C_{w100})^{0.4}} + 1.31 \right)^{1.61} \quad [\text{When } 5 \leq T_{c100} \leq 180]. \quad (4.1)$$

Where:

$T_{c100}$  = Time of concentration for the 100-year flood, in minutes;

$n_{bw100}$  = Weighted basin factor for the 100-year flood;

$L_c$  = Length of hydraulically longest watercourse, in feet;

$L_{ca}$  = Length from watershed outlet to geographical center of the watershed area, measured along the hydraulically longest watercourse, in feet;

$S_c$  = Mean channel slope of watershed, in feet per foot;

$P_{1,100}$  = Areally reduced one-hour, 100-year rainfall depth, in inches; and;

$C_{w100}$  = Weighted runoff coefficient for the 100-year flood.

For the preceding equation, note that  $T_{c100}$  must not exceed 180 minutes. If  $T_{c100} < 5$ , set  $T_{c100} = 5$  minutes (i.e., the minimum allowable time of concentration). Also note that future watershed conditions shall be used, instead of existing watershed conditions, in steps 10, 11, 13, and 15 if no critical or balanced basin designation exists for the watershed. This also applies if an adopted basin-management plan exists, or if some other City policy exists that allows detention to be waived within the upstream contributing area of the watershed under investigation.

#### IV. FLOOD PEAK/HYDROGRAPH METHODS (REV. 4/98)

**Step 17:** Compute 100-year rainfall intensity,  $i_{100}$ , in inches/hr., from the following equation:

$$i_{100} = 4P_{1,100}/(1 + 0.05T_{c100}). \quad (4.2)$$

**Step 18:** Calculate the 100-year flood peak using the formula:  $Q_{p100} = (C_{w100})(i_{100})(F_{Acw})A$ .

**Step 19:** Compute the more frequent flood peaks by multiplying  $Q_{p100}$  by the appropriate values obtained from Table 4.5. (Note: Use interpolated values for watersheds containing mixed land uses.) Using Equation 4.5, include  $T_c$  for the more frequent flood peaks.

<b>TABLE 4.1: AREALLY REDUCED ONE-HOUR RAINFALL DEPTHS, IN INCHES, FOR WATERSHED AREAS OF UP TO TEN SQUARE MILES IN SIZE LOCATED IN AND AROUND TUCSON, ARIZONA</b>						
WATERSHED AREA (SQ. MILES)	RETURN INTERVAL (YEARS)					
	2	5	10	25	50	100
1.00, or less	1.10	1.50	1.90	2.30	2.70	3.00
2.00	1.06	1.45	1.84	2.22	2.61	2.90
3.00	1.03	1.40	1.78	2.15	2.53	2.81
4.00	1.00	1.36	1.73	2.09	2.45	2.73
5.00	0.97	1.33	1.68	2.04	2.39	2.66
6.00	0.95	1.30	1.64	1.99	2.33	2.59
7.00	0.93	1.27	1.61	1.95	2.28	2.54
8.00	0.91	1.24	1.58	1.91	2.24	2.49
9.00	0.90	1.22	1.55	1.87	2.20	2.44
10.00	0.88	1.20	1.52	1.84	2.16	2.40

**NOTE:** To compute two-hour and three-hour areal rainfall depths, simply multiply the appropriate one-hour depth, as chosen from the above table, times the following factors:

STORM DURATION (HOURS)	MULTIPLICATION FACTORS
2.0	1.14
3.0	1.20

#### IV. FLOOD PEAK/HYDROGRAPH METHODS (REV. 4/98)

**TABLE 4.2: STANDARD BASIN FACTORS\* ( $n_{b100}$ 's) TO USE WHEN COMPUTING THE REGULATORY (100-YEAR) FLOOD FOR VARIOUS LAND USES AND CHANNEL TYPES LOCATED WITHIN THE CITY OF TUCSON**

NATURAL/RURAL				SUBURBAN				MODERATELY/HIGHLY URBAN & COMMERCIAL/INDUSTRIAL				
D.F.	N.C.	C.C.	I.C.	D.F.	N.C.	C.C.	I.C.	D.F.	U.C.	C.C.	I.C.	L.C.
0.055	0.045	0.035	0.024	0.052	0.042	0.032	0.023	0.048	0.038	0.028	0.022	0.016

Where, in Table 4.2:

- D.F. = Dispersed Flow (i.e., sheet flow, street flow, etc.) predominates within the watershed;
- N.C. = Natural Channels (i.e., typically bankfull capacity [ $Q_{cap}$ ]  $\leq$   $Q_{p10}$ ) predominate within the watershed;
- C.C. = Competent Channels (i.e.,  $Q_{cap} \approx Q_{p100}$ ) predominate within the watershed;
- I.C. = Improved Channels (i.e., concrete-lined banks and  $Q_{cap} \approx Q_{p100}$ ) predominate within the watershed;
- U.C. = Underfit Channels (i.e.,  $Q_{cap} \leq 0.5Q_{p100}$ ) predominate within the watershed; and,
- L.C. = Lined Channels (i.e., concrete-lined bed and banks and  $Q_{cap} \approx Q_{p100}$ ) predominate within the watershed.

#### EXPLANATORY NOTES FOR TABLE 4.2:

1. NATURAL/RURAL watersheds generally contain no houses to less than one house per acre, and anticipated future drainage improvements are negligible. Impervious surfaces generally cover less than 5% of the watershed area.
2. SUBURBAN watersheds generally contain two houses, or less, per acre, and typically have little or no drainage improvements. Impervious surfaces generally cover approximately 15% of the watershed area.
3. MODERATELY URBAN watersheds generally contain from three to five houses per acre (detached), with moderate to extensive drainage improvements. Impervious surfaces generally cover approximately 35% of the watershed area.
4. HIGHLY URBANIZED watersheds generally contain six or more houses per acre, and include COMMERCIAL, INDUSTRIAL, and MULTIPLE DWELLING uses, with extensive drainage improvements present. Impervious surfaces generally cover approximately 60%, or greater, of the watershed area.
5. The use of different basin factors ( $n_{b100}$ 's), other than the standard values shown within Table 4.2, for computing the regulatory (i.e., 100-year) flood shall only be permitted if and when technical evidence is submitted to the Office of the City Engineer, for review and approval, justifying the use of alternate  $n_{b100}$ 's (e.g., within some City "foothill" or "mountain" areas); or the City Engineer determines that use of the  $n_{b100}$ 's provided in Table 4.2 are inappropriate for the specific hydrologic conditions which exist within the watershed(s) under investigation.

\* Note: Basin factors ARE NOT EQUIVALENT to Manning's "n" values; such as those listed within Table 8.1 (see Chapter 8). Although the two parameters sometimes have similar numeric values, a basin factor is a *HYDROLOGIC* parameter which represents the composite effects of flow retardance within a watershed; while a Manning's "n" value is a *HYDRAULIC* parameter which represents resistance to flow created by the surface characteristics of the wetted perimeter of a specific stormwater conveyance element over or through which the storm water is flowing.

IV. FLOOD PEAK/HYDROGRAPH METHODS (REV. 4/98)

**TABLE 4.3: RUNOFF COEFFICIENTS VS. ONE-HOUR RAINFALL DEPTHS FOR APPLICABLE SOIL TYPES AND INTENSITY OF LAND USE IN THE GREATER TUCSON AREA**

RAIN-FALL DEPTH (in)	INTENSITY OF LAND USE*																		
	APPLICABLE SOIL TYPES				(<5%) Nat./Rural			(15%) Suburban			(35%) Mod. Urban			(60%) Hgly. Urban			(90%) Comm./Ind.		
	P <sub>1</sub>	B	C	D	I	B	C	D	B	C	D	B	C	D	B	C	D	B	C
0.9	.02	.09	.16	.88	.06	.13	.20	.15	.21	.27	.32	.37	.41	.54	.56	.59	.79	.80	.81
1.0	.05	.14	.22	.89	.09	.18	.25	.18	.25	.32	.34	.40	.45	.55	.59	.62	.81	.82	.82
1.1	.09	.19	.28	.90	.13	.23	.31	.21	.30	.37	.37	.44	.50	.58	.62	.65	.82	.83	.84
1.2	.12	.23	.33	.91	.16	.26	.36	.24	.33	.42	.40	.47	.53	.59	.64	.68	.83	.84	.85
1.3	.16	.28	.38	.91	.20	.31	.41	.27	.37	.46	.42	.50	.56	.61	.66	.70	.84	.85	.86
1.4	.20	.32	.42	.92	.24	.35	.45	.31	.41	.50	.45	.53	.60	.63	.68	.72	.85	.86	.87
1.5	.24	.37	.46	.92	.27	.40	.48	.34	.45	.53	.48	.56	.62	.65	.70	.74	.85	.87	.87
1.6	.28	.40	.50	.93	.31	.43	.52	.38	.48	.56	.51	.59	.65	.67	.72	.76	.87	.88	.89
1.7	.31	.44	.53	.93	.34	.46	.55	.40	.51	.59	.53	.61	.67	.68	.73	.77	.87	.88	.89
1.8	.34	.47	.56	.94	.37	.49	.58	.43	.54	.62	.55	.63	.69	.70	.75	.79	.88	.89	.90
1.9	.37	.50	.59	.94	.40	.52	.61	.46	.57	.64	.57	.65	.71	.71	.76	.80	.88	.90	.91
2.0	.40	.53	.62	.94	.43	.55	.64	.48	.59	.67	.59	.67	.73	.72	.78	.81	.89	.90	.91
2.1	.43	.55	.64	.94	.46	.57	.66	.51	.61	.69	.61	.69	.75	.74	.78	.82	.89	.91	.91
2.2	.45	.57	.66	.95	.48	.59	.67	.53	.63	.70	.63	.70	.76	.75	.80	.83	.90	.91	.92
2.3	.47	.59	.68	.95	.49	.61	.69	.54	.64	.72	.64	.72	.77	.76	.81	.84	.90	.91	.92
2.4	.50	.61	.69	.95	.52	.63	.70	.57	.66	.73	.66	.73	.78	.77	.81	.85	.91	.92	.92
2.5	.52	.63	.71	.95	.54	.65	.72	.58	.68	.75	.67	.74	.79	.78	.82	.85	.91	.92	.93
2.6	.53	.65	.72	.95	.55	.67	.73	.59	.70	.75	.68	.76	.80	.78	.83	.86	.91	.92	.93
2.7	.55	.66	.74	.96	.57	.68	.75	.61	.71	.77	.69	.77	.82	.80	.84	.87	.92	.93	.94
2.8	.57	.68	.75	.96	.59	.69	.76	.63	.72	.78	.71	.78	.82	.80	.85	.88	.92	.93	.94
2.9	.58	.69	.76	.96	.60	.70	.77	.64	.73	.79	.71	.78	.83	.81	.85	.88	.92	.93	.94
3.0	.60	.70	.77	.96	.62	.71	.78	.65	.74	.80	.73	.79	.84	.82	.86	.88	.92	.93	.94

Where:

- P<sub>1</sub> = One-hour rainfall depth
- B = Type "B" soils (SCS classification)
- C = Type "C" soils (SCS classification)
- D = Type "D" soils (SCS classification)
- I = Impervious surfaces

**EXAMPLE**

*Computation of 100-Year Weighted Runoff Coefficient:*

100-year Rainfall Depth = 2.45 inches.

Soil Types = 35% B; 65% D.

Pervious Cover = 70%; Impervious Cover = 30%.

$$C_{w100} = (0.7)(0.35)[0.50 + 0.5(0.52-0.50)] + (0.7)(0.65)[0.69 + 0.5(0.71-0.69)] + (0.3)[0.95 + 0.5(0.95-0.95)].$$

$$C_{w100} = (0.7)(0.634) + (0.3)(0.95) = \underline{0.729}.$$

(\*Note: Percent in parentheses represents amount of impervious cover for a specific land use, consistent with TSMS.)

#### IV. FLOOD PEAK/HYDROGRAPH METHODS (REV. 4/98)

TABLE 4.4: CONTRIBUTING AREA FACTORS				
TYPE OF LAND USE				
NATURAL/ RURAL	SUBURBAN	MODERATELY URBAN	HIGHLY URBAN	COMMERCIAL/ INDUSTRIAL
1.00	0.90	0.70	0.80	0.90

NOTE: While the Contributing Area Factors listed in Table 4.4 are consistent with TSMS hydrology, there are other values of these factors which may be more appropriate for use with the particular application intended. Accordingly, when applying the Flood Peak Estimator Procedure, it is the responsibility of the engineer to verify the appropriateness of using the factors listed in Table 4.4 in conjunction with the land-use characteristics of the contributing watershed associated with a site-specific project. Consequently, the engineer shall provide the City Engineer with sufficient supporting data (e.g., aerial-photographic analysis and field verification), as required, to justify use of the Contributing Area Factors which have been chosen. The TSMS, Phase II report titled: "Existing Conditions Hydrologic Modeling" (SLA, 1995), as well as TSMS, Phase II Technical Memorandum No. 4.10[f] (SLA, 1993), provide detailed documentation for the development and application of Contributing Area Factors for individual land uses within the City of Tucson.

TABLE 4.5: RATIOS OF MORE FREQUENT FLOODS TO THE 100-YEAR FLOOD					
PREDOMINANT WATERSHED TYPE	RECURRENCE INTERVAL				
	2-YR	5-YR	10-YR	25-YR	50-YR
NATURAL/RURAL	0.10	0.23	0.37	0.58	0.77
SUBURBAN	0.13	0.28	0.41	0.61	0.79
MODERATELY URBAN	0.18	0.30	0.46	0.65	0.85
HIGHLY URBAN/ COMMERCIAL-INDUSTRIAL	0.22	0.35	0.50	0.70	0.90

NOTE: The ratios listed in Table 4.5 are indexed to 100-year flood peaks computed from the procedures found within this chapter, and are compatible with TSMS hydrology. Consequently, if less than 100-year flood peaks are computed by using the full Flood Peak Estimator Procedure, the engineer should note that it may no longer be appropriate to use "100-year" basin factors from Table 4.2 of this chapter (i.e.,  $n_{b100}$ 's may be too large for computing the more frequent events).

City of Tucson  
Hydrologic Data Sheet for Computing 100-Year Peak Discharge ( $Q_{p100}$ )

1. Project Name and Location: \_\_\_\_\_

2. Drainage Concentration Point: \_\_\_\_\_

3. \*Watershed Area ( $A$ ) at Drainage Concentration Point: \_\_\_\_\_ acres. For (Check One):

4. Length of Hydraulically Longest Watercourse ( $L_c$ ): \_\_\_\_\_ ft.  Existing Conditions<sup>†</sup>

5. Length from center of Watershed Area ( $L_{ca}$ ), along  $L_c$ : \_\_\_\_\_ ft.  Future Conditions<sup>†</sup>

<u>Change in Length Factors - ft.</u>	<u>Change in Elevation Factors - ft.</u>
a. $\Delta L_1$ : _____ ( $\Delta L_1$ ) <sup>3</sup> : _____	$\Delta H_1$ : _____ ( $\Delta L_1$ ) <sup>3</sup> / $\Delta H_1$ : _____
b. $\Delta L_2$ : _____ ( $\Delta L_2$ ) <sup>3</sup> : _____	$\Delta H_2$ : _____ ( $\Delta L_2$ ) <sup>3</sup> / $\Delta H_2$ : _____
c. $\Delta L_3$ : _____ ( $\Delta L_3$ ) <sup>3</sup> : _____	$\Delta H_3$ : _____ ( $\Delta L_3$ ) <sup>3</sup> / $\Delta H_3$ : _____
d. $\Delta L_4$ : _____ ( $\Delta L_4$ ) <sup>3</sup> : _____	$\Delta H_4$ : _____ ( $\Delta L_4$ ) <sup>3</sup> / $\Delta H_4$ : _____

7.  $G = \left( \frac{\Delta L_1^3}{\Delta H_1} \right)^{1/2} + \left( \frac{\Delta L_2^3}{\Delta H_2} \right)^{1/2} + \left( \frac{\Delta L_3^3}{\Delta H_3} \right)^{1/2} + \left( \frac{\Delta L_4^3}{\Delta H_4} \right)^{1/2} = \underline{\hspace{2cm}} + \underline{\hspace{2cm}} + \underline{\hspace{2cm}} + \underline{\hspace{2cm}} = \underline{\hspace{2cm}}$

8. Mean Slope ( $S_c$ ) =  $(L_c/G)^2 = (\underline{\hspace{2cm}})^2 = \underline{\hspace{2cm}}$  ft./ft.

9. Areally reduced 100-year, one-hour rainfall depth ( $P_{1,100}$ ): \_\_\_\_\_ inches.

	<u>Subarea 1</u>	<u>Subarea 2</u>	<u>Subarea 3</u>	
10. Watershed Type(s) (% of Total Area): _____ (_____) _____ (_____) _____ (_____)				<u>Weighted Watershed Parameters</u>
11. Basin Factor ( $n_{b100}$ ): _____	_____	_____	_____	$n_{bw100} =$ _____
12. Soil Types, in %: _____	_____	_____	_____	
13. Imperviousness (%): _____	_____	_____	_____	$I_w =$ _____
14. Runoff Coefficient ( $C_{w100}$ ): _____	_____	_____	_____	$C_{w100} =$ _____
15. Contrib. Area Factor ( $F_{Ac}$ ): _____	_____	_____	_____	$F_{Acw} =$ _____

16. \*\*Time of Concentration ( $T_{c100}$ ): \_\_\_\_\_ minutes, determined from:

$$T_{c100} = \left( \frac{0.23 n_{bw100} (L_c L_{ca})^{0.3}}{(S_c P_{1,100} C_{w100})^{0.4}} + 1.31 \right)^{1.61} \quad \text{When } 5 \leq T_{c100} \leq 180.$$

17. At  $T_{c100}$ , 100-Year Rainfall Intensity ( $i_{100}$ ) =  $(4P_{1,100})/(1+0.05T_{c100}) =$  \_\_\_\_\_ inches/hour.

18. 100-Year Peak ( $Q_{p100}$ ) =  $(C_{w100})(i_{100})(F_{Acw})A =$  \_\_\_\_\_ x \_\_\_\_\_ x \_\_\_\_\_ x \_\_\_\_\_ = \_\_\_\_\_ cfs.

19. For Other Return Periods:	<u>2-Year</u>	<u>10-Year</u>	<u>25-Year</u>	<u>50-Year</u>
Ratio to 100-Year Peak:	_____	_____	_____	_____
$Q$ (cubic feet/second):	_____	_____	_____	_____
$T_c$ (minutes [Eqn. 4.5]):	_____	_____	_____	_____

\*A may not exceed 6,400 acres (10 square miles) in size. \*\* $T_{c100}$  may not exceed 180 minutes. If  $T_{c100} < 5$ , set  $T_{c100} = 5$  minutes.

†NOTE: Indicate whether hydrologic computations are for "Future Conditions" or "Existing Conditions" by checking the appropriate box above.

Prepared by: \_\_\_\_\_ Checked by: \_\_\_\_\_ Company: \_\_\_\_\_ Date: \_\_\_\_\_

**FIGURE 4.1: HYDROLOGIC DATA SHEET**

## IV. FLOOD PEAK/HYDROGRAPH METHODS (REV. 4/98)

### 4.3 Selection of Basin Factors ( $n_{b100}'s$ )

The updated basin factors shown within Table 4.2 of this Manual have been revised to more accurately represent the processes which offer resistance to the movement of a flood down a watercourse located within the City of Tucson *during a 100-year flood*. In addition, when coupled with the adjustment for Contributing Area Factor (described earlier within this chapter), these newest revisions to the standard basin factors produce results which are in general agreement with the City-adopted TSMS hydrology for regulatory (i.e., 100-year) floods. Accordingly, this section was prepared as an aid to the user in the selection of appropriate basin factors to use when computing a regulatory flood within the City of Tucson.

The basin factor is a parameter in the Flood Peak Estimator Procedure which represents the overall resistance to flow in a watershed. It has been observed that flood peaks on "underfit" channels and "dispersed-flow" watersheds within urban areas are typically lower than flood peaks which occur from normal rainfall-runoff relationships on "competent" (i.e., bankfull capacity [ $Q_{cap}] \approx Q_{p100}$ ) channels because overbank storage, resistance to flow, and the hydraulic geometry associated with "underfit" channels and "dispersed-flow" watersheds lead to greater attenuation of resultant flood peaks. Dependent upon the particular flood frequency of interest—especially the 100-year flood-recurrence interval—using basin factors which are higher than those which would normally be chosen according to primarily channel roughness can compensate for these effects, and result in more realistic peak-discharge estimates.

Basically, well-defined urban channels with capacities equal to or less than a 10-year flood are classified as "underfit." Urban areas wherein drainage is ordinarily conveyed by city streets, and/or by overland flow with no well-defined channels, are classified as "dispersed-flow" watersheds. Basin factors in all other areas of the City of Tucson are to be selected according to the normal guidelines for determining basin factors, as described within Section 4.2 of this Manual.

The actual selection of basin factors is the responsibility of the engineer. Under most circumstances, the standard values shown within Table 4.2 of Section 4.2 of this Manual shall be used when computing the 100-year flood, unless there is justification to the contrary. However, in the particular case of an "underfit" channel, an initial determination that a channel should be classified as "underfit" does not necessarily mean that the standard basin factor associated with an "underfit" channel can automatically be used. It is the responsibility of the engineer to demonstrate, through proper analytic calculations, that a channel may indeed be classified as "underfit," should the question be raised by the City of Tucson Floodplain Section. A recommended procedure is given in Section 4.3.2 of this Manual, and is entitled "Guidelines for Determination of Dispersed-Flow Watersheds and Underfit Channels."

A weighted basin factor is normally associated with the hydraulic conditions along the hydraulically longest watercourse within a watershed. However, it should be noted that it is possible for a particular watershed to have more than one basin-factor classification, depending upon the location of the concentration point under investigation. Once the hydraulically longest watercourse has been identified and delineated, the weighted basin factor to be used for computing a 100-year flood can be determined from the following procedure:



## IV. FLOOD PEAK/HYDROGRAPH METHODS (REV. 4/98)

### 4.3.1 Procedure for Determination of Weighted 100-Year Basin Factors ( $n_{bw 100} 's$ )

The appropriate, weighted 100-year basin factor can be determined for any watershed concentration point under investigation, once the contributing watershed area and hydraulically longest watercourse have been identified and delineated. The procedure is as follows:

1. Delineate the watershed area which is contributing runoff to the desired concentration point under investigation.
2. Delineate the hydraulically longest watercourse within the watershed. The hydraulically longest watercourse extends from the concentration point under investigation to the hydraulically most distant point on the watershed divide.
3. Determine which basin-factor classification should be used for the hydraulically longest watercourse. There may be several different basin-factor classifications applicable to the hydraulically longest watercourse.
4. Assign appropriate 100-year basin factors for each distinctly different hydraulic reach of the hydraulically longest watercourse. Field investigations and aerial photographs will aid in making such a determination. Note that any deviation from the 100-year basin factors within Table 4.2 of this Manual must first be justified to the satisfaction of the City Engineer (see Section 4.3.2 for further guidance in the selection of  $n_{b100} 's$ ).
5. Assign slope breaks to the hydraulically longest watercourse, according to the procedures presented within Section 4.2 of this Manual. When several slope breaks are assigned within a single basin-factor reach, a slope break must always occur at each end point of the basin-factor reach.
6. Determine the weighted 100-year basin factor for the watershed according to the following formula:

$$n_{bw100} = \frac{\sum_{i=1}^{N_r} (n_{i100} L_i) \left( \frac{S_c}{S_i} \right)^{1/2}}{L_c} \quad (4.3)$$

Where:

- $n_{bw100}$  = Weighted 100-year basin factor;
- $n_{i100}$  = 100-year basin factor for the  $i$ th reach of the hydraulically longest watercourse;
- $L_i$  = Length of channel for the  $i$ th reach of the hydraulically longest watercourse, in feet;
- $S_c$  = Mean channel slope of the hydraulically longest watercourse, in feet per foot;
- $L_c$  = Main channel length of the hydraulically longest watercourse, in feet;
- $S_i$  = Channel slope for the  $i$ th reach of the hydraulically longest watercourse, in feet per foot; and,
- $N_r$  = Number of reaches.

#### IV. FLOOD PEAK/HYDROGRAPH METHODS (REV. 4/98)

##### **EXAMPLE: DETERMINATION OF A WEIGHTED BASIN FACTOR FOR ARCADIA WASH AT PIMA STREET, WHEN COMPUTING A 100-YEAR FLOOD**

1. The Arcadia Wash watershed, and its hydraulically longest watercourse, are shown on Figure 4.2. The hydraulically longest watercourse is segmented by reach, according to the type of basin factor which is predominate along that reach. Upstream of 22nd Street, the Arcadia Wash watershed is classified as "dispersed flow," so a basin factor of 0.048 will be used. From 22nd Street to Craycroft, there exists an "underfit" channel, so a basin factor of 0.038 will be used. The Williams Center box culvert, between Broadway and Craycroft, is assigned a lined-channel basin factor of 0.016. This latter value is also chosen because there will be some minor overflow of the box, and a known constriction exists downstream. Downstream of Broadway, there again exists an "underfit" channel, so a basin factor of 0.038 will also be used for this reach.
2. Table 4.6 gives the channel lengths between slope breaks, and the basin-factor reach lengths, from upstream to downstream, of the Arcadia Wash.
3. The length of the hydraulically longest watercourse ( $L_c$ ) of the Arcadia Wash is 22,220 ft. The mean slope ( $S_c$ ) of the wash is 0.0058 ft/ft. Using Equation 4.3 of this Manual, the weighted basin factor,  $n_{bw 100}$ , of the Arcadia Wash is computed to be:

$$n_{bw 100} = \frac{(0.048)(6140)(0.0058/0.0072)^{1/2} + \dots + (0.038)(2800)(0.0058/0.0057)^{1/2}}{22,220}$$

Which yields:  $n_{bw 100} = \underline{0.039}$  (to three decimal places), for a 100-year flood.

<b>LENGTH BETWEEN SLOPE BREAKS (<math>L_i</math>), IN FEET</b>	<b>VERTICAL DROP BETWEEN SLOPE BREAKS, IN FEET</b>	<b>SLOPE (<math>S_i</math>), (FT./FT.)</b>	<b>BASIN FACTOR REACH LENGTH, IN FEET</b>	<b>100-YEAR BASIN FACTOR (<math>n_{i 100}</math>)</b>
(Upstream) 6140	44	0.0072	6990	0.048
850	4	0.0047		
1380	6	0.0043	4330	0.038
2950	16	0.0054		
1400	8	0.0057	1400	0.016
3940	19	0.0048	9500	0.038
2760	19	0.0069		
(Downstream) 2800	16	0.0057		

# IV. FLOOD PEAK/HYDROGRAPH METHODS

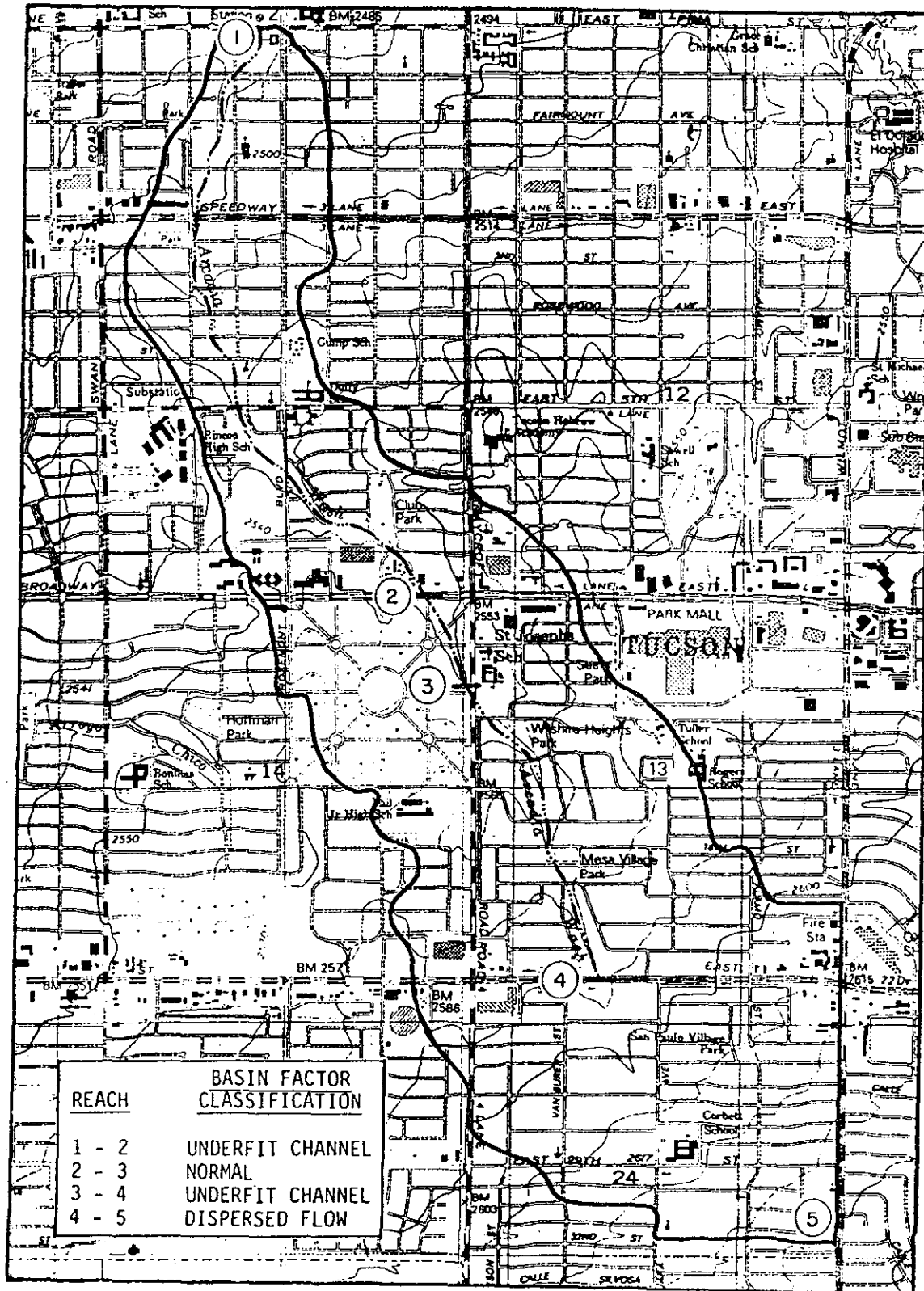

FIGURE 4.2

ARCADIA WASH WATERSHED

#### IV. FLOOD PEAK/HYDROGRAPH METHODS (REV. 4/98)

##### 4.3.2 Guidelines for Determination of Dispersed-Flow Watersheds and Underfit Channels When Computing a 100-Year Flood

Dispersed-Flow Watershed: A "Dispersed-Flow Watershed" is a watershed in which basically all flow is of a broad and shallow character, and is either overland in nature and/or is carried within streets. No constructed "drainageways" exist, except for the streets themselves. Storm drains, if present, are of low capacity (i.e., less than a 5-year discharge) in relation to the 100-year peak discharge generated by the watershed. For moderately to highly urbanized conditions, and in the absence of either detailed information to the contrary or any unusual hydraulic circumstances, a basin factor of 0.048 should be used for a dispersed-flow watershed when computing a 100-year flood.

However, it should also be noted that when choosing a basin factor for a dispersed-flow watershed with moderately to highly urbanized conditions, the engineer should take into account the capacity of the streets to convey floodwaters, as well as the overall drainage patterns within the watershed. In some cases, when a moderately to highly urbanized dispersed-flow watershed contains streets, particularly the street designated as the hydraulically longest watercourse, which have inverted crowns to convey floodwaters, it may be appropriate to treat such streets more like "underfit" channels—or in a few instances even more like "competent" channels—and assign a basin factor for the watershed which is lower than the value of 0.048. Conversely, for such a dispersed-flow watershed wherein the streets have little or no flow-conveyance capacity a basin factor which is higher than 0.048 may need to be assigned. The streets in this latter type of watershed may have no curbs, or the drainage pattern may be contrary to the alignment of the streets. The 1" = 200' aerial topographic mapping—available from the City Engineering Division, Floodplain Section—which covers most of the incorporated City limits, can be used as one source/guide for helping determine basin factors for moderately to highly urbanized dispersed-flow watersheds.

The majority of the Tucson inner-city watersheds contain crowned streets with curbs, into which stormwater runoff flows directly from adjacent residential lots. Consequently, in most instances, basin factors for these areas will be 0.048. A basin factor of 0.048 should also be used for paved industrial or commercial areas and P.A.A.L.'s, when and where applicable.

Underfit Channel: An "Underfit" channel is defined as a constructed channel which has a bankfull capacity ( $Q_{cap}$ ) equal to or less than 50% of its computed 100-year peak discharge. Watersheds should be classified as "underfit," if underfit channels predominate.

The determination as to whether to classify a channel as an underfit channel requires that the channel capacity and 100-year peak-flow rate first be estimated. The following procedure should

#### IV. FLOOD PEAK/HYDROGRAPH METHODS (REV. 4/98)

be used to determine if a channel is "underfit"; and is especially useful when working with 200-scale, aerial-topo maps, as will normally be the case:

Step 1: From a 200-scale, aerial-topo map, or any other appropriate topographic map, determine the average depth and bottom width for the channel within the reach in question.

Step 2: Determine the bankfull capacity of the channel either from Manning's formula for uniform flow or from another appropriate formula, such as:

$$Q_{cap} = [5.67b]Y^{1.5} \quad (4.4)$$

Where:

- $Q_{cap}$  = Bankfull capacity of the channel, in cubic feet per second;
- $b$  = Channel bottom width, in feet; and
- $Y$  = Channel depth, in feet.

NOTE: This formula assumes that, under bankfull conditions, the discharge within the channel is flowing at critical depth.

Step 3: Using "normal" 100-year basin factors for a channel (i.e., those basin factors *not* designated for "underfit" channels which are chosen from the basin factors provided in Table 4.2 of this Manual), first compute the 100-year discharge.

If the bankfull capacity of the channel, for example as determined by the use of Equation 4.4 above, is less than or equal to 50% of the 100-year discharge computed in the above manner, then the channel is classified as an "underfit" channel; and the 100-year basin factor for "underfit" channels may be used when computing a new 100-year discharge.

However, if the bankfull capacity of the channel is more than 50%, but less than 100%, of the 100-year discharge computed in the above manner, then a new discharge should be computed using a "composite" 100-year basin factor which incorporates both the "underfit" basin factor and the "normal" basin factor that would otherwise be chosen for the channel (Note: When  $Q_{bf} > 0.5Q_{p100}$ , a "normal" basin factor would typically have a value nearer the estimated "n-value" of either a "competent" channel or an "improved" channel). This "composite" basin factor ( $n_{bc100}$ ) is simply the product of the "normal" basin factor ( $n_{bn100}$ ) and the percent of peak discharge computed to be inside of the channel ( $Q_{pe}$ ) added to the product of the "underfit" basin factor ( $n_{bu100}$ ) and the percent of peak discharge

#### IV. FLOOD PEAK/HYDROGRAPH METHODS (REV. 4/98)

computed to be outside of the channel ( $Q_{po}$ ), all divided by the numerical value of 100 (i.e.,  $n_{bc100} = [n_{bn100}Q_{pc} + n_{bu100}Q_{po}]/100$ ).

Finally, if the bankfull capacity of the channel is equal to or greater than 100% of the computed 100-year discharge, then the 100-year basin factors originally chosen are the appropriate ones to be used.

The preceding evaluation procedure for the selection of 100-year basin factors should always be employed before classifying any channel within the City of Tucson as "underfit."

##### 4.4 Calculating Times of Concentration for Frequent Floods

This procedure should only be applied to "small watersheds," which are defined as watersheds whose times of concentration for a 2-year flood are less than 180 minutes.

Step 1: Compute the time of concentration ( $T_{c100}$ ) and the peak discharge ( $Q_{p100}$ ) for the 100-year flood using the City of Tucson Flood Peak Estimator Procedure.

Step 2: Compute  $Q_{pn}$  (see Equation 4.5) for floods with recurrence intervals of less than 100 years by multiplying  $Q_{p100}$  by the appropriate factors provided in Table 4.5.

Step 3: Compute the times of concentration for floods with recurrence intervals of less than 100 years by utilizing the following relationship:

$$T_{cn} = \left( \frac{Q_{p100}}{Q_{pn}} \right)^{0.4} T_{c100} \quad (4.5)$$

Where:

- $T_{cn}$  = Time of concentration for the n-year flood ( $T_{cn} > T_{c100}$ ), in minutes;
- $T_{c100}$  = Time of concentration for the 100-year flood, in minutes;
- $Q_{pn}$  = Peak discharge for the n-year flood (determined as described under Step Two of this procedure), in cubic feet per second (cfs); and,
- $Q_{p100}$  = Peak discharge for the 100-year flood, in cubic feet per second.

##### 4.5 Development of a Flood Hydrograph

When using the Flood Peak Estimator Procedure provided within this chapter, a corresponding flood hydrograph for the watershed under investigation shall be based upon the

#### IV. FLOOD PEAK/HYDROGRAPH METHODS (REV. 4/98)

curvilinear, dimensionless hydrograph shown in tabular form within Table 4.7. The symbols used in Table 4.7 are defined below.

$t$  = Cumulative time from beginning of runoff, in minutes;

$T_r$  = Rise time of the hydrograph, in minutes (Use values obtained from Table 4.8, when  $T_c$  is less than or equal to 60 minutes);

or

$$T_r = \frac{0.7869P_n T_c}{P_{T_c}} \quad (4.6)$$

when  $T_c$  is greater than 60 minutes; and where  $P_n$  is greater than or equal to  $P_{T_c}$ .

Where:

$T_c$  = Time of concentration of the watershed, in minutes, and represents the theoretical time required for runoff to travel from the hydraulically most remote point in the watershed to the point under investigation;

$P_n$  = The  $n$ -hour precipitation depth, in inches; and

$P_{T_c}$  = Precipitation depth at  $T_c$ , in inches.

NOTE: " $n$ -hour" refers to the 2-, 3-, 6-, 12-, or 24-hour precipitation depths, where " $n$ " should normally be the smallest of these values which is greater than  $T_c$ . In addition,  $P_{T_c}$  is calculated by linear interpolation between the calculated precipitation depths which bracket  $T_c$  (e.g., if  $T_c = 2.5$  hours, then  $P_{T_c}$  is halfway between the 2-hour and 3-hour precipitation depths).

$Q$  = Instantaneous discharge at time  $t/T_r$ , in cubic feet per second;

$Q_p$  = Peak discharge, in cubic feet per second;

$v$  = Accumulated runoff volume under the hydrograph at time  $t$ , in acre-feet;

$V$  = Total runoff volume under the hydrograph, in acre-feet.

The rainfall intensity,  $i$ , in inches per hour, at time  $T_c > 60$  minutes, may be determined from the following relationship:

$$I = 60 \frac{P_{T_c}}{T_c} \quad (4.7)$$

IV. FLOOD PEAK/HYDROGRAPH METHODS (REV. 4/98)

<b>TABLE 4.7: CURVILINEAR, DIMENSIONLESS FLOOD HYDROGRAPH</b>					
$t/T_r$	$Q/Q_p$	$v/V$	$t/T_r$	$Q/Q_p$	$v/V$
0.0	0.000	0.000	1.6	0.545	0.671
0.1	0.025	0.002	1.7	0.482	0.707
0.2	0.087	0.007	1.8	0.424	0.742
0.3	0.160	0.020	1.9	0.372	0.773
0.4	0.243	0.036	2.0	0.323	0.799
0.5	0.346	0.063	2.2	0.241	0.841
0.6	0.451	0.096	2.4	0.179	0.875
0.7	0.576	0.136	2.6	0.136	0.900
0.8	0.738	0.180	2.8	0.102	0.917
0.9	0.887	0.253	3.0	0.078	0.932
1.0	1.000	0.325	3.4	0.049	0.953
1.1	0.924	0.400	3.8	0.030	0.965
1.2	0.839	0.464	4.2	0.020	0.973
1.3	0.756	0.523	4.6	0.012	0.979
1.4	0.678	0.578	5.0	0.008	0.983
1.5	0.604	0.627	7.0	0.000	1.000



IV. FLOOD PEAK/HYDROGRAPH METHODS (REV. 4/98)

TABLE 4.8: FLOOD HYDROGRAPH RISE TIMES FOR  $T_c \leq 60$  MINUTES  
( $T_c$  AND  $T_r$  ARE IN MINUTES)

$T_c$	$T_r$	$T_c$	$T_r$
5	13.6	33	31.9
6	14.2	34	32.3
7	15.0	35	33.0
8	15.8	36	33.5
9	16.6	37	34.2
10	17.5	38	34.7
11	18.1	39	35.2
12	18.7	40	36.0
13	19.4	41	36.6
14	19.9	42	37.2
15	20.7	43	37.8
16	21.3	44	38.4
17	21.9	45	38.7
18	22.5	46	39.3
19	23.1	47	40.0
20	23.7	48	40.4
21	24.5	49	41.1
22	25.0	50	41.8
23	25.7	51	42.2
24	26.2	52	42.9
25	27.0	53	43.3
26	27.6	54	43.7
27	28.1	55	44.5
28	28.8	56	45.0
29	29.3	57	45.4
30	29.9	58	46.3
31	30.7	59	46.7
32	31.3	60	47.2

## CHAPTER V: FLOODPLAIN DELINEATION

### 5.1 Purpose

This chapter describes policies for delineating floodplain limits and water-surface elevations shown on Development Plans and Tentative/Final Subdivision Plats, as well as policies for approving developments located within the boundaries of regulatory 100-year flood plains, as designated by the Federal Emergency Management Agency (FEMA) and others. In addition, this chapter presents general analytical procedures for determining floodplain widths and water-surface elevations for flow systems found within urban settings.

### 5.2 Policies

All Tentative/Final Subdivision Plats submitted to the City for approval shall contain the following drainage-related information, as shall certain Site Plans and Development Plans which involve new construction or substantial additions to existing construction, if requested by the City Engineer:

1. For each significant watercourse entering or leaving the development, the contributing drainage area and the 100-year peak discharge must be shown. For the purpose of this policy, a significant watercourse is defined as any watercourse with a contributing drainage area equal to or greater than one standard acre (i.e., 43,560 square feet) in size.
2. For each watercourse where the 100-year peak discharge exceeds 100 cubic feet per second (cfs) and the flow is *not* entirely contained within a street section or constructed drainageway, the limits of the 100-year flood-prone area must be shown, along with the 100-year water-surface elevations, at sufficient intervals to define the drainage pattern on, across, and adjacent to the site. These floodplain limits are to be identified and labeled as either (1) "to be left natural" or (2) "to be channelized". They should also be labeled, if applicable, as being a private easement, with owner maintenance; or as being dedicated to either the City of Tucson or a Homeowner's Association as a flowage easement, drainage easement, or as fee-simple right-of-way.
3. 100-year floodplain limits which are entirely contained within a street section or constructed drainageway shall be labeled as such on the plan/plat, or a general note shall be included on the plan/plat which states same.
4. For both internal drainage carried in streets and small watercourses conveying 100-year flows less than 100 cfs, flow arrows, as well as contributing drainage areas, must be shown.
5. The grading and site plan for any development adjacent to or within the regulatory flood plain, including those that will and will not modify the regulatory flood plain as part of the development, shall show the floodplain limits, along with 100-year water-surface elevations, at sufficient intervals to define the drainage patterns on, across, and adjacent to the site. Floodway limits are also to be shown, when deemed necessary by the City Engineer.

## V. FLOODPLAIN DELINEATION

6. For those developments that will be located within the regulatory flood plain, as designated by FEMA and others, a note shall be added stating that the owner/developer agrees to (1) have an Arizona Registered Professional Land Surveyor certify the finished-floor elevations of all new structures located within the flood plain; and (2) obtain a Floodplain Use Permit from the City Engineer.

### 5.3 Analytical Procedures for Evaluating Floodplain Widths and Depths in Channels with Uniform Hydraulic Roughness

In the following sections, general analytical procedures are presented for evaluating floodplain hydraulics, with an emphasis on determining floodplain widths and flow depths in either natural washes or constructed channels having uniform hydraulic roughness.

#### 5.3.1 *Normal Flow Depth*

If the depth and direction of the design flow in an open channel are nearly constant with regard to both time and the channel reach (i.e., steady, uniform-flow conditions), the flow regime is said to be "normal." Under such conditions, the hydraulic characteristics of a channel can be evaluated by using the well-known Manning's equation, which is described in such hydraulics texts as *Open-Channel Hydraulics*, by V. T. Chow (1959), and the *Handbook of Hydraulics*, by E. F. Brater and H. W. King (sixth edition, 1982).

When delineating natural flood plains using the Manning's equation, it is important to ensure that the energy grade line slopes continuously in the downhill direction. The energy grade line is defined as a line connecting points of known total head or total specific energy,  $H$ , as computed by:

$$H = Y + V^2/2g \quad (5.1)$$

Where:

- $H$  = Total specific energy, in feet;
- $Y$  = Depth of flow, in feet;
- $V$  = Average flow velocity, in feet per second; and,
- $g$  = Gravitational constant = 32.2 ft/sec<sup>2</sup>.

In those cases where the slope of the energy grade line does not nearly equal the channel-bed slope, the assumption of uniform flow is not strictly valid. In such instances, backwater calculations must be made, instead of the much simpler analysis based upon the Manning's equation.

## V. FLOODPLAIN DELINEATION

### 5.3.2 *Backwater Flow Depth*

The previous section contained a brief discussion on computing normal depth, which assumes that changes in discharge, bed slope, and cross-sectional area and form occur relatively gradually.

However, in the event of sudden changes, there will be additional turbulent energy losses which are not accounted for in the Manning's equation. This may be particularly true in cases of sudden contractions or expansions of the channel cross section.

In those instances where an upstream or downstream hydraulic control exists, thereby necessitating a more detailed analysis than that provided by the Manning's equation, the Standard Step Method should be used for evaluating water-surface profiles.

The procedure for making Standard Step calculations is given in several easily obtainable text books or references; one of which is *Open-Channel Hydraulics*, by Chow (1959). Should computer facilities be available, it is recommended that Standard Step calculations be performed by using the readily available and well-documented computer program HEC-2, written and distributed by the U.S. Army Corps of Engineers (1982).

One of the advantages of the Standard Step Method is that if the computation is started at an assumed elevation that is incorrect for the given discharge, the resulting flow profile will become more nearly correct with each succeeding cross section evaluated within a reach. Therefore, if no accurate elevation is known within or near the reach under consideration, an arbitrary elevation may be assumed at a cross section far enough away from the "starting" cross section to correct for any initial error.

The step computations should be carried upstream if the flow is subcritical, and downstream if the flow is supercritical. Otherwise, step computations carried in the wrong direction tend to make the results diverge from the correct flow profile.

### 5.4 Analytical Procedures for Evaluating Floodplain Widths and Depths in Channels with Composite Hydraulic Roughness

In the following sections, general analytical procedures are presented for evaluating floodplain hydraulics, with an emphasis on determining floodplain widths and flow depths in either natural washes or constructed channels having non-uniform or composite hydraulic roughness.

#### 5.4.1 *Composite Channels*

The cross section of a watercourse or a street right-of-way may be composed of several distinct sub-sections, with each sub-section having different hydraulic characteristics, such as hydraulic roughness and average flow depth. For example, an alluvial channel may have a primary, sand-bed channel which is bounded on both sides by densely-vegetated, overbank flood plains; or a flooded street section may be

## V. FLOODPLAIN DELINEATION

bounded on both sides by landscaped front yards having shallower flood depths and slower flow velocities.

In cases of composite channels, such as the preceding two examples, the discharge is computed for each sub-section which has distinct and different hydraulic characteristics, and the total computed discharge is set equal to the sum of the individual discharges. Similarly, the mean velocity for the entire flow cross section is assumed to be equal to the total discharge divided by the total water area. The easily obtainable text entitled *Open-Channel Hydraulics*, by V. T. Chow (1959), provides an example of computing uniform flow in channels which have composite roughness.

### 5.4.2 Manning Roughness Coefficients

Manning Roughness Coefficients, for use in water-surface-profile calculations, should be carefully estimated by experienced engineers. The estimates should include consideration that roughness may vary with flood stage, depending on such factors as the width-depth ratio of the wash; presence of vegetation in the main channel and the overbank areas; the types of materials making up the channel bed; and the degree of meandering. Additional information concerning Manning roughness coefficients may be found in Chapter 8 of this Manual.

In the urban setting, it is not unusual for buildings and other structures to occupy a significant portion of any given hydraulic cross section. Under these circumstances, it is often difficult to estimate both the effective width of the cross-section and the Manning Roughness Coefficients for the overbank areas. When faced with such a situation, the engineer has two options for computing water-surface profiles:

1. Eliminate the portion of the cross section occupied by the buildings; or,
2. Use the total area of the cross section, and estimate a average value for the Manning Roughness Coefficient, which includes the effects of the buildings and other obstructions.

The first option is often selected whenever detailed aerial photographic and/or topographic information concerning the study area is available.

The 100-year water-surface elevation computed using these two alternative analytical approaches will be nearly equivalent; however, the computed flow velocity obtained from the first option, in which the ineffective flow areas have been removed from the hydraulic cross section, will always be greater than the velocity computed using the second approach. Whenever an accurate estimate of flow velocity is required, such as in determining all-weather access or in evaluating sediment-transport rates, the first option should be utilized. In those cases where only an estimate of the computed water-surface elevation is needed, the second option may be selected.

Should the second option be selected, the adjusted urban roughness coefficient,  $n_u$ , to be used with the total cross-sectional area, can be computed from (Hejl, 1977):

## V. FLOODPLAIN DELINEATION

$$n_u = n_o \left[ \frac{3}{2} \left[ \frac{W_T}{\Sigma W_o} \right] + \left[ 1 - \frac{W_T}{\Sigma W_o} \right] \frac{\Sigma L_o}{L_T} - \frac{1}{2} \right] \quad (5.2)$$

Where also, as seen in Figure 5.1:

- $n_o$  = Roughness coefficient for the area between the buildings in the flood plain (e.g., streets, yards, etc.);
- $W_T$  = Total width of the flood plain, including buildings, in feet;
- $W_o$  = Individual widths between buildings, measured perpendicular to the direction of flow, in feet; and,
- $\Sigma L_o/L_T$  = Ratio of the summation of the distances between rows of buildings,  $L_o$ , to the total length of the reach,  $L_T$ , along a profile parallel to the direction of flow, in feet/foot.

### 5.5 City of Tucson Requirements for Evaluating Flood Plains and Floodways Subject to Agency Review

#### 5.5.1 *Floodplain Delineations*

Flood plains shall be shown on all Tentative/Final Subdivision Plats, and on certain Development Plans and Site Plans, for all computed offsite and onsite 100-year flows equal to or greater than 100 cfs. However, all flows, even those less than 100 cfs, are to be considered during the design of any development.

When delineating natural flood plains, the 100-year flood peaks shall be computed based upon existing watershed conditions, and based upon the assumption that the effects of future watershed urbanization will be mitigated by the concurrent construction of local, small-scale detention/retention basins. Furthermore, the estimation of existing and future 100-year flood peaks should be based upon information available from land-use area plans and existing drainage studies affecting the drainage areas under investigation.

All Subdivision Plats and certain Development Plans and Site Plans shall contain the floodplain-delineation information specified in Tucson Development Standards 2.03.2.2D and 2-03.2.3K.

The method of floodplain delineation can vary, depending upon the precision of existing topographic and hydrologic data, as well as upon the desired level of precision needed in the analytical results.

Typically, the majority of the flood plains that are delineated on Tentative/Final Subdivision Plats, Development Plans, and Site Plans can be based upon "normal-flow" computations (i.e., the Manning's equation). However, when normal depth is below critical depth (i.e., supercritical flow), the floodplain delineation shall be based upon water-surface elevations equivalent to critical depth. In those areas where greater detail is needed, for example where hydraulic structures or topographic features effect the floodplain width and depth, the Standard Step Method should be employed.

V. FLOODPLAIN DELINEATION

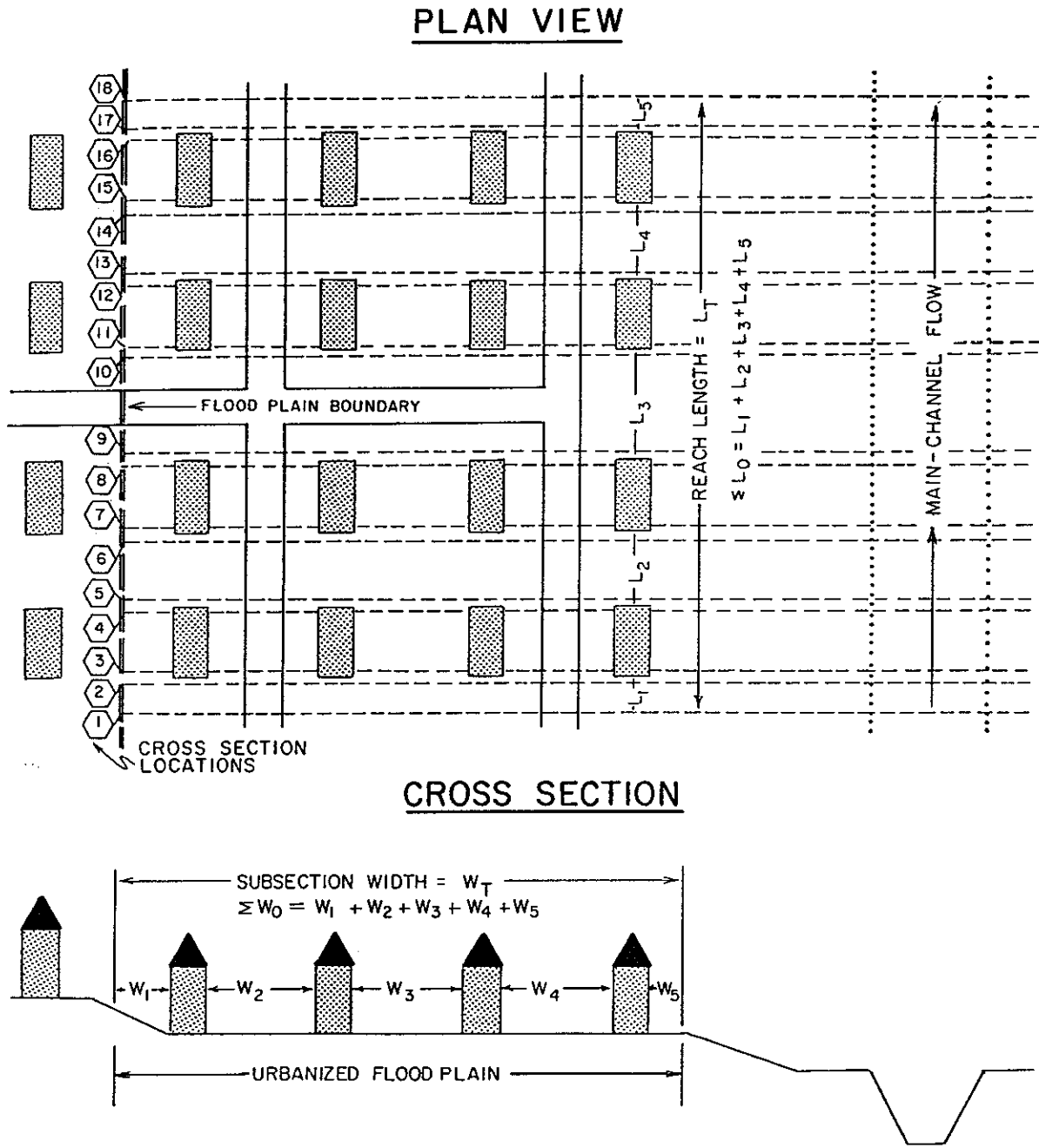

FIGURE 5.1  
 DIAGRAM OF IDEALIZED URBAN FLOOD PLAIN

## V. FLOODPLAIN DELINEATION

Boundary geometry for floodplain studies is specified in terms of ground-surface profiles or cross sections, along with the measured distances between cross sections. Cross sections are to be located at sufficient intervals to allow for adequate modeling of the flow characteristics of the channel and flood plain. They should extend all the way across the flood plain, and be perpendicular to flow lines (i.e., approximately perpendicular to ground contour lines). In addition, the cross section location and skew relative to the channel center line shall be adjusted, as appropriate, so that both the quantity and distribution of flows in the left and right overbank areas are consistent between adjoining cross sections.

Traditionally, cross sections are always oriented looking downstream, with the lowest station numbers located to the far left.

### 5.5.2 *Floodway Delineations*

The floodway is normally defined as the main channel of a watercourse and those adjacent land areas which must be kept essentially free of development in order to allow for the conveyance of the 100-year flood. The floodway is analytically determined by incrementally reducing the original floodplain width such that it does not result in a cumulative increase in the computed water-surface elevation which exceeds one foot in height (See Arizona Revised Statutes §48-3601 and §48-3609).

More specifically, the term floodway, in the context of this document, means a delineated area, including sheet-flow areas, as determined by an hydraulic analysis approved by the City Engineer, where the hypothetical encroachment into the flood plain will allow passage of the regulatory flood without increasing the flood height by more than one foot. Additional hydraulic criteria that shall be applied to determine the boundaries of the floodway are:

1. Removal of equal flow conveyance from each side of the flood plain shall be assumed; and,
2. The exact boundary of the floodway shall be selected so that its alignment will ultimately be streamlined in relation to upstream and downstream developments.

Typically, the floodway shall be determined assuming equal loss of conveyance on opposite sides of the adjoining flood plain of the channel. If equal loss of conveyance is not technically appropriate, as in the case of existing bank protection on only one side of the channel under investigation, the Engineer shall select and justify the most appropriate method for evaluating the hypothetical encroachment.

In addition, encroachment, in the context of this document, means the advancement or infringement of land uses, fill, or structures onto the flood plain in a manner which reduces the flow capacity of the channel and/or flood plain of a watercourse. An equal degree of encroachment is a standard applied to the evaluation of the effects of development upon increases in flood heights. This standard assumes that if a development is permitted to encroach onto a flood plain, the approval to do so confers upon all property owners on both sides of the watercourse an equal right to encroach to the same hydraulic degree within that reach. Since the factors affecting



## V. FLOODPLAIN DELINEATION

hydraulic efficiency are usually not uniform within a reach, this will usually not result in equal distances between floodway limit lines and the sides of the watercourse. A schematic diagram depicting a floodway and the areas of equal encroachment can be found in either the Flood Insurance Study for the City of Tucson (Federal Emergency Management Agency, 1988) or the Flood Insurance Study for Pima County (Federal Emergency Management Agency, 1982).

Where flow is in the supercritical regime, or where velocity conditions are such that normal encroachment analyses are either not possible or are inappropriate, the allowable one-foot rise shall be applied to the energy grade line instead of the water-surface elevation.

### 5.6 Administrative Procedures for Revising Effective Flood Insurance Rate Maps

#### 5.6.1 *Federal Flood Insurance Rate Maps*

In 1968, the U.S. Congress established the National Flood Insurance Program (NFIP), which enables property owners within participating communities to purchase flood insurance at reasonable rates. The flood-hazard areas identified as Special Flood Hazard Areas have been delineated on Flood Insurance Rate Maps (FIRMs) which are now available for Tucson, Arizona, and the surrounding unincorporated areas of Pima County. These maps depict 100-year-flood boundaries, flood-insurance rate zones, and regulatory flood elevations--most of which are the result of detailed engineering analyses performed as part of a Flood Insurance Study (FIS).

FIRMs for the City of Tucson are available for many of the significant watercourses, based upon FISs published in both 1982 and 1988. For those areas with flood limits shown, the flood-hazard zone was either determined by approximate methods, where no flood elevations are given, or by detailed hydraulic analyses, where base (100-year) flood elevations are shown, based upon the best available hydrologic and topographic information available at the time of the investigation.

FIRMs are used for establishing flood-insurance rates for affected buildings, and for floodplain management by the City of Tucson and Pima County.

All new development within federally-recognized flood plains must be approved by the City Engineer, or his official designee. During the site-plan review process, the staff from the City Floodplain Section may require a more-detailed hydrology/hydraulics study than that presented in the FIS. For smaller developments, the staff from the City Floodplain Section may use the FIRMs to establish a minimum acceptable finished-floor elevation, or other site grade elevations.

#### 5.6.2 *Map Amendments and Revisions*

Occasionally, because of limitations of the scale at which a NFIP map was prepared, the floodplain boundaries are not delineated in sufficient detail to reflect individual structures that are elevated on relatively high ground, or to show small parcels of land that have been filled. Similarly, floodplain information is subject to change, as for example after the construction of drainage improvements. Because

## V. FLOODPLAIN DELINEATION

FIRMs are subject to change as better information becomes available, FEMA has developed a map modification process designed to keep maps updated with current information.

Information depicted on effective NFIP maps may be changed by a physical revision of the map, by a Letter of Map Revision (LOMR), or by a Letter of Map Amendment (LOMA). New maps may be printed; or, if the revisions are relatively small in areal extent, a LOMR/LOMA may be written that describes the modifications. Changes to effective FIRMs resulting from the exclusion of individual structures and undeveloped parcels are described in a LOMA; whereas, communities having new data which show the old studies to be in error may request a LOMR.

The general requirements for technical and scientific data needed to substantiate a LOMR or LOMA are similar. However, there are procedural differences that determine the amount of data required, and when the data are to be submitted. A detailed description of the FIRM modification process is included in the FEMA (1985) publication entitled "Appeals, Revisions, and Amendments to Flood Insurance Maps: A Guide For Community Officials".

A LOMA is a document from FEMA describing approved changes to the regulatory flood plain. Approval is based on prescribed administrative procedures in which FEMA reviews the scientific or technical submissions of an owner or lessee of property who believes his or her property has been inadvertently included in designated A, A0, A1-A99, V0, and V1-V30 Zones as a result of the transposition of the curvilinear water-surface contour intervals of the base (100-year) flood to either street or other readily identifiable features shown on FIRMs. The necessity for a LOMA procedure for making map corrections is due in part to the technical difficulty of accurately delineating the curvilinear water-surface contour intervals of the base (100-year) flood on a FIRM. Where there has been a final determination of a base flood elevation, any alteration of the topography shall not be acceptable as a basis for initiating a LOMA procedure. The Federal requirement for flood insurance does not apply to unimproved land, because flood insurance is available only for structures and their contents.

A LOMR is a document from FEMA which describes changes to the regulatory flood plain shown on effective FIRMs. The LOMR gives a detailed description of the Base Flood Elevation (BFE) and changes that will be made to the Special Flood Hazard Area (SFHA) currently delineated on the effective FIRM and/or Flood Hazard Boundary Map (FHBM). FEMA will then revise the effective Flood Insurance Study (FIS) to reflect the new information which shows the original FIS to be incorrect, such as physical changes which invalidate the original FIS analyses or presentation of data. Updated or corrected topographic mapping, hydrologic data, or hydraulic data constitutes new information which may warrant a revision. Flood-protection projects and any form of topographic alterations (e.g., channelization or encroachments) constitute physical changes which may also warrant a map revision. The map-revision process cannot be initiated without the City of Tucson's endorsement, since it is generally the community that adopts the effective FIS. Therefore, any individuals requesting a change to the FIS must do so through the Office of the City Engineer. The City of Tucson, in turn, may support the request and forward the information to FEMA for evaluation and approval.

## V. FLOODPLAIN DELINEATION

If construction is proposed on land within a SFHA, a *Conditional* LOMA or a *Conditional* LOMR can be issued provided that the proposed structural information meets the established criteria for a standard LOMA or LOMR. After construction is completed, certified as-built information must be submitted to FEMA for the purpose of obtaining a LOMA or LOMR. The information required for a *Conditional* LOMA or a *Conditional* LOMR is basically the same information that is required for either a LOMA or LOMR. Property owners and developers should note that a *Conditional* LOMA or a *Conditional* LOMR merely provides a comment on the proposed plan, and does not amend the map or waive the requirement to purchase flood insurance.

## CHAPTER VI: EROSION AND SEDIMENTATION

### 6.1 Introduction

The hydrology and hydraulics of floodwaters are not the only concern of floodplain-management administrators and/or drainage design engineers who work in arid or semi-arid environments which contain alluvial rivers such as those that exist both within and around the City of Tucson, Arizona. The transport of sediment by floodwaters is also a major concern because of the potential for rapid bank erosion and changes in channel bed elevations. Bank erosion can often be so severe that it causes much more damage than inundation by floodwaters. Aggradation or degradation of the channel bed can rapidly change flood limits, or cause bank protection and other channel improvements to fail over a very short period of time.

The study of fluvial geomorphology and the analysis of sediment transport are usually undertaken in an attempt to quantify the broad effects of erosion and sedimentation and the impacts of sediment-transport capacity upon channel morphology. Sediment-transport analysis is a relatively specialized field of study. Predictions based upon its application are often expensive to produce, and can be highly variable in nature. Therefore, as an aid to the user, this chapter of the Manual presents some design and predictive guidelines that can be used within the City of Tucson in the absence of a more detailed sediment-transport analysis.

### 6.2 Purpose

The purpose of this chapter is to provide guidelines for the estimation of erosion, sedimentation, and channel bed scour when designing drainage channels and hydraulic structures which are to be located within the City of Tucson. These design guidelines and procedures are to be used when normal design situations are encountered. Deviations from these guidelines may occur, provided that the user has experience in sediment-transport technology; and provided that the deviation is technically justified, through detailed sediment-transport analysis, to the satisfaction of the City Engineer.

### 6.3 Fluvial Geomorphology

The study of fluvial geomorphology normally involves analyses which encompass entire drainage systems. This is so because the response of an individual channel to change within a watershed can often have an effect upon the entire drainage system. Conversely, the fluvial system, as a whole, will ultimately dictate the response of an individual channel to overall change within a watershed. Rarely is it possible to understand the fluvial processes which occur within even a short reach of an alluvial channel in isolation from its upstream and downstream system controls.

The fluvial system is generally divided into three zones (Schumm, 1977). Zone 1 is characterized as the drainage basin, watershed, or source area for sediment. This is the area from which water and sediment are derived. Storage of sediment is not significant in this zone. Zone 2 is characterized as the transport zone; where, for a stable channel, sediment input can equal sediment output. For those reaches where the sediment-transport capacity exceeds the upstream supply, it can be assumed that the sediment deficit will be made up out of the channel bed or banks. Channel bed

## VI. EROSION AND SEDIMENTATION

degradation or erosion of channel banks will be the result. Zone 3 is characterized as the sediment sink or area of deposition.

Obviously, the division between these three zones is indiscrete. Each zone has characteristics of the other two, which are subordinate to the primary characteristic of the zone. Zone 2 is of major concern to the hydraulic and river-control engineer, and to geomorphologists concerned primarily with river-channel morphology. It is this zone with which this chapter deals.

### 6.3.1 Channel Morphology

Sediment and water moving through alluvial channels are the independent variables that determine the size, shape, and pattern of the channel. Numerous empirical relations have been developed that relate channel morphology to water and sediment discharge.

#### 6.3.1.1 Hydraulic Geometry of Alluvial Channels

As a general rule, the greater the quantity of water that moves through a channel, the larger is the cross-sectional area of that channel. Preceded by numerous studies of canal morphology and stability, Leliavsky (1955) and Leopold and Maddock (1953) demonstrated that, for most rivers, the water surface width,  $T$ , and depth,  $Y$ , increase with mean-annual discharge,  $Q_a$ , in a downstream direction such that:

$$T = k_1 Q_a^b \quad (6.1)$$

and,

$$Y = k_2 Q_a^c \quad (6.2)$$

Both the coefficients and exponents of Equations 6.1 and 6.2 (i.e., the " $k_1$ ," " $k_2$ ," " $b$ ," and " $c$ " values) are different for each river and, when data from a number of rivers are plotted against discharge, the scatter covers an entire log cycle. For a given discharge, there is an order of magnitude range of width and depth. Therefore, other variables apparently influence the hydraulic geometry of channels as well.

#### 6.3.1.2 Influence of Sediment Load

A primary variable which significantly controls river morphology is sediment load. Bed-material load is defined as that part of the stream's sediment load that consists of sediment sizes comprising a significant part of the streambed. The other component of total sediment load is wash load, which is part of the total load not significantly represented in the bed. In and around the Tucson area, wash load is generally composed of sediments smaller than sand (i.e., smaller than about 0.06 mm to 0.07 mm). Wash load is held in suspension by the turbulence of the flowing water, and therefore is transported at the same velocity as the water. Bed-material load is composed of sands and larger sediments, and therefore is generally transported at an average velocity less than the velocity of flowing water.

## VI. EROSION AND SEDIMENTATION

From an analysis of data from regime canals, Lacey (1930) concluded that the wetted perimeter of a channel is directly dependent upon discharge; but that channel shape reflects sediment size. It is also generally recognized that coarse sediment produces channels with high width/depth ratios, while fine sediment produces channels with narrow and deep cross sections.

In addition to the size of the transported sediment, relative amounts of bed-material load and wash load significantly influence the morphology of sand-bed streams. Large bed-material loads are associated with wide channels, and large wash loads are associated with narrow widths.

The type of sediment load is considered to be a more important control on stable channel shape than the total quantity of sediment transported through a channel. For example, in one channel a certain quantity of bed-material load may exert the dominant control if it is the total load, whereas in another channel the same amount of bed-material load may exert much less influence on channel shape because it is only a small part of the total sediment load (i.e., wash load and bed-material load). Therefore, when load and discharge are constant, an increase in the quantity of bed-material load will cause an increase in channel width, and a corresponding increase in the width/depth ratio. This phenomenon is probably related to the high gradient and velocity of flow generally associated with large bed-material loads.

In summary, for alluvial channels which occur in the Tucson area, the type and amount of sediment load exerts a major control on their shape. Therefore, for a single channel under the ideal assumption of a constant discharge and a fixed amount of wash load, a change in bed-material load would be reflected by a change in both the shape and gradient of the channel.

### 6.4 Sediment-Transport Theory

Sediment particles are transported by flowing water in one or more of the following ways: (1) surface creep, (2) saltation, and (3) suspension. Surface creep is the rolling or sliding of particles along the bed. Saltation (jumping) is the cycle of motion above the bed, with resting periods on the bed. Suspension involves the sediment particle being supported by the water during its entire motion. Sediments transported by surface creep, sliding, rolling, and saltation are referred to as bed load, and those transported by suspension are called suspended load. The suspended load consists of sands, silts, and clays. Total sediment load is defined as the sum of the bed load and suspended load. Generally, the amount of bed load transported by a large river is on the order of five to twenty-five percent of the suspended load. Although the amount of bed load may be relatively small compared with total sediment load, it is important because it shapes the bed, influences channel stability, determines the form of bed roughness, and affects various other hydraulic factors as well.

As presented earlier, the total sediment load in a channel can be more simply defined as the sum of bed-material load and wash load; where the bed-material load is the sum of bed load and suspended bed-material load, representing that part of the total sediment discharge which is composed of grain sizes found in the bed; and the wash load is that part of the sediment discharge which is composed of particle sizes

## VI. EROSION AND SEDIMENTATION

finer than those found in appreciable quantities in the bed (Simons and Senturk, 1977). The presence of wash load can increase bank stability, reduce seepage, and increase bed-material transport. Wash load can be easily transported in large quantities by the stream, but is usually limited by availability from the watershed. The bed-material load is more difficult for the stream to move, and is normally limited in quantity by the transport capacity of the channel. Figure 6.1 summarizes the various definitions of the components of sediment load, and their contribution to total sediment load.

There is no clear size distinction between wash load and bed-material load. As a rule of thumb for the Tucson area, it should be assumed that the size of bed-material particles is equal to or larger than 0.0625 mm, which is the division point between sand and silt. The sediment load consisting of grains smaller than this size is then considered as wash load. It is generally assumed that most of the wash load is transported through the system by stream flow, and that little wash load is deposited on or in the stream bed. Wash load deposited with coarse material is usually only a very small fraction of the total bed material within the channel.

The amount of material transported, eroded, or deposited in an alluvial channel is a function of both the sediment supply and the sediment-transport capacity of the channel. Sediment supply includes the quality and quantity of sediment brought to a given reach. Sediment-transport capacity is a function of the size of bed material, flow rate, and geometric and hydraulic properties of the channel. Generally, the single most important factor determining sediment-transport capacity is flow velocity. Additionally, since sediment-transport capacity is generally proportional to the third to fifth power of the velocity, small changes in velocity can cause large changes in sediment-transport capacity (Simons, Li & Associates, 1982, 1985). Either the sediment supply or sediment-transport capacity may limit the actual sediment-transport rate in a given reach.

### 6.5 Sediment Routing

Supported by qualitative and quantitative analysis, a detailed evaluation of the fluvial-system response can be made based upon mathematical-modeling concepts. A mathematical model is simply a quantitative expression of the physical processes. The mathematical processes governing watershed and river responses are complicated. Computer programs can provide a means of assessing the many parameters of these complex processes within a fluvial system. There are several computer models available which are applicable to this region. For information on where to obtain these models, the user should contact the City Engineer.

#### 6.5.1 *Simplified Sediment Modeling*

After evaluating the hydraulic conditions of the river by water-routing programs such as the U.S. Army Corps of Engineers HEC-2 program, the sediment-transporting capacity can be established. Sediment-transport equations are used to determine the sediment-transport capacity for a specific set of flow conditions. Different transport capacities can be expected for different sediment sizes. For each sediment size, the transport rate includes the transport rate of the bed load and the transport rate of the suspended bed-material load.

## VI. EROSION AND SEDIMENTATION

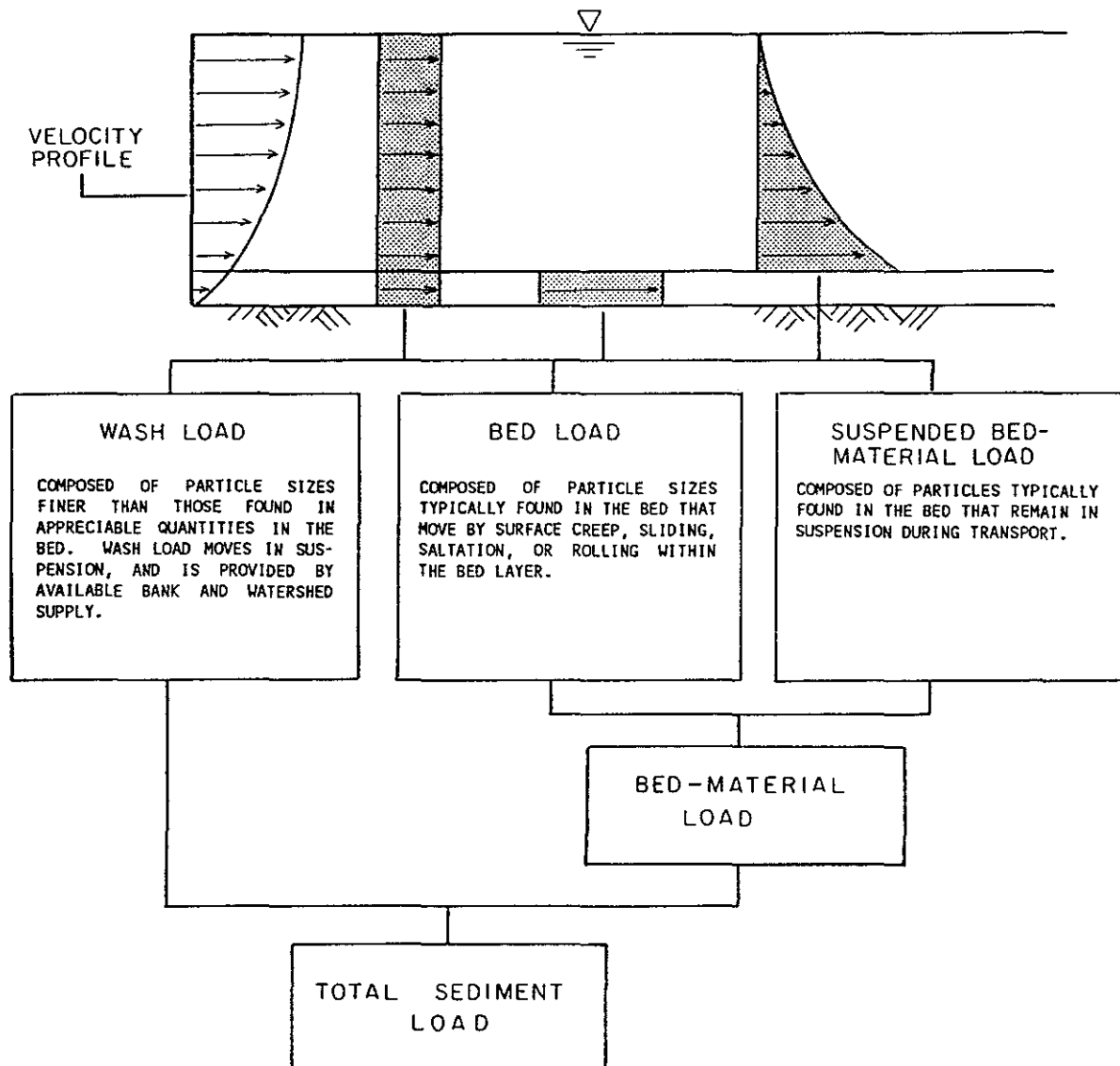

NOTE:

THE TERM "SUSPENDED LOAD" IS USED WHEN REFERRING TO THE SUM OF THE "WASH LOAD" AND "SUSPENDED BED-MATERIAL LOAD" COMPONENTS. THEREFORE, AN ALTERNATE DEFINITION OF TOTAL SEDIMENT LOAD IS THE SUM OF THE SUSPENDED LOAD AND BED LOAD.

**FIGURE 6.1**  
DEFINITION OF SEDIMENT-LOAD COMPONENTS



## VI. EROSION AND SEDIMENTATION

One modeling method uses hydraulic conditions from a rigid-boundary model such as HEC-2, or an equivalent program, and computes sediment transport based upon the Meyer-Peter, Muller bed-load equation and the Einstein suspended-load procedure for each sediment size found in the bed. The data required are the same as for HEC-2 (channel geometry, resistance, bridge constriction, etc.). Also needed are the size distribution of the bed-material and the upstream sediment supply. Using the generated hydraulic conditions, the transport capacity for each sediment size at each cross section is then determined.

Actual transport rates depend upon transport capacities as well as supply rates. The change in transport capacity between two cross sections can be used to estimate aggradation or degradation, based upon availability. For example, if sediment is in ample supply to meet the transport capacity at an upstream cross section but at the next cross section downstream the transport capacity is only one-half as much, then the other one-half of the sediment passing the upstream cross section must be deposited between the upper and lower cross sections. This comparison of transport capacities continues reach by reach and size fraction by size fraction through the entire stream segment. The drawback to this simplified approach is that the hydraulic conditions are not readjusted, due to aggradation or degradation, at frequent time increments during the passage of the flood hydrograph. However, this technique does provide "trends" in bed-elevation changes without using more complex techniques.

### 6.5.2 *Quasi-Dynamic Sediment Modeling*

The sediment-routing model previously discussed is based upon a gradually-varied-flow backwater program which assumes a rigid-boundary system. This methodology can be extended to account for unsteady flow and alluvial-channel boundaries without going to a fully unsteady water and sediment-routing model.

The quasi-dynamic sediment model uses the same gradually-varied-flow backwater program for hydraulic computations. However, the flow is assumed constant for a given time increment  $\Delta t$ . A flow event, either short-term or long-term, can be broken into a number of time increments, each with a different flow rate, but during each increment the flow is considered steady.

To account for a non-rigid or alluvial boundary, when a predetermined volume of sediment is either deposited on or eroded from the streambed, the cross section is recomputed in the following manner.

Sediment aggradation or degradation within a reach for a given time period is  $\Delta V_s = (\text{sediment supply} - \text{sediment transport}) \times BF$ , where  $\Delta V_s$  is the change in sediment volume in the reach and  $BF$  is a bulking factor. The change in sediment volume is assumed to be uniformly distributed throughout the reach. Change in area for each cross section is determined by a weighting factor based upon the conveyance in adjacent segments of the cross sections. The changes in elevation are used to generate a new HEC-2 data file for the next time period. Therefore, during any given time period the channel boundary is assumed to be rigid and the HEC-2 analysis is assumed to be valid. After evaluating the hydraulic conditions and the sediment-transport capacity, the channel boundary is modified to reflect the aggradation/

## VI. EROSION AND SEDIMENTATION

degradation changes occurring throughout the river, and to establish the new channel configuration for the next time step.

This methodology has been successfully applied to a number of practical engineering problems. It provides a feasible and relatively cost-effective approach to design problems in alluvial rivers.

### 6.5.3 *Dynamic Mathematical Modeling*

Dynamic mathematical modeling of water and sediment routing is the next level of sophistication and complexity in determining alluvial-channel changes. It involves unsteady, non-uniform flow routing for determining the hydraulic conditions to be used to calculate sediment transport, aggradation, and degradation.

Unsteady, non-uniform flow routing solves equations governing the motion of water in open channels. These equations are mathematical descriptions of the physical phenomena. The two basic principles for water routing are continuity and momentum. Continuity states that water coming into a reach is either stored in the reach or passes downstream without gaining or losing water.

The momentum principle balances the forces and accelerations acting on flowing water. Generally, the continuity and momentum equations, along with a resistance to flow equation involving Manning's  $n$  or Chezy's  $C$ , are solved numerically in finite-difference form. The results are the hydraulic variables of velocity, depth, and width for unsteady, non-uniform flow. These are then used to route sediment. Sediment movement is controlled by the shear forces acting on the bed, transport capacity of the flow, and both availability and supply. Equations used in these calculations are described in most sedimentation textbooks. To compute aggradation and degradation, the sediment-continuity equation is used.

While dynamic mathematical modeling can give excellent results, it is very complex. Fortunately, it is not often required to solve many of the more straightforward, practical problems that designers will usually encounter within the Tucson area. In fact, most aggradation and degradation problems can be solved to an acceptable degree of accuracy by the several methods previously described within this chapter of the Manual.

## 6.6 Depth of Scour

Scour, or lowering of a channel bed (excluding long-term aggradation/degradation), can be caused by discontinuity in the sediment-transport capacity of the flow during a runoff event (general scour); the formation of anti-dunes in the channel bed during a runoff event; transverse currents within the flow through a bend (bend scour) during a runoff event; local disturbances, such as abutments or bridge piers, during a runoff event; and the formation of a low-flow channel thalweg. The design depth of scour (*excluding* long-term aggradation/degradation, which must be added for toe-down design) is the sum of all these individual scour components, and can be expressed by:

## VI. EROSION AND SEDIMENTATION

$$Z_t = 1.3 (Z_{gs} + 1/2Z_a + Z_{ls} + Z_{bs} + Z_{lft}) \quad (6.3)$$

Where:

- $Z_t$  = Design scour depth, *excluding* long-term aggradation/degradation, in feet;
- $Z_{gs}$  = General scour depth, in feet;
- $Z_a$  = Anti-dune trough depth, in feet;
- $Z_{ls}$  = Local scour depth, in feet;
- $Z_{bs}$  = Bend scour depth, in feet;
- $Z_{lft}$  = Low-flow thalweg depth, in feet; and,
- 1.3 = Factor of safety to account for nonuniform flow distribution.

The various equations for depth of scour which are to follow were developed strictly for use in conjunction with sand-bed channels in which the bed material is erodible to the depth specified by the applicable equations. However, this situation does not always exist in channels located within the City of Tucson. In some areas of the city, the channel has degraded to a point where the exposed bed is no longer composed of strictly unconsolidated alluvial material, but rather of consolidated hardpan or caliche. Channel beds composed of this type of material are not freely erodible, and thus the scour equations which follow may not strictly apply. Should such conditions be encountered, a geotechnical investigation should be submitted by an Arizona Registered Professional Civil Engineer to justify the use of a lesser scour depth than would be determined from the use of Equation 6.3.

### 6.6.1 General Scour

As previously discussed in Section 6.5 of this Manual, the depth of general scour is best estimated by performing a detailed sediment-transport analysis using the bed grain-size distribution, hydraulic conditions, sediment-transport capacity at different stages throughout the flow event, changes in bed levels throughout the event, and the sediment supply into the reach being studied. An analysis to this level of detail is beyond the scope of this Manual. However, there are several computer models commercially available to aid in making an estimate of general scour. Unfortunately, these models are very sensitive to input, and the results are best interpreted by someone with extensive experience in the field of sediment transport. A detailed discussion of sediment-transport analysis for computing general scour can be found in "Engineering Analysis of Fluvial Systems" (Simons, Li & Associates, 1982), and "Arizona Department of Water Resources Design Manual for Engineering Analysis of Fluvial Systems" (Simons, Li & Associates, 1985).

General scour on regional watercourses should be estimated by undertaking a detailed sediment-transport study, as described above, when and where it is feasible to do so. However, such a study is not usually practical on smaller watercourses. Therefore, as an alternative to the above, on watercourses other than regional watercourses, the following equation (Zeller, 1981) should be used to predict general scour:

## VI. EROSION AND SEDIMENTATION

$$Z_{gs} = Y_{max} \left[ \frac{0.0685V_m^{0.8}}{Y_h^{0.4}S_e^{0.3}} - 1 \right] \quad (6.4)$$

Where:

- $Z_{gs}$  = General scour depth, in feet;
- $V_m$  = Average velocity of flow, in feet per second;
- $Y_{max}$  = Maximum depth of flow, in feet;
- $Y_h$  = Hydraulic depth of flow, in feet; and,
- $S_e$  = Energy slope (or bed slope for uniform-flow conditions), in feet per foot.

NOTE: Should  $Z_{gs}$  become negative, assume that the general-scour component is equal to zero (i.e.,  $Z_{gs} = 0$ ).

### 6.6.2 *Anti-Dune Trough Depth*

Anti-dunes are bed forms, in the shape of dunes, which move in an upstream rather than a downstream direction within the channel; hence the term "anti-dunes." They form as trains of waves that build up from a plane bed and a plane water surface. Anti-dunes can form either during transitional flow, between subcritical and supercritical flow, or during supercritical flow. The wave length is proportional to the velocity of flow. The corresponding surface waves, which are in phase with the anti-dunes, tend to break like surf when the waves reach a height approximately equal to 0.14 times the wave length. A relationship between average channel velocity,  $V_m$ , and anti-dune trough depth,  $Z_a$ , can therefore be developed (Simons, Li & Associates, 1982). This relationship is:

$$Z_a = \frac{1}{2} (0.14) \frac{2\pi V_m^2}{g} = 0.0137V_m^2 \quad (6.5)$$

A restriction on the above equation is that the anti-dune trough depth can never exceed one-half the depth of flow. Therefore, if the computed depth of  $Z_a$  obtained by using Equation 6.5 exceeds one-half of the depth of flow, the anti-dune trough depth should then be taken as equal to one-half the depth of flow. Figure 6.2 shows a definition sketch for anti-dune trough depth.

### 6.6.3 *Low-Flow Thalweg*

A low-flow thalweg is a small channel which forms within the bed of the main channel, and in which low discharges are carried. Low-flow thalwegs form when the width/depth ratio of the main channel is large. Rather than flow in a very wide, shallow state, low flows will develop a low-flow channel thalweg below the average channel bed elevation in order to provide more efficient conveyance of these discharges.

## VI. EROSION AND SEDIMENTATION

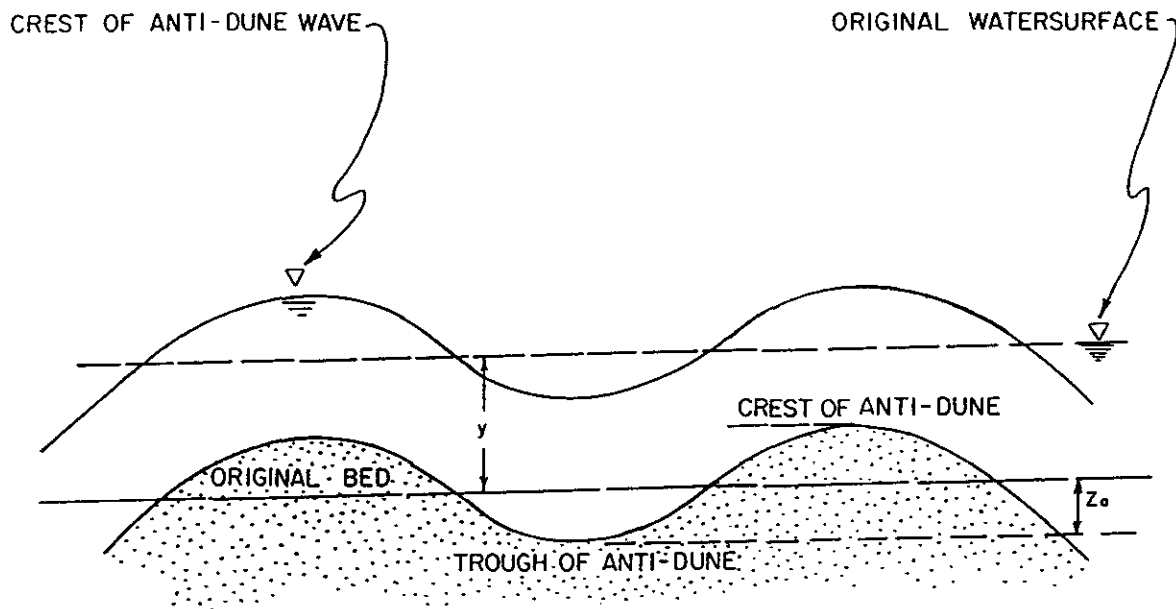

FIGURE 6.2  
DEFINITION SKETCH FOR ANTI-DUNE TROUGH DEPTH

## VI. EROSION AND SEDIMENTATION

When the ratio of the flow width to the flow depth of a channel is greater than 1.15 times the average velocity of flow for the 100-year discharge, a low-flow thalweg must be included in all scour calculations. When the flow width or flow depth exceeds the top width and bank heights of the channel, use the top width and flow depth at bank-full conditions, instead of the actual flow width and flow depth. Presently, there is no known methodology for predicting low-flow thalweg depth. However, observation of channels in the Tucson area has revealed that low-flow thalwegs are normally one to two feet deep. Therefore, if a low-flow thalweg is predicted to be present, it should be assumed to be at least two feet deep within regional watercourses, and at least one foot deep within all other watercourses, unless field observations dictate otherwise.

### 6.6.4 Bend Scour

Bend scour normally occurs along the outside of bends, and is caused by spiral, transverse currents which form within the flow as the water moves around the bend. Presently, there is no single procedure which will consistently and accurately predict bend scour over a wide range of hydraulic conditions. However, the following relationship has been developed by Zeller (1981) for estimating bend scour in sand-bed channels based upon the assumption of the maintenance of constant stream power within the channel bend:

$$Z_{bs} = \frac{0.0685 Y_{max} V_m^{0.8}}{Y_h^{0.4} S_e^{0.3}} \left[ 2.1 \left[ \frac{\sin^2(\alpha/2)}{\cos \alpha} \right]^{0.2} - 1 \right] \quad (6.6)$$

Where:

- $Z_{bs}$  = Bend-scour component of total scour depth, in feet;  
 = 0 when  $r_c/T \geq 10.0$ , or  $\alpha \leq 17.8^\circ$   
 = computed value when  $0.5 < r_c/T < 10.0$ , or  $17.8^\circ < \alpha < 60^\circ$   
 = computed value at  $\alpha = 60^\circ$  when  $r_c/T \leq 0.5$ , or  $\alpha \geq 60^\circ$
- $V_m$  = Average velocity of flow immediately upstream of bend, in feet per second;
- $Y_{max}$  = Maximum depth of flow immediately upstream of bend, in feet;
- $Y_h$  = Hydraulic depth of flow immediately upstream of bend, in feet;
- $S_e$  = Energy slope immediately upstream of bend (or bed slope for uniform-flow conditions), in feet per foot; and,
- $\alpha$  = Angle formed by the projection of the channel centerline from the point of curvature to a point which meets a line tangent to the outer bank of the channel, in degrees (see Figure 6.3).

NOTE: Mathematically, it can be shown that, for a simple circular curve, the following relationship exists between  $\alpha$  and the ratio of the centerline radius of curvature,  $r_c$ , to channel top width,  $T$ .

$$\frac{r_c}{T} = \frac{\cos \alpha}{4 \sin^2(\alpha/2)} \quad (6.7)$$

## VI. EROSION AND SEDIMENTATION

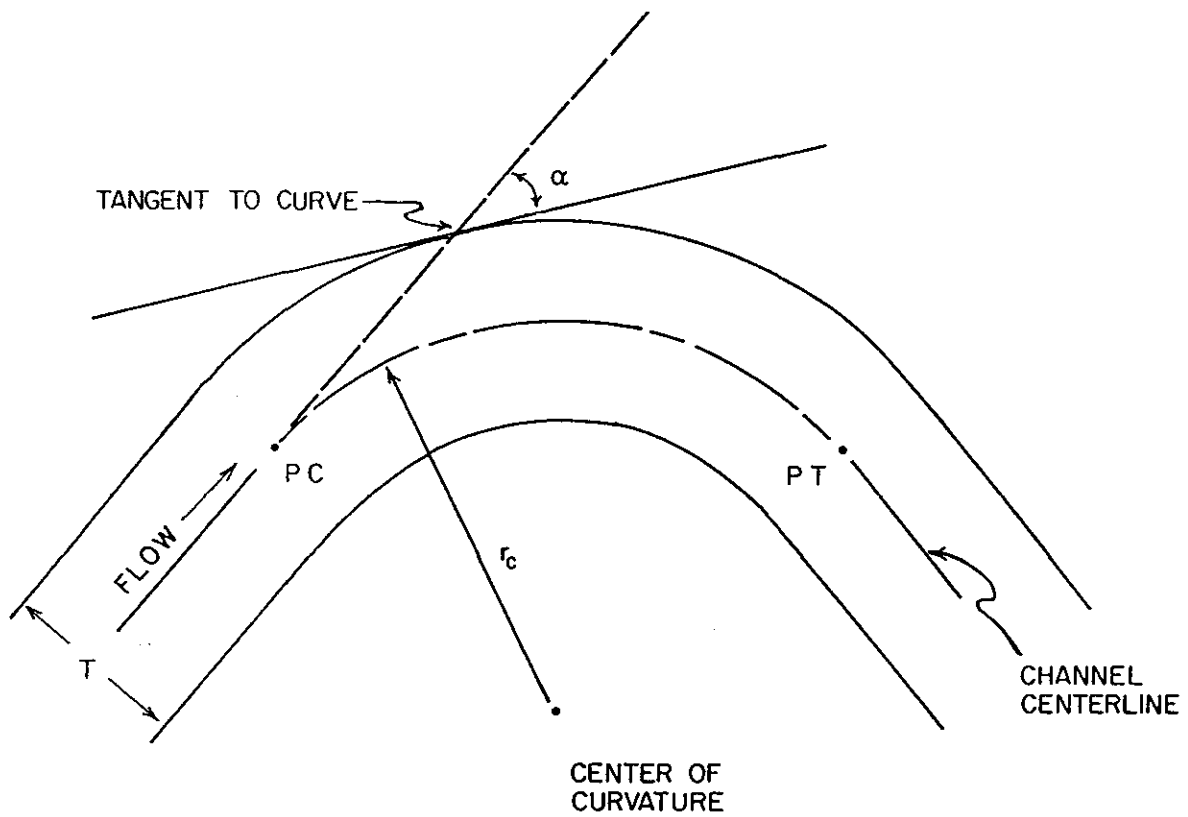

PT = Downstream point of tangency to the centerline radius of curvature.  
PC = Upstream point of curvature at the centerline radius of curvature.

FIGURE 6.3

ILLUSTRATION OF TERMINOLOGY FOR BEND-SCOUR CALCULATIONS

## VI. EROSION AND SEDIMENTATION

Where:

- $r_c$  = Radius of curvature along centerline of channel, in feet; and,  
 $T$  = Channel top width, in feet.

If the bend deviates significantly from a simple circular curve, the curve should be divided into a series of circular curves, and the bend scour computed for each segment should be based upon the angle  $\alpha$  applicable to that segment.

Equation 6.6 can be applied to obtain an approximation of the scour depth that can be expected in a bend during a specific water discharge. The impact that other simultaneously occurring phenomena such as sand waves, local scour, long-term degradation, etc., might have upon bend scour is not known for certain, given the present state of the art. Therefore, in order that the maximum scour in a bend not be underestimated, it is recommended that bend scour be considered as an independent channel adjustment that should be added to those adjustments computed for long-term degradation, general scour, and sand-wave troughs.

The longitudinal extent of the bend-scour component is as difficult to quantify as the vertical extent. Rozovskii (1961) developed an expression for predicting the distance from the end of a bend at which the secondary currents will have decayed to a negligible magnitude. This relationship, in a simplified form, can be expressed as:

$$x = \frac{0.6}{n} Y^{1.17} \quad (6.8)$$

Where:

- $x$  = Distance from the end of channel curvature (point of tangency, PT) to the downstream point at which secondary currents have dissipated, in feet;  
 $n$  = Manning's roughness coefficient;  
 $g$  = Acceleration due to gravity, 32.2 ft/sec<sup>2</sup>; and,  
 $Y$  = Depth of flow (to be conservative, use maximum depth of flow, exclusive of scour, within the bend), in feet.

Equation 6.8 should be used for determining the distance downstream of a curve that secondary currents will continue to be effective in producing bend scour. As a conservative estimate of the longitudinal extent of bend scour, both through and downstream of the curve, it would be advisable to consider bend scour as commencing at the upstream point of curvature (PC), and extending a distance  $x$  (computed with Equation 6.8) beyond the downstream point of tangency (PT).

### 6.6.5 Local Scour

Local scour occurs whenever there is an abrupt change in the direction of flow. Abrupt changes in flow direction can be caused by obstructions to flow, such as bridge piers or abrupt contractions at bridge abutments.



## VI. EROSION AND SEDIMENTATION

The depth of scour at bridge piers is highly dependent upon the shape of the pier. Figure 6.4 gives several common pier shapes. A square-nosed pier causes the deepest scour. The depth of scour caused by a square-nosed pier is computed from (Richardson et al., 1975):

$$Z_{lsp} = 2.2 Y \left[ \frac{b_p}{Y} \right]^{0.65} F_u^{0.43} \quad (6.9)$$

Where:

- $Z_{lsp}$  = Local scour depth due to pier, in feet;
- $Y$  = Flow depth, in feet;
- $b_p$  = Pier width normal to the flow direction, in feet; and,
- $F_u$  = Upstream Froude number.

Table 6.1 can be used for computing the reduction in the depth of pier scour for the various types of piers shown in Figure 6.4.

TABLE 6.1: REDUCTION FACTORS TO BE USED WHEN APPLYING SCOUR FORMULAS FOR SQUARE-NOSED PIERS TO OTHER SHAPES (assuming equally projected widths of piers)	
Type of Pier	Reduction Factor
Square Nose	1.0
Cylinder	0.9
Round Nose	0.9
Sharp Nose	0.8
Group of Cylinders	0.9

Scour is reduced if the pier is streamlined in the direction of flow. However, many watercourses transport significant amounts of debris during large floods. Such debris can become impaled upon bridge piers, leading to an increase in the pier-width component,  $b_p$ , found in Equation 6.9. Therefore, in instances where significant debris

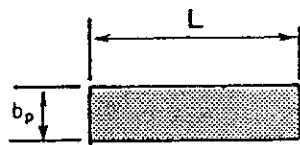

(a) Square nose

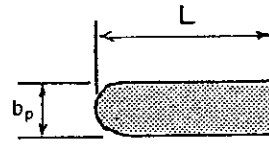

(b) Round nose

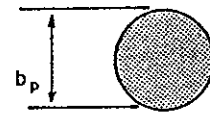

(c) Cylinder

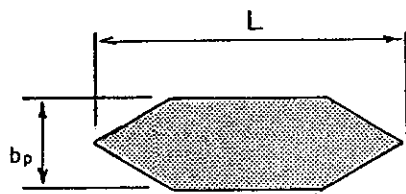

(d) Sharp nose

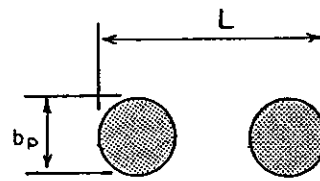

(e) Group of Cylinders

FIGURE 6.4  
COMMON PIER SHAPES

## VI. EROSION AND SEDIMENTATION

transport is anticipated (e.g., within regional watercourses),  $b_p$  should be assumed equal to a width of five feet or  $1.5 b_p$ , whichever value is greater. Additionally, pier scour will increase significantly as the direction of flow at the pier becomes more and more skewed in relationship to the pier wall. In such instances, an effective pier width,  $b_{pe}$ , can be calculated from the following equation and substituted into Equation 6.9 in lieu of  $b_p$ .

$$b_{pe} = L \sin \phi_p + b_p \cos \phi_p \quad (6.10)$$

Where:

- $b_{pe}$  = Effective pier width, in feet;
- $L$  = Length of pier wall, in feet;
- $\phi_p$  = Angle of approach flow in relationship to pier wall, in degrees ( $\phi_p = 0^\circ$  for cylindrical piers); and,
- $b_p$  = As defined in Equation 6.9.

In Equation 6.10,  $b_p$  should incorporate any width increase due to debris, where applicable.

Local scour caused by embankments projecting into the flow, such as at bridge abutments, fill projections, and overbank levees, can be computed from the following equation:

$$Z_{lse} = 2.15 \sin(\theta_a) Y \left[ \frac{a_e}{Y} \right]^{0.4} F_u^{0.33} \quad (6.11)$$

Where:

- $Z_{lse}$  = Local scour depth due to embankment, in feet;
- $\theta_a$  = Slope angle of abutment face, measured from the horizontal, in degrees;
- $Y$  = Upstream normal flow depth, in feet;
- $a_e$  = Embankment or encroachment length, measured normal to the edge of the floodplain or channel bank, in feet (see Figure 6.5); and,
- $F_u$  = Upstream Froude number.

For embankments where the quantity  $a_e/Y$  is exceedingly large, such that  $Z_{lse}/YF_u^{0.33} \geq 4.0$ , the following equation (Richardson et al., 1975) should be used in lieu of Equation 6.11:

$$Z_{lse} = 4YF_u^{0.33} \quad (6.12)$$

Equations 6.11 and 6.12 are based upon relationships developed from both empirical observations and experiments in laboratory flumes. As can be seen from the formulas, the scour depth can be significantly affected by embankment length. In

## VI. EROSION AND SEDIMENTATION

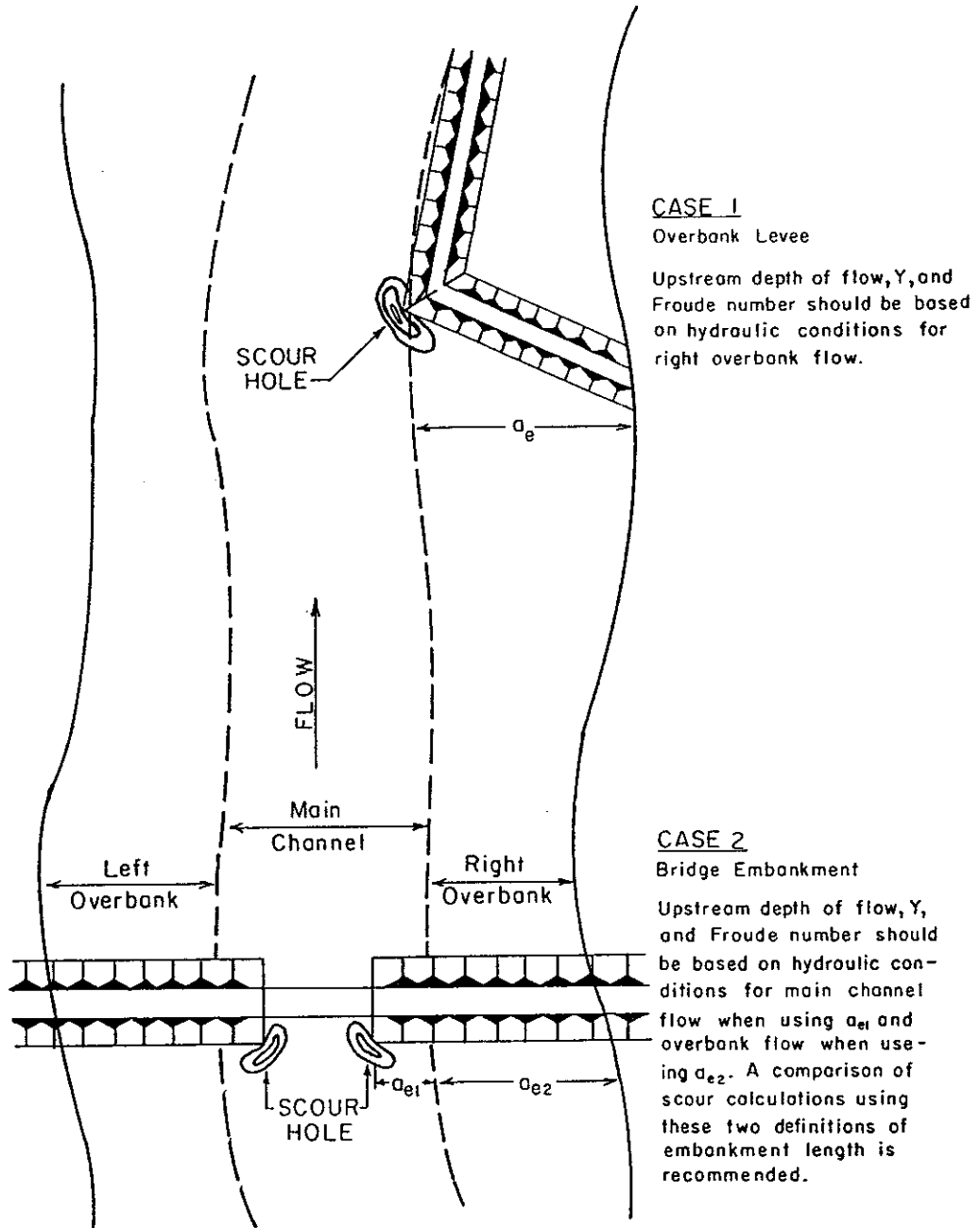

**FIGURE 6.5**

DEFINITION SKETCH OF EMBANKMENT LENGTH " $a_e$ "

## VI. EROSION AND SEDIMENTATION

practical situations, the embankment may span a wide floodplain overbank and extend partially into the main channel itself. Due to the normally large differences which exist between channel and overbank hydraulics, caution must be exercised in defining the embankment length. Figure 6.5 shows a recommended embankment length definition for different cases that might be encountered. In the situation where the embankment crosses the entire overbank and extends into the main channel, it is recommended that the scour be computed by utilizing the overbank hydraulics in combination with the embankment length  $a_{e2}$ , and that this depth of scour then be compared to the scour depth computed by utilizing the main-channel hydraulics in combination with the embankment length  $a_{e1}$ . The larger of the two values should then be used for design purposes.

### 6.6.6 Scour Below Channel Drops

Scour below channel drops, such as grade-control structures, is a special case of local scour. Where the drop consists of a free, unsubmerged overfall, the depth of scour below the drop (U.S. Bureau of Reclamation, 1977) shall be computed from:

$$Z_{1sf} = 1.32 q^{0.54} H_t^{0.225} - TW \quad (6.13)$$

Where:

- $Z_{1sf}$  = Depth of local scour due to a free-overfall drop, in feet, measured below the streambed surface downstream of the drop;
- $q$  = Discharge per unit width of the channel bottom, in cubic feet per second per foot;
- $H_t$  = Total drop in head, measured from the upstream energy grade line to the downstream energy grade line, in feet; and
- $TW$  = Tailwater elevation (downstream water-surface elevation), in feet.

Figure 6.6 shows the relationship of the parameters in Equation 6.13.

Where the drop is submerged, as will be the case for most instances involving grade-control structures placed along watercourses located within the City of Tucson, the depth of scour below the drop (Simons, Li & Associates, 1986) shall be computed from:

$$Z_{1ss} = 0.581q^{0.667} (h/Y)^{0.411} [1-(h/Y)]^{-0.118} \quad (6.14)$$

Where:

- $h/Y \leq 0.99$ ; and,
- $Z_{1ss}$  = Depth of local scour due to a submerged drop, in feet, measured below the streambed surface downstream of the drop;
- $q$  = Discharge per unit width of the channel bottom, in cubic feet per second per foot;
- $h$  = Drop height, in feet; and,
- $Y$  = Downstream depth of flow, in feet.

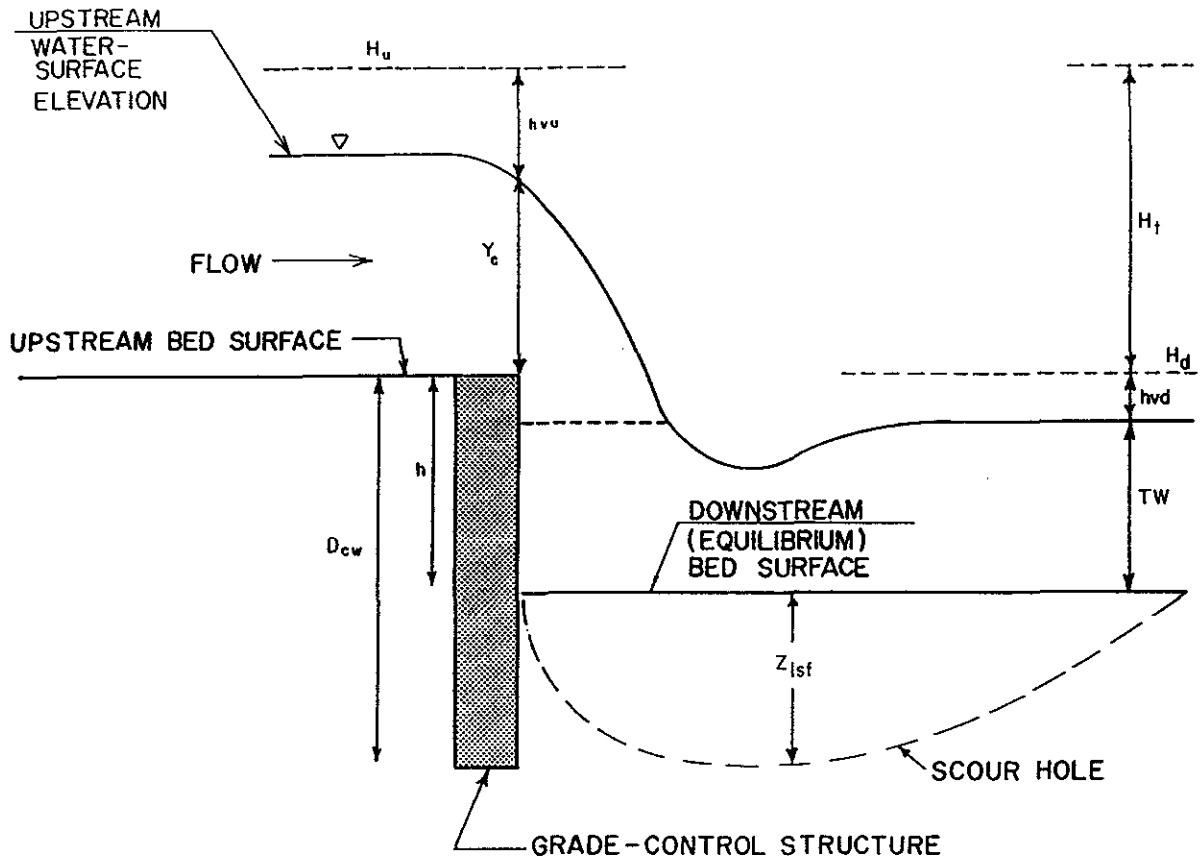

FIGURE 6.6  
DEPTH OF SCOUR BELOW A FREE OVERFALL

## VI. EROSION AND SEDIMENTATION

NOTE: If  $h/Y > 0.85$ , the predicted scour below a channel drop should also be computed using Equation 6.13. The smaller of the two values thus computed should then be used for design purposes.

Figure 6.7 gives the relationship of the parameters in Equation 6.14.

The longitudinal extent of a scour hole created by either a free or submerged overfall is represented by the distances  $x_{sce}$  and  $L_g$ , as depicted in Figure 6.7. These dimensions are given by the equations:

$$x_{sce} = 6.0 Z_{lsf}, \text{ or } 6.0 Z_{lss} \quad (6.15)$$

$$L_g = 12.0 Z_{lsf}, \text{ or } 12.0 Z_{lss} \quad (6.16)$$

Bank protection toe-downs downstream of a grade-control structure shall extend to the computed depth of scour for a distance equal to  $x_{sce}$  beyond of the grade-control structure, as computed by Equation 6.15. They shall then taper back to the normal toe-down depth within a total distance downstream of the grade-control structure equal to  $L_g$ , as computed by Equation 6.16. Note that  $L_g$  includes  $x_{sce}$ .

In the absence of bridge piers and/or abutments, the depth of scour below grade-control structures is not added to the other scour components. Rather, the depth of scour caused by the grade-control structure is compared to the depth of scour computed by Equation 6.3, and the larger of the two values is then used for toe-down design.

### 6.7 Scour-Hole Geometry at Culvert Outlets

Culverts normally have less cross-sectional area available for the conveyance of flow than do the natural channels they replace. Consequently, flow velocities are increased and a potential for erosion is created at the culvert outlet. Often there is a drop at the culvert outlet, either under design conditions or as a result of outlet scour, and this further increases the possibility of outlet scour. The scour hole created at the outlet of a culvert can become large enough to threaten the culvert, the roadway, adjacent property, or other nearby improvements.

For non-cohesive soils, the dimensions of a scour hole downstream of a culvert outlet *where no drop exists* can be computed by:

$$DSG = \alpha \left( \frac{Q_r}{g^{1/2} D^{5/2}} \right)^\beta (0.09)^\theta \quad (6.17)$$

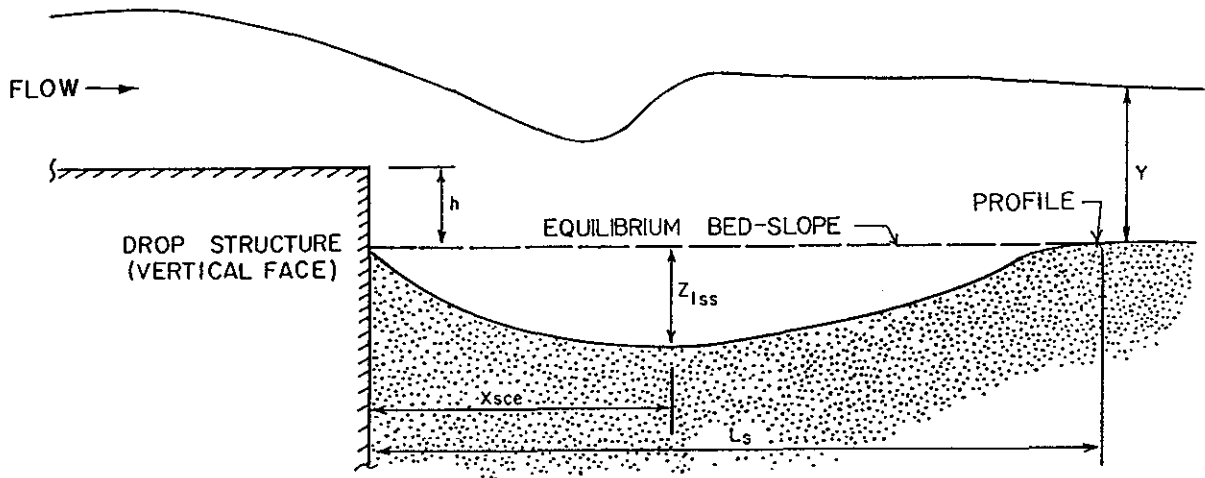

FIGURE 6.7  
 RELATIONSHIP OF VARIABLES IN EQUATION FOR SCOUR BELOW  
 A SUBMERGED GRADE-CONTROL STRUCTURE



## VI. EROSION AND SEDIMENTATION

Where:

$$DSG = \text{Dimensionless scour geometry} = \frac{Z_{1sc}}{D}, \frac{W_{sc}}{D}, \frac{L_{sc}}{D} \text{ or } \frac{V_{sc}}{D}; \text{ and,}$$

$Z_{1sc}$	=	Depth of scour hole below culvert, in feet;
$W_{sc}$	=	Width of scour hole below culvert, in feet;
$L_{sc}$	=	Length of scour hole below culvert, in feet;
$V_{sc}$	=	Volume of scour hole below culvert, in cubic feet;
$D$	=	Culvert diameter, in feet;
$Q_r$	=	Representative discharge, in cubic feet per second;
$g$	=	Acceleration due to gravity (32.2 ft/sec <sup>2</sup> ); and,
$\alpha, \alpha_e, \beta, \theta$	=	Empirically derived coefficients (see Table 6.2).

The representative discharge is the average maximum discharge that can be expected to occur within a thirty-minute time period during the storm runoff event which is selected for design. In the City of Tucson, the design discharge is the 100-year flood. The representative discharge is calculated by:

$$Q_r = \frac{Q_{100}}{2} \left[ 1 + \frac{T_r - 10}{T_r} \right] \quad (6.18)$$

Where:

$Q_r$	=	Representative discharge, in cubic feet per second;
$Q_{100}$	=	100-year peak discharge, in cubic feet per second; and,
$T_r$	=	Hydrograph rise time, in minutes (see Chapter IV, Section 4.5, of this Manual).

For either non-circular or partially-full culverts, the culvert diameter,  $D$ , should be replaced in Equation 6.17 by an equivalent depth,  $Y_e$ , where  $Y_e$  is defined as:

$$Y_e = \left[ \frac{A}{2} \right]^{0.5} \quad (6.19)$$

Where:

$A$  = Cross-sectional area of flow, in square feet.

Equation 6.18 is then modified to the following form:

VI. EROSION AND SEDIMENTATION

TABLE 6.2A: EXPERIMENTAL COEFFICIENTS FOR SCOUR DEPTH,  $Z_{isc}$ , AT CULVERT OUTLETS

MATERIAL	NOMINAL GRAIN SIZE $D_{50}$ (mm)	SCOUR EQUATION	COEFFICIENTS			
			$\alpha$	$\beta$	$\theta$	$\alpha_e$
Uniform Sand	0.20	6.17 or 6.20	2.72	0.375	0.10	2.79
Uniform Sand	2.0	6.17 or 6.20	1.86	0.45	0.09	1.76
Graded Sand	2.0	6.17 or 6.20	1.22	0.85	0.07	0.75
Uniform Gravel	8.0	6.17 or 6.20	1.78	0.45	0.04	1.68
Graded Gravel	8.0	6.17 or 6.20	1.49	0.50	0.03	1.33
<u>Cohesive Sandy Clay:</u>						
60% Sand, PI 15	0.15	6.17 or 6.20	1.86	0.57	0.10	1.53
Clay, PI 5-16	Varies	6.22 or 6.23	0.86	0.18	0.10	1.37

## VI. EROSION AND SEDIMENTATION

TABLE 6.2B: EXPERIMENTAL COEFFICIENTS FOR SCOUR WIDTH,  $W_{sc}$ , AT CULVERT OUTLETS

MATERIAL	NOMINAL GRAIN SIZE $D_{50}$ (mm)	SCOUR EQUATION	COEFFICIENTS			
			$\alpha$	$\beta$	$\theta$	$\alpha_e$
Uniform Sand	0.20	6.17 or 6.20	11.73	0.92	0.15	6.44
Uniform Sand	2.0	6.17 or 6.20	8.44	0.57	0.06	6.94
Graded Sand	2.0	6.17 or 6.20	7.25	0.76	0.06	4.78
Uniform Gravel	8.0	6.17 or 6.20	9.13	0.62	0.08	7.08
Graded Gravel	8.0	6.17 or 6.20	8.76	0.89	0.10	4.97
<u>Cohesive Sandy Clay:</u>						
60% Sand, PI 15	0.15	6.17 or 6.20	8.63	0.35	0.07	9.14
Clay, PI 5-16	Varies	6.22 or 6.23	3.55	0.17	0.07	5.63

VI. EROSION AND SEDIMENTATION

TABLE 6.2C: EXPERIMENTAL COEFFICIENTS FOR SCOUR LENGTH,  $L_{sc}$ , AT CULVERT OUTLETS

MATERIAL	NOMINAL GRAIN SIZE $D_{50}$ (mm)	SCOUR EQUATION	COEFFICIENTS			
			$\alpha$	$\beta$	$\theta$	$\alpha_e$
Uniform Sand	0.20	6.17 or 6.20	16.82	0.71	0.125	11.75
Uniform Sand	2.0	6.17 or 6.20	18.28	0.51	0.17	16.10
Graded Sand	2.0	6.17 or 6.20	12.77	0.41	0.04	12.62
Uniform Gravel	8.0	6.17 or 6.20	14.36	0.95	0.12	7.61
Graded Gravel	8.0	6.17 or 6.20	13.09	0.62	0.07	10.15
<u>Cohesive Sandy Clay:</u>						
60% Sand, PI 15	0.15	6.17 or 6.20	15.30	0.43	0.09	14.78
Clay, PI 5-16	Varies	6.22 or 6.23	2.82	0.33	0.09	4.48

## VI. EROSION AND SEDIMENTATION

TABLE 6.2D: EXPERIMENTAL COEFFICIENTS FOR SCOUR VOLUME,  $V_{sc}$ , AT CULVERT OUTLETS

MATERIAL	NOMINAL GRAIN SIZE $D_{50}$ (mm)	SCOUR EQUATION	COEFFICIENTS			
			$\alpha$	$\beta$	$\theta$	$\alpha_e$
Uniform Sand	0.20	6.17 or 6.20	203.36	2.0	0.375	80.71
Uniform Sand	2.0	6.17 or 6.20	101.48	1.41	0.34	79.62
Graded Sand	2.0	6.17 or 6.20	36.17	2.09	0.19	12.94
Uniform Gravel	8.0	6.17 or 6.20	65.91	1.86	0.19	12.15
Graded Gravel	8.0	6.17 or 6.20	42.31	2.28	0.17	32.82
<u>Cohesive Sandy Clay:</u>						
60% Sand, PI 15	0.15	6.17 or 6.20	79.73	1.42	0.23	61.84
Clay, PI 5-16	Varies	6.22 or 6.23	0.62	0.93	0.23	2.48

## VI. EROSION AND SEDIMENTATION

$$DSG = \alpha_e \left( \frac{Q_r}{g^{1/2} Y_e^{5/2}} \right)^\beta (0.09)^\theta \quad (6.20)$$

The coefficient  $\alpha_e$  can also be found in Table 6.2.

Bed materials are classified in Table 6.2 as being either uniform or graded. Uniform materials are classified as those for which the standard deviation ( $\sigma$ ) of the grain-size distribution is less than or equal to 1.5. The material is classified as graded if the standard deviation of the grain-size distribution is greater than 1.5. A simple formula often used for computing the standard deviation is:

$$\sigma = \left( \frac{D_{84}}{D_{16}} \right)^{0.5} \quad (6.21)$$

Where:

- $D_{84}$  = The grain-size diameter for which 84% of the bed material consists of smaller particles; and
- $D_{16}$  = The grain-size diameter for which 16% of the bed material consists of smaller particles.

The grain-size distribution can be determined by a sieve analysis of the bed material. For planning purposes, or in the absence of a sieve analysis, bed material in the City of Tucson should be classified as graded sand, with a median diameter,  $D_{50}$ , equal to one millimeter and  $\sigma = 4.0$ .

If the soil at the culvert outlet is a sandy clay with a mean grain size in the range of 0.10 to 0.20 mm and a plasticity index,  $PI$ , of approximately 15, either Equation 6.17 or 6.20 may be used; where the coefficients for such a soil type are also given in Table 6.2.

Equations 6.17 and 6.20 are not applicable to cohesive soils, which have very different properties than the soil types described above. The potential for scour in cohesive soils is related to the critical shear stress of the soils, and is reflected by Equations 6.22 and 6.23. These equations have a wider range of applicability than do the above expressions. These equations are:

$$DSG = \alpha \left( \frac{\rho V^2}{\tau_c} \right)^\beta (0.09)^\theta \quad (6.22)$$

For circular culverts, and

## VI. EROSION AND SEDIMENTATION

$$DSG = \alpha_e \left( \frac{\rho V^2}{\tau_c} \right)^\beta (0.09)^\theta \quad (6.23)$$

For culverts with other shapes.

Where:

$$\begin{aligned} \frac{\rho V^2}{\tau_c} &= \text{Modified shear number;} \\ V &= \text{Average velocity at outlet, in feet per second;} \\ \tau_c &= \text{Critical tractive shear stress, in} \\ &\text{pounds per square foot; and,} \\ \rho &= \text{Fluid density, in slugs per cubic foot.} \end{aligned}$$

All other terms are as previously defined.

The critical tractive shear stress is defined as:

$$\tau_c = 0.0001 (S_v + 180) \tan (30 + 1.73 PI) \quad (6.24)$$

Where:

$$\begin{aligned} S_v &= \text{Saturated shear strength, in pounds per square inch; and,} \\ PI &= \text{The plasticity index (limits 5-16).} \end{aligned}$$

Equations 6.17 to 6.24 can therefore be used to estimate the dimensions of the scour hole that would form at the outlet of a culvert for varying types of soils. Figures 6.8 and 6.9 should be used to determine the shape of the scour hole. If the scour hole is large enough to threaten nearby improvements, adjacent property, or the culvert itself, outlet protection will be required to contain and/or prevent erosion. The user is referred to a publication by the Federal Highway Administration (1983) for further information regarding the design of culvert outlet protection.

### 6.8 Design of Sediment Basins

On watercourses with a potential for high sediment discharge, sediment basins may be necessary to protect detention basins, culverts, or storm drains from being filled with sediment. If it is felt that sedimentation could pose a problem for a proposed structure, basins should be built to collect and hold sediment for later removal by maintenance personnel. The design of these basins on watercourses where the upstream watershed area is one square mile, or less, shall be in accordance with the guidelines as presented within Section 3.4 of the Pima County and City of Tucson Stormwater Detention/Retention Manual (1987).

VI. EROSION AND SEDIMENTATION

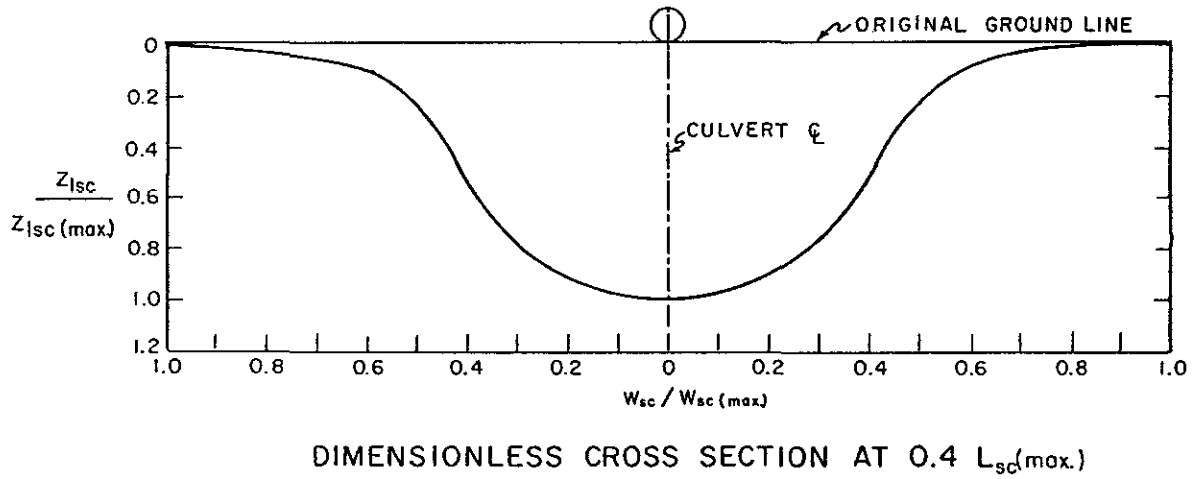
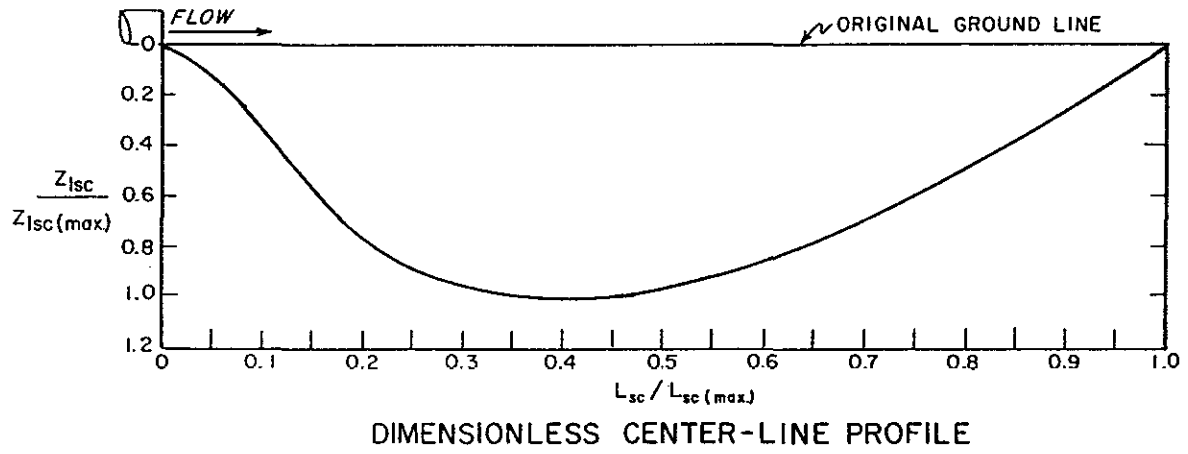

FIGURE 6.8  
 DIMENSIONLESS SCOUR-HOLE GEOMETRY  
 FOR MAXIMUM TAILWATER



VI. EROSION AND SEDIMENTATION

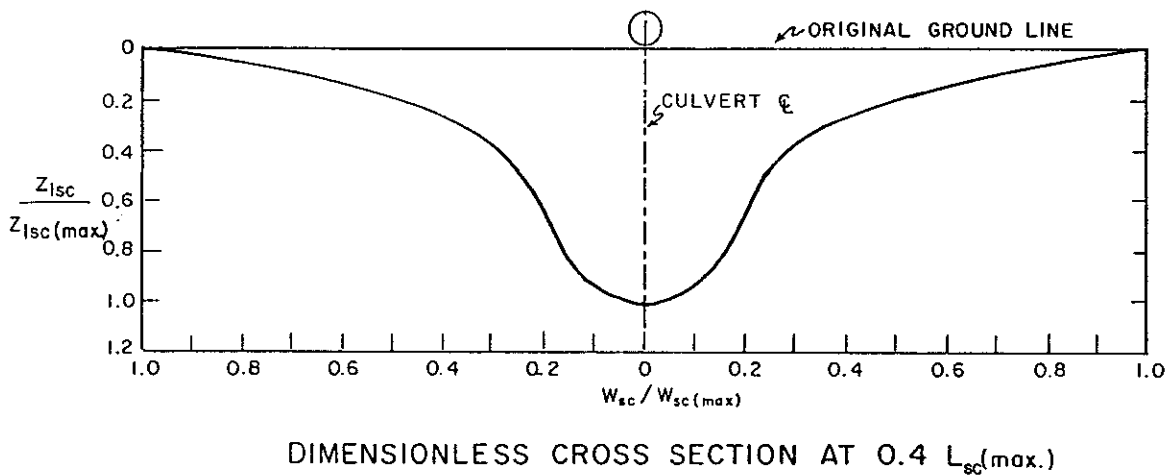
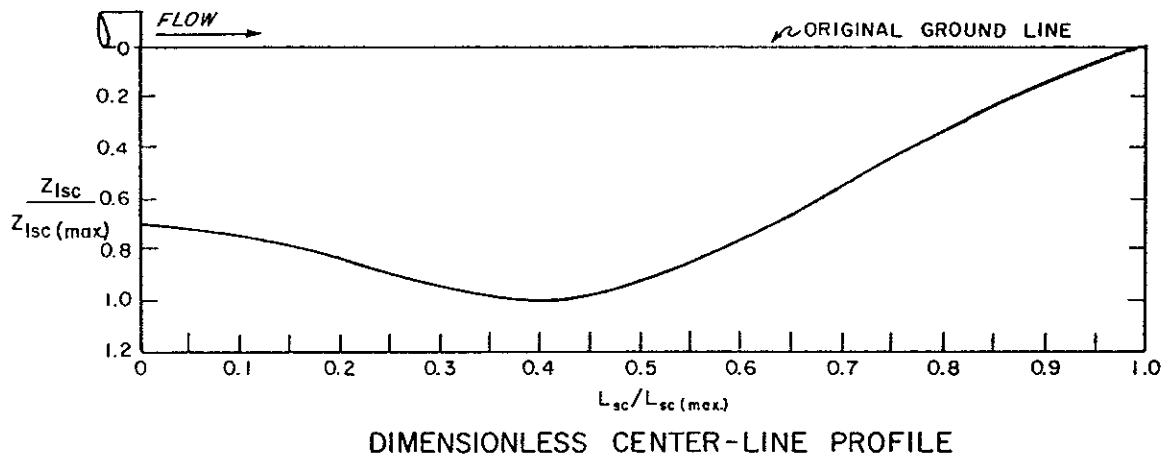

FIGURE 6.9  
 DIMENSIONLESS SCOUR-HOLE GEOMETRY  
 FOR MINIMUM TAILWATER

## VI. EROSION AND SEDIMENTATION

On watersheds larger than one square mile, the guidelines cited above may result in overdesign. The design of sediment basins on these watersheds is a more complicated procedure, involving total watershed sediment yield and channel sediment-transport capacity over a range of discharges. Total watershed sediment yield can be estimated by such methods as the Modified Universal Soil Loss Equation (Williams, 1975; and Williams and Berndt, 1977), the Pacific Southwest Inter-Agency Committee (PSIAC) Method (Pacific Southwest Inter-Agency Committee, 1968), the Flaxman Method (Flaxman, 1972), the SCS Method (U.S. Soil Conservation Service, 1971), the Dendy/Bolton Method (Dendy and Bolton, 1976), and the Renard Method (Renard, 1972). A publication by Renard and Stone (1981) contains a detailed discussion and comparison of some of these methods.

The equations for watershed sediment yield which are listed above do not readily distinguish between sediment production that would be classified as wash load and sediment production that would be classified as bed load. Wash load particles are so small that they would generally remain in suspension as the water passes through the detention basin. Therefore, the wash load is not generally to be considered in sediment basin design. An estimate of wash load, as compared to bed load estimated from equations for total watershed sediment yield, can be made by taking samples of the topsoil throughout the watershed.

Total watershed sediment production may not be an entirely accurate estimate of the amount of sediment that would be delivered to a certain point, because there is sediment storage within the watershed system. Sediment-volume estimates must therefore also consider the sediment-transport capacity of the channel. A detailed discussion of this type of analysis will not be presented here. However, the reader is referred to publications by the U.S. Army Corps of Engineers (1977), Simons, Li & Associates (1982, 1985), the American Society of Civil Engineers (1977), Simons and Senturk (1977), and Zeller and Fullerton (1983) for more detailed information about performing such analyses.

### 6.9 Equilibrium Slopes within Constructed Channels

Given a fixed size distribution of sediments, the sediment-transport capacity of a stream is dependent primarily upon flow velocity and depth. Within the City of Tucson, transport of all particle sizes of bed material increases, as flow velocity increases, at a rate proportional to approximately the third to fifth power of the velocity. Correspondingly, transport of sediment particles composed of bed material generally decreases as depth increases, while transport increases with decreased depth. However, flow velocity is by far the more important variable.

For purposes of analysis and design, most natural, undisturbed channels in the Tucson area can be assumed to be at or near a state of dynamic equilibrium with regard to sediment transport. This means that, for a given reach of the channel, the sediment-transport capacity of the channel, over the long term, is more or less equal to the sediment supply. The channel bed slope is therefore "stable."

When channelization occurs, the channel top width is often narrowed, and channel roughness is normally decreased. The result is an increase in velocity and depth, with

## VI. EROSION AND SEDIMENTATION

a corresponding increase in sediment-transport capacity. Sediment-transport capacity then exceeds the sediment supply; and, if the bed is composed of sediment that can be transported, the deficiency will be made up from bed material--causing the channel to degrade. Another factor that contributes to this degradation is upstream urbanization. Urbanization increases flood peaks, which also lead to higher flow velocities and depths. Urbanization also reduces the watershed sediment supply, and increases the frequency of runoff. The result of all these occurrences is that channel bed degradation will occur until the channel slope is flat enough to cause the sediment-transport rate to be equal to the incoming sediment supply. This slope then becomes the new, "stable," equilibrium slope. Streambed degradation can threaten underground improvements, bank-protection toe-downs, culverts, and other hydraulic structures that are within and/or that cross the channel. Grade-control structures, or lining of the channel bed, are usually required in order to prevent damage caused by streambed degradation.

The equilibrium slope for a channel which has an upstream sediment supply that is considered to be essentially zero (e.g., a channel located within a highly urbanized watershed) can be computed from:

$$S_{eq} = \left( \frac{1.45n}{q^{0.11}} \right)^2 \quad (6.25)$$

Where:

- $S_{eq}$  = Equilibrium slope after urbanization, in feet per foot;
- $n$  = Manning's roughness coefficient; and,
- $q$  = Channel unit discharge, in cubic feet per second per foot.

For use with Equation 6.25, channel unit discharge is defined as the channel discharge divided by the channel bottom width. Use of this equation will produce the flattest slope that can be reasonably expected to transport sediment within channels located in the Tucson area. The discharge associated with a 10-year flood is normally chosen when computing the unit discharge for use in Equation 6.25.

For lesser degrees of urbanization, the equilibrium slope is computed from Equation 6.26, which is a generalization of the theoretically derived sediment-transport relationships for sandbed channels developed by Zeller and Fullerton (1983):

$$S_{eq} = \left[ \left[ \frac{n_u}{n_n} \right]^2 \left[ \frac{Q_{u,10}}{Q_{n,10}} \right]^{-1.1} \left[ \frac{b_u}{b_n} \right]^{0.4} (1-R_s)^{0.7} \right] S_n \quad (6.26)$$

## VI. EROSION AND SEDIMENTATION

Where:

- $n_u$  = Manning's roughness coefficient for an urban channel;
- $n_n$  = Manning's roughness coefficient for a natural or existing channel;
- $Q_{u,10}$  = Ten-year discharge, under urbanized conditions, in cubic feet per second;
- $Q_{n,10}$  = Ten-year or bank-full discharge (whichever is less), under natural conditions, in cubic feet per second;
- $b_u$  = Bottom width of channel, under urbanized conditions, in feet;
- $b_n$  = Bottom width of channel, under natural conditions, in feet;
- $R_s$  = Reduction factor for sediment supply. This factor is usually assumed to be equal to the ratio of the impervious area to the total area of the upstream watershed (i.e.,  $0.0 \leq R_s \leq 1.0$ ); and,
- $S_n$  = Natural or existing channel slope, in feet per foot.

The roughness coefficients for natural and urbanized channel beds are often very nearly the same, so the term in which these coefficients appear in Equation 6.26 can usually be assumed equal to the value 1.0. However, from time to time exceptions to this assumption may occur. For instance, when the existing channel is a wide, flat, sheetflow watercourse; and the proposed channel is a narrow, sand-bed channel,  $n_u$  will ordinarily not be equal to  $n_n$ .

For moderately urbanized to highly urbanized watersheds, the equilibrium slope should be computed by using both Equation 6.25 and Equation 6.26. The steeper of the two computed slopes should then be used for design. The reason for this is that Equation 6.26 can sometimes produce slope values that are too flat to generate reasonable sediment-transport rates for maintenance of channel stability, when impervious cover within a watershed is very high.

Equation 6.26 should be used with caution within the City of Tucson. An underlying assumption of this equation is that the existing or natural channel is itself in equilibrium. This is not always true in the City, because most channels have undergone alteration. If there is any question as to whether or not the existing channel is in equilibrium, it is best to try and determine through old (pre-development) aerial photographs and topography what the channel characteristics were in its original, undisturbed (i.e., natural) state. In the absence of historical information about the original channel, an examination may be made of existing stable channels in the area to help estimate what the channel in question may have looked like before urbanization.

Equation 6.26 can be used for more than merely the quantification of streambed degradation. It can also be used to determine whether aggradation will occur when a channel is widened beyond existing or natural conditions. Another application would be to use it to design a stable channel cross-section in lieu of installing grade-control structures to otherwise control degradation of the channel bed.

## VI. EROSION AND SEDIMENTATION

### 6.10 Spacing and Depth of Grade-Control Structures

If the equilibrium slope of a channel, as determined by use of either Equation 6.25 or Equation 6.26, is flatter than the design slope, grade-control structures may be needed to limit degradation from exceeding a certain depth at any point along the channel. Grade-control structures, sometimes called "cut-off walls" or "check dams," are non-erodible vertical barriers in the channel that prevent the channel bed from degrading at a point located immediately upstream of where they are located. After the channel bed has reached equilibrium, the bed elevation immediately upstream of the grade-control structure is at the design elevation. Downstream of the grade-control structure, the bed is at an "equilibrium" elevation that is lower than the design elevation. For most channels, the design of grade-control structures is an iterative process, involving drop height, reach length, and depth of scour downstream of the drop.

Once a drop height is chosen, the reach length, or spacing, between adjacent structures can be computed from:

$$L_r = \frac{h}{S_{ib} - S_{eq}} \quad (6.27)$$

Where:

- $L_r$  = Reach length, or spacing, between adjacent grade-control structures, in feet;
- $h$  = Drop height downstream of the grade-control structure, in feet;
- $S_{ib}$  = Initial channel bed slope, in feet per foot; and,
- $S_{eq}$  = Channelized equilibrium bed slope, in feet per foot.

If the initial and final bed slopes are approximately the same, the distance between grade-control structures will be very large. Under these circumstances, such structures may not be required.

Normally, the drop height downstream of a grade-control structure which consists of poured concrete without reinforcements shall not exceed two feet; and preferably should be only one foot, where feasible. For economical and technical reasons, grade-control structures should be spaced no closer together than twelve times the local scour depth below the grade-control structures, as computed by the use of either Equation 6.13 or Equation 6.14.

The total height of a cut-off wall or a grade-control structure ( $D_{cw}$ ), from top to toe, shall not be less than the drop height plus the computed depth of scour below the wall or structure (see Figure 6.6). The depth of scour below grade-control structures should be computed according to the guidelines presented in Section 6.6.6 of this Manual. For a one-foot-wide, unreinforced concrete cut-off wall, if structural calculations support same, the maximum allowable height of a cut-off wall, from top to toe, can be six feet. If the depth of scour plus the drop height is greater than six feet, the drop shall be considered to be too great for unreinforced concrete cut-off walls, unless a structural analysis can demonstrate otherwise, and the spacing between

## VI. EROSION AND SEDIMENTATION

the cut-off walls must be reduced. The example which follows (i.e., Example 6.1), illustrates the recommended procedure for cut-off wall design.

There will be many design situations, especially when unit discharges are high, where a cut-off wall with a height of six feet, from top to toe, is not sufficient. In such cases, a reinforced concrete cut-off wall that has a height greater than six feet, from top to toe, may be used, provided that a structural analysis is submitted showing that the proposed cut-off wall will be structurally stable. If a structural analysis is submitted and approved, the maximum drop height of two feet will no longer apply.

Grade-control structures for large discharges need not necessarily be vertical on the downstream side. For structural stability, a triangular or wedge-shaped soil-cement grade-control structure is recommended for use on regional watercourses. However, for hydraulic reasons, the use of any grade-control structure with a face flatter than 1:1 on the downstream side shall not be permitted without prior written approval from the City Engineer.

### EXAMPLE 6.1: SPACING AND DEPTH OF GRADE-CONTROL STRUCTURES

A channel in a highly urbanized watershed is to be built to contain the 100-year-flood discharge. The sides of the channel are to be of shotcrete, the bottom of earth.

Channel characteristics are as follows:

Bottom Width	= 20 feet
Design Slope	= 0.006 feet/foot
Side Slopes	= 1:1
Manning's "n"	= 0.022

Hydraulic characteristics are as follows:

$Q_{100}$ = 700 cfs	$Q_{10}$ = 350 cfs
$Y_{100}$ = 3.1 feet	$Y_{10}$ = 2.1 feet
$V_{100}$ = 9.7 fps	$V_{10}$ = 7.7 fps
$q_{100}$ = 35.0 cfs/foot	$q_{10}$ = 17.5 cfs/foot

Because the watershed is highly urbanized, Equation 6.25 will be used to compute the equilibrium slope. Therefore:

$$S_{eq} = \left[ \frac{1.45 (0.022)}{(17.5)^{0.11}} \right]^2 = 0.0005 \text{ feet/foot.}$$

Assume a two-foot drop height. From Equation 6.27, the spacing between grade-control structures should be:

## VI. EROSION AND SEDIMENTATION

$$L_r = \frac{2.0}{(0.006)-(0.0005)} = 364 \text{ feet.}$$

The grade-control structure will be submerged. Using Equation 6.14 yields:

$$Z_{1ss} = 0.581(q_{100})^{0.667}(h/Y_{100})^{0.411}[1-(h/Y_{100})]^{-0.118};$$

$$q_{100} = 35.0 \text{ cfs;}$$

$$Z_{1ss} = 0.581(35.0)^{0.667}(0.645)^{0.411}(0.355)^{-0.118}; \text{ so,}$$

$$Z_{1ss} = 5.9 \text{ feet.}$$

Therefore, the total height of the grade-control structure, from top to toe, should be 5.9 feet *plus* the two-foot drop height; or, 7.9 feet (round to 8.0 feet).

However, it is desirable to keep the total vertical dimension of the grade-control structure, from top to toe, equal to or less than six feet. Therefore, a smaller drop height should be used.

Using a drop height of one foot yields:

$$L_r = \frac{1.0}{(0.006)-(0.0005)} = 182 \text{ feet.}$$

$$Z_{1ss} = 0.581(35.0)^{0.667}(0.323)^{0.411}(0.677)^{-0.118}; \text{ so,}$$

$$Z_{1ss} = 4.10 \text{ feet (round to 4.0 ft).}$$

Since, in this example, the ultimate drop height at the downstream side of a grade-control structure will be set at one foot, cut-off walls with a height of five feet, from top to toe, could be placed at approximately 180-foot intervals along the bottom of the channel to serve as grade-control structures in order to limit long-term bed degradation to a maximum of one foot anywhere along the subject channel.

## CHAPTER VII: EROSION-HAZARD/BUILDING-SETBACK CRITERIA

### 7.1 Introduction

Flood hazards in the Tucson area are not simply limited to inundation of properties by surface waters. Erosion of channel banks during flow events is often an additional flood hazard. In some instances, as was demonstrated during the October, 1983 flood, erosion may even be the primary flood hazard. Historically, along regional watercourses, channel banks have moved literally hundreds of feet during a single flood, and have destroyed buildings that would not otherwise have been damaged by mere flooding. For this reason, the City of Tucson floodplain regulations incorporate building-setback criteria relative to both natural watercourses and unstabilized, engineered channel banks. This chapter provides the criteria to be used for analyzing such channel erosion and meander hazards.

### 7.2 Purpose

The purpose of this chapter is to provide guidelines for the evaluation of the erodibility of either natural or engineered channel banks, and to establish setback criteria for natural watercourses and unlined, engineered channels.

The guidelines for the evaluation of the erodibility of channel banks are to be used in conjunction with the design of open channels. The setback criteria are to be used as a floodplain-management tool in determining building setbacks for construction near either natural watercourses or unlined, engineered channels.

### 7.3 Applicability

The equations and guidelines contained in this chapter of the Manual are applicable for general use with all watercourses located within the limits of the City of Tucson. The equations for determining soil erodibility are based upon the allowable-velocity approach, the tractive-stress approach, and the tractive-power approach. All of these approaches are acceptable methods for determining whether or not, from a maintenance standpoint, bank protection is necessary along either an engineered channel or a natural watercourse. The "setback" equations presented within this chapter of the Manual are general equations that may be used to calculate building setbacks along erodible watercourses, unless more detailed information is available which is acceptable to the City Engineer.

Predicting the location and magnitude of bank erosion and/or bank migration is an uncertain process. There are many variables involved with such phenomena which can not be encompassed by the simple equations presented herein. For this reason, this chapter also includes information on where the engineer may find more detailed procedures for predicting bank erosion and/or bank migration which involve sediment-transport analysis. However, caution is advised in attempting to perform a detailed sediment-transport analysis to estimate bank erosion and/or bank migration unless the user has had considerable experience in sediment-transport analysis. There are many sediment-transport models available. Some are more applicable for use in the Tucson area than others. Each model will produce highly variable results, depending upon input and interpretation. Therefore, it is recommended that these models be used with caution by persons with limited expertise in the field of sediment transport.



## VII. EROSION/SETBACK CRITERIA

### 7.4 Policies

1. All buildings constructed near a natural watercourse or an unprotected, engineered drainage channel located within the City of Tucson shall be set back from the channel a sufficient distance, as specified by the criteria presented within this chapter, in order to protect against erosion and migration of the channel banks. On each side of a natural watercourse or an unprotected, engineered drainage channel, the setback shall be measured from the top edge of the highest channel bank or the 100-year water-surface elevation, whichever is closer to the channel centerline. Exceptions may be made only if detailed soil-stability or sediment-transport studies are submitted to and approved by the City Engineer. Minimum setbacks from bank-protected channels should be based upon access and maintenance considerations.
2. A slope-stability analysis of a proposed channel may be required by the City Engineer if, by his determination, unusual conditions exist which indicate that a proposed channel bank may not be stable.
3. Unlined, engineered drainage channels accepted for maintenance by the City, or private channels draining into public watercourses, may not have 10-year flow velocities that exceed those allowable velocities computed by use of procedures contained within this chapter of the Manual.
4. Building setbacks from either natural watercourses or unlined, engineered drainage channels may be applicable, under certain circumstances, even though it is demonstrated that the channel is stable under policy #3, stated above.
5. Generally, vegetation is not an acceptable means of bank stabilization for the purpose of reducing building setbacks. However, vegetation may be used along watercourses where flow velocities are less than five feet per second during a 10-year discharge, provided that there is an acceptable program of seeding and maintenance. This policy is not to be interpreted as either a requirement or a justification for removal of existing vegetation along natural watercourses. Refer to the Appendix to this Manual for more information on vegetal channel linings.
6. There shall be no minimum building setback from streets and/or parking and access lanes (P.A.A.L.'s), except as otherwise provided by the City of Tucson Zoning Code.

### 7.5 Erosion Resistance of Unlined Channels

#### 7.5.1 *Allowable-Velocity Approach*

The allowable-velocity approach presented in this chapter for evaluating the erosion resistance of earthen channels was developed by the United States Department of Agriculture, Soil Conservation Service (1977). Figure 7.1 gives the basic maximum

VII. EROSION/SETBACK CRITERIA

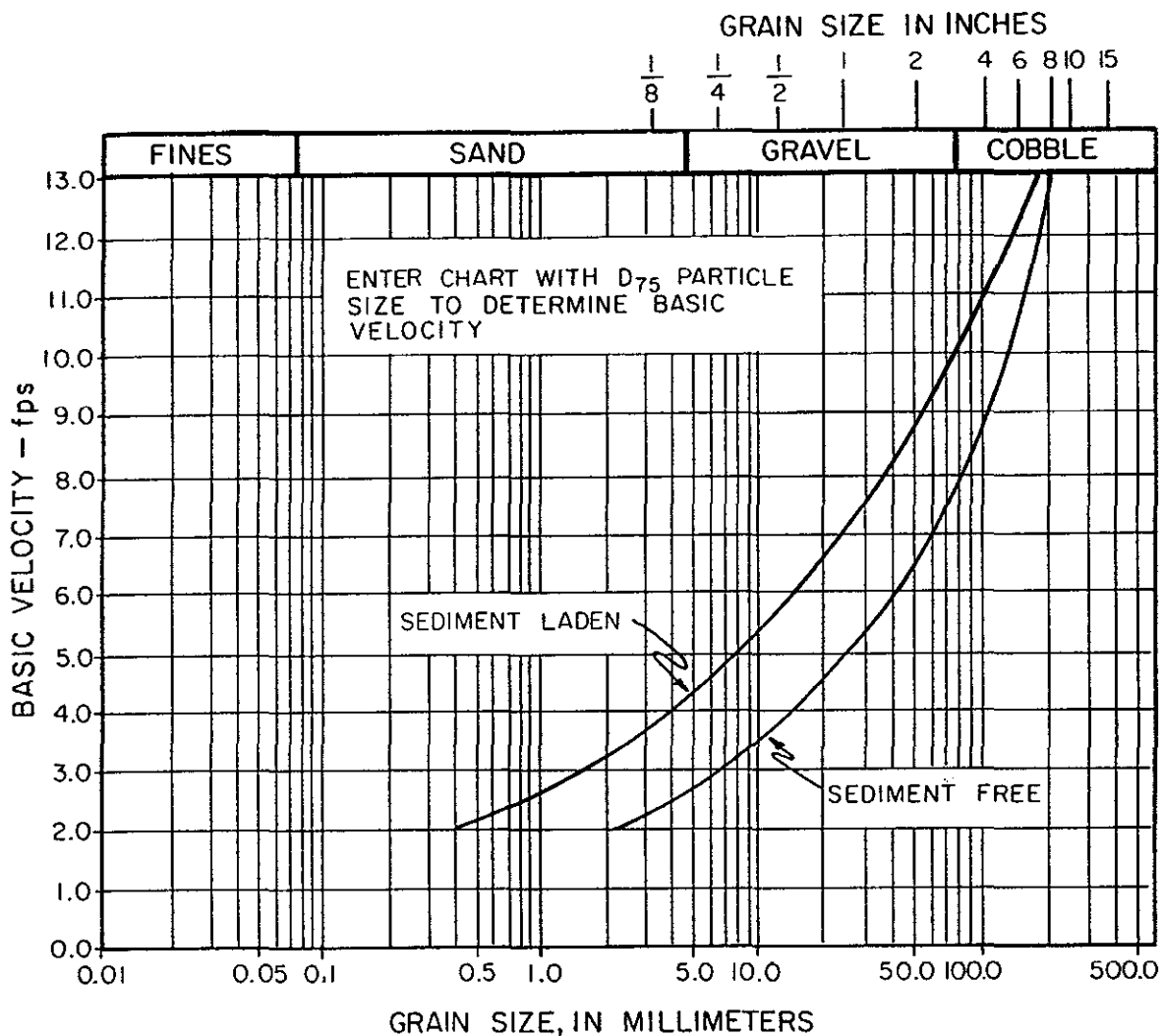

FIGURE 7.1  
BASIC ALLOWABLE VELOCITY FOR EARTHEN CHANNELS

## VII. EROSION/SETBACK CRITERIA

allowable velocity for unprotected earthen channels. The 10-year discharge is used in this analysis. In order to use Figure 7.1, flow must be classified as either sediment free or sediment laden. Sediment-free flow is defined as flow in which fine material in suspension is at concentrations so low that it has negligible effect upon channel stability. Sediment-free flows generally have sediment concentrations of less than 1,000 parts per million (ppm), by weight. Sediment-laden flows are classified as flows carrying sediments in concentrations equal to or exceeding 20,000 ppm, by weight.

Most watercourses within the City of Tucson can be characterized as "sediment-laden" when flow occurs. Note that the sediment-free curve in Figure 7.1 should be used only under unusual circumstances, such as for runoff which emanates from a totally impervious watershed.

The allowable-velocity approach requires that the  $D_{75}$  particle size (i.e., the size for which 75% of the sediment, by weight, is finer) be known for the soil forming the channel banks. This information can be obtained from a sieve analysis. In the absence of sieve-analysis information, it can be assumed that  $D_{75}$  is equal to approximately four millimeters (4 mm) for watercourses located within the City of Tucson.

The basic allowable maximum velocity obtained from Figure 7.1 must normally be modified to account for variations in channel design. This is done by the use of correction factors for channel alignment, bank slope, and depth of flow. The equation for allowable velocity,  $V_a$ , in an unprotected earthen channel then becomes:

$$V_a = V_b \times C_a \times C_b \times C_d \quad (7.1)$$

Where:

- $V_a$  = Maximum allowable 10-year flow velocity, in feet per second;
- $V_b$  = Basic maximum allowable flow velocity obtained from Figure 7.1, in feet per second; and,
- $C_a, C_b, C_d$  = Correction factors for channel alignment, bank slope, and flow depth, respectively (see Figure 7.2 through Figure 7.4).

NOTE: In Figure 7.3,  $Z$  is the bank side-slope (horizontal:vertical,  $H:V$ ).

### 7.5.2 *Tractive-Stress Approach*

Flowing water exerts a tangential-boundary pull on the wetted perimeter of the channel boundary. The total force exerted on the boundary by the flow of water is called the tractive force. The tractive stress is the tractive force per unit area of the boundary. Tractive force and tractive stress are equal to the friction forces resisting the flow of water. Tractive stress can therefore be used as a method of determining the erodibility of an earthen channel. To accomplish this, the tractive stress is compared to an allowable tractive stress for the bed material.

## VII. EROSION/SETBACK CRITERIA

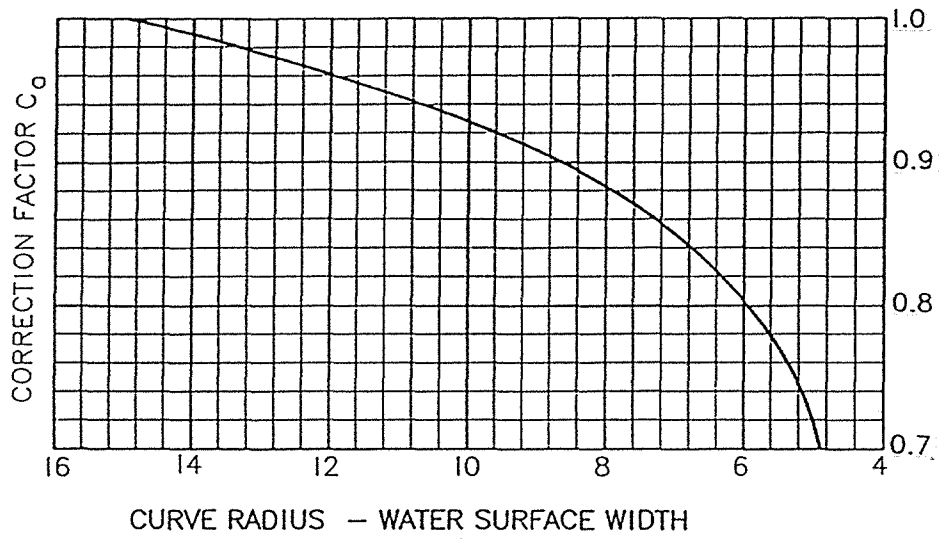

FIGURE 7.2  
CORRECTION FACTOR  $C_d$  FOR CHANNEL ALIGNMENT

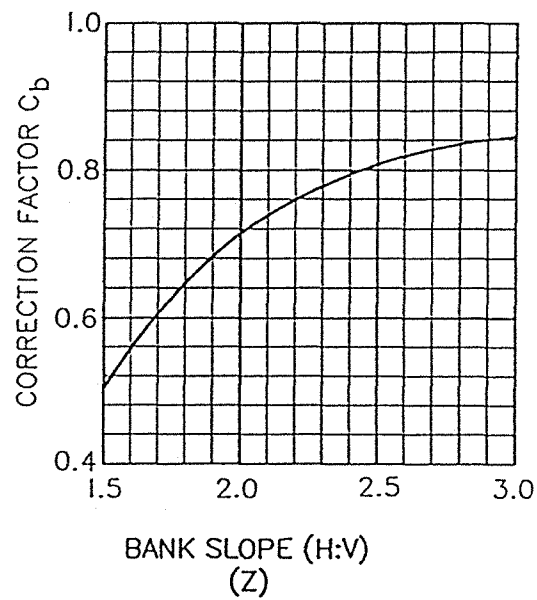

FIGURE 7.3  
CORRECTION FACTOR  $C_b$  FOR BANK SLOPE

VII. EROSION/SETBACK CRITERIA

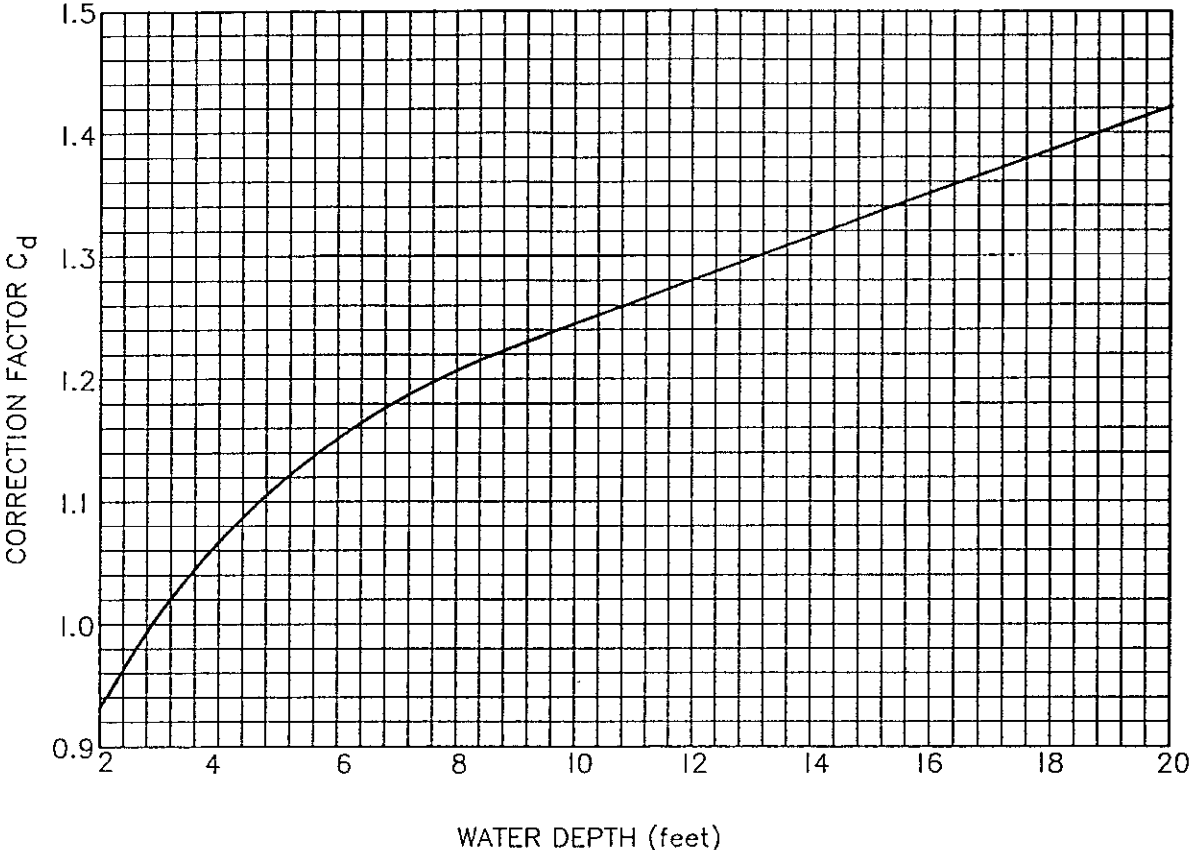

FIGURE 7.4  
CORRECTION FACTOR  $C_d$  FOR DEPTH OF FLOW

## VII. EROSION/SETBACK CRITERIA

Case 1: 0.25 in (6.35 mm) <  $D_{75}$  < 5.0 in (127 mm)

The tractive stress acting on the soil grains in an infinitely wide channel can be computed from:

$$\tau_{\infty} = \gamma_w Y \left[ \frac{D_{75}^{1/6}}{39n} \right]^2 S_e \quad (7.2)$$

Where:

- $\tau_{\infty}$  = Tractive stress for an infinitely wide channel, in lbs/ft<sup>2</sup>;
- $\gamma_w$  = Unit weight of water = 62.4 lbs/ft<sup>3</sup>;
- $D_{75}$  = Diameter of soil particle for which 75 percent of the total soil consists of smaller particles, in inches;
- $n$  = Manning's roughness coefficient for the channel;
- $S_e$  = Energy slope of flowing water, in feet per foot (use bed slope if no backwater analysis is available); and,
- $Y$  = Depth of flow, in feet.

Implicit in Equation 7.2 is the assumption that the Manning's roughness coefficient is the sum of the resisting forces in the channel. The roughness coefficient should therefore be estimated by a procedure similar to those given within Chapter 8 of this Manual.

Once the tractive force for an infinitely wide channel is determined, it must be modified for a narrower trapezoidal channel. Figures 7.5, 7.6, and 7.7 give correction factors for tractive stresses in trapezoidal and curved channels. The correction factors taken from these figures are multiplied by the tractive stress computed by Equation 7.2 to obtain the actual tractive stress.

The definitions of the symbols shown in Figures 7.5, 7.6, and 7.7 are as follows:

- $\tau_s$  = Actual maximum tractive stress on sides of straight trapezoidal channels, in pounds per square foot;
- $\tau_{sc}$  = Actual maximum tractive stress on sides of trapezoidal channels within a curved reach, in pounds per square foot;
- $\tau_{st}$  = Actual maximum tractive stress on sides of trapezoidal channels in straight reaches immediately downstream from curved reaches, in pounds per square foot;
- $Z$  = Channel side-slope (horizontal/vertical), in feet per foot;
- $b$  = Channel bottom width, in feet;
- $y$  = Flow depth, in feet;
- $r_c$  = Radius of curvature of channel centerline, in feet; and,
- $L_c$  = Length of curve, in feet.

## VII. EROSION/SETBACK CRITERIA

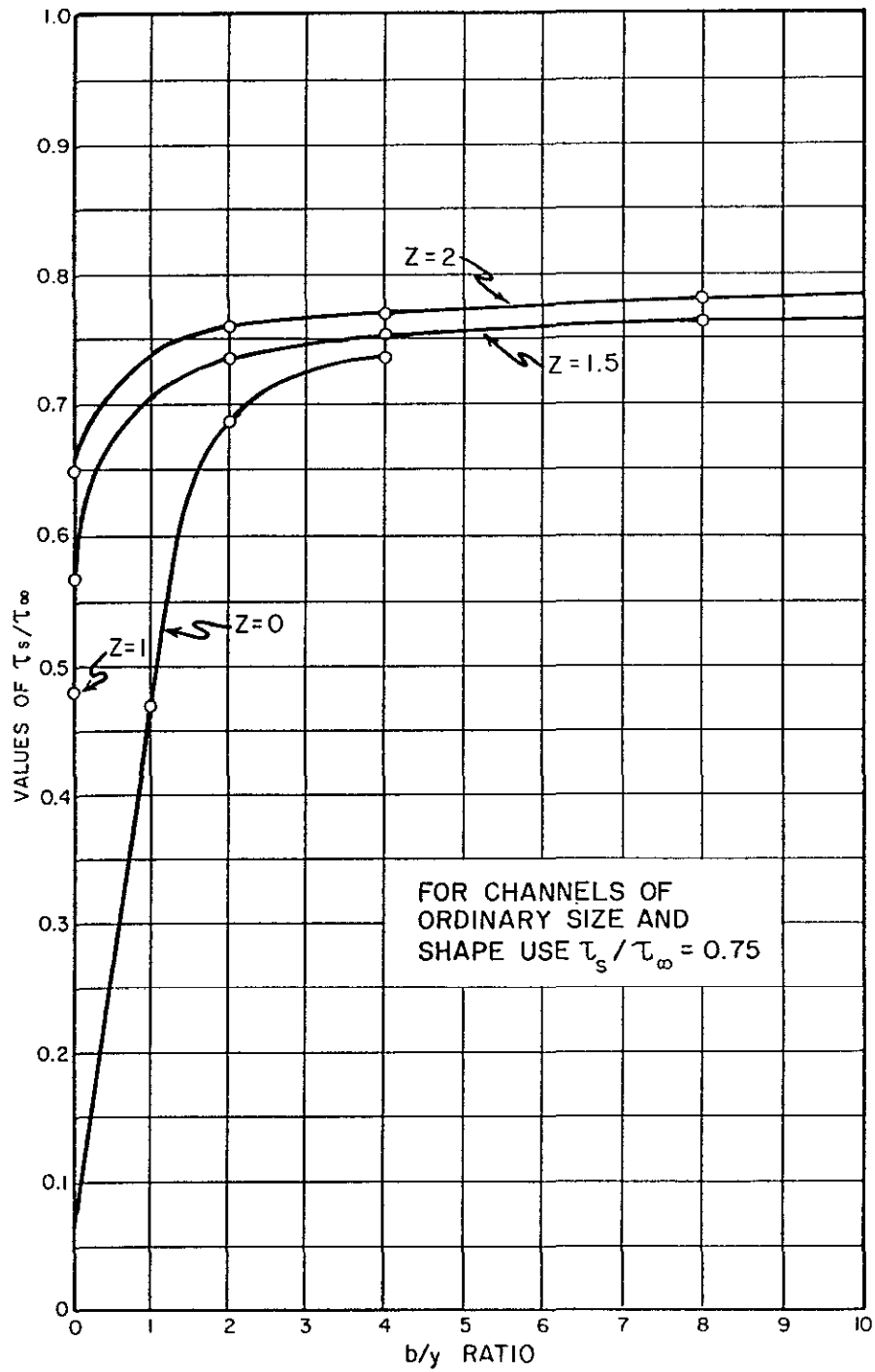

FIGURE 7.5  
ACTUAL MAXIMUM TRACTIVE STRESS,  $\tau_s$ , ON  
SIDES OF STRAIGHT TRAPEZOIDAL CHANNELS

VII. EROSION/SETBACK CRITERIA

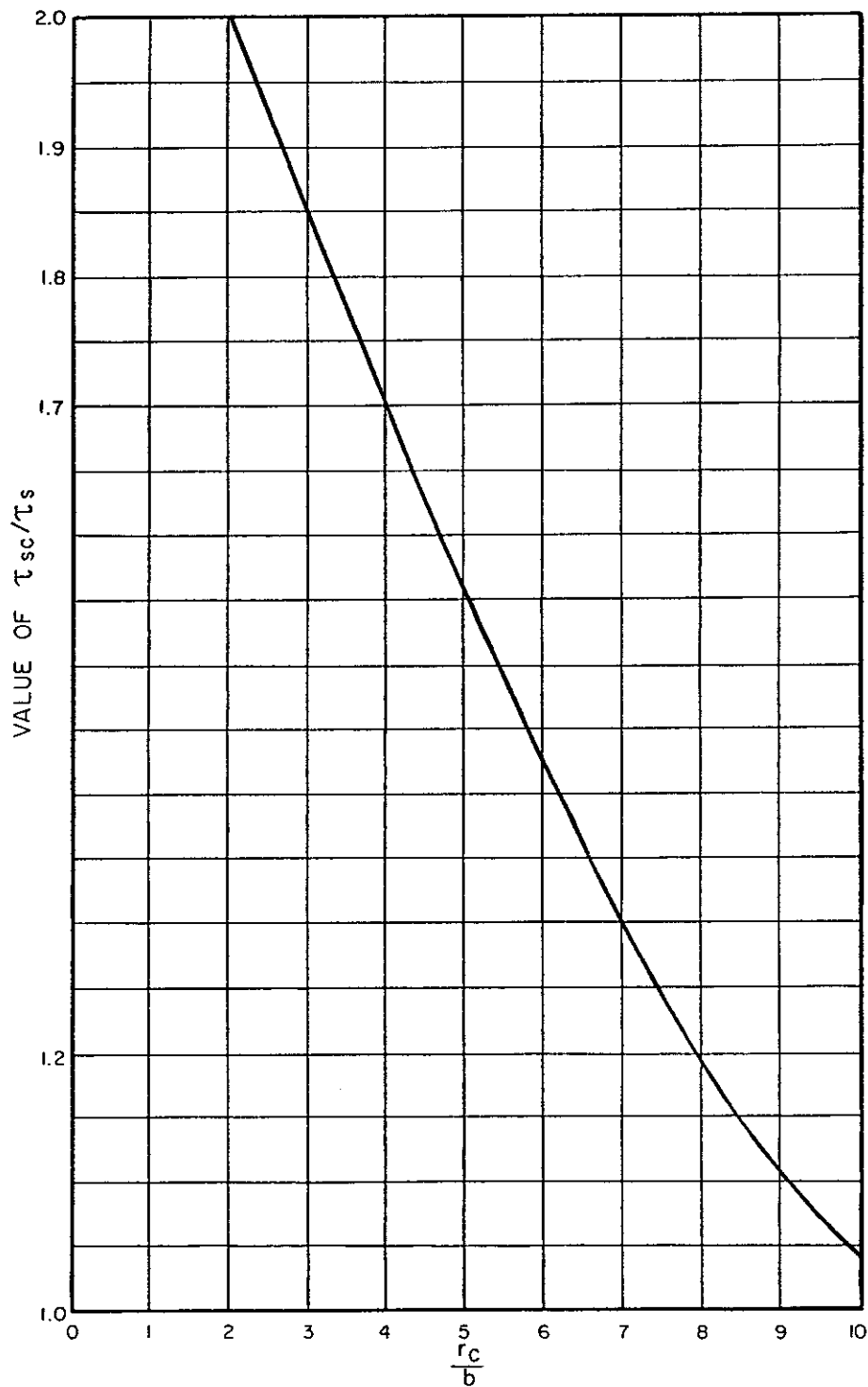

FIGURE 7.6  
ACTUAL MAXIMUM TRACTIVE STRESS,  $\tau_{sc}$ , ON SIDES OF  
TRAPEZOIDAL CHANNELS WITHIN A CURVED REACH



## VII. EROSION/SETBACK CRITERIA

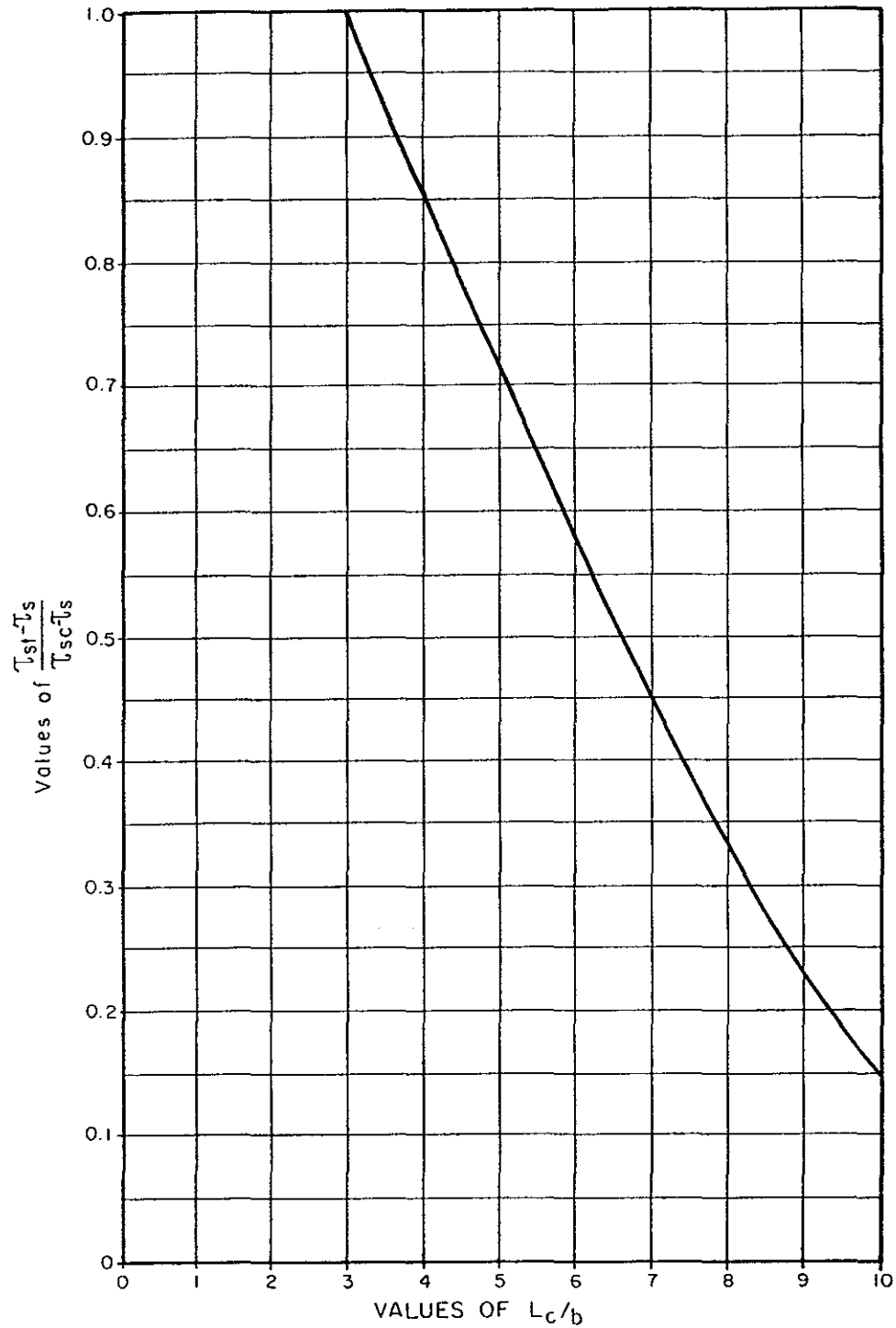

FIGURE 7.7  
ACTUAL MAXIMUM TRACTIVE STRESS,  $\tau_{st}$ , ON SIDES OF  
TRAPEZOIDAL CHANNELS IN STRAIGHT REACHES IMMEDIATELY  
DOWNSTREAM FROM CURVED REACHES

## VII. EROSION/SETBACK CRITERIA

The actual tractive stress is compared to an allowable tractive stress to determine the propensity of the soil to erode under the expected hydraulic conditions. The allowable tractive stress is calculated by:

$$\tau_{1s} = 0.4 \left[ \frac{Z^2 - Cot^2 \phi R}{1 + Z^2} \right]^{1/2} D_{75} \quad (7.3)$$

Where:

- $\tau_{1s}$  = Allowable tractive stress, in lb/ft<sup>2</sup>; and,  
 $\phi R$  = Angle of repose of soil, in degrees (see Figure 7.8).

All other terms are as previously defined.

Case 2:  $D_{75} \leq 0.25$  inch (6.35 mm)

This approach uses a reference tractive stress that is modified for channel side slope and curvature. The reference tractive stress can be determined from Figures 7.9 and 7.10 by the following procedure:

1. Determine the velocity ( $V$ ), kinematic viscosity ( $\nu$ ), and the energy slope ( $S_e$ ) for the channel. Assume that the value for kinematic viscosity is equal to  $1.21 \times 10^{-5}$  ft<sup>2</sup>/sec (corresponding to a water temperature of 60°), when information to the contrary is lacking.
2. Enter Figure 7.9 or 7.10, from the top, with a value computed from the expression:

$$\frac{V^3}{g\nu S_e} \quad (7.4)$$

And find the point of intersection of this value and the value:

$$\frac{V}{(gk_s S_e)^{1/2}} \quad (7.5)$$

Where:

- $k_s$  = Equivalent roughness height =  $D_{65}$ , in feet (i.e., the size for which 65% of the sediment, by weight, is finer).

VII. EROSION/SETBACK CRITERIA

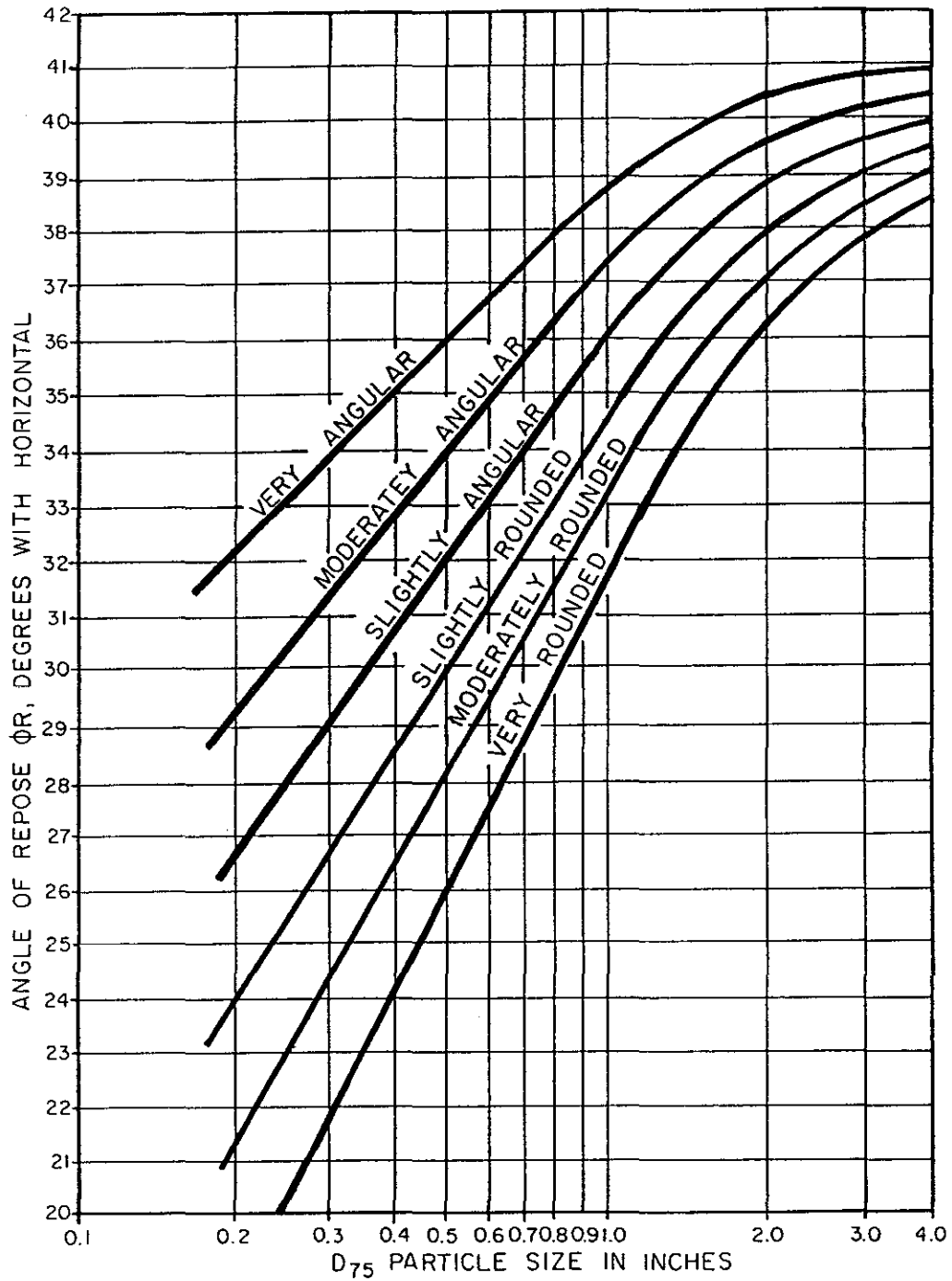

FIGURE 7.8  
 ANGLE OF REPOSE,  $\phi_R$ , FOR NON-COHESIVE MATERIALS

VII. EROSION/SETBACK CRITERIA

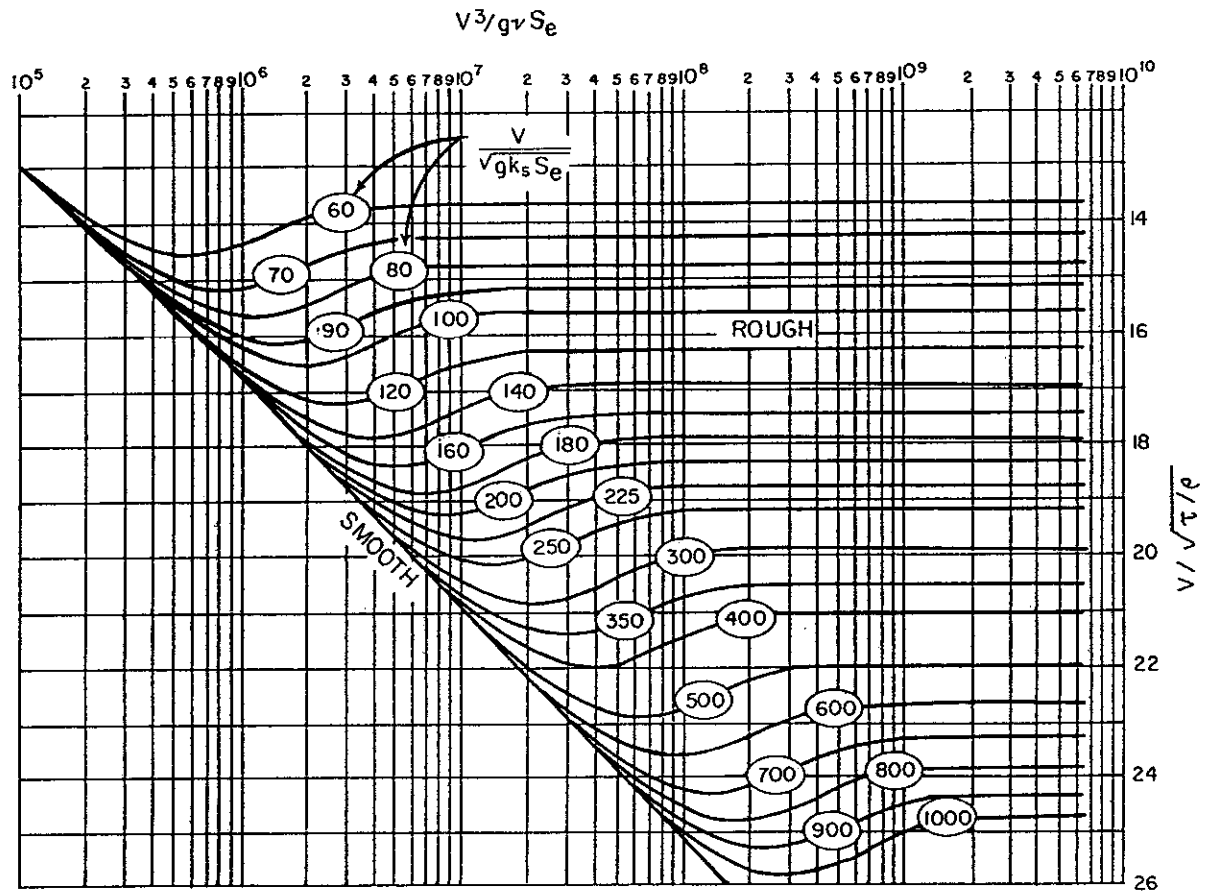

FIGURE 7.9  
GRAPHIC SOLUTION OF REFERENCE TRACTIVE STRESS

VII. EROSION/SETBACK CRITERIA

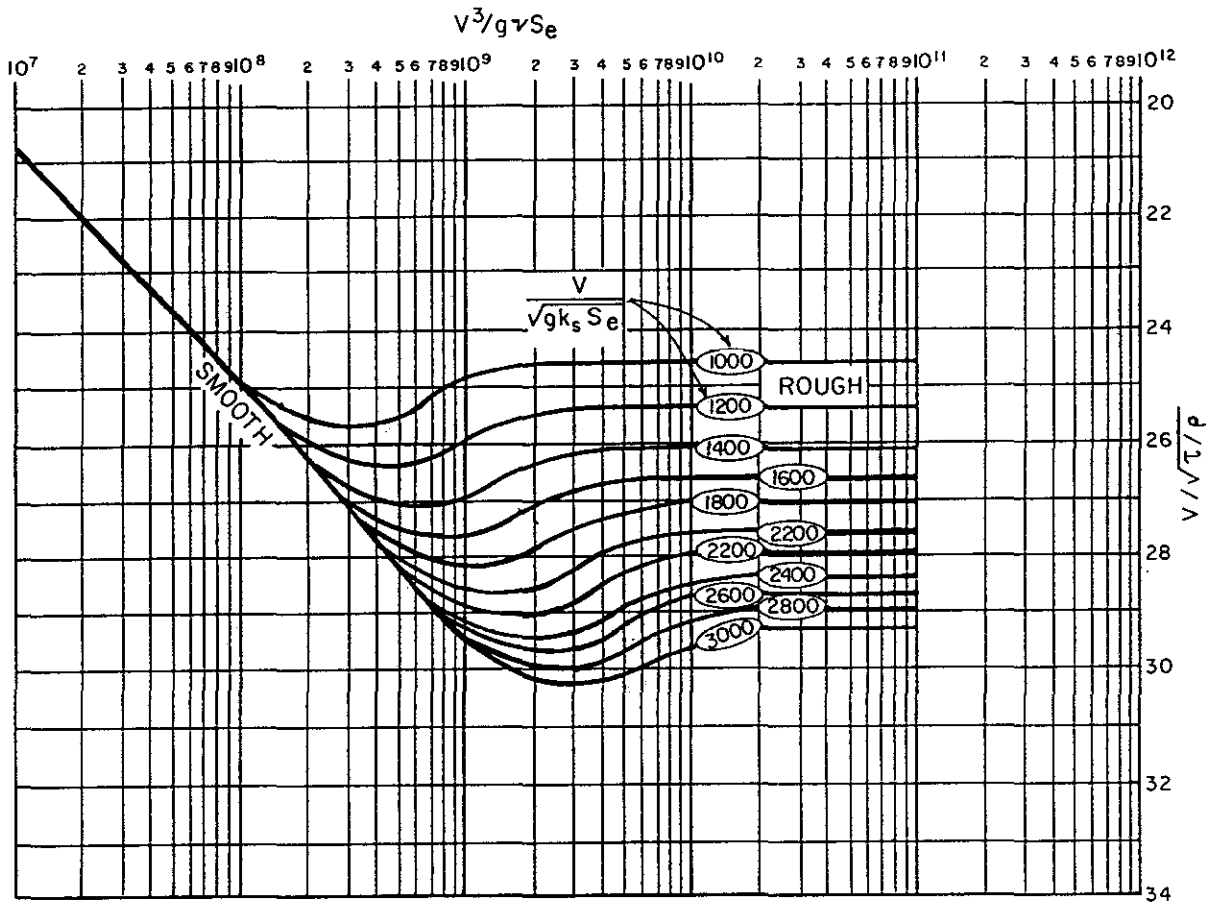

FIGURE 7.10  
 GRAPHIC SOLUTION OF REFERENCE TRACTIVE STRESS  
 (CONTINUED)

## VII. EROSION/SETBACK CRITERIA

3. Move horizontally along the figure to read the numerical value for:

$$\frac{V}{(\tau/\rho)^{1/2}} \quad (7.6)$$

Where:

- $\tau$  = Reference tractive stress, in pounds per square foot;
- $V$  = Flow velocity, in feet per second; and,
- $\rho$  = Density of water = 1.94 slugs per cubic foot.

The value of  $\tau$  can then be found by simply equating this numerical value to Equation 7.6.

The maximum tractive stress on the sides of the channel,  $\tau_s$ , can be computed from the reference tractive stress and a correction factor obtained from Figure 7.11. Figures 7.6 and 7.7 may be used to further modify the reference tractive stress for curved channel reaches. If the maximum tractive stress is greater than the allowable tractive stress (Figure 7.12), bank protection will be required. The ten-year discharge is to be used in this analysis.

Curve number 1 in Figure 7.12 is to be used when the flow is expected to have a high sediment content. A high sediment content is considered to be 20,000 ppm, by weight, or more of sediment. When larger flows occur, most Tucson watercourses will carry this amount of sediment, or close to it.

Curve number 2 is to be used for watercourses with low sediment contents of no more than 2,000 ppm, by weight, during larger flows. This curve should only be used in association with areas of high impervious cover (i.e., >50%) and/or downstream of urban-area detention basins. Interpolate between curves 1 and 2 for water courses with known sediment content between 2,000 ppm and 20,000 ppm.

Curve number 3 is to be used for watercourses conveying clear water (i.e., less than 1,000 ppm), and should not be used unless unusual circumstances exist (e.g., runoff which emanates from a totally impervious watershed).

If  $D_{50}$  is greater than 5 mm, use the value for 5 mm obtained from Figure 7.12. If  $D_{50}$  is less than 0.1 mm, use the value for 0.1 mm obtained from Figure 7.12. For this latter case, 0.1 mm should also be used as  $D_{65}$  when obtaining the reference tractive stress.

### 7.5.3 Tractive-Power Approach

Tractive power is defined as the product of the mean velocity of flow and the tractive stress. The tractive-power approach is a method that takes into consideration the effects of cementation, partial lithification, and other long-term processes that can affect the ability of the channel to withstand erosion. Neither of the previous methods account for the effects of these long-term processes. With the tractive-power

VII. EROSION/SETBACK CRITERIA

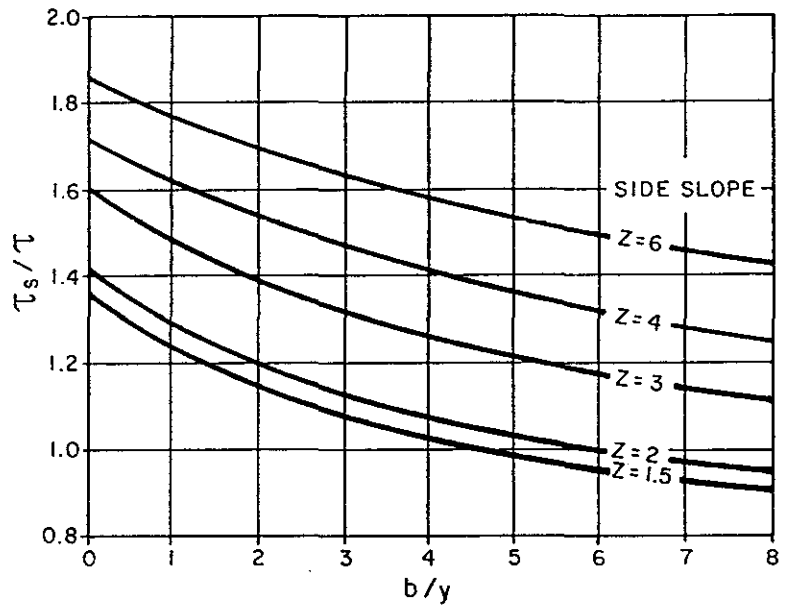

FIGURE 7.11  
APPLIED MAXIMUM TRACTIVE STRESSES,  $\tau_s$ , ON  
SIDES OF STRAIGHT TRAPEZOIDAL CHANNELS

VII. EROSION/SETBACK CRITERIA

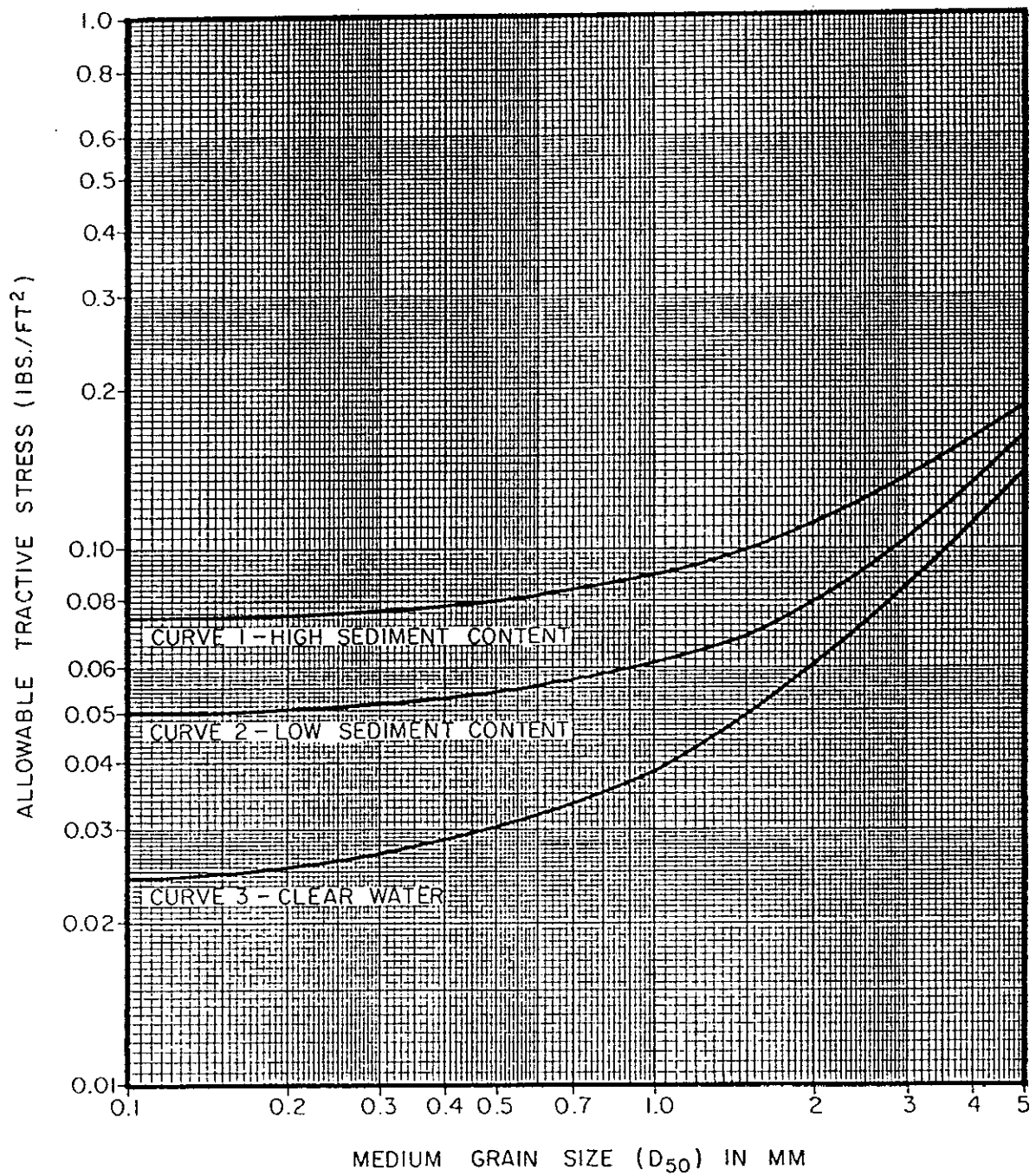

FIGURE 7.12

MAXIMUM ALLOWABLE TRACTIVE STRESS FOR NON-COHESIVE SOILS,  $D_{75} < 0.25''$



## VII. EROSION/SETBACK CRITERIA

approach, the stability of *saturated* soils comprising the channel banks is first assessed by the use of an unconfined compression test. The unconfined compressive strength (UCS) of these *saturated* embankment soils is then *reduced by at least a factor of two*, for design purposes, and compared to the tractive power of the flow by use of Figure 7.13. Those soils falling above the S-line in Figure 7.13 are considered to be erosive. Those falling below the S-line are considered to be non-erosive. When site-specific information regarding the UCS value of an in-situ embankment soil is lacking, it should be assumed that its *design* UCS value, for use in conjunction with Figure 7.13, equals 600 lbs/ft<sup>2</sup>.

### 7.5.4 *Effect of Vegetation upon Channel Stability*

Vegetation along the banks of a channel has the effect of slowing flow velocities along the bank and providing a covering over the base soil. Both of these effects tend to retard erosion. Mature vegetation along a channel bank can be an indicator of channel stability. However, caution is advised against depending purely upon vegetation as the sole means of bank stabilization along a channel.

Tucson's arid climate makes it very difficult to establish vegetation on a recently constructed bank. In most cases, new vegetation will be in the form of small, annual plants, which ordinarily provide little protection against erosion. Water and maintenance requirements for large amounts of vegetation are also very high.

Existing, mature vegetation along a natural channel bank may only indicate that there have been no large floods on that channel since the vegetation first began to grow. As was demonstrated in the October, 1983 flood, mature vegetation often has little effect upon the erosive potential of very large floods.

The U.S. Soil Conservation Service (1977), recommends that vegetation not be used as bank protection where flow velocities will exceed five feet per second, unless good cover and proper maintenance are assured. Even with good cover and proper maintenance, they recommend that maximum velocities should never exceed eight feet per second. For these reasons, vegetation alone is not normally acceptable as bank protection on any channel accepted for maintenance by the City of Tucson unless (1) its 100-year discharge is 500 cfs, or less, *and* its 10-year flow velocity is no greater than five feet per second; and (2), an acceptable program of seeding and maintenance is implemented.

## 7.6 Setbacks

### 7.6.1 *Equations to Compute Setbacks*

To compute a setback to guard against lateral migration of a channel which has either engineered or natural, unstabilized banks, the following formulas can be used:

For regional watercourses (e.g., the Santa Cruz River, Rillito River, Tanque Verde Creek, Pantano Wash, and the Cañada del Oro Wash) use:

VII. EROSION/SETBACK CRITERIA

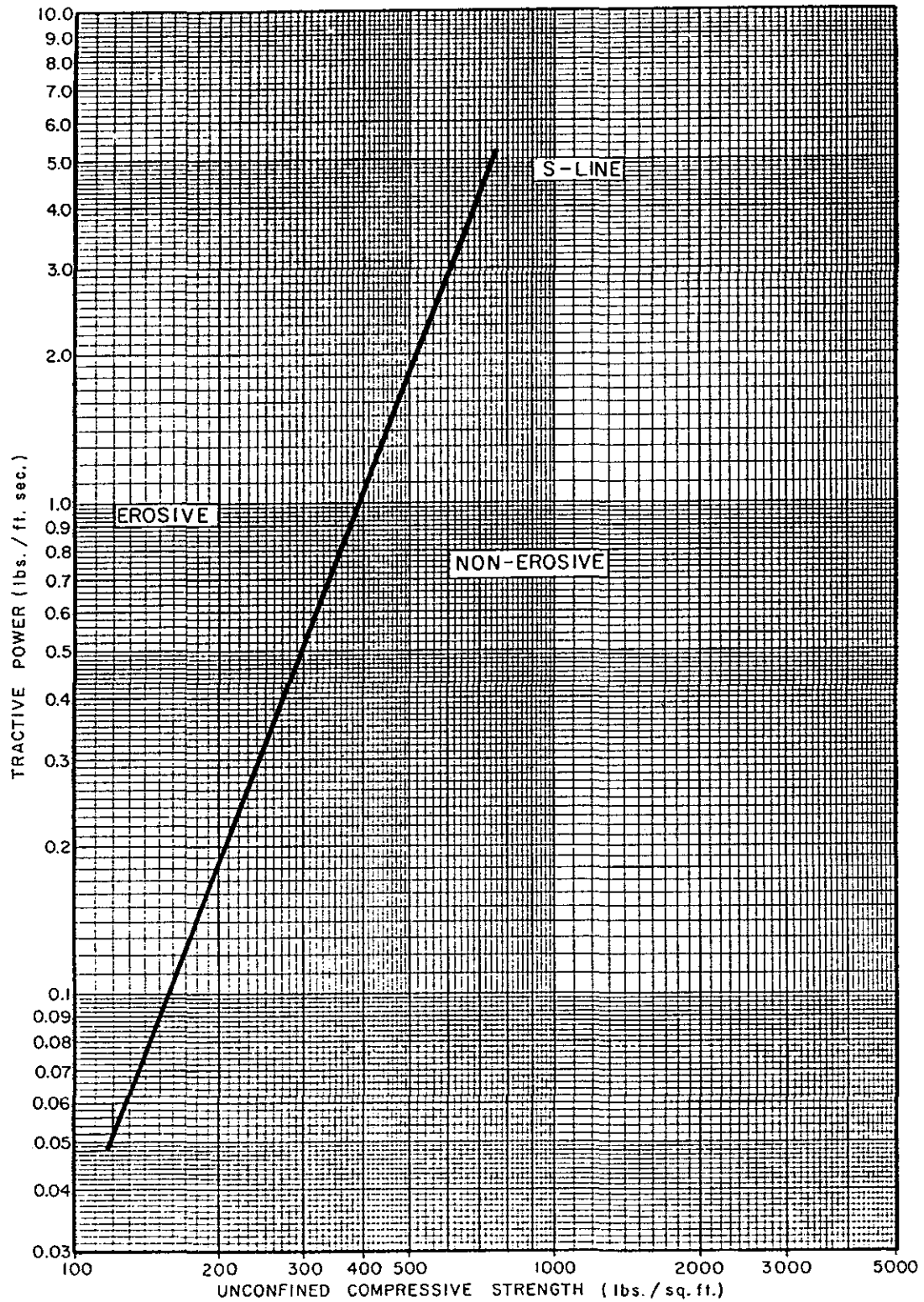

FIGURE 7.13  
UNCONFINED COMPRESSIVE STRENGTH AND TRACTIVE  
POWER AS RELATED TO CHANNEL STABILITY

## VII. EROSION/SETBACK CRITERIA

$$SB \geq 2 (Q_{p100})^{0.5}, \text{ for } r_c/T_w \geq 10 ; \quad (7.7a)$$

$$\text{or, } SB \geq 3.4 (Q_{p100})^{0.5}, \text{ for } 5 < r_c/T_w < 10 ; \quad (7.7b)$$

$$\text{or, } SB \geq 5 (Q_{p100})^{0.5}, \text{ for } r_c/T_w \leq 5 . \quad (7.7c)$$

Where:

- $SB$  = Minimum setback, in feet, measured from the top edge of the highest channel bank or from the edge of the the 100-year water-surface elevation, whichever is closer to the channel centerline;
- $Q_{p100}$  = Peak discharge of 100-year flood, in cubic feet per second;
- $r_c$  = Radius of curvature of channel centerline, in feet; and,
- $T_w$  = Top width of channel, in feet.

The determination of the ratio of the centerline radius of curvature of a channel to channel top width (i.e.,  $r_c/T_w$ ) can be determined by use of the procedure described in Chapter VIII of this Manual.

For all other watercourses (i.e., watercourses which have drainage areas less than 30 square miles in size, or times of concentration less than three hours during a 100-year flood) use:

$$SB \geq 1.0 (Q_{p100})^{0.5}, \text{ for } r_c/T_w \geq 10 ; \quad (7.8a)$$

$$\text{or, } SB \geq 1.7 (Q_{p100})^{0.5}, \text{ for } 5 < r_c/T_w < 10 ; \quad (7.8b)$$

$$\text{or, } SB \geq 2.5 (Q_{p100})^{0.5}, \text{ for } r_c/T_w \leq 5 . \quad (7.8c)$$

Where all terms are as previously defined.

Lesser setbacks than those determined from Equations 7.7 and 7.8 *may* be allowed, but only if they can be justified by use of one of the following methods, listed in order of preference, which would indicate that a lesser setback is appropriate:

1. A detailed sediment-transport analysis, prepared by an Arizona Registered Professional Civil Engineer; or,
2. The Allowable-Velocity Approach, Tractive-Stress Approach, or Tractive-Power Approach, any or all of which must indicate that the channel banks are *not* erosive for the flow conditions associated with runoff events up to and including a 100-year flood on the affected watercourse.

## VII. EROSION/SETBACK CRITERIA

However, under no circumstances shall the setback be less than 50 feet from an unprotected bank of any regional watercourse, or less than 10 feet from an unprotected bank of any other watercourse. Access requirements may make the effective setback greater than the values just noted.

### 7.6.2 Sediment Supply Rates/Transport Capacity

Sediment-transport rates, in particular the sediment-transport capacity of a reach in relation to its sediment supply, can have a significant effect upon the tendency of the channel banks to erode. In general, watercourses in which the sediment-transport capacity exceeds the sediment supply will degrade and/or meander in an effort to reduce the sediment-transport capacity. Watercourses in which the sediment supply exceeds the transport capacity will aggrade and/or widen in an effort to increase sediment-transport capacity. In both cases, there is the potential for bank movement over the long term.

Because an imbalance in sediment-transport capacity will increase the potential for bank erosion, the engineer is advised to investigate each stream or channel under study for any indication of tendencies toward aggradation or degradation. Any evidence of a sediment imbalance within a stream or channel under investigation is also an indication that bank erosion could occur.

In the long run, watercourses will have a tendency to achieve a balance (equilibrium) between the product of water flow and channel slope and the product of sediment discharge and sediment size. The most widely known geomorphic relation embodying this equilibrium concept is known as the Lane Relationship (Lane, 1955). This basic relationship is:

$$QS \propto Q_s D_{50} \quad (7.9)$$

Where:

- $Q$  = Discharge, in cubic feet per second;
- $S$  = Channel slope, in feet per foot;
- $Q_s$  = Sediment discharge, in cubic feet per second; and,
- $D_{50}$  = Median diameter of bed material, in feet.

This relationship can be used to indicate the direction of channel response to a change in one of the four variables. For instance, an increase in water discharge, with sediment transport and sediment size being held equal, will result in a decrease in channel slope. A decrease in channel slope will create a tendency for the channel to meander. Simons, Li & Associates (1982, 1985) and the Federal Highway Administration (1975), give more detailed descriptions of these types of geomorphic relationships.

Utilizing the preceding relationship (i.e., Equation 7.9) will provide an indication as to whether or not a stream bank is likely to be unstable over time. Unfortunately, the magnitude of this instability is more difficult to predict. Two methods of predicting the magnitude of any bank instability are (1) to observe historic aerial

## VII. EROSION/SETBACK CRITERIA

photographs for past trends, or (2) to look at meanders or channel widening along similar reaches in other segments of the watercourse.

### 7.6.3 *Bank Sloughing/Slope Stability*

One type of channel bank failure is sloughing or collapse of the soil along the banks due to lack of support at the toe or along the exposed vertical face. Failure of this type is frequently unrelated to the immediate flow of water within the channel. The type of soil and the depth and angle of the cut are more important. Gravity is the major force causing this type of failure. The major resisting force is the shear resistance of the soil.

The analysis of soil embankments for possible failure of this type is basically an analysis of the factor of safety against slope failure. The factor of safety is computed as the ratio of the sum of the forces resisting movement to the sum of the forces causing movement. There are several different methods of performing this analysis. Generally, it is a trial and error procedure using assumed failure surfaces within the soil. Sowers (1979) and the U.S. Soil Conservation Service (1977), provide detailed information on slope-stability analysis.

The presence of water in the soil can increase the possibility of failure by increasing the weight of the soil and altering the resistance of soil to sliding pressure. The seepage of water through a soil will set up drag forces which further decrease the stability of the bank. Rapid drawdown of water on a saturated channel bank can also cause bank failure, because of the effects of water in the soil.

Piping is a special case of bank failure caused by the flow of water through the soil from the surface of the ground outside the channel to a point along the face of the channel where the soil is exposed to the air. This flow causes internal erosion, which often results in tunnels, holes which are sometimes very large at the inlet and outlet, and soil collapse. Piping is common in both natural and constructed channels located within the bottomlands along regional watercourses such as the Santa Cruz River, Rillito River, Tanque Verde Creek, Pantano Wash, and the Cañada del Oro Wash.

A slope-stability analysis is not required for every channel which is to be built within the City of Tucson. The design engineer is required to use judgement in determining whether or not a slope-stability analysis is needed and, if so, to perform one. An assessment of the need for a slope-stability analysis should consider both the long-term effects and the conditions present immediately after construction. Long-term conditions that can increase the possibility of slope failures are:

1. Degradation of the channel bottom;
2. Undercutting of a bank because of channel obstructions, improper curvature, or other factors that direct currents toward the bank;
3. Loss of toe support from internal erosion (piping); and,
4. Rodent burrowing.

## VII. EROSION/SETBACK CRITERIA

Should unusual conditions exist, the City Engineer may require that a slope-stability analysis be performed by an Arizona Registered Professional Civil Engineer.

### 7.6.4 *Detailed Sediment-Transport Analysis*

One method of making an estimate of the possible magnitude of bank erosion is through a detailed sediment-transport analysis. This method has the advantage that the bank scour is predicted based upon an estimate of the sediment supply in comparison to the sediment-transport rate within the reach in question. Should a sediment deficit occur, meaning that the transport rate is greater than the supply, the deficit is assumed to be made up by the removal of material from the channel bank. It can be assumed that this material is either removed uniformly along the reach in question, or removed from single or multiple embayment areas along one or both banks.

There are various computer models available for doing a detailed sediment-transport analysis. Several are applicable to this area, and are currently in use within the City of Tucson. However, it is important to realize that all of the available models are highly dependent upon input and interpretation. The use of these models should therefore be used with caution by persons with little expertise in sediment-transport analysis.

### 7.6.5 *Drainage Swales, Roads, and P.A.A.L.'s*

Building setbacks from small drainage swales constructed for site drainage shall be computed using the appropriate version of Equation 7.8. If the 100-year discharge in the swale is less than 100 cfs, and the swale is privately maintained, the setback may be reduced to ten feet, if it can be shown to the satisfaction of the City Engineer that the swale shall not be prone to erosion; or, in the event that some minor erosion should occur, that any such minor erosion would not damage the building.

Drainage that is carried in roads and private parking and access lanes (P.A.A.L.'s) is generally minor in nature, and hydraulically wide in relation to depth. Flow depths at the curb are generally only a few inches, with associated flow velocities normally low in magnitude. Erosion, should it occur to the asphalt pavement on the roadway, is likely to progress vertically downward, as the water seeks a more hydraulically efficient cross section. Therefore, there is no required building setback from roadways and P.A.A.L.'s that are also to be used for drainage purposes, as long as curbs and pavement are installed to contain the flow.

## VII. EROSION/SETBACK CRITERIA

### EXAMPLE 7.1: TRACTIVE-STRESS APPROACH

Design Channel Hydraulic Parameters, Earthen Channel:

$Q_{10}$	=	530 cfs
Bottom Width	=	15 feet
Roughness ( $n$ )	=	0.030
Side Slopes ( $Z$ )	=	2 feet:1 foot
Flow Depth	=	3 feet
Flow Velocity	=	8.4 feet/second
Channel Slope ( $S$ )	=	0.01 feet/foot
$D_{75}$	=	4 mm = $1.3 \times 10^{-2}$ feet
$D_{65}$	=	1.2 mm = $3.9 \times 10^{-3}$ feet
$D_{50}$	=	0.6 mm = $2.0 \times 10^{-3}$ feet

Since  $D_{75}$  is less than 6.35 mm, the "Reference Tractive Stress" method will be used.

1. Assume a water temperature of 60°F. Then the kinematic viscosity ( $\nu$ ) =  $1.21 \times 10^{-5}$  ft<sup>2</sup>/sec.

2. Compute  $V^3/g\nu S_e = 1.52 \times 10^8$

$$\text{Compute } V/[(gD_{65}S_e)^{1/2}] = 237$$

3. From Figure 7.9,

$$\frac{V}{(\tau/\rho)^{1/2}} = 19.0$$

4. From the above equation, find  $\tau = 0.38$  pounds/square foot.

5. From Figure 7.12, Curve 1 (for high sediment content), the allowable tractive force is 0.083 pounds/square foot. Since 0.083 is less than 0.38, the channel is erosive. Lining is needed.

## CHAPTER VIII: OPEN-CHANNEL DESIGN

### 8.1 Purpose

The purpose of this chapter is to (1) provide the minimum requirements for the hydraulic design of all open channels which fall within the jurisdiction of the City of Tucson (both public and private); (2) provide the additional requirements which must be met before the city will accept a channel for maintenance (public channels); and, (3) provide the design requirements for those new channels which will either be constructed near or discharge directly into natural channels. Because erosion, sedimentation, and channel-stabilization components are also an integral part of any channel design, these topics are discussed in much greater detail in Chapters VI, VII, and IX, of this Manual, respectively.

### 8.2 Introduction

The hydraulic design of drainage channels is not a simple procedure. For a relatively long, straight, and uniform channel, normal-depth (i.e., uniform-flow) calculations can be used to determine the discharge capacity at varying depths for a constant cross-sectional area. However, practicing engineers working in an urban environment will rarely encounter either existing conditions or design conditions where uniform-flow calculations are adequate to totally define the flow conditions associated with a given discharge. Transition sections, channel junctions or confluences, channel bends, and hydraulic structures (e.g., culverts and bridges) can create deviations from uniform-flow conditions. Therefore, the engineer must consider these deviations when designing or analyzing drainage channels.

The procedures outlined in this chapter, although not exhaustive, are sufficient for most situations that will be encountered by design engineers. The basic principles behind these design procedures are found in standard textbooks and manuals which deal exclusively with open-channel hydraulics. The design engineer is encouraged to consult the references for this chapter cited at the end of this Manual for a more complete understanding of these principles. Many of the procedures presented herein are particularly similar to those included within the referenced documents prepared by the Los Angeles Flood Control District (1973) and the U.S. Army Corps of Engineers (1970). However, where appropriate, they have been modified to account for local requirements and regulations. As with the other chapters in this Manual, the procedures outlined herein shall be adhered to unless otherwise stated in the Manual, or unless prior approval to deviate from same is obtained, in writing, from the office of the City Engineer.

### 8.3 Requirements for Natural Channels

Washes which traverse land designated for a proposed development may be left in their natural state provided that doing so would not be in conflict with an approved master drainage plan for the area, if one exists; and provided that the development is adequately protected from flooding and erosion. One method of developing in the vicinity of a natural wash is to keep all structures out of its 100-year floodplain, as well as its attendant erosion-hazard areas. Floodplain delineations and erosion-setback distances are discussed in Chapters V and VII of this Manual. Another



## VIII. OPEN-CHANNEL DESIGN

possible method of developing in the vicinity of natural washes is to utilize part of the floodplain for development, while leaving the channel in its natural state. However, this approach would involve demonstrating that (1) the encroachment would not adversely affect adjacent properties; that (2) the development would be located outside of any erosion-hazard areas which border the natural wash; and that (3) in certain key areas, as identified by the City and through the 404-permit process, the disturbance to existing riparian vegetation and habitat is minimized.

### 8.4 Floodplain Encroachments

Encroachments into the floodplain of a natural wash are to be analyzed according to the procedures outlined in Chapter V. The City of Tucson "Floodplain Regulations" state that the maximum allowable rise in water-surface elevation for the 100-year discharge shall be one-tenth of a foot. However, if the natural wash is small enough that the entire width of the floodplain is owned or controlled by a single entity or corporation, and there are no existing structures in the floodplain, it is possible that an exception to this rule might be granted by the City. Under these circumstances, the maximum rise in the water-surface elevation would be limited to one foot, as per Federal Emergency Management Agency guidelines. However, as with all floodplain encroachments, the development must be adequately protected from flooding and erosion, and must not violate restrictions imposed by area plans, basin-management plans, or Mayor and Council policies. At no time may an encroachment adversely affect the river's stability or adversely alter flooding conditions on other properties. Although the limit of encroachment under these circumstances is more flexible, it is still subject to review and approval by the City Floodplain Engineer. When encroachment is proposed within the floodplain of a watercourse, the City Floodplain Engineer may, at his discretion, request that a detailed study be performed to determine if a reduction in overbank flood storage will significantly affect downstream flood peaks.

When fill material is placed in an encroachment area for the purpose of creating a building pad or pads, each pad must be adequately protected against erosion. In cases where these building pads will be placed outside the limits of an erosion-hazard area, as defined in Chapter VII of this Manual, erosion protection shall be designed using the hydraulic parameters associated with the overbank flow. If the building pads will be located inside an erosion-hazard area, erosion protection shall be designed to reduce the erosion-hazard area by using the hydraulic parameters associated with the main channel. See Section 8.5.5 and Chapter VI of this Manual for information on bank-protection toe-down design.

In some cases, the City will require that the existing riparian vegetation be preserved or enhanced. Therefore, it may not be possible to alter a wash or to provide certain types of bank protection, because doing so would result in the loss of significant riparian vegetation. However if, as with most small washes, the riparian vegetation exists only along the banks of the wash, it may be possible to construct erosion protection of some type outside of this vegetation zone. The width of this zone shall be determined on a case-by-case basis, as reviewed and approved by the City Engineer.

## VIII. OPEN-CHANNEL DESIGN

Individual building sites may encroach into a floodplain under circumstances where the sites would be completely surrounded by floodwaters during a regulatory flood provided that (1) the general requirements of the floodplain ordinance are met; (2) the fill slopes for any building pad or pads are protected from erosion; and (3) all-weather access is provided to all building sites.

Erosion protection for the building pads shall be designed using the post-development hydraulic conditions of the overbank floodwaters in the immediate vicinity of the building site. No building shall be built within the erosion-hazard setback limit associated with the main channel, unless adequate bank protection (running the entire length of the development) is first installed to prevent lateral migration of the main channel in the direction of the development. Fill material used to elevate individual building sites must extend at least twenty-five feet away from the building in all directions, unless a study or analysis prepared by an Arizona Registered Professional Civil Engineer demonstrates that a lesser distance is acceptable or that the fill is protected from erosion. In addition, the elevation of the building pad must not be lower than the 100-year water-surface elevation. In all cases, the pad or structure must not worsen flooding on other property.

All-weather access in wide floodplains must be along an obvious, commonly used route that can be easily found by drivers of emergency vehicles who may be unfamiliar with the area. Thus, all-weather-access criteria shall apply to the entire all-weather-access route.

### 8.5 Constructed Channels

In many cases, the proposed density of a development will require the use of constructed channels. When such a use is permitted, constructed channels can minimize floodplain widths, thereby maximizing the developable area. However, the increased flow velocities generally associated with constructed channels often mandate that constructed channels be stabilized in order to prevent bed and/or bank erosion. Channelization and lining allows the channel alignment to be modified, to a certain degree, in order to accommodate urban development. Therefore, in most cases in the past, engineers and planners have found it easier, and more economical, to restructure a given parcel using constructed channels than to plan the development around natural channels. However, this policy of channelization has resulted in a significant reduction of riparian vegetation and habitat, as well as other adverse effects such as increased downstream flood peaks and channel erosion.

The following discussion provides the basic design criteria for the design of constructed channels. More specific and detailed information can be obtained in the published material cited in the "References and Selected Bibliographies" section found at the end of this Manual.

#### 8.5.1 *Channel Geometry*

Open drainage channels shall be designed using either trapezoidal, rectangular, or compound cross sections, unless the prior approval of an alternate design is granted, in writing, by the City of Tucson Floodplain Engineer.

## VIII. OPEN-CHANNEL DESIGN

### 8.5.1.1 *Side-Slopes*

Side-slopes for constructed earthen or riprap channels shall be no steeper than 3:1, unless an approved soils analysis demonstrates that steeper side-slopes are stable. Side-slopes for lined channels may be steeper, depending upon the structural stability of the lining. Reinforced concrete lining may have vertical side-slopes, provided that the design is adequate to prevent failure from hydrostatic or earth pressures. Shotcrete may be placed on side-slopes as steep as 1:1, if these side-slopes are not significantly steeper than the natural angle of repose of the soil. A soil-cement lining may be placed on 1:1 side-slopes, provided it is of sufficient thickness to be structurally stable. The minimum thickness of soil cement on a 1:1 side-slope should be four feet, measured normal to its face. Where soil cement is used as slope paving, with a thickness no greater than one foot, the maximum allowable side-slope should be 4:1. Actually, for ease of construction, even flatter side-slopes (e.g., 6:1) are desirable under such circumstances.

### 8.5.1.2 *Width*

Ordinarily, the minimum bottom width of a channel must be ten feet before it will be accepted for maintenance by the City of Tucson. Occasionally, bottom widths as narrow as eight feet may be allowable in certain cases, with prior approval from the City of Tucson Floodplain Engineer. Privately maintained channels have no mandatory, minimum bottom width, except as dictated by hydraulic and/or sediment-transport considerations, as described in subsequent sections of this chapter.

The bottom width of constructed channels which lack bed and/or bank protection should not vary by more than fifteen percent between control points, such as at culverts, junctions, changes in slope, or abrupt contractions or expansions, except at the confluence of a major tributary. The purpose of this constraint is to prevent severe aggradation, degradation, or bank erosion from occurring due to sudden changes in sediment-transport rates. In addition, when channelizing a natural wash, the bottom width should be constructed so that the discharge per unit width within the engineered channel is approximately equal to the discharge per unit width of the natural channel of the wash. Typical ways to mitigate this latter constraint are (1) to line both the bottom and sides of the engineered channel, or (2) to line just the channel sides and install grade-control structures.

The bottom widths of constructed channels which have earthen bottoms should be designed to prevent the formation of an incised, meandering, low-flow channel. Theoretically, a relatively wide channel, designed to convey the 100-year discharge, would convey the more-frequent, low-flow discharges at very shallow depths, were there an equal flow distribution across the entire flow cross section. However, by the laws of nature, such an occurrence is not the case within an alluvial channel. Under such circumstances, the channel will develop a narrow, incised, low-flow channel for more efficient conveyance of these flows. This low-flow channel will often meander within the main channel, and is capable of eroding earthen banks and/or undermining bank protection along engineered channels. In order to avoid this occurrence, the channel either should be stabilized, in order to prevent the formation of an incised low-flow channel, or should be designed so that the following equation is satisfied:

## VIII. OPEN-CHANNEL DESIGN

$$\frac{b}{V_{p100}Y_{p100}} \leq 1.15 \quad (8.1)$$

Where:

- $b$  = Channel bottom width, in feet;
- $V_{p100}$  = Average velocity of flow at the peak of a 100-year flood, in feet per second; and,
- $Y_{p100}$  = Maximum depth of flow at the peak of a 100-year flood, in feet.

### 8.5.1.3 Depth

The depth of flow in channels, where relatively steady, uniform-flow conditions exist, can be computed by an iterative solution of Manning's equation:

$$Q = \frac{1.486}{n} R^{2/3} S_f^{1/2} A \quad (8.2)$$

Where:

- $Q$  = Discharge, in cubic feet per second;
- $n$  = Manning's roughness coefficient (see Table 8.1);
- $R$  = Hydraulic radius of flow ( $= A/P$ ), in feet;
- $A$  = Cross-sectional area of flow, in square feet;
- $P$  = Wetted perimeter of flow, in feet; and,
- $S_f$  = Friction slope, in feet per foot.

The depth of flow in Equation 8.2 is implicit within the terms  $A$  and  $R$ . To solve for the depth of flow, given a known discharge, the normal procedure is to make an estimate of the depth of flow; compute  $A$ ,  $P$ , and  $R$  from the channel cross-section characteristics; then solve for  $Q$  using Manning's equation. If the computed discharge is not equal to the known discharge, the depth of flow is adjusted accordingly, and the process is repeated until the computed and known discharges are sufficiently close.

Under steady, uniform-flow conditions, the friction slope is assumed equal to the channel slope. Therefore, channel slope can be used for the friction slope, when channels are designed utilizing Manning's Equation.

Uniform flow does *not* exist under most design conditions, due to disturbances caused by changes in the channel width, discharge, or slope. In addition, the presence of channel bends, transitions, junctions, or obstructions such as culverts can create conditions which lead to non-uniform flow. The effect of such disturbances can propagate far upstream, or downstream, depending upon whether or not the flow is subcritical or supercritical. Whenever there is any reason to suspect that uniform-flow conditions do not exist, the depth of flow shall be determined from backwater computations.

VIII. OPEN-CHANNEL DESIGN

TABLE 8.1: MANNING'S ROUGHNESS COEFFICIENTS*			
CHANNEL MATERIAL	ROUGHNESS COEFFICIENT ( <i>n</i> )		
	Minimum	Normal	Maximum
Corrugated metal	0.021	0.025	0.030
Concrete			
1) Trowel finish	0.011	0.013	0.015
2) Float finish	0.013	0.015	0.016
3) Unfinished	0.014	0.017	0.020
4) Shotcrete, good section	0.016	0.019	0.023
5) Shotcrete, wavy section	0.018	0.022	0.025
Asphalt (use maximum value when cars are present)	0.013	0.016	0.020
Soil Cement	0.018	0.020	0.025
Riprap (bottom and sides)	--	** $n = 0.04D_{50}^{0.167}$	--
Constructed channels with earth or sand bottom, sides of			
1) Clean earth; straight	0.018	0.022	0.025
2) Earth with grass and weeds	0.020	0.025	0.030
3) Earth with trees and shrubs	0.024	0.032	0.040
4) Shotcrete	0.018	0.022	0.025
5) Soil cement	0.022	0.025	0.028
6) Concrete	0.017	0.020	0.024
7) Dry rubble or riprap	0.023	0.033	0.036
Natural channels with sand bottom, sides of			
1) Trees and shrubs	0.025	0.035	0.045
2) Rock	0.024	0.032	0.040
Natural channel with rock bottom	0.040	0.060	0.090
Overbank Floodplains			
1) Desert brush, normal density	0.040	0.060	0.080
2) Dense vegetation	0.070	0.100	0.160

\* Adapted from Chow (1959) and Aldridge and Garrett (1973).

\*\*  $D_{50}$  in feet.

## VIII. OPEN-CHANNEL DESIGN

Backwater computations proceed upstream for subcritical flow and downstream for supercritical flow. A control section must be established for computations to begin. A control section is a section at a place of known water-surface elevation. Control sections can be at such places as channel confluences, culvert inlets, or at where the flow goes through critical depth. Critical depth occurs when the Froude number ( $F$ ) is equal to one.

The Froude number is calculated from:

$$F = \frac{V}{(gY_h)^{1/2}} \quad (8.3)$$

Where:

- $V$  = Average velocity of flow, in feet per second;
- $Y_h$  = Hydraulic depth of flow (area/top width), in feet; and,
- $g$  = Acceleration due to gravity = 32.2 ft/sec<sup>2</sup>.

Equation 8.3 should be used with care whenever there is overbank flooding or variations across the cross section which cause the flow velocity to vary within the cross section. In such cases, critical depth should be estimated by the graphical method described in Section 4-4 of Chow (1959).

The hydraulic flow depth,  $Y_h$ , used in the Froude-number calculation represents the actual flow depth for a rectangular section, but represents the cross-sectional area of flow divided by the top width of flow for either trapezoidal sections or natural channel sections.

Critical depth can occur at locations where a subcritical channel slope changes to a supercritical slope, and at locations where there is an abrupt drop in the elevation of the channel bed, when subcritical flow exists upstream. Backwater calculations should proceed both upstream and downstream from critical depth at locations where a subcritical slope changes to a supercritical slope.

Backwater calculations in trapezoidal channels of uniform cross section are generally performed by the Direct Step Method. This method is easily adaptable to the computer or hand-held calculator. For those who are interested in doing these calculations manually, a very good discussion and description of the Direct Step Method can be found on page 262 of Chow (1959).

### 8.5.1.4 Freeboard

Freeboard is the additional depth required in a channel beyond the depth which is calculated for conveyance of the design discharge. The purpose of freeboard is to protect against hydraulic disturbances such as waves, unforeseen obstructions of flow, debris, or sediment accumulation. In addition, freeboard provides a margin of safety against (1) the uncertainties which exist in the methods used to predict design discharges; and (2) floods that are larger than the design flood. The amount of

## VIII. OPEN-CHANNEL DESIGN

freeboard required depends upon whether the flow is supercritical or subcritical, the flow velocity, the design discharge, the consequences of overtopping, and the magnitude of flow disturbances at locations such as junctions and culverts.

The freeboard requirement for channels shall be computed from Equation 8.4, with a minimum freeboard of one foot for channels with design depths of three feet or more.

$$FB = 1/6 \left[ Y_{\max} + \frac{V^2}{2g} \right] \quad (8.4)$$

Where:

- $FB$  = Freeboard, in feet;
- $Y_{\max}$  = Maximum depth of flow, in feet;
- $V$  = Average velocity of flow, in feet per second; and,
- $g$  = Acceleration due to gravity = 32.2 ft/sec<sup>2</sup>.

The freeboard requirements described above are for uniform channel reaches where no unusual flow disturbances are anticipated. Additional freeboard is required at channel bends and junctions, where backwater effects may occur; and at locations where hydraulic jumps may occur. The additional freeboard required at channel bends and junctions is described in Sections 8.5.10 and 8.5.12 of this Manual. At those locations where a hydraulic jump could form, additional freeboard shall be provided to contain the jump according to the guidelines provided within Section 8.5.9 of this Manual.

Freeboard in regional watercourses, such as the Santa Cruz River, Rillito Creek, Tanque Verde Creek, Pantano Wash, and the Cañada del Oro Wash, shall be determined on a case-by-case basis, following a detailed river-mechanics study.

The lining of protected channels shall extend to an elevation necessary to include the freeboard requirement, unless approval to the contrary is granted, in writing, by the City of Tucson Floodplain Engineer.

### 8.5.2 *Safety Considerations*

Deep channels with steep side-slopes and high flow velocities can be a hazard to the health, safety, and welfare of the general public. Therefore, the design engineer must always consider the safety aspects of any design. The design of hazardous channels should be avoided, if possible. All channels greater than five feet deep which have side-slopes steeper than 2:1 shall have emergency escape ladders consisting of a series of iron rungs every 600 feet. Other site-specific safety measures shall be installed as deemed necessary by either the design engineer or the City Engineer.

### 8.5.3 *Right-of-Way*

All channels that are to be maintained by the City of Tucson must be dedicated to the City. Dedication may be either in fee title or in the form of an easement. The

## VIII. OPEN-CHANNEL DESIGN

width of the dedication shall be the width of the channel, including key-ins, plus the width of a maintenance access lane or lanes. The minimum maintenance access width for regional watercourses is thirty feet on each side of the channel. More right-of-way may be required, if a linear park is planned along the watercourse. For major watercourses greater than 2000 cfs, the required width for maintenance access is sixteen feet on each side of the channel. However, one of these access lanes may be omitted, at the discretion of the City Engineer, provided that the channel bottom equals or exceeds twenty feet in width, and is drivable utilizing maintenance vehicles. Maintenance access lanes on minor watercourses are variable, and will be established on a case-by-case basis. Generally, a 16-foot maintenance access lane on one side will be required, as a minimum. In all cases, the right-of-way must be sufficient to allow maintenance vehicles to operate freely.

In areas where basin-management plans have recommended particular channel alignments, or an alignment for a watercourse has been established by a regulatory agency, dedication shall be in accordance with same. The width of dedication in these areas shall be as recommended in the basin-management plan, or as established by the agency, unless a more recent study shows that an alternative alignment and/or width is adequate. Studies of this type must clearly demonstrate that there are no conflicts or adverse effects with existing upstream and/or downstream improvements.

### *8.5.4 Bank-Protection Key-Ins and Minor Side Drainage*

Bank-protection key-ins refer to the additional material provided beneath the surface of the ground at the top of the bank protection. Key-ins are normally provided for concrete and shotcrete bank protection; for thin, soil-cement bank protection; and for riprap bank protection. Their purpose is (1) to prevent fractures along the upper edge of the bank protection; (2) to provide added structural stability for the bank protection; and (3) to help prevent minor side inflow from undermining and damaging the bank protection from the top. Typical key-ins are shown in Figure 8.1. The minimum key-in depth on major channels (excluding regional watercourses) shall be eighteen inches. On minor watercourses, the key-in depth shall also be eighteen inches, unless a lesser key-in is justifiable. Key-ins for soil-cement bank protection along regional watercourses are generally not required because of the thickness of the bank protection. However, if key-ins are required, the design shall be determined by a site-specific engineering analysis acceptable to the City Engineer.

When minor tributary or surface flows enter an unlined channel over its side, rill erosion can create headcuts that will travel away from the channel in the opposite direction of the tributary inflow. If the channel is lined, the side drainage can erode the soil from behind the bank protection and create hydrostatic pressures and seepage problems that can cause failure of the bank protection. Therefore, side drainage must be confined to selected entry points that are adequately protected, or the key-in associated with the lining must be deep enough to prevent, or lessen, the buildup of hydrostatic pressure and seepage behind the bank protection. Under such circumstances, and in the absence of a detailed soils analysis and a knowledge of subsurface flow patterns, the key-in shall extend to a depth that equals the depth of the channel along the tributary inflow area.



VIII. OPEN-CHANNEL DESIGN

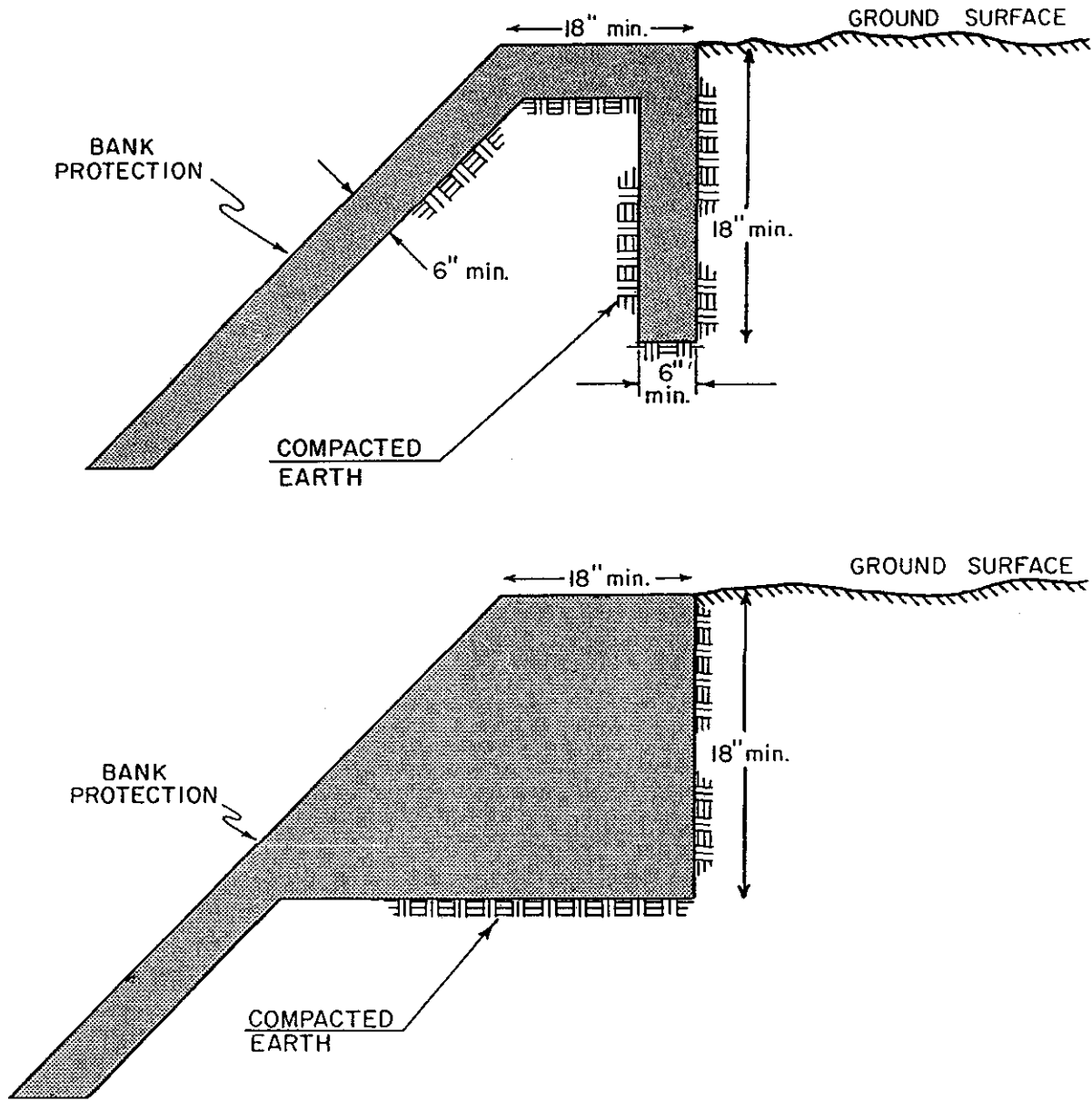

FIGURE 8.1  
TYPICAL BANK-PROTECTION KEY-INS  
(NOT TO SCALE)

## VIII. OPEN-CHANNEL DESIGN

### 8.5.5 *Bank-Protection Toe-Downs*

Bank-protection toe-downs refer to the extension of bank protection below the channel bed. Although shallow (i.e.,  $\leq 6.0$  feet) toe-downs are normally vertical, they sometimes are extended below the channel bottom along the same side-slope as the bank itself. The purpose of a toe-down is to prevent failure of the bank protection due to scour or long-term degradation of the channel bed.

Bank-protection toe-downs shall extend to the combined depth associated with general scour, bend scour, local scour, low-flow incisement, sand-wave troughs, and long-term degradation predicted to occur within the channel. The procedures used in calculating these depths are presented in Chapter VI of this Manual. Below grade-control structures, the toe-down shall conform to the geometry of the scour hole, as determined by the methodology also presented in Chapter VI of this Manual.

The soil beneath the channel bed may contain erosion-resistant material, such as caliche. The scour depth calculated using the methodologies outlined in Chapter VI of this Manual may then become unrealistic. A geotechnical report which demonstrates that the bed is composed of erosion-resistant material may be submitted by a soils engineer to justify a reduction in the toe-down depth. However, the toe-down depth along major washes shall never be less than four feet, nor shall toe-downs along minor washes be less than one-half the depth of flow, unless bedrock is encountered.

### 8.5.6 *Low-Flow and Compound Channels*

#### 8.5.6.1 *Low-Flow Channels*

Frequently, the design of a drainage channel that conveys the 100-year discharge leads to a situation in which the bottom of the channel cross section is too wide to efficiently convey the low-flow discharges. As a consequence, these more frequent discharges will create an incised low-flow channel that may meander back and forth across the bed of the channel, instead of allowing flow to spread uniformly across the entire channel width. This meandering process can cause frequent and unnecessary scouring at the toe of the primary banks; and, if left unchecked, can ultimately threaten both the horizontal and vertical stability of the channel. This meander action might even have the capability to destabilize totally lined channels by attacking the lining at the joint between the toe of the bank and the channel bottom. To avoid this meandering process, it is recommended that consideration be given to constructing a small low-flow channel within any larger channel in order to restrict the low flows to a designated area within the primary channel. This low-flow channel should be designed, where practicable, in a manner such that the unit discharge associated with the 2-year event is the same as that which exists under natural conditions. However, practical considerations may require that the low-flow channel, if installed, be somewhat smaller.

#### 8.5.6.2 *Compound Channels*

A variation upon the concept of a constructed low-flow channel is the compound channel. A compound channel contains a significant portion of the design discharge in a stabilized lower channel. A terrace on each side of the stabilization contains the

## VIII. OPEN-CHANNEL DESIGN

remainder of the design discharge at a level above the low-flow channel. This terrace may or may not be stabilized. Compound channels are normally constructed in order to satisfy a multi-use concept (e.g., flood-control channels combined with linear parks). The Appendix to this Manual contains more information on the construction of compound channels.

When a compound channel is to be constructed within the corporate limits of the City of Tucson, the normal design discharge to be used in the low-flow portion of such a channel should be the 2-year to 10-year discharge. Because of the potential for erosion of a compound channel terrace during a large discharge event, bank protection which consists of a thin shell, or "veneer," over the supporting embankment is not recommended for these channels. However, observations made during major flood events in the Tucson area indicate that 9-foot-thick soil cement will remain in place following extensive removal of the bank material behind it. Therefore, this "massive" type of bank protection is recommended for the banks of a low-flow channel constructed within a compound channel, unless technical evidence can be provided to the City Engineer which clearly demonstrates that an alternate approach will function effectively within such a channel during a large discharge event. Because hydraulic roughness varies over the cross section of a compound channel, the hydraulic roughness must be "weighted" to develop a composite roughness coefficient for determining the correct depth/discharge relationship. Equation 6-18 in *Open-Channel Hydraulics* (Chow, 1959) is recommended for use in "weighting" roughness coefficients for compound channels.

Since compound channels are normally maintenance intensive, they may not be accepted for maintenance by the City of Tucson. The City Engineer will evaluate the acceptability of these channels on a case-by-case basis. The City Engineer may also increase building setbacks from compound channels over those normally associated with completely lined channels, should the erosion potential of the affected watercourse warrant an increased setback. Figure 8.2 illustrates typical cross sections for low-flow and compound channels.

### 8.5.7 *Upstream and Downstream Controls*

The upstream end of constructed channels must be designed to collect the entire design discharge without raising water-surface elevations on adjacent properties. This may be accomplished by providing wide entrance transitions, or collector channels, at the upstream end. See Section 8.5.11.1 of this Manual for information on entrance transitions.

The downstream end must also be designed to minimize adverse impacts upon adjacent properties. Adverse impacts could result from increased discharge, velocity, or concentration of flow. Mitigation measures to reduce or eliminate these impacts can be achieved by (1) providing expansions at the downstream end of the channels; (2) providing energy-dissipation structures; or (3) building box culverts at street crossings. See Section 8.5.11.2 of this Manual for information on exit transitions.

Drainage must be collected and delivered in the same manner and to the same concentration points that existed prior to channelization, unless a drainage master plan for the area dictates otherwise; or unless an agreement acceptable to the City Engineer

VIII. OPEN-CHANNEL DESIGN

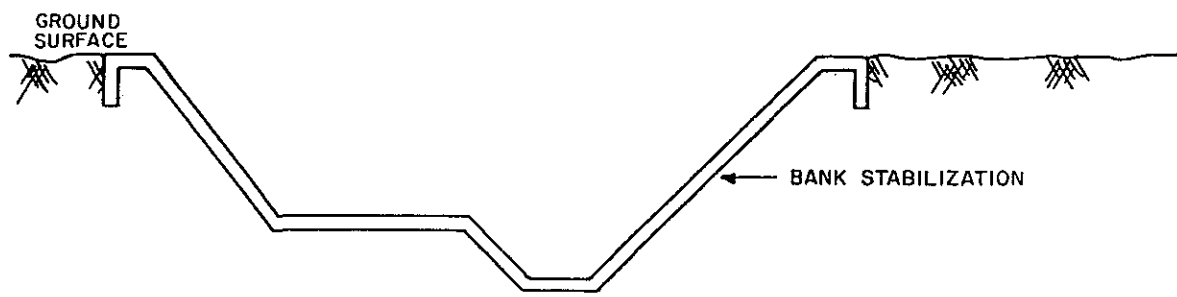

CHANNEL WITH LOW-FLOW CHANNEL (NTS)

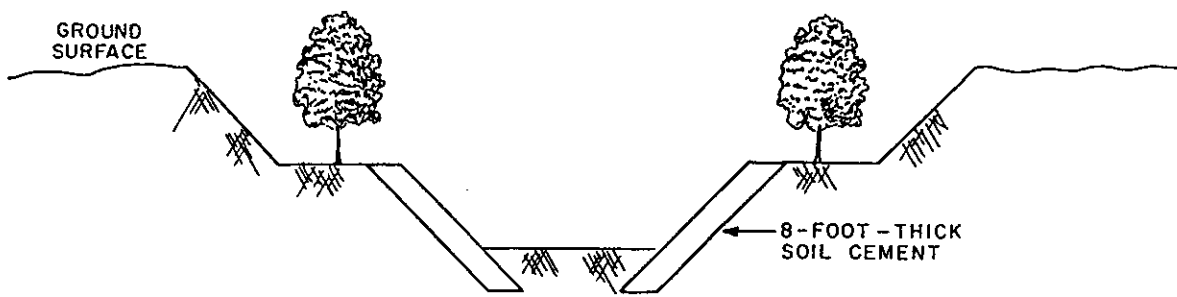

COMPOUND CHANNEL (NTS)

FIGURE 8.2  
TYPICAL LOW-FLOW AND COMPOUND CHANNELS

## VIII. OPEN-CHANNEL DESIGN

is obtained from all affected property owners. If a drainage master plan is available, dedication of all necessary rights-of-way shall be required, as specified within the master plan.

### 8.5.8 *Channel Slope*

The slope for a proposed channel is, to a great extent, dependent on the natural topography. However, variations can be achieved by altering the channel alignment within a development, and by adjusting the elevation of inflow and outflow points.

In general, channels with unlined bottoms should not be designed with a slope less than 0.3% in order to prevent vegetation and bed irregularities from creating stagnant pools of water after flows subside. Channels with a concrete bottom may be flatter. Where the natural fall of the land is less than 0.5%, the channel alignment producing the steepest possible slope should be chosen to avoid sediment buildup.

Abrupt changes in slope should be avoided, except where necessary to achieve a specific purpose (e.g., such as to induce a hydraulic jump). For example, if an abrupt change in slope might result in the formation of a hydraulic jump that is not desired, an analysis should be performed to determine whether a jump will occur, and where it will be located. When abrupt slope changes are unavoidable, the slope changes should not cause the channel top width to vary by more than fifteen percent.

Whenever possible, channels should be designed to convey the incoming sediment supply without causing aggradation or degradation. Refer to Chapter VI of this Manual, which addresses erosion and sedimentation, for more detailed information.

Channels with design Froude numbers between 0.86 and 1.16 should be avoided, if at all possible, because of the instability associated with critical flow.

Most channels with earthen beds are constructed on slopes that are steeper than their equilibrium slopes. In such cases, grade-control structures are required. Refer to Chapter VI for grade-control design guidelines.

### 8.5.9 *Hydraulic Jump*

A hydraulic jump occurs when flow changes rapidly from low-stage supercritical flow to high-stage subcritical flow. Hydraulic jumps can occur (1) when the slope of the channel abruptly changes from steep to mild; (2) at sudden expansions or contractions in the channel section; (3) at locations where a barrier, such as a culvert or bridge, occurs in a channel of steep slope; (4) at the downstream side of dip crossings or culverts; (5) where channels of steep slope discharge into other channels; and (6) at sharp bends.

Hydraulic jumps are useful in dissipating energy, and consequently they are often purposely forced to occur at drainageway outlet structures in order to minimize the erosive potential of floodwaters. However, because of the large amount of energy dissipated in hydraulic jumps, it is not advisable to allow them to occur except under controlled circumstances. Therefore, if during the design of a channel, it appears that a hydraulic jump might occur at an undesirable location, computations should be made

## VIII. OPEN-CHANNEL DESIGN

to determine the height, length, and characteristics of the jump. In addition, steps should be taken to either eliminate the jump or contain it, in order to prevent damage to the channel or surrounding property.

The type of hydraulic jump that forms, and the amount of energy it dissipates, is dependent upon the upstream Froude number,  $F_1$ .

The various types of hydraulic jumps that can occur are listed in Table 8.2.

TABLE 8.2: TYPES OF HYDRAULIC JUMPS		
UPSTREAM FROUDE NUMBER	TYPE OF JUMP	ENERGY LOSS (%)
$1 < F_1 \leq 1.7$	Undular Jump	0-5
$1.7 < F_1 \leq 2.5$	Weak Jump	5-18
$2.5 < F_1 \leq 4.5$	Oscillating Jump	18-44
$4.5 < F_1 \leq 9$	Steady Jump	44-70
$F_1 > 9$	Strong Jump	70-85

### 8.5.9.1 Height of a Hydraulic Jump

The depth of flow immediately downstream of a hydraulic jump is referred to as the sequent depth. The sequent depth in rectangular channels can be computed by use of the following equation:

$$Y_2 = 1/2 Y_1 ([1 + 8F_1^{2.1/2}]^{1/2} - 1) \quad (8.5)$$

Where:

$Y_1$  = Initial (upstream) flow depth, in feet;

$Y_2$  = Sequent (downstream) flow depth, in feet; and,

$F_1$  = Froude number upstream of the jump =  $V_1/(gY_1)^{0.5}$ , where  $V_1$  = initial (upstream) flow velocity, in feet per second.

## VIII. OPEN-CHANNEL DESIGN

The solution for sequent depth in trapezoidal channels can be obtained from a trial-and-error solution of Equation 8.6. Equation 8.6 is derived from momentum equations (see Morris and Wiggert, 1972). It is also acceptable, for design purposes, to determine the sequent depth in trapezoidal channels from Equation 8.5. Equation 8.5 is much simpler to solve, and produces only slightly greater values for sequent depth for trapezoidal channels than does Equation 8.6.

$$\frac{ZY_1^3}{3} + \frac{bY_1^2}{2} + \frac{Q^2}{gA_1} = \frac{ZY_2^3}{3} + \frac{bY_2^2}{2} + \frac{Q^2}{gA_2} \quad (8.6)$$

Where:

- $Y_1$  &  $Y_2$  are as defined in Equation 8.5; and,
- $b$  = Channel bottom width, in feet;
- $Z$  = Channel side-slope (horizontal/vertical), in feet per foot;
- $Q$  = Channel discharge, in cubic feet per second; and,
- $A_1$  &  $A_2$  = Cross-sectional areas of flow upstream and downstream, respectively, of the hydraulic jump, in square feet.

Figures 8.3 and 8.4 can also be used to determine the height of a hydraulic jump.

### 8.5.9.2 Length of a Hydraulic Jump

The length of a hydraulic jump,  $L$ , is defined as the distance from the front face of the jump to a point immediately downstream of the roller. Jump length can be determined from Figures 8.5 and 8.6.

### 8.5.9.3 Surface Profile of a Hydraulic Jump

The surface profile of a hydraulic jump may be needed to design the profile of extra bank protection, or training walls, required to contain the jump. The surface profile can be determined from Figure 8.7.

### 8.5.9.4 Location of a Hydraulic Jump

In most cases, a hydraulic jump will occur at the location in a channel where the initial and sequent depths and upstream Froude number satisfy Equation 8.5. This location can be found by performing direct-step calculations in either direction toward the suspected jump location, until the terms of the equation are satisfied. Refer to Section 15.7 of Chow (1959) for detailed information and an example on locating hydraulic jumps.

### 8.5.9.5 Undular Hydraulic Jumps

An undular hydraulic jump is the type of jump which occurs where the upstream Froude number is between 1.0 and 1.7. This type of jump is characterized by a series of undular waves which form on the downstream side of the jump. Experiments have shown that the first wave of an undular jump is higher than the height given by Equation 8.5. Therefore, the height of this wave should be determined as follows:

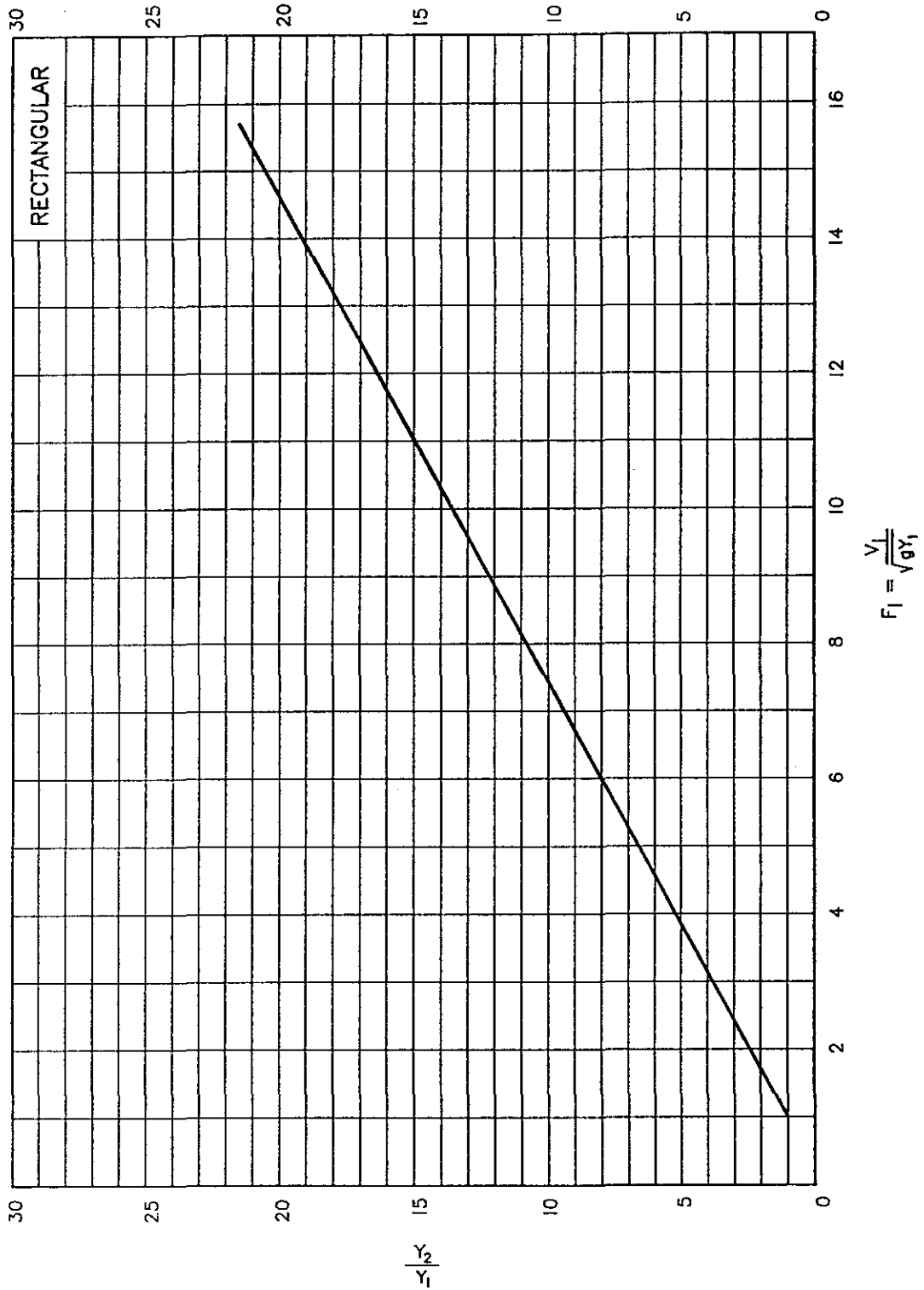

FIGURE 8.3  
HEIGHT OF A HYDRAULIC JUMP FOR A HORIZONTAL, RECTANGULAR CHANNEL



VIII. OPEN-CHANNEL DESIGN

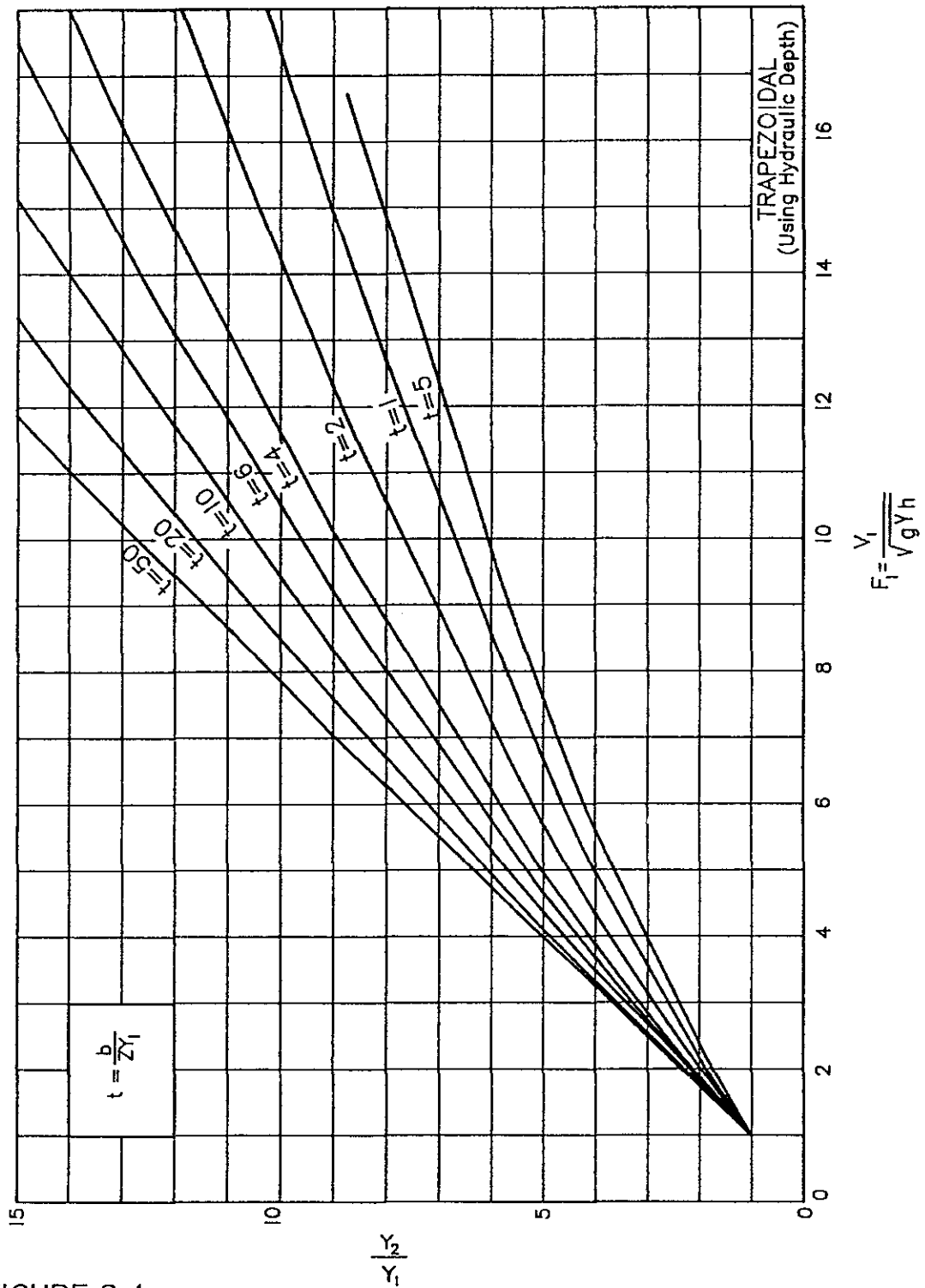

FIGURE 8.4  
HEIGHT OF A HYDRAULIC JUMP FOR A HORIZONTAL, TRAPEZOIDAL CHANNEL (USING HYDRAULIC DEPTH)

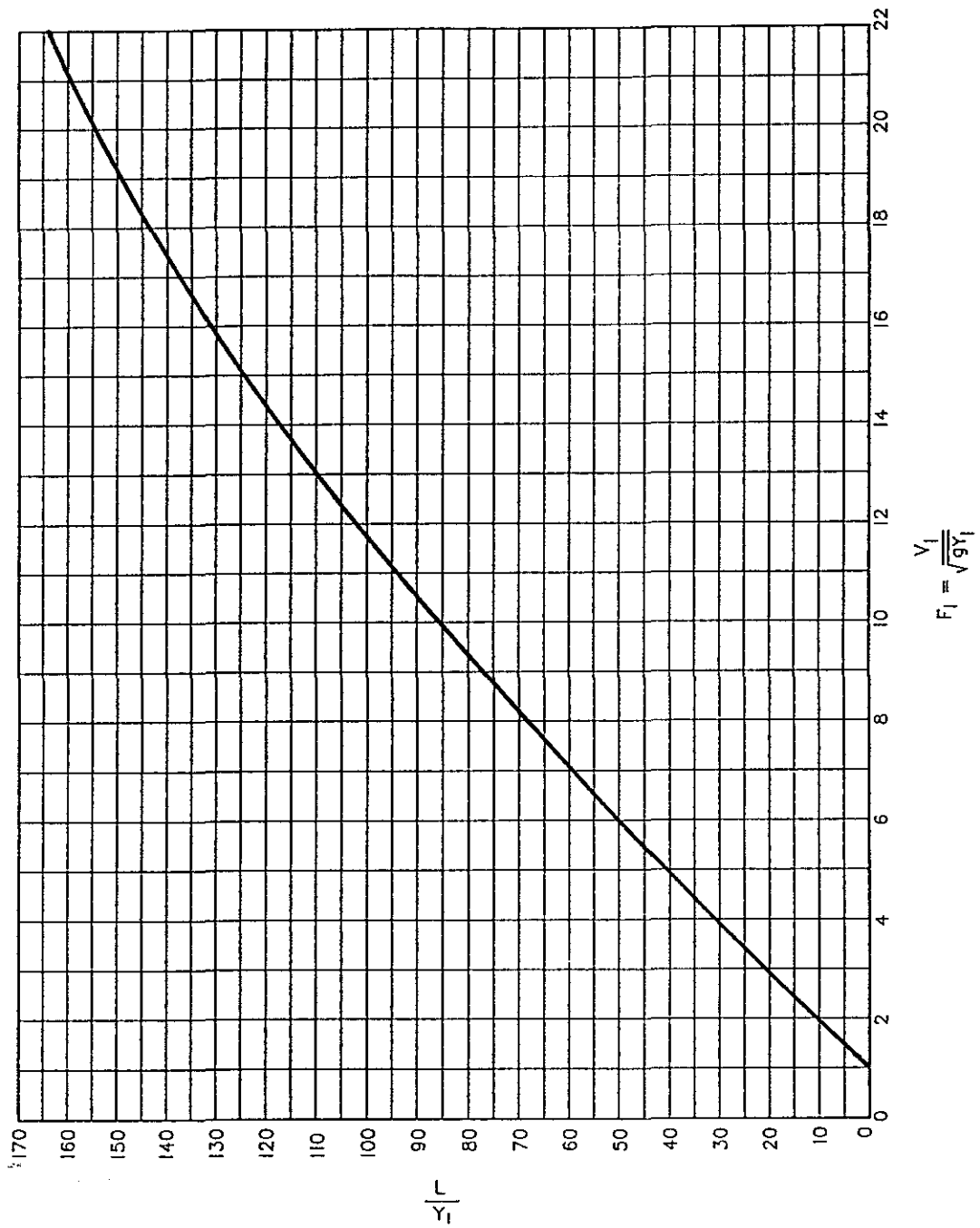

FIGURE 8.5  
LENGTH OF A HYDRAULIC JUMP FOR A RECTANGULAR CHANNEL

VIII. OPEN-CHANNEL DESIGN

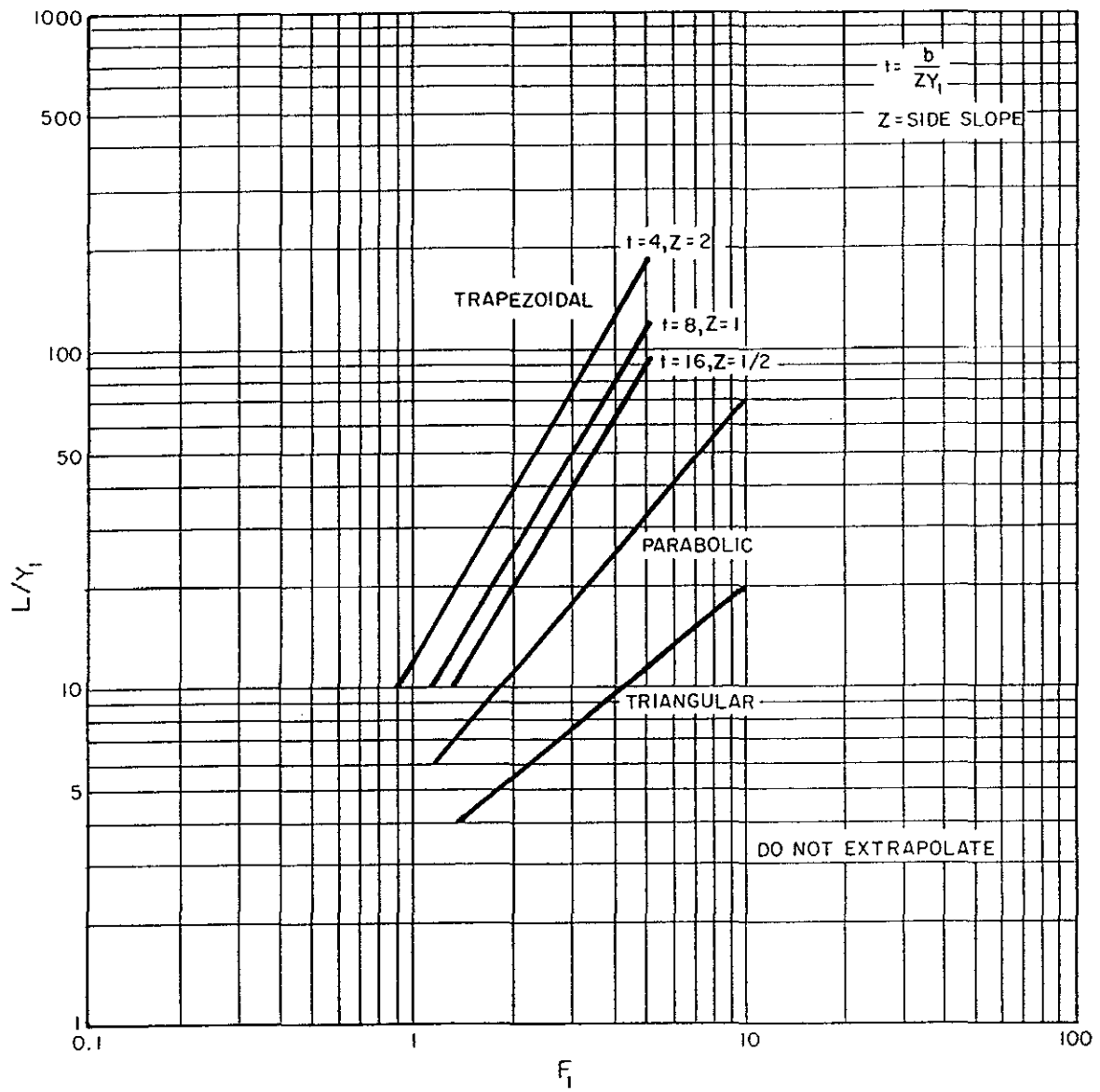

FIGURE 8.6  
LENGTH OF A HYDRAULIC JUMP FOR NONRECTANGULAR CHANNELS

VIII. OPEN-CHANNEL DESIGN

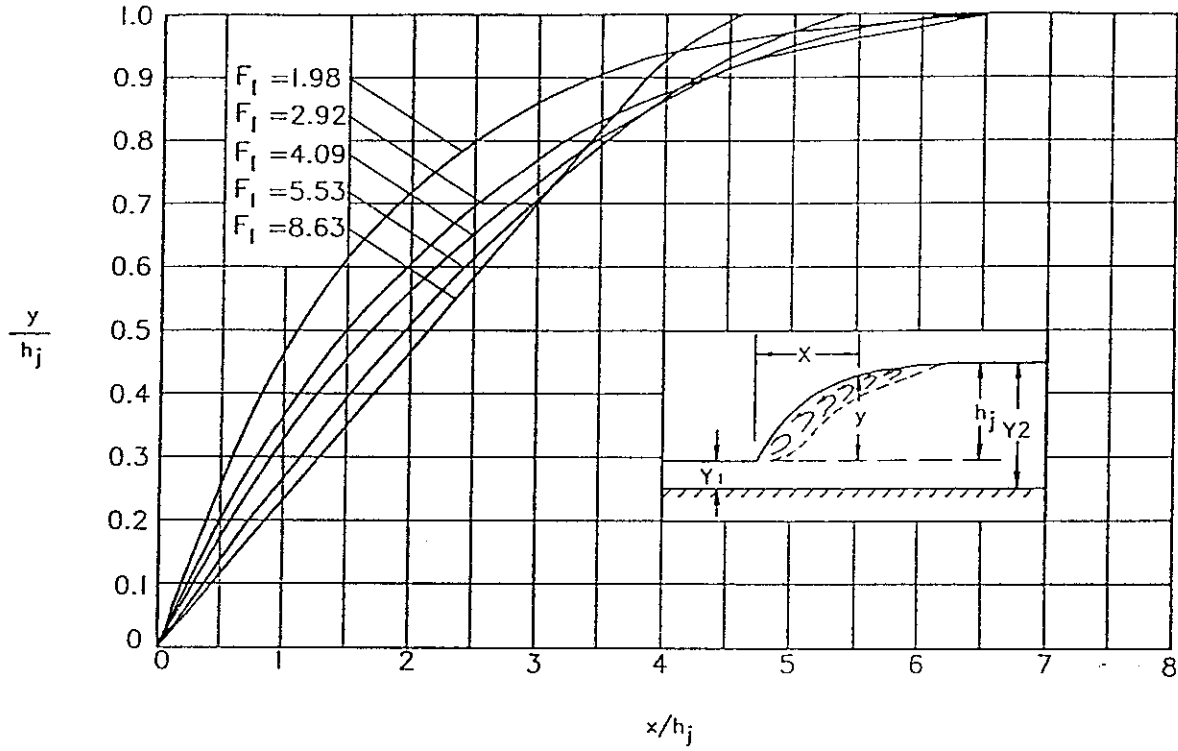

FIGURE 8.7  
SURFACE PROFILE OF A HYDRAULIC JUMP

## VIII. OPEN-CHANNEL DESIGN

$$\frac{Y_2 - Y_1}{Y_1} = F_1^2 - 1 \quad (8.7)$$

Where all terms are as previously described.

See U.S. Army Corps of Engineers (1970) for the source of this equation.

### 8.5.10 Flow in a Curved Channel

Flow in a curved channel will create centrifugal forces which will cause a rise in the water surface along the outside of a bend. At the same time, a corresponding depression will be created in the water surface along the inside of the bend. In addition, spiral secondary currents tend to form within the bends. These currents can cause scour to occur along the outside of a bend, and deposition along the inside of a bend. Cross waves that propagate downstream will also form, if the flow around the bend is supercritical.

Although curves are inevitable in the design of most open channels, they should be minimized in order to avoid the special problems associated with their design. The design of channel bends must include consideration for superelevation, limiting curvature, bend scour, and special design curves.

#### 8.5.10.1 Superelevation

Superelevation is the rise in the water-surface elevation around the outside of a channel bend, with an accompanying lowering of the water surface along the inside of the bend. This outside rise in the water surface is generally measured with respect to the mean depth of flow in an equivalent straight reach. Additional freeboard is required along the outside of a channel bend to account for this rise (see Figure 8.8). Superelevation is computed as follows:

$$\Delta Y = \frac{1.5CV^2T}{gr_c} \quad (8.8)$$

Where:

- $\Delta Y$  = Rise in water-surface elevation (superelevation) around the outside of a channel bend, in feet;
- $C$  = A coefficient (see Table 8.3);
- $V$  = Average velocity of flow, in feet per second;
- $T$  = Channel width at elevation of water surface, in feet;
- $g$  = Acceleration due to gravity (= 32.2 ft/sec<sup>2</sup>);
- $r_c$  = Radius of curvature of channel centerline, in feet; and,
- 1.5 = Factor of safety to account for alluvial channel conditions.

See U.S. Army Corps of Engineers (1970) for the source of this equation.

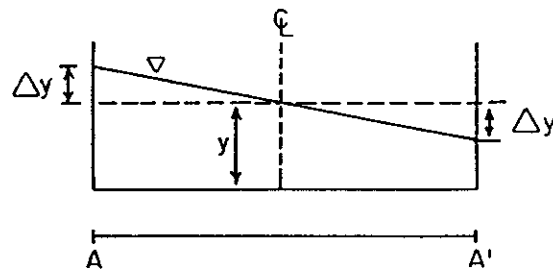
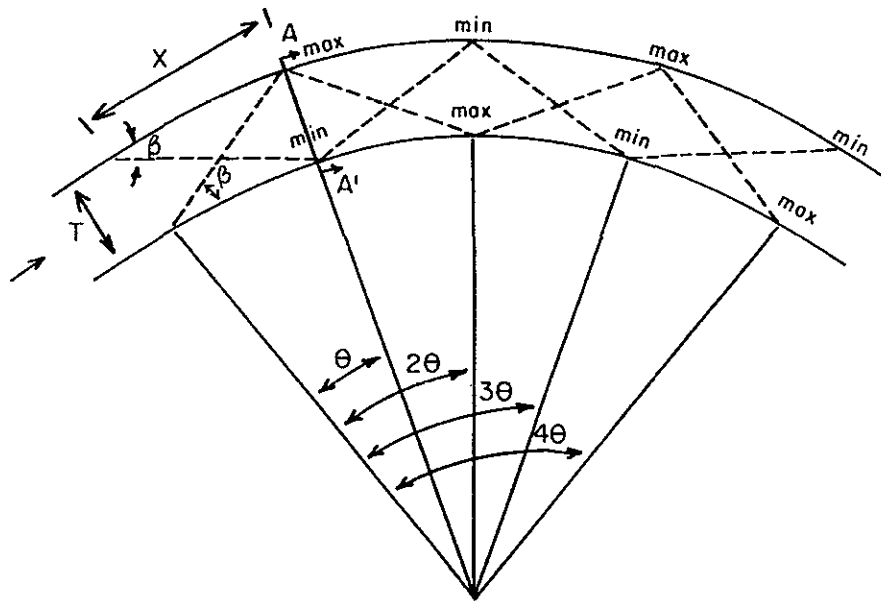

FIGURE 8.8

CROSS-WAVE PATTERN FOR SUPERCRITICAL FLOW IN A CURVED CHANNEL

## VIII. OPEN-CHANNEL DESIGN

The coefficient  $C$  in Equation 8.8 takes into account the rise due to cross waves and centrifugal forces.

TABLE 8.3: COEFFICIENTS FOR USE IN SUPER-ELEVATION FORMULA			
FLOW TYPE	CROSS SECTION	TYPE OF CURVE	VALUE OF $C$
Tranquil	Rectangular	Simple Circular	0.5
Tranquil	Trapezoidal	Simple Circular	0.5
Rapid	Rectangular	Simple Circular	1.0
Rapid	Trapezoidal	Simple Circular	1.0
Rapid	Rectangular	Easement Transition	0.5
Rapid	Trapezoidal	Easement Transition	1.0

For subcritical flow, the upstream and downstream limits of additional freeboard shall correspond to the beginning and ending points of curvature according to the guidelines in U.S. Army Corps of Engineers (1970). The normal channel freeboard is expected to be adequate to contain any backwater effects of the superelevation upstream of the curve.

For supercritical flow, the disturbances caused by bends (cross waves) can propagate far downstream of the bend. Therefore, special treatment is required to eliminate or minimize these disturbances. Figure 8.8 shows a typical cross-wave pattern. The central angle of the cross-wave pattern,  $\theta$ , is computed by use of the following equation:

$$\theta = \tan^{-1} \left( \frac{2b}{(2r_c + b)\tan\beta} \right) \quad (8.9)$$

## VIII. OPEN-CHANNEL DESIGN

Where:

- $\theta$  = Central angle of the cross-wave pattern, in degrees;
- $b$  = Channel bottom width, in feet;
- $r_c$  = Radius of curvature of channel centerline, in feet;
- $\beta$  = Wave front angle =  $\text{Sin}^{-1}(1/F)$ , in degrees; and,
- $F$  = Froude number.

See Rouse (1950) for the source of this equation.

Freeboard to account for superelevation in channels with supercritical flow shall begin at the upstream point of curvature, and continue at that level to a point downstream of the end of the curve a distance computed by Equation 8.10.

$$L' = \frac{3 T}{\text{Tan } \beta} \quad (8.10)$$

Where:

- $L'$  = Distance of *maximum* superelevation downstream of a curve in a channel with supercritical flow, in feet.

All other terms are as defined previously.

Beyond this point, freeboard to account for superelevation shall taper downward to the normal bank-protection height over an *additional* distance equal to  $0.67L'$ .

### 8.5.10.2 Easement Curves

Easement curves can be used to reduce cross waves in bends with supercritical flow (see Table 8.3). Easement curves are placed at both ends of the curve proper, and may be either spiral or circular in order to produce the same hydraulic effect. Circular easement curves are recommended, and must have a radius equal to twice the radius of the main curve. The length of the easement curve,  $L_e$ , is computed by:

$$L_e = \frac{0.32 TV}{Y^{1/2}} \quad (8.11)$$

Where all terms are as previously described.

### 8.5.10.3 Banking

Banking is an alternative to providing additional freeboard in order to contain superelevated flows around a channel bend. Banking is a modification of the cross slope of the channel bed such that the inside of the bend is lower than the outside of



## VIII. OPEN-CHANNEL DESIGN

the bend. When banking a channel, the difference in elevation between the inside of a bend (lowest point) and the outside of a bend (highest point) should be equal to the quantity  $V^2 T / g r_c$ , in feet, where all terms are as previously defined. Hydraulically, this method is preferable to providing additional freeboard, but banking is difficult to construct. Therefore, *banking should only be used in conjunction with the design of totally lined channels.*

### 8.5.10.4 Limiting Curvature

For flow with a design Froude number less than 0.86, the minimum radius of curvature along the center line of the channel shall be three times the channel top width. For flow with a Froude number greater than or equal to 0.86, the minimum radius of curvature shall be computed as follows:

$$r_c = \frac{4V^2 T}{g Y_h} \quad (8.12)$$

Where:

- $r_c$  = Radius of curvature of channel centerline, in feet;
- $V$  = Average velocity of flow, in feet per second;
- $T$  = Channel top width at the water surface, in feet; and,
- $Y_h$  = Hydraulic depth of flow, in feet.

See U.S. Army Corps of Engineers (1970) for the source of this equation.

The radius of curvature for channels with design Froude numbers greater than or equal to 0.86 shall not be less than  $4T$ .

### 8.5.11 Transitions

Transition sections designed to collect and/or discharge flow between the natural floodplain and constructed channels can be located at either the upstream or downstream ends of the constructed channels. They can also be located along a segment, or segments, of a constructed channel itself. In either case, it is necessary to design the flow transition to minimize the disturbance to flow. In the case where flow in a constructed channel is being transitioned back to the natural floodplain, sufficient distance must be allowed for the flow to adequately expand to the original width of the natural floodplain.

#### 8.5.11.1 Entrance Transitions

When the upstream width of flow in a natural channel exceeds the width of proposed channel, a transition section must be provided. For subcritical flow, the angle of convergence,  $\theta$ , between the center line of the proposed channel and the transitioning levee, or bank, is computed by use of the following equation:

$$\theta = \tan^{-1} \left( \frac{1}{3.375 F_u} \right) \quad (8.13)$$

## VIII. OPEN-CHANNEL DESIGN

Where:

- $\theta$  = Transition angle, in degrees (see Figure 8.9); and,  
 $F_u$  = Upstream Froude number.

See Pima County Department of Transportation and Flood Control District (1984) for the source of this equation.

The length,  $L$ , of the transition is computed by use of the following equation:

$$L = \frac{\Delta T}{2 \tan \theta} \quad (8.14)$$

Where  $\Delta T$  is the change in top width, in feet.

See U.S. Army Corps of Engineers (1970) for the source of this equation.

The maximum allowable transition angle is thirty degrees, unless supplemental engineering calculations demonstrate to the satisfaction of the City Engineer that an angle greater than thirty degrees can be used.

In addition to the design calculations associated with the transition section, a backwater analysis must be performed to determine what effect, if any, the transition will have upon upstream water levels.

The transition losses,  $h_t$ , to be used in the backwater analysis are to be computed by use of the following equation:

$$\text{or } h_{tc} = C_c \Delta h_v \quad (8.15a)$$

$$h_{te} = C_e \Delta h_v \quad (8.15b)$$

Where:

- $h_{tc}, h_{te}$  = Transition losses in contracting and expanding reaches, respectively, in feet;  
 $C_c$  = Coefficient of contraction;  
 $C_e$  = Coefficient of expansion; and,  
 $\Delta h_v$  = Difference in velocity head between the upstream and downstream end of the transition, in feet.

See U.S. Army Corps of Engineers (1970) for the source of this equation.

The head-loss coefficients of expansion and contraction,  $C_c$  and  $C_e$ , are obtained from the following table:

### VIII. OPEN-CHANNEL DESIGN

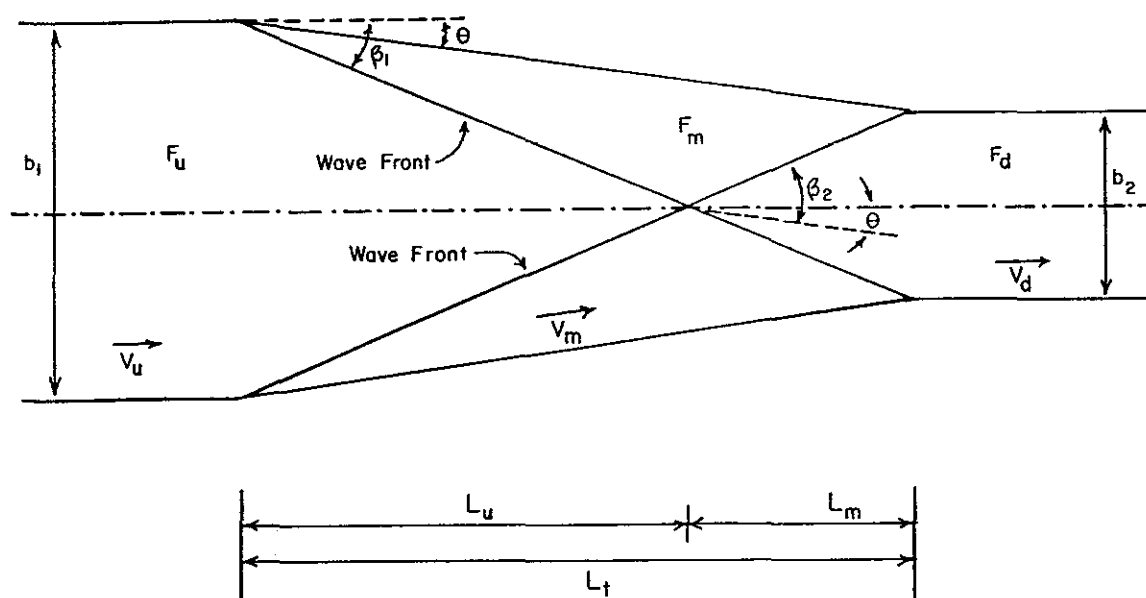

NOTE: The subscripts u, m, and d represent upstream, midpoint, and downstream flow conditions, respectively.

**FIGURE 8.9**  
**TRANSITION FOR CHANNEL CONTRACTIONS**  
**IN SUPERCRITICAL FLOW**

## VIII. OPEN-CHANNEL DESIGN

TABLE 8.4: HEAD-LOSS COEFFICIENTS FOR USE WITH TRANSITIONS IN OPEN CHANNELS		
TRANSITION TYPE	$C_c$	$C_e$
Warped	0.10	0.20
Cylindrical quadrant	0.15	0.25
Wedge	0.30	0.50
Straight Line	0.30	0.50
Square End	0.30	0.75

For supercritical flow, entrance transitions must be designed to prevent flow disturbances which could propagate downstream. The convergence angle,  $\theta$  (Figure 8.9), must be chosen to minimize cross-wave action. To accomplish this, the following three equations must also be satisfied:

$$(1) \quad L_1 = \frac{b_1}{2 \tan \beta_1}; \quad (8.16)$$

and,

$$(2) \quad L_2 = \frac{b_2}{2 \tan(\beta_2 - \theta)}; \quad (8.17)$$

and,

$$(3) \quad L = L_1 + L_2 \quad (8.18)$$

$$(4) \quad L = \frac{b_1 - b_2}{2 \tan \theta} \quad (8.19)$$

Where all terms are as defined in Figure 8.9.

See U.S. Army Corps of Engineers (1970) for the source of these equations.

## VIII. OPEN-CHANNEL DESIGN

The procedure for design of a supercritical transition is as follows:

1. Using the upstream Froude number,  $F_u$ , compute the wave-front angle,  $\beta_1$ , from the formula:

$$\beta = \text{Sin}^{-1}(1/F) \quad (8.20)$$

Where:

$$\beta = \beta_1 \text{ and } F = F_u \text{ (see Figure 8.9).}$$

2. Compute the distance  $L_1$  from Equation 8.16.
3. Choose a trial transition length,  $L$ , where  $L > L_1$ .
4. Determine the trial transition angle,  $\theta$ , from  $L$ ,  $b_1$ , and  $b_2$ .
5. Determine the transition Froude number,  $F_t$ , from the hydraulic conditions at the distance  $L_1$ .
6. From  $F_t$ , compute a new wave-front angle,  $\beta_2$ , using Equation 8.20.
7. Compute  $L_2$  according to Equation 8.17.
8. Repeat steps 3 through 7 until Equations 8.18 and 8.19 are both satisfied.

The table below is provided as an additional guide to aid in designing entrance transitions under supercritical flow conditions.

TABLE 8.5: RECOMMENDED CONVERGENCE RATES FOR ENTRANCE TRANSITIONS WITH SUPERCRITICAL FLOW		
MEAN CHANNEL VELOCITY (FPS)	WALLFLARE (HORIZONTAL TO LONGITUDINAL)	$\theta$ DEGREES
10 - 15	1:10	5.71
15 - 30	1:15	3.81
30 - 40	1:20	2.86

## VIII. OPEN-CHANNEL DESIGN

### 8.5.11.2 Exit Transitions

The length of the exiting transition section,  $L_{TR}$ , where flow from the proposed channel is expanded to match the width of the natural floodplain, shall be computed by use of the following equation:

$$L_{TR} = 6.5 (X_2 - 0.7X_1) \quad (8.21)$$

for subcritical flow ( $F_u \leq 1$ ); and

$$L_{TR} = 6.5 F_u (X_2 - 0.7X_1) \quad (8.22)$$

for supercritical flow ( $F_u > 1$ ).

Where the terms for both equations are as described in Figure 8.10 ( $F_u$  = upstream Froude number).

Equations 8.21 and 8.22 are modified from equations found on Plate 24 of "Hydraulic Design of Flood Control Channels," U.S. Army Corps of Engineers (1970).

Exit transition sections are necessary to prevent adverse downstream impacts caused by increased flow velocities and depths. Acceptable transitions are required in all cases unless (1) an agreement, satisfactory to the City Engineer, can be made with all affected downstream property owners; or (2) a drainage master plan has been developed for the wash, which specifies a particular outlet configuration.

### 8.5.11.3 Internal Channel Transitions

Internal channel transitions must be gradual to minimize flow disturbances. The same formulas presented in the previous sections for entrance and exit transitions shall be used for contractions and expansions of flow within the channel. For transitions which constrict flow under subcritical conditions, use Equation 8.13 to determine the convergence angle. The maximum transition angle shall be thirty degrees. The length of the transition is computed by using Equation 8.14.

Contractions under supercritical flow conditions are computed by using Equations 8.16 through 8.20. The required length for internal expansions under supercritical flow conditions is computed by using Equation 8.22. Should a shorter transition be desired, it must be justified by computations that document the expected wave heights in accordance with procedures contained in standard hydraulics textbooks, such as Chow (1959) and Morris and Wiggert (1972). Additional freeboard, and possibly additional reinforcement of the channel lining, will be required to account for the destructive effects associated with wave formation.

## VIII. OPEN-CHANNEL DESIGN

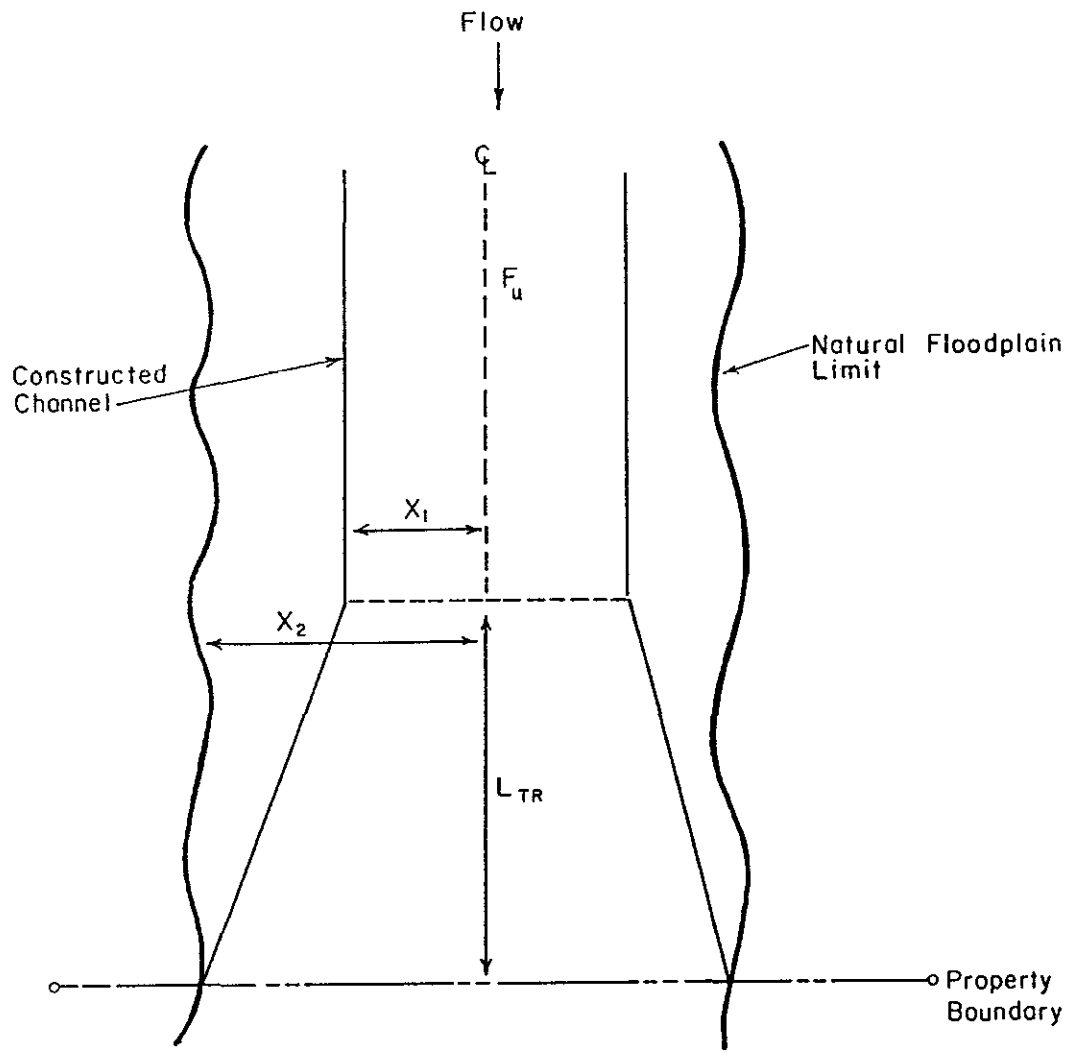

FIGURE 8.10  
TRANSITION DISTANCE REQUIRED TO ALLOW FLOW TO  
RETURN TO NATURAL CONDITIONS

## VIII. OPEN-CHANNEL DESIGN

Where flow is to be transitioned from a supercritical state to a subcritical state, a hydraulic jump will develop. The jump must be contained within the transition structure. Additional freeboard will be required, as needed, to contain the jump (refer to Section 8.5.12 of this Manual for information on hydraulic jumps). Additional reinforcement of the channel lining may also be required. One method of ensuring that a hydraulic jump is contained within the designated area is to build an energy dissipator or stilling basin that is designed to contain the jump within a specified reach length. Refer to Chapter IX of this Manual for more detailed information concerning energy dissipators and/or stilling basins.

### 8.5.12 Channel Confluences

The design of a channel junction or a channel confluence is a very complex procedure due to the many variables involved (e.g., the angle of intersection, discharges, channel and junction shape, and the number of adjoining channels and type of flow encountered). Junctions under subcritical flow conditions must be designed to allow water to merge without creating a backwater condition that can result in the overtopping of one or more of the converging channels. The maximum wave height is generally located on the side-channel wall opposite the junction point, and on the main-channel wall downstream of the junction.

#### 8.5.12.1 General Design Guidelines

General design guidelines for junctions are as follows:

1. Tapered training walls should be constructed between adjoining flows.
2. The side-channel wave originating at the junction apex should impinge upon the main-channel wall downstream of the enlargement (see Section 8.5.12.3 of this Manual).
3. Junction angles,  $\theta$ , should be no greater than twelve degrees for subcritical flow, and no greater than six degrees for supercritical flow. Angles greater than these are acceptable, but only if extra bank protection is provided to heights equal to or greater than the maximum wave heights given by Figure 8.11. In addition, if the tributary flow is greater than ten percent of the main channel flow, the maximum angle of the confluence should not be allowed to exceed forty-five degrees. The extra height of bank protection required at a junction should extend downstream of same a distance,  $L$ , which is computed from the following equation:

$$L = \frac{3b_2V_2}{V_3\sin\theta} \quad (8.23)$$

Where:

$b_2$  = Bottom width of the main channel downstream of the junction, in feet;



### VIII. OPEN-CHANNEL DESIGN

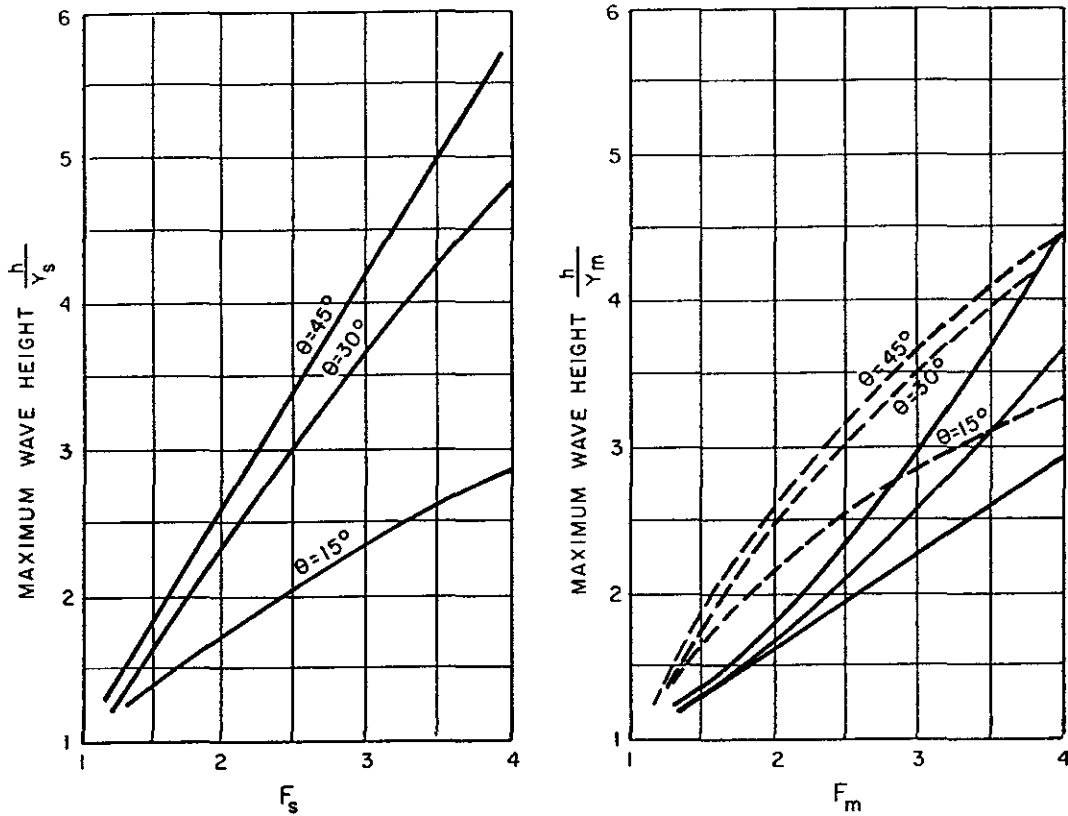

NOTE: The subscripts m and s represent the main channel and side channel flow conditions, respectively.

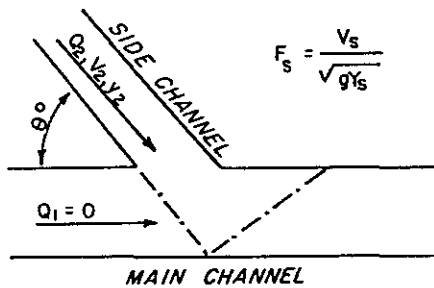

a. SIDE CHANNEL FLOW ONLY

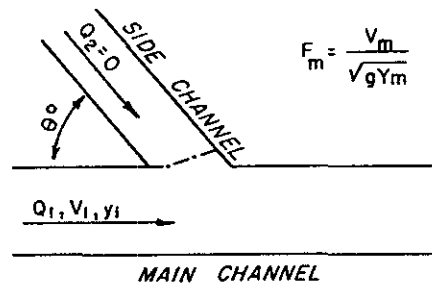

b. MAIN CHANNEL FLOW ONLY

- RECTANGULAR CHANNEL
- TRAPEZOIDAL CHANNEL
- - - - - APPROXIMATE FLOW LINE PATTERN

FOR DESIGN PURPOSES  $\theta$  SHOULD NOT BE GREATER THAN  $12^\circ$  FOR SUBCRITICAL FLOWS, AND NOT GREATER THAN  $6^\circ$  FOR SUPERCRITICAL FLOW.

FIGURE 8.11  
MAXIMUM WAVE HEIGHT AT A CHANNEL JUNCTION

## VIII. OPEN-CHANNEL DESIGN

- $V_2$  = Flow velocity in the main channel downstream of the junction, in feet per second;  
 $V_3$  = Flow velocity in the tributary or side channel, in feet per second; and,  
 $\theta$  = Junction angle, in degrees.

Tributary flows that are less than ten percent of the main channel flow may enter at angles up to ninety degrees, but only if extra bank protection is provided to a height that equals the elevation of the energy grade line of the tributary flow. If the angle of confluence is greater than forty-five degrees, the extra bank protection must extend upstream of the junction at least for a distance equal to the bottom width of the tributary channel.

4. Critical flow conditions at junctions should be avoided, if at all possible. Froude numbers should either be below the value 0.86, or greater than the value 1.13.
5. Transition sections should be avoided in the immediate vicinity of junctions.

### 8.5.12.2 Momentum Equation

Open-channel flow at a junction is best analyzed using the principle of conservation of momentum. There are many momentum-balance equations available that make simplifying assumptions about the flow and confluence configuration. These equations should be used with caution, because many design situations will not adequately meet the assumptions implicit in these equations.

A series of equations developed by the Los Angeles Flood Control District (1973) are of sufficient detail to be applicable for most junctions. These equations shall be used for designing projects to be located within the City of Tucson, unless the engineer can justify using other equations. The general form of the momentum equation is:

$$P_{h2} + M_2 = P_{h1} + M_1 + M_3 \cos \theta + P_{hi} + P_{hw} - P_{hf} \quad (8.24)$$

Where:

- $P_{h1}$  = Hydrostatic pressure on Section 1;  
 $P_{h2}$  = Hydrostatic pressure on Section 2;  
 $P_{hi}$  = Horizontal component of hydrostatic pressure on the channel invert;  
 $P_{hw}$  = Axial component of hydrostatic pressure on the channel walls;  
 $P_{hf}$  = Retardation force of friction;  
 $M_1$  = Momentum of the moving mass of water entering the junction at Section 1;

## VIII. OPEN-CHANNEL DESIGN

- $M_2$  = Momentum of moving mass of water leaving the junction at Section 2; and,  
 $M_3 \cos \theta$  = Axial component of momentum of the moving mass of water entering the junction at Section 3.

Figures 8.12 and 8.13 show the relationship between the main channel and the tributary channel with respect to the preceding equation. For a trapezoidal channel, the following equations represent the variables comprising Equation 8.24:

$$M_1 = \frac{Q_1^2}{g(b_1 + Z_1 Y_1) Y_1} = \frac{Q_1^2}{g A_1} \quad (8.25)$$

$$M_2 = \frac{Q_2^2}{g(b_2 + Z_2 Y_2) Y_2} = \frac{Q_2^2}{g A_2} \quad (8.26)$$

$$M_3 = \frac{Q_3^2}{g(b_3 + Z_3 Y_3) Y_3} = \frac{Q_3^2}{g A_3} \quad (8.27)$$

$$P_{h1} = \frac{Y_1^2}{6} (3b_1 + 2Z_1 Y_1) \quad (8.28)$$

$$P_{h2} = \frac{Y_2^2}{6} (3b_2 + 2Z_2 Y_2) \quad (8.29)$$

$$P_{hi} = \frac{b_1 + b_2}{2} h_d \left[ Y_1 + \frac{(Y_2 - Y_1)(b_1 + 2b_2)}{3(b_1 + b_2)} \right] \quad (8.30)$$

$$P_{hw} = \frac{Y_1 + Y_2}{4} \left[ \frac{b_1 + b_2}{2} (Y_1 - Y_2) + h' (Z_1 Y_1 + Z_2 Y_2) + (b_2 + Z_2 Y_2) Y_2 - (b_1 + Z_1 Y_1) Y_1 \right] \quad (8.31)$$

$$P_{hf} = \frac{L(S_1 + S_2)}{4} \left[ (b_1 + Z_1 Y_1) Y_1 + (b_2 + Z_2 Y_2) Y_2 \right] \quad (8.32)$$

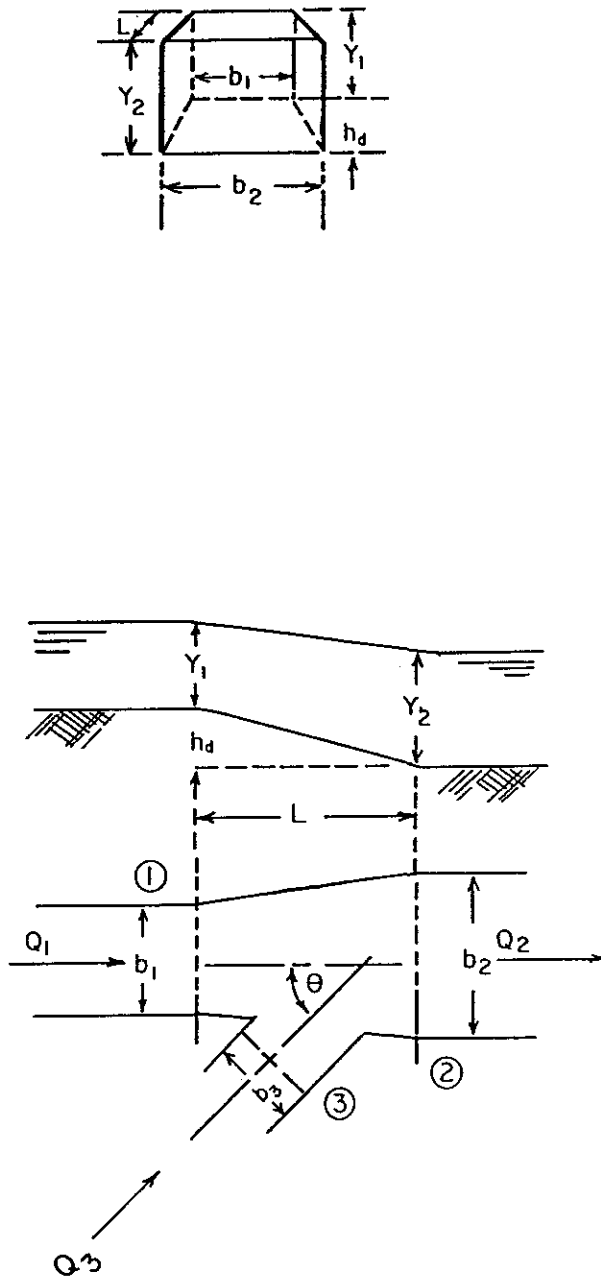

**FIGURE 8.12**  
**RECTANGULAR CHANNEL JUNCTION**

VIII. OPEN-CHANNEL DESIGN

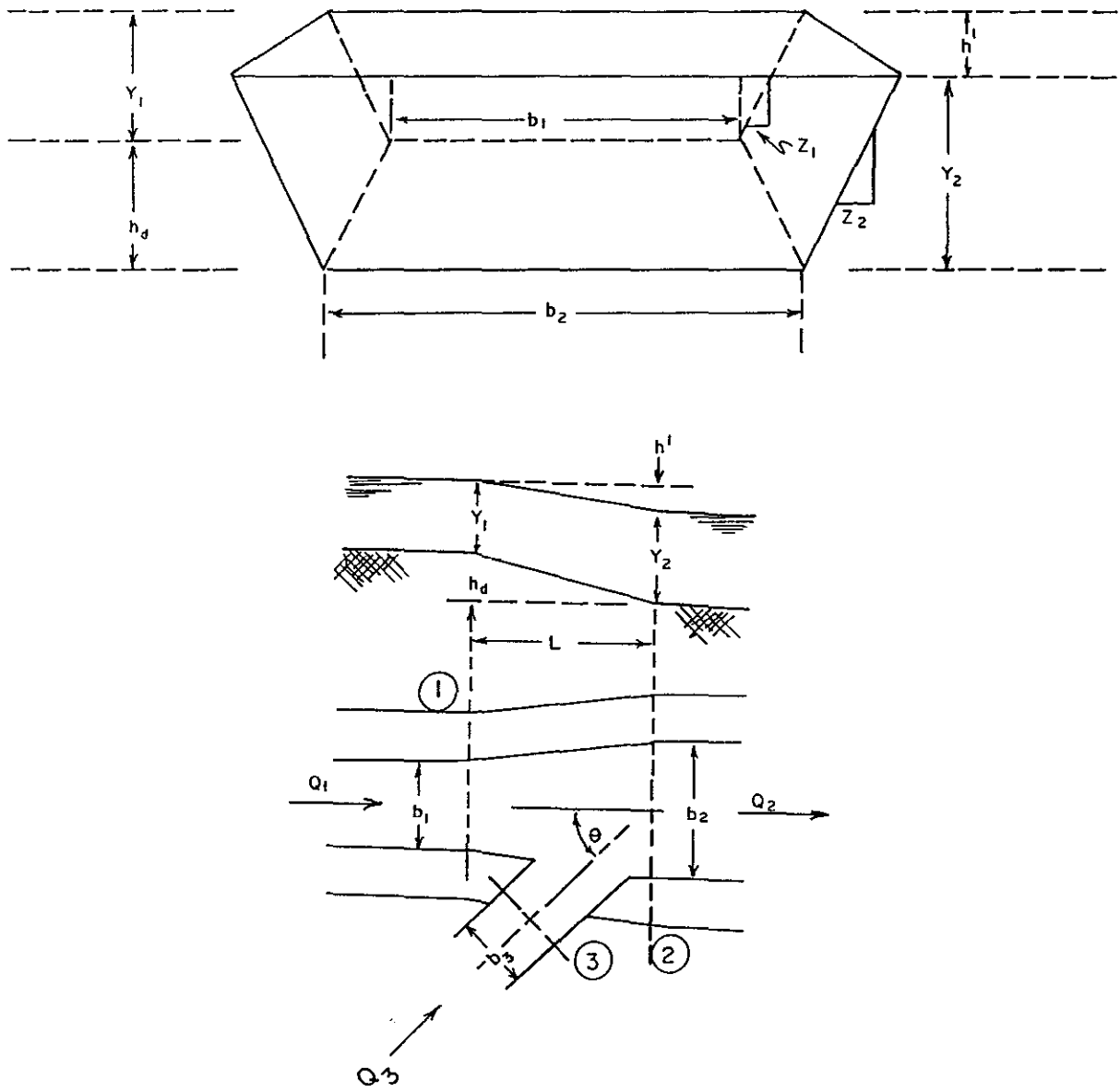

FIGURE 8.13  
TRAPEZOIDAL CHANNEL JUNCTION

### VIII. OPEN-CHANNEL DESIGN

For a rectangular channel, the equations which represent the variables comprising Equation 8.24 are:

$$M_1 = \frac{Q_1^2}{gb_1Y_1} \quad (8.33)$$

$$M_2 = \frac{Q_2^2}{gb_2Y_2} \quad (8.34)$$

$$M_3 = \frac{Q_3^2}{gb_3Y_3} \quad (8.35)$$

$$P_{h1} = \frac{b_1Y_1^2}{2} \quad (8.36)$$

$$P_{h2} = \frac{b_2Y_2^2}{2} \quad (8.37)$$

$$P_{hi} = h_d \left[ \frac{b_1+b_2}{2} \right] \left[ Y_1 + \frac{(Y_2-Y_1)(b_1+2b_2)}{3(b_1+b_2)} \right] \quad (8.38)$$

$$P_{hw} = \frac{Y_1+Y_2}{4} (b_2-b_1) \left[ Y_1 + \frac{(Y_2-Y_1)(Y_1+2Y_2)}{3(Y_1+Y_2)} \right] \quad (8.39)$$

$$P_{hf} = \frac{L(S_1+S_2)}{4} (b_1Y_1+b_2Y_2) \quad (8.40)$$

Where:

- $b_1, b_2, b_3$  = Bottom widths of channels 1, 2, and 3, respectively, in feet;
- $Y_1, Y_2, Y_3$  = Flow depths in channels 1, 2, and 3, respectively, in feet;
- $Q_1, Q_2, Q_3$  = Discharges in channels 1, 2, and 3, respectively, in cubic feet per second;
- $Z_1, Z_2, Z_3$  = Side-slopes of channels 1, 2, and 3, respectively (horizontal/vertical), in feet per foot;
- $S_1, S_2$  = Friction slopes of channels 1 and 2, respectively.
- $L$  = Length of channel junction, in feet.

## VIII. OPEN-CHANNEL DESIGN

- $h_d$  = Vertical drop in channel bottom through the junction, in feet; and,  
 $h'$  = Vertical drop in water surface through the junction, in feet.

### 8.5.12.3 Design Procedure: Supercritical Flow

The design of junctions under supercritical flow conditions involves an iterative procedure in which different curve layouts are checked against the momentum equation until one is found that is acceptable. The upstream channel widths and hydraulic conditions are known, while the downstream channel width and depth of flow are the unknown parameters. The procedure is as follows:

1. Assume a downstream width of the channel bottom based upon the total discharge, the approximate channel shape, the selected roughness, and the slope. It is suggested that the first estimate of the width be the combined width of the two upstream channels ( $b_1+b_3$ ).

(In the following discussion  $b_1$  refers to the upstream width of the main channel,  $b_2$  is the width of the main channel at the downstream end of the junction,  $b_3$  is the width of the secondary [tributary] channel, and  $b_4$  is the width of the main channel downstream and beyond the influence of the junction).

2. Prepare the confluence layout assuming that the main-channel walls are parallel to the channel center line, as shown in Figure 8.14. If the difference ( $\Delta b_1$ ) in widths between  $b_1$  and  $b_2$  is less than  $b_3$ , a centerline offset, as shown in Figure 8.14 A, is recommended. If  $\Delta b_1$  is greater than  $b_3$ , an offset with respect to the right bank, as shown in Figure 8.14 B, is recommended to ensure that the horizontal distance between the parallel alignment of the left banks of the main channels  $b_1$  and  $b_2$  is equal to or less than  $b_3$ .
3. Using the point of intersection,  $PI$ , of the channel walls, draw a circular curve which is determined by the apex angle,  $\theta$  (Figure 8.14). The radius of curvature of the curve is determined by use of the following equation:

$$r_c = \frac{4V_3^2 b_3}{gY_3} + 400 \quad (8.41)$$

Where all terms are as previously defined.

See U.S. Army Corps of Engineers (1970) for the source of this equation.

This curve will connect the intersecting, straight channel walls, as shown in Figure 8.14, and will represent the revised edge of the bottom of the channel through the confluence area.

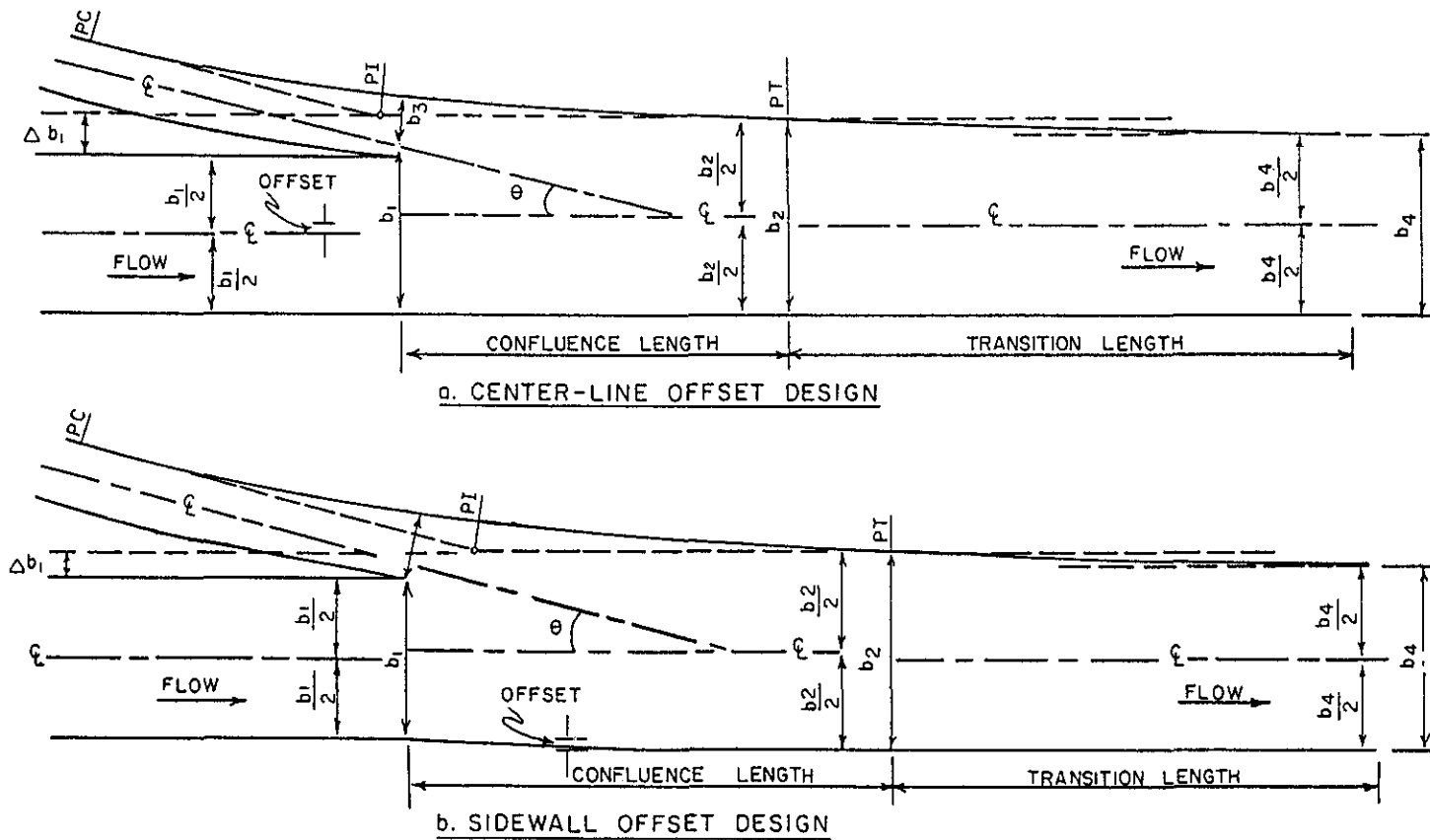

FIGURE 8.14  
TYPICAL CONFLUENCE LAYOUTS

\* FOR DESIGN PURPOSES,  $\theta$  SHOULD BE NOT GREATER THAN 12 DEGREES FOR SUBCRITICAL FLOW AND NOT GREATER THAN 6 DEGREES FOR SUPER-CRITICAL FLOW.



## VIII. OPEN-CHANNEL DESIGN

4. Make the inside bank of the tributary channel bottom concentric with the circular curve, and locate the apex of the junction at the point where this edge of the tributary channel meets the main channel. The distance,  $L_o$ , between the Point of Tangency,  $PT$ , and the junction apex is computed by use of the following equation:

$$L_o = (r_c + b_3) \sin \left[ \cos^{-1} \left[ 1 - \frac{b_3 - \Delta b_1}{r_c + b_3} \right] \right] \quad (8.42)$$

The total length of the curve,  $L_{ct}$ , from  $PC$  to  $PT$ , can be computed from:

$$L_{ct} = \frac{2\pi r \theta}{360} \quad (8.43)$$

The location of the point of curvature,  $PC$ , can be computed from:

$$PC = PI - r \tan \frac{\theta}{2} \quad (8.44)$$

The location of the point of Tangency,  $PT$ , can be computed from:

$$PT = PC + L_{ct} \quad (8.45)$$

Figure 8.14 shows the relationship of these parameters.

5. Compute the confluence length,  $L_c$ , by using the following equations (Los Angeles County Flood Control District, 1973):

$$L_{c1} = \frac{b_3}{\sin \theta} ; \quad (8.46)$$

and,

$$L_{c2} = 5(b_2 - b_1) \quad (8.47)$$

and compare these lengths to the distance  $L_o$  (Equation 8.42) from the apex to the  $PT$  point. The longest of the three is the confluence length,  $L_c$ .

## VIII. OPEN-CHANNEL DESIGN

6. Using the confluence length,  $L_c$ , and the momentum equation (i.e., Equation 8.24), determine the depth of flow and hydraulic conditions at  $b_2$ . If either the depth of flow or water-surface elevation is significantly different than its value in the upstream main channel, select a new  $b_2$  and repeat the procedure.
7. Once satisfactory hydraulic conditions at  $b_2$  have been established, determine the transition distance to  $b_4$  by the procedure outlined in Section 8.5.11 of this Manual. (Note:  $b_2$  in Section 10.5.11 of this Manual is equivalent to  $b_4$  in this section of the Manual.)

An example of this procedure is provided at the end of this chapter.

When designing junctions, consideration should be given to the waves that will occur along the opposite channel wall when only one of the converging channels is discharging into the composite channel. Due to the sporadic nature of thunderstorms in the Tucson Area, it is possible to have flow in one channel and not in the other. Under supercritical flow conditions, experiments have shown that waves can be quite high, particularly if the angle of confluence is excessive. Fortunately, if the angle of confluence is equal to or less than twelve degrees (preferably six degrees), and the design procedure described above is followed, these type of waves should not be a problem. However, should a greater angle of confluence be dictated by site conditions, extra freeboard will be required according to the procedure described in Section 8.5.12.1(3) of this Manual in order to contain waves created by flow impinging onto the opposite bank.

### 8.5.13 Collector Channels

Collector channels are generally designed to collect unconsolidated sheet flow, or wide, shallow, braided flow for the purpose of removing the downstream property from the floodplain. Collector channels generally do not follow the existing drainage pattern. Therefore, they have more stringent design requirements than do most other channels.

#### 8.5.13.1 Cross Section and Slope

Collector channels provide the best hydraulic performance if the width/depth ratio is as low as possible. Cross sections with wide bottoms and low depths should be avoided, if topography permits. Channel slopes should be as steep as reasonably possible to help accelerate the water and prevent sediment buildup.

#### 8.5.13.2 Depth

The discharge in collector channels increases with distance along the channel. Collector channel flows are subject to head losses associated with the impact and turbulence created by flow entering the channel over its bank, in addition to the normal losses created by friction. Therefore, normal-depth procedures and step-backwater calculations are *not* applicable. The correct procedure for analyzing spatially-varied flow of the type that occurs in collector channels is given in many

## VIII. OPEN-CHANNEL DESIGN

hydraulics textbooks under the heading "Side-Channel Spillways" (e.g., see Chow, 1959, page 329).

The minimum depth of a collector channel in the City of Tucson shall be twice the critical depth of the design flood for channels with supercritical slopes, and twice the normal depth of the design flood for channels with subcritical slopes. This depth will vary along the length of the channel as the discharge increases. The transition from the collector channel to the main channel shall be designed using standard backwater procedures. Backwater computations should begin at the point where inflow over the side of the collector channel ceases, and end at a point where normal depth is encountered, or where flow is no longer affected by the collector channel.

When unusual circumstances exist, such as the presence of a definite control point at or near the end of a collector channel, the "Method of Numerical Integration," as outlined in Chow (1959) shall be used to design same. This method may also be used if there is reason to believe that the guidelines presented above result in an overdesign of a collector channel.

### 8.5.13.3 *Erosion Protection*

Erosion protection for a collector channel requires special consideration because of inflow from the side. Hydrostatic pressure in the soil and seepage behind the bank protection can cause the bank protection to fail. Another problem is scour caused by side inflow.

To prevent failure of the bank protection along a collector channel due to side inflow, seepage, and/or hydrostatic pressure, a horizontal concrete apron is normally required along the top of the upstream (inflow) side of the collector channel. This concrete apron shall be connected to the bank protection, and have a width, measured perpendicular to the bank, which is at least four times the critical depth of side inflow during the design flood. A key-in at the upstream edge of the concrete apron should extend to a depth equal to the depth of the collector channel. However, the apron and key-in are not required if the channel bank is constructed of 9-foot-thick soil cement.

The bottom of the collector channel shall be lined, unless the toe-down protection for the bank is deep enough to protect against the scour caused by side inflow. The procedures given in Chapter VI of this Manual shall be used to compute side-inflow scour depth. Normal-depth shall be used as the tailwater depth in the channel for this equation. If the width of the channel is less than five times the computed scour depth, extra toe-down protection to the full depth of scour is needed on *both* banks. For channel bottom widths at least ten times the depth of scour, no extra toe-down is needed on the opposite bank. For widths between five and ten times the depth of scour, the toe-down on the opposite bank should be computed via a linear interpolation between the side-flow scour depth and the normal toe-down depth. A typical collector channel is shown in Figure 8.15.

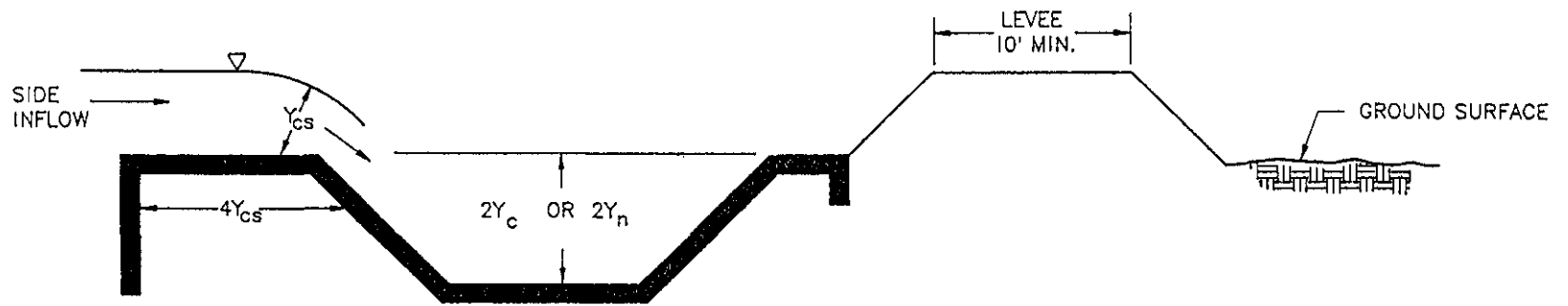

$Y_{cs}$  = CRITICAL DEPTH OF SIDE FLOW

$Y_c$  = CRITICAL DEPTH OF CHANNEL FLOW

$Y_n$  = NORMAL DEPTH OF CHANNEL FLOW

NOTE:  
 A PROPERLY DESIGNED LEVEE OF HEIGHT  $Y_{cc}$  OR  $Y_{nc}$   
 CAN BE CONSTRUCTED ALONG THE BANK OPPOSITE  
 THE SIDE INFLOW IN LIEU OF THE  $2Y_{cc}$  OR  $2Y_{nc}$   
 REQUIREMENT.

8.45

FIGURE 8.15  
 TYPICAL COLLECTOR-CHANNEL CROSS SECTION

## VIII. OPEN-CHANNEL DESIGN

### 8.5.13.4 *Sediment*

Depending upon the amount of sediment supply, and upon sediment-transport capacity, a collector channel could either aggrade or degrade, if not properly designed. The reader is referred to Chapter VI of this Manual for those procedures that consider the effects of deposition and/or scour of alluvial sediments upon open-channel design.

### 8.5.13.5 *Additional Design Considerations*

Material removed by excavation to form the collector channel could be used to construct a levee along the side opposite the lateral inflow. Such a levee, if properly designed, would then be able to serve as a substitute for the depth requirement otherwise imposed upon the design of a collector channel (i.e., two times the appropriate flow depth), and would ensure that all lateral inflow is captured by the collector channel. The minimum height of such a levee should be equal to the normal depth of flow at the peak of the design flood for subcritical conditions, and equal to the critical depth of flow at the peak of the design flood for supercritical conditions.

The lowest floor of the first tier of buildings along the downstream side of a collector channel should be at least one foot above the 100-year water-surface elevation in the collector channel in order to safeguard against possible failure of the collector-channel embankment. This water-surface elevation shall be determined either by the Method of Numerical Integration or by assuming an elevation equal to either (1) two times the normal depth at the peak of the design flood for subcritical flow, or (2) two times the critical depth at the peak of the design flood for supercritical flow, whichever is greater.

**EXAMPLE 8.1: SEQUENT DEPTH IN A TRAPEZOIDAL CHANNEL**

A hydraulic jump is to be formed in a trapezoidal channel through the use of baffle blocks and an abrupt change in slope from steep to mild. Hydraulic conditions *upstream* of the jump are:

Discharge ( $Q$ )	=	500 cfs
Channel Slope ( $S$ )	=	0.015
Bottom Width ( $b$ )	=	10 ft
Side Slopes ( $Z$ )	=	1:1
Roughness ( $n$ )	=	0.015
Depth ( $Y$ )	=	2.3 ft
Froude Number ( $F_u$ )	=	2.2
Hydraulic Depth ( $Y_h$ )	=	1.9 ft

Equation 8.6 will be used. Normal depth *upstream* of the jump is 2.3 feet; so, as an initial estimate, a sequent depth of four feet will be chosen. From Equation 8.6:

$$\frac{1(2.3)^3}{3} + \frac{10(2.3)^2}{2} + \frac{500^2}{g(28.3)} = \frac{1(4)^3}{3} + \frac{10(4)^2}{2} + \frac{500^2}{g(56.0)}$$

$$304.9 = 240.0$$

Momentum does not balance, so a new sequent depth is chosen. By trial and error, the sequent depth is found to be 5.6 ft:

$$\frac{1(2.3)^3}{3} + \frac{10(2.3)^2}{2} + \frac{500^2}{g(28.3)} = \frac{1(5.6)^3}{3} + \frac{10(5.6)^2}{2} + \frac{500^2}{g(87.4)}$$

$$304.9 = 304.2 \quad (\text{close enough})$$

The engineer should exercise care in using Equation 8.6, especially with calculator or computer-program "root solvers," because there are two other roots besides the correct one for sequent depth. One obvious solution is  $Y_2 = Y_1$ . The third root is usually negative. In this case, the value -13.1 also satisfies the equation.

Figure 8.4 can also be used to solve for sequent depth in this example. To do this, first compute  $t = 10/[1(2.3)] = 4.3$ . From Figure 8.4, using  $F_u = 2.2$  and  $t = 4.3$ ,  $Y_2/Y_1 = 2.4$ .  $Y_2$  is then:  $2.4(2.3 \text{ ft}) = 5.5 \text{ ft}$ .

## VIII. OPEN-CHANNEL DESIGN

### EXAMPLE 8.2: THE DESIGN OF AN OPEN-CHANNEL JUNCTION UNDER SUPER-CRITICAL FLOW CONDITIONS

In this example, a main-channel flow,  $Q_1$ , of 2000 cubic feet per second (cfs) is to be joined by a side-channel flow,  $Q_3$ , of 775 cfs. The confluence angle,  $\theta$ , is six degrees. The slope and bottom-width of the side channel have been established to ensure that the depth of flow at the junction is the same as the depth of flow in the main channel. It is desired that this depth of flow be maintained throughout the junction.

Hydraulic conditions in the section located upstream of the channel junction are as follows:

<u>Main Channel</u>		<u>Side Channel</u>	
$Q_1$	= 2000 cfs	$Q_3$	= 775 cfs
$n$	= 0.015 (concrete)	$n$	= 0.015 (concrete)
$b_1$	= 20.0 ft	$b_3$	= 8.0 ft
$Y_1$	= 4.0 ft	$Y_3$	= 4.0 ft
$Z$	= 1:1	$Z$	= 1:1
$S_1$	= 0.01 ft/ft	$S_3$	= 0.008 ft/ft
$F_1$	= 2.0	$F_3$	= 1.70
$A_1$	= 95.8 ft <sup>2</sup>	$A_3$	= 47.8 ft <sup>2</sup>
$V_1$	= 20.9 fps	$V_3$	= 16.2 fps

Hydraulic conditions in the composite channel section located downstream of the junction are as follows:

$Q_4$	= 2775 cfs
$n$	= 0.015 (concrete)
$b_4$	= 28.0 ft
$Y_4$	= 4.0 ft
$Z$	= 1:1
$S$	= 0.01 ft/ft
$F$	= 2.0
$A_4$	= 127.7 ft <sup>2</sup>
$V_4$	= 21.7 fps

## VIII. OPEN-CHANNEL DESIGN

STEP 1: Assume  $b_2 = b_1 + b_3 = 20 + 8 = \underline{28 \text{ feet}}$ .

Use centerline offset (Figure 8.14 A).

$$\Delta b_1 = 8 \text{ ft}$$

$$r_c = \frac{4V_3^2 b_3}{gY_3} + 400 = \frac{4(16.2)^2(8)}{g(4)} + 400 = \underline{465.2 \text{ feet}}$$

Assume station  $PI = \underline{100+00}$

$$\text{Station } PC = 100+00 - r_c \tan \frac{\theta}{2}$$

$$\text{Station } PC = 100+00 - 465.2 \tan 6/2 = \underline{99+75.62}$$

$$\text{Curve length, } L_{ct}, = r_c (\theta) \frac{2\pi}{360}$$

$$L = 465.2(6) \frac{2\pi}{360} = \underline{48.72 \text{ feet}}$$

$$\text{Station } PT = 99+75.62 + 48.72 = \underline{100+24.34}$$

Because  $b_3 = \Delta b_1$ , the distance from the apex to  $PT$  is 0.

The confluence length,  $L_c$ , is:

$$L_c = \frac{(8)}{\sin(6^\circ)} = \underline{76.5 \text{ feet}}$$

or

$$L_c = \frac{(28-20)10}{2} = \underline{40.0 \text{ feet}}$$

Using the largest of these values yields:

$$L_c = \underline{76.5 \text{ feet}}$$



## VIII. OPEN-CHANNEL DESIGN

Assume the depth of flow at  $b_2 = 4$  feet.

From Equations 8.25 to 8.32:

$$M_1 = \frac{(2000^2)}{[20+1(4)]g(4)} = \underline{1294.0}$$

$$M_2 = \frac{(2775)^2}{[28+1(4)]g(4)} = \underline{1868.4}$$

$$M_3 = \frac{(775)^2}{(47.8)g} = \underline{390.2}$$

$$P_{h1} = \frac{(4)^2}{6} [3(20) + 2(1)4] = \underline{181.3}$$

$$P_{h2} = \frac{(4)^2}{6} [3(28) + 2(1)4] = \underline{245.3}$$

$$P_{hi} = \left[ \frac{20+28}{2} \right] 0.77 \left[ 4 + \frac{(4-4)[20+2(28)]}{3(20+28)} \right]$$

$$= \underline{73.9}$$

$$P_{hw} = \frac{4+4}{4} \left[ \frac{20+28}{2} (4-4) + 0.77 [1(4)+1(4)] + [28+1(4)]4 - 4[20+1(4)] \right]$$

$$= \underline{76.3}$$

$$P_{hf} = \frac{76.5(0.01+0.01)}{4} \left[ [20+1(4)]4 + [28+1(4)]4 \right]$$

$$= \underline{85.7}$$

## VIII. OPEN-CHANNEL DESIGN

Using Equation 8.24:

$$245.3+1868.4 = 181.3+1294.0+390.2\cos 6^\circ+73.9+76.3-85.7$$

$$2113.7 = \underline{1927.9}$$

Since forces do not balance, another depth should be tried using the same width.

By trial and error, obtain  $D_2 = \underline{4.5 \text{ feet}}$ .

$$M_2 = \frac{(2775)^2}{[28+1(4.5)]g(4.5)} = \underline{1635.2}$$

$$P_{h2} = \frac{(4.5)^2}{6} [3(28) + 2(1)4.5] = \underline{313.9}$$

$$P_{hi} = \left[ \frac{20+28}{2} \right] 0.77 \left[ 4 + \frac{(4.5-4.0)[20+2(28)]}{3(20+28)} \right]$$

$$= \underline{78.8}$$

$$P_{hw} = \frac{4.0+4.5}{4} \left[ \frac{20+28}{2} (4.0-4.5) + 0.27[1(4)+1(4.5)] + [28+1(4.5)]4.5 - [20+1(4)]4 \right]$$

$$= \underline{86.2}$$

$$P_{hf} = \frac{76.5(0.01+0.01)}{4} \left[ [20+1(4)]4 + [28+1(4.5)]4.5 \right]$$

$$= \underline{92.7}$$

## VIII. OPEN-CHANNEL DESIGN

By Equation 8.23:

$$313.9+1635.2 = 181.3+1294.0+390.2\cos 6^\circ+78.8+86.2-92.7$$

$$1949.1 = \underline{1935.7} \quad (\text{close enough})$$

The momentum balance at this point is close enough to cease further iterations. Therefore, the hydraulic conditions at the end of the junction are as follows:

$$Q = 2775 \text{ cfs}$$

$$b_3 = 28.0 \text{ ft}$$

$$Y_3 = 4.5 \text{ ft}$$

$$Z = 1:1$$

$$F_3 = 1.7$$

$$V_3 = 19.0 \text{ fps}$$

$$A_3 = 146.3 \text{ ft}^2$$

Additional bank-protection height will be needed to accommodate this depth. A step-backwater computation may be used to compute the distance from the end of the junction to the point at which normal depth occurs.

## CHAPTER IX: CHANNEL STABILIZATION AND HYDRAULIC STRUCTURES

### 9.1 Introduction

Channel stabilization is used to control the horizontal and/or vertical alignment of a watercourse, whether natural or man-made. Hydraulic structures are used to control the flow of water. Hydraulic structures can be used for flow conveyance, such as with open channels, or for energy dissipation, such as with baffle blocks and/or drop structures. The purpose of using channel stabilization and hydraulic structures in conjunction with stormwater drainage is to reduce flood hazards and maintenance costs associated with the drainage of natural or urban runoff.

This chapter covers some of the design considerations for the most common channel-stabilization and hydraulic structures found within the City of Tucson.

### 9.2 Purpose

The purpose of this chapter is to provide guidelines for the design of stabilized channels, energy dissipators, and bridges. The design of other hydraulic structures, such as grade-control structures and cut-off walls, can be found in other chapters of this Manual.

Due to the complexity of some of the design procedures involved, it is not intended that this chapter of the Manual be complete in every respect. Other easily obtainable documents already contain adequate design procedures related to methods of channel stabilization and the use of hydraulic structures. For this reason, only basic design procedures for the more common applications are provided within this chapter of the Manual. The user should consult the Appendix to this Manual, entitled "Evaluation of Alternative Flood-Control and Erosion-Control Techniques for Watercourses in Tucson, Arizona," for detailed information concerning the subject topic. This Appendix provides information regarding the application of alternate forms of channel stabilization measures, in addition to the more common applications presented herein. Additionally, an Interim Watercourse Improvement Policy was adopted by the Tucson City Council on June 27, 1988, which provides guidelines for improvements made to watercourses within Tucson. The City Engineer should be contacted to obtain these policies, and any updates which may be made to them.

### 9.3 Stabilization Methods

The type of stabilization which may be best suited for a particular purpose will depend upon a variety of factors, including hydraulic conditions, economic factors, soil conditions, material availability, aesthetics, and compatibility with existing improvements at the site. A variety of stabilization methods are acceptable within their range of applicability. Stabilization methods which have been found to be acceptable for use within the City of Tucson include those described within the following paragraphs.

## IX. STABILIZATION/STRUCTURES

### 9.3.1 *Soil Cement*

Soil cement is a versatile material which has been widely used in this area for channel bank stabilization on regional watercourses. It may also be used to line channel bottoms, as well as for use in the construction of grade-control structures, collector dikes, and spillways. Soil-cement bank stabilization is normally placed on 1:1 slopes, and consists of six-inch to eight-inch vertical lifts, eight to ten feet in width, placed horizontally in a stair-step manner in order to attain the maximum level of protection. However, soil cement can also be placed on 3:1 (or flatter) slopes, at a minimum thickness of eight to twelve inches (dependent upon the mixing technique), where a lesser level of protection is permissible. This latter technique is often called soil-cement "slope paving."

### 9.3.2 *Concrete or Shotcrete*

Concrete or shotcrete channel linings are often used when flow velocities are high, or when it is necessary to maximize usable land area on a site. Concrete lining of the entire channel (i.e., both channel banks and bottom) is usually required for very high flow velocities and steep channel gradients. However, an earthen bottom and concrete-lined banks, with appropriately spaced grade-control structures, are the more standard stabilization measures employed within the City of Tucson along channels having milder gradients.

### 9.3.3 *Rock Riprap*

Rock-riprap stabilization consists of either dumped rock, or rock held in place with wire mesh and rail piles. Historically, this type of bank stabilization has not performed well on the major channels in the Tucson area, probably due to inadequate design and/or construction. However, with proper design and construction, riprap bank stabilization and energy dissipation structures are acceptable for use within the City of Tucson, if designed in accordance with the procedures presented within the following sections of this Manual. Methods of riprap design other than the one presented herein may also be used, provided they are first approved by the City Engineer.

#### 9.3.3.1 *Riprap Sizing*

When designing dumped-riprap bank protection, the chart provided on Figure 9.1, which graphically depicts the median size of riprap,  $D_{50}$ , versus the average velocity of flow *with the riprap in place*, shall be used to determine the minimum  $D_{50}$ , in feet, for the rock material utilized. Other methods of riprap design may be acceptable, with prior approval of the City Engineer. This chart shall be used to size riprap for either straight channels or channels with mild to severe curvature. The angle  $\alpha$  is defined as the angle made by the intersection of the centerline of the straight channel with a line tangent to the outside bend (see Chapter VI of this Manual, especially Figure 6.3). The chart provided on Figure 9.1 was developed under the assumption that the specific weight of the rock will be equal to 165 pounds per cubic foot. If rock of a substantially different specific gravity is to be used, the  $D_{50}$  should be adjusted by use of Equation 9.1.

Side Slope = 3:1 or Flatter

Stone Weight = 165 lbs per cubic foot

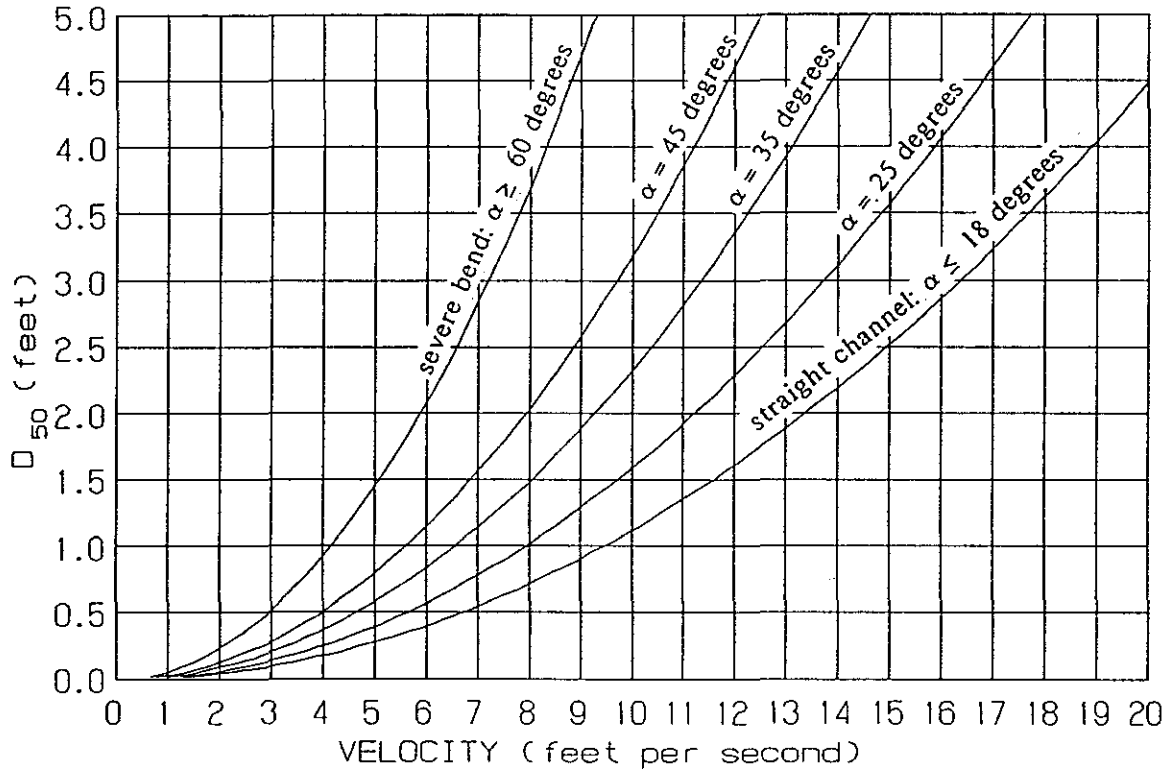

SOURCE : SIMONS, LI & ASSOCIATES, INC. (1988)

FIGURE 9.1

RIPRAP DESIGN CHART

## IX. STABILIZATION/STRUCTURES

$$k_r = \frac{102.96k}{\gamma_r - 62.4} \quad (9.1)$$

Where:

- $k$  =  $D_{50}$  from Figure 9.1, in feet;
- $k_r$  =  $D_{50}$  for rock to be used, in feet;
- $\gamma_r$  = Unit weight of rock to be used, in pounds per cubic foot.

Figure 9.1 also assumes that the riprap will be placed on channel banks having side-slopes no steeper than three feet horizontal to one foot vertical (3:1). For channels located within the City of Tucson, dumped riprap is not permitted as a method of bank protection on side-slopes steeper than 3:1. If side slopes steeper than 3:1 are required for rock bank protection, then the rock must be held in place with either wire mesh and piles or gabion baskets. Additionally, if either wire mesh and piles or gabions are utilized, then the rock size indicated by Figure 9.1 is no longer applicable. Rather, the rock must be of an adequate size such that it will not fall through the openings in either the wire mesh or gabion baskets; and the minimum thickness of such protection measures, measured normal to the embankment slope, should be equal to  $1.0D_{50}$  for wire-mesh structures, and  $0.67D_{50}$  for gabion baskets (where  $D_{50}$  is determined from Figure 9.1).

### 9.3.3.2 Riprap Gradation, Blanket Thickness, and Stone Shape

The gradation of rock riprap should follow a smooth curve. The ratio of the largest size rock to  $D_{50}$  should be about two, and the ratio of  $D_{20}$  to  $D_{50}$  should be about one-half. A riprap blanket shall have a minimum thickness of  $2.0D_{50}$ . However, a thickness of  $3.0D_{50}$  is recommended to offset the probable occurrence of segregation of the rock sizes when the rocks are simply machine dumped, rather than hand placed or keyed in place.

The shape of the riprap stone should be "blocky," rather than elongated. More nearly cubical stones "nest" together, and are more resistant to movement. Also, stones with sharp, clean edges and relatively flat faces will form a riprap mass having an angle of internal friction greater than rounded stones, and therefore will be less susceptible to slope failures. The following shape specifications are suggested for riprap obtained from quarry operations:

1. The stone shall be predominantly angular in shape.
2. Not more than 25 percent of the stones reasonably distributed throughout the gradation shall have a length more than 2.5 times the breadth or thickness.
3. No stone shall have a length exceeding 3.0 times its breadth or thickness.

## IX. STABILIZATION/STRUCTURES

### 9.3.3.3 Riprap Filters

Filters are generally required underneath rock riprap to prevent fine material from being leached out through the riprap. Two types of filter materials are commonly used: gravel filters and fabric filters. Gravel filters consist of a layer of well-graded sands and gravels. Generally, the thickness of a gravel filter should not be less than nine inches, and may vary depending upon the riprap thickness. A suggested specification for a gravel-filter gradation is as follows (Federal Highway Administration, 1975):

$$\frac{D_{50} \text{ (filter)}}{D_{50} \text{ (base)}} < 40 \quad (9.2)$$

$$5 < \frac{D_{15} \text{ (filter)}}{D_{15} \text{ (base)}} < 40 \quad (9.3)$$

$$\frac{D_{15} \text{ (filter)}}{D_{85} \text{ (base)}} < 5 \quad (9.4)$$

Fabric filter cloths have been used beneath riprap and other revetments with good success. Although some care must be exercised in placing large rocks on the fabrics, it is generally much easier and more economical to install a fabric filter than a gravel filter. Unfortunately, a fabric filter will also preclude the growth of vegetation through the riprap.

### 9.3.4 Gabion Baskets and Mattresses

Gabion baskets and mattresses are specially designed wire-mesh containers for rock-riprap stabilization. Gabions are generally used when adequate rock size or gradation is unavailable for ordinary dumped riprap. Additionally, gabion structures can be constructed on much steeper slopes than dumped rock, and will therefore generally require less right-of-way. In general, the thickness of a gabion basket should equal two-thirds of the diameter of the  $D_{50}$  rock size (i.e.,  $0.67D_{50}$ ) for ordinary dumped riprap (where  $D_{50}$  is determined from Figure 9.1). Additionally, an adequate gravel or fabric filter should always be installed with gabions.

### 9.3.5 Articulated Revetment Units

Articulated revetment units (ARUs) are a stabilization material which is composed of a system of interlocking concrete blocks which may be used to line drainageways. ARUs have limited application in this area, and are used primarily on small watercourses (e.g., drainage swales) which have very flat side-slopes and very low velocities of flow.



## IX. STABILIZATION/STRUCTURES

### 9.3.6 *Other Forms of Channel Stabilization*

Other, less common, forms of channel stabilization may also be acceptable to the City of Tucson, provided that it can be demonstrated that the particular stabilization method proposed is capable of withstanding the hydraulic conditions which can occur within the channel during larger flow events.

## 9.4 Energy Dissipators

"Energy dissipator" is a term which encompasses a wide variety of hydraulic structures that are intended to dissipate the kinetic energy of flowing water. It becomes necessary to dissipate this energy when flow velocities are such that excessive erosion or damage to channels and hydraulic structures is likely. Unacceptably high flow velocities generally occur at locations where the energy slope of the flow becomes very steep. Examples include drop structures, spillways, drop inlets, constrictions at culverts and bridges, etc. The type of energy dissipator which is appropriate for a particular installation will depend upon a number of factors, including hydraulics, economics, potential damage to structures, surrounding improvements, and the environment. The following sections provide guidelines and suggested reference material for use in the analysis and design of various energy-dissipator structures.

### 9.4.1 *Culvert Outlets*

Energy dissipators are frequently needed at culvert outlets for the reason that culverts concentrate flow and increase flow velocities. Concentrated, high-velocity flow is erosive, and scour holes will form at culvert outlets unless protective measures are taken. The potential size of a scour hole can be determined according to the procedures described in Chapter VI of this Manual. Should energy dissipation be necessary at a culvert outlet, there are several designs that could be effectively used. Among these are riprap plunge basins, stilling basins, impact basins, and drop structures. Detailed design procedures for these energy-dissipating devices can be found in publications of the U. S. Bureau of Reclamation (1964), and the Federal Highway Administration (1983).

### 9.4.2 *Channel Outlets*

Where a narrow, lined channel ends at an unlined or natural channel, energy dissipation may be needed to prevent erosion from the release of concentrated flow. As with culvert outlets, there are many types of energy dissipators that can be used, such as flow spreaders, pre-formed scour holes, and stilling basins. The references for this chapter, which are listed at the end of this Manual, can also be used to design energy dissipators at channel outlets.

### 9.4.3 *Channel Drops*

Channel drops are places where the bed of a channel makes an abrupt drop in a very short distance. Headcuts are examples of channel drops in unlined channels. Protection against the energy dissipation of low channel drops often can be provided by merely increasing the toe-down on the bank protection and drop structure, as is

## IX. STABILIZATION/STRUCTURES

done with most grade-control structures. Higher drops require energy-dissipation structures.

Energy-dissipation structures for channel drops normally take the form of chutes with baffle blocks or stilling basins (U.S. Bureau of Reclamation, 1964; Federal Highway Administration, 1983). Examples of energy dissipators for channel drops within the City of Tucson are located on the Kinnison Wash at Lakeside Park, the Pantano Wash at Broadway Boulevard, and the Airport Wash west of Interstate 19.

### 9.4.4 Seepage Forces

Seepage forces occur whenever there is flow through the bed and banks of a channel formed in permeable alluvium. The flow through the interface between the water and the channel wall depends upon both the difference in pressure across the interface and the permeability of the bed material. Seepage forces can act to reduce the effective weight and stability of the bed and bank materials.

Seepage forces may create an upward hydrostatic pressure on structures (uplift). The magnitude and distribution of seepage forces in a foundation, as well as the amount of underseepage for a given coefficient of permeability, can be obtained utilizing a coefficient from a flow net. The Weighted-Creep Theory, as developed by Lane (1935), is suggested as a means for designing hydraulic structures on pervious foundations so that they will be safe against uplift pressures and piping. Lane's theory defines the weighted-creep ratio as:

$$C_{rw} = \frac{\Sigma L_H + 3\Sigma L_V}{3H} \quad (9.5)$$

Where:

- $C_{rw}$  = Weighted-creep ratio;
- $L_H$  = Horizontal, or flat, contact distance (flatter than 45°), in feet;
- $L_V$  = Vertical, or steep, contact distance (steeper than 45°), in feet; and,
- $H$  = Head on structure (headwater - tailwater), in feet.

Lane's recommended weighted-creep ratios for various foundation materials are given in Table 9.1. An example of the application of Lane's Weighted-Creep Theory is provided in "Design of Small Dams" (U.S. Bureau of Reclamation, 1977, pp. 341-342).

Piping under the structure foundation occurs when the upward seepage force at the downstream toe of the structure exceeds the submerged weight of material. The soil is flooded out and the erosion progresses backwards along the seepage flowline until a "pipe" is formed, allowing rapid flow under the foundation and subsequent failure of the structure.

## IX. STABILIZATION/STRUCTURES

TABLE 9.1: WEIGHTED-CREEP RATIOS

Material	$C_{rw}$
Very fine sand and silt	8.5
Fine sand	7.0
Medium sand	6.0
Coarse sand	5.0
Fine gravel	4.0
Medium gravel	3.5
Coarse gravel, including cobbles	3.0
Boulders, with some cobbles and gravel	2.5
Soft clay	3.0
Medium clay	2.0
Hard clay	1.8
Very hard clay or hardpan	1.6

Cutoff walls, aprons, and drains are generally installed to control the amount of seepage under the structure, and to limit the intensity of the uplift so that the stability of the structure will not be threatened.

### 9.5 Bridges

In general, bridges should be designed to have as little effect as possible upon the flow passing beneath them. If possible, bridges over constructed channels should be designed so that there is no disturbance to the flow whatsoever. Impacts upon natural floodplains created by bridges usually take the form of increased water-surface elevations upstream of bridges, increased flow velocities through and downstream of bridges, increased scour at and in the vicinity of bridges, and increased deposition upstream of bridges.

## IX. STABILIZATION/STRUCTURES

### 9.5.1 *Hydraulic Analysis*

The hydraulic analysis of bridge encroachments in the floodplain is best performed using a computerized step-backwater model. Cross sections for the model must be taken 1) at a sufficient distance downstream of the bridge so that the bridge has no effect upon flow characteristics; 2) at the downstream face of the bridge; 3) at the upstream face of the bridge; and 4) a sufficient distance upstream of the bridge opening so that the bridge has no effect upon flow characteristics. Normal coefficients of expansion and contraction are not applicable, and must be increased in order to account for the constriction of the bridge opening. Publications of the Federal Highway Administration (1978a, 1978b) and the U.S. Army Corps of Engineers (1982) give detailed descriptions of the hydraulics of bridge openings.

### 9.5.2 *Scour*

Increased flow velocities through bridge openings and the presence of obstructions in the flow path make scour a prime concern in bridge design. The effects of scour can be counteracted by providing deep toe-downs on bridge piers and abutments, and by constructing spur dikes or jetties (Federal Highway Administration, 1978a).

### 9.5.3 *Freeboard*

Freeboard at a bridge is the vertical distance between the design water-surface elevation and the low-chord of the bridge. The bridge low-chord is the lowest portion of the bridge deck structure. The purpose of freeboard is to provide room for the passage of floating debris, to provide extra area for conveyance in the event that debris build-up on the piers reduces hydraulic capacity of the bridge, and to provide a factor of safety against the occurrence of waves or floods larger than the design flood. The minimum freeboard, in feet, at bridges across regional watercourses located within the City of Tucson shall be no less than the value  $0.88(V^2/2g)$ , plus four feet, where  $V$  represents the average velocity of flow approaching the bridge structure. Along other watercourses, the minimum bridge freeboard, in feet, shall be no less than the value  $0.88(V^2/2g)$ , plus one foot.

## 9.6 Structure Aesthetics

The appearance of a drainage structure is very important relative to the acceptability of the structure by the public, and especially to the neighborhood in which the structure is to be built. The design engineer should therefore consider aesthetics whenever designing drainage structures. Methods of making drainage structures more aesthetically pleasing could include landscaping with vegetation alongside the drainageway, providing linear parks or pedestrian walkways, using soil cement instead of concrete, constructing compound channels, installing rail fences, and using stained concrete. Both the City of Tucson Watercourse Improvement Policy, adopted by the Tucson City Council on June 27, 1988, and the Appendix to this Manual should be referred to for more detail regarding alternate methods of constructing drainage structures.

## **IX. STABILIZATION/STRUCTURES**

**This page intentionally left blank.**

## CHAPTER X: STORM DRAINS

### 10.1 Purpose

The purpose of this chapter is to provide guidelines for the hydrologic and hydraulic analysis and design of storm drains. Hydrologic analysis consists of establishing the design discharge at specific points along the storm-drain system. Hydraulic design consists of inlet and conduit sizing, as well as quantifying various other storm-drain components, such as outlet works, conduit grade, junctions, transitions, etc.

### 10.2 Introduction

The primary purpose for the construction of storm drains is to remove stormwater runoff from streets and parking lots in as efficient a manner as possible. Water on street pavement can be a severe traffic hazard due to hydroplaning and loss of visibility from splash and spray. Pondered water in sumps can be especially hazardous due to the loss of vehicular control which results from one wheel catching the pondered water and the other remaining on drained pavement. Water on streets also causes traffic delays which result in loss of time and money. Storm drains are designed to reduce these risks to acceptable levels.

There are many reference sources available for storm-drain design. Some of these are listed in the "References and Selected Bibliographies" section of this Manual. Portions of this chapter were taken from these sources--primarily from the Federal Highway Administration (1984) and the Arizona Department of Transportation (1975). It is the purpose of this chapter to provide sufficient information for basic storm-drain design which will be applicable to most situations that will be found in the City of Tucson. More-detailed information can be found in the listed references, if a design situation should arise that is not covered in this manual. Where information in other references conflicts with this manual, the guidelines presented herein must be used, unless prior approval to the contrary is obtained, in writing, from the City of Tucson Engineering Division.

A storm-drain system designed for street drainage consists of a series of inlets designed to intercept street flow and convey it in an underground conduit to some logical outlet, such as a natural watercourse. Curbs, gutters, and transverse street slopes all function together to collect the water along either one or both sides of a street, where it can drain into the inlets. In order to understand how the complete storm-drain system operates, it is first necessary to understand how the individual components function. For this reason, design discharge and hydrology, street and gutter flow, and pavement inlet capacity and pipe flow are discussed in detail prior to presenting the overall design procedure.

### 10.3 Policies

Although there are many *technical* guidelines listed in this chapter regarding storm-drain design, there are also several other guidelines that could be considered as the *policies* which form the basis for storm-drain design in the City of Tucson. These policies are as follows:

## X. STORM DRAINS

1. The City of Tucson Hydrology method shall be used for storm-drain design, unless another method is approved in advance, and in writing, by the City of Tucson Engineering Division.
2. All offsite runoff, from whatever source, must be taken into account in storm-drain design, if the runoff could affect the street which the storm drain is designed to service.
3. Storm drains on arterial streets must keep at least one lane of traffic free from runoff during a 10-year flow. On lesser streets, storm drains must keep at least the 10-year flow between the curbs along the street.
4. The minimum pipe size allowable for public storm-drain systems is eighteen inches, unless otherwise approved in advance, and in writing, by the City of Tucson Engineering Division. In general, main-line sewers should be at least twenty-four inches in diameter.
5. Public storm drains may be designed for either open-channel or pressure flow, unless debris or the depth of cover is expected to be a problem. However, prior approval is required, in writing, from the City of Tucson Engineering Division if the storm drain is to be designed for open-channel flow conditions.
6. The self-cleaning flow velocity in storm drains shall be a minimum of three feet per second at a flow depth equal to 0.15 the pipe diameter.
7. The minimum allowable storm-drain slope for concrete pipe or smooth metal pipe shall be 0.1 percent. However, it is desirable that a slope of not less than 0.3 percent be maintained for all storm-drain pipe, whenever possible.
8. The minimum right-of-way width for storm drains should be the pipe diameter plus ten feet on each side of the pipe, unless a different right-of-way width is approved in advance, and in writing, by the City Engineer.
9. Public storm sewers shall be either RCP or an approved equal, except where CMP is required for the installation of vein drains or similar structures.

### 10.4 Design Discharge and Hydrology

Because storm drains are relatively expensive in comparison to surface-drainage systems, it is not often economically justifiable to design them for infrequent flow events, such as a 100-year flood. Where pavement drainage is concerned, the design is usually based upon keeping a specified width of pavement free from flow during a defined return-period runoff event. City of Tucson Development Standards (3.01.3.7A & B) require that, on arterial streets, storm drains be adequately designed to keep at least one lane of traffic, in each direction, free from accumulated runoff during a 10-year runoff event. On lesser streets, storm drains are required only if the 10-year runoff event cannot be contained between the curbs of the street.

## X. STORM DRAINS

There are other purposes for storm drains, such as drainage of detention basins or parking lots. The specified design discharge for these purposes may vary. In such cases, the design discharge would depend upon the particular situation, as well as the needs of the developer and/or regulatory agency.

Discharges and times of concentration for storm-drain inlets shall be computed according to the guidelines found in Chapter IV of this Manual, "City of Tucson Method for Estimating Flood Peaks and Flood Hydrographs". Where discharges less than the 100-year flood are required, as will be the case most of the time for storm drains, the appropriate ratios for peak flow rates, and corresponding formulas for their times of concentration, should be used at inlets.

### 10.5 Street and Gutter Flow

Flow in a street and gutter is normally confined by a curb, usually six to eight inches in height. The street-and-gutter cross section is generally either triangular or compound. A triangular section has a continuous grade, normally two percent, from the base of the curb to the crown of the roadway. The roadway surface can be one material, such as asphalt, from the base of the curb to the crown. However, it is not uncommon to install a concrete gutter adjacent to the curb. A typical compound section has a 1.75-foot-wide concrete gutter at a 4.8% grade adjacent to the curb, then a flatter (usually 2%) pavement grade to the roadway crown.

The capacity of a gutter depends upon its cross-sectional geometry, grade, and roughness. Grade and roughness are normally fixed by the topography and other design considerations. Consequently, cross-sectional geometry is usually the most flexible variable when increased capacity is desired.

The Manning equation should not be applied to flow in shallow, triangular gutter sections without modification, since the term for the hydraulic radius does not adequately describe the gutter cross section. Instead, the following equation should be used to compute gutter flow, rather than the conventional Manning equation:

$$Q = 0.56 \left[ \frac{Z S_o^{1/2} Y^{8/3}}{n} \right] \quad (10.1)$$

or

$$Q = 0.56 \left[ \frac{S_x^{5/3} T^{8/3} S_o^{1/2}}{n} \right] \quad (10.2)$$



## X. STORM DRAINS

Where:

- $Q$  = Discharge, in cubic feet per second;
- $n$  = Manning's roughness coefficient (see Table 10.1);
- $S_o$  = Longitudinal slope, in feet per foot;
- $S_x$  = Cross-slope of pavement, in feet per foot;
- $Y$  = Flow depth at curb, in feet;
- $T$  = Top width of water surface, in feet (commonly referred to as "spread"); and,
- $Z$  = Invert of pavement cross-slope, in feet per foot =  $1/S_x$ .

**TABLE 10.1: MANNING'S ROUGHNESS COEFFICIENT ("n") FOR STREETS AND GUTTERS**

Description	n-value
A. Concrete Gutter (Troweled Finish)	0.012
B. Asphalt Pavement	
(1) Smooth Texture	0.013
(2) Rough Texture	0.016
C. Concrete Gutter With Asphalt Pavement	
(1) Smooth	0.013
(2) Rough	0.015
D. Concrete Pavement	
(1) Float Finish	0.014
(2) Broom Finish	0.016
E. Brick	0.016
For gutters with small slopes (i.e., $\leq 0.3\%$ ), where sediment may accumulate, increase all values of "n" listed above by 0.002.	

Equations 10.1 and 10.2 apply only to streets with a uniform cross-slope. The solution to the equations can be obtained arithmetically, or by using the nomograph in Figure 10.1. Flow in composite gutters can be computed by breaking the cross-sectional area of flow into a triangular section and a trapezoidal section, and using the following formulas:

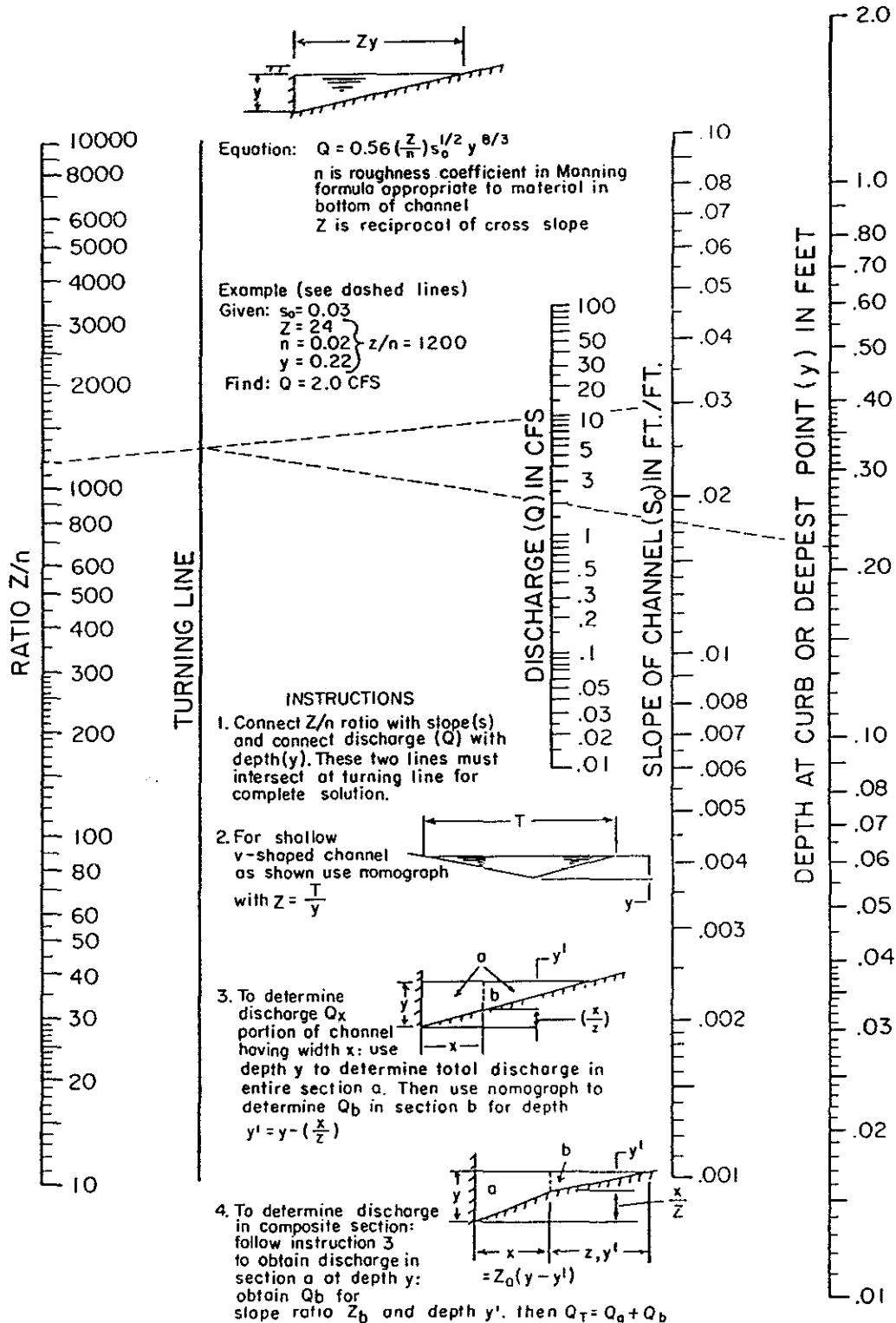

FIGURE 10.1  
 NOMOGRAPH FOR FLOW IN A WIDE, SHALLOW TRIANGULAR CHANNEL

## X. STORM DRAINS

### TRIANGULAR SECTION:

$$Q = 0.56 \left[ \frac{Y^{5/3} S_o^{1/2} T}{n} \right] \quad (10.3)$$

### TRAPEZOIDAL SECTION:

$$Q = 0.56 \left[ \frac{S_o^{1/2} T}{n} \right] \left[ \frac{Y_{cf}^{8/3} - Y_{gb}^{8/3}}{Y_{cf} - Y_{gb}} \right] \quad (10.4)$$

The variables  $Y$ ,  $Y_{cf}$ ,  $Y_{gb}$ , and  $T$  are defined as shown in Figure 10.2. All remaining variables are as defined for Equations 10.1 and 10.2, and as shown on Figure 10.2.

The nomograph in Figure 10.1 can also be used to compute flow in composite gutter sections.

When gutters are on a continuous grade, the depth of flow at the curb affects the capacity of curb inlets. Correspondingly, the discharge across the width of a grate inlet determines grate capacity. Thus, the ideal gutter section for hydraulic efficiency will carry the design discharge concentrated near the curb, and at the greatest practical depth. This is more effectively accomplished with a composite section, rather than a triangular section. The recommended composite section has a 1.75-foot-wide concrete gutter, with a one-inch drop from the edge of the gutter to the base of the curb. Gutters with composite cross sections have the added advantage of carrying more water than triangular gutters, and without increasing the spread of water on the street.

Pavement cross sections in older streets are often more closely parabolic than triangular. Where the parabolic cross section rises upward from the base of a curb to a crown, it can be described by the following equation:

$$Z_p = 2 \left[ \frac{x H_c}{B_p} \right] - \left[ \frac{x^2 H_c}{B_p^2} \right] \quad (10.5)$$

Where:

- $Z_p$  = Vertical rise of the pavement elevation along distance  $x$  of a parabolic curve, in feet.
- $x$  = Horizontal distance from the base of curb ( $x \leq B_p$ ), in feet; and,
- $H_c$  = Crown height of pavement cross section, in feet;
- $B_p$  = Horizontal distance from the base of curb to the crown, in feet;

TRIANGULAR SECTION

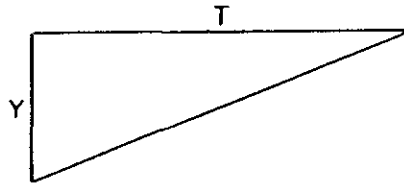

$$Q = \frac{0.56}{n} Y^{5/3} S_o^{1/2} T$$

TRAPEZOIDAL SECTION

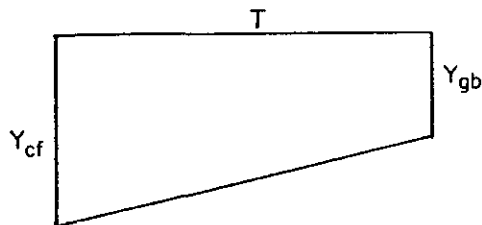

$$Q = \frac{0.56}{n} S_o^{1/2} T \left[ \frac{Y_{cf}^{8/3} - Y_{gb}^{8/3}}{Y_{cf} - Y_{gb}} \right]$$

FIGURE 10.2  
COMPOSITE GUTTER SECTIONS

## X. STORM DRAINS

To determine total gutter flow, the cross section is divided into segments of equal width, and the discharge for each segment is computed by Manning's equation. The parabola can be approximated very closely by two-foot-wide segments. The total discharge is the sum of the discharges in all segments. This procedure is illustrated by Example 10.13.1, found at the end of this chapter.

Some streets within the City of Tucson have inverted crowns (i.e., the lowest point is at the center of the street, instead of at the curb). Discharge for this type of street cross section can be estimated using the following procedures.

For a parabolic cross section, use Manning's equation, along with the following relationships:

$$\text{Area } (A) = 2/3TY, \text{ in square feet;} \quad (10.6)$$

$$\text{Wetted perimeter } (P) = T + 8/3 \left[ \frac{Y^2}{T} \right], \text{ in feet;} \quad (10.7)$$

$$\text{Top Width } (T) = 3/2 \left[ \frac{A}{Y} \right], \text{ in feet; and,} \quad (10.8)$$

$$\text{Hydraulic Depth } (Y_h) = 2/3 Y, \text{ in feet.} \quad (10.9)$$

Where:

$Y$  = Maximum Depth, in feet.

However, it should be noted that, within the City of Tucson, streets with inverted crowns are normally built using a triangular cross section. For flow in a triangular inverted-crown section, use either Equation 10.3 or the nomograph shown in Figure 10.1.

### 10.6 Pavement Inlets

The capability of pavement inlets to quickly remove water from the street and into a storm drain depends upon their inlet geometry and upon the flow characteristics in the street and gutter. Pavement inlets are normally divided into the following three general types, with each having many variations:

1. Grate inlets: These inlets consist either of an opening in the gutter, covered by one or more grates, or an opening which spans the entire width of pavement (i.e., a "street grate").

## X. STORM DRAINS

2. Curb inlets: These inlets consist of a vertical opening in the curb, through which the gutter flow passes.
3. Combination inlets: These inlets consist of a curb inlet and a grate inlet acting as a single unit.

Grate inlets are most effective where clogging due to debris is not a problem. Excluding the effect of debris, the inlet capacity of grates in a sag condition depends mainly upon the open area of the grate and upon the depth of ponding. Capacity of grate inlets on a continuous grade depends primarily upon the discharge flowing directly over the grate, and upon the length and type of grate.

Grate inlets become more effective in relation to curb inlets as the grade of the roadway increases. *On grades of over three percent, grate inlets should be used instead of curb inlets.* Grates are also useful where cross-slopes for depressed gutters at curb inlets are not desirable, from a traffic standpoint, and at locations other than the edge of curb. For instance, grates are commonly used to collect flow at the middle of an inverted street.

The most efficient types of grates on a continuous grade are those which have all bars parallel to the direction of flow. Unfortunately, these grates typically are not safe for bicyclists; and therefore are *not permitted* to be used on City streets. However, there are many varieties of "bicycle-safe" grates which can be used on City streets (the interested reader should refer to a publication by the American Society of Civil Engineers and the Water Pollution Control Federation, 1987).

Curb inlets have few clogging problems; and they are most effective on relatively flat grades, where the depth of flow is sufficient for the inlet to perform efficiently. The interception capacity of curb inlets is largely dependent upon flow or ponding depth at the curb, and upon the length and height of the curb inlet. The flow-interception capacity is increased by a gutter depression at the curb inlet, or a depressed (composite) gutter to increase the proportion of the total flow adjacent to the curb. Top-slab supports can decrease the capacity of an inlet, if placed flush with the opening. Supports should be recessed several inches from the curb line.

One advantage to curb inlets is that they pose little threat to bicyclists. A disadvantage is that the openings are relatively wide, and could pose a danger to children. Therefore, it is recommended that curb inlets with a height of six inches or more be fitted with cross bars. Another disadvantage of curb inlets is that the depression adjacent to them could be hazardous to traffic at some locations.

Combination inlets can be very effective if the grate is placed at the downstream end of the structure--thereby allowing the curb inlet to collect the debris before it can clog the grate. The design capacity of these structures is the sum of the individual design capacities. If the curb inlet and grate are placed adjacent to each other, the total design capacity is only that of the grate alone.

## X. STORM DRAINS

Capacity charts for grate and curb inlets are widely available. However, due to the variety of configurations on the market, it is considered more useful here to merely present the basic relationships under which they operate.

### 10.6.1 Capacity of a Grate Inlet in a Sag

At low-water depths, a grate inlet in a sag operates as a weir, with a crest length equal to the outside perimeter of the grate along which the flow enters. Weir operation continues to a depth of about 0.4 foot above the top of grate, and the discharge intercepted by the grate is:

$$Q_i = 3.0 P_g Y^{3/2} \quad (10.10)$$

Where:

- $Q_i$  = Rate of discharge into the grate opening, in cubic feet per second;
- $P_g$  = Perimeter of grate opening, in feet, disregarding bars and neglecting the side against the curb, if present; and,
- $Y$  = Depth of water at the grate, in feet.

When the depth at the grate exceeds about 1.4 feet, the grate begins to operate as an orifice, and the discharge intercepted by the grate is:

$$Q_i = 5.35 AY^{1/2} \quad (10.11)$$

Where:

- $Q_i$  = Rate of discharge into the grate opening, in cubic feet per second;
- $A$  = Clear-opening area of the grate, in square feet; and,
- $Y$  = Depth of ponded water above the top of grate, in feet.

For depths over the grate between about 0.4 feet and about 1.4 feet, the operation of the grate inlet is indefinite. In this case, the depth of flow should be computed by both equations. The equation which yields the higher of the two values for depth should then be used for design purposes.

If the grate is sloped such that the side away from the curb is considerably higher than the curb side, the side inflow and end inflow should be computed separately. Inflow over the end of a grate, when it is operating as a weir, should be computed from:

$$Q_e = 2/5 \left[ \frac{CL}{Y_2 - Y_1} \right] \left[ Y_2^{5/2} - Y_1^{5/2} \right] \quad (10.12)$$

## X. STORM DRAINS

Where:

- $Q_e$  = Rate of discharge over the end of the grate opening, in cubic feet per second;
- $Y_1$  = Depth of flow at the shallow side of the grate, in feet;
- $Y_2$  = Depth of flow at the deep side of the grate, in feet;
- $L$  = Distance from  $Y_1$  to  $Y_2$ , in feet; and,
- $C$  = Weir coefficient = 3.0.

Total interception of the flow is then computed by summing the flows calculated at each end of the grate opening, using Equation 10.12, with the flow calculated on each side of the grate opening, using Equation 10.10.

When a sloped grate is operating under conditions of orifice flow, the following equation should be used to compute its interception capacity:

$$Q_i = 3.60 \left[ \frac{A}{Y_2 - Y_1} \right] \left[ Y_2^{3/2} - Y_1^{3/2} \right] \quad (10.13)$$

Where all terms are as previously defined within Equation 10.11 and Equation 10.12.

### 10.6.2 Capacity of a Curb Inlet in a Sag

A curb inlet in a sag operates as a weir to depths up to the height of the curb inlet, and as an orifice at depths greater than 1.4 times the opening height. Between those depths, flow is in a transition stage.

The equation for computing the interception capacity of a curb inlet *without a depression* which operates as a weir is:

$$Q_i = 2.3 LY_i^{3/2} \quad (10.14)$$

Where:

- $L$  = Length of curb inlet, in feet; and,
- $Y_i$  = Depth at lip of curb inlet, in feet (i.e.,  $Y_i = TS_x$ ).

The equation for computing the interception capacity of a *depressed* curb inlet which operates as a weir is:

$$Q_i = 2.3 (L + 1.8W)Y_i^{3/2} \quad (10.15)$$



## X. STORM DRAINS

Where:

$W$  = Lateral width of depression, in feet; and all other terms are as previously described.

Equation 10.15 is applicable to depths at the curb which are approximately equal to the height of the opening, plus the depth of the depression.

Curb inlets operate as orifices at depths greater than  $1.4(h)$  (see Figure 10.3). The equation for interception capacity is then:

$$Q_i = 5.35A(Y_i - h/2)^{1/2} \quad (10.16a)$$

or

$$Q_i = 5.35 AY_o^{1/2} \quad (10.16b)$$

Where:

$Y_o$  = Effective head on the center of the orifice throat, in feet;

$A$  = Clear area of opening, in feet;

$Y_i$  = Depth at lip of curb inlet, in feet;

$h$  = Height of curb-inlet orifice, in feet; and,

$L$  = Length of curb inlet, in feet.

Figure 10.3 gives the relationship between the variables for horizontal-throat, inclined-throat, and vertical-throat inlets.

Curb-inlet capacity in the transition stage, when ponding depth is 1.0 to 1.4 times the opening height, should be computed using both the weir equation and the orifice equation. The equation which yields the lesser discharge at equal head should then be used for design purposes.

### 10.6.3 Capacity of a Combination Inlet in a Sag

When weir-flow applies, the interception capacity of a combination inlet in a sag, consisting of a grate and a curb inlet, is essentially equal to the capacity of the grate only, unless the grate becomes clogged. In orifice flow, the capacity is equal to the capacity of the grate, plus the capacity of the curb inlet.

### 10.6.4 Capacity of a Slotted Inlet in a Sag

A slotted inlet in a sag normally operates as a weir to depths of about 0.2 feet. At depths greater than about 0.4 feet, it performs as an orifice. Between these depths, the more conservative of the two equations (i.e., the one which predicts the greatest depth) should be used for design purposes. The interception capacity,  $Q_i$ , of a slotted inlet operating as an orifice should be computed from:

$$Q_i = 6.42 LWY^{1/2} \quad (10.17)$$

X. STORM DRAINS

$$Q = 5.35hLY_o^{1/2}$$

L = Length of Opening

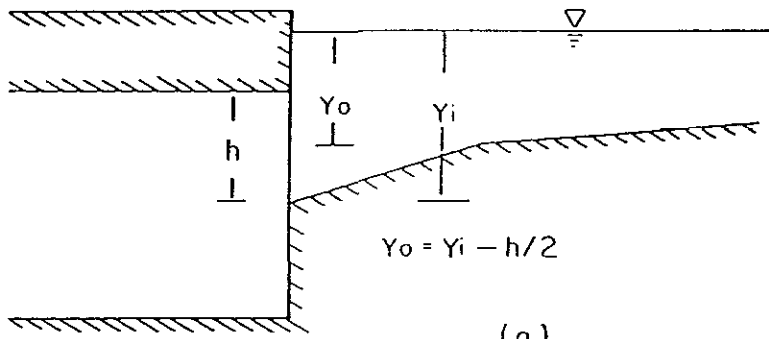

(a)  
HORIZONTAL THROAT

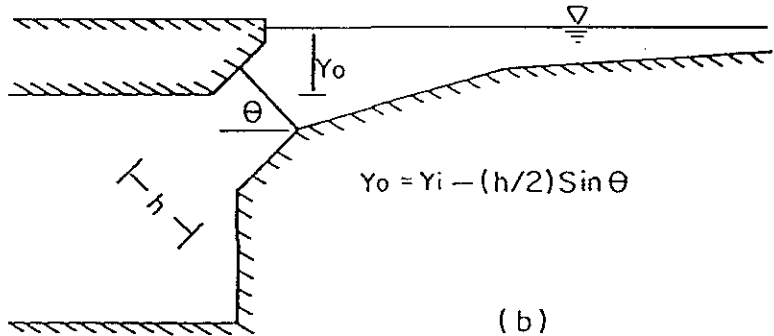

(b)  
INCLINED THROAT

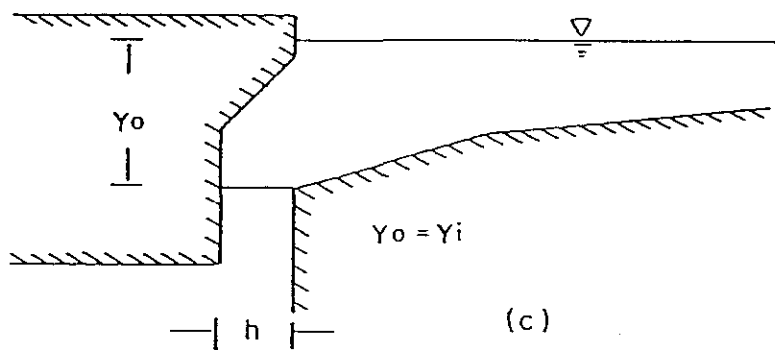

(c)  
VERTICAL THROAT

FIGURE 10.3  
CURB-OPENING INLETS

## X. STORM DRAINS

Where:

- $L$  = Length of slot, in feet;
- $W$  = Width of slot, in feet; and,
- $Y$  = Depth of water at slot, in feet.

### 10.6.5 Capacity of a Grate Inlet on a Continuous Grade

A grate inlet on a continuous grade will intercept all of the frontal flow passing over the grate, unless the grate becomes clogged or splash-over occurs. Splash-over will occur, and only a portion of the frontal flow will be intercepted, if the velocity is high or the grate is short. Normally, a small part of the flow along the side of the grate will also be intercepted. Therefore, the total capacity of a grate is the sum of the frontal flow and the side flow, minus the splash-over flow.

The amount of frontal flow,  $Q_f$ , should be computed with the following equation:

$$\frac{Q_f}{Q_T} = E_o = 1 - (1 - W/T)^{8/3}$$

Where:

- $Q_f$  = Frontal flow at width  $W$ , in cubic feet per second;
- $Q_T$  = Total gutter flow, in cubic feet per second;
- $W$  = Width of grate, in feet;
- $T$  = Total spread of water at the gutter, in feet; and,
- $E_o$  = Ratio of frontal flow to total gutter flow.

Figure 10.4 provides a graphical solution of the frontal-flow equation.

The ratio,  $R_f$ , of frontal flow intercepted,  $Q_{fi}$ , to total frontal flow,  $Q_f$ , is expressed by:

$$\frac{Q_{fi}}{Q_f} = R_f = 1 - 0.09 (V - V_o) \quad (10.19)$$

Where:

- $V$  = Velocity of flow in the gutter, in feet per second; and,
- $V_o$  = Gutter velocity at which splash-over first occurs, in feet per second.

$V_o$  is different for different grates, and must be determined experimentally. Figure 10.5 gives splash-over velocities for several common grate types and sizes described in a publication by the American Society of Civil Engineers and Water Pollution Control Federation (1987). Figure 10.5 also provides a graphical solution to the ratio of frontal flow captured to total frontal flow.

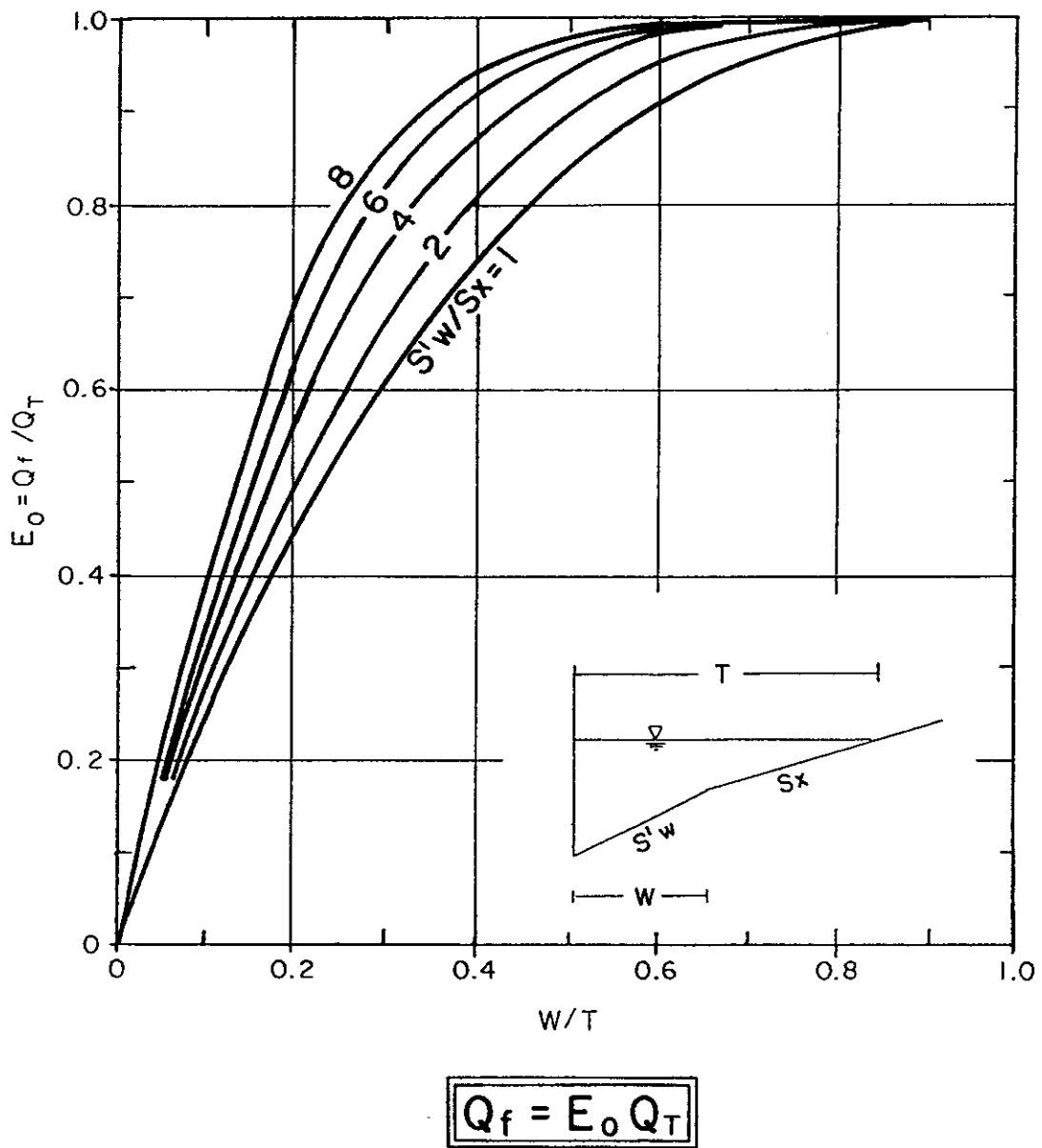
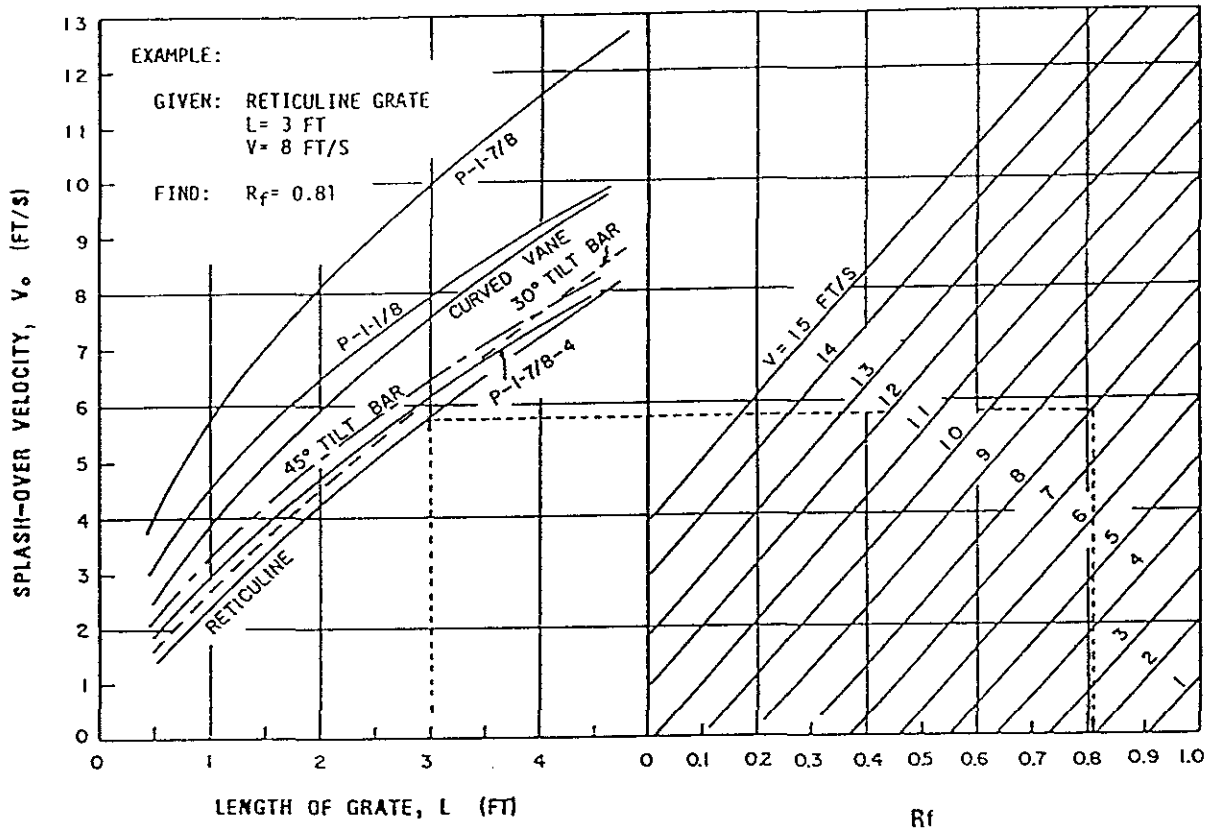

FIGURE 10.4  
RATIO OF FRONTAL FLOW TO TOTAL GUTTER FLOW

# X. STORM DRAINS



$$Q_{fi} = R_f Q_f$$

FIGURE 10.5  
 FRONTAL-FLOW INTERCEPTION EFFICIENCY FOR GRATE INLETS

## X. STORM DRAINS

The amount of side flow,  $Q_s$ , is equal to the total flow minus the frontal flow (i.e.,  $Q_s = Q_T - Q_f$ ).

The ratio,  $R_{sf}$ , of side flow intercepted,  $Q_{si}$ , to total side flow,  $Q_s$ , is given by:

$$\frac{Q_{si}}{Q_s} = R_{sf} = \left[ 1 + \frac{0.15 V^{1.8}}{S_x L^{2.3}} \right]^{-1.0} \quad (10.20)$$

Where:

$L$  = Length of the grate, in feet, and the other terms are as previously defined.

Note the negative exponent in this equation. Figure 10.6 provides a graphical solution to this equation.

The total interception capacity ( $Q_i$ ) of a grate inlet on a continuous grade is therefore equal to:

$$Q_i = R_f Q_f + R_{sf} Q_s \quad (10.21)$$

### 10.6.6 Capacity of a Curb Inlet on a Continuous Grade

The length of a curb inlet required for total interception of gutter flow on a pavement section with a straight cross-slope (i.e., no gutter depression) is expressed by:

$$L_t = 0.6 \left[ Q_T^{0.42} S_o^{0.3} \right] \left[ \frac{1}{n S_x} \right]^{0.6} \quad (10.22)$$

Where:

$L_t$  = Curb-inlet length required to intercept 100 percent of the gutter flow, in feet;

$S_x$  = Pavement cross-slope, in feet per foot;

$S_o$  = Longitudinal slope of gutter, in feet per foot; and,

$n$  = Manning's roughness coefficient.

# X. STORM DRAINS

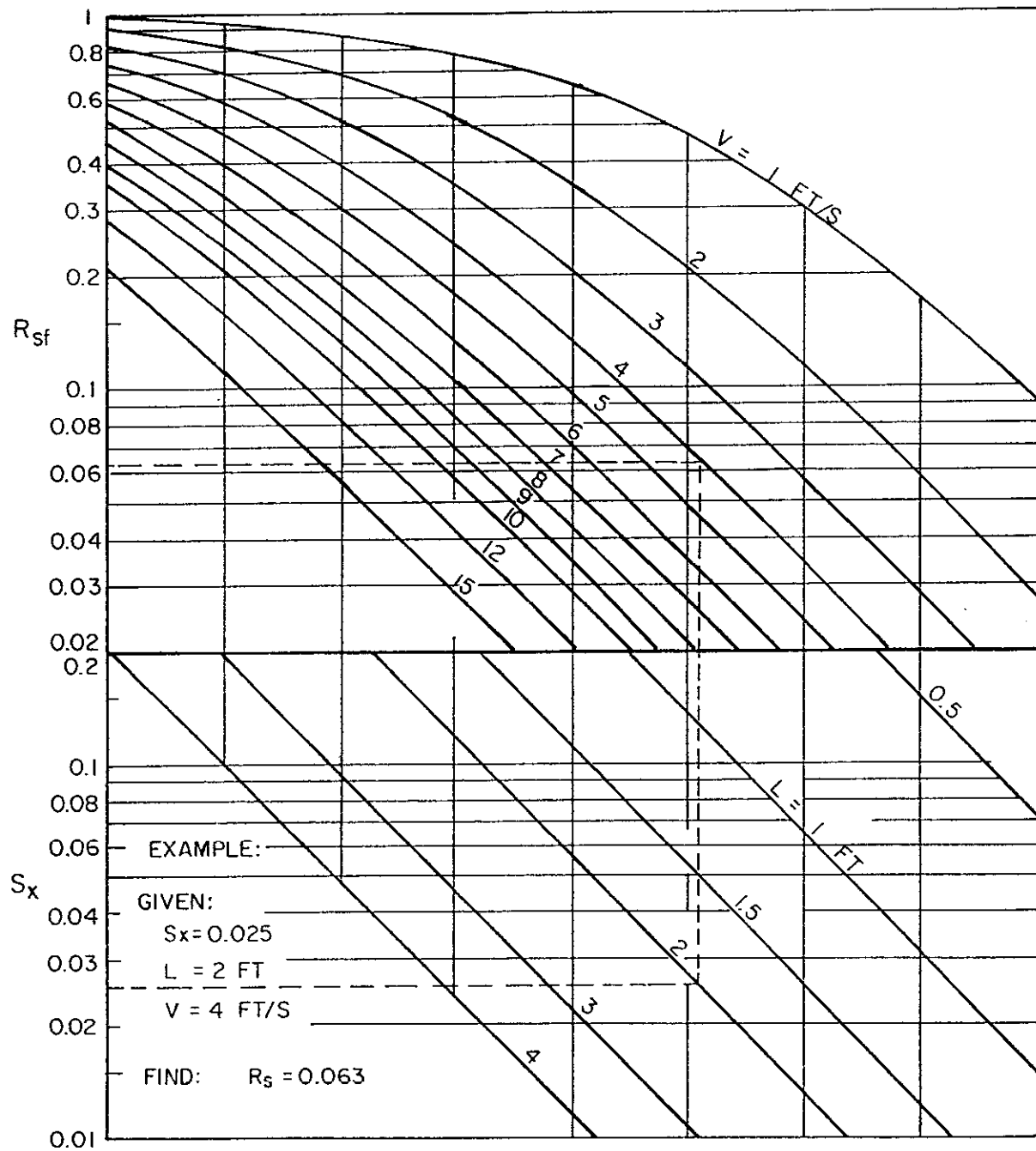

$$Q_{si} = R_{sf} Q_s$$

FIGURE 10.6  
 SIDE-FLOW INTERCEPTION EFFICIENCY FOR GRATE INLETS

## X. STORM DRAINS

The efficiency of curb inlets shorter than the length required for total interception is expressed by:

$$E_i = 1 - (1 - L_i/L_t)^{1.8} \quad (10.23)$$

Where:

$E_i$  = Ratio of discharge intercepted by the curb inlet to total discharge (i.e., the "efficiency" of the curb inlet);

$L_i$  = Curb-inlet length, in feet; and,

$L_t$  = As defined in Equation 10.22

Figure 10.7 is a nomograph for the solution of Equation 10.22, and Figure 10.8 provides a solution of Equation 10.23.

The length of inlet required for total interception by depressed curb inlets, or curb inlets in depressed gutter sections, can be found by the use of an equivalent cross slope,  $S_e$ , in place of  $S_x$  in Equation 10.22, as determined by the following equation:

$$S_e = S_x + S'_w E_o \quad (10.24)$$

Where:

$$S'_w = \frac{a}{12W} = \text{Cross-slope of the gutter, measured from the cross-slope of pavement, } S_x, \text{ in feet per foot.}$$

And where:

$a$  = Gutter depression, in inches, at the curb inlet (measured as the vertical distance between the low point of the gutter and the point where the cross slope of the pavement intersects the curb. For a standard twenty-one-inch gutter width, with a one-inch drop from one side to the other and a two-percent street cross-slope, "a" is equal to six-tenths of an inch);

$W$  = Width of depressed gutter, in feet; and,

$E_o$  = Ratio of flow in the depressed section to total gutter flow.

NOTE:  $E_o$  is the same ratio as that used to compute the frontal flow interception of a grate inlet.

Equations 10.22 and 10.23 can be combined to directly compute the length of the curb inlet required to intercept a certain percentage of the total discharge. This expression is:



X. STORM DRAINS

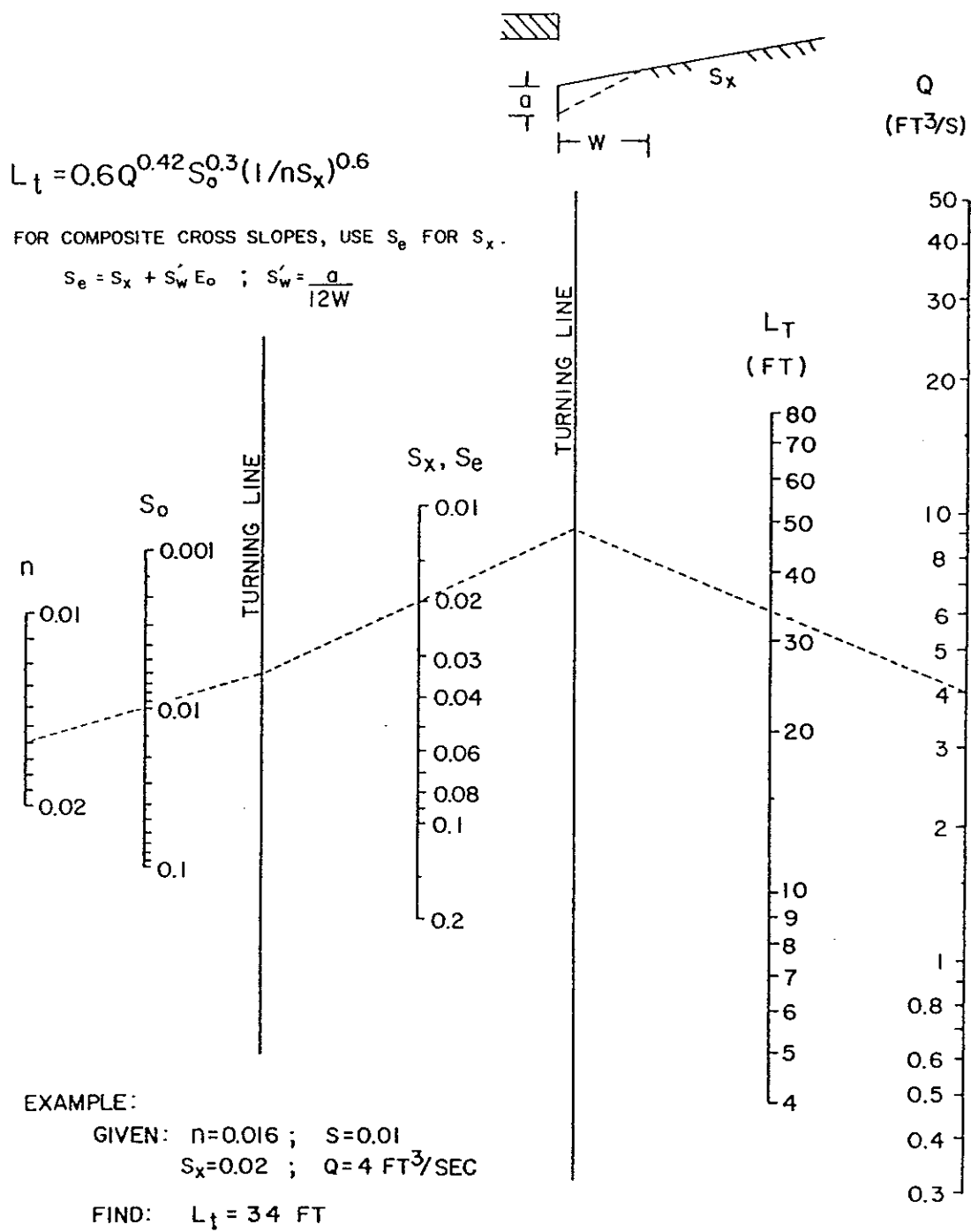

FIGURE 10.7  
 INLET LENGTH FOR TOTAL INTERCEPTION BY  
 CURB OPENINGS AND SLOTTED DRAINS

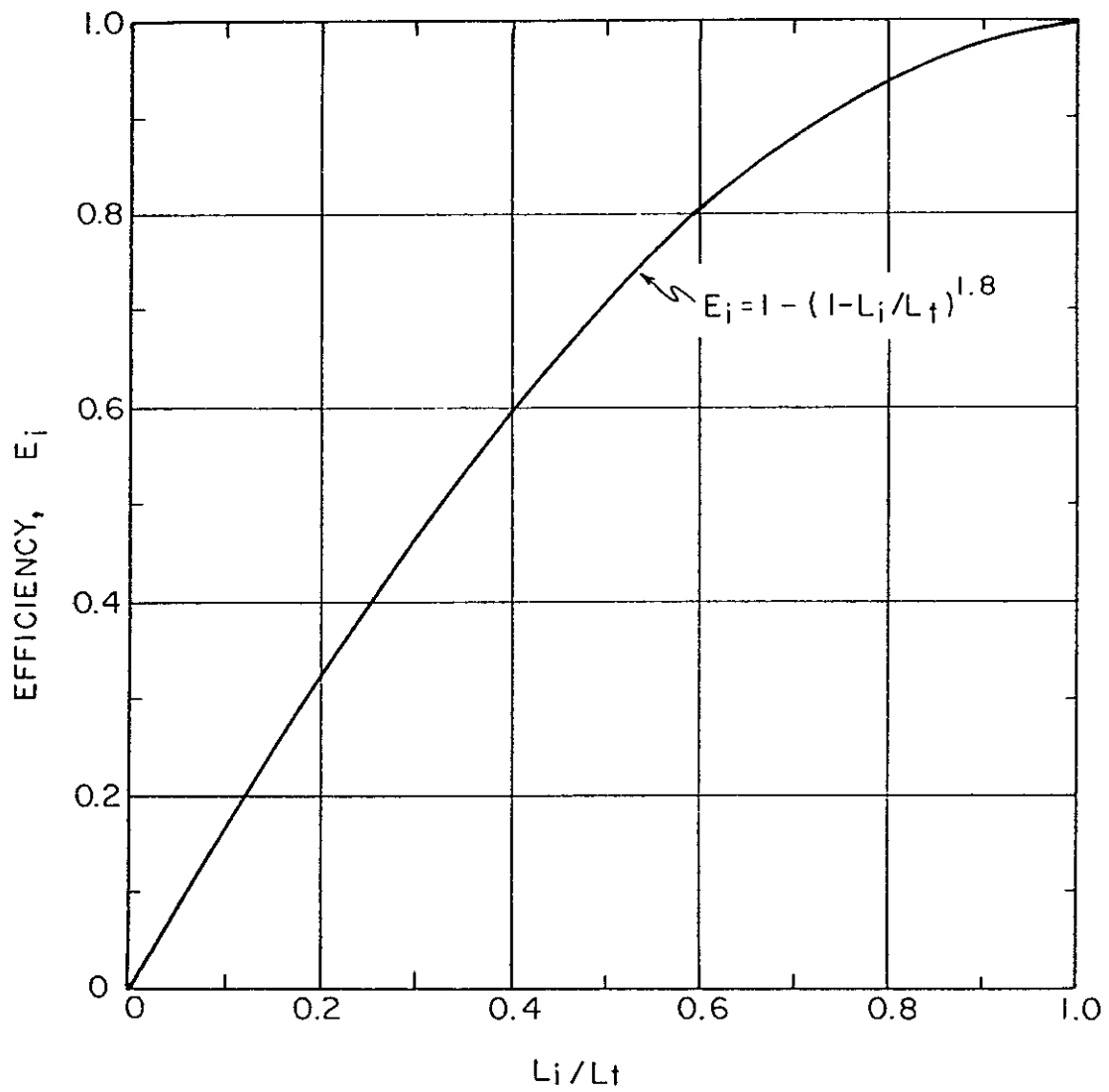

FIGURE 10.8  
INLET INTERCEPTION EFFICIENCY FOR  
CURB OPENINGS AND SLOTTED DRAINS

## X. STORM DRAINS

$$L_i = 0.6 \left[ \frac{Q^{0.42} S_o^{0.3}}{n^{0.6} S_x^{0.6}} \right] \left[ 1 - [1 - E_i]^{0.56} \right] \quad (10.25)$$

Where all terms are as previously defined.

As with Equation 10.22, the  $S_x$  term is replaced by an equivalent cross slope,  $S_e$ , for a compound gutter section (see Figure 10.9). The equivalent cross slope can then be computed by combining Equations 10.4 and 10.24 to form the expression:

$$S_e = S_x + 0.0467 \left[ \frac{a S_o^{1/2}}{Q n} \right] \left[ \frac{Y_{cf}^{8/3} - Y_{gb}^{8/3}}{Y_{cf} - Y_{gb}} \right] \quad (10.26)$$

Where all terms are as previously defined.

NOTE: In Equation 10.24, the " $Y_{cf}$ " and " $Y_{gb}$ " terms represent the depth of flow at the curb face and the depth of flow at the gutter edge, in the gutter approaching the curb inlet, respectively.

As a rule of thumb, for preliminary sizing of curb-inlet lengths with compound gutter sections, it can be assumed that the curb-inlet capacity is 0.75 cfs/foot, if the pavement spread is over two lanes, and 0.40 cfs/foot, if the pavement spread is over only one lane. This assumes a two-inch depressed gutter at the curb inlet; a 75-percent inlet efficiency; and *no consideration for clogging due to debris*.

### 10.6.7 Capacity of a Combination Inlet on a Continuous Grade

A combination inlet on a continuous grade, where the curb inlet and grate are placed side-by-side, does not have much greater capacity than the grate alone. This type of inlet should not be used on a continuous grade. However, combination inlets with the curb inlet located upstream of the grate are useful, because the curb inlet intercepts normal debris loads which could otherwise clog the grate on a frequent basis. The capacity of these inlets is the sum of the capacities of the curb inlet and the grate. However, the discharge over the grate must be reduced by an amount equal to the interception capacity of the curb inlet.

### 10.6.8 Capacity of a Slotted Inlet on a Continuous Grade

The capacity of a slotted inlet on a continuous grade can be computed using the same formulas and charts that are used for computing curb-inlet capacities. The advantage of using slotted inlets is their versatility. They can be used on both curbed and uncurbed streets to collect a wide variety of flow patterns.

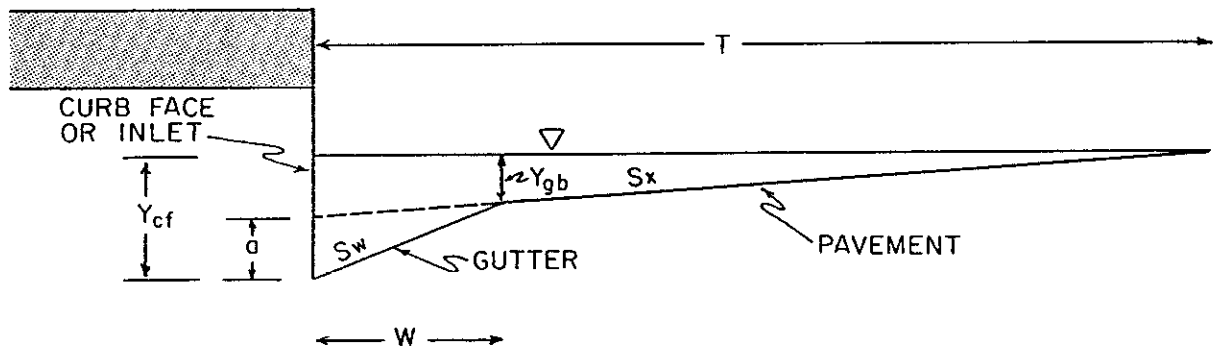

FIGURE 10.9  
COMPOUND GUTTER SECTION

## X. STORM DRAINS

### 10.6.9 Clogging

The following guidelines should be followed to provide an appropriate factor of safety against clogging at pavement inlets:

#### GRATES AND SLOTTED DRAINS:

1. Sump Conditions:
  - a. Orifice Flow: required area = 2.0 x calculated area.
  - b. Weir Flow: required perimeter = 2.0 x calculated perimeter.
2. Continuous-grade conditions:
  - a. Required length of opening = 2.0 x calculated length.

#### CURB INLETS:

1. Sump Conditions:
  - a. Required length of opening = 1.50 x calculated length.
2. Continuous-grade conditions:
  - a. Required length of opening = 1.25 x calculated length.

#### COMBINATION GRATE AND CURB INLET:

1. Sump Conditions:
  - a. Orifice Flow: required area = 2.0 x calculated area for grate; required length = 1.25 x calculated length for curb inlet.
  - b. Weir flow: required perimeter = 1.0 x calculated perimeter for grate; required length = 1.25 x calculated length for curb inlet.
2. Continuous-grade conditions:
  - a. Required length of opening = 1.0 x calculated length for grate; required length = 1.25 x calculated length for curb inlet.

## X. STORM DRAINS

### ADOT STANDARD TYPE-3 CATCH BASINS:

1. Continuous-Grade Conditions:
  - a. Required curb-inlet length upstream from catch basin = 1.25 x calculated length.
  - b. Required length of grate = 1.0 x calculated length.

These general guidelines should be used unless more-detailed information about clogging for a specific grate type is available. A publication by the American Society of Civil Engineers and Water Pollution Control Federation (1987) gives relative rankings for debris-handling efficiencies of several types of grates. Figure 10.5 can also be used to obtain an estimate of the ability of a grate to handle debris. Grates that are longer than necessary to intercept 100 percent of frontal flow will have greater debris-handling efficiencies than will shorter grates.

### 10.7 Inlet Design Procedure

#### Inlet Locations:

1. Using the plan-and-profile information developed for the proposed roadway, locate all points where 100-percent interception of runoff will be required. These will be located at sumps, street intersections, and at other locations where it is felt that anything less than 100-percent interception would be unacceptably hazardous.
2. Choose a proposed street-and-gutter cross section. The maximum allowable cross-slope for a street is two percent. Depressed concrete gutters with a width of twenty-one inches and a cross-slope of 0.048 may be used to increase gutter capacity. Using the proposed cross section and slopes, determine the maximum discharge that the street will carry according to the design limitations.
3. Locate drainage area (D.A.) concentration points and determine discharges for all offsite runoff affecting the project. Offsite inlets will be needed for all offsite drainage exceeding the design capacity of the street.
4. The remaining drainage area should consist of the street itself, and possibly some offsite sheet flow. The watershed should be long, and more or less of uniform width. Using (1) an assumed time of concentration of five minutes; (2) the maximum discharge capacity computed in Step Two; and (3) an appropriate runoff coefficient, apply the City of Tucson hydrology method in order to determine the area of watershed required to produce the maximum allowable street discharge. When this area is divided by the width of the watershed, it will give the length of the watershed from its approximate upstream end to the first storm-drain inlet. Check the watershed hydrology to ensure that the assumed five-minute time of concentration is correct.

## X. STORM DRAINS

For design discharges less than the 100-year flood, use appropriate ratios and procedures as outlined in Chapter IV of this Manual.

5. Choose a type of inlet that is appropriate for the location; and, using the appropriate procedures as described herein, develop a preliminary inlet design. Approximately 75 percent of the flow should be intercepted for maximum design efficiency.
6. Repeat Step Four to determine the distance to the next downstream inlet. Although not strictly accurate, the carry-over flow,  $Q_{co}$ , is added directly to the discharge produced in the intervening watershed between the two inlets. In reality, there should be a lag in peaks, and the amount to be accepted by a downstream inlet should be determined by adding hydrographs. However, this procedure would soon become very tedious. In view of the fact that the times of concentration are generally small, and that the inlets are spaced close together, direct adding of peaks is acceptable, and provides a measure of safety to the final design of the inlets.
7. Steps Five and Six are repeated, as necessary, until all drainage is accounted for within the system. At this time, needed revisions may become apparent for practical or economic reasons. Revisions should be made, and standard designs chosen, for all inlets. If the standard designs differ from the preliminary designs, the procedure should be repeated with the standard designs in order to ensure that the system works properly.

Work sheets for this procedure are presented in Figure 10.10, and an example is provided at the end of this chapter.

### 10.8 Storm-Drain Calculations

The two simplest methods of hydraulic analysis for use in the design of storm drains are (1) the "normal-flow method", and (2) the "pressure-flow method". The "normal-flow method" is much simpler to utilize, but it is often inaccurate. Its use often results in undersized pipes--especially if there are manholes, bends, junctions, and transitions that create energy (head) losses in the storm drain. On the other hand, the "normal-flow method" could also result in the design of storm drains that are larger and more expensive than necessary--particularly if there is sufficient head to create higher than normal flow velocities.

The pipe slope and the friction slope of storm drains designed for normal flow are assumed to be equal. It is therefore not necessary to calculate a hydraulic grade line for these storm drains if the soffits of connecting pipes of unequal size are set at the same elevation, and if the so-called "minor" head losses along the storm drain are minimal.

A hydraulic grade line for pressure flow will need to be computed whenever there is a high tailwater; or when it is desired to determine the effects which occur when a larger than design-frequency storm occurs; or whenever minor losses or pipe alignment may induce pressure flow; or when it is desired to check to see if a smaller pipe size

PAVEMENT-DRAINAGE WORKSHEET

LOCATION DATA:

Location: \_\_\_\_\_  
 Project No: \_\_\_\_\_

DESIGN DATA:

Frequency \_\_\_\_\_  
 $T_{all} =$  \_\_\_\_\_  $n =$  \_\_\_\_\_  
 Curb Height = \_\_\_\_\_

RUNOFF CALCULATIONS:

From Station	To Station	L ft.	W ft.	D.A. acre,	$C_w$	$T_c$ min.	I in/hr.	$Q_{100}$ cfs	$Q_{design}$ cfs	$Q_{co}$ cfs	$Q_T$ cfs	$S_o$ ft/ft	$S_y$ ft/ft	$D_{ft}$	$T_{ft}$

10.27

INLET CALCULATIONS

Station	Inlet Type	Y ft.	$Q_i$ cfs	$Q_{co} = Q_T - Q_i$

Computed by: \_\_\_\_\_ Checked by: \_\_\_\_\_

Figure 10.10: Pavement Drainage Worksheet



## X. STORM DRAINS

could be used under conditions of pressure flow. It will generally be a requirement to compute the design hydraulic grade line for any proposed storm drain.

### 10.8.1 Normal-Depth Calculations

Normal-depth calculations are accomplished by using Manning's equation:

$$Q = \frac{1.486}{n} \left( \frac{A}{P} \right)^{2/3} S_o^{1/2} A \quad (10.27)$$

Where:

- $Q$  = Discharge, in cubic feet per second;
- $A$  = Flow area within the pipe, in feet<sup>2</sup>;
- $n$  = Manning's roughness coefficient;
- $P$  = Wetted perimeter of flow, in feet; and,
- $S_o$  = Pipe slope, in feet per foot.

Figure 10.11 shows the relationship of these parameters for a circular conduit.

### 10.8.2 Pressure-Flow Calculations: Computation of Hydraulic Grade Line

Hydraulic grade-line computations for pressure flow are based on the Bernoulli equation. This equation is as follows:

$$\frac{V_1^2}{2g} + D_{hg1} + S_o L = \frac{V_2^2}{2g} + D_{hg2} + S_f L + H_m \quad (10.28)$$

Where:

- $H_m$  = "Minor" head losses, in feet, and all other terms are as defined by Figure 10.12.

The hydraulic grade line is computed by starting with the control tailwater elevation at the drain outlet, and subsequently performing a hydraulic grade-line calculation in the upstream direction. Friction and minor losses are computed for each segment of the storm drain. These energy losses are added to the total energy elevation at the downstream endpoint of the storm-drain segment in order to obtain the total energy elevation at the upstream endpoint of the segment. The hydraulic grade line is equal to the total energy grade line, minus velocity head at any point along the storm drain.

X. STORM DRAINS

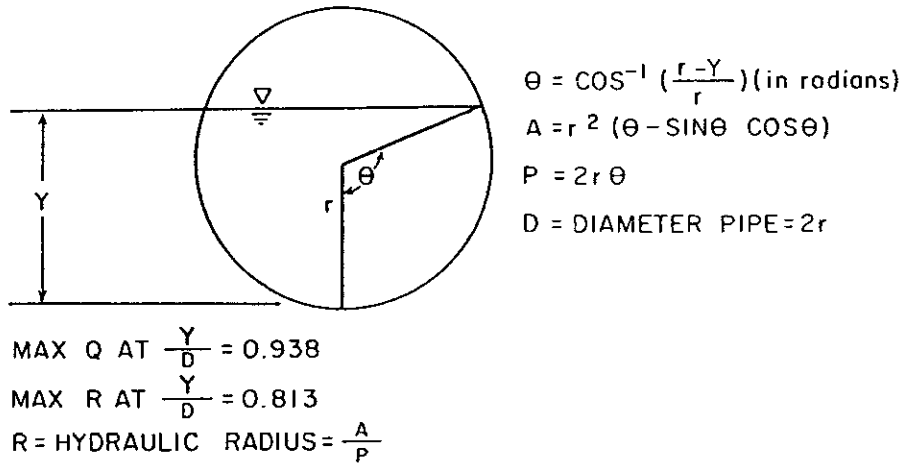

FIGURE 10.11  
HYDRAULIC PARAMETERS OF A CIRCULAR CROSS SECTION

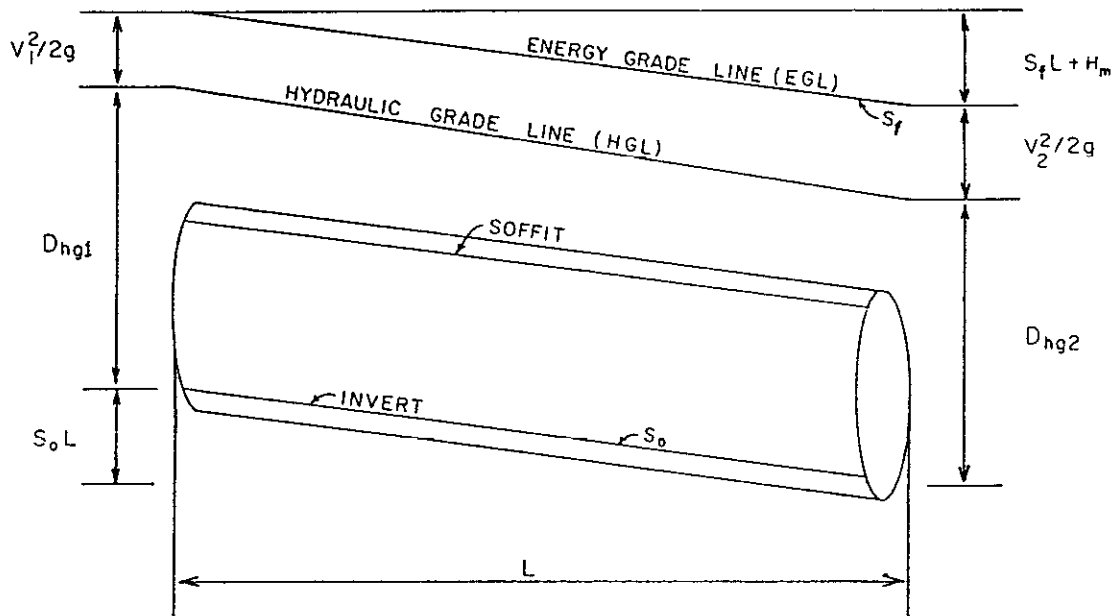

FIGURE 10.12  
HEAD-LOSS DIAGRAM FOR PIPES

## X. STORM DRAINS

### 10.8.3 Friction Losses

Friction losses,  $h_f$ , are computed by Manning's equation for an assumed or given discharge. The form of Manning's equation used is:

$$S_f = \frac{29.2n^2}{R^{1.33}} \left[ \frac{V^2}{2g} \right] \quad (10.29)$$

Where:

$R$  = Hydraulic radius (i.e., the cross-sectional area of flow divided by the wetted perimeter of flow), in feet.

All other terms are as previously defined.

The friction loss for a storm-drain segment is then computed by the following equation:

$$h_f = S_f L = \text{Friction loss} \quad (10.30)$$

### 10.8.4 Minor Losses

"Minor" losses in a storm drain are those that are associated with the energy necessary for the passage of water through areas such as junctions, manholes, and transitions. The total head loss is the sum of friction losses and minor losses. Minor losses,  $H_m$ , are normally represented as a factor  $K$  of velocity head:

$$H_m = K \left[ \frac{V^2}{2g} \right] \quad (10.31)$$

The factor  $K$  varies widely, depending on the type of loss (e.g., bend, entrance, junction, manhole, etc.) and the configuration of the particular structure creating the head loss. A publication by the Denver Regional Council of Governments (1969) gives detailed information on minor losses, as do many hydraulics text books. It is important to note that these so-called "minor" losses can sometimes exceed friction losses within a storm-drain system, and therefore should always be evaluated at some point during the design process. Some of the more common minor losses encountered in storm-drain design are covered in the following sections.

### 10.8.5 Bend Losses

Head-loss coefficients for pipe bends with a deflection angle of 90 degrees,  $K_{b90}$ , can be determined from Figure 10.13.

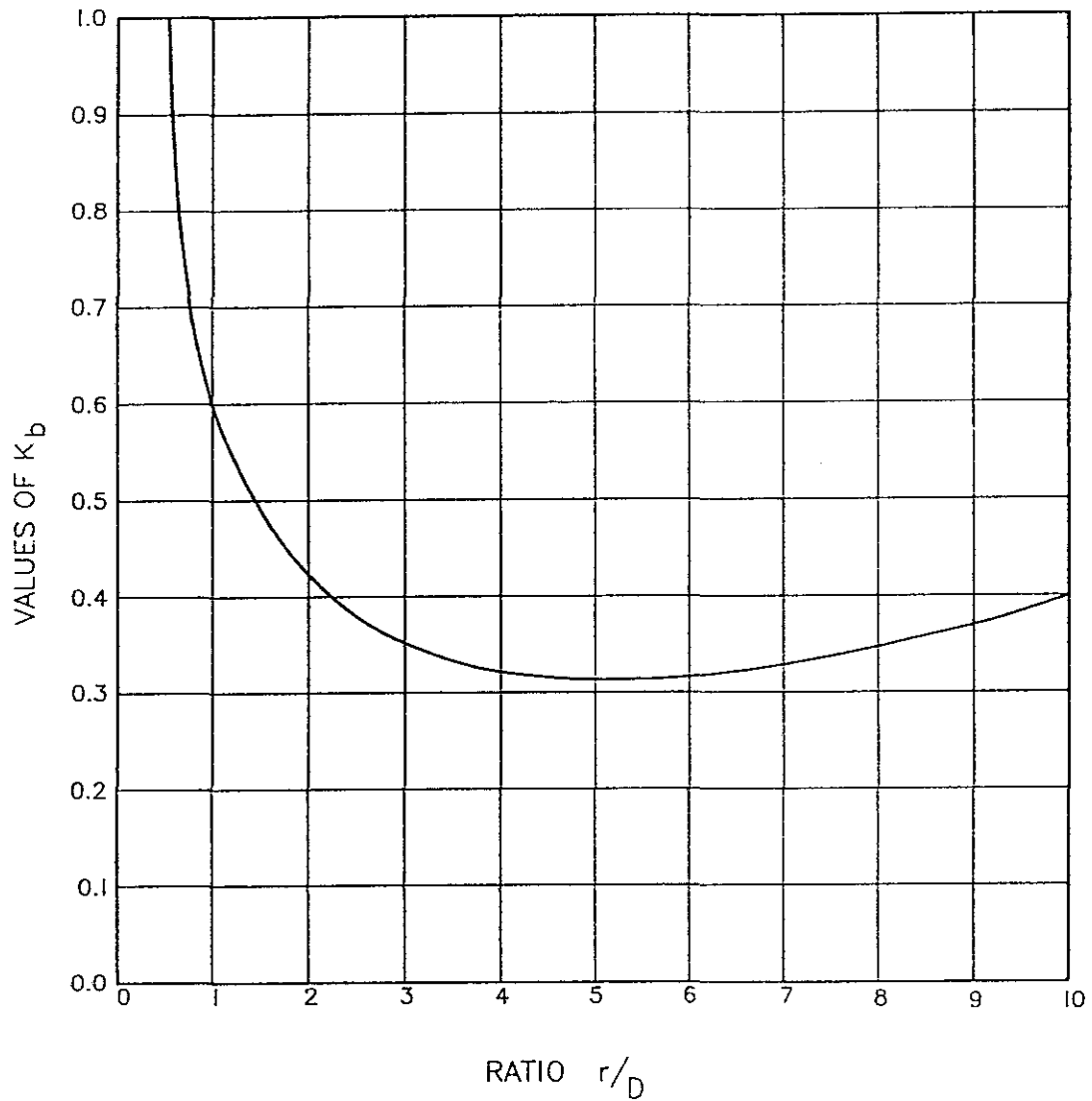

$r$  = radius of  $\odot$  of bend;  $D$  = diameter  
of circular section or side of square section

FIGURE 10.13  
HEAD-LOSS COEFFICIENT FOR 90° PIPE BEND

## X. STORM DRAINS

$K_{b90}$  for 90-degree, square elbows, where there is no rounding of corners of the intersecting conduits, ranges from 1.25 to 1.50. In cases of bends where the deflection is less than 90 degrees, determine the head-loss coefficients for bends as follows:

$K_b$  (For bend  $< 90^\circ$ ) =

$$\left[ 1 - \left[ \frac{90 - \text{deflection in degrees}}{90} \right]^2 \right] K_{b90} \quad (10.32)$$

Bend head loss,  $h_b$ , is then:

$$h_b = K_b \left[ \frac{V^2}{2g} \right] \quad (10.33)$$

### 10.8.6 Junction Losses

Junction losses,  $h_j$ , where the diameter of the main pipe does not change, shall be computed by:

$$h_j = \frac{V_2^2}{2g} - \frac{V_1^2}{2g} - \left[ \frac{A_3 V_3^2}{A_2 g} \right] \text{Cos}\theta \quad (10.34)$$

Figure 10.14A illustrates this type of junction.

In the case where  $D_1 \neq D_2$ , junction loss shall be calculated by the Thompson equation:

$$\Delta HG = \left[ \frac{2}{A_1 + A_2} \right] \left[ \frac{Q_2 V_2 - Q_1 V_1 - Q_3 V_3 \text{Cos}\theta}{g} \right] \quad (10.35)$$

Figure 10.14B illustrates this type of junction.

Where:

$\Delta HG$  = Difference in hydraulic gradient for the two ends of the junction, in feet;

A JUNCTION

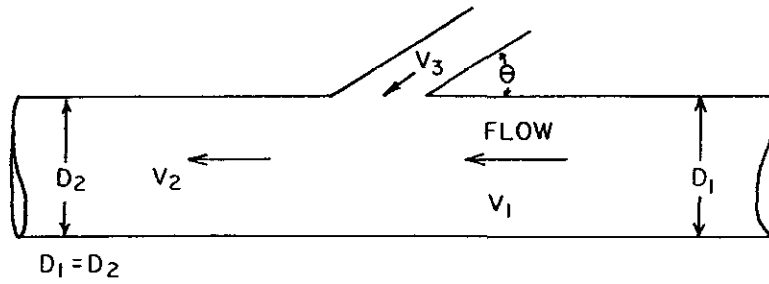

B JUNCTION

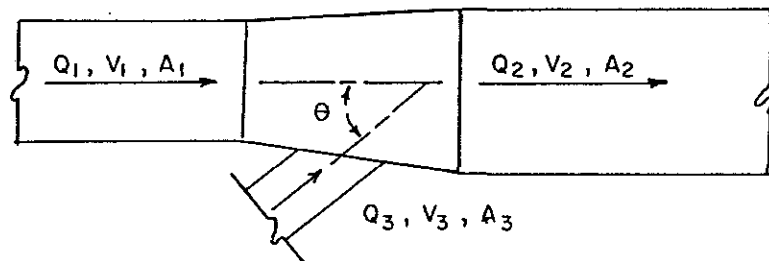

C TRANSITION

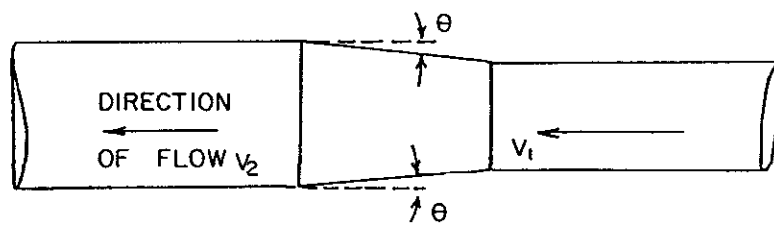

FIGURE 10.14  
 JUNCTION AND TRANSITION CONFIGURATIONS

## X. STORM DRAINS

- $A_1$  = Flow area of mainline pipe upstream of the junction, in square feet;  
 $A_2$  = Area of mainline pipe downstream of the junction, in square feet;  
 $A_3$  = Area of tributary pipe, in square feet;  
 $Q_1$  = Discharge of mainline pipe upstream of the junction, in cubic feet per second;  
 $Q_2$  = Discharge of mainline pipe downstream of the junction, in cubic feet per second;  
 $Q_3$  = Discharge of tributary pipe, in cubic feet per second;  
 $V_1$  = Flow velocity in mainline pipe upstream of the junction, in feet per second;  
 $V_2$  = Flow velocity in mainline pipe downstream of the junction, in feet per second;  
 $V_3$  = Flow velocity in tributary pipe, in feet per second; and,  
 $\theta$  = The angle formed by the junction between the tributary pipe and the mainline pipe, in degrees.

It is very important to note that  $\Delta HG$  in this equation is the difference in hydraulic grade-line elevation, not the energy grade line. The total energy loss at the junction,  $h_j$ , is represented by:

$$h_j = \Delta HG + \frac{V_1^2}{2g} - \frac{V_2^2}{2g} \quad (10.36)$$

Junction loss should always be applied at the upstream side of the junction.

At junctions where there is more than one tributary inflow, the computation of head loss becomes more complicated. In most simple cases, Equation 10.35 can be used by subtracting  $Q_n V_n \cos \theta$  terms in the numerator for each junction pipe. A publication by the Denver Regional Council of Governments (1969) gives junction losses for many detailed examples found in storm-drain design.

### 10.8.7 Transition Losses

Transition losses,  $h_t$ , for velocities which increase in the direction of flow (i.e., a contraction) are to be calculated using the following formula:

$$h_{tc} = 0.1 \left[ \frac{V_2^2}{2g} - \frac{V_1^2}{2g} \right] \quad (10.37)$$

Where velocities decrease in the direction of flow (i.e., an expansion), the formula to be used is:

## X. STORM DRAINS

$$h_{te} = 0.2 \left[ \frac{V_1^2}{2g} - \frac{V_2^2}{2g} \right] \quad (10.38)$$

See Figure 10.14C for a diagram which illustrates how to calculate transition losses using Equation 10.36.

### 10.8.8 Manhole Losses

For manholes with no change in pipe size or discharge, and where the flow is straight through, manhole losses,  $h_{mh}$ , shall be computed by:

$$h_{mh} = K_{mh} \left[ \frac{V^2}{2g} \right] \quad (10.39)$$

Where  $K_{mh} = 0.05$ .

Head loss for manholes where flow changes direction, but where there is no change in discharge or pipe size, should be determined from Figure 10.15.

For manholes which contain junctions, or that have changes in pipe size, the head loss associated with these elements should be computed according to the guidelines for junction and transition losses, as presented within this chapter. This head loss should then be added to the head loss computed by use of either Equation 10.39 or Figure 10.15, in order to obtain the total head loss through these types of manholes.

### 10.8.9 Entrance and Outlet Losses

Entrance losses,  $h_e$ , are calculated by the following equation:

$$h_e = K_e \left[ \frac{V^2}{2g} \right] \quad (10.40)$$

Values for  $K_e$  are given by:

<u>TYPE OF INLET</u>	<u>VALUE OF <math>K_e</math></u>
Inward Projecting	0.78
Sharp Cornered	0.50
Bell Mouth (Beveled)	0.04



# X. STORM DRAINS

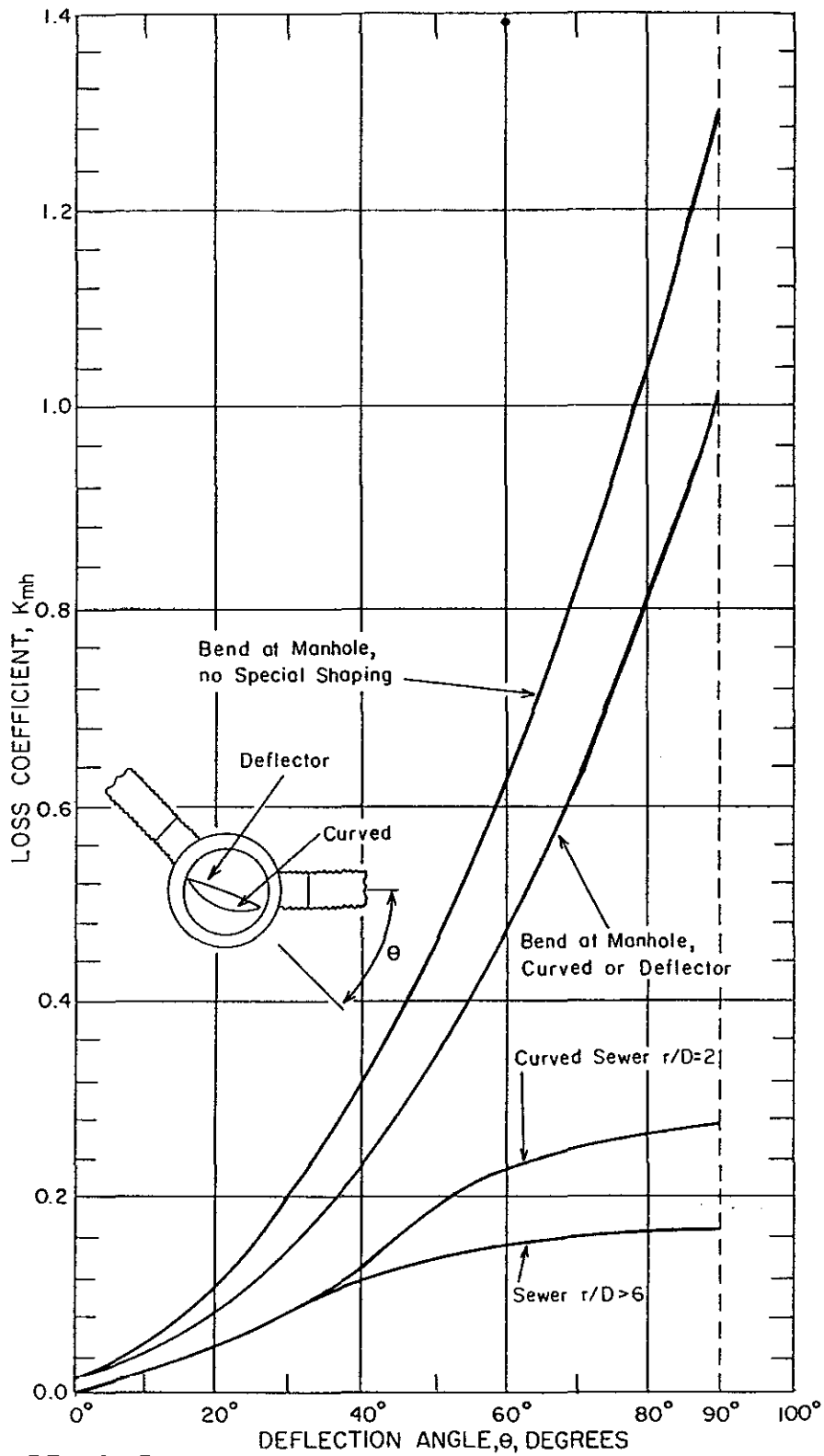

FIGURE 10.15  
MANHOLE HEAD LOSS

## X. STORM DRAINS

Outlet losses,  $h_o$ , are only considered if the outlet is fully submerged, and are calculated by the following equation:

$$h_o = \frac{V^2}{2g} \quad (10.41)$$

### 10.9 Storm-Drain Design Procedure

#### 10.9.1 Preliminary Design

After the storm-drain inlet locations have been established, preliminary pipe sizes should be chosen. Design discharges for the storm drain are computed using the City of Tucson hydrology method, according to the guidelines presented within Chapter IV of this Manual. *Basin factors should be computed according to Equation 4.2, using appropriate Manning's "n" values for the pipe sections.* A separate hydrologic data sheet is required at each inlet. The watershed area at each inlet is equal to the entire watershed draining to that point, including offsite watersheds that are to be connected into the storm-drain system. Consequently, a five-minute time of concentration *cannot* be assumed in every case.

Preliminary pipe sizes are established by using Manning's equation, as well as assuming "full-flow" conditions and a roughness coefficient 25-percent higher than what would be contemplated for use in final design (see Guideline No. 15, to follow) in order to tentatively account for the so-called "minor" losses in the system. Pipes should be sized for total discharge, minus allowable street flow. At first, the pipe slope can be assumed to be equal to either the surface grade or street grade, whichever is appropriate.

Junction and bend locations will already be known from the overall layout and inlet locations. In addition, transitions and manholes can be located and designed at this time, on a preliminary basis. In setting up the preliminary design, the guidelines listed below shall be followed:

1. Velocities shall always equal or exceed three feet per second at a flow depth equal to 0.15 the pipe diameter, and shall increase in the downstream direction in order to prevent sediment buildup.
2. The minimum pipe diameter for public storm-drain systems shall be eighteen inches, unless unusual design situations are encountered and written approval to use a smaller pipe size is provided, in advance, by the City of Tucson Engineering Division.
3. If possible, gutter flow should not cross intersections during the design runoff event.
4. The minimum allowable storm-drain slope for concrete pipe or smooth metal pipe shall be 0.1 percent. However, it is desirable that a slope of not less than 0.3 percent be maintained for all storm-drain pipe, whenever possible.

## X. STORM DRAINS

5. Channel bank protection shall be required at points where storm drains discharge into earthen channels.
6. Unless calculations show that head loss will not be excessive, the angle of confluence between a mainline and a lateral shall not exceed forty-five degrees; and, as an additional requirement, shall not exceed thirty degrees under any of the following conditions:
  - a) Where the flow in the lateral exceeds ten percent of the mainline flow;
  - b) Where the velocity of flow in the lateral is twenty feet per second, or greater;
  - c) Where the diameter or equivalent size of the lateral is sixty inches, or greater; and,
  - d) Where hydraulic conditions indicate that excessive head losses may occur in the mainline due to a confluence.
7. The soffits of adjoining pipes in a transition or junction shall be set at the same elevation.
8. Manholes shall be located at such places as junctions; changes in pipe size; sharp curves and angle points in excess of ten degrees; and points where an abrupt change in grade occurs. In addition, it is suggested that manholes be located at regular intervals along the line. It is recommended that the minimum spacing interval for manholes along conduit less than or equal to thirty inches in diameter be 300 feet; and if the conduit is greater than thirty inches in diameter, but less than or equal to forty-five inches in diameter, the minimum spacing be 400 feet. Also, if the conduit is greater than forty-five inches in diameter, the recommended minimum spacing is 500 feet; and for conduit less than or equal to thirty inches in diameter, the recommended minimum spacing is 200 feet, if there are bends and angles within the system.
9. Manholes shall be located in the center of the street travel lane, where possible; and not in the wheel path or within street intersections.
10. Storm-drain conduits shall always be designed to flow full and under pressure, unless debris is expected to be a problem; or unless prior approval is obtained, in writing, from the City of Tucson Engineering Division which permits designing for open-channel flow conditions.
11. Pipe sizes shall generally increase in the downstream direction, unless smaller pipe would operate just as effectively and thereby allow for a savings in the overall cost of the system. For such cases, the minimum diameter to which a conduit can be decreased shall be thirty inches. Six inches shall be the maximum allowable decrement in the conduit diameter.

## X. STORM DRAINS

12. Where storm drains discharge into an open channel, the water-surface elevation within the channel which has the equivalent return-period that is used for the storm-drain design discharge shall be the controlling water-surface elevation for hydraulic grade-line calculations, unless approval to the contrary is obtained, in writing, from the City of Tucson Engineering Division. When discharge is into another conduit, the design hydraulic grade line must become the controlling water-surface elevation.
13. In most cases, the hydraulic grade line of conduits flowing under pressure shall be at or below the level of the ground. At inlets, the hydraulic grade line shall be at least six inches below the ground surface.
14. Storm drains draining long roadways need not always run the entire length of the roadway, even though the roadway may be on a continuous grade. Where feasible, discharging into convenient outlets along the way can reduce costs by minimizing the required pipe size.
15. It is recommended that roughness coefficients used for final design be for "aged" conditions, and be approximately fifteen percent greater than those coefficients ordinarily used for new conduits.
16. A drop of 0.1 foot shall be provided at a through manhole, and a drop of 0.3 feet at a manhole intersection with two laterals. If a conduit changes direction in a manhole without changing size, a drop of 0.4 feet shall be provided.
17. When two laterals intersect a manhole, the laterals shall not be aligned opposite one another. The centerlines of the two laterals shall be separated laterally by at least the sum of their pipe diameters. A deflection shall be used, if necessary, to achieve this layout.
18. Storm drains shall be straight, with uniform slopes between manholes, if possible. The minimum radius of curvature for bends shall be 100 feet. Shorter radius curves, but not less than the minimum values given in the following table, are acceptable only by obtaining written permission from the City of Tucson Engineering Division.

### MINIMUM ALLOWABLE RADIUS OF CURVATURE

<u>PIPE DIAMETER</u>	<u>MINIMUM RADIUS OF CURVATURE</u>
24" - 54"	28.5 Feet
57" - 72"	32.0 Feet
78" - 108"	38.0 Feet

Short-radius bends, such as the above, shall only be used where the conduit is to make a direction change just upstream of junctions or manholes, in order to meet the previous design criterion (i.e., item 17 above).

## X. STORM DRAINS

19. Crossings with other underground utilities shall be avoided, if at all possible. Crossings, if absolutely necessary, shall be at angles greater than forty-five degrees.
20. The minimum allowable clearance between sanitary sewers and storm drains shall be twenty-four inches, unless the upper pipe is founded (such as with piles) in the vicinity of the crossing.
21. There shall be a minimum of three feet of cover over the crown of the conduit, wherever possible.
22. The minimum right-of-way width for the installation of a storm drain shall be the pipe diameter, plus ten feet on each side of the pipe.

### 10.9.2 *Final Pipe Sizing: Hydraulic Grade-Line Calculations*

The final design of a storm-drain system is done either through backwater calculations (if the flow has a free surface) or through hydraulic grade-line computations (if the pipe flows full and under pressure). The hydraulic grade line is the level to which water would rise were it not constrained by the physical boundaries of the pipe. Where there are manholes and inlets with clear passageways to the surface, water will rise to the level of the hydraulic grade line. For this reason, it is very important that the hydraulic grade line be kept below the ground surface. Otherwise "blow-outs" of manhole covers could occur, and water could flow out of the storm-drain system into the streets. In order to provide for a safety factor, the hydraulic grade line should be kept a minimum of six inches below the level of surface inlets such as grates, curb inlets, and manholes.

If the hydraulic grade line extends above the ground surface, or drops below the soffit of the pipe, revisions to the design will be needed. These revisions could include changing the pipe size, slope, depth, or roughness; or making transitions, bends, manholes, and junctions more efficient in order to reduce head loss.

Hydraulic grade-line calculations normally proceed in an upstream direction, according to the following procedure (An example of this procedure is provided at the end of this chapter):

1. Establish a control water-surface elevation and total energy level at the storm-drain outlet. Generally, it shall be assumed that the tailwater elevation at the storm-drain outlet is equivalent to the water-surface elevation within the receiving channel which has the same return period as the storm-drain design discharge, unless approval to the contrary is obtained, in writing, from the City of Tucson Engineering Division. If the tailwater is above the soffit of the pipe, the control water-surface elevation and total energy level shall both be assumed to be equal to the elevation of the tailwater pool. If the drain has a free outfall, the elevation of the soffit of the pipe at the outfall shall be assumed to be the control elevation. Add velocity head to this elevation to obtain total head.

## X. STORM DRAINS

2. Using the known discharge, preliminary pipe size, and layout computed previously, compute friction slope,  $S_f$ , for the flow at the outlet, using Equation 10.29.
3. Choose a straight length of pipe,  $L$ , upstream of the outlet for which the pipe discharge, slope, diameter, and roughness do not change; and compute the friction loss,  $h_f$ , for that reach by Equation 10.30. Add the friction loss,  $h_f$ , to the total energy elevation at the outlet. This is the elevation of the energy grade line, *EGL*, at distance  $L$ . Subtract velocity head from this elevation in order to obtain the elevation of the hydraulic grade line, *HGL*.
4. Step 3 is repeated in logical steps, in an upstream direction, to the end of the pipe. "Minor" losses at bends, junctions, and transitions are taken into account, using the formulas given in Section 10.9. Hydraulic grade-line calculations are to be performed at every point where a "minor" head loss exists; where there is a change in a pipe slope or diameter; and at any other point where hydraulic characteristics change. Hydraulic grade-line calculations should be based on *total* head, instead of hydraulic head, in order to avoid confusion and error. The sheet in Figure 10.16 is provided for use in organizing and documenting information as the computations proceed upstream.
5. Plot the hydraulic grade line and total energy grade line in relation to the storm drain and ground surface. *Care should be taken to ensure that the pressure within a pipe does not exceed the manufacturer's maximum safe limits for joints and seals.*
6. Make design revisions, as necessary, and repeat the procedure until the desired optimization of the storm-drain system is achieved.

### 10.10 Suggested Design Practices

In addition to the information presented in the earlier portions of this chapter, there is a certain amount of minimum information which must be available to the storm-drain designer in order to produce a complete and accurate design. Some of this information, which is likely to apply to most storm-drain designs, is listed below. Because every design case is different, this list should not be considered as complete. Additional information, as needed, should be obtained by the designer as the situation arises.

1. Accurate, recent topography, at a scale no smaller than 1" = 200', preferably with at least two-foot contour intervals superimposed on aerial topography, should be obtained for delineation of all offsite watersheds and for determining watershed parameters. Zoning maps, area plans, and projected zoning predictions should be used for estimating future watershed development.

HYDRAULIC GRADE--LINE CALCULATION SHEET

Sheet \_\_\_\_ of \_\_\_\_

PROJECT: \_\_\_\_\_ CALCULATED BY: \_\_\_\_\_

LINE: \_\_\_\_\_ DATE: \_\_\_\_\_

STA.	ELEV. INV.	D	ELEV. H.G.L.	SEC-TION	$D_{hg}^*$	A	Q	V	$\frac{v^2}{2g}$	$S_f$	AVG $S_f$	L	$h_f$	$h_b$	$h_j$	$h_t$	$h_{mh}$	ELEV. E.G.L.

\* Conduit unseals when  $D_{hg}$  is less than D.

FIGURE 10.16  
HYDRAULIC GRADE--LINE CALCULATION SHEET  
FOR PRESSURE FLOW

## X. STORM DRAINS

2. Detailed site information for all points of offsite drainage concentration should be obtained. This should include topography, land ownership, construction plans, and all other information necessary to determine flow hydraulics and to design pavement inlets.
3. The storm-drain designer must have detailed information, or control of detailed information, on final grades, street geometries, and all other street details affecting the design, construction, or operation of the storm drain.
4. Records must be obtained ("as-builts," when available) showing the size, construction details, and location of all existing utilities, pipelines, and structures above and below ground. This would include, but not be limited to, water lines, sanitary sewers, storm drains, gas lines, electric lines, telephone lines, and traffic-signal lines. Current plans for future installations should be checked to prevent conflicts. Information that is incomplete should be checked by a field survey.
5. Traffic, pedestrian, and general public-safety considerations should be listed in order to produce a compatible design. For instance, these considerations could have an impact upon the type of inlets proposed at certain locations.
6. Right-of-way constraints should be accurately mapped. In most cases, the storm drain will be entirely within a street right-of-way; but there can be cases in which additional right-of-way will be needed, such as at offsite inlets or outlets.
7. All possible storm-drain outlet locations should be identified and investigated. Outlet locations along the length of the storm drain could be used to reduce the cost of the storm drain. All locations where outlets are contemplated should be studied to determine governing tailwater elevations, and possible erosion and right-of-way concerns.
8. As-built drawings of all streets and highways affecting the project should be obtained and thoroughly reviewed.

### 10.11 Check List for Design Submittals

The following check list is provided as an aid to the in-house, quality-control reviewer of storm-drain design reports and plans. This check list should be used as a guide to the minimum items necessary for storm-drain design. It is the duty of the in-house, quality-control reviewer to ensure that any additional information that is necessary for the specific storm-drain design be identified and provided, and that all such information be technically accurate and correct. Included within, or on, any reports/plans should be:

1. An overall map of the project site showing the storm drain, streets, drainageways, and land use.



## X. STORM DRAINS

2. Offsite watershed map, at a scale no smaller than  $1'' = 200'$ , with at least two-foot contour intervals superimposed on aerial topography. All concentration points and watershed definitions shall be clearly shown on these maps.
3. All offsite hydrologic data sheets and supporting information for offsite drainage calculations.
4. Site information for offsite drainage concentration points. This should include hydraulic information and calculations at the points where offsite drainage is to be intercepted. Two main points to consider are:
  - a) Is the proposed inlet really adequate to intercept all of the offsite flow it is designed to intercept; and,
  - b) Is there enough information provided to determine what impact flow into this inlet will have upon the downstream storm-drain system?
5. Proposed street cross sections, grades, and compositions. These should be in the form of plan-and-profile sheets, with street cross sections shown.
6. Calculations showing street capacities at the allowable design limit of flow spread along the entire length of the storm drain. Points where drainage must be entirely (i.e., 100 percent) removed from the street should also be located.
7. Inlet calculations, according to the procedure outlined in Section 10.8 (see Example 10.2) or by use of a similar method. All hydrologic data sheets used in this step should be included, as should assumptions, supporting calculations, and proposed inlet types and sizes. Also included should be detailed watershed maps showing drainage areas, land use, and topography. These maps should be of a more detailed scale than  $1'' = 200'$ . A scale no smaller than  $1'' = 100'$  is mandated. A scale of  $1'' = 40'$  is preferable, where appropriate.
8. All hydrologic data sheets and supporting calculations for discharges used in conduit sizing. Additional watershed maps should be provided, if necessary, in order to show larger watershed delineations.
9. When a storm drain is designed for pressure flow, the intermediate calculations for pipe size need not be included. However, final pressure-flow calculations must be included. These shall include hydraulic grade-line calculations, as described in Sections 10.9 and 10.10 (see Example 10.3), or calculations which employ a similar procedure. There should be a storm-drain profile, drawn to scale; and showing, at a minimum, the storm-drain soffit and invert, ground surface, hydraulic grade line, energy grade line, outlet control elevation, manholes, junctions, transitions, bends, and inlets. A plan-view map should show the storm drain, adjacent streets, and proposed inlets and manholes. Calculations of minor losses should be provided, and should include a clearly labeled diagram of the structure, or structures,

## X. STORM DRAINS

involved. Calculations and supporting ground information showing how the controlling water-surface elevation was determined are required.

10. There should be a clear, concise, text description of the design process, and the assumptions upon which the analysis was based. The drainage report should follow the City of Tucson guidelines for drainage-report submittals.

### EXAMPLE 10.1: STREET FLOW IN A PARABOLIC SECTION

Compute the discharge for a parabolic, crowned, street section with a longitudinal slope of one percent, in which the depth of flow at the curb is 0.48 feet.

The parabolic section has the properties shown in Figure 10.17.

Using Equation 10.5, and an incremental segment width of two feet, the table entitled "Computations for Example 10.1," found on page 10.47 of this Manual, is produced.

### EXAMPLE 10.2: STORM-DRAIN INLET SPACING AND SIZING

In this example, it is assumed that a storm drain will be built along 22nd Street, between Beverly Avenue and Mountain View Avenue. The design criterion is to maintain two of the three lanes of traffic open to flow during the 10-year runoff event. For simplicity, only drainage south of the median island will be taken into account. The storm drain will discharge into the Naylor Wash at Mountain View Avenue.

This example is chosen to illustrate the design procedure for storm-drain inlets, as well as to demonstrate both the hydraulic and the economic impact of using a depressed gutter. For these reasons, no gutter depression is assumed for this example. However, at the end of this example, a comparison will be made of the assumed design versus a design with a depressed gutter.

### PROCEDURE

1. The offsite watershed draining onto this street is generally rectangular in shape, with Naylor Wash as the south boundary (See Figure 10.18). Although Naylor Wash overflows into 22nd Street during a 100-year flood, all rainfall falling north of the wash in this area flows into 22nd street. Development along the watershed is heavy commercial, with an anticipated impervious cover of 90 percent in the future. There is assumed to be no inflow from upstream of Rosemont Blvd. The watershed slope, which is the same as the street slope, is one percent. The runoff coefficient is 0.95, and the rainfall intensity for a time of concentration,  $T_c$ , equal to five minutes is 9.6 inches/hour.

X. STORM DRAINS

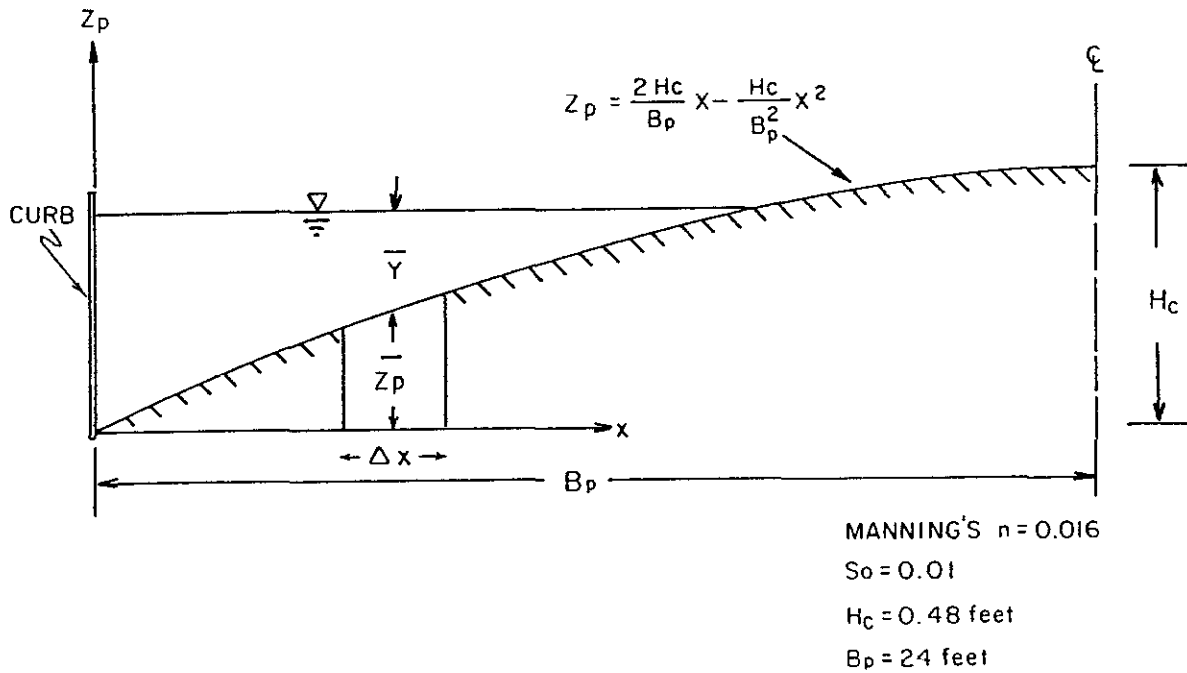

FIGURE 10.17  
 PARABOLIC STREET SECTION FOR EXAMPLE 10.1

## X. STORM DRAINS

Computations for Example 10.1

<u>X</u> DISTANCE FROM CURB (ft)	<u>Z<sub>p</sub></u> VERTICAL RISE (ft)	<u>Y</u> DEPTH OF FLOW (ft)	<u>Δx</u> WIDTH OF SECTION (ft)	<u>ȳ</u> MEAN DEPTH (ft)	<u>A</u> AREA OF SECTION (ft <sup>2</sup> )	<u>K*</u> CONVEYANCE FACTOR
0	0	0.480				
2	0.077	0.403	2	0.442	0.884	47.64
4	0.147	0.333	2	0.368	0.736	35.10
6	0.210	0.270	2	0.302	0.604	25.25
8	0.267	0.213	2	0.242	0.484	17.46
10	0.317	0.163	2	0.188	0.376	11.46
12	0.360	0.120	2	0.142	0.284	7.18
14	0.397	0.083	2	0.102	0.204	4.14
16	0.427	0.053	2	0.068	0.136	2.10
18	0.450	0.030	2	0.042	0.084	0.94
20	0.467	0.013	2	0.022	0.044	0.32
22	0.477	0.003	2	0.008	0.016	0.06
24	0.480	0	2	0.002	0.004	0.01
<b>ΣK = 151.66</b>						

$$*K = (1.486/n)(A/P)^{2/3} A$$

From which is obtained:

$$Q = \Sigma K S^{1/2} = (151.66)(0.01)^{1/2} = 15.17 \text{ cfs}$$

# X. STORM DRAINS

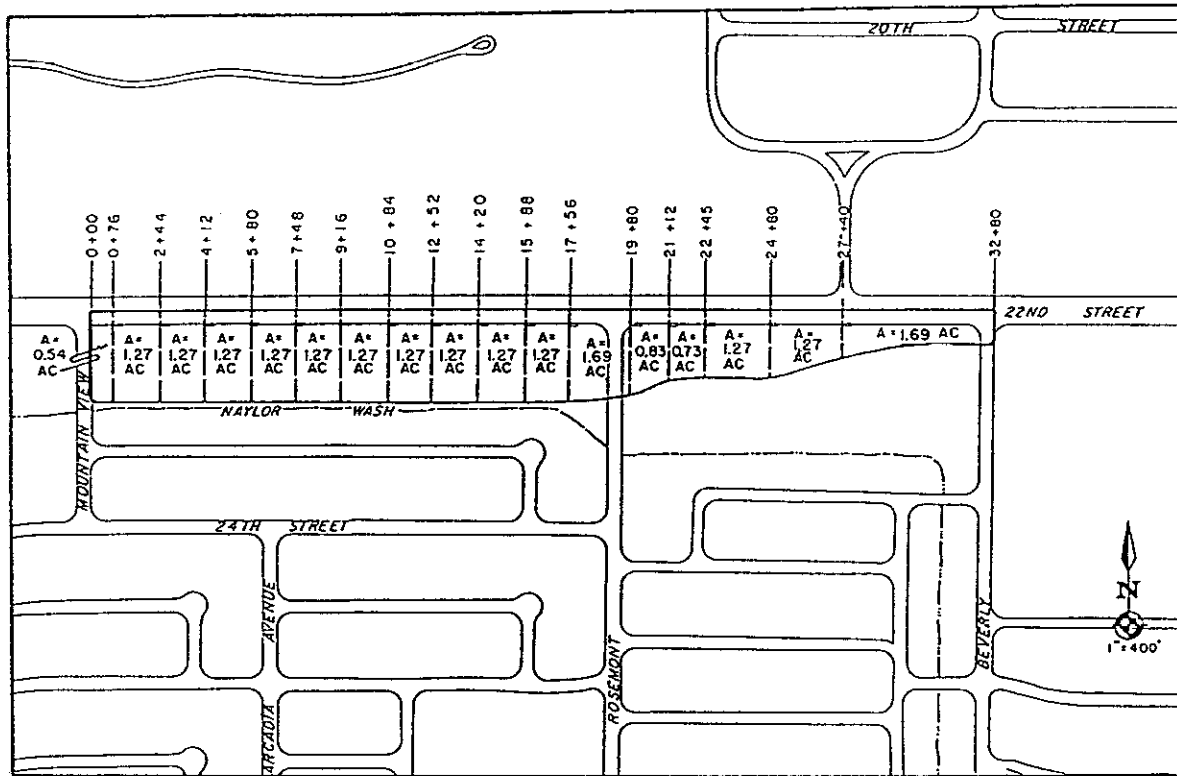

## EXPLANATION

- WATERSHED BOUNDARY
- - - SUBWATERSHED BOUNDARY
- CURB INLET

FIGURE 10.18  
WATERSHED BOUNDARIES AND INLET SPACING  
FOR EXAMPLE 10.2

## X. STORM DRAINS

2. The assumed street cross section (not the real one) is shown in Figure 10.19. It consists of three lanes, with no gutter present. The maximum allowable spread of water is twelve feet, at a depth of 0.36 feet at the curb. (i.e., 4+ inches).

Using Manning's "n" = 0.016, the maximum allowable discharge,  $Q_d$ , is computed using Equation 10.2:

$$Q_d = 0.56 \left[ \frac{(0.03)^{5/3} (12.0)^{8/3} (0.010)^{1/2}}{0.016} \right]$$

Hence,

$$Q_d = \underline{7.7 \text{ cfs.}}$$

3. For impervious cover = 90 percent,

$$Q_{100}/Q_{10} = 2.0$$

Therefore,

$$Q_{100} = 2.0(7.7 \text{ cfs}) = \underline{15.4 \text{ cfs.}}$$

Using the Rational Formula,  $Q = CiA$ ,

$$A = \frac{15.4}{(0.95)(9.6)}; \quad A = \underline{1.69 \text{ acres.}}$$

Place the first catch basin at a point where the watershed area = 1.69 acres (See Figure 10.18). The watershed area = 1.69 acres at STA 27 + 40.

4. Use a curb inlet.

Equations 10.22 and 10.23 give the required curb-inlet length in order to intercept 75 percent of the flow.

$$L_i/L_t = 1 - (1 - 0.75)^{0.556} = \underline{0.54.}$$

X. STORM DRAINS

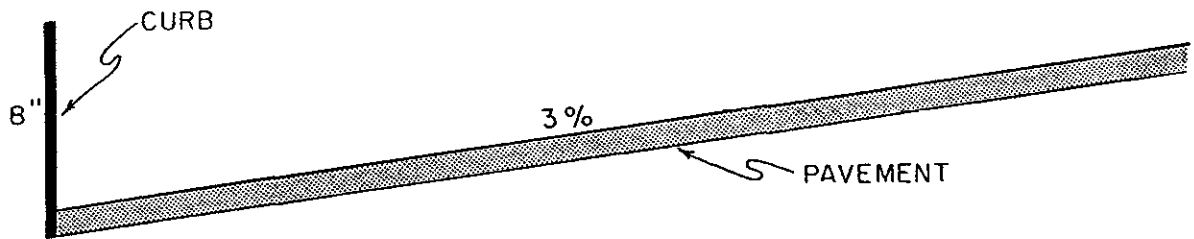

FIGURE 10.19  
ASSUMED STREET CROSS SECTION FOR EXAMPLE 10.2

## X. STORM DRAINS

$$L_t = 0.6(7.7)^{0.42}(0.01)^{0.3} \left[ \frac{1}{.016(.03)} \right]^{0.6} = \underline{34.8 \text{ feet.}}$$

$$L_i = 0.54(34.8) = \underline{19 \text{ feet.}}$$

Use a 20-foot-long standard ADOT catch basin, Type 3.

Carryover flow is:  $7.7 \text{ cfs} - 0.75(7.7 \text{ cfs}) = \underline{1.9 \text{ cfs.}}$

5. The next downstream watershed, considering carryover, must generate:

$$0.75(7.7 \text{ cfs}) = 5.8 \text{ cfs}$$

$$Q_{100} = 2.0(5.8 \text{ cfs}) = \underline{11.6 \text{ cfs.}}$$

Therefore,

$$A = \frac{11.6}{(0.95)(9.6)} = \underline{1.27 \text{ acres.}}$$

A watershed area equal to 1.25 acres is reached at Station 24+80. Use another catch basin of the same size at this location.

6. Following the same procedure, another catch basin is needed at Station 22+45. However, looking ahead, a catch basin with 100-percent efficiency will be needed at Station 19+80, because of the intersection. Unfortunately, the intervening watershed is large enough to produce a flow spread beyond the allowable, unless proportionately more flow is collected. Therefore, install another standard catch basin at Station 21+12.

The watershed area at Station 21+12 is 0.73 acres.

$$Q_{100} = 0.73(0.95)(9.6) = \underline{6.7 \text{ cfs.}}$$

$$Q_{10} = 0.5(6.7) = \underline{3.4 \text{ cfs.}}$$



## X. STORM DRAINS

Adding carryover:  $Q = 3.4 + 1.9 = \underline{5.3 \text{ cfs}}$ .

The length of curb inlet required to intercept 5.3 cfs is:

$$L_t = 0.6 (5.3)^{0.42} (0.01)^{0.3} \left[ \frac{1}{0.016(0.03)} \right]^{0.6} = \underline{30 \text{ feet.}}$$

The efficiency of a 20-foot-long curb inlet is:

$$E_i = 1 - \left[ 1 - \frac{20}{30} \right]^{1.8} = \underline{0.86.}$$

Curb-inlet capacity is:

$$0.86(5.3 \text{ cfs}) = \underline{4.6 \text{ cfs.}}$$

Carryover flow is:

$$5.3 \text{ cfs} - 4.6 \text{ cfs} = \underline{0.7 \text{ cfs.}}$$

7. The watershed area at Station 19+80 is 0.83 acres.

$$Q_{100} = 0.83(0.95)(9.6) = \underline{7.6 \text{ cfs.}}$$

$$Q_{10} = \underline{3.8 \text{ cfs.}}$$

Adding carryover,  $Q = 3.8 + 0.7 = \underline{4.5 \text{ cfs.}}$

The curb-inlet length required to collect 100 percent of this flow is:

$$L_t = \frac{0.6(4.5)^{0.42}(0.01)^{0.3}}{[(0.016(0.03))^{0.6}} = \underline{28 \text{ feet.}}$$

## X. STORM DRAINS

Use a 20-foot-long standard ADOT catch basin, Type 3, with a 10-foot-long extension.

8. The watershed downstream of Station 19+80 is more or less uniform in width (329 ft). As before, the area required to generate the maximum allowable discharge of 7.7 cfs is 1.69 acres.

Therefore, the distance to the next catch basin is:

$$\frac{1.69 \text{ ac } (43560 \text{ ft}^2/\text{ac})}{329 \text{ ft}} = \underline{224 \text{ feet.}}$$

Accordingly a standard ADOT catch basin, Type 3, is placed at Station 19+80, minus 224 ft., which is Station 17+56. Catch basins are then placed at intervals of 168 feet, in order to collect intervening watersheds of 1.27 acres in size.

9. At Mountain View Ave., STA 0+00, 100 percent of the flow must be collected. The watershed area downstream of STA 0+76 is 0.57 acres.

The 100-year peak discharge at this location is:

$$Q_{100} = 0.57(0.95)(9.6) = \underline{5.2 \text{ cfs.}}$$

Therefore, the 10-year peak discharge is:

$$Q_{10} = 0.5(5.2) = \underline{2.6 \text{ cfs.}}$$

The design discharge at Station 0+00 is  $Q_{10}$ , plus the carryover discharge:

$$2.6 \text{ cfs} + 1.9 \text{ cfs} = \underline{4.5 \text{ cfs.}} \text{ at station 0+00.}$$

The length of curb inlet required is:

$$L_t = \frac{0.6(4.5)^{0.42}(0.01)^{0.3}}{[0.016(0.03)]^{0.6}} = \underline{28 \text{ feet.}}$$

## X. STORM DRAINS

Use a 20-foot-long standard ADOT catch basin, Type 3, with a 10-foot-long extension.

The pavement-drainage worksheets for Example 10.2 can be found on the following three pages of this Manual.

-----

NOTE: In practice, it is probably cheaper to run the flow in the storm drain at Station 19+80 down Rosemont; then directly into the Naylor Wash, instead of continuing down 22nd St. A second storm drain would then begin at station 17+52.

The design criterion of one-lane maximum spread of water was chosen for illustrative purposes only. The normal requirement of leaving one lane open would allow the spread of water to extend across two lanes.

Normally, a clogging factor would be used to account for debris. Therefore, *the size of the curb inlets computed for this example should be increased by a factor of 1.25, for design purposes, in order to account for the possibility of clogging.*

Now, if a standard 1.75-foot-wide, one-inch-deep concrete gutter were added to the edge of the roadway, the street capacity would increase to 11.1 cfs. Therefore, the curb inlets could be spaced farther apart, with a total reduction in their number of about one-third. The number of curb inlets could be reduced even further by using a two-percent pavement cross-slope, and allowing water to spread across two of the three traffic lanes. This would reduce the number of required curb inlets to only about one-fifth of those shown in this example. However, the length of each curb inlet would then have to be doubled.

The purpose of presenting the preceding two scenarios is merely to demonstrate to the designer that one should always investigate several alternatives in order to develop the most hydraulically efficient, economical inlet design practicable.

PAVEMENT-DRAINAGE WORKSHEET FOR EXAMPLE 10.2

LOCATION DATA: 22nd St. STORM DRAIN      DESIGN DATA:  
 Frequency 10 YEARS

Location: Beverly to Mountain View  
 Project No: Example 10.2       $T_{all} = 12$  feet       $n = 0.016$   
 Curb Height = 0.67 feet

RUNOFF CALCULATIONS:

From Station	To Station	L ft.	W ft.	D.A. acre,	C	$T_c$ min.	i in/hr.	$Q_{100}$ cfs	$Q_{design}$ cfs	$Q_{co}$ cfs	$Q_T$ cfs	$S_o$ ft/ft	$S_x$ ft/ft	$D$ ft	$T$ ft
32 + 80	27 + 40	540	136	1.69	0.95	5	9.6	15.4	7.7	0	7.7	0.01	0.03	0.36	12
27 + 40	24 + 80	260	213	1.27	0.95	5	9.6	11.6	5.8	1.9	7.7	0.01	0.03	0.36	12
24 + 80	22 + 45	235	235	1.27	0.95	5	9.6	11.6	5.8	1.9	7.7	0.01	0.03	0.36	12
22 + 45	21 + 12	133	239	0.73	0.95	5	9.6	6.7	3.4	1.9	5.3	0.01	0.03	0.31	10.3
21 + 12	19 + 80	132	274	0.83	0.95	5	9.6	7.6	3.8	0.7	4.5	0.01	0.03	0.30	10.0

10.55

INLET CALCULATIONS

Station	Inlet Type	Y ft.	$Q_i$ cfs	$Q_{co} = Q_T - Q_i$
27 + 40	ADOT TYPE-3 CATCH BASIN	0.36	5.8	1.9
27 + 80	ADOT TYPE-3 CATCH BASIN	0.36	5.8	1.9
22 + 45	ADOT TYPE-3 CATCH BASIN	0.36	5.8	1.9
21 + 12	ADOT TYPE-3 CATCH BASIN	0.31	4.6	0.7
19 + 80	ADOT TYPE 3 WITH 10' EXT.	0.30	4.5	0

Computed by: \_\_\_\_\_

Checked by: \_\_\_\_\_

X. STORM DRAINS

PAVEMENT-DRAINAGE WORKSHEET FOR EXAMPLE 10.2 (continued)

LOCATION DATA: 22nd St. STORM DRAIN      DESIGN DATA:  
 Frequency 10 YEARS

Location: Beverly to Mountain View  
 Project No: Example 10.2       $T_{all} = 12$  feet     $n = 0.016$   
 Curb Height = 0.67 feet

RUNOFF CALCULATIONS:

From Station	To Station	L ft.	W ft.	D.A. acre,	C	$T_c$ min.	i in/hr.	$Q_{100}$ cfs	$Q_{design}$ cfs	$Q_{co}$ cfs	$Q_T$ cfs	$S_o$ ft/ft	$S_x$ ft/ft	$D_{ft}$	$T_{ft}$
19 + 80	17 + 56	224	329	1.69	0.95	5	9.6	15.4	7.7	0	7.7	0.01	0.03	0.36	12
17 + 56	15 + 88	168	329	1.27	0.95	5	9.6	11.6	5.8	1.9	7.7	0.01	0.03	0.36	12
15 + 88	14 + 20	168	329	1.27	0.95	5	9.6	11.6	5.8	1.9	7.7	0.01	0.03	0.36	12
14 + 20	12 + 52	168	329	1.27	0.95	5	9.6	11.6	5.8	1.9	7.7	0.01	0.03	0.36	12
12 + 52	10 + 84	168	329	1.27	0.95	5	9.6	11.6	5.8	1.9	7.7	0.01	0.03	0.36	12
10 + 84	9 + 16	168	329	1.27	0.95	5	9.6	11.6	5.8	1.9	7.7	0.01	0.03	0.36	12
9 + 16	7 + 48	168	329	1.27	0.95	5	9.6	11.6	5.8	1.9	7.7	0.01	0.03	0.36	12

10.56

X. STORM DRAINS

INLET CALCULATIONS

Station	Inlet Type	Y ft.	$q_i$ cfs	$Q_{co} = Q_T - q_i$
17 + 56	SINGLE ADOT TYPE 3	0.36	5.8	1.9
15 + 88	SINGLE ADOT TYPE 3	0.36	5.8	1.9
14 + 20	SINGLE ADOT TYPE 3	0.36	5.8	1.9
12 + 52	SINGLE ADOT TYPE 3	0.36	5.8	1.9
10 + 84	SINGLE ADOT TYPE 3	0.36	5.8	1.9
9 + 16	SINGLE ADOT TYPE 3	0.36	5.8	1.9
7 + 48	SINGLE ADOT TYPE 3	0.36	5.8	1.9

Computed by: \_\_\_\_\_

Checked by: \_\_\_\_\_

PAVEMENT-DRAINAGE WORKSHEET FOR EXAMPLE 10.2 (continued)

LOCATION DATA: 22nd St. STORM DRAIN      DESIGN DATA:  
 Frequency 10 YEARS

Location: Beverly to Mountain View  
 Project No: Example 10.2       $T_{all} = 12$  feet       $n = 0.016$   
 Curb Height = 0.67 feet

RUNOFF CALCULATIONS:

From Station	To Station	L ft.	W ft.	D.A. acre,	C	$T_c$ min.	$i$ in/hr.	$Q_{100}$ cfs	$Q_{design}$ cfs	$Q_{co}$ cfs	$Q_T$ cfs	$S_o$ ft/ft	$S_x$ ft/ft	$D_{ft}$	$T_{ft}$
7 + 48	5 + 80	168	329	1.27	0.95	5	9.6	11.6	5.8	1.9	7.7	0.01	0.03	0.36	12
5 + 80	4 + 12	168	329	1.27	0.95	5	9.6	11.6	5.8	1.9	7.7	0.01	0.03	0.36	12
4 + 12	2 + 44	168	329	1.27	0.95	5	9.6	11.6	5.8	1.9	7.7	0.01	0.03	0.36	12
2 + 44	0 + 76	168	329	1.27	0.95	5	9.6	11.6	5.8	1.9	7.7	0.01	0.03	0.36	12
0 + 76	0 + 00	76	329	0.57	0.95	5	9.6	5.2	2.6	1.9	4.5	0.01	0.03	0.29	9.7

10.57

INLET CALCULATIONS

Station	Inlet Type	$Y$ ft.	$Q_i$ cfs	$Q_{co} = Q_T - Q_i$
5 + 80	SINGLE ADOT TYPE 3	0.36	5.8	1.9
4 + 12	SINGLE ADOT TYPE 3	0.36	5.8	1.9
2 + 44	SINGLE ADOT TYPE 3	0.36	5.8	1.9
0 + 76	SINGLE ADOT TYPE 3	0.36	5.8	1.9
0 + 00	ADOT TYPE 3 WITH 10' EXT.	0.29	4.5	0

Computed by: \_\_\_\_\_

Checked by: \_\_\_\_\_

X. STORM DRAINS

## X. STORM DRAINS

### EXAMPLE 10.3: HYDRAULIC GRADE-LINE COMPUTATION

Figures 10.20 and 10.21 show the plan-and-profile information for the storm drain to be analyzed. This information, along with preliminary information about inlet locations and sizes, manhole locations and sizes, transition and junction locations and sizes, pipe lengths and sizes, and design discharges, must be available before the hydraulic grade-line computations can proceed.

Corrugated metal pipe will be used, so Manning's "n" is assumed equal to 0.024. The following conditions apply at the outlet:

Design Discharge = 145 cubic feet per second;

Invert of pipe elevation = 95.0 feet;

Diameter of pipe = 5.5 feet;

Hydraulic grade elevation = 100.50 feet;

Area of pipe = 23.76 square feet;

Velocity of flow = 6.1 feet per second; and,

Hydraulic radius = 1.38 feet.

Using Equation 10.29, Compute  $S_f = 0.0064$  feet/foot.

The elevation of the energy grade line at the outlet is  $HG + V^2/2g = 100.50 + 0.58 = 101.08$  feet. At station 1+00, friction loss,  $S_f = 100(0.0064) = 0.64$  feet. The energy grade-line elevation at station 1+00 is  $101.08 + 0.64 = 101.72$  feet. Computations proceed upstream in this manner. "Minor" losses are added in, as encountered, as illustrated on the hydraulic grade-line calculation sheet, and as follows:

1. Station 1+50: *bend loss*  
Radius of curvature,  $r$ , = 54 feet,  
Pipe diameter,  $D$ , = 5.5 feet,  
 $r/D = 9.8$ .

From Figure 10.13,  $K_b$  for  $90^\circ$  bend = 0.39. Angle of deflection,  $\theta$ , =  $30^\circ$ .

From Equation 10.32:

$$K_b = 0.39 \left[ 1 - \left[ \frac{90-30}{90} \right]^2 \right] = \underline{0.22.}$$

X. STORM DRAINS

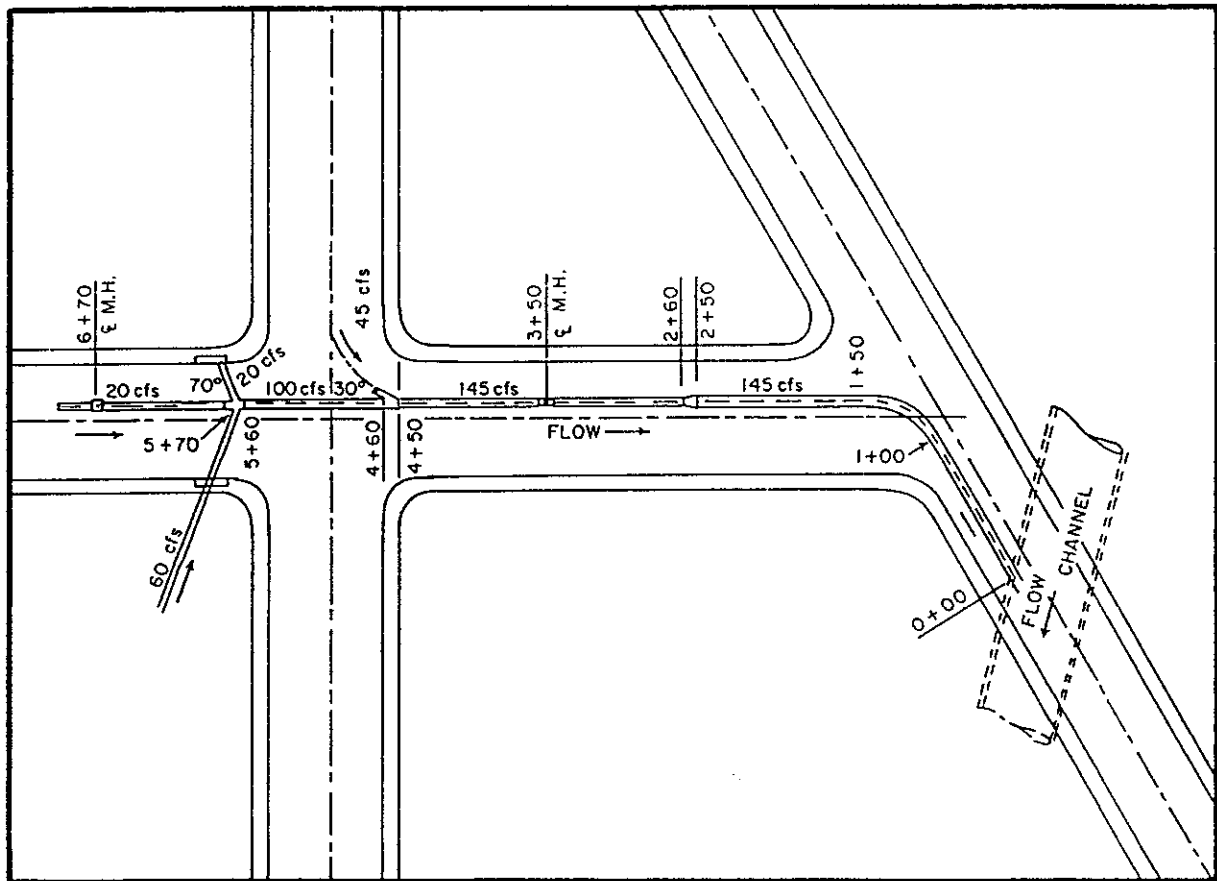

FIGURE 10.20  
PLAN VIEW OF STORM DRAIN FOR EXAMPLE 10.3



## X. STORM DRAINS

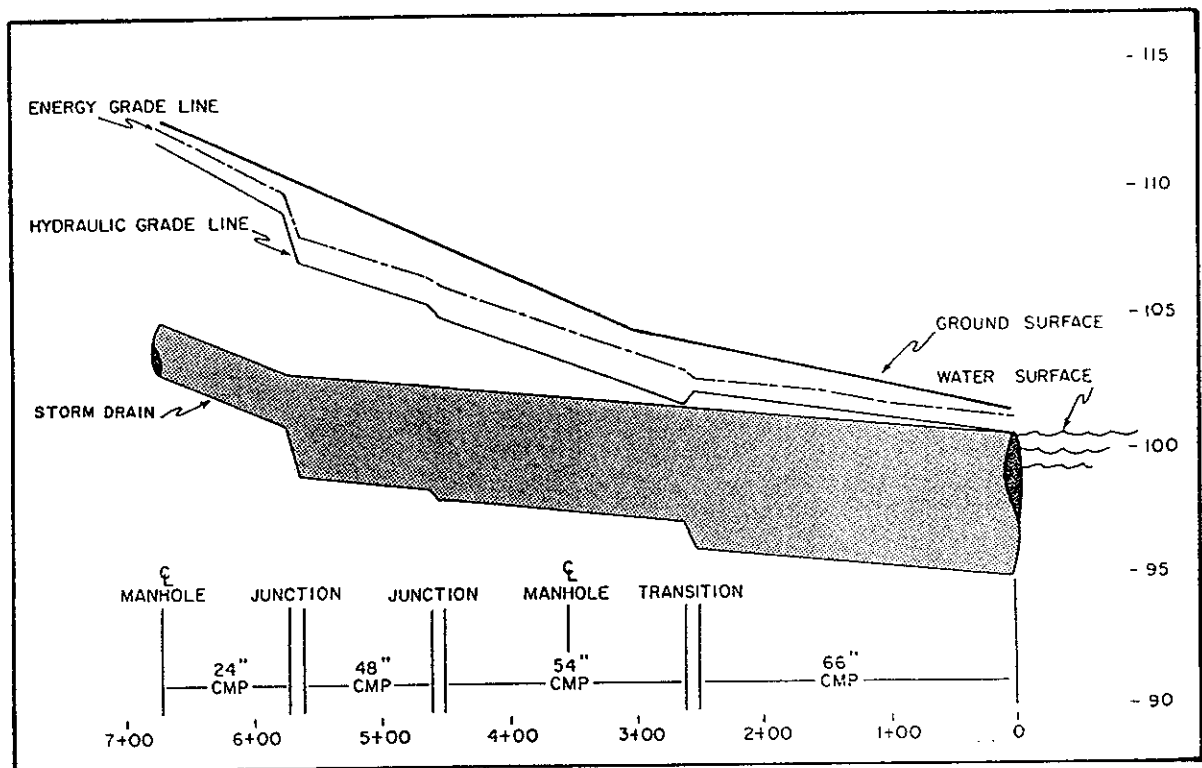

FIGURE 10.21  
PROFILE OF STORM DRAIN FOR EXAMPLE 10.3

## X. STORM DRAINS

$$h_b = 0.22 \frac{V^2}{2g} = 0.22 (0.58) = \underline{0.13 \text{ feet.}}$$

2. Station 2+60: *transition loss*

From Equation 10.38:

$$h_t = 0.2(1.29 - 0.58) = \underline{0.14 \text{ feet.}}$$

3. Station 3+50: *manhole loss*

From Equation 10.39:

$$h_{mh} = 0.05 \left[ \frac{V^2}{2g} \right] = 0.05 (1.3) = \underline{0.06 \text{ feet.}}$$

4. Station 4+60: *junction loss* (See Figure 10.22)

Use Equations 10.35 and 10.36. Then:

$$\begin{array}{lll} Q_1 = 100 \text{ cfs} & Q_2 = 145 \text{ cfs} & Q_3 = 45 \text{ cfs} \\ A_1 = 12.57 \text{ ft}^2 & A_2 = 15.90 \text{ ft}^2 & A_3 = 5.00 \text{ ft}^2 \\ V_1 = 8.0 \text{ cfs} & V_2 = 9.1 \text{ cfs} & V_3 = 9.0 \text{ cfs} \\ \theta = 30^\circ & & \end{array}$$

From which:

$$h_j = \underline{0.08 \text{ feet.}}$$

5. Station 5+70: *junction loss* (See Figure 10.23)

As with Step 4, above:

$$\begin{array}{ll} Q_1 = 20 \text{ cfs} & Q_2 = 100 \text{ cfs} \\ A_1 = 3.14 \text{ ft}^2 & A_2 = 12.57 \text{ ft}^2 \end{array}$$

X. STORM DRAINS

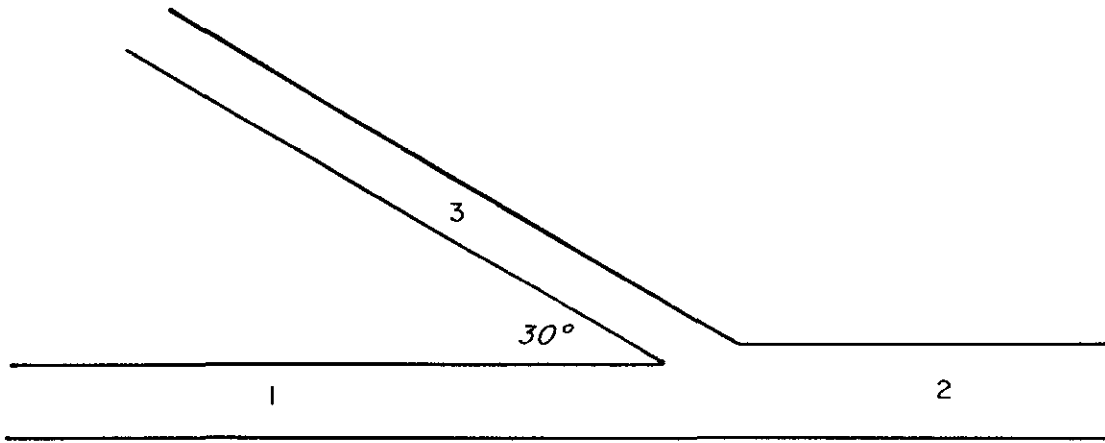

FIGURE 10.22  
STATION 4+60: JUNCTION FOR EXAMPLE 10.3

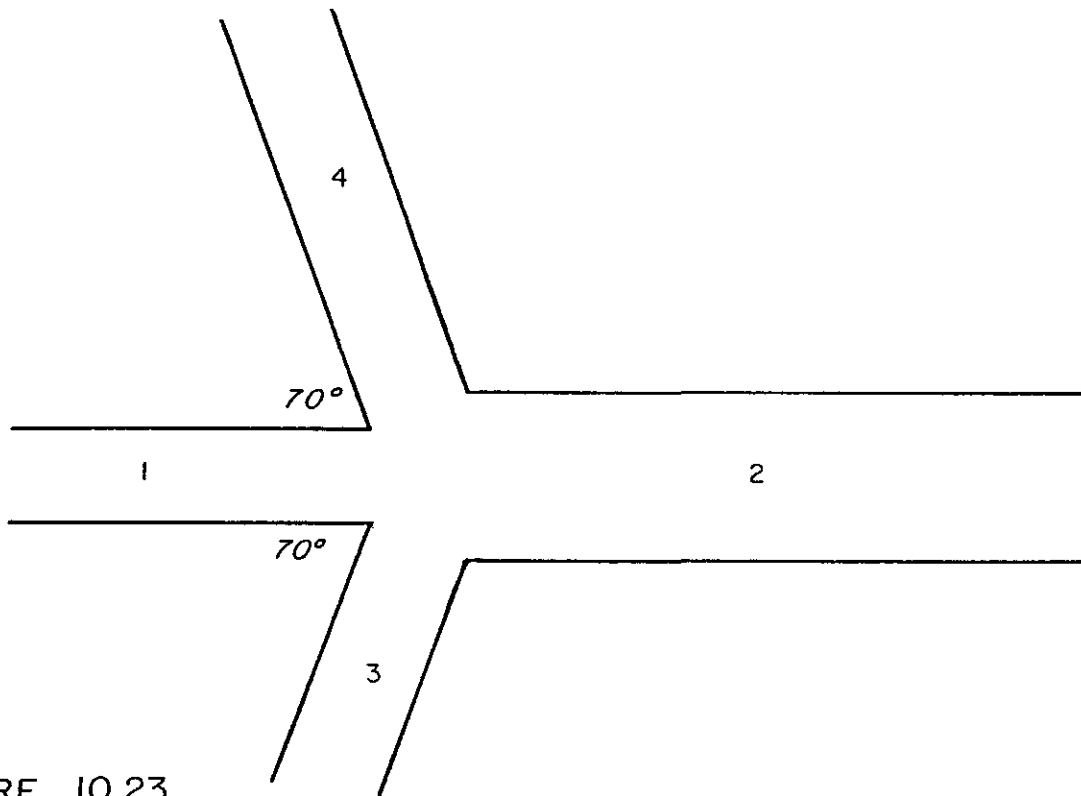

FIGURE 10.23  
STATION 5+70: JUNCTION FOR EXAMPLE 10.3

## X. STORM DRAINS

$V_1 = 6.4 \text{ fps}$	$V_2 = 8.0 \text{ fps}$
$Q_3 = 60 \text{ cfs}$	$Q_4 = 20 \text{ cfs}$
$A_3 = 7.07 \text{ ft}^2$	$A_4 = 3.14 \text{ ft}^2$
$V_3 = 8.5 \text{ fps}$	$V_4 = 6.4 \text{ fps}$
$\theta_3 = 70^\circ$	$\theta_4 = 70^\circ$

Now, use  $\Delta HG = \left[ \frac{2}{A_1 + A_2} \right] \frac{Q_2 V_2 - Q_1 V_1 - Q_3 V_3 \cos \theta_3 - Q_4 V_4 \cos \theta_4}{g}$

Then:

$$h_j = \Delta HG + \frac{V_1^2}{2g} - \frac{V_2^2}{2g}$$

From which:

$$\Delta HG = \underline{1.79 \text{ feet}} \text{ and } h_j = \underline{1.43 \text{ feet.}}$$

6. Station 6+70: *manhole loss*

Again, from Equation 10.39:

$$h_{mh} = 0.05 \left[ \frac{V^2}{2g} \right] = 0.05 (0.64) = \underline{0.03 \text{ feet.}}$$

NOTE: Using normal design procedures, the roughness coefficient would be increased by fifteen percent in order to account for aging effects upon the pipe. The roughness value used would then be 0.028, instead of 0.024.

Figure 10.24 on the following page is the hydraulic grade-line calculation sheet for this example.

## HYDRAULIC GRADE—LINE CALCULATION SHEET

Sheet \_\_\_\_\_ of \_\_\_\_\_

PROJECT: \_\_\_\_\_ CALCULATED BY: \_\_\_\_\_

LINE: \_\_\_\_\_ DATE: \_\_\_\_\_

STA.	ELEV. INV.	D	ELEV. H.G.L.	SEC-TION	D <sub>hg</sub> *	A	Q	V	$\frac{v^2}{2g}$	S <sub>f</sub>	AVG S <sub>f</sub>	L	h <sub>f</sub>	h <sub>b</sub>	h <sub>j</sub>	h <sub>t</sub>	h <sub>mh</sub>	ELEV. E.G.L.
0+00	95.00	5.5	100.50	CIR	5.50	23.76	145	6.1	0.58	.0064	.0064	100	0.64					101.08
1+00	95.50	5.5	101.14	CIR	5.64	23.76	145	6.1	0.58	.0064	.0064	50	0.32	0.13				101.72
1+50	95.75	5.5	101.59	CIR	5.84	23.76	145	6.1	0.58	.0064	.0064	100	0.64					102.17
2+50	96.25	5.5	102.23	CIR	5.98	23.76	145	6.1	0.58	.0064	.0064	100	0.64					102.81
2+60	97.25	4.5	101.78	CIR	4.53	15.90	145	9.1	1.29	.0185	.0125	10	0.12			0.14		103.07
3+50	97.70	4.5	103.51	CIR	5.81	15.90	145	9.1	1.29	.0185	.0185	90	1.67				0.06	104.80
4+50	98.20	4.5	105.36	CIR	7.16	15.90	145	9.1	1.29	.0185	.0185	100	1.85					106.65
4+60	98.70	4.0	105.92	CIR	7.22	12.57	100	8.0	0.99	.0167	.0176	10	0.18		0.08			106.91
5+60	99.20	4.0	107.59	CIR	8.39	12.57	100	8.0	0.99	.0167	.0167	100	1.67					108.58
5+70	101.20	2.0	109.59	CIR	8.39	3.14	20	6.4	0.64	.0269	.0218	10	0.22		1.43			110.23
6+70	103.20	2.0	112.31	CIR	9.11	3.14	20	6.4	0.64	.0269	.0269	100	2.69				0.03	112.95

\* Conduit unseals when D<sub>hg</sub> is less than D.

FIGURE 10.24  
HYDRAULIC GRADE—LINE CALCULATIONS FOR EXAMPLE 10.3

## CHAPTER XI: CULVERTS

### 11.1 Purpose

The purpose of this chapter is to provide technical information for the planning and hydraulic design of roadway culverts. The contents of this chapter deal only with hydraulic design. Other important design factors which are not covered in this chapter include the design of culverts to withstand earth and traffic loads, use of headwalls to prevent floatation, and construction techniques.

### 11.2 Design Criteria and Policies

1. All-weather crossings will be required in accordance with Floodplain Regulations as found under Section 23-467 of the Tucson Zoning Code and within Development Standard 2-03.2.5.A.4. At those locations where all-weather crossings are required, drainage flowing across the street in an amount greater than 100 cubic feet per second (cfs) shall be contained in a culvert, or a dip and culvert combination, which is capable of conveying runoff during a 100-year flood such that the depth of flow,  $y$ , in feet, plus the velocity head,  $V^2/2g$ , in feet, shall not exceed the numerical value of 1.30 for more than 30 minutes during the 100-year flood. In addition, under no circumstances shall the maximum flow depth in the street, in feet, exceed one foot at any time during a 10-year event. At those locations where all-weather crossings are not needed, culverts shall not be required unless the maximum flow depth during the 100-year flood exceeds two feet; or unless the depth of flow during the 100-year flood exceeds one foot for a duration in excess of 30 minutes.
2. In general, the rise in headwater elevation on the upstream side of a culvert shall conform with floodplain regulations.
3. Unless a variance is granted, *in writing*, by the City Engineer or a designated representative, the minimum acceptable pipe/culvert diameter shall be two feet for urbanized watersheds and four feet for unurbanized watersheds; and the minimum acceptable box-culvert height shall be four feet. However, for access and maintenance considerations, a minimum box-culvert height of five feet is recommended.
4. When constructing culvert systems, it is acceptable to use corrugated metal pipes in lieu of concrete pipes if the development project is private, and there is no likelihood of future public dedication and public maintenance. The use of corrugated metal pipes for projects funded by municipal monies, or for projects which are to be dedicated to the City, shall be determined by the City Engineer, or a designated representative, on a case-by-case basis.

### 11.3 Procedure for Culvert Design

Many well-written and readily available manuals describe step-by-step procedures for designing culvert systems (See, for example, Federal Highway Administration, 1965,

## XI. CULVERTS

1972, 1974, and 1985). One of most comprehensive manuals to address culvert design was published in 1985 by the Federal Highway Administration, and is entitled "Hydraulic Design of Highway Culverts" (sometimes referred to as "HDS-5").

In order to expedite review and approval of the hydraulic design of culverts by City staff, the Culvert Design Form on Figure 11.1 should be used. Earlier versions of the Culvert Design Form were published by the Arizona Department of Transportation (1973) and the Federal Highway Administration (1965).

### 11.3.1 *Step-by-Step Procedure for Sizing Culverts*

Both the Culvert Design Form and the accompanying text which describes the design procedure come largely from the manual entitled "Hydraulic Design of Highway Culverts, HDS-5", prepared by the Federal Highway Administration (1985).

STEP 1: Summarize the design discharge, tailwater height, drainage-basin area, stream slope, and the general shape of the cross section in the spaces provided under the heading "Hydrological Data" found on Figure 11.1.

STEP 2: Select a preliminary culvert shape, size, material, and entrance type, and enter this information in the space provided under the heading "Culvert Description," found on Figure 11.1. Next, enter the total design flow and the flow per culvert barrel in Row 1. In addition to floodwater conveyance, the selection of a preliminary culvert design should be based on many other factors, including right-of-way and construction costs, available embankment height, and pipe cover.

STEP 3: Evaluate inlet control.

- a. Referring to either the reinforced concrete pipe (RCP) or the reinforced concrete box culvert (RCBC) nomographs on Figures 11.2 and 11.3, locate the selected culvert size and flow rate on the appropriate scales. Nomographs for less common culvert shapes and materials can be found in the HDS-5, HEC-5, HEC-10, or HEC-13 publications prepared by the Federal Highway Administration.
- b. Using a straight edge, extend a line from the culvert size through the design flow rate to the first headwater/culvert-height ( $HW/D$ ) scale. Enter  $HW/D$ , found by projecting a line on the appropriate nomograph, in Row 2 of the Culvert Design Form.
- c. If wingwalls or a beveled culvert entrance are proposed, thereby requiring another  $HW/D$  scale, extend a horizontal line from the first  $HW/D$  scale to the desired scale. Note that 45 degrees is often used as the standard wingwall flare for pipe and box culverts, without a skewed alignment.
- d. Multiply  $HW/D$  by the culvert height,  $D$ , to obtain the required headwater,  $HW$ . If the approach velocity is negligible, or if it is intentionally disregarded by the engineer, the headwater at the inlet,

11.03

PROJECT : _____		STATION : _____		<b>CULVERT DESIGN FORM</b>													
SHEET _____ OF _____		DESIGNER / DATE : _____ / _____		REVIEWER / DATE : _____ / _____													
<p style="text-align: center;"><u>HYDROLOGICAL DATA</u></p> <p>SEE ADD'L. SHTS.</p> <input type="checkbox"/> METHOD: _____ <input type="checkbox"/> DRAINAGE AREA: _____ <input type="checkbox"/> STREAM SLOPE: _____ <input type="checkbox"/> CHANNEL SHAPE: _____ <input type="checkbox"/> ROUTING: _____ <input type="checkbox"/> OTHER: _____ <p style="text-align: center;"><u>DESIGN FLOWS/TAIWATER</u></p> <table style="width:100%; border-collapse: collapse;"> <tr> <td style="text-align: center; border-bottom: 1px solid black;">R.I. (YEARS)</td> <td style="text-align: center; border-bottom: 1px solid black;">FLOW (cfs)</td> <td style="text-align: center; border-bottom: 1px solid black;">TW (ft)</td> </tr> <tr> <td style="border-bottom: 1px solid black;"> </td> <td style="border-bottom: 1px solid black;"> </td> <td style="border-bottom: 1px solid black;"> </td> </tr> </table>		R.I. (YEARS)	FLOW (cfs)	TW (ft)				<p style="text-align: right;">ROADWAY ELEVATION : _____ (ft)</p> <p style="text-align: center;"><math>S = S_0 - FALL / L_0</math>  <math>S =</math> _____  <math>L_0 =</math> _____</p>									
R.I. (YEARS)	FLOW (cfs)	TW (ft)															
<b>CULVERT DESCRIPTION:</b> MATERIAL - SHAPE - SIZE - ENTRANCE		TOTAL FLOW Q (cfs)	FLOW PER BARREL Q/N (1)	<b>HEADWATER CALCULATIONS</b>										CONTROL HEADWATER ELEVATION	OUTLET VELOCITY	COMMENTS	
				INLET CONTROL					OUTLET CONTROL								
				HW <sub>i</sub> /D (2)	HW <sub>i</sub>	FALL (3)	EL <sub>hi</sub> (4)	TW (5)	d <sub>c</sub>	$\frac{d_c + D}{2}$	h <sub>o</sub> (6)	k <sub>e</sub>	H (7)	EL <sub>ho</sub> (8)			
<b>TECHNICAL FOOTNOTES:</b>		(4) EL <sub>hi</sub> = HW <sub>i</sub> + EL <sub>i</sub> (INVERT OF INLET CONTROL SECTION)					(6) h <sub>o</sub> = TW or (d <sub>c</sub> + D / 2) (WHICHEVER IS GREATER)					(7) H = $\left[ \frac{1 + k_e + (29 n^2 L)}{R^{1.33}} \right] v^2 / 2g$		(8) EL <sub>ho</sub> = EL <sub>o</sub> + H + h <sub>o</sub>			
(1) USE Q/NB FOR BOX CULVERTS		(2) HW <sub>i</sub> /D = HW / D OR HW <sub>i</sub> /D FROM DESIGN CHARTS					(5) TW BASED ON DOWN STREAM CONTROL OR FLOW DEPTH IN CHANNEL.										
(3) FALL = HW <sub>i</sub> - (EL <sub>hd</sub> - EL <sub>st</sub> ); FALL IS ZERO FOR CULVERTS ON GRADE																	
<b>SUBSCRIPT DEFINITIONS:</b>		<b>COMMENTS / DISCUSSION:</b>										<b>CULVERT BARREL SELECTED:</b>					
o. APPROXIMATE i. CULVERT FACE hd. DESIGN HEADWATER hi. HEADWATER IN INLET CONTROL ho. HEADWATER IN OUTLET CONTROL i. INLET CONTROL SECTION o. OUTLET i. STREAMBED AT CULVERT FACE tw. TAILWATER												SIZE : _____ SHAPE : _____ MATERIAL : _____ ENTRANCE : _____					

**FIGURE 11.1**  
**WORKSHEET FOR CULVERT CAPACITY CALCULATIONS**



# XI. CULVERTS

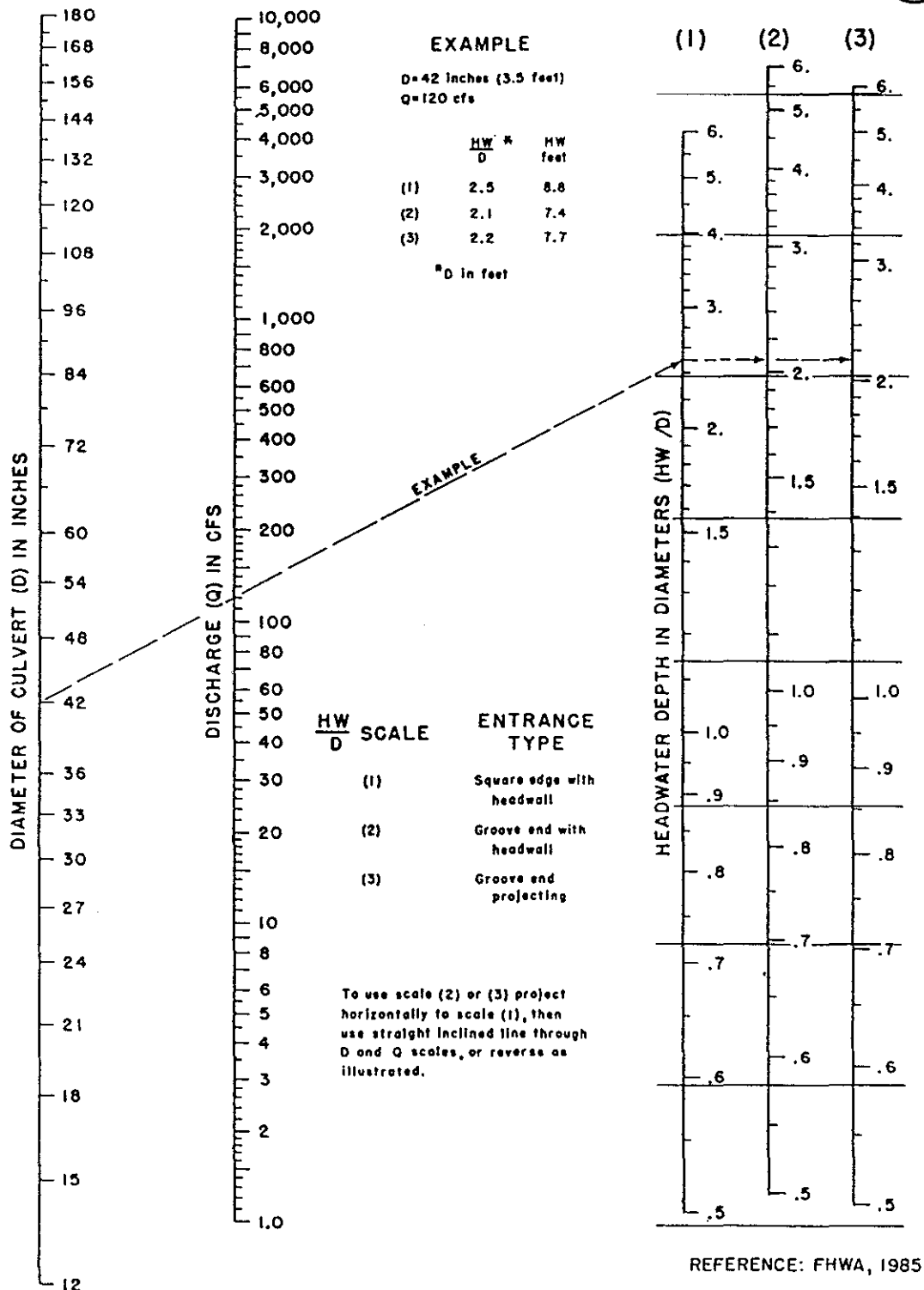

**FIGURE 11.2**  
 NOMOGRAPH FOR COMPUTING HEADWATER DEPTH FOR CONCRETE PIPE CULVERTS WITH INLET CONTROL

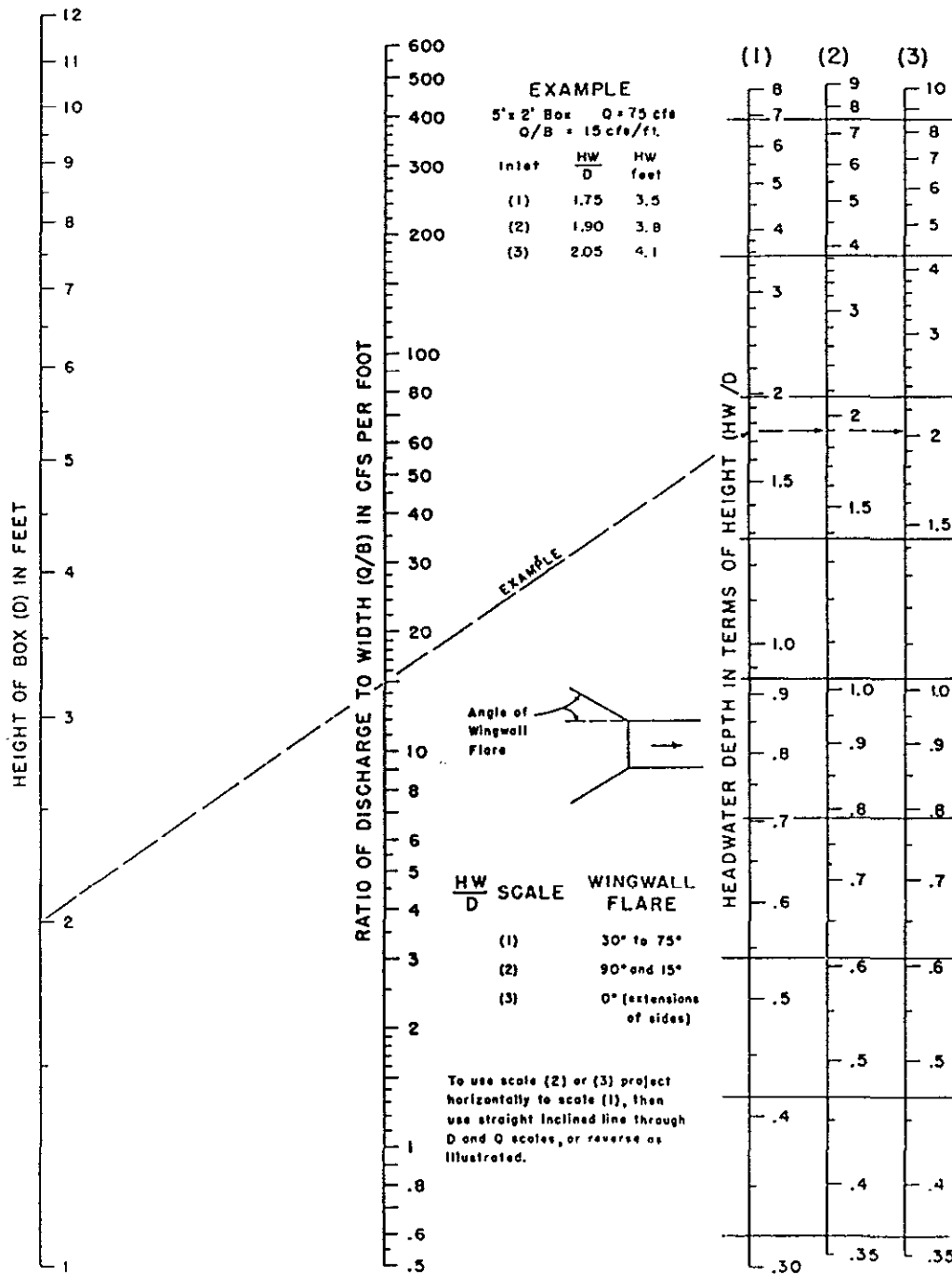

REFERENCE: FHWA, 1985

FIGURE II.3

NOMOGRAPH FOR COMPUTING HEADWATER DEPTH FOR BOX CULVERTS WITH INLET CONTROL

## XI. CULVERTS

$HW_i$ , is equal to the headwater,  $HW$ , computed from the  $HW/D$  ratio. However, if the approach velocity is to be considered, subtract the approach velocity head,  $V_i^2/2g$ , from  $HW$  to get  $HW_i$ , where  $g$  is the gravitational constant (32.2 ft/sec<sup>2</sup>) and  $V_i$  is the average flow velocity measured at an appropriate point upstream of the culvert inlet.

- e. Evaluate whether or not the inlet should be depressed below the streambed in order to obtain additional hydraulic head needed to operate the proposed culvert. When making such an evaluation, the impacts of sedimentation should be kept clearly in mind (see Chapter VI of this Manual). Referring to the culvert schematic on Figure 11.1, the fall, or height, of depression is evaluated as follows:

$$FALL = HW_i - HW_d \quad (11.1)$$

Where, symbolically,

$$HW_d = EL_{hd} - EL_{sf} \quad (11.2)$$

and,

- $HW_d$  = Design headwater depth, in feet;
- $EL_{hd}$  = Design headwater elevation, in feet;
- $EL_{sf}$  = Streambed elevation at the culvert face, in feet; and,
- $HW_i$  = Required headwater depth, in feet.

If  $FALL$  is negative, or zero, set  $FALL$  equal to zero, and proceed to Step 3f. When  $FALL$  is positive, the invert, under inlet control, must be depressed below the streambed at the face by that amount. If the  $FALL$  is acceptable, proceed to Step 3f and enter  $FALL$  in Row 3. If  $FALL$  is positive, but unacceptably large, select another culvert configuration and begin again at Step 3a.

- f. Compute, and enter in Row 4, the invert elevation,  $EL_i$ , of the inlet-control section as follows:

$$EL_i = EL_{sf} - FALL \quad (11.3)$$

### STEP 4: Evaluate Outlet Control.

- a. Determine the tailwater depth above the outlet invert,  $TW$ , by either normal depth or backwater calculations (as appropriate) for the outlet channel, and enter this value in Row 5.
- b. Determine the critical depth of flow,  $d_c$ , in the culvert by entering either the circular culvert chart on Figure 11.4, or the rectangular culvert chart on Figure 11.5. For culvert shapes other than circular or rectangular, refer to HDS-5.

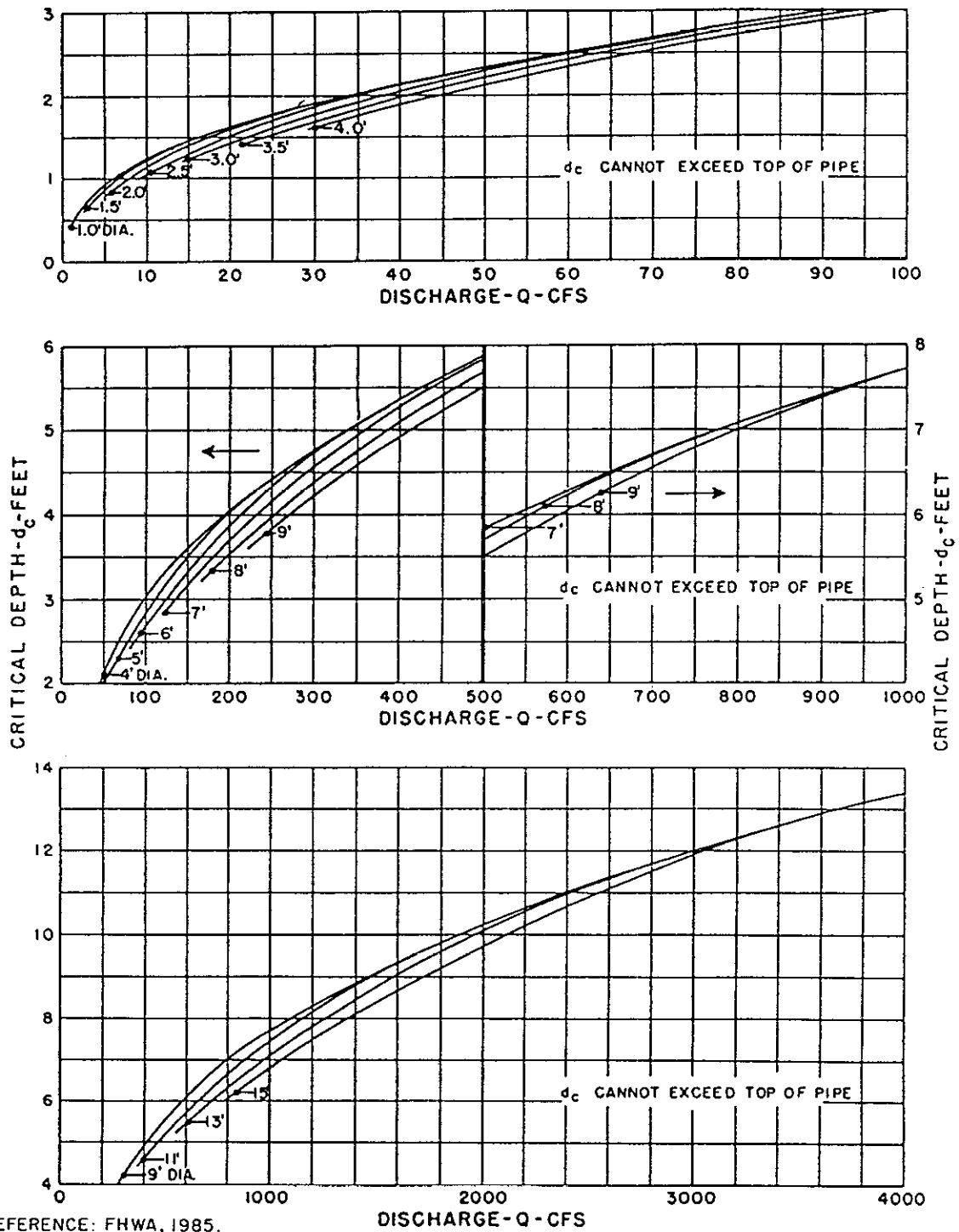

REFERENCE: FHWA, 1985.

FIGURE II.4

GRAPH FOR DETERMINING CRITICAL DEPTH IN CIRCULAR PIPES

XI. CULVERTS

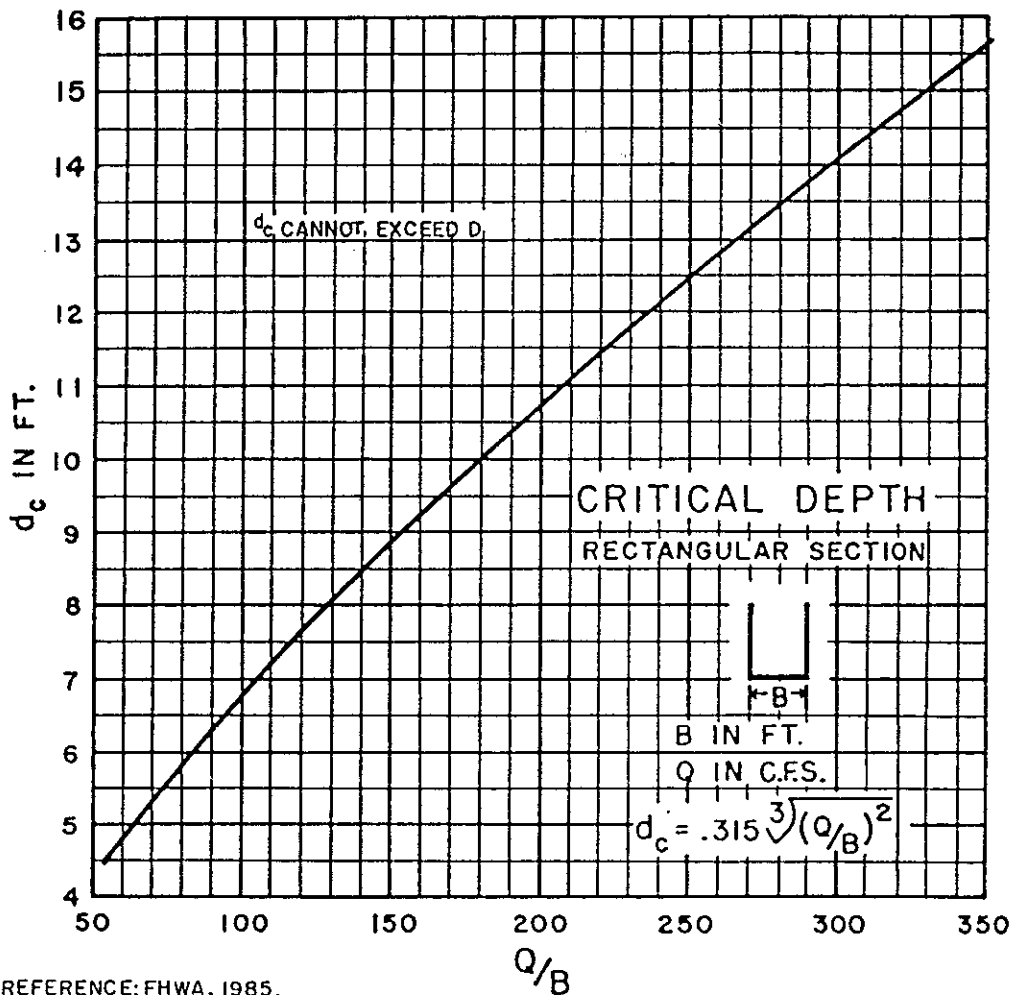
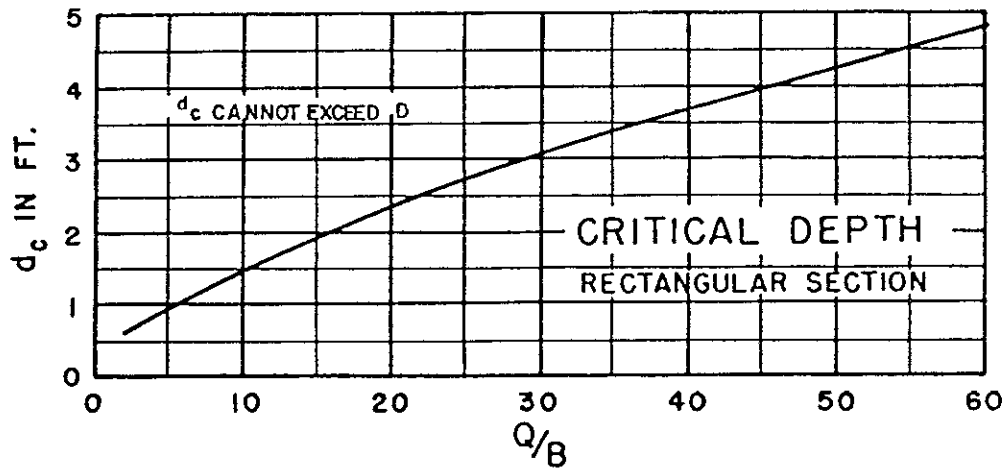

REFERENCE: FHWA, 1985.

FIGURE II.5  
GRAPH FOR DETERMINING CRITICAL DEPTH IN RECTANGULAR  
SECTIONS

## XI. CULVERTS

- c. For tailwater elevations,  $TW$ , less than the top of the culvert, calculate  $(d_c + D/2)$ , where  $D$  is the height of either the box or pipe culvert.
- d. Determine the depth from the outlet invert to the hydraulic grade line,  $h_o$ , by selecting the larger of either  $TW$  or  $(d_c + D/2)$ . Enter this larger value in Row 6.
- e. From Table 11.1, obtain the appropriate entrance loss coefficient,  $K_e$ , for the proposed inlet configuration of the culvert.
- f. Compute the head loss which occurs as the flow passes through the culvert,  $H$ . If the downstream channel velocity is included in the analysis, then use the equation:

$$H = \left[ \frac{V^2}{2g} - \frac{V_d^2}{2g} \right] + \left[ K_e + \frac{29n^2L}{R^{1.33}} \right] \frac{V^2}{2g} \quad (11.4)$$

Or, when the downstream channel velocity is neglected, use the equation:

$$H = \left[ 1 + K_e + \frac{29n^2L}{R^{1.33}} \right] \frac{V^2}{2g} \quad (11.5)$$

Enter  $H$  in Row 7.

In Equation 11.4 and Equation 11.5, the symbols are defined as:

- |       |   |   |
|-------|---|---|
| $H$   | = | Head losses through the culvert, in feet;                         |
| $g$   | = | Gravitational constant, 32.2 ft/sec <sup>2</sup> ;                |
| $K_e$ | = | Entrance loss coefficient, dimensionless;                         |
| $n$   | = | Manning's roughness coefficient;                                  |
| $L$   | = | Barrel length, in feet;   |
| $R$   | = | Hydraulic radius of the full culvert barrel, in feet;             |
| $R$   | = | $A/P$ ;   |
| $A$   | = | Full cross-sectional area of flow, in square feet;                |
| $P$   | = | Wetted perimeter of the barrel, in feet;                          |
| $V$   | = | Average velocity of flow in the culvert barrel, in feet/sec; and, |
| $V_d$ | = | Channel velocity downstream of the culvert, in feet/sec.          |

## XI. CULVERTS

**TABLE 11.1: ENTRANCE LOSS COEFFICIENTS FOR OUTLET CONTROL:  
FULL, OR PARTLY FULL, ENTRANCE HEAD LOSS**

$$h_e = K_e(V^2/2g)$$

Type of Structure and Design of Entrance	Coefficient $K_e$
<b><u>Pipe, Concrete</u></b>	
Projecting from fill, socket end (groove-end)	0.2
Projecting from fill, square-cut end	0.5
Headwall, or headwall and wingwalls	
Socket end of pipe (groove-end)	0.2
Square-edged	0.5
Rounded (radius = 1/12D)	0.2
Mitered to conform to fill slope	0.7
End-Section conforming to fill slope	0.5
Beveled edges, 33.7° or 45° bevels	0.2
Side-tapered or slope-tapered inlet	0.2
<b><u>Pipe, or Pipe-Arch, Corrugated Metal</u></b>	
Projecting from fill (no headwall)	0.9
Headwall, or headwall and wingwalls, square-edged	0.5
Mitered to conform to fill slope, paved or unpaved slope	0.7
End-Section conforming to fill slope	0.5
Beveled edges, 33.7° or 45° bevels	0.2
Side-tapered or slope-tapered inlet	0.2
<b><u>Box, Reinforced Concrete</u></b>	
Headwall parallel to embankment (no wingwalls)	
Squared-edged on 3 edges	0.5
Rounded on 3 edges to radius of 1/12 barrel dimension, or beveled edges on 3 sides	0.2
Wingwalls at 30° to 75° to barrel	
Squared-edged at crown	0.4
Crown edge rounded to radius of 1/12 barrel dimension, or beveled top edge	0.2
Wingwall at 10° to 25° to barrel	
Squared-edged at crown	0.5
Wingwalls parallel (extension of sides)	
Squared-edged at crown	0.7
Side-tapered or slope-tapered inlet	0.2

(Reference: Federal Highway Administration, 1985)

## XI. CULVERTS

If the culvert has bends, junctions, or grates, Equations 11.4 and 11.5 do not strictly apply, and the engineer should consult Chapter IV in HDS-5 for appropriate head-loss factors. Similarly, nomographs for evaluating head loss under outlet control can be found in HDS-5.

- g. Calculate the required outlet-control headwater elevation,  $EL_{ho}$ , which is defined as:

$$EL_{ho} = EL_o + h_f + h_o \quad (11.6)$$

Where:

- $EL_o$  = Outlet invert elevation;
- $h_f$  = Friction (barrel) head losses; and,
- $h_o$  = Difference in height between the outlet invert and the hydraulic grade line.

Enter  $EL_o$  in Row 8.

STEP 5: Compare the headwater elevations computed for inlet and outlet control. The higher of either  $HW_i$  or  $EL_{ho}$  is designated as the controlling headwater elevation. If the controlling headwater elevation is higher than the design headwater elevation, which is established beforehand by the Engineer, the potential for use of an improved entrance should be examined if the culvert is under inlet control, giving due consideration to the possibility of sedimentation. However, under outlet control, an enlarged barrel should not be considered, because inlet improvements are of little benefit. Instead, the engineer should consider either enlarging the culvert barrel or adding more barrels.

STEP 6: Calculate the outlet velocity as follows:

- a. If the controlling headwater is based upon inlet control, determine the normal depth and velocity in the culvert barrel from Manning's Equation. The velocity at normal depth is assumed to be the outlet velocity.
- b. If the controlling headwater is based upon outlet control, determine the area of flow at the outlet based on the barrel geometry and the following:
  1. Critical depth--if the tailwater is below critical depth;
  2. The tailwater depth--if the tailwater is between critical depth and the top of the barrel; and,
  3. The height of the barrel--if the tailwater is above the top of the barrel.



## XI. CULVERTS

Once the flow area at the outlet has been determined, the outlet velocity can be calculated by merely dividing the discharge in the culvert by the computed flow area.

Once determined, compare the outlet velocity with the existing channel velocity to see whether or not outlet protection measures are needed. Refer to Section 11.4.4.2 of this Manual for evaluation criteria.

STEP 7: Repeat the design process until an acceptable culvert configuration is determined. Once the barrel geometry is selected, it must be fitted into the roadway cross section. The culvert barrel must have adequate cover; its length should be close to the roadway right-of-way width; and the headwalls and wingwalls must be properly dimensioned.

If the selected culvert will not fit the site, return to the culvert design process and select another culvert. If neither tapered inlets nor flow routing are to be applied, document the design. An acceptable design should always be accompanied by a performance curve which displays culvert behavior over a range of discharges. If tapered inlets are to be investigated, refer to Chapter IV in HDS-5.

Situations are sometimes encountered, particularly where the upstream channel is lined and very steep, in which normal depth upstream of the culvert is less than the required height of the culvert, as determined from the nomographs. In such situations, alternate design procedures may be used if prior approval is obtained, in writing, from the City Engineer.

### 11.4 Guidelines for Culvert Design

The physical setting found at each proposed culvert location, such as topography and the amount of encroachment into the wash, play an important roll in selecting the alternative culvert designs and appurtenances to be considered. The quantity and direction of flow, the amount of sediment and debris being carried by the flow, and the need for vehicular and pedestrian safety measures all must be evaluated individually at each site on a case-by-case basis. Requiring that minimum design standards be followed under all conditions may be detrimental in terms of adding unnecessary costs or promoting inadequate performance. Therefore, the following section contains guidelines that are not necessarily required for all projects; but which will nevertheless be an aid to designing culvert inlets and outlets based on hydraulic efficiency, possible sedimentation, erosion, and/or debris accumulation, and the need to control pedestrian access.

#### 11.4.1 *Hydraulics of Culverts and Dip Sections*

A detailed description of culvert hydraulics may be found in either HEC-5 (Federal Highway Administration, 1965) or HDS-5 (Federal Highway Administration, 1985). The evaluation of culvert flow is in terms of either inlet or outlet control.

## XI. CULVERTS

The capacity of culverts flowing under inlet control is not affected by hydraulic conditions within the culvert. Since the control section is located at the inlet, only the headwater depth and inlet geometry affect culvert performance. Inlet-control culverts generally do not flow full throughout their length.

The capacity of culverts flowing under outlet control is affected by hydraulic conditions within the culvert. Controlling factors are headwater depth, inlet geometry, barrel length and slope, and tailwater elevation. For relatively long culverts, a comparison of normal depth with critical depth will generally indicate whether inlet or outlet control will exist.

During the design flood, the culvert system may alternate between inlet and outlet control as the magnitude of flow changes with time. Similarly, the roadway may be overtopped--thus changing the stage-discharge relationship dramatically. Therefore, it is beneficial to construct a performance curve for the roadway crossing.

Generally, when roadways are overtopped by floodwaters, they hydraulically behave as broad-crested weirs. For cases where the approach velocity is negligible and there is little variation in flow depth across the street sag, the specific head,  $H$ , used in the typical broad-crested weir equation

$$Q = CLH^{3/2} \quad (11.7)$$

is set equal to the ratio of cross-sectional area,  $A$ , and channel top width,  $TW$  (i.e.,  $H = A/TW$ ). However, for cases where the approach velocity is significant,  $H$  should include the velocity-head component,  $V^2/2g$ .

When flow depth varies considerably across the roadway, the cross section should be divided into several segments, and the flow computed for each segment using the equation:

$$q = \left[ \frac{2}{5} \right] \left[ \frac{CL}{(H_2 - H_1)} \right] \left[ H_2^{2.5} - H_1^{2.5} \right] \quad (11.8)$$

Where:

- $q$  = Discharge per segment, in cubic feet per second;
- $L$  = Weir-segment crest length, in feet;
- $C$  = Weir coefficient (see standard hydraulic reference texts); and,
- $H_1$  and  $H_2$  = Specific heads, in feet, at the ends of the segment; where  $H_1$  must not equal  $H_2$  (i.e.,  $H_2 > H_1$ ).

Figure 11.6 may be used to summarize the computations for embankment overflow.

**XI. CULVERTS**

CLIENT \_\_\_\_\_ JOB NO. \_\_\_\_\_ PAGE \_\_\_\_\_  
 PROJECT \_\_\_\_\_ DATE CHECKED \_\_\_\_\_ DATE \_\_\_\_\_  
 DETAIL \_\_\_\_\_ CHECKED BY \_\_\_\_\_ COMPUTED BY \_\_\_\_\_

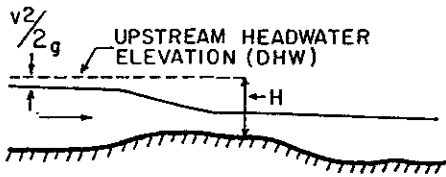

CROSS SECTION OF OVERFLOW SECTION

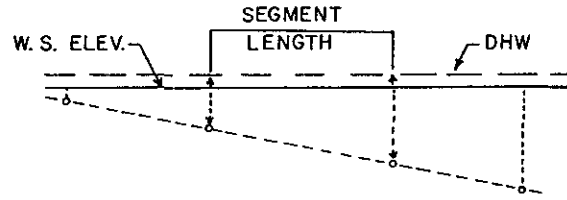

TYPICAL SEGMENT CONFIGURATION

Segment Number	Offset Station	Weir Crest Elevation	Segment Length	DHW =		DHW =		DHW =		DHW =		DHW =		COMMENTS
				H	q	H	q	H	q	H	q	H	q	
TOTAL Q =														

$Q = \sum q$  of All Segments, in cfs;  
 $q = \left(\frac{2}{5}\right)\left(\frac{CL}{H_2 - H_1}\right)(H_2^{2.5} - H_1^{2.5});$   
 $C = 2.6;$   
 $L =$  Segment Length, in feet;  
 $H_1 \neq H_2;$  and,  
 $H =$  DHW - Crest Elevation, in feet

**FIGURE II.6**  
**WORKSHEET FOR ROADWAY-EMBANKMENT OVERFLOW COMPUTATIONS**

## XI. CULVERTS

It should be noted that armoring of the sides of the roadway may be necessary if the roadway will be overtopped by a flood. The need for armoring will depend upon the frequency and severity of overtopping, and the consequences of sustaining a damaged roadway. Therefore, armoring is required for all overtopping situations, unless waived, in writing, by the City Engineer.

### 11.4.2 *Culvert Inlets and Outlets*

#### 11.4.2.1 *Inlets*

If it is determined by hydraulic analysis that (1) the proposed culvert is under inlet control and that (2) the required headwater elevation is greater than the allowable or design headwater elevation, additional culvert conveyance and a proportionate reduction in headwater can be obtained by adding any of the following improvements at the inlet: wingwalls, side-tapered and/or slope-tapered inlets, or a beveled inlet edge. Hydraulically, these inlet improvements, individually or collectively, can reduce the entrance loss coefficient,  $K_e$ , increase the entrance area, and increase the effective headwater depth. However, the potential for sedimentation within improved inlets should always be given due consideration whenever their use is contemplated.

Because of the limited use of improved inlets (particularly tapered inlets), a detailed description is not provided in this manual. However, a detailed description of the specific hydraulic theory, as well as a step-by-step procedure for designing improved inlets for culverts, can be found in HDS-5 (Federal Highway Administration, 1985).

For information regarding the structural design of improved inlets for culverts, the engineer should examine the "Structural Design Manual For Improved Inlets And Culverts" (Federal Highway Administration, 1983a); or the Standard Drawings published by the Structures Section of the Arizona Department of Transportation (1987).

In order to reduce the design effort and to minimize construction costs, it is recommended that the beveled inlets and wingwalls be used as detailed in either A.D.O.T. construction drawings or the A.D.O.T. Structures Section's Standard Drawings.

#### 11.4.2.2 *Outlets*

The design of culvert outlets is based primarily upon structural considerations aimed at protecting either the culvert or the embankment from channel scour or bank sloughing, rather than for hydraulic efficiency.

Therefore, it is extremely important that the design engineer examine whether or not the stream channel in which the culvert is placed is undergoing either aggradation or degradation in response to urbanization, channelization, excavation, etc., that either has occurred or is occurring within the contributing watershed system. If degradation is anticipated, then the future equilibrium slope should be determined (see Chapter VI of this Manual), and a structurally sound cutoff wall should be designed to prevent the culvert and embankment from being undermined.

## XI. CULVERTS

Similarly, if the outlet velocity is found to be excessive, in accordance with criteria as outlined in Section 11.4.4.2 of this Manual, outlet scour protection should be provided. If scour protection is needed at an outlet, the design engineer is advised that design information can be obtained from Hydraulic Engineering Circular Number 14 (HEC-14), entitled "Hydraulic Design of Energy Dissipators For Culverts and Channels" (Federal Highway Administration, 1983b).

### 11.4.3 *Debris Gates*

In the design process, the engineer should consider whether or not the upstream watershed will yield sufficient naturally-produced or man-made debris to pose a potential blockage problem. If debris is considered a problem, then an appropriate grate should be installed. Because of the large number of combinations of culverts and types of debris possible, there is no single standard grate design. Instead, the engineer is advised to review the Federal Highway Administration (1971) manual entitled "Debris-Control Structures" prior to designing any inlet structure.

It is the policy of the City Engineer that debris grates on culverts be used only as a last resort. The recommended method of accounting for an expected debris problem is to increase the size of the culvert, whenever possible.

### 11.4.4 *Sedimentation and Erosion*

#### 11.4.4.1 *Inlet Recommendations*

It is recommended that:

1. For either aggrading channels or those channels carrying significant sediment loads, both the inlet velocity and the inlet-pool velocity of flow at the entrance to a culvert should very nearly equal the approach velocity of flow in the upstream channel.
2. Drop inlets (abrupt) should only be used when the upstream channel is totally bank protected (i.e., both sides and channel bottom), and when significant sediment loads are not anticipated.

#### 11.4.4.2 *Outlet Recommendations*

It is recommended that:

1. Outlet protection must be installed if it is shown that the expected scour from the culvert will pose a threat to downstream property or bank protection. The procedure for estimating scour hole geometry is given in Section 6.7 of this Manual. The following guidelines adapted from the Arizona Highway Department are suggested for determining where and what type of outlet protection is required (Pima County Department of Transportation and Flood Control District, 1984, Pages VI-9 and VI-10):

## XI. CULVERTS

<u>CULVERT OUTLET VELOCITY</u>	<u>SUGGESTED OUTLET PROTECTION</u>
Less than 4 fps	No protection required
More than 4 fps and less than 10 fps	Dumped rock riprap
More than 10 fps	Wire-tied riprap

If the velocity is greater than 10 fps, consider using a concrete energy dissipator, or increasing culvert size.

2. Structurally-designed downstream cut-off walls should be installed whenever the equilibrium channel slope is less than the existing channel slope. Refer to Chapter VI of this Manual for the sizing and spacing of cut-off walls.
3. Downstream embankment stabilization should be provided whenever the 100-year design flood overtops the roadway for a continuous period of time exceeding 10 minutes in duration (Pima County Department of Transportation and Flood Control District, 1984, P. VI-8).

### 11.5 Culvert vs. Bridge Crossings

Sedimentation at culvert crossings may be a problem when the culvert cannot transport all of the sediment being delivered by the approach channel. In general, pipe culverts will transport less sediment than box culverts, and smooth pipes (e.g., concrete) will transport more sediment than corrugated metal pipes. However, the most effective method of eliminating sedimentation problems is to utilize a bridge structure which minimizes changes to the hydraulics or geometry of the approach channel. Equation 11.9 is provided as an aid to the engineer in determining if a particular culvert crossing may experience sediment deposition either within the culvert or at its entrance.

$$\mathfrak{R}_s = \frac{Q_{ac}}{Q_p} \left( \frac{S_{ac}}{S_p} \right)^{1.66} \left( \frac{n_{ac}}{n_p} \right)^{-1.55} \left( \frac{R_{ac}}{R_p} \right)^{0.91} \quad (11.9)$$

Where:

- $\mathfrak{R}_s$  = Sediment-transport ratio (channel to culvert);
- $Q_{ac}$  = Discharge in approach channel, in cubic feet per second;
- $Q_p$  = Total culvert discharge, in cubic feet per second;
- $S_{ac}$  = Longitudinal slope of approach channel, in feet/foot;
- $S_p$  = Longitudinal slope of culvert, in feet/foot;
- $n_{ac}$  = Manning's roughness coefficient for the approach channel;

## XI. CULVERTS

- $n_p$  = Manning's roughness coefficient for the culvert;  
 $R_{ac}$  = Hydraulic radius of flow in approach channel, in feet; and,  
 $R_p$  = Hydraulic radius of flow within the culvert, in feet.

If the value  $\mathfrak{R}_g$  in Equation 11.9 is less than 1.0, the culvert will most likely be able to transport the sediment being delivered by the approach channel. If the value of  $\mathfrak{R}_g$  is greater than 1.0, sedimentation may occur, and an alternate culvert or a bridge structure should be considered. The value of  $S_p$  in Equation 11.9 should never exceed the critical slope of the culvert for the discharge involved. The culvert itself may be placed on a slope greater than critical, but critical slope should always be used in Equation 11.9 under such circumstances. Additionally, if tailwater exceeds the soffit of the culvert, then a hydraulic grade line should be calculated, and the friction slope of the culvert should be used in Equation 11.9.

### 11.6 At-Grade (Dip) Crossings

Crossings of watercourses which are designed to allow drainage to flow across roadways at-grade are commonly referred to as either *at-grade* or *dip* crossings. These "structures" are often used where strict all-weather-access criteria do not need to be met. Nevertheless, when flows pass over *at-grade* crossings, hazardous conditions may be created both during and immediately after such flows because of downstream erosion and/or sediment and debris buildup within the crossing itself.

In order to minimize these hazardous conditions during and immediately after a flow event, the *at-grade* crossing should be built with a minimum four-percent cross slope, unless horizontal and vertical controls for traffic safety dictate otherwise, in order to reduce the potential for sedimentation within the crossing. The cross-slope should be accomplished by providing the vertical rise on the upstream side of the crossing, with the downstream side meeting existing grade (Pima County Department of Transportation and Flood Control District, 1984). At a minimum, a two-foot-deep cutoff wall should be placed along the upstream side of the *at-grade* crossing in order to protect the pavement edge from general scour. In addition, an adequately deep cutoff wall (i.e., based upon criteria contained within this Manual, but in no case less than three feet in depth), should be placed along the downstream side of the pavement in order to prevent erosion damage, due to local scour and channel degradation, from occurring immediately downstream of the *at-grade* crossing.

## CHAPTER XII: STREET AND PARKING LOT DRAINAGE

### 12.1 Purpose

The purpose of this chapter is to present drainage design criteria for local, collector, and arterial streets, as well as for alleys and paved parking lots (see Section 11.2 of this Manual for criteria concerning drainage crossings).

### 12.2 Street Drainage Design Criteria

#### 12.2.1 *Local, Collector, and Arterial Streets*

All new local, collector, and arterial streets, as defined in Tucson Development Standard 3-01.1.3, shall, as a minimum, meet the following drainage design criteria:

1. Runoff from a 10-year storm must be contained between the curbs of the street. On arterial streets or multi-laned roadways, at least one travel lane in each direction shall be free from flooding during a 10-year flood. Otherwise, storm drains, drainage channels, or other acceptable methods shall be required where all-weather access cannot be achieved.
2. Storm-drain systems shall be designed such that the 10-year storm is contained in the combined street-gutter and storm-drain system. Whenever developments occur in areas not adequately served by existing storm drains and/or drainage channels, and street-drainage design criteria dictate installation of storm drains, the City Engineer shall make a determination as to the type of drainage facility most beneficial for the area in question.
3. When designing streets which will extend through existing developments, the computed water-surface elevation for the 100-year design flow shall be at least one foot below the adjacent finished-floor elevations of any existing residential, commercial, or industrial buildings. Exceptions to this requirement will be reviewed by the City Engineer on a case-by-case basis.
4. Streets required for paved, permanent access shall be designed and constructed so that the flow depths over them do not exceed one foot in depth during a base (i.e., 100-year) flood, except at drainage crossings. At least one paved, permanent access shall be provided to each lot over terrain which can be traversed by conventional motor vehicles in times of flooding.
5. The minimum acceptable diameter of any public storm-drain pipe is 18 inches.
6. When private streets cross public drainageways, the crossing structure shall be designed to convey either the channel design discharge or the 100-year discharge, whichever is larger, unless this requirement is waived by the City Engineer. The crossing structure shall be designed for minimum maintenance, using standards acceptable to the City Engineer. If the drainageway is located inside a flowage easement or a drainage easement, at a minimum both the Floodplain Section and the Development Section must approve the proposed drainage crossing. Finally, if the drainageway to be



## XII. STREET/PARKING LOT DRAINAGE

crossed is located inside City right-of-way, a perpetual easement, approved by Mayor and Council, will be needed which stipulates responsibility for maintenance and liability. In all cases, a Floodplain Use Permit shall be required.

7. Unless specifically approved by the City Engineer or his designated representative, all new development and grading adjacent to existing streets shall neither block, divert, impede the flow of water away from, nor direct storm runoff into the street in an amount and/or at a location significantly different than that which occurred prior to development, construction, or grading.

### 12.2.2 *Collector and Arterial Streets*

All new collector and arterial streets shall also meet the following minimum drainage design criteria:

1. All-weather crossings will be required in accordance with the Floodplain Regulations found in Section 23-467 of the Tucson Zoning Code.
2. Unless accepted by the City Engineer, detention/retention basins shall not discharge stored runoff directly onto streets via outlet-control structures for a period in excess of 60 minutes immediately following the end of the design storm--especially if such discharge would flow into intersections of arterial/arterial or arterial/collector streets. Discharging storm runoff upstream of major intersections is acceptable only if catch basins are located between the point of release and the intersection in order to intercept releases from the detention/retention basin after the storm runoff has diminished.

### 12.3 P.A.A.L. Drainage Design Criteria

All new paved parking lots and parking and access lanes (P.A.A.L.'s) shall meet the following minimum design criteria:

1. The construction and use of a parking area in the floodplain of a Regional Watercourse shall not be permitted unless it can be shown, to the satisfaction of the City Engineer, that it does not:
  - a) Acting alone or in combination with any existing or future uses create a danger or hazard to life or property. The City Engineer may require certification by an Arizona Registered Professional Civil Engineer that the proposed use will not result in any increase in the floodway elevation during the occurrence of the 100-year flood; and/or will not result in the proposed use diverting, retarding, or obstructing the flow of flood waters;
  - b) Increase the 100-year flood elevation by more than 0.1 feet;
  - c) Adversely affect ground-water recharge;

## XII. STREET/PARKING LOT DRAINAGE

- d) Increase erosion potential upstream and/or downstream; and,
  - e) Adversely affect important riparian habitats, as identified on maps maintained by the City Engineer.
2. Parking shall be permitted in the flood plains of Regional Watercourses, Major Washes, and Minor Washes provided that the maximum depth of flooding does not exceed two feet during a 100-year flood. Overnight parking and unattended vehicles will be limited to flood plains where the flooding does not exceed one foot in depth during the 100-year flood.
  3. Any parking lot that is subject to flooding from either a Regional Watercourse, a Major Wash, or a Minor Wash shall have a prominent sign posted at each entrance to the parking area that contains the following words: "Warning, this parking lot is subject to periodic flooding at depths of up to two feet. No unattended or overnight parking is permitted".
  4. Parking shall be permitted in local detention/retention basins, provided the maximum depth of flooding is one foot or less during a 100-year flood.

### 12.4 Alley Drainage Design Criteria

All new alleys are to be designed to meet or exceed the following minimum criteria:

1. When an alley is located adjacent to a constructed drainage channel, the alley shall be at least twenty feet wide, which includes a minimum of four feet of additional right-of-way between the top of the channel slope and the edge of the alley. Safety barriers may be required if the channel bank is steeper than 3H:1V.
2. Generally, alleys shall not be used as drainageways. Alleys may be used to convey nuisance flows, but only if a 100-year flood can be contained within the alley, and the alley is protected from erosion. When an alley is used either for primary access or for utilities, paving may be required.

### 12.5 Flow-Through Openings in Perimeter Walls

In accordance with Chapter 11, Section 58, of the Tucson City Code, as well as Section 23-470.7 of the Tucson Floodplain Regulations, it is unlawful for any person to divert, retard, or obstruct the flow of waters in a watercourse--especially when it might create a hazard to life or property--without first securing a Floodplain Use Permit. Therefore, flood waters must be accepted and released from developments essentially at the same locations, and with the same magnitudes, as encountered under natural or existing conditions.

The design implication of the above statement is that whenever perimeter walls are erected, they must have adequate flow-through wall openings for accepting and

## XII. STREET/PARKING LOT DRAINAGE

releasing drainage without elevating or ponding water on the upstream side of the development. Likewise, they must have adequate flow-through wall openings so as to not concentrate or increase flow on the downstream side. Unless a recorded flowage easement has been granted to allow for the offsite diversion, collection, and concentration of dispersed flow, both on the upstream and downstream side of the development, sufficient flow-through wall openings must be provided to accept and release runoff.

The base of flow-through wall openings shall be placed "at grade", with most of these openings located in low spots established by grading plans, by topographic surveys, or by topographic mapping of the site.

Whenever perimeter walls cross arroyos or washes, their openings are to be hydraulically designed in conjunction with the open-channel system utilized.

However, if the perimeter wall crosses areas of dispersed flow, then the total length of flow-through wall openings is to be determined by assuming that each opening hydraulically behaves as a miniature rectangular box culvert acting under inlet control.

Under the preceding assumption, the total length of wall openings required to convey either the 100-year offsite or onsite flow, or combination thereof, is computed from:

$$L = 0.52 \left[ \frac{Q}{HW^{1.33} D^{0.17}} \right] \quad (12.1)$$

or,

$$L = 0.21 \frac{Q}{D} \left[ \frac{1}{HW - 0.82D} \right]^{0.5} \quad (12.2)$$

Where:

- $L$  = Total length of the flow-through wall openings, in feet;
- $Q$  = Total design discharge, in cubic feet per second;
- $D$  = Height of the flow-through wall openings, in feet; and,
- $HW$  = Headwater height at the inlet, in feet.

Equation 12.1 is valid whenever  $HW$  is less than  $D$ , and whenever the quantity  $Q/AD^{0.5}$  is less than 3.5, where  $A$  equals the cross-sectional area of flow (HDS-5, Page 146, Federal Highway Administration, 1985). Equation 12.2 is valid whenever  $HW$  is greater than  $D$ , and whenever the quantity  $Q/AD^{0.5}$  is more than 3.5 (HDS-5, Page 146, Federal Highway Administration, 1985).

As a factor of safety to account for possible debris blockage, the computed length ( $L$ ) of the flow-through wall openings shall be doubled (i.e., multiplied by two) for

## XII. STREET/PARKING LOT DRAINAGE

natural contributing watersheds; and increased by fifty percent (i.e., multiplied by 1.5) for substantially paved contributing watersheds, which are generally found in residential, commercial, and industrial developments.

The required inlet headwater,  $HW$ , can either be assumed to be some fraction of the height ( $D$ ) of the flow-through wall openings; or it can be set equal to or greater than same, provided that the resulting ponding depth is less than one foot, does not affect all-weather access; and does not adversely affect nearby buildings, roadways, or parking areas, nor affect the future development of same.

### 12.6 Computation of Flow Splits at Intersections

It is not uncommon in urbanized areas for runoff being conveyed in streets to be either augmented or diminished in quantity by flows entering or departing at street intersections. The evaluation of converging flows can be done by adding either the two contributing hydrographs or the two flood peaks, dependent upon the comparative lag times of the flood peaks. The evaluation of flow splits at intersections may be evaluated by use of Equation 12.3 below.

$$Q_L = 0.042 \left[ \frac{Q_m^{0.93} W_{ss}^{0.85}}{S_m^{0.41} W_m^{0.79}} \right] \quad (12.3)$$

Where:

- $Q_L$  = Lateral flow into the side street, in cubic feet per second;
- $Q_m$  = Main street flow measured between the curbs, in cubic feet per second;
- $S_m$  = Longitudinal slope of the main street, in feet per foot;
- $W_m$  = Width of the main street, in feet; and,
- $W_{ss}$  = Width of the side street, in feet.

When applying Equation 12.3, the following items must be taken into consideration:

1. If the main street has an inverted crown, or if the side street has been crested to impede flow,  $Q_m$  should be calculated as only that portion of the total discharge flowing above the elevation of the crest (see Figure 12.1).
2. If flow extends beyond the curbs,  $Q_m$  should be only that portion of the total discharge which would be flowing between the curbs. Equation 12.4, below, is then used to calculate the maximum amount of "overbank" flow which will also turn and flow down the side street. Note that if  $Q_o$  calculated from Equation 12.4 is positive and is greater than the actual overbank flow, it should be assumed that *all* of the actual overbank flow turns and flows down the side street. Also, if  $Q_o$  calculated from Equation 12.4 becomes negative, it should be assumed that *no* overbank flow turns and flows down the side street.

## XII. STREET/PARKING LOT DRAINAGE

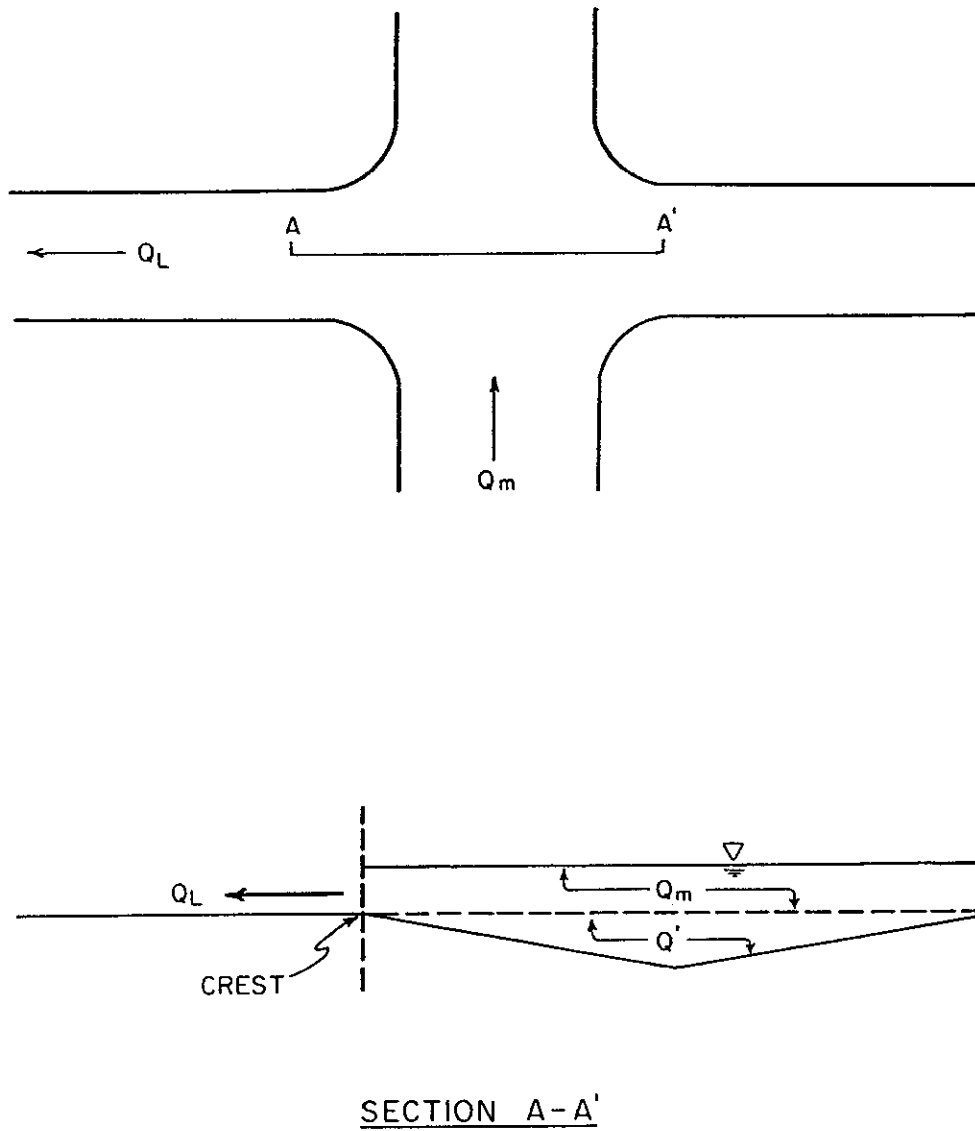

TOTAL DISCHARGE IN MAIN STREET EQUALS  $Q_m + Q'$ .  $Q_m$  (AS USED IN EQUATION 12.3) IS ONLY THAT PORTION OF THE TOTAL DISCHARGE ABOVE THE ELEVATION OF THE CREST OF THE SIDE STREET.

FIGURE 12.1  
DEFINITION SKETCH FOR COMPUTING  $Q_m$  IN AN  
INVERTED-CROWN STREET

## XII. STREET/PARKING LOT DRAINAGE

$$Q_o = 46.8y_oW_{ss}S_s^{0.5} - Q_L \quad (12.4)$$

Where:

- $Q_o$  = Overbank flow intercepted by the side street, in cubic feet per second;  
 $y_o$  = Average depth of overbank flow intercepted by the side street, in feet;  
 $S_s$  = Longitudinal slope of the side street, in feet/foot; and,

All other terms are defined in Equation 12.3.

3. If  $Q_L$  is calculated to be greater than  $Q_m$ ,  $Q_L$  shall be set equal to  $Q_m$ .
4. Specific site conditions, such as walls, buildings, etc., which may affect flow characteristics at the intersection, must be carefully considered before applying Equation 12.1.

### EXAMPLE 12.1: SPLIT FLOW AT AN INTERSECTION

A flow split must be calculated at the intersection shown on Figure 12.2. A hydrologic analysis determined that the 100-year peak discharge at a point just south of the intersection is 400 cfs. Street A slopes downward and to the north at 0.005 ft/ft, and street B slopes downward and to the west at 0.005 ft/ft. For the purposes of this example, it will be assumed that no flow enters the intersection via street B. It is also known, from the results of a hydraulic analysis, that at a flow of 400 cfs, 300 cfs will be flowing between the curbs ( $Q_m$ ), 40 cfs will be flowing outside of the curb to the west ( $Q_{LOB}$ ) at an average depth of one foot, and 60 cfs will be flowing outside of the curb to the east ( $Q_{ROB}$ ) at this same depth.  $Q_L$  is then calculated, to the nearest cfs, from Equation 12.3 as follows:

$$Q_L = 0.042 \left[ \frac{(300)^{0.93} (24)^{0.85}}{(0.005)^{0.41} (48)^{0.79}} \right] = 52 \text{ cfs}$$

The maximum amount of flow from the left overbank which can flow west on street B is calculated, to the nearest cfs, from Equation 12.4 as follows:

$$Q_o = 46.8(1)(24)(0.005)^{0.5} - 52 = 27 \text{ cfs}$$

Therefore, the total side flow into street B is calculated to be:

$$Q_L + Q_o = 52 + 27 = 79 \text{ cfs}$$

## XII. STREET/PARKING LOT DRAINAGE

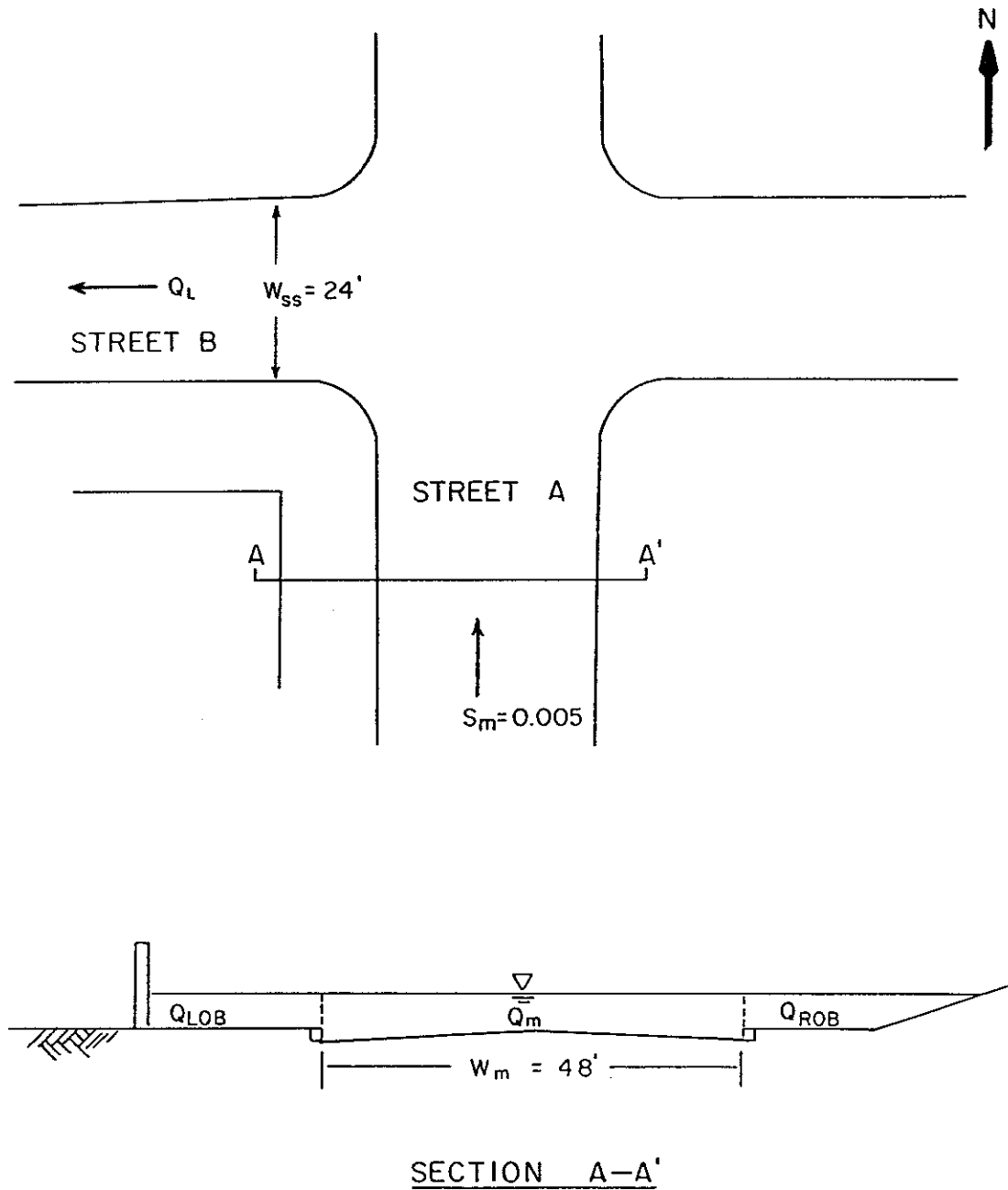

FIGURE 12.2  
EXAMPLE OF FLOW SPLIT AT A STREET INTERSECTION

## CHAPTER XIII: FLOODPROOFING

### 13.1 Purpose

The purpose of this chapter is to give a general overview and introduction to floodproofing and floodproofing techniques. Guidelines are given for a decision-making process that can aid in choosing an appropriate method of floodproofing. Detailed descriptions of the wide range of specific floodproofing practices in existence are beyond the scope of this chapter. Consequently, it is recommended that the user refer to the documents cited in the "References and Selected Bibliographies" section, found at the end of this Manual, for such specific, detailed information. In particular, the publications by the Federal Emergency Management Agency (FEMA) entitled "Design Manual for Retrofitting Flood-Prone Residential Structures" (1986a) and "Floodproofing Non-Residential Structures" (1986b) are recommended.

### 13.2 Policies

All new structures built in the regulatory floodplain must comply with floodplain regulations. This means that the lowest finished floor of any structure must be at least one foot above the base (100-year) flood elevation. Floodproofing, as is generally described in this Manual, is therefore not allowed for new construction, unless a waiver of the pertinent floodplain regulations is granted by the Mayor and Council of the City of Tucson, sitting as the Floodplain Board.

Because floodproofing of existing flood-prone structures is normally applied to private structures at private expense, the City of Tucson has no specific policies that should be followed. However, there are many good, detailed manuals on floodproofing in existence; and it is recommended that these manuals--the FEMA publications (1986a, 1986b) in particular--be used whenever floodproofing is being considered.

The City of Tucson recognizes that floodproofing should be considered when the effect of a proposed development would increase flooding hazards at only a few existing structures. Under such a scenario, the cost of a major flood-control project would far exceed the benefits received. In these instances, the developer and engineer are encouraged to design floodproofing measures for the affected structures; and should attempt to obtain approval for individual floodproofing in lieu of large-scale, flood-control facilities. Should floodproofing be approved by all affected property owners, the floodproofing design (which shall be prepared by an Arizona Registered Professional Civil Engineer) must conform to the guidelines contained herein, as well as those contained in FEMA publications (1986a, 1986b). The design must also be reviewed and approved by the City Engineer.

Should a new structure be built in a flood-hazard area in violation of floodplain regulations, and subsequently allowed to remain, floodproofing would be required. The floodproofing design must be prepared by an Arizona Registered Professional Civil Engineer according to the guidelines in this chapter, along with those contained in FEMA publications (1986a, 1986b), and be approved by the City Engineer. In such cases, approved floodproofing is required to be installed before occupancy permits are granted.



### XIII. FLOODPROOFING

#### 13.3 When to Floodproof

All new construction which is to be located in floodplains within the City of Tucson must, according to floodplain regulations, be protected from flooding by elevating the lowest floor(s) to a level at least one foot above the base (100-year) flood elevation. At present, no other method of floodproofing of new structures is permitted. However, the City may sometimes require floodproofing by other methods, if a building is built in violation of floodplain regulations such that its lowest floor is below the 100-year water-surface elevation.

FEMA regulations will allow non-residential buildings to be built with the lowest floor below the 100-year water-surface elevation, if adequate floodproofing is provided by other means. Floodproofing in this manner is allowable within the City of Tucson, in certain instances, outside of the regulatory floodplain. Specifically, commercial buildings in the inner city are not necessarily prohibited from having basements, even if it is shown that some minor amount of flow covers all or part of the site under existing conditions. Floodproofing, in the sense that the floodplain is moved away from the site by fill or walls, is allowable; but only if there is no chance that water could enter the building, and the encroachment would not cause damage to adjacent properties.

Floodproofing existing structures in the floodplain is normally the decision of the owner of the building. This decision is based upon an evaluation of the risks involved, the potential damage in the event of a flood, the costs of floodproofing, and the suitability of the structure for floodproofing. Obviously, it is recommended that any person owning property in the floodplain seriously consider floodproofing all existing buildings on said property which have their lowest floors below the base (100-year) flood elevation.

Floodproofing can also be an alternative to flood-control projects with low benefit/cost ratios. In this case, the floodproofing may be partially or completely financed by the local governmental agency responsible for flood control.

Floodproofing requires knowledge of hydrology, hydraulics, structures, building practices, and architecture; so most property owners will need the advice of professionals when exploring the possibilities of floodproofing. Professional engineers can recommend a particular type and level of floodproofing based upon the type of structure; its structural stability; use and access requirements; depth, duration, and velocity of flow; location of the structure on the property; and soil and foundation considerations.

The final decision as to whether or not to floodproof should be based upon a cost/benefit analysis of the potential damages versus the cost of floodproofing. Potential damages should not be based only upon one flood, but upon average-annual damages derived from estimating the probability of the occurrence of floods over a range of return periods. The expected benefit over time is compared to the cost of floodproofing, and a decision can be made as to whether or not to pursue floodproofing as a flood-mitigation option.

### XIII. FLOODPROOFING

The following procedure gives the basic steps in undertaking a cost-benefit analysis:

1. Obtain the flood profile from the Flood Insurance Study, published by FEMA, which contains the portion of the stream, and its associated flood plain, that impacts the structure. Locate the site of the structure on the profile. If the structure is within the FEMA floodplain, an engineering study will need to be performed in order to determine water-surface elevations at the structure for the various flood-recurrence intervals to be considered.
2. Determine the elevation of the lowest finished floor(s) of the structure. An Arizona Registered Professional Land Surveyor should provide this information.
3. Estimate the damages that would be caused by several different flood levels. Usually, analysis of the 10-, 50-, and 100-year floods is sufficient. However, if the structure is subject to very frequent flood damage, events as small as the 2-year flood may also have to be considered. Flood damage is expected to occur when the water level reaches an elevation one tenth of a foot *below* the level of the lowest finished floor, unless site-specific information to the contrary is available. The following steps will be necessary to determine these damage estimates:
  - a. Determine the water-surface elevations for those floods on the flood profile which would cause flood damage to the structure. Normally, there are four flood elevations shown on a flood profile published by FEMA, the 10-year, 50-year, 100-year, and 500-year flood-recurrence intervals. For the purposes of this procedure, the 500-year flood-recurrence interval is not considered.
  - b. Subtract the lowest finished-floor elevation from the water-surface elevation of each flood which would damage the structure.
  - c. Obtain an appraisal of the fair-market value of the structure.
  - d. Determine the value of the contents of the structure. This may be available from insurance records. A rough estimate for homes is thirty percent of the fair-market value of the structure.
  - e. Using the various depths of flooding in relation to the finished-floor level, determine the cost of damage for each flood. An estimate of the damage as a percentage of the value of the structure and its contents for different depths of flooding can be obtained from Table 13.1. The cost of damage for each flood can be obtained from the percentages and the value of the improvements. A table similar to Table 13.2 is compiled to determine the cost of damage.
4. Determine the value of the annual risk of flood damage by completing a table similar to Table 13.3. The total expected annual damages are equal to the expected yearly cost of the risk of flooding over the range of flood-

### XIII. FLOODPROOFING

<b>TABLE 13.1: FLOOD DAMAGES AS A PERCENTAGE OF VALUE FOR RESIDENTIAL STRUCTURES</b>		
<b>Depth of Flooding Above Lowest Floor (ft)</b>	<b>Damage to Structure (%)</b>	<b>Damage to Contents (%)</b>
-0.1	6	0
0	11	0
0.5	15	18
1.0	21	35
1.5	27	45
2.0	32	50
2.5	37	55
3.0	40	60

\* Source: Arizona Department of Water Resources.

XIII. FLOODPROOFING

TABLE 13.2: COST OF DAMAGE

Estimated value of the house = \_\_\_\_\_

Estimated value of the contents = \_\_\_\_\_

Elevation of the lowest floor of the house = \_\_\_\_\_

FLOOD			DAMAGE AS %		COST OF DAMAGE (\$)		
Recurrence Interval	Flood Elevation	Depth of Flooding (ft)	Structure	Contents	Structure	Contents	Total
Col. 1	Col. 2	Col. 3	Col. 4	Col. 5	Col. 6	Col. 7	Col. 8
10-Yr							
50-Yr							
100-Yr							

Explanation

Column 1: Recurrence interval of flood.

Column 2: Elevation of each flood (from flood profile).

Column 3: Column 2 minus elevation of the lowest finished-floor elevation of the structure.

Column 4 & 5: From Table 13.1

Column 6: Column 5 times estimated value of the structure, divided by 100.

Column 7: Column 6 times estimated value of the contents, divided by 100.

Column 8: Column 6 plus Column 7.

FLOOD RECURRENCE INTERVAL (Years)	FLOOD PROBABILITY	DAMAGE (Dollars)	PROBABILITY INTERVAL	AVERAGE DAMAGE (Dollars)	EXPECTED ANNUAL DAMAGE (Dollars)
			TOTAL EXPECTED ANNUAL DAMAGE		

TABLE 13.3  
EXPECTED ANNUAL DAMAGES

13.06

### XIII. FLOODPROOFING

recurrence intervals being investigated. An estimate of expected annual damages is obtained by summing the products derived by multiplying the average expected damages between two flood-recurrence intervals by the probability interval between those recurrence intervals. An example of the procedure is given at the end of this chapter.

The final decision on whether or not to floodproof must also be based upon considerations of local regulations and planned, future flood-control projects in the area. As an example of how local regulations could come into effect, floodproofing by building a dike around the property might be the most efficient method of floodproofing a residence; but the dike could also increase flooding on other property, and therefore be prohibited by local regulations.

An alternative to complete floodproofing of a residence would be partial floodproofing, if necessary. This could be done by raising machinery or electrical circuits and sealing certain key, interior rooms. Owners of homes located near regional watercourses, such as the Santa Cruz River, should have some advance warning of flooding; and therefore could have a plan of action for reducing flood loss by removing or protecting damageable materials just before a flood.

FEMA has produced a decision matrix for floodproofing methods (Federal Emergency Management Agency, 1986a). This decision matrix is reproduced in Table 13.4 as an aid to the reader in selecting a suitable floodproofing method, when appropriate.

#### 13.4 Types of Floodproofing

There are two basic types of floodproofing: "wet" floodproofing and "dry" floodproofing. "Wet" floodproofing allows water to enter the building, or parts of the building, as long as it does no serious damage. "Dry" floodproofing prevents water from entering the building entirely.

WET FLOODPROOFING can be useful in buildings which have little or no flood-damage potential. An example is given in the "Handbook for Arizona Communities on Floodplain Management and The National Flood Insurance Program" (Arizona Department of Water Resources, 1984). The example is for a building in the Salt River floodplain, which is used in conjunction with the dismantlement of junk cars. This building was wet floodproofed because the junk cars were not considered to have high flood-damage potential.

Several considerations must be taken into account when designing a building for wet floodproofing. The velocity and depth of flow should not be high enough to cause structural damage to the building. Extra reinforcement may be required, or openings should be left in the walls to allow water to rise to the same level on both sides without imposing pressure loads. All electrical utilities and sanitary equipment must be elevated to at least one foot above the 100-year water-surface elevation, as must all rooms and storage areas where flooding could cause significant damage.

TABLE 13.4: RETROFITTING METHODS

RETROFITTING FACTORS	ELEVATION (FOUNDATION WALL)	ELEVATION (ON PIERS)	ELEVATION (ON POSTS)	ELEVATION (ON PILES)	RELOCATION	LEVEES	FLOODWALLS	FLOODWALLS (WITH CLOSURES)	SEALANTS	CLOSURES
<b>1. Flood Depth</b>										
Shallow (less than 3 feet)	YES	YES	YES	YES	YES	YES	YES	YES	YES	YES
Moderate (3-6 feet)	YES	YES	YES	YES	YES	YES	YES	YES	NO	NO
Deep (greater than 6 feet)	YES	YES	YES	YES	YES	NO	NO	NO	NO	NO
<b>2. Flood Velocity</b>										
Slow (less than 3 fps)	YES	YES	YES	YES	YES	YES	YES	YES	YES	YES
Moderate (3-5 fps)	YES	YES	YES	YES	YES	YES	YES	YES	NO	NO
Fast (greater than 5 fps)	NO	NO	YES	YES	YES	NO	NO	NO	NO	NO
<b>3. Flash-Flood Potential</b>										
Yes	NO	YES	YES	YES	YES	YES	YES	NO	NO	NO
No	YES	YES	YES	YES	YES	YES	YES	YES	YES	YES
<b>4. Long-Duration Flooding</b>										
Yes	YES	YES	YES	YES	YES	NO	NO	NO	NO	NO
No	YES	YES	YES	YES	YES	YES	YES	YES	YES	YES
<b>5. Debris/Ice-Flow Potential</b>										
Yes	NO	YES	YES	YES	YES	YES	YES	NO	NO	NO
No	YES	YES	YES	YES	YES	YES	YES	YES	YES	YES
<b>6. Site Location</b>										
Floodway or Coastal V-Zone	NO	YES	YES	YES	YES	NO	NO	NO	NO	NO
Riverine Floodplain	YES	YES	YES	YES	YES	YES	YES	YES	YES	YES
<b>7. Soil Type</b>										
Permeable	NO	YES	YES	YES	YES	NO	NO	NO	NO	NO
Impermeable	YES	YES	YES	YES	YES	YES	YES	YES	YES	YES
<b>8. Building Foundation</b>										
Slab on Grade	YES	YES	YES	NO	NO	YES	YES	YES	YES	YES
Crawl Space or Basement	YES	YES	YES	YES	YES	YES	YES	YES	YES	YES
<b>9. Building Construction Type</b>										
Concrete or Masonry	YES	YES	YES	NO	YES	YES	YES	YES	YES	YES
Wood	YES	YES	YES	YES	YES	YES	YES	YES	YES	NO
<b>10. Building Condition</b>										
Excellent to Good	YES	YES	YES	YES	YES	YES	YES	YES	YES	YES
Fair to Poor	NO	NO	NO	NO	NO	YES	YES	YES	YES	NO

### XIII. FLOODPROOFING

DRY FLOODPROOFING consists of improvements to or near a structure for the purpose of preventing flood waters from entering the structure. Dry floodproofing can be included in the design of new buildings, or retrofitted into existing buildings in the floodplain. Dry floodproofing is most effective when it is incorporated into the original design of a structure. However, as stated before, City of Tucson regulations presently do not permit the floodproofing of a new structure by any method other than raising the lowest finished floor at least one foot above the highest water-surface elevation intersecting the footprint of the structure during a base (i.e., 100-year) flood.

Dry floodproofing of existing structures can be accomplished through the use of levees, floodwalls, closures, sealants, and utility protection. Relocation of buildings can also be considered a form of floodproofing. The choice of which method to use will depend on the building construction, age, and site characteristics; as well as the type, depth, rate of rise, velocity, and frequency of flooding; along with local governmental standards and regulations, cost, and individual preference on the part of the building owner. More information on "dry" floodproofing will be provided in the section to follow entitled "Engineering Aspects" (i.e., Section 13.5 of this Manual).

Floodproofing can also be divided into three types of measures: permanent measures, contingent measures, and emergency measures. Permanent measures are those that, once in place, will protect the structures without additional human aid. Levees are an example of this type of floodproofing measure.

PERMANENT FLOODPROOFING is generally more effective at reducing flood loss, but sometimes there are disadvantages, such as restricted access and inefficient utilization of space. CONTINGENT FLOODPROOFING includes removable flood shields, watertight doors, and movable floodwalls. The advantage to contingent floodproofing is that components may be moved aside and stored during dry periods, so that the visual appearance of the property is not altered and access to or utility of the site is not reduced. On the other hand, the major disadvantage of contingent floodproofing is the possibility for human error. For example, floodproofing shields can be installed improperly, or not at all, in the short warning time that often precedes a flood. Should this happen, the cost of flooding would be the cost of the flood damage plus the cost of the flood-protection system.

In and around the City of Tucson, there is typically very little warning time before floods occur, due to the rapid response of watersheds to short-duration, high-intensity storm events. For this reason, contingency floodproofing is not recommended within the City of Tucson, except near regional watercourses (such as the Santa Cruz and Rillito Rivers); and then only after flood-warning systems, acceptable to the City Engineer, are in existence.

EMERGENCY FLOODPROOFING, such as sandbagging, should be available; but it is not recommended for the individual property owner, for the same reasons that contingency floodproofing is not recommended.



### XIII. FLOODPROOFING

#### 13.5 Engineering Aspects

##### 13.5.1 *Flooding Characteristics*

The depth, velocity, and duration of flow are of primary concern in the design of floodproofing measures. In some cases, this information is available from the Federal Insurance Rate Maps (FIRM), and from the engineering studies upon which the maps are based. These maps can be obtained from FEMA. They are also available for inspection at the City of Tucson Floodplain Office. If FIRM maps are not available, the flood information must be obtained through engineering studies performed by an Arizona Registered Professional Civil Engineer.

##### 13.5.2 *Floodproofing Methods*

Several of the major methods of floodproofing are discussed in this section. It is not intended that this Manual provide complete design guidelines for floodproofing. If more information is required, the FEMA publications (1986a, 1986b), cited in the "References and Selected Bibliographies" section, found at the end of this Manual, are suggested. Every floodproofing case will pose a different design situation. Therefore, it is imperative that each design be either prepared or reviewed by an Arizona Registered Civil Engineer with expertise in floodproofing techniques.

Approval from the City Engineer is required for any kind of floodproofing, such as levees and floodwalls, which alters the floodplain. The City Engineer should be notified if other methods of floodproofing are contemplated, but approval is not necessary unless the floodproofing is for a city-owned building or is ordered by the City Engineer.

##### 13.5.2.1 *Sealants*

SEALANTS make the exterior of a building impervious so that water may rise against the building without entering. Most wall materials are permeable to water; therefore, special construction techniques or materials must be used in order to prevent seepage. When using sealants, it is important to consider that the hydrostatic forces created by floodwaters rising against a wall can be considerable. The U.S. Army Corps of Engineers has determined that, as a general rule, no more than two feet of standing water should be allowed on a brick veneer wall, and no more than three feet of standing water on a masonry wall. A structural analysis should be performed for every building for which floodproofing by sealants is contemplated. The structural analysis should include an analysis of the building foundation, if the flood duration is expected to be long enough to cause saturation of the soils. Additional loads, referred to as hydrodynamic loads from flowing water, as well as impact loads from floating debris, are normally present during flooding within the City of Tucson. These loads can also be significant, and should be taken into account when designing floodproofing measures.

Sealing can be done in brick homes by adding a layer of impermeable material between two layers of brick, or by applying a sealant to the outside surface of the wall. Homes made of material other than brick or concrete block cannot be sealed by this method. A method of sealing that can be used with most homes consists of

### XIII. FLOODPROOFING

wrapping the structure with polyethylene film. When using this technique, it is important to ensure that the film be placed on the outside of the wall so that the water pressure acts against the wall. In addition, there must be a drain system underneath the film, located *outside* of the structure, in order to carry away water that leaks through the film. Protecting homes with plastic film is a contingent method of floodproofing that, for the average home, takes several hours of work by four to six people. For this reason, this method of floodproofing is not recommended, except near regional watercourses where a flood-warning system is in existence.

#### 13.5.2.2 Closures

CLOSURES of openings such as doors and windows are required if retrofitting is to be done by sealants. If flooding will be shallow, doors can be retrofitted by installing a waterproof gasket, reinforcing the door jam and hinge points, and painting with waterproofing paint. These techniques have the advantage of being permanent. For deeper flooding, a special reinforced door or shield will be necessary to withstand the expected forces. A shield can be permanent or portable. Windows subject to flood pressures can be bricked up, if necessary, with glass bricks; or removable shields can be placed over them.

#### 13.5.2.3 Floodwalls and Levees

Buildings that are not structurally able to withstand the forces involved in floodproofing by sealing of walls and closure of openings may be floodproofed by floodwalls or levees. Floodwalls and levees are designed to keep water away from the structure, and therefore have the advantage that they can be used to protect any kind of structure in any condition. A disadvantage is that these types of measures can cause obstructions to flow that may create adverse impacts upon other property. The possibility of this effect should be taken into account when designing this type of floodproofing measure.

FLOODWALLS are generally more expensive than levees, due to higher costs for materials and labor. However, they take up less space than levees, and can be built in such a manner so as to actually enhance the physical appearance of a structure.

The design of floodwalls must take into account hydrodynamic and hydrostatic forces, and therefore should be designed by either an Arizona Registered Professional Structural Engineer or Civil Engineer with expertise in structural analysis. Additional concerns include scour at the base and corners of a wall, and saturation of the soil. Scour can be deep enough in some cases to topple a wall, and should therefore be taken into account when designing the wall footings. Saturated soil may be structurally different from dry soils, and this condition should also be taken into account.

Of particular concern in the design of floodwalls is access through the wall. Gaps are generally needed for access. However, if these gaps are used frequently, they could cause the floodwall to be categorized as "contingent floodproofing" instead of permanent floodproofing. One way to lessen risks associated with gaps in low floodwalls is to use a stile or ramp for primary day-to-day pedestrian access, and have gaps for vehicular access that are closed with flood gates the majority of the time.

### XIII. FLOODPROOFING

Drainage of runoff water originating inside a floodwall may be difficult to achieve. One method of drainage would be to create a sump, which is pumped out when necessary. Another would be to use drain pipes with flap valves, in order to prevent flow from entering the inside of a structure from the outside. Drain pipes and flap valves would require regular inspections to keep them free from debris. Care should be taken to ensure that the sump has sufficient volume to hold the runoff generated within the wall without overflowing and causing drainage. Sufficient volume for a 24-hour, 100-year rain is recommended. If a pump is used for drainage, an auxiliary power source is recommended.

LEVEES are embankments of compacted soil, often covered with an impermeable veneer, that are designed to keep flood waters from reaching a structure. As with floodwalls, they have the advantage of not subjecting the structure to hydrostatic and hydrodynamic forces. Because levees are often made of earth, they can usually be landscaped to blend in with the surrounding environment.

The main drawback in the use of levees is that they require a significant area around the structure for construction. Therefore, levees can not be used for individual floodproofing on very small parcels of land; nor can they be used if they would adversely affect flooding on other properties, or block natural drainage.

Levees must be constructed of compacted soil suitable to prevent the seepage of water during the period of time that the area will be inundated. A Soils Engineer should be employed to make recommendations whenever a levee is to be built. If suitable soil must be transported from a long distance, the cost of a levee may make other floodproofing measures more attractive. Armoring of the levee sides, or creating an impervious cover or core, would eliminate the need for importing fill, if the site material is otherwise unsuitable.

Flood flows with high velocities can erode an unprotected, earthen levee to the point of failure. Therefore, earthen levees should not be used in areas with erosive flow velocities, unless armoring is used. Scour and erosion can be reduced by aligning the levee so that the direction of flow is parallel to the levee alignment. Additionally, angle points that might create flow patterns conducive to scour should be eliminated. Flattening the outside face of the levee also reduces the potential for erosion.

Draining a levee is similar to draining a floodwall. A sump pump, or a drain with a check valve, should be used if the levee completely encircles the structure. In some cases, it may be possible to build a horseshoe-shaped levee with the open end downstream of the protected structure at a point where the water-surface elevation is below the lowest floor level. Drainage of this type of levee would be out the open end.

Earthen levees are prone to chronic damage caused by rodent burrows, settlement, cracking, vegetal growth, and long-term weathering of the surface. A continuous inspection program is necessary to maintain an earthen levee in good condition. At a minimum, inspections should be made in late spring, early fall, and after each flood.

## XIII. FLOODPROOFING

### 13.5.2.4 Protection of Utilities

Flooding of utilities is a very common and easily prevented source of flood damage to structures. As with protecting the structure proper, there are also permanent, contingent, and emergency methods of floodproofing utilities. The simplest emergency measures would be to shut off the main gas valve to the structure, shut off the main power switch, and remove all fuses or switch off every circuit breaker. Electrical equipment protected in this manner should be cleaned and dried before use after a flood.

Permanent protection can be provided by shielding, anchoring, relocation, elevation from the floor, or suspension from the ceiling. Shielding is best when flooding is of shallow depth and use of the utilities is infrequent, such as with a furnace or air conditioner. Permanent in-place elevation or relocation to a place free from flooding, such as an elevated utility room, is recommended.

Protection of plumbing from backflow may be necessary in some areas, especially along regional watercourses. This can be accomplished by installing a one-way check or backwater valve in the sewer pipe, or installing a gate valve which is operated manually. The disadvantage to the check valve is that debris could cause it to become stuck in an open position. The disadvantage to the gate valve is that it requires a person to be present to operate it at the time of the flood.

### 13.5.2.5 Elevation

ELEVATION of a structure above the base (100-year) flood elevation is the *most effective form of floodproofing*. For new structures, this should be done in accordance with the City of Tucson floodplain regulations, which require that the lowest finished floors of all structures be elevated to at least one foot above the 100-year flood level. It is required that fill be protected from erosion, or extend at least 25 feet away from the building in all directions.

Other methods of elevating structures include extended foundation walls, piers, posts, or piles. Extended foundation walls are not recommended if, in the estimation of the design engineer, velocities are expected to be high, since unprotected foundation walls are subject to hydrostatic and hydrodynamic forces. Hydrostatic forces can be eliminated by elevating structures on piers, posts, or piles; thereby allowing the water to freely pass underneath them. Care should be taken to ensure that submergence or saturation of the soils beneath the foundation of an elevated structure will not be a problem.

### XIII. FLOODPROOFING

#### EXAMPLE 13.1: COMPUTING EXPECTED ANNUAL FLOOD DAMAGE FOR A RESIDENCE

A residence in the floodplain has its lowest finished-floor elevation at 2584.8 feet above mean sea level. It has been determined from the applicable FEMA maps that the elevations of the 10-, 50- and 100-year floods at the residence are 2585.0, 2586.5 and 2587.5 feet above mean sea level, respectively. The market value of the home is \$100,000, with its contents valued at \$30,000. From this information, and utilizing Table 13.1, the following table is created:

FLOOD-DAMAGE COSTS FOR EXAMPLE 13.1						
Column 1	Column 2	Column 3	Column 4	Column 5	Column 6	Column 7
Flood-Recurrence Interval	Depth of Flooding (ft)	Percent Damage to Structure	Percent Damage to Contents	Damage to Structure \$	Damage to Contents \$	Total Damage \$
10-year	0.2	12.6	7.2	12,600	2,160	14,760
50-year	1.7	29.0	47.0	29,000	14,100	43,100
100-year	2.7	38.2	57.0	38,200	17,100	55,300

For this example, there is no flood with a known water-surface elevation which would *not* damage the structure. Therefore, the analysis of annual risk of flood damage must begin with the assumption that no flooding of the structure translates into an exceedance probability equal to one (i.e., *all* floods will cause at least some damage to the structure.) Table 13.3 is used, as follows, to perform the risk analysis.

1. Columns 1-3 are completed by using the information already available.
2. Column 4 is computed as the difference between the values in column 2.
3. Column 5 is computed as the average of the adjacent values in column 3.
4. Column 6 is computed as the product of column 4 and column 5.
5. The total expected annual damage (i.e., column 7) is the sum of the values in column 6.

In this case, the total expected annual damage is \$9,448.00 (see Figure 13.1). If the cost of floodproofing is less than the present value of a yearly payment in this amount over the period of time the structure will be used, floodproofing is considered to be cost-effective, and should be pursued as a viable option for the prevention of flood damage.



**XIII. FLOODPROOFING**

This page intentionally left blank.

## CHAPTER XIV: DETENTION/RETENTION BASINS

### 14.1 Purpose

The following section briefly describes design criteria and policies which are to be followed by the design engineer whenever planned developments are to occur within a drainage basin which has been identified by the City of Tucson as either a Balanced Basin or a Critical Basin. Please review the City Engineer's "Balanced and Critical Basin" map to determine the watersheds which have been designated as Balanced or Critical Basins. For those watersheds which have not been designated as either balanced or critical, detention/retention requirements may be waived for new development provided new or existing stormwater conveyance facilities can safely release and convey the increased onsite runoff without increasing flood hazards to adjacent properties.

The criteria and policies contained herein are intended for designing small-scale, local detention/retention basins in partial fulfillment of requirements as set forth in Section 26-10 of the Tucson Code. Most of the criteria and policies which follow are to be used in addition to those policies and design guidelines which can be found in the Pima County/City of Tucson "Stormwater Detention/Retention Manual" (1987), also referred to in this Manual as Tucson Development Standard 10-01.0.

### 14.2 Design Policies

This section provides a summary of general design policies related to stormwater detention/retention systems. Many of the policies presented below may be found, along with other detention policies, in Tucson Development Standard 10-01.0.

1. Retention requirements apply to any commercial or industrial development on a site or lot larger than one standard acre in size, and to any lot subdivided since September 4, 1984, from a lot larger than one standard acre in size. In addition, detention requirements generally apply to all residential developments occurring on sites larger than one standard acre in size. However, under certain circumstances, detention may be waived for residential developments having gross densities of less than three dwelling units per acre, if it can be shown that such a waiver will not result in any adverse downstream effects, nor create any disturbance to the existing drainage patterns both within and adjacent to any such developments.

In no case will detention requirements be imposed upon an individual residential lot used for single-family residential applications, regardless of lot size. Stormwater detention/retention may be waived for certain types of development which meet the hydrologic criteria presented in Section 1.4 and Section 2.3 of Tucson Development Standard 10-01.0.

2. Developments which require detention, and which are phased, shall prepare a master stormwater-detention scheme for the entire development. However, construction of the detention/retention basins, and their attendant drainageways, may also be phased "in-step" with the development project, with the prior written approval of the City Engineer.



#### XIV. DETENTION/RETENTION BASINS

3. Except for large-scale, regional detention/retention basins, the City of Tucson shall not accept small-scale, local detention/retention basins for operation, maintenance, or liability. The City of Tucson may accept large-scale, regional detention/retention basins on a case-by-case basis. If it is intended that a proposed basin be operated and maintained by the City, the City Engineer shall be consulted in advance.
4. Finished floors of structures shall be a minimum of one foot above the 100-year water-surface elevation of any adjacent detention basin(s), unless the City Engineer, or a duly authorized representative, approves a reduced minimum freeboard based upon consideration of the ability of the site to convey storm runoff away from the structures should the basin capacity be exceeded.
5. If a pump is to be used, the rate at which the pump is to operate must not overtax downstream drainage systems. A pump should be provided with an automatic control switch with a vertical float mechanism, or an equivalent device. Pumps should be accessible when the basin is full, and pump inlets should be screened. A pump-inlet box should be provided with a means to drain when the pump is not running. The outflow point for a pump must be acceptable to the City. Pumping the retained water into a street for periods longer than four hours is normally not acceptable because of the hazards and inconveniences that are created by prolonged periods of runoff in the streets, and because of the possible accelerations of pavement deterioration that are caused by prolonged exposure of the pavement to flowing water.
6. At the time of building-permit submittal, the Tucson Building Safety Division will require a soils report for all developments with on-site detention basins. Relative to the design of detention basins, the soils report, at a minimum, shall contain (a) technical information regarding soil classification, soil erodibility, soil permeability and infiltration rate, slope stability, and ground-water elevation; (b) a recommended minimum setback from buildings and other structures; (c) an evaluation of whether or not hydro-collapsing soils are present on the site; and (d) the results from a minimum 30-foot-deep soil boring, which is then used as the basis for the information and design recommendations summarized within the soils report. In conjunction with the soils report, either the soils engineer or the civil engineer of record for the development shall provide written certification to the City Floodplain Section, prior to issuance of a Building Permit, that the proposed buildings or structures, shown on the previously approved site plan, development plan, or tentative/final plat, are in compliance with the recommended minimum building setback from the detention/retention basin, as stipulated by the soils report. Should the soils report indicate that the proposed setback is inadequate, then it will be incumbent upon the owner/developer to provide mitigation measures, or an additional setback, for the approval of appropriate review agencies. In developments that require on-site detention/retention basins, but that are not located within a suspected area of hydro-collapsing soils, Building Safety and the Floodplain Section will accept, upon prior written approval from Building Safety, (a) a written certification from the soils engineer which states that the danger of soil collapse does not exist, and that the proposed buildings and structures satisfy the

## XIV. DETENTION/RETENTION BASINS

recommended minimum setback from detention/retention basins; and (b) the results of a test boring less than the typical 30-foot-deep test hole.

7. Prior to issuance of the first Certificate of Occupancy for a development, where required, or the release of assurances for a subdivision, Building Safety and Floodplain Section staff must receive a certificate from an Arizona Registered Professional Civil Engineer stating that the drainageways and detention/retention basins have been constructed in accordance with the approved plans.
8. Parking lot detention/retention basins shall be discouraged, whenever a separate set-aside area can be provided within the development site.
9. Requirements for security barriers shall be in accordance with the Pima County/City of Tucson "Stormwater Detention/Retention Manual" (1987), also referred to in this Manual as Tucson Development Standard 10-01.0.
10. New developments are required to practice stormwater harvesting to the maximum extent reasonably possible. The volume of runoff collected for stormwater harvesting may be utilized to offset the volume required for threshold retention.

### 14.3 Inspection and Maintenance Policies

It is important to recognize that some on-going maintenance will be required at all detention basins. A quality maintenance program, starting with careful design, will help minimize the long-term cost of maintenance, as well as enhance the facility in terms of it potentially functioning as a multi-purpose neighborhood activity center.

On-going maintenance includes both scheduled and unscheduled maintenance activities. **SCHEDULED MAINTENANCE** involves such things as mowing, pruning, and trash removal, which are performed on a regular basis. **UNSCHEDULED MAINTENANCE** involves repairs, usually made necessary by storms and floods, which are discovered either during regularly scheduled inspections, or during inspections made after flooding.

The following policies shall be observed during the design and preparation of site plans:

1. The responsibility of operating and maintaining a local detention basin rests with the owner of the facility. However, the City of Tucson reserves the right to periodically inspect or review any private-maintenance actions that would help to ensure that private maintenance, related to facility operation and safety, is being adequately provided.
2. The Covenants, Conditions, and Restrictions (CC&Rs), Final Plats, or Development Plans shall have a note stating (a) that the owner or owners shall be solely responsible for operation, maintenance, and liability for drainage structures and detention basins; (b) that the owner or owners shall have an Arizona Registered Professional Civil Engineer prepare a certified inspection report for the drainage and detention/retention facilities at least once each year,

#### XIV. DETENTION/RETENTION BASINS

and that these regular inspection reports will be on file with the owner for review by City staff, upon written request; (c) that City staff may periodically inspect the drainage and detention/retention facilities to verify that scheduled and unscheduled maintenance activities are being performed adequately; and (d) that the owner or owners agree to reimburse the City for any and all costs associated with maintaining the drainage and detention/retention facilities, should the City find the owner or owners deficient in their obligation to adequately operate and maintain their facilities.

3. The certified annual inspection report shall contain the following summaries: (a) either a statement that no maintenance work is needed at that time, or a list of repairs and work to be done to correct deficiencies or potential problems and/or to restore the aesthetics, followed by a letter of certification from an Arizona Registered Professional Civil Engineer stating that the recommended work has been satisfactorily completed; and (b) a statement either indicating that watershed conditions have not changed since the previous inspection report, or stating that specific changes have occurred which alter or eliminate some of design features and affect the level of service of the drainage and detention/retention systems. The City Engineer is to be notified if watershed conditions have changed to the extent that drainage and detention/retention systems no longer satisfy the requirements of the Floodplain Regulations found in the Tucson Zoning Code.
4. A minimum of one 15-foot-wide vehicular access ramp shall be provided into each basin. The maximum roadway or access ramp slope shall not exceed 15 percent. Alternate means of access will be reviewed by the City Engineer on a case-by-case basis.

##### 14.4 Fees in Lieu of Detention/Retention Requirements

A fee may be imposed in lieu of a detention/retention system when it can be clearly demonstrated that detention at the site does not provide off-site flood relief due to the parcel size, due to its location within the drainage basin, due to the requirements set forth by a basin-management study, or due to any other factors deemed to be appropriate by the City Engineer, as determined on a case-by-case basis. The fees collected will be used to study, design, and construct public flood-control improvements which will mitigate the potential damage of flood waters originating from the property owned by those contributing the fees. Where development is less than three units to the acre, the payment of a fee will be encouraged in lieu of a detention system, in order to preserve the natural drainage patterns of the area.

The fee shall be negotiated on a case-by-case basis. However, this fee ordinarily should not be substantially less than the cost to the developer of installing on-site detention/retention facilities. Therefore, before negotiation begins, it may be appropriate for the Engineer to first conceptually design an acceptable detention/retention system; and then, based upon that conceptual design, prepare a cost estimate for the detention/retention facility which shall consider, at a minimum, the cost of the land, construction, design, and the present value of any long-term maintenance, operation, and liability coverage.

## XIV. DETENTION/RETENTION BASINS

### 14.5 Stormwater-Infiltration Systems

Detention/retention systems which utilize a method of subsurface disposal (i.e., dry wells, engineered basin floors, trenches, etc.) shall meet or exceed the following minimum criteria:

1. Stormwater-infiltration systems shall not be permitted either in industrial developments or any development where the City Engineer has determined that there is a potential for the infiltration system to receive fluids or materials which may adversely affect ground-water quality.
2. Stormwater-infiltration systems shall not admit runoff from intensively irrigated landscaped areas where pesticides and insecticides may be routinely used.
3. Stormwater-infiltration systems constructed within moderate to low-density residential areas (i.e., less than six residences, or dwelling units, per acre) shall have a minimum vertical separation of 75 feet from the invert of the infiltration system to the elevation of the static ground-water table.
4. Stormwater-infiltration systems constructed within high-density residential developments (i.e., six or more residences per acre), and areas zoned for commercial uses, shall have a minimum vertical separation of 125 feet from the invert of the infiltration system to the elevation of the static ground-water table.
5. All stormwater-infiltration systems shall have a minimum horizontal separation of 300 feet from a cased water well, and 500 feet from an uncased water well.
6. The owners are to register all new dry wells with the Arizona Department of Health Service (ADHS) within thirty (30) days of the beginning of operation. For more information, the well owner and their engineer should contract the Water Permits Unit of ADHS, located at 2005 North Central Avenue, Room 300, Phoenix, Arizona, 85004 (Phone: 257-2270).
7. All dry wells constructed after the date that applicable ADHS Standards were adopted are to be inspected and cleaned, if necessary, by either the owner or a designated representative at least once a year. Records of all inspections and maintenance shall be systematically maintained by the owner, and be available for review by City staff upon written request. Sediment or debris that is periodically removed from a dry-well settling chamber is to be disposed of at an approved City or County-operated sanitary landfill.
8. Floodplain Section staff shall review percolation test results, submitted prior to the issuance of a Certificate of Occupancy, in order to verify the performance of the proposed dry-well site. During the percolation test, the dry well shall be filled with clean water until the rate of inflow and the percolation rate have stabilized for a period of one hour. If a rate of inflow below that required is obtained, then additional dry wells will be required.

#### XIV. DETENTION/RETENTION BASINS

9. In confirming the design of the minimum number of dry wells, length of infiltration trench, or the area of engineered basin floors required to drain the basin in the time required (refer to Section 3.5 in Tucson Development Standard 10-01.0), the rate of drainage shall be based on the results of a standard percolation test and a factor of safety of two (i.e., divide the field-test percolation rate by two).
10. In areas of high sediment yield, the dry-well inlet shall be elevated no less than six inches above the adjacent grade in order to reduce the influx of sediment into the dry-well system. The height above grade shall be increased based upon expected sediment yields emanating from the contributing drainage area. The retained storm runoff found below the dry-well inlet must infiltrate into the ground according to the time constraints given in Section 3.5.1 of the Pima County/City of Tucson "Stormwater Detention/Retention Manual" (1987). However, if the infiltration test rate, or estimate presented in the Soils Report, is less than twice the infiltration rate used in the basin design; or, if the basin, after construction, does not drain in the required time, a sub-drain system shall be installed by the owner according to plans approved by City staff.

Additional requirements related to stormwater-infiltration systems can be found in Section 3.5.5 of Tucson Development Standard 10-01.0 (i.e., the Pima County/City of Tucson "Stormwater Detention/Retention Manual").

# TUCSON STORMWATER MANAGEMENT STUDY BALANCED AND CRITICAL BASIN MAP

## WATERSHED INDEX

- AC HUGHES WASH WATERSHED
- AG EL VADO WASH WATERSHED
- AH SANTA CLARA WASH WATERSHED
- AL VALENCIA WASH WATERSHED
- AW AIRPORT WASH WATERSHED
- BC WYOMING WASH WATERSHED
- BG WEST BRANCH SANTA CRUZ RIVER DIVERSION CHANNEL WATERSHED
- BL IRVINGTON WASH WATERSHED
- BR RODEO WASH WATERSHED
- BW TUCSON DIVERSION CHANNEL/ JULIAN WASH WATERSHED
- CC MISSION VIEW WASH WATERSHED
- CG WEST BRANCH SANTA CRUZ RIVER WATERSHED
- CL 18TH STREET WASH WATERSHED
- CR CUSSING STREET WASH WATERSHED
- CT DOWNTOWN WATERSHED
- CW TUCSON ARROYO WATERSHED
- DA WEST UNIVERSITY WATERSHED
- DC BRONX WASH WATERSHED
- DD GRANT WASH WATERSHED
- DF GRUBBER WASH WATERSHED
- DG FLOWING WELLS WASH WATERSHED
- DL SILVERCROFT WASH WATERSHED
- DR CAMINO DE OESTE WASH WATERSHED
- DF TRAILS END WASH WATERSHED
- EC ROGER WASH WATERSHED
- EG BUTTKAUFF WASH WATERSHED
- EL SWEETWATER WASH WATERSHED
- ER DEL CERRO WASH WATERSHED
- GC ALAMO WASH WATERSHED
- GD SWAN ROAD WATERSHED
- GE CREEKSIDE WASH WATERSHED
- GF CHRISTOPHER CITY WASH WATERSHED
- GG ALTERNOR WASH WATERSHED
- GL CHRISTMAS WASH WATERSHED
- GM TUCSON GENERAL WASH WATERSHED
- GQ NORTH MOUNTAIN AVENUE WASH WATERSHED
- GR FIRST AVENUE WASH WATERSHED
- GW RACE TRACK WASH WATERSHED
- HC FRIENDLY VILLAGE WASH WATERSHED
- HL STONE AVENUE WASH WATERSHED
- HL POMA WASH WATERSHED
- HR WETMORE WASH WATERSHED
- MC REYES WASH WATERSHED
- MD UDALL PARK WASH WATERSHED
- MG ESTE WASH WATERSHED
- ML WRIGHTSTOWN WASH WATERSHED
- MR FAIRBURNER WASH WATERSHED
- MR HIDDEN HILLS WASH WATERSHED
- MW ROBB WASH WATERSHED
- TL ESCALANTE WASH WATERSHED
- TR SPANISH TRAIL WASH WATERSHED
- TW EASTVIEW WASH WATERSHED
- UC ROLLING HILLS WASH WATERSHED
- UC ATENBURY WASH WATERSHED
- UU OWENS PARK WASH WATERSHED
- UL ROSE HILL WASH WATERSHED
- UN MESQUITE RANCH WASH WATERSHED
- UR CIVANO WASH WATERSHED
- UZ GUILLERMO WASH WATERSHED

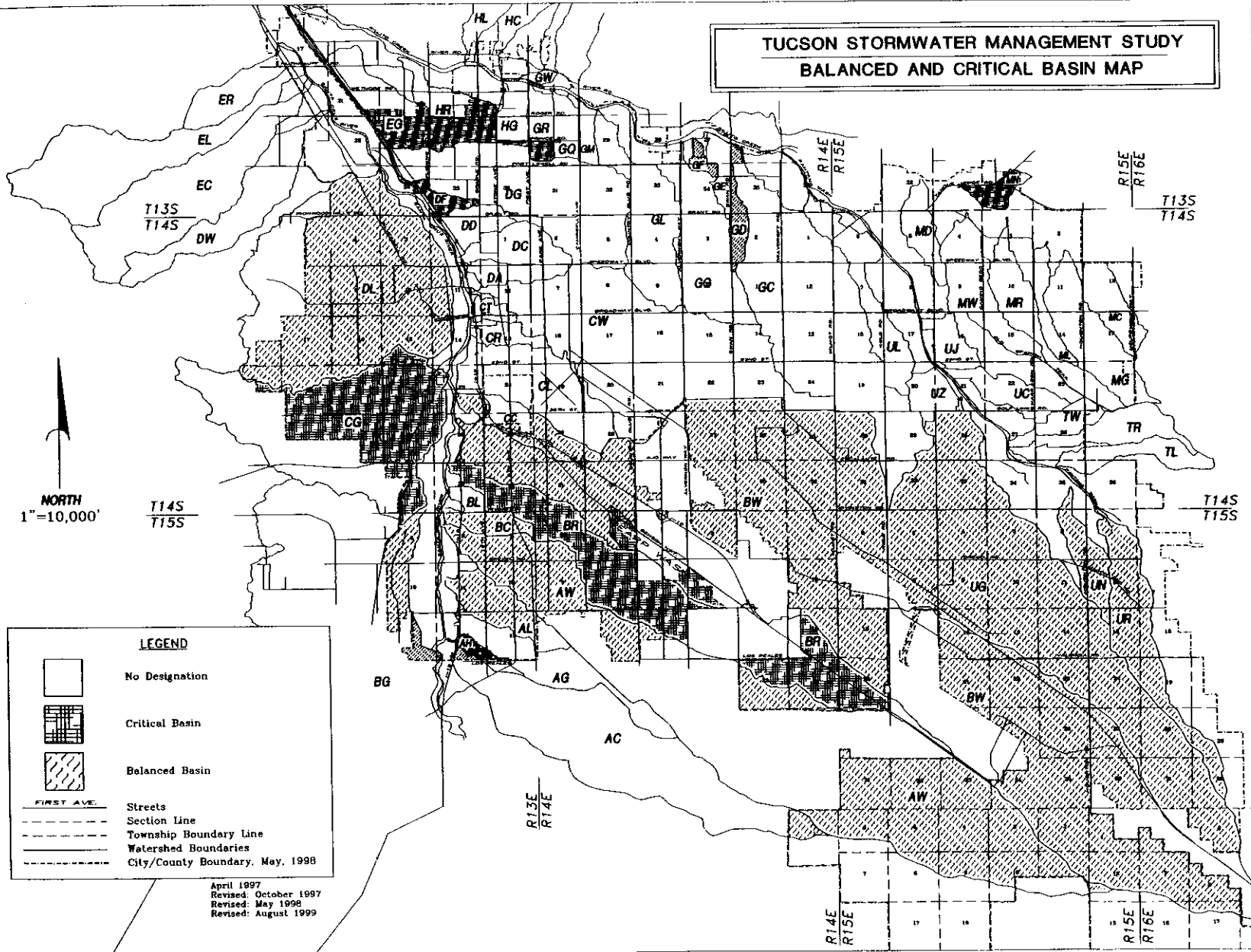

NORTH  
1" = 10,000'

### LEGEND

- No Designation
- Critical Basin
- Balanced Basin
- Streets
- Section Line
- Township Boundary Line
- Watershed Boundaries
- City/County Boundary, May, 1998

April 1997  
Revised: October 1997  
Revised: May 1998  
Revised: August 1999

## REFERENCES AND SELECTED BIBLIOGRAPHIES

### Chapter I. Introduction

#### References

Simons, Li & Associates, Inc., 1987, "Summary and Evaluation of Current Drainage Review Practices and Floodplain/Drainage Standards for the City of Tucson Floodplain and Drainage Standards Manual," prepared for the City of Tucson Department of Transportation, Engineering Division.

### Chapter II. Policies, Procedures, and Formats for Drainage Reports Hydrology Reports, and Drainage Statements

No references cited.

### Chapter III. Planning

No references cited.

### Chapter IV. City of Tucson Method for Estimating Flood Peaks and Flood Hydrographs

#### References

Zeller, M. E., 1979, "Hydrology Manual for Engineering Design and Flood Plain Management within Pima County, Arizona," Pima County Department of Transportation and Flood Control District, Tucson, Arizona.

#### Selected Bibliography

City of Tucson, 1982, "Flood Peak Estimator," City of Tucson Department of Transportation, Engineering Division.

Simons, Li & Associates, Inc., 1982, "Simplified Method of Estimating Flood Peaks," prepared for the City of Tucson Department of Transportation, Engineering Division.

Simons, Li & Associates, Inc., 1985, "One-Hour Areal Rainfall Depths for Watershed Areas of Up to Ten (10) Square Miles Located in and around Tucson, Arizona," prepared for the City of Tucson Department of Transportation, Engineering Division.

Simons, Li & Associates, Inc., 1986, "Simplified, Step-By-Step Procedure for Computing Times of Concentration for Flood-Recurrence Intervals of Less Than 100 Years on Small Watersheds," prepared for the City of Tucson Department of Transportation, Engineering Division.

## REFERENCES/BIBLIOGRAPHIES

- Simons, Li & Associates, Inc., 1987, "Recommended Revisions to Basin-Factor Selection in City of Tucson Peak-Flow Estimator Procedure," prepared for the City of Tucson Department of Transportation, Engineering Division.
- Zeller, M. E., 1980, "Method of Hydrograph Synthesis," Pima County Department of Transportation and Flood Control District, Tucson, Arizona.

### Chapter V. Floodplain Delineation

#### References

- Brater, E. F., and H. W. King, 1982 (Sixth Edition), *Handbook of Hydraulics*, McGraw-Hill Book Company, New York.
- Chow, V. T., 1959, *Open-Channel Hydraulics*, McGraw-Hill Book Company, New York.
- Federal Emergency Management Agency, 1982, "Flood Insurance Study, Pima County, Arizona, Unincorporated Areas."
- Federal Emergency Management Agency, 1985, "Appeals, Revisions, and Amendments to Flood Insurance Maps, A Guide to Community Officials".
- Federal Emergency Management Agency, 1988, "Flood Insurance Study, City of Tucson, Arizona, Pima County."
- Hejl, H. R., Jr., 1977, "A Method for Adjusting Values of Manning's Roughness Coefficients for Flooded Urban Areas," *Journal of Research*, U.S. Geol. Survey, 5(6), 541-545.
- U.S. Army Corps of Engineers, 1982, "HEC-2, Water-Surface Profiles," Users Manual, Davis, California.

### Chapter VI. Erosion and Sedimentation

#### References

- American Society of Civil Engineers, 1977, *Sedimentation Engineering*, V. A. Vanoni, ed., ASCE Manuals and Reports on Engineering Practice, No. 54, 345 East 47th St., New York, NY 10017.
- Dendy, F. E., and G. C. Bolton, 1976, "Sediment Yield-Runoff Drainage Area Relationships in the United States," *Journal of Soil and Water Conservation*, 31(6), 264-266.
- Federal Highway Administration, 1983, "Hydraulic Design of Energy Dissipators for Culverts and Channels," Hydraulic Engineering Circular No. 14.



## REFERENCES/BIBLIOGRAPHIES

- Flaxman, E. M., 1972, "Predicting Sediment Yield in Western United States," *Journal of the Hydraulics Division*, ASCE, 98(HY12).
- Lacey, G., 1930, "Stable Channels in Alluvium," *Inst. Civil Engr. Proc.*, 229, 259-384.
- Leliavsky, S., 1955, *An Introduction to Fluvial Hydraulics*, Constable, London, 256 pp.
- Leopold, L. B., and T. Maddock, 1953, "The Hydraulic Geometry of Stream Channels and Some Physiographic Implications," *U.S.G.S. Prof. Paper 252*, U.S. Geological Survey, Washington, D.C.
- Pacific Southwest Inter-Agency Committee, Water Management Subcommittee Sedimentation Task Force, 1968, "Report on Factors Affecting Sediment Yield in the Pacific Southwest Areas," 13 p.
- Pima County Department of Transportation and Flood Control District and City of Tucson, 1987, "Stormwater Detention/Retention Manual," prepared for Pima County Department of Transportation and Flood Control District by Simons, Li & Associates, Inc., in association with Rogers, Gladwin and Harmony, Inc.
- Renard, K. G., 1972, "Sediment Problems in the Arid and Semiarid Southwest," *Proceedings, 27th Annual Meeting, Soil Conservation Society of America*, Portland, Oregon.
- Renard, K. G., and J. J. Stone, 1981, "Sediment Yield from Small Semiarid Rangeland Watersheds," *Proceedings of the Workshop on Estimating Erosion and Sediment Yield on Rangelands*, Tucson, Arizona, U.S. Department of Agriculture, Agricultural Research Service, Agricultural Reviews and Manuals, ARM-W-26.
- Richardson, E. V., D. B. Simons, S. Karaki, K. Mahmood, and M. A. Stevens, 1975, "Highways in the River Environment, Hydraulic and Environmental Design Considerations, Training and Design Manual," prepared for U.S. Department of Transportation, Federal Highway Administration.
- Rozovskii, I. L., 1961, *Flow of Water in Bends of Open Channels*, Israel Program for Scientific Translations, Jerusalem, Israel.
- Schumm, S. A., 1977, *The Fluvial System*, John Wiley and Sons, Inc., New York.
- Schwab, G. O., R. K. Frevert, T. W. Edminster, and K. K. Barnes, 1966, *Soil and Water Conservation Engineering*, John Wiley and Sons, Inc., New York.
- Simons, Li & Associates, Inc., 1982, *Engineering Analysis of Fluvial Systems*, Fort Collins, CO 80522.
- Simons, Li & Associates, Inc., 1985, "Arizona Department of Water Resources Manual for Engineering Analysis of Fluvial Systems."

## REFERENCES/BIBLIOGRAPHIES

- Simons, Li & Associates, Inc., 1986, "Hydraulic Model Study of Local Scour Downstream of Rigid Grade-Control Structures," prepared for Pima County Department of Transportation and Flood Control District, Tucson, Arizona.
- Simons, D. B., and F. Senturk, 1977, *Sediment Transport Technology*, Water Resources Publications, Fort Collins, Colorado 80522.
- U.S. Army Corps of Engineers, 1977, "Generalized Computer Program HEC-6, Scour and Deposition in Rivers and Reservoirs," The Hydrologic Engineering Center, 609 Second Street, Davis, California 95616.
- U.S. Bureau of Reclamation, 1977, *Design of Small Dams*.
- U.S. Soil Conservation Service, 1971, "Sediment Sources, Yields and Delivery Ratios," *National Engineering Handbook, Section 3, Sedimentation*.
- Williams, J. R., 1975, "Sediment-yield Prediction with Universal Equation Using Runoff Energy Factor," *Present and Prospective Technology for Predicting Sediment Yields and Sources*, Agricultural Research Service, USDA.
- Williams, J. R., and H. D. Berndt, 1977, "Sediment Yield Prediction Based on Watershed Hydrology," *Transactions ASCE*, 20(6), 1100-1104.
- Zeller, M. E., 1981, "Scour Depth Formula for Estimation of Toe Protection Against General Scour," Pima County Department of Transportation and Flood Control District, Tucson, Arizona.
- Zeller, M. E., and W. T. Fullerton, 1983, "A Theoretically Derived Sediment Transport Equation for Sand-Bed Channels in Arid Regions," Proc. of the D. B. Simons Symposium on Erosion and Sedimentation, R.-M. Li and P. F. Lagasse, editors.

### Chapter VII. Erosion-Hazard/Building-Setback Criteria

#### References

- Federal Highway Administration, 1975, "Highways in the River Environment, Hydraulic and Environmental Design Considerations," Training and Design Manual.
- Lane, E. W., 1955, "The Importance of Fluvial Morphology in Hydraulic Engineering," *Proceedings*, ASCE, 81(745), 17 pp.
- Simons, Li & Associates, 1982, *Engineering Analysis of Fluvial Systems*, Fort Collins, CO 80522.
- Simons, Li & Associates, 1985, "Design Manual for Engineering Analysis of Fluvial Systems," prepared for the Arizona Department of Water Resources.
- Sowers, G. F., 1979, *Introductory Soil Mechanics and Foundations: Geotechnical Engineering*, MacMillan Publishing Co., Inc., New York.

## REFERENCES/BIBLIOGRAPHIES

U.S. Soil Conservation Service, Engineering Division, 1977, "Design of Open Channels," Technical Release No. 25, Washington, D.C.

### Selected Bibliography

Chow, V. T., 1959, *Open-Channel Hydraulics*, McGraw-Hill Book Company, New York.

### Chapter VIII. Open-Channel Design

#### References

Aldridge, B. N., and J. M. Garrett, 1973, "Roughness Coefficients for Stream Channels in Arizona," U.S. Geological Survey Open-file Report, Tucson, Arizona.

Chow, V. T., 1959, *Open-Channel Hydraulics*, McGraw-Hill Book Company, New York.

Los Angeles County Flood Control District, 1973, "Hydraulic Design Manual," Los Angeles, CA.

Morris, H. M., and J. M. Wiggert, 1972, *Applied Hydraulics in Engineering*, John Wiley and Sons, New York.

Pima County Department of Transportation and Flood Control District, 1984, "Drainage and Channel Design Standards for Local Drainage," Tucson, Arizona.

Rouse, H., 1950, *Engineering Hydraulics*, John Wiley and Sons, New York.

U.S. Army Corps of Engineers, 1970, "Hydraulic Design of Flood Control Channels," Engineer Manual No. 1110-2-1601.

### Selected Bibliography

Federal Highway Administration, 1983, "Hydraulic Design of Energy Dissipators for Culverts and Channels," U.S. Department of Transportation Hydraulic Engineering Circular No. 14.

French, R. H., 1985, *Open Channel Hydraulics*, McGraw-Hill Book Company, New York.

Simons, Li & Associates, 1982, *Engineering Analysis of Fluvial Systems*, Fort Collins, Colorado 80522.

U.S. Bureau of Reclamation, 1964, "Hydraulic Design of Stilling Basins and Energy Dissipators," Engineering Monograph No. 25.

U.S. Bureau of Reclamation, 1978, *Design of Small Canal Structures*, U.S. Government Printing Office, Denver, Colorado.

U.S. Soil Conservation Service, 1956, "Hydraulics," Engineering Handbook No. 5.

## REFERENCES/BIBLIOGRAPHIES

U.S. Soil Conservation Service, 1977, "Design of Open Channels," Technical Release No. 25.

### Chapter IX. Channel Stabilization and Hydraulic Structures

#### References

Federal Highway Administration, 1975, "Highways in the River Environment, Hydraulic and Environmental Design Considerations," Training and Design Manual.

Federal Highway Administration, 1978a, "Countermeasures for Hydraulic Problems at Bridges, Volume 1, Analysis and Assessment," Report No. FHWA-RD-78-162.

Federal Highway Administration, 1978b, "Hydraulics of Bridge Waterways," Hydraulic Design Series No.1.

Federal Highway Administration, 1983, "Hydraulic Design of Energy Dissipators for Culverts and Channels," Hydraulic Engineering Circular No. 14.

Lane, E. W., 1935, "Security From Underseepage," *Trans.*, ASCE, 100(1), 235.

U.S. Army Corps of Engineers, 1982, "HEC-2 Water Surface Profiles, Users Manual," Hydrologic Engineering Center, Davis, California.

U.S. Bureau of Reclamation, 1964, "Hydraulic Design of Stilling Basins and Energy Dissipators," Engineering Monograph No. 25.

U.S. Bureau of Reclamation, 1977, *Design of Small Dams*.

### Chapter X. Storm Drains

#### References

American Society of Civil Engineers and Water Pollution Control Federation, 1987, *Design and Construction of Sanitary and Storm Sewers*.

Arizona Department of Transportation, 1975, "Hydraulic Design for Highway Drainage in Arizona."

Denver Regional Council of Governments, 1969, "Urban Storm Drainage Criteria Manual."

Federal Highway Administration, 1984, "Drainage of Highway Pavements," Hydraulic Engineering Circular No. 12.

#### Selected Bibliography

American Iron and Steel Institute, 1980, *Modern Sewer Design*.

## REFERENCES/BIBLIOGRAPHIES

- Federal Highway Administration, 1979, "Design of Urban Highway Drainage--The State of the Art."
- Los Angeles County Flood Control District, 1982, "Hydraulic Design Manual."
- U.S. Soil Conservation Service, 1955, "SCS Engineering Handbook, Hydraulics, Section 5."

### Chapter XI. Culverts

#### References

- Arizona Department of Transportation, 1973, "Hydrologic and Hydraulic Training Session," Phoenix, Arizona.
- Arizona Department of Transportation, Highways Division, Structures Section, 1987, "Standard Drawings."
- Federal Highway Administration, 1965, "Hydraulic Charts for the Selection of Highway Culverts, HEC-5," Government Printing Office, Washington, D.C.
- Federal Highway Administration, 1971, "Debris Control Structures, HEC-9," Government Printing Office, Washington, D.C.
- Federal Highways Administration, 1972, "Capacity Charts for the Hydraulic Design of Highway Culverts, HEC-10," Government Printing Office, Washington, D.C.
- Federal Highway Administration, 1974, "Hydraulic Design of Improved Inlets for Culverts, HEC-13," Government Printing Office, Washington, D.C.
- Federal Highway Administration, 1983a, "Structural Design Manual for Improved Inlets and Culverts," Government Printing Office, Washington, D.C.
- Federal Highway Administration, 1983b, "Hydraulic Design of Energy Dissipators for Culverts and Channels, HEC-14," Government Printing Office, Washington, D.C.
- Federal Highway Administration, 1985, "Hydraulic Design of Highway Culverts, HDS-5," Government Printing Office, Washington, D.C.
- Pima County Department of Transportation and Flood Control District, 1984, "Drainage and Channel Design Standards for Local Drainage," Tucson, Arizona.

#### Selected Bibliography

- Arizona Highway Department, Structures Section, Hydraulics Branch, 1972, "Storm Sewer System Design."

## REFERENCES/BIBLIOGRAPHIES

### Chapter XII. Street and Parking Lot Drainage

#### References

Federal Highway Administration, 1985, "Hydraulic Design of Highway Culverts, HDS-5," Government Printing Office, Washington, D.C.

### Chapter XIII. Floodproofing

#### References

Arizona Department of Water Resources, 1984, "Handbook for Arizona Communities on Floodplain Management and the National Flood Insurance Program."

Federal Emergency Management Agency, 1986a, "Design Manual for Retrofitting Flood-Prone Residential Structures" (FEMA 114).

Federal Emergency Management Agency, 1986b, "Floodproofing Non-Residential Structures" (FEMA 102).

#### Selected Bibliography

Federal Insurance Administration, National Flood Insurance Program, Department of Housing and Urban Development, 1976, "Elevated Residential Structures."

Sheaffer, J. R., 1967, "Introduction to Flood Proofing--An Outline of Principles and Methods," Center for Urban Studies, The University of Chicago.

U.S. Army Corps of Engineers, Office of the Chief of Engineers, 1972, "Flood Proofing Regulations," Government Printing Office, Washington, D.C.

U.S. Army Corps of Engineers, 1984, "Flood Proofing Systems and Techniques--Examples of Flood-Proofed Structures in the United States."

### Chapter XIV. Detention/Retention Basins

Pima County Department of Transportation and Flood Control District and City of Tucson, 1987, "Stormwater Detention/Retention Manual," prepared for Pima County Department of Transportation and Flood Control District by Simons, Li & Associates, Inc., in association with Rogers, Gladwin and Harmony, Inc.

## INDEX

- Abutments, 6.16
- Access Lanes, 8.09
- ADOT Catch Basin, Type 3, 10.25, 10.54
- Aesthetics, 9.09
- Aggradation, 6.06
- All-Weather Access, xvii, 8.03
- All-Weather Crossings, 11.01, 12.02
- Alley Drainage, 12.03
- Allowable Velocity, 7.03
- Allowable-Velocity Approach, 7.01, 7.02
- Alluvial Channels, 6.02, 8.04
- Alluvial Rivers, 6.01
- Angle of Repose, 7.12
- Annual Flood Damage, 13.14
- Annual Risk, 13.03
- Anti-Dune, 6.09, 6.10
- Approach Velocity, 11.06
- Arterial Streets, xvii, 12.02
- Articulated Revetment Units, 9.05
- Assurances, 1.05
- At-Grade (Dip) Crossing, xvii, 11.18
- Average-Annual Damages, 13.02
- Backwater, xvii, 5.02, 8.07, 8.27, 8.33, 8.44
- Backwater Calculations, 5.02, 10.40
- Balanced Basin, xvii, 3.02, 14.01
- Balanced and Critical Basin Map, 14.01
- Bank Protection, xvii, 8.12, 10.38
- Bank Sloughing, 7.22, 11.15
- Banking, xvii, 8.25
- Base Flood, xvii, 5.08
- Base Flood Elevation, 5.09
- Basements, 13.02
- Basin Factor, 4.03, 4.04, 4.06, 4.08-4.12, 4.14-4.16, 10.37
- Basin-Management Plans, 8.09
- Bed-Material Load, 6.03, 6.04
- Bend Losses, 10.30
- Bend Scour, 6.11, 6.12
- Bends, 8.22, 10.39
- Benefit/Cost Ratios, 13.02
- Bernoulli Equation, 10.28
- Beveled Inlet Edge, 11.15
- Bicycle-Safe Grates, 10.09
- Blowouts, 10.40
- Braided Flow, 8.43
- Bridge Crossings, 11.17
- Bridges, 9.08
- Broad-Crested Weirs, 11.13
- Building Pad, 8.02, 8.03

## INDEX

- Building Permit, 2.03
- Bulking Factor, 6.06
- Caliche, 8.11
- Carryover Flow, xvii
- Catch Basin, xviii
- Centrifugal Forces, 8.22
- Certificate of Occupancy, 14.03, 14.05
- Channel, xviii, 1.03, 8.01
- Channel Drops, 9.06
- Channel Geometry, 8.03
- Channel Morphology, 6.02
- Channel Outlets, 9.06
- Channel Stabilization, 9.01
- Channelization, 6.31, 8.03
- Check Dams, 6.34
- Check List, 10.43
- Clogging, 10.24
- Clogging Factor, 10.54
- Closures, xviii, 13.11
- Coefficient of Contraction, 8.27
- Coefficient of Expansion, 8.27
- Collector Channels, xviii, 8.43, 8.44
- Collector Streets, 12.02
- Combination Inlets, xviii, 10.09, 10.12, 10.22
- Competent Channels, 4.08
- Composite Channels, 5.03
- Composite Gutter Sections, 10.06, 10.22
- Composite Hydraulic Roughness, 5.03
- Compound Channels, 8.11
- Compound Gutter Sections, 10.22
- Concrete, 8.09, 9.02
- Concrete Pipes, 11.01
- Conditional LOMA, 5.09
- Conditional LOMR, 5.09
- Condominium, 2.03
- Confluences, 8.33
- Constructed Channels, 8.03, 8.04
- Contingent Floodproofing, 13.09, 13.10, 13.11
- Continuous Grade, 10.06
- Contributing Area Factor,  $F_{ac}$ , xviii, 4.03, 4.04, 4.08, 4.10
- Contractions, 8.31
- Control Section, 8.07
- Controls, 8.12
- Convergence Angle, 8.31
- Corrugated Metal Pipes, 11.01
- Cost-Benefit Analysis, 13.03
- Cover Sheet, 2.05
- Critical Basin, xviii, 3.02, 14.01



## INDEX

- Critical Depth, xviii, 5.05, 8.07, 8.44, 11.06, 11.07, 11.08
- Critical Flow, xviii, 8.35
- Cross Bars, 10.09
- Cross Section, 8.43
- Cross Slope, xviii, 10.04
- Cross Waves, 8.22, 8.24
- Culvert, xix, 1.04, 6.20, 6.22, 6.23-6.26, 6.27, 6.28, 11.01-11.18
- Culvert Design, 11.01, 11.12
- Culvert Outlets, 9.06
- Curb Inlets, xix, 10.09
- Curb-Opening Inlets, 10.06, 10.09, 10.11, 10.17, 10.19, 10.24
- Curb-Opening Lengths, 10.22
- Curb Openings, 10.09, 10.12
- Curvature, 6.11, 6.12
- Curved Channel, 8.22
- Cut-Off Wall, 6.34, 11.15, 11.17, 11.18
- Debris, 10.09
- Debris Grates, 11.16
- Degradation, 6.06, 8.11, 8.14
- Depth, 8.05, 8.43
- Detention, 1.05, 1.08, 6.28, 14.01-14.06
- Detention Basins, xix, 2.12, 10.03, 14.01-14.06
- Detention/Retention Basins, 12.02, 12.03, 14.01-14.06
- Development Plans, 2.02, 5.01, 5.05
- Dip, xix, 11.01
- Dip Sections, 11.12
- Direct Step Method, 8.07
- Dispersed Flow, xix, 4.06, 4.10, 4.12, 4.14
- Drainage Easement, 2.12
- Drainage Master Plan, 8.12
- Drainage Report, 1.02, 2.01-2.16
- Drainage Statement, 2.01, 2.02, 2.03, 2.15
- Drop Height, 6.35
- Drop Inlets, 11.16
- Drops, 6.18
- Dry Floodproofing, xix, 13.07, 13.09
- Dry Well, xix, 14.05, 14.06
- Earthen Channels, 7.02, 8.04
- Easement, 3.04
- Easement Curves, xx, 8.25
- Elevation, 13.13
- Embankment, 6.16, 6.17, 11.14, 13.12
- Embankment Stabilization, 11.17
- Emergency Measures, 13.09
- Encroachment, xx, 5.07, 8.02
- Energy Dissipator, 8.33, 9.06

## INDEX

- Energy Grade Line, 5.02, 10.41
- Engineered Basin Floor, xx
- Entrance Loss Coefficient, 11.09, 11.10, 11.15
- Entrance Losses, 10.35
- Entrance Transitions, 8.26, 8.29, 8.30
- Equilibrium Slopes, 6.31, 6.32, 6.34
- Equivalent Cross Slope, 10.19, 10.22
- Erosion, xx, 6.01, 6.02, 7.01, 7.02, 11.16
- Erosion Protection, 8.44
- Erosion Resistant, 8.11
- Exit Transitions, 8.31
- Expansions, 8.31
- Fair-Market Value, 13.03
- FEMA, xx, 5.02
- Finished Floors, 14.02
- FIRM, xx
- Flood, xx
- Flood Damage, 13.03
- Flood Hazard Boundary Map, 5.09
- Flood Insurance Rate Maps, 5.08
- Flood Insurance Study, 5.08
- Flood Peaks, 4.01-4.03, 4.05, 4.08-4.10, 4.16
- Flood Peak Estimator Procedure, 4.01
- Flood Plain, xx, 3.03, 5.05
- Floodplain Analyses, 2.09
- Floodplain Delineation, 1.03, 5.01-5.10
- Floodplain Use Permits, 2.04
- Floodproofing, xx, 13.01-13.15
- Floodproofing Methods, 13.10
- Floodwall, xxi, 13.11
- Floodway, xxi, 3.03, 5.05
- Floodway Delineations, 5.07
- Flow Splits, 12.05, 12.07
- Flow-Through Wall Openings, xxi, 12.03, 12.04
- Fluvial Geomorphology, 6.01
- Freeboard, xxi, 8.07, 8.08, 8.22, 8.31, 8.43, 9.09
- Free Overfall, 6.18, 6.19
- Friction Loss, xxi, 10.30
- Friction Slope, xxi, 8.05, 10.26, 10.41
- Frontal Flow, 10.14
- Froude Number, xxi, 8.07, 8.15, 8.16, 8.26, 8.27, 8.35
- Gabion, 9.05
- General Scour, 6.08
- Grade-Control Structures, 6.34, 6.35
- Grading Permit, 2.03
- Grate, 10.10, 10.24

## INDEX

- Grate Inlets, xxi, 10.08, 10.09, 10.14
- Gutter, xxii, 10.03
- Gutter Depression, 10.19
- Head, xxi
- Headcuts, xxii, 8.09
- Head Losses, 8.27, 8.43, 10.28, 10.30, 10.41, 11.9, 11.10
- Headwater, 11.01, 11.15
- HEC-2, 5.03
- Horizontal-Throat Inlet, 10.12
- Hydraulic Calculation Sheets, 2.10, 2.11, 2.12, 2.13
- Hydraulic Flow Depth, 8.07
- Hydraulic Grade Line, xxii, 10.26, 10.28, 10.39, 10.41, 10.58
- Hydraulic Grade-Line Computations, 10.40
- Hydraulic Improvements, 2.11
- Hydraulic Jump, xxii, 8.08, 8.14, 8.15, 8.16, 8.33
- Hydraulic Roughness, 8.12
- Hydraulic Structures, 2.11, 9.01
- Hydrodynamic Forces, 13.11
- Hydrodynamic Loads, 13.10
- Hydrographs, 4.01, 4.16-4.19
- Hydrologic Calculation Sheets, 2.15
- Hydrologic Data Sheets, 2.08, 2.09, 4.02
- Hydrology Report, 2.05
- Hydrostatic Forces, 13.10, 13.11
- Hydrostatic Pressures, 8.09, 8.35, 8.44
- Implementation, 1.05
- Improved Inlets, 11.15
- Improvement District, 1.06
- Inclined-Throat Inlet, 10.12
- Infiltration, 14.02, 14.05, 14.06
- Infiltration Trench, xxii
- Initial Depth, 8.15, 8.16
- Inlet, 11.15, 11.16
- Inlet Control, 11.13, 11.15
- Inlet Design, 10.25
- Inlet Velocity, 11.16
- Internal Channel Transitions, 8.31
- Inverted Crowns, 10.08
- Inverted Street, 10.09
- Junction, 8.33, 8.35, 8.40, 8.43, 8.48
- Junction Angles, 8.33
- Junction Loss, 10.32, 10.34
- Key-Ins, xxii, 8.09, 8.44
- Lane Relationship, 7.21
- Lateral, 10.38

## INDEX

- Letter of Map Amendment, xxii, 2.02, 5.09
- Letter of Map Revision, xxii, 2.02, 5.09
- Levee, xxiii, 6.16, 6.17, 8.46, 13.11, 13.12
- Limiting Curvature, 8.26
- Linear Park, 3.03, 8.09, 8.12
- Local Scour, 6.13, 6.16
- Long Culverts, 11.13
- Low-Flow Channel, 8.04, 8.11
- Main Line, 10.38
- Maintenance, 1.06, 1.07, 1.08, 2.13, 8.09, 8.12, 11.01, 14.02-14.05
- Maintenance Easements, 3.04
- Maintenance Responsibility, 2.07
- Major Wash, xxiii, 12.03
- Manhole, xxiii, 10.38, 10.39, 10.40
- Manhole Losses, 10.35
- Manning's Equation, 5.02, 5.03, 5.05, 8.05, 10.03, 10.08, 10.28
- Manning's Roughness Coefficients, 5.04, 8.06, 10.04
- Map Revision, 2.04
- Meander, 8.11
- Minimum Diameter, 12.01
- Minor Losses, xxiii, 10.28, 10.30, 10.41
- Minor Wash, xxiii, 12.03
- Mitigation, 8.12
- Modeling, 6.06, 6.07
- Momentum, 8.35
- Momentum Balance, 8.52
- Multi-Laned Roadways, 12.01
- Multi-Use, 8.12
- National Flood Insurance Program, 5.08
- Natural Channels, 8.01
- Natural Wash, 8.01, 8.02
- Normal Flow Depth, 5.02
- Normal-Flow Method, 10.26
- Normal Depth, 5.05, 10.28
- Open Channel, 10.39
- Open-Channel Design, 8.01
- Orifice, 10.10, 10.11, 10.12, 10.24
- Outlet Control, 11.06, 11.13
- Outlet Losses, 10.35, 10.37
- Outlet Protection, 11.16, 11.17
- Outlets, 11.15
- Outlet Scour Protection, 11.16
- Outlet Velocity, 11.16
- P.A.A.L., xxiv, 4.13, 12.02
- Parabolic Cross Section, 10.06, 10.08
- Parabolic Section, 10.45

## INDEX

- Parking, 12.03
- Parking Area Access Lanes, xxiv, 12.02
- Parking Lot, xxiv, 1.04, 10.03
- Pavement Inlets, xxiv, 10.08
- Perimeter Walls, 12.04
- Permanent Floodproofing, 13.09
- Pier, 6.14, 6.15
- Piping, 7.22, 9.07
- Planning, 3.01-3.04
- Policies, 1.02
- Polyethylene Film, 13.10
- Pressure Flow, xxiv, 10.27, 10.28
- Pressure-Flow Method, 10.26
- Private Drainage Improvements, 1.06
- Private Improvement Agreement, 1.05
- Private Roadways, 12.01
- Pump, 14.02
- Quality Control, 10.43
- Radius of Curvature, 10.39
- Rainfall, 4.03-4.05, 4.7, 4.9, 4.10, 4.17
- Rectangular Channel, 8.39
- Regional Watercourse, xxiv, 12.03
- Reinforced-Concrete Pipe, 11.02
- Reservoir-Routing Calculation Sheets, 2.13
- Retention, xxiii, xxiv, xxv, 1.05, 1.08, 14.01-14.06
- Retention Basins, xxv, 2.12, 14.01-14.06
- Rezoning Applications, 2.02
- Right-of-Way, 8.08, 8.14, 10.02, 10.40
- Rill Erosion, xxv, 8.09
- Riparian Vegetation, 8.02
- Riprap, 9.02
- Riprap Channels, 8.04
- Rise Times, 4.19
- Rock Riprap, 9.02
- Roughness Coefficients, 10.39
- Runoff Coefficient, 4.03, 4.04, 4.07, 4.09
- Safety, 3.04, 8.08
- Sag, xxv, 10.10
- Saltation, 6.03
- Sanitary Sewers, 10.40
- Scour, 6.07, 6.08, 6.14, 6.18, 6.19, 8.11, 8.22, 8.44, 9.09, 13.11
- Scour Depth, 6.23
- Scour Hole, 6.20, 6.28
- Scour-Hole Geometry, 6.20, 6.29, 6.30
- Scour Length, 6.25
- Scour Protection, 11.16
- Scour Sloughing, 11.15

## INDEX

- Scour Volume, 6.26
- Scour Width, 6.24
- Sealants, xxv, 13.10, 13.11
- Section 404 Permit, 2.07
- Sediment, 6.01, 6.02, 6.03, 8.46
- Sediment Basins, 6.28
- Sediment Deposition, 11.17
- Sediment Modeling, 6.04
- Sediment Routing, 6.04, 6.06
- Sediment Transport, 6.03, 6.08, 7.21, 7.23
- Sediment Yield, 6.31
- Sedimentation, 6.01, 8.14, 11.16, 11.17
- Seepage, 7.22, 8.09, 8.44
- Seepage Forces, 9.07
- Self-Cleaning Flow Velocity, 10.02
- Sequent Depth, 8.15, 8.16
- Setback, xxv, 7.18, 7.20, 7.23, 8.03, 8.12
- Setback Criteria, 7.01
- Shear Number, 6.28
- Shear Strength, 6.28
- Shear Stress, 6.28
- Sheet Flow, xxv, 5.07, 8.43
- Shotcrete, 8.04, 8.09, 9.02
- Side Drainage, 8.09
- Side Flow, 10.14, 10.17
- Side-Slopes, 8.04, 8.08
- Side-Tapered Inlets, 11.15
- Significant Watercourse, xxv, 5.01
- Site Plans, 5.01, 5.05
- Slope, 8.14, 8.43, 10.02
- Slope Stability, 7.22
- Slope-Tapered Inlets, 11.15
- Sloped Grate, 10.11
- Slotted Inlet, xxv, 10.12, 10.22
- Soffits, xxv, 10.38
- Soil Cement, 8.04, 8.12, 9.02
- Soil Types, 4.03, 4.07, 4.09
- Special Flood Hazard Areas, 5.08
- Spiral Currents, 8.22
- Splash-Over, 10.14
- Standard Step Method, 5.03, 5.05
- Stilling Basin, 8.33
- Storm Drain, xxvi, 6.28, 10.01-10.64
- Storm-Drain Design Procedure, 10.37
- Storm-Drain Inlet Spacing, 10.45
- Storm-Drain Inlets, 10.03
- Storm-Drain Systems, 12.01
- Stormwater Harvesting, xxvi, 14.03
- Stormwater Master Plan, 4.01
- Street, 1.04, 10.03

## INDEX

- Street Drainage, 12.01
- Subcritical, 5.03, 8.31
- Subcritical Flow, xxvi, 8.07, 8.14, 8.24, 8.33
- Subdivision Plats, 2.02, 5.01, 5.05
- Submerged Drop, 6.18
- Supercritical, 5.03, 5.08, 8.29, 8.31
- Supercritical Flow, xxvi, 5.05, 5.08, 8.07, 8.14, 8.24, 8.30, 8.33, 8.40, 8.43
- Superelevation, 8.22, 8.24, 8.25
- Surface Creep, 6.03
- Suspension, 6.03
- Tailwater, xxvi, 8.44, 10.28
- Thalweg, 6.09
- Thompson Equation, 10.32
- Time of Concentration, xxvi, 4.04, 4.09, 4.16, 10.03
- Toe-Down, xxvi, 8.11, 8.44
- Total Expected Annual Damages, 13.03
- Total Gutter Flow, 10.08
- Total Head, 10.41
- Total Interception, 10.19
- Total Interception Capacity, 10.17
- Tractive Force, 7.04, 7.07
- Tractive Power, 7.15, 7.19
- Tractive-Power Approach, 7.01
- Tractive Stress, 7.04, 7.07
- Tractive-Stress Approach, 7.01
- Training Walls, 8.33
- Transition Angle, 8.27, 8.31
- Transition Losses, 8.27, 10.34
- Transition Sections, 8.31, 8.35
- Transitions, xxvi, 8.26
- Trapezoidal Channel, 8.15, 8.36
- Trapezoidal Section, 10.06
- Triangular Section, 10.06
- Tributary, 8.09
- Tributary Flows, 8.35
- TSMS Hydrology, 4.01
- Tucson Stormwater Management Study (TSMS), 4.01
- Underfit Channels, 4.06, 4.10, 4.14
- Undular Hydraulic Jump, 8.16
- Uniform Flow, 5.02, 8.05
- Uniform Hydraulic Roughness, 5.02
- Urban Roughness Coefficient, 5.04
- Utilities, 10.40, 13.12
- Vegetation, 7.18
- Vegetation Zone, 8.02
- Vertical-Throat Inlet, 10.12

## INDEX

Wash Load, 6.03, 6.04

Wave Heights, 8.31

Waves, 6.09, 8.33, 8.43

Weighted-Creep, 9.07

Weir, xxvii, 10.10, 10.11, 10.12, 10.24

Wet Floodproofing, xxvii, 13.07

Width, 8.04

Wingwalls, 11.02, 11.15



**EVALUATION OF ALTERNATIVE FLOOD-CONTROL  
AND EROSION-CONTROL TECHNIQUES FOR  
WATERCOURSES IN TUCSON, ARIZONA**

**APPENDIX TO  
STANDARDS MANUAL FOR DRAINAGE DESIGN  
AND FLOODPLAIN MANAGEMENT  
IN TUCSON, ARIZONA**

**PREPARED FOR  
CITY OF TUCSON  
ENGINEERING DIVISION**

**PREPARED BY  
SIMONS, LI & ASSOCIATES, INC.**

**DECEMBER, 1989**

## TABLE OF CONTENTS

	<u>Page</u>
PRESENTATION AND EVALUATION OF ALTERNATIVE FLOOD-CONTROL AND EROSION-CONTROL TECHNIQUES (Background, Purpose of Appendix, Format of Appendix, General Design Guidelines) . . . . .	1
ALTERNATIVE FLOOD-CONTROL AND EROSION-CONTROL TECHNIQUES EVALUATED . . . . .	5
PRESERVATION OF NATURAL WASHES . . . . .	7
NATURAL WASHES WITH PERIODIC GRADE-CONTROL STRUCTURES . . . . .	11
NATURAL WASHES WITH TRAINING STRUCTURES . . . . .	16
WASHES WITH PIECEMEAL BANK PROTECTION . . . . .	20
EARTHEN CHANNELS . . . . .	24
CHANNELS WITH VEGETAL LININGS . . . . .	29
CHANNELS WITH COMPOUND CROSS SECTIONS . . . . .	34
CHANNELS WITH MODULAR LININGS . . . . .	40
CHANNELS LINED WITH RIPRAP, OR ITS VARIATIONS. . . . .	46
CHANNELS LINED WITH SOIL CEMENT . . . . .	50
CHANNELS LINED WITH CONCRETE . . . . .	55
UNDERGROUND STORM-DRAIN SYSTEMS. . . . .	59
EVALUATION MATRIX OF ALTERNATIVE FLOOD-CONTROL AND EROSION-CONTROL TECHNIQUES FOR WATERCOURSES IN TUCSON, ARIZONA . . . . .	62
REFERENCES . . . . .	74

# EVALUATION OF ALTERNATIVE FLOOD-CONTROL AND EROSION-CONTROL TECHNIQUES FOR WATERCOURSES IN TUCSON, ARIZONA

## APPENDIX TO STANDARDS MANUAL FOR DRAINAGE DESIGN AND FLOODPLAIN MANAGEMENT IN TUCSON, ARIZONA

### Background

This document was prepared by Simons, Li and Associates, Inc., in order to familiarize members of the City Engineer's staff, as well as other interested individuals, with (1) the recommended minimum design standards; (2) the relative costs and maintenance requirements; and (3) the expected benefits and likely disadvantages associated with alternative forms of bank protection and erosion-control techniques that are known to exist; but which may or may not have been used in the past within the City of Tucson.

Regulatory provisions and City policy have not been included herein, because it is believed that City staff is the more appropriate source with whom to discuss and justify such administrative procedures.

### Purpose Of Appendix

The purpose of this Appendix is to briefly identify and describe as many alternative forms of flood-control and erosion-control techniques as possible which are currently being utilized locally and/or nationwide. Because many of the structural and non-structural channel-treatment alternatives which were evaluated are highly technical in their design and application, and are described in other easily obtainable references available to the reader, they are presented herein at a concept level only. For those individuals interested in further examining the design standards and construction specifications of each method of watercourse treatment, appropriate references are provided at the end of this document.

It is important for the reader to note that some of the treatments presented within this Appendix do not have available design standards, either from other governmental agencies or from the actual manufacturers promoting the use of their particular materials or erosion-control techniques. Similarly, the minimum design

standards presented in this Appendix may be implemented by a broad spectrum of users, and applied under a wide range of site conditions. As such, these minimum standards were prepared using the best available technical information for each given technique, and by exercising engineering judgment based upon relevant design experience.

Although the minimum design standards presented herein are believed to be conservative in nature, there may be specific site conditions encountered for which a particular watercourse treatment may be found acceptable, according to these standards; but in actuality may be inappropriate for use within the specific environment containing the site. Therefore, engineering judgement must always be exercised when selecting and designing an alternative type of watercourse treatment. In addition, the recommended design standards contained within this Appendix may be subject to change in the future, as more detailed design information becomes available.

### Format of Appendix

Much of the remainder of this Appendix focuses on the merits and values of each bank-protection technique. Initially, each of the many known types of bank-protection techniques were categorized into twelve general groups depending upon (1) the relative degree to which each technique would alter a natural, undisturbed watercourse during construction; and (2) the degree to which each watercourse technique could accommodate landscape elements.

As an aid to increased comprehension, and for later referral, each section of this Appendix has been uniformly structured, or formatted, and describes only one of the twelve separate categories of bank-protection techniques at a time. Each section begins with a pictorial representation and a brief definition, followed by separate sub-sections, as follows:

- (1) Description/Application. This sub-section contains a more complete description of each technique and its application to urban watercourses.
- (2) Possible Variations. This sub-section contains a description of some of the possible variations to each technique within its broader category.
- (3) Design Guidelines. Minimum design guidelines are provided in this sub-section. Many of the alternative flood-control and erosion-control techniques presented in this Appendix inherently have varying abilities for maintaining bank stability. Therefore, as an aid in the design and application of these particular techniques, maximum allowable flow velocities have been provided. For those individuals interested in a more detailed analysis of each watercourse treatment, these sub-sections also contain some of the available bibliographic references and technical publications which describe the design of the particular watercourse treatment examined.
- (4) Maintenance Requirements. The anticipated maintenance requirements for each watercourse treatment is described in this sub-section in order to give

the reader an indication of the long-term maintenance associated with each alternative bank-protection technique. Understandably, the maintenance requirements for any given watercourse treatment is a function of the quality of both design and construction. Long-term maintenance is also dependent upon both the inherent durability of the structural channel improvements, as well as the biological and aesthetic requirements associated with vegetative erosion-control treatments.

- (5) Construction Costs. This sub-section provides an estimated cost for each type of watercourse treatment. Because many of the flood-control and erosion-control techniques presented in this Appendix may be used in our community as an alternative to traditional concrete bank protection, as suggested by the City of Tucson Interim Watercourse Improvement Policy (adopted by the Mayor and Council on June 27, 1988), it is believed that many of the readers would be interested in knowing the costs of alternative techniques relative to the costs of traditional concrete-lined channels. Therefore, where feasible, cost estimates for alternative techniques are compared directly to construction costs for channels which have equivalent flow conveyance that are lined with pneumatically placed concrete.
- (6) Advantages and Disadvantages. The last two sub-sections contain lists of expected benefits and likely disadvantages of each type of watercourse treatment. Because the selection of a watercourse treatment for a particular location is not merely determined by construction costs alone, these last two sub-sections were included in order to demonstrate some of the less tangible, less quantifiable, social, environmental, economic, and technical factors associated with each type of treatment. For an explanation of these factors, the reader should refer to the last section of this Appendix.

As a further aid, the listing on pages 5 and 6 of this Appendix presents each of the twelve major categories of flood-control and erosion-control techniques which were evaluated, including their subsets.

Following the individual sections describing the various flood-control and erosion-control techniques presented within this Appendix, the reader will find a comparison of all alternatives, provided in the form of an Evaluation Matrix. This Matrix enables one to quickly compare the relative advantages and disadvantages of the various flood-control and erosion-control techniques evaluated herein.

### General Design Guidelines

All new channels and bank protection built within or adjacent to any watercourse located in Tucson, Arizona, shall be designed and constructed according to current City of Tucson standards and specifications. This includes appropriately designed key-ins at both the upstream and downstream limits of the bank protection, as well as sufficient toe-downs below the channel bed, as needed. Any non-standard design or construction material must be approved, beforehand, by either the City Engineer or his designated staff.

If it is found by an approved engineering analysis that bank protection (or enhanced bank protection) is only required in the curved portions of a channel, the upstream end of the bank protection should begin at the initial point of curvature (P.C.) of the channel, and extend a sufficient distance downstream from the point of tangency (P.T.) to where the secondary currents have dissipated. An analytical procedure for evaluating the distance from the end of channel curvature (P.T.) to the downstream point where secondary currents have dissipated is described in Chapter VI of the "Standards Manual For Drainage Design And Floodplain Management In Tucson, Arizona" (City of Tucson, 1989). In addition, both the upstream and downstream edges of the discontinuous bank protection should have cut-off walls constructed which have been designed according to procedures also found within Chapter VI of the aforementioned Manual.

In all cases, appropriate building setbacks are required--unless it can be satisfactorily demonstrated by the design engineer that the bed and banks of the proposed channel are non-erosive during the 100-year design flood.

## ALTERNATIVE FLOOD-CONTROL AND EROSION-CONTROL TECHNIQUES EVALUATED

1. Preservation of natural washes
2. Natural Washes with periodic grade-control structures
  - a) Reinforced concrete
  - b) Soil cement
  - c) Rock riprap
3. Natural washes with training structures
4. Washes with piecemeal bank protection
  - a) Concrete or soil cement
  - b) Auto bodies, rubber tires, and concrete rubble
5. Earthen channels
  - a) Unlined
  - b) Periodic grade-control structures
  - c) Chemically-reinforced or mechanically-reinforced soil
  - d) Geotextiles
6. Channels with vegetal linings
  - a) Small trees and shrubs
  - b) Grasses
  - c) Biotechnical soil stabilization
7. Channels with compound cross sections
  - a) All channel surfaces armored
  - b) Low-flow channel armored
  - c) Designed to carry less than 100-year discharge
8. Channels with modular linings
  - a) Articulated revetment units
  - b) Gobimats and Revetmats
  - c) Biodegradable sacks filled with concrete
9. Channels lined with riprap, or its variations
  - a) Dumped or hand-placed rock riprap
  - b) Grouted riprap (pigmentation of grout is optional)
  - c) Natural and manufactured materials

- d) Channels lined with gabions
    - 1) Rectangular wire baskets
    - 2) Tied wire-mesh fabric
  - e) Rock and rail
10. Channels lined with soil cement
- a) Channel sides are lined
  - b) Channel sides and bottom are lined
  - c) Buried beneath a shallow soil mantle, and subsequently revegetated
  - d) Hydrated lime used instead of portland cement to chemically stabilize clayey soils
11. Channels lined with concrete
- a) Channel sides are lined
  - b) Channel sides and bottom are lined
  - c) Asphaltic concrete
  - d) Artificial rock (e.g., the large-animal enclosures recently constructed at Reid Park Zoo)
  - e) Concrete masonry-block units
12. Underground storm-drain systems



## PRESERVATION OF NATURAL WASHES

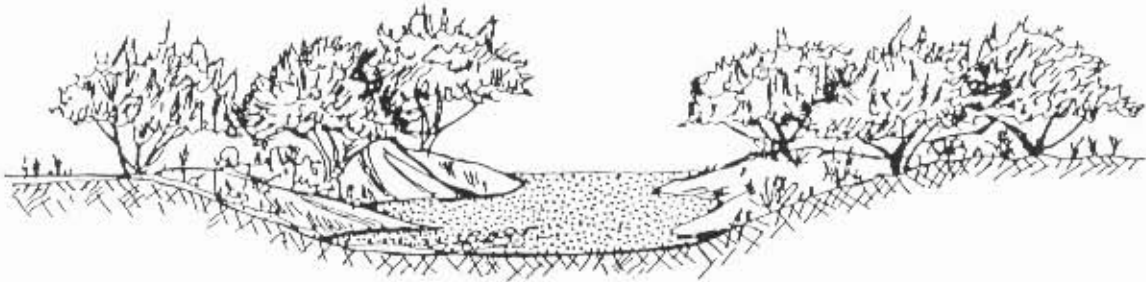

\* \* \* \* \*

### Definition

A natural wash, in the context of this presentation, is a naturally occurring watercourse which has not been appreciably altered by man, in either its location or its cross section, through the process of channelization and/or stabilization. A natural wash is characterized as that undisturbed area found along and adjacent to a watercourse, including the bed, banks and the immediately adjacent riparian vegetation associated with the watercourse.

### Description/Application

Natural washes are generally found in relatively low-density residential developments, which typically allow for greater flexibility in accommodating both the proposed development plan and the existing drainage patterns without mass grading the site and without channelizing the wash. They are retained primarily in developments where preservation of the native environment is desirable, from both a social and economic standpoint.

Out of a concern by City staff for both maximizing public safety and for minimizing long-term channel-maintenance costs, the preservation of natural washes are often encouraged during the development review process in those cases where a stable channel alignment and a stable channel bed can be reasonably assured during the life expectancy of the project. Otherwise, grade-control structures and/or structural erosion-control measures are usually required to be installed at the time of development.

The primary purposes for maintaining a watercourse in its natural condition are (a) to preserve the natural riparian vegetation and wildlife habitat; (b) to minimize long-term maintenance; (c) to maintain the overbank storage characteristics of the wash, and thus minimize downstream flood peaks; (d) to minimize cost of drainage improvements; and (e) to enhance the aesthetic quality of urban development.

### Possible Variations

In most areas of our community, encroachment and/or placement of earthen fill in the regulatory flood plain of a natural wash for purposes of modifying its floodplain limits is permitted within the guidelines prescribed under the City of Tucson's Floodplain Ordinance.

### Design Guidelines

The "design" of natural washes is typically limited to the determination of minimum building setbacks, which are a function of a specific 100-year peak discharge and degree of channel curvature. Specific setback criteria for evaluating the minimum allowable building setbacks for regional watercourses and for other major and minor watercourses can be found within Chapter VII of the "Standards Manual For Drainage Design And Floodplain Management In Tucson, Arizona" (City of Tucson, 1989).

There is no artificial limitation upon the maximum allowable velocities permitted for flows within natural washes, subject to appropriate building setbacks.

### Maintenance Requirements

With minimal upstream development, natural washes normally require little or no regular maintenance. At a minimum, natural washes should be inspected at least once a year--preferably prior to the summer rainy season. At that time, any debris or trash should be removed. Also, during the regular annual inspection, particular attention should be given to any channel scour that may develop at bends or immediately downstream from roadway crossings. Protective measures should be installed during the regular maintenance cycle, if it has been found that channel scour and/or channel bed scour are threatening adjacent developments or improvements.

### Construction Cost

Except for the cost of right-of-way or easements, and for engineering analyses needed to demonstrate long-term stability of the watercourse, there are generally no direct construction costs associated with preserving natural washes.

### Advantages

- a) High aesthetic quality
- b) High social acceptability
- c) High multi-purpose use potential
- d) Provides good linear-park opportunities
- e) Minimum hazard and nuisance potential
- f) Preserves and/or restores riparian vegetation
- g) Preserves wildlife habitat/corridors
- h) Maintains natural floodplains
- i) Preserves existing infiltration and recharge characteristics
- j) Low drainageway construction costs
- k) Low operation and maintenance costs
- l) No special maintenance alley and/or easement required
- m) Minimal exposure to legal liability
- n) Reduces the potential increase in downstream flood peaks normally resulting from urbanization by maintaining relatively low flow velocities and by providing some overbank storage.
- o) No irrigation and landscaping requirements

### Disadvantages

- a) Large right-of-way requirements due to the relatively wide and irregular floodplain associated with natural washes
- b) No immediate benefits upon development
- c) Large erosion/building setback from channel edge

- d) Requires assurance of long-term channel stability
- e) Requires high degree of site-plan flexibility
- f) Natural washes can only be satisfactorily preserved under a narrow range of site conditions
- g) Does not reduce the frequency/severity of local erosion/flooding
- h) Is not always compatible with other techniques

## NATURAL WASHES WITH PERIODIC GRADE-CONTROL STRUCTURES

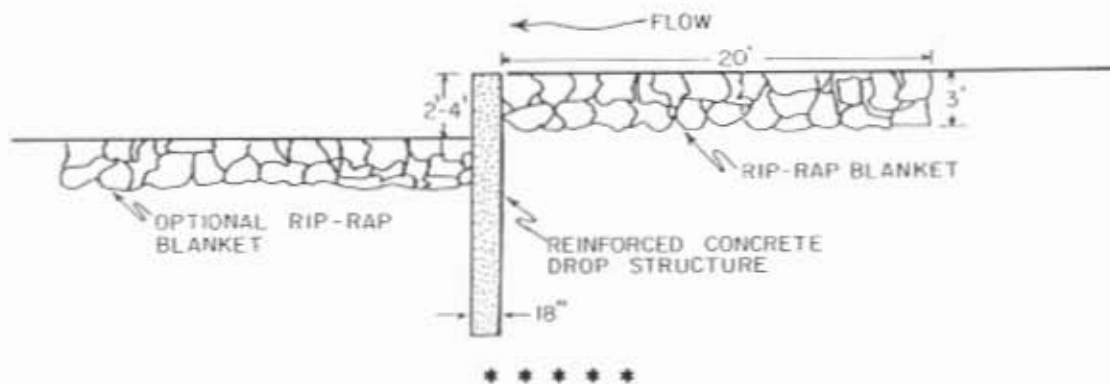

### Definition

Grade-control structures are narrow, permanent barriers placed across the width of a sandy-bottomed channel to effectively limit the amount of channel downcutting.

### Description/Application

When it is reasonable to believe that upstream urbanization and/or channelization may affect future sediment supply, some form of erosion control should be implemented, even on an otherwise natural wash. One of the least conspicuous mitigation alternatives for controlling erosion is a grade-control structure. Typically, grade-control structures perform better when placed within channels having milder slopes.

Acting alone, or as part of an integral series, grade-control structures primarily function as a means of decreasing the slope of the channel by providing a fixed point around which the upstream channel slope can pivot downward; thereby re-establishing a balance between sediment inflow and sediment outflow within the grade-controlled reach.

If flumes, or similar hydraulic control structures, are required in conjunction with grade-control structures in order to control the width and location of the scour hole that is anticipated to develop beneath the grade-control structure, and if grade-control structures are required at intervals closer than about 1000 feet, generally more than about ten percent of the channel will require some form of structural erosion control. Therefore, under such circumstances, other forms of watercourse treatment should also be considered during the evaluation of alternative forms of watercourse treatment. Similarly, if more than ten percent of the length of a natural wash and its adjoining natural vegetation corridor will be disturbed during the construction of grade-control structures and their attendant flumes, in some instances the affected watercourse may no longer be designated by City and County agencies as a "natural wash". Thus, frequent grade-control structures may tend to disturb a natural wash to the extent that some other form of watercourse treatment will be preferable, from the standpoints of both aesthetics and cost.

The primary purposes for building grade-control structures in channels or a natural watercourse are (a) to minimize long-term channel degradation; (b) to preserve the natural riparian vegetation and wildlife habitat; (c) to minimize long-term maintenance; and (d) to maintain the overbank storage characteristics of a natural wash--thus minimizing downstream flood peaks.

### Possible Variations

Depending upon site-specific factors, such as flow velocity, channel slope, and the availability of construction materials, grade-control structures and their attendant flumes may be constructed from different materials, each of which has its own unique set of physical and visual characteristics. Some of the more common materials used to build grade-control structures include, for smaller structures, unreinforced concrete; and, for larger structures, reinforced concrete; soil cement; rock masonry; rock riprap; or rock-filled, wire-tied baskets (usually referred to as gabions).

### Design Guidelines

The design of grade-control structures for placement within constructed channels is typically limited to the determination of an equilibrium channel slope and to the subsequent determination of the spacing of the grade-control structures. Specific design criteria for evaluating the spacing of grade-control structures for placement within constructed channels having bank-protected sides can be found within Chapter VI of the "Standards Manual For Drainage Design And Floodplain Management In Tucson, Arizona" (City of Tucson, 1989). These same design procedures may be used in designing grade-control structures for natural washes.

There are no limitations upon the maximum allowable velocity for which grade-control structures may be constructed in an otherwise unlined channel. However, channel applications having high flow velocities will require deeper toe-downs, with additional structural reinforcement.

There are some additional considerations, not mentioned in the above-referenced Manual, that should be taken into account when designing grade-control structures for placement within natural washes. These additional design concerns include:

- a) Evaluating the long-term channel widening that is expected as a result of a reduction in incoming sediment supply following urbanization;
- b) Evaluating the maximum potential for long-term channel migration, in order to establish the minimum width of the grade-control structure (Note that these analyses should be based on the wider and less steep channel geometry expected in the future);
- c) Evaluating the stability of the steep and incised channel banks located immediately beside the scour hole that will normally develop downstream of the grade-control structure (Bank stabilization and/or greater than usual building-setback distances may be required, if the channel banks are found to be unstable);
- d) Designing a hydraulic control section, or flume, with which to restrain the flood flows to a prescribed location next to, and near the center of, the drop structure, should the channel banks be found to be unstable and/or the width of the future scour hole be unacceptably wide; and,
- e) Locating the proposed grade-control structures based upon site topography and channel alignment, in addition to utilizing the distances obtained from the equilibrium-slope procedure.

If flumes, or other similar hydraulic control structures, are proposed, they should be designed with a downstream length equal to twelve times the maximum predicted depth of scour, as measured from the transverse centerline of the grade-control structure, and an upstream length equal to either four times the critical depth, measured immediately upstream of the grade-control structure, or one-half of the downstream length of the flume, whichever is greater.

### Maintenance Requirements

With moderate upstream development, properly designed and constructed grade-control structures will require little or no regular maintenance. At a minimum, natural washes with grade-control structures should be inspected at least twice a year. The first inspection should be made in May or June, prior to the summer rainy season, at which time any debris or trash should be removed. The second inspection should be made in October or November, after the summer rainy season, at which time any necessary repairs to the structures can be made and/or scheduled. Additional maintenance of any landscaping may be necessary during the initial establishment of the plants and trees, as well as later in order to enhance compatibility with adjoining recreational and open-space uses.

### Construction Cost

Except for the cost of right-of-way or easements, and the cost for the engineering analyses needed to demonstrate the long-term stability of the natural wash which contains grade-control structures, the cost of grade-control structures and their attendant flumes should be approximately equivalent to the cost of concrete bank protection, on a per-linear-foot basis.

### Advantages

- a) High aesthetic quality
- b) Moderate social acceptability
- c) High multi-purpose use potential
- d) Provides good linear-park opportunities
- e) Moderate hazard and nuisance potential
- f) Preserves riparian vegetation
- g) Preserves wildlife habitat/corridors
- h) Essentially maintains natural floodplains
- i) Preserves existing infiltration and recharge characteristics
- j) Low drainageway construction costs
- k) Low operation and maintenance costs
- l) No irrigation and landscaping requirements
- m) No special maintenance alley and/or easement required
- n) Minimal exposure to legal liability
- o) Reduces the potential increase in downstream flood peaks normally resulting from urbanization by maintaining relatively low flow velocities and by providing some overbank storage.



**Disadvantages**

- a) Large right-of-way requirements due to the relatively wide and irregular floodplain associated with natural washes
- b) Benefits relative to a reduction in building setback distances are not received upon construction
- c) Large erosion/building setback from channel edge relative to the minimum setback distance allowed for armored channels
- d) Requires assurance of long-term channel stability
- e) Requires high degree of site-plan flexibility
- f) Does not reduce local erosion
- g) Small range of application
- h) Not always compatible with other techniques

## NATURAL WASHES WITH TRAINING STRUCTURES

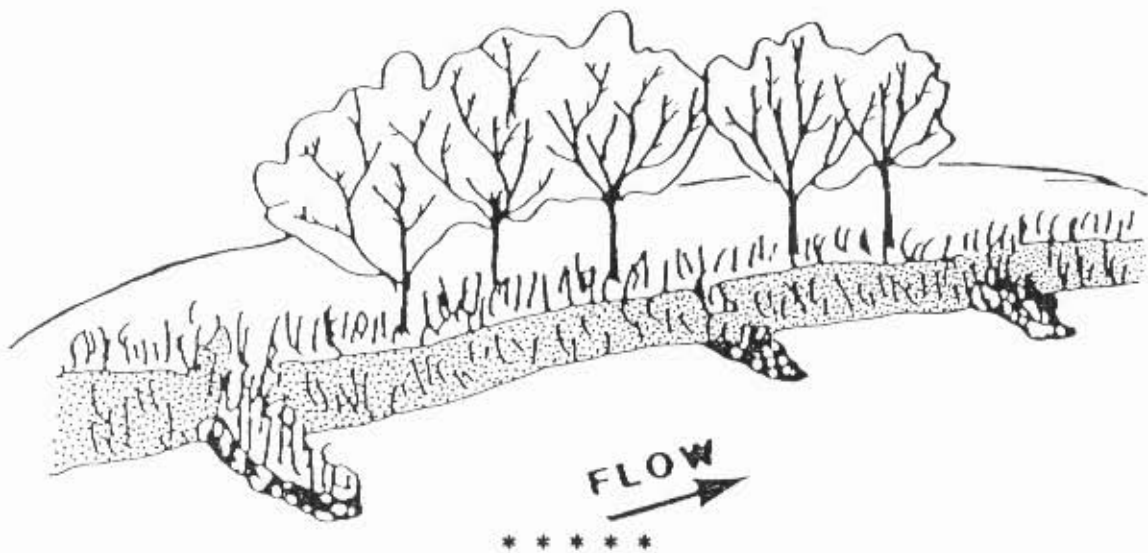
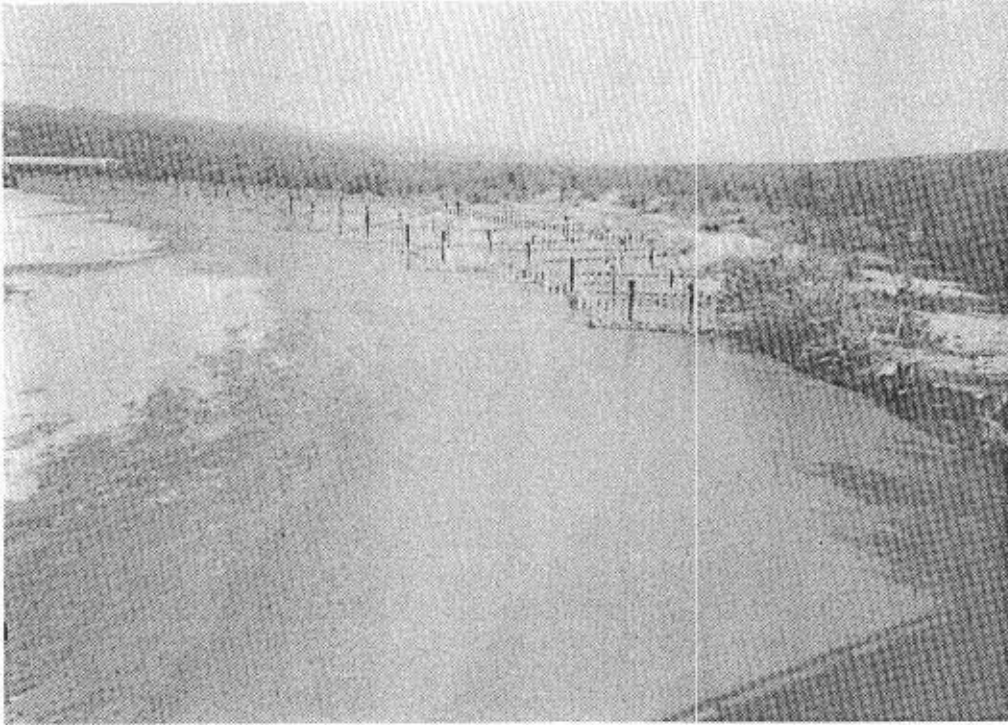

### Definition

Training structures, such as jetties, structural retards, and dikes are relatively long, narrow devices placed in series along edges of a watercourse. They are normally used to guide the flood flows, and to protect the banks from further erosion.

### Description/Application

Typically, streambank erosion occurs as the current scours away the streambank on the outside portion of a bend. At first, the toe or base of the bank is eroded, then the riverbank becomes undermined until it collapses and further erodes the usable dry land. On the other hand, transverse currents cause sandbars to be deposited along the inside of a bend, where the flow velocities are somewhat reduced.

Due to the relatively high cost of rock riprap, soil cement, or concrete bank stabilization, several river-training techniques have been used along larger watercourses to either deflect the high-velocity flows away from the outside of the river bend or to act as a highly permeable barrier which permits flow to pass through them, but with reduced velocity and force--thereby allowing sediment to be deposited.

The primary purposes for building training structures in natural watercourses are (a) to minimize long-term, lateral channel migration or channel widening; (b) to preserve the natural riparian vegetation and wildlife habitat; (c) to minimize long-term maintenance; and (d) to maintain the overbank storage characteristics of the wash--thus minimizing downstream flood peaks.

### Possible Variations

Some of the more successful river-training techniques which have been developed include jetties, structural retards, and dikes. Jetties or jetty fields are evenly spaced rows of steel frames tied together with heavy cables, and usually angled about 45 degrees to 70 degrees downstream from the bank. They are ideally designed to entangle large, waterborne debris. Structural retards are permeable wooden fences, or steel frames, which are like jetties, but placed parallel to the river banks. In general, dikes extend outward from the bank at right angles, and can be highly permeable, like jetties and retards; or they can be impermeable barriers, made of riprap or gabions, which act to deflect, rather than slow, flow velocities.

### Design Guidelines

In general, training structures may be effectively used on the outside of river bends of regional and major watercourses in Tucson in order to arrest ongoing streambank erosion, or in order to protect bridge abutments. However, these three types of river-training techniques would probably be ineffective on the smaller, minor watercourses in Tucson, due to the highly concentrated nature of the flow within these types of fluvial systems.

There are no limitations upon the maximum allowable velocity for which jetties, structural retards, and dikes may be constructed in an otherwise unlined channel. However, channel applications having high flow velocities will require larger and more frequent river-training structures to preclude their premature failure.

As mentioned above, the benefits of training structures may not necessarily be realized immediately upon construction, except for impermeable river-training devices, because several small floods may be necessary for sufficient waterborne debris to accumulate and for sediment to be deposited in the resulting slackwater areas. As such, there may be some risk of immediate erosion damage associated with these types of river-training techniques. Therefore, this immediate damage potential should always be considered relative to the design and utilization of adjoining properties or structures.

Specific design guidelines for these types of river-training techniques can be found in several publications prepared by the Federal Highway Administration (e.g., "Countermeasures For Hydraulic Problems At Bridges," Report No. FHWA-RD-78-162, 1978; or "Design Of Spur-Type Streambank Stabilization Structures," Report No. FHWA/RD-84/101, 1985).

### Maintenance Requirements

Properly designed and constructed jetties, structural retards, and dikes will require moderate, regular maintenance. At a minimum, these streambank stabilization structures should be inspected at least once a year, after the summer rainy season. At that time, any debris or trash that has accumulated within or behind these structures should *not* be removed, but any needed flood-damage repairs can be made and/or scheduled.

### Construction Cost

Because of the relatively small area typically covered by spur-type streambank stabilization techniques, and because of the limited number of qualified local contractors that would submit competitive bids, the relative cost for these types of river-training structures is moderately high; but is still less than the cost of pneumatically placed concrete, on a per-linear-foot basis.

### Advantages

- a) Moderate aesthetic quality
- b) Moderate social acceptability
- c) Moderate multi-purpose use potential
- d) Moderate hazard and nuisance potential
- e) Partially preserves riparian vegetation
- f) Partially preserves wildlife habitat/corridors
- g) No irrigation and landscaping requirements
- h) Preserves existing infiltration and recharge characteristics
- i) Maintains natural floodplains
- j) Relatively moderate construction costs

- k) Relatively moderate operation and maintenance costs
- l) No special maintenance alley and/or easement needed
- m) Reduces erosion damage at a localized point without requiring the channelization of long reaches.
- n) Does not increase downstream flood peaks.
- o) Moderately capable of withstanding high flow velocities
- p) Design life is moderate, and dependent upon the durability of the materials used in its construction--such as wood and wire fabric
- q) Reduces the potential increase in downstream flood peaks normally resulting from urbanization by maintaining relatively low flow velocities and by providing some overbank storage.

#### Disadvantages

- a) Greater right-of-way requirements due to the relatively wide and irregular floodplain associated with natural washes
- b) Benefits are not all realized immediately upon construction, except for impermeable river-training devices, because several small floods may be necessary for sufficient water-borne debris to accumulate and for sediment to be deposited in the resulting slackwater areas
- c) Requires high degree of site-plan flexibility if used in conjunction with new development
- d) Special maintenance alley and/or easement may be required
- e) Generally is not accepted by City/County staff as a form of bank stabilization which entitles a developer to reduce the width of the minimum prescribed erosion/building setback zone
- f) Moderate exposure to legal liability because of the likelihood that the design flood will occur prior to the necessary accumulation of waterborne debris and sediment
- g) Narrow range of applicability because river-training techniques are most feasible for use along the outside, or concave side, of a river bend on large watercourses which carry moderate amounts of waterborne debris
- h) Relatively low reduction in flood-related damages resulting from very large flood events; however, may reduce flood-related damages for small to moderately-sized floods
- i) Not very compatible with other techniques

## WASHES WITH PIECEMEAL BANK PROTECTION



\* \* \* \* \*

### Definition

Piecemeal bank protection refers to relatively short lengths of bank protection installed in an attempt to protect a single parcel of land, or a single group of structures, and is usually not designed as an integral part of a regional solution to erosion and flooding problems.

### Description/Application

In general, piecemeal bank protection is discouraged on all watercourses in Tucson. Nevertheless, the practice of using piecemeal bank protection continues because of its relatively moderate construction cost and because it provides immediate protection to affected areas. Piecemeal bank protection is discouraged under the City's floodplain policies, because it has been found that in those instances where piecemeal bank protection was not carefully designed from a larger, regional perspective, the piecemeal bank protection often times caused or exacerbated both localized and adjacent flood and erosion damage. The continued use of piecemeal bank protection within the City and County is still evident, mostly because of its construction cost and because individual property owners are able to do much of the construction work themselves. Also, property owners often wish to reclaim that portion of their land which may have washed away in previous floods, which frequently dictates piecemeal bank protection as the only economically viable solution.

The primary purposes for piecemeal bank protection are (a) to minimize the initial construction cost by limiting the total length of the project; and (b) to eliminate short-term lateral migration or channel widening in those areas protected by the piecemeal bank protection.

### Possible Variations

Examples of the types of construction materials commonly used to build piecemeal bank protection include concrete rubble, auto bodies, and rubber tires. Less common in their usage are such materials as pneumatically placed concrete and soil cement.

### Design Guidelines

In accordance with the "Standards Manual For Drainage Design And Floodplain Management In Tucson, Arizona" (City of Tucson, 1989), all new piecemeal bank protection, if and when permitted, shall be designed and constructed according to current standards and specifications. The maximum allowable design velocity for piecemeal bank protection is directly dependent upon the type of bank protection used in a particular river reach. All piecemeal bank protection should include appropriately designed key-ins at both the upstream and downstream limits of the bank protection, as well as sufficient toe-downs below the channel bed. Any nonstandard design or construction material must be approved beforehand, and in writing, by either the City Engineer or a designated staff member.

### Maintenance Requirements

Properly designed and constructed piecemeal bank protection will require above-average maintenance--particularly at both the upstream and downstream ends, where severe local scour can be anticipated. At a minimum, piecemeal bank protection should be inspected at least twice a year. The first inspection should be made in May or June, prior to the summer rainy season, at which time any debris or trash should be removed. The second inspection should be made in October or November, after the summer rainy season, at which time any necessary repairs to the bank protection can be made and/or scheduled.

### Construction Cost

The unit (i.e., "per-foot") cost of constructing piecemeal bank protection varies widely, depending upon the amount of site grading required, as well as the type of bank-protection material used in a particular application. Because piecemeal bank protection, by definition, is typically installed along short channel reaches, and is only intended to solve very local erosion problems, rather than regional erosion problems, the anticipated construction cost of piecemeal bank protection will typically be less than a larger project made of the same material. However, due to key-in requirements and the relatively small length of channel normally involved, the cost per foot for piecemeal bank protection will be higher than for larger projects.

### Advantages

- a) Does not normally require additional right-of-way, and in some instances may even reclaim "lost" property from the watercourse.
- b) No irrigation and landscaping requirements
- c) Moderate multi-purpose use potential
- d) Provides a moderate degree of site-plan flexibility
- e) Provides a reduction in the frequency and severity of damages to local structures caused by the relatively small, frequently occurring flows
- f) Reduces erosion damage at a localized point, without requiring the channelization of long reaches.

### Disadvantages

- a) Moderate aesthetic quality
- b) Moderate social acceptability
- c) May lessen linear-park opportunities
- d) Moderately high hazard and nuisance potential
- e) Does not preserve riparian vegetation
- f) May disrupt wildlife habitat/corridors



- g) Does not maintain natural floodplains
- h) May reduce existing infiltration and recharge characteristics
- i) Moderately high construction costs on a per-square-foot basis
- j) Relatively high operation and maintenance costs
- k) Design life can be short because of (1) severe local scour that may develop at the upstream and downstream ends of the short length of bank protection, or (2) poor construction techniques
- l) Many forms of piecemeal bank protection are not accepted by City/County staff as a form of bank stabilization which entitles a developer to reduce the width of the minimum prescribed erosion/building setback zone
- m) Moderate to large exposure to legal liability because of possibility of transferring an erosion problem to adjoining properties
- n) In most instances, piecemeal bank protection has a narrow range of application. Also, it does not insure protection during very large and damaging floods
- o) May contribute to an increase in the frequency and severity of downstream flooding and erosion, and may even transfer the problem to an adjoining property
- p) Can be incompatible with other flood-control and erosion-control techniques
- q) Prone to failure because of lateral migration of the unprotected upstream bank
- r) Only moderately capable of withstanding high flow velocities

## EARTHEN CHANNELS

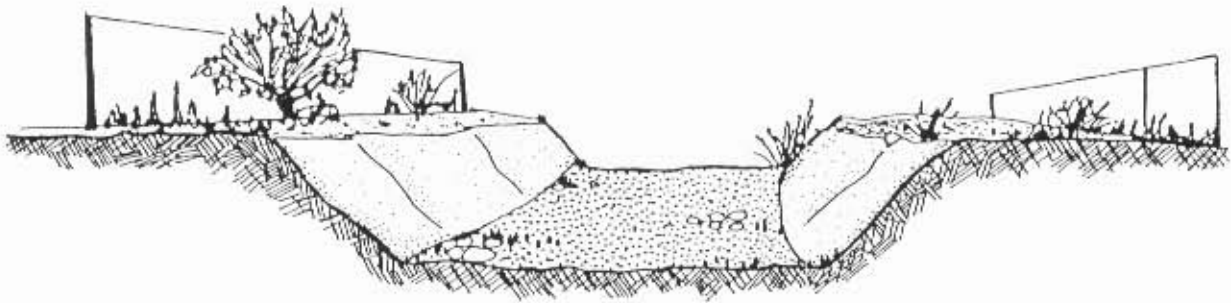

\* \* \* \* \*

### Definition

Within the context of this presentation, when a natural wash has been significantly altered by man in location (i.e., plan form), and/or slope, and/or width and depth (i.e., cross-section); and, in addition, it has not been artificially armored or bank protected, it shall be referred to as an earthen channel. A manmade watercourse, with unprotected bed/banks and free of vegetal lining, also is referred to as an earthen channel.

### Description/Application

Earthen channels are designed to confine low-velocity flows within a predetermined cross section and alignment.

Intuitively, it is understandable that an earthen channel may not have identical hydraulic characteristics as its natural-wash predecessor, and that its flow velocity and its sediment-carrying characteristics may therefore be significantly different. Unless landscaped, several years are usually required before natural vegetation that can provide important aesthetic value, as well as some measure of erosion control, reappears along an earthen channel. During the initial period before vegetation reappears; or even afterwards, if channel maintenance includes vegetation removal and grading, the channel is apt to erode--particularly at channel bends and other areas where flows are accelerated. The bed and banks of an earthen channel are vulnerable to varying degrees of erosion. Therefore, adjacent structures must be placed an appropriate distance away from the channel to preclude significant damage. This distance is referred to in the City's Floodplain Ordinance as the *Erosion/Building Setback*. This setback is related to the magnitude and duration of flow, as well as the degree of curvature along a channel.

The primary purposes for constructing earthen channels are (a) to provide flexibility in the design of an urban development; (b) to achieve a greater development density; and (c) to minimize construction costs by avoiding the installation of bank protection.

### Possible Variations

During the design process, the engineer usually considers the stability of the earthen channel, and whether or not the channel bottom will aggrade/degrade, or the channel sides will erode. The engineer will also consider whether or not future vegetation inside the channel will act to impede flow, thus requiring a wider channel at that time for a given discharge. In addition, the design engineer will also consider whether or not future upstream development will upset the supply of incoming sediment by creating new, impervious surfaces; or by building detention/retention basins which act as very effective sediment traps. Based on these, and other design considerations, the design engineer may elect to construct grade-control structures within the channel in order to control the level of channel downcutting.

Pre-conditioned soil may be used to increase the stability of channels with stable bottoms by providing denser, more erosion-resistant soil in the channel banks. The soil banks may be "conditioned" by one or more of the following techniques:

- a. Compacting the existing soil to a greater density;
- b. Over-excavating the channel, and replacing the original soil with a less permeable, more erosion-resistant soil; or,
- c. Adding chemical binding agents to the soil.

When placed directly on, or just below, the surface of the channel banks, non-woven polyester fabric (called geotextiles) may be used to control erosion on earthen channels that are free of vegetation and have stable bottoms. Geotextiles are presently manufactured in many textural variations ranging from flat, coarse mesh, which act as sand filters, to thick, honeycomb designs, which can be filled with soil. Geotextiles can be successfully applied to earthen channels that are free of vegetation and have stable bottoms and low design velocities.

### Design Guidelines

Earthen channels are permitted within the City of Tucson whenever (1) they can be designed according to current City standards; and (2) it can be adequately demonstrated that long-term channel maintenance will be minimal because the bed and banks of the watercourse will be stable during the 10-year design discharge.

In the absence of an approved engineering analysis demonstrating otherwise, earthen channels will not require bank protection in order to minimize long-term maintenance whenever an earthen channel can be satisfactorily designed with side slopes equal to or milder than 3H:1V such that the average flow velocities within the main channel during the 10-year design flood do not exceed 3.0 feet per second (fps) along straight reaches, and 2.2 fps along curved channel reaches with a mild curvature of up to 30 degrees (i.e., where the centerline radius of curvature of the channel is never less than three times the channel top width).

In all cases, appropriate building setbacks are required, unless it can be satisfactorily demonstrated that the earthen channel is non-erosive during the 100-year design flood.

In addition, if it is intended during the design process that naturally occurring desert vegetation be allowed to become established within the channel, and afterward retained and/or maintained by a designated individual or agency, the Manning's roughness coefficient used in either the evaluation of channel stability or the channel conveyance capacity will be reviewed and approved by City staff on a case-by-case basis. However, it is recommended that bank stability be based on a smooth n-value, representative of initial, pre-vegetation channel conditions; whereas a rougher n-value, representative of "aged" channel conditions, be used in establishing the size and alignment of the channel.

### Maintenance Requirements

Properly designed and constructed earthen channels will require regular maintenance--particularly at those locations where flow is accelerated, such as at channel bends, confluences, or roadway crossings. At a minimum, earthen channels should be inspected at least twice a year. The first inspection should be made in May or June, prior to the summer rainy season, at which time any debris or trash should be removed. The second inspection should be made in October or November, after the

summer rainy season, at which time any necessary repairs to the channels can be made and/or scheduled.

### Construction Cost

The construction cost for an earthen channel will be considerably less than a comparably sized, pneumatically placed concrete channel. However, the total width of the channel and the minimum required building setback distance will generally be greater than that required for a concrete channel.

### Advantages

- a) Moderate aesthetic value, particularly if vegetation is re-established, and if debris and rubbish are periodically removed
- b) Moderate social acceptability
- c) Moderate multi-purpose use potential
- d) May provide linear-park opportunities within the channel bottom or within the maintenance easements located on one or both sides of the earthen channel
- e) Minimal hazard and nuisance potential--particularly if the side-slopes are 3H:1V, or milder
- f) Does not significantly effect infiltration
- g) No irrigation and landscaping requirements
- h) Moderate to low construction cost
- i) Moderate number of benefits received upon construction
- j) Allows for greater flexibility over natural channels during site design because of channelization
- k) Moderate range of application
- l) Permits flexibility in the design of future bank-stabilization projects
- m) Moderately compatible with other flood-control and erosion-control techniques

### Disadvantages

- a) Does not preserve riparian vegetation
- b) Does not preserve wildlife habitat/corridors
- c) Does not maintain natural floodplains
- d) Moderate exposure to legal liability due to the likelihood of bank erosion
- e) Moderate to high right-of-way requirements because an earthen channel is relatively wide and shallow; and because it requires a parallel maintenance alley and/or easement. In addition, all new structures must be placed at the largest minimum erosion/building setback required
- f) High operation and maintenance costs
- g) Special maintenance alley and/or easement required

- h) Design life can be short due to possible channel erosion
- i) Does not reduce localized scour
- j) May increase the frequency and severity of downstream erosion/flooding due to the loss of floodwater storage in the overbank areas, as well as the increase in flow velocities typically associated with channelization
- k) Not capable of withstanding high flow velocities

## CHANNELS WITH VEGETAL LININGS

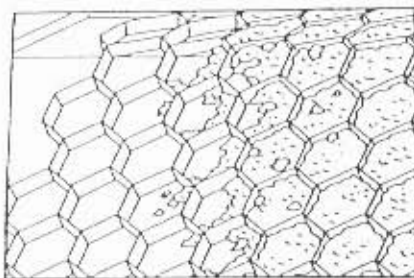
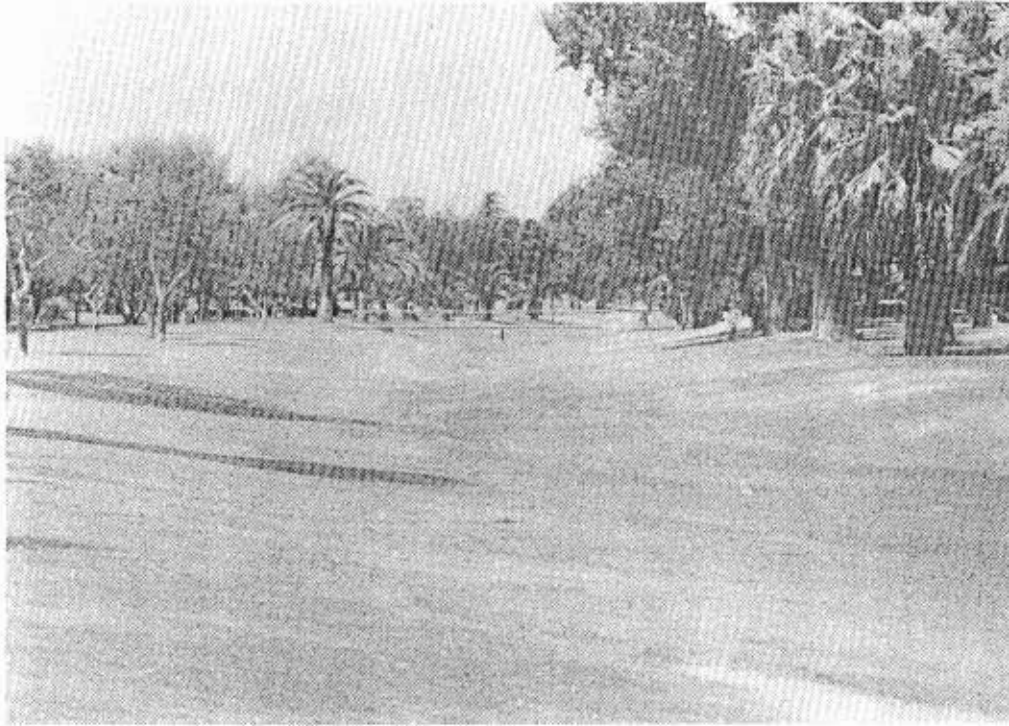

DETAIL OF BURIED GEOMATRIX

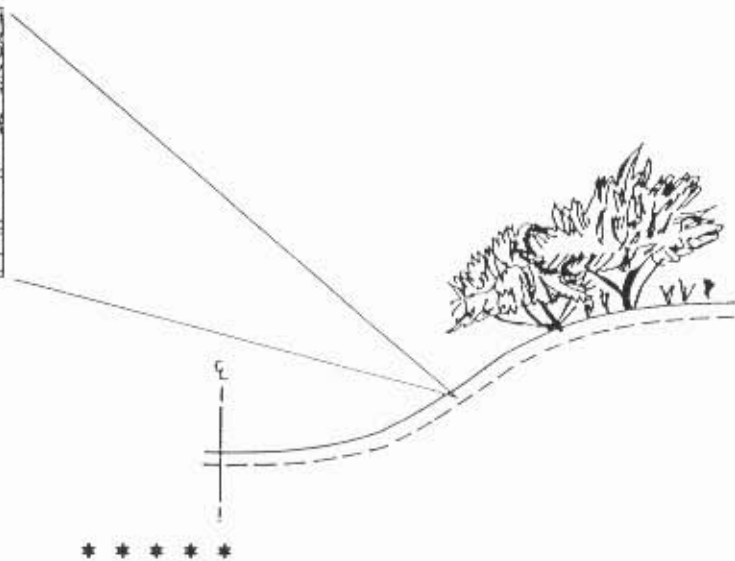

### Definition

Channels with vegetal linings are channels that may be either fully or partially lined with vegetation, or a combination of structural and vegetative elements, in anticipation of, or as a remedial measure for, localized bank erosion.

### Description/Application

The placement of small trees, shrubs, and grasses along the edges of channels as an erosion-protection measure has proven to be moderately successful in those instances where flow velocities have been relatively low, and the erosive forces relatively small. Vegetative erosion protection offers a minor degree of additional protection to otherwise exposed earthen channel banks. In principal, the tree trunks and branches impede the flow of floodwaters while, at the same time, the roots provide additional resistance to erosion below the water surface. As the trees become established, sediment is progressively deposited in the slackwater created behind the trees. While this elevates the land and further reduces erosion, it may also reduce channel capacity, which must be accounted for during design.

Vegetative lining of earthen channels is tenable whenever there is a nearly constant supply of water, which is needed to satisfy the plants evapotranspiration requirements; and whenever the flow velocities equal or just barely exceed the threshold for initiation of sediment motion and transport.

Locations in Tucson where vegetative lining, such as grasses, may be considered include public parks and commercial and/or residential developments with established maintenance programs.

It may be necessary to use temporary materials, such as straw, Aspen-wood excelsior, or heavy-duty polypropylene netting, in order to protect the seedlings and small plants against erosion from wind and runoff during the initial period of establishment. However, in themselves, these temporary materials do not provide any significant bank stabilization over the long term. It is only the combined effect of both the vegetation and the artificial fabric that produces a moderate increase in allowable flow velocities over that of an unprotected earthen channel.

Limitations placed on the maximum allowable velocity for biotechnical channel stabilization will typically limit its application to those channels having shallow flow depths and wide channel widths. However, the reader is cautioned that wide channel widths relative to flow depths can often result in the development of an unstable, meandering flow pattern, or "low-flow channel," in the bottom of an unlined channel bottom which may direct the faster and more damaging flows towards the channel lining. Therefore, unless biotechnical channel-stabilization techniques are used in conjunction with a compound channel design, most channels where vegetative bank stabilization can satisfactorily be used generally will be limited to those channels with maximum design flows less than 500 cfs on mild bottom slopes of about 0.007 feet/foot, and less than about 1000 cfs on flat bottom slopes less than about 0.004 feet/foot. The construction of pilot channels or mild V-shaped grade-control structures may, in some instances, reduce the tendency for the development of incised, low-flow channels, and thereby allow for a moderate increase in design flow.

The primary purposes for constructing earthen channels with vegetal linings are (a) to provide flexibility in the design of urban development; (b) to achieve a greater development density; and (c) to provide an opportunity for native vegetation to become re-established, and thus enhance channel aesthetics.



### Possible Variations

In the past, native trees and non-native grasses have been used in Tucson to line channels, and thereby provide a small increase in erosion control over that provided by exposed soil. In addition, vegetation, in conjunction with structural measures such as woven branches, excelsior mats, heavy-duty polypropylene netting, or a semi-rigid polyester fabric with an open honeycomb pattern, may also be used to provide erosion control in an amount greater than that offered by an unprotected earthen channel bank. These biotechnical techniques are usually applicable to channels with stable bottoms (i.e., not degrading or downcutting) which have moderate to low design flow velocities.

### Design Guidelines

Before vegetal lining should be considered, it should be successfully demonstrated that the channel bottom is stable and not degrading or aggrading over time. If this can be successfully demonstrated (with or without grade-control structures), then vegetal lining may be used in order to minimize long-term channel maintenance--provided it can be designed with side slopes equal to or milder than 3H:1V such that the average flow velocities within the main channel during the 10-year design flood do not exceed 5.0 feet per second (fps) along straight reaches, and 3.8 fps along curved channel reaches with a mild curvature of up to 30 degrees (i.e., where the centerline radius of curvature of the channel is never less than three times the channel top width).

When using vegetal-lining techniques, other than cultivated grasses or sod, it should clearly be the intent that naturally occurring desert vegetation be allowed to become established within the channel, and afterward retained and/or maintained by a designated individual or agency. The Manning's roughness coefficient used in either the evaluation of channel stability or the channel conveyance capacity will be reviewed and approved by City staff on a case-by-case basis. However, it is recommended that bank stability be based on a smooth n-value, representative of initial, pre-vegetated channel conditions; whereas a rougher n-value, representative of long-term landscaping and maintenance, be used for establishing the minimum size and alignment of the channel.

Additional technical information concerning the design of channels with vegetal linings can be found in several publications (e.g., Federal Highway Administration, Hydraulic Engineering Circular No. 15, "Design of Roadside Channels With Flexible Linings," 1988; or Virginia Soil And Water Conservation Commission, "Virginia Erosion And Sediment Control Handbook," 1980).

### Maintenance Requirements

Properly designed and constructed channels with vegetal lining will require extensive and regular maintenance. Generally, the ability of vegetation to resist erosive forces is dependent upon the density of the root system below the soil surface, as well as the density of tree branches found below flood depth. Therefore, in order to avoid disturbing the root zone and the lower portions of the plant structure, it is recommended that tractor-driven mechanical equipment not be used to maintain the banks and bed of a watercourse, except as needed in those locations where cultivated grass is used jointly as bank protection and as a recreation area. In addition to assuring the viability of each plant by providing adequate water during its initial establishment, and later to provide for long-term growth, the frequency and type of landscape maintenance are also dependent upon the highly variable, multi-use aspects of the watercourse. Therefore, at a minimum, channels with vegetal lining should be inspected at least twice a year. The first inspection should be made in May or June, prior to the summer rainy season, at which time any debris or trash should be removed. The second inspection should be made in October or November, after the summer rainy season, at which time any necessary repairs to the channels can be made and/or scheduled. Any additional landscape maintenance required for plant viability or for watercourse aesthetics should be planned on a case-by-case basis.

### Construction Cost

Except for the costs associated with earthwork, the total construction cost of vegetal bank protection is estimated to be approximately \$15.50 per square yard (in 1989 dollars). This cost includes plantings, irrigation pipelines and controls, geotextile filter fabric, and long-term maintenance (i.e., equivalent to the Present Value of an average-annual maintenance cost of \$0.20 per square yard per year, for 50 years, at 10% interest).

On a per-square-yard basis, the estimated equivalent construction cost for a vegetal lining is about one-half the cost of a pneumatically placed concrete lining--which is about \$30.0 per square yard, installed. However, because vegetal linings require flatter, or milder, channel side-slopes, wider channel-bottom widths, and larger Manning's roughness coefficients than an equivalently sized concrete channel, a direct cost comparison is not immediately possible.

Neglecting the cost of the land for small channels carrying less than about 500 cfs, and assuming equivalent depths for each channel alternative, the relative cost of vegetal lining will be about 80% to 90% of the cost of concrete lining (i.e., channel sides only). However, when the cost of land is included (estimated to average about \$5.00 per square foot for inner-City residential property), the cost of vegetal lining will typically be about one and one-half to two times more expensive than a concrete-lined channel. This cost differential may be even greater, considering that the flow depths for vegetal linings must be kept shallow, and thus the total channel width kept wide, in order to have flow velocities less than 3.8 to 5.0 feet per second. This is so because the flow depths and velocities can be substantially greater, and the channel

width substantially decreased, for a concrete-lined channel carrying the same discharge. In addition, the possibility of reducing the building/erosion setback from the edge of the channel must also be included in any analysis of costs for these two alternative forms of erosion control.

#### Advantages

- a) High aesthetic quality
- b) High social acceptability
- c) High multi-purpose use potential because of the mild channel side-slopes, and because of the potential availability of the erosion/setback zone for other uses
- d) Minimum hazard and nuisance potential
- e) Potentially restores riparian vegetation
- f) Provides a moderate degree of site-plan flexibility over natural channels by allowing channel alignments and widths to be changed.
- g) Moderately feasible at most locations
- h) Moderately compatible with other flood-control and erosion-control techniques

#### Disadvantages

- a) May reduce existing stormwater infiltration and groundwater recharge
- b) May not preserve wildlife habitat/corridors
- c) Does not maintain natural floodplains
- d) High water-use requirement
- e) Moderate to high right-of-way requirements, because (1) an earthen channel with vegetal lining is relatively wide and shallow, (2) it requires a parallel maintenance alley and/or easement, and (3) vegetative linings may not be adequate to reduce erosion-hazard setbacks
- f) Moderate construction costs
- g) High operation and maintenance costs
- h) Moderate exposure to legal liability because of the possibility that the design flood will occur before the vegetation has had an opportunity to mature and provide erosion control
- i) Special maintenance alley and/or easement required
- j) Benefits are not immediately received upon construction---particularly for vegetative and biotechnical techniques, which require time for plants to become established
- k) Design life can be moderate, depending upon the quality and frequency of long-term maintenance
- l) Applicability generally limited to channels with low discharge rates
- m) May increase the frequency and severity of downstream erosion/flooding due to the loss of floodwater storage in the overbank areas, as well as the increase in flow velocities typically associated with channelization
- n) Low capability of withstanding high flow velocities

# CHANNELS WITH COMPOUND CROSS SECTIONS

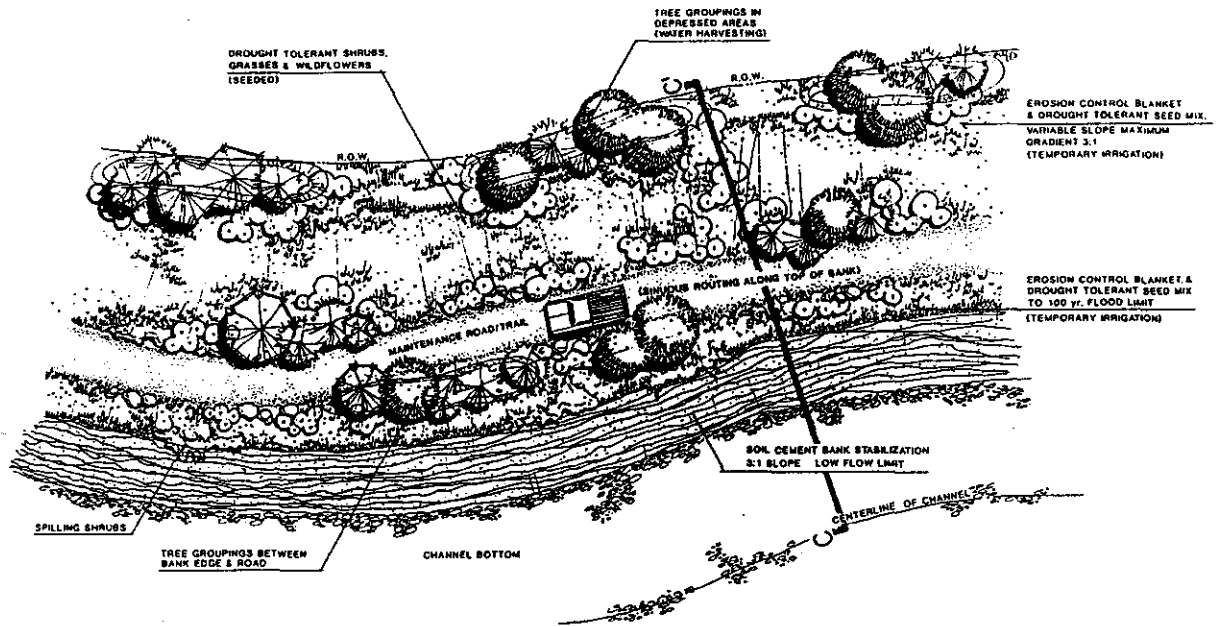

VIEW LOOKING DOWNSTREAM

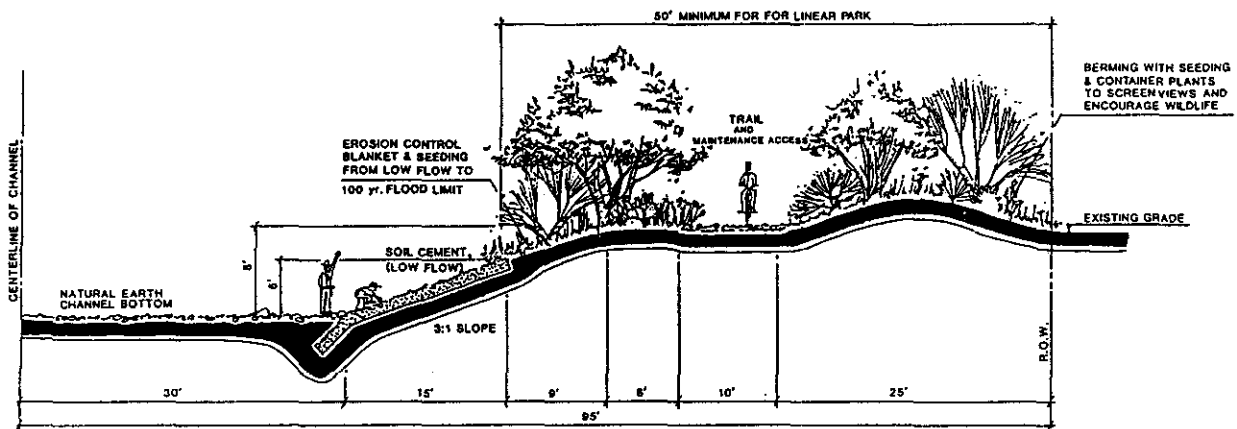

\* \* \* \* \*

## Definition

A compound channel, within the context of this presentation, is one that contains a smaller, interior channel used primarily confine the more frequent low flows, and isolate them from the remainder, or outer portions, of the channel.

### Description/Application

Natural washes typically have relatively narrow, sandy channels with discernable bed and banks, which are bounded on both sides by a higher, more densely vegetated floodplain. The more frequent low flows follow the sandy wash bottom, whereas the less frequent high flows occupy both the sandy wash and the floodplain. Earthen channels can be built with compound cross sections, similar to natural washes, so that the higher floodplain areas can be landscaped and used for more intensive recreation, with minimal likelihood of sustaining frequent damage.

The primary purposes for constructing channels with compound cross sections are (a) to provide greater flexibility in the design of urban development in relation to leaving the channels in a natural state; (b) to achieve a greater development density than would otherwise be possible by leaving the channels in a natural state; (c) to provide an opportunity for native vegetation to become re-established, and thus enhance channel aesthetics; and (d) to provide an opportunity for multiple uses of the channel.

### Possible Variations

Depending upon site-specific conditions, such as the magnitude and velocity of the 10-year and 100-year-flood discharges and the intensity and proximity of nearby development, compound channels can be protected by vegetation or biotechnical stabilization or by a flexible or rigid lining. When bank protection is needed, it can extend from the channel bottom to the top of the low-flow channel; or it can extend the full height of the channel sides to the top of the high-flow portion of the channel.

In the past, drainage standards promulgated by the City of Tucson often required that all new channels be designed to convey within their banks the entire regulatory (or so-called 100-year) flood. However, given additional attention during design, new channels could be constructed to carry less than the regulatory discharge, provided sufficient overbank area is present in order to carry the excess flow without jeopardizing homes or obstructing safe vehicular movement. These "underfit" channels are similar to compound channels, in that they allow for more intensive land use within the flood plain while also maintaining many of the important hydraulic characteristics of natural watercourses.

### Design Guidelines

The successful design of a compound channel includes consideration of (1) the erosion-control qualities of the materials proposed along all of the wetted surfaces; and (2) the structural integrity of the low-flow portion of the channel--particularly its ability to resist hydrostatic pressures during the receding limb of the hydrograph and its ability to resist failure should localized erosion occur along the outside edges of

the low-flow bank protection. Therefore, in order to mitigate the effects of hydrostatic pressures, any relatively impermeable material used in the construction of bank protection within the low-flow portion of the channel (e.g., concrete or a thin veneer of soil cement) should have frequently spaced toe drains, or it should have key-ins that extend downward to the depth equivalent to the bottom of the channel. On the other hand, standard 9-foot-thick soil-cement bank protection should be capable of withstanding both hydrostatic pressures and forces induced by undercutting along the outside edges of the massive structure without the addition of toe drains or key-ins.

In all cases, appropriate building setbacks are required, unless it can be satisfactorily demonstrated that the banks of the high-flow portions of the compound channels are non-erosive during the regulatory flood.

When using vegetal-lining techniques in conjunction with a compound-channel cross section, it should clearly be the intent that vegetation, preferably naturally occurring desert vegetation, should be allowed to become established within the channel, and afterward retained and/or maintained by a designated individual or agency. The Manning's roughness coefficient used in the evaluation of either channel bed stability or channel conveyance capacity will be reviewed and approved by City staff on a case-by-case basis. However, it is recommended that bank stability be based on a smooth n-value, representative of initial channel conditions; whereas, a rougher n-value, representative of "aged" conditions, be used for establishing the minimum size and alignment of the channel.

Because hydraulic roughness typically varies over the cross section of a compound channel, the hydraulic roughness must be "weighted" to develop a composite roughness coefficient for determining the correct depth/discharge relationship. Equation 6-18 in Open-Channel Hydraulics, by V.T. Chow (1959), is recommended for use in "weighting" roughness coefficients in compound channels.

### Maintenance Requirements

Properly designed and constructed compound channels with vegetal lining will require extensive, regular maintenance--particularly at those locations where flow is accelerated, such as at channel bends, confluences, or roadway crossings, or at such areas where there is an interface between adjoining forms of bank protection.

Generally, the ability of vegetation used in conjunction with compound-channel cross sections to resist erosive forces is dependent upon the density of the root system below the soil surface, as well as the density of tree branches found below flood depth. Therefore, in order to avoid disturbing the root zone and the lower portions of the plant structure, it is recommended that tractor-driven mechanical equipment not be used to maintain the banks and bed of a compound channel, except as needed in those locations where cultivated grass is used jointly as bank protection and as a recreation area. In addition to assuring the viability of each plant by providing adequate water during its initial establishment, and later to provide for long-term growth, the frequency and type of landscape maintenance are also dependent upon the highly variable, multi-use aspects of the watercourse. Therefore, at a minimum, compound

channels with vegetal lining should be inspected at least twice a year. The first inspection should be made in May or June, prior to the summer rainy season, at which time any debris or trash should be removed. The second inspection should be made in October or November, after the summer rainy season, at which time any necessary repairs to the channels can be made and/or scheduled.

Any additional landscape maintenance required for plant viability, or for watercourse aesthetics, should be planned on a case-by-case basis.

### Construction Cost

The total construction cost of compound channels will vary greatly, depending upon the type of bank protection selected for the low-flow channel, the method selected for preventing the low-flow bank protection from failing due to hydrostatic pressure, and the type of landscaping and bank protection used in the high-flow portion of the compound channel.

In the most cases, compound channels will cost between one and one-half to two times more than a traditional channel which has the same conveyance capacity and is lined with pneumatically placed concrete.

For the purpose of demonstrating the difference in cost between a vegetatively lined compound channel and a trapezoidal shotcrete channel, the price per linear foot of a compound channel with a 100-year peak discharge of 1000 cfs is compared to a traditional shotcrete channel having the same design discharge. In this example, the low-flow channel of the compound channel is assumed to be (1) totally lined with shotcrete, having key-ins located along the outside edges which extend to the level of the low-flow channel bed; and (2) capable of conveying the 10-year peak discharge. In addition, the high flow portion of the compound channel is assumed to be protected with a landscaped biotechnical lining, capable of withstanding a maximum 100-year design velocity of five feet per second. The cost comparison between the two channels includes landscaping (at \$7.50 per square yard, in 1989 dollars), bank protection costs of the concrete-lined low-flow channel (at \$30.00 per square yard), and long-term landscape-maintenance costs (with a Present Value of \$2.00 per square yard). In this simple example, the cost of the compound channel is approximately one and one-half times the cost of the traditional channel, without considering the cost of land or excavation. However, when considering that the cost of inner-City residential property averages about \$5.00 per square foot, the compound channel becomes about two times the cost of an equivalent shotcrete channel.

This range of cost ratios for a compound channel versus a traditional concrete channel should be considered as the minimum difference in estimated total costs. Other watercourse treatments besides concrete, such as riprap and gabions, are expected to make the cost of a compound channel even higher than the cost of a traditional concrete channel.

A further consideration, when comparing the cost of compound channels with traditional shotcrete channels, is the width of the minimum allowable building setback. Building setbacks from compound channels will generally be greater than the setbacks from concrete channels, if either of the two outside sub-channels in a compound channel are expected to be unstable during the 100-year design flood. A wider setback will reduce the amount of developable area adjacent to a compound channel; thereby further increasing the total cost of the compound-channel alternative.

#### Advantages

- a) Moderate aesthetic quality
- b) High social acceptability
- c) High multi-purpose use potential
- d) Moderate hazard and nuisance potential
- e) Provides a moderate degree of site-plan flexibility over natural channels by allowing channel alignments and widths to be changed.
- f) Moderately feasible at most locations
- g) Moderately compatible with other flood-control and erosion-control techniques
- h) Provides opportunity for construction of linear parks

#### Disadvantages

- a) Does not preserve riparian vegetation; although some restoration may be possible
- b) May not preserve wildlife habitat/corridors
- c) Does not maintain natural floodplains
- d) May reduce existing stormwater infiltration and groundwater recharge
- e) High water-use requirement--particularly if biotechnical stabilization techniques are utilized
- f) Moderate to high right-of-way requirements
- g) High construction costs
- h) High operation and maintenance costs
- i) Special maintenance alley and/or easement required
- j) Benefits may not be received upon construction
- k) Moderate exposure to legal liability--particularly if biotechnical stabilization techniques are utilized
- l) Moderate range of applicability
- m) Moderate compatibility with other techniques
- n) Design life can be relatively moderate, depending upon maintenance
- o) May not be accepted as a technique that enables a developer to reduce the erosion/building setback
- p) Applicability generally limited to channels with low to moderate flow velocities
- q) Provides only a moderate reduction in localized erosion



- r) May increase the frequency and severity of downstream erosion/flooding due to the loss of natural floodwater storage in the overbank areas, as well as the increase in flow velocities typically associated with channelization

## CHANNELS WITH MODULAR LININGS

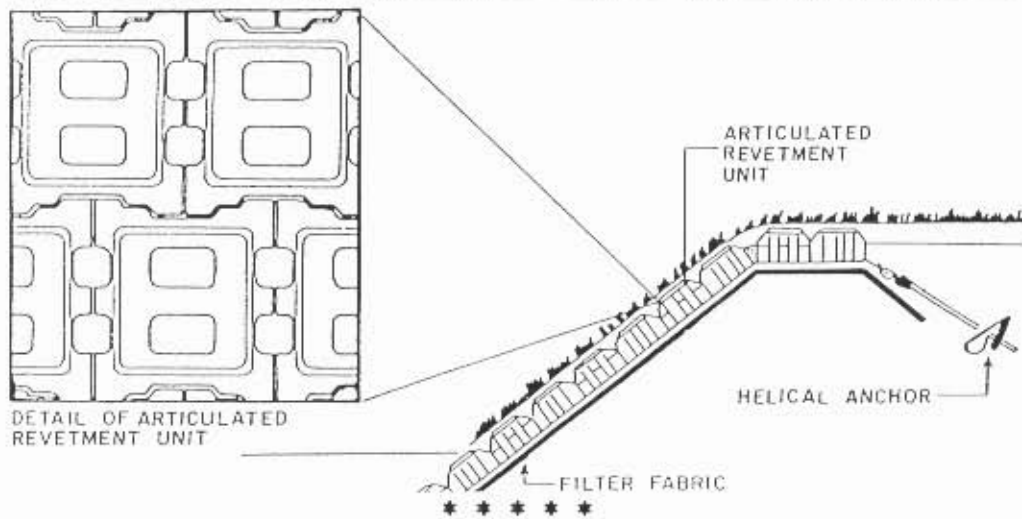

### Definition

Channels with modular linings are channels armored with flexible, yet durable, concrete blocks or units which together form an interconnected membrane designed to permit the channel bottom to degrade within limits, and which also permit some vegetation to grow through their openings without jeopardizing the structural integrity of the linings themselves.

### Description/Application

Modular linings, such as Articulated Revetment Units (ARUs), can be more attractive than rigid linings, such as concrete or soil cement, and modular linings have self-healing qualities which reduce long-term maintenance costs. Modular linings usually have a somewhat natural appearance, especially after vegetation is established. They are also hydraulically rougher than smooth, rigid linings; and therefore both flood velocities and flood peaks are comparatively reduced.

Because of their more natural appearance, modular linings are often used near public open-spaces, where appearance is considered especially important.

The primary purposes for constructing channels with modular lining, instead of leaving channels in their natural state, are (a) to provide flexibility in the design of urban development; (b) to achieve a greater development density by reducing the width of the erosion setback; and (c) to provide a limited opportunity for native vegetation to become re-established, and thus enhance channel aesthetics.

Within the City of Tucson, the application of modular bank protection is limited to a specified maximum allowable flow velocity, according to weight of the individual modules and according to the channel side-slope upon which the modular bank protection is placed.

### Possible Variations

Modular linings are typically made from individual Articulated Revetment Units (ARUs). These are interlocking, pre-cast concrete blocks which are set on a geotextile or filter fabric placed on the surface of the channel to form an integrated bank-protection system. ARUs are moderately expensive, are easy to install, and have numerous small openings to permit the establishment of vegetation. However, the application of ARUs is generally limited to channels with very mild flow velocities.

Like ARUs, concrete-filled burlap bags can be stacked on channel banks, while the concrete is still pliable, to form highly-textured bank protection. For larger projects, a similar cobbled or corrugated appearance can be reproduced by injecting mortar or concrete into long, narrow, porous, nylon sacks (commercially known as gobimats or fabriform revetmats), which results in high-strength, textured bank protection. In both cases, the concrete units may not form a rigid, monolithic surface, thus allowing minimal movement of the channel bank without sustaining significant structural damage.

Commercially, there are three known types of articulated revetment units (ARUs). These three types of ARUs are usually made of 3000-psi concrete, as a minimum, and come in a wide range of sizes from which to select a weight sufficient to withstand the anticipated erosional forces. One type of ARU is called "Tri-Lock", and it consists of triangular, pre-fabricated concrete blocks that interlock with a smaller and lighter key block that can be easily lifted and removed after installation. "Tri-Lock" is

available from the American Excelsior Company, located in Arlington, Texas. A second type of ARU is called "Flexible-Slab", and it consists of square, pre-fabricated blocks with interlocking edges designed to prevent a single interior block from being lifted after installation. "Flexible-Slab" is available from Scan-Gabions, A.S., located in Copenhagen, Denmark. The third known type of ARU is called "Armorflex", and it consists of approximately square, pre-fabricated blocks that are interlocked with a continuous, flexible, steel cable. "Armorflex" is available from Armortec, Inc., located in Atlanta, Georgia. Each of these three types of ARUs may be available for fabrication by a local distributor.

**NOTE:** The reader is advised that these three examples of ARUs are being provided merely for illustrative purposes only, and are *not* to be construed as an endorsement by the City of Tucson of any commercially available revetment system. In addition, other types or brands of ARUs may be locally available which were inadvertently excluded from this list. However, it is strongly recommended that any ARU selected for a specific watercourse application in Tucson be constructed with concrete having a minimum 28-day compressive strength of 3000 psi, unless authorization to the contrary is granted, in writing, by either the City Engineer or a designated staff member.

#### Design Guidelines

Before the use of modular lining is considered, it should be successfully demonstrated, using analytical procedures described within Chapter VII of the "Standards Manual For Drainage Design And Floodplain Management In Tucson, Arizona" (City of Tucson, 1989), that the channel bottom is stable and not degrading or aggrading over time. If this can be successfully demonstrated, with or without grade-control structures; then, in the absence of a detailed engineering study demonstrating the stability of modular bank protection, modular lining with a single block weight of 65 pounds, or more, and a diameter and thickness of 16 inches and 4 inches, respectively, may be used in watercourses in order to minimize long-term channel maintenance--provided they can be designed with side-slopes milder than 2H:1V such that the average flow velocities within the main channel during the 10-year design flood do not exceed 8.0 feet per second (fps) in straight reaches and 5.0 fps for curved channel reaches with a mild curvature of up to 30 degrees (i.e., where the centerline radius of curvature of the channel is never less than three times the channel top width). ARU sizes significantly different from the aforementioned shall be reviewed and approved on a case-by-case basis by the City Engineer or a designated staff member.

Side slopes for ARUs should be no steeper than 2H:1V. In addition, either a filter blanket or a filter fabric should *always* be installed beneath the ARU matrix, in accordance with the manufacturer's specifications (Note: a filter *blanket* would be preferable if it were desired to allow vegetation to grow through the spacings in the ARU matrix, since a filter fabric will prevent the growth of vegetation).

Appropriate toe-downs and key-ins should be designed according to the design criteria described within Chapter VIII of the aforementioned Manual.

All upstream and downstream edges of the ARU matrix should be suitably attached to concrete or soil cement cut-off walls, in order to prevent uplifting of the matrix during extreme flows. Large gaps within the interior portions of the matrix should not be permitted for any purpose, including the placement of trees.

All small openings within the surface of the ARU matrix, such as the spaces between each ARU block, should be filled with mortar sand. This is needed in order (1) to help stabilize or lock the individual ARU blocks, (2) to permit grass and other small vegetation to become established, if a filter *blanket* is utilized, and (3) to protect the filter *fabric*, if utilized in lieu of a filter blanket, from exposure to the potentially damaging ultra-violet radiation which exists in sunlight.

In cases where channels are constructed with modular lining, building setbacks may be required unless it can be satisfactorily demonstrated that the protected banks of the channels are non-erosive during the 100-year design flood. The required building setback, if any, should be measured from the top edge of the highest channel bank or from the edge of the 100-year water surface elevation, whichever is closer to the channel centerline.

When using vegetal-lining techniques in conjunction with the design of a modular-lined channel, it should clearly be the intent to allow naturally occurring desert vegetation to become established within the channel bottom and along the channel banks, and afterward retained and/or maintained by a designated individual or agency. As such, the selection of a Manning's roughness coefficient must include consideration of future maintenance. In all cases, the Manning's roughness coefficient used for either the evaluation of channel-bed stability or channel conveyance capacity will be reviewed and approved by City staff on a case-by-case basis.

Manning's roughness coefficients for articulated revetment units generally range from 0.028 to 0.032 for new installations. These basic n-values must be adjusted to account for the effects of vegetation on the channel sides and bottom, anticipated channel maintenance, presence (or absence) of erosion-control measures on the channel bed, degree of channel curvature, changes in channel width, and other factors, as deemed appropriate.

### Maintenance Requirements

Properly designed and constructed channels with modular linings will require moderate, but regular, maintenance--particularly at those locations where flow is accelerated, such as at channel bends, confluences, or roadway crossings, or at such areas where there is an interface between adjoining forms of bank protection.

Wherever vegetation is used in conjunction with modular bank protection, it is recommended that tractor-driven mechanical equipment not be used to maintain the banks and bed of a channel with modular lining, except as needed in those locations where cultivated grass is used jointly as bank protection and as a recreation area. In addition to assuring the viability of each plant by providing adequate water during its

initial establishment, and later to provide for long-term growth, the frequency and type of landscape maintenance are also dependent upon the highly variable, multi-use aspects of the watercourse.

At a minimum, channels with modular linings should be inspected at least twice each calendar year. The first inspection should be made in May or June, prior to the summer rainy season. At that time, all undesirable debris or trash should be removed. The second inspection should be made in October or November, after the summer rainy season, at which time any necessary repairs to the channels can be made or scheduled.

### Construction Cost

The total cost of modular bank protection, on a per-square-yard basis, is approximately equivalent to the cost of concrete bank protection. However, because of the flatter side-slopes and shallower depths required for modular bank protection, the overall cost of a channel with modular bank protection will be about 1.2 to 1.6 times more than the cost of an equivalent concrete channel. This cost comparison includes the cost of the bank protection and the filter blanket or filter fabric. When the cost of land is included at \$5.00 per square foot, in 1989 dollars, the modular bank protection becomes one and one-half to two times more expensive than concrete. It should also be noted that the difference in cost between these two alternative forms of bank protection is expected to increase as the conveyance capacity of the channel increases.

### Advantages

- a) Moderate aesthetic quality, particularly if vegetation is encouraged to grow between the individual modules
- b) Moderate social acceptability
- c) Moderate multi-purpose use potential within the parallel maintenance alley/easement
- d) Moderate hazard and nuisance potential
- e) Low right-of-way requirements
- f) Moderate operation and maintenance costs
- g) Relatively long design life
- h) Benefit received immediately upon construction
- i) Allows for reduction in width of erosion/setback zone if designed properly
- j) Provides a moderate degree of site-plan flexibility over natural channels by allowing channel alignments and widths to be changed.
- k) Reduces local erosion
- l) Small localized failures are easily and quickly repaired without need to rework large areas of bank protection
- m) Compatible with other flood-control and erosion-control techniques
- n) The modular design is flexible, and therefore able to conform to minor changes in bank position over time

Disadvantages

- a) Does not preserve riparian vegetation; however, restoration may be possible
- b) Does not preserve wildlife habitat/corridors
- c) Does not maintain natural floodplains
- d) May reduce existing groundwater recharge and stormwater infiltration
- e) Moderate irrigation and landscaping requirements
- f) Moderate to high construction costs
- h) Special maintenance alley and/or easement required
- i) Applicability limited to channels with low to moderate discharge rates
- j) Moderate exposure to legal liability
- k) May increase the frequency and severity of downstream erosion/flooding over natural conditions due to the loss of floodwater storage in the overbank areas, as well as the increase in flow velocities typically associated with channelization.

## CHANNELS LINED WITH RIPRAP, OR ITS VARIATIONS

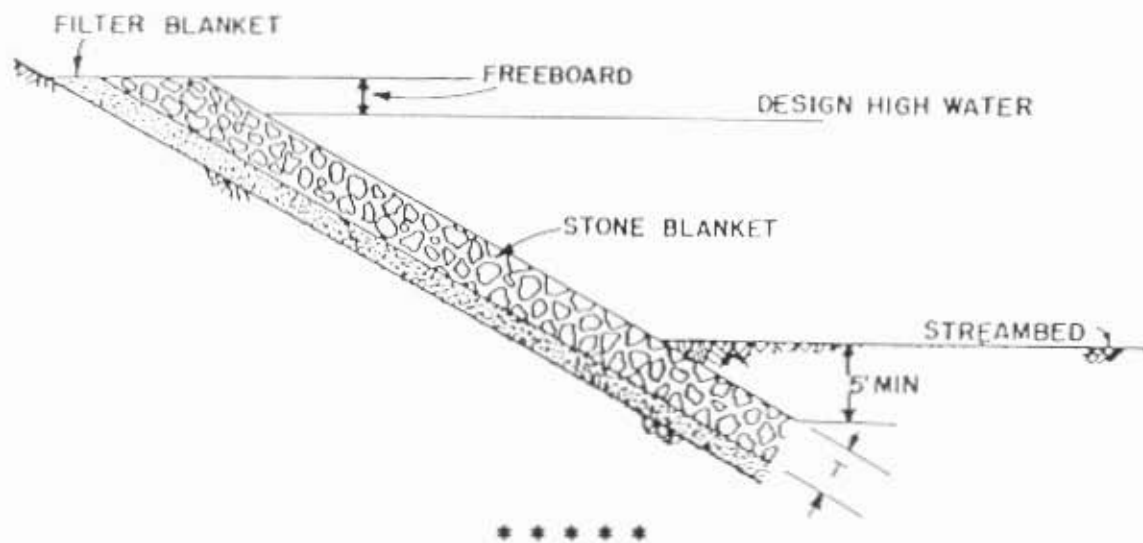

### Definition

Large, angular rock used to armor channels and abutments is commonly referred to as riprap.



### Description/Application

Large, angular rocks are often placed on the bed and banks of a channel in a thick layer or blanket to form riprap bank protection. The side-slopes of riprap-lined channels are usually milder than those for concrete channels, in order to reduce the size and cost of rock material used to construct the riprap. The size, shape, and range of rock sizes used is dependent upon the design characteristics of the wash or earthen channel to be protected. Rock sizes increase with an increase in flow velocity, steeper channel-side slopes, and increased channel curvature. Rock riprap has many advantages over other forms of permanent protection. Rock riprap is flexible--thereby eliminating possible foundation problems. In addition, it is simpler to repair localized damage to riprap, should it occur. The appearance of riprap is somewhat natural; and, if allowed to do so, vegetation (especially within the more humid environments) will grow between the rocks--further enhancing its appearance. Finally, when the usefulness of riprap is finished, the rock may be salvaged for other purposes.

### Possible Variations

Riprap can either be dumped from large trucks, or it can be hand-placed for greater uniformity over mild side slopes (3H:1V, or less) of the earthen channel. Grout, or concrete mortar, can be placed between the large stones to provide additional resistance to turbulent flow, or to allow smaller stones to be used without movement occurring during the event. Earth-tone coloring can be added to the grout, whenever a more natural appearance is desired.

Gabions, or rock-filled rectangular wire baskets, are often used to secure rocks that would otherwise be swept away by floodwaters. Gabions are much more rigid, and generally more expensive than rock riprap. Gabions can be placed on steeper slopes than riprap--thereby providing greater design flexibility. For example, gabions can even be stacked *vertically*, whenever channel width is limited.

Often, railroad rails, wire fabric, and heavy rocks are also combined--especially for the purpose of forming *vertical* bank protection.

Riprap, gabions, and rock-and-rail bank protection are all permeable to rain and floodwaters, thus encouraging vegetation (especially within the more humid environments) to grow and become part of the bank protection, both structurally and visually.

### Design Guidelines

Rock riprap and its variations, including gabions, which are used for lining drainage channels shall be designed using the riprap design procedure described within Chapter IX of the "Standards Manual For Drainage Design And Floodplain Management

In Tucson, Arizona (City of Tucson, 1989). This design procedure provides the median diameter,  $D_{50}$ , of the riprap to be used along a specific reach of a channel, based upon (1) a known (or predicted) average flow velocity *with the riprap in place*; (2) a channel side-slope of 3H:1V, or flatter; and (3) the degree of channel curvature.

### Maintenance Requirements

Properly designed and constructed channels lined with riprap, or its variations, will require moderate, but regular, maintenance--particularly at those locations where flow is accelerated, such as at channel bends, confluences, or roadway crossings, or at such areas where there is an interface between adjoining forms of bank protection. At a minimum, channels with riprap lining should be inspected at least twice each year. The first inspection should be made in May or June, prior to the summer rainy season. At that time, all undesirable debris or trash should be removed. The second inspection should be made in October or November, after the summer rainy season, at which time any necessary repairs to the channel can be made or scheduled. Any landscape-maintenance requirements should be evaluated on a case-by-case basis.

### Construction Cost

A direct, per-unit-cost comparison of riprap bank protection versus concrete bank protection is difficult to make because the thickness of a riprap blanket varies with design velocity; whereas the thickness of concrete bank protection usually does not vary as a function of the flow velocity, except under certain extreme conditions. Also, the side-slopes necessary for riprap are flatter than those necessary for concrete-lined channels--thereby increasing the amount of bank protection and land required for riprap channels in comparison to concrete-lined channels. As a general rule, riprap channels can be expected to cost at least 1.2 to 1.8 times the cost of concrete channels, on a per-linear-foot basis, depending upon whether or not the cost of land is considered. It should also be noted that as discharges and flow velocities increase, the differential in cost between riprap and concrete channels will be ever more pronounced.

### Advantages

- a) Moderate aesthetic quality, particularly if vegetation can be established within and/or adjacent to the rock blanket
- b) Moderate social acceptability
- c) No irrigation and landscaping requirements
- d) Minimal right-of-way requirements
- e) Moderate operation and maintenance costs
- f) Benefits are received upon construction
- g) Relatively long design life
- h) Reduces the width of the erosion/building setback zone if properly designed

- i) Provides a moderate degree of site-plan flexibility over natural channels by allowing channel alignments and widths to be changed.
- j) Reduces or eliminates the risk of local erosion damage to existing structures near the channel bank
- k) The riprap is flexible, and therefore able to conform to minor changes in bank position over time

#### Disadvantages

- a) Moderate multi-purpose use potential
- b) Moderate hazard and nuisance potential because of the hazards associated with the angular rock, and sometimes with the wire fabric used to construct the riprap bank protection
- c) Does not preserve riparian vegetation
- d) Does not preserve wildlife habitat/corridors
- e) Does not maintain natural floodplains
- f) May reduce existing stormwater infiltration and groundwater recharge
- g) Moderately high construction costs. Construction costs increase rapidly with increased discharge because the riprap size and blanket thickness must also increase to withstand higher velocities.
- h) Moderate exposure to legal liability
- i) Special maintenance alley and/or easement required
- j) May increase the frequency and severity of downstream erosion/flooding over natural conditions due to the loss of floodwater storage in the overbank areas, as well as the increase in flow velocities typically associated with channelization
- l) Loose riprap in urban areas is susceptible to removal by the public for landscaping of private property
- m) Effectiveness is highly dependent upon the availability of correctly sized and graded rock, and upon correct placement in the field
- n) Not well suited for protection where water will flow over the riprap from outside the channel
- o) Moderate range of applicability
- p) Moderately compatible with other techniques

## CHANNELS LINED WITH SOIL CEMENT

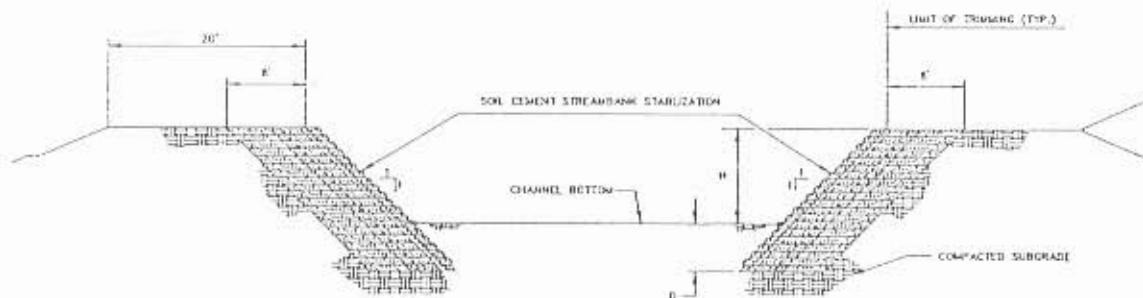
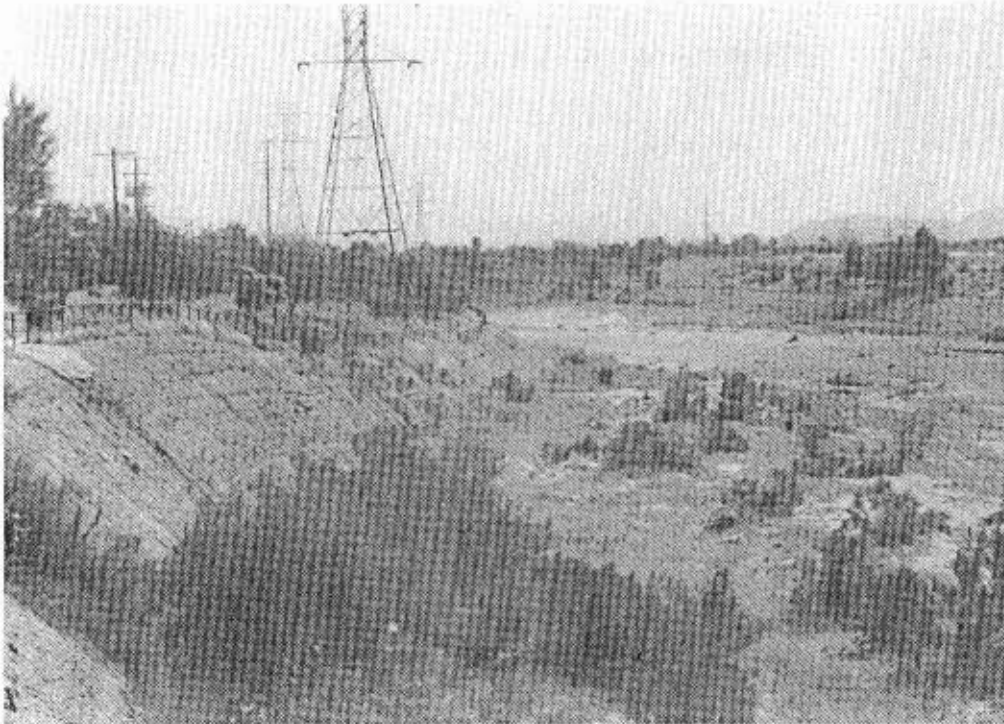

\* \* \* \* \*

### Definition

Channels whose sides and/or bottoms are lined with soil cement are referred to in this presentation as soil-cement channels.

### Description/Application

Soil cement is comprised of a mixture of sands, gravels, and portland cement in proportions generally less than those required to make conventional concrete. Advantages of using soil cement as a channel-stabilization technique within the City of Tucson include its relative low cost, ease of construction, and the convenient utilization of sands and gravels found at the actual construction site. Consequently, soil-cement applications are moderately economical, highly practical, and somewhat aesthetically attractive. Soil cement has been used within the City of Tucson to successfully construct channel bank stabilization, grade-control structures, and bridge-abutment protection.

In and around the Tucson area, rock riprap, wire-tied rock-and-rail, and gabions are all typically more expensive than soil cement for most applications because of (1) the greater hauling distances required to bring adequately sized rock to the job site; (2) the labor-intensive nature of the construction of the former protection measures; (3) the quality-control required to produce a stable bank-protection system utilizing the former protection measures; and (4) the difficulty of obtaining rock of sufficient size for use as riprap along large, high-velocity watercourses.

Both the color and strength of soil cement varies with the amount of portland cement added to the in-situ sands and gravels. It will become stronger, and more "concrete gray", as the proportion of cement to sands and gravels increases. During construction, soil cement is moldable, and can be formed into almost any desired shape. However, once dry and hard, it is rigid, inflexible, and impermeable--providing excellent bank-protection material, but also providing an inhospitable environment for vegetation.

### Possible Variations

As a common, technically acceptable, cost-saving measure, channels which are stable and are not degrading, but which require bank protection, may be designed with a thick layer of soil cement covering only the channel banks, while leaving the channel bottom unlined.

Within environmentally sensitive areas which will be experiencing long-term channel degradation, soil-cement-lined channels may be placed under a relatively thick mantle of soil. This technique allows the smaller native plant species to become re-established, while simultaneously providing an effective lower boundary for future channel downcutting.

**NOTE:** Soils with a high clay content, which are normally *not* encountered in and around the Tucson area, may be chemically stabilized by adding lime, or a combination of lime and fly ash. Presently, very little information exists concerning the application of lime in the design and construction of bank protection along watercourses. However, lime-based bank protection may have many of the same advantages and

disadvantages as standard soil cement, plus lime has the added benefit of being able to be applied to clayey soils that might not otherwise be suitable for use in soil cement.

### Design Guidelines

Standard, 9-foot-thick, soil-cement bank protection shall be designed based upon the procedures described within Chapter IX of the "Standards Manual For Drainage Design And Floodplain Management In Tucson, Arizona" (City of Tucson, 1989).

Maximum allowable flow velocities for channels lined with soil cement have not been established. However, it is believed that properly constructed, 9-foot-thick, soil-cement bank protection will function adequately as an erosion-control measure for most design velocities encountered within the City of Tucson.

In order to avoid creating soil cement which has the characteristic "gray" color of traditional concrete, instead of the "sandy-brown" color typically found along our natural watercourses, it is recommended that the soil-cement design have a seven-day compressive strength of 500 psi; as opposed to the current design used by the Pima County Department of Transportation and Flood Control District, which dictates use of the soil cement with a seven-day compressive strength of 750 psi, with an additional two percent, by weight, of concrete added for durability. Similarly, it is also recommended that fly ash not be used as an additive, because it has a marked tendency to give soil cement even more of a "gray" color.

The soil used to make soil cement should be well graded (i.e., poorly sorted), and have a range in aggregate size ranging from fine sands and gravels to small cobbles in order to provide both added strength and a more "natural" appearance. However, the maximum size stone allowed in the concrete/sand mixture should not exceed one-half the thickness of the individual lift, or layer, of soil cement applied.

Additional information concerning the use of soil cement as a watercourse treatment can be found within a 1985 report prepared by the Pima County Department of Transportation and Flood Control District entitled "Soil Cement Applications And Use In Pima County For Flood Control Projects."

Along minor watercourses, a relatively thin layer, or veneer, of soil cement placed on mild side-slopes has been successfully used as bank protection. This process is often referred to as *soil-cement paving*. If the soil cement is made at a local batch plant, then the soil cement can be placed in a single lift, eight inches thick, on the banks of the channel. However, if the soil cement is mixed-in-place, then two lifts of soil cement, each having a six-inch-minimum thickness, should be applied on the banks of the channel. The use of a relatively thin layer of soil cement as a channel lining is preferably limited to channels having side-slopes equal to or milder than 4H:1V. However, in no case should soil-cement paving be used to line channels designed with side-slopes steeper than 3H:1V.

### Maintenance Requirements

Properly designed and constructed soil-cement-lined channels will require minimal, but regular, maintenance. Regular maintenance is usually limited to inspections and repairs, if necessary, at confluences or roadway crossings, or at such areas where there is an interface between adjoining forms of bank protection. At a minimum, channels with soil-cement lining or paving should be inspected at least twice each year. The first inspection should be made in May or June, prior to the summer rainy season. At that time, all undesirable debris or trash should be removed. The second inspection should be made in October or November, after the summer rainy season, at which time any necessary repairs to the channels can be made or scheduled.

### Construction Cost

Except for the cost of right-of-way and earthwork, the total construction cost of a channel lined with soil cement which has attained a seven-day compressive strength of 500 psi is estimated to be approximately \$15.00 per cubic yard (in 1989 dollars). Consequently, 9-foot-thick soil cement placed at a 1H:1V side-slope will cost about \$45.00 per square yard of bank-protection surface, installed. This cost includes placement and compaction of the layered soil cement. The cost of long-term maintenance is considered negligible, unless landscaping is placed outside the soil-cement bank protection within an adjoining linear park.

Although 9-foot-thick soil cement is approximately 1.5 times the cost of traditional concrete lining (not including the extra cost in land), a direct comparison is not necessarily useful in all cases. Massive, high-strength soil cement has traditionally been used to protect regional watercourses in Pima County, and concrete would not usually be used on watercourses of this magnitude. Still, if 9-foot-thick soil cement with a seven-day compressive strength of 500 psi is contemplated for use on minor watercourses, the cost can be expected to be approximately 1.5 times the cost of a concrete channel, not including the cost for additional land that may be required at \$5 per square foot.

At first glance, it would appear that channels protected with soil-cement paving would be less expensive than channels protected with 9-foot-thick soil cement. These thin layers of soil cement are generally applicable to smaller-sized or intermediate-sized watercourses, which traditionally have been protected with concrete. For such applications, the construction cost of soil-cement paving can be expected to be approximately 0.60 times the cost of concrete channels. However, when including the cost of land, at \$5 per square foot, soil-cement channels which are paved should cost approximately 1.3 times the cost of concrete channels, due to the mild side-slopes required for construction of these types of channels, which is only slightly less than the cost ratio for the 9-foot-thick, soil-cement bank protection described above.

Advantages

- a) Moderate multi-purpose use potential because of the possible utilization of the maintenance and access alley for passive and active recreation
- b) Provides moderate linear-park opportunities within the parallel maintenance easement
- c) Low right-of-way requirements, depending upon the soil-cement thickness and side-slopes
- d) Low irrigation and landscaping requirements
- e) Low operation and maintenance costs
- f) Benefits are received immediately upon construction
- g) Provides high degree of site-plan flexibility
- h) Applicable over a wide range of discharges and design situations
- i) Reduces or eliminates the width of the erosion/building setback zone
- j) Feasible at most locations
- k) Reduces or eliminates the risk of local erosion damage to existing structures near the channel bank
- l) Compatible with other channelization/erosion-control techniques

Disadvantages

- a) Moderate aesthetic quality
- b) Moderate social acceptability
- c) Moderate hazard and nuisance potential
- d) Does not preserve riparian vegetation
- e) Does not preserve wildlife habitat/corridors
- f) Does not preserve natural floodplains
- g) Other than soil-cement, bank-stabilization applications along the regional watercourses, such as the Santa Cruz River and Rillito Creek, most soil-cement applications along smaller channels involve total lining of the bed and banks; and therefore may reduce stormwater infiltration and groundwater recharge
- h) Moderately high construction costs
- i) Moderate exposure to legal liability because of alteration of the natural watercourse
- j) Special maintenance alley and/or easement required
- k) May increase the frequency and severity of downstream erosion/flooding over natural conditions due to the loss of floodwater storage in the overbank areas, as well as the increase in flow velocities typically associated with channelization



## CHANNELS LINED WITH CONCRETE

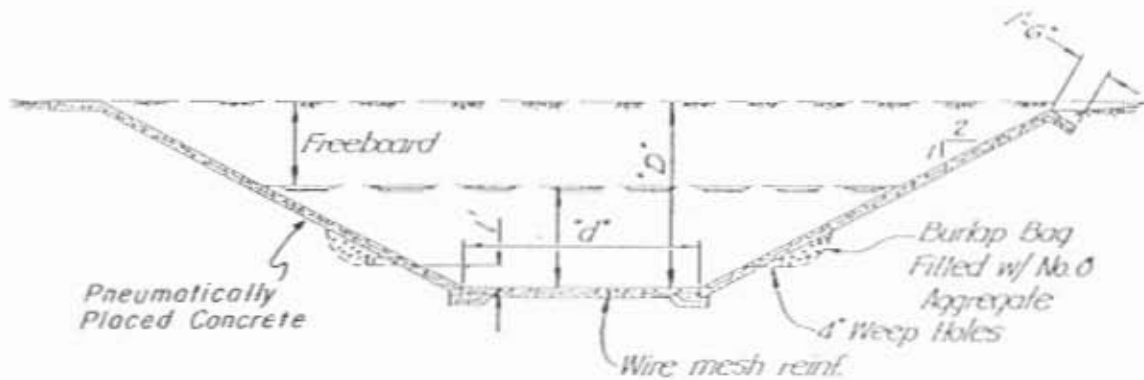

\*\*\*\*\*

### Definition

Channels having bed and/or banks stabilized with a thin, reinforced veneer of either pneumatically placed or formed Portland Cement Concrete are referred to as concrete channels.

### Description/Application

Despite its objectional appearance from the perspective of both homeowners and real-estate developers alike, pneumatically-placed concrete (also called "shotcrete") and formed concrete have historically been among the most widely used forms of bank protection utilized along small-sized and moderately-sized washes within our community. The high cost of channelizing and forming the concrete lining is partially compensated for by the greater flexibility in site design, and the reduced erosion/building-setback distance that exists when utilizing concrete-lined channels. Of all the materials and techniques used to permanently stabilize and protect channels from erosion, most of which have been briefly described in this presentation, concrete is one of the strongest and most versatile materials available.

Concrete bank protection is best suited for use along watercourses that are subject to erosion caused by high flow velocities. Channels lined with concrete are particularly adaptable at locations where a natural appearance is not required, and where minimal maintenance and maximum hydraulic efficiency afforded by a smooth surface are important design considerations.

The primary purposes for selecting concrete to line the bed and/or banks of drainage channels are (a) to permanently protect the bed and/or banks of channels from the erosive forces of flowing water; (b) to minimize long-term maintenance; (c) to improve the hydraulic efficiency of the channel; and (d) to substantially reduce the width of the erosion/building-setback zone.

### Possible Variations

Small, concrete-lined channels, which are otherwise stable and are not degrading, may be designed with the channel bottom exposed. However, if degradation occurs, grade-control structures or a channel floor will ultimately become necessary.

Pigmentation, or colorization, of the concrete may be used when a more "natural" appearance is desired. Landscaping near the concrete channel may be used provided that large trees placed adjacent to the channel be selected with care so that only those species with root systems which extend directly downward into the ground are used. Large trees with spreading root systems should be avoided unless training sleeves are installed to direct the roots downward below the bank protection.

Asphaltic concrete, more commonly referred to as simply "asphalt," has been tried with little success as a form of bank stabilization. This is because asphalt will readily deteriorate in the semi-arid Tucson environment. Therefore, unless used principally as a roadway surface, asphalt is not widely accepted as a material to be used for the bank protection of channels.

When cost is not a primary consideration, artificial rock made from concrete, using specially designed forms and molds, has been used in some locales to protect the banks of visually important reaches of small washes. Although uncommon, particularly

as a form of bank protection, an example application of artificial rock can be readily seen within the large animal enclosures which were recently constructed at the City's Reid Park Zoo. From a technical standpoint, the extension of such an application to washes should be a relatively straightforward, albeit *expensive* one.

Concrete-masonry blocks can also be used to construct bank protection. Because they are less resistant to repeated abrasion by silt-laden floodwater than cast-in-place concrete, application of concrete blocks should be used to either line those channels receiving relatively sediment-free runoff, such as runoff produced from fully-paved parking areas; or be used to provide freeboard at the tops of lined channels for the purposes of resisting wave action and/or to preclude overtopping caused by an uneven flow distribution in the channel.

### Design Guidelines

Presently, the City of Tucson does not have Standard Specifications or Standard Details for concrete-lined channels. However, in the absence of a standard, many of the trapezoidal, concrete-lined channels currently being constructed within the City have side-slopes of 1H:1V; and are protected with a minimum 6-inch-thick, 3000-psi concrete, and are reinforced with 6" X 6"/W2.1 X W2.1 welded-wire fabric. Typically, structural calculations are required whenever the proposed side-slopes of a concrete-lined channel exceed 1H:1V.

Maximum allowable flow velocities for channels lined with concrete have not been established. However, it is believed that properly constructed concrete bank protection will function adequately as an erosion-control measure for most design velocities encountered within the City of Tucson.

### Maintenance Requirements

If designed and constructed properly, concrete-lined channels will require little or no regular maintenance. Channels that have been protected only along their sides, and not along their bottoms, should be periodically inspected to insure that there is no appreciable downcutting of the channel that would expose the toe-down portion of the channel lining. Also, particular attention should be given to performing regular inspections for channel scour that may develop at transitions from concrete to some other, less durable, type of bank-protection material.

### Construction Cost

On a per-cubic-yard basis, the in-place construction cost for concrete (excluding site preparation and grading) is normally very high, and ranges from about \$150 per cubic yard for unreinforced concrete to about \$275 per cubic yard for reinforced concrete (in 1989 dollars). The in-place cost of pneumatically placed concrete is about

\$30 per square yard for six-inch-thick bank protection with wire-mesh reinforcing. For price comparison purposes, the concrete channels referred to elsewhere in this document are assumed to be pneumatically placed concrete channels.

When compared to other methods of bank protection, rectangular, reinforced concrete channels will typically show the least *annual* costs when flow velocities are high, right-of-way is expensive, and wall heights are less than about 15 feet. Trapezoidal, reinforced concrete channels will typically show the least *annual* costs when flow velocities are high, right-of-way costs are more moderate, and the wall heights are greater than 15 feet.

#### Advantages

- a) Low right-of-way requirements, because the concrete-lined channel can be designed with a relatively narrow, deep cross section
- b) No irrigation and landscaping requirements, other than those needed for channel aesthetics
- c) Low operation and maintenance costs
- d) Benefits are received immediately upon construction
- e) Reduces the width of the erosion/building setback zone
- f) Provides a high degree of site-plan flexibility over natural channels by allowing channel alignments and widths to be changed.
- g) Feasible at most locations
- h) Reduces or eliminates the risk of local erosion damage to existing structures near the channel bank
- i) Highly capable of withstanding high flow velocities
- j) Highly compatible with other flood-control and erosion-control techniques

#### Disadvantages

- a) Low aesthetic quality
- b) Low social acceptability
- c) Presently provides low linear-park opportunities
- d) Moderate hazard and nuisance potential
- e) Does not preserve riparian vegetation
- f) Does not preserve wildlife habitat/corridors
- g) Does not preserve natural floodplains
- h) May reduce existing stormwater infiltration and groundwater recharge
- i) High construction costs
- j) Moderate exposure to legal liability because of alteration of the natural wash
- k) Special maintenance alley and/or easement required
- l) May increase the frequency and severity of downstream erosion/flooding over natural conditions due to the loss of floodwater storage in the overbank areas, as well as the increase in flow velocities typically associated with channelization

## UNDERGROUND STORM-DRAIN SYSTEMS

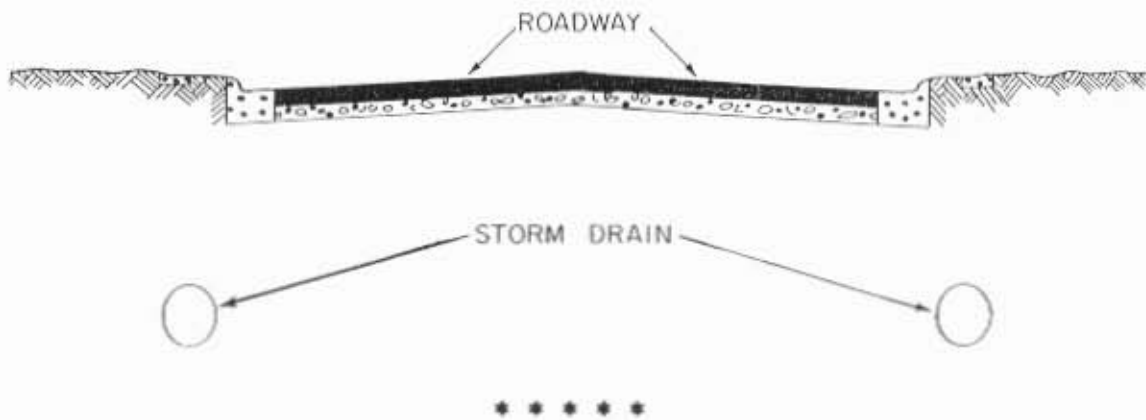

### Definition

Storm drains are underground, enclosed conduits used for conveying floodwaters.

### Description/Application

In areas or locations where it is desired to utilize the space occupied by either a natural wash or an earthen channel to develop more intensive and/or less restricted land uses, an underground storm-drain system may be a viable alternative. Typically, storm-drain systems, such as networks of pipe culverts and/or box culverts, are used under major roadways and under commercial/industrial land uses. These systems can also be effectively used in conjunction with a high-flow channel, similar in some respects to the upper portion of the compound channel described in a previous section of this presentation; wherein small, frequent flows would be conveyed underground, while the above-ground channel would be retained for outdoor recreational activities, such as those commonly found at parks.

### Possible Variations

Storm-drain systems are most commonly placed under public arterial roadways in Tucson and other communities. Less common, but equally acceptable, is the placement of culverts beneath parking areas and public open spaces. Culverts can either be circular or oval pipes, or reinforced box culverts or tunnels. They can be constructed from galvanized steel, aluminum, or concrete.

### Design Guidelines

Storm-drain systems shall be designed using the design procedures described within Chapter X of the "Standards Manual For Drainage Design And Floodplain Management In Tucson, Arizona" (City of Tucson, 1989).

### Maintenance Requirements

If designed and constructed properly, storm drains will require little or no regular maintenance.

### Construction Cost

For relatively small projects, the cost of storm drains constructed with reinforced concrete pipe can be expected to be about \$1.75 per inch of diameter for each foot of pipe length (in 1989 dollars). Therefore, for pipe diameters less than about 72 inches, the cost of storm drains constructed with reinforced concrete pipe will be at least 1.5 times the cost of pneumatically placed concrete channels, if the cost of land is not included. However, the advantage of storm drains is that the land above them is left available for development. Therefore, if the cost of the overlying land is considered in

the economic analysis, and the land costs are assumed to be \$5 per square foot, the cost of storm drains which convey relatively small flows is generally about 0.75 that of pneumatically placed concrete channels which convey these same flow quantities. In those areas where land values are considerably higher than \$5.00 per square foot, the cost for storm drains may be even more economical in relation to pneumatically placed concrete channels.

#### Advantages

- a) No irrigation and landscaping requirements
- b) Low hazard and nuisance potential
- c) Low operation and maintenance costs
- d) Low right-of-way requirements, because the storm-drain system is located underground
- e) No special maintenance alley required
- f) Benefits are received immediately upon construction
- g) Eliminates the erosion/building setback zone
- h) Storm drains allow a high degree of site-plan flexibility
- i) Moderately feasible at most locations
- j) Eliminates local erosion damage to existing structures near the channel bank
- k) Capable of withstanding high flow velocities

#### Disadvantages

- a) Low aesthetic quality
- b) Moderate social acceptability as replacement for natural washes
- c) Low linear-park opportunities
- d) Does not preserve riparian vegetation
- e) Does not preserve wildlife habitat/corridors
- f) Does not preserve natural floodplains
- g) Eliminates stormwater infiltration and groundwater recharge
- h) Very high construction costs
- i) Moderate exposure to legal liability
- j) May increase the frequency and severity of downstream erosion/flooding over natural conditions due to the loss of floodwater storage in the overbank areas, as well as the increase in flow velocities created by their construction
- j) Moderately compatible with other techniques

## EVALUATION MATRIX OF ALTERNATIVE FLOOD-CONTROL AND EROSION-CONTROL TECHNIQUES FOR WATERCOURSES IN TUCSON, ARIZONA

### Description

The preceding sections of this Appendix have focused upon twelve major types of flood-control and erosion-control techniques, as well as their possible variations. While the evaluation of each technique includes a definition, a description/application, its possible variations, design guidelines, maintenance requirements, construction costs, and its advantages/disadvantages, a comparative evaluation must also be made in order to provide the reader with some "feel" for the relative merits of selecting one technique over another for a specified use or purpose.

To accomplish this objective in a relatively straightforward manner, the Evaluation Matrix displayed on page 73 of this Appendix has been prepared in order to graphically depict, via a single overview, comparisons of each technique.

When reading the Matrix, an "open" circle represents a positive evaluation of the applicable technique, relative to the specific evaluation criterion identified. Conversely, a "closed" circle represents a negative evaluation of the applicable technique, relative to the specific evaluation criterion identified. Finally, a "partially open" circle indicated within the Matrix represents an intermediate evaluation between the two extremes.

### Explanation Of Factors

The selection of a flood-control and erosion-control technique for use in a particular natural wash and/or constructed channel within the Tucson area should be based upon a rational assessment of the overall needs of the community as they relate to social, environmental, economic, and technical factors. These factors, which are also included within the Evaluation Matrix, are briefly discussed below:

#### *A. Social Factors:*

1. Aesthetic Quality. The network of interconnected washes and riverbeds is one of the many prominent natural features of metropolitan Tucson, and as such, the aesthetic treatment of these natural features should be carefully considered during the initial planning phase of all channelization projects.

While recognizing the aesthetic qualities that are unique to urbanized desert washes, the Pima County Urban Design Commission (1986) reported that natural watercourses also contribute to the unifying element of the unique Sonoran desert environment found in the greater Tucson metropolitan area. More recently, the City of Tucson Mayor and Council recognized that



concrete channels have typically been among the least attractive forms of watercourse stabilization techniques presently being used within our community. Therefore, they approved an "Interim Watercourse Improvement Policy" on June 27, 1988, which states that it is preferential that all new private and public watercourse improvements within the City of Tucson will (1) be unlined and/or constructed with bank protection having a somewhat natural appearance; and (2) include visual and environmental mitigation measures, such as landscaping with native plant species and the addition of color and texture to the bank-protection materials.

During the preparation of this Appendix, each of the twelve flood-control and erosion-control techniques were subjectively evaluated in terms of their potential aesthetic quality, relative to preservation of a natural wash, and the results were included in the accompanying Evaluation Matrix. Those techniques that either preserve the natural riparian vegetation or utilize native and non-native plant species as part of a biotechnical erosion-control technique were given relatively higher scores for aesthetic quality than those techniques which do not permit the re-establishment of native vegetation within the bed and banks of a watercourse.

During this evaluation, it was assumed, with the exception of underground storm-drain systems, that each of the techniques presented could incorporate landscape elements within their adjoining access/maintenance easement. Therefore, although a landscape-based mitigation plan is important for those areas outside the channel, only the potential landscaping located within the channel (i.e., the bed, banks, and immediately adjacent vegetation) was considered as a principal determinant in the evaluation of aesthetics.

From the Evaluation Matrix presented herein, it is readily apparent that techniques that either preserve or allow for the restoration of some or all of the native riparian vegetation have greater aesthetics than those techniques that do not permit the re-establishment of any channel-bed and/or channel-bank vegetation.

Although storm-drain systems are underground, and therefore out of sight of the residents of Tucson, they are not immediately considered as a prominent and unattractive geographical feature. Nevertheless, storm-drain systems were given a poor aesthetic rating because they generally do not contribute to the visual quality of our community.

2. Social Acceptability. The treatment of washes within our community has been, and will continue to be, a highly emotional issue for those individuals residing in the area near a wash that has been selected for "improvement". Thus, this index is a subjective measure of how well the proposed types of watercourse treatments will be accepted by the affected residents.

As seen on the Evaluation Matrix, those watercourse treatment alternatives which have a more natural appearance, and can be landscaped to provide visual-impact mitigation, have higher social acceptability than those alternatives that can be less attractive.

3. Potential For Multi-Purpose Use/Linear Park Opportunities. This index is a measure of how well the proposed alternative will facilitate public and private non-vehicular access to lands contiguous with floodprone areas. During the preparation of the Evaluation Matrix, emphasis was given to the potential establishment of linear parks that can be designed to encourage the use of the area by pedestrians, equestrians, and bicyclists. Even though roadway crossings of watercourses represent one of many possible multi-purpose uses, they were not considered in this category during the preparation of the Matrix because each type of watercourse treatment would be equally affected by all types of road crossings.

With the exception of those watercourse treatment alternatives which partially retain the existing configuration of natural washes (e.g., grade-control structures and river-training structures), each of the techniques presented within this Appendix will normally require an access and maintenance alley, or easement, on one or both sides of the watercourse. Similarly, those techniques that partially preserve natural washes normally require wider building setbacks than those techniques based on structural stabilization. It is within each of these adjoining access/maintenance areas and building-setback zones that multi-purpose uses and linear parks can be used for the benefit of the non-motoring public.

Within the Evaluation Matrix, compound channels were given higher scores for potential multi-purpose use and linear-park opportunities than most of the other techniques because the "upper-flow" portions of the channel are ideally suited for the placement of linear parks. On the other hand, storm-drain systems were given poorer scores because, although the above-ground areas are nearly always put to multi-purpose uses, these systems do not always contribute to the visual qualities generally attributed to existing linear parks within our community; nor do storm-drain systems encourage the development of a clearly-defined pattern of interconnected pedestrian trails.

4. Minimize Hazard And Nuisance Potential. This index is an indicator of how well the overall design of the alternative watercourse treatment addresses the safety and convenience afforded the public.

Consideration must always be given to the potential for physical threat to the safety of children and others during periods of both flooding and non-flooding. During times of flooding, the magnitude of flow velocities within the main channel can directly affect the hazard and nuisance aspects of each channel treatment alternative. Those alternatives having higher flow velocities, such as concrete and soil cement, were given poorer hazard and nuisance ratings within the Matrix than were natural washes and earthen channels having slower flow velocities. During periods when the channels are dry, those alternatives which have relatively steep sides-slopes and/or mild channel slopes covered by rough, wire-enclosed rocks represent a somewhat greater risk, and consequently have a poorer hazard and nuisance rating within the Matrix than do earthen channels and natural washes having mild side-slopes covered by vegetation.

*B. Environmental Factors:*

1. Preservation/Restoration of Riparian Vegetation. The natural riparian vegetation found along most of the undisturbed watercourses in the Tucson area includes some of the most diverse and attractive plant communities in the Sonoran Desert. Shaw and others (1986) stated that it is important as a developing community that naturally occurring riparian vegetation be preserved, not only for environmental reasons, but also for social reasons, such as the establishment of linear open space as sources of visual enjoyment and community identity.

Although not specifically directed towards the selection of watercourse treatments, the City of Tucson Floodplain Regulations state that it is City policy that development will not be allowed within either the regulatory floodway or the regulatory floodway fringe whenever such development would unnecessarily alter riparian habitats found within, and beside, natural washes (Section 23-464 of the Tucson Zoning Code).

For the purposes of this report, riparian vegetation can be broadly classified as either naturally occurring within an undisturbed wash or as vegetation that has been reintroduced into a watercourse after it has undergone channelization. Generally, riparian vegetation that occurs in natural washes is more diverse in its range of species, and it is less apt to require landscaping and irrigation than a watercourse that has been channelized and then revegetated.

In this evaluation, naturally occurring vegetation is considered to be more environmentally desirable than imported species of plants, even though both may be very pleasing aesthetically. Therefore, channels which retain the natural vegetation have been given high ratings, whereas channels with landscaped vegetation, such as compound channels, have been given medium ratings. Channels which inhibit the growth of riparian vegetation have been given low ratings.

2. Preservation Of Wildlife Habitat/Corridors. A relatively small number of interconnected natural washes, found mostly along the periphery of our community, have been identified by Shaw and others (1986) as having the ability to provide sensitive and critical wildlife habitat which should be preserved and/or otherwise protected from continued land development.

From a wildlife-management perspective, it is primarily the relatively undisturbed riparian and upland areas of a watershed that provide places for wildlife movement and habitat. In its pre-development condition, these desert ecosystems will be used to varying degrees by most species of wildlife that live within the area. However, as urban development encroaches into these original habitats, certain species of wildlife, particularly large mammals and certain species of reptiles, can be expected to abandon the area--except for possible rare transitory use of the watercourses as corridors for their movement from one area to another. Although their species diversity will diminish, birds will be the most numerous and visible kind of wildlife that

can be expected to inhabit the reintroduced, riparian vegetation within an urban area.

For the purpose of evaluating each watercourse treatment, those channel treatments which preserve existing natural wildlife habitat are rated high in this category. Compound and artificially-vegetated channels are given a medium rank because these types of watercourse treatments are frequently landscaped with imported plant species which do not provide the highly specialized habitat required in order to attract and maintain a diverse bird and small mammal population. Low rankings were given to those watercourse treatments that do not provide suitable habitat for native desert wildlife.

3. Maintenance Of Natural Floodplains. From an environmental perspective, the maintenance of natural floodplains is considered to be more desirable than removing or modifying them. This is because periodic inundation of the floodplain aids in the preservation of a diverse and visually attractive riparian zone used by desert wildlife.

From a flood-control perspective, the maintenance of natural floodplains helps preserve the overbank storage areas which are occupied during times of flood flows--thus helping to control the magnitude of downstream flood peaks.

Those channel treatments which maintain the natural floodplain are rated higher in this category than those that do not.

4. Impact Upon Infiltration And Recharge Characteristics. Those channel treatments which maintain or increase infiltration of storm runoff are favored in this category over those which reduce infiltration. The main channel of natural washes are typically widened during channelization in order to increase floodwater conveyance; thereby also increasing the surface area available for infiltration.

Most channel treatments are classified as beneficial in this regard. Storm drains are classified as unfavorable because they do not allow for any infiltration. Channels lined with concrete or soil cement have only been given moderate ratings within the Matrix, because the channel bed may sometimes be totally lined--thus precluding infiltration.

#### C. *Economic Factors:*

1. Right-Of-Way/Setback Requirements. The cost of land and the availability of right-of-way or easements should be considered in the selection of any channel treatment. Some of the "soft", or more naturally appearing, types of watercourse treatments may require wider right-of-way or easements than some of the "hard", or less naturally appearing, types of watercourse treatments. In addition, the width of the minimum erosion setback may vary, depending upon the type of watercourse treatment selected.

Right-of-way is the land area that must be set aside specifically for the drainage channel, and for ancillary purposes such as maintenance easements and linear parks. No other uses are normally allowed in this area. Right-of-way is normally dedicated to, and/or purchased by, the City for ownership and maintenance. In some instances, a drainage easement may be substituted for right-of-way, in which case the ownership of the land is retained by a non-public entity, while the responsibility for long-term maintenance of the drainageway is transferred to the City of Tucson.

The total width of either the channel right-of-way or easement is dependent upon (1) the width of the channel bottom needed to convey the design flood; (2) the additional width of the watercourse that is occupied by the mildly-sloped or steeply-sloped channel banks; (3) the width of the maintenance and access easement, usually found on one or both sides of the channel; and (4) the width of the linear park that may also be found beside the channel.

The "setback" is that area which must be left free of buildings in order to minimize possible erosion damage. The width of a minimum erosion/building setback is directly proportional to the design discharge for the channel. The building setback area is normally privately owned. As such, a building-setback zone may be utilized for uses other than floodwater conveyance, such as privately owned yards, parking, or open space.

Together, right-of-way and building setbacks comprise the overall land-area requirement for the channel treatment.

For ranking purposes, it was assumed that those treatments which use the least amount of land were economically better than those that use relatively larger amounts of land.

For example, the preservation of natural washes usually requires large amounts of land because of shallow flow depths, uneven alignments, and the large building setbacks that are required. On the other hand, concrete-lined channels are typically deeper, straighter, and have smaller building setbacks than natural channels. However, these apparent advantages are partially diminished by the fact that maintenance and access alleys are generally required for all new concrete channels. Still, with regard to right-of-way and building-setback requirements, concrete channels are considered to be *economically* superior to natural channels.

Similarly, earthen channels and channels with vegetative linings normally use less land than natural linings, because of their straighter alignments. Because of their mild side-slopes and wide bottom widths, combined with the large building setback that may be necessary, earthen channels and channels with vegetative linings will require more right-of-way than will equivalently sized concrete channels.

2. Construction costs. This index is a measure of the total cost of constructing an equivalently sized channel, using the channel treatment techniques presented herein. Total construction costs include earth work,

materials and labor, and building-setback distance. Under this category, those channels having relatively lower construction costs are ranked better within the Evaluation Matrix than are those channels with relatively higher construction costs.

The initial construction costs of various channel treatment types is, and will always be, one of the most important factors in the selection process. However, when viewed from a long-term perspective, both the cost of maintenance and the cost of replacement of the drainageway, or of the adjoining inadequately protected structures, may actually be more important to the total, overall cost of providing adequate levels of protection over time; and therefore must always be considered in the planning, design, and construction of channel treatment measures.

Representative estimates for construction costs were obtained from the City of Tucson's Stormwater Control Program, Capital Improvement Needs Inventory (1984), as well as from cost estimates provided by manufacturers or their local distributors, and were updated to 1989 dollars, as necessary.

In general, it has been found that some alternative forms of bank protection, such as vegetation, are less expensive than pneumatically placed concrete on a per-square-yard basis, and this fact is demonstrated within the Evaluation Matrix.

However, these relatively inexpensive forms of bank protection require flatter side-slopes, and have higher roughness coefficients than concrete. Thus, the additional channel size required for the less expensive bank-protection techniques, combined with the additional excavation that may be needed, can make the overall cost for these alternative forms of bank protection actually equivalent to, or more than, the cost for a comparably sized channel lined with pneumatically placed concrete.

3. Operation And Maintenance Costs. This is an index of the anticipated long-term operation and maintenance costs associated with each of the alternative forms of watercourse treatment presented.

The selection of a channel treatment type should include analyses of both long-term and short-term maintenance requirements. Generally, the amount of scheduled and unscheduled maintenance will vary according to the type of treatment. However, all flood-control facilities, including channelized watercourses, should be able to function properly (1) throughout a single design flood with no maintenance; (2) throughout one flood season with very little maintenance; and (3) from one flood season to another with regular, but minimal, maintenance requirements.

Those flood-control/erosion-control techniques which require minimal amounts of long-term operation and maintenance were considered "better" under this category than those techniques requiring greater amounts of operation and maintenance over the long term.

Storm drains, single-use channels with non-erodible linings (such as concrete and soil cement), and natural channels were considered to have minimal operation and maintenance costs because, once properly designed and constructed, these types of channels will require very little regular, annual maintenance in order to keep these types of drainage channels in good working order. Normally, most channels will require the regular removal of debris and trash. In addition to debris and trash removal, channels with vegetative linings require regular operation and maintenance because of the landscaping and irrigation requirements. For comparison purposes, the annual cost of maintaining a landscaped channel was converted to a lump-sum Present Value.

In addition to regular operation and maintenance, those channels with vegetative linings will also require a continual and dependable source of irrigation water. It should be remembered that channels lined with vegetation will require a large amount of water; and if reclaimed sewage water is not available, as will be the case most of the time, this water must be taken directly from some drinking-water supply. Aside from the cost, the desirability of using potable water for channel maintenance should be a factor in the process of selecting a watercourse treatment.

4. Benefits Received Upon Construction. The benefits received upon construction have been evaluated in the context of a reduction in both the extent and frequency of local flooding and erosion hazards, and a reduction in the minimum required building setback distance. In addition, the time frame over which the benefits are realized was also considered during the preparation of the Evaluation Matrix.

Channels left in their natural state were given relatively poor scores in this category, simply because there are no benefits received upon construction. The reduction or prevention of flood and erosion damage can only be achieved by designing the surrounding development to avoid such damage. Similarly, the preservation of a natural wash will not, in itself, reduce the flood and/or erosion damages to an existing structure located near the watercourse.

Benefits received from non-erodible channels were given better rankings under this category because these types of channels will protect development from flood and erosion damage, and thus will provide an immediate benefit upon construction. On the other hand, those channels with erodible linings do not provide erosion protection upon construction, and thus were given moderate ratings within the Matrix.

5. Degree Of Site-Plan Flexibility. This is an index as to whether or not a particular watercourse treatment will provide a higher degree of site-plan flexibility over that offered by a natural wash. Those techniques which provided greater development flexibility and greater potential development densities were given higher rankings under this category than were those techniques that tended to either preserve or partially preserve natural washes.

Generally, constructed channels, with or without erodible linings, will provide a higher degree of site-plan flexibility than natural washes because channelization, by definition, is the relocation and/or widening of a drainage channel to allow for a more "efficient" use of the affected property. Channelization, as opposed to the preservation of natural washes, may also improve existing drainage and erosion problems. Constructed channels with erodible linings, or with linings which require flat side-slopes, allow for less flexibility because of the land-use and setback requirements. Natural channels allow the least amount of site-plan flexibility because they require developments to be built around an existing natural feature that may not be well suited for the intended land use.

6. Minimize Legal Liability. This index is a measure of the potential liability that may be incurred as a result of altering the natural drainage.

The selection of a channel treatment type should be based upon careful consideration of potential safety hazards dictated by the adjacent or nearby land uses. Potential safety hazards should be initially identified during the treatment selection process, and appropriate design elements should be added in order to mitigate any known or suspected safety hazards.

Although it is recognized that legal liability or accountability cannot be established except in a court of law, and that there could be some liability associated with any situation where there is a risk of damage or harm, for the purposes of this evaluation those channels which have been altered by man are generally considered to have higher liability than those channels which have not been similarly altered. This is because it is generally perceived that there is some level of responsibility associated with altering drainage in a manner which causes it to deviate from its natural condition.

*D. Technical Factors:*

1. Range of applicability. This is an index of the range of hydraulic conditions in which a particular watercourse treatment can be reasonably applied with an acceptable level of success.

Those types of watercourse treatments with a wide range of applicability were assigned a better score within the Evaluation Matrix than were those types of treatments with a narrow range of applicability.

For example, concrete has a wide range of applicability because it is extremely durable, and can be formed into almost any shape that may be required for a particular flood-control structure. On the other hand, vegetation and other erodible linings are limited to applications associated with relatively low flow velocities. Thus, these latter techniques require relatively broad, nearly straight channels. Therefore, their range of applicability is considerably less than that of concrete or soil cement. Similarly, the preservation of natural channels require long-term channel stability and



relatively low-density, upstream development. Consequently, natural channels can be retained only under a limited range of development conditions.

2. Reduction In Frequency/Severity Of Local Erosion/Flooding. This is an index of how well each technique will minimize local erosion and/or flooding.

The reduction in frequency and severity of local erosion and/or flooding is a function of both design discharge and channel treatment. However, considering equivalent discharges, those channel treatments which provide significant protection against local erosion and/or flooding are ranked higher within the Matrix than are those types which do not provide such protection.

For instance, concrete channels can be designed to provide a prescribed level of protection. Consequently, they are ranked high. Constructed channels made of materials more erodible than concrete may provide good protection against flooding, but protection against erosion may be somewhat less. Natural channels normally provide no protection from flooding and/or erosion, and are therefore ranked as least desirable in this category.

3. Effect On Frequency/Severity Of Downstream Erosion/Flooding. This is an index of how well each technique will affect downstream erosion and/or flooding.

The frequency of downstream flooding can be affected by channel treatment through an increase in hydraulic efficiency and a decrease in overbank flood-storage areas.

Peak-discharge rates are directly related to the watershed "time of concentration." That is, for a given thunderstorm, the shorter the time of concentration, the larger the discharge. Generally, channel treatments which increase flow velocities also tend to reduce the time of concentration. This, in turn, increases peak-flow rates. Flow velocities and flood peaks are higher along more hydraulically efficient systems, such as concrete channels.

An increase in downstream peaks is also directly related to a reduction in overbank storage volume resulting from channelization within a flood plain.

Because increasing downstream peak flow rates is normally considered to be a negative effect, channel treatments which do this, such as concrete channels, are ranked lower under this category than are channel treatments which do not tend to increase downstream flood peaks.

It should be remembered that leaving washes in their natural condition will not necessarily guarantee that the downstream flood peaks will not increase with urbanization. Flood peaks are also dependent upon the amount of impervious area within a watershed. Development normally increases impervious area, so the frequency and severity of downstream flooding will increase with urbanization, regardless of the channel treatment, unless other suitable preventative measures are taken (e.g., stormwater detention).

The possible detrimental effects of channelization upon downstream flood peaks are particularly important when planning "retrofit" flood-control improvements within existing urbanized areas. Placing an existing, wide floodplain into an efficient concrete channel may merely transfer the problem downstream, and thereby require that more flood-control improvements be built. Therefore, consideration should be given to the fact that, if right-of-way is available, compound channels may be a better solution to existing inner-city flood problems than are traditional concrete or soil-cement channels.

4. Compatibility With Other Techniques And/Or Alternatives. This index is a measure of how well each technique can operate immediately adjacent to other types of channel treatment without sustaining, or causing, significant damage.

The selection of a particular watercourse treatment should include consideration of the effects or impacts that existing and proposed upstream and downstream treatment types may have upon channel stability and long-term maintenance--particularly as it relates to the erosion and sedimentation that may occur at the interface of two dissimilar types of channel treatment. In addition, at those locations where more than one type of channel treatment is proposed at a given location (e.g., a compound channel with a rock-lined, low-flow channel and biotechnically or vegetatively protected high-flow portions of the channel cross section), consideration should be given to the local scour that may occur at the interface or edges of the different treatment types.

When designing flood-control channels, it is usually desirable to keep flow velocities, depth, and channel width relatively the same from one point to the next. Also, the aesthetic quality of the channels should be taken into consideration. From an aesthetic point of view, it is more desirable to maintain similar channel treatments, such as vegetative linings adjacent to natural channels and soil-cement channels adjacent to concrete or riprap channels, throughout the length of a watercourse.

GENERAL EVALUATION CRITERIA

EVALUATION MATRIX FOR FLOOD-CONTROL AND EROSION-CONTROL TECHNIQUES

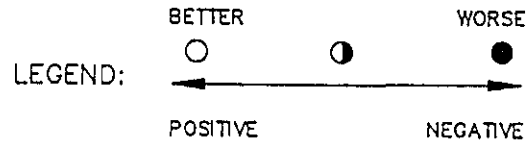

(REFER TO THE TEXT FOR AN EXPLANATION OF FLOOD-CONTROL AND EROSION-CONTROL ALTERNATIVES AND EVALUATION CRITERIA.)

FLOOD-CONTROL AND EROSION-CONTROL ALTERNATIVES

	SOCIAL FACTORS				ENVIRONMENTAL FACTORS				ECONOMIC FACTORS				TECHNICAL FACTORS				
	AESTHETIC QUALITY	SOCIAL ACCEPTABILITY	POTENTIAL FOR MULTI-PURPOSE USE/LINEAR PARK OPPORTUNITIES	MINIMIZE HAZARD AND NUISANCE POTENTIAL	PRESERVATION/RESTORATION OF RIPARIAN VEGETATION	PRESERVATION OF WILDLIFE HABITAT/CORRIDORS	MAINTENANCE OF NATURAL FLOODPLAINS	IMPACT UPON INFILTRATION AND RECHARGE CHARACTERISTICS	RIGHT-OF-WAY/SETBACK REQUIREMENTS	CONSTRUCTION COSTS	OPERATION AND MAINTENANCE COSTS	BENEFITS RECEIVED UPON CONSTRUCTION	DEGREE OF SITE-PLAN FLEXIBILITY	MINIMIZE LEGAL LIABILITY	RANGE OF APPLICABILITY	REDUCTION IN FREQUENCY/SEVERITY OF LOCAL EROSION/FLOODING	EFFECT ON FREQUENCY/SEVERITY OF DOWNSTREAM EROSION/FLOODING
PRESERVATION OF NATURAL WASHES	○	○	○	○		○	○	○		○	○	○	○		○	○	○
NATURAL WASHES WITH PERIODIC GRADE-CONTROL STRUCTURES	○	○	○	○		○	○	○		○	○	○	○		○	○	○
NATURAL WASHES WITH TRAINING STRUCTURES	○	○	○	○		○	○	○		○	○	○	○		○	○	○
WASHES WITH PIECEMEAL BANK PROTECTION	○	○	○	○		○	○	○		○	○	○	○		○	○	○
EARTHEN CHANNELS	○	○	○	○		○	○	○		○	○	○	○		○	○	○
CHANNELS WITH VEGETAL LININGS	○	○	○	○		○	○	○		○	○	○	○		○	○	○
CHANNELS WITH COMPOUND CROSS SECTIONS	○	○	○	○		○	○	○		○	○	○	○		○	○	○
CHANNELS WITH MODULAR LININGS	○	○	○	○		○	○	○		○	○	○	○		○	○	○
CHANNELS LINED WITH RIPRAP, OR ITS VARIATIONS	○	○	○	○		○	○	○		○	○	○	○		○	○	○
CHANNELS LINED WITH SOIL CEMENT	○	○	○	○		○	○	○		○	○	○	○		○	○	○
CHANNELS LINED WITH CONCRETE	○	○	○	○		○	○	○		○	○	○	○		○	○	○
UNDERGROUND STORM-DRAIN SYSTEMS	○	○	○	○		○	○	○		○	○	○	○		○	○	○

## REFERENCES

- Chow, V. T., 1959, *Open-Channel Hydraulics*, McGraw-Hill Book Co., New York.
- City of Tucson Engineering Division, 1989, "Standards Manual for Drainage Design and Floodplain Management in Tucson, Arizona."
- City of Tucson Engineering Division, 1988, "Interim Watercourse Improvement Policy." This policy was prepared by the City Council's Environmental Committee in conjunction with local consulting engineers along with administrative staff within the Engineering Division, and finally adopted by the City of Tucson Mayor and Council on June 27, 1988.
- City of Tucson Engineering Division, 1984, "Stormwater Control Program, Capital Improvement Needs Inventory." A consulting report prepared by Simons, Li and Associates, Inc.
- Federal Highway Administration, 1988, "Design of Roadside Channels With Flexible Linings," Hydraulic Engineering Circular No. 15.
- Federal Highway Administration, 1978, "Countermeasures For Hydraulic Problems At Bridges," Report No. FHWA-RD-78-162.
- Federal Highway Administration, 1985, "Design Of Spur-Type Streambank Stabilization Structures," Report No. FHWA/RD-84/101.
- Pima County Department of Transportation and Flood Control District, 1985, "Soil Cement Applications And Use In Pima County For Flood Control Projects."
- Pima County Urban Design Commission, 1986, "The Urban Design Of The Tucson Basin."
- Shaw, W., J. M. Burns, and K. Stenberg, 1986, "Wildlife Habitats in Tucson: A Strategy for Conservation" School of Renewable Natural Resources, University of Arizona, Tucson.
- Virginia Soil and Water Conservation Commission, 1980, "Virginia Erosion And Sediment Control Handbook."