



# Summerfield™ Honeycomb Shades



2021 Product Reference & Price Guide

# SUMMERFIELD™

## HONEYCOMB SHADES

### Program Summary

- Design options include light filtering and room darkening fabrics in Single, Double, Triple, and Grand Pleat cell sizes.
- No visible cords - reduces light leaks and improves privacy
- Neutral backing to the outside
- Superior insulation and energy efficiency
- Multiple Operating Systems:
  - Standard Shade
  - Premium Cordless
  - Lift & Lock™ Cordless
  - Continuous Cord
  - Top-Down
  - Top-Down/Bottom-Up
  - Day/Night
  - Two-on-One Headrail
  - AMP™ Motorization
  - Vertical Honeycomb
- Specialty Arches and Skylight Shades
- Select fabrics available in wide widths for larger windows
- Designer Sample Book available
- Limited Lifetime Warranty
- Made in the USA



### Table of Contents

Fabric Reference Guide.....	3
Features & Options.....	4
Color Reference Guide.....	5
Summerfield™ Price Grids.....	6 - 13
Grand Pleat Summerfield™ Price Grids.....	14 - 15
Vertical Summerfield™ Honeycomb Price Grids.....	16 - 17
Vertical Summerfield™ Honeycomb Specifications.....	18 - 19
Shade Specifications By Fabric.....	20 - 21
Arches and Quarter Circle Specifications.....	22
Stacking Heights.....	23
Dimensions and Mounting Specifications.....	24
Skylight Specifications.....	25
AMP™ Motorization Details.....	26 - 27
Shade Product Details.....	28
Measuring Instructions.....	29
How to Order and Ordering Tips.....	30
Summerfield™ Order Forms.....	31 - 33
Care, Safety & Warranty Information.....	34

# FABRIC REFERENCE GUIDE

<b>SUMMERFIELD™ HONEYCOMB - GRAND PLEAT</b>		<b>Fabric Width</b>	<b>PRICE GRID</b>	
Majestic Dawn 4032	Grand Pleat Spun Lace - Light Filtering	144"	4032	price grid 9
Majestic Sunset 4037	Grand Pleat Spun Lace - Room Darkening	132"	4037	price grid 10
<b>SUMMERFIELD™ HONEYCOMB - LIGHT FILTERING</b>				
Essence D8/D9	3/4" Sheer Single Cell	174"	D8/D9	price grid 8
Allure D6	3/4" Semi Sheer Single Cell	174"	D6	price grid 7
Shimmer D13/D14	3/4" Spun Lace Single Cell	174"	D13/D14	price grid 8
Brushed F36	3/4" Spun Bond Single Cell	174"	F36	price grid 6
Daybreak F16	3/4" Spun Bond Single Cell	174"	F16	price grid 3
Petite Daybreak F8	3/8" Spun Bond Single Cell	174"	F8	price grid 4
Splendor H56	3/4" Spun Bond Single Cell	174"	H56	price grid 6
Trio 4012	Triple Cell Spun Lace	144"	4012	price grid 6
Timeless 4003	9/16" Spun Lace Single Cell	144"	4003	price grid 2
Timeless 4005	3/4" Spun Lace Single Cell	144"	4005	price grid 3
Timeless 4004	1/2" Spun Lace Double Cell	144"	4004	price grid 4
Whisper 4014	3/8" Spun Lace Double Cell	144"	4014	price grid 3
Advantage 4041	3/4" Spun Lace Single Cell	144"	4041	price grid 1
Advantage 4043	1/2" Spun Lace Double Cell	144"	4043	price grid 1
<b>SUMMERFIELD™ HONEYCOMB - ROOM DARKENING</b>				
Aurora G23/G24/G25	3/4" Spun Lace Single Cell	174"	G23/G24/G25	price grid 8
Brushed Eclipse F37	3/4" Spun Bond Single Cell	174"	F37	price grid 7
Nightfall F17	3/4" Spun Bond Single Cell	174"	F17	price grid 7
Petite Nightfall F9	3/8" Spun Bond Single Cell	174"	F9	price grid 7
Midnight 4008	3/4" Spun Lace Single Cell	144"	4008	price grid 5
Cache Linen 4021L	3/4" Spun Lace Single Cell	144"	4021L	price grid 5
Tranquil 4023	1/2" Spun Lace Double Cell	128"	4023	price grid 6

### SEMI-SHEER FABRIC

Transmits light with view through the shade.  
Does not provide privacy.

### LIGHT FILTERING FABRIC

Transmits filtered light with no view through the shade.  
Provides moderate privacy.

### ROOM DARKENING FABRIC

Blocks 99% of outside light, OB.  
Provides complete privacy and light control, OB.

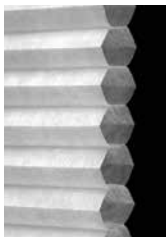

3/8" Single Cell



9/16" Single Cell

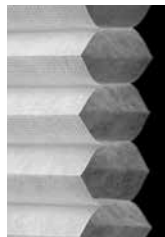

3/4" Single Cell



Double Cell

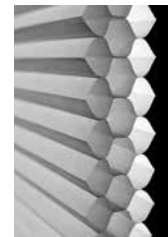

Triple Cell

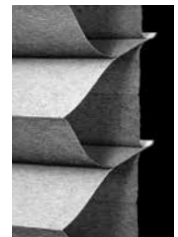

Grand Pleat

# FEATURES & OPTIONS

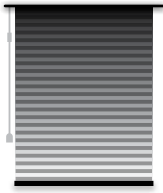

## STANDARD SHADE

- Aluminum rail & cord-operated
- Color-coordinated components



## 2-ON-1 HEADRAIL

- Perfect for larger windows
- Allows two shades to mount on one rail
- Each shade is adjusted independently

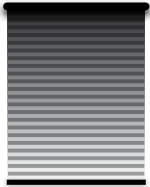

## PREMIUM CORDLESS

- **Enhanced Safety** design eliminates cords
- Superior performance
- Also available in Top-Down/Bottom-Up

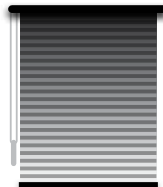

## CONTINUOUS CORD

- Perfect for larger windows
- Smooth lift-assisted movement
- Eliminates dangling cords

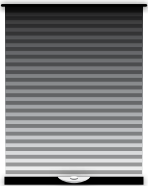

## LIFT & LOCK™ CORDLESS

- **Enhanced Safety** design eliminates cords
- Handle to control operation by locking shade in desired location
- Also available in Top-Down/Bottom-Up

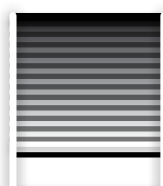

## SKYLIGHT SHADE

- Perfect application for hard to reach skylights
- Available in AMP™ Motorized system option

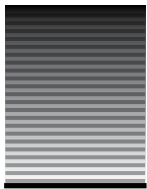

## AMP™ MOTORIZED SHADE

- Perfect for hard-to-reach windows
- Programmable remote control
- **Enhanced Safety** design eliminates cords
- Compatible with smart phone or tablet app



## DAY/NIGHT

- Provides privacy & controls light with two fabrics
- Translucent fabric on top to enhance light
- Blackout fabric on bottom to eliminate light
- Middle rail connects & adjusts both fabrics
- Also available in **Lift & Lock™ Cordless & Premium Cordless**

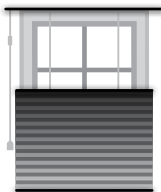

## TOP-DOWN

- Provides privacy & enhances light flow and view
- Stacks neatly at bottom of window



## SPECIALTY ARCHES

- Fan-style arches & quarter circles
- Moveable or stationary systems

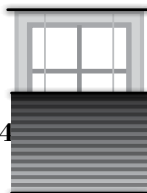

## TOP-DOWN/BOTTOM-UP

- Maximum privacy & light control
- Middle rail & bottomrail adjust to desired locations
- Raise shade up from bottom to maximize light
- Available in **Premium Cordless, Lift & Lock™ Cordless, Continuous Cord and Motorized options**

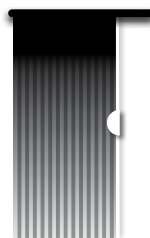

## VERTICAL HONEYCOMB

- Side-to-side operation
- Accommodates sliding doors
- Perfect for room dividers & rectangular windows
- Grand Pleat size available
- **Enhanced Safety** design eliminates cords



## ENHANCED SAFETY DESIGN

Cordless, Motorized and Vertical Honeycomb operating systems utilize enhanced safety cordless design to offer a safer alternative for children and pets.

Refer to pages 20 - 23 for fabric specifications and limitations. Some systems have limited rail color coordination available.

# SUMMERFIELD™ Honeycomb Shades

## COLOR REFERENCE GUIDE

Color #	Color Name	Fabric
851	Acorn Yellow	4012
445	Aged Brass	F36, F37
835	Alpine White	4014
961	Apple Blossom	D6
989	Bamboo	F8, F16
813	Barley	4008
955	Beechwood	F8, F9, F16, F17, 4032, 4037
839	Birch	4014
796	Birch White	4008
470	Biscotti	H56
806	Biscuit	4003, 4004, 4005, 4012
698	Bison	H56
860	Black	4008
748	Black Suede	D9
519	Blonde Oak	4012
859	Blue Lapis	4014
537	Boulder	4041, 4043
702	Buff	4012, 4014
701	Buttercream	4003, 4004, 4005, 4014
840	Cameo	4014
701	Canyon Cloud	D8
533	Caper	4041, 4043
863	Chai	4008, 4023
602	Cloud	F9, F17, 4037
468	Copper Radiance	G25
960	Crystal	D6
792	December White	4008, 4023, 4037
722	Deep Silver	4003, 4004, 4005, 4023, 4032, 4037
930	Deep Silver	4021L
932	Earth	4021L
530	Ecru	4041, 4043
853	Fern	4014
820	Fossil White	4023
700	Frost	D8
755	Fudge (discontinued)	4003, 4004, 4005
625	Fudge Truffle	F8, F16
708	Ginger	4003, 4004, 4005, 4014
702	Glow	D8
989	Gold Brilliance	D14
468	Gold Leaf	D14, G24
955	Gold Shimmer	D14
439	Golden	F36, F37
795	Graphite	H56
925	Honey	4021L
795	Irish Slate	D6
791	Ivory	D6
838	Ivory	4014
721	Ivy	4014
466	Latte	4008
562	Linen	4003, 4004, 4005

Color #	Color Name	Fabric
540	Lunar	4041, 4043
531	Merino	4041, 4043
164	Moonlight	4008
962	Moonstone	D6
908	Mushroom	F16
707	Oatmeal	4003, 4004, 4005, 4014
843	Papyrus	4014
834	Pebble Beach	4014
458	Pewter	F36, F37
844	Pinecone	4008
829	Platinum	H56
401	Porcelain	F8, F16
503	Powder	4014
620	Prisitne Beach	F8, F16
807	Pure	4003, 4004, 4005
503	Pure White	4032
535	Putty	4041, 4043
773	River Bed	4023
448	Rosemary	F36, F37
762	Sandrift	4003, 4004, 4005, 4008, 4032, 4037
538	Sandstone	4041, 4043
931	Seaside Blue	4021L
536	Shale	4041, 4043
933	Ship Gray	4021L
830	Silken White	4014
682	Silver Birch	D13
977	Silver Birch	F8, F16
829	Silver River	D13, G23
686	Silver Truffle	D13
208	Smoke	4003, 4004, 4005, 4012, 4014
503	Snow	4003, 4004, 4005, 4012
794	Soapstone	D6
951	Star Magnolia	F8, F9, F16, F17
841	Stone Mountain	4014
401	Sugar	H56
949	Sunbeam	F8, F16, 4032
534	Teak	4041, 4043
928	Toffee	4021L
611	Tranquil Tea	F8, F9, F16, F17
878	True Camel	4008
454	Twilight	F36, F37
627	Vanilla	H56
400	Vintage Lace	F36, F37
532	Wafer	4041, 4043
766	Whisper	4037
766	Whisper White	4008
952	White Azalea	F8, F9, F16, F17
164	White Satin	4023
528	Whitecap	4032
541	Woodsmoke	4041, 4043



# 1 SUMMERFIELD™ Honeycomb Shades

## RETAIL PRICE GRID

- Advantage 4041 3/4" Spun Lace Single Cell - Light Filtering
- Advantage 4043 1/2" Spun Lace Double Cell - Light Filtering

WIDTH TO:	24"	30"	36"	42"	48"	54"	60"	66"	72"	84"	96"	108"	120"	132"	144"
<b>36"</b>	151	164	178	189	201	214	227	239	257	293	331	410	444	482	514
<b>42"</b>	157	171	187	200	215	230	245	265	283	322	356	449	491	530	567
<b>48"</b>	163	179	196	212	227	245	266	287	311	354	402	489	531	575	621
<b>54"</b>	170	186	204	223	239	265	286	312	336	384	437	527	574	623	671
<b>60"</b>	174	194	212	230	257	282	311	336	362	416	473	566	620	671	722
<b>HEIGHT TO:</b> <b>66"</b>	181	200	221	245	273	302	331	359	387	445	508	605	663	720	776
<b>72"</b>	185	209	230	262	293	322	353	383	413	476	545	646	704	765	828
<b>78"</b>	194	217	243	275	311	344	375	409	441	507	580	688	750	817	884
<b>*84"</b>	198	223	255	287	329	365	399	434	467	536	614	729	796	867	933
<b>90"</b>	204	230	267	302	346	383	420	456	493	566	650	765	841	912	987
<b>96"</b>	212	243	280	319	365	403	443	482	520	599	686	808	885	961	1041
<b>108"</b>	223	266	310	352	400	444	487	531	575	660	758	891	978	1062	1152
<b>120"</b>	239	286	336	383	437	484	531	580	628	723	831	967	1065	1160	1257

\*Maximum drop on Cordless is 84".

Continuous Cord Loop System recommended for sizes within gray area in chart.

### LIFT SYSTEM SURCHARGES

WIDTH TO:	24"	30"	36"	42"	48"	54"	60"	66"	72"	84"	96"	108"	120"	132"	144"
<b>Continuous Cord Loop</b>	89	91	99	102	105	110	113	118	126	134	140	151	163	172	179
<b>Lift &amp; Lock Cordless*</b>	89	91	99	102	105	110	113	118	126	134	140	151	163	172	179
<b>Premium Cordless*</b>	119	124	126	131	142	145	147	154	160	204	212	224	233	263	293

\*Maximum drop on Cordless is 84".

### ARCHES

WIDTH TO:	24"	30"	36"	42"	48"	54"	60"	66"	72"	84"
<b>Perfect Arches - Stationary &amp; Movable</b>	148	167	189	212	240	274	309	348	383	422
<b>Quarter Circle - Stationary &amp; Movable</b>	148	167	189	212	240	274	309	348	383	422

See page 22 for specifications

### SHADES OPTIONS & SURCHARGES

(add to Standard Rectangular price)

TDBU Corded.....	Price as Standard + \$100
TDBU Cont. Cord Loop.....	Price as Cont. Cord Loop + \$100
TDBU Cordless.....	Price as Cordless + \$125
Top Down Only.....	Price as Standard + \$100
Day Night.....	Price as Sum of Two Shades
Two-On-One.....	Price overall width as Standard + \$50
Summerfield Skylight.....	Price as Standard + \$100
Projection Brackets, Hold Down Brackets.....	No Charge
Cord Cleats, Shims.....	No Charge

### AMP MOTORIZATION SURCHARGES

AMP Motorized Standard w/ Battery Pack ..	Price as Cont. Cord Loop + \$580
AMP Remote for Standard .....	\$150
AMP TDBU Motorized w/Battery Pack .....	Price as Cont. Cord Loop + \$636
AMP Remote for TDBU.....	\$185
AMP Charger.....	\$85
AMP Bridge.....	\$440

See pages 26 - 27 for details on AMP Motorization

See pages 20 - 21 for Shade Specifications by Fabric

# 2 SUMMERFIELD™ Honeycomb Shades

## RETAIL PRICE GRID

• Timeless 4003 9/16" Spun Lace Single Cell - Light Filtering

WIDTH TO:	24"	30"	36"	42"	48"	54"	60"	66"	72"	84"	96"	108"	120"	132"	144"
<b>36"</b>	187	202	220	239	257	273	291	311	333	379	431	529	577	624	666
<b>42"</b>	199	215	235	256	273	292	318	344	368	419	464	584	636	686	734
<b>48"</b>	206	226	248	272	294	318	345	374	405	459	523	636	689	749	807
<b>54"</b>	227	236	262	286	311	344	372	405	437	498	567	685	745	810	870
<b>60"</b>	229	247	278	300	332	367	403	437	471	538	612	733	803	870	935
<b>HEIGHT TO:</b> <b>66"</b>	233	258	283	318	355	393	431	468	505	577	659	785	859	933	1007
<b>72"</b>	240	266	300	337	379	418	455	496	537	619	707	837	915	995	1075
<b>78"</b>	247	272	315	357	405	446	485	528	573	658	752	893	970	1060	1147
<b>*84"</b>	255	283	331	374	426	474	516	562	607	694	797	947	1034	1125	1210
<b>90"</b>	263	300	346	393	449	496	546	592	641	733	846	995	1092	1184	1279
<b>96"</b>	271	314	365	414	472	523	573	624	676	774	890	1048	1149	1247	1350
<b>108"</b>	279	345	401	455	518	577	633	689	749	858	987	1156	1267	1378	1494
<b>120"</b>	288	372	436	494	564	629	689	752	815	938	1081	1256	1380	1505	1632

\*Maximum drop on Cordless is 84".

Continuous Cord Loop System recommended for sizes within gray area in chart.

### LIFT SYSTEM SURCHARGES

WIDTH TO:	24"	30"	36"	42"	48"	54"	60"	66"	72"	84"	96"	108"	120"	132"	144"
<b>Continuous Cord Loop</b>	89	91	99	102	105	110	113	118	126	134	140	151	163	172	179
<b>Lift &amp; Lock Cordless*</b>	89	91	99	102	105	110	113	118	126	134	140	151	163	172	179
<b>Premium Cordless*</b>	119	124	126	131	142	145	147	154	160	204	212	224	233	263	293

\*Maximum drop on Cordless is 84".

### ARCHES

WIDTH TO:	24"	30"	36"	42"	48"	54"	60"	66"	72"	84"
<b>Perfect Arches - Stationary &amp; Movable</b>	148	167	189	212	240	274	309	348	383	422
<b>Quarter Circle - Stationary &amp; Movable</b>	148	167	189	212	240	274	309	348	383	422

See page 22 for specifications

### SHADES OPTIONS & SURCHARGES

(add to Standard Rectangular price)

<b>TDBU Corded</b> .....	Price as Standard + \$100
<b>TDBU Cont. Cord Loop</b> .....	Price as Cont. Cord Loop + \$100
<b>TDBU Cordless</b> .....	Price as Cordless + \$125
<b>Top Down Only</b> .....	Price as Standard + \$100
<b>Day Night</b> .....	Price as Sum of Two Shades
<b>Two-On-One</b> .....	Price overall width as Standard + \$50
<b>Summerfield Skylight</b> .....	Price as Standard + \$100
<b>Projection Brackets, Hold Down Brackets</b> .....	No Charge
<b>Cord Cleats, Shims</b> .....	No Charge

### AMP MOTORIZATION SURCHARGES

<b>AMP Motorized Standard w/ Battery Pack</b> ..	Price as Cont. Cord Loop + \$580
<b>AMP Remote for Standard</b> .....	\$150
<b>AMP TDBU Motorized w/Battery Pack</b> .....	Price as Cont. Cord Loop + \$636
<b>AMP Remote for TDBU</b> .....	\$185
<b>AMP Charger</b> .....	\$85
<b>AMP Bridge</b> .....	\$440

See pages 26 - 27 for details on AMP Motorization

See pages 20 - 21 for Shade Specifications by Fabric

# 3 SUMMERFIELD™ Honeycomb Shades

## RETAIL PRICE GRID

- Daybreak F16 3/4" Spun Bond Single Cell - Light Filtering
- Timeless 4005 3/4" Spun Lace Single Cell - Light Filtering

- Whisper 4014 3/8" Spun Lace Double Cell - Light Filtering

WIDTH TO:	24"	30"	36"	42"	48"	54"	60"	66"	72"	84"	96"	108"	120"	132"	144"
<b>36"</b>	201	221	245	270	290	313	339	366	394	447	505	627	679	733	788
<b>42"</b>	214	223	261	285	313	343	375	401	433	495	546	688	750	807	867
<b>48"</b>	221	238	278	306	339	375	405	439	474	542	614	747	810	879	947
<b>54"</b>	231	263	294	329	366	401	438	477	512	588	667	805	878	955	1026
<b>60"</b>	243	277	313	353	394	433	474	512	553	636	723	866	945	1026	1104
<b>HEIGHT TO:</b> <b>66"</b>	256	290	332	375	420	463	507	548	594	680	776	926	1014	1099	1188
<b>72"</b>	263	305	353	399	447	494	538	586	634	729	831	988	1079	1171	1266
<b>78"</b>	274	322	370	422	475	526	574	624	672	776	888	1055	1145	1247	1347
<b>*84"</b>	285	336	389	439	500	557	609	662	713	818	938	1112	1217	1326	1427
<b>90"</b>	298	353	406	465	531	586	641	698	755	866	994	1171	1285	1395	1508
<b>96"</b>	310	368	428	489	555	617	675	734	795	913	1048	1236	1351	1469	1590
<b>108"</b>	325	389	453	515	588	653	717	781	846	973	1117	1307	1437	1563	1691
<b>120"</b>	353	422	494	562	638	712	781	851	923	1065	1219	1425	1564	1706	1844

\*Maximum drop on Cordless is 84".

Continuous Cord Loop System recommended for sizes within gray area in chart.

### LIFT SYSTEM SURCHARGES

WIDTH TO:	24"	30"	36"	42"	48"	54"	60"	66"	72"	84"	96"	108"	120"	132"	144"
<b>Continuous Cord Loop</b>	89	91	99	102	105	110	113	118	126	134	140	151	163	172	179
<b>Lift &amp; Lock Cordless*</b>	89	91	99	102	105	110	113	118	126	134	140	151	163	172	179
<b>Premium Cordless*</b>	119	124	126	131	142	145	147	154	160	204	212	224	233	263	293

\*Maximum drop on Cordless is 84".

### ARCHES

WIDTH TO:	24"	30"	36"	42"	48"	54"	60"	66"	72"	84"
<b>Perfect Arches - Stationary &amp; Movable</b>	148	167	189	212	240	274	309	348	383	422
<b>Quarter Circle - Stationary &amp; Movable</b>	148	167	189	212	240	274	309	348	383	422

See page 22 for specifications

### SHADES OPTIONS & SURCHARGES

(add to Standard Rectangular price)

TDBU Corded.....	Price as Standard + \$100
TDBU Cont. Cord Loop.....	Price as Cont. Cord Loop + \$100
TDBU Cordless.....	Price as Cordless + \$125
Top Down Only.....	Price as Standard + \$100
Day Night.....	Price as Sum of Two Shades
Two-On-One.....	Price overall width as Standard + \$50
Summerfield Skylight.....	Price as Standard + \$100
Projection Brackets, Hold Down Brackets.....	No Charge
Cord Cleats, Shims.....	No Charge

### AMP MOTORIZATION SURCHARGES

AMP Motorized Standard w/ Battery Pack ..	Price as Cont. Cord Loop + \$580
AMP Remote for Standard .....	\$150
AMP TDBU Motorized w/Battery Pack .....	Price as Cont. Cord Loop + \$636
AMP Remote for TDBU.....	\$185
AMP Charger.....	\$85
AMP Bridge.....	\$440

See pages 26 - 27 for details on AMP Motorization

See pages 20 - 21 for Shade Specifications by Fabric



# 4 SUMMERFIELD™ Honeycomb Shades

## RETAIL PRICE GRID

- **Petite Daybreak F8** 3/8" Spun Bond Single Cell - Light Filtering
- **Timeless 4004** 1/2" Spun Lace Double Cell - Light Filtering

WIDTH TO:	24"	30"	36"	42"	48"	54"	60"	66"	72"	84"	96"	108"	120"	132"	144"
<b>36"</b>	206	230	254	283	311	339	367	396	425	482	545	677	733	789	848
<b>42"</b>	219	243	274	308	339	370	403	434	467	533	588	741	808	869	936
<b>48"</b>	230	259	294	330	367	403	437	475	511	583	663	806	873	948	1022
<b>54"</b>	241	275	316	354	396	434	471	514	552	634	719	868	945	1029	1104
<b>60"</b>	253	290	336	380	423	467	511	552	596	683	778	935	1020	1106	1190
<b>66"</b>	268	311	358	403	451	500	548	592	640	733	837	997	1094	1185	1279
<b>72"</b>	283	329	380	433	480	532	582	633	682	785	895	1063	1160	1262	1364
<b>78"</b>	295	347	401	453	511	566	618	672	724	837	954	1135	1233	1346	1454
<b>*84"</b>	308	361	417	475	539	601	656	713	768	882	1011	1198	1311	1427	1538
<b>90"</b>	320	380	438	501	570	633	691	751	812	931	1071	1262	1384	1501	1625
<b>96"</b>	334	399	461	524	597	667	727	790	857	985	1128	1330	1456	1582	1711
<b>108"</b>	351	417	487	555	634	704	773	841	912	1045	1201	1406	1549	1682	1824
<b>120"</b>	380	453	530	605	688	767	841	917	994	1147	1316	1533	1685	1836	1988

\*Maximum drop on Cordless is 84".

Continuous Cord Loop System recommended for sizes within gray area in chart.

### LIFT SYSTEM SURCHARGES

WIDTH TO:	24"	30"	36"	42"	48"	54"	60"	66"	72"	84"	96"	108"	120"	132"	144"
<b>Continuous Cord Loop</b>	89	91	99	102	105	110	113	118	126	134	140	151	163	172	179
<b>Lift &amp; Lock Cordless*</b>	89	91	99	102	105	110	113	118	126	134	140	151	163	172	179
<b>Premium Cordless*</b>	119	124	126	131	142	145	147	154	160	204	212	224	233	263	293

\*Maximum drop on Cordless is 84".

### ARCHES

WIDTH TO:	24"	30"	36"	42"	48"	54"	60"	66"	72"	84"
<b>Perfect Arches - Stationary &amp; Movable</b>	148	167	189	212	240	274	309	348	383	422
<b>Quarter Circle - Stationary &amp; Movable</b>	148	167	189	212	240	274	309	348	383	422

See page 22 for specifications

### SHADES OPTIONS & SURCHARGES

(add to Standard Rectangular price)

<b>TDBU Corded</b> .....	Price as Standard + \$100
<b>TDBU Cont. Cord Loop</b> .....	Price as Cont. Cord Loop + \$100
<b>TDBU Cordless</b> .....	Price as Cordless + \$125
<b>Top Down Only</b> .....	Price as Standard + \$100
<b>Day Night</b> .....	Price as Sum of Two Shades
<b>Two-On-One</b> .....	Price overall width as Standard + \$50
<b>Summerfield Skylight</b> .....	Price as Standard + \$100
<b>Projection Brackets, Hold Down Brackets</b> .....	No Charge
<b>Cord Cleats, Shims</b> .....	No Charge

### AMP MOTORIZATION SURCHARGES

<b>AMP Motorized Standard w/ Battery Pack</b> ..	Price as Cont. Cord Loop + \$580
<b>AMP Remote for Standard</b> .....	\$150
<b>AMP TDBU Motorized w/Battery Pack</b> .....	Price as Cont. Cord Loop + \$636
<b>AMP Remote for TDBU</b> .....	\$185
<b>AMP Charger</b> .....	\$85
<b>AMP Bridge</b> .....	\$440

See pages 26 - 27 for details on AMP Motorization

See pages 20 - 21 for Shade Specifications by Fabric

# 5 SUMMERFIELD™ Honeycomb Shades

## RETAIL PRICE GRID

- **Midnight 4008** 3/4" Spun Lace Single Cell - Room Darkening
- **Cache Linen 4021L** 3/4" Spun Lace Single Cell - Room Darkening

WIDTH TO:	24"	30"	36"	42"	48"	54"	60"	66"	72"	84"	96"	108"	120"	132"	144"
<b>36"</b>	225	253	281	302	333	360	392	421	451	514	582	722	783	841	905
<b>42"</b>	240	270	299	330	360	396	433	465	500	568	625	789	862	926	997
<b>48"</b>	250	284	318	352	392	431	467	507	543	620	705	860	932	1012	1090
<b>54"</b>	268	301	338	380	421	465	503	550	587	675	769	925	1009	1097	1178
<b>60"</b>	278	319	360	405	451	498	543	587	637	732	832	995	1088	1179	1271
<b>HEIGHT TO: 66"</b>	294	336	383	433	484	533	584	633	683	783	891	1062	1167	1264	1364
<b>72"</b>	308	355	405	464	514	568	619	672	727	837	955	1135	1237	1347	1456
<b>78"</b>	320	369	426	484	548	605	658	715	774	891	1018	1211	1316	1433	1549
<b>*84"</b>	334	384	446	507	574	640	700	760	821	943	1077	1278	1400	1523	1642
<b>90"</b>	346	405	469	534	609	672	740	801	869	994	1143	1347	1478	1601	1732
<b>96"</b>	362	426	489	564	638	709	777	842	913	1052	1207	1416	1554	1689	1827
<b>108"</b>	390	446	520	595	675	751	826	900	971	1119	1282	1503	1650	1795	1944
<b>120"</b>	413	485	566	647	736	819	900	979	1059	1224	1404	1635	1797	1961	2122

\*Maximum drop on Cordless is 84".

Continuous Cord Loop System recommended for sizes within gray area in chart.

### LIFT SYSTEM SURCHARGES

WIDTH TO:	24"	30"	36"	42"	48"	54"	60"	66"	72"	84"	96"	108"	120"	132"	144"
<b>Continuous Cord Loop</b>	89	91	99	102	105	110	113	118	126	134	140	151	163	172	179
<b>Lift &amp; Lock Cordless*</b>	89	91	99	102	105	110	113	118	126	134	140	151	163	172	179
<b>Premium Cordless*</b>	119	124	126	131	142	145	147	154	160	204	212	224	233	263	293

\*Maximum drop on Cordless is 84".

### ARCHES

WIDTH TO:	24"	30"	36"	42"	48"	54"	60"	66"	72"	84"
<b>Perfect Arches - Stationary &amp; Movable</b>	148	167	189	212	240	274	309	348	383	422
<b>Quarter Circle - Stationary &amp; Movable</b>	148	167	189	212	240	274	309	348	383	422

See page 22 for specifications

### SHADES OPTIONS & SURCHARGES

(add to Standard Rectangular price)

<b>TDBU Corded</b> .....	Price as Standard + \$100
<b>TDBU Cont. Cord Loop</b> .....	Price as Cont. Cord Loop + \$100
<b>TDBU Cordless</b> .....	Price as Cordless + \$125
<b>Top Down Only</b> .....	Price as Standard + \$100
<b>Day Night</b> .....	Price as Sum of Two Shades
<b>Two-On-One</b> .....	Price overall width as Standard + \$50
<b>Summerfield Skylight</b> .....	Price as Standard + \$100
<b>Projection Brackets, Hold Down Brackets</b> .....	No Charge
<b>Cord Cleats, Shims</b> .....	No Charge

### AMP MOTORIZATION SURCHARGES

<b>AMP Motorized Standard w/ Battery Pack</b> ..	Price as Cont. Cord Loop + \$580
<b>AMP Remote for Standard</b> .....	\$150
<b>AMP TDBU Motorized w/Battery Pack</b> .....	Price as Cont. Cord Loop + \$636
<b>AMP Remote for TDBU</b> .....	\$185
<b>AMP Charger</b> .....	\$85
<b>AMP Bridge</b> .....	\$440

See pages 26 - 27 for details on AMP Motorization

See pages 20 - 21 for Shade Specifications by Fabric

# 6 SUMMERFIELD™ Honeycomb Shades

## RETAIL PRICE GRID

- Splendor H56 3/4" Spun Bond Single Cell - Light Filtering
- Brushed F36 3/4" Spun Bond Single Cell - Light Filtering

- Trio 4012 Triple Cell Spun Lace - Light Filtering
- Tranquil 4023 1/2" Spun Lace Double Cell - Room Darkening

WIDTH TO:	24"	30"	36"	42"	48"	54"	60"	66"	72"	84"	96"	108"	120"	132"	144"	
36"	246	274	311	350	386	417	454	488	523	596	675	837	908	975	1050	
42"	264	298	340	383	417	459	502	539	579	658	725	914	999	1074	1156	
48"	280	322	365	408	454	500	542	588	630	719	817	998	1081	1173	1264	
54"	298	342	392	441	488	539	584	637	681	783	892	1072	1170	1272	1365	
60"	313	360	416	469	523	578	630	681	739	849	965	1154	1261	1367	1474	
HEIGHT TO:	66"	332	386	444	502	561	618	678	734	792	908	1033	1231	1354	1465	1581
72"	350	407	469	538	596	658	718	779	843	971	1108	1316	1434	1562	1689	
78"	366	427	494	561	636	701	762	829	898	1033	1181	1404	1526	1662	1796	
*84"	383	445	517	588	666	742	812	882	952	1093	1249	1482	1623	1766	1905	
90"	396	469	544	619	706	779	858	929	1008	1153	1325	1562	1714	1857	2009	
96"	411	494	567	654	740	822	901	977	1059	1220	1400	1642	1802	1958	2119	
108"	433	517	603	689	783	871	957	1044	1126	1297	1486	1742	1913	2082	2254	
120"	469	563	657	750	853	950	1044	1135	1228	1419	1628	1896	2083	2274	2460	

\*Maximum drop on Cordless is 84".

Continuous Cord Loop System recommended for sizes within gray area in chart.

### LIFT SYSTEM SURCHARGES

WIDTH TO:	24"	30"	36"	42"	48"	54"	60"	66"	72"	84"	96"	108"	120"	132"	144"
Continuous Cord Loop	89	91	99	102	105	110	113	118	126	134	140	151	163	172	179
Lift & Lock Cordless*	89	91	99	102	105	110	113	118	126	134	140	151	163	172	179
Premium Cordless*	119	124	126	131	142	145	147	154	160	204	212	224	233	263	293

\*Maximum drop on Cordless is 84".

### ARCHES

WIDTH TO:	24"	30"	36"	42"	48"	54"	60"	66"	72"	84"
Perfect Arches - Stationary & Movable	148	167	189	212	240	274	309	348	383	422
Quarter Circle - Stationary & Movable	148	167	189	212	240	274	309	348	383	422

See page 22 for specifications

### SHADES OPTIONS & SURCHARGES

(add to Standard Rectangular price)

TDBU Corded	Price as Standard + \$100
TDBU Cont. Cord Loop	Price as Cont. Cord Loop + \$100
TDBU Cordless	Price as Cordless + \$125
Top Down Only	Price as Standard + \$100
Day Night	Price as Sum of Two Shades
Two-On-One	Price overall width as Standard + \$50
Summerfield Skylight	Price as Standard + \$100
Projection Brackets, Hold Down Brackets	No Charge
Cord Cleats, Shims	No Charge

### AMP MOTORIZATION SURCHARGES

AMP Motorized Standard w/ Battery Pack	.. Price as Cont. Cord Loop + \$580
AMP Remote for Standard	..... \$150
AMP TDBU Motorized w/Battery Pack	..... Price as Cont. Cord Loop + \$636
AMP Remote for TDBU	..... \$185
AMP Charger	..... \$85
AMP Bridge	..... \$440

See pages 26 - 27 for details on AMP Motorization

See pages 20 - 21 for Shade Specifications by Fabric

# 7 SUMMERFIELD™ Honeycomb Shades

## RETAIL PRICE GRID

- Allure D6 3/4" Semi Sheer Single Cell - Light Filtering
- Brushed Eclipse F37 3/4" Spun Bond Single Cell - Room Darkening

- Nightfall F17 3/4" Spun Bond Single Cell - Room Darkening
- Petite Nightfall F9 3/8" Spun Bond Single Cell - Room Darkening

WIDTH TO:	24"	30"	36"	42"	48"	54"	60"	66"	72"	84"	96"	108"	120"	132"	144"
<b>36"</b>	288	324	367	410	450	491	530	573	612	697	901	981	1058	1146	1229
<b>42"</b>	311	345	396	444	491	536	582	630	677	772	981	1072	1169	1263	1355
<b>48"</b>	329	375	425	478	530	582	634	690	738	845	1058	1167	1267	1375	1477
<b>54"</b>	350	400	457	515	573	628	687	744	801	916	1146	1255	1367	1492	1601
<b>60"</b>	368	424	488	548	611	674	738	801	864	991	1222	1350	1475	1601	1726
<b>HEIGHT TO: 66"</b>	391	450	519	582	657	722	791	857	926	1062	1310	1442	1584	1715	1849
<b>72"</b>	410	474	548	624	697	772	844	915	989	1136	1396	1542	1683	1827	1979
<b>78"</b>	426	500	577	657	739	820	893	974	1054	1211	1478	1641	1789	1942	2105
<b>*84"</b>	444	530	607	690	782	867	950	1030	1113	1278	1563	1733	1901	2065	2224
<b>90"</b>	466	561	650	737	824	915	1001	1088	1178	1349	1650	1827	2003	2174	2341
<b>96"</b>	498	589	679	773	865	964	1054	1146	1240	1425	1730	1925	2108	2290	2480
<b>108"</b>	534	642	744	857	968	1069	1171	1294	1405	1644	1826	2038	2238	2436	2637
<b>120"</b>	586	698	806	928	1048	1176	1282	1418	1570	1788	1997	2219	2437	2660	2876

\*Maximum drop on Cordless is 84".

Continuous Cord Loop System recommended for sizes within gray area in chart.

### LIFT SYSTEM SURCHARGES

WIDTH TO:	24"	30"	36"	42"	48"	54"	60"	66"	72"	84"	96"	108"	120"	132"	144"
<b>Continuous Cord Loop</b>	89	91	99	102	105	110	113	118	126	134	140	151	163	172	179
<b>Lift &amp; Lock Cordless*</b>	89	91	99	102	105	110	113	118	126	134	140	151	163	172	179
<b>Premium Cordless*</b>	119	124	126	131	142	145	147	154	160	204	212	224	233	263	293

\*Maximum drop on Cordless is 84".

### ARCHES

WIDTH TO:	24"	30"	36"	42"	48"	54"	60"	66"	72"	84"
<b>Perfect Arches - Stationary &amp; Movable</b>	148	167	189	212	240	274	309	348	383	422
<b>Quarter Circle - Stationary &amp; Movable</b>	148	167	189	212	240	274	309	348	383	422

See page 22 for specifications

### SHADES OPTIONS & SURCHARGES

(add to Standard Rectangular price)

TDBU Corded.....	Price as Standard + \$100
TDBU Cont. Cord Loop.....	Price as Cont. Cord Loop + \$100
TDBU Cordless.....	Price as Cordless + \$125
Top Down Only.....	Price as Standard + \$100
Day Night.....	Price as Sum of Two Shades
Two-On-One.....	Price overall width as Standard + \$50
Summerfield Skylight.....	Price as Standard + \$100
Projection Brackets, Hold Down Brackets.....	No Charge
Cord Cleats, Shims.....	No Charge

### AMP MOTORIZATION SURCHARGES

AMP Motorized Standard w/ Battery Pack ..	Price as Cont. Cord Loop + \$580
AMP Remote for Standard .....	\$150
AMP TDBU Motorized w/Battery Pack .....	Price as Cont. Cord Loop + \$636
AMP Remote for TDBU.....	\$185
AMP Charger.....	\$85
AMP Bridge.....	\$440

See pages 26 - 27 for details on AMP Motorization

See pages 20 - 21 for Shade Specifications by Fabric

# 8 SUMMERFIELD™ Honeycomb Shades

## RETAIL PRICE GRID

- Essence D8/D9 3/4" Sheer Single Cell - Light Filtering
- Shimmer D13/D14 3/4" Spun Lace Single Cell - Light Filtering

- Aurora G23/G24/G25 3/4" Spun Lace Single Cell - Room Darkening

WIDTH TO:	24"	30"	36"	42"	48"	54"	60"	66"	72"	84"	96"	108"	120"	132"	144"
<b>36"</b>	339	381	432	482	530	578	624	710	759	863	1116	1215	1310	1420	1522
<b>42"</b>	366	406	466	523	578	631	685	780	838	956	1215	1327	1448	1564	1678
<b>48"</b>	387	441	500	563	624	685	746	854	914	1047	1310	1445	1569	1703	1829
<b>54"</b>	412	470	537	606	674	738	808	921	992	1135	1420	1555	1693	1848	1982
<b>60"</b>	433	499	575	657	732	806	881	992	1070	1227	1514	1672	1827	1982	2138
<b>66"</b>	460	535	623	711	786	876	956	1061	1147	1315	1622	1787	1962	2123	2290
<b>72"</b>	482	558	645	734	820	908	993	1133	1226	1407	1729	1910	2084	2263	2451
<b>78"</b>	515	614	711	811	908	1003	1102	1207	1305	1500	1830	2033	2216	2406	2608
<b>*84"</b>	550	647	752	854	968	1073	1177	1276	1405	1683	1808	2145	2412	2483	2763
<b>90"</b>	571	679	788	903	1020	1133	1240	1365	1471	1816	2044	2263	2481	2692	2899
<b>96"</b>	615	728	844	962	1095	1220	1334	1456	1575	1944	2142	2384	2611	2837	3072
<b>108"</b>	665	789	923	1054	1198	1332	1464	1632	1762	2031	2445	2729	2997	3261	3531
<b>120"</b>	716	862	1004	1146	1304	1454	1593	1828	1976	2285	2621	3054	3354	3660	3958

\*Maximum drop on Cordless is 84".

Continuous Cord Loop System recommended for sizes within gray area in chart.

### LIFT SYSTEM SURCHARGES

WIDTH TO:	24"	30"	36"	42"	48"	54"	60"	66"	72"	84"	96"	108"	120"	132"	144"
<b>Continuous Cord Loop</b>	89	91	99	102	105	110	113	118	126	134	140	151	163	172	179
<b>Lift &amp; Lock Cordless*</b>	89	91	99	102	105	110	113	118	126	134	140	151	163	172	179
<b>Premium Cordless*</b>	119	124	126	131	142	145	147	154	160	204	212	224	233	263	293

\*Maximum drop on Cordless is 84".

### ARCHES

WIDTH TO:	24"	30"	36"	42"	48"	54"	60"	66"	72"	84"
<b>Perfect Arches - Stationary &amp; Movable</b>	148	167	189	212	240	274	309	348	383	422
<b>Quarter Circle - Stationary &amp; Movable</b>	148	167	189	212	240	274	309	348	383	422

See page 22 for specifications

### SHADES OPTIONS & SURCHARGES

(add to Standard Rectangular price)

<b>TDBU Corded</b> .....	Price as Standard + \$100
<b>TDBU Cont. Cord Loop</b> .....	Price as Cont. Cord Loop + \$100
<b>TDBU Cordless</b> .....	Price as Cordless + \$125
<b>Top Down Only</b> .....	Price as Standard + \$100
<b>Day Night</b> .....	Price as Sum of Two Shades
<b>Two-On-One</b> .....	Price overall width as Standard + \$50
<b>Summerfield Skylight</b> .....	Price as Standard + \$100
<b>Projection Brackets, Hold Down Brackets</b> .....	No Charge
<b>Cord Cleats, Shims</b> .....	No Charge

### AMP MOTORIZATION SURCHARGES

<b>AMP Motorized Standard w/ Battery Pack</b> ..	Price as Cont. Cord Loop + \$580
<b>AMP Remote for Standard</b> .....	\$150
<b>AMP TDBU Motorized w/Battery Pack</b> .....	Price as Cont. Cord Loop + \$636
<b>AMP Remote for TDBU</b> .....	\$185
<b>AMP Charger</b> .....	\$85
<b>AMP Bridge</b> .....	\$440

See pages 26 - 27 for details on AMP Motorization

See pages 20 - 21 for Shade Specifications by Fabric

# 9 SUMMERFIELD™ Grand Pleat Honeycomb Shades

## RETAIL PRICE GRID

• **Majestic Dawn 4032** Grand Pleat Spun Lace - Light Filtering

WIDTH TO:	24"	30"	36"	42"	48"	54"	60"	66"	72"	84"	96"	108"	120"	132"	144"
<b>36"</b>	284	316	359	404	445	482	525	564	604	688	779	967	1049	1127	1213
<b>42"</b>	304	344	392	442	482	530	580	623	669	760	838	1056	1154	1240	1335
<b>48"</b>	323	372	421	471	525	578	626	679	728	831	944	1152	1249	1355	1460
<b>54"</b>	344	396	452	509	564	623	674	736	786	905	1030	1238	1352	1469	1577
<b>60"</b>	361	416	482	542	604	668	728	786	853	980	1115	1333	1457	1579	1703
<b>HEIGHT TO:</b> <b>66"</b>	384	445	513	580	648	714	783	848	915	1049	1194	1422	1564	1693	1827
<b>72"</b>	404	470	542	621	688	760	829	900	974	1121	1280	1521	1656	1804	1951
<b>78"</b>	423	494	571	648	734	810	881	958	1037	1194	1364	1622	1763	1920	2074
<b>*84"</b>	442	514	597	679	769	857	937	1018	1099	1263	1443	1711	1875	2040	2200
<b>90"</b>	458	542	628	716	815	900	991	1073	1164	1331	1531	1804	1980	2145	2320
<b>96"</b>	475	571	655	755	855	949	1041	1128	1223	1409	1617	1897	2081	2262	2448
<b>108"</b>	501	597	697	796	905	1006	1106	1206	1300	1498	1717	2012	2210	2405	2604
<b>120"</b>	542	650	759	867	986	1097	1206	1311	1419	1639	1880	2190	2406	2627	2842

\*Maximum drop on Cordless is 84"

### GRAND PLEAT LIFT SYSTEMS

Continuous Cord Loop or Lift & Lock™ is included with Grand Pleat Honey Comb Shades.

- Standard Operating System Not Available.
- Premium Cordless available (surcharge applies)

### GRAND PLEAT LIFT SYSTEM SURCHARGES

WIDTH TO:	24"	30"	36"	42"	48"	54"	60"	66"	72"	84"	96"	108"	120"	132"	144"
<b>Premium Cordless*</b>	128	133	135	141	153	156	158	166	172	220	228	241	251	282	315

\*Maximum drop on Cordless is 84".

### GRAND PLEAT SHADE OPTIONS

Projection Brackets (Long, Medium, Short) .....	No Charge
Hold Down Brackets .....	No Charge
Cord Cleats .....	No Charge
Shims .....	No Charge

See pages 20 - 21 for Shade Specifications by Fabric

### AMP MOTORIZATION SURCHARGES

AMP Motorized Standard w/Battery Pack .....	\$580
AMP Remote for Standard .....	\$150
AMP Charger .....	\$85

See pages 26 - 27 for details on AMP Motorization



# 10 SUMMERFIELD™ Grand Pleat Honeycomb Shades

## RETAIL PRICE GRID

• **Majestic Sunset 4037** Grand Pleat Spun Lace - Room Darkening

WIDTH TO:	24"	30"	36"	42"	48"	54"	60"	66"	72"	84"	96"	108"	120"	132"	144"
<b>36"</b>	392	440	499	557	612	667	721	820	876	997	1289	1403	1513	1640	1758
<b>42"</b>	423	469	538	604	667	729	791	902	968	1104	1403	1533	1673	1807	1939
<b>48"</b>	447	509	578	650	721	791	862	987	1055	1209	1513	1669	1812	1968	2113
<b>54"</b>	476	543	621	700	779	853	934	1064	1146	1311	1640	1796	1955	2134	2290
<b>60"</b>	500	576	664	759	846	931	1018	1146	1236	1417	1749	1932	2111	2290	2469
<b>HEIGHT TO:</b>															
<b>66"</b>	531	618	720	821	908	1012	1104	1226	1325	1519	1874	2064	2266	2453	2645
<b>72"</b>	557	645	745	848	948	1049	1147	1309	1416	1626	1997	2207	2408	2614	2831
<b>78"</b>	595	709	821	937	1049	1159	1273	1394	1508	1732	2114	2348	2560	2779	3012
<b>*84"</b>	635	748	869	987	1119	1240	1359	1474	1623	1944	2088	2477	2786	2868	3191
<b>90"</b>	659	784	911	1043	1178	1309	1432	1577	1699	2097	2361	2614	2866	3110	3349
<b>96"</b>	710	841	975	1111	1265	1409	1540	1682	1820	2245	2475	2753	3016	3277	3548
<b>108"</b>	768	911	1066	1217	1383	1538	1691	1885	2035	2346	2824	3153	3462	3767	4078
<b>120"</b>	827	996	1160	1324	1506	1680	1840	2112	2283	2639	3027	3528	3874	4228	4572

\*Maximum drop on Cordless is 84".

### GRAND PLEAT LIFT SYSTEMS

Continuous Cord Loop or Lift & Lock™ is included with Grand Pleat Honey Comb Shades.

- Standard Operating System Not Available.
- Premium Cordless available (surcharge applies)

### GRAND PLEAT LIFT SYSTEM SURCHARGES

WIDTH TO:	24"	30"	36"	42"	48"	54"	60"	66"	72"	84"	96"	108"	120"	132"	144"
<b>Premium Cordless*</b>	128	133	135	141	153	156	158	166	172	220	228	241	251	282	315

\*Maximum drop on Cordless is 84".

### GRAND PLEAT SHADE OPTIONS

Projection Brackets (Long, Medium, Short) .....	No Charge
Hold Down Brackets .....	No Charge
Cord Cleats .....	No Charge
Shims .....	No Charge

See pages 20 - 21 for Shade Specifications by Fabric

### AMP MOTORIZATION SURCHARGES

AMP Motorized Standard w/Battery Pack .....	\$580
AMP Remote for Standard .....	\$150
AMP Charger .....	\$85

See pages 26 - 27 for details on AMP Motorization

# SUMMERFIELD™ Vertical Honeycomb Shades

## RETAIL PRICE GRID

**11**

• **Advantage 4041** 3/4" Spun Lace Single Cell - Light Filtering

WIDTH TO:		24"	30"	36"	42"	48"	54"	60"	66"	72"	78"	84"	96"	108"	120"	132"	144"	156"	168"
HEIGHT TO:	36"	537	590	645	698	742	786	836	885	931	1003	1022	1114	1275	1341	1413	1474	1587	1593
	42"	551	606	664	718	765	815	869	920	971	1048	1069	1152	1332	1408	1483	1551	1676	1682
	48"	561	624	684	739	792	845	897	955	1008	1092	1112	1216	1391	1467	1551	1628	1766	1772
	54"	584	637	702	762	816	869	930	991	1044	1135	1155	1266	1445	1529	1622	1701	1851	1860
	60"	607	652	722	783	842	899	964	1024	1082	1181	1201	1320	1502	1593	1689	1777	1941	1949
	66"	627	668	738	804	866	927	995	1060	1121	1224	1243	1371	1559	1659	1759	1855	2029	2036
	72"	648	709	758	827	893	956	1025	1093	1161	1270	1290	1422	1618	1720	1829	1929	2118	2125
	78"	669	748	785	848	920	986	1057	1131	1197	1314	1335	1474	1681	1783	1901	2006	2209	2217
	84"	690	758	817	865	943	1016	1092	1167	1235	1355	1374	1523	1737	1851	1974	2083	2290	2297
	90"	710	780	829	890	972	1044	1122	1200	1273	1400	1420	1577	1791	1916	2040	2159	2378	2385
	96"	732	806	854	912	994	1074	1155	1235	1312	1445	1464	1629	1853	1979	2111	2236	2471	2477
	108"	770	851	905	938	1025	1109	1195	1279	1361	1501	1521	1693	1921	2060	2199	2332	2581	2588
120"	816	887	958	982	1074	1164	1255	1346	1433	1588	1609	1791	2032	2181	2336	2477	2756	2763	

**12**

• **Daybreak F16** 3/4" Spun Bond Single Cell - Light Filtering

WIDTH TO:		24"	30"	36"	42"	48"	54"	60"	66"	72"	78"	84"	96"	108"	120"	132"	144"	156"	168"
HEIGHT TO:	36"	580	637	697	754	802	849	903	956	1006	1083	1104	1203	1377	1448	1526	1592	1714	1720
	42"	596	654	718	776	827	880	938	994	1048	1131	1155	1244	1439	1521	1601	1675	1810	1817
	48"	606	673	738	798	855	912	969	1032	1089	1179	1201	1313	1503	1584	1675	1758	1907	1914
	54"	631	688	758	823	881	938	1004	1070	1128	1226	1247	1368	1561	1652	1752	1837	1999	2009
	60"	655	705	780	846	910	971	1041	1105	1169	1275	1298	1426	1622	1720	1824	1919	2097	2105
	66"	677	721	797	868	935	1002	1074	1144	1211	1322	1343	1480	1684	1792	1900	2003	2191	2199
	72"	699	766	819	893	964	1033	1107	1181	1253	1371	1394	1536	1748	1858	1975	2084	2287	2295
	78"	723	808	847	916	994	1065	1142	1221	1292	1419	1442	1592	1815	1925	2053	2167	2386	2394
	84"	745	819	882	934	1019	1098	1179	1260	1334	1464	1484	1645	1876	1999	2132	2250	2473	2481
	90"	767	842	895	961	1050	1128	1212	1296	1375	1512	1534	1704	1935	2070	2203	2332	2568	2576
	96"	790	871	923	985	1073	1160	1247	1334	1417	1561	1582	1759	2001	2137	2280	2415	2669	2675
	108"	832	919	977	1013	1107	1198	1291	1382	1470	1621	1643	1828	2075	2225	2374	2518	2787	2795
120"	881	958	1034	1060	1160	1257	1356	1453	1548	1715	1737	1935	2194	2355	2522	2675	2976	2984	

### VERTICAL HONEYCOMB SHADE SURCHARGES

**Center Stack**  
Price as Standard + 195

**Split Stack/Center Opening**  
Price as Standard + 195

**Dual Panel**  
Price as two separate units and add together

# SUMMERFIELD™ Vertical Honeycomb Shades

## RETAIL PRICE GRID

13

- **Splendor H56** 3/4" Spun Bond Single Cell - Light Filtering
- **Brushed F36** 3/4" Spun Bond Single Cell - Light Filtering
- **Cache Linen 4021L** 3/4" Spun Lace Single Cell - Room Darkening
- **Nightfall F17** 3/4" Spun Bond Single Cell - Room Darkening
- **Majestic Dawn 4032** Grand Pleat Spun Lace - Light Filtering
- **Brushed Eclipse F37** 3/4" Single Cell - Room Darkening

WIDTH TO:		24"	30"	36"	42"	48"	54"	60"	66"	72"	78"	84"	96"	108"	120"	132"	144"	156"	168"
HEIGHT TO:	36"	626	648	675	732	781	824	881	932	982	1060	1080	1179	1358	1430	1503	1576	1700	1707
	42"	636	662	697	757	804	858	918	973	1025	1110	1131	1219	1420	1503	1583	1660	1801	1808
	48"	645	703	718	779	834	891	952	1013	1067	1161	1180	1294	1487	1569	1663	1748	1902	1909
	54"	676	721	746	804	863	923	985	1052	1109	1210	1230	1354	1547	1641	1743	1830	2002	2009
	60"	702	742	772	827	891	954	1022	1087	1153	1263	1282	1413	1612	1716	1819	1917	2104	2111
	66"	720	765	795	863	921	986	1061	1131	1199	1311	1331	1468	1676	1789	1899	2005	2202	2209
	72"	742	785	828	894	950	1020	1093	1167	1240	1361	1382	1528	1743	1855	1976	2090	2304	2311
	78"	770	812	863	913	982	1054	1131	1209	1282	1413	1432	1587	1813	1928	2058	2177	2405	2412
	84"	798	846	888	947	1006	1086	1169	1249	1328	1460	1480	1642	1877	2006	2143	2265	2498	2505
	90"	827	869	918	988	1039	1116	1205	1289	1371	1509	1528	1702	1940	2080	2215	2349	2596	2603
	96"	837	900	953	1022	1078	1151	1241	1328	1413	1562	1582	1762	2006	2150	2296	2438	2701	2707
	108"	879	945	1013	1080	1152	1228	1312	1379	1467	1624	1646	1832	2088	2242	2397	2547	2824	2832
120"	920	996	1078	1147	1227	1304	1383	1466	1550	1723	1743	1947	2211	2378	2551	2712	3025	3034	

14

- **Essence D8/D9** 3/4" Sheer Single Cell - Light Filtering
- **Shimmer D13/D14** 3/4" Spun Lace Single Cell - Light Filtering
- **Aurora G23/G24/G25** 3/4" Spun Lace Single Cell - Room Darkening
- **Majestic Sunset 4037** Grand Pleat Spun Lace - Room Darkening

WIDTH TO:		24"	30"	36"	42"	48"	54"	60"	66"	72"	78"	84"	96"	108"	120"	132"	144"	156"	168"
HEIGHT TO:	36"	661	732	805	874	937	998	1064	1133	1194	1299	1320	1563	1692	1787	1923	2106	2256	2404
	42"	685	753	837	910	977	1043	1118	1190	1259	1375	1396	1644	1785	1900	2036	2219	2369	2517
	48"	704	782	865	944	1016	1092	1168	1250	1320	1450	1470	1724	1881	1999	2136	2318	2468	2613
	54"	726	809	899	982	1062	1136	1223	1307	1385	1521	1542	1813	1974	2101	2237	2420	2570	2705
	60"	782	834	930	1015	1100	1185	1275	1363	1449	1599	1619	1890	2069	2212	2348	2530	2681	2801
	66"	793	880	961	1051	1145	1233	1329	1421	1513	1671	1691	1979	2163	2323	2459	2642	2792	2894
	72"	829	906	992	1092	1188	1285	1383	1480	1578	1746	1767	2067	2264	2424	2560	2742	2893	2996
	78"	869	954	1046	1125	1230	1331	1433	1541	1643	1822	1843	2150	2364	2532	2668	2850	3000	3096
	84"	899	992	1070	1171	1271	1380	1491	1596	1703	1889	1910	2237	2460	2644	2780	2963	3113	3193
	90"	928	1022	1118	1212	1317	1428	1543	1656	1768	1964	1984	2326	2555	2748	2885	3067	3217	3287
	96"	960	1063	1163	1260	1358	1480	1596	1715	1833	2039	2060	2406	2654	2856	2993	3175	3325	3386
	108"	1027	1138	1239	1360	1410	1583	1700	1812	1909	2133	2154	2505	2769	2989	3125	3308	3458	3502
120"	1095	1212	1315	1459	1461	1686	1805	1909	1985	2227	2248	2603	2885	3121	3257	3440	3590	3616	

### VERTICAL HONEYCOMB SHADE SURCHARGES

**Center Stack**  
Price as Standard + 195

**Split Stack/Center Opening**  
Price as Standard + 195

**Dual Panel**  
Price as two separate units and add together

# VERTICAL HONEYCOMB SPECIFICATIONS

## VERTICAL HONEYCOMB SHADES

Vertical Honeycomb shades fit rectangular windows, sliding glass doors, and door openings. Vertical Honeycomb shades open and close from side-to-side to accommodate sliding glass doors and are perfectly suited for use as room dividers. Vertical Honeycomb shades operate without dangling cords, hanging chains, or wands making them a safer choice for children and pets.

Available in 3/4" Single Cell Blackout, 3/4" Single Cell Translucent and Grand Pleat fabrics.

Color coordinated components.

## VERTICAL HONEYCOMB SHADE SURCHARGES

<b>Center Stack</b> .....	Price as Standard + 195
<b>Split Stack/Center Opening</b> .....	Price as Standard + 195
<b>Dual Panel</b> .....	Price as two separate units and add together

## SIZE SPECIFICATIONS

<b>Minimum Width:</b> .....	12"
<b>Minimum Height:</b> .....	24"
<b>Maximum Width:</b> .....	168"
<b>Maximum Height:</b> .....	120"

**NOTE:**  
For Center Opening or Dual Panels, specifications are per fabric panel.

**NOTE:**  
Center Opening shades are available in widths up to 336".  
If width is greater than 168", it will be fabricated as two shades with a single valance piece to create the illusion of a single shade.

## NO SURCHARGE OPTIONS

- Extension brackets
- Spacer blocks

**Note on order any options required**

## FINISHED DIMENSIONS

<b>Inside Mount:</b>	
<b>Headrail Unit:</b> .....	less 3/16"
<b>Shade Height:</b> .....	less 1/2"
<b>Valance Width (non-flush):</b> .....	plus 1 1/4"
<b>Valance Width (flush):</b> .....	less 3/16"

## Outside Mount:

<b>Headrail Unit:</b> .....	ordered width
<b>Shade Height:</b> .....	ordered height
<b>Valance Width:</b> .....	plus 1 1/4"

Width and height measurements may vary +/- 1/8".

## VERTICAL HONEYCOMB SHADE STACKING CONFIGURATIONS

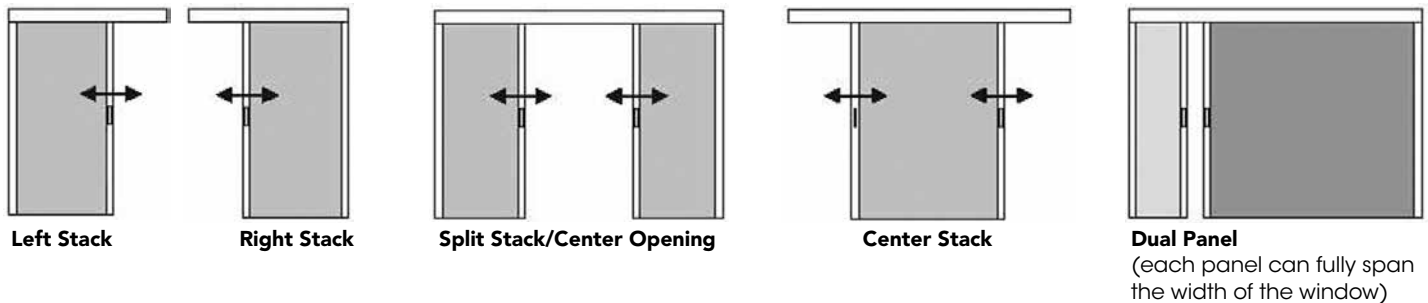

Refer to pages 16 - 17 for Summerfield™ Vertical Retail Price Grids  
Refer to pages 20 -21 for Shade Specifications by Fabric

# VERTICAL HONEYCOMB SPECIFICATIONS

## ALUMINUM VALANCE

An Aluminum valance comes standard with Pinnacle® Summerfield Honeycomb Vertical shade order.

Aluminum Valance Height: 2 3/4"

Color coordinated components.

**NOTE:**

Vertical Honeycomb shade widths over 190" may require the valance to be spliced.

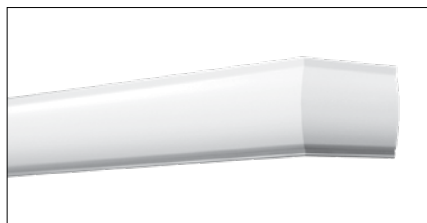

## MOUNTING REQUIREMENTS

### Inside Mount:

Minimum Mounting Depth: ..... 3/4"

### Flush Mount:

Minimum Mounting Depth for Aluminum Valance ..... 3 5/8"

Minimum Mounting Depth for Alternative Wood Valance ..... 4"

### Outside Mount:

Minimum flat vertical surface ..... 5/8"

### Fabric Stacking:

Stack determined by hardware, not ordered width ..... 6 1/2"

## FABRICS AVAILABLE

<b>Majestic Dawn 4032</b>	Grand Pleat Spun Lace
<b>Majestic Sunset 4037</b>	Grand Pleat Spun Lace
<b>Essence D8/D9</b>	3/4" Single Cell Sheer
<b>Shimmer D13/D14</b>	3/4" Single Cell Woven
<b>Brushed F36</b>	3/4" Single Cell Spun Bond
<b>Daybreak F16</b>	3/4" Single Cell
<b>Splendor H56</b>	3/4" Single Cell Spun Bond
<b>Advantage 4041</b>	3/4" Single Cell Spun Lace
<b>Aurora G23/G24/G25</b>	3/4" Single Cell Woven
<b>Brushed Eclipse F37</b>	3/4" Single Cell Spun Bond
<b>Nightfall F17</b>	3/4" Single Cell Spun Bond
<b>Cache Linen 4021L</b>	3/4" Single Cell Spun Lace

Refer to pages 16 - 17 for Summerfield™ Vertical Retail Price Grids

Refer to pages 20 -21 for Shade Specifications by Fabric

## CHECKLIST FOR ORDERING

- Specify inside flush, inside non-flush, or outside mount. If inside non-flush mount, either the inside mounting depth or the exact valance return length (minimum 1 1/2") must be specified.
- With outside mounts, allow 3" to 6" overlap on each side to minimize light gap, and account for minimum vertical mounting surface and desired floor clearance when specifying height.
- Specify stacking configuration.
- On split stack shades, both panels will be of equal width, unless otherwise specified.
- On dual panel shades, specify which fabric stacks to the left and which fabric stacks to the right. Note: Different pleat sizes cannot be combined on the same shade.
- Standard handle height ranges from 40" to 50" from bottom of moving rail; specify any non-standard handle height.
- An aluminum valance is included in the price of each shade.
- Specify spacer blocks or extension brackets, if desired.

# SHADE SPECIFICATIONS BY FABRIC

		Standard Rectangular	Top-Down	Top-Down/Bottom-Up	Day/Night	Two-on-One Standard	Lift & Lock™ Cordless	Lift & Lock™ Cordless TD/BU	Premium Cordless	Premium Cordless TD/BU	Continuous Cord	2-On-1 Continuous Cord	AMP™ Standard Motorization	Vertical
<b>Minimum Size: (All Fabrics)</b>	Width:	12"	12"	12"	12"	44"	18"	18"	18"	18"	22"	44"	18"	12"
	Height:	8"	12"	12"	18"	8"	8"	8"	8"	8"	8"	8"	8"	24"

## Maximum Size: (Fabric Specific)

<b>Majestic Dawn 4032</b> Grand Pleat Spun Lace Light Filtering	Width:	N/A	N/A	N/A	N/A	N/A	120"	120"	120"	N/A	144"	N/A	98"	168"
	Height:	N/A	N/A	N/A	N/A	N/A	84"	84"	84"	N/A	120"	N/A	84"	120"
	Sq Ft:	N/A	N/A	N/A	N/A	N/A	70	70	70	N/A	120	N/A	56	140

<b>Majestic Sunset 4037</b> Grand Pleat Spun Lace Room Darkening	Width:	N/A	N/A	N/A	N/A	N/A	120"	120"	120"	N/A	132"	N/A	98"	168"
	Height:	N/A	N/A	N/A	N/A	N/A	84"	84"	84"	N/A	120"	N/A	84"	120"
	Sq Ft:	N/A	N/A	N/A	N/A	N/A	70	70	70	N/A	120	N/A	56	140

<b>Essence D8/D9</b> 3/4" Single Cell Sheer	Width:	144"	108"	72"	72"	144"	120"	120"	120"	120"	144"	144"	144"	120"
	Height:	120"	120"	108"	96"	120"	84"	84"	84"	84"	120"	120"	108"	120"
	Sq Ft:	60	60	48	30	60	70	70	70	70	120	60	75	140

<b>Allure D6</b> 3/4" Single Cell Semi-Sheer	Width:	144"	108"	72"	72"	144"	120"	120"	120"	120"	144"	144"	144"	N/A
	Height:	120"	120"	108"	96"	120"	84"	84"	84"	84"	120"	120"	108"	N/A
	Sq Ft:	60	60	30	30	60	70	70	70	70	120	60	75	N/A

<b>Shimmer D13/D14</b> 3/4" Single Cell Spun Lace Light Filtering	Width:	144"	108"	72"	72"	144"	120"	120"	120"	120"	144"	144"	144"	168"
	Height:	120"	120"	108"	96"	120"	84"	84"	84"	84"	120"	120"	108"	120"
	Sq Ft:	60	60	30	30	40	70	70	70	70	120	60	75	140

<b>Brushed F36</b> 3/4" Single Cell Spun Bond Light Filtering	Width:	144"	108"	72"	72"	144"	120"	120"	120"	120"	144"	144"	144"	168"
	Height:	120"	120"	108"	96"	120"	84"	84"	84"	84"	120"	120"	84"	120"
	Sq Ft:	60	60	40	48	60	70	70	70	70	120	60	90	140

<b>Daybreak F16</b> 3/4" Single Cell Light Filtering	Width:	144"	108"	72"	72"	144"	120"	120"	120"	120"	144"	144"	144"	168"
	Height:	120"	120"	108"	96"	120"	84"	84"	84"	84"	120"	120"	108"	120"
	Sq Ft:	60	60	40	48	60	70	70	70	70	120	60	90	140

<b>Petite Daybreak F8 ▼</b> 3/8" Single Cell Light Filtering	Width:	144"	108"	72"	72"	144"	120"	120"	120"	120"	144"	144"	144"	N/A
	Height:	120"	120"	108"	96"	120"	84"	84"	84"	84"	120"	120"	108"	N/A
	Sq Ft:	60	60	48	48	60	70	70	70	70	120	60	90	N/A

<b>Splendor H56</b> 3/4" Single Cell Spun Bond Light Filtering	Width:	144"	108"	72"	72"	144"	120"	120"	120"	120"	144"	144"	144"	168"
	Height:	120"	120"	108"	96"	120"	84"	84"	84"	84"	120"	120"	84"	120"
	Sq Ft:	60	60	40	48	60	70	70	70	70	120	60	90	140

<b>Trio 4012</b> Spun Lace Triple Cell Light Filtering	Width:	144"	72"	72"	72"	144"	120"	120"	84"	84"	144"	144"	N/A	N/A
	Height:	120"	96"	96"	96"	120"	84"	84"	84"	84"	120"	120"	N/A	N/A
	Sq Ft:	60	48	48	48	60	70	70	49	49	120	60	N/A	N/A

<b>Timeless 4003</b> 9/16" Spun Lace Single Cell Light Filtering	Width:	144"	72"	72"	72"	144"	120"	120"	120"	120"	144"	144"	98"	N/A
	Height:	120"	96"	96"	96"	120"	84"	84"	84"	84"	120"	120"	84"	N/A
	Sq Ft:	60	48	48	48	60	70	70	70	70	120	60	56	N/A

<b>Timeless 4005</b> 3/4" Spun Lace Single Cell Light Filtering	Width:	144"	72"	72"	72"	144"	120"	120"	120"	120"	144"	144"	98"	N/A
	Height:	120"	96"	96"	96"	120"	84"	84"	84"	84"	120"	120"	84"	N/A
	Sq Ft:	60	48	48	48	60	70	70	70	70	120	60	56	N/A



# SHADE SPECIFICATIONS BY FABRIC

		Standard Rectangular	Top-Down	Top-Down/Bottom-Up	Day/Night	Two-on-One Standard	Lift & Lock™ Cordless	Lift & Lock™ Cordless TD/BU	Premium Cordless	Premium Cordless TD/BU	Continuous Cord	2-On-1 Continuous Cord	AMP™ Standard Motorization	Vertical
<b>Minimum Size: (All Fabrics)</b>	Width:	12"	12"	12"	12"	44"	18"	18"	18"	18"	22"	44"	18"	12"
	Height:	8"	12"	12"	18"	8"	8"	8"	8"	8"	8"	8"	8"	24"

## Maximum Size: (Fabric Specific)

<b>Timeless 4004</b> 1/2" Spun Lace Double Cell Light Filtering	Width:	144"	72"	72"	72"	144"	120"	120"	120"	120"	144"	144"	98"	N/A
	Height:	120"	96"	96"	96"	120"	84"	84"	84"	84"	120"	120"	84"	N/A
	Sq Ft:	60	48	48	48	60	70	70	70	70	120	60	56	N/A

<b>Whisper 4014</b> 3/8" Soft Double Cell Light Filtering	Width:	144"	72"	72"	72"	144"	120"	120"	120"	120"	144"	144"	108"	N/A
	Height:	120"	96"	96"	120"	84"	84"	84"	84"	84"	120"	120"	84"	N/A
	Sq Ft:	60	48	48	48	60	70	70	70	70	120	60	60	N/A

<b>Advantage 4041</b> 3/4" Single Cell Spun Lace Light Filtering	Width:	144"	72"	72"	72"	144"	120"	120"	120"	120"	144"	144"	120"	168"
	Height:	120"	96"	96"	96"	120"	84"	84"	84"	84"	120"	120"	84"	120"
	Sq Ft:	60	48	48	48	60	70	70	70	70	120	60	70	140

<b>Advantage 4043</b> 1/2" Double Cell Spun Lace Light Filtering	Width:	144"	72"	72"	72"	144"	120"	120"	120"	120"	144"	144"	120"	N/A
	Height:	120"	96"	96"	96"	120"	84"	84"	84"	84"	120"	120"	84"	N/A
	Sq Ft:	60	48	48	48	60	70	70	70	70	120	60	70	N/A

<b>Aurora G23/G24/G25</b> ■ 3/4" Single Cell Woven Room Darkening	Width:	144"	108"	72"	72"	144"	120"	120"	120"	120"	144"	144"	144"	168"
	Height:	120"	120"	108"	96"	120"	84"	84"	84"	84"	120"	120"	108"	120"
	Sq Ft:	40	40	40	40	40	70	70	70	70	120	60	75	140

<b>Brushed Eclipse F37</b> ■ 3/4" Single Cell Spun Bond Room Darkening	Width:	144"	108"	72"	72"	144"	120"	120"	120"	120"	144"	144"	144"	168"
	Height:	120"	120"	108"	96"	120"	84"	84"	84"	84"	120"	120"	108"	120"
	Sq Ft:	40	40	40	40	40	70	70	70	70	120	60	75	140

<b>Nightfall F17</b> ■ 3/4" Single Cell Spun Bond Room Darkening	Width:	144"	108"	72"	72"	144"	120"	120"	120"	120"	144"	144"	144"	168"
	Height:	120"	120"	108"	96"	120"	84"	84"	84"	84"	120"	120"	108"	120"
	Sq Ft:	40	40	40	40	40	70	70	70	70	120	60	75	140

<b>Petite Nightfall F9</b> ■ ▼ 3/8" Single Cell Room Darkening	Width:	144"	108"	72"	72"	144"	120"	120"	N/A	N/A	144"	144"	144"	N/A
	Height:	120"	120"	108"	96"	120"	84"	84"	N/A	N/A	120"	120"	108"	N/A
	Sq Ft:	60	40	40	48	60	70	70	N/A	N/A	120	60	90	N/A

<b>Midnight 4008</b> 3/4" Single Cell Room Darkening	Width:	144"	72"	72"	72"	144"	120"	120"	84"	84"	144"	144"	76"	N/A
	Height:	120"	96"	80"	80"	120"	84"	84"	84"	84"	120"	120"	84"	N/A
	Sq Ft:	60	40	40	40	60	70	70	49	49	120	60	44	N/A

<b>Cache Linen 4021L</b> ■ 3/4" Single Cell Spun Lace Room Darkening	Width:	144"	108"	72"	72"	144"	120"	120"	120"	120"	144"	144"	120"	168"
	Height:	120"	120"	108"	96"	120"	84"	84"	84"	84"	120"	120"	84"	120"
	Sq Ft:	40	40	40	40	40	70	70	70	70	120	60	70	140

<b>Tranquil 4023</b> ■ 1/2" Double Cell Room Darkening	Width:	128"	72"	72"	72"	128"	120"	120"	84"	84"	128"	128"	80"	N/A
	Height:	120"	96"	96"	96"	120"	84"	84"	84"	84"	120"	120"	84"	N/A
	Sq Ft:	60	40	40	40	53	70	70	49	49	106	53	46	N/A

■ If specifying Day-Night Shade, this fabric is available for bottom panel.

▼ F8 and F9 Fabrics are not available with Lift & Lock Day/Night Shades.

Maximum Size for Lift & Lock Day/Night Shade is 48" width x 60" length.

# ARCHES & QUARTER CIRCLE SPECS

	Moveable Arch	Stationary Arch	Moveable Quarter Circle	Stationary Quarter Circle
<b>Minimum Size: (All Fabrics)</b>	Width: 18" Height: 9"	Width: 18" Height: 9"	Width: 10" Height: 9"	Width: 10" Height: 9"
<b>Maximum Size: (Fabric Specific)</b>				
<b>Essence D8/D9</b> 3/4" Single Cell Sheer	Width: 72" Height: 36"	Width: 72" Height: 36"	Width: 48" Height: 48"	Width: 48" Height: 48"
<b>Allure D6</b> 3/4" Single Cell Semi-Sheer	Width: 72" Height: 36"	Width: 72" Height: 36"	Width: 48" Height: 48"	Width: 48" Height: 48"
<b>Shimmer D13/D14</b> 3/4" Single Cell Spun Lace Light Filtering	Width: 72" Height: 36"	Width: 72" Height: 36"	Width: 48" Height: 48"	Width: 48" Height: 48"
<b>Brushed F36</b> 3/4" Single Cell Spun Bond Light Filtering	Width: 72" Height: 36"	Width: 72" Height: 36"	Width: 48" Height: 48"	Width: 48" Height: 48"
<b>Daybreak F16</b> 3/4" Single Cell Light Filtering	Width: 72" Height: 36"	Width: 72" Height: 36"	Width: 48" Height: 48"	Width: 48" Height: 48"
<b>Petite Daybreak F8</b> 3/8" Single Cell Light Filtering	Width: 72" Height: 36"	Width: 72" Height: 36"	Width: 48" Height: 48"	Width: 48" Height: 48"
<b>Splendor H56</b> 3/4" Single Cell Spun Bond Light Filtering	Width: 72" Height: 36"	Width: 72" Height: 36"	Width: 48" Height: 48"	Width: 48" Height: 48"
<b>Trio 4012</b> Spun Lace Triple Cell Light Filtering	Width: 60" Height: 30"	Width: 60" Height: 30"	Width: 48" Height: 48"	Width: 48" Height: 48"
<b>Timeless 4003</b> 9/16" Spun Lace Single Cell Light Filtering	Width: 60" Height: 30"	Width: 60" Height: 30"	Width: 48" Height: 48"	Width: 48" Height: 48"
<b>Timeless 4005</b> 3/4" Spun Lace Single Cell Light Filtering	Width: 60" Height: 30"	Width: 60" Height: 30"	Width: 48" Height: 48"	Width: 48" Height: 48"
<b>Timeless 4004</b> 1/2" Spun Lace Double Cell Light Filtering	Width: 60" Height: 30"	Width: 60" Height: 30"	Width: 48" Height: 48"	Width: 48" Height: 48"
<b>Whisper 4014</b> 3/8" Soft Double Cell Light Filtering	Width: N/A Height: N/A	Width: 60" Height: 30"	Width: N/A Height: N/A	Width: 30" Height: 30"
<b>Advantage 4041</b> 3/4" Single Cell Spun Lace Light Filtering	Width: 72" Height: 36"	Width: 72" Height: 36"	Width: 48" Height: 48"	Width: 48" Height: 48"
<b>Advantage 4043</b> 1/2" Double Cell Spun Lace Light Filtering	Width: 72" Height: 36"	Width: 72" Height: 36"	Width: 48" Height: 48"	Width: 48" Height: 48"
<b>Aurora G23/G24/G25</b> 3/4" Single Cell Woven Room Darkening	Width: 72" Height: 36"	Width: 72" Height: 36"	Width: 48" Height: 48"	Width: 48" Height: 48"
<b>Brushed Eclipse F37</b> 3/4" Single Cell Spun Bond Room Darkening	Width: 72" Height: 36"	Width: 72" Height: 36"	Width: 48" Height: 48"	Width: 48" Height: 48"
<b>Nightfall F17</b> 3/4" Single Cell Spun Bond Room Darkening	Width: 72" Height: 36"	Width: 72" Height: 36"	Width: 48" Height: 48"	Width: 48" Height: 48"
<b>Petite Nightfall F9</b> 3/8" Single Cell Room Darkening	Width: 72" Height: 36"	Width: 72" Height: 36"	Width: 48" Height: 48"	Width: 48" Height: 48"
<b>Midnight 4008</b> 3/4" Single Cell Room Darkening	Width: 60" Height: 30"	Width: 60" Height: 30"	Width: 48" Height: 48"	Width: 48" Height: 48"
<b>Cache Linen 4021L</b> 3/4" Single Cell Spun Lace Room Darkening	Width: 72" Height: 36"	Width: 72" Height: 36"	Width: 48" Height: 48"	Width: 48" Height: 48"
<b>Tranquil 4023</b> 1/2" Double Cell Room Darkening	Width: 60" Height: 30"	Width: 60" Height: 30"	Width: 48" Height: 48"	Width: 48" Height: 48"

# STACKING HEIGHTS

## SUMMERFIELD™ HONEYCOMB - Grand Pleat

<b>Majestic Dawn 4032</b> Grand Pleat Spun Lace Light Filtering				
<b>DROP</b>	48"	72"	84"	120"
<b>STACK</b>	2 5/8"	3 5/8"	4"	6 7/8"
<b>RAILS</b>	1"	1"	1"	1"

<b>Majestic Sunset 4037</b> Grand Pleat Spun Lace Room Darkening				
<b>DROP</b>	48"	72"	84"	120"
<b>STACK</b>	2 5/8"	3 5/8"	4"	6 7/8"
<b>RAILS</b>	1"	1"	1"	1"

## SUMMERFIELD™ HONEYCOMB - Light Filtering

<b>Essence D8/D9</b> 3/4" Single Cell Sheer				
<b>DROP</b>	48"	72"	84"	120"
<b>STACK</b>	1/2"	9/16"	5/8"	1"
<b>RAILS</b>	1"	1"	1"	1"

<b>Shimmer D13/D14</b> 3/4" Single Cell Woven				
<b>DROP</b>	48"	72"	84"	120"
<b>STACK</b>	1/4"	1/2"	3/4"	1 1/4"
<b>RAILS</b>	1"	1"	1"	1"

<b>Daybreak F16</b> 3/4" Single Cell				
<b>drop</b>	48"	72"	84"	120"
<b>STACK</b>	1/4"	1/2"	3/4"	1 1/4"
<b>RAILS</b>	1"	1"	1"	1"

<b>Splendor H56</b> 3/4" Single Cell Spun Bond				
<b>DROP</b>	48"	72"	84"	120"
<b>STACK</b>	1/4"	1/2"	3/4"	1 1/4"
<b>RAILS</b>	1"	1"	1"	1"

<b>Timeless 4003</b> 9/16" Spun Lace Single Cell				
<b>DROP</b>	48"	72"	84"	120"
<b>STACK</b>	1 1/2"	2"	2 1/4"	4"
<b>RAILS</b>	1"	1"	1"	1"

<b>Timeless 4004</b> 1/2" Spun Lace Double Cell				
<b>DROP</b>	48"	72"	84"	120"
<b>STACK</b>	2 1/8"	3 1/8"	3 1/2"	6"
<b>RAILS</b>	1"	1"	1"	1"

<b>Advantage 4041</b> Spun Lace Single Cell				
<b>DROP</b>	48"	72"	84"	120"
<b>STACK</b>	1"	1 1/2"	2"	3"
<b>RAILS</b>	1"	1"	1"	1"

<b>Advantage 4043</b> Spun Lace Double Cell				
<b>DROP</b>	48"	72"	84"	120"
<b>STACK</b>	2 1/8"	3 1/8"	3 1/2"	6"
<b>RAILS</b>	1"	1"	1"	1"

<b>Allure D6</b> 3/4" Single Cell Semi-Sheer				
<b>DROP</b>	48"	72"	84"	120"
<b>STACK</b>	1 1/4"	1 3/4"	2"	3 1/4"
<b>RAILS</b>	1"	1"	1"	1"

<b>Brushed F36</b> 3/4" Single Cell Spun Bond				
<b>DROP</b>	48"	72"	84"	120"
<b>STACK</b>	1/4"	1/2"	3/4"	1 1/4"
<b>RAILS</b>	1"	1"	1"	1"

<b>Petite Daybreak F8</b> 3/8" Single Cell				
<b>DROP</b>	48"	72"	84"	120"
<b>STACK</b>	3/4"	1 1/8"	1 3/8"	2 1/8"
<b>RAILS</b>	1"	1"	1"	1"

<b>Trio 4012</b> Spun Lace Triple Cell				
<b>DROP</b>	48"	72"	84"	120"
<b>STACK</b>	2 1/2"	3 1/2"	4"	6"
<b>RAILS</b>	1"	1"	1"	1"

<b>Timeless 4005</b> 3/4" Spun Lace Single Cell				
<b>DROP</b>	48"	72"	84"	120"
<b>STACK</b>	1"	1 1/2"	2"	3"
<b>RAILS</b>	1"	1"	1"	1"

<b>Whisper 4014</b> 3/8" Soft Double Cell				
<b>DROP</b>	48"	72"	84"	120"
<b>STACK</b>	2 1/8"	3 1/8"	3 1/2"	4"
<b>RAILS</b>	1"	1"	1"	1"

## SUMMERFIELD™ HONEYCOMB - Room Darkening

<b>Aurora G23, G24, G25</b> 3/4" Spun Lace Single Cell				
<b>DROP</b>	48"	72"	84"	120"
<b>STACK</b>	1/2"	3/4"	1 1/8"	1 3/4"
<b>RAILS</b>	1"	1"	1"	1"

<b>Nightfall F17</b> 3/4" Single Cell Spun Bond				
<b>DROP</b>	48"	72"	84"	120"
<b>STACK</b>	1/2"	3/4"	1 1/8"	1 3/4"
<b>RAILS</b>	1"	1"	1"	1"

<b>Midnight 4008</b> 3/4" Single Cell				
<b>DROP</b>	48"	72"	84"	120"
<b>STACK</b>	1 1/2"	2"	2 1/2"	4"
<b>RAILS</b>	1"	1"	1"	1"

<b>Tranquil 4023</b> 1/2" Double Cell				
<b>DROP</b>	48"	72"	84"	120"
<b>STACK</b>	1 1/2"	2"	2 1/2"	4"
<b>RAILS</b>	1"	1"	1"	1"

<b>Brushed Eclipse F37</b> 3/4" Single Cell Spun Bond				
<b>DROP</b>	48"	72"	84"	120"
<b>STACK</b>	1/2"	3/4"	1 1/8"	1 3/4"
<b>RAILS</b>	1"	1"	1"	1"

<b>Petite Nightfall F9</b> 3/8" Single Cell				
<b>DROP</b>	48"	72"	84"	120"
<b>STACK</b>	1"	1 1/2"	1 5/8"	2 3/4"
<b>RAILS</b>	1"	1"	1"	1"

<b>Cache Linen 4021L</b> 3/4" Single Cell Spun Lace				
<b>DROP</b>	48"	72"	84"	120"
<b>STACK</b>	1 1/2"	2"	2 1/2"	4"
<b>RAILS</b>	1"	1"	1"	1"

**DROP** - Refers to Shade Fully Extended  
**STACK** - Refers to Shade Fully Raised  
**RAILS** - Add to Stack Measurement

# DIMENSIONS & MOUNTING SPECS

## FINISHED DIMENSIONS

### Inside Mount:

Headrail\* will measure ordered width less 3/8"

### Outside Mount (End Cap to End Cap):

Headrail\* will measure ordered width.

\*Headrail Measurements include end caps.

Width and Height Measurements may vary +/- 1/8".

## NO CHARGE OPTIONS:

- Special Cord Lengths
- Hold Down Brackets
- Spacer Blocks
- Extension Brackets
- Cord Cleats
- Side Mount

Note on order any options required.

## WIDTH LIMIT - SIDE MOUNT BRACKETS

Recommended 48" width limit on shades installed with side mount brackets.

## MOUNTING:

### Standard Rail & Lift & Lock™ Standard Rail:

Minimum Shallow Mounting Surface:	1/2"
Minimum Flush Inside Mounting Surface:	2"
Minimum Outside Mounting Surface:	3/4"

### Deluxe Rail\* & Lift & Lock™ Deluxe Rail:

Minimum Shallow Mounting Surface:	1/2"
Minimum Flush Inside Mounting Surface:	2 1/2"
Minimum Outside Mounting Surface:	3/4"

### Continuous Cord System:

Minimum Shallow Mounting Surface:	1"
Minimum Flush Inside Mounting Surface:	2"
Minimum Outside Mounting Surface:	1"

### Premium Cordless System\*:

Minimum Shallow Mounting Surface:	1"
Minimum Flush Inside Mounting Surface:	2"
Minimum Outside Mounting Surface:	1"

### AMP™ Motorization:

Minimum Shallow Mounting Surface:	1 1/2"
Minimum Flush Inside Mounting Surface:	3 3/8"
Minimum Outside Mounting Surface:	1 1/4"

Deluxe rail is used for fabrics with larger pleat size.

## RAIL MEASUREMENTS

When measuring and installing, please keep in mind the following rail measurements:

### Standard Rail & Lift & Lock™ Standard Rail:

Depth:	1 7/16"
Height:	1/2"

### Deluxe Rail & Lift & Lock™ Deluxe Rail:

Depth:	1 7/8"
Height:	1/2"

### Deluxe Continuous Cord System:

Depth:	2"
Height:	2"

### Premium Cordless System:

Depth:	1 11/16"
Height:	1 5/16"

### AMP™ Motorization System:

Depth:	1 11/16"
Height:	1 5/16"

## FABRICS FOR DELUXE RAIL

<b>Majestic Dawn 4032</b>	Grand Pleat Spun Lace
<b>Majestic Sunset 4037</b>	Grand Pleat Spun Lace
<b>Essence D8/D9</b>	3/4" Single Cell Sheer
<b>Allure D6</b>	3/4" Single Cell Sheer
<b>Shimmer D13/D14</b>	3/4" Single Cell Spun Lace
<b>Brushed F36</b>	3/4" Single Cell Spun Bond
<b>Daybreak F16</b>	3/4" Single Cell Spun Bond
<b>Splendor H56</b>	3/4" Single Cell Spun Bond
<b>Trio 4012</b>	Triple Cell Spun Lace
<b>Timeless 4005</b>	3/4" Single Cell Spun Lace
<b>Timeless 4004</b>	1/2" Double Cell Spun Lace
<b>Advantage 4041</b>	3/4" Double Cell Spun Lace
<b>Advantage 4043</b>	1/2" Single Cell Spun Lace
<b>Aurora G23/G24/G25</b>	3/4" Single Cell Spun Lace
<b>Brushed Eclipse F37</b>	3/4" Single Cell Spun Bond
<b>Nightfall F17</b>	3/4" Single Cell Spun Bond
<b>Midnight 4008</b>	3/4" Single Cell Spun Lace
<b>Cache Linen 4021L</b>	3/4" Single Cell Spun Lace
<b>Tranquil 4023</b>	1/2" Double Cell Spun Lace

# SUMMERFIELD SKYLIGHT SPECS

## APPLICATIONS

- Fits rectangular window openings
- Operates manually (with handle) on any slope or orientation; ideal for skylights (extension pole available)
- AMP™ motorization available
- Ends of headrail, moving rail, and anchor rail are enclosed by side tracks
- Can be ordered to have the fabric stack at the top or bottom

## STANDARD SIZES

Minimum Width:.....	18"
Maximum Width:.....	60"
Minimum Height:.....	6"
Maximum Height:.....	72"
Maximum Square Feet:.....	25

## MOUNTING REQUIREMENTS

### Inside Mount 3/8" Single Cell:

Minimum Mounting Depth:.....	1"
Minimum Mounting Depth Flush Mount:.....	1 11/16"

### Outside Mount 3/8" Single Cell:

Minimum flat vertical surface.....	5/8"
------------------------------------	------

### Inside Mount 3/4" Single Cell:

- Minimum Mounting Depth:..... 1 1/4"
- Minimum Mounting Depth Flush Mount:..... 2 1/2"

### Outside Mount 3/4" Single Cell:

- Minimum flat vertical surface..... 1"

## HOW TO PRICE

### Add Skylight surcharge of \$100 to standard base price

- All base prices are predicated on Ordered Dimensions not Finished Dimensions
- Optional extension pole available with a surcharge
- AMP™ Motorization available

## CHECKLIST FOR ORDERING

- Specify inside (IB) or outside (OB) mount
- Specify shade orientation - vertical, sloped, or horizontal
- Specify fabric stacking - stack top, stack bottom, or stack side
- For stack side applications, use width specification for height and use height specifications for width
- Specify optional extension pole, if desired

## FINISHED DIMENSIONS

All allowances are taken from ordered dimensions and may vary  $\pm 1/8"$  from those shown below.

### Inside Mount:

Headrail Unit:.....	less 3/16"
Shade Height:.....	ordered height
Fabric Width:.....	less 3/4"

### Outside Mount:

Headrail Unit:.....	plus 3/4"
Shade Height:.....	ordered height
Fabric Width:.....	ordered width

*Note: All finished dimensions include side tracks.*

## HARDWARE

- 785 Aspen White only
- Installation brackets included
- Extension pole available (surcharge applies - specify on order)

## NOTES

- Support cord is required when shade is over 36" wide in sloped or skylight applications
- Rail stiffener required with shades over 42" wide

## SKYLIGHT WITH AMP MOTORIZATION SPECS

Maximum Width:.....	48"
Maximum Height:.....	72"
Maximum Square Feet:.....	24

## FABRICS AVAILABLE

<b>Essence D8/D9</b>	3/4" Single Cell Sheer
<b>Allure D6</b>	3/4" Single Cell Sheer
<b>Shimmer D13/D14</b>	3/4" Single Cell Spun Lace
<b>Brushed F36</b>	3/4" Single Cell Spun Bond
<b>Daybreak F16</b>	3/4" Single Cell Spun Bond
<b>Splendor H56</b>	3/4" Single Cell Spun Bond
<b>Timeless 4005</b>	3/4" Single Cell Spun Lace
<b>Aurora G23/G24/G25</b>	3/4" Single Cell Spun Lace
<b>Brushed Eclipse F37</b>	3/4" Single Cell Spun Bond
<b>Nightfall F17</b>	3/4" Single Cell Spun Bond
<b>Cache Linen 4021L</b>	3/4" Single Cell Spun Lace

# AMP™ MOTORIZED LIFT SYSTEM

## AMP™ MOTORIZATION DETAILS:

Summerfield Honeycomb shades can be motorized with the AMP Motor powered by a rechargeable Li-ion battery. Shades can be controlled with AMP Remote via AMP App using USB Bridge. AMP App allows voice command and other home integration devices.

## APPLICATIONS:

- Fits rectangular window opening
- Standard Shades in Select Summerfield Fabrics
- Skylight AMP Motorization Available

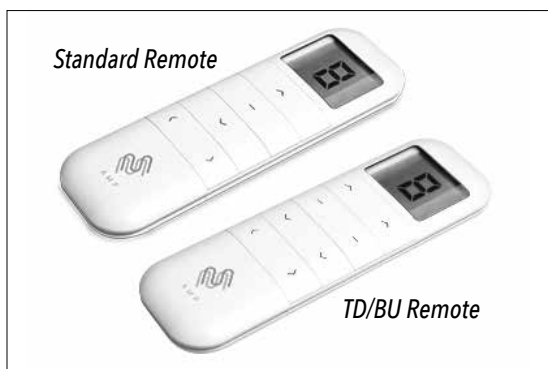

## AMP™ Remote

- Up to 15 channel remote with 3V (CRV2450) battery
- Standard Remote available in black or white
- TD/BU Remote available in white
- Magnetic holder included
- Channel 0 (zero) controls all shades assigned to remote
- Ability to hide extra channels
- Locking feature prevents unwanted configuration changes



## AMP™ Bridge

- USB Bridge enable App control from iOS and Android devices
- Radio frequency 433Mhz with 2.4 Ghz Wifi built-in
- Bi-directional RF communication allows shade position and battery level status to be seen on the APP
- Integrated with Amazon Alexa, Google Assistant, Apple Shortcuts, and IFTTT

## SPECIFICATIONS

- Wire-free motor powered by rechargeable Li-ion battery
- 500 cycles per charge; 500 recharges per motor
- Variable speed control
- Shades can be controlled via Remote or AMP™ App using USB Bridge
- AMP™ USB Bridge allows bi-directional communication with shade position reporting & battery level status



## AMP™ Charger

- 5V/2A charger for DC battery motors
- Fully charges in approximately 4-6 hours
- Has LED indicator
- Micro USB wire cable included (6 feet)



## AMP™ APP

- IOS / Android compatible
- Voice control - Google Home / Amazon Alexa / Siri integrated
- Rooms / Scenes / Timer features
- Live feedback
- Monitor battery level status
- Easy shade scheduling



# AMP™ MOTORIZATION

**HOW TO PRICE** - Price shade as Continuous Cord Loop and add for motorization

## Standard Motorized

Motorized Standard with Battery Pack.....	<b>\$490</b>
AMP Remote Control for Standard .....	<b>\$150</b>
AMP Charger .....	<b>\$85</b>

\* Add surcharge for at least one Remote Control per order.

## Top Down / Bottom Up Motorized

Motorized TDBU with Battery Pack.....	<b>\$650</b>
AMP Remote Control for TDBU .....	<b>\$185</b>
AMP Charger.....	<b>\$85</b>

\* Add surcharge for at least one Remote Control per order.

## ADDITIONAL AMP™ MOTORIZED OPTIONS AVAILABLE

See Reference Guide AMP Motorization for breakdown including item numbers (chart below).

### AMP Motorization Options

AMP Bridge .....	<b>\$440</b>
AMP 10' Cable Only (for charger).....	<b>\$20</b>
AMP Motor Extension Cable Only - 4' .....	<b>\$10</b>

### Motorization Details:

- Minimum Width for Standard Motorization - 18"
- Minimum Width for TDBU Motorization - 27"
- Minimum Width for Skylight Motorization - 18"
- Maximum width and height will vary by fabric.
- See Shade Specifications by Fabric pages 20 - 21

### Mounting Requirements:

#### Inside Mount:

Minimum Mounting Depth.....	1 1/2"
Minimum Mounting Depth for Flush Mount .....	3 3/8"

#### Outside Mount:

Minimum Flat Vertical Surface .....	1 1/4"
-------------------------------------	--------

### Ordering Considerations

- Order shade size and specify inside or outside mount
- Price all applicable surcharges
- Specify right or left side for motor
- Specify number of remotes and chargers
- Specify programming on order form
- Initial charge of battery - 6 hours

### AMP™ Motorization - 5 Year Warranty

## Reference Guide - AMP™ Motorization for Summerfield™

	<i>Retail</i>
<b>Summerfield AMP Motor - Standard with Battery</b>	<b>\$490</b>
<i>includes:</i>	
62006000 AMP Motor	\$300
62203100 AMP External Battery Pack (fits inside headrail)	\$190
<i>At least one remote and charger required per order</i>	
<b>Summerfield AMP Motor - Standard with Plug In Transformer</b>	<b>\$390</b>
<i>Includes:</i>	
62006000 AMP Motor	\$300
62209000 AMP Plug In Transformer (AC Adapter) with 60" Cord	\$90
<i>At least one remote required per order</i>	
<b>Summerfield AMP Standard Remote</b>	<b>\$150</b>
<i>Specify by Color. At least one remote required per order</i>	
62101000 AMP 15 Channel Remote White	\$150
62101010 AMP 15 Channel Remote Black	\$150
<b>Optional Extension Cable</b>	<b>\$10</b>
<i>Extension available for alternate battery placement away from shade</i>	
62207000 AMP 4' (48") Standard Motor Extension Cable	\$10
<b>Summerfield AMP TDBU Motor</b>	<b>\$650</b>
<i>includes:</i>	
62009000 AMP TDBU Motor	\$290
62009100 AMP TDBU End Cap Receiver	\$145
AMP Cable TDBU Motor to End Cap	\$25
62203100 AMP External Battery Pack (fits inside headrail)	\$190
<i>At least one remote and charger required per order</i>	
<b>Summerfield AMP TDBU Remote</b>	<b>\$185</b>
<i>At least one remote required per order</i>	
62101100 AMP TDBU Remote 15 Channel (White Only)	\$185
<b>AMP Charger</b>	<b>\$85</b>
62205000 AMP Charger includes 3' USB Cable *	\$85
<i>* Motor may be charged with cell phone charger</i>	
<b>Optional USB Cable for purchase</b>	<b>\$20</b>
<i>USB Cable Only - For charger to replace 3' cable</i>	
62206000 AMP 10' (120") USB	\$20
<b>AMP Bridge</b>	<b>\$440</b>
62102000 AMP Bridge	\$440

### AMP™ External Battery Pack



**AMP™ Inside Headrail External Battery Pack - 62203100**  
For TDBU - Fits inside of headrail

# SUMMERFIELD™

## HONEYCOMB SHADES

# SHADE PRODUCT DETAILS

## Large Bracket Specs

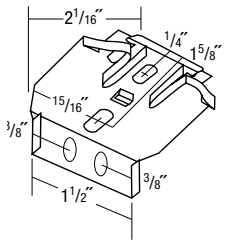

## Small Bracket Specs

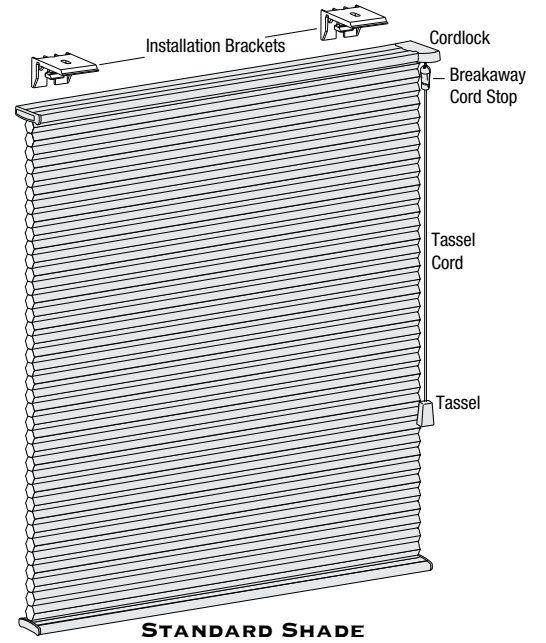
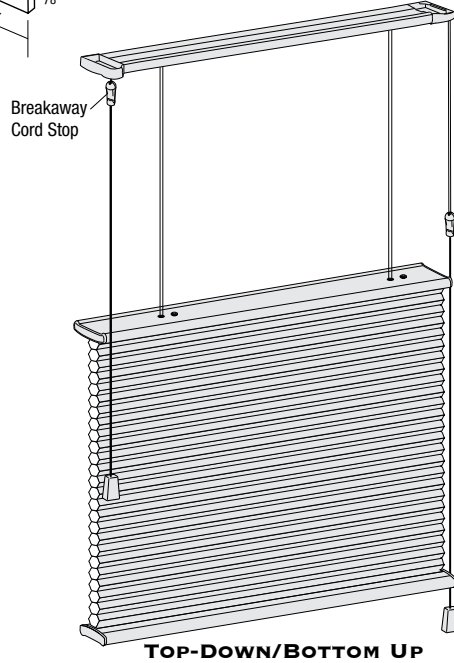
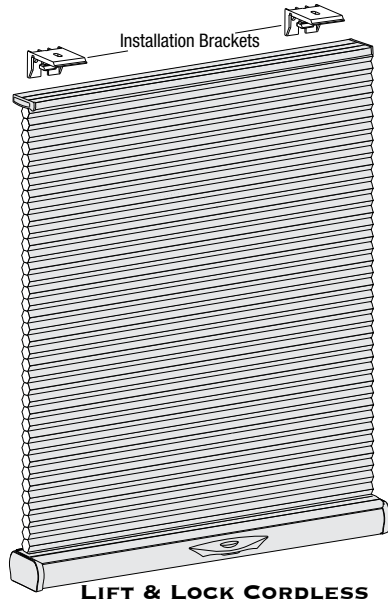
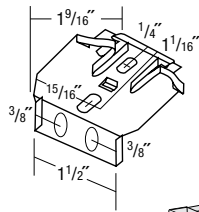

## Bracket Specs

Premium Cordless, Continuous Loop, and AMP™ Motorized

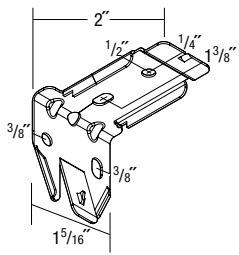

## Vertical Bracket Specs

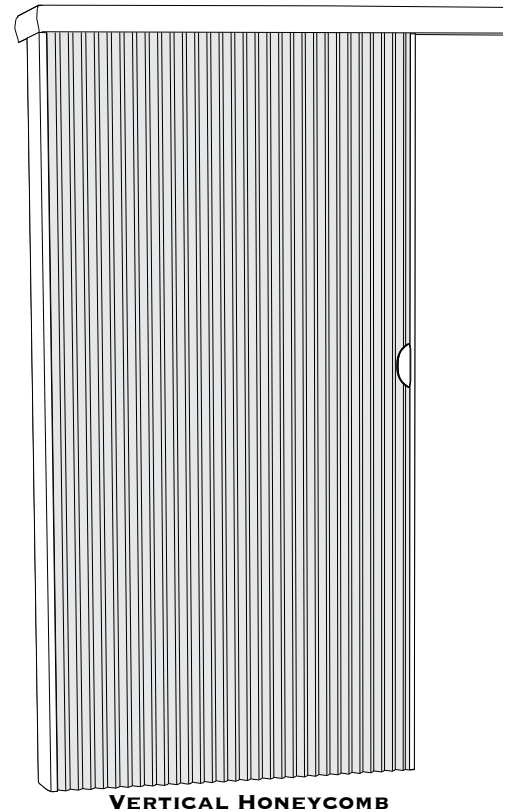
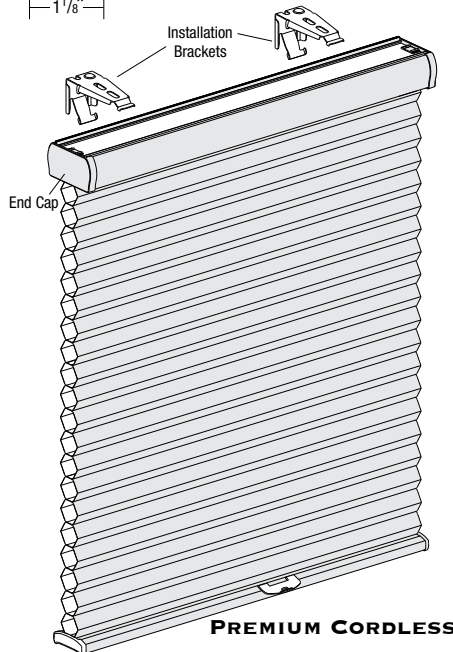
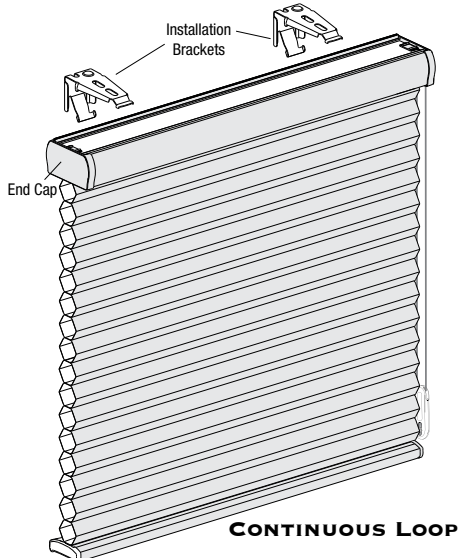
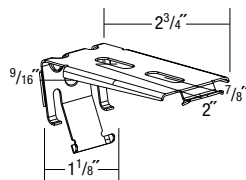

# MEASURING INSTRUCTIONS

Accurate measurements are essential, for both correct pricing and proper fit. Use only a hard-edged ruler or steel tape, never a cloth tape. For inside mounts, width measurements (A) should be rounded down to the nearest 1/8" to prevent shade or vertical honeycomb from binding against the window casing.

## INSIDE MOUNT (IB)

Use a steel tape to measure the opening width (A) at three different places, and use the narrowest dimension when ordering. Be exact! The factory will make the fabric 3/8" narrower so it will not rub against the window casing and the headrail 1/16" narrower. Measure the height (B) of the window from the top (Soffit) down to the sill.

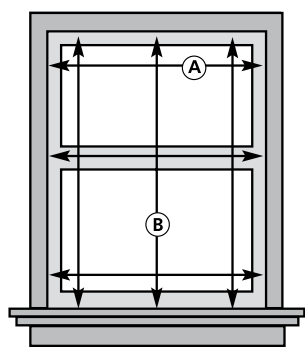

**INSIDE MOUNT (IB)**  
Honeycomb Shade

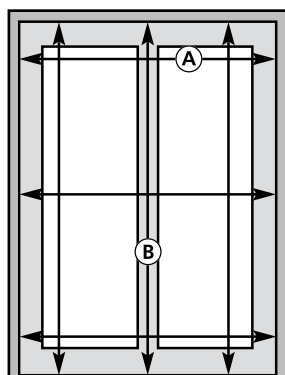

**INSIDE MOUNT (IB)**  
Vertical Honeycomb

## OUTSIDE MOUNT (OB)

Use a steel tape to measure the exact width (A) and height (B) of the area to be covered. It is recommended that the shades overlap the window by at least 1 1/2" on each side. When installation has no sill, allow the shade to overlap the bottom of the window casing by at least 1 1/2". Shade or vertical honeycomb will measure width indicated on the order form.

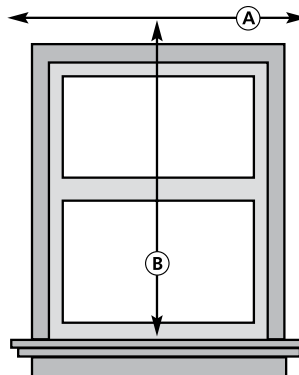

**OUTSIDE MOUNT (OB)**  
Honeycomb Shade

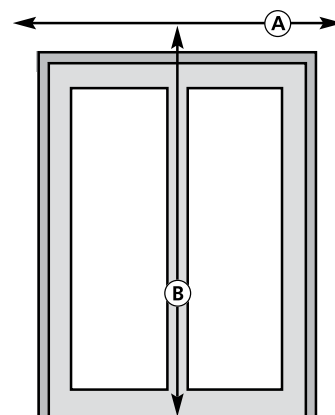

**OUTSIDE MOUNT (OB)**  
Vertical Honeycomb

## 5 STEPS TO AN ACCURATE TEMPLATE

1. Tape butcher paper or heavy wrapping paper over the window opening, allowing plenty of overlap. Do not use paper that has ever been folded; a template can have no folds or creases.
2. Draw an exact outline of the window opening. Do this by carefully tracing over the inside edge of the window frame.
3. Remove the paper from the window opening. If the shade is an outside mount, add the desired amount of overlap to the window outline and draw a second outline around it to match the shape of the finished shade.
4. Mark the shade dimensions on the template. Check that the template dimensions match the measurements of the actual window opening.
5. Identify the template and its orientation. Write the customer's name and PO# on the template, and mark the ROOM SIDE and TOP. Roll up the template and place it in a mailing/shipping tube.

### DO NOT FOLD TEMPLATE

#### IMPORTANT:

*Template must be cut out in the exact shape of the window opening and tested in window for correct fit.*

## ARCHES & QUARTER CIRCLES

- For inside mounts, measure the exact width and height inside the window opening.
- For outside mounts, measure the desired width and height.
- Measure the height at its tallest point.
- All arch shades can only be made for perfect arches. For perfect arches height will equal one-half the width.
- For quarter circles, height must equal width.

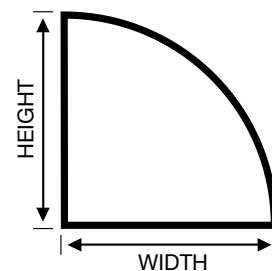
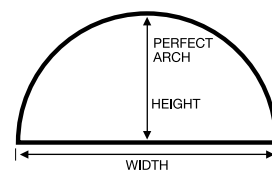

### TEMPLATE REQUIRED FOR ALL ARCHES AND QUARTER CIRCLES

# SUMMERFIELD™ Ordering Reference Steps and Tips

## How To Order

The total retail price for a Summerfield™ Honeycomb Shade is determined by the following information:

1. Fabric selection
2. The size of the shade ordered
3. Options requested

---

### 1. FABRIC SELECTION

Each fabric uses a separate price chart located in the pricing section, pages 6 - 17 for Summerfield™ Honeycomb grids. Take note of size limitations. Some options are only available in restricted sizes.

---

### 2. SIZE OF SHADE

**On the appropriate price chart, the shade's base price is determined by the size of the shade.**

- Round up the shade's measured width and height to the nearest width and height dimensions on the chart.
- Locate the shade's base price - follow down the column under the shade's rounded-up width until it crosses the line of prices for the shade's rounded-up height. Where the two intersect is the shade's correct base price.

---

### 3. OPTIONS REQUESTED

Below each price chart is information for that fabric's available options. Add the appropriate surcharges to the shade's base price to arrive at the shade's total price.

## Ordering Tips

**Use Standard Order Form on page 31 when ordering Summerfield™ Honeycomb Shades.**

**Use Motorized Order Form on page 32 when ordering Summerfield™ Motorized Shades.**

**Use Vertical Order Form on page 33 when ordering Summerfield™ Vertical Shades.**

- Size Limitations: Some options are only available in restricted sizes. See pages 20 - 21 for Shade Specification by Fabric.
- Day-Night Shade Fabric Restrictions: Fabric combinations are limited to two fabric groups. Refer to the appropriate specifications page for details.
- Continuous Cord Recommendations: Large shades, within the boxed area of the price charts, are easier to operate using a Continuous Cord system.
- Be sure to use exact width and height dimensions when ordering.

*In addition to the correct price, all orders must include the following information:*

- Fabric selection
- Color name & color number
- All options requested
- Position of controls, left or right side
- Accurate measurements for the shade's width and height
- Type of mounting required:
  - Inside Mount (IB)
  - Outside Mount (OB)
- Desired window/wall clearance
- Other options such as hold-down brackets



**SUMMERFIELD™**  
**HONEYCOMB SHADES**

# SUMMERFIELD™ HONEYCOMB SHADES



## ORDER FORM

ACCOUNT NAME: \_\_\_\_\_

SHIP TO: \_\_\_\_\_

Account #:

Address: \_\_\_\_\_

Contact Person:

Address: \_\_\_\_\_

Phone #:

City/State/Zip: \_\_\_\_\_

Fax #:

Sidemark:

PO #:

Date: \_\_\_\_\_

Line # / Sidemark	QTY	Pattern / SKU #*	Measurements in inches to the nearest 1/8"		Mount IB or OB	Control Side L or R	Operating Systems	Additional Requests
			Width	Height				
1							<ul style="list-style-type: none"> <li>Standard</li> <li>TDBU Cont. Cord</li> <li>Two-on-One</li> <li>Premium Cordless</li> <li>TDBU Cordless</li> <li>Skylight</li> <li>Lift &amp; Lock™</li> <li>Top Down Only</li> <li>AMP Motorization</li> <li>TDBU Corded</li> <li>Day Night</li> </ul>	<ul style="list-style-type: none"> <li>Hold Down Brackets</li> <li>EXT Brackets</li> </ul>
2								
3								
4								
5								
6								
7								
8								
9								
10								

Special Instructions:

\_\_\_\_\_

\_\_\_\_\_

\_\_\_\_\_

\_\_\_\_\_

\_\_\_\_\_

Phone: 1-800-334-1207

Fax: 1-800-400-1795



\* Please Note: Dye Lots May Vary From Order To Order

# SUMMERFIELD™ HONEYCOMB SHADES

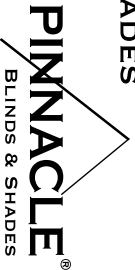

## AMP™ Motorization Order Form

ACCOUNT NAME: \_\_\_\_\_

SHIP TO: \_\_\_\_\_

Account #: \_\_\_\_\_

Address: \_\_\_\_\_

Contact Person: \_\_\_\_\_

Address: \_\_\_\_\_

Phone #: \_\_\_\_\_

Fax #: \_\_\_\_\_

City/State/Zip: \_\_\_\_\_

Sidemark: \_\_\_\_\_

PO #: \_\_\_\_\_

Date: \_\_\_\_\_

Line # / Sidemark	QTY	Pattern / SKU # *	Measurements in Inches to the nearest 1/8"	Mount IB or OB	Motor Position L or R	Standard Motorized Must Order at least One remote per order - See Options Below -	TDBU Motorized Must Order at least One remote per order - See Options Below -	Note Channel Number For Programming Include Any Additional Programming Instructions Below
Width	Height							
1								
2								
3								
4								
5								
6								
7								
8								
9								
10								

\* Please Note: Dye Lots May Vary From Order To Order

### Standard Motorized Honeycomb Options

- RETAIL PRICING**
- Remote - Black or White (\$150) \_\_\_\_\_
  - AMP™ Charger (\$85) \_\_\_\_\_
  - 10' (120") USB Cable for Charger (\$20) \_\_\_\_\_
  - To replace 3 cable
  - AMP™ BRIDGE (\$440) \_\_\_\_\_
  - 4' (48") Extension Cable (\$10) \_\_\_\_\_
  - for alternate battery placement away from shade

### TDBU Motorized Honeycomb Options

- RETAIL PRICING**
- Remote - White Only (\$185) \_\_\_\_\_
  - AMP™ Charger (\$85) \_\_\_\_\_
  - 10' (120") USB Cable for Charger (\$20) \_\_\_\_\_
  - To replace 3 cable
  - AMP™ BRIDGE (\$440) \_\_\_\_\_

Special Programming Instructions: \_\_\_\_\_

\_\_\_\_\_

\_\_\_\_\_

\_\_\_\_\_

\_\_\_\_\_

Phone: 1-800-334-1207  
Fax: 1-800-400-1795





# SUMMERFIELD™ HONEYCOMB SHADES



## VERTICAL ORDER FORM

ACCOUNT NAME: \_\_\_\_\_

SHIP TO: \_\_\_\_\_

Account #:

Address: \_\_\_\_\_

Contact Person:

Address: \_\_\_\_\_

Phone #:

Fax #:

City/State/Zip: \_\_\_\_\_

Sidemark:

PO #:

Date:

Line # / Sidemark	QTY	Pattern / SKU #*	Measurements in inches to the nearest 1/8"		Mount IB or OB	Control Side L or R	Stack			Aluminum Valance <i>Specify any custom returns if required</i>	Additional Requests		
			Width	Height			Left	Right	Center		Spit	Dual Panel	EXT Brackets
1													
2													
3													
4													
5													
6													
7													
8													
9													
10													

Special Instructions:

\_\_\_\_\_

\_\_\_\_\_

\_\_\_\_\_

\_\_\_\_\_

\_\_\_\_\_

Phone: 1-800-334-1207  
Fax: 1-800-400-1795



\* Please Note: Dye Lots May Vary From Order To Order

# CARE, SAFETY & WARRANTY INFORMATION

## CARING FOR SHADES

While beautiful and pleasing to the eye, all products are designed to be durable, easily cared for, and easily cleaned. Non-woven fabrics are inherently anti-static and repel dust, but occasional feather dusting or vacuuming may be necessary to keep the fabrics clean and bright.

Spills and stains can be lightly blotted with a cloth or damp sponge. More difficult stains may require soaking in water with mild soap. To clean shades, remove them from the window and submerge in soapy

water, soak, and rub lightly. Lay flat to dry or place back in window and raise tightly to re-crisp pleats. Be sure to test any stronger cleaners on an unobtrusive portion of the shade before use. **DO NOT** submerge the Cordless headrail or Soft Double Cell fabric in water.

Summerfield Honeycomb shades should be raised and lowered monthly for pleat retention. Particularly important with Premium Cordless operating system.

## LIMITED LIFETIME WARRANTY

United Supply Company offers a limited lifetime warranty for Pinnacle Summerfield Honeycomb Shades. Summerfield Honeycomb Shades will be free from defects in materials and workmanship, under normal conditions of use and treatment, provided that the products were properly installed, and the products were made or assembled exclusively from United Supply Company materials and components. The obligations of United Supply Company, its fabricators, and distributors are limited to the repair or replacement of the shade or components found to be defective. This excludes shipping charges and labor costs for measuring, fabricating, and installation. United Supply Company will not be held responsible for any trip charges.



This warranty does not include any conditions or damages resulting from accidents, alterations, misuse, abuse, or failure to follow printed instructions on care and cleaning, installation, or repairs. This warranty also does not apply to conditions resulting from normal wear and tear. Please keep in mind that cords and like materials will wear over time and will have to be replaced. Cords are under warranty for 3 years.

Before using Summerfield Honeycomb Shades, the buyer should determine the suitability of the product for its intended use. United Supply Company shall not be held liable for any injury, loss, or damage resulting from the use of the shades.

This warranty does not cover damage to shade fabrics from using window cleaners or any similar substances. Please follow the printed instructions on **Care and Cleaning for Shades**. This warranty does not cover any damages incurred from removal or relocation of the shades.

**THIS WARRANTY IS EXCLUSIVE AND IN LIEU OF ALL OTHER OBLIGATIONS, LIABILITIES, OR WARRANTIES.**

In no event shall United Supply Company, its licensed fabricators, or distributors be liable or responsible for INCIDENTAL OR CONSEQUENTIAL DAMAGES or any other loss, cost, or fee associated with such damage. Some states do not allow the exclusion or limitation of incidental or consequential damages, so the above limitation may not apply. AMP Motorization system motors and components hold a five-year warranty.

## CHILD SAFETY

Summerfield Honeycomb Shades are designed with child safety as a top priority. To reduce the risk of strangulation, fabrication methods incorporate features that comply with the current ANSI cord safety standards.

For Summerfield Honeycomb shades made with a clutch operating system, a tension device is provided by United Supply Company as a

safety measure. The tension device can help prevent children and pets from pulling cords around their necks. If the tension device is tampered with or modified, it will not work properly. Please take the necessary measures to ensure that the tension device has been properly installed to prevent accidental strangulation.



# SUMMERFIELD™ Honeycomb Shades

## Sampling Information



SUMMERFIELD™  
HONEYCOMB  
SAMPLE BOOK  
ITEM #PNCCELL-2016

Updated 2021 Sample Book  
Includes - PNCCELL-UPDATE21



SUMMERFIELD™ UPDATE KIT  
To update existing Summerfield™  
Sample Book order update kit  
PNCCELL-UPDATE21



**WARNING**  
**ADVERTENCIA**

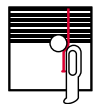

Window Treatment/Blind Cord Can STRANGLE  
Your Child. To prevent strangulation, purchase  
cordless products with inaccessible cords.

La cuerda de la persiana puede ESTRANGULAR a su niño.  
Para evitar el estrangulamiento, compre alternativas cuerdo  
o productos con cuerdas inaccesibles.

**PINNACLE®**  
BLINDS & SHADES



Softer shades of living.



Summerfield™  
Honeycomb Shades  
Made in the USA



Charlotte, NC • Atlanta, GA • Nashville, TN • Raleigh, NC • Pittsburgh, PA • Chicago, IL

PNHCPL-2021