

Stereo Review

SEPTEMBER 1989 ● \$2.50

INCORPORATING HIGH FIDELITY®

**HOW TO BUY
A LOUDSPEAKER**

**SPECIAL TEST REPORT:
MERIDIAN'S DIGITAL
ACTIVE SPEAKER SYSTEM**

**ALSO TESTED:
NAD TAPE DECK,
FISHER CD CHANGER,
LUXMAN TUNER/PREAMP,
ALLISON SPEAKERS, MORE...**



MR DAVID S BUCHANAN
8900 YELLOW WOOD PL 40242
LOUISVILLE KY 40242
09#XD

#259B*****5-DIGIT 40242
#BCH8900Y091#
430492 BCH 8900Y091 741J JAN90



The RTA Series



RTA 111

"They provide smooth, fast and incredibly well detailed sound."

"Polk's RTA Tower Loudspeakers Combine Legendary Polk Performance with Contemporary Style."

Big speaker performance with an efficient use of space.

RTA 11t

The RTA 11t is the finest conventional (non-SDA) speaker that Polk Audio manufacturers. Its extremely high power handling (250 watts) and high efficiency (90dB) provide remarkable dynamic range from both large and small amplifiers. The RTA 11t utilizes the same technologically advanced fluid-coupled subwoofer design found in Polk's flagship model. Dual 8" sub-bass radiators are coupled to two 6½" mid/bass drivers, resulting in a fast, powerful, deep, and ultra-accurate bass response, without the boomy, undetailed sound of large woofer systems.

RTA 8t

In a slightly smaller package, the RTA 8t offers the same driver complement as the larger, more expensive RTA 11t, and thus shares its benefits of superior imaging, musicality, and detail.

Both Polk RTA series loudspeakers achieve the extremely rare combination of good looks and state-of-the-art performance. The tall, elegantly slender, and deep "tower" design cabinets allow for substantial internal volume for high efficiency and powerful bass, while requiring less than one square foot of floor space. The small baffle surface area around each driver minimizes diffraction (sonic reflections), thereby insuring outstanding imaging and low coloration.

Positioning the 1" silver-coil dome tweeter between the two 6½" trilaminate polymer bass/midrange drivers achieves what is called "coincident radiation." This means that both the mid- and high-frequencies appear to radiate from the same place on the baffle resulting in perfect blending at the critical crossover point. (See illustration, below).

Polk RTA speakers have an uncanny ability to perfectly reproduce the human voice, pianos, guitars, and every other instrument whose faithful reproduction demands superlative midrange and high-frequency performance. Bass and percussion instruments are accurately reproduced with full visceral power and realism, without the heaviness, boominess, or lack of detail that plague lesser designs.

The discriminating listener who seeks state-of-the-art performance and design will find the quintessential combination of both in Polk's RTA series loudspeakers.

THE PRINCIPLES OF COINCIDENT RADIATION

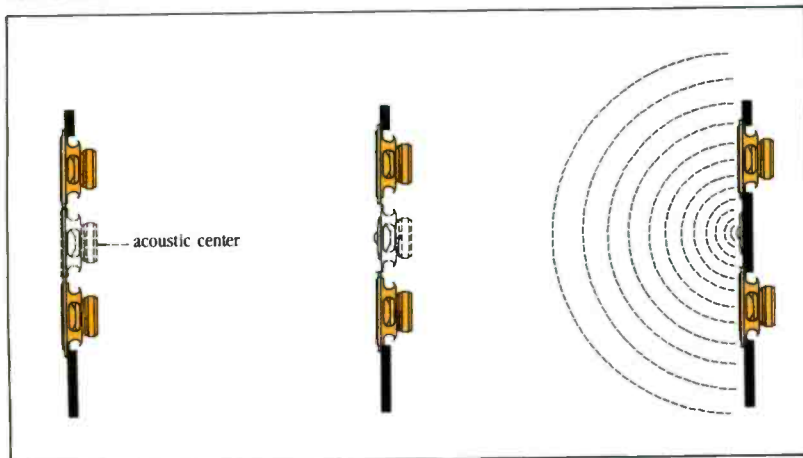

The perceived source of sound of two identical drivers is centered in the area between them.

The benefit of coincident waveform propagation resulting in precise imaging, uniform vertical dispersion and startling midrange accuracy.

In the Polk RTA loudspeaker, the tweeter is positioned at the acoustic center of the drivers.



Polk Audio's RTA 8t and RTA 11t High Performance Tower Speakers

polk audio
The Speaker Specialists®

5601 Metro Drive, Baltimore, Md. 21215

Where to buy Polk Speakers? For your nearest dealer, see page 158.

CIRCLE NO. 90 ON READER SERVICE CARD

The Monitor Series



Monitor 10B

"The best high performance speaker value on the market today." Off The Record

“Polk’s Remarkable Monitors Redefine Incredible Sound/Affordable Price”

“At their price, they’re simply a steal” Audiogram Magazine

Monitor 10B

Considered one of the worlds’ best sounding loudspeakers and, in the words of Audiogram magazine, “At the price they are simply a steal.” The Polk 10B utilizes dual trilaminate polymer drivers coupled to a built-in subwoofer for accurate bass response and superior dynamic range. A 1” dome tweeter perfectly complements the other drivers to insure outstanding reproduction of every type of music.

Monitor 7C

Basically a smaller, less expensive version of the Monitor 10B. By offering superlative performance whether mounted on a shelf or a speaker stand, the 7C is a highly versatile addition to any audio system. How good does it sound? Audio Alternative magazine said, “It is amazing.”

Monitor 5B

Similar in design and performance to the Monitor 7C, however it utilizes an 8” subwoofer (rather than 10”) and is more compact. The 5B represents one of the best values of the entire Monitor Series.

Monitor 5Jr. +

Called the best sounding speaker of its price in the world regardless of size. It achieves life-like three-dimensional imaging which 10 years ago was not available in any bookshelf speaker at any price.

Monitor 4.5

Shares most of the high technology components and rewarding musical performance of the larger Polk speakers at a surprisingly low price. A critically tuned bass duct insures high efficiency and great bass performance despite its convenient compact design.

Monitor 4A

Identical to the 4.5 in a smaller cabinet. Audio critic Lawrence Johnson called it, “an all around star of great magnitude.” The 4A’s affordable price means that no matter how small your budget, you can afford the incredible sound of Polk!



Matthew Polk with his incredible sounding/affordably priced Monitor Series loudspeakers. Front row (L to R) Monitor 5Jr. + , Monitor 4A, Monitor 4.5 Back row (L to R) Monitor 10B, Monitor 7C, Monitor 5B

Matthew Polk’s Vision: Superior Sound for Everyone

Polk Audio is an American company that was founded in 1972 by three Johns Hopkins University graduates who were fanatical audiophiles with a common vision. They believed that it was possible to make speakers that performed as well as the most exotic and expensive systems at a fraction of the price. Starting with only \$200, they began by designing and manufacturing the Monitor Series loudspeakers. The Monitor Series combined the advantages of American high technology and durability with European styling and refinement. Over the years an unending stream of rave reviews, industry awards, and thousands of enthusiastic Polk customers have established the Monitor Series as the choice for those looking for both incredible sound and an affordable price. There is no better value in audio equipment today than a Polk Monitor series loudspeaker.

Uncompromising Standards at Every Price

A limited budget does not mean a limited ability to appreciate fantastic sounding music. That’s why we put our best engineering efforts and only the finest materials into every Polk product regardless of price.

Every Polk Monitor Series speaker uses the same trilaminate polymer cone technology as the flagship SDA-SRS 1.2. Every Polk Monitor utilizes a 1” polymer dome tweeter, and most use exactly the same tweeter found in the SRS 1.2. All Polk Monitors employ costly multi-component crossover networks and ¾” thick high density, non-resonant cabinets. Pick up a Polk Monitor 4A, then pick up a comparably priced but larger speaker from a different manufacturer. You’ll notice that the Polk is heavier, more solidly built, and sports a superior fit and finish. Now compare the sound. We are sure you’ll agree with Musician magazine, which said Polk Monitors are: “Vastly superior to the competition.”

The Thrilling Sound of Polk Monitors

Polk Monitors achieve open, boxless, three-dimensional imaging surpassed only by the SDAs. Their silky smooth frequency response assures natural, non-fatiguing, easy to listen to sound, while their fast transient response results in music that is reproduced with life-like clarity and detail. In addition, dynamic bass performance, ultra-wide dispersion, high efficiency and high power handling are all hallmarks of Monitor Series performance.

There is a Polk Monitor Perfect for You

Each time you advance through the six Monitor Series models, you’ll immediately hear a remarkable improvement in efficiency, bass response, and output volume. They are designed so that a smaller Polk played in a small room will sound nearly identical to a larger Polk played in a large room. A larger Polk in a small room will, of course, play that much louder with even better bass. No matter what price range fits your budget, there is a spectacular Polk Monitor Series speaker waiting to fulfill your sonic dreams.

**Where to buy Polk Speakers?
For your nearest dealer, see page 158.**



They said it was impossible to build an AM/FM multi-play CD controller and cassette deck with a detachable face.



But Pioneer pulled it off. Introducing the Premier™ KEX-M800.

What's in a name? Everything if it's the new Premier™ KEX-M800.

The world's first car stereo that not only offers you a combination multi-play compact disc player, AM/FM tuner, and cassette deck. It also features an anti-theft detachable face plate to help keep your system safe from prying eyes.

The only thing more exclusive than the KEX-M800 is our dealer network. Premier Installation Specialists are expert craftsmen, so you know your system will be custom installed with the utmost care.

So see your Pioneer Premier dealer. And watch us pull off the impossible.

For your nearest dealer call 1-800-421-1404.

PREMIER™

Premier™ Advanced technology from Pioneer. ©1989 Pioneer Electronics (USA) Inc., Long Beach, CA

CIRCLE NO. 31 ON READER SERVICE CARD

Stereo Review

Incorporating High Fidelity®

BULLETIN.....	9	GOING ON RECORD.....	32
EDITORIAL.....	10	TECHNICAL TALK.....	37
LETTERS.....	14	POPULAR REVIEWS.....	128
NEW PRODUCTS.....	17	CLASSICAL REVIEWS.....	144
AUDIO Q&A.....	26	RECORD MAKERS.....	162
SIGNALS.....	28	THE HIGH END.....	164

EQUIPMENT

NEWS FLASH: DAT GOES VIDEO A report from Japan	by Bryan Harrell	36
HIRSCH-HOUCK LABS EQUIPMENT TEST REPORTS Denon AVC-2000 Integrated A/V Amplifier, page 45 Allison AL 120 Speaker System, page 47 Fisher DAC-Z1 Compact Disc Changer, page 52 NAD Model 6320 Cassette Deck, page 56 Luxman TP-117 Tuner/Preamplifier, page 64		45
SHOW STOPPERS Outstanding new products from the Consumer Electronics Show	by Rebecca Day	95
HOW TO BUY SPEAKERS Selecting the right speaker can be enjoyable— if you're prepared	by Ian G. Masters	100
MERIDIAN D600 DIGITAL ACTIVE SPEAKER A special test report	by Julian Hirsch	108
THE NOISE ABOUT FMX Controversy surrounds what seemed to be a promising technique for improving stereo FM reception	by Rich Warren	113
PSYCHO-WHAT? Psychoacoustics. Without understanding how we perceive music, how could we reproduce it?	by Ken C. Pohlmann	116

MUSIC

ROGER NORRINGTON "You can dance the whole of Bach's St. Matthew Passion"	by David Patrick Stearns	105
BEST RECORDINGS OF THE MONTH Marshall Crenshaw, Haydn piano sonatas, "Tribute to John Coltrane," and Hanson's Symphonies Nos. 1 and 2		123

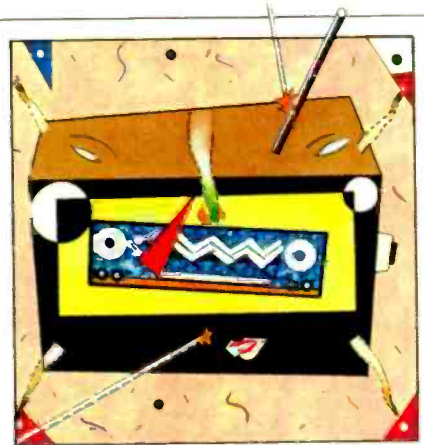

PAGE 113



PAGE 100



Cover: design by Sue Llewellyn.
photo by Hing/Norton.

COPYRIGHT © 1989 BY DIAMANDIS COMMUNICATIONS INC. All rights reserved. Stereo Review, September 1989, Volume 54, Number 9. Stereo Review (ISSN 0039-1220) is published monthly by Diamandis Communications Inc. at 1515 Broadway, New York, NY 10036; telephone (212) 719-6000. Also publishers of Car Stereo Review, Stereo Buyers' Guide, Compact Disc Buyers' Guide, and Video Buyers' Guide. One-year subscription rate for the United States and its possessions, \$13.94; Canada, \$18.94; all other countries, \$21.94, cash orders only, payable in U.S. currency. Second-class postage paid at New York, NY 10001, and at additional mailing offices. Printed in the U.S.A. Authorized as second-class mail by the Post Office Department, Ottawa, Canada, and for payment of postage in cash. POSTMASTER/SUBSCRIPTION SERVICE: Please send change-of-address forms and all subscription correspondence to Stereo Review, P.O. Box 55627, Boulder, CO 80322-5627. Please allow at least eight weeks for the change of address to become effective. Include both your old and your new address, enclosing, if possible, an address label from a recent issue. If you have a subscription problem, write to the above address or call (800) 876-9011. PERMISSIONS: Material in this publication may not be reproduced in any form without permission. Requests for permission should be directed to: The Editor, Stereo Review, Diamandis Communications Inc., 1515 Broadway, New York, NY 10036. EDITORIAL CONTRIBUTIONS must be accompanied by return postage and will be handled with reasonable care, but the publisher assumes no responsibility for return or safety of unsolicited art, photos, or manuscripts.

At Altec Lansing, we think it's time you had a hand in what you hear. That's the idea behind the new Altec 511 Tower, the first loudspeaker that gives you total control of amplification, tonal balance and imaging for each midrange, tweeter, upper bass and woofer. The result is a sound system that lets you mold the music precisely to your taste, so everything from Mozart to Motown will sound exactly the way you want it.

AN UNHEARD OF ADVANCE IN AUDIO TECHNOLOGY.

Five years in the making, this towering achievement lets the discriminating audiophile choose between single, bi, tri or quad amplification and an impressive range of tonal balance levels, all through a simple control panel. So now, you can tell the philharmonic how to conduct itself.

SPEAKERS THAT LISTEN TO YOU.



The remarkable 511 Tower is one of twelve new Altec Lansing speakers, all designed to reproduce sound with unheard-of accuracy.

If the new 511 sounds good, call 1-800-Altec 88 for the dealer nearest you. Then take a pair home and tell them what you want to hear.

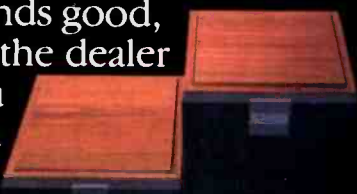

**LOUDSPEAKERS FOR THE
WELL TRAINED EAR.**



DENON

PCM AUDIO TECHNOLOGY / COMPACT DISC

WHAT MAKES ONE AUDIO BRAND SOUND BETTER.

CD PLAYERS have always been susceptible to errors in converting digital data to analog audio. In fact, academic researchers recently declared that error in converting the Most Significant Bit is a primary cause of audible problems. Every Denon Compact Disc Player since 1983 has corrected this problem with the Super Linear Converter.

Now, with the new "Delta" conversion circuit, Denon's DCD-3520 and DCD-1520 represent the closest approach yet to true 16-bit linearity. Denon's 20-bit 8x oversampling digital filter joined to a pair of true 20-bit Super Linear Converters quite simply elevate digital playback to a new level of musicality.

DCD-1520



But then, Denon built the world's first professional digital audio recorder back in 1972. And we've recorded digital master tapes of unsurpassed musical accuracy.

It's simply easier to make digital audio sound more like music when you know what music sounds like.

DENON

DESIGN INTEGRITY

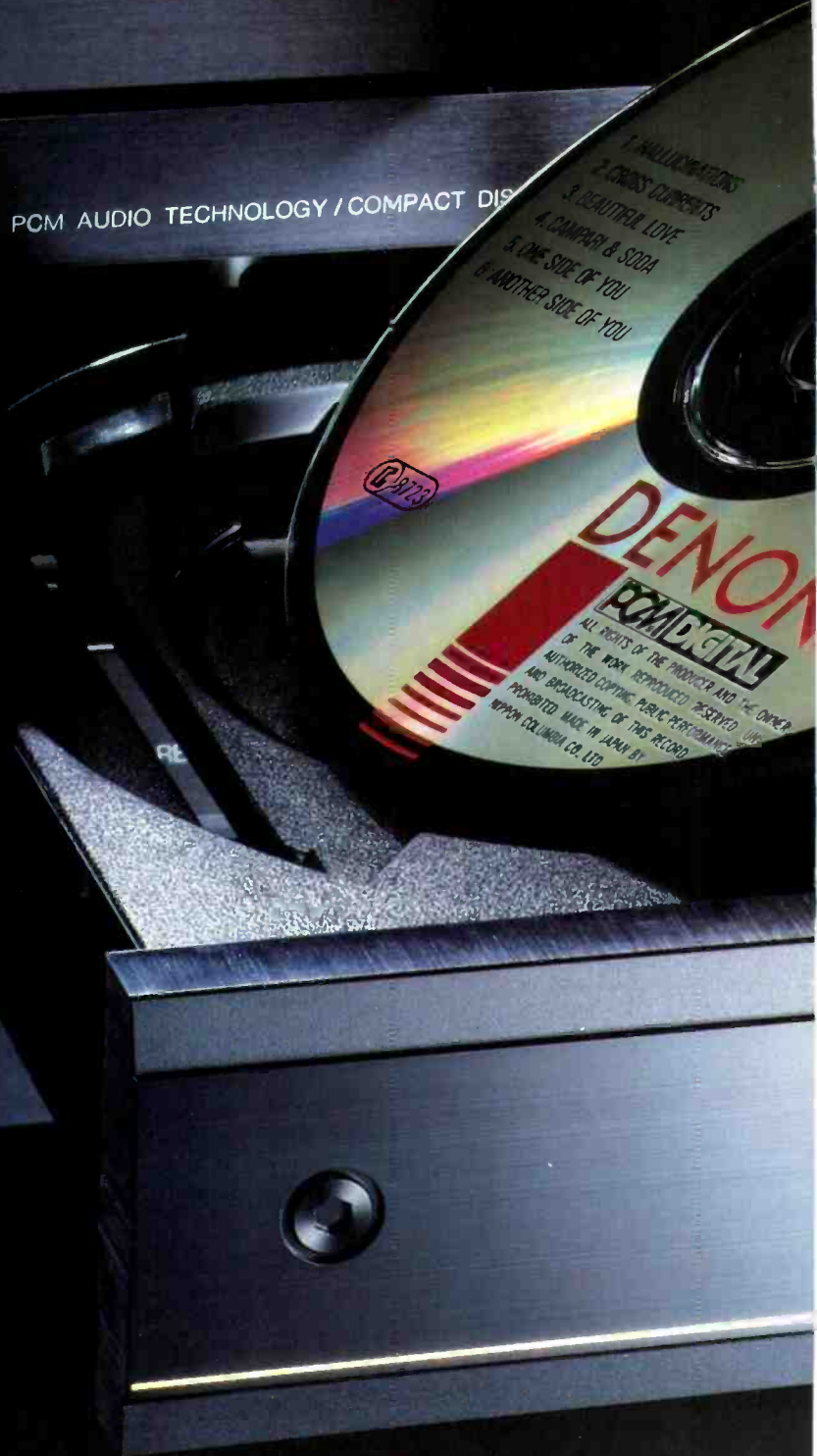

CIRCLE NO. 27 ON READER SERVICE CARD

Denon America Inc., 222 New Road, Parsippany, NJ 07054 (201) 575-7810
Denon Canada, Inc., 17 Denison Street, Markham, Ont. L3R 1B5 Canada

BULLETIN

by Christie Barter
and Rebecca Day

DAT... FINALLY?

In late July, as we went to press, the logjam between equipment manufacturers and the recording industry over digital audio tape (DAT) had broken. The EIA and the RIAA agreed to support legislation requiring a "Serial Copy Management System" to be built into all DAT recorders shipped to the U.S. Unlike current DAT decks, those with the new system will permit direct digital copies of a CD, a prerecorded DAT, or a digital broadcast, but they will not permit second-generation digital copies (copies of copies). The system will also permit first- and second-generation digital copies of analog sources—but not third-generation copies. Pending legislation, it is expected to be several months at least before properly equipped machines arrive in the U.S.

STONES ROLLING

The Rolling Stones embark on their recently announced four-month North American tour on September 1 at Rich Stadium in Buffalo, New York. It's the Stones' first tour since 1981 and has been timed to coincide with the release of their new Columbia album, "Steel Wheels." Other cities on their itinerary this month are Toronto (September 3), Pittsburgh (6), East Troy, Wisconsin (9 and 11), Cincinnati (14), Raleigh (16), Philadelphia (21), Washington, D.C. (25), and Cleveland (27).

TECH NOTES

Audio systems made by Pioneer and Nakamichi are featured in Toyota's Lexus LS400 luxury cars, which will begin delivery September 1. The Pioneer system is standard, the Nakamichi system a \$1,000 option; you can add a six-disc CD changer to either system for another \$900. ... Ford Motor Co. is offering a Sony CD changer as a dealer-installed option on eleven Ford and Lincoln-Mercury cars. The ten-disc, trunk-mounted changer

is operated by remote control. ... Three new VCR's in Sharp's Optonica line—the VC-6960UA (\$450), VC-6980UA (\$650), and VC-6990UA (\$1,000)—come with a voice-activated remote control called Voice Coach that walks users through the programming steps. ... Magnavox has introduced its first two combination TV/VCR units. The 20-inch CRK120AT has a suggested retail price of \$799.95, and the 13-inch CRK113 lists for \$749.95. ... All Koss headphones are now covered by a lifetime "no questions asked" warranty.

BONUSES

Pioneer is offering \$5 discounts on videodisc purchases to consumers who buy LaserDisc players or Pioneer combination players for CD's, videodiscs, and CD-V's. With each purchase through the end of 1989, the buyer will get six coupons each worth \$5 off the price of any videodisc on the Warner Bros., Disney/Touchstone, MGM/UA, Paramount, RCA/Columbia, Pioneer Artists, or Nelson Entertainment labels. ... Fuji will launch a year-long promotion in September with Enigma Entertainment. Customers who buy four-packs of Fuji's FR-IIx Pro premium high-bias cassettes or five-packs of the regular FR-IIx cassettes will also get a sampler CD of Enigma recordings.

MUSIC NOTES

Sting is starring as MacHeath in a new version of *The Threepenny Opera* opening in Washington this month and due on Broadway by Thanksgiving. ... The Library of Congress, Mrs. Ira Gershwin, and Elektra/Nonesuch have entered into an agreement to record and document the musical-theater works of George and Ira Gershwin. ... Live from Lincoln Center launches its fifteenth season on public television on September 20 with the New York Philharmonic's opening concert, conducted by Zubin Mehta. Jessye Norman is the soprano soloist. ... National Public Radio will broadcast live

from the Chicago Jazz Festival, August 31 through September 3.

NEW ARTISTS SCORE

The Recording Industry Association of America reports that twelve debut albums were certified Platinum—meaning they have sold in excess of one million units—during the first six months of this year. That's up from nine in the first half of 1988 and just three in the first half of 1987. The best-selling new artists and groups include Guy, Karyn White, Living Colour, Tone-Loc, the Boys, Eazy-E, Milli Vanilli, Rob Base & D.J. E-Z Rock, Edie Brickell and the New Bohemians, Paula Abdul, Winger, and the Traveling Wilburys.

MOZART'S HAIR SOLD

A lock of brown hair from the head of Mozart was auctioned off at Sotheby's in London for £11,000 (about \$17,700). Though framed with a lock of Beethoven's hair, Mozart's was what fetched the record price—especially since it was authenticated by a mistress of the composer's son Franz Xaver Wolfgang Mozart. According to a Sotheby's representative, this was the first time a specimen of Mozart's hair had come up for sale in sixty years.



FROM THE EDITOR



I AM pleased to welcome the readers of *High Fidelity* to **STEREO REVIEW**. *High Fidelity* has suspended publication.

In the future, subscribers to *High Fidelity* will receive **STEREO REVIEW**. If you were a subscriber to both **STEREO REVIEW** and *High Fidelity*, your subscription to **STEREO REVIEW** has been extended by the number of issues remaining in your subscription to *High Fidelity*. If you have any questions about your subscription to *High Fidelity*, you may call (800) 525-0643, free of charge, and someone in Customer Service will help you.

It is widely agreed in the publishing industry that few people ever read the mastheads of magazines except those whose names are in them, but this month I want to direct your attention to **STEREO REVIEW**'s masthead,

which is just to the right here on this page. Executive Editor Michael Smolen, Art Director Sue Llewellyn, Music Editor Christie Barter, Editor at Large William Livingstone— if you have looked at our masthead in recent years those names are familiar to you, and so are the names of William Wolfe, David Stein, Rebecca Day, and others. This month we added a name: Michael Riggs has just joined our staff as Editor at Large. His name will be familiar to any of you who has read the masthead of *High Fidelity*, for he was Editor in Chief of that magazine for several years.

In one sense, the editors and contributors who are identified in the masthead make the magazine. They are responsible for planning and shaping **STEREO REVIEW**, and every month they work hard to make it useful, to make it informative and readable, to make it exciting, beautiful, entertaining, provocative, enjoyable. I think they do a good job of it. I hope you think so, too, and if you don't, or if you have suggestions about how we can make the magazine better—more useful, more informative, readable, exciting, etc., I know you will let us know about it. For in another sense, a very real one, it is the readers who make the magazine.

Whether you are a long-time reader or a new one, then, welcome to **STEREO REVIEW**. Here's to many rewarding years together. □

Louise Boundas
Editor in Chief

Stereo Review

LOUISE BOUNDAS
Editor in Chief

MICHAEL SMOLEN
Executive Editor

SUE LLEWELLYN
Art Director

CHRISTIE BARTER **WILLIAM WOLFE**
Music Editor Technical Editor

DAVID STEIN
Managing Editor

REBECCA DAY, **WILLIAM GOLDMAN**
ROBERT ANKOSKO
Senior Editors

LOREN FALLS
Associate Art Director

CATHERINE FLEMING
Assistant Art Director

BARBARA AIKEN, **ROCCO MATTERA**
MARYANN SALTZER
Editorial Assistants

MICHAEL RIGGS
WILLIAM LIVINGSTONE
Editors at Large

Contributing Editors: Robert Ackart, Chris Albertson, Richard Freed, Phyl Garland, David Hall, Ron Givens, Bryan Harrell (Tokyo), Roy Hemming, Julian Hirsch, Ralph Hodges, Stoddard Lincoln, Ian Masters, Louis Meredith, Alanna Nash, Mark Peel, Henry Pleasants (London), Ken Pohlmann, Parke Puterbaugh, Charles Rodrigues, Eric Salzman, Steve Simels, Craig Stark, David Patrick Stearns
Production Director: Karen L. Rosen
Production Manager: Michele Lee

WINSTON A. JOHNSON
Vice President and Publisher

ADVERTISING

Advertising Director: Nick Matarazzo
National Manager: Charles L. P. Watson
(212) 719-6038
Consultant: Richard J. Halpern
(212) 719-6940
Account Manager: Sharon Dube
(212) 719-6037
Corporate Account Manager: Tom McMahon
(212) 719-6025
Assistant to the Publisher: Nadine L. Goody
Classified Advertising: (800) 445-6066
Midwestern Managers: Arnold S. Hoffman,
Jeffrey M. Plaster, (312) 679-1100
Western Managers: Robert Meth,
Paula Borgida Mayeri, (213) 739-5130
Tokyo Office: Iwai Trading Co., Ltd.
603 Ginza Sky Heights Building, 18-13,
Ginza 7-Chome, Chuo-Ku, Tokyo, Japan 104
Japan Representative: J. S. Yagi, (03) 545-3908



STEREO REVIEW is published by Diamandis Communications Inc., a wholly owned subsidiary of Hachette Publications, Inc.

President & CEO: Peter G. Diamandis
Executive Vice President: Robert F. Spillane
Senior Vice President, Finance, & CFO: Arthur Sukel
Senior Vice President, Manufacturing & Distribution: Murray Romer
Senior Vice President, Operations & Administration: Robert J. Granata
Vice President, Controller: David Pecker
Vice President, General Counsel: Catherine Flickinger
Vice President, Circulation, Leon Rosenfield;
Vice President, Communications, Phyllis Crawley Gates;
Vice President, Marketing, Anthony F. Incalcaterra;
Vice President, Research, Bruce Gershfield;
Senior Vice President, Sales, James A. Frahm

Say "No" To Oatmeal

I've been a studio drummer for eight years. So, I'm very critical about speakers, mostly because I know what drums are supposed to sound like. Most speakers make a kick drum sound like someone's playing a bowl of oatmeal. I don't even like the way oatmeal tastes, let alone how it sounds.

One day, a friend and I stopped at a hi-fi store to pick up some cassette tapes. Off in one of the listening rooms, I heard some music that sounded live. It was the drums I noticed first. Forget oatmeal, what I heard was a really tight, clean, punchy sound.

We strolled into the room halfway expecting to find a jam going on. But it was a recording. I looked at one of the speakers. It was a KLIPSCH® CHORUS®.

This was a new KLIPSCH speaker. A speaker with professional drivers in a real dressy cabinet. A speaker with a surprisingly good price. A speaker good enough to qualify for the home of a most critical musician. Good enough for me. And that's very, very good.

*For your nearest KLIPSCH dealer,
look in the Yellow Pages or call toll free,
1-800-223-3527.*

 **klipsch**®
A LEGEND IN SOUND.™

P.O. BOX 688 • HOPE, ARKANSAS USA 71801

CIRCLE NO. 2 ON READER SERVICE CARD



If you've vowed not to compromise this time around, consider the rich rewards of owning Carver. Each component includes unique innovations designed to confront and solve real-world sonic problems.

Power unleashed: Simultaneous high current/high voltage output. The TFM-25 is capable of delivering more simultaneous current, power and voltage into a wider range of speaker loads than any other competitively priced design: 225 watts per channel into 8 ohms 20-20kHz with no more than 0.5% THD. Its patented Magnetic Field Power Supply can draw up to 200% more line current, store more joules of energy in its unique distributed capacitance system, and then deliver up to 500% more current during musical peaks. With the right speakers, this kind of serious power can achieve a full restoration of the robust percussive attacks and lightning transients so

necessary to achieving musical realism from digital sources.

Accuracy and musicality through Transfer Function Modification. Over the past two decades, Bob Carver has worked on the problem of replicating one power amplifier's sonic signature in another dissimilar design. Through thousands of hours of painstaking tests and modifications, he has been able to closely match the TFM-25's transfer function with that of his highly acclaimed \$17,500.00 Silver Seven vacuum tube reference power amplifier. When you hear the warm, natural sound of the TFM-25, you'll know that Transfer Function Modification is an audible reality.

New flexibility in a classic preamplifier design. The Carver C-16 is at once a purist, "straight-wire-with-gain" design and a wonderful wealth of sonic options. Including individual left/right tone controls with variable

POWERFUL

MUSICAL

ACCURATE

BE THE MASTER OF YOUR OWN SONIC DESTINY.

turnover, full-band Spectral Tilt, and of course Sonic Holography* with a new Blend control that further extends the remarkable spacial restoration abilities of this exclusive Carver technology.

ACCD turns "dirty" FM into fresh air. Unlike any competitive tuner model, the Carver TX-12 can actually transform a noisy, multipath distortion-ravaged FM signal into clean, hiss-free music with full stereo separation. The key is the TX-12's Asymmetrical Charge-Coupled FM Detection circuitry. A lengthy name for a wonderfully fast solution to expanding your listening possibilities. When you experience ACCD's effect, you may consider the TX-12's full remote control, 20 FM/AM presets with preview scan, stereo/mono switch and dual antenna inputs, mere icing on the cake.

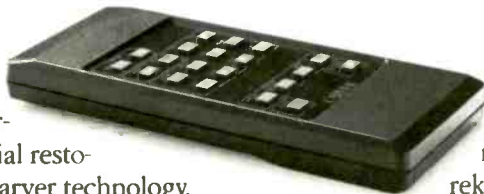

Hear why we stack up ahead of the competition. The TFM-25, C-16 and TX-12 are just three of over a dozen new Carver designs. Each is designed to rekindle your sense of musical wonder. It all begins with a visit to your nearest Carver dealer.

To receive White Papers on Simultaneous High Current High Voltage Transfer Function Modification and Sonic Holography, details of Spectral Tilt and the name of your nearest Carver Dealer, call 1-800-443-CAVR, 8-5 PM Pacific time.*

CARVER

CARVER CORPORATION, LYNNWOOD, WASHINGTON, U.S.A.
Distributed in Canada by EVOLUTION AUDIO INC. 1-(416) 847-8888

LETTERS

Format Wars

Having just purchased a CD player about a week ago, I connected it with much excited anticipation and settled back to hear the new laser sound that everyone is raving about. One of my CD purchases was a Supraphon recording of Mahler's Second Symphony performed by the Czech Philharmonic conducted by Vaclav Neumann. Imagine my surprise when I found that a twenty-five-year-old Columbia open-reel tape of the work, with Leonard Bernstein conducting the New York Philharmonic, was much superior.

This discovery taught me that the new silvery little marvels do not necessarily provide the music lover with the final solution for a perfect listening experience. Generally, I've found that CD's and open-reel tapes recorded at 7 1/2 ips are a very close match as far as fidelity is concerned. The CD certainly beats the old format in the convenience department, however.

GEORGE NUSSBAUM
New York, NY

I am confused over the "battle" between the CD, LP, cassette, and open-reel formats. I find it hard to say which is "better." I appreciate each medium for its own worth. There are some pieces that, to me, sound better on vinyl than on CD, and vice versa. The same with cassettes and open-reel tapes.

I have transferred some of my favorite CD's to open-reel, and the results are wonderful! Each sound is unique, and I feel fortunate to be able to listen to so many variations. Although I'm not closed to the option of upgrading any single piece, I still smile ear to ear when my system is cranking out *In-a-Gadda-da-Vida* on the open-reel deck!

SUE-ELLEN SULLIVAN
Wallingford, CT

I have collected numerous LP's over the years, and I have considered an upgrade to either CD's or digital audio tape (DAT). At this point I have not acquired a compact disc player because of the ultimate availability of DAT technology, which seems preferable to me, primarily because of its ability to record as well as play back. I am aware that DAT decks are available, but at what I would consider prohibitive cost.

Please give me your informed opinion as to when DAT decks are likely to become readily available at an affordable price. Does it depend on resolution of the U.S. recording industry's threat to file suit against DAT component manufacturers who attempt to market their products in the U.S.?

JOHN F. VOMACKA
Vancouver, WA

The issue may be resolved soon. The Recording Industry Association of America and the Electronic Industries Association have announced their agreement to seek legislation requiring DAT decks sold in the U.S. to incorporate a system to limit the number of direct digital copies they could make of tapes dubbed from CD's and other sources (see "Bulletin," page 9). Even with this agreement, however, it will still take time to draft legislation and get it through Congress as well as to make the necessary changes in the equipment before putting it on the market. Moreover, the DAT decks will be expensive at first, almost certainly over \$1,000 apiece. Meanwhile, it still makes sense to buy a CD player.

CD Longevity

From personal experience I must disagree with the optimistic conclusion of Rebecca Day's article on "CD rot" in the April issue, that with proper care CD's "should last at least as long as the people who own them," especially if they were made by a major manufacturer. Over three years my CD set of Verdi's *Falstaff* on Philips developed two large lines on the second side. These blemishes were not there when I purchased the recording, and they resulted in stuttering in playback even on my superb Sony ES-705. Happily, the record store took the set back.

WILLIAM M. SMITH
Long Beach, CA

JBL Credits

While I was grateful to be included in Warren Berger's "The Explorers" in June, I did not design the original JBL L250 speaker. The L250 and its successor, the L250Ti, were engineered by Gregory Timbers of JBL's Transducer Engineering Department. My input in the development of the L250 was from the marketing side, basically in terms of broad product definition and field evaluation of the prototype stages. The L250Ti was Mr. Timbers' creation in all respects, and it remains JBL's flagship product in the consumer area.

JOHN EARGLE
Senior Director of Product
Development and Application
JBL Inc.
Northridge, CA

Record Quality

I have always been puzzled by the ratings of recording quality in STEREO REVIEW's review section. I have to wonder what kind of reproduction equipment your reviewers listen to.

Example: In the July issue Keith Jar-

rett's "Dark Intervals" was rated as having a "very good" recording. Compared with what? By my ears, and those of several friends with discriminating hearing, the album's recording quality is mediocre at best. I know that's subjective, but so is any audio evaluation.

ARNOLD GREGG
Anaheim Hills, CA

Help Wanted

I purchased a discontinued Pioneer cassette deck, Model CT-7R, at a yard sale. While I am overjoyed at the quality of sound it delivers, I would dearly love to have the manual and the remote-control unit for it. Pioneer hasn't been able to help me. I sincerely hope that someone reading this magazine can be of assistance.

JOHN M. BECK
3513 Terrace Dr., #D
Suitland, MD 20746
(301) 423-8418

Alternate Takes

In the April and June issues, you printed letters from two readers who had noticed alternate takes of songs on Columbia CD's released originally as LP's only. I've noticed some on Columbia's "Greatest Hits" CD's by Chicago (*Does Anybody Really Know What Time It Is* and *Only the Beginning*), Blood, Sweat & Tears (*Spinning Wheel* and *And When I Die*), and Simon and Garfunkel (*Homeward Bound* and *The 59th Street Bridge Song*). In my opinion, these alternate versions are quite inferior to the ones originally released.

The CD's carry the same Columbia identification codes as the LP versions, so one would expect the contents to be the same. I don't know the rationale for this irritating practice. I feel Columbia owes consumers an explanation. Meanwhile, I think I'll keep my LP's.

DAVID A. CROWELL
Bartlesville, OK

Corrections

The test report on the Mitsubishi M-AV1 receiver in the July issue was incorrect in stating that its Dolby Surround decoder is not licensed by Dolby Laboratories. The receiver's documentation does not indicate a license arrangement and the faceplate does not carry the Dolby logo, but the M-AV1 contains a licensed Dolby Surround circuit.

The address given for Precise Acoustic Laboratories in the August test report on the Precise Monitor 5 speaker was incomplete. The correct address is: 200 Williams Dr., Suite B, Ramsey, NJ 07446. □

SURGEON GENERAL'S WARNING: Smoking Causes Lung Cancer, Heart Disease, Emphysema, And May Complicate Pregnancy.

17 mg. "tar", 1.2 mg. nicotine av. per cigarette by FTC method.

© 1989 R.J. REYNOLDS TOBACCO CO.



Salem

the refreshest

"McIntosh . . . no other transistor amplifier is capable of reproducing as well."

"All the sounds, even those different one from another, remain separated and distinctive. There results a sensation of contrast, precision, and uncommon clarity.

. . . A close analysis of different frequencies reveals an extremely deep bass, very rich in spatial detail . . . The upper bass region is very linear testifying to an extraordinary richness of information. The very structured mid-range contributes enormously to listening pleasure.

The feeling of power is never refuted and instead of stunning the listener, the 7270 recreates an audio environment of a majesty that no other transistor amplifier is capable of reproducing as well." Need we say more?

—REVUE DU SON, foremost French stereo magazine.

For a copy of the REVUE DU SON and information on the McIntosh MC 7270 Amplifier and other McIntosh products write:
MCINTOSH LABORATORY INC.
P.O. Box 96 EAST SIDE STATION, DEPT. A47
BINGHAMTON, NY 13904-0096



NEW PRODUCTS



AIWA

The X-79M is one of six new matched minicomponent systems from Aiwa. The 40-watt-per-channel integrated amplifier incorporates BBE sound-enhancement circuitry. Aiwa's Dynamic Super Loudness (DSL) bass-enhancement system, a five-band graphic equalizer, and surround-sound circuitry. The tuner has ten AM and ten FM station presets, a timer, and adjustable wake-up volume. The dual-well cassette deck has

autoreverse record and playback in Deck 2, Dolby B noise reduction, and high-speed dubbing. A six-disc CD changer with double oversampling, a pair of three-way speakers, and a remote control complete the system. A turntable and mini surround speakers are optional. Price: from \$1,050 to \$1,220. Aiwa America, Dept. SR, 35 Oxford Dr., Moonachie, NJ 07074.
Circle 120 on reader service card

BOSE

The Acoustimass 3 is the smallest of Bose's three-piece loudspeaker systems. Its full-range, wedge-shaped satellite speakers measure only 3½ x 4½ x 4½ inches and weigh 18 ounces each; they are magnetically shielded to avoid interference with a TV set or video monitor. The bass module (top rear in photo) measures 8 x 8 x 14 inches and weighs 14 pounds. Its output is nondirectional so that it can be placed out of sight anywhere in the room. Price: \$599. Bose Corp., Dept. SR, The Mountain, Framingham, MA 01701.

Circle 121 on reader service card



DANA AUDIO

The Model 1 acoustic-suspension speaker from Dana Audio has a 6½-inch woofer and ¾-inch titanium-dome tweeter. There is a first-order crossover at 3,150 Hz. Frequency response is rated as 63 to 20,000 Hz ± 3 dB, sensitivity as 90 dB sound-pressure level at 1 meter with a 1-watt input. Nominal impedance is 8 ohms. Dimensions are 14¾ x 8¾ x 7½ inches, weight about 10 pounds. Finish is black vinyl laminate. The speakers are available only factory-direct from Dana and come with a three-year warranty; there is a 15-day money-back home-trial program. Price: \$155 a pair. Dana Audio, Dept. SR, P.O. Box 1, Austin, TX 78767; (512) 251-7701.

Circle 122 on reader service card

THE CUTTING WEDGE

The Cutting Wedge acoustical tile is said to reduce ambient noise, slap echo, and standing waves. The 1-foot-square tiles are available in 2-, 3-, 4-, and 6-inch thicknesses; larger sheets and custom sizes are also available. For consistency, only medical-specification foam stock is used. Price: \$3 each for a 2-inch-thick tile (volume discounts are available). Thomas M. Chaffee Music Associates, Inc., Dept. SR, P.O. Box 66, Beachwood, NJ 08722.



JENSEN

Jensen's JCX-226 is a 6½-inch coaxial car speaker designed for use in shallow doors. Mounting depth is only 1½ inches. The bridgeless design mounts the 2½-inch dynamic-cone tweeter on a post at the center of the woofer. Power handling is rated as 80 watts peak, 35 watts continuous. Frequency response is given as 60 to 20,000 Hz. Price: \$69.95. International Jensen, Dept. SR, 4136 N. United Pkwy., Schiller Park, IL 60176.

Circle 123 on reader service card



In designing the new LS 400 luxury sedan, Lexus engineers were as preoccupied with frequency response and harmonic distortion as horsepower and handling. Their aim, you see, was to create car audio as advanced as the LS 400 itself.

The Engineers At Lexus Were Just As Concerned With Impressing Stereo Review As Road & Track.

They began by setting performance goals beyond the best premium level systems available. In the end, they'd created two of the finest audio systems ever engineered for the automobile.

The first is the standard Lexus 7-speaker high-output audio system with bi-amplified subwoofer. Its continuous average



The Lexus LS 400

output is 65 watts,* with a maximum of 140—enough power to please the ear

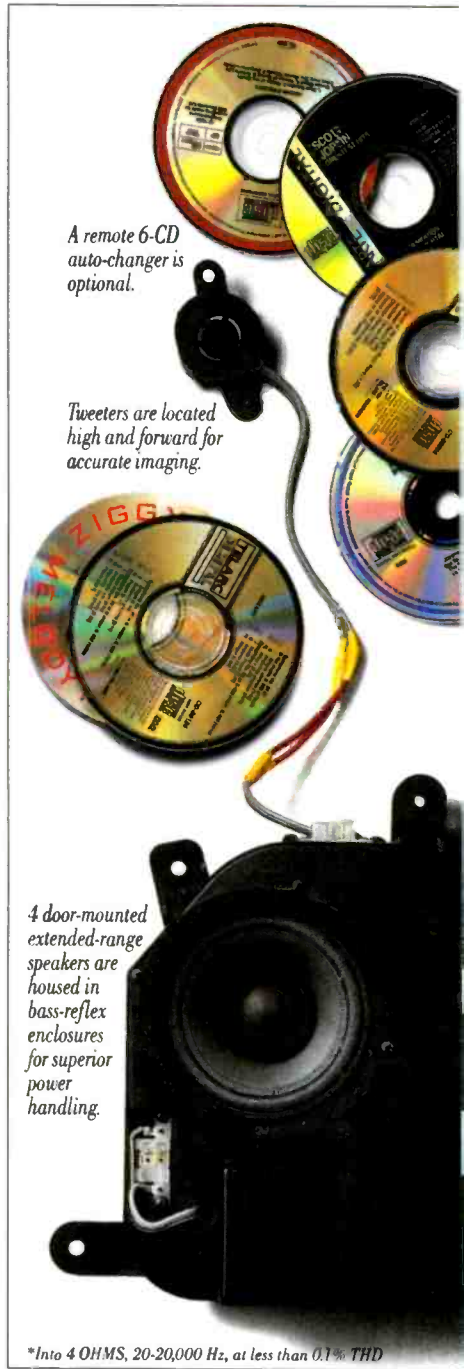

A remote 6-CD auto-changer is optional.

Tweeters are located high and forward for accurate imaging.

4 door-mounted extended-range speakers are housed in bass-reflex enclosures for superior power handling.

*Into 4 OHMS, 20-20,000 Hz, at less than 0.1% THD

of both the casual listener and the confirmed audiophile.

The optional Lexus/Nakamichi Premium Sound System is simply car audio without compromise.



Car audio without compromise: the Lexus/Nakamichi Premium Sound System. Lexus is the first to offer Nakamichi as original equipment.

The LS400 audio system is pre-equalized to the interior's unique acoustics.



The Lexus/Nakamichi system is even equalized for the difference between cloth and leather trim.

BASS

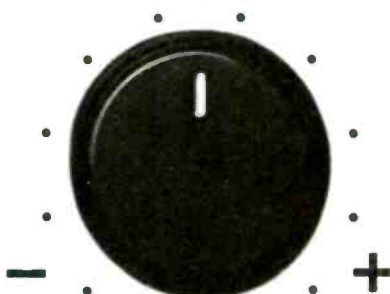

A bi-amplified 9-inch subwoofer punches out deep, tight bass.

The power mast antenna even adjusts to 3 positions for ideal AM and FM reception.

The Premium ETR radio/auto-reverse cassette includes an FM diversity tuner with dual antennas.

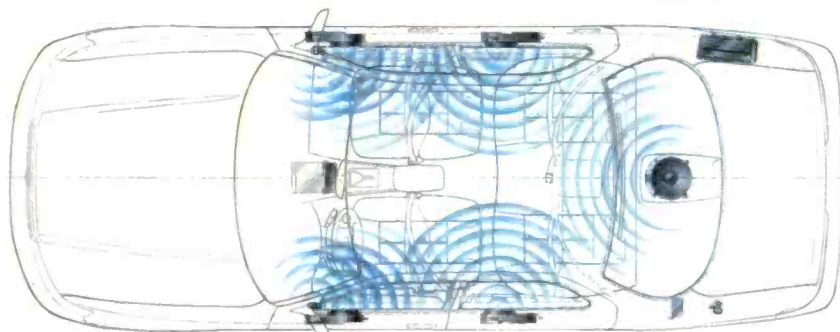

7 speakers are ideally-located for accurate balance and sound staging. Electronic cross-over networks feed specific frequencies to each.



Its RMS output power is nearly doubled to 126 watts,* with a maximum of 220. The result? Bass response so deep, so tight, you don't just hear it. You feel it.

And with its more sophisticated specifications, refined circuit design and advanced speaker technology, you'll hear sound reproduction like you've never heard before in a car.

But then, doing what's never been done before is what Lexus is all about.



The Relentless Pursuit Of Perfection.

NEW PRODUCTS

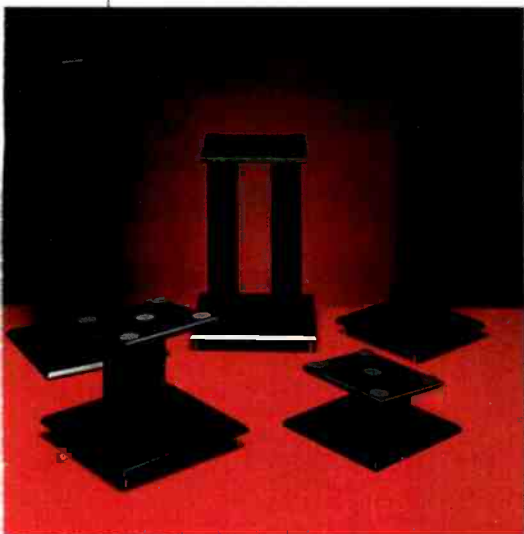

GOLDSTANDS

The Goldstands speaker stands range in height from 1½ to 5 feet and are available in black or with a walnut base and black border, post, and top. The stands come assembled. Prices for the five models shown here range from \$39.95 to \$89.95 a pair, including shipping. Extra-cost options include spiked bases (\$20 a pair), sand filler (\$20 a pair), and a white finish (\$30 a pair). Goldstands, Dept. SR, 229 Nassau Rd., Huntington, NY 11743.

Circle 124 on reader service card



SABRE SOUND

Sabre Sound's HB-1520 biampable car speaker system has two 15-inch woofers, two horn-loaded midrange drivers, and two matched piezoelectric tweeters. Power-handling capability is said to be over 200 watts, and sensitivity is rated as 92 dB. The 36 x 19½ x 17-inch ported enclosure is designed to be installed in hatchback cars and recreational and sport-utility vehicles. Price: \$649.95. Sabre Sound, Dept. SR, 702 Colorado, Suite 660, Austin, TX 78701.

Circle 125 on reader service card

TECHNICS

The SST-1 speaker system from Technics uses a pair of computer-designed, front-loaded folded-horn drivers combined with an acoustic filter. The "Sound Space Twin-Load" design is said to "mirror the shape and function of a fine musical instrument." Frequency response is rated as 55 to 20,000 Hz, sensitivity as 92 dB. Nominal impedance is 6 ohms. Dimensions are 22¼ x 25½ x 7½ inches. Available finishes are glossy metallic black, pearl silver, and metallic red. Price: \$2,300 a pair. Technics, One Panasonic Way, Secaucus, NJ 07094.

Circle 126 on reader service card

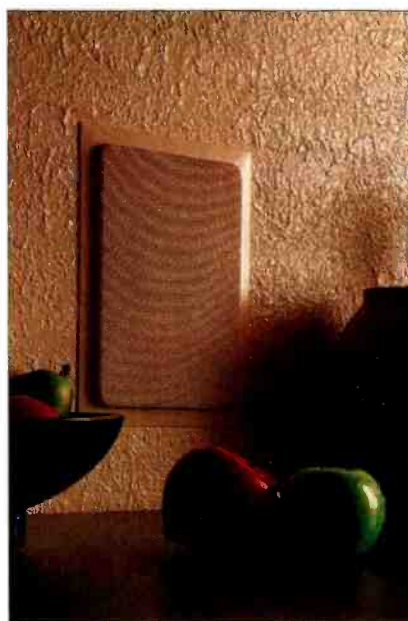

TANNOY

The top loudspeaker in Tannoy's Series 90 is the floor-standing DC-3000, which has an 8-inch dual-concentric midrange/tweeter and an 8-inch woofer in an enclosure with a slotted port. Crossover frequencies are 400 and 2,300 Hz. Frequency response is rated as 30 to 25,000 Hz ± 3 dB, impedance as 6 ohms nominal, 4 ohms minimum. Sensitivity is rated as 92 dB. Made of Medite for high rigidity, the cabinet has gold-plated terminals suitable for biwiring and measures about 10 x 35½ x 1½ inches. Weight is almost 59 pounds. Available finishes are black-ash and rosewood veneers. Price: \$1,900. Tannoy North America, Inc., Dept. SR, 300 Gage Ave., Unit 1, Kitchener, Ontario N2M 2C8, Canada.

Circle 128 on reader service card

PHASE TECHNOLOGY

The top model in Phase Technology's new line of in-wall speakers is the CI-60, which uses a 1-inch soft-dome tweeter and a solid, flat-piston midrange/woofer made of rigid polymer foam. Recommended amplifier power is 15 to 80 watts per channel. Frequency response is rated as 40 to 20,000 Hz into 4 ohms. The CI-SUB in-wall subwoofer (not shown), also in the new line, can extend response down to 28 Hz. The CI-60's outside dimensions are 8 inches wide and 11¾ inches high; the CI-SUB is 11¾ inches wide and 8 inches high. Both require only a 3⅝-inch mounting depth. Prices: CI-60, \$480 a pair; CI-SUB, \$225. Phase Technology, Dept. SR, 6400 Youngerman Circle, Jacksonville, FL 32244.

Circle 127 on reader service card



Announcing an enormous improvement in improved-definition television.



ID² is a trademark of NEC Home Electronics (USA) Inc. Dolby is a registered trademark of Dolby Laboratories Licensing Corporation. © 1988 NEC Home Electronics (USA) Inc.

Introducing the 52" ID²™ Big-Screen Television.

We came up with an advancement for improved-definition television that was so terrific, we decided

to make a big deal out of it.

Namely, our ID-5282S ID² Big-Screen Television.

Utilizing 11 megabits of signal processing memory, it combines 3D motion adaptive interpolation and digital Y/C separation.

The result: up to 450 lines of vertical resolution. A 40% improvement.

We've also incorporated the NEC digital noise reduction system. Plus

Hall, Matrix and Dolby® Surround Sound.

The 52" ID-5282S from NEC. It takes improved-definition television to new heights.

And widths.

C&C
Computers and Communications

NEC

CIRCLE NO. 75 ON READER SERVICE CARD



Richard Marx—Repeat Offender (EMI) 380-915



Cyndi Lauper—A Night To Remember (Epic) 377-887

GREAT

David Benoit—Urban Day Dreams (GRP) 384-628
Johnny Diesel & The Injections (Chrysalis) 384-925
Jean Luc Ponty—In The Fast Lane (Columbia) 383-521

Bad English (Epic) 353-463
The Joe Zawinul Syndicate—Black Water (Columbia) 383-455
Dan Hill—Real Love (Columbia) 383-380

Jean-Pierre Rampal—Mozart: Flute Concertos, K.313/314 Adante, K.315/ Rondo K.184 Israel Philharmonic/ Zubin Mehta (CBS Masterworks) 383-364
Emanuel Ax—Haydn: Sonatas Nos. 33, 38, 58 & 60 (CBS Masterworks) 383-331

Black Sabbath—Headless Cross (I.R.S.) 383-109
Clarence Clemons—A Night With Mr. C (Columbia) 383-067
Donna Summer—Another Place And Time (Atlantic) 382-960

Roger Norrington—Berlioz: Symphonie Fantastique, Op.14 London Classical Players (Angel) 382-747

Alyson Williams—Raw (Def Jam / Columbia) 382-465

Alex Bugnon—Love Season (Orpheus) 382-432
Bobby Lyle—Ivory Dream (Atlantic) 382-390

Stevie Ray Vaughan & Double Trouble—In Step (Epic) 382-374
Alice Cooper—Trash (Epic) 382-366

The Nitty Gritty Dirt Band—Will The Circle Be Unbroken, Volume Two (Universal) 382-267

Cutting Crew—The Scattering (Virgin) 382-168
Triumph—Classics (MCA) 382-135

Donny Osmond (Capitol) 382-119

L.L. Cool J—Walking With A Panther (Def Jam / Columbia) 381-988

The Dirty Dozen Band—Voodoo (Columbia) 381-962
Earl Klugh—Whispers And Promises (Warner Bros.) 381-806

Barry Manilow (Arista) 381-707

Larry Carlton—On Solid Ground (MCA) 383-661

Roger Norrington—Beethoven: Symphony No.3 In E Flat, OP.55 (Erica) (Angel) 382-754
Stray Cats—Blast Off (EMI) 381-442

Great White—Twice Shy (Capitol) 381-178

De La Soul—3 Feet High And Rising (Tommy Boy) 381-160

Dirty Dancing—Live In Concert. Original Soundtrack (RCA) 381-152

Bonnie Raitt—Nick of Time (Capitol) 381-087

Working Girl—Original Soundtrack (Arista) 380-972

Aretha Franklin—Through The Storm (Arista) 380-873

Kirk Whalum—The Promise (Columbia) 380-436

Wendy & Lisa—Fruit At The Bottom (Columbia) 380-386

Henry Lee Summer—I've Got Everything (CBS Associated) 380-352

The Jacksons—2300 Jackson Street (Epic) 380-337

Steve Reich—Different Trains - Kronos Quartet / Electric Counterpoint - Pat Metheny (Nonesuch) 380-071

Portrait Of Yo-Yo Ma (CBS Master) 379-941

Canadian Brass—The Gabrieli Album (CBS Masterworks) 379-933

Enya—Watermark (Geffen) 379-925

John Patitucci—On The Corner (GRP) 379-909

Tone.Loc—Loc'ed After Dark (Delicious Vinyl) 379-875

Harry Connick, Jr.—20 (Columbia) 379-818

George Duke—Night After Night (Elektra) 379-719

Milli Vanilli—Girl You Know It's True (Arista) 379-610

Hiroshima—East (Epic) 379-321

Andreas Vollenwelder—Dancing With The Lion (Columbia) 379-313

Duke Ellington Orch.—Digital Duke (GRP) 357-350

Squeeze—Singles—45's And Under (A&M) 317-974

Living Colour—Vivid (Epic) 370-833

Steps Ahead—N.Y.C. (Intuition) 381-681

The Doobie Brothers—Cycles (Capitol) 382-457

Gloria Estefan—Cuts Both Ways (Epic) 382-341

Andres Segovia, Guitar—Segovia Collection, Vol. 5 (MCA Classics) 379-297

Placido Domingo—At The Philharmonic (CBS Master) 379-289

Badlands (Atlantic) 384-388

Branford Marsalis—Trio Jeepy (Columbia) 381-830

The Cult—Sonic Temple (Sire) 381-798

Enrico Caruso—Opera Arlas and Songs Milan 1902-1904 (Angel) 379-255

Michel Camilo (Portrait) 379-107

Judy Collins—Sanity And Grace (Gold Castle) 379-081

Wang Chung—The Warmer Side Of Cool (Geffen) 381-764

Stevie Nicks—The Other Side Of The Mirror (Modern) 381-103

Lyle Lovett And His Large Band (MCA) 378-935

Lisa Lisa & Cult Jam—Straight To The Sky (Columbia) 378-893

Roachford (Epic) 382-010

Jody Watley—Larger Than Life (MCA) 381-061

Introducing The Chick Corea Akoustic Band (GRP) 379-891

Portrait Of Vladimir Horowitz—Plays Mozart, Beethoven, Chopin, etc. (CBS Master) 378-604

Dave Grusin Collection (GRP) 378-398

Joe Sample—Spellbound (Warner Bros.) 378-224

Gipsy Kings (Elektra) 377-812

Prokofiev—Piano Concertos 1, 2. Vladimir Feltsman; Zubin Mehta (CBS Master) 377-390

Roy Orbison—Mystery Girl (Virgin) 377-101

Rosanne Cash—Hits 1979-1989 (Columbia) 376-665

Crosby, Stills, Nash and Young—American Dream (Atlantic) 376-533

Lee Ritenour—Festival (GRP) 376-301

Tiffany—Hold An Old Friend's Hand (MCA) 376-236

Franck/Brahms: Violin Sonatas. Nadja Salerno Sonnenberg, Cecile Licad (Angel) 376-038

Andres Segovia Collection, Vol. 4. Baroque guitar (MCA Classics) 375-998

Jeff Healy Band—See The Light (Arista) 375-873

Was (Not Was)—What's Up Dog? (Chrysalis) 375-857

Fleetwood Mac—Greatest Hits (Warner Bros.) 375-782

Journey's Greatest Hits (Columbia) 375-279

R.E.M.—Green (Warner Bros.) 375-162

Classics from the 50s, 60s, 70s

Woodstock II—Original Soundtrack (Atlantic) 382-143/392-142

Crosby, Stills, Nash and Young—So Far (Atlantic) 378-745

Grateful Dead—Skeletons From The Closet (Warner Bros.) 378-406

Roy Orbison—The All-Time Hits, Vols. 1 & 2 (Col. Special Pro) 377-945

Rockpile—Seconds Of Pleasure (Columbia) 377-846

The Who—Who's Better, Who's Best (MCA) 376-657

Jerry Lee Lewis—18 Original Sun Greatest Hits (Rhino) 369-108

Joni Mitchell—Blue (Reprise) 365-411

Traffic—John Barleycorn Must Die (Island) 364-935

Little Feat—Dixie Chicken (Warner Bros.) 363-515

Best Of The Doors (Elektra) 357-616/397-612

Yes—Close To The Edge (Atlantic) 351-965

Traffic—The Low Spark Of High Heeled Boys (Island) 351-924

Rolling Stones—Sticky Fingers (Rolling Stones Rec.) 350-645

Buddy Holly—From The Orig. Master Tapes (MCA) 348-110

The Who—Tommy (MCA) 345-223/395-228

The Byrds—Greatest Hits (Columbia) 342-501

A Decade Of Steely Dan (MCA) 341-073

Joe Cocker—Greatest Hits (A&M) 320-911

Led Zeppelin (Atlantic) 299-966

U2—Rattle And Hum (Island) 374-017

Spyro Gyra—Rites Of Summer (MCA) 370-767

David Sanborn—Close Up (Warner Bros.) 370-304

Wynton Marsalis Quartet—Live At Blues Alley (Columbia) 370-080/390-088

Tracy Chapman (Elektra) 369-892

Van Halen—OU812 (Warner Bros.) 369-371

Bobby McFerrin—Simple Pleasures (EMI) 369-306

New Kids On The Block—Hanging Tough (Columbia) 368-423

Basia—Time And Tide (Epic) 368-043

Carly Simon—Greatest Hits Live (Arista) 365-874

Guns N' Roses—Appetite For Destruction (Geffen) 359-984

Portrait of Wynton Marsalis (CBS Master) 373-555

Motown's 25 #1 Hits (Motown) 319-996/399-998

Elton John—Greatest Hits (MCA) 319-541

Eagles—Greatest Hits Vol. 2 (Asylum) 317-768

Creedence Clearwater Revival—20 Greatest Hits (Fantasy) 308-049

Woodstock—Orig. Soundtrack (Atlantic) 291-864/391-862

Best Of The Doobie Bros. (Warner Bros.) 291-278

Linda Ronstadt—Greatest Hits (Asylum) 286-740

Best Of The Band (Capitol) 269-365

Chicago—Greatest Hits (Columbia) 260-638

Simon & Garfunkel—Greatest Hits (Columbia) 219-477

Bob Dylan—Greatest Hits (Columbia) 138-586

Luciano Pavarotti—Pavarotti in Concert (CBS Master) 373-548

Libera—Greatest Hits (Columbia) 354-522

U2—The Joshua Tree (Island) 354-449

The Police—Every Breath You Take... The Singles (A&M) 348-318

Peter Gabriel—So (Geffen) 345-777

Kiri Te Kanawa—Verdi & Puccini Arias (CBS Master) 343-269

Billy Joel—Greatest Hits Vols. 1 & 2 (Columbia) 336-396/396-390

Dire Straits—Brothers In Arms (Warner Bros.) 336-222

David Bowie—Let's Dance (EMI Amer) 319-822

Foreigner—Records (Atlantic) 318-055

Kenny G—Silhouette (Arista) 371-559

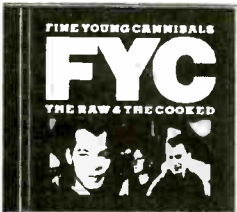

Fine Young Cannibals—The Raw & The Cooked (I.R.S.) 379214

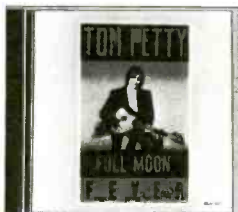

Tom Petty—Full Moon Fever (MCA) 382-184



Guns N' Roses—GN'R Lies (Geffen) 376-087



Wynton Marsalis—The Majesty Of The Blues (Columbia) 380-394



The Movies Go To The Opera—Various Artists (Angel Studio) 372-342

NEW PRODUCTS

MONSTER CABLE

Monster Cable's new speaker cable has separate conductors for the high and low frequencies, eliminating the need for multiple cable sets for biwired or biamplified speakers. Its angled, gold-plated pins can fit both push-type and five-way binding-post speaker terminals and are said to facilitate connection to hard-to-reach outputs on receivers and amplifiers. Price: \$1.25 a foot. Monster Cable, Dept. SR, 101 Townsend St., San Francisco, CA 94107.

Circle 129 on reader service card

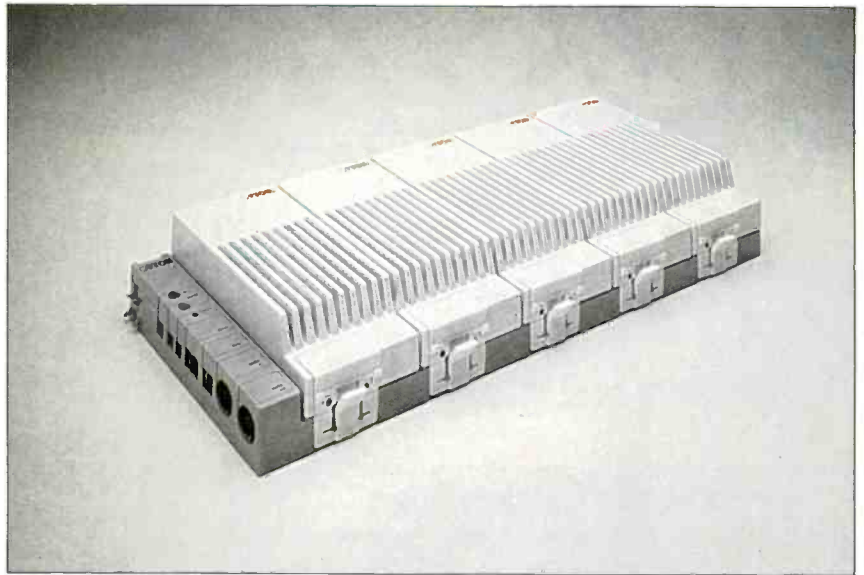

CANTON

Canton's Mainframe outboard amplifier system is its first car stereo product. The modular system consists of the five-port MF 5 base unit (shown) or the three-port MF 3 and up to five M 50 monophonic plug-in amplifiers. Each of the 50-watt amplifiers has its own active crossover. For more amplification,

users can daisy-chain additional base units and amps into the system. Prices: MF 5 base unit, \$325; MF 3 base unit, \$225; M 50 amplifiers, \$300 each. Canton North America, Dept. SR, 915 Washington Ave. S., Minneapolis, MN 55415-1245.

Circle 130 on reader service card

PIONEER

Pioneer's Premier KEX-M800 cassette receiver has a detachable faceplate that can fit into a pocket or purse, leaving the electronics in the dash. The unit includes controls for an outboard CD player and can be operated by its wireless remote control. An automatic level adjuster matches volume for all three sources. The tuner section has twenty-four station presets and a best-station

memory function, which allows users to preset automatically the six most powerful stations in an unfamiliar area. A radio-intercept function automatically switches the program source to the radio while a cassette is fast-winding. Price: \$600. Pioneer Electronics, Dept. SR, 2265 E. 220th St., P.O. Box 1720, Long Beach, CA 90801-1720.

Circle 131 on reader service card



EJ MECHANICAL SYSTEMS

The modular Discube CD storage device from EJ Mechanical Systems has a spring-action ejection system. Made of high-grade plastic, the Discube comes with cover, carrying handle, connecting clips, spring lock, and felt feet. Modules hold ten discs each and are available in black, red, ash-gray, and white. Price: \$19.95. EJ Mechanical Systems, Dept. SR, 10-12 County Line Rd., Somerville, NJ 08876.

Circle 132 on reader service card

Our version of image advertising.

Recently, we asked ourselves what a Merit "image" ad would look like. Cowboys and camels being taken, the best image we could think of was straightforward and direct. How else to portray Enriched Flavor™? How else could we show satisfying taste, and up to 27% less tar than other leading lights? How else could our advertising reflect what you already know? There is no better way to smoke than Merit. No matter how you look at it.

Enriched Flavor,™ low tar. A solution with Merit.



**SURGEON GENERAL'S WARNING: Cigarette
Smoke Contains Carbon Monoxide.**

© Philip Morris Inc. 1989

Kings: 8 mg "tar," 0.6 mg nicotine av. per cigarette by FTC method.

by Ian G. Masters



Which Dolby?

Q My new cassette deck offers both Dolby B and Dolby C noise reduction, but the owner's manual says virtually nothing about which system should be used at any particular time. Which should be used when?

ROBERT JOSEPHS
Woodstock, GA

A For best results, you should always use the most advanced noise reduction you have, in this case Dolby C. Virtually all decks with Dolby C also include provision for the somewhat simpler Dolby B, however, because it is something of a standard and because most commercially recorded cassettes are Dolby B-encoded.

When you make recordings to be played back on the same machine, you should employ Dolby C. On the other hand, you may want to make tapes to use in your car or your portable player, which may be able to decode only Dolby B; in that case the lesser system should be used. By the same token, if you are making tapes to send to a distant friend, you can pretty well count on his being equipped with Dolby B, but he may not have Dolby C. In that case, play it safe and use Dolby B.

Multiplex Filter

Q I often record FM broadcasts on an open-reel tape recorder and then transfer the parts I want to keep onto cassette. The open-reel machine isn't

equipped with a multiplex filter, but my cassette deck is. Should I use it when dubbing?

PAUL WILKINSON
Washington, DC

A It may not be necessary, depending on your equipment, but it's probably a good idea in any case. The audio portion of an FM signal rolls off sharply above 15 kHz, but if it's a stereo program (and most are), a 19-kHz tone is added to tell your tuner to switch in the stereo decoding circuitry. While this "stereo beacon" would not be audible to most of us, it can still have an effect on the Dolby noise-reduction circuitry in a cassette deck. To avoid this, all FM tuners attempt to eliminate the beacon by means of a filter above 15 kHz, but because the filter has to have an extremely steep slope, it is rare that the 19-kHz tone is removed entirely. For that reason, cassette decks with Dolby contain multiplex filters in their input circuits to reduce the tone further.

Because open-reel decks rarely include Dolby, they are not provided with a similar filter. If yours has reasonable response at the high end, therefore, recordings made on it might well contain enough 19-kHz information to disturb the cassette deck's Dolby circuits when you dub from one to the other. Using the multiplex filter would reduce this possibility.

Phase Inversion

Q Both my preamplifier and my CD player provide switches to invert phase. Why do some manufacturers include this while others do not?

WILLIAM E. WOODS
Pittsburgh, PA

A In audio, the word "phase" can mean several things. The most familiar is *relative* phase, which is the relationship between stereo channels. A center-channel signal requires that the cones of the two speakers move in and out at the same time ("in phase"). If one moves in while the other is moving out, they are "out of phase," a condition that makes it virtually impossible to locate the instruments in the sound stage and also usually results in selective cancellation of the low frequencies.

Relative phase is rarely a problem once your equipment has been set up correctly. Speakers (and occasionally phono cartridges) may be wired out of phase, but the solution is simply to reverse the polarity in one channel: once the proper phase relationship has been set up, it's unlikely to change. Nevertheless, some early hi-fi equipment did include a front-panel phase switch to do the same thing.

Another meaning of the term, however, is *absolute* phase. A live sound is a complex succession of compressions and rarefactions of the air, and a high-fidelity system should reproduce this pattern exactly—a compression in the studio should be a compression in the listening room. To reverse the polarity of *both* stereo channels would mean that they would still be in phase with respect to each other, but out of phase with respect to the original signal. Such phase reversals are common throughout the audio chain from studio to home, but what matters is what comes out of the speakers at the end, and for this reason some components, such as yours, provide a switch to restore proper absolute phase.

Whether or not this is useful is a matter of some debate. In the first place, most people can only hear a difference in a direct A/B comparison, if they can hear one at all, and even then it's very difficult to tell which is "better." In most cases, there is no way of determining the absolute phase of the original sound, nor whether it was maintained in the final mix of the recording. So the best that phase-inverting controls can do is to make sure proper phase is maintained throughout the playback system—something that could be done just as easily by switching the speaker connections.

Matching Input Levels

Q Although my moving-coil phono cartridge is a high-output type designed to be used with a moving-magnet input, when I connect it this way I have to set the amplifier's volume control much higher than with other sources to obtain the same sound level. When I connect the cartridge to the moving-coil input, however, the level is roughly equivalent to that of the other sources. Would there be any harm to the components involved if I were to continue using this arrangement?

DENNIS E. FLORY
Maynard, MA

A If it works, do it; you can't hurt your equipment that way. The only possible problem might be input overload. Like amplifier output sections, phono preamplifiers can be subject to clipping if driven too hard, and the distortion caused will be amplified (and recorded if you're dubbing to tape). Listen carefully to high-level passages on your records, as that's where the overload is likely to occur; if they sound clean, there's no reason to change your arrangement. If distortion does happen, however, you might be better off using a cartridge that's better matched to your receiver. □

*“If the PS•3 speakers were sold like magic elixirs, I would have bought a case!”**



Introducing the unique new PS•3 speaker system.

With every two-piece stereo speaker system you must resolve two quandaries: 1) where will it sound best, and 2) where will it fit? Often these are different and conflicting places in your listening room. Even worse, the best place for bass response is rarely ideal for stereo imaging.

“The PS•3 satellites sound smooth and natural.”

The new Design Acoustics PS•3 Micro-Monitor™ three-piece design offers a versatile answer to these dilemmas. Simply place the two tiny Point Source™ oak veneer satellites exactly where they create the best stereo image. Small and handsome, they fit almost anywhere without compromise.



“The woofer continues the smooth work...”

Then locate the bass module wherever it creates the smoothest, deepest bass...even out of sight. Again, without sonic compromise. The result is far better imaging and wider, flatter response than you can hear from any comparable two-enclosure system. And the PS•3 looks and sounds great no matter the shape or size of your room.

“...you can tune the bass...without affecting the midrange or treble balance.”

The new PS•3 has many more advantages that make it the ideal system for your home. Don't choose any speaker system without first hearing and seeing the new PS•3. Visit a Design Acoustics dealer near you. Write for brochure and dealer list today.

*All quotes by noted audio critic Rich Warren, Chicago Tribune, May 12, 1989

DA DESIGN[®] ACOUSTICS
An Audio-Technica Company
1225 Commerce Drive, Swoy OH 44224 • (216) 686-2600

THE NEXT REVOLUTION(S)

by Ken C. Pohlmann

THE Audio Engineering Society (AES) is a professional organization for the audio industry. Engineers, researchers, educators, and even audio journalists make up its worldwide membership. They look to the society's *Journal* for reports on the latest developments in audio technology and theory, they attend the society's international conventions to see the newest professional audio hardware and software. Members also look to the AES to communicate specialized technical information through international conferences devoted to an in-depth examination of a particular topic.

The seventh and most recent AES International Conference, titled "Audio in Digital Times," convened in Toronto last May 14. For three and a half days, an overflow crowd listened as forty-eight presenters delivered a cutting-edge look at digital audio technology. Braving future shock, information overload, and a surfeit of acronyms, and struggling under the weight of 10 pounds of technical papers, the 450 attendees rode the wave of the latest thinking in digital audio.

The conference sampled the state of the art in digital audio devices, and the discussions of the audio experts who took part—the people actively planning the industry's future—provided us with a forecast of what lies ahead for consumer audio. For example, advances in basic technology such as information storage will greatly influence future audio products. The three primary forms of storage—magnetic, optical, and semiconductor—are all in the midst of technical revolutions, and they're leapfrogging to new data densities. Look for new forms of optical and magnetic storage and a megabyte or more of memory in future digital audio products.

Of course, most audio signals must undergo analog-to-digital (A/D) conversion before entering a digital circuit and digital-to-analog

(D/A) conversion at the output. There is a growing awareness of the limitations of existing converter technology. When performance is scientifically reviewed in terms of human auditory capabilities, it is clear that conversion techniques can indeed introduce audio artifacts (distortions). Careful converter design and careful evaluation of the results are needed to minimize the effects. Expect to see more 18- and 20-bit converters and circuits using noise-shaping and high oversampling rates to reduce distortion. The new A/D converters incorporating such techniques will finally enable development of digital microphones—which should cause a revolution in audio recording.

Digital signal processing (DSP) is another revolution in the making. Applications for DSP chips (manufactured by such companies as Motorola, Texas Instruments, and AT&T) are endless: New kinds of filter implementations, single-bit A/D converters, digital loudspeaker crossover networks, new reverberation processors and algorithms, new systems for music analysis and synthesis, and low-bit-rate encoding, which can greatly extend the playing times of recording media through data-compression techniques, are all being developed.

Recording professionals at the AES Conference were anxious to survey the latest in pro recording gear. Several systems for multichannel audio recording on computer hard disks have been developed. Professional digital audio tape (DAT) hardware is springing up all over: Pro DAT decks will feature tape monitoring, recording and playback of SMPTE time codes, editing capability, variable pitch control, digital inputs and outputs, and external synchronization. There are also many real-world problems to be overcome, such as data degradation in copies, longevity of archives, and format incompatibility.

The professionals also discussed issues in digital studio design and practice. The multichannel-audio digital interface (MADI) format permits multitrack digital recorders to be connected to digital consoles with a single pair of wires. In the

future, studio components could be linked by a digital audio synchronizing signal so that they could talk to each other over a data bus. But before that happens, many studios will opt for a digital audio workstation, a device that integrates all the operations of a recording studio into a single controller.

The status of consumer digital audio is also of great interest to professionals because the consumer market is a driving force in the industry. Nakamichi unveiled a new magneto-optical recorder using a 3½-inch disc to store 15 minutes of CD audio; the lecture concluded with a demonstration, perhaps the first public look at an erasable audio optical-disc system. Sony presented a look at the new DSP chips used in its TA-E1000ESD digital preamplifier. And Yamaha discussed reproduction of architectural acoustical effects using DSP.

DIGITAL audio is also changing the face of film, video, and broadcasting. Although commercial radio broadcasting systems using digital RF modulation are still years away, many radio stations are using digital audio for news gathering and post-production. Companies are examining the feasibility of optically recording digital soundtracks on motion-picture film in the area now devoted to analog soundtracks. Meanwhile, post-production facilities are already heavily involved with digital technology for television and film projects, using it for such tasks as audio and video recording and editing, signal distribution and routing, and bit-rate and format conversion. Although its future in the U.S. is still cloudy, high-definition TV (HDTV) is forging ahead in other countries using digital techniques for the audio transmission and reproduction.

The AES Conference presented a clear (but often complex) picture of the fast-moving pace of digital audio technology. Much earlier technology is now obsolete, and new technology will replace it. While we'll have to wait for the specifics of these new technologies, one thing is certain: Intense research will surely bring new opportunities for digital audio and new digital products. □

Investing in sound? Here's how to make it pay off.



Great buys—at a great buy: SAVE UP TO 62%!

Stereo Review is written for people who want to make smart buying decisions. We'll help you find the right stereo equipment—the *first* time you buy—and show you how to use it the right way. Because *sound information* is the key to getting an audio system that gives you what you really want.

We test over 70 stereo products in all price ranges each year. *Stereo Review's* product evaluations tell you how the components sound... identify unique features... compare models to others in the same price bracket. We warn you about design quirks, distortion, potential problems. We make the components suffer—so you don't have to.

You'll appreciate our straightforward explanations of audio technology. Telling you how to get more out of your equipment. Announcing important breakthroughs. Clueing you in on professional maintenance tips. The kind of inexpensive know-how that can make a million-dollar difference in how your system sounds.

Even if you already have the perfect system, you'll value *Stereo Review's* record reviews. An average of 30 a month, in all categories of music. They'll insure that your system's power isn't wasted on inferior recordings. **Use this coupon to subscribe to *Stereo Review* at UP TO 62% OFF. It's one of the best sound investments you'll ever make!**

Stereo Review

P.O. Box 55627
Boulder, CO 80322-5627

YES! I want superior stereo sound. Please enter my subscription to *Stereo Review* for the term checked below:

- One year (12 issues) \$13.94
 Two years (24 issues) \$24.94
 Three years (6 issues) \$34.94

CHECK ONE: Payment enclosed. Bill me later.

Mr. _____
Mrs. _____
Ms. _____

(please print full name) 81459

Address _____

City _____

State _____ Zip _____

Annual newsstand cost is \$30.45. The full one-year subscription price is \$13.94.

Foreign postage: Add \$5 a year for Canada, \$8 a year (payment in U.S. currency—must accompany order) for other countries outside U.S. and possessions. Please allow 30 to 60 days for delivery of first issue.

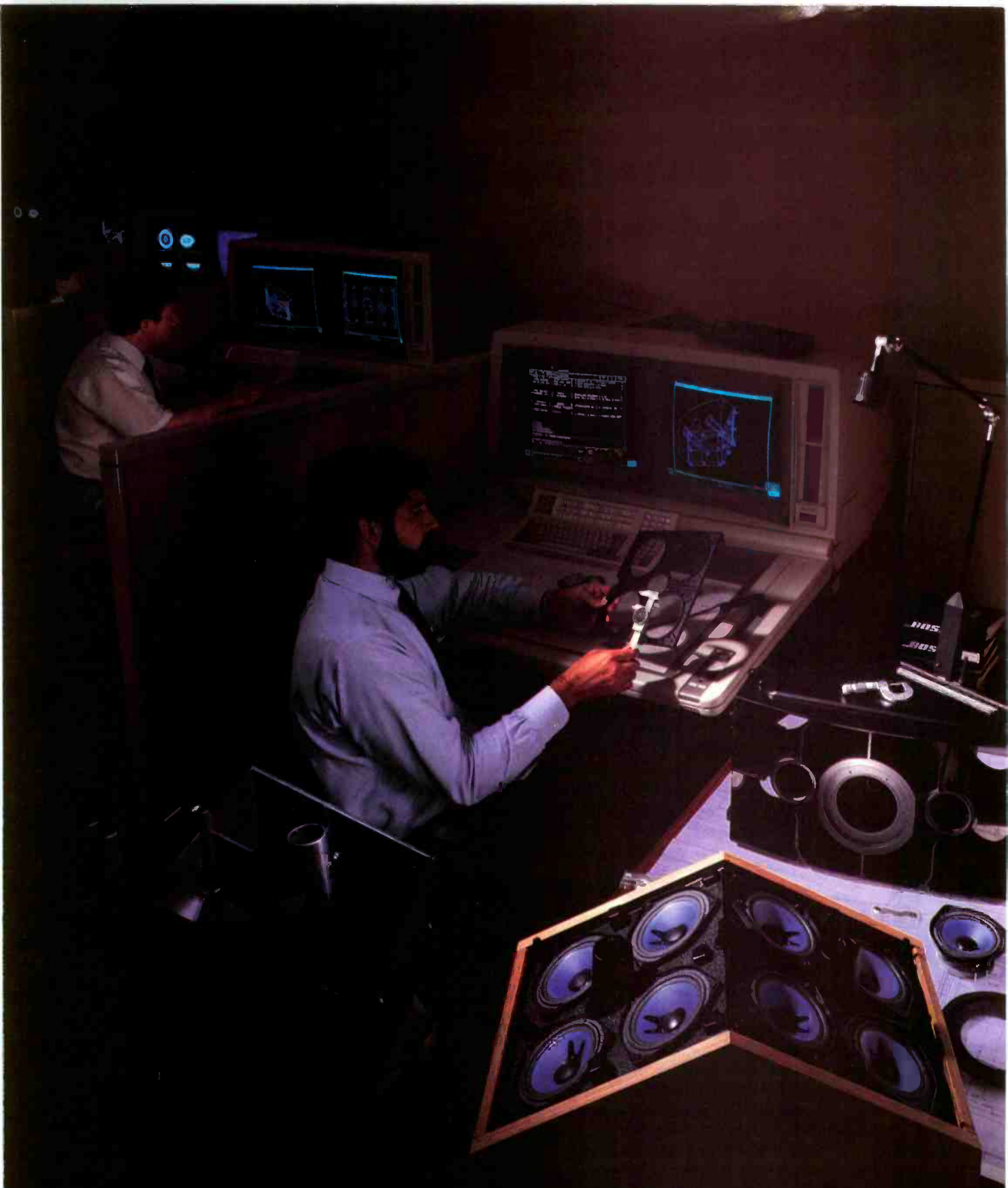

Bose® engineers use advanced design systems to bring the benefits of new technologies to the constantly-refined 901® Direct/Reflecting® speaker. The Intergraph InterAct 32 CAD/CAM system (above) at Bose Corporation's Framingham, Massachusetts worldwide headquarters is part of this commitment to "better sound through research."

The Bose® 901® Direct/Reflecting® speaker system: A technological breakthrough 20 years ago— pushed to the edge of today's technologies.

Twenty-five years ago Dr. Amar Bose directed a research program at the Massachusetts Institute of Technology on the physical acoustics and psychoacoustics of sound reproduction. The results of this effort provided the theoretical basis for the design of the first Bose 901 Direct/Reflecting® speaker system five years later. Its introduction in 1968 was greeted with the highest critical acclaim ever accorded to a loudspeaker.

"... I must say that I have never heard a speaker system in my own home which could surpass, or even equal, the Bose 901 for overall "realism" of sound."

—Julian Hirsch, *Stereo Review* 1968

"There is no doubt that the much-abused and overworked term, 'breakthrough,' applies to the Bose 901 system and its bold new concepts."

—Bert Whyte, *Audio* 1969

"Many people swear by these speakers as the ultimate."

—*Complete Buyer's Guide to Stereo Hi-Fi Equipment* 1975

But this was just the beginning. Bose research continued to focus on the 901 system, incorporating the latest technology as it was developed. For example, in 1976 two new innovations were brought to the system to dramatically improve its efficiency and power handling. These new technologies—the Acoustic Matrix™ enclosure and the Helical Voice Coil driver—alone represent a significant investment in research and development. As a result of this commitment, the rave reviews continued.

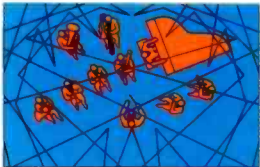

Live music is a combination of direct and reflected sound energy.



Bose Direct/Reflecting® speakers accurately reproduce live music's natural balance of direct and reflected sound energy, in full stereo (blue area) throughout the room.

"... it has a total sound that soars, with a brilliance that defies description."

—*Modern Hi-Fi & Music* 1977

Bose engineers work continuously to develop and perfect new audio technologies with one common denominator: if they demonstrate the potential to improve performance, they

become part of the Bose 901 system. In today's era of digital sound, with hundreds of engineering and design improvements over the original 901 system, the 901 Series VI Direct/Reflecting® speaker system is the technological flagship of Bose Corporation.

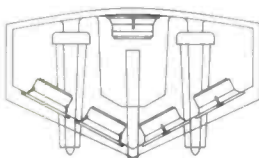
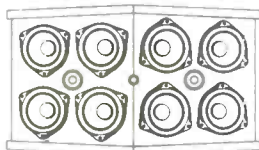
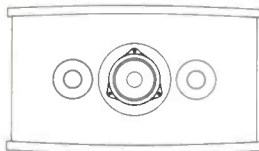

"The 901 VIs sound live and exciting the moment you fire them up... There are more than a few music lovers who won't listen to anything else..."

—Daniel Kumin, *Digital Audio* 1988

We submit that the research and development behind the Bose 901 system make it the most advanced, lifelike sounding speaker you can buy. But you must be the final judge. Ask your dealer to give you an "A-B" demonstration comparing the Bose 901 system to any other speaker, regardless of size or price.

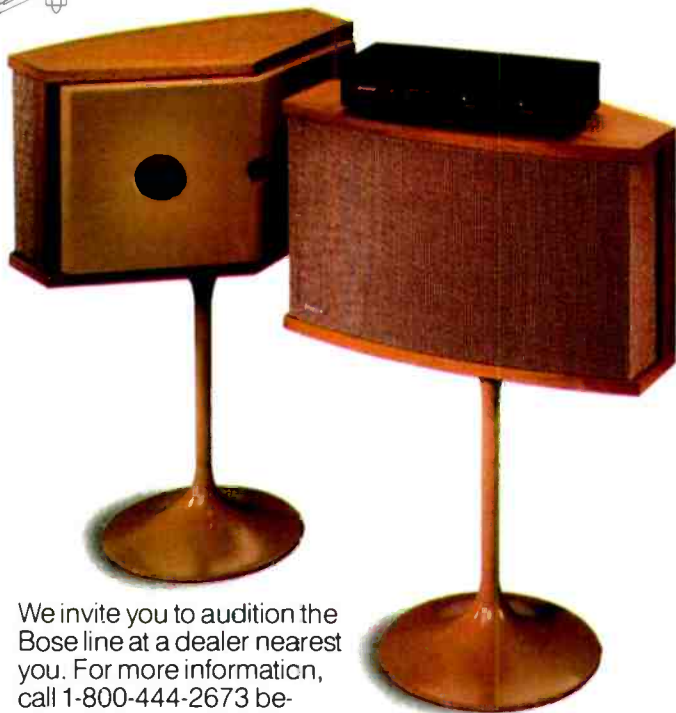

We invite you to audition the Bose line at a dealer nearest you. For more information, call 1-800-444-2673 between 9 a.m. and 5 p.m. EST.

BOSE®
Better sound through research.

RECORDING AMERICAN

by William Livingstone

FOR complicated reasons American orchestras have been at a disadvantage in making recordings. The centers of classical recording are in Europe, and because of other factors than geography it costs considerably more to record here than in most European countries. Nevertheless, record companies have vied for the services of America's Big Five—usually with a glamorous foreign maestro on the podium. But the orchestras of, say, Dallas, Indianapolis, and Pittsburgh were less well represented on vinyl. With the beginning of the compact-disc era the appearances of American orchestras on CD were even more spotty.

In the middle 1980's, Michael J. Koss, president of Koss Corporation (a company best known for its manufacture of headphones), began building his library of compact discs. He was disappointed that much of the symphonic and chamber music he enjoyed was not yet available on CD's. He was distressed to see that European orchestras were out-recording American orchestras by about three to one.

With the energy, initiative, and true grit typical of the Midwest (or thought to be typical by those of us who live elsewhere), Koss decided to do something about it himself. He has formed Koss Classics, a new label that will produce and market a line of compact discs by musicians resident in Milwaukee, where Koss Corporation has its headquarters.

Koss Classics has made its first recordings, with the Milwaukee Symphony and the Paganini Trio, and at the Consumer Electronics Show in Chicago this summer the first two CD's were launched—two all-Dvořák programs played by the Milwaukee Symphony conducted by its young Czech music director, Zdenek Macal. After hearing them, Hans Fantel, audio and video columnist for the *New York Times*, said he was happy to have them in time to take on vacation in his

native Austria. "I want to tell them that in America this is what a *provincial* orchestra sounds like."

On the strength of Koss Classics KC-1001, I am as impressed as Fantel. Its program is Dvořák's *Husitská* (or *Hussite*) Overture and his Symphony No. 6, which sounds not unlike his more familiar *New World* Symphony (No. 9) in its alternation of exciting, dramatic passages and ones that are more lyrical and serene. The playing is anything but provincial.

What is more interesting to me is the quality of the recording, supervised by engineers from WFMT in Chicago who handle the broadcasts of the Milwaukee Symphony. The one CD I've heard has a wonderfully warm concert-hall aura without sacrificing detail. There is a particularly appealing tawny color to the sound of the oboe, for example. I applaud this auspicious beginning, and I look forward to future releases.

Koss Classics recordings will retail for \$17.95 and will be sold principally (at first) by the audio dealers who handle Koss headphones and other products. If you cannot find them, write to Koss Corporation, 4129 N. Port Washington Ave., Milwaukee, WI 53212. Or call 1-800-USA-KOSS.

MAKING recordings of American musicians is not just a community service for a prosperous young businessman and music lover like Michael Koss, and, of course, he is not the only person doing it. Telarc, the independent American label headquartered in Cleveland, Ohio, has made prize-winning recordings with the Cincinnati Pops and the Atlanta Symphony. Energy, initiative, and true grit are not found only in the Midwest. Two still smaller companies, Delos, headquartered in Los Angeles, and Newport Classic in Providence, Rhode Island, have also made notable recordings with American ensembles and soloists.

Newport Classic has recorded an East Coast original-instruments group, the Philomusica Antiqua of New York. In October the company will release an album of Baroque music by women composers per-

formed by the [San Francisco] Bay Area Women's Philharmonic. The principal soloists on Newport Classic are both keyboard artists—Anthony Newman (organ and piano) and Jeffrey Reid Baker (piano and synthesizers).

Delos, which in the beginning recorded even the Philadelphia Orchestra, has made some of its finest recordings with the Seattle Symphony and the Oregon Symphony. The label's principal artists include the



Michael Koss (left) and Koss Classics recording producer Evans Mirageas

American conductors Gerard Schwarz and James DePreist and the American pianist Carol Rosenberger. Delos has just launched a complete cycle of the seven symphonies of the American composer Howard Hanson performed by Schwarz and the Seattle Symphony. The first CD, containing Symphonies Nos. 1 and 2, is reviewed by David Hall in the "Best Recordings of the Month" section of this issue.

I have followed the development of Delos and Newport Classic because they make interesting records and make them well, and I couldn't understand how they stayed afloat without personal fortunes behind them or the backing of big companies. Fortunately, the quality of both catalogs has attracted big-time record companies. Delos records are now being distributed by A&M, and Newport Classic releases are being handled by MCA, which should relieve the founders, Amelia Haygood (Delos) and Lawrence Kraman (Newport Classic), of some financial worries and leave them free to invest their energy and determination in artistic matters. □

LEAVING A SYMPHONY UNFINISHED SHOULD BE UP TO THE COMPOSER. NOT YOUR TAPE.



Schubert had a pretty good reason for not completing music. He died.

But abrupt endings while taping CDs are not so excusable. Which is why Maxell now offers 100-minute cassettes designed specifically for digital sources. With superior frequency response and noise reduction, they actually rival CDs in sound quality. And with an extra ten minutes of

recording time, they do the same in sound quantity.

Instead of being frustrated by the shortcomings of other tapes, try our new XLII 100 and XLII-S 100. And you may never have to settle for Vivaldi's "Three-And-A-Half Seasons" again.



maxell®

© 1989 Maxell Corporation of America, 22-08 Route 208, Fairlawn, N.J. 07410

CIRCLE NO. 25 ON READER SERVICE CARD

THE PERFECT HARMONY.

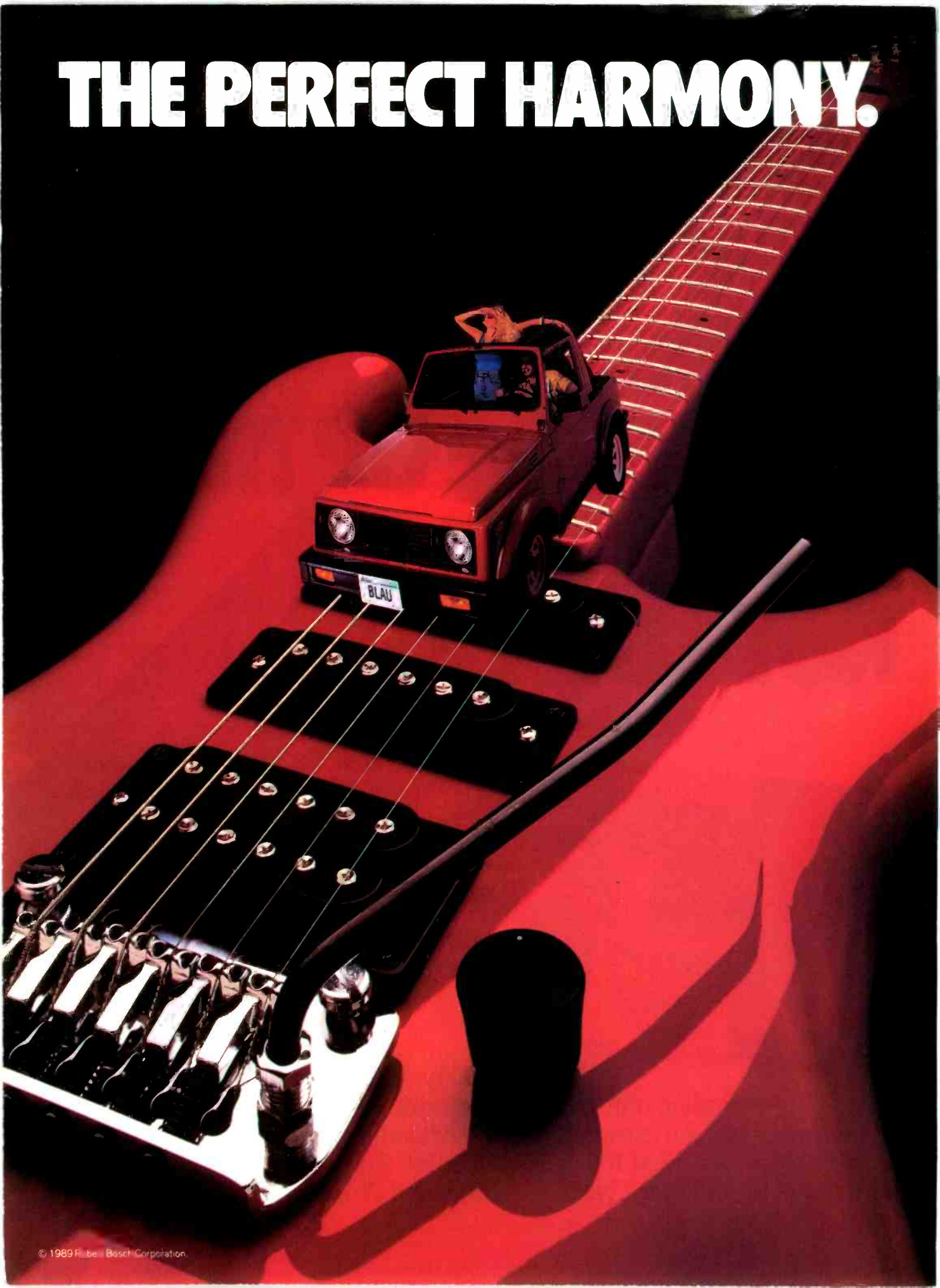

PRICE AND PERFORMANCE.



Introducing three slick new performers from Blaupunkt. Finally, legendary performance without a legendary price tag. That's the Blaupunkt difference. Just feast your eyes on our three latest innovations. The Phoenix and Boston cassette/receiver combinations and the QL6500 speakers. Compare the features. Then visit a Blaupunkt dealer and compare the performance. Once you do, you'll see there's no comparison.

- The Phoenix SQR 29 (\$279.95) Quick release removable chassis Auto reverse cassette deck CPS cassette program search AM/FM stereo with 20 presets TS travel store with 5 presets True 4-channel preamp-out Separate bass/treble Loudness Noise reduction system Flex-Fader Code Protection with flashing LED Multifunction display 15 watts total power.
- The Boston SQR 49 (\$299.95) High power 50 watts Auto reverse cassette deck AM/FM stereo with 24 presets TS travel store with 6 presets True 4-channel preamp-out Separate bass/treble Flex-Fader Code Protection with flashing LED Multifunction display.
- QL6500 Speakers (\$179.95) 6.5-inch Coaxial Quartz polypropylene cone Altanium tweeter for optimum high frequency response 50-20,000 Hz overall frequency response 100 watts max 90 dB sensitivity.
- For the Blaupunkt dealer nearest you, call 1-800-237-7999.

BLAUPUNKT
BOSCH Group
The difference is pronounced.™

DAT GOES VIDEO

REPORTED BY BRYAN HARRELL

TOKYO—Aiwa, the first company to release a digital audio tape deck nearly two years ago, has announced the development of a portable DAT recorder hardly bigger than the first Sony Walkman tape players of a decade ago. Measuring approximately $5\frac{3}{4} \times 3\frac{3}{4} \times 1\frac{1}{2}$ inches and weighing only $1\frac{1}{2}$ pounds (including a rechargeable battery), the new portable DAT deck has no definite release date or fixed price. Reports are, however, that it will be released in Japan this fall with a price tag of ¥100,000 (about \$700).

One remarkable aspect of Aiwa's new portable is that in addition to digital audio recording and playback, it is capable of recording still-video images—as many as 1,800 frames on a 2-hour DAT cassette—when it is used with an optional adaptor. Possible sources include hand-held video cameras and the new crop of floppy-disc still-video cameras as well as conventional camcorders, VCR's, and TV sets. Image playback is through an ordinary TV or video monitor. During still-video recording, a continuous digital soundtrack can also be recorded, though the quality is lower than that of an audio-only recording.

Digital recording from analog sound sources is also possible through an optional adaptor that contains analog-to-digital circuitry and functions as an interface with microphones and other analog sound inputs. Aiwa claims that sound quality in audio-only recording is on par with its component DAT deck, though no specifications have been released yet.

An adaptor for car audio playback use has also been developed. The deck rests on a platform supported by a floor-mounted gooseneck. Signal input is either through stereo input jacks on the head unit's front panel (a feature of Aiwa's more expensive car audio units) or through a cassette-shaped adaptor that routes the signal through the head unit's tape heads.

The portable deck's compact dimensions were achieved through the devel-

opment of a new transport mechanism that places the rotating head drum closer to the DAT cassette. The head drum itself, however, is still the standard size (30-millimeter diameter) to keep costs down and maintain standard DAT search performance.

Aiwa announced that several other parts of the new portable were developed for it, including a new high-density lead-acid rechargeable battery. The company is said to have a total of forty-three patents pending on various aspects of the deck's design.

The DAT still-video format is not exclusive to Aiwa; rather, it is one that has been adopted by the industry-wide DAT standards committee, thus assuring compatibility with any similar devices developed by other manufacturers in the future. The digital recording of still-video images should be an advantage during copying and editing.

Despite the DAT format's high data-storage capacity, some compromises had to be made to enable the recording of 1,800 still-video images and a digital soundtrack on a 2-hour DAT cassette.

The palm-size Aiwa DAT deck is only a little bigger with the still-video adaptor added (lower photo).



The DAT still-video format calls for two modes, both of which reduce dynamic range while maintaining frequency response to 22,000 Hz.

Mode I calls for the 16-bit encoding to be divided into 6 bits for video and 10 bits for audio. One still-video frame, with 350 lines of horizontal resolution, is recorded every 4 seconds. Audio dynamic range is 62 dB.

Mode II makes higher-resolution video stills possible by dividing the 16 bits evenly into 8 for video and 8 for audio. The result is 450 lines of horizontal resolution in video images recorded every 5 seconds. This works out to 1,440 frames per 2-hour tape. Audio dynamic range is lowered to 50 dB, but the sound is not affected by certain noises common to analog formats.

The new Aiwa portable also offers a third mode that is *not* part of the formal DAT still-video standard. Mode III has the same video specs as Mode II, but the 8-bit digital audio is *non-linear*, which is said to afford 90 dB of dynamic range. It should be noted that the audio in this mode is not compatible with the standard DAT format, and sound-quality deterioration is likely if Mode III tapes are played on an ordinary DAT deck. The audio portion of a program recorded in Modes I and II can be played back on any DAT deck, however.

Aiwa cites a myriad of applications for the new DAT portable apart from its use as a portable digital audio recorder and player. Among them are business and educational presentations, personal photo albums, image files for institutions, and A/V publishing. A lot of text can be presented in 1,800 frames, particularly when it is supported by a continuous soundtrack.

This new DAT product can be interpreted as an attempt to revitalize the format, which is generally recognized to be going nowhere even in its country of origin. Aiwa may have found the key. Remember that the CD never really caught on in Japan until the appearance of those (relatively) inexpensive portable players. □

The International Preview Society

**3 COMPACT
DISCS
FOR JUST \$1**

plus shipping
and handling
with Club
membership

**With No Obligation
To Buy Anything ... Ever!**



Perlman; Mozart,
Sinfonia Concertante
25032

Vivaldi, Concerto "L'Amoroso;" 5 more
The English Concert/Pinnock. "Luscious
[sound]."—*Billboard* Archiv 25187

Heifetz: The Decca Masters, Vol. 1
Humoreske, Clair de Lune, Golliwog's
Cakewalk, many more. MCA 00604

Respighi: The Pines Of Rome; The Foun-
tains Of Rome; Roman Festivals - The
Philadelphia Orch./Muti. Angel 34443

Rachmaninov, Symphony No. 1 - Con-
certgebouw Orchestra/Ashkenazy. "Full
of churning, driving energy."—*Fanfare*
London 15347

The Academy—By Request - Academy of
St. Martin-in-the-Fields/Marriner. Sheep May
Safely Graze, more. Angel 54094

Beethoven, Symphonies Nos. 2 & 8 - Lon-
don Classical Players/Norrington. "Brilliantly
executed."—*Opus* Angel 00466

Rhapsody In Electric Blue - Jeffrey Reid
Baker, synthesizers. Rhapsody In Blue, 3
Preludes, more. Newport Classic 34647

Horowitz Plays Liszt - Sonata in B Minor,
Consolation No. 3, more. RCA 00511

Beethoven, Symphony
No. 6 (Pastorale);
more - Royal Phil/
Previn. RCA 43612

D. Scarlatti, 7 Sonatas;
Larghetto; more - Nar-
ciso Yepes, guitar.
DG 15497

Tchaikovsky,
Symphony No. 4
Chicago Symphony
Orchestra/Solti,
London 25038

Holst, The Planets - Montreal Symphony
Orchestra/Dutoit. London 15448

Rimsky-Korsakov, Scheherazade - Vienna
Philharmonic/Previn. Philips 15415

Rossini, Overtures - Barber Of Seville, more.
Orpheus Chamber Orch. DG 15527

Mahler, Symphony No. 4 - Concertgebouw
Orchestra/Bernstein. DG 15526

Vivaldi, 9 Concerti a Quattro - 1 Musici. "A
must."—*Fanfare* Philips 15313

Saint-Saëns, Symphony No. 3 (Organ)
Montreal Symphony/Dutoit. London 15529

Bach, Brandenburg Concertos Nos. 4-6
The English Concert/Pinnock. Archiv 25417

Berlioz, Symphonie Fantastique - The
Philadelphia Orchestra/Muti. Angel 54244

Mozart, Piano Sonatas Nos. 6 & 16 - Mitsuko
Uchida, piano. Philips 15377

Vivaldi, 4 Seasons - Simon Standage;
English Concert/Pinnock. Archiv 15356

Perlman: Brahms, Sonatas for Violin &
Piano; more - Angel 33760

Mozart, Piano Concertos Nos. 20 & 21
Malcolm Bilson, fortepiano. Archiv 25208

Sibelius, Symphony No. 4; more - Philhar-
monia Orchestra/Ashkenazy. London 05272

Suppe, Overtures - Light Cavalry, more.
Montreal Sym./Dutoit. London 25219

Barry Douglas: Brahms, Piano Concerto
No. 1 - London Symphony Orchestra/
Skrowaczewski. RCA 00732

Andrés Segovia Plays Bach - Chaconne,
Siciliano, 3 Pieces For Lute, Gavotte en Ron-
deau, more. MCA 63600

Sibelius, Finlandia; Valse triste; Tapiola;
The Swan Of Tuonela - Berlin Philharmonic/
Karajan. DG 25399

Krystian Zimerman: Chopin, The 4
Ballades - Plus Barcarolle & Fantaisie In F
Minor. "Dramatic."—*Gramophone* DG 15332

Ravel, Bolero; La Valse; Rapsodie Espa-
gnole; Alborada del Gracioso - Montreal
Symphony Orch./Dutoit. London 15199

Jascha Heifetz: Bruch, Violin Concerto No.
1 & Scottish Fantasy; Vieuxtemps, Concer-
to No. 5 - RCA 44363

Kronos Quartet: Winter Was Hard - Title
piece by Sallinen; Barber, Adagio; more by
Webern, others. Nonesuch 00675

Pavarotti At Carnegie Hall
Songs and arias by Schubert,
Verdi, Flotow, Liszt, Scarlatti,
others. London 15311

Dvořák,
"New World"
Sym.
Cleveland/
Dohnányi
15018

Ute Lempert Sings Kurt Weill - Mack The
Knife, Speak Low, I'm A Stranger Here Myself!
11 more. London 15163

Copland, Billy The Kid; Rodeo (Complete
Ballsets) - St. Louis Symphony/Slatkin.
"Brilliant."—*Gramophone* Angel 41491

The Performing Piano,
Vol. 1 - Live performances
by Paderewski, Rachmani-
noff, Schnabel, others.
Newport Classic 14708

Prokofiev, Peter And The
Wolf; Tchaikovsky,
Nutcracker Suite - Dud-
ley Moore, narrator.
Boston Pops/Williams,
Philips 15137

Handel, Music For The
Royal Fireworks; Concerti a Due Cori Nos.
2 & 3 English Concert/Pinnock. Archiv 25375

Classic Marches - St. Louis Sym./Slatkin.
Rakoczy March, Turkish March, Wedding
March, Radetzky March, more. RCA 00996

Adams, The Chairman Dances - Plus Chris-
tian Zeal And Activity, more. San Francisco
Symphony/deWaar. Nonesuch 00491

Beethoven, Symphony No. 6 (Pastorale); 2
Overtures - Academy of Ancient Music/Hog-
wood. L'Oiseau-Lyre 25397

Perlman: Mozart, Violin Concerto No. 1;
more - Vienna Philharmonic Orch./Levine. "A
pleasure."—*Fanfare* DG 25438

Van Cliburn: Rachmaninoff, Piano Sonata
No. 2; Prokofiev, Piano Sonata No. 6;
more - RCA 00607

Stravinsky, Petrouchka; Song Of The
Nightingale; 4 Studies - Montreal Symphony
Orchestra/Dutoit. London 15331

Into The Woods - Bernadette Peters &
original cast. Title song. No One Is Alone,
many more. RCA 61656



Cilburn:
Liszt & Grieg
Piano Concertos
00606

Strauss, Don Quixote; Burleske - Janigro,
cello; Janis, piano. Chicago Symphony
Orchestra/Reiner. RCA 63643

Ashkenazy: Rachmaninov, Piano Concerto
No. 3 - Concertgebouw Orchestra/Haitink.
"Fabulous."—*Hi-Fi News* London 25157

Gregorian Chant - Schola of the
Hofburgkapelle. 10 Propers from the "Grada-
le Romanum", more. Philips 15434

Handel, Water Music - The English Concert/
Pinnock. "The playing is everywhere fresh and
vital."—*Ovation* Archiv 15306

Mozart, Haffner Serenade; more - Academy
of St. Martin/Marriner. "An outstanding ver-
sion."—*Gramophone* Philips 15533

COMPLETE AND MAIL THIS CARD TODAY!

The International Preview Society

YES! Please accept my membership in The International Preview Society and send me, for 10 days' FREE examination, the 3 CDs I have indicated below, under the terms of this offer. I may return them after 10 days and owe nothing, or keep them and pay only \$1 (shipping and handling added to each shipment). I understand that I'm not obligated to buy anything...ever!

Write Selection
Numbers Here:

--	--	--

Mr.
 Mrs. _____ First Name Initial Last Name (PLEASE PRINT)
 Miss

Address _____ Apt. _____

City _____ State _____ Zip _____

Telephone (_____ Area Code) _____

NOTE: Members will be serviced by the BMG Compact Disc Club. Current members not eligible for this offer. Full membership details will follow with the same 10-day, no-obligation, no-minimum purchase privilege. Limited to new members; continental U.S.A. only; one membership per family. We reserve the right to request additional information or reject any application. Local taxes, if any, will be added.



The International Preview Society

3 COMPACT DISCS FOR JUST \$1

plus shipping and handling with Club membership

With No Obligation To Buy Anything ... Ever!

James Galway & Kazuhito Yamashita: Italian Serenade • Charming pieces by Paganini, Rossini, Bazzini, others. RCA 73824

Isn't It Romantic • Michael Feinstein sings title song, A Fine Romance, No Other Love, many more. Elektra 72393

Dvořák, Symphony No. 7 The Cleveland Orchestra/Dohnányi. "One of the finest."—*Digital Audio* London 15018

Strauss, Also sprach Zarathustra; Der Rosenkavalier Waitzes; more. Chicago Symphony Orchestra/Reiner. RCA 63627

Joplin, Piano Rags • Joshua Rifkin plays Maple Leaf Rag, The Entertainer, The Ragtime Dance, 14 more. Nonesuch 64055

Pinnock: Bach, 2 Concertos for 3 Harpsichords • With Kenneth Gilbert & others. English Concert/Pinnock. Archiv 25348

The Mystery Of Bulgarian Voices Bulgarian State Radio & TV Female Choir. "Absorbing...haunting."—*Fanfare* Nonesuch 01081

Fête à la Française • Montreal Symphony Orchestra/Dutoit. The Sorcerer's Apprentice, more. London 25235

Empire Brass: A Bach Festival • Sleepers Wake, A Mighty Fortress Is Our God, Sheep May Safely Graze, more. Angel 64211

Rachmaninoff, Piano Concerto No. 2; 6 Etudes-tableaux • Evgeny Kissin, piano. London Sym./Gergiev. RCA 00915

Copland, Appalachian Spring (Complete); Cortège macabre (from Grohg); more • St. Louis Sym./Slatkin. Angel 54176

Mozart, Overtures • Magic Flute, Marriage Of Figaro, Don Giovanni, more. Academy of St. Martin/Marriner. Angel 34267

Leontyne Price & William Warfield: Gershwin, Porgy & Bess (Highlights) • Summer-time, My Man's Gone Now, more. RCA 00994

Itzhak Perlman: Brahms, Violin Concerto Chicago Symphony Orch./Giulini. A Grammy Award Winner! Angel 63343

Mozart, Serenade No. 3; more • Academy of Ancient Music/Hogwood. "Played with... style."—*Fanfare* L'Oiseau-Lyre 15000



Vienne Bonbons/Maazel 15287

Andrés Segovia Plays Rodrigo, Ponce & Torroba • Fantasia para un Gentilhombre, Castles Of Spain, more. RCA 63579

Simon Rattle: The Jazz Album • Rhapsody In Blue, Ebony Concerto, more. London Sinfonietta, others. Angel 72226

By Request • The Boston Pops/Williams. Olympic Fanfare, many more. Philips 25360



Horowitz Plays Mozart 15436

Tchalkovsky, 1812 Overture /Soliti. 25179



Kiri te Kanawa Sings Gershwin • Somebody Loves Me, I Got Rhythm, The Man I Love, Summertime, more. Angel 70258

Pinnock: Bach, 3 Concertos for 2 Harpsichords • With Kenneth Gilbert. The English Concert/Pinnock. Archiv 15338

Mozart, Eine kleine Nachtmusik • Plus Pachelbel, Canon; more. Academy of St. Martin/Marriner. Philips 15530

Itzhak Perlman: French Violin Showpieces • N.Y.Phil./Mehta. Carmen-Fantasy, Tzigane, Havanaise, more. DG 15457

Anything Goes • Broadway revival cast. Title song, I Got A Kick Out Of You, Friendship, many more. RCA 43950

Andrew Lloyd Webber, Variations; William Lloyd Webber, Aurora • Julian Lloyd Webber, cello. Maazel cond. Philips 15473

The Digital Fox • Organist Virgil Fox plays Toccata & Fugue in D Minor; Widor, Toccata; more. Balmbridge 62889

Itzhak Perlman: Mozart, Violin Concertos Nos. 3 & 5 • Vienna Phil./Levine. "Extraordinarily rich."—*Fanfare* DG 15146

James Galway's Greatest Hits • The Man With The Golden Flute plays Memory. Angel Of Music, Greensleeves, more. RCA 73233

SAVE 50%
with our Instant Half-Price Bonus plan.

Unlike other clubs that force you to buy 2, 4, or even 6 CDs before you can get bonus savings, we give you 50%-off bonus savings with every CD you buy at regular Club price...right with your very first purchase.



NO POSTAGE NECESSARY IF MAILED IN THE UNITED STATES

BUSINESS REPLY MAIL
FIRST CLASS PERMIT NO. 5071 INDIANAPOLIS, IN

POSTAGE WILL BE PAID BY ADDRESSEE

The International Preview Society

P.O. BOX 91406
INDIANAPOLIS IN 46209-9987

This remarkable \$1 offer is being made to introduce you to an outstanding classical music membership—with never any obligation to buy.

You'll find hundreds of outstanding albums in each issue of the Society's magazine, which will be sent to you approximately every 3 weeks. That gives you 19 convenient, shop-at-home opportunities a year. But there is no obligation to accept any offering at any time.

You choose only the music you want!
If you'd like to accept the Main Selection, you need not do a thing. It will be sent automatically. If you'd prefer an alternate selection or none at all, just mail back the Notification Card by the specified date. You'll always have at least 10 days to decide. But if you don't, you may return your Main Selection at our expense. You may cancel your membership whenever you wish, simply by writing to us. Or, remain a member and take advantage of future money-saving bargains.

3 Compact Discs for just \$1!
Begin your membership now by choosing any 3 CDs shown here for just \$1, plus shipping and handling. Send no money now. We want you to judge for yourself before you decide to buy. If not delighted, return your 3 albums at the end of 10 days without obligation. (Shipping and handling added to each shipment.)



by Julian Hirsch

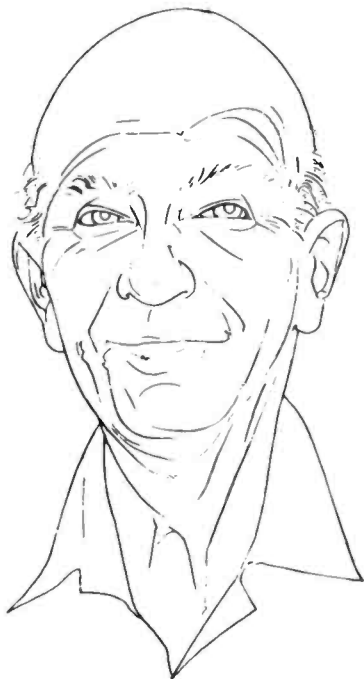

EVOLVING TEST PROCEDURES

As long-time readers know, my test procedures have been evolving for as long as I have been making them, about thirty-five years. When I started testing audio equipment, there were literally no standard methods of measurement that were suitable for evaluating hi-fi components (even though their "fi" was not very "hi" in those days). Of necessity, I had to establish my own arbitrary criteria, modifying them as the state of the art required (because of improved component performance) or permitted (because of improvements in test equipment).

As recognized measurement standards are issued, we attempt to adhere to them to the extent that circumstances allow. This does not mean that we make every test defined by any given standard. Some, in our view, are not very useful for making a judgment on a product's quality, while others may require extremely specialized test equipment that is not readily available.

Although Electronic Industries Association (EIA) test standards have been developed for most electronic components, including tuners, amplifiers, CD players, and tape decks, no standards are available for loudspeakers, with the possible exception of those dealing with mechanical construction, power handling, and sensitivity. In my opinion, there will never be a universally accepted loudspeaker measurement standard, in the sense that such standards now exist for the other system components, partly because there is no universal loudspeaker "load" (the listening-room environment) that will be optimum for every speaker. Standard listening rooms have been proposed, but I cannot imagine that any speaker manufacturer would accept testing in such an environment should that result in diminished ratings for its products.

Actually, we face this problem with every speaker we test. Lacking a large (or even a small) anechoic chamber, our speaker measurements are necessarily adapted to suit the acoustic environment we have. A further complication is that no speaker measurement I am aware of can provide an unambiguous sense of the speaker's sound. Only the human ear and brain can do that, and despite their incredible sensitivity and computing powers, they are notoriously fallible.

One test we do make on speakers, because it has considerable bearing on their usefulness in a home hi-fi system, is of their power-handling ability. Existing power-handling standards are meant to judge a speaker's suitability for commercial or public-address service, and they usually use mere survival of the test sample as a criterion for passing the test. Our aim is to drive the speaker at increasing power levels until non-linear distortion becomes obvious (like testing an amplifier by increasing the drive level until its output clips). We have arbitrarily chosen test frequencies of 100, 1,000, and 10,000 Hz for these tests, because they fall within the operating ranges of typical woofers, midrange drivers, and tweeters. The speaker's acoustic output is picked up by a closely spaced microphone and

viewed on an oscilloscope together with its electrical input (the signal from the driving amplifier).

Because speaker drivers (especially tweeters) are easily burned out by continuous high-level input signals, we use a low-duty-cycle tone burst, consisting of a single cycle at the test frequency followed by 128 cycles of "off" time. Before making this test, we measure the speaker's impedance across the audio frequency range. The driving amplifier, a Carver Mono-Block, can deliver a maximum power in this test corresponding to 800 watts into a 8-ohm load and as much as 1,500 to 2,000 watts, or more, into 4 or 2 ohms.

At the two higher frequencies, the amplifier usually clips before the speaker's output waveform shows any evidence of overload. Woofers, however, deliver a harsh, rasping sound when they reach their mechanical limits. This is easily heard as the driving level is increased and represents a practical upper limit on a speaker's power-handling ability. The results of this test appear in all our speaker reports, although we may omit the specific power limits at the higher frequencies when the amplifier is the limiting factor.

Sometimes specific tests are added or deleted because of test-equipment changes. For a number of years, our power-amplifier measurements included total harmonic distortion (THD) readings from 20 to 20,000 Hz at three different power levels: rated power, one-half rated power, and one-tenth rated power. The test was very time consuming, involving thirty-nine separate distortion readings, plus plotting the data on a graph. Today, our Audio Precision System One does this test in a couple of minutes, including plotting the graphs. The results appear in our reports as before, but the reduced measurement time helps us evaluate more products.

While I still feel strongly that an amplifier should be able to drive load impedances as low as 2 ohms, we have had to modify our power and distortion tests somewhat. Most amplifiers are not rated for 2-ohm operation even though some may function quite well under that condition. Because we have had

"Superb sound and virtual invisibility."

—Stereo Review, Julian Hirsch



Acoustimass[®] array with optional mounting accessory for unobtrusive placement.

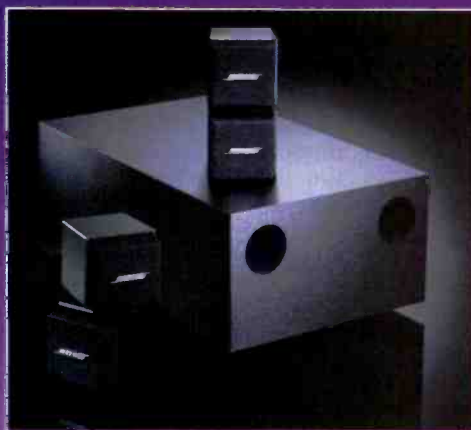

The Bose[®] Acoustimass speaker system.



Both arrays are equipped with magnetic shielding for high-fidelity video listening.



The system's heart—the Acoustimass[®] module—can be completely hidden, providing *virtual invisibility*.



Presenting the Bose® Acoustimass® Direct/Reflecting® Speaker System

“In our listening room, side by side with speakers costing three to five times as much, the AM-5 consistently produced the more exciting and listenable sound in A/B tests.

—Stereo Review, Julian Hirsch

“... a sonic standout.”

—The New York Times, Hans Fantel

To hear the sound they're talking about, look for an Acoustimass® speaker system.

Take the room-filling, full fidelity sound you expect from full-sized speakers, and imagine it coming from two tiny arrays, each no larger than a quart carton of milk.

This is the Acoustimass speaker listening experience.

“Superb sound . . .

An Acoustimass speaker launches sound into the room by two air masses, producing the purest sound possible from any present-technology speaker design—regardless of size or price. Its purer sound, wider dynamic range and greater output mean that any sound source—music or video—will sound more lifelike, with much of its original realism and impact reproduced right in the listening room.

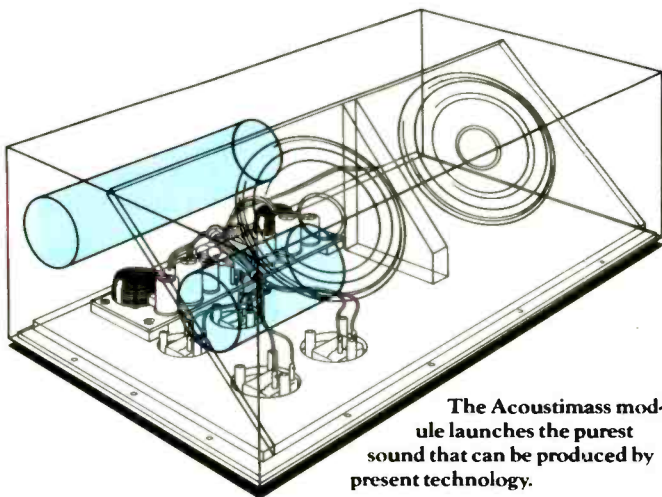

... and virtual invisibility.”

An Acoustimass system also leaves more of the listening room to enjoy. The Acoustimass module can be hidden out of sight, behind or under the furniture. All sound appears to come from two tiny arrays a fraction of the size of typical “satellite” speakers. Optional accessories allow them to be unobtrusively mounted in places beyond the reach of ordinary speakers—above the listening area like lighting fixtures, for example. The computer-optimized arrays precisely shape the sound, delivering the life-like spaciousness and clarity of a Bose Direct/Reflecting® speaker—while setting an open, natural stereo image listeners can enjoy throughout the room, regardless of where they sit or stand.

How an Acoustimass® speaker works.

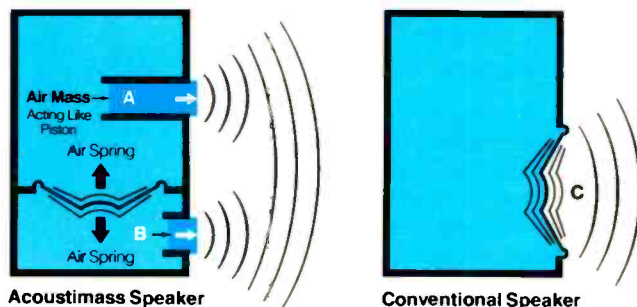

Improving speaker performance means first reducing distortion. The design of an Acoustimass® speaker substantially reduces distortion (see diagrams and graph). The benefits of this patented speaker technology are: purer sound and virtual invisibility, along with higher power handling and wider dynamic range.

Left: An Acoustimass speaker launches sound into the room using two masses of air working like pistons (A&B, darker blue), rather than by a surface vibrating directly into the room. The sound launched into the room by the Acoustimass speaker's air pistons is the purest sound that can be produced by present technology.

Right: A vibrating cone radiating directly into the room (C) produces unfiltered sound.

Cone Excursion Comparison

(lower excursion means lower distortion)

Graph: This distortion produced by any speaker rises dramatically with cone motion, or excursion. At port-tuned frequencies, a typical Acoustimass speaker's cone has less than 1/15 the maximum excursion* of sealed and ported cones. Inside an Acoustimass speaker, the interaction of the air springs with the air masses in the ports produces a very high pressure at the surface of the cone. This greatly reduces the cone's excursion, and therefore reduces distortion. The air springs act with their respective masses to form low-pass filters, removing any small distortion components generated by the cone.

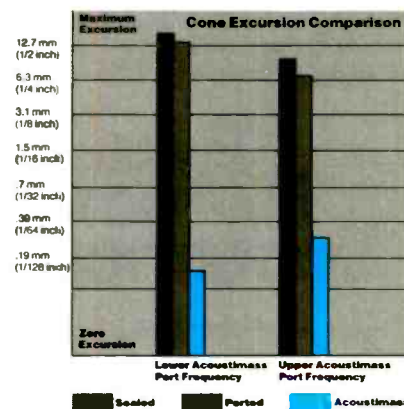

* based on cone travel measurements at 128 watts input.

A difference you can see and hear.

There are a number of three-piece speakers available. But only Acoustimass speaker technology delivers the full benefits of “superb sound and virtual invisibility.” Ask your Bose dealer to give you an A/B demonstration comparing the Acoustimass system to any other speaker on display—and judge for yourself. For more information call toll-free 1-800-444-2673.

BOSE®

Better sound through research.

© Copyright 1988 Bose Corporation. All rights reserved. Covered by patent rights issued and/or pending. Julian Hirsch, Stereo Review, April 1987. Reprinted with permission from High Fidelity Magazine, March 1987. Copyright © All rights reserved. Copyright © 1987 by The New York Times Company. Reprinted by permission.

Transport Yourself.

The IRS 690 cordless headphone system.

Escape to a deeply personal world of sonic pleasure. The Beyerdynamic IRS 690 system. With the warmth and intimacy that is distinctively Beyer. Advanced infrared technology for cordless, 360-degree movement without static or interference. And the same diffuse-field design as the DT 990's—the world's most critically-acclaimed dynamic headphones—for superior imaging and startling accuracy.

Let the IRS 690 system transport you. Experience them at your local Beyer headphone dealer.



Ecstasy in Audio

beyerdynamic 

Beyerdynamic 5-05 Burns Avenue, Hicksville, NY 11801 Tel. (516) 935-8000 Fax (516) 935-8018

CIRCLE NO. 51 ON READER SERVICE CARD

TOTAL HARMONIC DISTORTION

...AT LAST! THE FUNNIEST RODRIGUES CARTOONS FROM THE PAST TWO DECADES OF STEREO REVIEW HAVE FINALLY BEEN COLLECTED IN BOOK FORM...

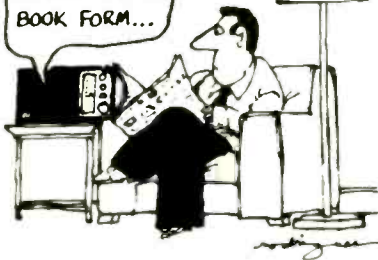

Yes, now you can own **TOTAL HARMONIC DISTORTION** by Charles Rodrigues!

This handsome, 128-page paperback—with 118 classic cartoons, a foreword by William Livingstone, and an illustrated autobiographical sketch by Rodrigues himself—is only \$7.95. Enjoy your favorites again, catch the gems you missed, and share the laughs with friends!

Makes a great gift!

Get two copies for the full stereo effect!

TO ORDER: Send check or money order for \$7.95 per copy, plus \$1.50 for postage & handling to:

Perfectbound Press
Suite 4118 N
1120 Ave. of the Americas
New York, NY 10036

Type or print mailing address with order. New York State residents add 65¢ sales tax per copy. **Outside U.S.:** add \$1.75 postage & handling for first copy and 50¢ for each additional copy (U.S. bank funds only). *Allow six to eight weeks for U.S. delivery, longer outside U.S.*

TECHNICAL TALK

several cases of amplifier failure during 2-ohm continuous-power distortion measurements, and even during a simple determination of clipping power, I will occasionally limit low-impedance testing to dynamic power measurements, which are unlikely to cause equipment failure. This is done at my discretion, based on a personal judgment of the product's survival chances during a continuous-power measurement.

Since CD players first became available, we have used a Philips test disc (TS5A) to evaluate their error-correction abilities. This disc has calibrated "damage" areas superimposed on its outer surface and on its information layer, and by playing it until a player begins to skip or show evidence of dropouts, the effectiveness of the player's error correction can be judged. The test results are expressed in terms of the physical size of the damage, in micrometers, up to the 900-micrometer maximum on the disc. After a few years of CD player development, however, we rarely found a player that could not play the 900-micrometer defects without difficulty. Last year a new test disc, from Pierre Verany in France, greatly expanded this kind of test in a much more usable form, allowing us to test for dropouts with calibrated defects ranging up to 4,000 micrometers (which no player I know of has yet been able to handle).

There have been, and will continue to be, many other instances of change in test-procedure details that are reflected in our reports only by omissions of formerly referenced tests or the appearance of a new one. Technology is changing so rapidly that we cannot remain frozen into a pattern that no longer fits our needs. Fortunately, the basic ends of our lab tests remain unchanged: to establish as much as possible what a product *really* does (or does not do), as distinguished from any personal reactions to its operating characteristics or sound. The latter are also valid and important, however, and they are included in test reports to cover some of the characteristics of hi-fi components that are not readily quantifiable. But on these matters, every listener is entitled to judge for himself. □

THE END OF THE RECEIVER.



The GTP-500 is the most innovative and logical audio component in years. A superb tuner and preamplifier together on one chassis, completely separate from the power amplifier. This eliminates all the technical limitations of the receiver, assuring uncompromised sonic performance as well as an unrestricted choice of power. And a wireless remote controls the entire system—from your favorite chair or from several rooms in your home. The GTP-500 tuner/preamplifier is shown here with our 60 watt-per-channel* power amplifier. Up to 600 watts per channel are also available. In short, you're witnessing the dawn of a new era. To get the full story, write for our literature and reviews.

ADCOM®

11 Elkins Road, East Brunswick, NJ 08816 201-390-1130
Distributed in Canada by PRO ACOUSTICS, INC., Pointe Claire, Quebec H9R 4X5

*Continuous (not instantaneous or peak) power, both channels driven into 8 ohms, 20Hz-20kHz, <0.09% THD. Adcom specifications meet all FTC measurement requirements.

CIRCLE NO. 60 ON READER SERVICE CARD

“They Were Designed To Play Music This They Do Very Well, In At A Bargain Price... It's Hard To Ima

It has always been true that placement in the listening room has a profound effect on the sound of any loudspeaker, regardless of its inherent qualities. Cambridge SoundWorks has confronted this fact and created Ensemble™, a speaker system that can provide in your home, the superb sound once reserved for the best conventional speakers under laboratory conditions. And because we market it directly, Ensemble costs far less than previous all-out designs. Perhaps best of all, it virtually disappears in your listening room.



Henry Kloss, creator of the dominant speaker models of the '50s (Acoustic Research), '60s (KLH), and '70s (Advent), brings you Ensemble, a genuinely new kind of speaker system for the '90s, available factory direct from Cambridge SoundWorks.

The best sound comes in four small packages.

Ensemble consists of four speaker units. Two compact low-frequency speakers reproduce the deep bass, while two small satellite units reproduce the rest of the music. Separating the low bass on both channels from the rest of the range makes it possible to reproduce just the right energy in each part of the musical spectrum without turning your listening room into a stereo showroom. With clumsy conventional systems, you can either strive for that balance by letting loudspeakers dominate your room, or sacrifice it for less conspicuous speaker placement.

Your listening room works with Ensemble, not against it.

Room acoustics emphasize and de-emphasize various parts of the musical

Unlike satellite systems which use a single large subwoofer, Ensemble features separate compact bass units for each stereo channel. They fit more gracefully into your living environment, and help minimize the effects of the listening room's standing waves.

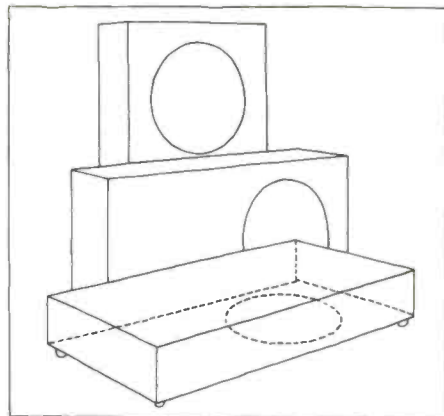

Because low frequencies are non-directional, Ensemble's bass units can be installed horizontally, vertically, facing upwards, or facing downwards.

range, depending upon where the speaker is placed in the room. If you put a conventional speaker where the room can help the low bass, it may hinder the upper ranges, or vice-versa.

Ensemble, on the other hand, takes advantage of your room's acoustics. You put the low-frequency units where they provide the best bass, whether or not that location is good for the high frequencies (and it usually



-And Make It Sound Like Music. A Most Unobtrusive Way, "Engine Going Wrong With Ensemble"

Julian Hirsch
Stereo Review, Sept. '88

isn't for any speaker). Then you put the satellites where they provide a well-defined stereo "stage."

The ear can't tell where bass sounds come from, which is why Ensemble's bass units can be tucked out of the way—on the

in gunmetal gray Nextel, a suede-like finish highly resistant to scratching. We even gold-plate all connectors to prevent corrosion. But perhaps an even bigger difference between Ensemble and other speakers is how we sell it...

Try Ensemble Risk-free for 30 days.
Call 1-800-AKA-HIFI†

Our toll-free number will connect you to a Cambridge SoundWorks audio expert. He or she will answer all your questions from

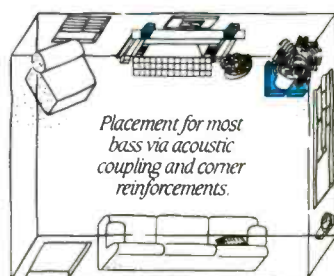
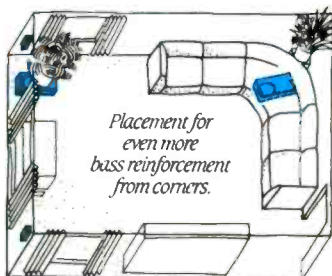
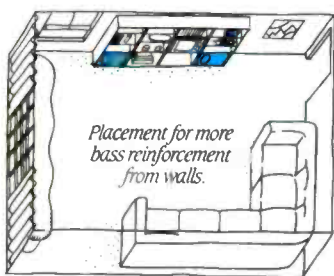
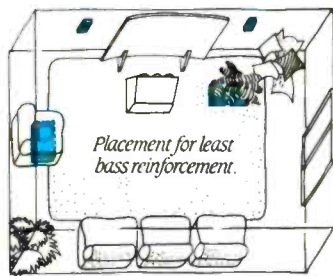

You can put Ensemble's low-frequency units exactly where they should go for superb bass. You can't do this with conventional speakers because you have to be concerned about the upper frequencies coming from the same enclosures as the low ones.

floor, atop bookshelves, or under furniture. The satellites can be hung directly on the wall, or placed unobtrusively on windowsills or shelves (among other possibilities). The result is extraordinary. There are no bulky speaker boxes to dominate your living space, yet Ensemble reproduces the satisfying deep bass that no mini speakers can.

Not all the differences between Ensemble and other speaker systems are as obvious as our two subwoofers.

Unlike three-piece satellite systems that may appear similar, Ensemble's four-piece design doesn't cut any corners. We use premium quality components for maximum power handling, individual crossovers that allow several wiring options and cabinets ruggedly constructed for proper acoustical performance. The low-frequency units use the classic acoustic suspension design, and are finished in black laminate. The satellites are finished

**The best showroom of all:
your living room.**

Choosing a loudspeaker after a brief listen at a dealer's showroom is like deciding on a car after one quick trip around the block. Therefore we make it possible to audition Ensemble right in your own home. In fact, Ensemble is sold *only* by Cambridge SoundWorks directly from the factory.

That only makes sense. You get to match Ensemble specifically to your listening room in a way no other system permits. You get to listen for hours without a salesman hovering nearby. And if after 30 days of all that you're not happy, you can return Ensemble for a full refund (we'll even reimburse the original UPS shipping charges in the continental U.S.).

You also get to save.

At only \$499* complete with all hardware, 100' of speaker cable, and free ongoing assistance—Ensemble

costs hundreds of dollars less than it would in a retail store.

What Henry Kloss tells his friends:

Every time I came out with a new speaker at AR, KLH, or Advent, my friends would ask me, "Henry, is it worth the extra money for me to trade up?" And every time I would answer, "No, what you've already got is still good enough."

But today, with the introduction of Ensemble, I tell them, "Perhaps now is the time to give your old speakers to the children."

why (or why not) to buy Ensemble to those you may have about related equipment. Your audio expert will take your order (you can use Visa, MasterCard or American Express), and arrange surface shipment via UPS (\$7 to \$25 anywhere in the continental U.S.). You should have Ensemble within one week. And your Cambridge SoundWorks audio expert will continue as your personal contact with us, to answer questions which might come up after you've begun to enjoy Ensemble at home. We think you'll like this new way of doing business.

†In Canada, call 1-800-525-4434. Audio experts are on duty Mon.-Sat., 9AM-10PM, Sun., 9AM-6PM Eastern Time. Fax #: 617-332-9229.

CAMBRIDGE SOUNDWORKS

Suite 102S 154 California St., Newton, MA 02158

- Send more information and test reports.
- Send Ensemble risk-free for 30 days, for \$499*
- Send an Ensemble Gift Certificate for \$499*

I'm paying by Check MC Visa AmEx

Acct. Number _____ Exp. _____

Signature _____

Name _____

Address _____

City _____ State _____ Zip _____

Phone (Area Code) _____ Number _____

FOR IMMEDIATE SERVICE: 1-800-AKA-HIFI
We ship worldwide, including APO & FPO.
MA residents add 5% sales tax.

*Plus freight (\$7-\$25). Delivery time usually 2-7 days.

"The stereo sounds so good I could drive all night."

It could happen to you! The exceptionally clean and acoustically pure sound of Pyle Driver® car stereo speakers makes driving so enjoyable time seems to fly by.

Now you can experience superior sound reproduction in virtually any type vehicle with Pyle Pounder® speaker systems. Innovative computer designed enclosures install in minutes to reproduce your favorite music with power and clarity panel-mounted speakers just can't match.

American-made Pyle Pounders® use the latest ducted port bass reflex technology, new heavy duty polymer laminate woofers, accurate dome tweeters, high fidelity crossovers – plus handcrafted construction to reproduce true rock-solid sound with explosive realism.

For maximum power and performance, combine Pyle Pounders® with Pyle Digital Demand amplifiers – then "Crank It Up" and let time fly by.

•• *"You just did."*



PYLE

For the name of the Pyle dealer nearest you write:
Pyle Industries, Inc. • Huntington, IN 46750



A Ha-man International Company

CIRCLE NO. 94 ON READER SERVICE CARD



DENON AVC-2000 INTEGRATED AUDIO/VIDEO AMPLIFIER

Julian Hirsch, Hirsch-Houck Laboratories

THE Denon AVC-2000, an exceptionally versatile integrated amplifier, was designed for use in a variety of audio and audio/video systems. It provides Dolby Pro Logic surround-sound decoding for video sources plus stereo-enhancement modes that simulate the acoustics of a concert hall or a stadium.

The main front-channel outputs of the AVC-2000 are rated at 75 watts per channel into 8 ohms from 20 to 20,000 Hz with no more than 0.08 percent total harmonic distortion (THD). The rear channels deliver up to 20 watts each into 8 ohms at 1,000 Hz with 2 percent distortion. There is also a mono center-channel amplifier rated at 20 watts from 20 to 20,000 Hz with 0.4 percent THD. The AVC-2000 has line-level outputs for the front, center, and rear channels for driving additional or more powerful amplifiers.

The AVC-2000 accepts a full complement of audio inputs, including a moving-magnet (MM) phono cartridge, a CD player, a tun-

er, and four additional high-level sources such as the audio signal from a TV set or videodisc player. Front-panel jacks accept the video and audio signals from a second videodisc player, and there are rear audio input and output terminals for three VCR's and three audio tape decks. In an A/V system, the AVC-2000 can also control the video signals to and from up to three VCR's, sending the selected signal to an external video monitor. For suitably equipped video systems, the amplifier can also channel S-video signals from two of the VCR's to the monitor.

The extensive input and output capabilities of the AVC-2000 are complemented by its switching flexibility, which provides completely independent selection of audio and video program sources for recording or monitoring. Program switching is done with front-panel pushbuttons, separately grouped for audio and video, that have red status LED's. Other buttons operate the surround-sound circuits, selecting hall or sta-

dium effects, simulated stereo (from a mono source), or slightly different configurations of Dolby Pro Logic operation. A PHANTOM mode can simulate the effect of a center-front speaker when one is not available, and a WIDE mode provides enhanced quality with a center speaker. There is also a button that sets the rear-channel delay time to 15, 20 (normal), or 30 milliseconds.

The AVC-2000 also has video-enhancement circuits: SHARPNESS and DETAIL buttons each provide three degrees of improved picture quality from the video outputs of a VCR during viewing or recording on another machine. A small display window on the front panel shows the status of the audio and video record selectors, the Dolby Pro Logic and surround-sound modes, and the selected delay time for the rear-channel signal.

Across the bottom of the front panel are a number of fairly conventional knobs for the bass and treble tone controls, center-channel level, input level into the surround circuits, and input left/right balance. There is a front-panel headphone jack, individual speaker-selector buttons for two pairs of front-channel speakers, and a mono/stereo mode button. The main volume control, a large knob with an LED bar as an index pointer, is motor-

TEST REPORTS

driven when operated from the supplied wireless remote control. Beneath it are up and down buttons for electronic adjustment of the rear-channel level.

The large remote control contains sixty-four buttons of identical size. Fortunately, they are grouped by function and clearly marked to correspond with the amplifier's front-panel markings. Virtually every front-panel control is duplicated on the remote unit, which also has a few exclusive functions, such as test tones for balancing the Dolby Pro Logic system, audio muting, and controls to display the unit's operating status on a video monitor.

Twenty-six of the keys on the remote control are dedicated to operating compatible Denon CD players, cassette decks, FM tuners, and digital audio tape decks (not yet

available in the United States). Furthermore, the remote can be programmed to duplicate the functions of controllers for products of other manufacturers.

The Denon AVC-2000 is a large and heavy component, partly because of the considerable circuitry it contains and partly because a large front panel and rear apron are needed to accommodate its many controls and connectors. It measures 17 $\frac{1}{8}$ inches wide, 15 $\frac{3}{4}$ inches deep, and 6 $\frac{1}{4}$ inches high, and it weighs about 33 pounds. Price: \$1,000. Denon America, Dept. SR, 222 New Rd., Parsippany, NJ 07054.

Lab Tests

The "75-watt" rating of the Denon AVC-2000's main outputs proved to be very conservative. At

1,000 Hz, the front outputs clipped at 114.3 watts into 8 ohms and at 178.5 watts into 4 ohms. Since the amplifier is rated only for 8-ohm service, we did not attempt continuous operation into 2 ohms. We did make dynamic power tests at all three impedance levels, measuring 121 watts into 8 ohms, 176 watts into 4 ohms, and an impressive 225 watts into 2 ohms.

The THD plus noise, when the amplifier was driving 8 ohms at 75 watts, was 0.0085 to 0.01 percent from 20 to 8,000 Hz, reaching 0.015 percent at 20,000 Hz. Readings were slightly higher at lower power outputs because of the greater contribution of noise, reaching a maximum of 0.02 percent at 7.5 watts. At a constant 0.1-percent distortion, the amplifier delivered 65 watts into 8 ohms at 20 Hz, 90 watts from 1,000 to 10,000 Hz, and 75 watts at 20,000 Hz. With 4-ohm loads, the maximum output at 0.1-percent distortion was 100 watts at 20 Hz, 118 watts at 20,000 Hz, and 140 watts between 2,000 and 6,000 Hz.

The frequency response through a high-level input was +0, -1 dB from 20 to 20,000 Hz, and the RIAA phono-equalization error was less than 0.1 dB from 200 to 20,000 Hz and -1.2 dB at 20 Hz. The sensitivity, for a 1-watt reference output, was 18.5 millivolts (mV) through a high-level input and 0.35 mV through the phono input, with respective A-weighted noise levels of -83.2 dB and -75.5 dB. The phono preamplifier overloaded at 170 mV input at 20 and 1,000 Hz and 157 mV at 20,000 Hz. The phono-input impedance was 47,000 ohms in parallel with 160 picofarads.

Comments

Our measurements showed the Denon AVC-2000 to be a very good integrated amplifier, with adequate power for most purposes and probably more flexibility than most people will ever need. Like any A/V product, its true worth can best be judged by actual use, so we assembled a system around the AVC-2000, consisting of a good, typical VDP, VCR, and monitor, a pair of Allison AL-120 speakers for the front channels, and other speakers of comparable size for the center

FEATURES

- Stereo front and rear channels, mono center channel
- Outputs for two pairs of front-channel speakers
- Line-level preamplifier outputs for external amplifiers
- Bass and treble tone controls
- Dolby Pro Logic surround decoder
- Phantom center-channel mode for use without center speaker
- HALL and STADIUM ambience-enhancement effects
- Adjustable rear-channel delay time (15 to 30 ms)
- Audio inputs for phono (MM), CD, tuner, auxiliary, three audio tape decks, three VCR's, two VDP's, TV set
- Video inputs for three VCR's, two VDP's (one VDP on front panel)
- Video output to monitor
- S-video terminals for two VCR's and monitor
- Three-position video sharpness and detail controls
- Control settings viewable on video display
- Supplied remote control for all front-panel functions; operates compatible Denon components and can learn commands of other controllers

LABORATORY MEASUREMENTS

- Output power at clipping** (1,000 Hz, front channels): 114.3 watts into 8 ohms, 178.5 watts into 4 ohms
- Clipping headroom** (relative to rated output): 1.83 dB into 8 ohms
- Dynamic power output:** 121 watts into 8 ohms, 176 watts into 4 ohms, 225 watts into 2 ohms
- Dynamic headroom:** 2.1 dB into 8 ohms
- Harmonic distortion** (THD + noise at 1,000 Hz into 8 ohms): 1 watt, 0.9%; 10 watts, 0.3%; 75 watts, 0.009%
- Maximum full-power distortion** (20 to 20,000 Hz into 8 ohms): 0.015% at 75 watts (20,000 Hz)
- Sensitivity** (for a 1-watt output into 8 ohms): CD, 18.5 mV; phono, 0.35 mV
- Phono-input overload:** 157 to 170 mV
- A-weighted noise** (referred to a 1-watt output): CD, -83.2 dB; phono, -75.5 dB
- Phono-input impedance:** 47,000 ohms in parallel with 160 pF
- RIAA equalization error:** +0.05, -1.2 dB from 20 to 20,000 Hz
- Tone-control range:** +10.5, -9.5 dB at 100 Hz; +9, -10 dB at 10,000 Hz
- Frequency response:** +0, -1 dB from 20 to 20,000 Hz

TEST REPORTS

and rear channels. The program material consisted of several good videodiscs and a videocassette of excerpts from various films chosen for their effectiveness in demonstrating Dolby Surround sound.

Everything on the AVC-2000 worked as it was supposed to, and both the sound and picture were as good as the recordings and ancillary equipment would permit (which was very good indeed, especially with the newer demo discs using digital audio). We found, as the instruction manual for the AVC-2000 implied, that the video-enhancement circuits had little effect on most program material.

In the beginning, operating the AVC-2000 effectively was not an easy matter. The large number of controls, many of them unfamiliar, led to some temporary frustration even when we attempted such an apparently basic operation as trying to get the picture and sound simultaneously from the same source. The instruction manual appears to be quite complete and was able to clear up any confusion, but because the AVC-2000 is so different in its operation from many ordinary audio integrated amplifiers, practice is a must!

When we used the AVC-2000 as an audio control center to play CD's, we encountered another small snag, the low power output of its rear-channel amplifiers. With most of the video material we used, the rear volume could be set at maximum with excellent surround-sound effects, but when we played certain CD's having very high levels of bass transients (such as drums), the rear amplifiers became overloaded too readily. Turning down the rear gain cured the problem, but this experience emphasized some of the differences between movie surround sound and wide-dynamic-range digital music recordings.

All things considered, the Denon AVC-2000 is an exceptionally versatile A/V control center, ideal for those whose involvement in video (in particular, those who have several video sources) outstrips the capabilities of more basic audio products. Few people will find the AVC-2000 wanting in this respect!

Circle 140 on reader service card



ALLISON AL 120 SPEAKER SYSTEM

Julian Hirsch, Hirsch-Houck Laboratories

THE AL 120, at the middle of a new series of loudspeakers from Allison Acoustics, is a compact two-way, floor-standing system. The cabinet is finished in a light oak-grain veneer, and all four front edges are grooved to retain the curved black plastic grille, which is easily removed and replaced.

The AL 120 uses two 6-inch woofers in an acoustic-suspension enclosure. The upper one, located in the middle of the front panel, faces forward in the conventional manner. The lower one, however, is physically reversed, with its cone facing inward and the magnet facing forward. Both woofers cover the same frequency range (up to 2,000 Hz), but they are connected electrically out of phase to compensate for their opposite orientation, so that their

cones operate acoustically in phase. This "push-pull" configuration, which is similar to the one Allison uses in its top-of-the-line IC-20 system, is said to reduce low-frequency, even-harmonic distortion resulting from driver-suspension nonlinearity during large cone excursions. Such distortions tend to cancel out in the combined output of the two drivers, whose cones are at opposite ends of their travel when driven to extremes.

At 2,000 Hz there is a crossover to a 1-inch Allison convex-diaphragm tweeter, cooled and damped with ferrofluid, that is located conventionally at the top of the front panel. Its dome is protected by a metal mesh grille. The AL 120 has no external level adjustments.

The system's specifications include a 6-ohm nominal, 3.5-ohm

TEST REPORTS

minimum impedance, a 90-dB sensitivity, and a low-frequency resonance of 65 Hz. The bass response is rated as -3 dB at 52 Hz and -6 dB at 42 Hz. To protect against thermal overload, all the drivers are wired in series with Power Guard bistable resistors, which normally have a very low resistance and do not affect the speaker's performance. If excessive current flows through a voice coil, however, the protective resistance suddenly increases to hundreds of ohms, reducing the speaker drive to a safe level. When the overload is removed, the system automatically returns to normal operation.

According to Allison, the AL 120 may be used with amplifiers with up to 150 watts output, clipping 10 percent of the time, and over most of the frequency range it will handle at least 350 watts for 0.1 second, 125 watts for 1 second, and 60 watts for 10 seconds.

The input binding posts recessed into the rear of the speaker cabinet can accept single or dual banana plugs. The Allison AL 120 measures 24 inches high, 11 $\frac{1}{8}$ inches wide, and 10 $\frac{1}{2}$ inches deep (11 $\frac{3}{4}$ inches including the curved grille). Weight is about 33 pounds. Price: \$600 a pair. Allison Acoustics, Dept. SR, 1590 Concord Ave., Framingham, MA 01710.

Lab Tests

When we spliced our close-miked woofer-response curve with the room response of the AL 120, the resulting composite curve had a dip of about 4 dB from 650 to 700 Hz and a peak of the same amplitude at 1,600 Hz. The lower-midrange and upper-bass response was within +1.5, -1 dB from 100 to 550 Hz, with a small rise to +3 dB at 75 Hz and a 12-dB-per-octave rolloff below 70 Hz. The overall response variation was ± 4 dB from 48 to 20,000 Hz, with the maximum output occurring at about 1,800 Hz.

The close-miked woofer measurements were made with the microphone midway between the two woofers to measure their combined output. The response curve showed a large dip at 700 Hz, of about 9 dB amplitude, that was apparently the result of interference between the

outputs of the two drivers. As the room response showed, however, this dip affected the total output of the system rather than being an artifact of the close-miked measurement. Individual close-miked measurements of the two drivers suggested that the effect was associated with the lower (inward-facing) woofer, although the two had nearly

The Allison AL 120 uses two woofers in a "push-pull" configuration that is said to reduce low-frequency, even-harmonic distortion.

identical response curves up to 400 Hz except that the output level of the lower cone was about 6 to 7 dB lower than that of the upper cone. The close-miked measurements also indicated that the crossover frequency to the tweeter was, as specified, about 2,000 Hz.

Allison convex-diaphragm tweeters are noted for their dispersion, which was amply demonstrated by our measurements. The response curves measured on-axis and 45 degrees off-axis were virtually identical up to 10,000 Hz and then diverged. The system's overall group-delay variation was within 0.2 millisecond from 2,000 Hz to beyond 20,000 Hz, reaching about 2 milliseconds at 180 Hz.

The sensitivity of the AL 120 was slightly higher than rated, with a measured 92-dB sound-pressure level (SPL) at 1 meter with a 2.83-volt input of pink noise. Its impedance, however, was unusually low, measuring 3 ohms below 40 Hz and between 100 and 300 Hz. At the bass resonance frequency of 65 Hz, the impedance was 5 ohms, and it rose to a maximum of 9 to 10 ohms between 1,600 and 3,000 Hz before dropping to 3.5 to 4 ohms from 6,000 to 20,000 Hz. Although the speaker's impedance had no effect on its acoustic performance, we do question its "6-ohm" impedance rating. A 4-ohm rating might be justifiable, although it did have a 3-ohm impedance over a wide frequency range.

Because of the system's unusual

woofer configuration, we were especially interested to check the low-frequency distortion. With a constant drive level of 2.25 volts (equivalent to a 90-dB SPL at 1 meter), the distortion was only 8 percent at 20 Hz, 2.5 percent at 40 Hz, and between 0.5 and 0.7 percent from 60 to 130 Hz. This is exceptional performance for a pair of 6-inch drivers and seems to confirm the merit of the push-pull design.

The power-handling ability of these drivers was impressively demonstrated by the way they absorbed a single-pulse input of 330 watts into their 3.2-ohm impedance at 100 Hz before generating an audible rattle. In pulse tests at middle and high frequencies, our amplifier clipped at outputs in the 1,200- to 1,600-watt range before there was any audible sign of distress from the speakers.

Comments

The installation instructions for the Allison AL 120 speakers recommend that they be placed on the floor, several feet from any wall, for optimum performance. Although the instructions do not rule out placement on a table, shelf, or stands, we chose to follow the recommendation of the manufacturer.

On first hearing, perhaps the most obvious characteristic of the AL 120 was its apparent brightness. In comparison, our reference speakers temporarily seemed rather dull or muted. Since measurements did not reveal a rising high-end response, we had to conclude that the AL 120's emphasized output from 1,000 to 3,000 Hz was responsible for this effect. Experiments with a graphic equalizer soon confirmed that hypothesis.

More extended listening indicated that the brightness we had heard was program dependent. Unless the recording we played had an overabundance of upper-midrange content, the sound was excellent without resorting to external equalization. And at all times the smooth, extended, and nonboomy bass response of the AL 120 set it apart from most other speakers of comparable size, demonstrating its worthiness to bear the Allison name.

Circle 141 on reader service card

MAGNA

Good Smoke.
Great Price.



© 1988 R.J. REYNOLDS TOBACCO CO.

LITES BOX: 9 mg. "tar", 0.6 mg. nicotine, FILTER: 14 mg.
"tar", 0.9 mg. nicotine, av. per cigarette by FTC method.

**SURGEON GENERAL'S WARNING: Quitting Smoking
Now Greatly Reduces Serious Risks to Your Health.**

RAVES FROM THE CRITICS.



The Mirage M-1s have garnered their fair share of raves from the industry. They've invoked such comments as "...I'm completely bonkers over this product..." and "...the best conventional loudspeaker of the decade."

Upon first listen, most people are astonished by their sonic transparency. The speakers virtually seem to disappear. In our view, that's the mark of a good loudspeaker.

We've extended that philosophy to the Mirage 60-Series loudspeakers as well. Each reflects an overall concern for naturalness, genuine musicality and transparency.



For a free booklet of M-1 reviews from seven leading audio publications, write us or see your Mirage dealer.



WE'RE HAPPY TO
REPORT IT RUNS
IN THE FAMILY.

Like the M-1s, they're designed for optimum dispersion. The perceived sound stage is dramatically extended without compromising center imaging. The specially-designed woofers reproduce low frequencies with undaunted accuracy.

The mark that Mirage has made on the audiophile world is substantial. From the flagship M-1s to the wide range offered by the

Mirage 60-Series, you simply can't do better. Just give them a listen. You'll hear what we mean.

mirage[®]

AUDIO PRODUCTS INTERNATIONAL CORP.
3641 McNicoll Ave. Scarborough, Ontario, Canada M1X 1G5 (416) 321-1800

CIRCLE NO. 45 ON READER SERVICE CARD



FISHER DAC-Z1 COMPACT DISC CHANGER

Julian Hirsch, Hirsch-Houck Laboratories

THE Fisher DAC-Z1, one of the components in Fisher's Professional Digital Reference Series, is a somewhat unconventional and feature-laden CD changer whose performance specifications rank with those of some of today's most highly regarded single-disc CD players. It can be loaded with up to five discs (3-inch discs can be used without adaptor rings). Unlike CD changers using removable loading magazines or rotating carousels, the DAC-Z1 system resembles a fixed magazine. Pressing one of the DISC EJECT buttons on the front panel causes a door to hinge down and the selected disc tray to emerge for loading or unloading.

The DAC-Z1 uses two 18-bit digital-to-analog (D/A) converters with eight-times-oversampling (352.8-kHz) digital filtering and a linear-

phase analog filter. In addition to the usual analog audio outputs and a front-panel headphone jack with its own level control, the changer has both coaxial and optical digital outputs on its rear apron. (The instruction manual indicates that Fisher's companion RS-Z1 receiver contains its own D/A conversion circuits and accepts a digital output from the DAC-Z1.)

Among the features of the DAC-Z1 is a disc-title memory that can store titles of up to eight characters for up to 170 discs. Since the titles are linked to the discs' internal digital coding, whenever one of the discs is played, its stored title appears in large characters in the front-panel display window. The window normally shows the current disc, track, and index numbers and the elapsed playing time on the track. A display button toggles the

readout to show the total number of tracks and playing time or the number of unplayed tracks and the remaining playing time on the selected disc. Other displayed information includes the presence (and size) of discs in the five loading trays and the status of the player's operating features, including intro scan (the beginning of each track on a disc, programmable from 1 to 99 seconds), repeat of one or all tracks or all programmed selections, and random play of up to fifteen tracks from all loaded discs.

The DAC-Z1 allows direct access to any portion of a CD by entering the disc, track, and index numbers. It can be programmed to play up to thirty-two tracks from any or all of the loaded discs in any order. The usual track-stepping and bidirectional, two-speed fast search with audible sound are provided. The compact remote control duplicates all front-panel functions except power switching and headphone volume control, although the procedure for opening the disc compartment is slightly different: Instead of pressing a numbered DISC EJECT button, you press the OPEN/CLOSE

Rock 'n' Roll on CDs!

TIME-LIFE MUSIC presents the greatest collection of rock 'n' roll ever. And the digital sound is brighter and clearer than any rock 'n' roll you've ever heard! *The Rock 'n' Roll Era* features all the original stars and their original hit recordings.

1958 Johnny B. Goode/Chuck Berry • It's Only Make Believe/Conway Twitty • Good Golly, Miss Molly/Little Richard • Don't You Just Know It/Huey "Piano" Smith and the Clowns • Get a Job/The Silhouettes • Tequila/The Champs • Sweet Little Sixteen/Chuck Berry • Little Star/The Elegants • Breathless/Jerry Lee Lewis • Rock-In-Robin/Bobby Day • Just a Dream/Jimmy Clanton • To Know Him, Is to Love Him/The Teddy Bears • Summertime Blues/Eddie Cochran • Yakety Yak/The Coasters • Rebel 'Rouser/Duane Eddy • Tears on My Pillow/Little Anthony and the Imperials • Splish Splash/Bobby Darin • Maybe/The Chantels • Oh, Boy!/The Crickets • Book of Love/The Monotones • Endless Sleep/Jody Reynolds • Chantilly Lace/Big Bopper • Do You Wanna Dance/Bobby Freeman

1956 Let the Good Times Roll/Shirley and Lee • Roll Over Beethoven/Chuck Berry • Blueberry Hill/Fats Domino • Blue Suede Shoes/Carl Perkins • My Prayer/The Platters • Be-Bop-a-Lula/Gene Vincent • Long Tall Sally/Little Richard • plus 16 more!

1957 Whole Lot of Shakin' Going On/Jerry Lee Lewis • Little Darlin'/The Diamonds • Wake Up Little Susie/The Everly Brothers • Peggy Sue/Buddy Holly • At the Hop/Danny and the Juniors • I'm Walkin'/Fats Domino • plus 16 more!

Elvis Presley: 1954-1961 Heartbreak Hotel • Hound Dog • Don't Be Cruel • Hard Headed Woman • All Shook Up • Are You Lonesome Tonight? • Jailhouse Rock • Love Me Tender • plus 14 more!

1961 Runaway/Del Shannon • Blue Moon/The Marceles • Runaround Sue/Dion • Stand by Me/Ben E. King • Tossin' and Turnin'/Bobby Lewis • Shop Around/The Miracles • Please Mr. Postman/The Marvelettes • Dedicated to the One I Love/The Shirelles • The Lion Sleeps Tonight/The Tokens • plus 13 more!

Each album features:

- One laser-scanned compact disc, or one double-length chromium dioxide cassette, or two long-playing records on 100% virgin vinyl!
- Original recordings by the original artists
- All songs digitally remastered
- Informative liner notes and discography
- An average of one full hour of hits!

Clear Digital Sound on CDs, Cassettes and LPs



Chuck Berry

Elvis Presley

Get ready for a revolution in sound. *The Rock 'n' Roll Era* comes on compact discs. Each laser-scanned CD brings your hits to life with utterly flawless reproduction.

Or, order one double-length chrome cassette or two long-playing records.

Whichever format you choose, each album has been *digitally remastered* for state-of-the-art audio brilliance, and each comes with informative liner notes, and a discography.

Each album in *The Rock 'n' Roll Era* is devoted to a single year, from 1954 to 1964, plus albums spotlighting The Beach Boys, Elvis Presley, The Everly Brothers and The Supremes. *The Rock 'n' Roll Era* brings you more No. 1 and Top 10 hits than any collection ever offered.

Rock with the hits of 1958!

1958, your introductory album, makes it all come alive again--Jerry Lee Lewis, Chuck Berry, Big Bopper, Conway Twitty, The Coasters, Little Richard and more!

When you purchase **1958**, other albums will follow, one about every other month--same free trial and same low price.

Keep only the albums you want. There is no minimum number to buy, and you may cancel at any time simply by notifying us.

Mail the coupon today!

For faster service, use your credit card and call toll-free **1-800-548-4524**, 24 hours a day, 7 days a week.

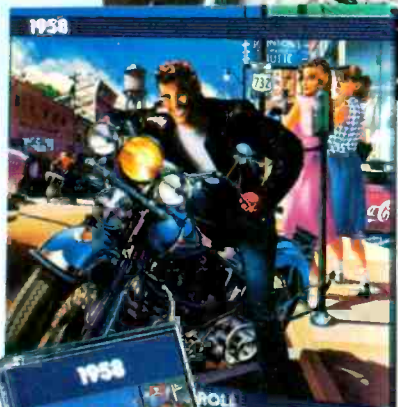

TIME LIFE MUSIC

Mail to: **TIME-LIFE MUSIC**
P.O. Box C-32350
Richmond, VA 23261

YES! Please send **1958** as my introduction to *The Rock 'n' Roll Era* for a 10-day free audition. I will then receive future albums under the terms described in this ad. (A shipping and handling charge will be added to each shipment.)

I prefer to receive:

- One Double-length Cassette (\$14.99) Branch MYE7B2
- Two LP Records (\$16.99) Branch MXGZR2
- One Compact Disc (\$16.99) Branch M9BMY8

Name _____

Address _____ Please print

City _____

State _____ Zip _____

Send no money now. All orders subject to approval.
©1987 TIME-LIFE BOOKS, INC.

TEST REPORTS

button and then one of the five DISC NUMBER buttons.

The Fisher DAC-Z1 is a large, handsomely styled, and solidly constructed machine. Its black front panel contrasts with its polished brass feet and trim and wood-grain side panels. The changer measures 19 inches wide, 15 inches deep, and 5½ inches high, and it weighs about 20½ pounds. Price: \$899.95. Sanyo/Fisher USA Corp., Dept. SR, 21314 Lassen St., Chatsworth, CA 91311.

Lab Tests

The frequency response of the Fisher DAC-Z1 was +0, -0.3 dB from 10 to 20,000 Hz, and channel levels were matched within 0.025 dB. The output was 2.04 volts from a 0-dB recorded signal. The de-emphasis was accurate within ±0.2 dB from 100 to 16,000 Hz.

The total harmonic distortion (THD) plus noise at a 0-dB level was between 0.0024 and 0.0018 percent for frequencies between 20 and 20,000 Hz. At 1,000 Hz, the distor-

tion was typically about 0.0014 percent between -20 and -70 dB, reaching 0.002 percent at 0 dB. The channel separation, identical for both channels, was 95 dB at 20,000 Hz, improving to 120 dB at 1,000 Hz and 128 dB at 100 Hz. The low-level linearity of the D/A converters was very good down to -70 dB, with about a -1-dB error at -80 dB. At -90 dB, one channel was almost perfectly accurate while the other showed a -2-dB error.

The A-weighted noise was -115 dB (a spectrum analysis showed that this was mostly low-level power-line hum at 60, 180, and 300 Hz). The quantization noise was -97 dB, and the dynamic range (EIAJ) was 99 dB. The frequency (speed) error of the player was a mere -0.0024 percent. The interchannel phase shift ranged between -0.2 and -0.4 degree from 5,000 to 20,000 Hz.

The DAC-Z1 was impervious to blows on its side plates but would mistrack and shut down if hit mod-

erately hard on the top cover. We tested its error correction with the Pierre Verany #2 test disc; the player tracked the 1,250-micrometer error without a problem, but the 1,500-micrometer error produced brief dropouts. Surprisingly, when playing the tracks containing two closely spaced errors it was able to handle 1,500-micrometer errors without audible mistracking.

The player mechanism was quiet except when changing discs (a characteristic of every changer we have tested). The slow time from the beginning to the end of a disc, and vice versa, was about 3 seconds, an average figure. As with other changers, an appreciable time was required to change discs; depending on the specific tracks accessed at the beginning and end of the change, the elapsed time ranged from 11 to 15 seconds. The headphone volume (with medium-impedance AKG K340 phones) was lower than we prefer for serious listening.

Comments

The Fisher DAC-Z1 was a pleasant surprise, since we had not seen a Fisher component in recent years whose performance was at or near the state of the art. We hope its companion components are designed to the same standards.

In fact, taking into account its measured performance, features, and quality of construction, the Fisher DAC-Z1 is one of the better CD players we have used. It is different from most other changers in its control features and layout, but with a little practice it was easy to operate. The "fixed-magazine" changer system makes it as convenient to use for playing a single disc as for a stack of five CD's. And the disc-title function, though not an exclusive feature, can be useful. Its memories are retained indefinitely, or for up to a month if the player is unplugged, and can be changed at any time.

We were glad to see that the DAC-Z1's random-play feature randomizes the sequence of discs as well as of tracks. It can also randomize a programmed sequence of selections, providing complete control over program choices.

Circle 142 on reader service card

FEATURES

- Three-beam laser pickup
- Dual 18-bit linear D/A converters
- Eight-times-oversampling digital filter (352.8 kHz)
- Linear-phase analog filter
- Fixed magazine for one to five discs; can accept CD-3's without adaptors
- Direct access by disc, track, and index numbers
- Programmable to play up to thirty-two tracks in any order
- Display of disc, track, and index numbers and elapsed time; switchable to remaining and total time on disc
- Memory for disc titles (up to eight characters) of up to 170 discs; automatically displayed when disc is played
- Intro-scan (programmable from 1 to 99 seconds)
- Repeats of one track, all tracks, or all programmed selections
- Track and index stepping in both directions
- Two-speed fast scan in either direction with audible sound
- Front-panel headphone jack with level control
- Optical and coaxial digital outputs on rear apron
- Furnished wireless remote control for all functions except power switch and headphone volume

LABORATORY MEASUREMENTS

- Maximum output level:** 2.04 volts
- Total harmonic distortion at 1,000 Hz:** less than 0.002% from 0 to -90 dB
- Signal-to-noise ratio (A-weighted):** 115 dB
- Channel separation:** 128 dB at 100 Hz, 120 dB at 1,000 Hz, 95 dB at 20,000 Hz
- Maximum phase shift (from 5,000 to 20,000 Hz):** -0.4 degree at 5,000 Hz
- Frequency response:** +0, -0.3 dB from 10 to 20,000 Hz
- Low-level linearity error:** less than 2 dB down to -90 dB
- Cueing time:** 3 seconds
- Cueing accuracy:** A
- Impact resistance:** top, B; sides A
- Defect tracking:** tracked 1,500-micrometer defects on Pierre Verany #2 test disc

Plain Vanilla

Not only do we design and build it, we know how to put it together

...simple as plain vanilla.

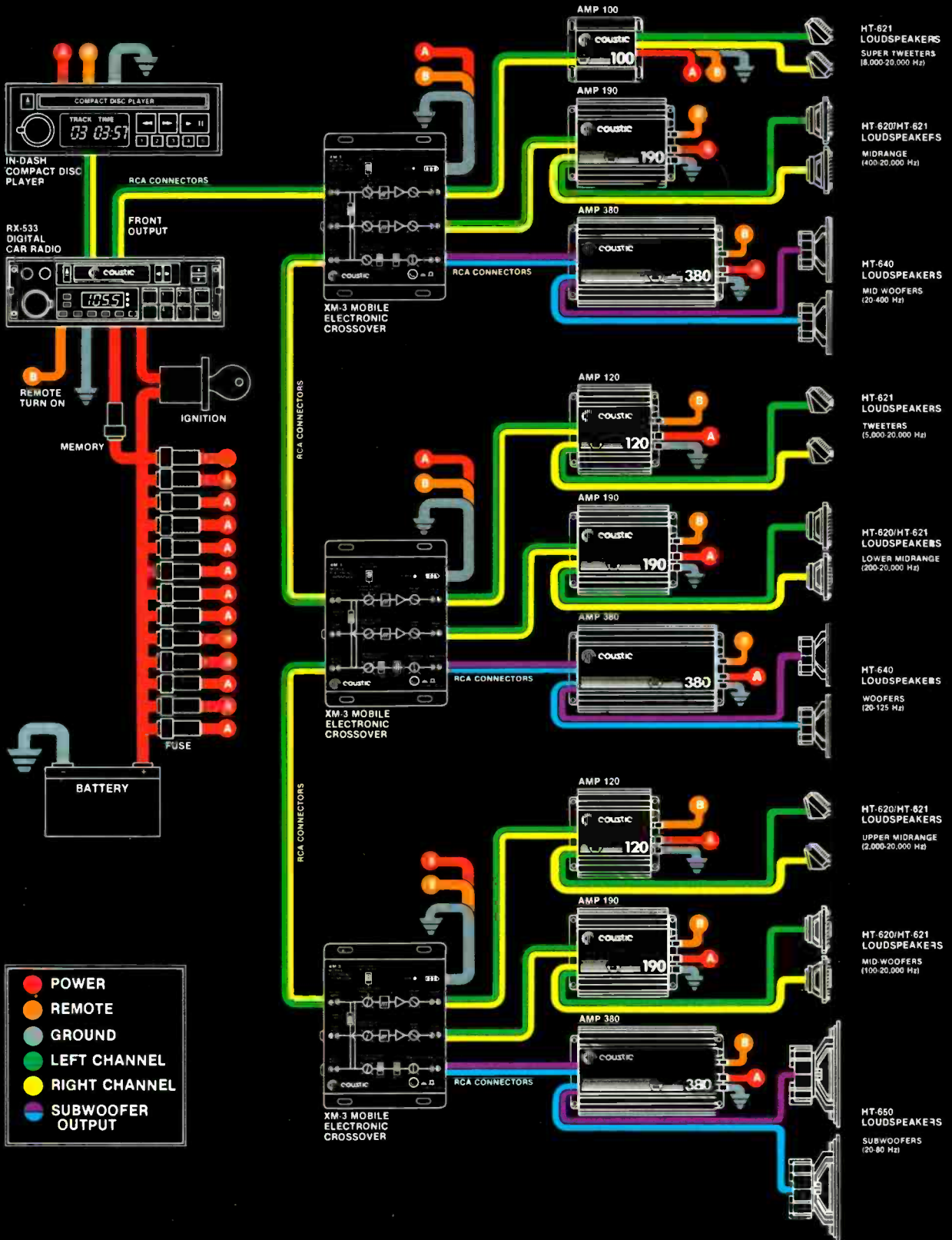



NAD MODEL 6340 CASSETTE DECK

Craig Stark, Hirsch-Houck Laboratories

THE moderately priced NAD Model 6340 cassette deck is a good example of why NAD equipment has become so popular. Almost defiantly plain in appearance and short on conveniences, it concentrates the buyer's investment in just those features that most directly affect audible quality.

The unconventional Model 6340 is a two-head, single-capstan deck that incorporates not only standard Dolby B and the higher-performance Dolby C noise reduction but also *both* Dolby HX Pro and Dyneq treble-extension circuits. And although it lacks all memory features and even so much as a headphone jack, it contains both a playback

high-frequency adjustment and a unique set of circuits designed to improve the sound of recordings made for use in the car.

The single record/playback head and most features of the solenoid-controlled transport system of the Model 6340 are unremarkable. One DC motor is used for the spooling functions, and another is belt-coupled to a flywheel that drives the single capstan. The tape counter is a three-digit mechanical type. An unlit cassette well provides no label visibility; indeed, it is difficult even to tell how much tape remains on a side without using a flashlight. The cassette well door is easily removed for routine head cleaning and demagnetizing.

The front-panel play-trim control is worthy of comment, however. A variety of causes often conspire to make tapes recorded on one machine sound dull on another. In part, this is a result of mistracking by the Dolby noise-reduction circuits. The treble boost/cut control incorporated in the NAD Model 6340 operates on the signal before it reaches the noise-reduction stages, and the shape of the control's response curve effectively offsets the kinds of losses that cause Dolby mistracking. (While no schematic diagram was provided with our test unit, the curves produced by the play-trim control suggest that NAD has used the head itself as one element in the kind of tuned circuit used in graphic equalizers. This technique has the additional advantage of saving both the cost and noise of an additional transistor stage in the playback circuitry.)

The inclusion of both Dolby HX Pro and Dyneq also addresses the problem of treble-shy cassette per-

Simple Impression.

Ergonomically simple, technologically impressive.

Our new 700 Series car radio/cassettes epitomize Coustic's commitment to **PRODUCT EXCELLENCE**. A balanced synthesis of technology, functionality and ergonomics aptly describes the 700 Series, which is the best selection of car radio/cassettes available today.

A full range of models boasting the technologically Advanced FM Optimizer IV Circuitry incorporating a QUASI 4-GANG HI-GAIN, LOW NOISE TUNED FRONT END. This circuitry continuously monitors FM signal strength to selectively adjust



RX-738 CAR RADIO/CASSETTE

and delivers a 3-dimensional "life-like" sonic performance.

THERE IS MORE ...

Cellular Phone Interrupt - You will never miss a call on your

Blending technology and simplicity the 700 series feature **DOLBY B+C NR** Preset Scan, Dolby B & C Noise Reduction Systems, Tape Program Search (TPS), Metal Tape Equalization (MTL), CD/AUX Input for digital program source, Radiocompact disc **COMPACT DIGITAL AUDIO** Monitor (R.MON), Active Bass & Treble Tone Controls, Front/Rear Pre-Amp Outputs for flexible system expansion and removable chassis option.

A custom oversized Liquid Crystal Display (LCD) provides easy identification day or night of frequency settings and each accessed function such as TFS, MTL, DD, CD, etc.

The 700 Series - simply impressive!

The 700 Series - simply impressive!



RX-728 CAR RADIO/CASSETTE

stereo separation and audio bandwidth. Automatically eliminating signal overload and the picket-fencing effect of multipath interference to produce the best stereo performance and cleanest FM reception possible.

The Auto-Aligned Azimuth (A³)™ **AUTO ALIGNED AZIMUTH SYSTEM** System is standard on all 700 Series auto-reverse cassette mechanisms. This unique A³ System employs a 2-track (in-

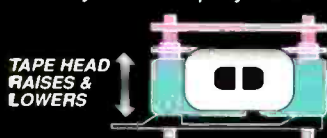

stead of a fixed four-track, crosstalk

prone) tape head that shifts linearly (up or down) into perfect azimuth alignment whenever tape direction is changed. This minimizes high frequency loss

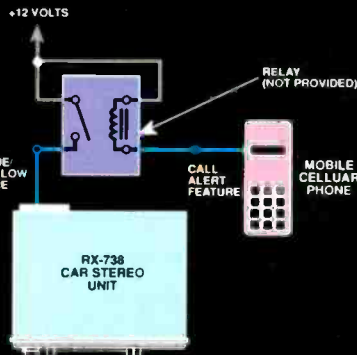

CELLULAR PHONE INTERRUPT

mobile phone (with "Call Alert") again! Our new I-SENS™ Circuitry instantaneously mutes the audio system when it detects an incoming call.



RX-738 MULTI-FUNCTION CONTROLS



RX-738 LCD DISPLAY



4260 Charter Street
Vernon, CA 90058-2596
213-582-2832

Dolby is a registered trademark of Dolby Laboratories

© Coustic 1989

TEST REPORTS

formance, this time from the recording rather than the playback perspective. Dolby HX Pro operates by dynamically reducing the bias current used during recording at

just the moments when very large treble signals are present, which enables the tape to store more high-frequency energy than it otherwise could. Permanently lowering the

bias level would result in higher distortion and a worse signal-to-noise ratio, which is why the Dolby HX Pro circuitry operates only during periods of peak treble demand.

Dyneq takes the complementary approach, that is, it reduces the high-frequency demand. Even with Dolby HX Pro it is all too easy, especially when recording from CD's, to drive cassette tapes beyond their treble capacity. When this happens, the high-frequency output from the tape does not simply level off; it actually *declines* as the demand rises. The Dyneq circuit monitors the signals flowing to the tape head and dynamically lowers the amount of record treble boost slightly when the current reaches the point where saturation would set in. Together, then, Dolby HX Pro and Dyneq might be said to address both the supply side and the demand side of cassette-sound economics.

A pushbutton, accompanied with one of the Model 6340's few front-panel indicator lights, switches in yet another of NAD's imaginative circuits. Called CAR (for compensated automobile reproduction), this circuit boosts low-level sounds by 12 dB, making them audible above the higher ambient noise level of a moving car. At the same time, it augments both the bass content (considerably) and the treble content (slightly) of these low-level sounds, giving them a fuller character. While the CAR circuit is obviously not a high-fidelity technique, the interior of an automobile moving at high speed is not the place to try to appreciate every nuance in the dynamic range of an orchestral composition, either.

Rather than restrict a recording's frequency response to the 15-kHz limit of stereo FM broadcasts, the NAD Model 6340 has a switchable multiplex filter. It also sports a user-adjustable control designed to optimize the bias level for recording different brands of tape. Since the deck's two-head design precludes directly comparing the source and the recorded sound, however, setting the fine-bias control accurately would require both considerable patience and external test instruments.

FEATURES

- Dolby HX Pro and Dyneq headroom-extension circuitry
- Playback frequency-response trim control
- Switchable CAR processor (dynamic-range compressor with bass and treble boost)
- Dolby B and Dolby C noise reduction
- Switchable multiplex filter
- Solenoid-controlled two-motor, single-capstan transport
- Twelve-LED-per-channel peak-reading level indicator
- User-adjustable bias control

LABORATORY MEASUREMENTS

Fast-forward time (C-60): 91 seconds

Rewind time (C-60): 92 seconds

Speed error: +0.18%

Dolby tracking error: Dolby B, +0.7, -2.0 dB; Dolby C, +1, -1 dB

Wow-and-flutter: 0.036% wrms, 0.070% DIN peak-weighted

Line input for indicated 0 dB: 36 mV

Line output at indicated 0 dB: 0.505 volt

Meter indication at IEC-standard 0 dB: +0 dB

Tape: TDK AD (Type I, ferric)

IEC 0-dB distortion: 0.64%

Meter indication at 3% THD + noise: +5 dB

Signal-to-noise ratios (in decibels):

	Unwtd.	A-wtd.	CCIR/ARM
NR off	53.0	58.4	56.4
Dolby B	61.1	68.5	66.7
Dolby C	63.5	73.9	76.4

Tape: TDK SA (Type II, chrome-equivalent)

IEC 0-dB distortion: 0.92%

Meter indication at 3% THD + noise: +3 dB

Signal-to-noise ratios (in decibels):

	Unwtd.	A-wtd.	CCIR/ARM
NR off	54.0	58.5	56.2
Dolby B	61.0	68.2	66.5
Dolby C	63.5	75.0	76.2

Tape: TDK MA (Type IV, metal)

IEC 0-dB distortion: 1.2%

Meter indication at 3% THD + noise: +3 dB

Signal-to-noise ratios (in decibels):

	Unwtd.	A-wtd.	CCIR/ARM
NR off	54.0	58.7	56.0
Dolby B	61.2	68.3	66.3
Dolby C	63.7	75.0	76.0

NAD 6340 CASSETTE DECK
RECORD-PLAYBACK RESPONSES

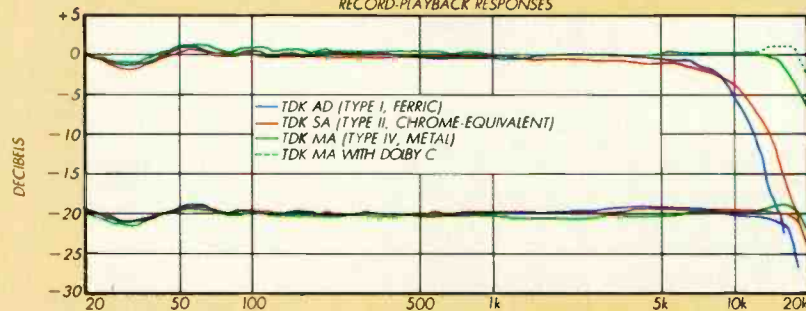

PLAYBACK-ONLY RESPONSES
(IEC-STANDARD BASF TEST TAPES)



FREQUENCY IN HERTZ

Impress your system. And your system will impress you!

Impress your car audio system with our Power Logic series of component speakers and your system WILL impress the discriminating you.



TWEETERS: HT-602, HT-600

From 15" monstrous subwoofers, to powerful mid/woofers, to super tweeters and multi-driver speaker systems, our Power Logic component speakers are ready for any frequency response and sound pressure level (SPL) requirements with minimum distortion.

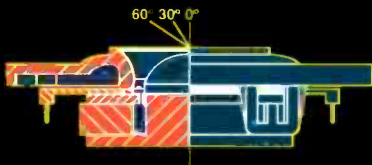

Your system will be wowed by our **SYMMETRICAL WAVE LOADING TECHNIQUE** on the Power Logic component tweeters which produces crisp high frequency performance even when mounted "off-axis".

Your power amplifier will be pleasantly surprised to find that **POLYIMIDE DIAPHRAGMS** are built into the tweeters to ensure structural integrity and significantly minimize distortion when subjected to high power.

Your system will concur with our research findings that **HIGH DENSITY, POLYPROPYLENE-LAYERED, AIR-DRIED, DOUBLE-RIGID PAPER CONE** carries the lowest second and third harmonic distortion characteristics, manifesting the best

sound quality.

This cone material is standard on all Power Logic component speakers.

Your power amplifier system will certainly appreciate the combination of **HIGH TEMPERATURE ALUMINUM VOICE COIL** and **HI-ENERGY STRONTIUM MAGNET STRUCTURE** built for maximum heat dissipation and extreme power handling capability, with more accurate cone displacement resulting in faster transient re-



MID WOOFERS: HT-604, HT-606, HT-603, HT-605

sponse and lower distortion.

The Power Logic component speaker series rigorously produces, in an anti-acoustic automotive environment, crisp high fre-

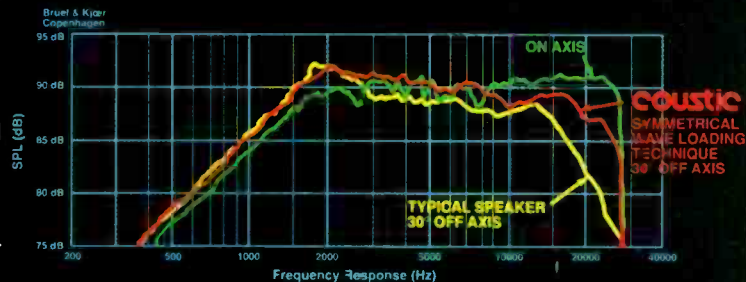

quency response, sumptuous midrange, tight and distortion-free low bass, superb instantaneous power handling and precise stereo imaging. In short, the illusion of life-like musical performance with superior clarity and 3-dimensional imaging.

Our Power Logic component speakers will no doubt impress your system. All it takes is for your system to impress YOU.



SUBWOOFERS: HT-610, HT-615, HT-608, HT-612



4260 Charter Street
Vernon, CA 90058-2596
213-582-2832

TEST REPORTS

Three-position lever switches are used to select a noise-reduction circuit and to switch the overall bias and equalization for ferric, CrO₂, or metal-particle tape. Overall record levels and channel balance are controlled with a clutched-knob. The tape levels are displayed on a pair of twelve-segment-per-channel peak-reading LED displays that are calibrated from -20 to +8 dB.

Overall, the NAD Model 6340 measures 16½ inches wide, 9¾ inches deep, and 4¾ inches high, and it weighs 10 pounds. Price: \$398. NAD, Dept. SR, 575 University Ave., Norwood, MA 02062.

Lab Tests

The playback frequency response of the NAD Model 6340, measured with IEC-standard ferric and CrO₂-calibrated tapes from BASF, was very flat and smooth, varying by only ±1 dB from 31.5 to 18,000 Hz (the highest tone on the tapes), where it was down by less than 2 dB. Without extraordinary measures, this is about the best you can do in a deck with a single record/playback head.

As usual, we used our center-line samples of TDK AD (ferric), SA (chrome-equivalent), and MA (metal) to check the overall record-playback performance of the Model 6340. At the bass end, frequency response was remarkably flat all the way down to 20 Hz (most decks give up at 50 Hz). In the high frequencies, the practical limit of the deck is just above 18,000 Hz. At the full IEC 0-dB level (250 nanowebers per meter), the contribution of the Dolby HX Pro and Dyneq circuits pushed the point at which response dropped to the -6-dB level (half the voltage output) above 10,000 Hz for the ferric tape, above 12,000 Hz for the chrome-equivalent, and very nearly to 20,000 Hz for the metal. This level of performance is usually found only in more costly three-head decks.

The signal-to-noise ratio (S/N) also invites comparison with decks costing two and three times the price of the Model 6340. The limit we encountered here lay in the deck's inability to take the fullest advantage of the potential of metal-particle tapes. The S/N figures for

ferric, CrO₂, and metal tapes were essentially identical. The metal tape should have done somewhat better, but even there the deck's performance was very impressive.

Our wow-and-flutter measurements, though well within the man-

The unconventional NAD Model 6340 cassette deck incorporates not only standard Dolby B and the higher-performance Dolby C but also both Dolby HX Pro and Dyneq treble-extension circuits.

ufacturer's ratings, were far less impressive. When we tested the much more costly NAD Model 6300 (June 1987), the wow-and-flutter figures for its twin-capstan drive were among the lowest we had ever encountered. The Model 6340 does as well as can be expected for a single-capstan (and thus less costly) drive. It is certainly adequate.

The tracking of the Dolby noise-reduction circuits was extremely good, and the sensitivity and output levels were unexceptionable. Fast-winding times were distinctly on the slow side, though acceptable.

Comments

In terms of its human engineering, the NAD Model 6340 made no secret of the cost-cutting measures needed to bring it to market at so modest a price. The transport solenoids clunked, getting into record mode was a cumbersome two-step process, the cassette-well door was utterly undamped, and the mechanical index counter and the level display seemed relics of older designs. These are not, however, things that will matter seriously to the music lover who is trying to get maximum performance at a minimum price.

Such a music lover will be mightily impressed by the Model 6340. Its frequency-response and imaging characteristics were superb. The signal-to-noise ratio was adequate, and when we suspected a slight softening of the attack edge on piano notes recorded using Dolby C, we found that the play-trim control brought it back to near perfection. Wow-and-flutter were not audible as such, though they contributed to the deck's inability to make sonically perfect copies. Such perfection is not to be found in *any* cassette deck, however, at any price, and the NAD Model 6340 is easily among the most musical decks you can buy. And at its price, you can afford to buy it.

Circle 143 on reader service card

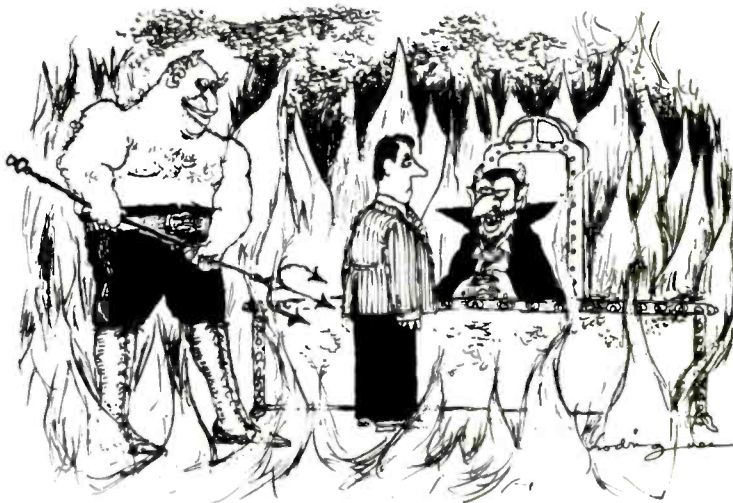

"... So you were an audiophile—well, ain't that nice. Leo, put this mutt in the multipath room with the rest of the auuuuuuudio-philés! Ha, ha, ha, . . ."

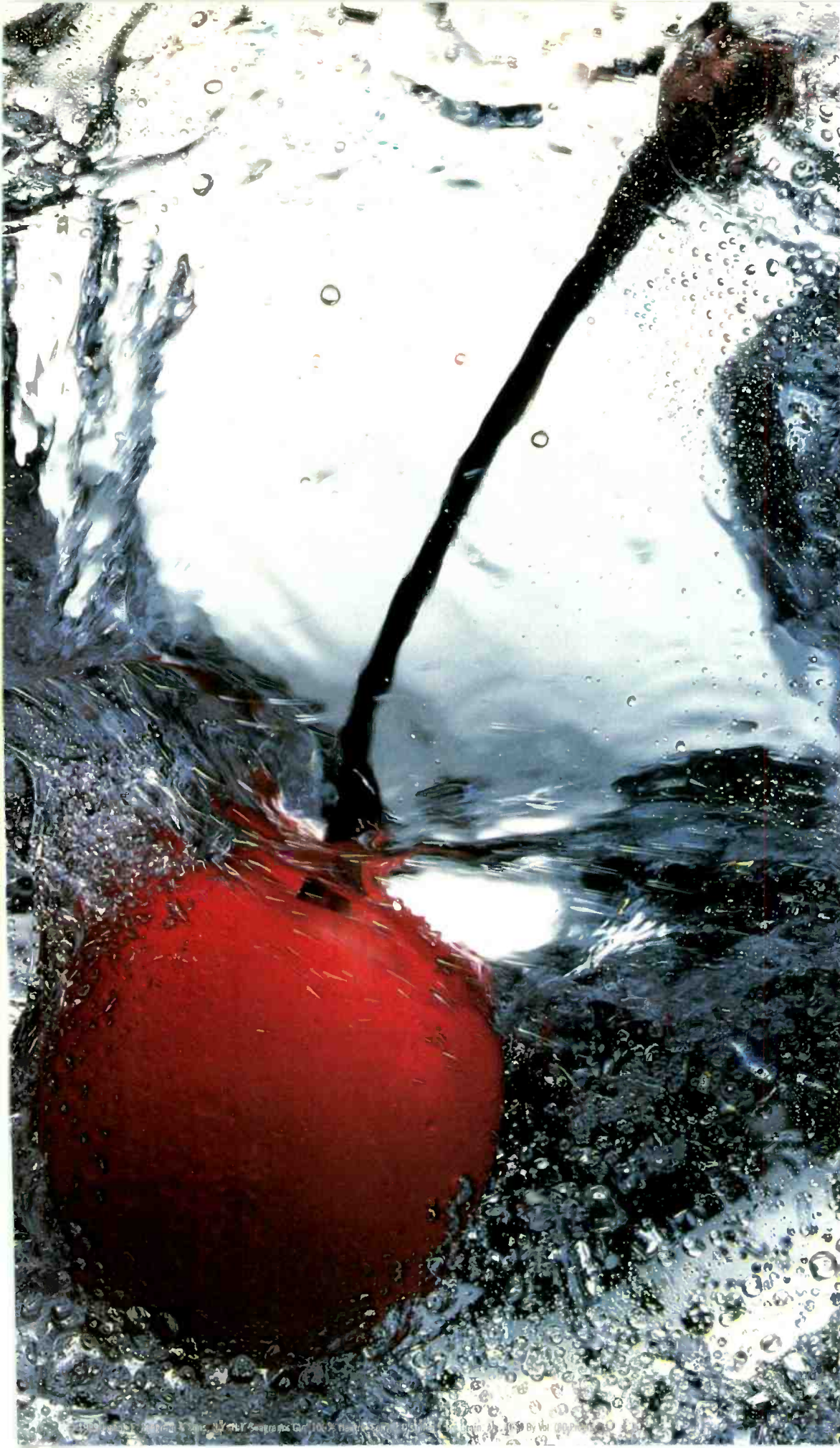

ENOUGH
TO MAKE A
CHERRY
BLUSH.

REFRESHING
SEAGRAM'S
GIN.



AMERICA'S No. 1
SELLING GIN

A video receiver designed for audiophiles.



Until now, video receivers have overlooked a distinct segment of the Nielsen population.



Those people who listen to TV as well as watch it. Which is why Mitsubishi engineers developed the M-AV1. A video receiver

inspired from the philosophy that a soap opera should sound every bit as good as an Italian opera. At the heart of the system is a powerful amplifier with Dolby Surround™ sound. It boasts 125-watts per channel* With a generous dose of 25-watts per channel in the rear for surround sound. A time delay of 20 milliseconds has also been encoded into the rear channels to increase depth perception and maintain separation from the front speakers. And with our Dynamic Delay Line, we've expanded the dynamic range of our rear channels by as much as 40 dB over other conventional designs. It also offers four video inputs (two of which are Super-VHS compatible). And comes complete with an award-winning remote that's easy-to-use and capable of controlling all functions via on-screen displays. So you never have to get up from your recliner on our account. But now that you've got a great video receiver, as an audiophile, you might be in the market for an audio receiver. In which case read the other side of the page.

An audio receiver designed for videophiles.

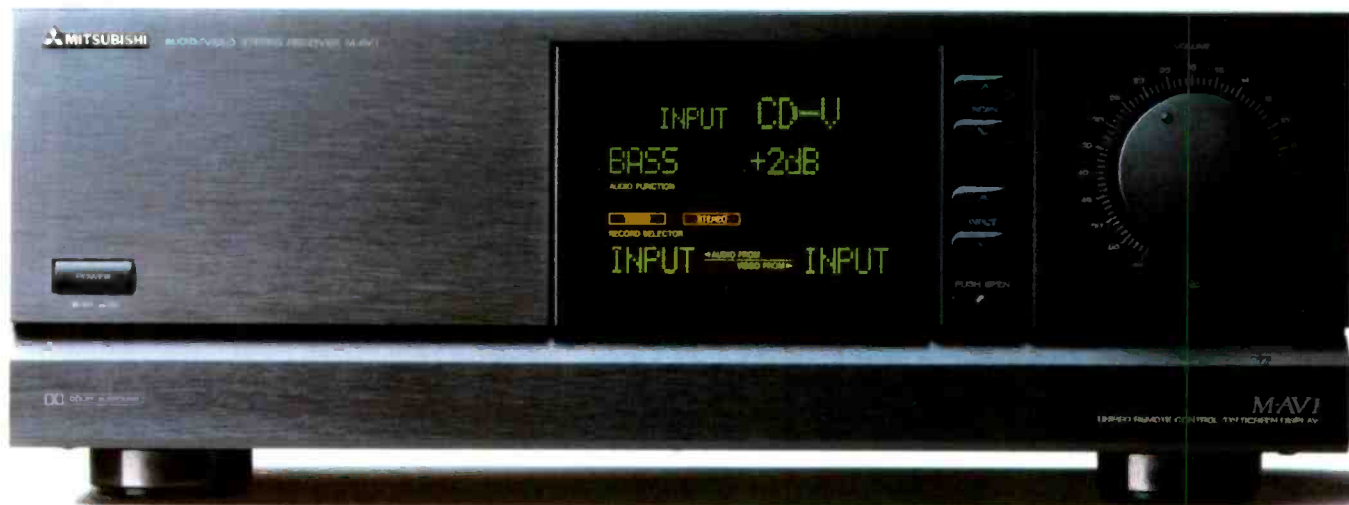

If like most people you read this ad from left to right, you know by now that the M-AVI distinguishes itself as a superb video receiver. But what makes the M-AVI a rare species in the A/V receiver jungle is that it also makes an equally superb audio receiver. For starters, it's so full of technical goodies that it makes the average audio receiver, much less the average A/V receiver, blush. You'll find our dual J-FET preamp provides low-noise and minimum distortion characteristics to the output amplifiers. We've utilized discrete components instead of integrated circuits for the output devices for maximum headroom and separation. Our own Multi-Feedback Servo system faithfully reproduces low frequency music with a minimum of distortion while protecting your loudspeakers from potentially damaging DC signal components. And there's also a remote-operated motorized volume control that provides smooth attenuation while avoiding distortion. Of course, if you decide you're still a hard-core videophile and only care about obtaining a great video receiver, we have a small suggestion. Buy the receiver on the other side of the page.



*125-watts per channel minimum RMS, both channels driven into 8 ohms from 20Hz - 20kHz with no more than 0.05% total harmonic distortion. For the name of your authorized Mitsubishi dealer, call (800) 527-8888 ext. 145 © 1989 Mitsubishi Electric Sales America, Inc. Dolby Surround is a trademark of Dolby Laboratories Licensing Corp.

 **MITSUBISHI**
TECHNICALLY, ANYTHING IS POSSIBLE™

CIRCLE NO. 22 ON READER SERVICE CARD



JOCK LEUNG

LUXMAN TP-117 TUNER/PREAMPLIFIER AND MULTIROOM SYSTEM CONTROLLER

Julian Hirsch, Hirsch-Houck Laboratories

THERE is a growing trend toward home audio/video entertainment systems that can provide different programs in several rooms from a single group of source components. This approach can offer both aesthetic and performance advantages: by minimizing the visible presence of the major system components and by channeling the total equipment investment into higher-quality components instead of several systems of lesser quality.

In its simplest form, a "multi-room system" might consist of a stereo receiver driving separate pairs of speakers in different rooms. But such an arrangement does not permit different programs to be sent to the two rooms, nor does it provide for independent volume adjustment or program selection from each listening location.

At the other extreme of complexity (and cost) is a system that permits program selection and control of all key operating functions from each listening location. This degree

of versatility is likely to be expensive, frequently involving a number of custom-designed components and typically requiring that all of the components come from the same manufacturer.

Somewhere between these limits is a new multiroom system based on standard Luxman components but able to use (and control) source components and speakers made by other companies. The heart of this system is the Luxman TP-117, which combines a tuner, a preamplifier, and a system remote-control center.

From the user's perspective, the TP-117 resembles a rather simple conventional stereo receiver. Its front panel contains a display window that shows the selected tuner frequency, band, preset channel number, and operating mode, or comparable information for another selected input source. There are several tuner-control buttons, but the twenty FM or AM preset channels are accessible only through the supplied wireless remote control. The

FM tuner is unusual in having tuning increments of 25 kHz instead of the customary 200 kHz (an internal switch can be set to disable the 25-kHz feature).

The TP-117's audio control section consists of small, center-detented tone and balance knobs, a large volume knob, and buttons to bypass the tone controls and activate the subsonic filter and loudness-compensation circuits. A CD STRAIGHT button connects the CD input signal directly to the volume control, bypassing all input switching and other controls.

A narrow panel extending across the full width of the unit hinges down to reveal a number of buttons, three small knobs, and a headphone jack. One group of buttons selects the source(s) supplied to the recording outputs, and another selects the dubbing interconnections between two audio recorders and a VCR. The remaining controls duplicate the front-panel audio controls and are identified as SYSTEM-2.

The subpanel SYSTEM-2 controls are the only clue to the unique nature of the TP-117. Within this conventional appearing case is not only an AM/FM tuner but *two* separate preamplifiers, all of excellent quality. The rear apron is studded with some forty-five phono jacks, a number of 1/4-inch-*phone* and DIN jacks, antenna binding posts, and no fewer than *eight* AC outlets, all of them switched. Since there are two pairs of power-amplifier outlets,



REALISTIC®

The CD Player for the Changing Times

America's biggest name in audio presents a better way to enjoy the best in sound—the Realistic compact disc changer. You can load up to six discs in its magazine and enjoy hours of superb digital stereo. Or, program up to 32 selections from the discs to play in any sequence. Either way, you can pause, replay, program and search, using the wireless remote control.

The large LED display simplifies remote operation. Manual and automatic search make it easy to find selections.

This high-performance changer has a Tri-Spot laser pickup system for accurate tracking. Two-times oversampling

provides super sound. And Radio Shack carries extra magazines so you can protect all of your CDs and have them loaded and ready for play.

Come in and try the Realistic CD-6000. It's affordably priced at only 359.95 and available today.



Exclusively at

Radio Shack® The Technology Store™

A DIVISION OF TANDY CORPORATION

Price applies at participating Radio Shack stores and dealers.

FREE 184-Page Radio Shack Catalog! Write Dept. 135-03, 300 One Tandy Center, Fort Worth, TX 76102

TEST REPORTS

one pair for System-1 and one for System-2, with each pair rated to handle a total load of 500 watts, as well as two pairs of source-component outlets, each pair rated for 300 watts total, it's clear that the TP-117 is able to control *two* rather complete A/V systems.

In a multiroom setup, the RTP-117 remote control—two of which are supplied with the TP-117—

selects the input source for whichever room it is used in. Options include tuner, CD, phono, tape 1 or 2, videodisc, VCR, and AV (which can be an additional VCR or videodisc audio channel). Many of the remote unit's buttons operate specific functions of Luxman components, including CD players and tape decks. The numerical buttons of the CD section can also be used to select

tuner presets, and other buttons adjust the volume, switch between AM and FM, and turn either the system in the room or the entire system on or off.

Through the RTP-117 units, a single TP-117 can control two "zones," each covering one or more rooms. Each zone uses one of the systems in the TP-117, and up to three TP-117 units can be "daisy-chained" to control a total of six zones, each with independent program selection and volume control. Each system within a TP-117 has its own motor-driven volume control, which can be operated remotely.

A multiroom system requires accessory modules that connect to the TP-117. The RC-501 infrared remote sensor picks up control signals from a nearby RTP-117 controller and relays them down a coaxial cable to a TP-117 in another location. The RC-501 can also pass a VHF TV signal (Channel 3 or 4) coming from a VCR connected to the TP-117 via the coaxial cable to a TV set in the remote room. The RC-502 remote signal converter can be used to connect additional RC-501 sensors to the same TP-117 or to increase video-signal switching capacity. An RC-503 infrared remote-control repeater can be connected to the TP-117 to allow control of non-Luxman units such as VCR's or videodisc players through a TP-117 without hard-wired connections. Finally, the RC-504 is an external infrared emitter that can be aimed more precisely than the RC-503.

Obviously, a system based on the Luxman TP-117 can be highly complex when the control center's capabilities are fully utilized. Space does not permit going into detail on the myriad system configurations and control possibilities; the instruction manual and an installer's guide cover these matters quite thoroughly, although the installation probably should be done by an experienced person.

The Luxman TP-117 measures 17¼ inches wide, 13 inches deep, and 4¾ inches high, and it weighs about 11½ pounds. Prices: TR-117 with one RTP-117, \$1,250; RC-501 sensor, \$100; RC-502 converter, \$180; RC-503 repeater, \$150; RC-504 emitter, \$20. Luxman, Dept.

FEATURES

- Digital-synthesis AM/FM tuner with twenty presets
- Tuning for FM band in 25-kHz steps
- Independent preamplifier sections for two systems
- Two independent, motor-driven volume controls with automatic low-level turn-on settings
- Inputs for CD, phono, videodisc, two audio tape decks, VCR, and auxiliary A/V
- Independent connection of any input with either preamplifier section
- Facilities for tape dubbing between audio decks and VCR
- CD STRAIGHT button to bypass input selectors for CD signal
- Bass and treble tone controls with bypass button
- Switchable subsonic filter
- Switchable loudness compensation
- Front-panel display of selected source for each system, station frequency, signal strength, tuner mode
- Dual-zone control system; up to three units can be "daisy chained" to control up to six separate zones of one or more rooms each
- Jacks for connecting external signal processor and remote-control jacks for Luxman tape recorders
- Accessory infrared repeaters to allow remote control of system from other rooms or to carry video signals (through coaxial cable) from TP-117 to remote TV set or monitor
- Eight switched AC outlets
- Two pairs of preamplifier outputs for each system (zone)
- Buffered video switching to allow use of video sources
- Can control dubbing from one VCR to another
- Supplied with multifunction infrared remote controls (two per unit) for full system control from any zone

LABORATORY MEASUREMENTS

- Tuner Section** (all figures for FM only except frequency response; measurements in microvolts, or μV , referred to 75-ohm input)
 - Usable sensitivity (mono): 10.4 dB (0.9 μV)
 - 50-dB quieting sensitivity: mono, 16 dBf (1.75 μV); stereo, 38 dBf (21.8 μV)
 - Signal-to-noise ratio at 65 dBf: mono, 77 dB; stereo, 71 dB
 - Harmonic distortion (THD + noise) at 65 dBf: mono, 0.145%; stereo, 0.073%
 - Capture ratio at 65 dBf: 1.1 dB
 - AM rejection: 62 dB
 - Selectivity: alternate-channel, unmeasurable (see text); adjacent-channel, 11 dB
 - Stereo threshold: 22 to 19 dBf (3.5 to 2.5 μV)
 - Pilot-carrier leakage: 19 kHz, -68 dB; 38 kHz, -68 dB
- Hum:** -78 dB (180 Hz)
- Stereo channel separation** at 100, 1,000, and 10,000 Hz: 42, 42.5, and 41 dB
- Frequency response:** FM, 30 to 15,000 Hz +0.5, -0.2 dB; AM, -6 dB at 45 and 3,600 Hz
- Preamplifier Section**
 - Clipping output level: 9 volts
 - Sensitivity (for 0.5-volt output): CD, 75 mV; phono, 1.25 mV
 - A-weighted noise (referred to a 0.5-volt output): CD, -90 dB; phono, -94 dB
 - Phono-input overload: 115 to 169 mV from 20 to 20,000 Hz
 - Phono-input impedance: 35,000 ohms in parallel with 95 pF
 - RIAA equalization error: +0.5, -1.25 dB from 20 to 20,000 Hz

DON'T BUY ONE OF THESE UNTIL YOU TAKE A HEARING TEST.

Warning: If you read this ad you'll wind up at your Sherwood dealer.

Why? Well, it won't be the fact that our current line of home components is the finest we've ever built. Or because our engineers didn't cut corners to assure excellent, long lasting performance. Or because you'll have enough jacks to handle an entire home entertainment center.

No, the reason you'll see your Sherwood dealer is to listen to these components for yourself. Because putting our sensibly priced components to the test is a heck of a lot more important than anything you'll find in an ad.

If you think they sound good now, wait until you hear them.

 **Sherwood**
LIVE PERFORMANCE SOUND™

13845 ARTESIA BLVD. CERRITOS, CA 90701 • IN CANADA: NORESKO CANADA INC., TORONTO, ONTARIO © 1989 INKEL CORPORATION

CIRCLE NO. T03 ON READER SERVICE CARD

TEST REPORTS

SR, 19145 Gramercy Pl., Torrance, CA 90501.

Lab Tests

We tested (and used) only the tuner and basic preamplifier functions of the Luxman TP-117, driving the speakers through a Luxman M-113 power amplifier.

The FM tuner's frequency response was very flat, measuring +0.5, -0.2 dB from 30 to 15,000 Hz, and its channel separation (rated as 48 dB at 1,000 Hz) was almost as uniform, between 40 and 42.5 dB from 30 to 11,000 Hz and 34 dB at 15,000 Hz. The mono FM usable sensitivity was slightly better than the rated 10.8 dBf, measuring 10.4 dBf (0.9 microvolts, or μV) into the 75-ohm antenna input. The mono 50-dB quieting sensitivity, rated as 14.8 dBf, was 16 dBf (1.75 μV), and the stereo figure matched the rated 38 dBf (21.8 μV). The signal-to-noise ratio (S/N) was 77 dB in mono (rated 78 dB), and in stereo it measured 71 dB (rated 72 dB). The total harmonic distortion (THD) plus noise was 0.145 percent in mono and 0.073 percent in stereo (rated 0.1 and 0.15 percent, respectively).

Image rejection, rated as 80 dB, was virtually unmeasurable, reading 138 dB (an improbably high figure). The alternate-channel selectivity was 66 dB, close to the rated 68 dB, and the adjacent-channel selectivity was 11 dB. The 1.1-dB capture-ratio measurement was not only exceptionally good, but it surpassed the rated 1.5 dB.

The preamplifier's frequency response (CD input) was +0, -0.05 dB from 60 to 20,000 Hz and -0.27 dB at 20 Hz. The response in the CD STRAIGHT mode was virtually identical, with a gain change of +0.03 dB. The subsonic-filter response was flat above 200 Hz, -0.5 dB at 60 Hz, and -3 dB at 22 Hz. The bass tone control had a maximum boost of 14 dB at 40 Hz and a maximum cut of 16.5 dB at 20 Hz. The treble control's maximum range was +10, -11 dB at 20,000 Hz. The loudness compensation introduced a fixed characteristic at volume settings lower than -10 or -15 dB, with a low-frequency boost of 7.5 dB below 30 Hz and a 6-dB boost at 20,000 Hz.

The RIAA phono-equalization error was +0.5 dB at 20,000 Hz and -1.25 dB at 20 Hz. The phono-input impedance was a lower-than-usual 35,000 ohms, in parallel with 95 picofarads, and the phono stage overloaded at inputs between 115 and 169 millivolts from 20 to 20,000 Hz.

The minimum preamplifier distortion (THD plus noise) occurred at 1.5 to 2 volts output, where it was 0.004 to 0.005 percent. It was still only 0.03 percent just before the output clipped, at 6 to 7 volts, and it was constant with frequency. The A-weighted noise level through the CD input was -90 dB referred to a 0.5-volt output; through the phono input it was -94 dB. A spectrum analysis of the output noise showed a decline from -102 dB at 20,000 Hz to -120 dB at 50 Hz. Power-line hum components (also referred to a 0.5-volt output) were present at very low levels, the largest being the 180-Hz component at -101 dB (60 Hz was -110 to -115 dB).

Comments

Our lab measurements clearly showed the Luxman TP-117 is a first-rate tuner and preamplifier. In general, it was well above average in respect to meeting its published ratings. The preamplifier performance was particularly excellent in respect to output voltage capability (9 volts at clipping) and noise level.

At another location, we observed a nine-room system being installed using four TP-117's, a Luxman CD player and cassette deck, ten Luxman power amplifiers, and a videodisc player, a VCR, and two TV sets from other manufacturers. While the installation process was indeed quite complex, Luxman's various auxiliary components appeared to provide all the flexibility that could be desired.

When completed, this installation will allow any of the program sources—CD, tape, tuner, phono, stereo TV, videodisc, or VCR—to be heard or seen in any room while any other source is heard or seen in any other location. Whichever room you're in, control is handled by the same simple RTP-117 remote unit.

Ergonomic considerations are especially important in a multiroom

system. First, it should be possible to operate all significant functions from any remote zone, and second, the user should have reasonable assurance that any given command has been executed. The first requisite appears to be met very neatly by the Luxman TP-117 system, thanks in good measure to the highly versatile, yet uncluttered, RTP-117 remote control. The second, which is far more difficult and costly to achieve, has been met only indirectly. From either zone, you can turn the system on or off, select any connected program source, select CD tracks or station presets, operate either or both tape decks in their various modes, and have some control over TV and VCR operation. The accomplishment of any given switching configuration is confirmed, however, only by the appearance of the expected *result*: the desired audio or video program.

There is evidence of thoughtful design throughout the Luxman TP-117/RTP-117. One of the best examples of this is the automatic initial setting of the motorized volume controls. Since listeners in any room may have set their system volume high (or fully off) during previous operation of the system, it would be possible to have it come on at an uncomfortably loud level, or with *no* audible output, the next time. Therefore, each time the TP-117 is turned on, both of its volume controls move to a low-level setting—about 20 percent of the maximum level—before the internal muting relay releases. Thus, the sound always comes on at a low, but audible, level. A red LED on the main knob serves as a pointer and shows its setting whenever the unit is powered.

The Luxman TP-117 and its related system components have far too many features for us to do full justice to them here. If you are interested in a fine multiroom system that can be set up to suit your personal needs at a much lower cost than a fully custom-designed installation, be sure to see a dealer equipped to demonstrate the Luxman system properly. Our experience with the TP-117 was a wholly positive one.

Circle 144 on reader service card

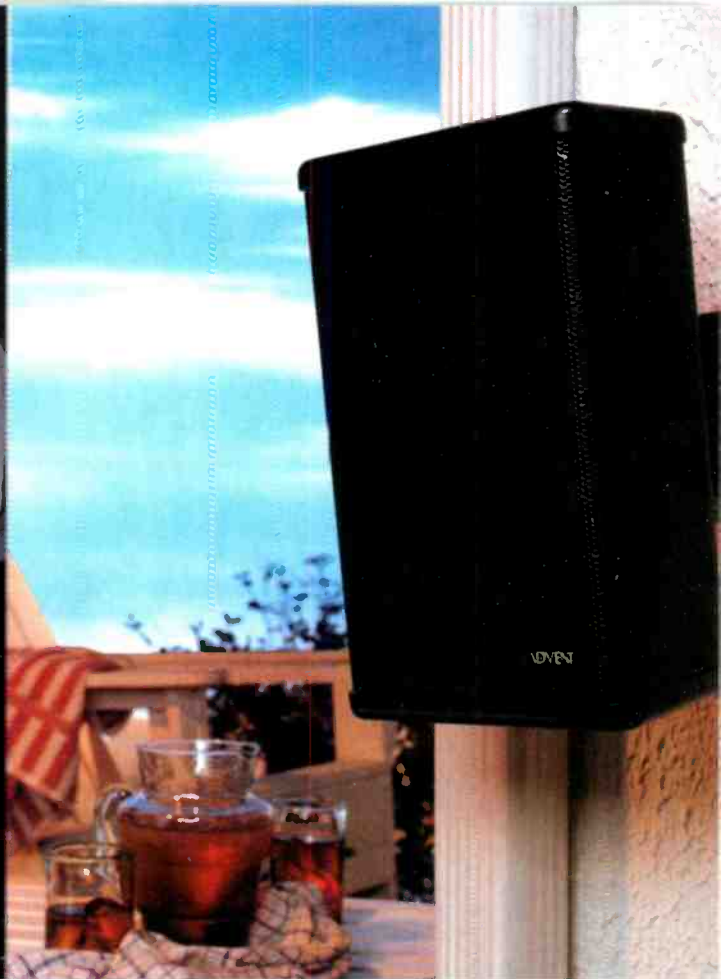
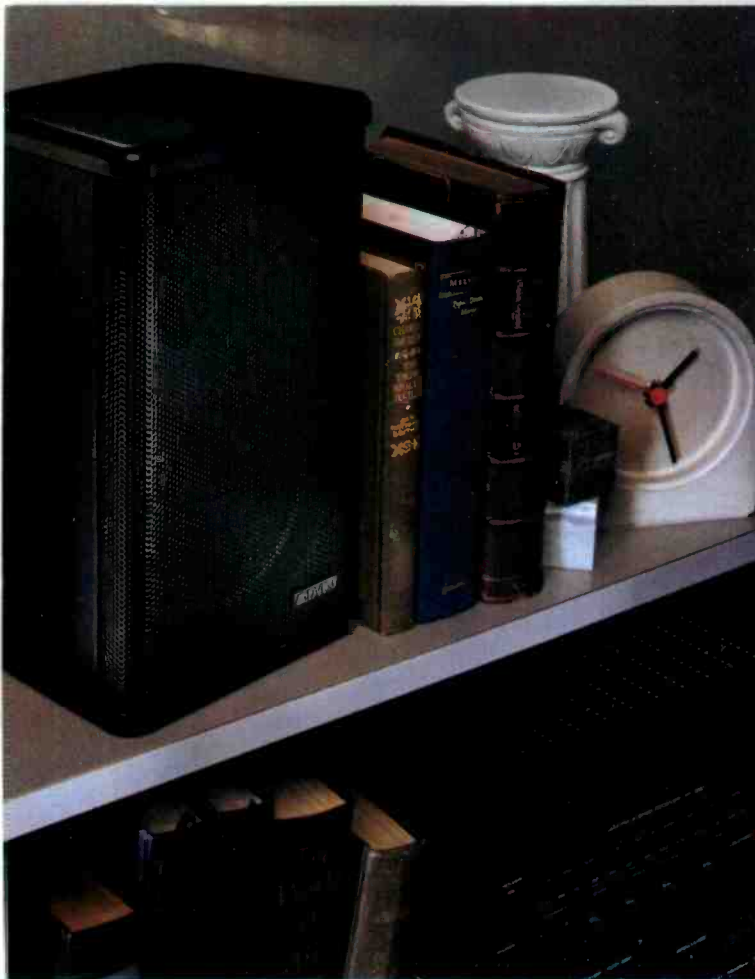

INTRODUCING PROOF THAT WE KNOW ACCURATE SOUND INSIDE AND OUT.

PRESENTING THE NEW INDOOR/OUTDOOR MINI ADVENT LOUDSPEAKERS.

Now you can hear the traditionally natural Advent® sound in a totally different environment. Outside.

Because our new Indoor/Outdoor Mini loudspeakers are resistant to water, humidity, heat and cold, the sound from your speakers will be accurate, even when the weatherman is not.

Plus, they've been designed with the same type of features that have made the Advent sound a legend indoors. Including 5¼" long throw polypropylene woofers. Polycarbonate hard dome tweeters.

And 120 watts peak power. (165, when connected to our Mini Subwoofer.) They sound terrific by themselves or completing a surround sound system.

Wrap it all up in sleek, black Eurostyle cabinets that go just about anywhere (especially when using our optional wall and ceiling mounts), and you have a pair of speakers that will definitely get you out of the house more often.

To hear our Indoor/Outdoor Mini loudspeakers, or any of the fine line of Advents (including the new Prodigy II), just step inside your nearest Advent dealer.



///ADVENT®

Sound as it was meant to be heard.

© 1988 International Jensen Inc.
Advent is a registered trademark of International Jensen Inc.

CIRCLE NO. 30 ON READER SERVICE CARD

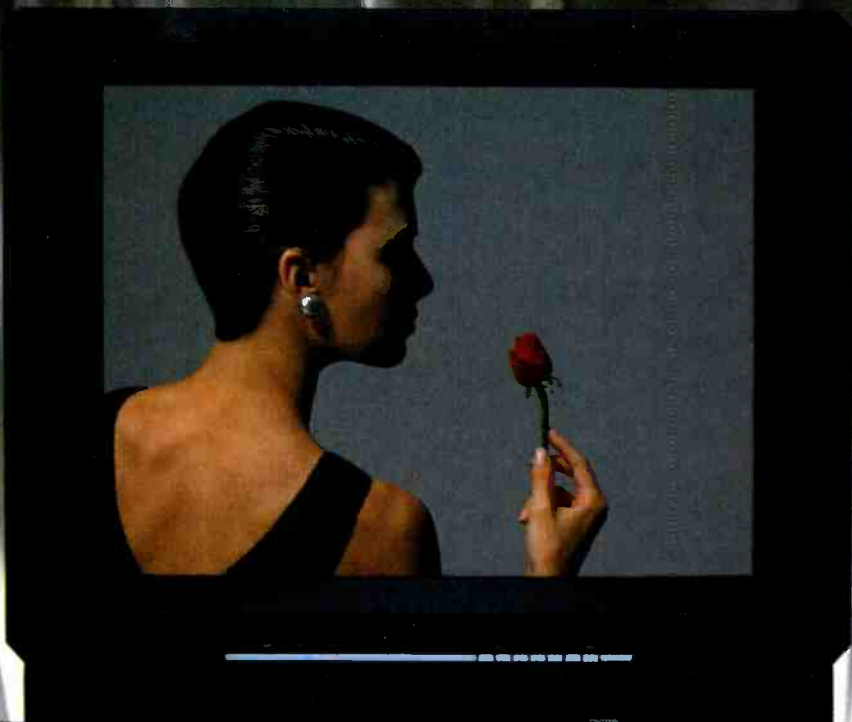

The Definition of Excellence. In Sight and Sound.

Introducing Proton's new big screen 31" monitor/receiver with Aphex Aural Exciter.®

Proton has always set the industry standard for breathtaking video performance. And our big new 31" picture follows in that tradition. But this time, the picture isn't all we've expanded.

By incorporating the Aphex Aural Exciter circuitry, we've achieved a new level of audio clarity and transparency. So harmonics are restored, highs more natural, and vocals more vivid. And, at the touch of a button, our Expander provides vastly superior stereo imaging.

With our SD-1000 Enhanced Surround Decoder, your enjoyment will be even greater. This Aphex innovation starts where Dolby® leaves off, creating an [REDACTED] expanded listening area that wraps you in pure listening pleasure.

Unmatched by many professional systems, the Dolby compatible SD-1000 offers dynamic surround sound from any stereo source.

We took the industry's best and brightest picture. And added the most advanced sound. Proton. The new definition of excellence.

For a free brochure and the Proton retailer nearest you, call (800) 772-0172. In California, (800) 428-1006. Or write to 5630 Cerritos Ave., Cypress, CA 90630.

PROTON®
CLEARLY THE BEST

ADVERTISING SUPPLEMENT

THE
LASER
ENTERTAINER

STEREO REVIEW TECHNOLOGY SUPPLEMENT

**YOUR
COMPLETE
GUIDE
TO THE
SIGHT
AND SOUND
SENSATION
OF THE
'90s**

By Bruce Apar



Until now, the audio section of most video disc players left a bit to be desired.

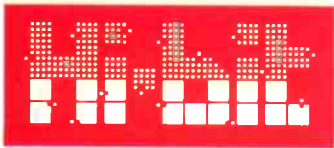

The ultimate goal of this exclusive Yamaha process is pure digital sound with absolutely no phase deviation. We come very, very close.

Most combi players sound like this headline looks.

Because four times oversampling is the best they can do.

Yamaha thinks you should hear what *eight* times oversampling sounds like.

By auditioning the phenomenally clear audio section of our new Yamaha CDV-1600 laser disc player.

It's the same sophisticated sound found in our finer CD players. And it fills in gaps other combi players are content to let you hear, thanks to an exclusive Yamaha process called Hi-Bit Technology.

Hi-Bit Technology uses an 18-bit 8-times oversampling digital filter to raise

If it's round, flat and shiny, the new Yamaha CDV-1600 plays it.



sampling noise so far above the audio spectrum it's virtually impossible for it to interfere with your listening.

More Hi-Bit wizardry comes from twin 18-bit D/A converters that deliver better separation and higher dynamic sound.

Of course, the CDV-1600 is chock-full of ingenious new *video* improvements, too.

There's a new pickup head designed for pinpoint tracking and precision signal pickup.

A unique new high-resolution time base corrector LSI that virtually eliminates video jitter once and for all.

And even enhanced picture quality and crisper detail from older, low quality or defective video discs.

There are ten different forward and reverse speeds for studying key frames and analyzing special effects.

And a remote with up to 15 programmable chapters and a handy one-key "Clear" command for deleting the last command entered without cancelling the entire program.

Not to mention gold-plated, audiophile-grade I/O jacks for no-loss, noise-free signal transmission.

In other words, impeccable audio.

And extraordinary video.

Together for the first time in the new Yamaha CDV-1600 laser disc player.

It's the unsurpassed quality you've come to expect from Yamaha.

Every bit of it.



Simulated Picture

Accuracy and color saturation are close to perfect. With 425-line resolution. And a very clean S/N ratio of 47 dB.

YAMAHA®



10 Reasons Laser is the Future of Home Entertainment

1. THE AGE OF LASERS

In the dawning era of 21st century communications, optical media using highly-concentrated forms of light energy will challenge the dominance of magnetic media and other conventional technology. Fiber optic lines carrying 100 billion bits of information per second—with two-way capability—enable advanced two-way telecommunications in phone and cable TV systems. High-density optical disks are gaining favor with high-tech computer users. In addition to compact discs (CDs) and video laserdiscs (LD), new digital laserdiscs for home use, such as CD-I (interactive) for information storage, and CD-ROM for videogame play, are expanding laser's domain. Other forms of laser optics promise to light up our world in the next decade.

2. THE NEW QUALITY STANDARD

Laser technology has revolutionized music with the compact disc breaking the sound barrier in the 1980s. No other form of entertainment in the home measures up to the technical specifications and sensory experience provided by laser's razor-sharp picture and digital sound.

3. ONE OF A KIND CONVENIENCE

New multi-disc (or "combination") laser models let you play any of five different types of laserdisc: 3-in. CD single, 5-in. CD, CD with video, 8-in. LD, and 12-in. feature-length LD. Even as new generations of laserdisc players are introduced, they remain fully compatible with all previous LaserVision (LV) models. On the way are portable CD-Video players with built-in color screens and TV/FM reception. Low-profile laser players and laserdiscs take up minimum space in your home media center.

4. MOVIE EXCITEMENT AT HOME

Digital surround sound movies and music programs and the exclusive videodisc release of movies in their original widescreen shape dramatically bring home the theater experience like never before.

5. AFFORDABILITY

New price breakthroughs let you own movie hits like *Rain Man* on laserdisc for under \$30 (the same movie costs three times as much on videotape). Laser players are available for under \$500.

6. SIMPLICITY & DURABILITY

The laserdisc is a non-contact, prerecorded medium with no moving parts to wear out or break down. As the laser never physically touches the disc, with reasonable care and handling, the disc itself is virtually indestructible and will last a lifetime. Its companion, the laser player, has minimal gears and other parts to wear down.

7. RECORDING CAPABILITY

Contrary to popular belief, optical discs can record as well as play back. Though not affordable for consumers yet, TEAC and others make LaserVision (LV) videodisc recorders for video production and business users. In the next couple of years, Tandy and other companies are planning to introduce CDs that can be used for home recording.

8. BEYOND ENTERTAINMENT

A compact disc can hold enough data to fill 110,000 pages of a book. The entire Oxford English Dictionary is available on three CDs. Grolier's Encyclopedia is in laserdisc form as the KnowledgeDisc. Virtually tens of thousands of pages of any type of information—text, graphics, fine art—can be viewed one page at a time on a single laserdisc.

9. BIG BUSINESS

In the U.S., less than 24% of homes own a CD player. The potential for laser growth in the '90s is extraordinary. Global technology leaders such as Pioneer, Philips, Sony and 3M, as well as entertainment giants like MGM, Paramount, Polygram, and Warner are committing many millions of dollars to ensure optical media such as laserdiscs become the international standard for recorded entertainment and information.

10. FREEDOM OF CHOICE

Top home electronics brands Mitsubishi, Sharp, and Sony have joined the growing number of companies selling laserdisc players. More new brands of laser players are expected to follow this year and next, giving you a greater choice of models to choose from at increasingly competitive prices. More movies, music and other programs are being released every month on laserdisc at attractive, collectible prices.

What kind of

The Laser Disc Jockey

Sharp's MV-D100 not only plays all five types of laser audio and video disc, but includes a three-disc changer for 3- and 5-inch CDs as well. Has S-video connector for optimum picture quality with compatible monitor. Auto-fade and auto-edit functions automatically arrange songs based on length for recording to tape. Scans first 15 seconds of CD or LD for previewing. Restarts disc from point where it was stopped. 20-track random access programming. Price: \$1,499.95.

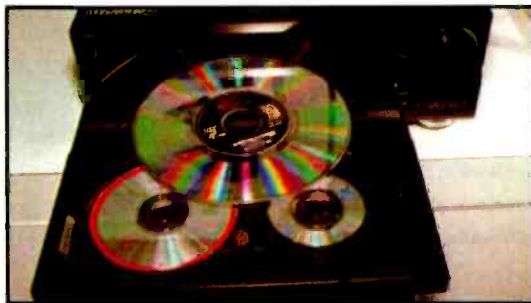

Most Value-for-the-Money Player

Pioneer's CLD-1070 lets you listen to CDs, hear and see CD-Videos and watch laserdiscs with digital soundtracks all on one unit at an unusually affordable price. Has ten-key direct access chapter- and track-search and visual scan. 20-track programming for CD play, random play, auto program edit for dubbing from disc to tape. Visual calendar displays table of contents. Plays back 3-in. CD singles as well as standard CDs. Smart remote control learns other remote functions. Price: \$600. Also: Pioneer model LD-870 plays 8- and 12-in. video laserdiscs, \$499.00.

The Armchair Jogger

Philips' CDV-488 plays a bit of one-upmanship on other players by accepting not five but six different types of disc. New is the 8-in. LD single (20 minutes of video and audio per side). The LCD remote can learn from other remotes and features a jog dial for more precise control of forward/reverse slow motion and fast motion of two to 10 times normal speed. Host of special effects include picture memory, mosaic effect, strobe and freeze frame on any disc. Also S-video output. Price: \$1300. Also: Philips' model CDV-487 has many of same functions without fully-featured jog remote, \$949.



player are you?



The Digital Artist

Sony's MDP-510 offers a variety of digital effects on any laserdisc, standard- or extended-play. Digital Memory is for clear fast scanning and variable speed playback, Digital Stop and Flash Motion can display images at various times. One-button Recall plays the last digitally memorized image. Plays back selected segments of any length. Five ways to repeat portions of disc. S-video output for improved picture quality. Price: \$700. Also: Sony model MDP-210 with similar features except digital effects. \$700.

The Sound Investor

Yamaha's CDV-1100 is a mid-priced combination player with CD performance comparable to the best audio-only compact disc models. Has 8-times oversampling and an 18-bit digital filter. Digital noise reduction system and analog-to-digital converter cleans up pops sometimes heard on analog videodiscs. Four repeat modes. 15-track or -chapter random access, 10-speed forward/reverse videodisc playback. Infrared remote learns other remotes. Price: \$799. Also: Yamaha's CDV-1600 with some added features, \$899.



The Convenience Freak

Mitsubishi's M-V7010 automatically plays both sides of a disc with your having to flip it over. The combination model handles five types of laserdisc. Can be used with outboard digital/analog converter. Previews first eight seconds of each track or chapter. 20-segment random access. Auto-edit for dubbing to tape. Library function for 8- and 12-in. videodiscs. A/B continuous play. Price: \$1,099.00

Music made Beautiful



Sonance makes music more beautiful with "Architectural Audio." Custom in-wall stereo speakers and controls that blend unobtrusively into your home's most discriminating decor.

All Sonance speakers and controls can be painted or cloth covered to aesthetically match any room's delicate design. Precision flush mounting insures excellent high fidelity response and consistent decorative perfection.

To experience "Architectural Audio" we invite you to call your local Custom Audio/Video Specialist.



2992 CALLE PERFECTA, SAN JUAN CAPISTRANO
CALIFORNIA 92675 (714) 561-7558
Outside CA (800) 5E2-7777 FAX (714) 240-4995

Canadian Distributor: Aralex Acoustics Ltd., 33 W. 8th Ave.
Vancouver B.C. V5Y 1M8, (604) 373-4475

Sonance Products include Five variations of Speakers,
One Passive & One Active Subwoofer, a Speaker Distribution System
and Five different Volume Controls & A/B Selectors.
*All Built-in Products fit in "2x4" wall

System Suggestions

Jumbo Vision

Mitsubishi's VS-7002R, with a 70-in. (diagonal) screen, is the largest rear-projection TV available. Has wide 120-degree horizontal viewing angle. Programmable remote control with 196 functions. Six-speaker sound, 20 watts per channel. External speaker terminals.



subwoofer out. On-screen displays for graphic equalizer, balance and stereo indicator. Dual A/B antenna inputs. S-video input for compatible laser player. Available October. Price: \$6,399. Also: Sharp has the XV-100 LCD TV system that projects an image up to 100-in. diagonal. \$6,500. Pioneer has several projection TV models, including the SD-P403 with 40-in. screen for \$3,100.

Sounds Around the World

Yamaha's DSP-100U is a digital sound field processor that recreates 33 different sound environments sampled from actual locations in Europe, Japan and the U.S. 12 preset positions let you alter room size, liveness and initial delay and to save the settings for future use. Six-gang master volume control for easy channel balance. Includes Dolby Surround setting. Price: \$699. Also: Mitsubishi, NEC, Pioneer, Sony, and others offer surround sound processors.



A Graphic Display

JVC's XL-G512BK is the first CD player with a built-in graphics decoder that displays on your videoscreen the visual portion of



CD + G(raphics) discs. Remote control has 10 direct-call keys. 15 graphics channels. Three-mode editing. Calendar, graphics and midi indication. Headphone output with volume. 18-bit digital-to-analog converter with four times oversampling. Price: \$500.

Winning Set Design

Proton's VT-331 video monitor/receiver with a 31-inch flat, square screen won a Design and Engineering Award at the summer 1989 Consumer Electronics Show. Stereo sound is enhanced with the Aphex Aural Exciter, used in professional broadcast and recording studios. Also in the audio section is an Expander feature, 10 watts per channel amplifier. MTS/SAP decoder, 4-x-6-in. built-in speakers, Distortion Noise Reduction and separate bass, treble and balance controls. Three pairs of video/audio inputs outputs, including pair on front panel. Price: \$2,499.



Surround Sound Central

Onkyo's TX-SV7M is a complete audio/video receiver with built-in MTS stereo TV tuning and Dolby Surround decoder. 36-position pre-set memory for AM, FM and TV automatic tuning. 100 watts per channel amplifier switches to 90 watts/ch for front speakers and 20 watts/ch rear in surround mode. dbx noise reduction for TV sound. Two video and five audio inputs. Dynamic bass expander enhances low-



range sounds. Programmable 55-function smart remote. Price: \$1,050. Also: Denon makes the AVC-2000 A/V receiver with surround sound, \$1000. Mitsubishi, NEC, Philips, Pioneer, Sony, Yamaha and several others offer A/V receivers.

Just the Right Ambiance

Cambridge SoundWorks is a special company for two reasons. It is headed by audio legend Henry Kloss (of KLH, Acoustic Research and AR), and it sells its speakers only by mail because hearing them in a store, says Kloss, is an injustice. Ambiance is its newest model, a compact, two-way system that is perfectly suited to a surround sound setup as the rear pair of speakers. It can work with a (minimum) 15 watt per channel amplifier and despite its size, offers clean, full bass response. In gunmetal gray for \$109 (left in picture) or solid oak, \$129. For more information, call 1-800-252-4434.



Secrets of the Amazing Laser

The Light Touch

Unlike cassettes or vinyl LPs, no stylus or tape head ever comes into contact with a laserdisc. Instead, a low-power laser beam of light less than .001 millimeter (one-millionth of an inch) wide "reads" audio and video signals encoded in as many as 14 billion microscopic pits on the disc.

BENEFIT: Purest sight and sound reproduction of any home entertainment medium.

All For One

In the new "combi" or multi-disc players, the laser plays at least five different types of audio and video/audio discs of various sizes. These ingenious machines automatically adjust themselves for each disc size and its soundtrack (digital or analog). The discs spin as fast as 2700 revolutions per minute, so that an electronic disc-drawer



The Imax film "Flyers" was recently turned into a video disc by Philips. "Flyers" director Dennis Earl Moore commented that the laser format "was the only one that could do justice to the detailed and defined audiovisual images Imax yields."

slides out and in to keep the disc safe and secure during play.

BENEFIT: Integration of a variety of audio and video entertainment in a single player.

The Stamp Of Quality

The silvery platter you play at home starts off in the pressing plant as a clear acrylic plate with microscopic pits of audio and video information stamped on it from a glass master disc. The laserdisc's unique mirrored surface reflects the laser beam back to the player, which sends the video and audio signals to your TV screen and speakers, respectively. Two aluminum-coated disc sides are pressed together for one complete laserdisc. The outer coating of acrylic lets you handle the disc more freely.

BENEFIT: Disc's usable life

Special Features

The LaserVision (LV) format offers several special playback features to enhance viewing pleasure. Those features below marked with an asterisk are available on standard-play discs. With certain deluxe-model players, however, the asterisked features apply to all laserdiscs.

Separate Audio Channels—laserdiscs allow digital as well as analog sound. They also have two separate audio channels for additional commentary or second-language translation on the second audio track.

* **Variable or Multi Speed**—move picture speed from super slow motion (one frame every few seconds) to fast motion (up to 3X times normal playback).

Fast Scan—skip through 60 minutes of a program in either direction in a matter of seconds to quickly find visual segment you want.

* **Still Picture with Sound**—activate freeze frame onscreen while sound plays at normal speed.

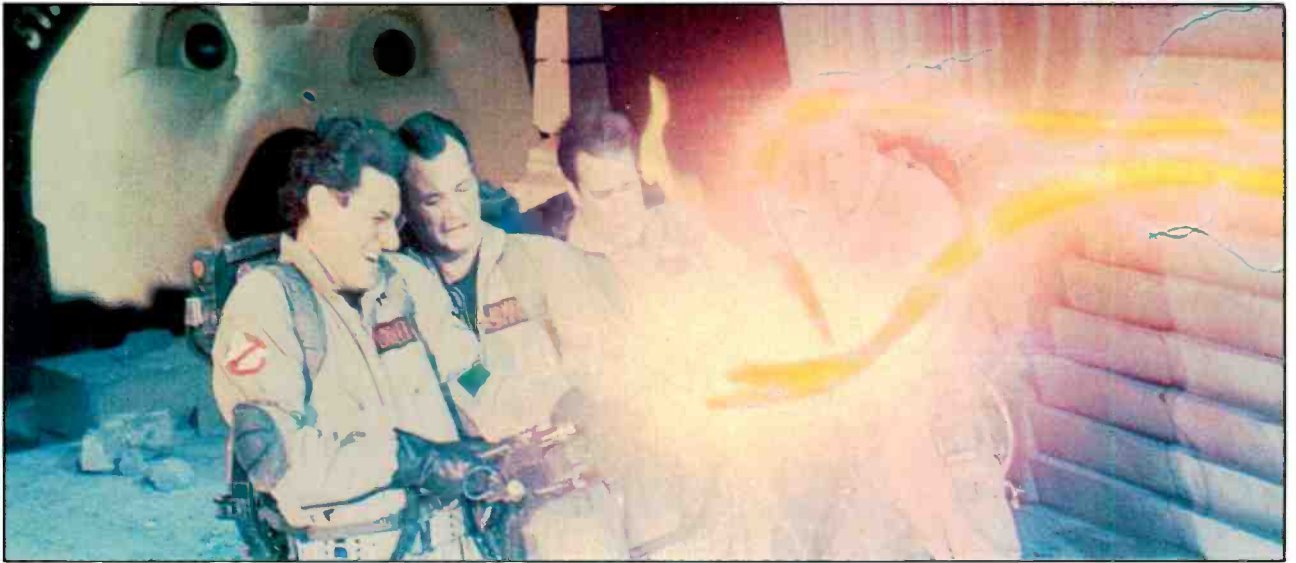

"Ghostbusters" is available on video disc in its original widescreen format.

greater than other recorded media. Space-saving shelf storage, like record albums. Can be wiped clean with a soft, dry cloth.

On The Right Track

There are as many as 54,000 circular tracks on one side of a laserdisc. Each track contains one complete frame of picture information, with 30 frames equal to one second of program time. The laser beam in the player starts at the center of the disc and moves in a straight line outward, so any frame or other point on the disc can be located swiftly and smoothly by the laser and displayed onscreen in seconds.

BENEFIT: Ideal medium for

interactive programs in education, instruction, and for information storage.

A Laser-Sharp Picture

In video, the quality of a picture is measured in lines. A VHS videocassette recorder, for example, is capable of about 240 lines of picture quality. The laserdisc has over 350 lines, comparable to broadcast television, for a 60% better picture than a VCR.

BENEFIT: Best video quality available in the home. Big-screen TVs display a bright, sharply defined image instead of magnifying flaws from an inferior signal source.

Sound That Astounds

Laserdiscs with digital sound have state-of-the-art specifications comparable to compact discs (CD). Signal to noise ratio is 96db compared with 80db on a VCR hi-fi model. Frequency response on a digital laserdisc is 5-20,000Hz, versus 20-20,000Hz on VCR hi-fi. Even in normal stereo, laser outperforms the VCR by 30dB on signal to noise ratio and with a 20-20,000Hz dynamic range versus a VCR's 50-10,000 range. A laser player also has separate audio channels that can be switched on and off independent of each other.

BENEFIT: Best sound quality available in the home.

Random Access Options

Different discs and player models offer variations on the basic features listed below:

* **Frame Number Search**—instantly locate any one of up to 54,000 frames on any side of a disc by entering frame number in keypad or move one frame at a time forward or back.

* **Time Number Search**—instantly locate any point on a disc by entering time elapsed to that point in keypad (not on standard play discs).

* **Chapter Search**—some discs are marked with chapter stops. These can be scenes in a movie or musical selections. You can: fast scan through the disc with momentary stops at each chapter; instantly random access any chapter number; or (on certain players) program chapters to watch them in any order desired.

Digital Effects

- * **Strobe**—special visual effect of rapidly flashing sequence of still frames.
- * **Mosaic**—multiple images (that can be still or moving) displayed onscreen simultaneously.



END OF CONVERSATION.

Close your eyes, put on your favorite CD and listen. That's the best way to appreciate the natural, accurate musical reproduction of the new Elite TZ Series reference loudspeakers from Pioneer.

Designed by the same engineering team that developed Pioneer's renowned TAD studio monitors, the TZ Series speakers are designed to accommodate the extended dynamic range, superb clarity and depth of digital source materials.

Pioneer began by developing two entirely new diaphragm materials—ceramic graphite and ceramic carbon. These unique low-mass materials are used to construct midrange and high-frequency dome-type diaphragms that virtually eliminate spurious resonance while providing lightness, stiffness and excellent signal propagation speed. Now critical midrange frequencies and delicate highs will sound clearer and more natural than ever before.

To reproduce the extended low frequencies found on digital recordings, Pioneer developed a twin woofer system that packs a punch you'll feel as well as hear. Opposite-mounted bar-jointed

woofers placed in the center of the TZ's cabinet minimize standing waves while providing accurate low-frequency response to 20 Hz.

The cabinet of the 143-lb. TZ-9

is specially constructed, using 1" thick high-density board and a separate inner baffle that isolates the negative influence of low-frequency



Unique bar-jointed twin-woofer system.

vibration. Corners are specially rounded to eliminate diffraction and drivers are arranged for optimum sound-field intensity. The result is imaging and clarity that bring performances alive with smooth, true-to-life sound.

But enough conversation. If you're interested in hearing more about Pioneer's new TZ Series speakers, call 1-800-421-1404 for a technical white paper and the Elite dealer nearest you.

And let the speakers do the talking.



© 1989 Pioneer Electronics (USA) Inc., Long Beach, CA
Model shown: TZ-9. Also available: TZ-7.

TRAILBLASERS

Timeline Of Highlights in Laser His

1877

Thomas Edison develops cylinder phonograph

1884

German scientist Paul Gottlieb Nipkow invents scanning device to transmit signals over short distances

1888

Emile Berliner demonstrates first flat-disc gramophone

1926

John Logie Baird publicly demonstrates Nipkow disc to transmit and receive visual images; later develops Photovision record

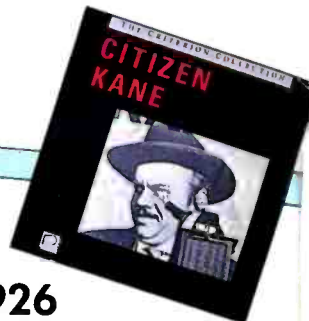

With the Levi's JeansScreen shoppers can press a touchscreen video monitor to find out more about Levi's apparel and watch music videos at the same time. The kiosk uses computer-controlled laserdiscs.



Developed by Warner New Media, CD+G means CDs now can offer visual material.



1984

RCA announces it will stop making its CED videodisc players

Optical Disc Corp. of Cerritos, Calif. creates first LaserVision (LV) compatible recorder. Price: \$160,000.

Washington D.C.'s National Gallery of Art issues laserdisc containing 1,645 paintings and sculptures, for \$95.

1985

"Wings In Concert" is first laserdisc with digital sound. Francis Ford Coppola's "The Cotton Club" is first laserdisc with digital soundtrack.

First laserdisc players with digital sound.

1987

Philips and Sony announce joint agreement to produce CD-Video (CDV) players and programs with five minutes of video and 20 minutes of digital audio on a compact disc

Apple debuts CD-ROM player for its Macintosh computer that also can play music CDs

1988

First CD-Video discs go on sale from Philips subsidiary Polygram

Tandy Corp. (parent of Radio Shack) announces plans to market by 1990 a compact disc (CD) recorder for \$500

In Japan, NEC begins selling CD player for use with its videogame system, due in U.S. fall 1989

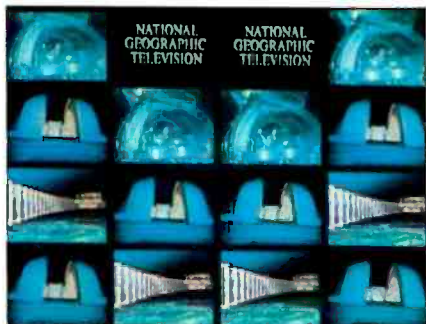

Created by Exhibit Technology, Inc. of New York, this award-winning, 16-screen videowall, The National Geographic Society Television Theater, features imagery run by 16 computer-controlled laserdisc players.

tory

c. 1965

RCA begins research & development on videodisc

1969

Physicist Kent Broadbent sells Universal Pictures parent MCA Inc. the rights to his concept for an optical videodisc

1974

MCA and Philips form joint venture to make and market laser videodisc system (later to be called LaserVision) with MCA providing programs and Philips supplying machines through U.S. subsidiary Magnavox



The first laserdisc player for the home went on sale in Rich's department store in Atlanta in December 1978 from Philips subsidiary Magnavox.

1962

First images recorded and played back from optical videodisc by 3M, which files patent to read video images with laser beam

1978

First MCA-Philips players and discs go on sale

1982

Philips and Sony jointly introduce first digital audio compact discs (CD), heralding new age in music reproduction for the home

1980

Magnavox, MCA DiscoVision and Pioneer form Optical Programming Associates (OPA) to create programming uniquely suited to laserdisc. First participative (or interactive) disc is "How to Watch Pro Football"

1983

"Dragon's Lair" is first arcade video game to use interactive laserdisc

"King Kong" and "Citizen Kane" are first laserdiscs from newly-created Criterion/Voyager Company, dedicated to producing collector's editions of great films. Kong offers analysis on second audio track and Kane has rarely-seen material including original theatrical trailer.



The new game system from NEC, TurboGrafx-16, can be played with an optional \$400 CD player, due this fall with the rest of the NEC game system.

Pioneer Japan introduces first 8-in. laserdiscs with up to 20 minutes of music video per side.



1990

Digital Video Interactive (DVI) to debut from Intel and later, built in to IBM PC computers. The CD-based Intel technology uses full-motion video, high-resolution stills, high-speed graphics, sound,

and text, all on one disc, for personal computers. Designed primarily for business users, Eastman Kodak, GE and National Geographic Society are creating programs for the new optical disc format.

1990-1991

CD-I (interactive) will also offer full-motion video, still images, sound, text and computer graphics on a compact disc, but is intended for use with a TV set in the home. Among familiar names developing CD-I programs are Time-Life (photography books), Children's Television Workshop (interactive Sesame Street shows), Parker Bros. (interactive Clue game) and Rand McNally (family atlas). Discs featuring Frank Sinatra and an oldies jukebox are also planned. It's estimated a CD-I player, also for playing regular CDs, will be \$1000 and the CD-I discs \$20 to \$50 each.

1989

Videogame pioneer Activision debuts its first CD-ROM entertainment program, the Manhole CD-ROM. Children's educational game uses 3D graphics, digitized voices and a continuous movie-like digital soundtrack.

First CD+G (graphics) player in U.S. stores from JVC

World's three leading consumer electronics companies—Matsushita, Philips and

Sony—announce they will join forces to promote and develop the market for CD-Interactive discs for home and business use

Voyager creates CD Companion Series with first title, "Beethoven's Ninth Symphony" on Polygram, packaged with Macintosh hypercard for \$99. Features computer text and graphics, using

audio passages from CD throughout fully-interactive program

In 1981 Sears mailed out 750 copies of an electronic mail-order catalog to owners of laserdisc players. The disc is now on display in The Smithsonian.





For Sound That's Picture Perfect.



100 Potrero Avenue, San Francisco, CA 94103-4813. Phone 415-558-0200. Telex 14409. Facsimile 415-863-1373. 146 Clapham Road, London SW9 8AP. Phone 01-720-1111. Telex 919109. Facsimile 01-720-4118. Dolby, Dolby Stereo and the Double-D symbol are trademarks of Dolby Laboratories Licensing Corporation. ©Dolby Laboratories Inc., 1989. S89/8692

 **Dolby**™

CIRCLE NO. 112 ON READER SERVICE CARD

Pioneer CLD-91

Quality, convenience and elegant engineering are the hallmarks of the LaserVision (LV) format. This model of superior design and performance, Pioneer's brand new CLD-91 (\$2000), puts it all together in unprecedented fashion to deliver the new state of the art in laser entertainment.

The first hint that this special player is not for everybody is the absence of the usual RF (or antenna) out jack on the back panel. It will only operate with TV/video monitors that have video inputs, which produces the finest picture quality possible for the home. Even on a 6½-foot Klass projection TV, the picture was sharper than anything we've seen on a recorded medium. It helps to be watching a mint disc from the Criterion Collection, like *Ghostbusters* or *2001: A Space Odyssey*. These are in the letterbox widescreen format so the entire effect is nothing short of startling.

The player's clean lines and simple layout of controls belies the sophisticated features that separate it from most other laserdisc players. The same holds true for the versatile but easy-to-use remote control. One of Pioneer's smart design decisions was placing many of the player's buttons and its visual readout on the front door that opens to eject and retract the drawer that holds six different types of disc: 1) 3-in. CD single; 2) 5-in. CD; 3) 5-in. CD-Video; 4) 8-in. LD single; 5) 8-in. LD; 6) 12-in. LD.

The CLD-91's most distinctive feature of comfort for home viewers is dual-side play. After side A has ended, you don't have to eject and turn over the disc to play side B. You just press a button marked "side B" and it plays automatically.

The player also sports its share of fun features that show off the laser's dazzling power to control and alter onscreen images. "One-shot memory," for example, lets you select any image from a program so when you're changing discs or taking a pause, the image remains on screen in the "still" mode. It stays there (without a disc in the player) until you turn the unit off. Other digital effects include variable-speed "strobe," for a pulsating picture, "solarization," "multi" for displaying many images at once onscreen, and "art," which lets you use the screen as an electronic canvas.

Several function keys work for both CDs and LDs, such as skipping to the next or previous selection (chapter on an LD, track on a CD), repeating selections or entire disc sides, and using random access, which lets you search for any point on the disc instantaneously.

A jog dial/shuttle ring on both the player and remote keypad gives you optimum control over the fast-scan and other onscreen picture functions, with nine different speeds possible, up to 10X normal playback.

Other special features include S-video output, optical digital out for CD Graphics decoders and

CD-Interactive accessories, and a file function to program messages and programming instructions for individual discs. For CDs, an "auto program editing" feature enables you to set time limits for dubbing onto cassette so the last selection on the tape won't be cut off before its over.

On a laser player like this, you don't merely watch contemporary classics like the Criterion laserdiscs or *E.T.* or *Ben-Hur*. You experience them on a level comparable to that of a scaled-down movie theater. It helps, of course, to have a speaker setup like the Ensemble from Cambridge SoundWorks (\$500), which we used to view some of the movies mentioned. This ingenious speaker model from audio wizard Henry Koss, the same man who made the TV mentioned above, is a marvel of compact design and clean, full sound. It has a pair of woofers that can be used as pedestals for plants or hidden beneath furniture, and a pair of deceptively small, high-range speakers. To this, we added the same company's new Ambiance speakers (\$109 to \$129), which are ideal as surround sound units.

There's so much more to see and hear on this machine, the only way to do it justice is to ask for a demonstration. After witnessing your favorite movies and music on a laser player, especially the Pioneer CLD-91, your perception of home entertainment will never be the same.



WHEN THE MAESTRO CONDUCTS IN NEW YORK, LONDON OR VIENNA, IT'S THE HOTTEST TICKET IN TOWN. YOU CAN SEE HIM AT HOME, ANYTIME. ON POLYGRAM CD VIDEO.



© Uninet

NOW YOU GET THE PICTURE



In addition to the world's most celebrated artists in their finest performances, PolyGram CD Video brings you digital audio, laser-read video and the best seat in the

house... *your house*. CD Video has something for everyone: Opera*, Ballet, Symphonies, plus thousands of favorite movies. And, PolyGram CD Video is compatible with all laser video discs and video players.

*All PolyGram CD Video Operas have English sub-titles.



Available this Fall:



66 CLASSICAL TITLES AVAILABLE AT FINE VIDEO & RECORD STORES



Starting a Laser Library

There are over 3000 titles available on laserdisc, with about 100 new video laserdiscs released each month. Pioneer and Sony operate U.S. pressing plants with a combined monthly output of 700,000 discs. In Japan, factories turn out almost twice that many discs per month.

There's more than one way to watch a laserdisc. In fact, there are at least four, with more on the way — 1) 12-in. discs offer up to two hours (one hour per side) of feature films, music videos, concerts and other programming. 2) 8-in. discs play up to 20 minutes (per side) of musical selections. 3) 5-in. CD-Videos (CDVs) have a music video clip (up to five minutes) plus 20 minutes of digital audio. 4) CD + G(raphics) titles are compact discs accompanied by video graphics (liner notes, guitar chords, lyrics, stills, and more) that are displayed on your videoscreen.

(Read more about the newest laser formats — such as CD-I(teractive) and CD-ROM — elsewhere in this supplement.)

Major Hollywood studios now are releasing hit movies on laserdisc at the same time they come out on cassette, and often for as low as \$24.95.

To help get you started on your laser library, here's a sampling of recommended releases.

Cinema Deluxe

Produced for film buffs, the Criterion Collection of standard-play (CAV) laserdiscs are shining examples of what makes the laser format so extraordinary. Many of the movies are in the same widescreen shape (called letterbox, or Videoscope by Criterion) as originally seen in theaters, not the boxy image that often requires editing out part of the frame for TV showing. These



©The Walt Disney Company



©Metro-Goldwyn-Mayer Inc.



discs often include supplementary visual material (such as scripts, production stills and trailers), and make use of special laser playback features such as still frame and dual audio tracks (for separate film analysis). Many are remastered for digital sound and made from mint film negatives for optimum picture quality.

The Adventures of Robin Hood 50th Anniversary Edition \$99.95

Bachdisc \$49.95

Blade Runner \$79.95

Citizen Kane \$89.95

Ghostbusters \$99.95

The Graduate \$89.95

Help! \$79.95

It's A Wonderful Life \$89.95

King Kong \$74.95

Monterey Pop \$49.95

North by Northwest \$124.95

Seven Samurai \$124.95

Singin' In the Rain \$89.95

2001: A Space Odyssey \$124.95

The Wizard of Oz 50th Anniversary Edition \$99.95



©1982 Universal City Studios Inc.

WHERE TO FIND LASERDISCS

In addition to shopping in video and record stores, you can order laserdiscs directly through these companies:

The Voyager Co. (Criterion Collection only)
2139 Manning Avenue
Los Angeles, CA 90025
(outside California) 1-800-446-2001
(California) 1-800-443-2001

LDC America Consumer Services
2265 E. 220th Street
Long Beach, CA 90810
1-800-255-2550

THE FUTURE IS HERE NOW.



© 1989 POLYGRAM RECORDS, INC.

CDV. NOW YOU GET THE PICTURE.



PolyGram Compact Disc Video is music to your eyes.

CIRCLE NO. 152 ON READER SERVICE CARD

Starting a Laser Library

Crowd Pleasers

These films have been selected for their general-audience appeal and are considered among the finest laserdiscs for picture and sound quality. Many have digital sound and some may be in widescreen and have supplementary visual material.

- Amadeus \$44.95
- Back to the Future \$34.98
- Ben-Hur \$39.95
- Bird \$29.98
- Casablanca \$39.98
- Die Hard \$49.98
- Dr. Zhivago \$39.95
- The Empire Strikes Back (CAV) \$69.98
- The Godfather (I & II) \$44.95 each
- E.T. \$39.98
- Gone With the Wind 50th Anniversary Edition \$49.95
- Patton \$69.98
- Poltergeist \$34.95
- Raiders of the Lost Ark (CAV) \$49.95
- Rain Man \$29.95
- Robocop \$39.95
- Star Wars (Digital) \$69.98
- The Untouchables \$39.95
- West Side Story \$34.95
- Who Framed Roger Rabbit N/A
- Woodstock \$39.98

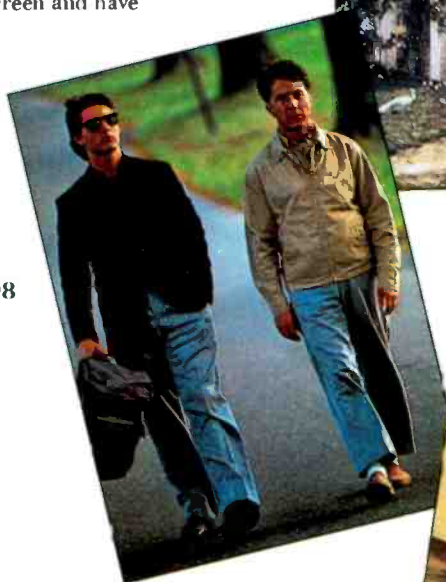

©Metro-Goldwyn-Mayer Inc.



Sandbox Cinema

- An American Tail \$49.95
- Bugs & Elmer \$34.95
- Cinderella \$29.95
- Daffy Duck's Quackbusters \$24.98
- Duck Tales \$29.95
- The Jetsons Meet the Flintstones \$39.95
- The Lady and the Tramp \$34.95
- The Land Before Time \$24.98
- Pinochio (CAV) \$49.95
- Willow \$34.95



©The Walt Disney Company

Culture Vultures

- John Coltrane—Legacy \$29.95
- Die Zauberflote (The Magic Flute) \$69.95
- George Gershwin Remembered \$34.95
- Vladimir Horowitz in London \$34.95
- Michael Jackson—Moonwalker \$39.95
- Madonna—Live Virgin Tour \$24.95
- Bobby McFerrin—Spontaneous Inventions \$24.95
- Live From the Met Highlights Vol. 1 \$34.95
- Motown 25th Anniversary Special \$39.95
- Mozart—The Marriage of Figaro \$39.95
- New Year's Concert in Vienna \$34.95
- Rubenstein in Concert \$34.95
- San Francisco Blues Festival \$29.95
- Diane Shuur/Count Basie \$29.95
- Solti—Bruckner Symphony No. 7 \$34.95
- Bruce Springsteen—Video Anthology \$39.95
- Barbra Streisand—One Voice \$29.95
- Tchaikovsky—Swan Lake \$34.95
- Verdi—Don Carlo: Metropolitan Opera (Placido Domingo) \$54.95
- The Who—Who's Better, Who's Best \$29.95

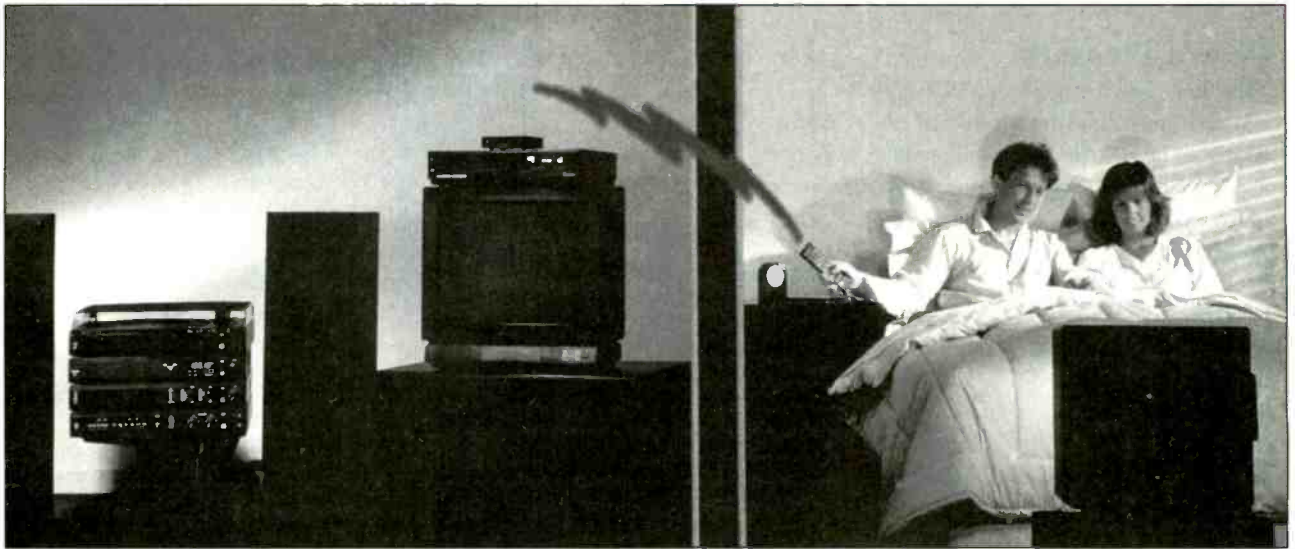

INTRODUCING THE ONLY UNIVERSAL REMOTE THAT WORKS THROUGH WALLS, DOORS, CEILINGS AND FLOORS.

Now you can control your TV, VCR, stereo and CD from any room in the house, up to 200 feet away.

Like conventional universal remotes, a single MasterMind replaces the audio/video remote controls that clutter up your coffee table. But this smart, programmable remote goes even further.

It lets you control your video tapes, cable TV or stereo from any room in your house.

Without buying extra VCRs, CDs or stereo receivers. It can even replace a second cable converter box—saving you monthly rental charges.

You simply plug MasterMind's base unit transponder into an electrical outlet near your components.

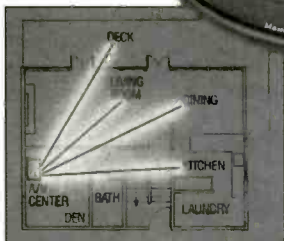

A single MasterMind can replace all the remotes in your house. But MasterMind goes much further—right through your walls, doors, ceilings and floors.

New UHF technology opens up a world of entertainment (not just your garage door).

MasterMind lets you control all your VCR functions while you watch a video tape on a second TV in another room. It can also control any kind of music programming sent to remote speakers. Or cable TV and satellite programming.

MasterMind sends commands via the UHF (Ultra High Frequency) band, the same band used by automatic garage door openers. No additional wiring is required (just make sure that your remote TV or speakers are already connected by normal cabling to the infrared components you want to control).

The first universal that's universally simple to use.

If you've ever used a universal remote, you know what a hassle it can be. All those buttons can be confusing, even intimidating. That's why we've reduced

MasterMind's hand-held remote unit will operate up to 200 feet away from the transponder—that's equivalent to two-thirds of a football field. It measures a thin $7\frac{3}{4}'' \times 2'' \times .75''$, so it fits in your shirt pocket.

the number of buttons. We've also added LED indicators that let you instantly switch between your four favorite components, although many more can be programmed.

Enjoy 30 days of remote control magic, risk-free.

Order now, and start enjoying the fun, convenience and power of MasterMind. We back MasterMind with a 30-day risk-free return privilege, a one-year warranty, and the strongest customer service in the business. And if we don't ship within 72 hours, we'll pay the freight. Act now—call 1-800-827-2626—and take advantage of our 90-day interest-free financing.

YES! Rush Me MasterMind Today!

I understand you will bill my credit card three low, no-interest monthly payments of \$49 each, plus a one-time freight charge of \$5.50. (Or I can mail a check for full payment of \$152.50.) And if I'm not absolutely satisfied, I can return MasterMind within 30 days for a full refund of every penny paid.

Call toll-free for fastest delivery
MON-FRI 9am-10pm EST
SAT 10am-8pm EST

1-800-827-2626

or write:

SatelliteSOURCE
P.O. Box 4907, Englewood, CO 80155



Starting a Laser Library

Music Video To Go-Go (8-in. LD)

- Beatles Live \$16.95
- David Bowie \$10.99
- Phil Collins \$10.99
- Whitney Houston \$12.99
- Prime Cuts (compilation) \$19.98
- Tears for Fears \$12.99
- Tina Turner—Private Dancer \$12.99
- Video A Go Go Vols. I & II (compilation) \$16.95 each
- Wham \$19.98



Eye-Fi (5-in. CD Graphics)

Labels here are included to help you identify the proper version of certain classical works. Also look for the distinctive CD + G logo on the CD package. Prices are listed where available:

- Anita Baker—Rapture (Elektra) \$13.98
- Beethoven—Symphony No. 7 (Teldec)
- Bruckner—Symphony No. 9 (Teldec)
- Placido Domingo—Belcanto Domingo
- Talking Heads—Naked (Sire) \$13.98
- Lou Reed—New York (Sire) \$13.98
- Mozart—The Magic Flute (Teldec)
- Phoebe Snow—Something Real (Elektra) \$13.98
- 10,000 Maniacs—Blind Man's Zoo (Elektra) \$13.98



Take Five (5-in. CD-Videos)

CD-Videos (CDV) are gold-colored compact discs, distinct from the silver audio-only CDs. All of the following, except where noted, are on Polygram labels.

- Bon Jovi—Never Say Goodbye \$9.95
- Cinderella—Nobody's Fool
- Robert Cray—Smokin' Gun \$9.95
- Donald Fagen—New Frontier (Warner)
- Level 42—Something About You \$9.95
- John Cougar Mellencamp—Paper in Fire \$9.95
- Moody Blues—Your Wildest Dreams \$9.95
- New Frontier—Under Fire \$9.95
- Randy Newman—I Love L.A. (Warner)
- Tears for Fears—Everybody Wants to Rule the World \$9.95
- Tony! Toni! Tone!—Born Not to Know \$9.95

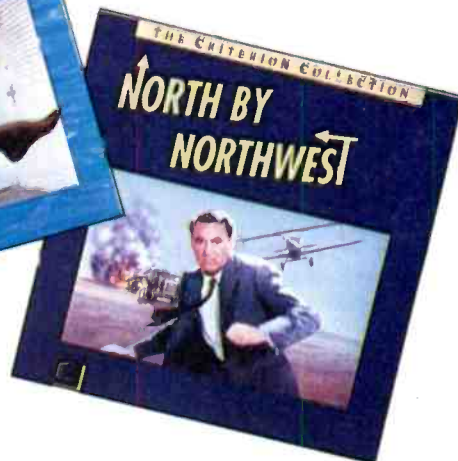
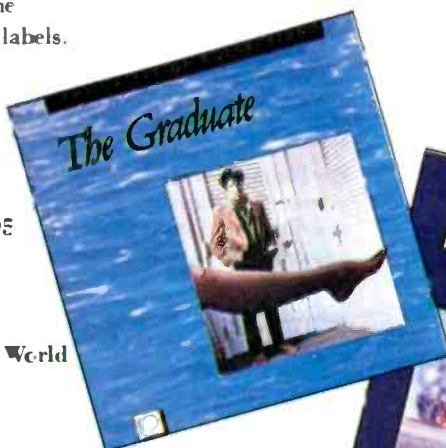

Glossary

CAV (Constant Angular Velocity)—standard-play laserdiscs with up to 30 minutes per side, allowing special features such as variable speed, and random access search and still/step of individual frames.

CLV (Constant Linear Velocity)—extended-play laserdiscs with up to 60 minutes per side, allowing random access of individual chapters and fast scan. Requires high-end disc player to use other, CAV playback features.

CD Graphics (CD + G)—technology developed by Warner New Media where the five percent of a compact disc not used for music reproduction contains graphics for electronic liner notes, such as animated sheet music, lyrics, artist background, that can be viewed on your TV screen.

CD-Interactive (CD-I)—new CD technology supported by Philips, Sony and now Matsushita (Panasonic, Technics) that will bring high-level, interactive programs to home video using the TV screen. Combines, text, high-speed graphics, high-resolution still photos, full-motion video, and sound.

CD-ROM (Compact Disc-Read Only Memory)—compact discs functioning as data bases for computer use. Require special CD-ROM reader, some of which also play music CDs. Contains data quantity equal to 1,200 floppy disks.

CX (Compress & eXpand)—noise reduction process developed by CBS that expands dynamic range of sound on discs and improves signal to noise ratio by 14dB.

CD-Video—compact discs with up to five minutes of a digital-sound video clip and 20 minutes of digital audio-only. Designation also used by Polygram for all its digital-sound videodiscs (i.e., CDV-EP is 8-in. disc, CDV-LP is 12-in.).

Closed Caption (CC)—10-year-old technology developed by National

Captioning Institute (NCI) for hearing-impaired people. With NCI decoder, captions (subtitles) included on many movies and other programs appear onscreen.

Digital Stereo—just like compact discs have digital sound, an increasing number of movies, music and other laserdisc programs are being released with digital soundtracks, including older movies remastered for digital sound.

DVI (Digital Video Interactive)—new CD technology developed by RCA and now owned by Intel that features high-level, interactive capability combining text, full-motion video, high-speed graphics, high-resolution still photos. Designed primarily for use with personal computers in institutional settings.

High Definition TV (HDTV)—new generation of television technology being developed that will greatly enhance the image quality of television pictures so they are comparable in resolution to 35-millimeter photography. High definition TV screens also may be in the same widescreen proportions (aspect ratio) as movie screens.

Horizontal Resolution—standard reference for measuring the quality of a television picture. The more lines of horizontal resolution, the better the picture.

laser disc (LD)—in lower case, generic for LaserVision format, and for any disc using laser technology. When used with upper case L and D, which is trademark of Pioneer Corp., refers only to 8-in. and 12-in. video laserdiscs.

LaserVision (LV)—the disc equivalent of tape's VHS standard, this mark on equipment or videodiscs ensures full compatibility with other laser optical video products bearing same mark.

Letterbox—black bands that appear at the top and bottom of a

video movie to retain the same widescreen proportions in which it was originally filmed and theatrically shown.

Pan and Scan—a process used to transfer films for TV showing. When certain movies are seen on TV, part of the picture frame is missing or shows up as a separate shot because the full movie-screen image cannot be squeezed into the square-ish proportions of the home screen. The result often diminishes the viewing experience when compared to the original theatrical showing.

Random Access—the ability of a laserdisc to instantly locate and display onscreen any point in a program, including individual frames, elapsed times or chapters (longer program segments such as movie scenes or musical selections).

S-Video (Super Video or Super VHS)—input/output jacks, also called Y/C connectors, found on newer video monitors, videodisc players and VCRs, that improve the picture quality of program material.

Smart Remotes—new generation of remote control keypads from major electronics brands that are able to "learn" the functions of other remotes so they can be used for most or all of a system's components.

Still Step—ability of certain laserdiscs and players to let you move frame by frame through a program to analyze visual information or to read text onscreen like pages in a book.

This special technology supplement was produced independently and without the participation of Stereo Review editors.

Bruce Apar is editor of Video Business, a weekly publication of International Thomson Retail Press

Cover photo by Lucien Flotte Photography
Design by Collette Episcopo-Carras and Bill Jobson

The Finest In Laser Videodiscs

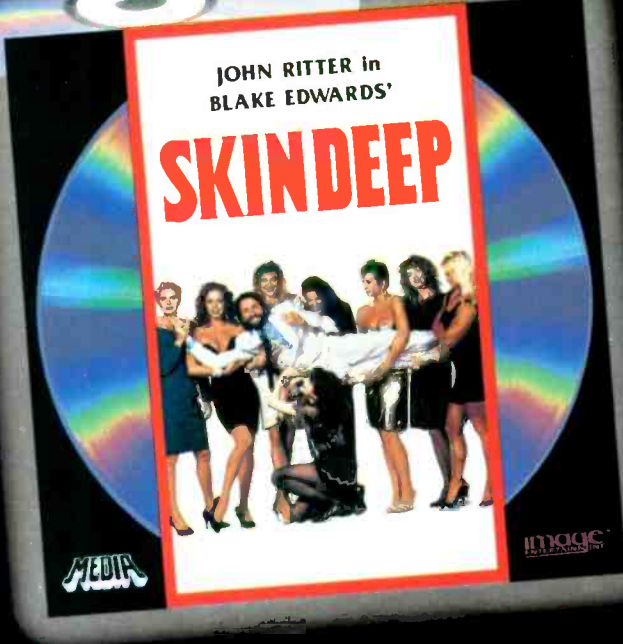

SKIN DEEP ID6632ME



DREAM A LITTLE DREAM ID6631VE

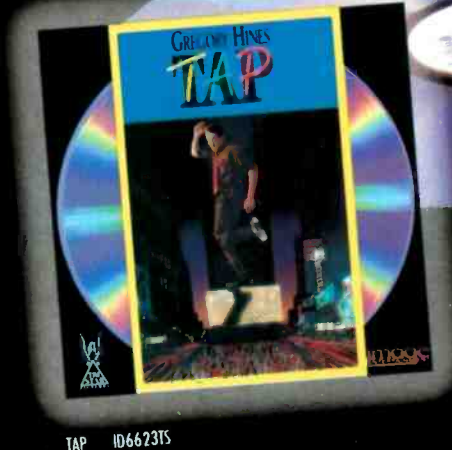

TAP ID6623TS



WINGS OF DESIRE ID6635DR



ROOFTOPS ID6633IV



GLEAMING THE CUBE ID6630VE



CHANCES ARE ID6621TS

imageTM
ENTERTAINMENT
The Finest in Laser Videodiscs
© 1989 IMAGE ENTERTAINMENT, INC.

6311 ROMAINE STREET HOLLYWOOD, CA 90038
(213) 468-8867 FAX: (213) 468-9236
Natl. Toll Free 800-421-4585 Calif. Toll Free 800-633-DISK
Image Entertainment, Inc. is a public corporation. Trading symbol DISK.

The Future in Home Entertainment
Come visit us at our booth at VSDA

CIRCLE NO. 100 ON READER SERVICE CARD



STOP BEDROOM HEADACHES BEFORE THEY HAPPEN.

You want to watch late-night TV while your wife sleeps. How can you turn on your set without turning off your spouse?

It's easy with Koss' JCK-200 Kordless Stereophone System.

Just plug the infrared transmitter into any TV, VCR, receiver or amplifier. Then slip on the stereophones.

Now you're ready to enjoy a night of first-class sound

while your wife enjoys a sound night's sleep. There's no cord, no hassles and no distractions to get in the way.

And if you think the Koss Kordless System is a pleasure in the bedroom, you'll be glad to know it sounds just as good in your living room, dining room or den.

So you can enjoy the great Sound of Koss when-

ever you get the urge.

For more information and the name of your nearest dealer, call toll free: 1-800-USA-KOSS.

Or write: Koss Stereophones, 4129 North Port Washington Road, Milwaukee, WI 53212.

KOSS
stereophones



C E S

SHOW STOPPERS

NEW PRODUCTS FROM
THE CONSUMER
ELECTRONICS SHOW
BY REBECCA DAY

THE semiannual Consumer Electronics Show may be the only place in the country to see more than 50,000 adults playing games, listening to music, and watching television—and getting paid for it. But for the 57,446 manufacturers, distributors, retailers, and journalists who attended the June 1989 show in Chicago, it was much more than just fun and games. The mammoth McCormick convention center and hotel suites around the city provided stages for the debuts of this fall's new audio and video equipment and other consumer electronics products.

Integrating stereo equipment into the home continues to be a major theme among manufacturers, and smaller electronic components, in-wall speakers, and inconspicuous three-piece subwoofer/satellites speaker systems flourished at the show. It seems that the LP-sized "midi" components of the Seventies were before their time; midi is making a comeback in upscale component systems from Luxman, Yamaha, Proton, and Aiwa, among others.

Bose, which helped popularize the three-piece-speaker concept a few years ago with its AM-5 Acoustimass system, brought out a smaller version called the AM-3. More three-piece speaker combos were shown by Allison, Boston Acoustics, Triad Designs, Design Acoustics, and others. Revox took the number of speaker components in the other direction, showing its one-piece prism-shaped Duetto stereo speaker, which consists of two acoustically coupled speaker systems back to back in a single enclosure. In-wall speakers were on prominent display, with new models from such companies as Polk Audio, Luxman, Canton, MB Quart, Sonance, Infinity, and Niles Audio.

Niles was also one of several companies showing new multiroom remote-control systems. Meridian unveiled a multiroom control

system for its Series 200 components, and Denon showed a universal room-to-room remote-control system. To help keep wires out of sight, Esoteric Audio introduced a flat audio cable that can run under a rug.

Compact disc players are still the driving force of new product introductions. Bit battles continue: Denon brought its 20-bit digital filtering to more affordable players, and Sansui and Harman Kardon showed 1-bit, or "bit-stream" players. Philips had its own 1-bit D/A chip on display and also demonstrated its fledgling CD-Interactive (CD-I) technology.

In mobile audio, compact disc changers maintained a high profile. JVC's car changer has two six-disc magazines, and Denon's and Nakamichi's new models have ten-disc magazines. Nakamichi's changer is also one of several autosound "firsts," having been equipped with a digital output for connection to Nakamichi's outboard D/A converter. Another groundbreaker was the first Carver Sonic Holography product—the X2-3 crossover—for the car. In addition, Blaupunkt became the first car stereo manufacturer to offer security-code protection for its complete line of head units.

On the video front, while mainstream HDTV in the U.S. may be a decade in the future, manufacturers will be filling the gap with exciting new products. Philips displayed four new improved-definition TV sets, including a 31-inch table model, and Hitachi showed a 50-inch projection IDTV for introduction next year. Panasonic, JVC, Sharp, and Toshiba showed prototypes of future LCD video projectors and small-screen TV's. And Go-Video took orders for its controversial VCR-2 dual-well VCR, which has MTS decoding and 100-year, sixteen-event, sixteen-hour programming capability.

Audio and video enthusiasts have a lot to look forward to this fall. The photos on the following pages represent those products that "stopped the show" for us in Chicago.



▶ Active Servo Technology is at the heart of Yamaha's new 90-Series, a line of ten smaller-size, European-styled components finished in "cosmic blue." The amplifier, CD player, cassette deck, and tuner are only 3 inches deep; they can be wall mounted. System price: up to \$3,320.



▶ Mitsubishi's 70-inch rear-projection TV set (\$6,399) is rated for up to 700 lines of horizontal resolution. It has direct S-VHS and videodisc inputs and a 20-watt amplifier for its three-way speakers.

▶ Thiel's Coherent Source CS5 speaker (\$9,700 a pair) has three 8-inch long-throw woofers, a 5-inch midrange, a 2-inch dome for the upper midrange, and a metal tweeter on a rigid, sloping baffle. Height is 64 inches.



▲ The HR-S10000U, JVC's top VCR, has comprehensive editing functions, including independent editing of S-VHS video and hi-fi soundtracks, and a wide range of special effects. Price: about \$3,000.

▲ Featuring motorized panels to conceal seldom-used controls, Proton's 600 series includes (top to bottom) the AM-656 integrated amplifier with Aphex Aural Exciter (\$700), the AT-670 tuner with Scholz II circuitry (\$400), the AD-630 cassette deck (\$800), and the AC-620 CD player (\$700).

▲ Sansui's Vintage Series AU-X911DG is a 100-watt integrated amplifier that includes a digital-to-analog converter using the company's new 1-bit Linear Direct Conversion System. Price: \$1,250. The Onkyo Grand Integra A-G10, in contrast, has an 18-bit D/A converter with eight-times oversampling. The 135-watt integrated amplifier accepts optical or coaxial digital inputs and lists for \$3,000.

Martin-Logan's Sequel II speaker system is a hybrid combining a broad-range electrostatic transducer with a subwoofer. Height is 72 inches, width 14 inches, and rated response is 28 to 24,000 Hz \pm 2 dB. Price: \$2,500 a pair.

The latest Bazooka powered subwoofer for autosound use from SAS is the T62-A, shown here in prototype form. It can take high- or low-level inputs, and its built-in 40-watt amplifier can run an extra speaker. Price: \$299.



Adcom's GTP-400 (\$350) combines an AM/FM tuner with eight presets per band and a full-function preamp that uses Class A circuits and offers independent source selection for listening and recording. Also in white. Harman

Kardon's HD7600 CD player features a 1-bit digital-to-analog converter, ultra-wide-band analog circuitry, and three power supplies. It has digital outputs, fixed and variable analog outputs, and a remote control. Price: \$599.

The first CD player with Sony's digital signal-processing technology, the D-555 Discman (\$450) also features eight-times oversampling and noise-shaping circuitry.



The remote control of Hafler's IRIS preamplifier (\$800) works from anywhere in a room. Its J-FET components are said to combine the virtues of tubes and transistors.

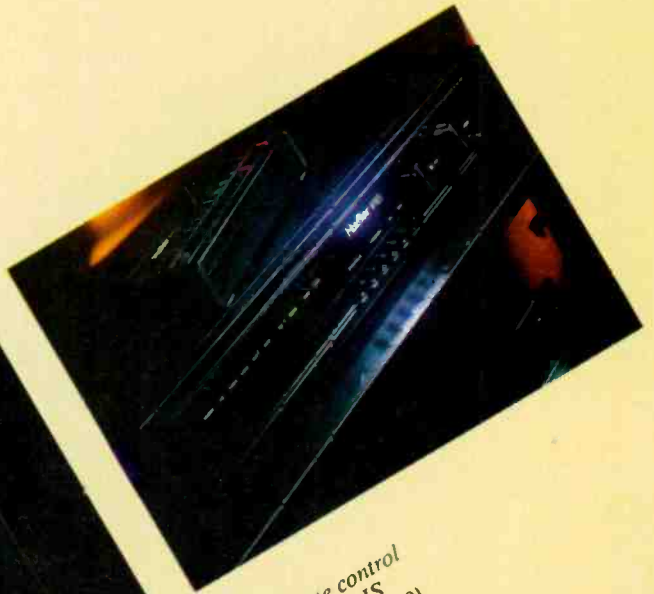

Alpine's Model S952 CD Shuttle (\$650) is a trunk-mounted, six-disc car CD changer that can be operated by several Alpine head units. Its dual D/A converters use four-times oversampling.



Hitachi's VP-F1 car videocassette player is designed to be used with the MCM-5 color monitor, which has a 5-inch LCD screen. The tape player, about 8 inches square, features VHS HQ circuitry and hi-fi audio. Combined price: \$2,995, including remote control.







HOW TO BUY SPEAKERS

Selecting the right speaker can be enjoyable — if you're prepared.



by Ian G. Masters

IN a perfect world, choosing a pair of speakers would be easy. After all, a speaker's function is fairly straightforward: to convert the electrical variations that constitute an audio signal into mechanical ones that produce sound. Simple!

Well, not so simple, as it turns out. In the first place, there are many different ways to accomplish that conversion, and they all have a solid following. Since none of them is perfect, the selection of one design approach over another is really a matter of choosing which compromise you can live with. Also, the room in which a speaker will be used has an enormous influence on how it will sound. A certain type of speaker may sound wonderful in one acoustic environment but terrible in another.

The result is that there is a truly staggering number of speakers on the market, all of them different to some degree and bearing a wide range of prices. The prospect of picking your way through this bewildering variety can be very intimidating. And yet, if you approach the selection process in an organized way and forearmed with some knowledge, finding the speakers that best suit your particular circumstances is possible. It can even be a rather enjoyable experience.

PHOTOGRAPH BY HING/NORTON
COVER/CHAIR BY DAVID MARSH



First Things First

At the very outset, you must decide what you need in a speaker. Equally important is some thought about what you *don't* want—we all live with some constraints, of size or shape or visual appeal. There's no point even considering speakers the size of dumpsters if you live in a small apartment. On the other hand, if your listening room is huge, forget minispeakers unless you're prepared to buy a whole bunch of them. Floor-standing speakers are a good bet if your room layout is appropriate, but if you only have bookshelf space, buy bookshelf speakers. And if you intend to place your speakers close to a TV set, make sure they are shielded so they won't degrade your picture.

The size and furnishings of your room are important as well. Large rooms need more acoustic output from a speaker than small ones to achieve the same apparent sound level. "Dead" rooms—those with overstuffed furniture and lots of heavy curtains and carpets—also need more sound from a speaker than "live" or highly reflective rooms need.

If you do need high power, you could just buy a big amplifier; watts are relatively economical these days. This is a reasonable option as long as the speaker you select can handle the power. The same thing can be achieved, however, by choosing a more sensitive speaker, one that will produce more acoustic output for a given signal level from the amplifier. Many speaker manufacturers specify how much output the speaker will produce with a 1-watt signal, in decibels of sound-pressure level (SPL) measured at a distance of 1 meter in an anechoic chamber. This is one of the few specs that allow you to compare speaker performance directly. Speakers with a sensitivity spec in the mid-80's are usually considered quite insensitive, those in the mid-90's are sensitive, and a few real blasters reach beyond 100 dB SPL. One caution: While speaker sensitivity is important, it has to do only with the quantity of sound, not its quality.

How you listen and what you listen to can also be important. Obviously, if you like to crank your sound up, even occasionally, you will need speakers that can handle considerable amounts of power. Digital audio, with its wide dy-

amic range, also increases the need for a high power-handling capacity. And certain types of music, notably rock, require speakers that can handle high levels more or less continuously rather than in the brief peaks of classical music.

Check Out the Field

Once you have a reasonable idea of the kind of speaker you are looking for, it's time to do some research into what's available in the category you have picked. A good place to start is with a directory of what's out there, such as STEREO REVIEW's annual *Stereo Buyers' Guide*, which lists prices and specifications for virtually every speaker on the market. If nothing else, studying such listings will familiarize you with who makes what, and in what price ranges. Once you know that, you can begin to establish a budget.

Try to build some flexibility into your budget, as you may fall in love with a speaker that's a bit out of your range. (You may be able to find a dealer offering your favorite at a discount.) But because speakers have such a wide range of prices, and fine speakers are available in every part of that range, you shouldn't have to spend more than you can afford to get good sound.

DON'T assume that more money will always buy you better sound. The relationship between price and quality is fairly weak in audio generally, and it's almost nonexistent with speakers. Some of the best-sounding speakers are very modestly priced, and the field abounds with high-ticket horrors. On the other hand, there are probably more truly bad speakers at the low end of the price spectrum than at the high end, so you may have to look a little harder to find the superb ones if you're shopping at the low end.

While examining directories can be useful in narrowing the speaker field, don't be taken in by the manufacturers' specs given there. The audio industry has traditionally relied very heavily on technical specifications to sell its goods, and in most cases these can be a useful guide for buyers. With speakers, however, there are few standards for measuring performance, so there is no way of knowing how a company has come up with its numbers, and there is no reliable way of comparing them with another manufactur-

er's specs. Some specifications are meaningful, of course: Size and weight may be important to you, for instance, and sensitivity—the one specification that approaches standardization—should be taken into consideration. Otherwise, speaker specifications are more likely to be misleading than informative.

BY now, you should have eliminated many—perhaps most—of the speakers that are available either on the grounds of unsuitability or simply because of price. To sift the remainder, a little more checking may be in order. Reviews in STEREO REVIEW and other audio magazines are a good place to start. Most of the favorable ones have been reprinted and are usually available in stereo stores. But read the magazines: You may find that one of your prime candidates has been reviewed unfavorably, and you can bet no store will have a reprint of that one.

Another source of useful information is your circle of friends and family. Almost everyone has stereo equipment of some sort these days, so ask around to see what your acquaintances have bought and how they like it. If one of them is especially enthusiastic about a particular speaker, cadge an invitation to go hear it—or, better still, borrow it and listen to it in your own room. If it's as good as your friend says, your quest could be over right there.

That's a long shot, however. For most buyers the next step is to get out into stores, not necessarily to buy yet, but to find out what's available locally. Choosing the dealer you want to buy from is almost as important as choosing the equipment itself, so take an afternoon and visit the retailers in your area. This will not only tell you who sells what but will give you some idea of what the stores themselves are like. While you're making this preliminary round of the stores, check out their service facilities, prices, and return policies—whatever speakers you finally decide on will not sound the same when you get them home as they did in the store, so make sure you can exchange them if the difference is unacceptable.

The Ultimate Test

Up to this point, your efforts have been aimed at reducing your list of possible buying choices to a handful of candidates. Now comes the time



Celestion's System 6000 (\$2,700 a pair) is a double-dipole bass-extension system. Its matched pair of low-frequency drivers are said to provide an optimally flat response down to 20 Hz when used with a smaller full-range system, such as the bookshelf-size Celestion SL-500Si (\$2,000 a pair) shown here sitting on top.

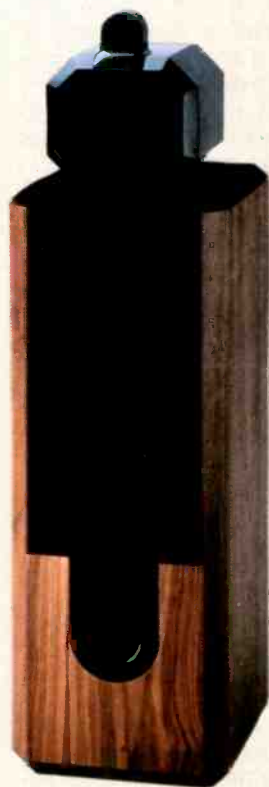

Carver's Silver Edition Amazing Loudspeaker (below) combines a full-range ribbon driver and three 12-inch, "very-long-throw" bipolar subwoofers. Height is 54 inches, width 27½ inches at bottom. Price: \$2,195 a pair.



The three-way B&W Matrix 802 (\$3,600 a pair) has many of the same technical refinements as the Matrix 801 Series 2 professional monitor, including a Kevlar midrange and a rotatable Fibercrte tweeter/midrange assembly, but takes up less than half the floor space. Dimensions are 11¾ x 41 x 14 inches.



The Acoustic Research TSW415A (\$600 a pair) is a three-way, floor-standing acoustic-suspension system with two 8-inch polypropylene-filled cone drivers and a ¾-inch nitrogen-fired titanium-dome tweeter. Height is 29½ inches.



The bookshelf-size KEF C55 features the company's Uni-Q driver, which combines an 8-inch woofer and a 1-inch tweeter in one assembly. Both have the same directivity in the crossover region, which is said to preserve tonal balance over a broad area of the room, not just a "sweet spot."

Below the Uni-Q driver is an 8-inch passive radiator for bass extension. Price: \$550 a pair.

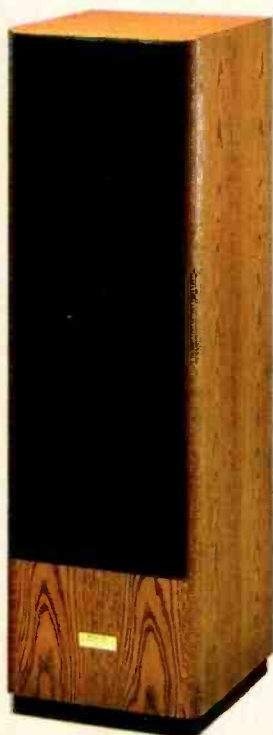

Pioneer's floor-standing Elite TZ-9 (\$4,000 a pair) has ceramic-graphite midrange and tweeter domes and two woofers mounted back to back in the center of the rigidly braced cabinet, firing in phase from the front and rear. The cabinet is only a little more than a foot wide, and the driver configuration is said to mimic a point source.



to listen to all of those candidates and make a final choice. Listening tests are one of the hardest things to conduct, and very few dealers are set up to demonstrate speakers in a scientifically valid way, but you can still get a pretty good idea of what a particular model will sound like by taking elementary precautions.

For one thing, audition speakers using music of your own choice. Any dealer will have a selection of demonstration material, but it may have been chosen to flatter a particular speaker that he wants to sell. Material you are already familiar with will provide a sort of anchor: You should be able to judge whether it sounds better or worse than you are used to. If the recordings you want to use for this purpose are getting a bit worn, it might be a worthwhile investment to buy new copies just for the tests (or use CD's).

Where possible, make sure you can compare the speakers on your short list with each other. The purpose of the listening tests at this stage is to help you choose one speaker from the selection you have already made, rather than come up with further candidates, so you should attempt to compare each model on your list with each of the others. In reality, this can only be taken so far, but no speaker should be listened to in isolation.

No two rooms have exactly the same acoustic characteristics, so the effect the dealer's showroom will have on the overall sound quality will be different from the effect your own listening room will have. You can minimize the differences by making sure that the speakers and the listening seat in the store are in approximately the same relative positions as they will be in your home. If the dealer objects to setting things up this way, perhaps he doesn't really want to make the sale.

Do lots of listening. With speakers more than any other sort of audio component, a snap judgment is almost invariably wrong. So take your time in the store, even if the dealer gets restless.

Speakers are the single most important part of your audio system; how it sounds will be determined almost entirely by how they sound. Making the right choice may take a lot of time in homework and in-store evaluations, but the right speaker for you does exist, and you will find it if you are patient. The effort will certainly be worth it. □

ROGER NORRINGTON

"You can dance the whole of Bach's St. Matthew Passion."

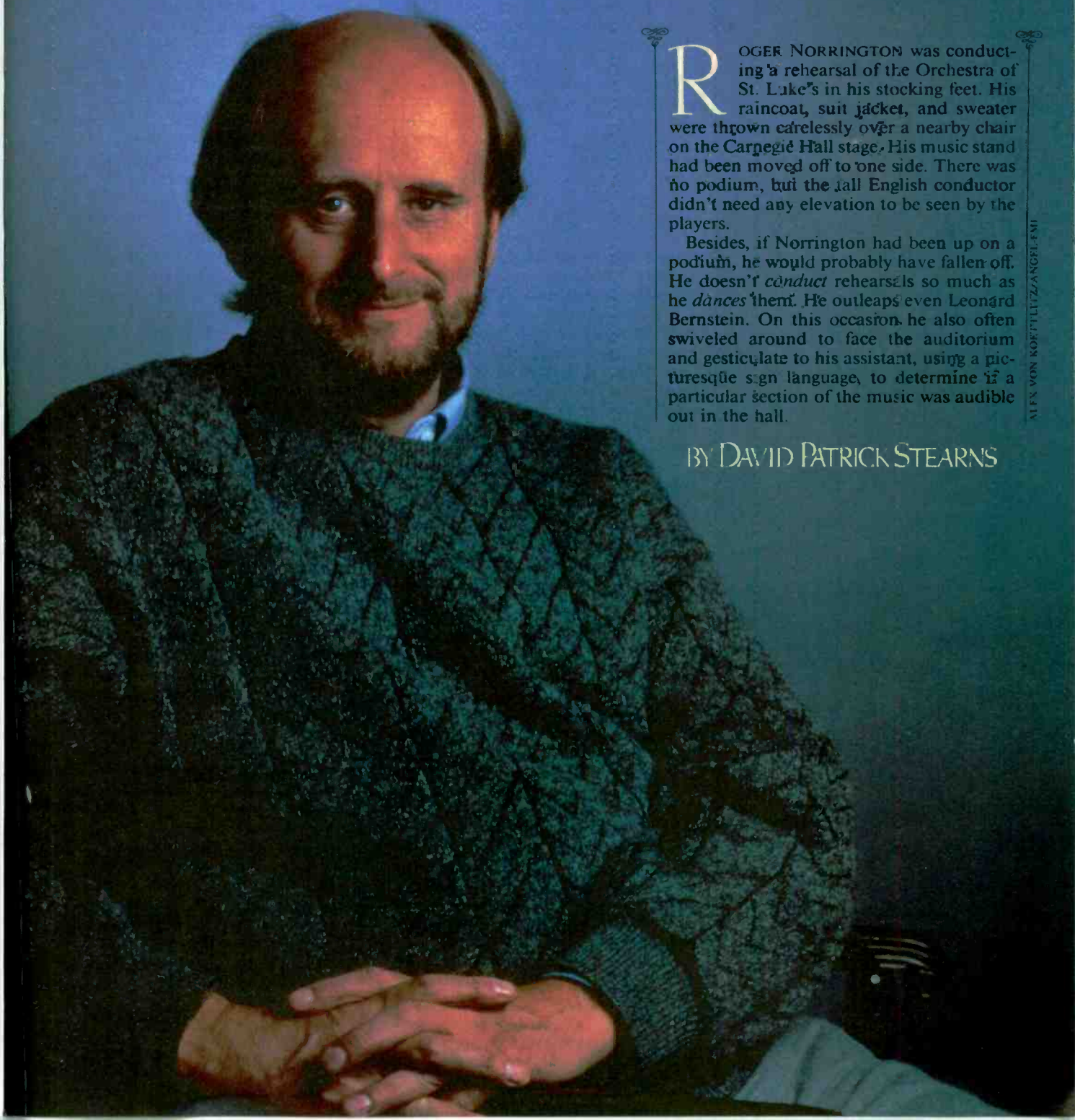

ROGER NORRINGTON was conducting a rehearsal of the Orchestra of St. Luke's in his stocking feet. His raincoat, suit jacket, and sweater were thrown carelessly over a nearby chair on the Carnegie Hall stage. His music stand had been moved off to one side. There was no podium, but the tall English conductor didn't need any elevation to be seen by the players.

Besides, if Norrington had been up on a podium, he would probably have fallen off. He doesn't conduct rehearsals so much as he dances them. He outleaps even Leonard Bernstein. On this occasion he also often swiveled around to face the auditorium and gesticulate to his assistant, using a picturesque sign language, to determine if a particular section of the music was audible out in the hall.

BY DAVID PATRICK STEARNS

ALF VON KÖPFLITZ/ANGEL-FINE

◆

"I react to the music. It hits me and makes me jump around. I hate being stuck up on a high podium. I'm not dispensing divine justice. I'm one of the workers. I get my hands dirty."



"I react to the music," he told me later. "It hits me and makes me jump around, I'm afraid. Sorry about that. I hate being stuck up on a high podium. I'm not dispensing divine justice. I'm one of the workers. I get my hands dirty."

That energy, friendliness, and expansiveness enliven Norrington's performances. Clearly, his current popularity among listeners who favor Beethoven and Mozart played on period instruments can't be traced simply to the fact that he and his group, the London Classical Players, were the first to make "authentic" recordings of such works as Beethoven's Symphony No. 9 and Berlioz's *Symphonie fantastique*. And it's not just because his Beethoven recordings for EMI, the piano concertos with fortepianist Melvyn Tan, are the first to use the composer's highly controversial metronome markings—and make a good case for them. The thing that makes Norrington's Beethoven so winning is that it dances.

"Dance is absolutely fundamental," Norrington said. "All the composers were deeply and intimately involved in dance. Mozart wrote thirty-five dances in the last year of his life. We constantly hear dance in *The Magic Flute*. You can dance the whole of Bach's *St. Matthew Passion*. It's how the music is propelled. It helps that I'm married to a dancer [the Baroque-dance specialist Kay Lawrence]. I'll say to Kay, 'How is it going?' And she'll say, 'It should be a little faster. It doesn't dance.' Nietzsche once said that all thought that does not dance is dead. And there's an intense amount of thought in Beethoven's music."

Unlike many early-music specialists, the fifty-five-year-old Norrington is not a harpsichordist who has graduated to the podium, but a seasoned conductor who knows the standard repertoire intimately. He conducts conventional orchestras, such as the Jerusalem Symphony and London's Philharmonia Orchestra, and sees no reason to stop just because he also works with period instruments. But the most formative professional influence in his life was perhaps his fifteen years as music director of the Kent Opera in England. Behind all of the grace, character, and sense of movement in Norrington's Beethoven symphonies and concertos, the music tells a story, almost like an opera.

That's something few musicians

have dared to do in modern times—or at least admit to. Finding programmatic significance in symphonic music is often dismissed as so much Romantic poppycock. But passages that Arturo Toscanini claimed meant nothing more concrete than "*allegro con brio*" suggest any number of scenarios to Norrington. He hardly seems able to stop himself. It is, after all, the "authentic" thing to do.

"Nobody ever thought that instrumental music was totally abstract," he said. "In an opera, the dominant passions were made manifest by the words. But in a symphony, you were supposed to divine them from the music, and that comes to a head with Beethoven. His symphonies are very dramatic. The Second Symphony is like a comic opera. But that doesn't mean I'm not interested in the structure. It's because Beethoven was a supreme formalist and a supreme Classicist that his symphonies were able to include so much drama. So I don't reckon that my subjectivism would betray my objectivity. It's the two at once."

Though you might expect that the discipline of authentic performance practice would have a purging effect on Romantic displays of passion, working within its parameters—as well as Beethoven's metronome markings—liberated Norrington. "Understanding of an eighteenth-century musical gesture doesn't stop me from being very personal about it. If you know you're not going to make gaffes of style, or cultural gaffes, like trying to eat an artichoke with a knife and fork, the more confident you can be, and the more passionate you can be. You're dealing with the music without fearing you'll make the wrong gesture."

The results can be unorthodox, such as the slow tempo Norrington takes for the Turkish-band music in the finale of Beethoven's Ninth. At first, it might seem willfully slow, but, typically, Norrington has thought it out thoroughly. "It comes right after the words, 'The cherub will stand before God'—a grandiose moment. And then the next thing you hear is this fart from the bassoon. Out comes this rusty village band. It's a ragged army . . . and they're on their way to the pub. It's faintly ridiculous."

But why Turkish music, particularly considering that the Turks were twice trounced when they laid

Norrington with
 fortepianist Melvyn
 Tan: exploring new
 ways of
 experiencing the
 Mozart and
 Beethoven piano
 concertos in
 concert
 and on records

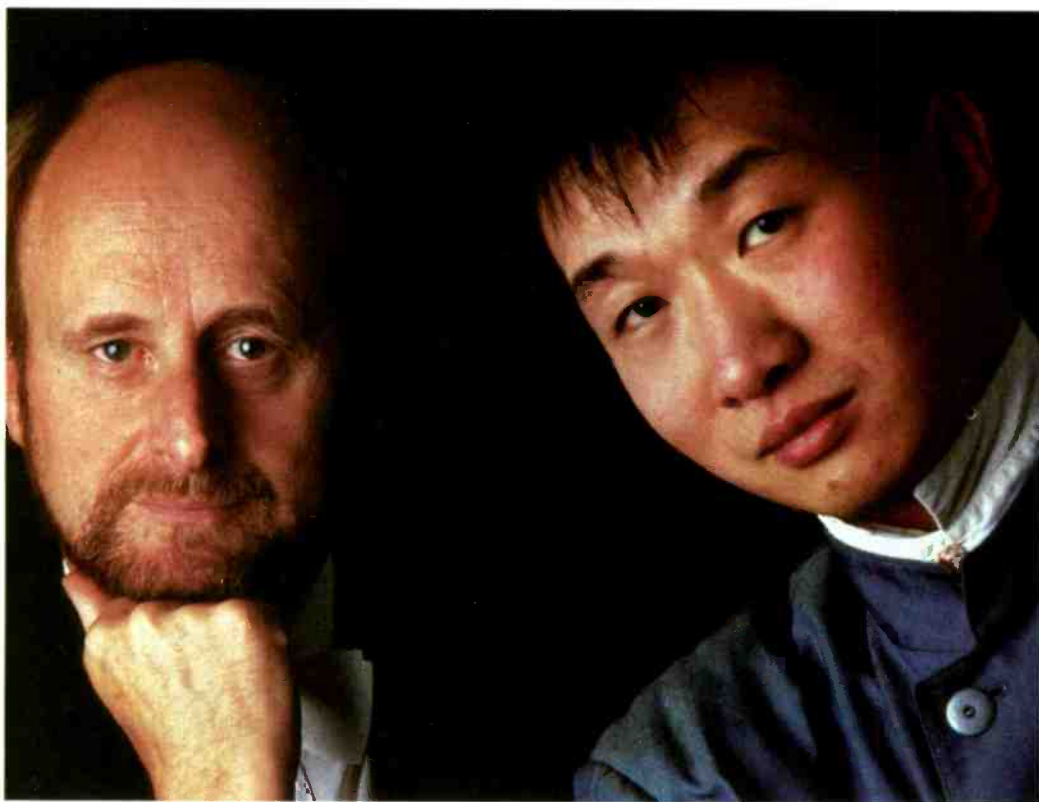

siege to Vienna? "Schiller's text [used in the finale of the Ninth] says that beggars will be princes' brothers. All men. All men!"

Norrington's interdisciplinary approach toward music is reflected in his attempts to make his concerts more than concerts—multifaceted "experiences," as he calls them, in which the musical performances are set in context by lectures, chamber concerts, and various demonstrations. A demonstration of dance styles in Beethoven's time was on the program of Norrington's two-day "Beethoven experience" focusing on the Ninth Symphony at this summer's PepsiCo Summerfare in Purchase, New York, the first stop in his first U.S. tour with the London Classical Players. This fall Norrington and Melvyn Tan will present a Mozart piano-concerto "experience" at the University of Michigan in Ann Arbor. And future "experiences" will move forward in musical chronology, to Brahms, Wagner, and even Mahler.

Is there as much "damage" to undo in the repertoire that is closer to our time? "The short-term answer is, 'I don't know.' The interim answer is, 'I wouldn't be at all surprised.' The long-term answer is, 'We're going to have a look.' We are

about to do some Brahms on early instruments, and I'm pretty sure it's going to come out different. I'm beginning to look for flecks of information. There's a letter from Brahms reminding [the violinist Joseph] Joachim that when there's a pair of notes, to shorten the second note. All of the violin treatises from Mozart to Joachim say that. So there's a Classical tradition that continued right through 1900, and Brahms was a part of that."

Norrington knows that being a pioneer in this area can involve a certain degree of career "instability." He once studied early performance practices under Raymond Leppard, whose approach is today considered out of date. Even now the critical tide seems to be turning against such second-generation authentic-performance musicians as Christopher Hogwood. Might the same happen to Norrington? "It might," he said. "But I think I get on with orchestras not because I'm fashionable but because we have a lot of fun together. There's steam going. Maybe other people might come along and do things better. On the other hand, I might change. I might do them better, too."

Norrington isn't likely to make the mistake of spreading himself too

thin, either. Just now, on the brink of international fame, he's slowing down.

"I don't want to get supercharged, fed up, or so tired that I can't enjoy it. In 1990, I'll be down to 220 conducting days, and in 1991, I'll be down to 180. That's half time. The rest will be study and relaxation. I'm more interested in working with particular groups than being everywhere. You *can't* be everywhere.

"I don't need to record everything in the world or make twelve records a year, like some of my friends do. We're going to make five records a year, and they're all going to be interesting. I'll do fourteen weeks a year with the London Classical Players and work with a few other bands I'm interested in historical stagings of operas. I need to work with St. Luke's, make friends, and have friends."

Norrington is more than a musician. He's also a farmer of sorts, a pastime he shares with another early-music conductor, John Eliot Gardiner, and he has a cottage in the Berkshire region of England, about seventy-five miles from London.

"It's a thatched house," he told me. "We're putting it back to its original, historical condition—needless to say." □



MERIDIAN D600 DIGITAL ACTIVE SPEAKER

Powered speakers
and full system control

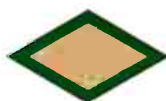

MANY audio products are advertised as "digital," often with little justification. For example, most "digital-ready" loudspeakers can claim little more than the ability to reproduce CD programs, something any speaker can do. Until now, CD players, digital audio tape (DAT) decks, and certain related components and processors have been the only consumer audio products to which the term "digital" could be justifiably applied. To this list we can now add the Meridian D600 Digital Active Loudspeaker from Boothroyd Stuart Ltd. of Huntington, England. This impressive and innovative product is all that its name implies, and much more, since it contains virtually every part of a top-quality analog or digital music system except the program source.

The loudspeaker itself has a relatively conventional "two-and-a-half-way" design that uses two 6½-inch polypropylene-cone woofers and a 1-inch aluminum-dome tweeter in a moderate-size vented columnar enclosure. Both woofers operate together below a few hundred hertz; above that the output of one woofer is rolled off, leaving the second, called a "mid/woofer," to radiate the midrange frequencies.

The "active" portion of the speaker's name derives from the fact that each driver

is powered by its own built-in 70-watt amplifier. The amplifiers use Meridian's Class AA nonswitching circuit, a sliding-bias system that lets the amplifier operate in Class A at low power levels, for minimum distortion, and change smoothly to Class AB when a higher power output is required. Each amplifier has its own active crossover network and is direct-coupled to its driver, eliminating any extraneous components or wiring between the amplifier output stages and the speakers' voice coils.

The D600 is designed to accept audio inputs in digital form through either coaxial or optical cables. Although the built-in amplifiers, like the speakers, are conventional analog components, the digital portion of the system contains quadruple-oversampling, true 16-bit digital-to-analog (D/A) converters that can operate at any of the standard sampling rates—32, 44, and 48 kHz—used by the current compact disc and digital audio tape formats.

System Control

In addition to its signal-conversion, amplification, and loudspeaker functions, the Meridian D600 serves as a full-fledged system control unit, providing most of the usual preamplifier functions. It has two

BY JULIAN HIRSCH

pairs of analog inputs, each of which can be used in a fully balanced mode or in the more usual unbalanced configuration. The system is operated by the Meridian Model 609 Handset remote control, which is supplied with each pair of D600 speakers. The cable connecting a compatible Meridian source component, such as the Model 207 CD player, to the master speaker—which is joined by another cable to the “slave” speaker—also carries return control signals, received via the speaker, from the Handset.

Most of the functions of the CD player can be operated by pointing the controller toward the master speaker, which is normally used for the left channel. In operation, the display panel on the top front of the master speaker shows the full operating status of the system, including the input source, the settings of the volume, balance, and tone controls, and time and track information for a connected CD player. The display on the slave speaker shows only its level setting, which is normally the same as the master speaker’s unless their balance has been changed. In the standby mode, the system’s normal nonoperating condition, the

amplifiers are shut down, but certain control circuits remain active and a small green light in each speaker’s display shows that it is energized. While the system is operating, the master display contains a clearly visible red light.

In order to take full advantage of the system-control and digital-input capabilities of the D600, it should be used with the Meridian Model 207 CD player. More than merely a CD player, the Model 207 has inputs for phono and line sources and tape input and output jacks as well as its own fixed- and variable-level analog outputs, optical and coaxial digital outputs, and a headphone jack. Its built-in phono preamplifier can be switched between moving-coil (MC) or moving-magnet (MM) modes by an internal control. Buttons on the Model 207’s panel select the program source and route it to the amplifier; when it is used with the D600 system, this selection can also be made from the speakers’ remote control. The normal connection to the D600 system is through one of the digital outputs. The program signal is converted to analog form in the speakers just before the amplifier stages.

Each speaker contains digitally controlled analog circuits, which follow the D/A converters when a digital source is used, for adjustment of volume and frequency response. The volume can be varied in sixty-four steps of 1.25 dB each, with the number of the current setting appearing in the display window. The TILT control offers up to ± 2 dB of shelved high-frequency boost or cut, in five steps each, beginning at about 1,500 Hz and reaching its full effect above 5,000 Hz. A similar adjustment is provided for the low frequencies by the bass control, which introduces a single-step 2-dB boost or cut below 100 Hz. In addition, the Q control rolls off the low bass at an unspecified rate to -3 dB at 50 Hz. All these adjustments are made with push-buttons on the speaker’s Handset controller.

Other Handset functions include input source selection (which also turns on the speakers), independent adjustment of left and right speaker levels, most basic CD player functions for the Model 207, volume control, and muting. A memory button stores the settings of the various level and equalization controls,

Multiroom Remote Control

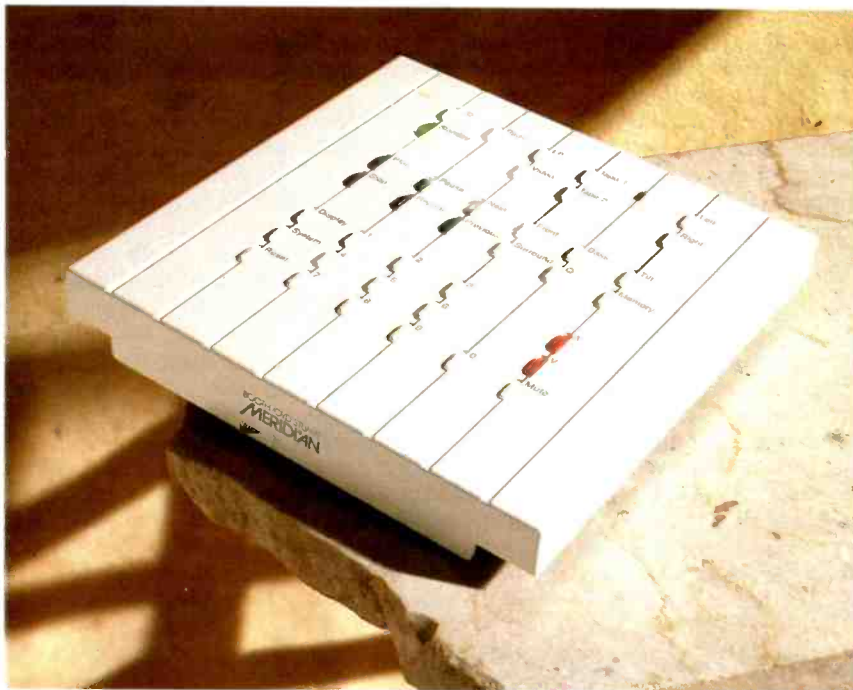

One of the more advanced features of the Meridian D600 system is its ability to act as the controller for a multiroom installation. The Meridian remote system enables users in two locations to listen to different programs from the same set of central components. It also includes a “lock-out” feature that prevents users in either location from affecting the other location’s system status or configuration. The Model 609 Handset (left) supplied with the D600 speaker system interfaces with all other Meridian Series 200 components, including the Model 204 tuner/timer and the Model 207 CD player.

The D600 itself includes a digital preamplifier that can select and control up to three digital sources directly and provide fixed- and variable-level digital outputs to another component. It has its own digital filter, error-correction circuitry, and quadruple-oversampling, 16-bit digital-to-analog converter. The D600 can also control two balanced or unbalanced analog inputs. The Handset can remotely control volume, balance, tone, muting, and even a surround-sound setup.

and a reset button restores their neutral settings. A display button cycles the displayed information through the volume setting, the CD track number, the elapsed time in that track, and the elapsed time on the disc.

Designed for Flexibility

A GROUP of four or six D600 speakers can be set up in a multichannel system for surround sound. In this mode, a single master speaker controls the entire system, including the volume and left/right balance for all the speakers. The Handset controls the front/rear balance. The D600 system can also be used in multiroom installations in combination with other Meridian Series 200 components, including the Model 201 remote-controlled pre-amplifier and the Model 204 stereo FM tuner in addition to the Model 207 compact disc player.

Each D600 speaker measures 35½ inches high, 8¼ inches wide, and 11⅞ inches deep and weighs 71 pounds. The rear panel is a metal plate that carries the digital and analog circuits and crossover components, DIN and phono-jack signal inputs and outputs, and a standard optical connector. The rear plate also serves as a heat sink for the electronic components.

The speakers are fitted with adjustable spiked feet, which can be capped if desired to protect finished floors. The rigidly braced cabinets are available in a choice of black ash, American walnut, or rosewood veneers. Except for the narrow display windows at the top, the front of each speaker is covered by a removable black grille.

The Handset does not resemble a typical hi-fi remote control. Finished in white, it is built on a metal base and weighs 18 ounces. It is square, 6⅞ inches on a side, and just under an inch thick (the "Handset" name seems inappropriate, since it is more easily used on a firm surface). Its thirty-seven buttons are slender and well spaced, with exceptionally clear black markings. Most of the buttons are white, but they are nonetheless very easily distinguished from the white surface of the Handset. The volume buttons

are red, and the standby button is green.

The Model 207 CD player consists of two separate components, identical-size transport and electronic units measuring about 4 inches high, 5¼ inches wide, and 12¾ inches deep. They can be installed side by side or one above the other. The front-panel control buttons are similar to those of the D600's Handset, although each can serve at least two functions, and in most respects the operation of the player is unlike that of any other CD player we have used. While we did not make any measurements on the Model 207, it performed well with the D600 speakers. Prices: Meridian D600 speaker system, consisting of two speakers, Model 609 Handset, and all necessary cables, \$5,490; Model 207 CD player, \$2,250. Meridian America, Dept. SR, 14120-K Sullyfield Circle, Chantilly, VA 22021.

Lab Tests

WE measured the performance of the Meridian D600 using essentially the same procedures we would follow for any loudspeaker, except that we applied line-level input signals directly to its analog inputs instead of through an external power amplifier. Many of the manufacturer's performance ratings apply only to the electronic portions of the system, but we did not attempt to open the speaker for access to the amplifiers or the driver voice coils.

The composite frequency response, including the averaged room response from the left and right speakers and a close-miked woofer response, was one of the smoothest we have yet measured. With the system's frequency-trim controls set to their midpoints, the response was flat within +2, -0 dB from about 38 to 1,000 Hz. Above 1,000 Hz, there was a very gentle downward slope to about -2 dB at 3,000 Hz and a slightly steeper slope above 3,000 Hz.

The overall composite response was within ±4.5 dB from 28 to 20,000 Hz, with much of the variation occurring in the uppermost octave, where the output increased

somewhat. When we used the low-bass cut of the Q control and the highest setting of the treble TILT, the composite response became an even more outstanding +3, -2 dB from 30 to 20,000 Hz. Close-miked woofer measurements indicated that the crossover to the tweeter was at about 2,500 Hz and that the responses of the two woofers began to diverge above 200 Hz, although they did not differ materially below about 500 Hz. The effective crossover between the cone and port radiation was at 65 Hz.

Our FFT response measurements showed the exceptionally good dispersion of the tweeter up to 10,000 Hz. It also confirmed an effect that we had detected in some of our swept-sine-wave measurements: a large (about 18 dB) and undamped tweeter resonance at about 26,000 Hz. Although this effect was not audible (not to us, at least), it was apparently responsible for the speaker's rising output between 15,000 and 20,000 Hz in several of our measurements.

The system's group-delay variation was less than 0.1 millisecond overall from 5,000 to 20,000 Hz, and its phase linearity at lower frequencies was equally impressive, with a maximum change of only +0.4 ms in the 500- to 2,500-Hz range.

The woofer's distortion with a constant drive corresponding to 90 dB sound-pressure level (SPL) in the middle of its range was not particularly low, rising from about 1 percent between 100 and 300 Hz to 5 percent at 70 Hz and 10 percent at 50 Hz.

Listening Tests

FROM our first hearing of the Meridian D600 system, it was obvious that this was no ordinary speaker. Its smoothness and the breadth of its stereo stage were outstanding, and so was its balance throughout the audible range. We found its default equalization settings to be quite satisfactory. The audible effects of even the extreme settings were generally negligible, although perhaps a very critical listener might find reason to prefer a particular response characteristic. Incidentally, we kept

the mounting spikes capped, since it was necessary to reposition the speakers several times during our testing.

We listened exclusively to CD's played on the Meridian Model 207, which was connected to the speakers with coaxial digital coupling. One of our earliest impressions was of the seemingly limitless dynamic range of the system. No matter how loudly we played the music, the sound was never strained or compressed. We would not have dared play music that loud with any conventional speaker/amplifier combination (especially one based on 6½-inch woofers!) for fear of blowing a driver or two, if not the amplifier. Measurements with a sound-level meter at the listening position (about 15 feet from the speakers) showed sustained levels as high as 107 dB with some program material. The speakers did not sound particularly strained, nor did they suffer any damage from this treatment, but we found such listening levels uncomfortable and backed down. Meridian claims that the D600's maximum SPL is 110 dB and its maximum frequency range 36 to 20,000 Hz; both ratings were amply confirmed by our experience with the system.

We were concerned about damaging the speakers by such high-level operation, but according to Meridian the amplifiers are protected against overheating and will shut down if abused, and apparently the speaker drivers are able to absorb the full output of their amplifiers without damage. At no time in our tests or use of the speakers did their back panels get more than mildly warm; presumably it would take a sustained diet of very loud music at full power to do that.

Remarkable as this system was, it *could* be driven beyond its limits. At high volume, the cannons on the Telarc CD of the *1812 Overture* were more than it (like most other speakers and amplifiers) could handle, and attempts to play this disc loud enough to *feel* the bass resulted in harsh clipping, either of a woofer or its amplifier. Devotees of ultra-deep bass will want to combine the D600 with a powered subwoofer. But for my taste, these handsome and terrific-sounding speakers did very well by themselves.

Happily, the Meridian D600 sounded as sweet and musical at the level of a whisper as it did at full-orchestral volume. In fact, if I had to pick a single adjective to describe it, it would be "effortless." "Awe-

some" is another likely choice. Meridian's considerable claims for this system were amply justified by any standard we could apply.

Adding It All Up

GOOD as the D600 is—and it is hard to imagine anyone considering it less than *very* good, whatever personal preferences might be—it does appear at first glance to be a very pricy item. Spending \$5,490 just for a pair of speakers? Well, for that money you not only get two excellent speaker systems, which are attractively styled to be at home in almost any environment. You also get six high-quality 70-watt amplifiers and two sets of three-way electronic crossovers. You get a pair of excellent preamplifiers, with remote digital operation of their controls and rather subtle but sophisticated "tone controls" that are just made to order for people who hate ordinary tone controls. You get a pair of really good 16-bit, four-times-over-sampling D/A converters. You get a variety of connection options that enable these speakers to interface with many different source components. And you get a versatile and attractive system remote control. When you look at it in that light, the price seems a bit more reasonable, doesn't it?

The sheer versatility of the D600 system makes it difficult to comprehend its operation fully without a careful study of its two spiral-bound manuals. Everything is done differently from the way it is done in ordinary hi-fi systems, and much of what the system does is not at all obvious to anyone familiar with conventional audio products.

We were told by Meridian America that the complexity of this system requires a close relationship between customer and dealer. As with certain other high-end components, it is advisable that the dealer install and set up the components to insure their satisfactory operation. And even after the system is installed, my advice to a user is to read the manual carefully and practice using the system's many features. It would be a shame to own a magnificent system like this one and not know how to use it effectively. □



Meridian's Model 207-Pro CD player is housed in two separate enclosures in order to isolate the transport from the electronic components. It can also serve as the preamp for an entire system.

THE NOISE ABOUT

F M X

BACK in the Forties, FM came to market as a panacea for the noise that plagued AM radio transmissions. The wide bandwidth of FM channels and the technique of frequency modulation itself were both intended to insure low-noise reception. Now, ironically, it is noise in FM signals that is at the heart of a controversy in audio circles over a technique called FMX that was developed to improve FM broadcasts.

In the beginning, FM was a very quiet medium, but the change to stereo complicated matters, increasing noise (especially on weak signals) and susceptibility to multipath distortion. Multipath, just as the name implies, occurs when a radio signal reaches a receiver along different routes. Radio waves all travel at the speed of light, but some reach your receiver directly while others bounce off buildings and mountains, reaching your receiver out of phase some fractions of a second later.

Multipath caused few problems for the original mono FM transmissions, but few people listened, and the FM broadcasters could barely support themselves. So the government permitted them to add SCA (Subsidiary Communications Authorization) subchannels for specialized programs, such as Muzak or stock quotations, for commercial customers with special receivers. By itself, an SCA causes only modest

BY RICH WARREN

Controversy surrounds what seemed to be a promising technique for improving stereo FM reception.



SUE LLEWELLYN

reception problems, but then came stereo FM, which requires an additional subchannel. When SCA's are combined with stereo transmission, the signal degradation from multipath can be severe, ranging from occasional whistles and "birdies" to unlistenable distortion.

Stereo FM begs for improvement, and various visionaries have risen to the challenge. In the early Seventies, Ray Dolby designed a modified version of his consumer noise-reduction system for FM. Dolby FM arrived with a great flourish but shortly faded. The Dolby system required changing the FM pre-emphasis time constant, which caused non-Dolby-equipped listeners to endure a brighter sound. Custom-application integrated circuits were uncommon fifteen years ago, which meant that equipping receivers for Dolby FM was expensive. Ultimately, consumers and broadcasters decided that the improvement was not significant enough for the required investment.

ABOUT a decade after Dolby's foray into FM, Emil Torick, an engineer at the CBS Technology Center (formerly known as CBS Laboratories), took up the quest for improved stereo FM. Torick and his associates seemed to discover a way of improving the stereo FM signal without negative side effects. They called their system FMX.

In effect, FMX employs techniques similar to a conventional tape-recording noise-reduction system: boosting the low-level signals, applying equalization during transmission (recording), and decoding the result with a complementary circuit on the receiving (playback) end. Unlike a tape noise-reduction system, however, FMX uses a control signal to insure accurate decoding. The existing stereo difference subchannel becomes a control for the compressed, equalized subchannel. (See box on page 115 for details.)

The idea is that listeners with non-FMX-equipped radios will hear minimal difference from an FMX-encoded broadcast, while those with FMX-equipped radios will benefit from reduced noise. Reducing noise should also increase the usable range of the stereo signal. If you live 60 miles from the transmitter and have been forced to listen in mono because of a noisy signal, FMX might enable you to listen in stereo.

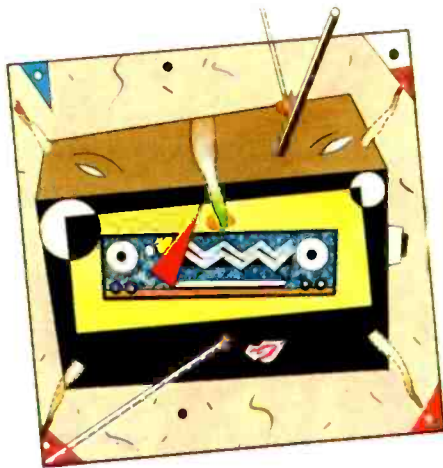

The first time out of the gate FMX stumbled. After considerable fanfare at the 1986 Winter Consumer Electronics Show, FMX made a major debut during the Summer CES later that year. The CBS Technology Center loaned classical-music radio station WFMT in Chicago a prototype FMX exciter. The station was ideal for the test because of its renowned signal quality. Without public announcement, WFMT began broadcasting with FMX. During the first week WFMT received a significant number of telephone calls from listeners complaining about poor reception. WFMT's engineers tied the listener complaints to exaggerated multipath distortion caused by FMX, and the station swiftly ended the experiment.

Undaunted, Torick and associates returned to the lab. Although CBS closed the Technology Center in 1987, the FMX project continued. The National Association of Broadcasters (NAB) subsequently became an investor in FMX, and Broadcast Technology Partners (BTP) was formed.

In the spring of 1988, BTP premiered the newly revised FMX system at the NAB convention. The new FMX reduced the compression curve (from 20 to 14 dB), altered the equalization, and inverted the phase of the FMX signal. Assuring broadcasters that all problems had been solved, BTP began to campaign for adoption of FMX by the world's FM broadcasters.

Meanwhile, FMX sounded like an interesting idea to Dr. Amar Bose, founder and chief executive of the Bose Corporation and a full professor at MIT. Bose began his academic career in communications theory, and he loves mathematics.

He obtained the specifications for the revised FMX system and began investigating them.

After mathematically analyzing the relationship between FM broadcasting and FMX, Bose reached the conclusion that FMX could not work as claimed. His calculations predicted that FMX could grossly degrade a stereo FM signal. The problem centered around multipath. Multipath changes the relationship between the normal stereo subcarrier and the FMX subcarrier. Thus, FMX loses its "control" signal, since the two subcarriers are in a different relationship when they're received than when they left the transmitter. In addition, Bose noted, the extra subcarrier increases "channel loading," which theoretically increases noise.

Research facilities at MIT aided Bose's investigation. He was joined by Dr. William Short of the Bose research staff, who conducted many of the experiments. First they created a computer model of the problem. Then they set up a laboratory experiment to simulate the effects of multipath. Basically, a signal was sent down two wires of different lengths, one very short and the other 2,000 feet long. One signal reached the receiver later than the other, just as with FM multipath. The laboratory findings confirmed the mathematics.

FOR the final step Short conducted actual off-the-air experiments. He obtained a current Inovonics FMX exciter for use by the MIT student radio station, WMBR. A car radio was modified to receive FMX with the latest Sanyo integrated circuit, and it tuned in a special test signal while the car was driven over a wide coverage area. The stereo outputs of the radio were digitally recorded for subsequent computer analysis in the laboratory. Both the transmitter and the radio were switched between conventional FM stereo, FMX transmission with conventional reception, and FMX transmission with FMX reception. The broadcast test also confirmed Bose's predictions.

Bose went public with his findings in a press conference at MIT last January. He was joined by Short, who presented the experimental portion of the project. In their initial publication of the results, which bears an MIT copyright, Bose and Short state: "We have examined

two systems of FM transmission that are of current interest—the existing FM stereo system and the proposed FMX system. The results of modeling, simulation, and objective field testing at 15,000 locations lead us inescapably to the following opinions: 1) Broadcast station coverage, instead of being increased as originally hoped, is decreased by the FMX system; 2) FMX transmission degrades reception on existing FM stereo receivers; 3) FMX receivers are inferior to existing FM stereo receivers for receiving FMX transmissions.” During the presentation Short played recordings of the various off-the-air tests. The FMX broadcasts, both with and without FMX decoding, contained nearly unlistenable amounts of distortion.

SHORTLY after the MIT presentation, BTP responded with a nine-page rebuttal. The BTP analysis disputes Bose on the following salient points: 1) The transmission equipment used for the Bose-Short broadcast tests was not properly adjusted. BTP claims that it offered to adjust WMBR's equipment but was refused (Bose denies this claim). BTP says that WMBR suffered synchronous amplitude modulation, a form of distortion that is often mistaken for multipath. 2) The modification of the car radio used in off-the-air compatibility tests resulted in misleading stereo/FMX comparisons. 3) The experimental radio used by Bose incorporated an unapproved prototype sample of the Sanyo FMX decoder chip. 4) The laboratory simulation was unrepresentative of real-world conditions. 5) There is only an extremely low probability that the kind of reception simulated by Bose and Short would occur in real life. 6) Bose's mathematical presentation does not describe parameters of the FMX system that differentiate it from regular stereo FM.

Regardless of the merit of BTP's arguments, FMX does lack compatibility with some FM receivers—certain receivers cannot properly process a signal with the kind of subcarrier FMX uses (see box). Therefore, the FMX system cannot support a claim of “universal” compatibility.

Broadcast engineers who have seen the Bose report tend to agree with Bose. While BTP's rebuttal lists stations using FMX, many of them have ceased using the system. For instance, WNIB, another classi-



WHAT FMX DOES

UST as today's FCC (Federal Communications Commission) has ruled that the competing high-definition television (HDTV) systems must either be compatible with our existing TV system or else their broadcasts must be simulcast with conventional TV signals, thirty years ago the FCC mandated that stereo FM transmissions be compatible with existing mono broadcasts. Furthermore, the FCC sought a system for stereo FM that would not penalize mono listeners in terms of reception quality.

The Zenith stereo FM system that was eventually accepted, and is still used today, barely affected mono reception, but it placed an 18-db penalty in signal-to-noise ratio on stereo transmissions. The system adds an amplitude-modulated stereo difference-signal (L - R) subchannel at 38 kHz to FM broadcasts, and a subcarrier is added at 19 kHz to help decode the stereo signal (this 19-kHz “pilot” signal is what triggers the “stereo” light on your receiver).

FMX was designed to improve the signal-to-noise ratio of stereo FM in a way that is compatible with the existing system. In operation, the FMX system boosts low-level program signals by 14 db. As program levels increase, the amount of boost is gradually reduced in order to permit transmission at full modulation to receivers without FMX decoders. FMX then applies fixed equalization to a compressed duplicate of the existing stereo difference signal; complementary equalization in an FMX receiver is used to provide optimum noise reduction.

The compressed FMX stereo difference signal is transmitted on a new “quadrature” subcarrier, which is 90 degrees out of phase with the existing 38-kHz stereo FM subcarrier (which transmits the original, uncompressed difference signal). In an FMX-equipped receiver, the conventional stereo subcarrier is used as a reference for decoding the FMX subcarrier. Finally, the system adds a new pilot signal at 10 Hz, well below the audible range, that switches an FMX-equipped receiver into FMX mode.

cal-music station in Chicago, broadcast with FMX last year but ceased doing so two months before the Bose/MIT press conference. WNIB staff member Ron Rai said that the station suffered too much distortion when broadcasting with FMX. An engineer at another Chicago radio station, however, suggested that the McIntosh tuner used by WNIB to receive its broadcast signal from the station's downtown transmitter, for relay to its repeater transmitter in Zion, Illinois, could not receive the FMX broadcast properly.

WBBM-FM, a CBS-owned rock station in Chicago, broadcast with FMX during the 1988 Summer Consumer Electronics Show but ceased using the system shortly thereafter. An engineering representative at the station referred questions to CBS corporate headquarters in New York. Helene Blieberg, a CBS representative in New York, said that WBBM-FM engineers “noticed interaction between FMX and subcarriers which resulted in noise on inexpensive radios.” She estimated that these radios constituted about 10 percent of those used by the station's listeners and added that CBS had discontinued FMX broadcasts until the engineering staff could correct the problem. As of July 1989, WBBM-FM had not returned to FMX broadcasting.

SANYO and Sprague are the only manufacturers of FMX integrated circuits. The only two audio companies actually marketing mobile FMX receivers are Alpine and JVC. The attitude of the rest of the industry varies from a cautious “wait and see” to a lack of interest. Aware of the financial beating suffered by NAD when it announced the first FMX receiver for the original FMX system three years ago, few companies are eager to invest in FMX. Tom Harvey, president of Sony's consumer products division, wants to see FMX operating “flawlessly” before considering it.

As far as the audio industry is concerned, the jury is still out on FMX. Home audio manufacturers apparently aren't willing to bank on FMX until its designers have shown that it works and is compatible with existing receivers. But, considering the severity of the problems associated with stereo FM reception, everyone concerned hopes that some solution is on the way. □

PSYCHO- WHAT?

Psychoacoustics.

*Without understanding our
perception of music,
how could we reproduce it?*

DEPENDING on your point of view, it would be accurate to describe contemporary audio reproduction as being either essentially perfect or abysmally poor. The difference in perspective, of course, depends on your method of evaluation.

On one hand, a CD player may have a total harmonic distortion of 0.002 percent, a signal-to-noise ratio of 110 dB, and virtually unmeasurable wow-and-flutter—specifications that surely pose few problems for music reproduction. On the other hand, if you played a compact disc of Beethoven's Ninth Symphony, absolutely no one would be fooled into thinking it was an actual live performance and not a mere recording. In spite of its apparent technical perfection, our audio equipment remains an obstacle to music re-creation.

For argument's sake, let's take the pessimistic view and consider the impossibility of the problem before us. Suppose we have a room with two loudspeakers at one end and a chair in the middle. It is unlikely that a true re-creation of the Ninth Symphony could ever come from such an

by Ken C. Pohlmann

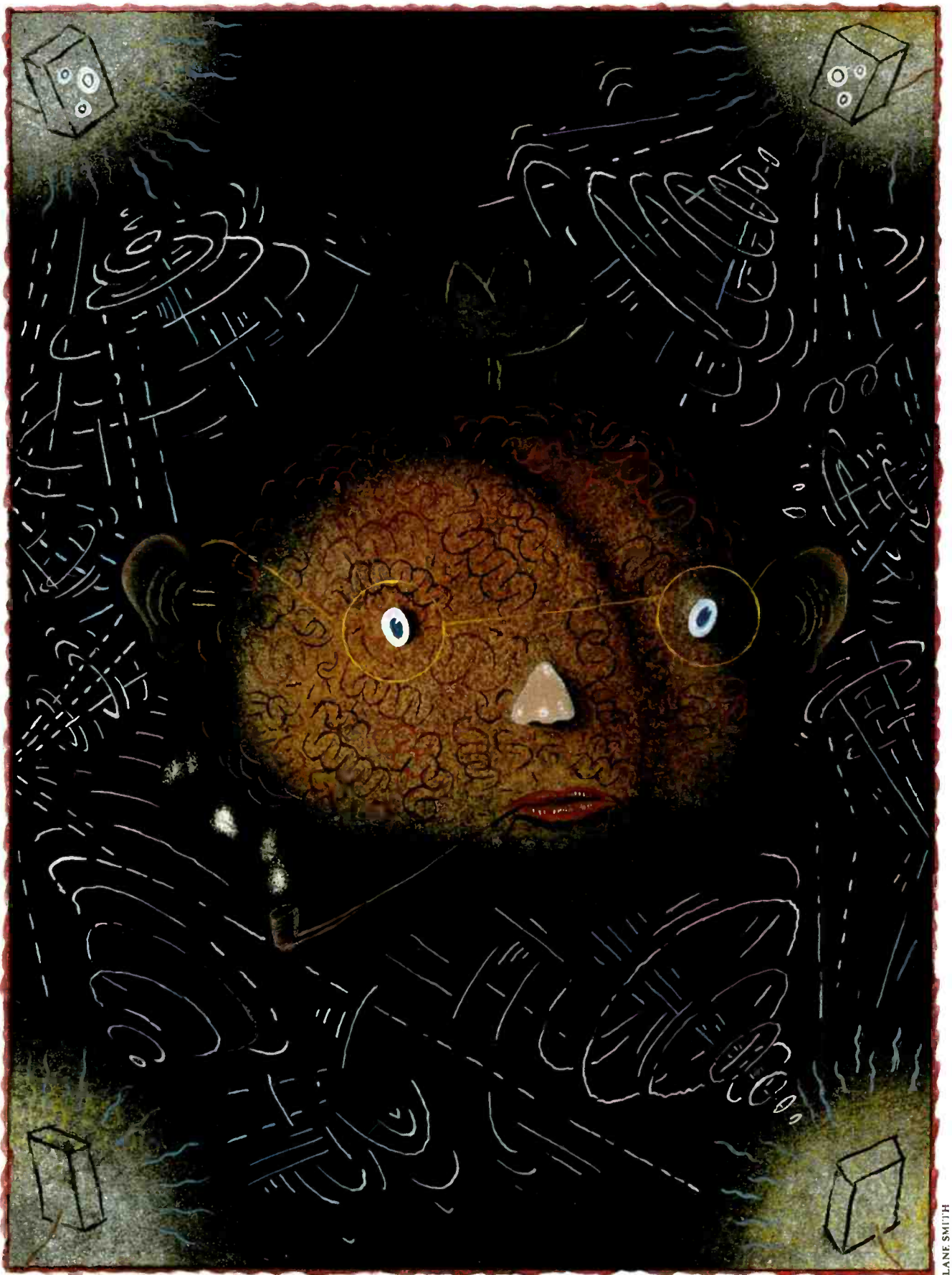

LANE SMITH

arrangement; how could dual-mono sources convey the impression of more than a hundred performers on a stage? In fact, we are only listening to a reproduction of the original event, one many generations removed from reality. Recording engineers perhaps have a better handle on the problem because they refer to loudspeakers as "monitors," clearly indicating that their purpose is merely to monitor what's going on and never to re-create it exactly.

Since the invention of the phonograph in 1877, audio engineers have refined that technology—and devised new ones—to reduce unwanted artifacts in equipment performance, culminating in digital equipment with its awesome specifications. The unwritten assumption has been that better technology would result in better reproduction. Surely that is true. But the fact that the good equipment we have today still fails to convey a sense of reality in music reproduction suggests that the effort has failed to consider all of the variables in the problem.

Psychoacoustics may help supply some of the missing variables. Rather than starting from a technological basis, psychoacoustics seeks to understand the problems of audio from a perceptual standpoint. As a discipline, psychoacoustics correlates acoustical stimuli with the psychological responses they evoke in the listener. In other words, psychoacoustics seeks to explain the listening experience itself. Clearly that's important; without understanding our perception of music, how could we ever artificially reproduce it? Thus, psychoacoustics is the final arbiter in audio. After all, ultimately it is only our response to sound that matters, not how the sound is produced.

Unfortunately, whereas audio electronics has evolved speedily over the last century, the progress in psychoacoustics has been a good deal more subtle. For example, the most fundamental question, how the ear responds to sound, is still a debatable issue. In 1857 Baron Helmholtz theorized that the inner ear's basilar membrane responds to particular frequencies, thus providing pitch discrimination as its vibrations are transformed into nerve impulses and sent to the brain. That theory was modified in 1956 by Georg von Békésy (who won a Nobel Prize for his work) and is generally accepted today. But arguments



about just how the ear works still rage. For example, Hugo Zuccarelli, founder of Zuccarelli Communications, insists that the ear emits a tone and that hearing is accomplished through analysis of an "acoustical hologram." Although the idea is greeted with skepticism by the traditional psychoacoustics community, MIT researchers have indeed detected a tone in the ears of some people. Its purpose, in their opinion, remains a mystery.



As a science unable to agree even on the operation of the primary sensory organ it studies, psychoacoustics has been prone to receive more than its fair share of scorn. But, in all fairness, it is also one of the most difficult of disciplines. Only a few researchers have the multifaceted scientific knowledge necessary to work in the field. Consider the work of researcher William S. Rhode (who improved on the findings of Békésy): To study the operation of the ear, he fixed a gamma-ray source to the basilar membranes of anesthetized squirrel monkeys so that motion in the membrane could be detected through Doppler shifts in the gamma rays caused by that motion. It is easy to see why most audio engineers instead prefer to reduce harmonic distortion in a circuit by another 0.001 percent.

Fortunately, many aspects of hearing are fairly well understood. Everyone agrees that the ear can detect amplitude, frequency, tonali-

ty, and directionality. The last, directionality, provides an excellent window onto some of the ear's most interesting aspects. Leslie R. Bernstein and Constantine Trahiotis have demonstrated, in work done in the Dept. of Speech and Hearing Science at the University of Illinois, that localization of a sound source is accomplished through several cues. Two of the most important are "interaural temporal disparities," or time differences between the ears, and "interaural intensity disparities," or intensity differences between the ears. In both cases the brain apparently compares how sounds strike each ear to help determine the location of the source.

For example, a sound from the left would strike the left ear before the right, and the listener would correctly localize the sound on the left. Similarly, a sound is louder at the ear nearer the source because amplitude falls off over distance and because of the head's own acoustical shadow. It also appears that reflections from the outer ear's folds and ridges help by causing a kind of comb filtering that is interpreted as directional cues by the brain; in other words, the perceived frequency response of a signal helps us determine the source's location.

But psychoacoustics isn't just a theoretical science. If its findings about the perception of sound were applied to the function of loudspeakers in a room, it should be possible to improve on the realism of music reproduction. If we knew how a reproduction differed psychoacoustically from an original acoustical event, we might be able to compensate for the difference. Of course, that idea isn't new. Researchers such as Ben Bauer at the old CBS Laboratories looked at the problem way back in 1961. Since then a number of audio companies have aggressively pursued their own research, and both recording and reproduction systems using psychoacoustic principles have reached the market.

For example, Hughes Aircraft's Sound Retrieval System (SRS) shapes the frequency response of a signal to dictate our perception of its location, supplying vital information that conventional microphones cannot. Except in the special case of binaural recording (which uses microphones inside the ears of a dummy head), recording microphones do not pick up directional

Everybody Wants My RoomMate®...

6/4
FROM DAY ONE
I KNEW I'D FOUND
THE PERFECT
ROOMMATE.

7/1
MY
GIRLFRIEND
AGREED.
SHE WANTED
MY ROOMMATE
MORE THAN
ME.



8/15
EVEN MY
ROOMMATE
WANTED
MY ROOMMATE.



9/4
MY BROTHER
SNUCK OFF WITH
MY ROOMMATE
TO COLLEGE.

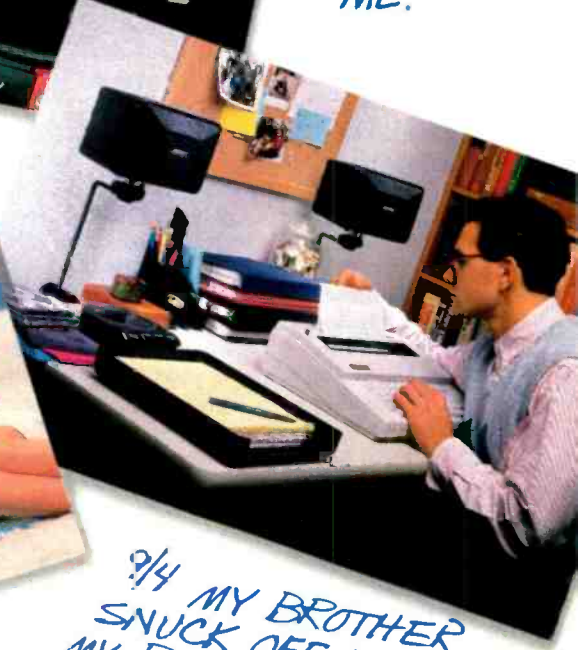

The Bose® RoomMate® II portable powered speaker system: high performance stereo for home and beyond.

Imagine having a rugged, go-anywhere sound system that fills your room—and your life—with high performance sound. That's the Bose RoomMate II speaker system!

Clear highs. Rich mid-range. Deep, powerful bass. All in a package small enough to go where you do.

At the heart of the system is a 4 1/2" Bose Helical Voice Coil driver delivering unmatched accuracy, efficiency, and reliability. Other features include a built-in amplifier and active equalizer for true high fidelity and aerodynamically tuned ports for impressive bass.

Since the system is already powered, you don't need an external amplifier. Just plug it into a portable CD player and you'll have all the stereo you need. And with

custom mounting accessories, you can put it in the most improbable places!

Stereo to go!

Headed to the lake? The beach? The mountains? Pack the RoomMate II system in its optional PC-1 powercase, and enjoy music for up to 12 hours at full volume! Then recharge it overnight. For music on the road or in the boat, simply plug in the car adapter.

"If music is important in your life, sooner or later you will own a Bose system."

For more information, call: 1-800-444-BOSE.



BOSE
Roommate II

© Copyright 1989 Bose Corporation,
The Mountain, Framingham, MA 01701-9168, USA
(508) 879-7330 FAX: (508) 872-6541
Bose products are distributed worldwide.

information in the same way as human ears. As a result, sound recorded through them is spectrally distorted and will suffer spatial distortion in the sound field when the recording is played back. The SRS circuit helps to restore correct spatial cues for the ear by selectively boosting parts of a recording's ambient signal (indirect sound). The result is more realistic reproduction and less critical listener positioning. The SRS circuit will be available in Sony stereo television sets this fall.

While the SRS system corrects for directional deficiencies in recordings, it perhaps makes more sense to record correctly in the first place. An early example of a more enlightened approach to microphone design was the Ambisonics concept behind the Calrec Soundfield microphone, which specifically attacks directional distortion by using a geometrical array of four microphone capsules. Signal addition and subtraction, equalization, filtering, and phase correction are employed to generate the encoded output signals, which contain directional information over a full 360 degrees.

The Calrec microphone has been used for many recordings (you can spot its use by the initials UHJ on a recording's cover), and its signals are stereo compatible. For full directionality in playback, however (that is, a realistic sound field from a few loudspeakers), you need an Ambisonics decoder. Unfortunately, while the Calrec microphone has found acceptance among professional recording engineers, consumers haven't embraced the decoder.

At the other end of the audio chain, loudspeaker design itself is profiting from the consideration of psychoacoustics. Companies such as Polk Audio have developed loudspeakers that seek to control interaural crosstalk. Although this crosstalk is an inescapable result of stereo reproduction, overcoming its effect can widen the "sweet spot" between speakers and improve imaging. Each of Polk's Stereo Dimension Array (SDA) loudspeakers contains a second set of drivers that reproduce the difference signals derived from the phase-inverted signal from the opposite channel. Because the secondary drivers are placed a head's width from the primary speakers, the sound from the left secondary drivers arrives at the left ear at the same time as the sound from the right loudspeaker, psy-



choacoustically canceling the crosstalk. That tricks the brain into thinking that each ear hears sound from only one source (the left or the right speaker), as with headphones.

Bose has tackled the problem of a small sweet spot with its Point Two Series loudspeakers, which shape their radiation patterns asymmetrically toward the middle of the room. As the listener moves toward one loudspeaker, its perceived loudness decreases relative to the other's. The increased loudness of the farther speaker at that position compensates for the later arrival of its sound. Bose has also probed psychoacoustics in work toward a headset designed for aircraft use, where intelligibility is often degraded by ambient noise. The headset feeds an inverted replica of the noise to the ears, where it and the real noise cancel each other, leaving a relatively silent background.



ETER Myers, a California inventor and entrepreneur, recently announced that he had developed a mathematical model for human sound localization. When the proper parameters are computer-adjusted in the recording chain, the sound field from two loudspeakers can, according to the inventor, be extended to "position each sound from an infinite number of points in the room." The needed cues can be recorded on just two channels.

Myers patented the technique while working for NASA, and he expects to develop it further for pro-

fessional recording gear and other applications, including avionics—for example, a radar system that would help a pilot sense the location of other aircraft through the use of directional sound. (The curious can check patent No. 4,817,149.)

Armed with a keen understanding of psychoacoustics, engineers could advance audio recording and reproduction tremendously. In a recent issue of *Business Week*, Matthew Polk of Polk Audio declared that "Psychoacoustics is the new frontier in sound." For example, we could use digital signal processing to encode psychoacoustical cues in a recorded signal that would enhance the realism of the playback. Or we could optimize a recording for different kinds of reproduction devices: home loudspeakers, a car system, or headphones. Or we could minimize the effects of loudspeaker placement. Whatever the application, psychoacoustic considerations combined with the advanced technology found in components such as CD players and digital preamplifiers could indeed result in a convincing Beethoven Ninth.

As researchers move further toward a complete understanding of the human auditory system, we may see less emphasis on traditional ways of measuring the worth of an audio system and a move toward wholly new descriptions. Human auditory systems simply do not process acoustical information the same way that electronic instruments do. Our hearing system provides information about a sound source's relationship to its acoustic environment. It is this interpretive power of our perception that is important, not simple measured acoustic properties.

In the future we will need to correlate measurements more closely with our perception. You'll know that psychoacoustics has truly arrived when, along with specifications like harmonic distortion and wow-and-flutter, you see equipment specified in terms of neural activity in the auditory cortex. That will mean that we have a real handle on how the brain processes auditory information. Then we'll have the key to music re-creation instead of just reproduction. The only task after that would be to generate a neural response directly and forget about the ear altogether. But that's a problem for audio researchers in the next millennium. □



RX-1130 RECEIVER

125 watts per channel into 8 ohms from 20-20,000 Hz at no more than 0.015% THD
Low impedance drive capability provides 360 watts per channel into 2 ohms dynamic power
Additional amplifier section for two rear channels with rear channel level control
Five digital Surround Sound modes (Dolby,* Natural, Hall, Simulated Stereo, Live)
Computer Servo Lock tuning
MM/MC Phono Selector
Banana plug compatible speaker connection terminals
24-segment signal quality meter
Continuously variable loudness control
Learning-capable multi-function remote control
Eight audio inputs, three video inputs
Four audio outputs, three video outputs
S-VHS compatible
Separate front and rear pre-main coupling terminals
Eight-mode REC OUT selector
Continuously variable delay time control
CD Direct switch
Motor-driven volume control with LED indicator
Sleep timer
Center defeat bass/mid-range/treble tone controls
16-station random access preset tuning with multi-status memory
Absolute Linear Amplification (ALA) circuitry
Preset indicators with preset number and station frequency
Front panel headphone jack
Tone bypass switch
High-gain AM loop antenna
Manual or auto IF Mode selector (wide or narrow)
Auto search tuning
Manual up/down tuning

If any of these features compromised its sound, this is the first thing we'd remove: **YAMAHA®**

TOP OF THE LINE

SUBWOOFERS

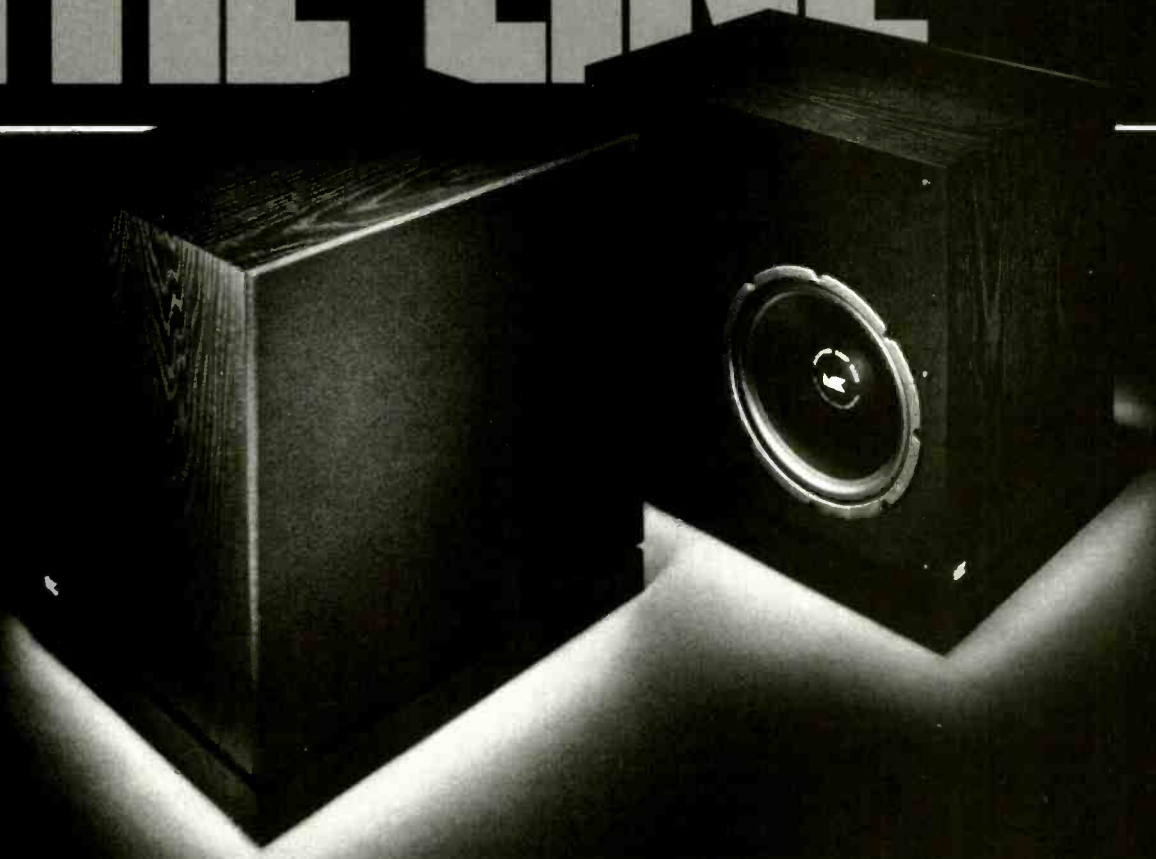

MX-2000 Push-Pull Dual Driver Powered Subwoofer

The new standard of subwoofer excellence has arrived—the M&K MX-2000. Reaching a new pinnacle in performance, the MX-2000 powered subwoofer proudly becomes the top of the audio industry's *only* eight model line of subwoofers.

The MX-2000 achieves this status by bringing together great clarity and detail; tremendous low frequency power and impact; high sound power levels down to 20 Hz; plus the ability to seamlessly blend with any speaker.

The 300 watt continuous RMS MX-2000 incorporates M&K's remarkable new Horizontal Push-Pull Dual Driver System—producing the lightest,

cleanest and most powerful bass M&K has ever offered. This innovative system delivers superior transient performance; lowers harmonic distortion; reduces cabinet coloration and vibration; and couples remarkably well to the listening room.

Building On Excellence

Fifteen years of unmatched experience puts M&K at the forefront of the subwoofer industry. No other manufacturer offers as wide a variety of styles and sizes of high-performance subwoofers. From the very affordable to the state-of-the-art, M&K subwoofers are unsurpassed in audio and audio/video system performance.

And, M&K offers the ultimate Satellite-Subwoofer systems, with a

choice of five highly acclaimed Satellite speakers. These small speakers are optimized for music or multi-channel surround-sound home theatre systems, and actually outperform large speakers.

The Only Choice

Building on M&K's legendary high level of subwoofer excellence, the MX-2000 becomes M&K's finest achievement in a subwoofer—blending seamlessly with any speaker. For high-performance audio and audio-video systems, the MX-2000 is "the only choice."



MILLER & KREISEL
SOUND CORP.

10391 Jefferson Blvd., Culver City, CA 90232 213/204-2854

CIRCLE NO. 48 ON READER SERVICE CARD

BEST RECORDINGS OF THE MONTH

Stereo Review's critics choose the outstanding current releases

MARSHALL CRENSHAW'S "GOOD EVENING"

MARSHALL CRENSHAW'S first album, a 1982 release, was so well crafted, so filled to bursting with magnificent pop/rock tunes magnificently played and sung, that his subsequent career, estimable as it's been, has always felt like something of a letdown. Now, however, after his appearance in *La Bamba*, where he nearly stole the picture with his portrayal of Buddy Holly as a hipster, Crenshaw finally weighs in with a new album, "Good Evening," that's as big a knockout as his stunning debut.

Cynics, of course, will suggest that the new album's high memorability quotient derives from Crenshaw's having availed himself, basically for the first time, of material from other writers. That shouldn't bother anybody, however, because it turns out that Crenshaw is as good an interpreter as he is a composer. In fact, he takes over the borrowed songs so completely that they all sound as if he would have written them himself if he'd gotten around to it. His version of Richard Thompson's *Valerie*, for example, recasts what was originally a sort of Celtic rocker into a wonderfully endearing slice of Cajun Merseybeat. And he makes John Hiatt's *Someplace Where Love Can't Find Me* a nearly perfect piece of power pop with a vocal performance so winsome and haunting that it's hard to imagine the song working for any other singer (and certainly not for a bluesman like Hiatt).

But the new originals are pretty swell, too, especially *She Hates to Go Home*, an immensely seductive ballad inhabiting a space between the Drifters and "Beatles VI," and *Radio Girl*, an ode to a disc jockey that isn't quite up there with Mojo

Nixon's *Stuffin' Martha's Muffin* but comes close enough.

"Good Evening" is also, perhaps not coincidentally, Crenshaw's best-sounding record, for which thanks are clearly due producer David Kershbaum. For once in a Crenshaw album, everything—drums, guitars, vocals—is big and right in your face, without the patina of murk this artist has sometimes misguidedly passed off as a Wall of Sound. Here, instead, Kershbaum's uncluttered directness serves the songs with remarkable aptness—giving, for example, a roots rocker like *Whatever Way the Wind Blows* exactly the Hank Williams Meets Dave Edmunds clarity it deserves.

Still, in the end, this is Crenshaw's album, and even when he's covering an obscure oldie like Bobby Fuller's *Let Her Dance* (a version that screams "hit," by the way), it's his sensibility and musical values that define the album's overall feel. "Good Evening" is one terrific piece of work that represents a long-

overdue return to form for Marshall Crenshaw. Pop heaven begins here.

Steve Simels

MARSHALL CRENSHAW: *Good Evening*. Marshall Crenshaw (vocals, guitar); Graham Maby (bass); Kenny Aronoff (drums); other musicians. *You Should've Been There; Valerie; She Hates to Go Home; Someplace Where Love Can't Find Me; Radio Girl; On the Run; Live It Up; Some Hearts; Whatever Way the Wind Blows; Let Her Dance*. WARNER BROS. 1-25908, © 4-25908, © 2-25908 (38 min).

EMANUEL AX PLAYS HAYDN SONATAS

HAYDN'S piano sonatas have in a sense been the Cinderellas among his instrumental works, far less prominent in the public's awareness, and far less seriously regarded, than his symphonies, his string

Marshall Crenshaw: as good an interpreter as he is a composer



BEST RECORDINGS OF THE MONTH

CHRISTIAN STEINER/ICM ARTISTS



Emanuel Ax: crystalline Haydn

quartets, and his piano trios. They have had their occasional champions on record: Alfred Brendel, András Schiff, Glenn Gould, Artur Balsam, and, most persuasive of all, Gilbert Kalish (in his still-uncompleted project for Nonesuch). The newest to enter the lists is Emanuel Ax, who plays four of the most substantial of the sonatas on a new CBS disc—two of the latest and greatest, both in C Major, and two of the most attractive of the earlier ones, in C Minor and F Major. None of them has been heard to better advantage in recordings.

Understanding and enthusiasm go hand in hand in Ax's enlivening approach, which is characteristically straightforward and uncluttered. These are large-scale interpretations, but they are not inflated with "scholarly" gestures or pronouncements; the music flows with apparent spontaneity, but the profundity is there, the insights are there, just as surely as the technical assurance. And what assurance! One can hardly help noticing the beautiful evenness in the runs, the crystalline beauty of every note in the spring-like flow, but Ax never allows the awareness of such factors—on the listener's part or his own—to get in the way of the music.

One of the measures of a true artist, setting him apart from performers for whom the term is a mere courtesy, is a sustained capacity for growth. All the freshness of spirit and affection for the material at hand that have informed Ax's earlier performances are in evidence

here, but these qualities are combined now with a still deeper sense of assurance, of compassion, of the illuminating balance of warmth and humor we associate with Haydn himself.

This release has not been announced as the beginning of a complete Haydn series, and I like the idea that it doesn't have to be. Almost all of the Haydn sonatas are remarkable works, and these four are no less so for being *only* four. They are, in fact, among his very finest works, and the listener unfamiliar with this part of the beloved composer's output could hardly ask for a handsomer introduction to it. The recorded sound is exemplary, and the documentation is first-rate too. Quite possibly the piano recording of the year.

Richard Freed

HAYDN: *Keyboard Sonatas: No. 58, in C Major (Hob. XVI:48); No. 33, in C Minor (Hob. XVI:20); No. 60, in C Major (Hob. XVI:50); No. 38, in F Major (Hob. XVI:23).* Emanuel Ax (piano). CBS © MT 44918, © MK 44918 (64 min).

"TRIBUTE TO JOHN COLTRANE"

On July 26, 1987, in Tokyo, a concert in the city's tenth annual Live Under the Sky series commemorated the twentieth anniversary of the death of saxophonist John Coltrane. And it was CBS/Sony's splendid idea to record it, resulting in the new "Tribute to John Coltrane."

Coltrane's spirituality has been described in reams of unbelievably bad prose (including the rambling liner notes that accompany the new album). The hype sometimes overwhelms people who are being introduced to his artistry, and, indeed, it has brought him followers who show less appreciation for his music than for the myths surrounding him. Zealous fans have a tendency to forget that while Coltrane was a wonderfully creative musician, a true original, he neither walked on

water nor changed it into wine. He did, however, alter the course of jazz, and many of his disciples have succeeded in their own right.

Two decades after his death, the disciples keep emerging. Among the established players who have followed Coltrane's path are saxophonists Wayne Shorter and Dave Liebman, the front line of the album's all-star quintet. Both are heard on soprano saxophone, an in-



John Coltrane: a true original

strument that Sidney Bechet introduced to jazz in its early days. Bechet's mastery of the soprano is not what inspired Coltrane to pick it up, as has been suggested. He told an interviewer that his introduction to the instrument came about by accident. Returning to New York from a Washington job in 1959, one of Coltrane's colleagues wandered off during a rest stop, leaving his instruments behind; Coltrane took them home, was intrigued by the small, straight saxophone, tried it, and liked it. The soprano saxophone was perfectly suited to his so-called "sheets of sound" style, and his frequent use of it reinstated it as a jazz instrument.

"Tribute to John Coltrane" is an inspired album that captures the intensity and beauty of Coltrane's music as the five players sail through as many of his compositions. Shorter and Liebman give dynamic performances; each has his own approach, but they're clearly on the same wavelength. The rhythm section, an integral part of the quintet, has pianist Richie Bei-

CHUCK STEWART/VAI



Take Ten

Introducing the
new ten disc
CD Changer,
another industry
first* from Ford.

Now you can enjoy hours of continuous music without having to load, unload, or store your compact discs while you drive.

This new state-of-the-art system uses interchangeable ten disc magazines in a changer unit that is stored safe and secure in the trunk of your car. And a full-function remote control allows the selection of any track on any disc

at the touch of a button.

The new ten disc CD Changer is compatible with any Ford, Mercury or Lincoln equipped with the optional Ford High Level Audio or Ford JBL Audio system. See your local Ford or Lincoln-Mercury dealer for details.

The new ten disc CD Changer from Ford. We're sure you'll rate it a "perfect 10."

*First optional dealer-installed CD Changer available from a U.S. automobile manufacturer.



AUDIO SYSTEMS
The Sound of Quality

BEST RECORDINGS OF THE MONTH

...rach weaving stunning melodies into the intricate rhythm patterns of bassist Eddie Gomez and drummer Jack DeJohnette. I could not begin to single out one moment from this exciting salute to the last great jazz stylist; there are so many fine ones. And the playing makes me hope that the quintet featured in this excellent live recording is soon reassembled. *Chris Albertson*

TRIBUTE TO JOHN COLTRANE—LIVE UNDER THE SKY. Wayne Shorter, Dave Liebman (soprano saxophone); Richie Beirach (piano); Eddie Gomez (bass); Jack DeJohnette (drums). *Mr. P.C.; After the Rain/Naima; India/Impressions.* COLUMBIA ● FC 45136, © FCT 45136, © CK 45136 (49 min).

HOWARD HANSON, AMERICAN ROMANTIC

EVEN more than Samuel Barber, Howard Hanson (1896-1981) can be described as the American Neoromantic composer *par excellence*. It would not be amiss, for that matter, to speak of Hanson as a U.S. counterpart to Rachmaninoff, though with a Scandinavian-American accent instead of a Russian one. The early Hanson symphonies, like Rachmaninoff's, are splendidly effusive, gorgeously orchestrated, rich in harmonic texture, and—especially in No. 2—generous with the “big tune.”

Hanson's first two symphonies, the *Nordic* (1922) and the *Romantic* (1930), are included in the first disc of a Delos series that is planned to encompass all seven. Both are three-movement structures. The *Nordic* Symphony was composed when Hanson was on a Prix de Rome fellowship; the *Romantic*, commissioned for the Boston Symphony Orchestra's fiftieth anniversary, has remained something of a classic in the American concert repertoire and has been fairly often recorded.

The *Nordic*, at least to my ears, does not convey the sense of inevitability achieved by its successors.



Gerard Schwarz: resplendent Hanson

Only in the final movement, when an epic funereal motive comes into play, with punctuation by a huge bass drum, does Hanson strike symphonic gold. With the *Romantic* Symphony there are no such problems, and if today we are bothered by what sounds like a succession of Hollywood film-music clichés, it should be remembered that in 1930 such musical rhetoric was somewhat novel.

The performances of both works, by the Seattle Symphony led by Gerard Schwarz, stand up to the very best, including the composer's own, and are recorded in most resplendent fashion. I have had my reservations about the acoustics of the Seattle Opera House, but this time engineer John Eargle and his colleagues have got it dead right!

A lovely bonus, fitted between the two symphonies on this well-filled CD, is the poignant and beautifully crafted *Elegy in Memory of Serge Koussevitzky* that Hanson composed in 1955 for the seventy-fifth Boston Symphony season. Chalk this disc up as a major achievement by Schwarz, his orchestra, and Delos. I look forward to more of the same as the series continues.

David Hall

HANSON: *Symphony No. 1, in E Minor, Op. 21* (“Nordic”); *Symphony No. 2, Op. 30* (“Romantic”); *Elegy in Memory of Serge Koussevitzky, Op. 44.* Seattle Symphony Orchestra, Gerard Schwarz cond. DELOS ● D/CD 3073 (71 min).

NOW ON CD

*Compact Discs of
previously released LP's*

POPULAR

□ **HARRY BELAFONTE:** *At Carnegie Hall.* RCA 6006-2-R. Originally released in 1959, the LP was on the *Billboard* chart for over three years.

□ **THE BYRDS:** *Never Before.* MURRAY HILL 32280-2. The ten “lost” tracks first released on LP and cassette in 1987, including a previously unreleased stereo mix of *Mr. Tambourine Man* and seven other tracks of unreleased material.

□ **ROBERT HUNTER:** *Tiger Rose.* RYKO RCD 10115. Country rock by the Grateful Dead lyricist, originally released in 1975.

□ **KEITH JARRETT:** *Personal Mountains.* ECM 1362. A concert recorded by the pianist's quartet in Tokyo in 1979, with a nine-minute track now available on CD only.

□ **LAWRENCE OF ARABIA** (Maurice Jarre). SILVA SCREEN FILMCD 036. A new recording of music from the film, including fifteen minutes of music omitted from the original-soundtrack album of 1963.

□ **THE ROCKY HORROR SHOW** (Richard O'Brien). ODE/RHINO R2 70090. The 1974 recording of the first American stage production, at the Roxy in Los Angeles, of the British rock musical whose film version developed a cult following in this country.

□ **FRANK ZAPPA:** *Broadway the Hard Way.* RYKO RCD 40096. Live recordings from Zappa's 1988 tour, plus eight CD-only bonus tracks.

CLASSICAL

□ **BACH:** *Sonatas and Partitas.* Menuhin. ANGEL CDHB-63034 (two CD's). Recorded in the mid-Thirties.

□ **BRITTEN:** *Billy Budd.* Glossop, Pears; Britten. LONDON 417 428-2 (three CD's). “Richly sung” (Best of Month, January 1969).

□ **GROFÉ:** *Grand Canyon Suite; Piano Concerto.* Sanromá, Grofě. PHILIPS 422 304-2. Recorded in 1960 by the Rochester Philharmonic.

□ **REICH:** *Drumming; Six Pianos.* Reich. DG 427 428-2. “At once exciting and boring” (June 1975).

□ **VERDI:** *Macbeth.* Milnes, Ludwig; Böhm. LEGATO LCD-143-2 (two CD's). Recorded in Vienna in 1970.

□ **WAGNER:** *Wesendonk-Lieder; Arias.* Flagstad. ANGEL CDH-63030. Recorded 1948-1951, with pianist Gerald Moore accompanying in the *Wesendonk* songs.

EXPENSIVE SOUNDING SPEAKERS!

Speakers are *the most important part* of your stereo system. It is the speaker that turns amplifier signal into sound and so ultimately determines what you hear. If your speakers do not perform well, your stereo system will simply not sound like music.

The search for musically satisfying speakers, however, can lead to some very expensive products. And if you have already bought those high priced speakers, then you better not listen to Paradigms. But if you haven't, better not miss them. Why? Because from the time they were first introduced, Paradigm's sheer musical ability utterly amazed listeners... but what caused even more amazement was the *unprecedented low price*.

So go ahead, get expensive sounding speakers... without the expense. Visit your authorized Paradigm dealer... *and listen*.

The critics agree:

"... For once we wholeheartedly agree... the Paradigm is most definitely a no-compromise two-way design capable of outperforming systems costing several times as much."

- Hi Fidelity Magazine

"... natural, open and clear... excellent depth... lots of hall sound... big, expansive soundstage... well defined... a rare achievement for any loudspeaker, but when the price is taken into account the Paradigm's performance must be considered as nothing short of remarkable."

- Sound & Vision Magazine

Sound & Vision



CRITIC'S CHOICE AWARD

Paradigm[®]

music . . . above all.

In the U.S.: AudioStream, MPO Box 2413, Niagara Falls, New York 14302
In Canada: Paradigm Electronics Inc., 457 Fenmar Drive, Weston, Ontario M9L 2R6

POPULAR MUSIC

*Discs and tapes reviewed by
Chris Albertson, Phyl Garland,
Ron Givens, Roy Hemming,
Alanna Nash, Parke
Puterbaugh, Steve Simels*

MARCIA BALL: *Gatorhythms*. Marcia Ball (vocals, keyboards); other musicians. *How You Carry On; La Ti Da; The Power of Love; Mobile; Find Another Fool; and five others*. ROUNDER 3101, © C-3101, © CD-3101 (34 min).

Performance: *Irrepressible*
Recording: *Very good*

When Marcia Ball cuts loose, you can't remain still. She has a crisp voice that's strong enough to belt a tune to the back



Sarah Brightman: spirited revivals

of a smoky bar and vulnerable enough to make the world share her blues. Her two-fisted piano style delivers rhythmic thunder with her left hand and melodic lightning with her right. Now a fixture in the Austin, Texas, music scene, Ball grew up in southern Louisiana, and "Gatorhythms" draws heavily on what she must have heard as a kid. From steady rolling Cajun to flat-out r-&-b, she plays and sings up a storm.

How You Carry On starts the album off on a strong note. This classic New

EXPLANATION OF SYMBOLS:

- = DIGITALLY RECORDED LP
- Ⓢ = TAPE CASSETTE
- Ⓢ = COMPACT DISC (TIMINGS ARE TO NEAREST MINUTE)

Orleans rocker, co-written with Dr. John, gets its gusto from Ball's rollicking piano—an irresistible mix of pumping bass and trilling treble. Elsewhere in the album she shows considerable compositional talent, having written or co-written seven of the nine other tunes. *Mobile* represents the boogie-woogie side of her personality, with a breezy lyric to match: "Mobile by the beautiful bay/Mobile why did I ever go away?" But she shows a tender side as well in songs like *The Power of Love*, *Find Another Fool*, *What's a Girl to Do*, and *You'll Come Around*. For all of her bravado, and her fealty to the r-&-b tradition of betrayed woman, Marcia Ball has a hurtin' side, too. She may be a hot lady who makes hot music, but she's also been burned. *R.G.*

CLINT BLACK: *Killin' Time*. Clint Black (vocals, acoustic guitar, harmonica); the Clint Black Band (instrumentals); vocal and instrumental accompaniment. *Straight from the Factory; A Better Man; Nobody's Home; Walkin' Away; and five others* (six others on CD). RCA 9668-1-R, © 9668-4-R, © 9668-2-R (31 min).

Performance: *A winner*
Recording: *Good*

With two one-syllable names and a face that weds the earnestness of Roy Rogers with the anxiety of Gary Cooper, Clint Black seems at first to be just a "Yep" and "Nope" kind of guy himself, thrust into the RCA spotlight as a foil for Warner Bros.' Randy Travis and MCA's George Strait.

But Black is a comer. Unlike Strait, who doesn't write at all, and Travis, who only picks up the pen once in a while, Black has a few things to say, both on his own and in tandem with Hayden Nicholas and Dick Gay, members of his road band who helped him shape this head-turning debut. But Black never lets the air get too rarified, even if a lyric or two ("you're the only lock that's made to fit my key") would likely make ol' Coop blush.

A Houstonian by birth, the twenty-seven-year-old Black grew up playing at country dances and clubs, and today he knows that if you're gonna keep 'em happy, you've gotta keep 'em twirlin'. Every song here is a lesson in classic, unpretentious country songwriting (in *A Better Man*, he makes being abandoned by his girl friend a positive learning experience), but every one is also a two-step, a Cajun waltz (complete with stuttering fiddle), or a slow country ballad, perfect for messing up a sawdust dance floor. In the end, though, it's the honky-tonk Black does best, moaning a hard country blues in *Killin' Time*, where he considers drinking himself to eternity in a perfect Keith Whitley exit.

Producers James Stroud and Mark Wright have seen to it that Black varies his material, but it's hard to listen to any of this album without also hearing mimicry of the young singer's heroes, predominantly Merle Haggard but also George Jones and Hank Thompson. Without question, Black lacks the vocal richness that comes naturally to those giants, and while he does write from personal experience, some of his world-weariness seems more like imitation than from the heart.

Still, with music as ingratiating as this, it's a pleasure to stick around while Black earns that fatigue on his own. He makes writing lyrics seem as easy as lifting longnecks, and he somehow finds melodies that wear as comfortably as a favorite pair of jeans. RCA has lassoed up a winner. You can carve his name on the fencepost anytime. *A.N.*

SARAH BRIGHTMAN: *The Songs That Got Away*. Sarah Brightman (vocals); orchestra, Marvin Hamlisch, Harry Rabinowitz, Michael Reed cond. *Meadowlark; If Love Were All; I Remember; Mr. Monotony; Silent Heart; Half a Moment; and eight others*. POLYDOR ● 839 116-1, © 839 116-4, © 839 116-2 (50 min).

Performance: *Appealing*
Recording: *Generally good*

Sarah Brightman, who had as many detractors as admirers for her Broadway performance last year in husband Andrew Lloyd Webber's *Phantom of the Opera*, should win many new friends with this album. Produced by Lloyd Webber himself and recorded in New York, London, and Vienna (which explains the multiplicity of conductors and sonic differences in ambience), it reveals that the sweet-voiced English soprano can sing with much more spirit and feeling than *Phantom* indicated. In fact, she really gets down for Irving Berlin's teasing *Mr. Monotony*, which was written for Judy Garland in 1948's *Easter Parade* but was cut from that film as well as from two later stage shows.

The other songs are mostly good ones too, from such forgotten shows as Stephen Sondheim's *Evening Primrose* (written for television in 1966), Richard Rodgers's *Rex* (Broadway 1976), Steven Schwartz's *The Baker's Wife* (which closed out of town in 1976), Marvin Hamlisch's *Jean Seberg* (London 1983), and Lloyd Webber's *Jeeves* (London 1975). There's also an interesting "early draft" of Frank Loesser's *Fugue for Tinhorns* from *Guys and Dolls*, here titled *Three-Cornered Tune*. I'm not quite sure what Noël Coward's hardly obscure *If Love Were All* is doing in such company, and Brightman's pinched, thin-sounding "*Chi il bel sogno*" (from Puccini's *La Rondine*) is completely out

of place. But she does nicely by the lovely, operetta-ish *Silent Heart* from Vivian Ellis's 1947 London hit *Bless the Bride*. R.H.

MARSHALL CRENSHAW: *Good Evening* (see Best of the Month, page 123)

DR. JOHN: *In a Sentimental Mood*. Dr. John (vocals, keyboards); Jeff Porcaro (drums); Hugh McCracken (guitar); other musicians. *Makin' Whoopee!*; *Candy*; *Accentuate the Positive*; *My Buddy*; *In a Sentimental Mood*; and four others. WARNER BROS. 25889-1, © 25889-4, © 25889-2 (40 min).

Performance: *Classy*
Recording: *Excellent*

We need another album of pre-rock pop tunes about as much as we need Wynton Marsalis arguing that jazz died sometime after the composition of *A Night in Tunisia*. But this major-label return by the estimable Dr. John, in which he recasts a bunch of generally familiar tunes from the days before Elvis Presley in his inimitable New Orleans barrelhouse style, is fun without a hint of condescension to the material. A good song is a good song whatever its age would seem to be the message here, and the good Doctor—a great pianist and a likably gruff singer—has chosen a bunch of very good songs by Harold Arlen, Duke Ellington, and Cole Porter, among other worthies, that need no defense whatever from a rock-era snot like me.

The best thing here may be the truly hilarious, bluesy version of *Accentuate the Positive*, although I'm also much taken with the neatly spiteful-sounding *Don't Let the Sun Catch You Cryin'* (not, praise be, the lachrymose Gerry and the Pacemakers ballad). But just about everything else works too, from a genuinely affecting version of the title song to the surprisingly effective *Love for Sale*. The one possible exception is Rickie Lee Jones's guest vocal in *Makin' Whoopee!*, which may strike some listeners as uncomfortably suggestive of Betty Boop on Quaaludes. It should also be noted that big-band purists might object to producer Tommy LiPuma's decision to feature electric rather than stand-up bass (it bothers me not a whit).

All in all, this is the kind of album the *Tonight Show* orchestra might make if it were a little younger, were a little hipper, and had a featured vocalist—which is to say that it's a collection of good but not particularly fashionable pop music played and sung to an absolute fare-thee-well. A nice job. S.S.

ARETHA FRANKLIN: *Through the Storm*. Aretha Franklin (vocals); James



BOWIE'S TIN MACHINE

DAVID BOWIE is in a black humor again, much like the ones that fueled albums like "Diamond Dogs" and "Scary Monsters," but now it's even more corrosive and nasty. His new "Tin Machine" could strip paint off a wall. File it next to Lou Reed's "New York," under the heading "Disillusionment and Foreboding—Late Twentieth Century." For this project, Bowie has formed a band and become one of its members, but don't take the intimation of democracy too seriously. Despite significant musical input from his three partners, the sensibility is pure Bowie, with his dyspeptic stamp evident in every lyric.

What's got him so cranked up? Oh, dopeheads and drunks, the filth in the streets, the scum in Washington, the rapid decline of even a pretense of civility in our cities, especially that teetering Babylon known as New York. He wanders among the dispossessed and the drug-crazed, sputtering a little crazily himself with the testy frustration of someone who knows the world is spinning out of control and time is running out—if it hasn't already expired.

"Tin Machine" is an album of earthy,

knife-edged emotions, from the flesh-on-flesh sexuality of *Heaven's in Here* to the noxious fumes of racism and corruption emanating from *Under the God* to the profane, splenetic tirades of *Crack City's* unsparing attack on street-corner drug dealers and sleaze-peddling rock-and-rollers. Throughout, Bowie's raw-throated singing is underscored by Reeves Gabrels's potent, raging guitar and the resounding kick of the Sales brothers' rhythm section. Tin Machine pulls no punches in this unrelenting album, which makes for difficult, demanding listening. Bowie's abrasive effrontery is welcome after the relative floundering of his last few albums. This is not "Let's dance." It's more like "Let's panic." Parke Puterbaugh

TIN MACHINE. David Bowie (vocals, guitar); Reeves Gabrels (guitar); Tony Sales (bass, vocals); Hunt Sales (drums, vocals). *Heaven's in Here*; *Tin Machine*; *Prisoner of Love*; *Crack City*; *I Can't Read*; *Under the God*; *Amazing*; *Working Class Hero*; *Bus Stop*; *Pretty Thing*; *Video Crime*; *Run*; *Sacrifice Yourself* (CD only); *Baby Can Dance* (CD only). EMI EI 91990. © E4 91990. © CDP 91990-2 (57 min).

Brown, Whitney Houston, Elton John, the Four Tops (vocals); Kenny G. (saxophone); other musicians. *Gimme Your Love; Mercy; He's the Boy; It Isn't, It Wasn't, It Ain't Never Gonna Be Through the Storm*; and three others. ARISTA AL-8572, © AC-8572. © ARCD-8572 (35 min).

Performance: *She overcomes*
Recording: *Good*

This new album by the Queen of Soul is appropriately titled, for she does indeed sing up a storm, lending her platinum pipes and distinctive stylings to an assortment of spirited selections. The album will be particularly appealing to younger listeners who have become her fans only in recent years, because it is cast very much in a contemporary vein. Some of the characteristics that make this such a "now" set, however, are likely to generate intermittent grumbles from those who have worshipped at Aretha Franklin's throne since B.R. (Before *Respect*).

As one of those original fans, I found the second half of "Through the Storm" more enjoyable than the first, primarily because it contains fewer songs produced by Narada Michael Walden, one of five producers or production teams involved in the album. Walden has tak-

Aretha Franklin: spirited



en a loud-is-good approach, employing such thunderous percussive effects that the singing seems merely incidental to the layers of sound. It's not so much of a problem in *Gimme Your Love*, Aretha's duet with James Brown, mostly because Brown does far more grunting than singing, but the heavy-handed production is downright offensive when she pairs with Whitney Houston in *It Isn't, It Wasn't, It Ain't Never Gonna Be*. Here two of the best female singers ever are reduced to screaming at each other as if they were trying to engage in conversation from opposite sides of a football field. It's a fun song, admittedly, but it didn't need women with voices like theirs to do it. A remarkable contrast is provided by the swinging *He's the Boy*, which Franklin wrote and produced herself. How great it is to hear her accompanying herself at the piano again. Her playful patter is delightfully amusing, and there is a new, mature huskiness to her voice that makes it even more attractive.

Walden redeems himself with the robust *Mercy*, which is suited to his treatment, and *Through the Storm*, in which Elton John joins the Soulful One for a duet that generates enough thunder and lightning to wake up the dead. Other genuine delights include an updated version of her wonderfully funky 1968 hit *Think*, again produced masterfully by Arif Mardin, and a profoundly moving rendition of *Come to Me*, which has the lyrics of a love song but is delivered with the feeling of a gospel hymn. The album closes on an especially sweet note as the Four Tops join Franklin for an exquisite reading of a ballad called *If Ever a Love There Was*. P.G.

PETER GABRIEL: *Passion*. Peter Gabriel (vocals, keyboards); David Sancious (keyboards); Billy Cobham (drums); Shankar (violin); other musicians. *The Feeling Begins; Gethsemane; Of These, Hope; Lazarus Raised; Of These, Hope (Reprise); In Doubt; A Different Drum; Zaar; Troubled; Open; Before Night Falls; With This Love*; and nine others. GEFLEN GHS 24206 two LP's © M5G 24206 one cassette, © 24206-2 one CD (66 min).

Performance: *Definitive*
Recording: *Excellent*

Without getting into a long political or religious discussion, I would say it's probably significant that at first glance "Passion" appears to be just a new Peter Gabriel album rather than what it really is—a slightly expanded version of Gabriel's soundtrack for Martin Scorsese's brilliant film *The Last Temptation of Christ*. I mean, if I were Geffen Records, I wouldn't want to contend with outraged fundamentalists picketing record stores either, so let's just say it's good this music has been released, even with somewhat, er, deceptive packaging, and leave it at that.

Prohles in courage aside, however,

the fact is that without Scorsese's visuals, a little of this stuff goes a fairly long way. To his credit, Gabriel has avoided the clichés of Biblical movie scoring—the angelic choirs and nineteenth-century Romantic orchestration associated with, say, Miklós Rózsa or Alfred Newman (estimable as some of their work may have been). Along with an interestingly international collection of musicians, Gabriel often manages a nicely postmodern mix of the sophisticated and the primitive that seems thoroughly apt for Scorsese's revisionist take on the Greatest Story Ever Told. Still, thematically the score is fairly parched, and over the course of more than an hour's playing time it gets a little tedious. There's also a faint, annoying whiff of that patronizing, "Isn't the Third World exotic?" attitude you can sense in similar work by Brian Eno or David Byrne.

In sum, this is well-crafted and occasionally attractive music, but if you must have it you'd do better to get a hi-fi videotape of the movie. S.S.

JOE JACKSON: *Blaze of Glory*. Joe Jackson (vocals, keyboards); Graham Maby (bass); Vinnie Zumbo (guitar); Gary Burke (drums); other musicians. *Tomorrow's World; Me and You (Against the World); Down to London; Sentimental Thing; Acropolis Now; Blaze of Glory*; and six others. A&M © SP-5249, © CS-5249. © CD-5249 (57 min).

Performance: *Not so hot*
Recording: *Excellent*

Considering that Joe Jackson once bid fair to equal Elvis Costello in the Angry Young Man competition of the late Seventies, it's ironic how thoroughly middlebrow he seems to have become. On the evidence of this new album, for example, Jackson still seems to have a lot on his mind; he tackles war, peace, growing up, the perils of the pop life, and all sorts of other weighty subjects. The trouble is, his approach to all of them is roughly as safe and uncontroversial as an episode of *thirtysomething*.

The man hasn't completely lost his gift. *Down to London*, for example, is on one level a nicely worked out homage to Sixties soul (specifically Stevie Wonder's *Fingertips*), and *Acropolis Now* is a sort of Greek New Wave/surf instrumental that is as amusing as its title. But the rest of the album veers all over the place stylistically, from genteel classical steals to vague Latinisms, without ever working up a rock-and-roll sweat. It's all pretty dire, and one track particularly, *The Best I Can Do*, in which Jackson does the eeriest unintentional imitation of Johnny Mathis you're ever likely to hear. Probably represents the nadir of his career so far. As sort of hip background music, I suppose "Blaze of Glory" could have its uses (the digital recording is most impressive), but at

Ohm CLS Drivers Make Your Speakers Disappear

From Our \$5000 Walsh 5 to
Our \$600 Sound Cylinders
the Critics are Impressed.



©1988 Ohm Acoustics Corp. 1 ©1988 Stereophile 2 ©1988 Diamond Communications Inc. 3 ©1988 Stereo Review 4 ©1988 The New York Times



Stereophile 8-88

"So the bottom line is quite favorable: The Walsh 5 is a full-range speaker that is quite clean and images very well." "Sound staging is another strength and joy, and at their best the 5s can set up a very palatable illusion of the original performing space." "In its present incarnation it is one of the few dynamic speakers that my jaded electrostatic taste buds could live with." -Dick Olsher, *Stereophile*, Volume 11, Number 8 (August, 1988).¹

Audio 6-88

"The Walsh 5 is one of the cleanest speakers available...I perceived remarkable depth and spaciousness to music well recorded in a concert hall. This spaciousness did not result in a vague mass of sound: image location is sharply defined and accurately placed...They are a masterpiece of the speaker designer's art."²

Stereo Review 1-88

"The sound of the Ohm Sound Cylinders was smooth, balanced and thoroughly enjoyable, well beyond what anyone would expect from such a small, light speaker. Its dispersion was subjectively complete, and we were never aware of the speakers as distinct sound sources, no matter how much we moved around the room...these speakers certainly offer impressive value for their price and size."³

New York Times 3-88

"...the various frequencies emerge in their natural phase relationship--more than in conventional designs. To what extent this accounts for the speakers fine sound may be debatable, yet there is no question that the Ohm Sound Cylinders represent an excellent bargain, with a clarity and richness of sound rarely found in a speaker of this size and price."⁴

Find out about buying, directly from the factory by calling toll free 800-221-6984

For Those Who Care
to Listen



CLEAN LICKS.

The sound is pure, pristine, immaculate. The artists, talented jazz musicians on the rise. The label is DMP. Compact discs and cassettes recorded live to digital for the most intimate, life-like sound possible.

D I G I T A L M U S I C P R O D U C T S I N C.

CIRCLE NO. 57 ON READER SERVICE CARD

THE LATEST LICKS FROM DMP.

Setting the standard for jazz performance and superior sound. Pure, clean, live and all digital.



WARREN BERNHARDT— Heat Of The Moment

Visionary pianist Warren Bernhardt leads a spirited and talented group—including Peter Erskine on drums—performing his originals and inventive readings of music by Gershwin, Ellington, Bill Evans and others.



BOB MINTZER—Urban Contours
A new direction for a contemporary master—Bob Mintzer. Accessible melodies that rock—and more—over a solid foundation of brass and reeds.



THOM ROTELLA—Home Again
The second dmp release by Thom Rotella. Acoustic moods and a warm California groove from a guitarist who paints emotional colors with a rich melodic brush. With special guest Tommy Tedesco on his own "Oriental Flower."

Digital Music Products, Inc.
Park Square Station, Box 15835
Stamford, CT 06901

dmp

bottom it only proves that the road to dull is paved with good intentions. S.S.

KINGDOM COME: *In Your Face*. Kingdom Come (vocals and instrumentals). *Do You Like It; Who Do You Love; The Wind; Gotta Go (Can't Wage a War); Highway 6;* and four others. POLYDOR 839 182-1, © 839 182-4, © 839 182-2 (44 min).

Performance: *Sounds like . . .*
Recording: *In your face*

If you're too young to have been around for Led Zeppelin in its heyday, you'll likely accept Kingdom Come's pale substitute as the next best thing. Believe me, it's not. Vocalist Lenny Wolf reduces Robert Plant to a neutered squeal, and the songs are played at surprisingly slow and sodden tempos. Though the band bends over backward to be serious, you can't suppress a smile when confronted with such lines as, "Who are we to try and stop what will and won't prevail?" (How can you stop what won't prevail?) When the message turned libidinous, as in *The Perfect 'O'* (as in orgasm—subtle, huh?), my opinion of the Parents' Music Resource Council temporarily softened. The music itself is strikingly banal: smeary wads of synthesizer, grotesque, waddling outbursts of guitar, a rhythm section that clomps along like a dinosaur marching to its own funeral. A real drag. P.P.

FRED KOLLER: *Songs from the Night Before*. Fred Koller (vocals, guitar, dobro); vocal and instrumental accompaniment. *Boom Town; Life As We Knew It; This Town; Heart to Heart; The Auctioneer;* and seven others. ALCAZAR © 107 (45 min).

Performance: *Winning*
Recording: *Good*

On the surface, it might be easy to compare singer/songwriter Fred Koller with Randy Newman or Leon Redbone—so unconventional is his vocal quality and so left-field are a number of his songs. But on a closer look, Koller, who has also written a suitcase full of No. 1 hits for established artists, is neither as cynical as Newman nor as self-consciously smug as Redbone. His songs offer up their open emotionalism or ridiculous, dry humor without apology or pretense.

In "Songs from The Night Before," his second album, Koller mixes intelligent, plangent songs about transience—a changing America, dissolution of relationships, personal evolution—with keen and humorous social observation. *Boom Town*, already recorded by Lacy J. Dalton, captures the awful fact that there is no truly unique American town left—every place is dotted with the same fast-food restaurants, malls, and discount department stores, or soon will be. *This Town*, which at first promises to mine the same territory, instead

finds the adult man returning to the burg of his youth in search of the person he used to be. These songs reflect one of Koller's best talents—a way of making you feel as if you, too, have done whatever it is he's singing about.

That sense of identity carries over to his satiric songs as well. No one is exempt from finding himself in *The Hell We Created*, a song where everyone from preachers to yuppies gets his comeuppance. Then there's a spoof on dead-celebrity sightings, *The King and I*, and a very funny fantasy/nightmare, *Dentist Blues*, about a guy who cheats with his dentist's wife and pays for it during his next checkup. And there's more where those came from.

While Koller may not be as well known as most of his co-writers (Shel Silverstein, John Hiatt, and others), he is highly regarded in songwriter circles, and, as his four-record contract with Alcazar might indicate, ripe for cult-following status. Like John Prine, Koller is careful to keep a homemade sound in both his performance and his production. In a time when Nashville is cloning more proven hits than ever before, Fred Koller is a quirky American original. "Songs from the Night Before" shows why. A.N.

DELBERT MCCLINTON: *Live! from Austin*. Delbert McClinton (vocals, harmonica); other musicians. *Maybe Someday Baby; Lipstick Traces; Standing on Shaky Ground; Sandy Beaches; Thank You Baby;* and six others. ALLIGATOR AL-4773, © AL-4773-CS, © ALCD-4773 (41 min).

Performance: *Sizzling*
Recording: *Very good*

Delbert McClinton hasn't released an album in nine years. Maybe that's why he sings like a man possessed in "Live! from Austin." McClinton blends the blues and r-&b with the lean, tough rock of his native Texas. Critics have long appreciated his music, but only 1980's *Givin' It Up for Your Love* made its way into the Top 40. This recording captures a riveting set: It would have been a "greatest hits" collection in a better world.

McClinton put together a kick-butt band for the public-TV show *Austin City Limits*, and this is the soundtrack. From jump blues to funky roadhouse r-&b, McClinton belts it out from his restless soul—and sometimes his insatiable id. (His *B Movie Boxcar Blues*, which was covered by the Blues Brothers, is a nasty concatenation of double entendres.) McClinton catches every gritty nuance of these songs, with a slightly hoarse voice that actually gives his performance an edge that hasn't come through in his studio work. This album is hotter than a \$3 pistol. R.G.

BOB MOULD: *Workbook*. Bob Mould (vocals, guitars, keyboard, percussion); instrumental accompaniment. *Sun-*

spots; *Wishing Well*; *Heartbreak a Stranger*; *See a Little Light*; *Poison Years*; *Sinners and Their Repentances*; and five others. VIRGIN 91240-1, © 91240-4, © 91240-2 (52 min).

Performance: *Passionate*
Recording: *Very good*

The songs in Bob Mould's "Workbook," as the title suggests, are a form of therapy in which he works through feelings of confusion, anger, and loneliness in the wake of the breakup of his band, Hüsker Dü. Largely recorded in his native Minnesota, the album is full of wide-open spaces, innocent days, and long-forgotten ways of doing things, butting incongruously against the ringing in his ears and the nagging memories of a good thing that turned bad and blew up. Hüsker Dü was a roaring, full-throttle power trio that evolved from hard-core to a brilliant, diamond-hard intensity. The end was none too pretty, with the suicide of a group aide and rumors of hard-drug use by one member (not Mould) contributing to the band's demise.

In the quiet hermitage that gave birth to this album, Mould wrote songs to exorcise poisonous feelings, along with songs of cautious celebration and re-awakening. Most are performed on acoustic guitar and given spare, tasteful arrangements. Mould's deep, full-bodied voice is effective, if not exactly attractive. In a lot of ways, "Workbook" evokes Richard Thompson's best work. In addition to their vocal similarities, both Mould and Thompson employ traditional folk-ballad styles to explore dark, deep-rooted emotions. The anger in the first half of "Workbook" is outer-directed, as in *Poison Years*, where he sings of another's betrayal ("Treason is the reason for my poison years") and self-destructiveness ("I see you swing by your neck on a vine"). The second half is more of an interior monologue about solitude and summoning up the mettle to start over. "You're lucky just to be alive," he tells himself in *Lonely Afternoon*.

Since the album is more of a workbook than a polished masterpiece, the images tumble out in bulky shards, unprocessed and raw. The music, though, is quite graceful—pretty even, and often given a plangent undercurrent by Jane Scarpantoni's cello. There are no dissonant guitar tantrums until the end, when Mould lets loose with a primal howl of disgust, sung in Br'er Rabbit dialect, called *Whichever Way the Wind Blows*. The moral? Choose the road you take very carefully, lest you get forced off it or run over. P.P.

THE RAINMAKERS: *The Good News and the Bad News*. The Rainmakers (vocals and instrumentals); other musicians. *Reckoning Day*; *Hoo Dee Hoo*; *Spend It on Love*; *Battle of the Roses*; *Wild Oats*; *We Walk the Levee*; *Thirty Days*; *Knock on Wood*; and four others.



Bob Mould: exploring the dark

MERCURY 838 232-1, © 838 232-4, © 838 232-2 (41 min).

Performance: *Extremely clever*
Recording: *Good*

The Rainmakers make plain-vanilla rock-and-roll. Coming from America's heartland, the anonymous Midwest, they seem to have absorbed a wealth of influences and come up with a seamless blend of them in music that represents the epitome of melting-pot rock. Much of the band's identity derives from the distinctive nasality of leader Bob Walkenhorst's singing, and while the overall sound is enjoyable, its impact is surprisingly mild. The guitars have an edge, the bass and drums kick things along, but for all of the fury of Walkenhorst's often moralistic songs, things never really get worked up.

Walkenhorst has a way with words, but his cleverness often gets in the way. The first song here, for example, *Reckoning Day*, takes a nasty swipe at the purveyors of truth: preachers, politicians, critics. It opens with this verse: "Well, I was thinking about a Lincoln/ And the enemies of the truth/ But I couldn't tell a Kennedy/ From a John Wilkes Booth." Truly a set of references that gives his message some punch. But then he moves, in another verse, to: "We're taking a history test/ About who's baddest and who is best/ Lennon the brother, Lennon the sisters, Lenin the Communist." It's imaginative and funny, but it's out of place. That kind of awkwardness and facile verbal overkill, which distracts you from otherwise powerful lyrics, is the bad news the Rainmakers deliver in this album along with the good. R.G.

RAMONES: *Brain Drain*. Ramones (vocals and instrumentals). *I Believe in Miracles*; *Zero Zero UFO*; *Don't Bust My Chops*; *Punishment Fits the Crime*; *All Screwed Up*; *Palisades Park*; *Can't Get You Outta My Mind*; and five oth-

ers. SIRE 25905-1, © 25905-4, © 25905-2 (35 min).

Performance: *Adult-oriented*
Recording: *Good*

On paper, the idea of grown-up Ramones is an oxymoron. Their rapid-fire bar chords, cartoon-bubble lyrics, and two-minute songs are better suited to 1977 than 1989. Yet they're still afloat, hammering out their vision of pop brawling with punk in a professional-wrestling arena of the mind.

They have made some changes along the way. Many Ramones songs now boast guitar solos—short, two-bar bursts of white noise, but solos nonetheless. The band that once sang, "Now I wanna sniff some glue," has a new agenda: "I believe in a better world/ For me and you." And rather than attacking every song like a four-headed but single-minded pit bull, they approach Dee Dee's songs differently from Joey's. Dee Dee writes in a boot-stomping cryptometal vein, and Joey generates poppier material. Dee Dee's *Pet Sematary*, written for Ramones fan Stephen King's latest book-turned-film, is as gothically dense as Blue Öyster Cult circa *The Reaper*.

The Ramones' evolution is inevitable and healthy, but they still sound like a never-say-die pack of punks most of the time. Any band that can dispense music this raucous while convincing you they've matured must be doing something right. P.P.

TODD RUNDGREN: *Nearly Human*. Todd Rundgren (vocals, guitars, keyboards); vocal and instrumental accompaniment. *The Want of a Nail*; *The Waiting Game*; *Parallel Lines*; *Two Little Hitlers*; *Can't Stop Running*; and five others. WARNER BROS. © 25881-1, © 25881-4, © 25881-2 (53 min).

Performance: *Righteous*
Recording: *Live in the studio*

Todd Rundgren's conspicuous absence from the recording scene has become something of a mystery and a frustration to his fans. His previous record, the experimental, voices-only "A Cappella," is four years old, and his last real song-oriented solo album dates from 1982. Apparently he lost his footing as a recording artist, or felt it wasn't worth the effort, though he's been doing good business as a producer. The reasons for his creative layoff are harder to figure than his motivation for returning, which is clearly spelled out in "Nearly Human." Rundgren has been moved by the spirit, and his passion fills this record, which finds him melding gospel-flavored vocal arrangements with high-tech, synth-pop settings.

Admittedly, it's not an immaculate conception. Several numbers are hampered by anemic keyboards and stillborn tempos, and his covers of Elvis Costello's *Two Little Hitlers* and the Tubes' *Feel It* are pointlessly faithful to

Stop.

Stop and consider the Allison difference. Roy Allison's unique room-matched design ensures that your loudspeakers sound as good – or better – at home as they do in the store. Unmatched quality control for top performance. Specifications are guaranteed by a full five-year warranty.

Look.

Look at the sculptured beauty of natural wood veneer cabinets, hand finished to look as great as they sound.

Listen.

Listen to the closest replica of the original music as is possible today.

Call us toll free at 1-800-225-4791 for the name of your nearest Allison dealer. (In Massachusetts call 508-788-1500.)

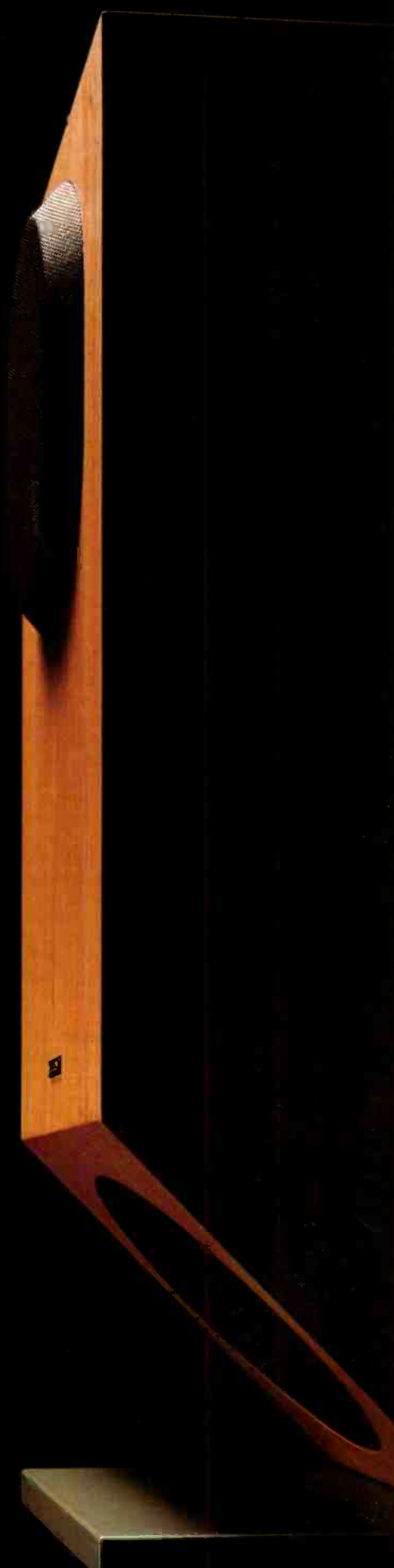

ALLISON

A little bit different.

CIRCLE NO. 4 ON READER SERVICE CARD

JERRY JEFF WALKER

Of all the arbiters of the progressive-country movement that eventually came to be known as "the Austin sound," Jerry Jeff Walker is perhaps the least promoted and least recognized—one of the few singer-songwriters associated with the once-thriving Austin music scene who chose to remain faithful to the music itself instead of slipping off to court national idol worship.

Granted, Walker's music has metamorphosed a few times since he started out in his native New York State as a folk singer, moving through a psychedelic-rock period before rounding up his outlaw country group, the legendary Lost Gonzo Band, and writing his best-known song, *Mr. Bojangles*. But even when the Gonzos broke up and Walker recruited a new band, only to go solo soon after, he continued to write songs that captured the spirit of his adopted Texas—as well as the softer underside of a dedicated hellraiser.

In "Live at Gruene Hall," a CD-only collection of performances recorded at Texas's oldest beer joint and dance hall (fifty miles from Austin in the tiny hamlet of Gruene, pronounced "Green"), Walker demonstrates that despite whatever has changed in his life—he has replaced songs about an itinerant life style with celebrations of marriage and family—he is still a master of the sparse and sensitive story song. Those who always considered him too immersed in "hippie sentimentalism and sanctimoniousness," as a critic once put it, will probably find such songs as *Little Bird* and *Woman in Texas* as grating as earlier efforts. But even the most jaundiced listener will fall for the gently loping *Lovin' Makes Livin' Worthwhile* and the *Pickup Truck Song*.

Even so, Walker was wise to call on friends Chris Wall and Steve Fromholz

for material for the album. Wall, a Montana songwriter, contributes three tunes, including the best song ever written to explain country music's plaintive appeal, *I Feel Like Hank Williams Tonight*. He also wrote the album's closing tune, *Trashy Women*, which explains why a guy reared on debutantes and symphonies likes his women a little on the tacky side—a cocktail waitress in a Dolly Parton wig. And Fromholz, already known to fans of Texas music, scores big with *The Man with the Big Hat*, as good an ode to the old-style cowboy as has ever come along, full of ambience and mystery and ghostly guest vocals by Willie Nelson.

Walker, whose friendly-dog baritone has mellowed and matured through the years, sings all of these songs with a looseness, spontaneity, and genuineness that befit the live format. His band sweats and slides and stomps along in style.

There aren't many honest-to-goodness troubadours left these days, and the fact that Walker now travels to his gigs in a private plane instead of thumbing his way across the country admittedly cuts into the mystique. But he may still be the closest thing to the genuine article. Either way, he remains a moving and wryly amusing musician—a redneck rocker and cosmic cowboy of the first order.

Alanna Nash

JERRY JEFF WALKER: *Live at Gruene Hall*. Jerry Jeff Walker (vocals, guitar); vocal and instrumental accompaniment. *Lovin' Makes Livin' Worthwhile*; *Pickup Truck Song*; *Long, Long Time*; *I Feel Like Hank Williams Tonight*; *Man with the Big Hat*; *Quiet Faith of Man*; *Little Bird*; *Woman in Texas*; *Rodeo Wind*; *Trashy Women*. TRIED & TRUE/RYKO © TTCS 9123, © RCD 10123 (45 min).

the originals. Still, "Nearly Human" contains some of Rundgren's most edgy and emotional performances. *Unloved Children* is a bold, unflinching look at the problem of "violent men, homeless women, and unloved children." The righteous anger in Rundgren's drily recorded vocal is matched by the fiery urgency of his guitar playing. *The Want of a Nail*, taking its cue from an old fable, points out that big things—from personal relationships to the fate of nations—fall apart when small details are not attended to.

The most striking aspect of this album is its pervasive religious fervor, which rises to a Pentecostal boil by the end. In *Hawking*, Rundgren testifies, "I met the world's greatest lover when God kissed me/And I knew it when I fainted in his arms." The lengthy closing song, *I Love My Life*, is a churchy raver, complete with two dozen back-up singers and a fervid sermonette. "I got caught, now I'm free," this holy rock-and-roller sings with the conviction of a convert who's found his stairway to heaven. Judging from this album, I'd say he's using music to piece his soul back together, and he feels "Nearly Human" again. The best part is that his inspiration is contagious.

P.P.

DONNA SUMMER: *Another Place and Time*. Donna Summer (vocals); vocal and instrumental accompaniment. *I Don't Wanna Get Hurt*; *When Love Takes Over*; *This Time I Know It's for Real*; *The Only One*; *In Another Place and Time*; and five others. ATLANTIC 81987-1, © 81987-4, © 81987-2 (38 min).

Performance: *By the numbers*
Recording: *Artificial-sounding*

Donna Summer's late-Seventies/early-Eighties hits have always been rated out of proportion to their actual aesthetic worth by disco apologists, but it's easy to understand why: Compared with most of the anonymous dance stuff ground out back then, Summer's records—*Bad Girls*, say, or *She Works Hard for the Money*—at least bore the stamp of a recognizable personality. Unfortunately, this comeback effort finds her in the ham-fisted grasp of British producer/writers Stock, Aitken, and Waterman, the last place any artist with even a shred of individuality should be. SAW run a well-oiled hit factory, and while there's no doubting the guys' commercial acumen, there's also no doubting that all their songs and all their records sound alike.

"Another Place and Time" is a case in point. Summer doesn't exactly get buried; in fact, her genuine soulfulness occasionally threatens to inject a measure of reality into SAW's cotton-candy disco settings. And what's here is superficially attractive: The synthesizers bubble and burble in a nicely kinetic way, the tracks are danceable, and the tunes are reasonably catchy. Mostly, though,



HELP US HELP YOU!

PARTICIPATE IN THE STEREO REVIEW BUYER POLL

Stereo Review wants to know more about our readers. How much equipment you buy (and how often), how much you spend on it, what sort of product features you like. That will help us create a better, more informative magazine, specially geared to your tastes and preferences.

To gather this important information, we've created the Stereo Review Buyer Poll. And we need your help to make it work.

If you've bought any equipment within the past 30 days, we'd like you to participate (see instructions below). We'll use the information you give us to keep manufacturers up to date on the buying habits of stereo enthusiasts—the most knowledgeable group of audio buyers in the country. And in the long run, that will mean better service for you.

HOW TO PARTICIPATE

You can participate in the Stereo Review Buyer Poll by sending in the Reader Service Card appearing next to this page. We've provided space for you to list any equipment purchased in the past 30 days. Any kind of audio/video equipment qualifies.

For example:

Home Audio Components

- Amplifier ■ Receiver/Tuner
- Speakers ■ Turntable
- Cassette Deck ■ Equalizer
- CD player

Portable Stereo

- Portable Cassette Player
- Portable CD Player
- Headphones

Car Stereo

- Tuner ■ Cassette Deck
- Speakers

Home Video

- VCR ■ Camcorder
- Videodisc Player
- Stereo TV

Fill in the type of equipment, manufacturer, model number, and price you paid. Include all the equipment you bought this month. Then print your name and address and drop it in the mail (we pay the postage). It's that simple!

★ ★ ★ **Free Information Service** ★ ★ ★

Get free literature on stereo products featured in this issue. Simply fill out your name and address, circle the number on the card that corresponds to the key number at the bottom of the advertisements and mail this card today.

1 2 3 4 5 6 7 8 9 10 11 12 13 14 15 16 17 18 19 20 21 22 23 24 25 26 27 28 29 30 31 32
33 34 35 36 37 38 39 40 41 42 43 44 45 46 47 48 49 50 51 52 53 54 55 56 57 58 59 60 61 62 63 64
65 66 67 68 69 70 71 72 73 74 75 76 77 78 79 80 81 82 83 84 85 86 87 88 89 90 91 92 93 94 95 96
97 98 99 100 101 102 103 104 105 106 107 108 109 110 111 112 113 114-115 116 117 118 119 120 121 122 123 124 125 126 127 128
129 130 131 132 133 134 135 136 137 138 139 140 141 142 143 144 145 146 147 148 149 150 151 152 153 154 155 156 157 158 159 160

STEREO REVIEW BUYER POLL

1. In the past 30 days, have you purchased any audio or video equipment or accessories?
A. YES B. NO → Thank You!

2. Which type(s) of equipment did you purchase in the past 30 days?
A. Home audio B. Portable stereo C. Car stereo D. Video

3. In the space below, please write in the type (speakers, car CD player, stereo VCR, etc.), the make, the model number and the price paid for each item purchased in the past 30 days.

TYPE	MAKE	MODEL	PRICE PAID
CD player	Kenwood	50-5933	\$379.00
Speakers	Kenwood	SS-10	\$155.00
car radio/cassette deck	Speaker	KT 9372 (A)	\$169.00

Indicate if you'd like to subscribe to STEREO REVIEW (you'll save 50% off our regular subscription rate!)
 Please send me 12 issues of STEREO REVIEW for \$5.99 and bill me. (Full year subscription price \$11.99)

PLEASE PRINT CLEARLY

NAME: STEVEN NELSON
ADDRESS: 158 LORRAINE AVENUE
CITY: NEW ROCHELLE STATE: NEW YORK ZIP: 10554

SR 88/11
Void after October 31, 1987

LOOK FOR THE BUYER POLL EVERY MONTH

The Stereo Review Buyer Poll will appear in every issue—just check the Table of Contents for that month's location. You can participate in any month in which you purchased audio/video equipment. Of course, even if you don't join our Poll, you can still send in the Reader Service card to get information about products advertised in that month's issue.

We hope you'll participate regularly in the Stereo Review Buyer Poll. Your answers are important to us—and you'll find the resulting benefits important to you.

Thanks for helping us out!

Stereo Review

**ENERGY. LOUDSPEAKERS.
DON'T LIVE IN ANECHOIC**

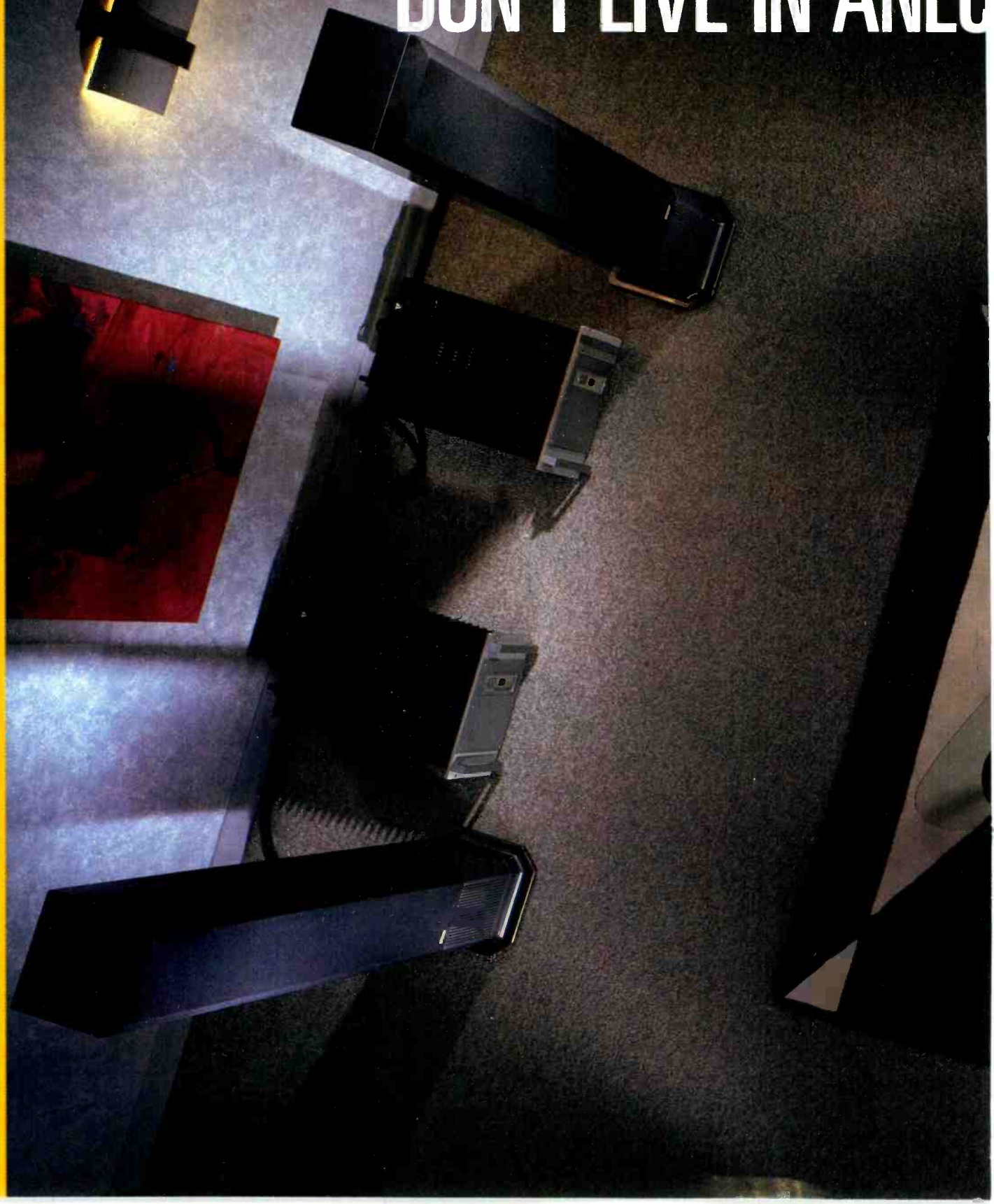

S FOR PEOPLE WHO HOIC CHAMBERS.



The true performance of a loudspeaker can only be measured in the real world. Not the ideal environment of an anechoic chamber. Even though Energy loudspeakers are the result of highly-sophisticated CAD/CAM modeling and anechoic testing, we take the extra measure of fine-tuning them through an exhaustive series of real-world listening tests. That's why Energy is the preferred choice of thousands of demanding listeners. Our unique tweeter design is case-in-point. It provides ideal off-axis frequency response for superior imaging, extended soundstage, and exquisite transparency. The "dual hyperdome" configuration dramatically increases low-frequency power handling when compared with conventional designs. It allows the low-frequency transducer to roll off naturally for a smoother transition to the tweeter. Our top-of-the-line model utilizes a triple-chamber vented woofer enclosure that greatly extends bass response and acoustically cancels output nonlinearities between the two woofers. The 7th-order bandpass design provides exceptional woofer damping for flatter response across the entire woofer range. All this "technospeak" is fine—and necessary for understanding why all Energy models sound so amazing. But the real test is your ears. Energy loudspeakers are more natural no matter what the listening room is like. Where the speakers are placed. Do your senses a favor. Take time to include them in your listening comparisons. You'll be immediately convinced of their sonic faithfulness and uncanny musicality.

ENERGY®

AUDIO PRODUCTS INTERNATIONAL CORP.
3641 McNicoll Ave. Scarborough, Ontario, Canada M1X 1G5 (416) 321-1800

CIRCLE NO. 58 ON READER SERVICE CARD

MAD, MAD, MAD. AVE.

THERE'S a wonderful scene in Woody Allen's *Hannah and Her Sisters* where Max von Sydow is watching television. "Imagine the mind that invented professional wrestling," he marvels, shaking his head at the tube. It's hard not to think something similar while listening to "TeeVee Toons: The Commercials." What kind of a mind, after all, would conceive of a record filled with old commercial jingles, those inane, annoying products of Madison Avenue at its most manipulative and demented? In fact, if Marxist theorizing weren't so suspect in the post-Reagan era, this is the kind of album that might make one mutter darkly about brainwashing or (worse) start constructing paranoid conspiracy theories. After all, as they say on the Left, it is no accident that an album like this exists at this point in time. We're all of us—Americans, Chinese, Poles—potential consumers now, and here comes an album seemingly designed to keep us buying the most ridiculous products imaginable.

Well, call me a capitalist tool or a running-dog lackey of bourgeois imperialism, but I think "TeeVee Toons: The Commercials," on TVT Records, is pretty remarkable—a kind of aural Found Art as impressive in its way as anything cobbled together by David Byrne or Brian Eno. Or, to be less pretentious about it, call it a hilarious tweak of our collective memory, a slightly nutty nostalgia trip.

Which is not to say that there isn't something rather deep going on here. Consider, if you will, the surreal tropical majesty of the *Chiquita Banana* song, the provocative *My Dog's Better Than Your Dog*, the sublime minimalism of the Meow Mix theme (the complete lyric is the word "meow" repeated fifty-one times—take that, Gertrude Stein), the soulful sudsiness of *Let It Be Löwenbrau*, the terrifyingly violent *Fruit Juicy Hawaiian Punch* song, or the urban mantra that is *Winston Tastes Good*. True, the unheralded craftsmen who concocted this stuff did not mean to create anything profound, but somehow they did anyway. In fact, there isn't a jingle here that doesn't resonate in the memory with an all but Proustian poignance—even if you profoundly wish it didn't.

Of course, there are other pleasures to be gleaned from this collection: For instance, you can play Spot the Celebrity Voices (personal faves: Edie Adams, Brit Invasion one-hit wonders the Fortunes, and Bob May, best known as the voice of the robot in *Lost in Space*). Or you can ruminate on the pleasures of old-fashioned, low-fidelity mono recording (TVT has done a respectable job of refurbishing the old tapes). And you can always lament the Roads Not

Taken, as in the famous Chock Full O' Nuts jingle, rendered here without its formerly actionable reference to the Rockefeller dynasty ("Better coffee a millionaire's money can't buy," indeed), or ponder the mysterious absence of the legendary *Honey, I'm Going to Change Your Sausage*.

All in all, then, what we have in "TeeVee Toons: The Commercials" is a truly democratic document of that weird aesthetic neverneverland where art, commerce, greed, stupidity, and unclassifiable whatsis meet and commingle, which also happens to be a pretty good description of rock-and-roll, a coincidence that perhaps explains why I find myself so inordinately fond of this album. In any case, I highly recommend it to all but weepy old Bolshies and the terminally grouchy, with but two caveats—there aren't any writer credits, and in the CD version, the track numbering is off by one. Otherwise, this is the kind of record that makes me proud to be an American.

Steve Simels



TEEVEE TOONS: THE COMMERCIALS. *Snap, Crackle, Pop* (Rice Krispies); *I'm a Chiquita Banana*; *Choo Choo Charlie* (Good & Plenty); *If You Like Fluff, Fluff, Fluff* (Fluffernutter); *Sometimes You Feel Like a Nut* (Mounds—Almond Joy); *I'd Like to Buy the World a Coke*; *It's the Real Thing* (Coca-Cola); *Come Alive* (Pepsi-Cola); *Be a Pepper* (Dr. Pepper); *The San Francisco Treat* (Rice-a-Roni); *Fruit Juicy* (Hawaiian Punch); *I Love Bosco*; *N-E-S-T-L-E-S* (Nestlé's Quick); *Oh Fab, I'm Glad; Stronger Than Dirt* (Ajax); *When You Say Bud*; *If You've Got the Time* (Miller High Life); *My Beer Is Rheingold, the Dry Beer*; *Winston Tastes Good*; *You Can Take Salem Out of the Country*; *See the U.S.A. in Your Chevrolet*; *Hey, Big Spender* (Muriel Cigars); *A Little Dab'll Do Ya* (Brylcreem); *How're You Fixed for Blades* (Gillette Blue Blades); *Nobody Doesn't Like Sara Lee*; *Plop, Plop, Fizz, Fizz* (Alka-Seltzer); and twenty-eight others. TVT 1400, © 1400, © 1400 (47 min).

the album is lyrically banal (sometimes amazingly so), annoyingly clean-cut, and ultimately indistinguishable from previous SAW product. It's hard to escape the feeling that the same tracks could have been sung over by anybody else from the SAW stable (the dreaded Rick Astley, perhaps, or Kylie Minogue) without affecting the overall sound in any significant way. In short, this is deliberately disposable stuff, depressing in its utter calculation and valuable only as a thoroughly representative artifact of its time. S.S.

SWING OUT SISTER: Kaleidoscope World. Corinne Drewery (vocals); Andrew Connell (keyboards); vocal and instrumental accompaniment. *You on My Mind*; *Where in the World*; *Forever Blue*; *Heart for Hire*; *Tainted*; and five others (nine others on CD). FONTANA 838 293-1, © 838 293-4, © 838 293-2 (60 min).

Performance: *Airy, adult pop*
Recording: *Shimmering*

Back in the kaleidoscope world of the late Sixties, the ever more baroque rock-and-roll scene gobbled up anything in its path. One of the more interesting tangents saw certain aspects of flower-power psychedelia absorbed into mainstream, supper-club pop, a form that reached its zenith when songwriter/arranger Jimmy Webb collaborated with the vocal group the Fifth Dimension. Twenty years later, it's up, up, and away all over again as the British duo Swing Out Sister enthusiastically skips down that fragrant path in a buoyant swirl of voices and snappy jazz-pop arrangements.

"Kaleidoscope World" is redolent not only of Webb and the Fifth Dimension but of Sergio Mendes and Brazil '66 and Astrid Gilberto. These antecedents may be lost on a lot of listeners, but the springlike freshness of the music will prove an attractive come-on. The album's ten songs are as light and airy as a soufflé, their engaging hummability belying the deft craftsmanship that went into the arrangements. Singer Corinne Drewery's enticing siren call is backed by warm, brassy horns, sweetened with strings, and given percussive texture through the use of such exotica as tubular bells and triangle.

Sometimes, as in the opening cut, *You on My Mind*, Swing Out Sister simply takes your breath away with the artful ingenuity of its brightly decorated, briskly paced pop. In a couple of songs, *Precious Words* and *Forever Blue*, Drewery and her partner, keyboardist Andrew Connell, have gone straight to the source and enlisted Jimmy Webb to score the arrangements and conduct the orchestra. There are no politics or polemics in "Kaleidoscope World," just a brilliant palette of musical colors for dreamers to get lost in. The approach is a bit recherché, but the results are mesmerizing. P.P.

Check Your Speakers For Holes.

If you're looking for great bass, we suggest you look behind your speakers.

For a hole about the size of a Q-ball. Or a tortilla.

Because a speaker that's tuned and "ported" to, say, 30 Hertz, is a full 3 decibels louder in the low frequency range. Which may not sound like much. On paper.

But an increase of 3 decibels is equal to doubling the amplifier power at the tuning frequency (30 Hertz).

And reduces what's known as "cone excursion." Because with the added sensitivity, the woofer requires less cone movement to generate low frequency sounds.

So what you'll hear is clean, loud and, yes, throbbing bass.



Now that you know what to look for in a speaker, this is the speaker you should be looking for.

Of course, with a vented speaker, there is one thing you'll miss.

Distortion.

Simply, a vented Cerwin-Vega speaker can reproduce more undistorted bass than a comparable "sealed system." Using less input power and thus, putting less stress on the woofer. And your amplifier.

Now remember, this is science, so there's more here

than just drilling holes.

Cerwin-Vega engineers fine tune each port for



optimum bass performance and efficient air movement. Not to mention, the best sound.

All of which means that if your speakers don't have holes, you might want to talk to a Cerwin-Vega dealer.

And get the hole truth.

 **Cerwin-Vega!**

555 East Easy Street, Simi Valley, CA 93065 805.584.9332

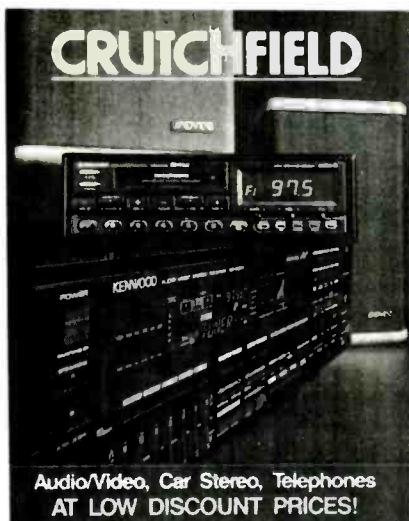

You'll find the most helpful shopping information in the 116 page Crutchfield catalog.

FREE Stereo Catalog

Refer to the Crutchfield catalog before buying your next car stereo, home stereo, or video product:

- 116 pages of helpful articles, consumer tips, charts, and installation guides.
- Color photos, complete descriptions and technical specifications on hundreds of the finest brand name products.

You get more value shopping Crutchfield:

- Toll-free product advice, ordering, and customer service.
- 24 hour shipping.
- Absolute satisfaction guaranteed.
- Full 30-day return privileges.
- Discount prices on Sony, Pioneer, JVC, Jensen, Proton, Advent, Clarion, Kenwood, AR, Infinity, Bose, and many more!

Call or send this coupon now for your FREE Catalog

800-336-5566

Be sure to mention *Stereo Review* when calling

Name _____

Address _____ Apt. # _____

City _____ State _____ Zip _____

Optional: Do you have space in your home that you use as an office? Yes No

CRUTCHFIELD

1 Crutchfield Park, Dept. SR, Charlottesville, VA 22906

JAZZ

LOUIE BELLSON: *East Side Suite*. Louie Bellson (drums); Clark Terry (trumpet); Louie Bellson Jazz Orchestra. *Blues for Uncommon Kids; My One and Only Love; Paddlin' Madeline; East Side Suite*; and three others. MUSICMASTERS © CIJD 60161T (53 min).

Performance: *Polished*
Recording: *Excellent*

Drummer Louie Bellson is in his mid-sixties, but he plays as energetically as ever in "East Side Suite," a new album that features his big band and takes its title from a three-part collaboration with composer/arranger Tommy Newsum. The album also contains several fine charts by long-time Bellson associate Don Menza and one by trombonist Hale Rood. Not surprisingly, the most dynamic track is the opening one, *Blues for Uncommon Kids*. Menza's answer to Aaron Copland's *Fanfare for the Common Man*: it spotlights the four-man trombone section and also gives center stage to the leader. Trumpeter Clark Terry is the band's guest for this outing, appearing advantageously in two selections. Menza's *Paddlin' Madeline*, which rides comfortably on Ellington's *Take the "A" Train*, and the suite's finale, *Village Hangout*. While all nine selections make positive statements, my favorite is the tenor conversation that brings it all to a close, *Tenor Time*, in which Menza and Kenny Hitchcock engage in meaningful dialogue. C.A.

THE CHARLIE BYRD TRIO WITH SCOTT HAMILTON: *It's a Wonderful World*. Charlie Byrd (guitar); Scott Hamilton (tenor saxophone); John Goldsby (bass); Chuck Redd (drums). *It's a Wonderful World; Between the Devil and the Deep Blue Sea; My Shining Hour; I Got It Bad and That Ain't Good; Caravan; Street of Dreams*; and five others. CONCORD JAZZ CJ-4374, © CJ-4374-C, © CCD-4374 (49 min).

Performance: *Silken*
Recording: *Excellent*

You couldn't ask for a smoother fit than guitarist Charlie Byrd and tenor saxophonist Scott Hamilton, who have combined their talents for the first time in "It's a Wonderful World." It makes you wish things ran so wonderfully well in the real world. The set of eleven standards moves along with silken smoothness, but it also has the beat and bite of real jazz. Although this is the regular Charlie Byrd Trio with Hamilton making a guest appearance, the quartet has the cohesive sound of a working ensemble accustomed to producing bouncy, fluent swing. I suspect these four will be called in for an encore—they certainly ought to be. C.A.

THE DIRTY DOZEN BRASS BAND: *Voodoo*. The Dirty Dozen Brass Band (instrumentals and vocals); other musicians. *It's All Over Now; Voodoo; Oop Pop a Dah; Gemini Rising*; and four others. COLUMBIA FC 45042, © FCT 45042, © CK 45042 (41 min).

Performance: *Disappointing*
Recording: *Quite good*

I was impressed when I first heard the Dirty Dozen Brass Band at the 1984 Umbria Festival, in Perugia, Italy. The group captured the spirit of traditional New Orleans jazz, and its music was a happy amalgam of everything I liked about jazz, with a few extra ingredients thrown in—it would, I thought, do rather well in an era of plugged-in jazz synthesis. Now, five years and three albums later, the best one can say for this group is that it has survived. Although it has moved to a major label, Columbia, it appears to have lost the spontaneity that originally contributed so much to its charm. While guest artists Dr. John, Dizzy Gillespie, and Branford Marsalis provide salient moments, their sparkling playing seems to relegate the headline band to an unimaginative supporting role. Even when it stands alone, the band seems content to play trite unison riffs and figures. Some band members do occasionally come up with an engaging solo, such as Kevin Harris's articulate statement in *Gemini Rising*, but "Voodoo" lacks the magic that I saw in the cards five years ago. It's a good album that ought to have been much better. C.A.

HERB ELLIS AND RED MITCHELL: *Doggin' Around*. Herb Ellis (guitar); Red Mitchell (bass, vocals). *Sweethearts on Parade; I'm Confessin' That I Love You; There's No Bad Blues; Easy Living; Over the Rainbow*; and five others (seven others on CD). CONCORD JAZZ CJ-372, © CJ-372-C, © CCD-4372 (56 min).

Performance: *Ultra-mellow*
Recording: *Excellent*

A mellow mood, skillful execution, and good taste prevail in "Doggin' Around," an album that captures, to great advantage, guitarist Herb Ellis and bassist Red Mitchell during a 1988 Santa Monica club appearance. Jazz musicians have engaged in and recorded two-way instrumental dialogues since the Twenties, when such teams as Louis Armstrong and Earl Hines or Lonnie Johnson and Eddie Lang conversed with enduring authority. This set is in that tradition, a wonderful, relaxed stroll through ballads and blues by two stellar musicians who first won the jazz world's respect in the Forties and Fifties. If someone ever asks you to define

jazz, this album might not provide the complete answer, but it will surely save you a lot of explaining. And the sound is first-rate. C.A.

SUSANNAH MCCORKLE: *No More Blues*. Susannah McCorkle (vocals); Dave Frishberg (piano); Bucky Pizzarelli, Emily Remler (guitar); other musicians. *Fascinating Rhythm; Swing That Music; The Ballad of Pearly Sue; P.S. I Love You; No More Blues*; and five others (seven others on CD). CONCORD JAZZ CJ-370, © CJ-370-C, © CCD-4370 (51 min).

Performance: *Sublime*
Recording: *Excellent*

In "No More Blues," Susannah McCorkle once again proves that she is one of the finest jazz singers on the scene today, and I mean one of a mere handful. So-called jazz singers seem to be springing up everywhere these days, but the Diane Schuurs, Anita Bakers, and Betty Carters of this world can't hold a candle to Susannah McCorkle. She is up there with Sarah Vaughan, and, frankly, I am hard put to come up with another name. The sad thing is that McCorkle's great albums of the past have done little to boost her career, having appeared on minor, poorly distributed labels. But

that should all change now. In Concord Jazz, McCorkle has finally found a fitting label, and her debut release on it is glorious.

Once again, this extraordinary singer has come up with a program of unusual material. This is not to say that you won't recognize some of the tunes, but unless you have treated yourself to a McCorkle club performance, you will never have heard songs like *Sometimes I'm Happy* and *Fascinating Rhythm* sung quite like this. There is also a greater variety of moods and pace than in previous McCorkle albums as well as a fuller accompaniment. I love it all, from her slinky reading of *Fascinating Rhythm* and a wonderful uptempo version of Louis Armstrong's 1936 hit *Swing That Music* to a butter-soft *P.S. I Love You*. The CD has two additional tracks, *Can't Take You Nowhere*, a typically whimsical song by the album's pianist, Dave Frishberg, and the Gershwin tune *Who Cares?* I highly recommend this album in any format. C.A.

JANE SCHECKTER: *I've Got My Standards*. Jane Scheckter (vocals); Mike Renzi (piano); Jay Leonhart (bass); Grady Tate (drums). *This Time the Dream's on Me; Haunted Heart; It Might As Well Be Spring; I'm in Love*

Again; I See Your Face Before Me; and seven others. DRG MRS 711, © MRSC 711, © CDMRS 711 (44 min).

Performance: *Indeed she does*
Recording: *Beautifully alive*

The double-edged title of this record is an honest one, for here's a singer who is not only fond of the songs of Arlen, Porter, Gershwin, Berlin, Schwartz, and other writers of "pop standards" but knows how to make the most of them with genuine style and panache. Jane Scheckter's voice is so warm and vibrant, and her feeling for the subtlest moods of the lyrics is so compelling, that only a cranky purist would quibble about her occasional tendency to "circle" certain tones rather than land precisely on them. Her choice of songs is refreshingly unhackneyed: Gershwin's *I've Got Beginner's Luck* and *For You, For Me, Forevermore* and Rodgers and Hart's *You Took Advantage of Me* are typical of her avoidance of the tired and trite. And her topnotch instrumental colleagues match her throughout with a spark and spontaneity that make each song catch fire. R.H.

TRIBUTE TO JOHN COLTRANE—LIVE UNDER THE SKY (see *Best of the Month*, page 124)

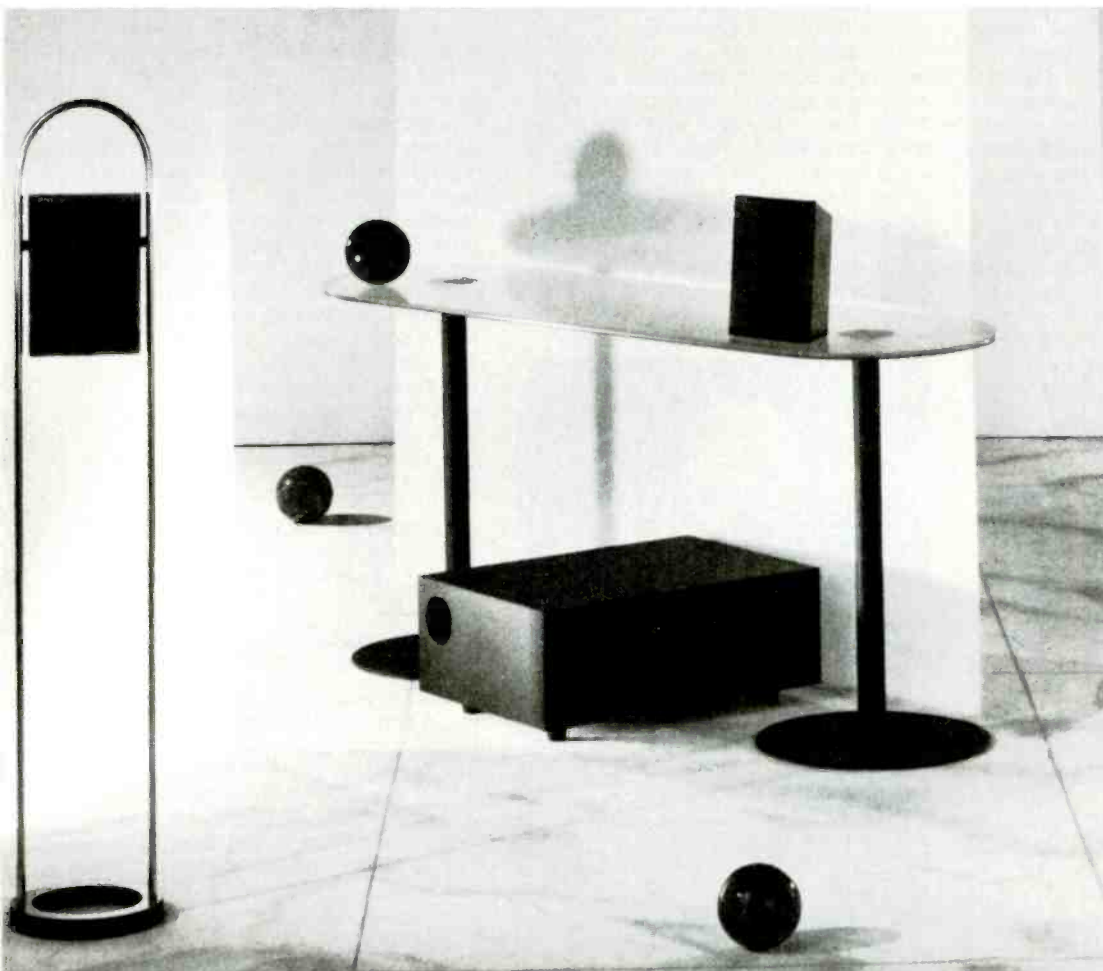

Three Easy Pieces . . .

She wants something to listen to,
not look at.

He wants the sound of success.

We gave them the SW-3 System.

Three easy pieces for room placement,
power efficiency, and superior sound
imaging. Plus optional satellite stands.
For those who want to go all the way.

From Denmark.

From Jama

Of course

Jamo 

JAMO Hi-Fi, USA, Inc.
425 Heuhl Rd., Bldg. 3A
Northbrook, IL 60062
312.498.4648

Discs and tapes reviewed by Robert Ackart, Richard Freed, David Hall, Stoddard Lincoln, Eric Salzman, and David Patrick Stearns

BRUCKNER: *Symphony No. 6, in A Major*. North German Radio Symphony Orchestra, Günter Wand cond. RCA © 60061-4-RC, © 60061-2-RC (55 min).

Performance: *Very good*
Recording: *Very good*

BRUCKNER: *Symphony No. 6, in A Major*. Frankfurt Radio Symphony Orchestra, Eliahu Inbal cond. TELDEC/WEA © 244 182-4, © 244 182-2 (59 min).

Performance: *Variable*
Recording: *Good*

The Sixth is not only the shortest of the late Bruckner symphonies, it is also atypical in that its outer movements are replete with sharply contrasting episodes instead of the long melodic periods over string tremolo that are thought to be part and parcel of the Bruckner idiom. And though not heard often in the concert hall, it has had a good many recorded performances, beginning with the pioneering one on Westminster in 1951. Of these two new versions I responded more positively to the one by veteran Brucknerian Günter Wand, recorded live in the fine acoustic of Hamburg's Musikhalle. He holds the symphonic structure together in masterly fashion and elicits both ardor and a convincing sense of momentum from his players. Except for some shifting and rustling among the audience during the interval between the last two movements, you'd be hard put to believe that this was not a studio session.

Eliahu Inbal, over the past few years, has not only given us a distinguished Mahler cycle with the Frankfurt Radio Symphony—recorded, like this Bruckner Sixth, in that city's Alte Oper—but he has put Bruckner lovers in his debt with the first recordings of the original, unrevised versions of the Third, Fourth, and Eighth Symphonies. Unlike those works, the Sixth never underwent revision, so the performance problem is essentially one of pacing and dynamics—keeping the flow and doing

justice to the inner drama. I find Inbal's rather freewheeling approach less successful than that of Wand, chiefly because Inbal tends to linger unduly over the lyrical-atmospheric episodes in the outer movements. The orchestral playing, however, is fine, by the strings especially. The recorded sound is generally good, but the Alte Oper acoustic seems to respond better to Mahler than to Bruckner. *D.H.*

CHARPENTIER: *Te Deum; Missa "Assumpta est Maria"; Litanies de la vierge*. Les Arts Florissants. William Christie cond. HARMONIA MUNDI © 901298 (75 min).

Performance: *Communicative*
Recording: *Good*

Marc-Antoine Charpentier's *Te Deum* was one of the first major rediscoveries in the ongoing Charpentier revival. Unlike the relentlessly imposing *Te Deum* written by his compatriot Lully in the same period (the late 1600's), Charpentier's setting of this text, which normally inspires bombast, surprises us with its disarming intimacy. But the intensity and sincerity of the music makes the work seem no less impressive than Lully's *Te Deum*—or Berlioz's.

The *Missa "Assumpta est Maria"* is in another style. It seems like an opera masquerading as a sacred choral work: Every line is charged with a kind of theatrical subtext. Finally, the ravishing vocal writing and inventive text settings of the third work here, the *Litanies de la vierge*, present a fairly complete cross section of Charpentier's multifaceted art. Altogether, the CD is an ideal introduction to the composer's music. Wil-

Günter Wand: masterly Bruckner



liam Christie's Les Arts Florissants is in splendid form throughout, and the performances clearly supersede those in previous recordings. *D.P.S.*

DVOŘÁK: *Piano Quintet in A Major, Op. 81; String Quartet No. 12, in F Major, Op. 96 ("American")*. Hiroko Nakamura (piano); Tokyo String Quartet. CBS © MT 44920, © MK 44920 (66 min).

Performance: *Large-scale*
Recording: *Powerful*

The unusually expansive opening of the Piano Quintet in this recording may put off some listeners, who may take it as a signal of sentimental indulgence. Sentiment is certainly given its due in these large-scale, intensely expressive performances, but they are at the same time as tasteful and fastidious as we have come to expect from the Tokyo Quartet. Rhythms are steady, and tempos, once set, are held firmly, with a minimum of gear-shifting. The balance between the instruments is virtually ideal in both works, making for a rich ensemble sound and at the same time allowing many felicities in Dvořák's writing that usually go unnoticed to emerge without being artificially spotlighted or disturbing the splendid momentum.

The recording itself can only be described as powerful. While it is close enough to make the most of the clarity and bigness of the performances, it adds none of the harshness that often comes from so close a focus. The silky voluptuousness of the Tokyo strings and Hiroko Nakamura's radiant piano tone are perhaps all the more impressive at close range. Such high-pressure chamber music as this may not be for everyone. There are more intimately scaled and straightforward performances of the quintet that may wear better, but there is room for intensity, too, when it is as tastefully conveyed as it is here, and there is really no more winning account of the F Major Quartet. *R.F.*

GETTY: *The White Election*. Kaaren Erickson (soprano); Armen Guzelimian (piano). DELOS © D/CD 3057 (72 min).

Performance: *Uneven*
Recording: *Excellent*

Emily Dickinson was known to play the piano and even to compose during her reclusive decades, so it's not surprising that her highly musical poems blossom in the respectful, affectionate hands of composer Gordon Getty. He has set thirty-two of them to music and arranged them into a roughly autobiographical scenario titled *The White Election*, a metaphor for the poet's renunciation of the world. The song cycle is something of a musical counter-

EXPLANATION OF SYMBOLS:

- = DIGITALLY RECORDED L.P.
- Ⓢ = TAPE CASSETTE
- Ⓣ = COMPACT DISC (TIMINGS ARE TO NEAREST MINUTE)

part to William Luce's Dickinson monodrama, *The Belle of Amherst*, which was pieced together from her letters.

Getty's mostly tonal musical language winningly recalls Schubert, with dashes of Prokofiev-style dissonance. At their best, Getty's concise settings meld so seamlessly into the verses that words and music seem inseparable. But there's a sameness to his approach that becomes wearisome after a while. His *idée fixe*, an eloquently resolved tritone, is heard so frequently that its reappearances seem to indicate flagging invention more than anything else.

Soprano Kaaren Erickson often achieves such a close communion with the material that it seems we're hearing the authentic utterance of Emily Dickinson. Much of the time, however, Erickson goes for large, operatic effects that overload these slender songs; her interpretive arsenal isn't as rich as the material requires. But then, this lengthy piece would challenge the most seasoned lieder singer. *D.P.S.*

HANDEL: *Jephtha*. Nigel Robson (tenor). Jephtha: Lynne Dawson (soprano). Iphis: Anne Sofie von Otter (contralto). Storgè: Michael Chance (countertenor). Hamor: Stephen Varcoe (baritone). Zebul: Ruth Holton (soprano). Angel. Monteverdi Choir; English Baroque Soloists, John Eliot Gardiner cond. PHILIPS © 422 351-4 three cassettes, © 422 351-2 three CD's (158 min).

Performance: *Variable*
Recording: *Bud*

John Eliot Gardiner's live recordings from the Göttingen Handel Festival have usually conveyed both deeply considered musical insights and the electricity of live performance, resulting in some of the finest Handel recordings ever. The prospect of hearing Handel's last and perhaps most forward-looking work, the oratorio *Jephtha*, as performed at Göttingen was thus quite exciting. As it turns out, however, the recording is poorly engineered—though the chorus sings splendidly, the recorded sound is so harsh and opaque that you can barely hear, much less enjoy, the music's inner details—and Gardiner's fast tempos sometimes seem to lack purpose. Some of the soloists, too, are disappointing. Nigel Robson, for instance, provides an intelligent, dramatic characterization of Jephtha, but he hasn't nearly the vocal range to carry the role. On the other hand, the vocal contributions of Lynne Dawson, Anne Sofie von Otter, and Michael Chance are well worth hearing. *D.P.S.*

HANSON: *Symphonies Nos. 1 and 2; Elegy in Memory of Serge Koussevitzky* (see Best of the Month, page 126)



BERNSTEIN'S MAHLER

Leonard Bernstein's new recording of Mahler's First Symphony with the Royal Concertgebouw Orchestra of Amsterdam is not only markedly superior to his earlier recording with the New York Philharmonic, but it is one of the high points of his current Mahler series for Deutsche Grammophon. It is also another impressive validation of the effectiveness of recording live. The audience is nowhere in evidence—except, one might say, in the electrifying impact of the performance, its level of continuity, and the sense of its being produced in response to real live listeners whose own response is obviously felt by the conductor.

In terms of such considerations as tempo and phrasing, this is one of the most straightforward of Bernstein's Mahler interpretations. Indeed, it is a good deal less fussy or overtly "individ-

ualized" than many others in its apparent surrender to the music's natural momentum, and yet it is illuminated everywhere by uncommon insights and conviction. Expressive points are made without in any way impeding the wonderful flow; climaxes seem to be allowed to occur, rather than being staged. Everywhere the coloring, the textures, the sense of *movement* combine to generate a remarkable freshness and vitality as well as a credible warmth of heart. The great orchestra is in top form, the sound rich and well focused. In sum, a distinguished addition to the discographies of both Bernstein and Mahler. *Richard Freed*

MAHLER: *Symphony No. 1, in D Major*. Royal Concertgebouw Orchestra, Leonard Bernstein cond. DEUTSCHE GRAMMOPHON © 427 032-1, © 427 032-4, © 427 032-2 (56 min).



Receiver Specials



Technics SA-R430
Remote Audio/Video Stereo Receiver
• 100 watts RMS per channel • Matrix A/V surround system • 44-key unified remote • 7-band EQ with memories • Digital tuner with 24 presets • Black finish

Sale Price **\$359⁹⁵** Retail \$520 (TEC SAR430)

Scott RS250
• 25-watts per/ch, LCD-tuner, 16-presets **\$99⁹⁵**

Sharp SAX50
• 50-watts/ch, Surround-Sound, EQ **\$124⁹⁵**

Sherwood S2770CP-II
• 74-watts/ch, remote, Surround **\$219⁹⁵**

Technics SA160
• 40-watts/ch, 24-presets, 5-band EQ **\$149⁹⁵**

Technics SAR330
• 70-watts/ch, unified remote, EQ **\$249⁹⁵**

Technics SAR530
• 100-watts/ch, Surround-Sound, EQ **\$499⁹⁵**

Tandberg 50 to 63% Off



Tandberg TPR-3080A
Audiophile Programmable Receiver
• State-of-the-art in audiophile performance from Tandberg • 80 watts per channel RMS • Zero negative feedback design • 16 FM presets • Black finish

Sale Price **\$999** Retail \$2000 (TAN 3080A)

Tandberg 3031A Tuner
• Orig. Mfg. \$1200... Save 58% **\$499⁹⁵**

Tandberg 3038A Preamp
• Orig. Mfg. \$1350... Save 63% **\$499⁹⁵**

Tandberg 3036A Power Amp
• Orig. Mfg. \$1350... Save 55% **\$599⁹⁵**

Tandberg 3015A CD Player
• Orig. Mfg. \$2000... Save 50% **\$999⁹⁵**

Tandberg 3008A Preamp
• Orig. Mfg. \$1200... Save 58% **\$499⁹⁵**

Tandberg 3018A Preamp
• Orig. Mfg. \$2500... Save 60% **\$999⁹⁵**

SAE 44 to 60% Off



SAE A-202
High Resolution Power Amplifier
• 100 watts RMS per channel • Complementarily amplifier design delivers greater stereo imaging and reduced phase shift • LED power output display • Black finish

Sale Price **\$249⁹⁵** Retail \$520 (SAE A2C2)

SAE A502 Power Amp
• Orig. Mfg. \$800... Save 44% **\$399⁹⁵**

SAE P102 Preamp
• Orig. Mfg. \$450... Save 44% **\$249⁹⁵**

SAE T101 Tuner
• Orig. Mfg. \$650... Save 61% **\$249⁹⁵**

SAE T102 Tuner
• Orig. Mfg. \$350... Save 50% **\$174⁹⁵**

SAE C102 Cassette Deck
• Orig. Mfg. \$500... Save 50% **\$249⁹⁵**

SAE D102 CD Player
• Orig. Mfg. \$600... Save 50% **\$299⁹⁵**

This Month's LPs, Cassettes & CDs

The Latest In Jazz From Novus



CHET BAKER
Chet Baker Sings And Plays From The Film "Let's Get Lost" A Film By Bruce Weber
Features: Imagination, My One And Only Love, Almost Blue

NOV 3054



ELEMENTS Liberal Arts
features: Amber Linn/Liberal Arts FB 206

NOV 3058

Also Available...
• Marcus Roberts: The Truth Is Spoken Here (NOV 3051)
• Christopher Hollyday: Christopher Hollyday (NOV 3055)

Your Choice

10⁹⁹ Per CD **6⁹⁹** LP or Cassette

Compact Disc Players



Technics SLP-250
Remote Compact Disc Player
• 4X oversampling and dual D/A converters for superb digital sound • Direct access remote • High speed transport • Track/disc/program repeat • 20-track random program memory

Sale Price **\$199⁹⁵** Retail \$300 (TEC SLP250)

Sharp DX670
• 3-beam laser, 20-track programming **\$129⁹⁵**

Teac PD165
• 3-beam laser, 16-track programming **\$139⁹⁵**

Teac PD470
• 16-bit, 4X-oversampling, remote **\$179⁹⁵**

Technics SLPI01
• 16-bit, 4X-oversampling, 2-D/A **\$164⁹⁵**

Technics SLP222
• 18-bit, 4X-oversampling, remote **\$219⁹⁵**

Technics SLP555
• 18-bit, 4X-oversampling, remote **\$299⁹⁵**

Compact Disc Players



Technics SL-P770
18-Bit Remote Compact Disc Player
• 4X oversampling digital filter • 4 D/A converters • 20-key direct access wireless remote • 2-speed search dial • Peak level search feature • 32 track memory

Sale Price **\$399⁹⁵** Retail \$620 (TEC SLP770)

JVC XL2411
• 18-bit, 4X-oversampling, remote **\$249⁹⁵**

Sharp DX770
• 20-track programming, 19-key remote **\$149⁹⁵**

Sherwood CDP250R
• 16-bit, 2X-oversampling, auto-space **\$109⁹⁵**

Teac PD265
• 16-bit, 3-beam pickup, remote **\$159⁹⁵**

Teac PD440
• 16-bit, 4X-oversampling, 16-key remote **\$179⁹⁵**

Technics SLPI02
• 16-bit, 4X-oversampling, remote **\$179⁹⁵**

Compact Disc Changers



Technics SL-PC20
Remote 5-Disc Rotary CD Changer
• 4X oversampling • 2 D/A converters • Remote control • 20-track random access programming • Disc-by-disc random play • 3" CD compatible • Linear motor transport

Sale Price **\$269⁹⁵** Retail \$329 (TEC SLPC20)

JVC XLM701
• 6+1 changer, 18-bit, 4X-sampling **CALL**

Magnavox CDB486
• 6-disc changer, remote, 16-bit **\$249⁹⁵**

Magnavox CDB586
• 6-disc changer, 4X-sampling, remote **\$299⁹⁵**

Teac PD700M
• 6-disc changer, 4X-oversampling **\$279⁹⁵**

Technics SLPC10
• 5-Disc rotary changer, 4X-sampling **\$239⁹⁵**

Toshiba XR9058
• 6+1 changer, 32-key remote **\$299⁹⁵**

Cassette Deck Specials



Teac V-285CHX
Stereo Cassette Deck
• Dolby B and C • Dolby HX Pro headroom extension system • Bias line tuning • LED peak level meter • 3-digital tape counter • Black finish

Sale Price **\$99⁹⁵** Retail \$160 (TEA V285CHX)

Teac R445
• Auto-reverse, dolby B/C, soft-touch **\$129⁹⁵**

Teac R455CHX
• Auto-reverse, dolby B/C & HX-Pro **\$149⁹⁵**

Teac R616X
• Auto-reverse, dolby B/C/HX-Pro & dbx **\$299⁹⁵**

Teac V570
• 2-motors, dolby B/C & HX-Pro **\$189⁹⁵**

Teac V670
• 3-heads, 2-motors, dolby B/C & HX-Pro **\$269⁹⁵**

Technics RS8905
• 3-heads, dolby B/C/dbx & HX-Pro **\$429⁹⁵**

Double Cassette Decks



Teac W-450R
Auto-Reverse Double Cassette Deck
• High-speed dubbing • Accurate rotary head auto-reverse • Continuous cassette playback • Dolby B/C noise reduction • Dolby HX-Pro headroom extension

Sale Price **\$189⁹⁵** Retail \$289 (TEA W450R)

Sharp RTW800
• Double auto-reverse, dolby B NR **\$159⁹⁵**

Teac W375C
• Dolby B & C NR, continuous play **\$129⁹⁵**

Teac W660R
• Double auto-reverse, dolby B/C **\$299⁹⁵**

Technics RST130
• Series play, dolby B, soft-touch **\$139⁹⁵**

Technics RSTR255
• Auto-reverse, dolby B/C, soft-touch **\$189⁹⁵**

Technics RST55R
• Auto-reverse, dolby B/C & dbx **\$269⁹⁵**

Home Speaker Specials



Technics SB-L35
2-Way Linear Phase Speaker System
• 2-way bass reflex design • 10-inch woofer • 2.5-inch tweeter • Defochable front grill • 100 watts maximum input power • Great sound at an even better price

Sale Price **\$99⁹⁵** Retail \$160/PR (TEC SBLS64)

Bose AMS
• Acoustimass subwoofer & two modules **\$749⁹⁵**

Camber 3.5A
• 2-way 8" speakers, mirror-image pair **\$499⁹⁵**

Celestion DL411
• 2-way 6.5", black or walnut **\$249⁹⁵**

OHM Fil
• Walnut speakers, walnut cabinet pair **\$899⁹⁵**

Technics SBLS6
• 10" 3-way speakers, bass-reflex pair **\$149⁹⁵**

Technics SBLS76
• 12" 3-way speakers, bass-reflex pair **\$199⁹⁵**

Mini Speaker Specials



Koss JCK/5000
Infrared Wireless Speaker System
• High-fidelity sound with the convenience of wireless listening • Ideal for "surround sound" systems • Comes complete with AC/DC adapters, and transmitter

Sale Price **\$174⁹⁵** Retail \$399/PR (KOS JCK5000)

AudioSource LSI
• 2-way micro speakers, black **\$119⁹⁵**

Bose I01
• 4.5" full range driver, black **\$179⁹⁵**

Bose RM2 RoomMate-II
• Built-in amp, 4.5" driver **\$299⁹⁵**

Goodmans Maxim
• 2-way speakers, black ash finish pair **\$179⁹⁵**

Koss M80+
• 2-way micro speakers, walnut **\$119⁹⁵**

Sony SRS150
• Amplified micro speakers **\$129⁹⁵**



ORDER TOLL-FREE 1-800-221-8180
 Mail Order Hours: Monday To Friday 8 AM to 8 PM, Saturday 9 AM to 6 PM, Sunday 10 AM to 4 PM
 Dealer & Institutional Inquiries Call Toll-Free 1-800-221-3191 — In New York 1-718-417-3747
 J&R Music World, Dept. SRO989, 59-50 Queens-Midtown Expressway, Maspeth, Queens, NY 11378

Outside U.S.A. Call: 1-718-417-3737





Super Specials!

LPs, Cassettes and CDs

The Latest In Jazz From Bluebird



RCA 6758

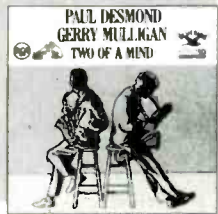

RCA 9654

Also Available...
 •Early Black Swing (RCA 9583)
 •Coleman Hawkins, Ben Webster, Benny Carter: Three Great Swing Saxophones (RCA 9683)

Your Choice

8⁹⁹ Per CD **4⁹⁹** LP or Cassette

Video Recorder Specials



Panasonic PV-4920 4-Head VHS Video Recorder

•Bar code programming •Synchro edit •155 channel digital quartz tuning •Variable and double-line slow motion •On-screen display •57-function remote control

Sale **\$349⁹⁵** Retail \$479 (PAN PV4920)

JVC HRD410U 3-heads, mid-size, LCD unified remote **\$299⁹⁵**

Panasonic PV2900 On-screen, 38-function remote **\$299⁹⁵**

Samsung VR2210 VHS player, 3-speeds, carry-handle **\$179⁹⁵**

Samsung VR2650 On-screen programming, remote **\$229⁹⁵**

Sony SL340 Sony-Beta, remote, Beta-I playback **CALL**

Toshiba M7850 4-heads, on-screen programming **\$319⁹⁵**

Hi-Fi Video Recorders



Panasonic PV-4860 4-Head VHS Hi-Fi Video Recorder

•4 video heads for great special effects •MTS stereo 155 channel cable ready tuner •Hi-Fi stereo sound •30-Day/8-event timer •44 function remote control

Sale **\$449⁹⁵** Retail \$640 (PAN PV4860)

JVC HRD750U 4-heads, MTS-stereo, on-screen, variable **CALL**

Panasonic PVS4764 Super-VHS, 4-heads, on-screen, MTS **\$599⁹⁵**

RCA VR630HF 4-heads, on-screen, MTS-stereo, 120-Ch **\$449⁹⁵**

Sony SLHF860 Super-Beta, digital-memory, stereo **CALL**

Teac MV900 4-head, 21-function remote, MTS **\$499⁹⁵**

Toshiba DX900 PCM digital, 4-heads, on-screen, MTS **\$669⁹⁵**

Camcorder Specials



FREE PVH33M CARRY CASE with PURCHASE

Panasonic PV-S350 Super-VHS Camcorder

•Digital effects •1/1000-sec. hi-speed shutter •CCD-image sensor •8:1 power zoom macro •Flying erase head •Low light 1-LUX •Auto date/time •Auto white balance

Sale **\$1399⁹⁵** Retail \$2150 (PAN PV3350)

JVC GR40 VHS-C Digital superimposer, Free-Case **\$999⁹⁵**

JVC GR30 VHS-C 8-LUX, flying erase, 6:1 zoom **\$699⁹⁵**

Panasonic PV400A 7-LUX, hi-speed shutter, Free Case **\$849⁹⁵**

Panasonic PV460 Elec Image stabilizer, Free-Case **\$1449⁹⁵**

Panasonic PVS150 Super VHS-C, 7-LUX, Free-Case **\$1099⁹⁵**

Sony CCD30 8mm, 2-page digital superimposer **\$799⁹⁵**

Television Specials



Panasonic CTK-2770S 27-inch Color TV/Monitor

•Square corner picture tube •22-function unified remote •155 channel cable ready stereo tuner •On-screen display •Sleep timer •S-VHS input •Oak woodgrain cabinet

Sale **\$599⁹⁵** Retail \$899 (PAN CTK2770S)

JVC AV2058S 20" color, remote, stereo, S-VHS input **\$399⁹⁵**

Magnavox CJ3922CH 5" color portable, AM/FM, AC/DC **\$239⁹⁵**

Samsung TB0570 5" black & white portable, AM/FM **\$79⁹⁵**

Samsung TC3823T 13" color, remote, 139-ch, cable **\$199⁹⁵**

Sony KV8AD10 8" color portable, remote, AC/DC **CALL**

Toshiba CX2788 27" color, Carter sonic holography **CALL**

DJ Equipment



Gemini MX-4200 Disco Mixer with Echo

•3-phonos inputs •3-line inputs •Separate faders •1-microphone input •Peak reading VU meters •Echo mixing •Black finish

Sale **\$99⁹⁵** Retail \$149 (GMI MX4200)

Atus AM300E Mixer/Preamp w/delay, rack-mount **\$199⁹⁵**

Atus AM50 Mixer, 2-phonos & 1-line input, cueing **\$59⁹⁵**

GLI 5991 Pro-mixer, 3-band EQ, beat-motch **\$99⁹⁵**

Gemini MX5400SE Mixer, sound-effects, 7-band EQ **\$199⁹⁵**

Gemini MX9200 Mixer/Preamp, 10-band EQ, echo **\$249⁹⁵**

We Carry A Complete Selection of Disco Lights **CALL**

Equalizer Specials



ADC SS-525X Computerized Graphic Equalizer

•12-bands per/channel •Automatic room equalization for flat room response •Wireless remote •Analyzer/EQ display •Pink noise generator •Microphone •Black finish

Sale **\$359⁹⁵** Retail \$599 (ADC SS525X)

ADC SS100SL 10-bands/ch, real-time analyzer display **\$99⁹⁵**

ADC SS300SL 10-bands/ch, 2-way dubbing, analyzer **\$159⁹⁵**

ADC SS325X 12-bands/ch, real-time analyzer **\$279⁹⁵**

AudioSource EQ8 10-bands/ch, LED spectrum display **\$89⁹⁵**

Teac EQA20 10-bands/ch, LED spectrum analyzer **\$89⁹⁵**

Technics SH858 7-bands/ch, 6-press curve memorize **\$179⁹⁵**

Audio Systems



Panasonic SC-T100 Compact Stereo System

•Quartz-synthesizer tuner W/presets •3-band EQ •Dual cassette w/high-speed editing •Series playback •Belt-drive turntable •Full range speakers

Sale **\$179⁹⁵** Retail \$249 (PAN SCT100)

Panasonic SCT105 Compact system with CD-player **\$349⁹⁵**

Panasonic SCT300 Remote system, dual-cassette **\$249⁹⁵**

Panasonic SCT305 Remote system with CD-player **\$399⁹⁵**

Panasonic SCT505 Remote, CD-player, dual-cass **\$479⁹⁵**

Panasonic SGX88K Dual-cassette, 3-band equalizer **\$129⁹⁵**

Technics SCAB10 100-watts/ch, dual-cassette, rack **\$499⁹⁵**

Turntable Specials



Dual CS-211CA Belt Drive Turntable

•Convenient semi-automatic, auto return operation featuring easy-to-use top mounted controls •Hinged dust cover •European styling

Sale **\$79⁹⁵** Retail \$189 (DUA CS2110A)

Dual CS5000/X3MC Semi-auto Table W/Ortolon cartridge **\$449⁹⁵**

Dual CS503-1 Semi-auto, belt-drive, standard mount **\$129⁹⁵**

Gemini DJM1100 Semi-auto, belt-drive, pitch-control **\$84⁹⁵**

Technics SL8D20 Semi-auto, belt-drive, P-mount **\$79⁹⁵**

Technics SLDD33 Fully-automatic, direct drive **\$119⁹⁵**

Technics SLJ33K Fully-automatic, linear-tracking **\$179⁹⁵**

Phono Cartridges

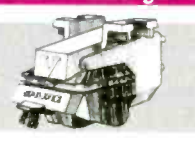

Shure V15 Type V-MRLE Limited Edition Micro Ridge Cartridge

•Micro-ridge •Lighter specifications •Micro-ridge stylus tip •Excellent trackability •Dynamic stabilizer •Side-guard stylus protection •Wood case & stylus gauge

Sale **\$189⁹⁵** Retail \$350 (SHU V15-VMRLE)

Audio Technica AT140ML Microline-stylus, standard **\$69⁹⁵**

Audio Technica AT211EP Bi-radial-stylus, universal **\$199⁹⁵**

Audio Technica AT231LP Linear-contact, universal **\$399⁹⁵**

Pickering XV15/120OE Elliptical-stylus, standard **\$44⁹⁵**

Shure M111HE Hyperelliptical stylus, universal **\$499⁹⁵**

Shure V15-VMR Micro-ridge stylus, standard-mount **\$129⁹⁵**

Disco Phono Cartridges



Stanton 680EL High Performance Disco Cartridge

•Designed for heavy duty disco applications •Standard-mount •Elliptical stylus •Frequency response: 20-18kHz •Tracking force: 2.0-10.5 gr. •Includes extra stylus

Sale **\$54⁹⁵** Retail \$109 (STA 680EL)

Audio Technica ATP2XN Elliptical-stylus, standard **\$299⁹⁵**

Ortolon CCPRO Spherical-stylus, standard-mount **\$89⁹⁵**

Pickering 625DJ Elliptical-stylus, standard-mount **\$32⁹⁵**

Shure DC40 Elliptical-stylus, standard-mount **\$299⁹⁵**

Stanton 500AL Spherical-stylus, standard-mount **\$199⁹⁵**

Stanton 680ELMP Twin-pack 680 cartridges **\$69⁹⁵**

CIRCLE NO. 39 ON READER SERVICE CARD

TO ORDER BY MAIL: SEND MONEY ORDER, CERTIFIED OR CASHIER'S CHECK, MASTERCARD, VISA, AMERICAN EXPRESS OR DISCOVER CARD (include Interbank No. expiration date and signature) TO: **J&R MUSIC WORLD, DEPT. 39089, 65-30 QUEENS MIDTOWN EXPRESSWAY, MASPETH, QUEENS, NY 11378.** Personal and business checks must clear our Authorization Center, before processing. Shipping, Handling & Insurance Charge is 5% of Total Order with a \$4.95 minimum. (Canadian Orders Add 15% Shipping, with a \$9.95 minimum charge). For shipments by air, please double these charges. **\$25 MINIMUM ORDER. DO NOT SEND CASH. SORRY, NO C.O.D.'S.** NEW YORK RESIDENTS PLEASE ADD SALES TAX. WE ARE NOT RESPONSIBLE FOR TYPOGRAPHICAL ERRORS. ALL PICTURES SHOWN FOR VISUAL REPRESENTATION ONLY. ALL MERCHANDISE SHIPPED BRAND NEW, FACTORY FRESH, AND 100% GUARANTEED.





Personal Stereos



Sony WM-AF604 MegaBass AM/FM Walkman Cassette Player
 • AM/FM stereo tuner • Mega-bass system
 • Auto-reverse • Dolby B • Includes lightweight headphones, rechargeable battery and charger • Requires 2 X AA batteries

Sale **\$129⁹⁵** Retail \$179 (SON WMAF604)
 Price

General Electric 71990
 • AM/FM/Cassette, splashproof . . . **\$24⁹⁵**

Panasonic RQV340
 • AM/FM/Cassette, XBS, A/R, daby . **\$129⁹⁵**

Panasonic RQV50
 • AM/FM/Cassette, DX/Local selector **\$29⁹⁵**

Sony WMAF48
 • AM/FM auto-reverse cassette walkman **\$49⁹⁵**

Sony WMF73
 • AM/FM/Cassette, water-resistant, daby **\$99⁹⁵**

Toshiba KT4048
 • AM/FM auto-reverse cassette, daby **\$64⁹⁵**

Portable CD Players



Technics SL-XP6 Portable Compact Disc Player
 • Ultra-compact & light weight • 4 times oversampling • 3-way power supply • Includes rechargeable Ni-Cad batteries • 3 play modes • Headphones & carrying case

Sale **\$259⁹⁵** Retail \$395 (TEC SLXP6)
 Price

Sony D160
 • Home/Car CD-player, car mount adapt. **CALL**

Sony D25
 • 4X-sampling, remote, Ni-Cad. . . **CALL**

Sony D88
 • Pocket size, Ni-cad batt & AC-adapt. **\$149⁹⁵**

Sony DT4
 • AM/FM/sterio & CD-player. . . **\$229⁹⁵**

Teac PDP7
 • 16-track programming, 2-way repeat **\$149⁹⁵**

Toshiba XR9437
 • AM/FM stereo, rechargeable battery **\$229⁹⁵**

Portable Audio



JVC PC-X300J HyperBass AM/FM Double Cassette CD-Player
 • Synthesizer tuner with 20-presets • Hyper-bass • High-speed dubbing • Relay-play • Dolby B • 5-band EQ • Detachable speakers • Mic mixing • Requires 8 D batteries

Sale **\$399⁹⁵** Retail \$649 (JVC PCX300J)
 Price

JVC PCV88J
 • AM/FM/Double-cassette, Hyper-Bass **\$219⁹⁵**

Panasonic RXDS30
 • AM/FM/Cassette & CD Player, clock **\$269⁹⁵**

Panasonic RXFS400
 • AM/FM & stereo cassette recorder . **\$49⁹⁵**

Sharp QTCD25
 • AM/FM/Cassette & CD, 3-band EQ . **\$174⁹⁵**

Sony CFDA54
 • AM/FM/Cass & CD, detachabl. spkrs **\$259⁹⁵**

Sony CFSW80
 • AM/FM/Double cassette, Mega-Bass **\$199⁹⁵**

This Month's

VHS Video Movies



JOHN COLTRANE
 The Coltrane Legacy

24⁹⁵ Each

Also Available

- Trumpet Kings \$24.95
- Piano Legends \$24.95
- Live At The Village Vanguard \$24.95
- Vol 1: Freddie Hubbard \$24.95
- John Abercrombie \$24.95
- Vol 3: M. Pettruccianni Trio \$24.95

Radios/Cassette Recorders



Grundig Satellit 500 International Receiver
 • AM/FM/LW and SW from 1.6-30 MHz
 • Multi-function LCD display • Dual clocks
 • Synchronous detector • Universal power supply • Built-in NiCad with charger

Sale **\$499⁹⁵** Retail \$699 (GRU 500)
 Price

GE 74100J
 • AM/FM radio, classic 1932 styling **\$69⁹⁵**

Grundig 400
 • Portable shortwave radio, 1.6-30MHz **\$349⁹⁵**

Panasonic RCX250
 • Stereo clock radio, dual alarm **\$74⁹⁵**

Panasonic RQ382
 • Portable cassette, auto-reverse **\$114⁹⁵**

Sony ICFC950
 • Stereo clock radio, dual alarm settings **\$49⁹⁵**

Sony WMD6C
 • Pro-record walkman, dolby B/C **\$329⁹⁵**

Audio Accessories



Audioquest Sorbothane Isolation Feet
 • Sorbothane has the remarkable ability to absorb and lose energy • For use under turntables or any equipment that needs to be vibration free • Supports up to 35 lbs.

Sale **\$34⁹⁵** Retail \$40 (ADQ FEET)
 Price

Audioquest CD30
 • 30 compact disc rings with locator **\$26⁹⁵**

Audioquest MAT
 • Sorbothane record mat for turntables **\$34⁹⁵**

Audioquest Pro Lift
 • Auto orm lifter for manual tables . **\$34⁹⁵**

Parsec Scratch Out
 • CD cleaner & repair kit **\$9⁹⁵**

Sumiko Tweek
 • Cleaning solution for all contacts **\$14⁹⁵**

Tiplotes Tall
 • Component or speaker feet . . . each **\$6⁹⁵**

Audio Accessories



Laserline GPX-1500 Nintendo Game Pak Storage Unit
 • Storage system for 15 Nintendo game cartridges • Same color as Nintendo game console • Cartridges fit in with original covers • Cover locks in to hold instructions

Sale **\$28⁸⁸** Retail \$45 (CP GPX1500)
 Price

AudioSource LLC1
 • Compact disc laser lens cleaner **\$24⁹⁵**

Discwasher CD
 • Radial CD-cleaner with cleaning fluid **\$11⁸⁸**

Discwasher RCS
 • Record cleaning system with fluid **\$8⁸⁹**

Leslie Dame LPI40
 • Oak storage unit for 140 LP's . . . **\$15⁵⁹**

Product Plus CD84
 • Oak storage unit for 84-CD's . . . **\$39⁹⁵**

Recolon CD20
 • CD player to car stereo cass adaptor **\$18⁸⁸**



RENATA TEBALDI In First Ladies Of The Opera

34⁹⁵

Also Available

- Der Rosenkavalier: Schwarzkopf/Karajan \$54.95
- Opera: Two To Six: Sutherland/Gobbi/Gedda \$34.95
- Lucia Di Lammermoor: Anna Moffo \$44.95
- The Marriage Of Figaro: Glyndebourne, Kanawa/Von Stade \$54.95
- Götte Parisienne: Danilova/Danielian/Franklin . . . \$34.95

FM Antennas



Terk FM-9500 Indoor FM Electronic Antenna
 • Perfect for the apartment or office • Modern high tech style • 24-dB's of gain
 • Omnidirectional pick-up • LED display • One year warranty • Black finish

Sale **\$39⁹⁵** Retail \$99 (TRK 9500)
 Price

Parsec LS3
 • Beambooster antenna, up to 18dB gain **\$29⁹⁵**

Parsec LS4
 • Omnidirectional, Schotz design . . . **\$49⁹⁵**

Parsec Stealth
 • Can mount behind stereo, 32dB gain **\$39⁹⁵**

Terk 8500
 • Electronic FM antenna, amplifies 20dB **\$29⁹⁵**

Terk 9600
 • Up to 30dB gain, (White or Grey) . . **\$79⁹⁵**

Terk FM2000
 • Omnidirectional or directional antenna **\$19⁹⁵**

Micro Televisions



Casio TV-400 Pocket Color LCD Television
 • Pocket size television, more portable than ever • HQM high quality matrix system delivers crisper, clearer and brighter images than ever • 2-inch screen

Sale **\$129⁹⁵** Retail \$199 (CAS TV400)
 Price

Casio TV810
 • 2" color LCD, audio/video jock . . **\$149⁹⁵**

Casio TV8500
 • 4" color LCD, operates on 6AA/Batt **\$319⁹⁵**

Sony FD44A-WH
 • 4" Black & White, sports watchman **\$179⁹⁵**

Sony FD500
 • 4.5" AM/FM, MegaBass, AC/DC . . **\$119⁹⁵**

Sony DFL330S
 • 2.7" color, can use as viewfinder **CALL**

Sony GV8
 • 3" LCD color with 8mm video recorder **CALL**

Video Add-Ons



JVC JX-S900 A/V Selector
 • 7 video inputs & outputs • 2-monitor outputs
 • S-video on all input & output packs • Remote control • Y/C separator circuit • Dual operation allows operation of 2-signal paths

Sale **\$649⁹⁵** Retail \$900 (JVC JXS900)
 Price

AudioSource SS-Two
 • Dolby surround sound processor **\$149⁹⁵**

Bose VRMI Video RoomMates
 • Shielded speakers Pair **\$299⁹⁵**

JVC JXS100
 • Audio/Video switcher, 4In/2 out . . **\$99⁹⁵**

Recolon V645
 • Remote control cable-ready tuner **\$119⁹⁵**

Technics SHAV40
 • Dolby surround sound processor **\$179⁹⁵**

Videonics Direct-Edit 4
 • Editor/Character-generator . . . **CALL**

Video Add-Ons



Vidicraft "The Detailer" Image Enhancer
 • Sharpen & enrich video quality during recording, playback and editing • Split screen shows on screen comparison • Separate sharpness & detail controls • AC operated

Sale **\$69⁹⁵** Retail \$159 (VID DET101)
 Price

Ambico VO612
 • Film to video transfer kit **\$52⁹⁵**

Azden WMS-Pro
 • Wireless mic for camcorders . . . **\$199⁹⁵**

Rabbit DP5000
 • Picture-in-picture, freeze-frame . . **\$149⁹⁵**

Recolon V623
 • MTS/SAP stereo TV/Cable decoder **\$69⁹⁵**

Sima SSM
 • Audio/Video mixer, adds narration **\$69⁹⁵**

Unomat LX775
 • Quartz halogen camcorder light **\$59⁹⁵**



ORDER TOLL-FREE 1-800-221-8180

Mail Order Hours: Monday To Friday 8 AM to 8 PM, Saturday 9 AM to 6 PM, Sunday 10 AM to 4 PM
 Dealer & Institutional Inquiries Call Toll-Free 1-800-221-3191 — In New York 1-718-417-3747

J&R Music World, Dept. SRO989, 59-50 Queens-Midtown Expressway, Maspeth, Queens, NY 11378

Outside U.S.A. Call: 1-718-417-3737





Super Specials!

VHS Video Movies



America's
 Number One
 Pin Up Girl
 is Back!

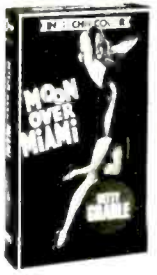

18⁹⁵
 Each



- Also Available...
- Pin Up Girl
 - The Beautiful Girl From Bashful Bend
 - Down Argentine Way
 - Springtime In The Rockies
 - Song Of The Islands
 - Footlight Serenade
 - I Wake Up Screaming
 - The Farmer Takes A Wife

Universal Remotes



- Memorex CP-8**
 Universal Programmable Remote Control
- Controls up to 8 wireless remote components
 - Built-in clock with five timers or unattended operations
 - Large LCD display
 - Infrared power booster
- Sale Price **\$69⁹⁵** Retail \$140 (MEM CF8)
- JVC RMS1**
 • Touch sensitive, 11-program sources **\$179⁹⁵**
- Memorex CP4**
 • Control 4-audio/video components **\$49⁹⁵**
- One-For-All URC 4000**
 • Controls 4-audio/video components **\$69⁹⁵**
- One-For-All URC 5000**
 • Controls audio/video & X-10 **\$89⁹⁵**
- Sony RMP700E**
 • Programmable audio/video remote **\$74⁹⁵**
- Technics SHR700**
 • 46-fixed & 98-learned functions **\$179⁹⁵**

Headphone Specials



- Sony MDR-1F5K**
 Wireless Stereo Headphones
- Infrared wireless system
 - Frequency response: 18-22,000Hz
 - 90dB dynamic range
 - Convenient combination transmitter & recharger
 - Digital ready
 - Uni-match plug
- Sale Price **\$168⁸⁸** Retail \$199 (SON MDR1F5K)
- Azden DM90**
 • Digital-ready monitor headphones **\$69⁹⁵**
- Koss JCK200**
 • Cordless digital-ready headphones **\$18⁸⁸**
- Koss Pw75**
 • Studio-fro monitor headphones **\$58⁸⁸**
- Koss Pw99**
 • Studio-fro, aluminum voice-call **\$79⁹⁵**
- Sennheiser HD480**
 • Digital-ready open-air headphones **\$68⁸⁸**
- Sony MDR550S**
 • Dynamic open-air headphones **\$39⁹⁵**

Blank Audio/Video Tape



- TDK SA-90 RBD 4-Pack**
 High Bias Super Avilyn Audio Tape
- The original high bias audio tape
 - Precision cassette shell
 - Includes \$5 coupon good toward the purchase of Reebok sneakers (Redeemable at stores that sell Reeboks)
- Sale Price **\$7⁹⁹** 4-Pack (TDK SA90 RBD)
- Maxell XLII-100**
 • High-bias, 100-minutes **\$23⁸⁸**
- Maxell XLIIIS90**
 • Extended High-bias, 90-minutes 10-Pack **\$21⁸⁸**
- Sony P6-120 8mm**
 • 120-minutes, metal particle **\$62⁸⁸**
- Sony UXES90-7**
 • High-bias, includes soft-case 7-Pack **\$17⁴⁹**
- Sony UXPRO90**
 • Designed for digital recording 10-Pack **\$23⁴⁹**
- TDK P120EHG**
 • Extra high grade VHS tape **\$43⁹⁵**

Home/Office



- Psion Organize LZ**
 32K Pocket Computer
- An incredible hand-held computer
 - Phone, address, & notebook
 - Diary program
 - alarm clock & calendar
 - Calculator
 - Easy-to-use operating programming language
- Sale Price **\$249⁹⁵** Retail \$350 (PSN LZ5)
- Casio FC1000**
 • Financial calculator, graphic function **\$89⁹⁵**
- Casio SF4000**
 • 32K Databank, 1500 names & numbers **\$89⁹⁵**
- Franklin LanguageMaster 3000**
 • Electronic speller **\$199⁹⁵**
- Hewlett Packard HP17B**
 • Plug financial calculator **\$79⁹⁵**
- Hewlett Packard HP285**
 • 32K scientific calculator **\$179⁹⁵**
- Sharp Wizard**
 • 32K organizer, clock, 8-line LCD **\$219⁹⁵**

Home/Office



- Panasonic KX-W1000**
 Portable Word Processor
- 50K text memory
 - 80 X 14-line adjustable LCD display
 - 63K word spell-check
 - Thesaurus
 - 353K 3.5" disk drive
 - Mail-merge
 - Spreadsheet
- Sale Price **\$499⁹⁵** Retail \$699 (PAN KXW1000)
- Brother 2T6**
 • Portable personal lettering system **\$99⁹⁵**
- Brother WP75**
 • Portable electronic word processor **\$529⁹⁵**
- Panasonic KXR800**
 • Wordprocessing typewriter, 27K mem **\$209⁹⁵**
- Royal 2100PD**
 • Heavy-duty printing calculator **\$79⁹⁵**
- Royal T6620**
 • Portable electronic typewriter **\$139⁹⁵**
- Smith Corona PWP2000**
 • Portable word processor **\$399⁹⁵**

Telephone Specials



- Sony IT-A550**
 Telephone/Answering Machine System
- Beepless remote dual microcassette answering machine
 - Dual outgoing message system
 - Message transfer
 - Tone/pulse
 - 10 memories
 - Toll saver
 - Hold button
- Sale Price **\$144⁴⁴** Retail \$239 (SON ITA550)
- Code-A-Phone 1620**
 • 6-function remote answering machine **\$39⁹⁵**
- Code-A-Phone 2720**
 • Remote answering machine, toll-saver **\$99⁹⁵**
- Panasonic KXT1450**
 • Dual standard mt. answering mach **\$74⁹⁵**
- Panasonic KXT4200**
 • Cordless phone & answering mach **\$169⁹⁵**
- Phonemate 6560**
 • Beepless remote answering machine **\$69⁹⁵**
- Sony SP110**
 • Cordless phone, 10-number memory **\$169⁹⁵**

Car Stereo Specials



- Clarion 9100RT**
 High Power Car Audio Receiver
- Digital Mag-Tune AM/FM tuner
 - 18-presets
 - 4+2-way balance bass & treble controls
 - Auto-reverse cassette
 - 25-watts X 2-channels
 - Compact chassis
- Sale Price **\$168⁸⁸** Retail \$279 (CLA 9100RT)
- Clarion 970RT**
 • Removable AM/FM/Cassette **\$238⁸⁸**
- Panasonic CQE410**
 • Pull-out, AM/FM/Cass, 25-wt X 4-ch **\$199⁹⁵**
- Panasonic CQE850**
 • Pull-out, AM/FM CD-player, pre-out **\$489⁹⁵**
- Panasonic CQH05**
 • Pull-out, AM/FM/Cassette, 7.5 wt/ch **\$179⁹⁵**
- Sherwood CRD210**
 • AM-sterio/FM stereo/Cass. dolby B/C **\$149⁹⁵**
- Sherwood XR1604**
 • Pull-out, AM/FM/Cassette, 24-presets **\$259⁹⁵**

Alarms/Radar Detectors



- Crimestopper CS-8706 "Sillette"**
 Remote Car Alarm System
- Passive last door alarm system
 - Remote transmitter with 3-channels
 - Key sensing trigger
 - Diagnostic test circuit
 - Easy to install
 - Limited lifetime warranty
- Sale Price **\$179⁹⁵** Retail \$219 (CRI CS8706)
- BEL 977 Vector 3R**
 • Remote radar detector, X, K & Ka **\$189⁹⁵**
- Page Alert LP2101**
 • Infrared sensor security lighting **\$28⁸⁸**
- Page Alert PA4000**
 • Car alarm with pager, 4-mile range **\$88⁸⁸**
- Uniden RD9**
 • Ultra-small superhet radar detector **\$99⁹⁵**
- Whistler Spectrum 2**
 • Radar detector, triple superhet **\$164⁹⁵**
- Whistler Spectrum 3SE**
 • Radar detector, digital display **\$229⁹⁵**

Keyboard Specials



- Casio SK-100**
 Programmable Sampling Keyboard
- Sample 2 different sounds
 - Chord and pattern memories
 - 49 key mini-keyboard
 - 10 auto rhythms
 - Built-in speaker
 - AC/DC operation
 - Lightweight portable design
- Sale Price **\$78⁸⁸** Retail \$299 (CAS SK100)
- Casio EPIO**
 • Muppet keyboard, 32-mini-keys presets **\$28⁹⁵**
- Casio M1520**
 • 49-key mini-keyboard, 12-voice, drums **\$99⁹⁵**
- Casio M1640**
 • Mid-size keyboard, with drum pad **\$209⁹⁵**
- Yamaha P55570**
 • 49-key mid-size keyboard, stereo **\$119⁹⁵**
- Yamaha P5580**
 • 32-key mid-size keyboard **\$39⁹⁵**
- Yamaha V55200**
 • 49-key mid-size keyboard, sampler **\$109⁹⁵**

Electronic Games

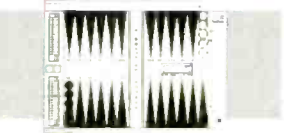

- Scisys Sensory Backgammon Computer**
- Fine quality board senses when pieces are moved
 - Quick response
 - 9 play levels
 - Auto scoring
 - Position & move verification
 - Manual or automatic dice
- Sale Price **\$99⁹⁵** Retail \$179 (SCY BACKGAMMON)
- Loftronics Lotto**
 • Electronic lotto number computer **\$24⁹⁵**
- Handel 7860 Wheel Of Fortune**
 • Matt held electronic game **\$59⁹⁵**
- Scisys Bridge**
 • Auto shuffle, deal and score **\$99⁹⁵**
- Scisys Cavalier**
 • Portable electronic chess, 17-levels **\$69⁹⁵**
- Scisys Conquistador**
 • Electronic chess, 2 LCD-clocks **\$159⁹⁵**
- Scisys Table-Checkers**
 • Electronic checkers, 8-levels **\$44⁹⁵**

CIRCLE NO. 39 ON READER SERVICE CARD

TO ORDER BY MAIL:
 SEND MONEY ORDER, CERTIFIED OR CASHIER'S CHECK, MASTERCARD, VISA, AMERICAN EXPRESS or DISCOVER CARD (Include interbank No. expiration date and signature), TO: J&R MUSIC WORLD, DEPT. 39099, 50-50 QUEEN'S MIDDLEWAY, MASPETH, QUEENS, NY 11378. Personal and business checks must clear our Authorization Center before processing. Shipping, Handling & Insurance Charge is 5% of Total Order with a \$4.95 minimum. (Canadian Orders Add 15% Shipping, with a \$9.95 minimum charge) For shipments by air please double these charges. \$25 MINIMUM ORDER. DO NOT SEND CASH. SORRY, NO C.O.D.'s. NEW YORK RESIDENTS PLEASE ADD SALES TAX. WE ARE NOT RESPONSIBLE FOR TYPOGRAPHICAL ERRORS. ALL PICTURES SHOWN FOR VISUAL REPRESENTATION ONLY.
 ALL MERCHANDISE SHIPPED BRAND NEW, FACTORY FRESH, AND 100% GUARANTEED.



HAYDN: *The Creation*. Lynne Dawson (soprano), Gabriel and Eve; Neil Rosenshein (tenor), Uriel; John Cheek (bass), Raphael and Adam; Minnesota Chorale; St. Paul Chamber Orchestra, Joel Revzen cond. ALBANY © AR005-6 two CD's (104 min).

Performance: *Solid*
Recording: *Fine*

The most exciting thing about this recording of Haydn's ever-popular *Creation* is Lynne Dawson's performance in the roles of Gabriel and Eve. Her bright, clear, keenly focused soprano projects through the ensemble work and is perfect for the arias both of the angel and of the first woman. She is thus equally at home with the coloratura of Gabriel's "Auf starkem Fittiche schwinget" and the naive simplicity of Eve's duet with Adam (John Cheek), "Von deiner Güte".



Shlomo Mintz: expressive Prokofiev

o Herr." Tenor Neil Rosenshein brings appropriate freshness and elegance to the part of Uriel, which contrasts dramatically with bass John Cheek's richly colored Raphael. Cheek is ideal as Raphael and is especially fine in "Rollend in schäumenden Wellen," as "foaming billows" gradually give way to a "softly purling" brook. As Adam, however, his dark, covered sound is somewhat at odds with the open innocence of the music.

The performance is well paced, and conductor Joel Revzen keeps things moving along with generally brisk tempos. The St. Paul Chamber Orchestra and Minnesota Chorale's contributions are solid, though I would have liked more articulation and a lighter overall sonority to bring out the music's inner voices. The recorded sound is just fine. S.L.

HAYDN: *Keyboard Sonatas* (see Best of the Month, page 123)

MAHLER: *Des Knaben Wunderhorn*. Lucia Popp (soprano); Andreas Schmidt (baritone); Royal Concertgebouw Orchestra, Leonard Bernstein cond. DEUTSCHE GRAMMOPHON © 427 302-2 (58 min).

Performance: *Disappointing vocals*
Recording: *Good*

Leonard Bernstein's earlier recording, for CBS, of Mahler's *Knaben Wunderhorn* songs was a classic, and this remake does not supersede it. His overview of the material remains essentially the same, and the Concertgebouw Orchestra (now named the Royal Concertgebouw) plays as splendidly in this 1987 concert performance as the New York Philharmonic did in the studio twenty years ago. The singers this time around, though, simply do not muster the sympathetic feeling for these songs that Christa Ludwig and Walter Berry did in the earlier recording. Lucia Popp seems no better suited to this material now than when she recorded it for EMI with Klaus Tennstedt, and Andreas Schmidt is even more given to barking, I'm afraid, than Bernd Weikl in that recording. Ludwig and Berry were superb companions for Bernstein, all three of them conveying the warmth, the urgency, and the humor that came from their instinctive and total identification with the music and the texts. That recording and Wyn Morris's on *Nimbus*, with Janet Baker and Geraint Evans, remain the top choices. R.F.

POULENC: *Figure humaine; Sept chansons; Chansons françaises; Un Soir de neige; Chanson à boire*. Groupe Vocal de France, John Alldis cond. EMI-PATHÉ MARCONI/ALLEGRO IMPORTS © CDC 49086 (57 min).

Performance: *Extraordinary*
Recording: *Radiant*

This collection of Poulenc's secular choral works is full of delightful discoveries, and the confident, idiomatic performances make it one of the most exciting recordings of its kind to come along in ages.

Though a minor masterpiece, *Figure humaine* (*Faces of Humanity*), a cantata for double choir a cappella, has always been on the fringes of the repertoire, probably because decent performances of it are so infrequent. Written in 1943 to poems by Paul Eluard, *Figure humaine* takes on the rather idiosyncratic shapes of the poet's meditations on repression and liberation. If Don Carlo Gesualdo had composed for the Bulgarian Women's Choir, it might have sounded something like this. The fifteen-voice Groupe Vocal de France sings with an almost superhuman accuracy, yet it is free enough with the music to capture its passion and yearning while giving an exquisite sense of color to the terraced vocal writing.

The *Sept chansons* from 1936 are earthy and descriptive, full of quicksil-

ver shifts and exclamatory outcries. The folk-like *Chansons françaises* of 1945 and the drinking song *Chanson à boire* of 1922 are boisterous and high-spirited—among the most winning pieces Poulenc ever wrote. Considerably darker is *Un Soir de neige*, a cantata written over Christmastime in 1944 that describes the cold and misery of war-torn France with the dignity that was always present in Poulenc's pathos.

The one drawback of the package is the lack of printed texts or translations, but the singers' enunciation is so clear that it's possible to follow the verses with only a middling knowledge of French. D.P.S.

PROKOFIEV: *Symphony No. 1, in D Major, Op. 23 ("Classical"); Symphony No. 5, in B-flat Major, Op. 100*. Orchestre Symphonique de Montréal, Charles Dutoit cond. LONDON © 421 813-4, © 421 813-2 (59 min).

Performance: *High-gloss*
Recording: *Very good*

The combination of Prokofiev's light-hearted *Classical* Symphony with his heroic wartime Fifth makes for just about an ideal program. Charles Dutoit's performance of the *Classical* is careful and precise in the first three movements and like a well-oiled machine in the finale. His reading of the Fifth is notable for its wealth of textural detail and poise in the first movement and for a fine sostenuto quality throughout the intensely tragic slow movement. The finale works up to a wonderfully ferocious conclusion and in this respect surpasses the mighty peroration of the first movement, which comes off a bit heavy-handedly. As always with recordings made at Montreal's St. Eustache church, the sound is brilliant and crystal clear. D.H.

PROKOFIEV: *Violin Sonatas Nos. 1 and 2*. Shlomo Mintz (violin); Yefim Bronfman (piano). DEUTSCHE GRAMMOPHON © 423 575-2 (55 min).

Performance: *Rich, romantic*
Recording: *Rich*

Prokofiev wrote a limited amount of chamber music, but what he did write is of high quality. His First Violin Sonata is a powerful, cyclical work that ranks with anything written in this century. The somewhat lighter Sonata No. 2 was actually written for flute and piano and transcribed, quite satisfactorily, at the suggestion of David Oistrakh. Both pieces date from the World War II period, and, like much of the composer's work of that time, they are vigorous and dramatic but quite accessible. Shlomo Mintz and Yefim Bronfman, Israeli musicians very much in the Russian tradition, bring out the romantic, *espressivo* side of this music, and the recording, like the performances, is rich and vibrant, halfway between mellow and melodramatic. E.S.

SAVE MONEY, TIME AND FREIGHT ON FAMOUS BRAND STEREO EQUIPMENT

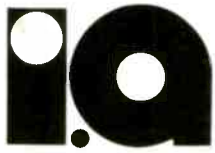

Illinois audio

(800) 621-8042 / (312) 664-0020

12 E. DELAWARE PLACE • CHICAGO, IL 60611

LOUDSPEAKERS



TECHNICS SBL-36
Powerful
Loudspeaker System
• Linear Phase 2-Way
System • Large Diam. 10"
Woofer • Anti-resonance
cabinet • Attractive
Woodgrain Finish
CALL FOR PRICE

E.P.I. CD55
3-Way Speaker
System

• 12" Bass Driver • Wide
Frequency Response
• Constant Dispersion
Design • Specially De-
signed High Efficiency
Cabinet
List \$250.00 ea.
SALE: \$99.00 ea.



TECHNICS SBS407
3-Way Speaker
System

• 12" Woofer • Horn Super
Tweeter • High Heat Resis-
tance • Efficiency Bass
Reflex Design • Heavy
Duty Anti-Resonance
Cabinet
CALL FOR PRICE



E.P.I. T/E320
Powerful 3-Way
Speaker System

• 10" Bass Drive • Amoz-
ingly Accurate Freque-
ncy Response • Ultra-Wide
Dispersion • Integrated
Midrange/treble
CALL FOR PRICE



PORTABLES

TOSHIBA KT4048
AM/FM Stereo Radio
Cassette Player

• Dolby B NR • Auto
Reverse • 3 Band EQ
• Built-in Stereo Tuner
• Auto Shut-Off • Light-
weight headphones &
Belt Clip included
List \$89.95
SALE: \$55.00



SONY WMF100III

Sony Super Walkman
• AM/FM Stereo Cassette
Player • Xtra Small Size
• Auto Reverse • Quick
Charger • Dolby B NR
List \$199.95
SALE: \$125.00



SONY D-25
Discman Portable
CD Player

• Ultra Small & Lightw! •
24-Track Random Music
Sensor • 4-Repeat Modes
• Unilinear Converter
w/ Digital Filter
CALL FOR PRICE



AUTO



SONY ES-S92
6" x 9" 2-Way Car Speakers
• Co-Axial • Hi-Power • Oval Shape
• 80 Watts Max Power Handling
List \$79.95 **SALE: \$39.95**



SHERWOOD CRD350
Car Stereo with Cassette Deck

• AM Stereo FM Stereo Receiver • Full Logic
Controlled • Dolby B C NR • Auto Re-
verse • Built-In Amp w/Balance & Fader
• Local Dist. Switch • Preset Scan • Clock
& Security Cover
List \$329.95 **SALE: \$182.00**

CASSETTE DECKS



TEAC V-285CHX
Stereo Cassette Deck

• Dolby B, C & HX PRO NR • Bias Fire Tuning
• Full Auto Stop Mech. • Metal Tape Com-
patible • 3-Pos. Tape Select • 3-Digit Tape
Counter
List \$49.95 **SALE: \$99.95**



TEAC R455X
Auto Reverse Cassette Deck

• Bi-Directional record/playback • Auto
reverse • Repeat • Dolby B & C NR • HX Pro
• Timer Rec./Play
List \$219.95 **SALE: \$139.95**



TECHNICS RS-TR555
Double Quick Auto Reverse
Cassette Deck

• Auto Reverse on both tape decks • 24 hour
contin. playback • Hi-sp. editing • Synchro
start & stop & mute • Dolby • HX-Pro
CALL FOR PRICE



TEAC W560R
Double Auto Reverse
Cassette Deck

• Dolby B & C • One touch high speed
dubbing • Continuous Play • Memory
play/search dubbing • Full logic control
List \$519.00 **SALE: \$299.95**

RECEIVERS



TECHNICS SA-160
Quartz Synthesizer
AM/FM Stereo Receiver

• 80 Watt (40x2) • 24 preset station file
• 5 Band Graphic Equalizer
List: \$209.95 **SALE: \$147.95**



TECHNICS SAR377
Quartz Synthesized
Remote Controlled Receiver

• AM / FM Stereo Receiver • 160 Watts
(80 RMSx2) • Full Remote Control • 24
Presets • 7-Band EQ w/ Spectrum Analyzer
• 4 Aud. Inputs plus 2 Aud. / Vid. Inputs
• Station File
CALL FOR PRICE



JVC RX-701VBK
Surround Sound Receiver

• AM / FM Stereo Digital Receiver • 160
Watts (80x2) • Dolby Surround Sound
• Built-in Synthesizer-Tuner • 40 Memory
Presets • 7-Band EQ • 2 PR. Speaker
Connections
CALL FOR PRICE



JVC RX-901VBK
Remote Controlled Receiver

• 200 Watts (100x2) • Dolby Pro-logic
with adjustable digital delay • 3 Video In-
puts • Program. 7 band EQ • Dig. Synth
Tuner • 80 presets • Preset Scan
CALL FOR PRICE

CD PLAYERS



SHARP DX670
Compact Disc Player

• 3-Beam Laser Pick-up • Programmable
Memory • Cue/Review
List \$249.95 **SALE: \$118.00**



TECHNICS SLP999
Remote Controlled CD Player
With The Works!

• 20 bit • 32 Track programmability
• 8X oversampling • 4 DAC's • Peak Level
Control • A/B Repeat/Auto Level • 3 CD
capable • Edit guide • Music Scan
CALL FOR PRICE



TEAC AD-4
CD Player/Cassette Deck Combo

• Remote control of CD player and cassette
deck • 16-Track random program dubbing
and play • Dolby B & C • Auto reverse rec.
play • Synchro start dubbing
List \$599.95 **SALE: \$275.00**



TECHNICS SLP300
Multi-Disc CD Changer

• Programmable 6-Disc Changer / Player
• 36 Step Random Access Program
• Quadruple Oversampling Digital Filter
• High Resolution Laser Pick-Up
CALL FOR PRICE



JVCXLM701BK
CD Multi-Changer

• 6+1 CD Changers player • Remote
control • Random Access program up to
32 steps • 18 bit DAC • 4 X oversamplings
• Digital Filter
CALL FOR PRICE

HEADPHONES

KOSS PRO/450
• Sound isolating • Dual
element dynamic driver
• Precision performance
• Perfect for digital music
List \$175.00 **SALE: \$138.00**

SENNHEISER HD480
• Digital • Open Air Design
• CD Perfect
List \$99.00 **SALE: \$69.95**

SONY MDR CD6
Adjustable • Open Air
• Digital Ready
List \$119.95 **SALE: \$79.00**

AUDIO TAPE

MAXELL XLII-100
• 100 minutes perfect for
CD recording • Improved
performance hi-bias
10 for **\$24.95**
SONY UX-PRO 90
High bias, perfect for live
or digital recordings
10 for **\$24.89**
TDK SA76
• Super high resolution
• Super ovilyn
• Anti-Resonance
10 for **\$17.95**
MAXEL MX90
Metaxial 90 min. cassette
10 for **\$28.95**

CARTRIDGES

SHURE M111HE
• Precision crafted hyperre-
litical diamond tip
• Dynamic stabilizer
• Side guard protector
List \$149.95 **SALE: \$49.95**
AT 122LP
Dual Magnet • Plug-In
Connector • Linear Contact
Diamond Stylus
List \$125.00 **SALE: \$49.95**

SHURE V15VMR
Ultra Accurate Tracking
• Dynamic Stabilizer • Side-
guard Protection
List \$275.00 **SALE: \$129.95**

TURNTABLES

TECHNICS SLLJ33
Programmable
Quartz Linear
Tracking Turntable

• 8-Band random pro-
gramming • Auto high
speed listing • Remote
control capable • TAP
cart connector system
CALL FOR PRICE



TECHNICS SLL25
Fully Automatic
Linear Tracking
Turntable

• Remote control capable
• Repeat function
• Front panel operation
• Anti-vibration
construction
CALL FOR PRICE

DUAL 503-1
Top Class, Audophile
Semi-Automatic
Turntable

• Belt driven • Low
resonance, anti-vibration
design • Electronic speed
control • Auto switch off
• Gimbal mount low mass tonearm
List \$259.00 **SALE: \$150.00**

Illinois audio
12 E. Delaware Pl., Chicago 60611

16 YEARS OF MEETING THE NATION'S STEREO NEEDS WITH
THE ABSOLUTE BEST PRICES ON TOP NAME NATIONAL BRANDS
Call Mon. thru Sat. 10 to 5 (312) 664-0020 • 1 (800) 621-8042



Prices in this ad are for mail-order only.
Freight charges not included in prices. All
merchandise shipped brand new, factory
fresh with full warranty. Not responsible for
typographical errors.



NOTE: This is just a partial listing of our extensive
inventory, please call for quotes on additional items
or to request a free price list.



DAWN UPSHAW'S AMERICAN MUSIC

FEW American singers in recent years have created such a stir as Dawn Upshaw. Within three years of completing her graduate work at the Manhattan School of Music in 1984 she had made her debuts at the Metropolitan Opera, the Netherlands Opera, and the Salzburg and Aix-en-Provence festivals, and she has established herself as both an uncommonly persuasive singer of lieder and a champion of the music of her own time and her own country. The voice itself is quite exceptional; so is the intelligence applied to its use. Her new Nonesuch recording featuring works by Barber and John Harbison is almost as impressive for the imaginative choice of repertoire (all the pieces were composed in the United States, between 1939 and 1982) as for the beauty of the performances. The latter quality, though, is more than merely impressive; these are not just "performances" but total characterizations. The beauty lies not in the sound alone, enchanting as it is, but in the way Upshaw seems to give herself up completely to the sense and spirit of what she is singing. Everything here, whether humorous, wistful, nostalgic, or erotic, is incredibly touching.

That is not to say that any emotion is indulged or "milked." In fact, Samuel Barber's *Knoxville: Summer of 1915*, which begins the program, is taken just a shade more briskly than in most performances of this well-loved piece, and it is especially convincing. The "homespun" quality of the James Agee text is offset by the realization that it evokes a fantasy world bordering on fairy tale. This effect is enhanced by the marvelous playing of the Orchestra of St. Luke's under David Zinman, emphasizing

the crystalline textures and imaginative scoring, which many a listener might mistake for vintage Ravel before focusing on the text—itsself articulated with the same crystalline clarity.

The verses of the sixteenth-century Indian writer Mirabai set by John Harbison (in translations by Robert Bly) evoke, of course, a totally different world in more austere textures: How stunning, in its understated eroticism, is the opening of the second of the six Mirabai songs, "All I was doing was breathing." And for this music Upshaw is quite a different singer—but a no less persuasive one than in the Barber, or in the filler pieces: arias from two operas with original English texts, *The Old Maid and the Thief* by Menotti and *The Rake's Progress* by Stravinsky.

Every aspect of the presentation is splendid. John Harbison wrote the annotation, providing concise background on the three other works as well as his own and an appreciation of the singer that is as tasteful and convincing as her performance. The quality of the orchestral playing, and the sensitivity of Zinman's conducting, cannot be overpraised, nor can the superbly balanced sonic frame Nonesuch has provided. Full texts are included for everything on this treasurable disc. *Richard Freed*

DAWN UPSHAW. Barber: *Knoxville: Summer of 1915, Op. 24.* Harbison: *Mirabai Songs.* Menotti: *The Old Maid and the Thief: "What a curse for a woman is a timid man."* Stravinsky: *The Rake's Progress: "No word from Tom."* Dawn Upshaw (soprano); Orchestra of St. Luke's, David Zinman cond. NONESUCH ● 79187-1, ● 79187-4, ● 79187-2 (42 min).

REICH: *Different Trains.* Kronos Quartet. *Electric Counterpart.* Pat Metheny (guitar). NONESUCH ● 79176-1, ● 79176-4, ● 79176-2 (40 min).

Performance: *Revelatory*
Recording: *Fine*

Steve Reich has scored a significant breakthrough in *Different Trains*, a work in which he seems to have grasped at a number of various techniques to jump-start his inspiration after years of writing fairly lifeless minimalist pieces. The somewhat contrived concept behind *Different Trains* is to use train travel as a framework for contrasting life in pre-World War II America (the first movement) with the fate of Europe's Holocaust victims (the second movement). The third, somewhat superfluous movement sounds a postwar "All clear." It's musically interesting but dramatically inconsequential.

The piece incorporates taped voices, ranging from that of Reich's governess to those of some Holocaust survivors, played in counterpoint with authentic train whistles from the Thirties and Forties and a lot of canonic string-quartet writing. The textures resulting from this odd combination easily accommodate the ebullience of the first movement as well as the tragedy of the mournful, broadly paced Holocaust movement. Both moods are eloquently conveyed here by the Kronos Quartet.

The emotional wallop of the second movement clearly reflects some pretty deep feelings, not cheap opportunism. The taped voices don't just give the piece documentary significance; Reich so effectively colors the different voices, with help from the strings, that the listener gets to know them almost as though they were characters in an opera.

Electric Counterpoint exemplifies the creative doldrums from which *Different Trains* arose. It's written for a single guitar that's overdubbed about a dozen times. Unfortunately, the writing doesn't take advantage of soloist Pat Metheny's specialized abilities but treads a rather resolute path, exhausting the contrapuntal possibilities of one bit of slender thematic material and then going on to something else. There are some interesting textures here and there, but little else. *D.P.S.*

D. SCARLATTI: *Keyboard Sonatas: A Minor (K. 175); C Major (K. 513); E Minor (K. 402); E Major (K. 403); G Major (K. 144); C Minor (K. 115); C Minor (K. 116); E-flat Major (K. 474); E-flat Major (K. 475); G Major (K. 449); G Minor (K. 450); B-flat Major (K. 544); B-flat Major (K. 545); D Minor (K. 516); D Minor (K. 517).* Andrés Schiff (piano). LONDON ● 421 422-2 (73 min).

Performance: *Superb*
Recording: *Close-up*

The Scarlatti sonatas are new territory for Andrés Schiff, and they are eminent-

SUPER VHS CAMCORDERS



CANON F1000 10:1Z

8mm HI-BAND



OLYMPUS VSX405

SONY IN STOCK CALL



KYOCERA MINOLTA JVC



HITACHI RCA MINOLTA

MOST POPULAR FEATURES

- SUPER VHS 8:1 ZOOM w/FLYING ERASE HEAD INCLUDES ALL ACCESSORIES
- SUPER VHS FULL SIZE TIME/DATE 8x ZOOM
- SAME AS ABOVE w/DIGITAL EFFECTS
- 8mm/SPECIAL EFFECTS 420 PIX. SLOW MO. HI-FI. 1:2000 SHUT

\$1199
\$995
\$1399
\$998

- VHS-C 6:1 ZOOM 5 LUX
- 8mm 5 LUX KD1700 FLY ERASE HI-FI
- VHS FULL-SIZE CAM TIME/DATE 6:1 ZOOM
- VHS-C FLY ERASE
- VHS FULL-SIZE CAM TIME/DATE 8:1 ZOOM
- VHS 8:1 ZOOM FLY ERASE w/CH GEN

INCLUDES ALL ACCESSORIES

\$699
\$749
\$749
\$759
\$850
\$975

BEST VALUE:

- PANASONIC PV 530
- PANASONIC PV 520
- OLYMPUS VX803
- OLYMPUS VXS405KU
- CANON E808
- RCA CC320
- JVC GRS707
- JVC GR60
- CANON A1
- RICOH R800

SUPER PRICE REDUCTIONS:

- YASHICA KD5010
- CANON E708
- HITACHI VM5200
- RCA CC310
- GE GE9825
- SONY CCDF35
- HITACHI VM3150
- MINOLTA C50
- JVC GRS77
- PV460

CANON E708, E808 E80 & A1



CANON A-1 HI-BAND 8MM IN STEREO

VCR's - VHS & BETA 8mm



- PANASONIC 4 HD VHS w/FLY ERASE HD \$359
- QUASAR 4+2 HD HI-FI ST MTS \$349
- 4+2 SUPER VHS HI-FI MTS SUPER & FLY ERASE \$649
- 4+2 SUPER VHS HI-FI MTS SUPER & FLY ERASE w/DIGITAL \$899
- VHS RECORDER \$200
- BETA DECK \$275
- PLAYER ONLY VHS \$159
- AC/DC VHS PLAYER \$198
- 8mm & STEREO PCM Hi-Fi PORT. \$700
- 20" TV VCR PANASONIC \$550
- 5" TV VHS PLAYER ONLY \$399

SPECIAL EFFECT & CHARACTER GEN. EDITING PROCESSOR



- JVC JXSV55
- SANSUI Character Generator VCG99 Call
- NEWMARK VAM2000 Digital Discov Call
- JVC JXW9 Special Effects \$319
- SANSUI VX99 \$350
- AZDEN or NADY Wireless Mics Call

ACCESSORIES

- JVC RMSI MEMOREX CP8
- SONY RMP 700 SONY SBV1000 SELECTOR

SUN PAK VIDEO LIGHT



- #150 \$88
- #300 \$68
- #P6120 8mm SONY
- SUPER VHS TAPE (T120)

TV's

20" REMOTE COLOR TV MTS STEREO \$299

40" PNP HI-RESOLUTION \$1995 STEREO

SUPER VHS 30" TV \$1299



AUDIO HI-FI RECEIVERS

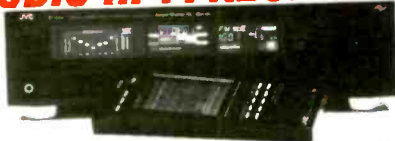

LASER DISC COMPACT DISC
Pioneer • Magnavox Pioneer • Magnavox • JVC • Teac

CAR STEREOS - CALL TOLL FREE - & RADAR DETECTORS



FAX MACHINES

- TOSHIBA 3700 \$1195
- 3300 \$988
- 30100 \$789
- MURATA M1200 \$619
- M1600 \$698



FOR MORE INFO, Call: (201) 696-6531

WE WILL MATCH OR BEAT ANY LEGITIMATE PRICE FEDERAL EXPRESS AVAILABLE

Call Toll-Free: **1 (800) 444-6300**
Orders: **1 (800) 247-4654**

We ship within 24 hours. All prices quoted included manufacturer's standard accessories & U.S. Warranty. All units are factory sealed. Shipping & handling extra. Not responsible for typographical errors. S&H non-refundable.

All merchandise brand new with USA warranty

HIGHVOLTAGE

RECEIVERS + AMPS

Pioneer VSX-9300S	Call
Pioneer VSX-7300	For
Pioneer VSX-5300	Lowest
Pioneer VSX-3300S	Price
Pioneer VSX-3300	249
Pioneer VSA-910	Wow
JVC RX 1001V	Best
JVC RX 901	Price
JVC RX 801	in
JVC RX 701	USA
Sony STR AV900	369
Sony STR AV290	199
NAD 7225	275
NAD 7240	385
NAD 7100	589
NAD 7600	1189
Yamaha RX 1130	825
Yamaha RX 930	679
Yamaha RX 730	459
Yamaha RX 530	315

CD PLAYERS

Pioneer PD M710	Call
Pioneer PD M610	For
Pioneer PD M510	Best
Pioneer PD M400	Price
Pioneer PD 5100	in
Pioneer PD 7100	USA
JVC XLM 701	369
JVC XLM 400	320
JVC XLM 301	249
JVC XL2 555	385
JVC XL2 444	225
Sony CDP C70	335
Sony CDP 350	189
Magnovox CDB 480	139
Magnovox CDB 473	Call
NAD 5220	259
NAD 5240	369
NAD 5100	465
NAD 5170	635
Yamaha CDX-1110	719
Yamaha CDX-910	535
Yamaha CDX-610	489

EXTENDED WARRANTIES

800-654-7787
FAX 212-268-6828

HIGHVOLTAGE, 39 W. 32nd St., New York, NY 10001
VISA, MC and COD Accepted. All Products New, Factory Fresh
and Subject to Availability. Customer Service Call 212-564-4410

CIRCLE NO. 66 ON READER SERVICE CARD

AZDEN HEADPHONES

New Digital Headphone	
Out Performs All Others	
D M-90 Pro Digital	75
D M-70 Digital	59

AZDEN CARTRIDGES

YM-P50E Elliptical	45
GM-1E Moving Coil	99

ADVENT

MAESTRO	469
LEGACY	349
PRODIGY	249
PRODIGYII	249
BBY	159
MINI/SUB	139 ea

RADAR DETECTORS

Uniden RD 9	105
Uniden RD 9XL	139
Uniden Talker	175
Cobra RD 3170	159
Whistler Spectrum I	99
Whistler Spectrum II	159

CAR STEREO

Pioneer DEX 77	We
Pioneer DEH 68	Have
Pioneer CDX M100	Your
Pioneer KEH 8050	Best
Pioneer KEH 6010	Price
Pioneer KEH 5856	USA
Sony CDX A20	Call
Sony CDX R88	For
Sony XR 7200	Low
Sony XR 7150	Price
JVC KS RX618	325
JVC KS RX518	309
JVC KS RX418	265
JVC KS R285	169

CASSETTE DECKS

Pioneer CT W900R	Best
Pioneer CT W700R	Price
Pioneer CT W500	in
Pioneer CT S800	The
JVC TDW 777	265
JVC TDW 444	205

ly well suited to his thoroughly pianistic approach. While his fellow pianist Maria Tipo makes no attempt at imitating the sound of a harpsichord in her admirable recent Scarlatti collection on Angel, her playing is marked by a clear acknowledgment of the harpsichord style. Schiff, however, as in his Bach recordings, takes the approach here that if the music is to be played on the modern piano it might as well be played pianistically.

A by no means trivial indication of Schiff's exceptionally sympathetic response to the material is the thoughtful layout of his recorded program, with the sonatas juxtaposed for maximal effect in terms of both contrast and smooth sequence. The second work here, for example, K. 513 in C Major, is a fairly extended *Pastorale* evoking the shepherd pipes of the Roman Campagna at Christmas time; it provides a sharp contrast to the brilliant opening piece in A Minor, whose guitar-like strokes place the music and its composer so clearly in Spain. The succeeding K. 402 in E Minor is a remarkably expansive and inward piece that, at eleven minutes, is more than twice as long as the Scarlatti norm. It is utterly absorbing in every bar, as is the rest of this hour-and-a-quarter recital. The recorded sound is close but well defined, quite in keeping with the warmhearted playing itself. And—best of all, for those who prefer these sonatas on the piano—there is no duplication between the fifteen items in Schiff's program and the eighteen (generally shorter) ones in Tipo's. R.F.

SCHUMANN: *Carnaval, Op. 9; Faschingschwank aus Wien, Op. 26; Allegro in B Minor, Op. 8.* Alicia de Larrocha (piano). LONDON © 421 525-2 (65 min).

Performance: *Tidy*
Recording: *Caressing*

Schumann's B Minor Allegro, a ten-minute remnant of one of his abortive sonata projects, is an out-and-out bravura piece, but it's not without a certain poetry. It brings out the very best in Alicia de Larrocha, who responds with both passion and grace and seems to revel in its dramatic gestures. If only the two more celebrated and more substantial works here had drawn a similar response. Alas, both the *Carnaval* and the *Faschingschwank* performances come off as tidy and dutiful, but little more. Here and there, as in the "Reconnaissance" and "Valse allemande" of *Carnaval*, Larrocha's innate elegance and rhythmic sense carry just the sort of conviction that seems to be missing in the rest. Throughout the *Faschingschwank* I was more intrigued by her finely controlled tone than by anything in the music itself. The tone is handsome, and the recording, though a little too reverberant, caresses it, but it is hardly enough to bring either of these big, freewheeling works to life. R.F.

SIBELIUS: *Pelléas et Mélisande, Suite, Op. 46; Valse romantique, Op. 62b; Spring Song, Op. 16; Swanwhite, Suite, Op. 54.* Royal Philharmonic Orchestra, Yondani Butt cond. ASV/HARMONIA MUNDI USA © CD DCA 649 (69 min).

Performance: *Sensitive*
Recording: *Excellent*

SIBELIUS: *Pelléas et Mélisande, Suite, Op. 46; Romance in C for Strings, Op. 42; Andante festivo; Valse triste, Op. 44, No. 1; Suite champêtre, Op. 98b; Rakastava, Op. 14; Suite mignonne, Op. 98a.* English String Orchestra, William Boughton cond. NIMBUS © NI 5169 (66 min).

Performance: *Good*
Recording: *Good*

These two CD's both include the suite extracted from Sibelius's music for Maeterlinck's play *Pelléas et Mélisande* as well as one excerpt each from his incidental music for Arvid Järnefelt's *Kuolema (Death)*—the familiar *Valse triste* and the lesser-known *Valse romantique*. The ASV disc also has a suite from music for August Strindberg's "fairy tale for grownups," *Swanwhite*, plus a mini tone poem from 1894, *Spring Song*, cast in a generic Scandinavian Romantic idiom. The Nimbus disc is filled out by the three-movement *Rakastava (The Lover)*, reworked in 1911 for strings, timpani, and triangle from an 1893 choral suite; the 1903 *Romance in C* for strings; the solemnly ceremonial *Andante festivo* of 1922, originally for string quartet but rescored for strings and timpani; and the *Suite mignonne* and *Suite champêtre* of Op. 98, which are essentially high-grade salon fare.

The voice of the master creator of symphonies and tone poems is little in evidence except in *Rakastava*, some isolated movements in the *Pelléas* suite, and the *Andante festivo*, which comes from the same fabric as the Seventh Symphony. A New Year's Day 1939 radio broadcast of the *Andante festivo* was the last appearance of Sibelius as conductor. A recording of it has been issued on LP in Finland, and I must say that the composer's intensely expansive reading results in a quite different listening experience from the small-scale affair offered on the Nimbus CD. Indeed, all the performances here under William Boughton are pleasant enough but lacking in subtlety. The central movement of *Rakastava*, a charming intermezzo titled "My Beloved's Path," is a bit slow-paced for my taste, and the *Andante festivo* is decidedly hasty. The sound, however, is generally good throughout.

The ASV recording, on the other hand, by the Macao-born, American-trained conductor Yondani Butt, is a winner on all counts, with remarkably sensitive playing by the Royal Philharmonic, especially the woodwinds. The

FREE

A DIFFERENT KIND OF RECORD CLUB

TREMENDOUS SAVINGS INCLUDING COMPACT DISCS...

on every record and tape in print—no "agree-to-purchase" obligation of any kind.

DISCOUNTS OF 20% TO 73% off mfg. suggested list... special catalog features hundreds of titles and artists.

MOST LABELS AVAILABLE

including most imports through special custom ordering service—guarantees satisfaction

SCHWANN CATALOG

lists thousands of titles.

DISCOUNT DIVIDEND COUPONS

redeemable immediately for extra discounts.

NEWSLETTERS

informational news and happenings in the world of music... special super sale listings.

DISCOUNT NEEDLE GUIDE

most mfg. replacements available.

QUICK SERVICE

same day shipping on many orders... rarely later than the next several days.

100% IRON-CLAD GUARANTEES

on all products and services—your total satisfaction is unconditionally guaranteed

Discount Music Club is a no-obligation membership club that guarantees tremendous discounts on all stereo records, tapes and CD's and let you buy what you want... when you want... or not at all if you choose.

These are just a few of the money-saving reasons to write for free details. You can't lose so why not fill out and mail the coupon below for immediate information.

DISCOUNT MUSIC CLUB, INC. 009-0989
481 Main Street, New Rochelle, N.Y. 10801

Name _____
Address _____
City _____
State _____ Zip _____

CIRCLE NO. 71 ON READER SERVICE CARD



WISCONSIN
DISCOUNT EST. 1954
STEREO
 2417 W. Badger Road
 Madison, WI 53713
 1-608-271-6889
 SOME ITEMS CLOSEOUTS

VHS

JVC HRD820 SPECIAL
 Dual-Cut Da-4 Head System

VHS MTS HIPI \$349
 On-Screen Programming

4-HEAD MTS HIPI \$389
 SPECIAL PURCHASE

PANASONIC PV4960 CALL
 4-Head MTS HiFi

JVC HRD750 SPECIAL
 Best 4-Head MTS HiFi

SONY SLV70 SPECIAL
 4-Head MTS HiFi with Effects

SHARP VCH857 \$399
 4-Head MTS HiFi

TOSHIBA DR900 SPECIAL
 PCM Audio SPECIAL PURCHASE

FISHER FV46600 CALL
 4-Head MTS HiFi

GE VGT790 CALL
 4-Head MTS HiFi

CAMCORDERS

CANON A1 SPECIAL
 HiFi 8mm

SONY CCD770 SPECIAL
 Call for Sony Camcorders

JVC GR35 SPECIAL
 Best VHS-C Camcorder

HITACHI VM5200 SPECIAL
 Audio Monitor, 8X Zoom

RCA CC310 SPECIAL
 Audio Monitor, 8X Zoom

JVC GR577 SPECIAL
 Super VHS-C with 8 Heads

SHARP VLL90U SPECIAL
 Flying Erase Heads

JVC GFS550 SPECIAL
 Super-VHS with 8X Zoom

RCA CC175 SPECIAL
 Super VHS-C

JVC GRA30 SPECIAL
 Auto-Focus 6X Zoom

WDS Rated #1 for SERVICE and PRICE
Guaranteed Low Price

- * We get the BEST volume discounts
- * LOW OVERHEAD—To sell at best discounts
- * We shop the competition to ensure the best price

Most Major Brands

THIS IS ONLY A PARTIAL LISTING
 IF YOU DON'T SEE IT LISTED—CALL!

10-Day Return

- * Returns accepted within 10 days (must be called in for prior authorization). Products must be in original condition. Returns subject to restocking fee. Shipping and handling not refundable.

Buyer Protection Plan—FREE

- * 30-DAY GUARANTEED NO LEMON
- * EVERY PRODUCT BRAND NEW—FULL WARRANTY

1-800-356-9514

IF YOU FIND A BETTER PRICE — CALL US



DISC MEN

CD PORTABLES

DISC PLAYERS

DISC PLAYERS



SONY D2 \$159
 Sony Quality

SONY D160 SPECIAL
 Home and Car Discman

SONY D25 SPECIAL
 Mega Bass Circuit

TOSHIBA XR9458 \$249
 Wired + Wireless Remote

TOSHIBA XR9437 SPECIAL
 Digital Tuner with Presets + CD



SHARP QTC255 \$189
 AM/FM/Cassette/CD

JVC PCV300 SPECIAL
 BEST CD Portable

SONY CFD64 \$189
 Slim Line with AMS

SONY DA54 \$239
 5 Band EQ with AMS

SHARP GFC055 SPECIAL
 X-Bass Speakers with EQ



SAE D102 \$289
 4X Oversampling, Remote

JVC XLM701 SPECIAL
 6+1 Stacker, Best Buy

10 DISC STACKER \$379
 32 Track Programming

TEAC PD700M \$269
 6 Disc Stacker

JVC XLZ611 SPECIAL
 18 Bit, 4X, Digital Outputs



TEAC AD5 \$355
 Combination CD/CASSETTE

TEAC PD470 \$197
 4X with Dual D/A's

TEAC ZD3000 \$297
 SPECIAL PURCHASE

PIONEER CLD1070 \$499
 Combination CD Player

JVC XLM401 CALL
 6 Disc, 18 Bit, 4X

SONY XBR SERIES SPECIAL
 We Carry All Size Screens

JVC AW3587 SPECIAL
 BEST 35" TV Made

PIONEER SPP502 SPECIAL
 50" Projection TV

JVC AW739 SPECIAL
 BEST 27" Made

TOSHIBA C2308 SPECIAL
 BEST 30" TV Made

SMITH CORONA PMP7 \$499
 Word Processor

SHARP Z70 \$759
 Copier

RICOH RF850 SPECIAL
 FAX Machine

SHARP UX350 \$1119
 FAX Machine

SHARP UX80 \$939
 FAX Machine

SONY MDR1FK SPECIAL
 Wireless Headphones

DUAL CS5000 SPECIAL
 Walnut Base Turntable

SHARP WIZARD SPECIAL
 Pocket Computer

BEARCAT TALKER SPECIAL
 Top Rated Radar Detector

YAMAHA PSR16 SPECIAL
 Keyboard

SONY WMF100H \$119
 Walkman

BEARCAT BC145XL \$149
 Scanner

TDK SA90 \$14.95
 Audio Tape 8-Pack

CODE-A-PHONE 2690 \$119
 Remote Answering Machine

SONY TT120 PRO \$67.00
 Video Tape 10-Pack

CELESTION DL10 II SPECIAL
 One of the Best British 10" 3-Ways

CELESTION DL12 II SPECIAL
 Floor Standing Tower

BOSE AM 5 CALL
 Sub-Woofer System

CELESTION DL8 II SPECIAL
 British 8" 2-Way Bookshelf

RECOTON WIRELESS 100 \$189
 Wireless Add-on Speakers

JVC KSR1010 SPECIAL
 High Power, Dolby, CD Input

CLARION 9700 \$219
 High Power, Dolby, AIR

SHERWOOD CRD210 \$149
 DOLBY B/C, CD Inputs

CLARION 9770 \$239
 Removeable DIN, Dolby

ALPHASONIC PMA2075 SPECIAL
 75 Wts/Ch AMP

SHERWOOD CRD350 \$179
 DIN with Dolby B/C

JVC KSR990 SPECIAL
 Removeable Din, AIR

PYLE KP6940 SPECIAL
 6X9 High Power Speakers

CLARION 5630 SPECIAL
 AM/FM CD Player

JVC CSX6936 SPECIAL
 6x9 3-Way High Power Spks

CASSETTE DECKS

REC/AMP/PREAMP



SAE C102 \$289
 2 Motor, Dolby B + C

JVC TDR611 SPECIAL
 Dolby B/C/HX PRO

TEAC V670X \$259
 3-Head, Dolby B/C/HX PRO

JVC TDV711 SPECIAL
 3-Head, Dolby B/C/HX PRO

TEAC V285CHX \$97
 Dolby B/C/HX PRO

TEAC X2000 CALL
 10" Reel-Reel, dtx

TEAC R616X \$297
 Auto-Reverse REO/PLAY

JVC TDV621 SPECIAL
 3-Head, Dolby B/C/HX PRO

JVC TDW801 SPECIAL
 Dubbing Auto Reverse REO/PLAY

TEAC W660 \$297
 Dubbing Auto-Reverse REO/PLAY



JVC RX701 SPECIAL
 70 Wts/Ch REC

SAE A202 \$229
 100 Wts/Ch AMP

SAE P102 \$239
 Computer Direct Line PREAMP

SAE A502 \$389
 200 Wts/Ch AMP

SAE T102 \$197
 Computer Direct Line Tuner

SHERWOOD S2770II \$239
 74 Wts/Ch REC

JVC RX501 SPECIAL
 60 Wts/Ch REC

PROTON D940 SPECIAL
 DPD Circuitry REC

JVC RX801 SPECIAL
 100 Wts/Ch REC

JVC RX901 SPECIAL
 120 Wts/Ch REC

PHONE HOURS
 M-F 8 a.m. - 8 p.m.
 SAT 8 a.m. - 5:30 p.m.
 SUN 11 a.m. - 5 p.m.
 Central Time Zone

CALL US TOLL FREE

- * For expert recommendations
- * For product information
- * TO ORDER PRODUCT

INDEX TO ADVERTISERS

READER SERVICE NO.	ADVERTISER	PAGE NUMBER
60	Adcom	41
30	Advent	69
4	Allison	135
80	Altec Lansing	6-7
58	API-Energy	138-139
45	API-Mirage	50-51
51	Beyerdynamic	40
67	Blaupunkt	34-35
	Bose	30-31
	Bose	38-39
	Bose	119
157	Cambridge SoundWorks	42-43
	Carver	12-13
	CBS Columbia House-CD Club	22-23
168	Cerwin-Vega	141
68	Coustic	55
113	Coustic	57
98	Coustic	59
	Crutchfield	142
27	Denon	8
32	Design Acoustics	27
57	Digital Products Int'l.	132-133
71	Discount Music Club	154
112	Dolby Labs	84
1	Electronic Wholesalers	153
58	Energy	138-139
	Ford Audio	125
66	Highvoltage	154
	Illinois Audio	151
100	Image Entertainment	93
30	Int'l Jensen-Advent	69
19	Infinity	Cover 4
115	Jamo	143
39	J&R Music World	146-149
2	Klipsch	11
55	Koss	94
154	Lexus	18-19
25	Maxell	33
29	McIntosh	16
48	Miller & Kreisel	122
45	Mirage	50-51
22	Mitsubishi	62-63
75	NEC	21
79	Ohm	131
97	Paradigm	127
	Perfectbound Press	40
	Philip Morris-Merit	25
	Philip Morris-Parliament	157
31	Pioneer-Car	4
31	Pioneer-Home	80-81
90	Polk Audio	Cover 2,1
90	Polk Audio	2-3
152	PolyGram	86,88
93	Proton	70
94	Pyle	44
	Radio Shack	65
	RCA-BMG Direct	36a,b
	R. J. Reynolds-Camel	Cover 3
	R. J. Reynolds-Magna	49
	R. J. Reynolds-Salem	15
	Satellite Source	90
	Seagram's	61
103	Sherwood	67
59	Sonance	76
107	Time-Life Music	53
	Wisconsin Discount Stereo	155
	Yamaha	72,121

SEPTEMBER

Pelléas is a joy to the ear, though I would question the slow tempo of the entr'acte. The sound is flawless in balance and coloration. *D.H.*

SMETANA: *Má vlast (My Fatherland). The Bartered Bride: Overture, Furiant, Dance of the Comedians.* Frankfurt Radio Symphony Orchestra, Eliahu Inbal cond. TELDEC/WEA © 244 183-4 two cassettes, © 244 183-2 two CD's (92 min).

Performance: *Good to excellent*
Recording: *Good*

Eliahu Inbal responds strongly to the lyrical-poetic aspects of the first three of Smetana's six tone poems gathered under the title *Má vlast* and celebrating the beauties and past glories of Bohemia. This is especially true in *The Moldau*, the second and most popular piece in the cycle. The fourth, *From Bohemia's Meadows and Forests*, elicits perhaps the finest playing in this set, notably in the triple-piano "nature" fugato introduced in the high strings, and its concluding section is most impressive. But Inbal scants the music's dramatic side until the succeeding fantasia on a Hussite hymn, *Tábor*, and the culminating *Blaník*, at the end of which the bardic theme of the first symphonic poem, *Vyšehrad*, is combined with the same Hussite hymn. The pastoral episode in the middle of *Blaník* also comes off well, with fine poetic feeling.

Inbal conducts the overture to *The Bartered Bride* with elegance and precision, for once avoiding putting it across as solely a virtuoso showpiece. The dances are done in genially joyous style, but it is a shame to have such short measure on the second tape or CD, which could have accommodated an additional dance from the opera or even one of the most brilliant of Smetana's tone poems, *Wallenstein's Camp*. The sonics are pleasing throughout, if not quite on the level of Inbal's Mahler cycle with the same orchestra. *D.H.*

R. STRAUSS: *Ein Heldenleben, Op. 40; Four Last Songs.* Arleen Augér (soprano); Vienna Philharmonic Orchestra, André Previn cond. TELARC © CD-80180 (69 min).

Performance: *Unheroic*
Recording: *Thickish*

R. STRAUSS: *Don Quixote, Op. 35; Romance in F Major for Cello and Orchestra; Ruhe, meine Seele!, Op. 27, No. 1; Gesang der Apollonpriesterin, Op. 33, No. 2.* Raphael Wallfisch (cello); Felicity Lott (soprano); Scottish National Orchestra, Neeme Järvi cond. CHANDOS © CHAN 8631 (66 min).

Performance: *Lumpy Quixote*
Recording: *Very good*

André Previn has become a distinguished Strauss interpreter, especially in his recordings with the Vienna Philharmonic, and the idea of packaging

Ein Heldenleben together with the Four Last Songs is quite fitting—as indeed it was when Chandos came up with the same coupling to launch its series of Strauss tone poems and songs with Neeme Järvi and Felicity Lott. Both works are retrospectives on Strauss's part, the self-congratulatory and showy tone poem composed at the age of thirty-five, the poignantly intimate songs nearly fifty years later as an affectionate valediction.

Both receive compassionate readings from Previn, but I suspect that he was influenced by the valedictory character of the songs in his approach to *Ein Heldenleben*, for the tone poem here exudes the same sort of mellow radiance and world-weariness as the songs. The grand swaggering assertiveness of the opening gesture and the snarling of the adversaries are both attenuated, as if to suggest the dimming memories of age, and Previn seems downright embarrassed about the extended "Hero's Battlefield" episode. The recorded sound, too, a bit thicker than ideal, emphasizes mellowness at the expense of crispness and definition—and this is even more true in the gorgeous accompaniments to the songs than in the splashy pages of the tone poem. Arleen Augér brings her customary distinction to those songs, but if you want this combination of titles the Chandos CD with Järvi and Lott is the one to go for. The finest realization of the tone poem is still Fritz Reiner's, which is now on CD with his recording of Strauss's *Don Juan*.

Don Quixote, one of the works quoted in the penultimate section of *Ein Heldenleben*, celebrates an altogether different sort of hero and is an altogether more elegant composition. Järvi's performance of it, I'm afraid, is as disappointing as Previn's of *Ein Heldenleben*. Raphael Wallfisch realizes a good deal of that elegance in his playing of the solo part, but the wit and subtlety that are the work's essence seem to elude Järvi, who draws only an efficient but somewhat lumpy performance from his orchestra.

The filler material comes off much better. The Romance in F—an agreeable but hardly significant early work—is not actually a "première recording" as Chandos claims, but the Wallfisch-Järvi performance benefits from greater momentum and richer sonics than the recent one by Julius Berger with the Polish Radio Orchestra under Andrzej Straszynski. *Ruhe, meine Seele!* is one of the most familiar of Strauss's songs but none the less welcome for that, and the seldom-heard *Gesang der Apollonpriesterin* is a most attractive discovery. Lott has been consistently satisfying in this series and almost redeems this disc with her two contributions. But it's really *Don Quixote* that is the issue here, and in that work, as in *Ein Heldenleben*, RCA's handsome CD reissue of the Reiner recording, with cellist Antonio Janigro, remains the nonpareil. *R.F.*

Stereo Review® Presents

Display until December 26, 1989 \$3.95

STEREO

BUYERS' GUIDE 1990

THE STEREO BUYERS' GUIDE OFFERS
FEATURE ARTICLES, PRODUCT LISTINGS FOR
EVERY AUDIO CATEGORY, AND MORE.

*How to buy a Stereo
System*

Audio Glossary

*Directory of
Manufacturers*

Product Listings for:

RECEIVERS	POWER AMPLIFIERS
PREAMPLIFIERS	INTEGRATED AMPLIFIERS
TUNERS	COMPACT DISC PLAYERS
CASSETTE DECKS	OPEN-REEL TAPE DECKS
TURNTABLES	CARTRIDGES & TONEARMS
SPEAKERS	HEADPHONES
DAT DECKS	COMPACT SYSTEMS
SIGNAL PROCESSORS	ACCESSORIES
POCKET STEREO	BLANK TAPE



Stereo Review's annual equipment buying guide, on sale October 3, 1989, offers the most comprehensive product listings for audio equipment available anywhere. The *STEREO BUYERS' GUIDE 1990* is sold at newsstands for \$3.95, or by mail for \$4.95, including postage and handling, from Stereo Buyers' Guide, P.O. Box 742, Holmes, PA 19043. For credit-card orders, call 1-800-345-8112.

Also available are Stereo Review's *COMPACT DISC BUYERS' GUIDE* (\$3.95) and, coming soon, Stereo Review's *VIDEO BUYERS' GUIDE* (\$3.95). Please add \$1 per copy for mail orders.

STEREO REVIEW
RETAIL MART

The Sound Seller

For the Musical Difference

Authorized Dealer For:

- | | |
|--|--|
| Acoustat
Audio Control
Nitty Gritty
M&K
Nakamichi
Oracle
Polk
PROAC
Proton
STAX
Thorens
Dahquist
Hafner
Monster Cable
Citation | NAD (in store only)
Belles
CWD
dbx
Fried
Harman Kardon
JBL
Onkyo
Grado
Lexicon
Celestion
DCM
Niles
Kinergetics
Duntech |
|--|--|

1706 Main St.
Marinette, WI 54143
(715) 735-9002

THE FINEST IN HOME AUDIO,
CAR STEREO & VIDEO EQUIPMENT

AUTHORIZED DEALER FOR

- | | |
|---|--|
| <ul style="list-style-type: none"> • ADS • ADVENT • AIWA • AKG • ALTEC LANSING • AUDIO CONTROL • AUDIO SOURCE • CERWIN-VEGA • CITIZEN • CWD • dbx • DCM • DENON • HAFNER • INFINITY (car) • KENWOOD • KICKER • MITSUBISHI | <ul style="list-style-type: none"> • MONSTER CABLE • MISSION • ONKYO • ORION CAR AMPS • PHILIPS • PINNACLE AUDIO • POLK AUDIO (car) • PROTON • SAE • SANSUI • SONANCE • SONY • SOUNDCRAFTSMEN • STAX • TOSHIBA • TRIAD • YAMAHA |
|---|--|

SOUND CITY
Meadow Shopping Center
Route 23 South
Kinnelon, N.J. (201) 838-3444

Where to buy Polk Speakers

AUTHORIZED HOME DEALERS

CANADA Call Evolution Technology, Toronto for nearest dealer: 1-416-847-8888
AK Anchorage: Magnum Electronics • **Fairbanks:** Houtis
AL Birmingham: Audition • **DeKalb:** International Audio • **Huntsville:** Sound Distributors • **Mobile:** Hi-Fi Zone • **Montgomery:** The Record Shop • **Tuscaloosa:** Kincaid Stereo & TV
AR Fayetteville: F. Smith: Stereo One • **Little Rock:** Leisure Electronics • **Scary:** Softmark
AZ Flagstaff: Audio Pro • **Phoenix:** Mesa: Hi-Fi Sales • **Tucson:** Audio Emporium • **Yuma:** Warehouse Stereo
CA Bakersfield: Casa Moore • **Campbell:** Sound Goods • **Canoga Park:** Shelley's • **Carpinteria:** Creative Stereo • **Chico:** Sounds By Dave • **Corona Del Mar:** Pacific Coast Audio Video • **Davis:** World Electronics • **Eureka:** Eureka Audio Video • **Lancaster:** California Soundworks • **Long Beach:** Audio Concepts • **Mountain View:** Sound Goods • **Napa:** Futurvision • **Orange:** Absolute Audio • **Penn-grove:** California Stereo • **Redondo:** Systems Design • **Riverside:** Speakerscraft • **Sacramento:** Good Guys • **San Diego:** Sound Company • **San Francisco & Suburbs:** Good Guys Stereo Store • **San Gabriel:** Audio Concepts • **San Jose:** Good Guys • **San Luis Obispo:** Audio Ecstasy • **Santa Barbara:** Creative Stereo • **Santa Cruz:** Sound Wave • **Santa Maria:** Creative Stereo • **Santa Monica:** Shelley's Stereo • **Sherman Oaks:** Systems Design • **Stockton:** Gluskins • **Thousand Oaks:** Creative Stereo • **Urbain:** Music Hut • **Up-land:** Audio Haven • **Ventura:** Creative Stereo • **Victorville:** Incredible Sounds • **Westminster:** Videotek Stereo
CO Boulder: Soundtrack • **Colorado Springs:** Sunshine Audio • **Denver & Suburbs:** Soundtrack • **Grand Junction:** Sound Company • **Minturn:** Custom Audio Video • **Pueblo:** Sunshine Audio
CT Avon: Hi-Fi Stereo House • **Danbury:** Carlson's • **Fairfield:** Audio Design • **Greenwich:** Al Franklin's • **Hartford:** Al Franklin's • **New Haven:** Audio Etc. • **Newington:** Hi-Fi Stereo House • **New London:** Robert's • **Norwalk:** AudioTronics • **Water-bury:** Zimo Music
DE Wilmington: Bryn Mawr Stereo
FL Daytona Beach: Stereotypes • **FL Myers:** Stereo Garage • **FL Lauderdale:** Sound Advice • **FL Pierce:** Sound Shack • **FL Walton Beach:** Audio International • **Gainesville:** Electronics World • **Jacksonville:** Audio Tech • **Katy West:** Audio International • **Lakeland:** Sound Factory • **Merrill Island:** Southern Audio • **Miami:** Electronic Equipment Co. • **Sound Advice** • **Naples:** Stereo Garage • **Panama City:** Watford Stereo • **Pensacola:** Fidler Hi-Fi • **Surfside:** Stereo Advice • **St. Petersburg:** Cooper for Stereo • **Sound Advice** • **Tallahassee:** Stereo Stereo • **Tampa:** Sound Advice • **W. Palm Beach:** Electronic Connection • **Sound Advice**
GA Athens: Hi-Fi Buys • **Atlanta & Suburbs:** Hi-Fi Buys • **Augusta:** Stereo City • **Brunswick:** Hi-Fi Service Store • **Columbus:** Merit TV • **Macon:** Georgia Music • **Savannah:** Audio Warehouse • **Val-dosta:** Stereo Connection
HI Honolulu: Honolulu Audio Video
IA Davenport: Grigg's Music • **Des Moines:** Audio Labs • **Dodge City:** Sound World • **Dubuque:** Renner • **Iowa City:** Hawk Eye Audio • **Mason City:** Sound World • **Sioux City:** Audio Visions • **Water-loo:** Team
IL Boise: Stereo Shoppe • **Moscow:** Stereo Shoppe • **Sandpoint:** Electracraft • **Trine Falls:** Audio Warehouse
IL Alton: Reliable Stereo • **Aurora:** Stereo Systems • **Carbondale:** Southern Stereo • **Champaign:** Good Guys • **Chicago & Suburbs:** United Audio • **Decatur:** Team Electronics • **DeKalb:** Audio Plus • **Highland Park:** Columbia • **Joliet:** Stereo Systems • **Kankakee:** Bartlett's Entertainment • **Lansing:** Audio Clinic • **Naperville:** Stereo Systems • **Normal:** Sundown One • **Peoria:** Team Electronics • **Rock-ford:** Columbia • **Springfield:** Sundown One • **Spring Valley:** Audio Labs • **Waukegan:** Alan's
IN Bloomington: Campus Audio • **Bluffton:** Eley TV & Appliance • **Evansville:** Risley's • **FL Wayne:** Classic Stereo • **Indianapolis:** Ovalton • **Lafayette:** Good Vibes • **Marion:** Classic Stereo • **Michigan** • **Audio Connection** • **Muncie:** Classic Stereo • **South Bend:** Classic Stereo • **Terra Haute:** Stereo Crafters
KS Junction City: Audio Junction • **Kansas City:** Brands Mart • **Overland Park:** Audio Electronics • **Brands Mart** • **Wichita:** Audio Visions • **Topoka:** Nelson's
KY Bowling Green: Audio Center • **Lexington:** Ovalton Audio • **Louisville:** Audio Video Buy De-sign • **Owensboro:** Paduchak • **Risley's** • **Pikeville:** Mays
LA Lafayette: Sound Electronics • **Metairie & New Orleans:** Alternan Audio • **Opelousas:** Sound Electronics
MA Boston: Waltham Camera & Stereo • **Fitch-burg:** Fitchburg Music • **N. Dartmouth:** Sound II • **Pittfield:** H B S Stereo • **Worcester:** O'Coins
ME Bangor: Sound Source • **Camden:** Harbor Au-dio • **Portland:** New England Music
MD Baltimore: Soundscape • **College Park:** Spawoods • **Garthersburg:** Audio Buys
MI Ann Arbor: Absolute Sound • **Hi-Fi Buys** • **Birmingham:** Almas Hi-Fi • **Dearborn:** Almas Hi-Fi • **Farmington Hills:** Almas Hi-Fi • **Flied:** Stereo Center • **Grand Rapids:** Classic Stereo • **Kala-mazoo:** Classic Stereo • **Lansing/Midland:** Hi-Fi Buys • **Potoskey:** Kurt Music • **Royal Oak:** Absolute Sound • **Court St. Listening Room** • **Traverse City:** Kurt Music
MN Duluth: Mel's TV & Audio • **Mankato:** Audio King • **Minneapolis & Suburbs:** Audio King • **Rochester:** Audio King • **St. Paul:** Audio King
MO Cape Girardeau: Stereo One • **Columbia:** Johnston Audio • **Rolla:** End of the Rainbow • **St. Louis:** Soul Central
MS & Hattisburg: McLelland TV • **Jackson:** Hooper's • **Pascagoula:** Empress
MT Billings: Video Sat & Sound Bozeman: Thirsty Ear • **Great Falls:** Rocky Mountain Hi-Fi • **Kalispell:** Audio Visions • **Missoula:** Aspen Sound
NC Boone: Hollins • **Chapel Hill:** Stereo Sound • **Charlotte:** Audio Video Systems • **Conover:** Tri-City • **Greensboro:** Stereo Sound • **Henderson-ville:** Pro Sound • **Kinston:** Stereo Concepts • **Moorehead City:** Anderson Audio • **New Bern:** Anderson Audio • **Raleigh:** Audio Buys • **Stereo Sound** • **Rocky Mount:** Microwave Audio • **Wili-mington:** Atlantic Audio • **Wilson:** Modern Stereo • **Winston-Salem:** Stereo Sound
ND Bismarck: Pacific Sound • **Fargo:** Today Electronics
NE Kearney: Midwest Audio • **Lincoln:** Stereo West • **Omaha:** Stereo West • **York:** Midwest Audio
NH Concord: Audio of New England • **Laconia:** Lakeside Stereo • **North Hampton:** The New Audi-ophile • **New London:** Norm Star • **Salern:** Cuomo's
NJ East Brunswick: Atlantic Stereo • **Maple Shade:** Bryn Mawr Stereo • **Montclair:** Perque Ra-dio • **Paramus:** Harvey Electronics • **Raritan:** AC Audio • **Ridgewood:** Sounding Board • **Shrews-bury:** Monmouth Stereo • **Toms River:** Rands Camera • **Wall Twp.:** Monmouth Stereo • **West Caldwell:** Perdue Radio
NM Alamogordo: D&K Electronics • **Albuquer-que:** West Coast Sound • **Carlsbad:** Beason's • **Clovis:** Towne Cre • **Santa Fe:** West Coast Sound
NV Las Vegas: Upper Ear • **South Shore Lake Tahoe:** Audio Video Den
NY Albany: Clark Music • **Batavia:** Unicorn Audio • **Buffalo:** Speaker Shop • **Corning:** Chemung • **Elmira:** Chemung • **Fredonia:** Studio One • **Glens Falls:** Audio Genesis • **Goshen:** Longplay's Stereo • **Ithaca:** Chemung • **Southern Image** • **Jamestown:** Studio One • **Manhasset:** Audio Breakthroughs • **Massena:** Hi-Fi Shop • **Newburgh:** Audio Expres-sions • **New Hartford:** Adirondack Music • **New York City:** Audio Breakthroughs, Electronic Work-shop, Harvey Electronics • **Rochester:** JB Sound • **Scarsdale:** Listening Room • **Syracuse:** Clark Music • **Vestal:** Hart Electronics • **White Plains:** Harvey Electronics • **Woodbury:** Audio Breakthroughs
OH Akron: Audio Craft • **Canton:** Belden Audio • **Cleveland & Suburbs:** Audio Craft • **Cincinnati:** Stereo Lab • **Columbus:** Stereo Lab • **Dayton:** Stereo Showcase • **Findlay:** Audio Craft • **Lima:** Classic Stereo • **Toledo:** Audio Craft
OK Lawton: Hi-Fi Shop • **Oklahoma City:** Audio Dimensions • **Shawnee:** Rave Sounds • **Stillwater:** Cartunes • **Tulsa:** Audio Advice
OR Beaverton: Stereo Superstores • **Eugene:** Univer-sity Hi-Fi • **Grants Pass:** Shekells • **Medford:** Shekells • **Portland:** Stereo Superstores
PA Allentown: Bryn Mawr Stereo • **Blakely:** Hart Electronics • **Bryn Mawr:** Bryn Mawr Stereo • **Camp Hill:** Bryn Mawr Stereo • **Chambersburg:** Sunrise Electronics • **Erie:** Studio One • **Harris-burg:** Bryn Mawr Stereo • **Johnstown:** Gary's Entertainment • **Kingston:** Hart Electronics • **Lan-caster:** G n T Stereo • **Lomborg:** Bryn Mawr • **Montgomeryville:** Bryn Mawr Stereo • **Natrona Heights:** Stereo Land • **Philadelphia & Suburbs:** Bryn Mawr Stereo • **Pittsburgh:** Audio Junction • **Quakertown:** Bryn Mawr Stereo • **Reading:** G n T Stereo • **Salisburg:** Stereo Shoppe • **State Col-lege:** Paul & Tony's Stereo • **Stroudsburg:** Main St. Audio Video • **Westport:** Audio Insight • **Wil-liamsport:** Robert M. Sides
PUERTO RICO Rio Piedras: Precision Audio
RI N. Providence: Eastern Audio
SC Anderson: Music Machine • **Charleston:** Au-dio Warehouse • **Columbia:** Music Machine • **Greenville:** Mitchell's Stereo • **Music Machine** • **Greenwood:** Stereo Shop • **Spartanburg:** Stereo Shop
SD Aberdeen: Engel Music • **Rapid City:** Team Electronics • **Sioux Falls:** Audio King
TN Chattanooga: R&R T.V. • **Cookeville:** Lindsey Ward • **Jackson:** New Wave Electronics • **Kings-port:** Audition • **Knoxville:** Lindsey Ward • **McMinnville:** Lindsey Ward • **Memphis:** New Wave Electronics • **Nashville:** Hi-Fi Buys
TX Amarillo: Sound Systems Ltd. • **Arlington:** Sound Idea • **Austin:** Marcom Electronics • **College Station:** Audio Video • **Corpus Christi:** Tape Town • **Dallas:** Wilcrest Hi-Fidelity • **El Paso:** Soundquest • **FL Hill:** Sound Idea • **Houston:** Sheffield Audio • **Hurst:** Sound Idea • **Lubbock:** Metex International • **Langvire:** Audio Techniques • **Lubbock:** Electronic Supercenter • **San Antonio:** Bill Case Sound • **San Marcos:** Discovery Audio Video • **Sherman:** Worldwide Stereo • **Temple:** Audio Tech • **Texasarkana:** Sound Towne • **Waco:** Audio Tech
UT Logan: Stokes Brothers • **Ogden:** Stokes Brothers • **Salt Lake City:** Broadway Music • **St. George:** Boulevard Home Furnishings
VA Bristol: Audition • **Charlottesville:** Holdrens Stereo Machine • **Falls Church/Manassas:** Audio Buys • **Richmond:** Gary's Stereo • **Roanoke:** Hol-drens • **Virginia Beach:** Digital Sound
VT Brattleboro: Scientific Stereo • **Essex Junc-tion:** Ceative Sound • **Rutland:** Mountain Music
WA Bellingham: QC Stereo • **Chelan:** Mountain Stereo • **Dak Harbor:** QC Stereo Center • **Spokane:** Elec-tracraft (Hals)
WI Appleton: Sound World • **Eau Claire:** EME Audio Systems • **Green Bay:** Sound World • **La-crosse:** Sound World • **Madison:** Happy Medium • **Marinette:** Sound Seller • **Milwaukee:** Audio Em-porium • **Wausau:** Sound World
WV Barboursville: Beckley • **Charleston:** Pied Piper • **Clarksburg:** Audio Visual Concepts • **Hunt-ington:** Pied Piper • **Piedmont:** Sound Gallery • **Wheeling:** Stereo Lab
WY Cheyenne: Electronics Unlimited • **Gillette/ Sheridan:** Star Video Library

polkaudio
The Speaker Specialists®

STEREO REVIEW
CLASSIFIED

FOR MORE ADVERTISING INFORMATION CALL 1-800-445-6066

AUTHORIZED

High-end and hard-to-find audio components. Low, low prices! AUDIO AMERICA (Virginia). Call 1-703-745-2223.

ORDER TOLL-FREE 1(800) 222-3465. DISCOUNTS! AR * AUDIOQUEST * BOSE * B&K * GRADO * HARMAN KARDON * JBL * LAST * LIVEWIRE * MONSTER CABLE * NITTY GRITTY * SONY * STAX * STRAIGHTWIRE * PLUS MORE. HCM AUDIO, 1015 MANGROVE, CHICO, CA 95926. (916) 345-1341.

LOUDSPEAKER COMPONENTS—KITS, Eton, Dynaudio, Focal, Eclipse. Catalog \$1.00. Meniscus, 2422 28th St., S.W. Wyoming, Michigan 49509. (616) 534-9121.

HIGH-END LOUDSPEAKER systems, speaker kits and the widest selection of raw drivers from the world's finest manufacturers. For beginners and audiophiles. Free catalog. A&S SPEAKERS, 3170 23rd St., San Francisco, CA 94110. 3(415) 641-4573

LOWEST PRICES
On over 150 brands
Car - Home - Video
For Specials List and Catalog only
800-233-8375

HIGH QUALITY BRANDS—Car, Home, Video including esoteric. Audio Unlimited, 1203D Adams Ave., La Grande, Oregon 97850. (503) 963-5731.

LOW PRICES!! Yamaha, Denon, Carver, Adcom, Boston Acoustics, Luxman, Haller, A/D/S, B&K, KEF, Onkyo, Proton, Bose, Snell, DCM, M&K, P.S. Audio, Nakamichi & others!! SOUND ADVICE: (414) 727-0071.

"STEREO WORLD" IS YOUR DISCOUNT MAILORDER SOURCE WITH SUPER DEALS ON HOME AND CAR STEREO LINES INCLUDING: KENWOOD, TECHNICS, MAGNAVOX, PANASONIC, JVC, SONY, PYLE, PIONEER, SHERWOOD, PHILIPS CAR, CLARION, BLAUPUNKT, AIWA, ADVENT, G & S DESIGNS AMPS AND MANY OTHERS. CALL OR WRITE FOR FREE CATALOG. FREE UPS IN 48 STATES. 10AM-6PM MON-FRI; WEDNESDAY TIL 7PM. VISA/MC; COD EXTRA. "CELEBRATING OUR 3RD YEAR." P.O. BOX 596, MONROE, NY 10950. (914) 782-6044.

REVOLUTIONARY 35MM 3-DIMENSIONAL CAMERA. Incredibly Beautiful Photographs. Easy To Operate. Brochure, Including Sample Photograph, ONLY \$2. NEW AGE OPTICAL, (714) 731-2129; 1088 Irvine Blvd., Suite 371, Tustin, CA 92680.

STEREO REVIEW CLASSIFIED

SAVE 40% ON HIGH-END home speakers, subwoofers, amplifiers. **FREE CATALOG!**
RTRD, 3021 Sangamon Ave., Springfield, IL 62702. (217) 529-8793.

SERIOUS AUDIOPHILES DESERVE SERIOUS SERVICE.

And that's what you'll get at Reference Audio Systems. We offer the best in high-end audio and the best in friendly service by our knowledgeable staff. From the latest CD player to a classic mega-watt amplifier, you'll like our surprisingly affordable prices and fast shipping.

COUNTERPOINT · N
PS AUDIO · BEYER
REVOX · MEITNER
JBL · HARMAN KAR
ONKYO · JSE · SON
HAFLER · PROTON
DAHLQUIST · BOSE
AUDIOQUEST · VPI
ACOUSTAT · TEAC
DCM · OHM · SMC
PHILIPS · DISTEC
MOD SQUAD · SAE
SUPERPHON · AKG
CAMBRIDGE · KL
FOSGATE · EMINE
MAGNAVOX · DBX
THORENS · NITTY
CELESTION · RAUN
STAX · AUDIOPRO
SONANCE · ENER
GRADO · MAGNUM
DUAL · ORTOFON

Reference Audio Systems

Call Us... (213) 719-1500

Member Better Business Bureau
18214 Dalton Ave., Dept. D, Gardena, CA 90248
Hours: M-F 9 to 6, Sat. 9 to 1 Pacific Time

CABLE TV CONVERTERS/DESCRAMBLERS Guaranteed lowest prices in U.S., Jerrold, Hamlin, Zenith—many others! Lowest dealer prices! Orders shipped within 24 hours! MasterCard—Visa—C.O.D. accepted. Free catalog—call (800) 345-8927 only! Pacific Cable Co., Inc., 7325 1/2 Reseda Blvd., 1353, Reseda, CA 91335. All other information, call (818) 716-5914.

WE SELL MORE HIGH PERFORMANCE SPEAKER KITS than anyone in the U.S. **FREE CATALOG:** 1 (800) 346-9183. **AUDIO CONCEPTS** Dept. A, 901 S. 4th St., LaCrosse, WI 54601.

EXPERIENCED, FRIENDLY ADVICE! AUDIRE, PS, CWD, STAX, KINERGETICS, THORENS, MIRAGE, GRADO, FRIED, MONSTER CABLE, QUAD, SPICA, STRAIGHT-WIRE, more. Immediate, **FREE Shipping!** READ BROTHERS STEREO, 593-B King Street, Charleston, South Carolina 29403. (803) 723-7276.

CALL TOLL FREE! 1(800) 826-0520.
ONKYO * DAN * HARMAN KARDON *
PROTON * AUDIO CONTROL * CITATION
* JBL * LEXICON * HAFLER * M&K * STAX
* CELESTION * KINERGETICS * NITTY
GRITTY * PROAC * DAHLQUIST * BELLES
* dbx * FRIED * ORACLE * THORENS * CWD
* THORENS * MONSTER CABLE * DCM
* GRADO * NILES * SOUND SELLER, 1706
MAIN ST., MARINETTE, WI 54143. FAX
#(715) 733-5838, PHONE (715) 733-9002.

FOR SALE

ARE YOU INTERESTED in Quality Preowned Audio Equipment? Subscribe to "The Sound Trek," published 6x annually, your listings of items for sale or wanted. \$10/yr. Call or write: Play It Again Sam, 12611-R Madison Avenue, Lakewood, Ohio 44107, (216) 228-0040, MC/MISA.

HIGH-END, LOW PRICES. ADS·BANG & OLUFSEN · CARVER·DBX·DENON·H/K·NAKAMICHI AND MANY MORE! FULL MANUFACTURERS WARRANTY. TECH ELECTRONICS SYSTEMS. SINCE 1981. GAINESVILLE, FL (904) 730-3885.

WE SELL SECOND HAND high quality audio-video with money back guarantee! Send your name and address for FREE monthly inventory. Ross Stereo, 2423 Morena Blvd. San Diego, CA 92110. (619) 275-3632.

ATTENTION DENON CUSTOMERS

Not everyone offering Denon products for sale is an authorized Denon dealer. This has great significance to you as a potential Denon customer.

Denon America's warranty applies to the original purchase only. Denon products sold by non-authorized dealers are not covered under our warranty.

Additionally, some of this equipment may have been designed for foreign markets and therefore will not meet Denon America's specifications.

So look for the Authorized Denon Dealer Sticker before you buy.

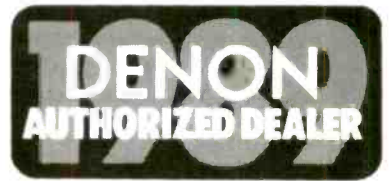

To find your nearest
AUTHORIZED Denon Dealer call:
1-201-575-7810 (9:00am - 5:00pm EST)

TANDBERG / TANDBERG / TANDBERG.
CLOSEOUTS/ALL MODELS. Lowest prices,
factory authorized warranty. Call **THE
SOUND APPROACH, 6067 Jericho Turnpike,
Commack 516/499-7680.**

CARVER, NAKAMICHI, BANG & OLUFSEN,
A.D.S., CROWN, REVOX, TANDBERG, HAFLER,
ADCOM, MISSION, N.A.D., HARMAN/
KARDON, KYOCERA, YAMAHA, LUXMAN,
DENON, KLIPSCH, B&W, KEF, D.C.M., E-V,
J.B.L., INFINITY, D.B.X., AKG, AND OTHER
QUALITY COMPONENTS. **BEST PRICES—
PROFESSIONAL CONSULTATION. ALL PROD-
UCTS COVERED BY MANUFACTURERS'
U.S.A. WARRANTY. OPEN 24 HOURS A DAY.
AMERISOUND SALES, INC., EAST: (904)
262-4000; WEST; (818) 243-1168.**

THE MINI AD WITH MAXI SAVINGS

S.B.H. ENTERPRISES
1678 - 53rd ST, BKLYN, NY 11204 · MON-FRI 8-7, SUN 9-6
CALL 1-800-451-5851 / IN NYC (718) 438-1027

WHISTLER		BEL		BLAUPUNKT CAR RADIOS	
New Spectrum 3	279.95	944 Express III	194.95	Berlin T8007	1179.00
Spectrum 2	157.00	New Real 574 King III	137.50	New Lexington SQR48	387.00
Spectrum 2 Ext	189.95	974 Metro III	151.00	Los Angeles SQR48	337.00
Spectrum 1	96.95			San Francisco SQR28	797.97
Whistler 5800 Ezer	333.50			Alpine SQR27	759.00
COBRA		SHERWOOD		PIONEER CAR STEREO'S	
CD-250	104.00	CD-278	145.00	DSR10	599.00
CD-278	145.00	CD-279	159.00	DSR10	599.00
CD-445	169.00	CD-303	147.00	DSR10	599.00
SE 506	209.00	SE 404	251.00	DSR10	599.00
	157.00			DSR10	599.00
	177.00			DSR10	599.00
UNIDEN		TECHNICS		MULTI TRACKERS/COLLECTORS	
UDP	103.00	UDP	142.00	HP178	815.00
UDP	103.00	UDP	142.00	HP178	815.00
UDP	103.00	UDP	142.00	HP178	815.00
UDP	103.00	UDP	142.00	HP178	815.00
UDP	103.00	UDP	142.00	HP178	815.00
UDP	103.00	UDP	142.00	HP178	815.00
UDP	103.00	UDP	142.00	HP178	815.00
UDP	103.00	UDP	142.00	HP178	815.00
UDP	103.00	UDP	142.00	HP178	815.00
UDP	103.00	UDP	142.00	HP178	815.00

CANON FAX

FAI 4 8 99, FAI 20 139,
FAI 15 849, FAI 25 1549.

© 1991 S.B.H. Enterprises. All rights reserved. All prices include shipping and handling per unit, anywhere in the continental U.S.A. Not responsible for typographical errors. Fax delivery: noon-7:30 pm.

GRAFM audio-technica **Tweak**

YOUR SEARCH IS OVER!

We specialize in hard to find phono cartridges and original replacement styli.

(800) 221-0906

CALL TOLL-FREE FOR FREE PRICE QUOTES AND VISAMC ORDERS N.Y. STATE (518) 599-1112

SEND SELF ADDRESSED STAMPED ENVELOPE FOR OUR FREE CATALOG.

LYLE CARTRIDGES
Dept. SR, Box 158
Valley Stream, N.Y. 11582

Phones Open Mon-Sat 9 am-8 pm

ortofon SHURE STANTON

PHILIPS, AUDAX, PEERLESS, FOCAL, AND DYNAUDIO LOUDSPEAKERS in stock with good prices and competent services. Crossover components also. MADISOUND SPEAKER COMPONENTS, 8608 University Green, Box 4283, Madison, WI 53711. (608) 831-3433.

CALL US LAST

WE WILL
BEAT ANY PRICE
PRINTED IN THIS MAGAZINE ON
AUDIO & CAR STEREO

The SOUND Approach
6067 Jericho Tpke., Commack, NY 11725
FAST DELIVERY (516) 499-7680
FULL WARRANTY

SINGERS!
REMOVE VOCALS
FROM RECORDS AND CDs!

SING WITH THE WORLD'S BEST BANDS!

An Unlimited supply of Backgrounds from standard stereo records! Record with your voice or perform live with the backgrounds. Used in Professional Performance yet connects easily to a home component stereo. This unique product is manufactured and sold exclusively by LT Sound - Not sold through dealers. Call or write for a Free Brochure and Demo Record.

LT Sound, Dept. SR-3, 7980 LT Parkway
Lithonia, GA 30058 (404) 482-4724
Manufactured and Sold Exclusively by LT Sound
24 HOUR PHONE DEMO LINE: (404) 482-2485

HIGH-END SPEAKER SOUND FOR \$155 PER PAIR! CALL FOR BROCHURE. DANA AUDIO MODEL 1. (512) 251-7701.

SHURE MONSTER CABLE GRADO

We Are Proud To Offer A LARGE SELECTION OF:

NEEDLES CARTRIDGES

TOLL FREE (800) 342-9969

High Quality Turntables & Accessories in Stock...

M&Y CO.
361 N. Crescent Heights Blvd.
Los Angeles, CA 90048

Featuring

- ORTOFON
- SHURE
- GRADO
- DYNAVECTOR
- AUDIO TECHNICA
- PICKERING
- SIGNET
- NITTY GRITTY
- STANTON
- BEYERDYNAMIC
- AUDIOQUEST
- STAX
- CARNEQUE ONE
- THORENS
- AR
- MICRO SEIKI
- AND MANY MORE

STANTON NITTY GRITTY

VISA

MAGNETIC SHIELDING

SIGNET ORTOFON BEYERDYNAMIC

CASH FOR ALL TYPES of used Stereo equipment. We buy by phone. THE STEREO TRADING OUTLET, 320 Old York Rd., Jenkintown, PA 19046. (215) 886-1650.

BUY/SELL IN THE MONTHLY AUDIO VIDEO TRADER \$15 YR, SAMPLE \$1 + SASE. FREE ADS! 330 S. MAIN, WAKE FOREST, NC 27587

Stereo Express CALL NOW (619) 578-9630

CALL FOR PRICE FAST & FRIENDLY SERVICE Most Orders Shipped Within 48 Hours

HOME AUDIO

YAMAHA, ADS, BOSE, HAFNER, HARMAN KARMAN INFINITY, AR, SONY, DBX, JBL, JVC, AIWA, TECHNICS, TEAC, SAE, ADOOM, STAX, AUDIO SOURCE, PIONEER, MAGNAVOX AND MANY MORE

CAR AUDIO

ADS, ALPINE, BLAUPUNKT, CONCORD, SONY KENWOOD, PIONEER, CLIFFORD, TECHNICS

VIDEO

SONY, JVC, RCA, PANASONIC, ZENITH, GE, MITSUBISHI
7915 Silverton Ave. # 303, San Diego, CA 92128

FOCUS Electronics

— INFO —
1-718-871-7600
— ORDERS —
1-800-223-3411

COMPACT DISC PLAYERS		YAMAHA NEW		PS-5		LOW	
— PIONEER NEW —		AVR-35 239.95		PS-6		LOW	
PDM-710 LOW		AVR-55 309.95		PS-6V		LOW	
PDM-510 LOW		AVR-75 489.95		PS-80		LOW	
PDM-510 LOW		R-9 324.95		PS-10		LOW	
PDM-410 LOW		R-8 434.95		PS-30		LOW	
PDI-500 LOW		RX-900 559.95		PS-35		LOW	
PDI-700 LOW		RX-1100 699.95		PS-LF		LOW	
PD-6300 LOW		CASSETTE DECKS		— PINNACLE —			
PD-4350 LOW		— PIONEER NEW —		PN2 99.95/PR			
— JVC NEW		CTW-910 LOW		PN5 + 149.95/PR			
XLZ-611 LOW		CTW-710 LOW		PN6 + 199.95/PR			
XLZ-411 LOW		CTW-600R LOW		PN8 209.95/PR			
XLM-701 LOW		CTW-510 LOW		MON. 230 289.95/PR			
XLM-401 LOW		CTV-500 139.95		— WHARFPALE —			
XLM-301 LOW		CTS-605 LOW		DIA. III 219.95/PR			
XLM-211 LOW		CTS-405 LOW		— ADVENT —			
XLV-311 LOW		CTS-305 LOW		MAESTRO LOW			
— MAGNAVOX NEW		— JVC NEW		LEGACY LOW			
CDD-473 239.95		TDW-901 LOW		PROD. TOWER LOW			
CDD-472 155.95		TDW-801 LOW		BAND 11 LOW			
CDD-484 219.95		TDW-500 LOW		MINI LOW			
CDD-466 257.95		TDW-301 LOW		SUB WOOF. LOW			
CDV-474 LOW		TDW-201 LOW		— PIONEER NEW —			
— DEMON —		TDR-421 LOW		ST-100 LOW			
DCD-610 249.95		TDX-321 LOW		ST-300 LOW			
DCD-1400 369.95		TDW-621 LOW		ST-500 LOW			
DCD-1500 11 489.95		— AIWA —		HEADPHONES			
DCD-1700 589.95		ADWX-909 LOW		— AZDEN —			
— YAMAHA —		ADWX-707 299.95		DM-90 74.95			
CDX-410 239.95		ADWX-505 149.95		DSR-46 34.95			
CD-3050 449.95		ADF-780 LOW		DSR-88 24.95			
CDC-610 479.95		SEPARATES		— KOSS —			
RECEIVERS		— YAMAHA —		JCK-200 119.95			
— PIONEER NEW —		AX-300 169.95		JCK-300 CALL			
VSX-9500S LOW		AX-400 229.95		— ALPINE —			
VSX-7500S LOW		TX-300 139.95		5950 849.95			
VSX-5500S LOW		TX-400 179.95		7280 379.95			
VSX-5400 LOW		CX-1000 699.95		7160 329.95			
VSX-4500S LOW		CX-800 519.95		3530 369.95			
VSX-4400 LOW		CX-600 359.95		3210 86.95			
VSX-3300 LOW		MX-1000 879.95		— PIONEER —			
SX-2300 LOW		MX-800 629.95		ALL IN STOCK AT GREAT PRICES			
— JVC NEW —		MX-600 429.95		— JVC —			
RX-901 LOW		MX-55 469.95		ALL IN STOCK AT GREAT PRICES			
RX-801 419.00		MX-35 219.95		ALL IN STOCK AT GREAT PRICES			
RX-701 LOW		TX-1000 419.95		HI-END SPEAKERS			
RX-501 LOW		— DESIGN ACOUSTICS		ALL IN STOCK AT GREAT PRICES			
RX-401 LOW		PS-3 LOW		FOCUS ELECTRONICS STORE, 4533 13th AVE. S. BAKERSFIELD, CA 93310			
RX-301 LOW				MAIL ORDER, 1223 39th STREET, BROOKLYN, NY 11210			

ORDER, 1-800-223-3411 FOR INFO. OR BY MAIL. CALL 1-9-53-17600
CUSTOMER SERVICE CALL 1-718-871-7600. CASH, VISA, MC, AMEX.
G.COD ACCEPTED. 14 DAY RETURN POLICY. ALL UNITS ARE SHIPPED NEW. ITEMS THAT
ARE ACCEPTED FOR RETURN MAY BE CHARGED A RESTOCKING FEE IF PACKAGING
AND/OR ITEM IS NOT AS NEW. NEW RETURNS ONLY. RETURNS AFTER 45 DAYS SHIP
HANDL. & INSURANCE ARE EXTRA AND NON-REFUNDABLE. NOT RESPONSIBLE FOR
TIPO, PRICES AND AVAILABILITY SUBJECT TO CHANGE WITHOUT NOTICE. ALL PRICES
IN THIS AD ARE FOR MAIL ORDER ONLY.

Custom-Finished Loudspeakers—We solve speaker vs. decor problems without compromising either. FREE brochure. Environmental Acoustics 1-800-EA-SPKRS.

RECORDS

RECORD COLLECTORS' SUPPLIES. REPLACEMENT JACKETS, inner sleeves, 78 RPM sleeves, CLD boxes, etc. COMPLETE CATALOG. Cabco, Box 8212, Room 640, Columbus, Ohio 43201.

A.S.Q. SOUNDTRACKS/O.C. DISCOUNT PRICES, RARE OUT-OF-PRINT, QUALITY GUARANTEED. FAST DEPENDABLE SERVICE. SEND FOR FREE MONTHLY CATALOG: A.S.Q. DEPT.A. P.O. BOX 404, SEELYVILLE, IN 47878. (812) 299-4154.

FREE RECORD, CASSETTE AND COMPACT DISC CATALOG: Features a tremendous selection of remaindered LP new releases at discount prices. Many imports and smaller labels offered. Prompt delivery. Rose Records, Dept. SR, 214 SO. Wabash Avenue, Chicago, IL 60604.

COMPACT DISCS

OVER 8000 USED CD's. \$5.99 to \$9.99. Buy/Sell, Monthly Catalog (FREE Sample), 5th Year. Shipping \$2.50 UPS, Lifetime Membership \$15, VISA/MC. Audio House CD Club, 4304 Braylan, Swartz Creek, Michigan 48473. (313) 655-8639.

COMPACT DISCS—At low warehouse prices. Now in our 5th year. CATALOG: Send \$2.00. OZ ENTERTAINMENT, 1575 P Highway 29, Lawrenceville, GA 30244.

LOW COMPACT DISC prices—Schwann CD and COLOR CATALOGS \$7.00—Mini-Catalogs \$2.00—DUWARS. P.O. Box 6662-D, Greenville, SC 29606.

LIKE-NEW CD'S \$4.65. UP. We pay you up to \$7.00! FREE STOCKLIST: CCM, 1105 Webster, Sandy, Utah 84094-3151. (801) 571-9767.

WE'VE SLIPPED OUR DISC PRICES TO FIT YOUR BUDGET. PRICES START AT \$8.99! WRITE: LASER LOCKER, BOX 8611, SOMERVILLE, NJ 08876.

SAVE MONEY ON NEW CD'S. Free Details. WILBUR TANSTAFF COMPANY, Box 308B, Middlefield, CT 06455-0308.

ANY U.S. RECORD OR CASSETTE \$4.99 EACH WHEN YOU PURCHASE 2 OR MORE ALL ORIGINAL ARTISTS—ORIGINAL LABELS COMPACT DISCS AND DOUBLE ALBUMS/TAPES SLIGHTLY HIGHER. \$20 MEMBERSHIP INCLUDES 20 CERTIFICATES FOR \$4.99 OFFER AS WELL AS OUR HITS CATALOG, INCLUDING POSTAGE & HANDLING. COUNTRY—CLASSICAL—JAZZ—ROCK—FOLK—SPIRITUAL—WE HAVE THEM ALL. IF NOT IN OUR CATALOG JUST REQUEST ARTIST AND LABEL. SATISFACTION GUARANTEED! N.Y. MUSIC, TAPE & VIDEO CLUB, P.O. BOX 224, KINGS PARK, NY 11754-0224.

CD-BINDER and other compact disc storage solutions. Call 1-800-992-8262 or write for FREE CATALOG. Univercite, Inc., Dept. SR, Box 570, Dublin, Ohio 43017.

COMPACT DISC CENTER
P.O. Box 616S, Clifton Park, NY 12065

CALL (518) 383-4855
FAX: (518) 383-4857

STARTING DISCS AT \$7.00
Quantity Discount Pricing.
\$3.00 Cont. U.S. Shipping
FREE CATALOGUE

DAMAGED CD'S?? SKIPPING CD'S ARE EXPENSIVE TO REPLACE. CD'S ARE EASILY REPAIRED WITH "DIGITAL BLUE" TREATMENT & REPAIR KIT. CORRECTS SKIPS WIPING & CLEANING CANNOT. REPELS DUST & FINGERPRINTS. USE ON ALL YOUR DISCS TO GUARD AGAINST FUTURE DAMAGE. SATISFACTION GUARANTEED. ORDER NOW! SEND \$12.95 (U.S.), \$16.95 (CAN.) + \$1.50 SHIP/HAND, W.R. MARKETING, BOX 697, PT. CLAIRE, QUE., CANADA H9R 458. (514) 695-2086.

CD COLLECTORS—NEW ROCK, POP, JAZZ AND CLASSICAL CD'S FOR "ONLY" \$4.99 EACH! FOR CATALOG SEND \$1. CD WAREHOUSE, U.S.F. 3060, TAMPA, FL 33620-3060.

CD-SINGLES, CD-EP'S CD PICTURE DISCS-EP'S AND RARE CD'S. For catalog call (305) 594-1811, Music Service, P.O. Box 561751, Miami, FL 33256-1751.

TAPES

3.95 SHIPPING ANY SIZE ORDER, UPS 1-800-245-6000

STOK	OCTAVE	SONY	MAXELL
MAX 680 1.99	RE-115 99	SONY UX-PRO-100 2.99	MAX-40 2.99
MAX 80 2.99	RE-120 99	SONY METAL E60 3.99	EL-90 2.99
MAX 80 3.99	RE-145 1.09	FUJIA DR 90 3.99	EL-90 1.99
S-100 2.99	RE-150 1.19	MAXELL XLI-100 2.99	LSR-100 2.99
ARR-90 2.19	RE-180 1.39	MAXELL XLIIS-100 2.99	UR-100 1.99
SA-100 2.99	RE-190 1.49	MAXELL XLIIS-150 3.49	UR-150 2.99
SA-100 1.99	RE-LEAS-15 99	MAXELL MAX-100 3.49	UD-15 90 6.99
SA-100 1.79	RE-LEAS-18 99	MAXELL MAX-150 3.49	UD-15 90 6.99
MA-100 2.99	RE-LEAS-20 99	MAXELL MAX-150 3.49	UD-15 90 6.99
AD-100 1.99	RE-LEAS-25 99	MAXELL MAX-150 3.49	UD-15 90 6.99
AR-100 1.99	RE-LEAS-30 99	MAXELL MAX-150 3.49	UD-15 90 6.99
D-100 1.99	RE-LEAS-35 99	MAXELL MAX-150 3.49	UD-15 90 6.99
D-100 1.99	RE-LEAS-40 99	MAXELL MAX-150 3.49	UD-15 90 6.99
FR-110 1.99	RE-LEAS-45 99	MAXELL MAX-150 3.49	UD-15 90 6.99
FUJIA METAL 2.89	RE-LEAS-50 99	MAXELL MAX-150 3.49	UD-15 90 6.99

VISA, MC NO EXTRA CHARGE

Special Offer FREE ZELL 50 WITH EVERY AUDIO TAPE (see Special Price of this Total Order including All Shipping & Handling Charges to you, 3.95 Shipping Any Size Order, C.O.D. Add \$1.75. All Tapes New U.S. Warranties. Postage Paid \$/H Call

TAPE WORLD
220 SPRING ST. BUTLER PA 16001
THAT'S TRIAD. DAT CALL

M-F 8:30-5:00
SAT 9:00-4:00
412/283-8621
800/245-6000

TEN AMPLEX 1800 REELS—USED ONCE, \$25.00 Sample: \$2.50. Also: New MAXELL Reels/Cassettes. AUDIO TAPES, Box 9584-A, Alexandria, VA 22304. (703) 370-5555 VISA/MC.

PURE CHROME BASF CASSETTES AT DISCOUNT PRICES. C-10 TO C-100, CLEAR SHELLS. CLASSIC CASSETTES. 1-(800)-777-8939.

DAT

The Digital Audio Tape STORE

(213) 828-6487
FAX (213) 470-6176
9 A.M. - 7 P.M. 7 DAYS
SHIP VIA UPS/FED-EX
AMEX • VISA • MC

RECORDABLE DAT'S IN STOCK NOW

- FULL WRITTEN WARRANTY PLUS FREE LOANERS
- IMMEDIATE DELIVERY
- NO DEPOSITS REQUIRED
- ENGLISH OWNERS MANUALS
- A/C ADAPTORS INCLUDED

HOME D.A.T	PORTABLE D.A.T
AIWA XD-999 ... 995	SONY TCD-D10 ... 2250.
SONY DTC-M100 ... 1400.	Includes all factory accessories
SONY DTC-1000ES ... 1950.	
SONY DTC-500ES ... 1750.	PROFESSIONAL D.A.T
SONY DTC-300ES ... 1650.	PANASONIC SV-3500CALL
JVC XD-2700 ... 1750	PANASONIC SV-2500 CALL
JVC XD-21100 ... 1850.	FOSTEX D-20 ... CALL
JVC XD-2900 ... 2250	SHARP SX-D100 ... CALL
AKAI D-9000 ... 1800.	SONY PCM-2500 ... CALL
PIONEER D-900 ... 1800.	SONY PCM-2000 ... CALL

BLANK TAPE—ALWAYS IN STOCK
Maxell, TDK, Fuji, Panasonic

COMPLETE INVENTORY OF ACCESSORIES

2624 Wilshire Blvd. • Santa Monica CA 90403

LASER VIDEO DISCS

SEM VIDEO "IS" LASERDISCS. Service & Selection at its Best! 2147 E. 17th Street, Brooklyn, NY 11229. 1-800-247-6644 ... 718-645-1663.

WIDESCREENS NOW! LASERDISCS! The Mission, Oklahoma, Empire & More. Sales + Fast UPS Nationwide Rentals. Free "Fresh Views" Laser Newsletter. HOLLYWOOD NORTH ENTERTAINMENT SERVICES, 840 Piner Rd., Santa Rosa, Ca. 95403 (707) 575-1225.

LASER VIDEO & COMPACT DISCS

- HUGE SELECTION - DOMESTIC & IMPORT
- FREE MONTHLY NEWSLETTER TO ALL CUSTOMERS
- LV IMPORT CATALOG AVAILABLE
- LASERDISC CD & HARDWARE TRADE-INS
- PIONEER LASERDISC PLAYERS IN STOCK
- LOWEST PRICES

Sight & Sound 1275 Main St. Waltham, MA 02154
(617) 894-8633

LASER SPECIALTY STORE. Since 1980. 10% OFF Retail! All Discs. Discounts on Players. THE LASER IMAGE (303) 586-5056.

FOR INVENTORS

INVENTORS! Can you patent and profit from your idea? Call AMERICAN INVENTORS CORPORATION for free information. Over a decade of service. 1(800) 338-5656. In Canada call (413) 568-3753.

INVENTIONS WANTED

A NEW IDEA? Call NATIONAL IDEA CENTER of Westington D.C. FREE INFORMATION—(1800) 247-6600, Ext. 150. Come see THE INVENTION STORE!!



by *Christie Barter*
& *Ron Givens*

IF you, like the Academy of Motion Picture Arts and Sciences, enjoyed Dave Grusin's score for the movie *The Milagro Beanfield War*, then you've probably wondered why you couldn't buy a recording of the music. Well, even though the score won an Oscar last spring, it wasn't considered long enough to release by itself on a soundtrack album. But the wait is now over. Grusin has included a *Milagro Beanfield* suite on his new album for his own GRP label, along with music he wrote for another film, *A Dry White Season*. The recordings aren't from the soundtracks but are new interpretations of the music by some major jazz musicians, including saxophonist **Branford Marsalis**, trumpeter **Hugh Masakela**, and, of course, Grusin himself. □

JUDY SCHILLER/GRP



Mitchell: brushing up

that he was co-producing, singing background vocals. That album has just been released by A&M. □

FANS of Rickie Lee Jones have been waiting five years for her to release a new album. Placated by a few duet appearances with **Rob Wasserman** and **Dr. John**, those devotees should be well satisfied by "Flying Cowboys" (Geffen), which she has been recording off and on since 1987. Among the ten songs on the record—eleven on CD—are more of Jones's evocative meditations on relationships and feelings. She wrote five of the songs herself, and in two of them, *Rodeo Girl* and *Ghost Train*, plays all of the accompanying instruments except percussion. Jones's husband, **Pascal Nabet-Meyer**, helped to write five of the remaining tracks. "Flying Cowboys," produced

Jones: evocative



by **Walter Becker** (of **Steely Dan** fame), also includes a remake by Jones of the 1964 Gerry and the Pacemakers hit *Don't Let the Sun Catch You Crying*. □

AMERICAN pianist **Richard Goode** is currently recording all the Beethoven piano sonatas for Elektra/Nonesuch. The first set in the projected series is devoted to the late sonatas, Nos. 28 through 32, and in the accompanying notes Goode makes a point worth pondering: "Beethoven has unavoidably become a classic, available to all of us at the flick of a switch, in multiple performances by hundreds of artists. While this is a great blessing, it is also a danger. As a performer and a listener I have two strong hopes: that easy availability does not blunt the incomparable power of Beethoven's music to move us, and that some of this power may be transmitted through these recordings so that the music will embody what Beethoven wrote in his dedication to the *Missa solemnis*: 'Written from the heart, may it go to the heart.'" □

SET for release this fall and winter are a half-dozen compact discs representing the first releases by a new label, **Premier Recordings**, serving "serious listeners devoted to American music." They include an album of compositions by songwriter

Harold Arlen, featuring his *Americanegro Suite* of 1939-1940; an "update" by **Galt McDermot** of his classic American musical *Hair*, performed by the composer on a variety of instruments; "A Blitzstein Cabaret," a collection of theater songs by **Marc Blitzstein**, many of which never even reached the stage; and an album of songs by the "March King," **John Philip Sousa**. Among the performing artists are sopranos **Judy Kaye**, **Helene Williams**, and **Maryanne Telese**, baritones **Stephen Lusmann** and **Ronald Edwards**, and pianist **Leonard Lehrman**. □

SUMMER may seem an odd time of year to release an album of music recorded at a New Year's concert, but CBS Masterworks had good reason for releasing in June a live recording of the Vienna Philharmonic's 1989 New Year's Day concert at the city's cherished Musikverein concert hall. Fact is, the traditional concert was conducted this year by **Carlos Kleiber**, and the recording—his first in seven years—marks his debut on the CBS label. The program, devoted to the music of **Johann Strauss Sr. and Jr.** and family, offers some of the best-loved Viennese favorites, including *The Blue Danube*, *Voices of Spring*, the *Pizzicato Polka*, and the *Radetsky March*, along with a number of rarer pieces.

Goode: from the heart



NORMAN SEEFF/GEFFEN

PETER SCHAAF/JAY HOFFMAN

Grusin: Oscar-winning score

PEOPLE who buy **Joni Mitchell** albums know that she's a fine painter as well as a singer. Nearly all of her covers have displayed an example of her graphic skill, and her work in the two art forms seems to go hand in hand. Last year she released the album "Chalk Mark in a Rain Storm" and put together, for an exhibition in Japan, a collection of paintings she had done since 1971. This summer she began painting again, and, with husband **Larry Klein**, started putting down basic tracks for her new Geffen album, as yet untitled. She also gave Klein a hand on a record by **Indio**

CRAIG DIFITZ/GEFFEN



Kleiber's last major commercial recording was his much-honored, but to some ears rather eccentric, account of Wagner's *Tristan und Isolde*, released in the early Eighties by Deutsche Grammophon—which apparently retained the video rights to his New Year's concert. DG



Kleiber: happy new label

has just released it on a 12-inch videodisc and on a VHS tape cassette. □

SEVERAL record companies commonly associated with purely instrumental New Age music have been broadening their artist-and-repertoire base lately by signing vocal artists. Their goal has been to produce albums that will win over a new audience of record buyers, one more interested in albums of commercial pop or jazz. In the trade it's called "cross-over," and there are no better examples than the two albums by Tuck & Patti, a singing duo that's earned a loyal following in the San Francisco Bay area. Their label is the Bay-area-based Windham Hill, the granddaddy of New Age record labels.

Tuck Andress and Patti Cathcart (Mrs. Andress) made their recording debut last year with an album called "Tears of Joy," which enjoyed a run of thirty-five weeks on *Billboard's* Contemporary Jazz chart. Their current release, "Love Warriors"—which, like its predecessor, was recorded without benefit of editing, overdub-

bing, or electronic "enhancements"—seems poised to do the same.

Other labels that have recently added vocal records to their predominantly instrumental output include Private Music, with albums by vocalists Bill Gable and Nora Hendryx, and RCA's jazz subsidiary Novus, with an album by singer/keyboardist Amina Claudine Myers. □

WITH their new Island album, "Peace and Love," the Pogues have broadened their musical horizons yet again. In addition to the traditional Irish folk idioms that have been the musical spine of the band, and the electrified blend of those idioms with rock-and-roll, the Pogues show flashes of big-band jazz and calypso in this fourth album. "Every record we've made has staked out new territory for us, and that's exactly what this one does," said Jem Finer, who plays banjo, saxophone, hurdy-gurdy, and piano in "Peace and Love."

The album's title is a homage (perhaps an ironic one) to the twentieth anniversary of Woodstock. "We're a bit cynical, I suppose," Finer told us, "but we're basically romantics at heart. The hu-



The Pogues: new territory

man condition is a combination of misery and joy, and the sanest way to approach life is with humor in the face of adversity. You have to laugh, because otherwise you'd cry."

"Just because the songs are about reality," said lead singer Shane MacGowan, "that's no reason to make the music boring and depressing. Music is about uplifting people, you know?" □

RACENOTES. Restless Records has released "Get Outta School," the de-

but album by Old Skull, a punk trio of boys aged eight, nine, and ten from Madison, Wisconsin. . . . A classic survey of important blues—the three volumes of "Chicago/The Blues/Today!"—has been reissued by Vanguard. . . . On the twenty-fifth anniversary of the "British Invasion," Rhino Video has issued a compilation called "British Big Beat: the Invasion," with clips by the Hollies, Lulu, and the Merseybeats, among others. . . . Fantasy Records has issued a lavish sixteen-CD collection of the work that alto saxophonist Art Pepper did for the Galaxy label from 1978 until his death in 1982. . . . Tenor Jerry Hadley was in London in August to record Kurt Weill's *Street Scene* for London/Decca and Benjamin Britten's *Serenade for Tenor, Horn, and Strings for Nimbus*. . . . Singer-pianist Michael Feinstein has just recorded an album of songs from some of the old MGM musicals for Elektra. . . . Multiple Grammy winner K.T. Oslin was recently made an honorable "80's Lady" by the City of Reno, Nevada. . . . Dennis Quaid, who plays (but does not sing) the Jerry Lee Lewis role in the movie *Great Balls of Fire*, has signed a recording contract with Capitol. . . . Singer/songwriter B. J. Thomas has just had his first Reprise album released under a new exclusive contract. □

Tuck & Patti: crossing over



by *Ralph Hodges*

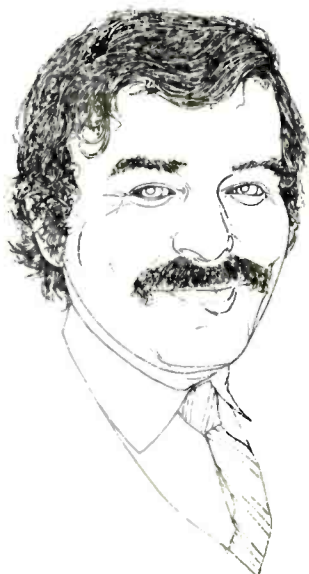

MASH TO THE RESCUE

IF there is any consensus about these things at all, it appears that digital-converter nonlinearity, particularly as it affects the fragile zero crossings of the music waveform, is a trouble area of great consequence. Under weak-signal conditions, distortion can dominate the music.

The cause of the nonlinearities is painfully obvious. Successful pulse-code modulation (PCM) requires quantization steps that are extremely precise. Some of the IC's involved in the quantization process come out well enough for high-quality audio applications, but many are problematically out of tolerance. Worse, a few manufacturers still use converters that are known in advance to be inherently flawed in design.

Because of these PCM frailties, there have been recent signs of a drift away from the PCM concept toward other forms of digital processing. A lot of this innovation is taking place overseas, so details at present are meager and pretty raw, if not downright incomprehensible because of language barriers. I think the new techniques are worth discussing now, however, since I have

heard some of their first implementations in products and have mostly liked what I heard.

At this past summer's Consumer Electronics Show, Sansui brought forth upon this continent a form of 1-bit digital-to-analog (D/A) conversion it calls a Linear Direct Conversion System (LDCS). It does not really seem all that "direct" to me, as it involves a conversion of the pulse-code-modulated signal from a CD into a pulse-width-modulated (PWM) signal and thence into usable analog form. Pulse-width modulation can be looked upon as a sort of transitional state between the digital and analog domains, and a PWM signal can take on some of the distortion and noise characteristics of both domains. But PWM does enjoy immunity to zero-crossing distortion, a waveform distortion that can be produced when a PCM signal makes the transition from positive to negative or negative to positive, and it is not critically dependent on precise values of circuit elements.

This important advantage of LDCS results from the inherent linearity of a 1-bit conversion system even at very low signal levels: The amplitude of the converter's output has only two possible values, corresponding to a binary 1 or 0. Nonetheless, the 65,536 discrete values that can be expressed by the 16-bit "words" of a CD's PCM signal must be represented somehow in the PWM signal.

LDCS achieves this translation through a combination of thirty-two-times oversampling and variable-width PWM pulses. A digital processing circuit translates each 16-bit PCM sample into a much larger number of pulses whose widths and values (0 or 1) depend on the value of that PCM word. (Linearity of the PWM signal is insured by digital synthesis of the pulses in synchronization with an extremely accurate and stable high-frequency quartz oscillator.) Low-pass filtering of this pulse train yields an accurate analog reconstruction of the original music signal.

Sansui's LDCS is built around Matsushita's MASH (Multistage Noise-Shaping) chip set, which incorporates a technique developed by the Nippon Telephone and Tele-

gram Company. Noise shaping—first used by Philips in its early oversampling CD players—enhances the system's performance by minimizing noise and distortion in the audio band.

Most U.S. journalists got their first exposure to LDCS at a Sansui press conference held in New York City prior to CES, and it must be admitted that gasps of pleased astonishment were not conspicuous by their audibility. Of course, there was the usual objectivity-destroying hubbub inevitable at such public affairs, plus a matter of perceived level difference between the LDCS converter and the PCM opposition that was not resolved. Nevertheless, I am persuaded I heard a difference between the two, and loath as I am to resort to subjective jargon, I can only describe it as "graininess." The LDCS's output had less graininess, and perhaps not any of its own making. It should be pointed out, however, that the PCM converter chosen for the comparison was only one example of its breed, and quite possibly not the best.

SANSUI picked its demonstration program material with obvious malice aforethought, and my overall impression was that a quiet male singing voice, miked fairly closely, is particularly revealing of what this technology is supposed to be about. There was no opportunity to make comparisons with the huge body of other sorts of music, however, and that's something you should certainly do if you're inclined to pay your Sansui dealer a visit.

The ability of digital processing to shift noise and distortion from here to there in the frequency or dynamic spectrum, or to convert it into something else entirely, has made evaluating the technology by ear a sometimes baffling business. You always knew where good old analog audio was going to go sour, and you just waited to pounce, whereas digital audio can slip things past you. I suspect the days of "perfect reproduction" and "no audible difference" are behind us, though. Digital audio is perfectible, and it's time to get to serious work on the project. Sansui, at least, seems to be trying. □

Smooth character.

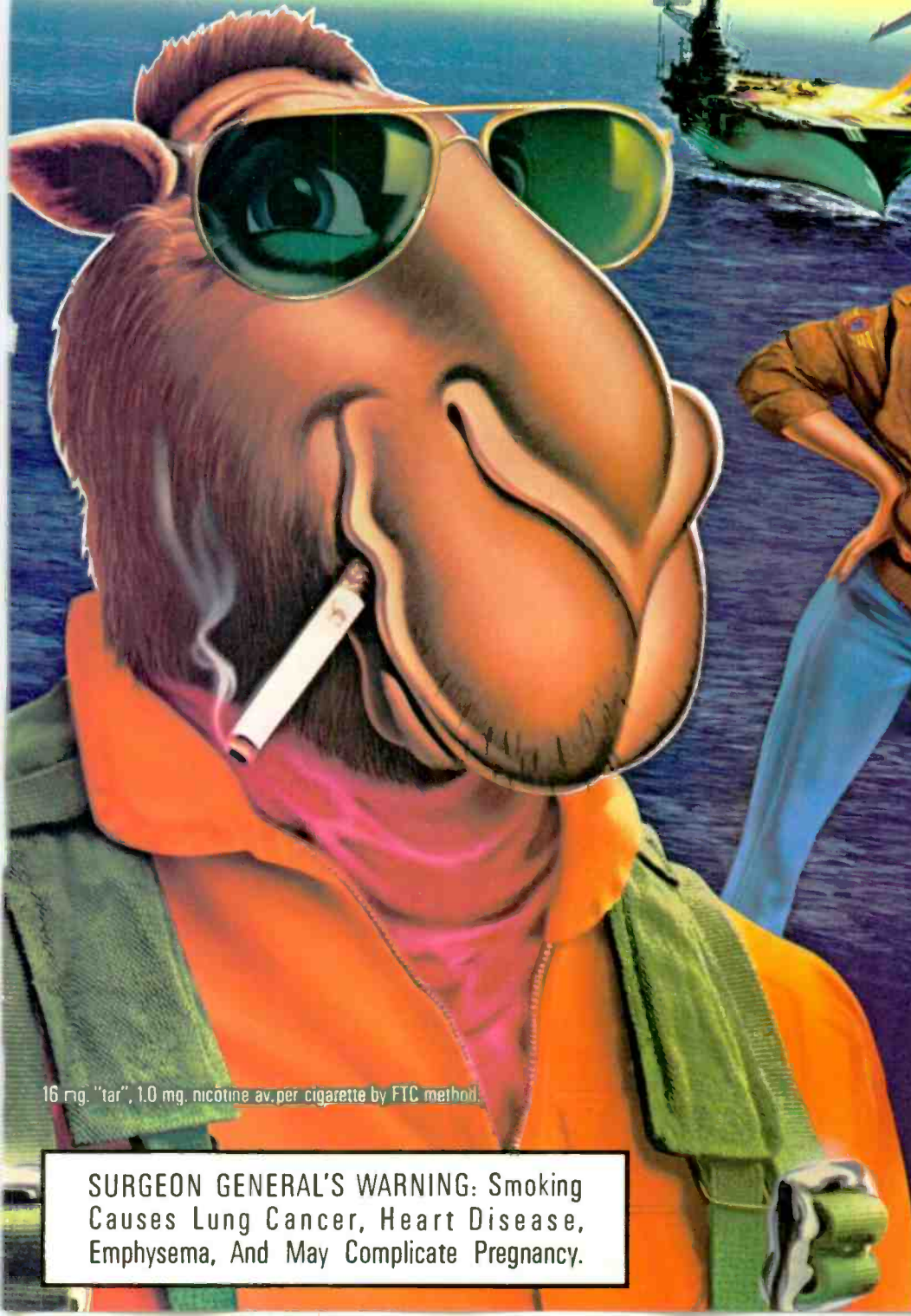

16 mg. "tar", 1.0 mg. nicotine av. per cigarette by FTC method.

SURGEON GENERAL'S WARNING: Smoking Causes Lung Cancer, Heart Disease, Emphysema, And May Complicate Pregnancy.



Invitation to a free concert. You bring the music.

You are cordially invited to attend the next best thing to a live concert by your favorite recording artists: an audition of your favorite recordings on some of the most technologically advanced speakers in the world.

At your Infinity dealer.

Ahead is a listening experience that will take you by surprise. Music you never knew was there before. Subtle inner voices and dynamic impact that lesser speakers simply aren't capable of delivering. And the uncanny sense

of the performers' presence that is Infinity's sonic signature.

So before you buy any loudspeakers, drop by your Infinity dealer with your favorite tape, CD or LP in hand and ask for an ear-opening demonstration of any Infinity speakers.

Then sit back and enjoy the music.



Infinity

We get you back to what it's all about. Music.

