



BRO
THE BUSINESS

Mr Conrad F Schader
4795 Isabella St.
Route 1
Golden Colo

NI154H
Y 3D
JUN 3 1963
NEWSPAPER

NG
RADIO

JUNE 3, 1963

FCC outlaws option time, but deed may come harder than the word 31

The 'no longer needed' plan for drop-ins gets an FCC burial 44

ARB voids Green Bay TV survey when station tries to contact diary keepers 70

Networks face a headache aspirin can't cure: negotiations with nine labor unions 64

COMPLETE INDEX PAGE 7

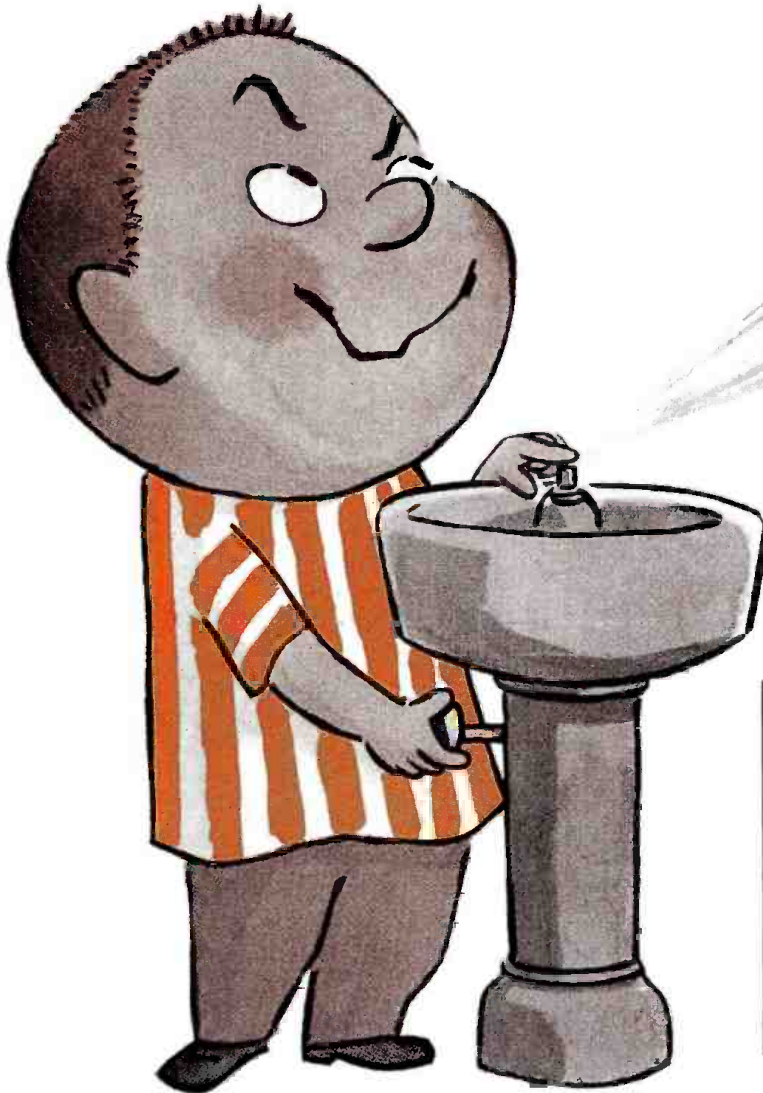

100%
FRESH



**ONE POWERFUL
STATION GIVES
YOU COMPLETE
COVERAGE
IN AMERICA'S
40TH
RADIO MARKET
THAT'S...**



WNAX-570

1963 AREA PULSE*—In each of the 36 half hours reported by Pulse (6 a.m.-midnight) WNAX was number one in Big Aggie Land.

1963 AREA PULSE*—From 6 a.m. to Noon and from Noon to 6 p.m. WNAX's share of audience is almost as large as the next two stations combined. From 6 p.m. to midnight it takes six stations combined to match powerful WNAX.

1963 AREA PULSE*—WNAX has the largest number of adult men, adult women and total listeners in every one of the 18 hours reported by Pulse.

In 5 state Big Aggie Land, there are over 2 million people who annually spend in excess of 3 billion dollars. You can reach and sell this huge portion of mid-America with one radio buy... that's powerful WNAX-570. See your Katz man for coverage in America's 40th radio market.

* WNAX, Yankton, South Dakota, 84 County Area Survey—January, 1963.



THE KATZ AGENCY, INC.
Sales Representatives



WNAX-570 CBS RADIO

PROGRAMMING FOR ADULTS OF ALL AGES

PEOPLES BROADCASTING CORPORATION
Sioux City, Iowa, Sioux Falls and Yankton, South Dakota
Represented by Katz

PEOPLES BROADCASTING CORPORATION

WNAX, Yankton, S. Dak.
KTV, Sioux City, Iowa
WGAR, Cleveland, Ohio
WRFD, Columbus, Ohio
Worthington, Ohio
WMMN, Fairmont, W. Va.



**Hey Pops,
wasn't that you
I heard on the
Big Band
sound of
WAVI, Dayton?**

**You're hip, chick,
but now I'm
blowing my horn about
The Bolling Company's
appointment as
exclusive national
representative
for WAVI.**

**If I wasn't
a mute
I'd tell his fife***

*And the whole world that WAVI is Dayton's most listened to radio station, according to the largest survey ever taken in the market.

New York/Chicago/Atlanta/Boston/Dallas/Denver/Detroit/Kansas City
Los Angeles/Memphis/Minneapolis/Philadelphia/St. Louis/San Francisco

THE bolling co

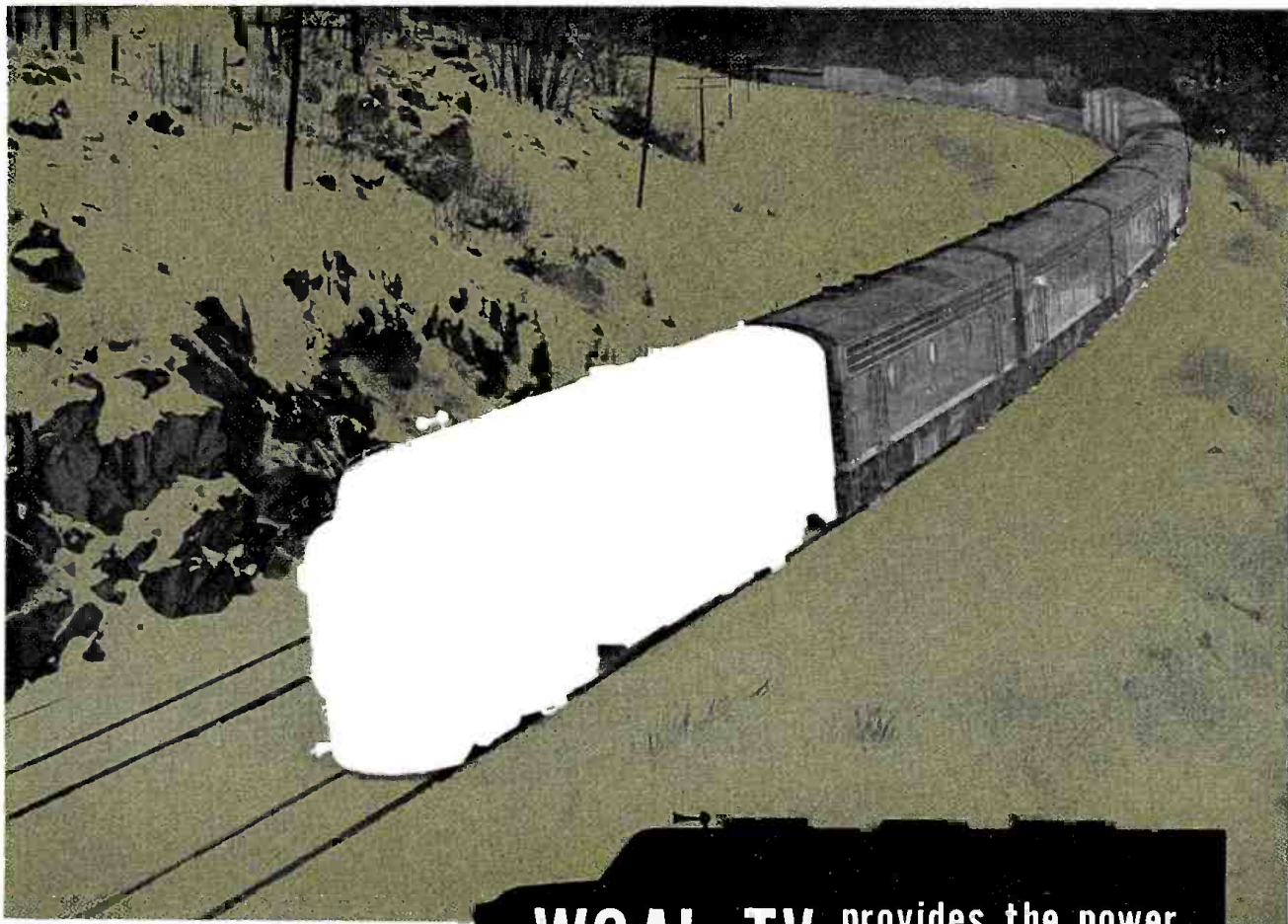

WGAL-TV provides the power that makes the sale

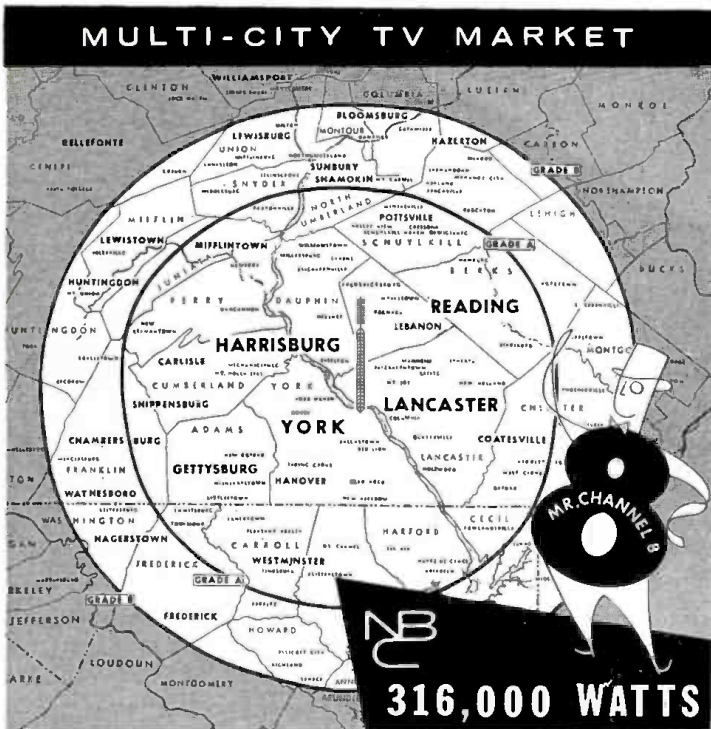

In this multi-city market, an advertising schedule without WGAL-TV is like a **TRAIN WITHOUT AN ENGINE**. Put the full sales power of Channel 8 back of your product. WGAL-TV is the only single medium that reaches the entire market and delivers viewers in far greater numbers than all other stations combined.

WGAL-TV
Channel 8
Lancaster, Pa.
 STEINMAN STATION • Clair McCollough, Pres.

Representative: The MEEKER Company, Inc. • New York • Chicago • Los Angeles • San Francisco

KTVU to Cox

Negotiations looking toward sale of ch. 2 KTVU(TV) Oakland-San Francisco independent to Miami Valley Broadcasting Corp. (Cox stations) for in neighborhood of \$10 million are underway. Transaction contemplates retention of present management and staff under new ownership. Station, on air since 1958, is owned by Ward D. Ingram, president and general sales manager (25.005%); William D. Pabst, executive vice president and general manager (25.005%); Edwin W. Pauley, (25.005%); Willet H. Brown (19.79%); Stoddard P. Johnston (4.94%) and Harry R. Lubcke (.25%).

Negotiations are being conducted principally by Messrs. Pabst and Ingram with J. Leonard Reinsch, executive director of Cox broadcast properties. Miami Valley stations are WHIO-AM-FM-TV Dayton, WSOC-AM-FM-TV Charlotte and WIOD-AM-FM-TV Miami. WSB-AM-FM-TV Atlanta is affiliated in ownership.

Preparation H appeal

Whitehall's Preparation H, hemorrhoid treatment that got extra dose of publicity several years ago by having its advertising banned by television code authorities, is due back in headlines soon. Ted Bates & Co., its agency, has been allotted time to make presentation for removal of ban at TV code board's meeting in New York next Monday and Tuesday. Bates and Whitehall are also involved in another protest that conceivably may reach code board level: efforts by Anacin, another Whitehall product handled by Bates, to upset interpretation that would ban Anacin's well-known descriptive line, "like a doctor's prescription," when code's so-called "men in white" prohibition goes into effect July 1. Most advertisers are said to be conforming their commercials to new rules, but Anacin reportedly is resisting prescription prescription.

Limelight for code meeting is on code's commercial time restrictions (which FCC has proposed to adopt in own rules), and there'll be no shortage of proposals. In addition to some already disclosed, one would keep present TV limits but allow prime-time commercials to be redistributed within that period so long as given "average" is observed. Another, considered by some to be most far-reaching of all, would retain present standards but authorize code director to make "exceptions" for stations individually on showing that they can't

CLOSED CIRCUIT®

afford to adhere strictly. If expert advertiser advice is needed, that, too, will be nearby: Association of National Advertisers' broadcast committee also meets next Monday and will lunch with code group, though its concern is expected to relate mainly to so-called "clutter," with which it has been preoccupied for past 18 months.

'Local live' now SOP

Stand by for biggest bombshell yet in FCC's drive to force local live programming in prime time. Three of New York City's six commercial TV outlets (WABC-TV, WCBS-TV and WPIX-TV) won't receive regular license renewals as of June 1 but will get letters asking them to explain what they have done in way of local live programming for viewers in New Jersey which constitutes part of their service area. In addition, WCBS-TV, WAST-TV and WTEN-TV Albany, and WKBW-TV Buffalo, last two owned by Capital Cities, will get letters asking them to explain paucity of local live programming. Letters will be similar to those sent five New England stations (BROADCASTING, May 27).

New York actions indicate FCC will make local live-prime time letter-writing standard operating procedure. Vote at last Wednesday's meeting was 5-1 (Minow absent; Hyde dissenting). Staff was instructed to process other applications among June renewals with similar letters where staff raised questions about local live programming. Although letters are aimed at prime time (6-11 p.m.) they do not confine responses to that period but seek descriptions of programming for each segment of broadcast day, thereby trying to dodge charge of attempting to influence programming.

Question of credits

Threat of injunction that could stop show faces June 9 broadcast of du Pont's *Show of the Week* on NBC-TV—all because of technicality in Writers Guild rule on air credits. James Ambandos, associate producer of June 9 play "The Triumph of Gerold Q. Wert" (starring Art Carney), rewrote original script submitted by Ernestine Barton, and wants to share credit with Miss Barton. But Writers Guild requires that at least 75% of script must have been written by producer if he is to get credit. Question: how to make so precise a measurement of Ambandos-Barton contributions. Guild officials will try

to solve it at meeting in New York today (June 3). If they rule against him, Mr. Ambandos threatens suit for injunction.

Is double billing fraud?

Remember double billing? It may be back in news soon in way that wouldn't help radio's image. U. S. Post Office Department has been investigating subject for over year and may soon file criminal court action charging fraud by mail. Post Office is known to be about ready to move against practice of submitting two bills, one for local client and larger one to be sent to national co-op advertiser. FCC warned stations against "reprehensible practice" over year ago and threatened "appropriate proceedings" against any guilty licensee (BROADCASTING, March 12, 1962). Several stations have admitted to FCC that they engaged in practice in past.

Bargain minutes

Heat's on network sales staffs to get rid of still-unsold portions of 1963-64 schedule. Reportedly NBC-TV now is offering commercial minute in *Espionage* (hour show that is slated for Wednesday, 8:30-9:30 p.m.) for about \$21,000 for time and talent. Selling rates for commercial minute (time and talent) in prime time on TV networks are usually in \$35,000 to \$38,000 range. This is nothing new in network selling. Similar patterns have developed before as networks moved into hot-weather season with time still unclaimed. In such cases, if show clicks, it's traditional for prices to advance.

Code pressures on buyers

Agencies and advertisers are getting the word that they, perhaps more than anybody else, hold firm answer to question of "overcommercialization" in radio-TV. Perhaps nobody's gone so far as to ask them not to buy time on stations that exceed National Association of Broadcasters' code limits, but they're free to reach that conclusion not only from NAB President LeRoy Collins's recent request for "cooperation" but also from position some station reps are taking. CBS Radio Spot Sales's Maurie Webster, for one, has just returned from meetings with agency and advertiser people in San Francisco, Los Angeles, Denver and St. Louis where, as in New York, his presentation urged that buyers, too, give thought to "the problems of overcommercialization."



Acquisitives*...buy more food in Cleveland

7th TV market...2nd in food purchases (per household).

WJW-TV's programming is for acquisitives—people with food money to spend.

*Ac-quis'-i-tive—given to desire, to buy and own.

LOS ANGELES KGBS	PHILADELPHIA WIGB	CLEVELAND WJW	MIAMI WGBS	TOLEDO WSPD	DETROIT WJBK	STORER BROADCASTING COMPANY
NEW YORK WHN	MILWAUKEE WITI-TV	CLEVELAND WJW-TV	ATLANTA WAGA-TV	TOLEDO WSPD-TV	DETROIT WJBK-TV	

ACQUISITIVES WATCH

WJW-TV

WEEK IN BRIEF

Option time is banned by the FCC; it's an "artificial restraint" and an "abdication of licensee responsibility," says commission in 6-1 vote. News received calmly by networks, agencies and producers. See . . .

GOODBYE OPTION TIME . . . 31

Agencies upset by disc-to-cartridge tape practices of radio stations. Fear quality of commercials may suffer in transference. Move is underway to impress stations with need for quality control. See . . .

HOW TO KEEP QUALITY . . . 34

Fraudulent promotion contests lose KWK its license. FCC says it may have been the fault of the manager, but owners must bear responsibility. Revocation is by 3-2 vote, reversing examiner. See . . .

KWK LOSES LICENSE . . . 46

Green Bay TV ratings survey called off by ARB when station broadcasts call to diary keepers to contact station. WLUK-TV claims move was effort to ensure accuracy of records. New survey possible. See . . .

RATINGS MONKEY BUSINESS . . . 70

Radio code board holds line on commercial time limits at this time, but names committee to look into question of quality. Board decries FCC proposal to use code standards as basis for regulation. See . . .

RADIO CODE BOARD MEETS . . . 72

Union negotiations loom for networks, with six crucial contracts on the line this year and three others, due in 1964, sure to be influenced by arrangements. Summer-fall will be the bad period. See . . .

HEADACHE PERIOD AHEAD . . . 64

British TV programers up in arms at proposed profit tax. Associated TeleVision says it is ready to bow out of field if levy is imposed. Government warned of big production cuts, unemployment. See . . .

TAX MAY BE TOO MUCH . . . 85

Commission makes final judgment on VHF drop-ins: t'aint necessary anymore. By one vote margin, FCC denies requests to move VHF channels into seven major markets because they might inhibit growth of UHF. See . . .

DROP-INS END UP IN GRAVE . . . 44

CBS-TV and NBC-TV split 12 Emmy awards, with ABC-TV garnering three. "The Tunnel" (NBC) and "Dick Van Dyke Show" (CBS) are top winners, with WCBS-TV and Granada TV receiving special citations. See . . .

CBS, NBC IN DEAD HEAT . . . 68

Direct television to brain, bypassing visual senses, seen as possibility by Allen DuMont. Electronics expert foresees three-dimensional color, receivers with own tape recorders, one pound cameras. See . . .

TELEVISION SYSTEM FOR BLIND . . . 78

DEPARTMENTS

AT DEADLINE	9	GOVERNMENT	44
BROADCAST ADVERTISING	31	INTERNATIONAL	85
BUSINESS BRIEFLY	36	LEAD STORY	31
CHANGING HANDS	74	THE MEDIA	70
CLOSED CIRCUIT	5	MONDAY MEMO	24
COMMERCIALS IN PRODUCTION	38	OPEN MIKE	26
DATEBOOK	15	OUR RESPECTS	99
EDITORIAL PAGE	100	PROGRAMING	64
EQUIPMENT & ENGINEERING	78	WEEK'S HEADLINERS	10
FANFARE	80		
FATES & FORTUNES	82		
FILM SALES	69		
FINANCIAL REPORTS	77		
FOR THE RECORD	88		



BROADCASTING
THE BUSINESSWEEKLY OF TELEVISION AND RADIO

Published every Monday. 53rd issue (Yearbook Number) published in November by BROADCASTING PUBLICATIONS, Inc. Second-class postage paid at Washington, D. C., and additional offices.

Subscription prices: Annual subscription for 52 weekly issues \$7.00. Annual subscription including Yearbook Number \$12.00. Add \$2.00 per year for Canada and \$4.00 for all other countries. Subscriber's occupation required. Regular issues 35 cents per copy. Yearbook Number \$5.00 per copy.

Subscription orders and address changes: Send to BROADCASTING Circulation Dept., 1735 DeSales St., N.W., Washington 6, D. C. On changes, please include both old and new addresses plus address label from front cover of magazine.



They laughed when I told them about our rating system

by Len Hensel of WSM

"I know my station had at least 3,246 listeners last month," I said.

"Do you use the diary or the recall method... and how big was your sample?" they said.

"We use the order system," I said. "And it wasn't a sample. It was our OPRY HISTORY BOOK, which goes at \$1 per. We've sold over 185,000 copies, offering it only on our station. Last month, 3,246

people ordered it (114 from Texas, 133 from Michigan, 230 from Illinois, 247 from Ohio . . . 43 states all told, plus D.C. and Canada). Isn't this some kind of a rating . . . like, maybe, AAA-1?"

And they laughed.

But then, so do our advertisers . . . year after year, sale after sale. The difference is, they laugh with us!

HENRY I. CHRISTAL, National Representative

the WSMpire



WSM CLEAR
CHANNEL 650
NASHVILLE, TENNESSEE

OWNED AND OPERATED BY THE NATIONAL LIFE & ACCIDENT INSURANCE COMPANY

Could UHF air shows affiliates reject?

FCC WANTS MEETING WITH NETWORKS TO FIND ANSWER

FCC has asked for meeting with representatives of three TV networks to determine feasibility of making network programming available to UHF stations in intermixed markets. Programming involved would be that rejected by affiliates.

Commission Friday disclosed it has written ABC, CBS and NBC, asking them to send representatives to meeting at commission offices "in near future." Action is part of FCC campaign to foster development of UHF.

Commission said it's concerned with availability of network programming for UHF stations which may come into existence in intermixed markets as result of all-channel-receiver legislation.

Public interest issue is involved, FCC said, when network affiliates refuse programs that might, therefore, be fed to

competing UHF stations.

Not only would this make more network programming available to public, FCC said, but it would "obviously promote development of UHF stations in the intermixed markets such as those involved" in drop-in case (see story page 44).

Commission said issue involved "is somewhat analogous" to that concerning availability of network programming to small-market stations. Agency noted some network programs have been provided such stations "under various special arrangements."

Question of how network programming can be made available to UHF stations is already under study by committee of FCC-sponsored Committee for the Full Development of All Channel Broadcasting.

for eight years to inform FCC that effective control of station had been transferred to licensee's nephew, and is to be held responsible for administration during that period.

ABC to go to court in FCC VHF denial

Unhappy ABC said Friday it will ask FCC to reconsider its May 29 decision denying short-spaced VHF drop-ins in seven cities (see page 44).

FCC's decision, ABC said, will affect 5 million people who will "continue to be denied at least three different entertainment, news and public affairs services. . . ."

Network took courage from concurring statement by outgoing FCC Chairman Newton N. Minow who says commission's decision shouldn't end effort to equalize competitive opportunities of three networks.

In concurring statement issued Friday, Mr. Minow said decision to vote with majority was most difficult he faced in his 27-month term.

Effects of all-channel receiver legislation, which is intended to stimulate UHF growth, won't be felt for several years, he said. During that time ABC's competitive disadvantage will persist, he added.

FCC finds 'no strings' on NBC gift to WNDR

FCC last Friday said it found no conditions attached by NBC to \$100,000 grant to WNDR(TV) New York, educational station on channel 13. Commission also reiterated its belief in independent programming decisions by licensee in closing WNDR investigation.

Commission began its investigation of donation last month after story appeared in *New York Times* dealing with correspondence between Robert Sarnoff, NBC board chairman, and Dr.

GAB adds Oren Harris for editorial conference

Labeling broadcast editorials "a matter of national importance," House Commerce Committee Chairman Oren Harris (D-Ark.) Friday accepted invitation to participate in first National Broadcast Editorial Conference July 25-27 in Athens, Ga.

Conference, sponsored by Georgia Association of Broadcasters, received added interest with disclosure two weeks ago that Communications Subcommittee of House Commerce would hold July hearings on editorializing (BROADCASTING, May 27). Representative Walter Rogers (D-Tex.), chairman of subcommittee, also was invited to participate and indicated Friday that

he may attend.

Representative Harris will speak July 26 at conference on University of Georgia campus and also is expected to participate in panel discussion. Others on program include FCC Commissioner Kenneth A. Cox, ABC commentator Howard K. Smith, Washington attorney W. Theodore Pierson and Mary Ann Cusack, special assistant to president of National Association of Broadcasters. Dick Mendenhall, editorial director of WSB-AM-TV Atlanta, is conference chairman.

Bureau says Pape guilty for WALA-AM-TV actions

FCC's Broadcast Bureau last Friday told commission that licensee must be held responsible for actions of station's manager, and opposed request by WALA-AM-TV Mobile, Ala., that revocation proceeding against it be dismissed. Bureau also said Mobile station failed to supply commission with adequate information concerning station's own investigation of its staff's actions.

WALA-AM-TV allegedly demanded "large sums of money" to refrain from editorial attacks on engineering firm and candidate for sheriff. Station has requested charges be dropped because violations were committed by licensee's nephew and general manager Wadsworth B. Pape (AT DEADLINE, May 20). William O. Pape is sole owner of station.

Bureau said that Mr. Pape neglected

Xerox hot for TV

Xerox Corp., Rochester, N. Y., which began using television for first time only two years ago, is fast becoming one of medium's heavy users. Firm, which invested about \$300,000 in *CBS Reports* (CBS-TV) in 1961-62 season, and about \$800,000 in *Chet Huntley Reporting* (NBC-TV) in 1962-63, is expected to place business worth nearly \$4 million in TV in 1964. Agency is Papert, Koenig, Lois Inc., New York.

Sneaky Moppets

Recent study in Helsinki, Finland, has proven truth of old adage that forbidden fruit is most desirable.

All Finnish TV shows banned to children, report released last week indicates, have been seen by half of 4,903 youngsters, aged 9-11, covered by survey. Every child had seen at least one of the proscribed programs.

WEEK'S HEADLINERS



Lee B. Bartell

Lee B. Bartell, executive VP and treasurer of Macfadden - Bartell Corp., Milwaukee, elected president, succeeding Gerald A. Bartell, his brother, who continues as chairman and chief executive officer. Lee Bartell continues as corporate treasurer. Frederick A. Klein, formerly executive VP-publishing, named corporate executive VP, and Jack Podell was elected VP-editorial. Macfadden-Bartell publishes magazines and owns and operates WADO New York; WOXY Milwaukee; KCBQ San Diego, Calif.; Macfadden Teleglobe pay television system in Denver, Colo., and Telecuracao, Netherlands, Antilles.



Mr. Bryant

Donald L. Bryant, former president and director of Q-Tips Inc., division of Chesebrough - Pond's Inc., Long Island City, N. Y., joins Miles Products division of Miles Laboratories, Elkhart, Ind., as executive VP. Walter B. Roberts Jr., account manager at J. Walter Thompson, New York, joins Miles as product manager of One-a-Day (brand) vitamins and with supervisory responsibility for Chocks. Mr. Bryant had been associated with Q-Tips since 1959. Earlier, he was with Warner-Lambert's Hudnut division in various posts including VP-advertising director, and later executive VP of division. Mr.

Roberts joined JWT's research department in 1952 and later was assigned to media and new business departments before becoming an account manager.

Robert Taylor, veteran motion picture actor and star of former network series, *Robert Taylor's Detectives*, elected VP of Four Star Television, North Hollywood, Calif. Mr. Taylor became fifth largest stockholder in firm earlier this year (BROADCASTING, Feb. 4) through exchange of interest in his series for Four Star stock.



Mr. Tooke



Mr. Israel

Rolland V. Tooke and Larry H. Israel appointed to new posts of executive VP's for staff-group operations and station operations, respectively, at Group W, Westinghouse Broadcasting Co., New York. Mr. Tooke was formerly executive VP of WBC, and Mr. Israel, president of TVAR, organization's wholly owned national sales representative. New assignments become effective July 1. Mr. Tooke joined WBC in 1941. He was elected executive VP in 1959. Mr. Israel previously served as general manager of WJZ-TV Baltimore. Westinghouse Stations are WINS New York; WBZ-AM-FM-TV Boston; KYW-AM-FM-TV Cleveland; KPIX(TV) San Francisco; KDKA-AM-FM-TV Pittsburgh; wowo Fort Wayne, Ind.; WIND Chicago; and WJZ-TV Baltimore.

Beech-Nut's \$8 million goes to Benton & Bowles

Estimated \$8 million Beech-Nut account, formerly held by Young & Rubicam, has been assigned to Benton and Bowles. Appointment of B&B comes five weeks after announcement of dismissal of Y&R.

Account covers Beech-Nut chewing gum, cough drops, baby foods, Life Savers and Pine Brothers cough drops. TV billing on account has been approximately \$7 million, mainly in network, but future allocation is unknown.

Beech-Nut-Y&R split was reportedly over disagreement on marketing policies. Other Beech-Nut agencies are Ogilvy, Benson & Mather (Tetley tea), Grey Advertising (Martinson's coffee), Charles W. Hoyt Co. (Beech-Nut coffee) and Furman-Roth & Co. (Bustelo coffee).

'Life Line' snarled in \$64,500 legal suit

J. Wayne Poucher, voice of ultra-conservative *Life Line* radio-TV program for past 4½ years, filed suit Friday (May 31) in U. S. District Court in Washington for more than \$64,500 in back salary, severance pay and other compensation.

Mr. Poucher alleges he was summarily discharged April 6 after dispute with H. L. Hunt, Texas oil millionaire and major contributor to Life Line Foundation Inc., over compensation terms for TV appearances. Mr. Poucher says that up to April 6 he was receiving \$1,600 month and had been promised \$100 for each TV appearance.

He also charged that *Life Line*, without payment to him, made use of his commentaries and inspirational talks and that H. L. Hunt Food Products used his radio and TV broadcasts to advertise its products.

In release issued same time as suit was filed, Mr. Poucher said *Life Line* received net income of \$446,784 in 1962 fiscal year, of which more than \$250,000 came from radio and TV programs plus additional \$150,000 from sale of his radio and TV scripts and other materials.

Dan Patterson, director of Life Line Foundation, said Friday he would have no comment until he has time to study complaint.

Fisher Body buys Thomas

Fisher Body division of General Motors Corp., tomorrow (June 4) begins alternate sponsorship of CBS Radio's *Lowell Thomas and the News*. Continuing as other sponsor is Oldsmobile division of GM. Agency for Fisher Body: Kudner Inc., New York.

For other personnel changes of the week see FATES & FORTUNES

Samuel Gould, president of WNDT, concerning grant from network (BROADCASTING, May 6).

Commission, in letter to WNDT, said it is "satisfied that no grant of funds . . . was conditioned on any understanding or commitment by you with regard to WNDT's programming."

FCC still divided on TV program forms

FCC was unable to reach agreement on revision of TV program reporting form despite all-day meeting on subject Friday. Commission had hoped to resolve issue—which it has been considering since 1960—in advance of out-

going Chairman Newton N. Minow's June 1 departure from agency.

One official said "some progress" was made in effort to reach consensus on how form should be modified to implement commission's 1960 program policy statement. But another source said seven commissioners "seemed to be pulling in seven different directions."

Commission had under consideration three proposed versions submitted by Commissioners Frederick W. Ford, Robert T. Bartley and Kenneth A. Cox, members of special program-form committee (BROADCASTING, May 27).

Committee will go back to work in effort to resolve conflicts in light of commission's discussion Friday.

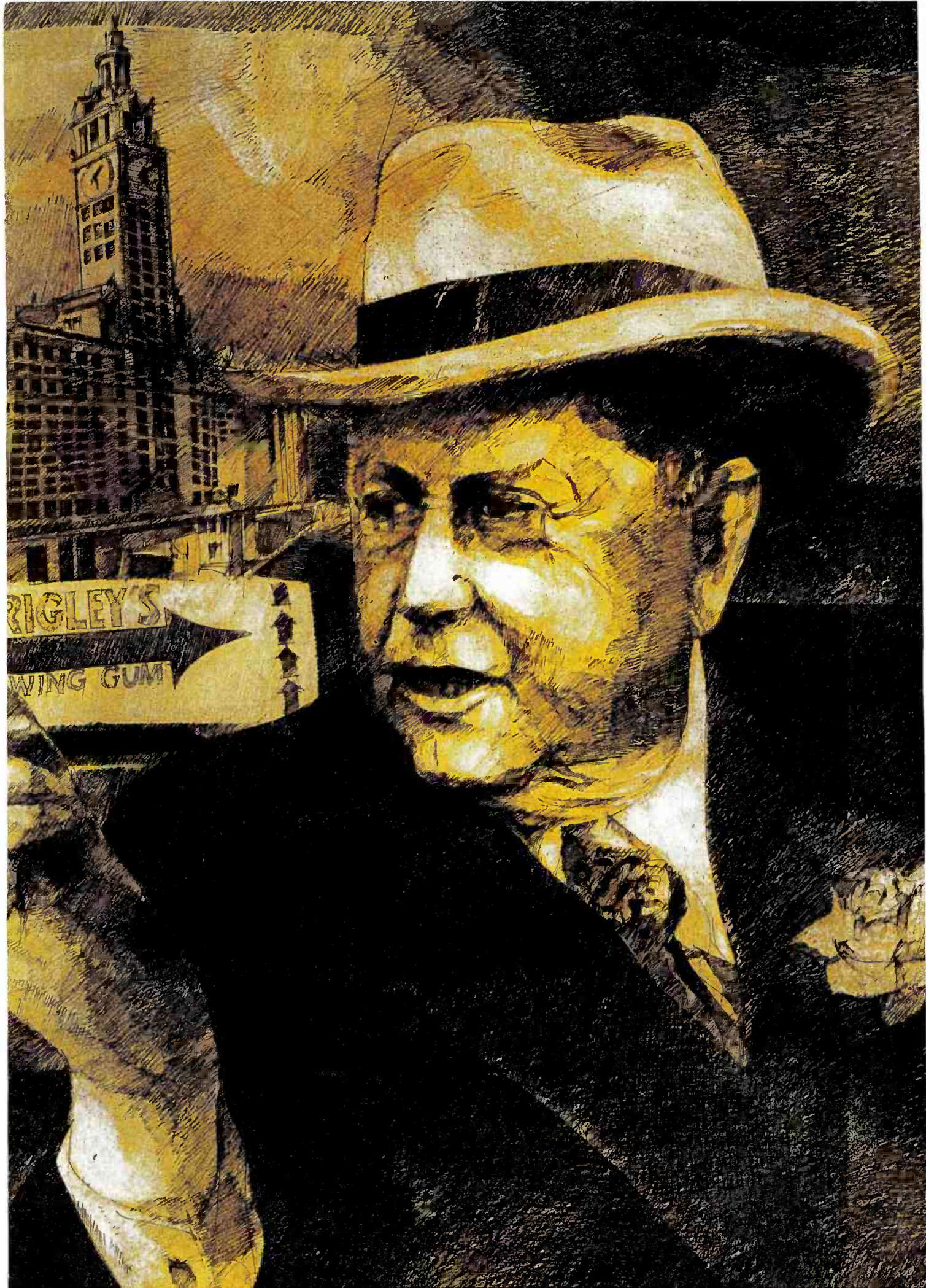

FAIR SHAKE...

we quote ratings... but
we sell everything else —
coverage, rates, personalities,
merchandising... and most
important... the integrity of the
station management.

Our salesmen visit our stations.

Station Reps

BOB DORE

ASSOCIATES

11 WEST 42nd STREET, NEW YORK 36, N. Y.
CHICAGO LOS ANGELES SAN FRANCISCO

Luxury Living! Sensible Location!

Specify The New Weston, in the heart of the advertising and broadcasting belt, as your in-town address. Our splendid rooms and suites make an ideal environment for living or entertaining. Theatres, clubs, shops are advantageously close. NOW COMPLETELY AIR CONDITIONED.

In the distinguished world of the

HOTEL New Weston
Madison Ave. at 50th St.
New York • Plaza 3-4800

World-Famous

**NEW WESTON BAR &
ENGLISH DINING ROOM**

Here you rub shoulders with the smartest people any time of day. Come in for cocktails and hot canapes. The cuisine is skillfully prepared to Continental tastes. Try it some day soon... at lunch or dinner.

Translator Association, Rainbow hotel, Great Falls, Mont.

June 8-11—Georgia Association of Broadcasters' convention, Holiday Inn motel, Callaway Gardens, Pine Mountain, Ga. Speakers will include FCC Commissioner Rosel H. Hyde; Representative William E. Miller (R-N.Y.), chairman of the Republican National Committee; Wrede Petersmeyer of Corinthian Broadcasting Co.; Miles David, administrative vice president of Radio Advertising Bureau; Lionel Baxter, Storer Broadcasting Co.; Bruce Merrill, Ameco Inc. (CATV); Robert Mason, All-Industry Music Licensing Committee; Larry Cervone, Gates Radio Co.; and Lee Mehlig, Broadcast Clearing House.

June 10—Reply comments due on FCC proposal to bar applications under multiple ownership rules unless applicant first disposes of one interest.

June 10-11—Representatives of the legal profession, the social sciences, and the mass media will discuss "The Right of Privacy and the Mass Media" at Pennsylvania State University. Conference is co-sponsored by Pennsylvania Bar Association and Pennsylvania State University's School of Journalism and Center for Continuing Liberal Education. Speakers and participants include Alan U. Schwartz, member of New York law firm of Greenbaum, Wolf and Ernest; Creed C. Black, vice president and executive editor of *Wilmington News and Evening Journal*; Morton J. Simon, Philadelphia communications attorney; and Robert V. Cahill, legal counsel for National Association of Broadcasters.

June 10—Sixty-sixth annual convention of American Federation of Musicians, Fontainebleau, Miami Beach, Fla.

June 10-11—NAB TV Code Review Board meeting, University Club, New York.

June 10-21—Radio Workshop, co-sponsored by Abilene Christian College and Texas Association of Broadcasters, Abilene Christian campus. Additional information about the workshop is available from Dr. Lowell G. Perry, Radio Workshop, Abilene Christian College, Abilene, Tex.

June 11—Debate between W. Theodore Pierson and Harry M. Plotkin on "The Need for Modification of Section 326." (censorship) luncheon meeting, Federal Communication Bar Association, Willard Hotel, Washington.

June 11—Annual stockholders meeting, United Artists Corp., Astor Theatre, New York City.

June 12-14—Thirty-third Institute for Education by Radio-Television, sponsored by Ohio State University Telecommunications Center, Nationwide Inn, Columbus. Theme is "The Program: The Heart of Broadcasting." The American Council for Better Broadcasts meets June 12 in conjunction with the institute. Keynote speaker will be Dr. Edward W. Rosenheim Jr., professor of English at University of Chicago.

June 12-14—Annual meeting of the Electronic Industries Association of Canada, Chantecler hotel, Ste. Adele-en-haut, Que.

June 13-14—Television Affiliates Corp. programming conference, Sheraton, Chicago. Speakers include Sylvester L. (Pat) Weaver Jr., board chairman of McCann-Erickson, and Jules Power, executive producer of ABC-TV's *Discovery* series.

June 13-15—Mutual Advertising Agency Network meeting, Palmer House, Chicago.

June 14—Wyoming AP Broadcasters Association meeting, Torrington.

*June 14-15—Annual meeting of the Wyoming Association of Broadcasters, Torrington.

June 15-19—Annual convention of Advertising Federation of America, Atlanta Biltmore hotel, Atlanta, Ga. Speakers include: Emerson Foote, McCann-Erickson, New York; Ralph McGill, *Atlanta Constitution*; Arthur E. Tatham, Tatham-Laird, Chicago; Dr. Lyndon Brown, Dancer-Fitzgerald-Sample, New York; Edward R. Morrow, director of U. S. Information Agency;

Fletcher Knebel, Washington correspondent for Cowles Publications; Sir Douglas Fairbanks Jr., former motion picture star and currently director of Scripto Inc.; and Paul Austin, president of The Coca-Cola Co.

June 16-18—Annual spring meeting of the North Carolina Association of Broadcasters, Holiday Inn, Durham.

June 15-Aug. 6—Summer workshop in closed circuit television teaching by the Department of Radio & Television, Indiana University, Bloomington. James D. Perry, instructor in radio-TV and supervisor of the I.U. closed circuit teaching program, will be director of the workshop.

June 17—Effective date for new FCC rule allowing automatic logging and requiring daily, five-times-a-week inspection of transmitting facilities of AM-FM stations.

June 17—Hollywood Ad Club luncheon at the Hollywood Roosevelt. AAW day, ushering in the convention of the Advertising Association of the West, to be held June 22-27 with Hollywood as host club.

June 17-19—Forty-sixth national conference of American Marketing Association, Statler hotel, Washington, D. C. Conference theme is "Innovation: Key to Marketing Progress." "Innovations In the Measurement of the Advertising Media Audience: A Roundtable Discussion" at 9:15 a.m., June 17. Speakers include Roger N. Humphries, Procter & Gamble Co.; Donald Graham McGlathery, A. C. Nielsen Co.; Paul H. Chook, Alfred Politz Research Inc.; and William M. Weilbacher, C. J. LaRoche & Co. "Innovations In Measuring Advertising Effectiveness" at 9:15 a.m., June 18. Speakers include Robert J. Fisher, Ford Motor Co.; Seymour Banks, Leo Burnett Co.; Stuart Henderson Britt, Northwestern University; Russell H. Colley, management consultant; and Leroy E. Purvis, Gallup & Robinson Inc.

June 18-20—Annual convention of Electronic Industries Association, Pick-Congress hotel, Chicago.

June 19-21—Annual meeting of Virginia Association of Broadcasters, Williamsburg Inn, Williamsburg, Va. Miles David, vice president of Radio Advertising Bureau, will head a team that will provide successful and interesting ideas for local selling, programming and sales-audience promotion. Speakers include FCC Commissioner Frederick W. Ford.

June 20-22—Florida Association of Broadcasters convention, Robert Meyer hotel, Jacksonville, Fla. Speakers will include LeRoy Collins, president of National Association of Broadcasters; Florida Governor Farris Bryant; Jack Thayer, vice president-general manager of WHK-AM-FM Cleveland; Harold Krelstein, Plough Broadcasting Inc.; Edmund Bunker, president of Radio Advertising Bureau; Robert J. Rawson, chief of FCC's Transfer and Renewals Division; Bill Ray, chief of FCC's Complaint and Compliance Division; Robert Heald, Spearman and Robertson; and Tom Wall, Dow, Lohnes and Albertson.

June 21—Colorado AP Broadcasters Association meeting, Durango, Colo.

June 21-22—Colorado Broadcasters Association convention, Strater hotel, Durango. Speakers will include Donald McGannon, president of the Westinghouse Broadcasting Co., and FCC General Counsel Max Paglin. Don Dailey and Tom Bostic, presidents of the Missouri and Washington State broadcasters associations, respectively, will also address the CBA meeting.

June 21-Aug. 17—Twenty-First Stanford Radio-Television Film Institute, sponsored jointly by Department of Communication of Stanford University and San Francisco stations: KPIX (TV), Westinghouse Broadcasting Co.; KQED (TV), Bay Area Educational Television Association; and KNBR-AM-FM, NBC. Courses meet alternately on the campus of Stanford University and in the San Francisco studios of the cooperating stations.

June 22-27—Advertising Association of the

HANDY DO-IT-YOURSELF RATING KIT

Complete on this page. Takes only 3 minutes to assemble, using this most important of all information. Simply fill in high score as you read:

1. What do the local businessmen think of the advertising effectiveness of the Des Moines TV Stations?

ANSWER: Nearly 80% of all local TV advertising is placed on KRNT-TV.

2. What station do local civic, cultural and religious groups count on for the most eager cooperation and support?

ANSWER: All know that KRNT-TV spends the most hours meeting with committees, helping write their copy and counseling them. Over 5,000 community service announcements, almost 500 program hours, last year.

3. What TV station do most people depend on for their news?

ANSWER: People look to KRNT-TV most for News. They know our nine, full-time, fully professional newsmen will get it first . . . and get it right. Our viewers have "rated" our 10 PM News by making it one of the most watched newscasts in a multiple-station market in the country.

4. Is the same true of Sports?

ANSWER: The daily sportscasts people watch most are on KRNT-TV. Our two top sportscasters beat the competition by a country mile. The three football coaches of the largest universities in Iowa are seen exclusively on Channel 8 in the Des Moines market.

5. What personalities do viewers know and trust the most?

ANSWER: KRNT-TV Personalities are "Old Friends" to everybody in Central Iowa. Folks know them as highly trained, highly accepted, adult personalities. People are reminded of them and get to know them even better because of frequent exposure on KRNT RADIO and live appearances out in our area. It's an important plus in their merchandising and sales effectiveness.

6. What station is the most promotion-minded?

ANSWER: KRNT-TV. We constantly publicize our activities, our people, our aims and aspirations. In this area we make no little plans and we carry through what we start. People hereabouts know everything about all we do.

VALIDATION TEST

This six-part questionnaire can be verified anytime, anywhere in Central Iowa. No rating period required . . . it's a 12-month continuous survey. To check the results above, simply send for a free page of the Des Moines telephone directory, take any number or numbers at random, and call yourself.

KRNT-TV

Des Moines Television

An Operation of

Cowles Magazines and Broadcasting, Inc.

REPRESENTED BY THE KATZ AGENCY, INC.

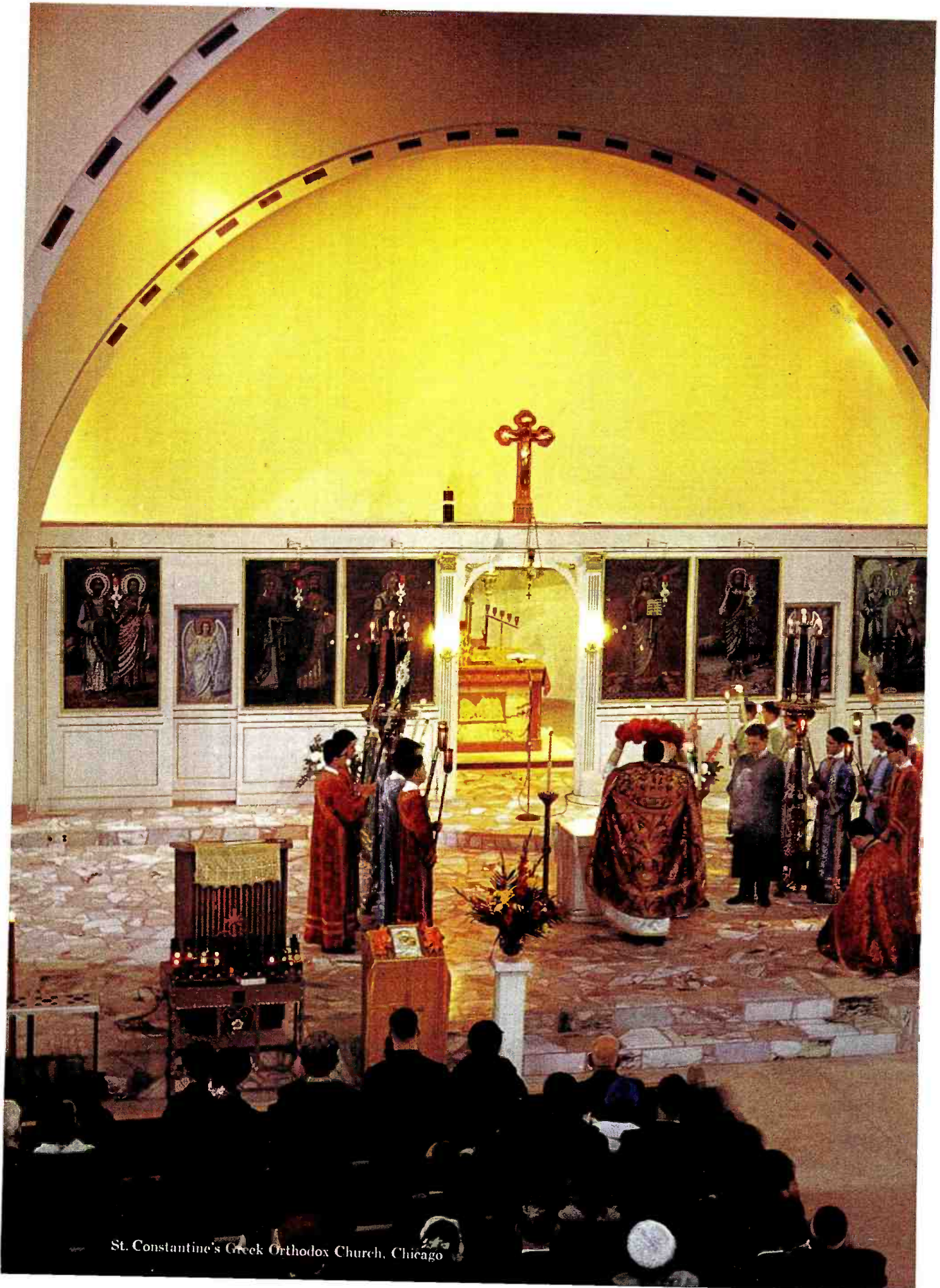

St. Constantine's Greek Orthodox Church, Chicago



REVERENTLY...COLORFULLY

It happens on Sunday in Chicago—WGN-Television takes one of the country's few mobile color units to church.

Thus the beauty of worship in Chicago's churches is faithfully mirrored in thousands of homes.

Over the last four years, Sunday church has become an honored television tradition. Yet, it is just one evidence of the depth of interest WGN-Television has in the expanding world of color.

This year we will televise 124 major league baseball games in color, also for the fourth year.

In 1962, WGN-Television—as an independent station—programmed more than 1800 hours of color, much of it locally produced. More than was originated by any other station in the nation.

And we welcome the opportunity to increase our color programming in Chicago this year, as more advertisers turn to color and its growing audience.

WGN believes that color holds television's brightest promise for the future—and we're not waiting.

WGN TELEVISION
2501 BRADLEY PL., CHICAGO 18, ILL.

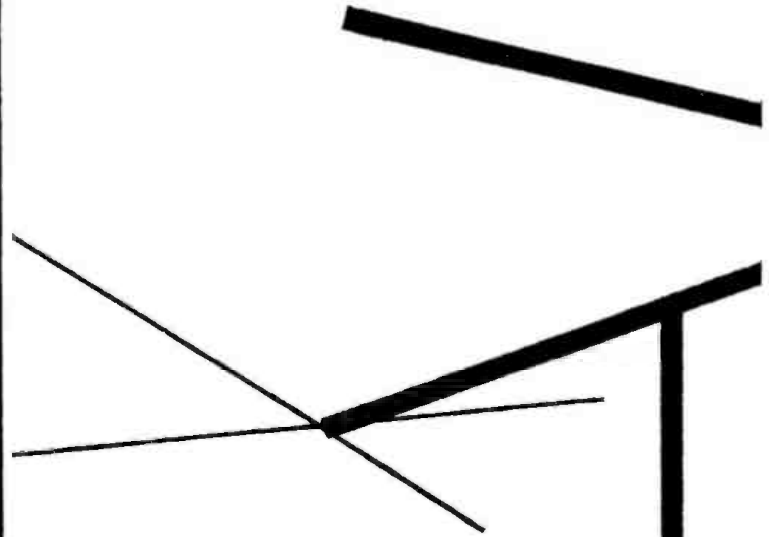

TOMBSTONE TERRITORY

...one of 268
syndicated
TV film series
which use*

BMI

*licensed music
and were
telecast locally
during the past year*

*out of a total of 390
syndicated TV film series

BMI

*

BROADCAST MUSIC, INC.

589 FIFTH AVENUE • NEW YORK 17, NEW YORK

CHICAGO • LOS ANGELES • NASHVILLE • TORONTO • MONTREAL



DATEBOOK

A calendar of important meetings and events in the field of communications

*Indicates first or revised listing

JUNE

June 3—Hollywood Ad Club luncheon at the Hollywood Roosevelt, 12 noon. Max Factor, founder of the cosmetic firm bearing his name, will receive the club's Founder's award. Marvin L. Mann, director of advertising for Max Factor & Co., will be program chairman.

June 4—Annual stockholders meeting, MCA Inc. (parent company of Revue Studios), Sheraton-Blackstone, Chicago.

June 4—Senate Commerce Committee public hearing on the appointment of Lee Loewinger as FCC commissioner.

June 4—Board of Broadcast Governors hearing, Ottawa.

June 4-6—National Visual Presentation Association, Hotel Commodore, New York.

June 4-6—Annual convention and exhibit of Armed Forces Communications & Electronics Association. Speakers are: H. I. Romnes, president of Western Electric Co., June 4 luncheon; Najeeb E. Halaby, administrator of Federal Aviation Agency, June 5 banquet; Lieutenant General Alfred D. Starbird, U.S.A., director of Defense Communications Agency, June 6 luncheon. Sheraton-Park Hotel, Washington.

June 5—Canadian TV Commercial Film Festival and Workshop, Royal York hotel, Toronto.

June 5—Annual meeting and premium round table of Premium Advertising Association of America, Hotel Roosevelt, New York City.

June 6—Special meeting of stockholders, Walter Reade/Sterling Inc., to merge Sterling Television Co. into Walter Reade/Sterling, which already owns 96% of Sterling TV. Coronet Theatre, New York.

June 6—Award luncheon of the Broadcast Pioneers' Washington chapter to honor Representative Oren Harris (D-Ark.), chairman of the House Interstate and Foreign Commerce Committee, 12:30, International Inn, Washington.

June 6—Chicago Copywriters Club's dinner preview of 1963 winners in American TV Commercials Festival, 5:30 a.m., Bernard Shaw Room, Sherman House hotel.

June 6-8—Los Angeles Advertising & Marketing Materials Show, Shrine Exposition Hall, Los Angeles.

June 7-14—Annual convention of National Community Television Association, Olympic hotel, Seattle. Senator Warren G. Magnuson, Commerce Committee chairman, will be the keynote luncheon speaker June 11.

June 8—UPI Broadcasters of Upper Michigan, Dee Park Lodge, Manitowish Waters, Wis.

June 8-9—Annual meeting of Tri-State TV

TVB SALES CLINICS

June 3—Boise, Idaho; Abilene, Tex.; Minneapolis. June 4—Duluth, Minn. June 5—Seattle; Odessa, Tex. June 6— Fargo, N. D.; Baltimore, June 7—Portland, Ore.; El Paso, Tex.; Bismarck, N. D.

June 10—Sacramento, Calif.; Albuquerque, N. M. June 12—San Diego; Salt Lake City. June 14—Phoenix, Ariz.; Denver.

June 18—Chicago; Los Angeles. June 20—Fresno, Calif. June 21—San Francisco; Monroe, La.

June 24—New Orleans. June 25—Baton Rouge, La.; Winston-Salem, N. C. June 27—Hattiesburg, Miss. June 28—Meridian, Miss.



The wondrous bee does plan and plan the filling of the comb



Your advertising planning can be greatly simplified by using BEE-LINE RADIO. You reach the vital markets of Inland California and Western Nevada with the four McClatchy stations. These stations have a record of program excellence. That's why they have the listeners you want to reach with your sales message.

McClatchy Broadcasting Company

delivers more for the money in Inland California-Western Nevada

PAUL H. RAYMER CO. — NATIONAL REPRESENTATIVE

KOH RENO • KFBK SACRAMENTO • KBEE MODESTO • KMJ FRESNO



What makes a great salesman?

America became a gum-chewing nation because of a soap salesman. William Wrigley, Jr. made himself well known as a premium distributor by offering gifts to jobbers who bought his soap products. One of the most popular premiums was chewing gum. When the cry for gum surpassed the demand for soap, he wisely changed course. It was a momentous decision, for Wrigley was just the man to bring salesmanship to a product few adults had even thought about twenty years before.

A firm believer in doing things on a big scale, Wrigley contracted for \$1 million in advertising during the panic of 1907 and practically *doubled* sales within a year. Twice he mailed free gum to every name listed in every telephone book in the country! His outdoor sign along the Trenton-Atlantic City railway tracks was nearly a mile long. For years two sticks of Wrigley gum were sent to as many American children as possible on their second birthday.

Because William Wrigley thought big, chewing gum emerged as big business. "Thinking big" accounts for the great selling ability of the Storer stations, too. Responsible management and operating efficiency are part of the story. So is programming keyed to individual audience attention and respect. Your message means more on a Storer station! In Cleveland, Storer's great salesmen are WJW-Radio and WJW-TV, two important stations in an important market.

LOS ANGELES KGBS	PHILADELPHIA W'IBG	CLEVELAND WJW	NEW YORK W'HN	TOLEDO W'SPD	DETROIT WJBA
MIAMI W'GBS	MILWAUKEE W'ITI-TV	CLEVELAND WJW-TV	ATLANTA W'AGA-TV	TOLEDO W'SPD-TV	DETROIT WJBA-TV





“For Distinguished Service in the field of television reporting,” the citation read, “the Sigma Delta Chi Award is made for 1962 to KWTV, Oklahoma City.”

For KWTV’s Newsman Ed Turner and Cameraman Bob Mathews, this represented the crowning achievement in a series of awards resulting from their initiative and enterprise in reporting “The War at Oxford.”

Along the road the KWTV news team of Turner and Mathews has been honored . . .

- as Oklahoma’s News Team of 1962 by the Oklahoma Professional Chapter of Sigma Delta Chi;
- by a special citation from The Department of Justice on behalf of the 24 Special Deputy U. S. Marshals who served at Oxford;
- for the Best Television News Story of 1962, by United Press International Broadcasters of Oklahoma;
- by Commendations for dedication to duty from Oklahoma’s Governor, State Senate and House of Representatives.

Looking toward the future, the staff and management of KWTV, Oklahoma City, pledge even greater initiative and enterprise in serving its 48-County Community.

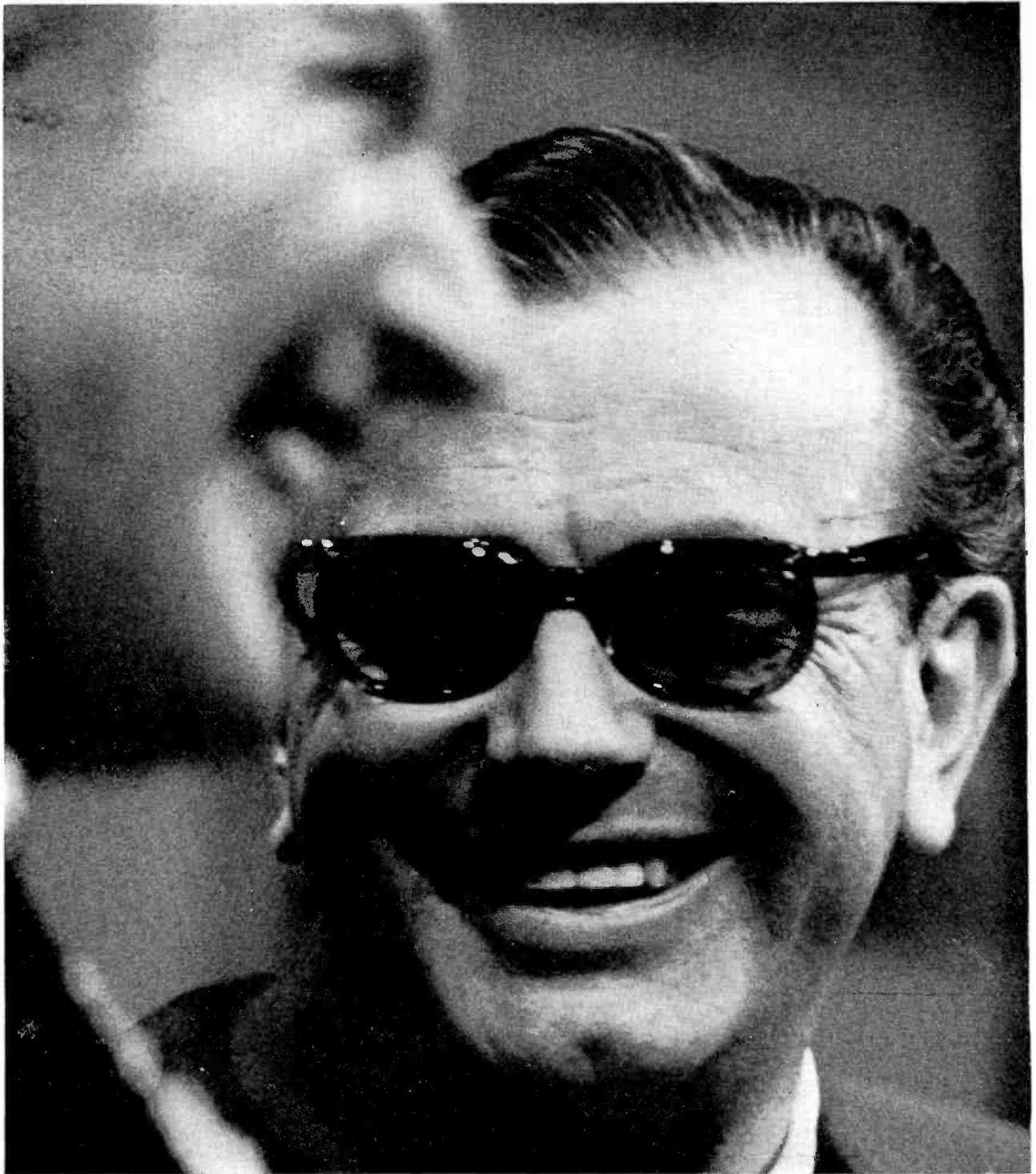

The Clock and Mr. Paar

It was a question you heard whispered ominously last summer all the way from Madison Avenue to Madison, Wisconsin: "Will a prime-time show mean a less informal Jack Paar?"

Then along came the September premiere of Jack's Friday-night series, and all speculation stopped at once. Obviously, Paar's unstuffiness and irreverence were delightfully intact.

They've remained so all season long. And no one doubts they'll be otherwise in the Fall when the full-hour color show begins its *second* year—as part of NBC-TV's '63-'64 lineup. For in a world that often equates slickness with talent, Jack and his "gemutlich" guests insist on being themselves.

On the current series, it's seemed the most natural thing in the world for Richard Nixon to play a piano solo; for Nat (King) Cole to chat about a recent trip to the Orient; for Liberace to launch

THE JACK PAAR SHOW



into a spirited demonstration of the twist.

Can there be anything more free-wheeling than an agenda that ranges from the far-out flippancies of the "Beyond the Fringe" cast to the wonderfully unsophisticated home movies of Jack and family touring the Holy Land?

During his approaching Summer vacation Paar and camera will be visiting such areas as Africa, Hawaii and Tahiti. So this Fall, Paar viewers will not be too surprised if they see films covering

everything from Dr. Schweitzer's feelings about Raymond Massey to a newly-discovered galley-menu (soaking wet) from HMS Bounty.

But best of all, there'll be Jack himself on stage — tossing off one-liners, swapping anecdotes with guests, and ribbing (but never deceiving) his audiences. You know something? We don't think the fellow *realizes* he's on prime-time. And you know something else? We're not going to tell him.



Look to NBC for the best combination of news, information and entertainment.



WLW COLOR TELEVISION

We're the national color TV leader. And our big color TV survey startled the industry when we proved that color programs rate double the popularity of the same programs in black and white. And color commercials rate 3½ times the impression as the same commercials in black and white.

WLW Television is ranked at the top in all phases of color TV—programs, production, talent, direction, sales, engineering. So let us tune your products to color programs and color commercials with all their golden rewards!

Call your WLW TV man!

CROSLY COLOR TV NETWORK

WLW-D WLW-C WLW-T WLW-I

Television Television Television Television
Dayton Columbus Cincinnati Indianapolis

WLW Radio—Nation's Highest Fidelity Radio Station

CROSLY BROADCASTING CORPORATION
a subsidiary of **Aereo**

West annual convention at Ambassador hotel, Los Angeles. Junior conclave, June 22; business sessions, June 24-28; president's dinner, June 28; golf tournament, June 27.

June 24-28—Meeting of National Association of Broadcasters radio, TV and combined boards, Statler-Hilton, Washington.

June 24-29—Ninth annual Writers' Conference, McKendree College, Lebanon, Ill.

June 24-29—International Telefilm Show, within framework of 13th International Film Festival Berlin (Germany) 1963.

*June 25—Annual stockholders meeting, The Jerrold Corp., Jerrold Building, Philadelphia.

June 26-29—Second annual executive conference of New York State Broadcasters Association, Gideon hotel, Saratoga Springs, N. Y. Panelists Joseph Morris, editor of *Advertising News of New York* and Arthur Perles, editor of *Radio-TV Daily*.

*June 27—Annual loudspeaker conference, Electronic Industries Association, Pick Congress hotel, Chicago.

June 27-29—Wisconsin Broadcasters Associated meeting, The Northernaire, Three Lakes, Wis. June 28 speakers include FCC Commissioner Frederick W. Ford, Radio Advertising Bureau President Edmund C. Bunker, and John Hurlbut, owner-manager of WVMC Mt. Carmel, Ill.

June 27-29—Maryland-D. C. Broadcasters Association, Sea Scape hotel, Ocean City, Md.

June 30-July 12—Fifth annual Advertising Federation of America marketing management and advertising seminar, Harvard Business School, Cambridge, Mass.

June 30-July 4—Annual convention of Kiwanis International, Convention Hall, Atlantic City, N. J. Ward Quaal, executive vice president of WGN Inc., Chicago, will speak July 2 on "Responsibility for Developing, Strengthening, and Preserving Free Enterprise."

JULY

July 10-14—Annual convention of American Federation of Television and Radio Artists, Ambassador hotel, Los Angeles. Keynote speakers will be California Governor Edmund G. Brown and Mayor Samuel W. Yorty.

*July 10-20—Fourteenth International Festival of Documentary Film, Venice, Italy.

July 11-13—Annual convention of Idaho Broadcasters Association, Moscow, Idaho.

July 14-16—Summer convention of South Carolina Broadcasters Association. Location to be announced.

July 14-26—Fourth annual NAB Executive Development Seminar, Harvard Business School, Cambridge, Mass. The general outline of subject matter includes: (1) development of the executive; (2) formulation and execution of competitive strategy; (3) organization and delegation of work; (4) planning, budgeting and controlling costs (5) management of people; (6) review and appraisal of management performance.

*July 20—Florida AP Broadcasters annual meeting, Cape Colony Inn, Cocoa Beach, Fla. News panels in the morning, a luncheon, afternoon tour of Cape Canaveral and an awards dinner at night.

*July 25-27—National Broadcast Editorial Conference (NBEC), co-sponsored by Henry Grady School of Journalism and the Georgia Association of Broadcasters, at the University of Georgia, Athens. Keynote speaker is Howard K. Smith of ABC-TV. Participants include FCC Commissioner Kenneth A. Cox; communications attorney Theodore Pierson of Washington, D. C.; Dr. Mary Ann Cusack, National Association of Broadcasters; and Ralph Renick, vice president of WTVJ(TV) Miami; and George Campbell Jr., executive vice president of Peoples Broadcasting Corp., Columbus, Ohio.

BROADCASTING PUBLICATIONS INC.

PRESIDENT SOL TAIHOFF
VICE PRESIDENT MAURY LONG
VICE PRESIDENT EDWIN H. JAMES
SECRETARY H. H. TASH
TREASURER B. T. TAIHOFF
COMPTROLLER IRVING C. MILLER
ASST. SEC.-TREAS. LAWRENCE B. TAIHOFF

BROADCASTING THE BUSINESSWEEKLY OF TELEVISION AND RADIO

Executive and publication headquarters:
BROADCASTING-TELECASTING Bldg., 1735 DeSales
Street, N.W., Washington 6, D. C. Telephone:
Area code 202 Metropolitan 8-1022.

EDITOR AND PUBLISHER
Sol Taishoff

Editorial

VICE PRESIDENT AND EXECUTIVE EDITOR
Edwin H. James

EDITORIAL DIRECTOR (New York)
Rufus Crater

MANAGING EDITOR
Art King

SENIOR EDITORS: J. Frank Beatty, Bruce Robertson (Hollywood), Frederick M. Fitzgerald, Earl B. Abrams, Lawrence Christopher (Chicago), Dawson Nail; ASSOCIATE EDITORS: George Darlington, Leonard Zeidenberg; STAFF WRITERS: Sid Booth, Sheim Brodey, Gary Campbell, Jim deBettencourt, Larry Michie; EDITORIAL ASSISTANTS: Tani Oman, Chuck Shaffer; SECRETARY TO THE PUBLISHER: Gladys Hall.

Business

VICE PRESIDENT AND GENERAL MANAGER
Maury Long

VICE PRESIDENT AND SALES MANAGER
Winfield R. Levi (New York)

ASSISTANT PUBLISHER
Lawrence B. Taishoff

SOUTHERN SALES MANAGER: Ed Sellers; PRODUCTION MANAGER: George L. Dant; TRAFFIC MANAGER: Harry Stevens; CLASSIFIED ADVERTISING: Dave Lambert; ADVERTISING ASSISTANTS: Robert Sandor, Carol Ann Jenkins, Ken Albright; SECRETARY TO THE GENERAL MANAGER: Doris Kelly.

COMPTROLLER: Irving C. Miller; ASSISTANT AUDITOR: Eunice Weston.

Publications and Circulation

DIRECTOR OF PUBLICATIONS
John P. Cosgrove

CIRCULATION MANAGER: Frank N. Gentile; CIRCULATION ASSISTANTS: David Cusick, Edith Liu, Burgess Hess, German Rojas, Joan Chang.

Bureaus

New York: 444 Madison Avenue, Zone 22. Telephone: Area code 212 Plaza 5-8354.

EDITORIAL DIRECTOR: Rufus Crater; BUREAU NEWS MANAGER: David W. Berlyn; ASSOCIATE EDITOR: Rocco Faiighetti; STAFF WRITERS: John Gardiner, Phil Grose, Diane Halbert, Larry Littman; ASSISTANT: Frances Bonovitch.

VICE PRESIDENT AND SALES MANAGER: Winfield R. Levi; EASTERN SALES MANAGER: Don Kuyk; INSTITUTIONAL SALES MANAGER: Eleanor R. Manning; ADVERTISING REPRESENTATIVE: Syd Abel; ADVERTISING ASSISTANT: Ellen Reilly.

Chicago: 360 North Michigan Avenue, Zone 1. Telephone: Area code 312 Central 6-4115.

SENIOR EDITOR: Lawrence Christopher; MIDWEST SALES MANAGER: Waiten W. Middleton; ASSISTANT: Barbara Kolar.

Hollywood: 1680 North Vine Street, Zone 28. Telephone: Area code 213 Hollywood 3-3148.

SENIOR EDITOR: Bruce Robertson; WESTERN SALES MANAGER: Bill Merritt.

Toronto: 11 Burton Road, Zone 10. Telephone: Area code 416 Hudson 9-2694. CORRESPONDENT: James Montagnes.

BROADCASTING* Magazine was founded in 1931 by Broadcasting Publications Inc., using the title, BROADCASTING*—The News Magazine of the Fifth Estate. Broadcast Advertising* was acquired in 1932, Broadcast Reporter in 1933 and Telecast* in 1953. BROADCASTING-TELECASTING* was introduced in 1946.

*Reg. U. S. Patent Office

Copyright 1963: Broadcasting Publications Inc.

Radio the keystone of Chicken Delight's growth

Advertising is the life-blood of any business. But in Chicken Delight's operation, it's the guts, muscle and nervous system as well. Broadcast advertising has swelled our chain of franchised stores in the western states from one location to 185 locations in just under four years, and in that period individual store volume has tripled.

We have 400 franchised stores from coast-to-coast, selling ready-to-eat chicken, shrimp, rib and fish dinners. Gross sales last year topped \$20 million. The price of the Chicken Delight dinner is \$1.39, and chicken makes up about 80% of our total volume. There's no eating on the premises, but we deliver one dinner or 100 dinners to a customer's home free.

Naturally, if customers prefer, they can pick up their dinners at one of our stores. And the dinners stay hot for about 45 minutes because of our patented packaging. The quality of the product, which is prepared and cooked like no other chicken, combined with our packaging and free delivery service are the three elements that make us unique in the food business.

A Factual Start ■ These were the facts we dropped in the lap of Tilds & Cantz Inc., our Los Angeles-based advertising agency, almost four years ago. Their approach to our problems, as well as their knowledge of both the franchising and food handling business, has encouraged us to include Walter Tilds, president of the shop, and Alan Berger, our account executive, in most key management decisions, both in and out of the marketing/advertising areas. They are truly synthesized into total over-all operations.

Here's what they did. Without our knowledge, they researched volume patterns, customer attitudes, economic profiles of our marketing areas, frequency of purchase data and the dozens of other facets that contribute to wooing and winning a potential customer. Then, with our guidance, they related the data to sales figures in the few stores we had operative in August 1959. A flexible formula, applicable to virtually any market, was then developed and put into operation.

The concept from the creative and media aspect was both logical and dynamic. The agency was quick to spot the impulse factor linked to a purchase from us, or any restaurant, for that matter. By the weekend, the housewife has run out of ideas for menus and is tired of cooking. Chances are, she's due for a supermarket shopping trip and

the cupboard is moderately bare. Most of our market shopping is done on weekends here, and after a housewife has spent over an hour surrounded by food, pushing a shopping cart and fighting crowds, she doesn't feel much like cooking. Coincidentally, about 75% of our total weekly volume comes on the weekends.

Weekend Saturation ■ The agency recommended we restrict our advertising to just two days, Saturday and Sunday, to squeeze impact from a severely limited budget. Our stores don't open until 4 p.m. and the peak traffic spans the 5:30 to 7:30 p.m. area. So we went on one station, a "middle-of-the-road" music, news and sports operation with 50 kw coverage and an excellent staff of on-air personalities. We ran 60-second or 30-second spots every half hour during our peak time and nothing else. Classic vertical saturation.

Commercial content was simple. At the time we started on the air, the Twist was the rage, so the agency created a 30-second musical jingle in a twist tempo. The next 30 seconds were aimed squarely at the housewife, with live copy delivered by a station personality, pointing out the convenience of not having to cook dinner or wash dishes. It's summed up by our slogan, "Don't cook tonight, call Chicken Delight."

Consumer response was almost immediate on the store level, but something we never expected was a welcome sidelight. People became so Chicken Delight-conscious that our franchise inquiries increased almost more rapidly than we could handle. The fact that we have opened 104 stores in just three years in Southern California alone

speaks for itself. This market is almost sold out, as are many of our West Coast medium and major cities.

Time To Expand ■ As we grew, so did our ad budget. The agency then applied what they call their "Stratified Media Technique." The middle-of-the-road station appeals to a broad segment of audience in the middle-to-high-middle income area. Next a "hard rocker" was added, shooting for the younger middle-to-middle-low income group. Finally, to get the upper income end of the population, and perhaps an older audience, an all-talk station was added. Listening trends and demographic research indicate we cover our market efficiently, with little duplication.

In the past three years, Tilds & Cantz has applied this formula (with some modifications) to San Diego, San Francisco, Seattle and, recently, New York as well as about 25 smaller markets. "Long Distance" media selection is never used. Our key account team visits every market at least twice yearly, with more frequent trips to key markets.

The sound of our commercials has changed with new musical arrangements of the same lyrics and melody. So has the live copy. The "nuts and bolts" approach has been modified to dwell more on the sensual areas of taste, appearance, warmth, etc. We have tested spot TV in selected markets, and the direct sales response indicates that television will be an important part of our future advertising.

But the foundation of our media approach, radio advertising, will not change. It will be expanded to every major market because we are convinced that radio convinces people, "Don't cook tonight, call Chicken Delight."



Werner H. Maahs left the White Fish Bay, Wis., police force in 1954 to open a Chicken Delight store in Milwaukee. In 1956 he was appointed vice-president of Chicken Delight Inc., Rock Island, Ill., and sent to Los Angeles in 1959 as president of its California corporation. He is one of the few business executives to be listed in "Who's Who in the West" at just 36 years of age. An avid hunter, fisher and golfer, he resides in West Los Angeles with his wife and four (soon to be five) children.

You can't cover Indianapolis with Indianapolis TV!

**The Indianapolis Market, we mean!*

WTHI-TV in combination with Indianapolis stations offers more additional unduplicated TV homes than even the most extensive use of Indianapolis alone.

More than 25% of consumer sales credited to Indianapolis comes from the area served by WTHI-TV, Terre Haute.

More than 25% of the TV homes in the combined Indianapolis-Terre Haute television area are served by WTHI-TV.

This unique situation revealed here definitely suggests the importance of re-evaluating your basic Indiana TV effort . . . The supporting facts and figures (yours for the asking) will show how you gain, at no increase in cost . . .

1. *Greatly expanded Indiana reach*
2. *Effective and complete coverage of Indiana's two top TV markets*
3. *Greatly improved overall cost efficiency*

So, let an Edward Petry man document the foregoing with authoritative distribution and TV audience data.

WTHI-TV*

CHANNEL 10
TERRE HAUTE,
INDIANA

**An affiliate of WTHI AM & FM*



**WTHI-TV
delivers more homes
per average quarter
hour than any
Indiana station *
(March 1962 ARB)**

**except Indianapolis*

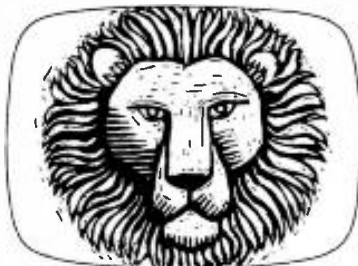

View from the Lion's Den

Atlantic City Isn't Nice

■ Before anyone sues, that's Nice, France, which isn't Atlantic City 'cause among other things there's no boardwalk or Steel Pier. But there is a girl from Atlantic City who's in Nice right now and she'll be appearing on a lot of people's TV screens AC to DC to LA to KC on NBC this fall. Her name is Dawn Nickerson. She's one of three girls in a mediocre night club act touring Europe with a hooper named Harry. That's part of the plot. They're *Harry's Girls*. The problem is to keep the girls in step in the act and out. It keeps Harry hopping and provides some harrowing and hilarious moments. It's all in fun. In fact, if you remember the MGM movie "Les Girls" you've got the idea behind *Harry's Girls*, now a weekly half-hour comedy series sponsored by Colgate.

■ But back to the girls. They're just wild about Harry, as their den mother. They are generally wild about something at any given moment: a rajah, a part in an Italian movie, perhaps even cello playing if there's a beau handy. Besides Dawn, there's Diahn Williams and Susan Silo. They are blonde, redhead and brunette in the same order. All three girls won out over 320 other actresses for the roles. It makes sense when you meet these girls. They are perfect for their parts. Scripts may not be necessary. They're already living their roles. In an interview with *Cecil Smith* of the Los Angeles Times before they left for shooting in Europe they delivered the following dialog...

Susan: I'm excited about Europe but I'm going to miss California.

Diahn: I wouldn't live there. I hear there are 10 girls to every man in Hollywood.

Susan: That's New York propaganda.

Dawn: Anyway, isn't that Washington that has 10 girls to every man?

Susan: With all those Kennedys around?

■ Lucky Pierre. And lucky Larry. He's Larry Blyden who is Harry in *Harry's Girls*. We can't feel sorry for him this coming television season, can we? He's got it real nice in Nice and the rest of the continent, episode after episode. It will be great fun watching the results starting September on Fridays at 9:30 PM NYT, NBC-TV.

OPEN MIKE

Blue chip client's reading

EDITOR: . . . Anyone who has anything to do with broadcasting is aware of the vital part your publications have played in the history of broadcasting. Certainly, Alberto-Culver finds rare newsworthiness in both BROADCASTING and TELEVISION.—*Morris Wattenberg, Alberto-Culver Co., 2525 Armitage Avenue, Melrose Park, Ill.*

A matter of semantics

EDITOR: YOUR MAY 20 CATV STORY OK EXCEPT THAT NO NCTA COMMITTEE HAS BEEN APPOINTED TO "NEGOTIATE" REGULATORY LEGISLATION WITH FCC. MALIN'S COMMITTEE WAS NOT AUTHORIZED BY NCTA BOARD TO NEGOTIATE BUT TO PRESENT OUR INDUSTRY'S VIEWPOINT TO FCC AND REPORT BACK TO BOARD. LET'S KEEP THE RECORD STRAIGHT.—*B. J. Conroy Jr., secretary, National Community Television Association, 220 North Getty Street, Uvalde, Tex.*

(Our reporter interpreted a statement in the NCTA membership bulletin that a "special task group will meet with the FCC to discuss issues involved in proposals for CATV legislation" to mean that this group was "negotiating.")

Monitored?

EDITOR: In keeping a parallel account of the radio coverage versus the wire coverage of the recent space orbit of Major Gordon Cooper, I was beginning to wonder where the wires were getting their news. While sitting in the news room, watching the wire and listening to a network account, at the moment the announcer described the capsule touching the water, one wire service stopped in the middle of a word, spaced about ten lines, rang the bell at least ten times, then wrote tersely "Cooper's down." This was followed by another similar clatter, and a repeat of the same performance.

Now I can understand that they have

correspondents close at hand, but to get the word back to the home office in an instant, when dozens of other services would be competing for the limited facilities available seems highly unlikely. And I wonder how many radio stations actually made use of this gem of information? They probably also got their information from other network stations.

All of which seems to point up one thing. Everybody listens to radio. Even radio stations. And wire services.—*R. S. Houston, Box 48-1148, Miami 48.*

Against daily inspection

EDITOR: We wonder if station operators realize that effective June 17, the FCC proposes to require their engineer to make a daily trip to the transmitter (five days a week), even though remote control equipment indicates that everything is operating properly.

The National Association of Broadcasters has a petition on file opposing the inspection portion of the rule. But if stations aren't aware, and don't file their opinions, the rule may become effective on schedule.—*Hayward L. Talley, president, KXGI Fort Madison, Iowa.*

Leads and suggestions

EDITOR: I wish to deeply thank you for the very splendid article you did concerning my proposed broadcast facility to be staffed by the physically disabled (BROADCASTING, May 13).

Through the article I have received many excellent leads and helpful suggestions concerning this enterprise. I'm sure it will be some time before I reap the full benefits from this article, but I am sure that the role [you] performed has been quite sufficient.—*Kenneth A. Jacuzzi, 1239 Upper Happy Valley, Lafayette, Calif.*

BOOK NOTE

"*The Technique of Documentary Film Production*," by *W. Hugh Baddley*. *Hastings House Publishers Inc., 151 East 50th Street, New York 22. 268 pp. \$10.*

It has not been too many years since the documentary film passed out of the travelogue class. Today's documentary-makers do more than take pretty pictures of streams, lakes and mountains. Documentaries have become "factual films," according to the author and in this volume he deals with all phases in the production of these films, from initial idea to distribution.

Mr. Baddley, who heads one of the

few companies producing educational and classroom films regularly in Great Britain since World War II, has written an essentially practical book; one which spells out the experienced judgment and practice needed to skillfully make documentary films.

The author has delved into his personal experience to offer practical hints and suggestions, valuable to novice and veteran.

Film making is a professional job, and Mr. Baddley's book is a text which can make professionals even more the masters of their cameras.

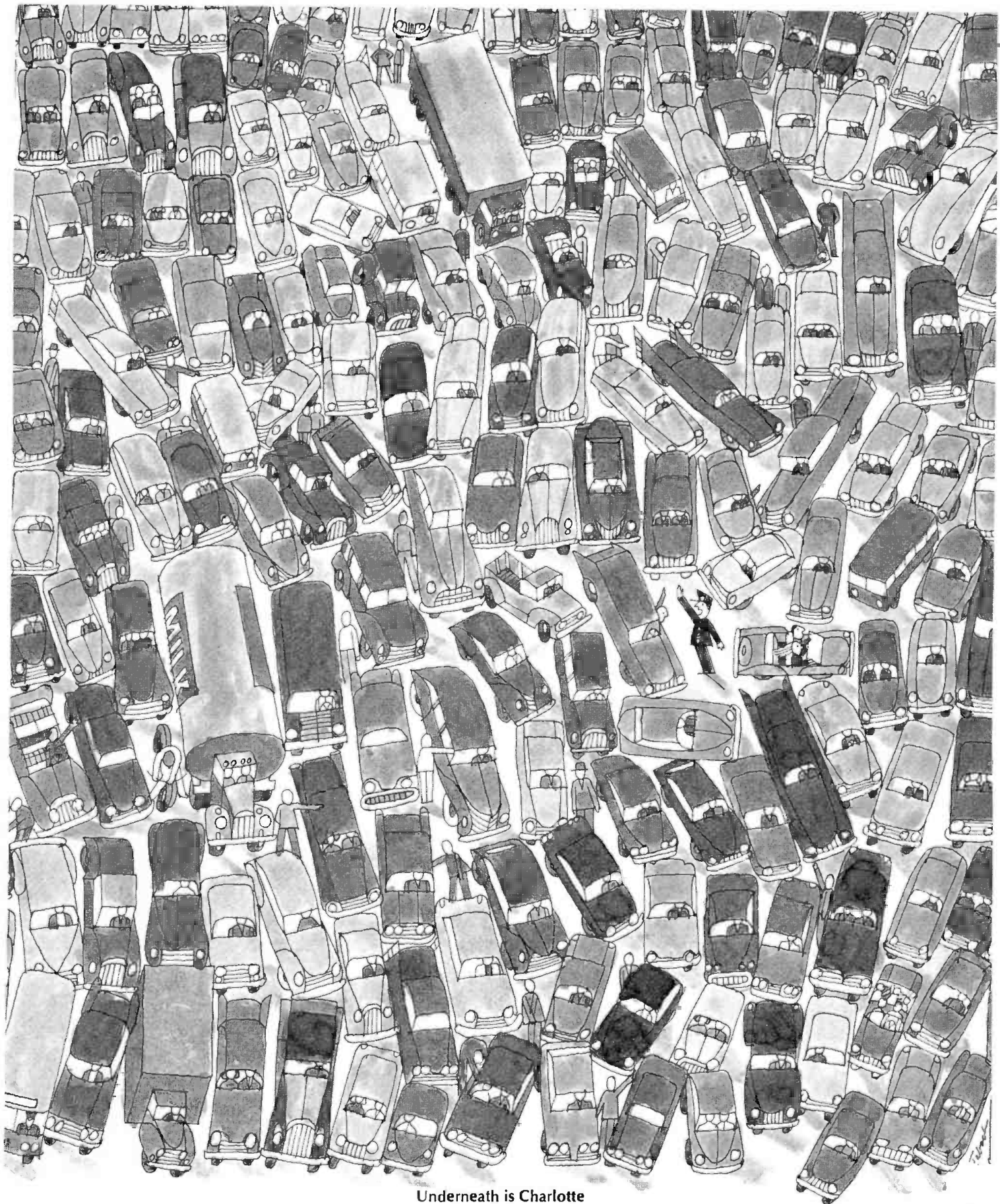

Underneath is Charlotte

Beneath all the business and bustle is Charlotte. More than 100,000 cars enter this booming city on an average day. And you'll find more people in the Charlotte 75-mile radius than in a corresponding radius around Atlanta, Indianapolis, Kansas City, and Minneapolis. 8th in per family sales in the United States...5th in the wholesale distribution of industrial chemicals. With building permits exceeding even those of Pittsburgh and Buffalo in 1961. With major installations of 40 out of the 50

larger corporations in the United States. What better way to get at this thriving market than through WBT Radio Charlotte? For over 40 years, WBT has had the largest adult audience for the 37-county basic area. And this is the audience that receives and spends most of Charlotte's \$2,612,784,000 worth of spending money.* Reach them with the station they turn to for responsible programming, outstanding service, and finer entertainment. **WBT Radio Charlotte** Represented nationally by John Blair & Co.

*SOURCE: SURVEY OF BUYING POWER

JEFFERSON STANDARD BROADCASTING COMPANY

THE HOLLYWOOD STORY

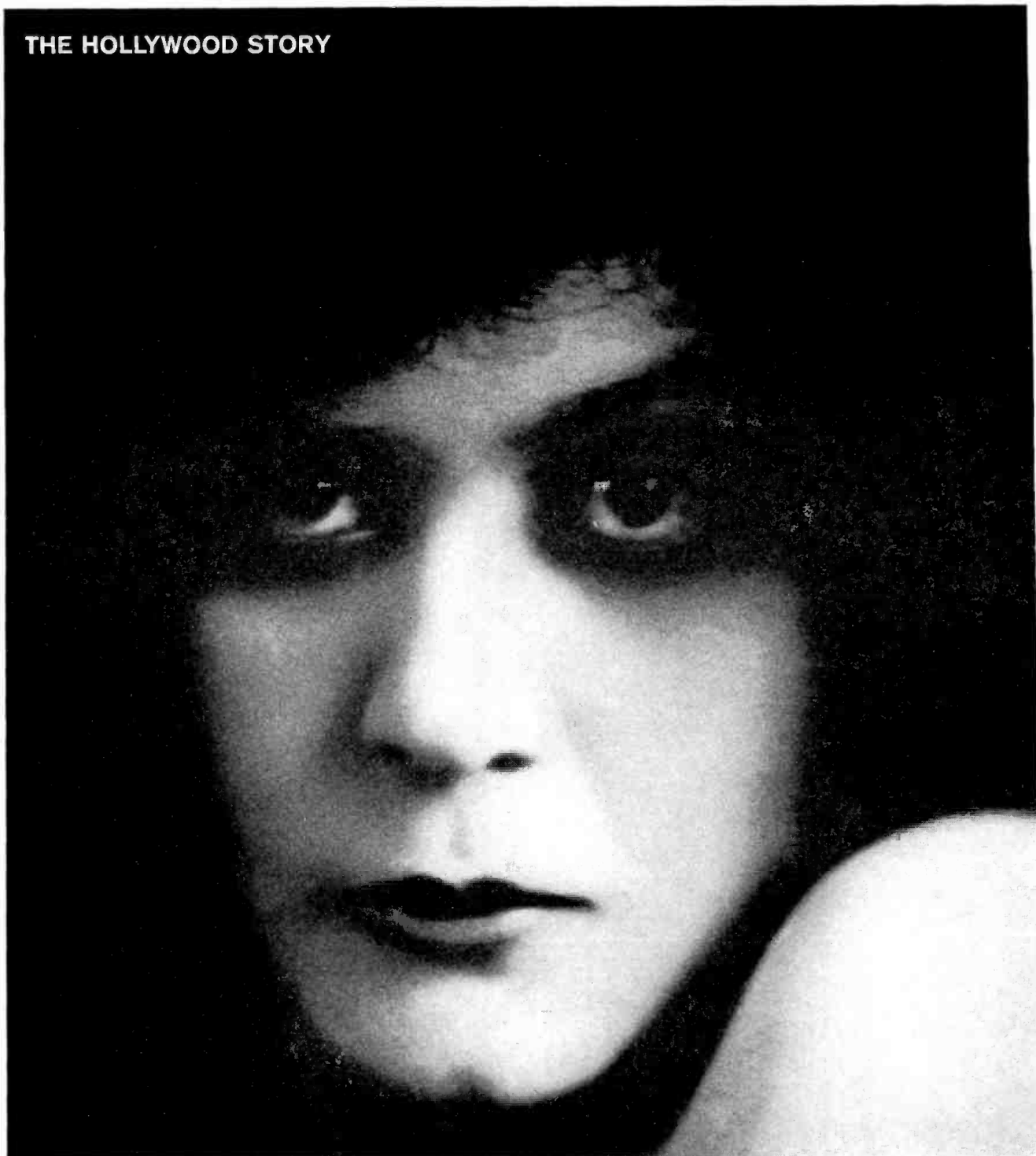

Better Than Ever

There's a world of difference between the passionate posturing of Theda Bara and the child-woman blandishments of Brigitte Bardot. And it's a world well worth the exploring.

But, fascinating as it is, the evolution in screen sirens is just *one* of the movieland developments to be examined in the new series tentatively called "The Hollywood Story." Scheduled right after

NBC-TV's Monday-night movies, the weekly program becomes a highlight of NBC's diversified schedule in the Fall.

The series—created by David L. Wolper and produced by him and Jack Haley, Jr.—offers a kaleidoscopic look at five decades of films. Wolper and his subject have already kaleided three times, and the happy results were "The Golden Years"; "The Fabulous Era"; and "The Great Stars"—a warmly received trio of television specials.



Among the myriad filmland phenomena slated to come under the new show's fond scrutiny are:

The gangster movies—with such beloved public enemies as Bogart, Cagney and Robinson brass-knuckling their way to top billing.

The monster cycle—in which the likes of Chaney, Lugosi and Karloff proved that looks aren't everything.

The comedy approach—from the Keystone Cops taking a corner on two reels, to Doris Day and

Rock Hudson swapping *sotto voce* pillow talk.

In all, "The Hollywood Story" shapes up as an out-of-the-ordinary portrait of the silver screen. As such, it's a fitting entry in NBC-TV's way-out-of-the-ordinary Fall schedule—a varied lineup that ranges from proven favorites like "Hazel" and "The Eleventh Hour" to such newcomers as "The Bill Dana Show" and the "Mr. Novak" dramas. We've never looked forward to so dazzling a season.



Look to NBC for the best combination of news, information and entertainment.

NO OTHER STATION CAN MAKE THIS STATEMENT 5 CONSECUTIVE YEARS

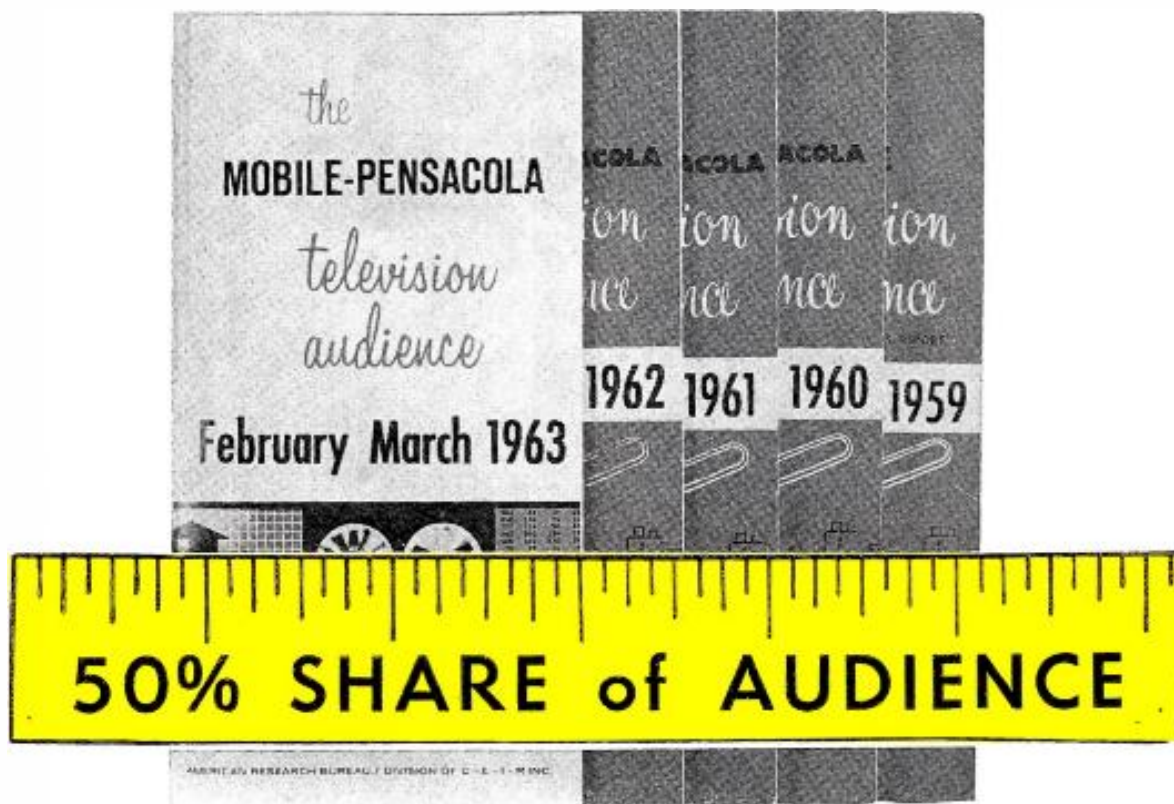

Exception To The Rule

WKRG-TV — Mobile — Pensacola

has averaged 50% or more share of audience in every March ARB measurement since 1959, from 9 a.m. to midnight.*



Represented by H-R Television, Inc.
or call

C. P. PERSONS, Jr., General Manager



*3 station VHF market.

GOODBYE OPTIONS; HELLO WHAT?

- FCC kills TV option time in hopes of curbing network power
- But some predict the deed may come harder than the word
- In companion action CBS-TV station payment plan is queered

The FCC outlawed television network option time last week—but years too late, in the opinion of some opponents of the practice.

The action was originally proposed to curb the growth of network influence in program origination. It came after the networks had become firmly established as the dominant suppliers of all kinds of programs except those that stations produce themselves.

Program syndicators, who were among the most vociferous advocates of option-time reforms several years ago, greeted last week's action mildly. Most of them doubted it would achieve now what they had hoped it would achieve when they were actively encouraging it. The syndicators, who were motivated originally by a desire to gain access to prime time for the first-run programs they were then producing, are mostly engaged now in distribution of network films in off-network runs.

Advertising agencies that at one time believed that a curtailment of option time would enormously increase their difficulties in obtaining station clearances on their network lineups reacted calmly to the news last week. Although some felt the elimination of the options would complicate their network buying, none saw now the possibilities of network fragmentation on the scale they once feared. The prevailing view was that the networks' grip on program sources was strong enough to assure a continuation of network clearances in desirable hours.

The networks themselves reserved official comment, but some of their executives appraised the FCC action as one that could be lived with—if it survived the inevitable court appeals—but would create new problems in maintaining stable lineups of stations.

Double Edge ■ The outlawing of option time was one of two actions the

FCC took last week to encourage competition in television program supplying. The second was an order holding that the CBS-TV plan of graduated compensation for its affiliated stations violates commission rules. Both actions had been anticipated (BROADCASTING, May 27).

The rule banning the networks' traditional method of assuring station clearances was adopted by a vote of 6-1, with Commissioner Robert E. Lee the lone dissenter. The commission vote declaring the CBS-TV plan a violation of the rules was 6-0, with Commissioner Frederick W. Ford abstaining.

Need For Competition ■ In both actions, the commission indicated its purpose is to strengthen the ability of non-network program producers to compete with the networks by giving television stations greater freedom in choosing programs from competing suppliers.

Both issues are likely to be settled

Nobody can say the FCC took hasty action

The drive for restriction or elimination of television network option time may be dated from 1954 when the Senate Communications Subcommittee attempted to find out why VHF was developing faster than UHF. Harry Plotkin, special counsel to the subcommittee (and now in private practice in Washington) wrote a report urging, among other reforms, the abolition of option time which he said was restricting competition.

The next year, at the prodding of influential senators and with a special appropriation from Congress, the FCC set up a special network study staff under the direction of Roscoe L. Barrow, dean of the University of Cincinnati law school.

In March 1956 Richard A. Moore, then president of the unaffiliated KTTV(TV) Los Angeles which was having trouble finding enough programming from film syndicators and other non-network sources, made a

major presentation to the Senate Commerce Committee in opposition to network practices. Option time, he asserted, was a violation of the antitrust laws and ought to be prohibited. (Mr. Moore left KTTV a year ago to develop a pay TV system. By coincidence, the FCC last week approved the sale of KTTV, at the highest price ever paid for a television station [see story page 75], on the same day it outlawed the system of option time.)

In the summer of 1957 Kenneth Cox, then special counsel to the Senate Commerce Committee, issued a denunciation of option time and called for its restriction as a means of freeing prime time on television stations for non-network programming. Last week, six years later, Mr. Cox got a chance to vote for action on his original proposal. Now a member of the FCC, he was one of the majority that decided to kill the option.

Also in the summer of 1957 a House Antitrust Subcommittee urged the FCC to restrict option time and said the practice raised antitrust questions.

In October 1957 the FCC's network study staff issued what came to be known as the Barrow Report—a 1,485-page indictment of network practices. Included was a firm recommendation that option time be outlawed.

In 1960 the FCC ruled that option time was necessary to network operations, but it reduced the permissible amount of it from three hours per broadcast segment to two-and-a-half hours. That order was appealed to the court by Mr. Moore. Upon the installation of Newton Minow as FCC chairman, the FCC asked the court to send the case back for commission reconsideration. Last week, more than two years later, the commission took final action to throw option time out.

Option time reaction: so what?

AGENCIES CALM; SOME NETWORK BRASS FEARS STATION UPRISING

The FCC's abolition of network option time was viewed by leading advertising agency executives last week as a potential rather than an immediate influence on their television buying practices.

Some alarm was voiced, along with frequent assertion that the networks henceforth may have to "guarantee" satisfactory clearance of programs. But for the most part these views appeared to be overshadowed by the feeling that significant changes will be slow in coming—and may not come at all.

The networks, which have protested that option time is essential to their operations, had no official comment last week on the FCC's move. They indicated they would have none—at least until they have had a chance to study the FCC's order.

Privately, however, network officials who were willing to talk about the move took somewhat differing positions.

They felt the effect would be harmful—that affiliates will be more inclined to substitute local or syndicated programming for network shows, so that network advertisers would be less certain of getting the lineups they want and therefore more reluctant to buy.

Timing in Question ■ They disagreed, however, on the extent to which this may happen, and on how soon it may come. Some predicted

flatly that the structure of network television will be changed almost beyond recognition. Others thought the changes might be erosive and less drastic.

Station representation company executives, who depend on network programs to provide some of the best adjacencies they sell to national spot advertisers, seemed inclined to think that little or no real harm will result on that score.

Film companies, which were among the original agitators against option time, appeared to side with those who thought the effects, if any, will be slow in emerging.

A few agency executives told broadcasting without qualification that the abolition of option time "will destroy the networks." One, who refused to believe the FCC would ever go so far, felt this "destruction" would not be long in coming if the FCC ever did.

Guarantees Seen ■ Several thought they would require guarantees or at least firmer assurances that the networks will be able to deliver the station lineups that their clients want.

Others felt that existing arrangements, in which networks sometimes get informal clearance commitments from their affiliates in advance, or make rebates to the advertiser for unsatisfactory clearance, will suffice at least until there's time to see what the effects actually are.

A number of agency executives said it was possible they will have to step up their own station-relations work in order to expedite clearances. Others doubted that this need would arise soon.

It was emphasized by many executives that clearance problems traditionally have been linked to the number of stations in a market, and that this probably will continue to be the case.

It is in the one, two and sometimes three-station markets—where networks have less chance to switch affiliation away from a recalcitrant affiliate—that most of the clearance problems have centered.

Even among those who foresaw the possibility of long-range bad effects on network advertising, a certain wait-and-see attitude was evident. And many executives felt that even the long term effects were not overly apt to be damaging either to the networks or to their use of networks.

The broadcast supervisor of a large agency, for example, argued that stations will still need top-flight programs for which the networks are the major source. "They have no place else to go to get the prime-time quality shows they need," he said. "Frankly, I can't take this abolition of option time too seriously."

The radio-TV vice president of

GOODBYE OPTIONS; HELLO WHAT? continued

in the courts. CBS has already appealed an FCC action declaring an earlier version of the compensation plan a violation of the rules. And an official of that network said the commission's decision last week might be appealed also. In addition, the Justice Department has brought suit against the network, contending the plan violates the antitrust laws.

In the option-time case, the commission points to one Supreme Court decision it says upholds the agency's authority to rule on the practice. This was the 1943 decision sustaining the agency's power to promulgate rules affecting network relations with their affiliates.

The new option-time rule (designated Sec. 3.658 [d]) becomes effective Sept. 10, 1963. It applies only to television—the present rules permitting the practice in radio are not affected—and

doesn't consider the legality of option time under the antitrust laws.

The commission, in adopting the new rule, said it finds that "time optioning in television is not essential to networking, is both an artificial restraint on access to TV station time and an abdication of TV licensee responsibility, [and] is contrary to the public interest."

The commission also said the rule, as adopted, prohibits "any arrangement between stations and networks having the same restraining effect." The new rule covers the CBS compensation plan.

Commission About Face ■ The commission's action reversed the position it adopted in 1960 when it held that TV option time was necessary to network operation and in the public interest. That finding was in the order reducing the amount of time an affiliate could option to a network from 3 to 2½ hours in each segment of the

broadcast day.

Commissioner Lee is the only member still with the commission who was in the majority three years ago when the FCC upheld option time by a 4-3 vote. In his dissent last week, he said he adheres to his original judgment that "option time is reasonably necessary to the successful operation of a network."

The commission has been considering the option-time question since July 1961, when the U. S. Court of Appeals remanded the issue at the agency's request. The question was in the court following an appeal taken by KTTV (TV), which argued that option time should be abolished on the ground it violates the antitrust laws. Coincidentally, the commission last week approved the sale of KTTV from the Los Angeles Times and Mirror Co., to Metromedia Inc. [see story page 75].

CBS Plan ■ The CBS "incentive com-

another agency anticipated "little immediate effect" although he thought it might accentuate the hitherto intermittent efforts of a number of advertisers to get some sort of "cost-per-thousand guarantee." He explained:

"Obviously, some kind of minimum guarantee will have to be made by the networks. If, say, 85 or 90 or 95% of the station lineup cannot be delivered, then some sort of cost adjustment will have to be made.

"In the long run," he added, "inability on the part of the networks to clear major stations would weaken the entire network system."

Others mentioned the possibility of guarantees figured "on a percentage basis" or calculated to "provide specific clearance levels in terms of stations and specific markets."

Another by-product seen as a long-term possibility by one agency executive was that "the rich networks may get richer and the poor networks poorer," with those having stronger affiliates and stronger programming more apt to get the clearances they need.

"Such a ban on option time," he asserted, "should be enacted only coincidentally with stepping up every market to three stations. The two actions should be married."

FCC Opposed ■ The FCC was criticized by the media director of another agency on the ground that it is "out to get the networks." This executive held that the commission has consistently spurred the networks to produce better program fare and yet now seem to be trying to "cut the financial legs out from

under them." If network finances suffer, he contended, network programming—and especially public affairs programming—will suffer.

This executive speculated that network clearances ultimately would be 10% below what they are now.

Film syndicators queried last week indicated for the most part that they don't expect the option time deletion to benefit them materially, for the same reason some of the agencies cited: The networks are the major sources of new programs of prime-time quality.

The director of syndication sales for a large film company speculated that there might have been a big difference six or seven years ago, when syndicators were distributing first-run programs.

He reasoned that if networks continue to produce hour programs that "eat up" schedules and continue to sell minute participations, the syndicator will still have to battle for time and for the type of national or regional advertiser that is likely to buy a first-run syndicated show.

Other executives of leading syndication firms were even more emphatic. They pointed out the abolition of option time in itself would make "very little difference" because stations, for competitive reasons, need a large supply of fresh programming in prime time. If the ruling not only banned option time but also forbade stations to take more than two or two and a half hours of network programs in prime time, that could spur the production of first-run syndicated properties, they asserted.

pensation plan" was found to be a violation of two rules: One prohibits stations from entering into contracts that prevent them from rejecting network programs. The other is the new option-time rule which not only bars time optioning contracts but any other arrangement "which has the same effect."

The commission ordered CBS and its affiliates who have signed incentive-compensation plan contracts to report on "steps taken to ensure compliance" with its ruling. Some 24 stations are affected, according to network officials.

The CBS plan is an amended version of one the commission rejected last year as a violation of the rules. The FCC said the earlier plan ran counter to a prohibition against affiliates entering into contracts that hinder them from taking programs from other networks.

The amended plan satisfied the com-

mission on this count. But the agency tentatively held last fall that the new version was contrary to the rule penalizing affiliates for refusing network programs—a position it affirmed last week.

Under the incentive plan, CBS affiliates are paid 10% of the station network rate for the first 60% of the programs they carry and 60% of the rate for the balance of the programming they accept.

'Frustrates Rule' ■ The amended plan, the commission said, "frustrates the purpose of the rule to reserve to stations freedom to reject network programs which the station reasonably believes to be unsatisfactory, unsuitable, or contrary to the public interest, or to substitute for CBS programs others of greater local or national importance."

The commission also said the plan, "both as originally tendered and as modified, involves a restraint which has

a like effect as does option time. It follows that the plan is inconsistent with the basic policy judgment arrived at [in the option-time decision], namely, that the networks cannot properly be afforded a restraint upon, or a 'shield' against, competition of the nature of option time."

Pharmacraft makes biggest summer buy

Pharmacraft Laboratories has bought \$4 million worth of summer business on NBC-TV, the largest summer order ever placed on that network by a single advertiser.

Included in the Pharmacraft order are the finals of the *International Beauty Pageant*, Friday, Aug. 16 (10-11 p.m. EDT); two other specials during the week of Aug. 11, and participations in programs in NBC-TV's regular summer nighttime schedule.

The order was placed through Pharmacraft's agency, Papert, Koenig, Lois Inc., New York.

Advertising by brewers is industry's main need

Beer advertising and lots of it is a prime need of the American brewing industry, Jack Samuels, marketing director of Lucky Lager Brewing Co. of San Francisco, told the Hollywood Advertising Club last Monday (May 27).

Beer consumption in the U. S. today is at a high of 90 million barrels a year, worth \$3.2 billion, Mr. Samuels reported. But, he noted, it has failed to keep pace with the population increase. Between 1950 and 1962, the nation's population rose from 151 million to 186 million (23.2%), while beer consumption rose only 8.4% (from 83 million to 90 million barrels a year). More than 60% of all beer sold today is packaged in bottles and cans and sold in food stores for home consumption, a radical change from the days when most beer was draft beer, purchased in restaurants and bars and consumed on the premises.

These two facts make advertising of utmost importance to brewers, Mr. Samuels stated. Lucky Lager, he said, is the only beer to start in California and move east (while Eastern beers were invading the West Coast) and he said this had been possible only because "Lucky Lager is a quality, well-advertised, well-merchandised beer."

The company's new advertising campaign, with the theme, "Go lively, get Lucky," was previewed by William L. Calhoun Jr., vice president of McCann-Erickson, San Francisco, Lucky Lager's agency. Radio and television commercials, outdoor posters and magazine pages will soon let the public know that "thirsty days are here again" and that Lucky Lager is the answer.

TAPE OR DISC FOR COMMERCIALS?

Agencies concerned over radio station transfer practices

A number of advertising agency executives disturbed last week by the disclosure that most radio stations are transferring their commercial messages from agency-supplied disc transcriptions to tape cartridges, seemed poised for a campaign of "friendly persuasion" with the local stations (CLOSED CIRCUIT, May 27).

The agencies were apprehensive that in the transfer from disc to tape the quality of the sound was being diluted. A survey conducted among 476 of the country's top 500 stations by agency D. P. Brother & Co. revealed that 406 of the stations did make transfers from disc to cartridge, and that among the other 71, there was considerable evidence that most of them used some sort of taping process for the broadcast of commercials.

Thus, the agencies felt, the careful attention they had given to quality supervision in the production and actual pressing of the records was lost in some cases by the not-so-careful transfer by the local station from disc to tape cartridge. "In one case," said an agency executive, "we found that a message had been recorded at 60 seconds, but after being transferred to tape, actually ran 64 seconds. You can imagine the loss of quality in that one."

Quality Concern — The concern of the agencies, however, was not in the use of tape itself. ("I have heard excellent tape transfers," said one executive, "and really couldn't tell it from the original disc recording.") Their expressed aims in a current series of agency meetings—thus far held in New York—is to seek a method of maintaining quality supervision over the commercial message through the transfer from disc to cartridge. Now the agency supervision ends with the pressing and shipping of discs to the stations.

"We realize that it is not feasible for many of the stations to use the actual disc. They are in a period of transition now and have spent thousands of dollars switching over to tape," said Mel Furney, the Brother agency executive who supervised the survey. "Nor is it feasible, though, for us to supply tape cartridges instead of disc recordings to the stations. They simply cannot be produced on the mass volume as disc recordings can."

Thus the stations are committed to tape, the agencies to discs. Out of such an impasse, the agencies hope to find an area of cooperation with the local stations by making specific technical recommendations to engineers who carry out the transfers to tape so that certain quality standards can be met.

Even here, however, the issue is clouded. The Brother survey indicated that among the 406 stations using tape cartridges for commercials, six different systems are widely used, and various others are used to a lesser degree. Thus the matter of making specific technical recommendations is complicated by the diversity of the equipment employed by the stations in making the transfers.

Hoping to reduce this diversity, representatives of various sound studios have contacted the tape manufacturers themselves seeking to bring about a greater uniformity of tape cartridges. A third phase involves an NAB study which has been going on for a year concerning such technical items as frequency response uniformity, flutter and wow and speed accuracy.

Several suggestions designed to bring stations and agencies into closer cooperation on the use of cartridges were advanced at a meeting last week in New York of several agencies who handle a large percentage of radio transcription work.

One proposal would have transcriptions labeled with instructions that the individual station contact the agency in

regard to taping procedure; another would have the agency insert a test cut on each transcription to allow station engineers to check out their tape cartridge equipment at the level at which the recording was made.

"We talked mainly in the area of communicating the situation to other agencies and to such groups as the Station Representatives Association, Radio Advertising Bureau and the American Association of Advertising Agencies," Mr. Furney said. "We eventually hope to have the 4A's issue a bulletin on the problem."

"Right now we are concerned with informing the stations that we are aware of their problem, and trying to find a manner in which we can help them. The stations have been very helpful so far, and we hope to find a way to solve this problem in a spirit of cooperation."

RADIO SUCCESS STORY

Household appliance firm's sales up 20-30% in 60 days

A campaign combining radio jingles with outdoor boards has achieved its intended goal. Re-establishing Mr. Gaffers and Mr. Sattler as readily recognizable advertising characters, identified with the household appliances marketed under the Gaffers & Sattler trademark. Robert Brandson, vice president and account supervisor, Charles Bowes Advertising, Los Angeles, told how it was done Thursday in a talk to the Southern California Broadcasting Association.

There has been a decided increase in consumer sales of the products—ranges, dishwashers, water heaters and air conditioners—which are running about 20-30% ahead of last year, he said. And it has been done in a period of 60 days.

Mr. Brandson and three other staff members of the Bowes agency—Harvey Pool, account executive; Mrs. Van Carlson, copy director, and Patricia Hale, media buyer—told SCBA that the characters had been introduced on television about 1958, but had not been advertised for some three years. The current campaign, they explained, was designed to re-establish recognition of these characters and their identification with the Gaffers & Sattler line of household appliances. A question-and-answer approach was adopted to tell the housewife what a Gaffers & Sattler appliance would do for her.

"Who bakes the cake? Gaffers and Sattler," a pair of male voices inform the radio audience. "Who keeps the water hot? Gaffers and Sattler." The rhythmic duet goes on to explain that "Gaffers & Sattler is the ultimate in cooking and no other range is so good looking" and that they are "skilled in



Pepsi introduces Patio

Pepsi-Cola has started a test campaign in Michigan for its new Patio Diet Cola with a broadcast-print saturation campaign. The soft drink, with one calorie per six ounces, is being introduced in a 12-week project. One-minute and 30-second spots have been placed on 30 radio stations in the state, including seven in the Detroit area. Pepsi's agency is BBDO.

WHICH IS THE IOWA FARMER'S ?

You think farm people are pretty much alike, all over the U.S. — or even in all “good farm states”?

Well, in Iowa, if you divide the farm population into gross farm income, you get \$4,214 *per person*. In rich Indiana, it's \$2,869. In rich Ohio, it's \$2,402. And Iowa has a lot *more* farm people than either!

We're not boasting. It's just that Providence gave us more than our share of Grade A land. Then the Grade A *farmers* came naturally — and prosperity, too, of course.

WHO Radio has been an enormous factor in the lives of Iowa farm people for *generations* — and WHO-TV is now. We believe we rank first in their confidence. You ought to come out and check it at their agricultural meetings, the Iowa State Fair, etc. You'd get some new insights on “audience loyalty.”



CHANNEL 13 • DES MOINES **WHO-TV**



PETERS, GRIFFIN, WOODWARD, INC.,
National Representatives



Cosmetics, toiletries up TV spending 33.1%

The 10 leading cosmetics and toiletries advertisers increased their television billings last year to \$117,319,730 from \$88,169,497 in 1961.

Alberto-Culver Co., with network and spot billings of \$24,477,005, led the 33.1% gain in TV expenditures.

The company, which rose from third to first place in product classification, spent \$12,319,093 in TV in 1961.

Procter & Gamble and Gillette were second and third, respectively, in television billings, with each showing increases of nearly \$1 million.

Other large increases reported last year were: Bristol-Myers, to \$14,677,433 from \$8,957,682; Chesebrough-Pond's to \$6,712,802 from \$3,626,473; and Armour & Co. (Dial soap and shampoo) to \$5,299,750 from \$2,691,663.

1962 COSMETICS & TOILETRIES TIME AND SPACE BILLINGS LEADING ADVERTISERS

	Total TV	Network TV	Spot TV	Magazines	Outdoor	Newspapers	Total	% TV
Alberto-Culver	\$ 24,477,005	\$13,322,015	\$11,154,990	\$ 20,424	\$ —	\$ —	\$ 24,497,429	99.9
Procter & Gamble	17,926,828	11,094,358	6,832,470	871,567	—	74,937	18,873,332	95.0
Gillette	17,402,597	13,550,447	3,852,150	527,707	—	813,309	18,743,613	92.8
Bristol-Myers	14,677,433	10,186,603	4,490,830	6,741,391	100,800	1,675,032	23,194,656	63.3
Colgate Palmolive	13,829,439	9,152,649	4,676,790	588,205	—	230,606	14,648,250	94.4
Chesebrough-Pond's	6,712,802	4,030,352	2,682,450	2,477,489	—	42,544	9,232,835	72.7
Carter Products	6,014,692	2,804,632	3,210,060	221,070	—	—	6,235,762	96.5
Helene Curtis Industries	5,798,242	2,749,472	3,048,770	1,391,524	—	434,187	7,623,953	76.1
Armour	5,299,750	3,141,840	2,157,910	2,279,360	—	541,214	8,120,324	65.3
Lever Bros.	5,180,942	3,882,572	1,298,370	769,414	—	10,797	5,961,153	86.9
	\$117,319,730	\$73,914,940	\$43,404,790	\$15,888,151	\$100,800	\$3,822,626	\$137,131,307	85.6%

Sources:

Television: TvB-Rorabaugh and LNA-BAR
Newspapers: Bureau of Advertising

Magazines: Leading National Advertisers
Outdoor: Outdoor Advertising Inc.

the sciences of making fine household appliances" and "our mission in life is making things easier for the housewife." The outdoor boards follow the same Q-and-A theme by showing an appetizing cake, a girl luxuriating in a hot tub and other pleasant results of the use of Gaffers & Sattler products, together with pictures of the two characters, but not of the appliances. "Nobody wants to buy a water heater," Mr. Brandon stated. "What the purchaser wants is plenty of hot water, for bathing—or dishes, so that's what we try to talk about in the advertising."

The 13-week campaign began March 25 in five markets, using four radio stations in Los Angeles, two in San Francisco, two in Sacramento, and one in San Jose (all California) and one in Houston, Tex., ("The distribution of Gaffers & Sattler products is spotty," the agency group commented.) The schedule calls for 10 to 20 spots a week per station. ("We'd like to use more, but that's all the budget permitted.")

Agency appointments...

▪ E. F. Hutton & Co., Los Angeles, names Interpublic's McCann-Marschalk Division to handle advertising for the brokerage firm's Southern California, Arizona and New Mexico offices.

▪ West Coast Trade Schools appoints Asher/Gould Advertising, Los Angeles. WCTS has budgeted \$200,000 for fiscal year ending June 1, 1964, to increase student enrollment through local newspapers and TV.

▪ Perfect Photo Inc., Los Angeles, has named Donahue & Coe, that city. Per-

fect Photo, which claims to be the largest independent photo processing firm in the nation, will have an estimated 1963 billing of over \$500,000. Donahue & Coe has already produced a series of radio and TV commercials featuring Art Linkletter.

▪ Orbar International Ltd., Aurora, Ill., proprietary manufacturer, has named Olian & Bronner Inc., Chicago, as agency. Radio will be used.

▪ Avery Adhesive Products has named Boylhart, Lovett & Dean, Los Angeles, to direct advertising and sales promotion for the company's new Rotex division, which is introducing on-the-spot marking equipment for home, business and industrial use. W. J. Boylhart is account group supervisor.

▪ The Monroe Auto Equipment Co., Monroe, Mich., appoints Daniel F. Sullivan Co., Boston, to handle advertising, publicity and sales promotion in New England states. Radio and newspapers will be used.

▪ National Mutual Benefit (life insurance firm), Madison, Wis., appoints Baker, Johnson & Dickinson, Milwaukee, to handle advertising and sales promotion.

Also in advertising...

AAAN is new name ▪ Affiliated Advertising Agencies International is the new name for the Affiliated Advertising Agencies Network. Approved at the organization's annual meeting in Los Angeles, the change reportedly reflects the organization's increasing international character, according to Virgil A.

Warren, managing director. AAAI has members in 25 states and 13 countries.

ABBB messages ▪ The Association of Better Business Bureaus has released a series of seven public service messages—color slides with related copy of 8, 20, or 60-second length—for use by TV stations. Following test airing of the announcements, the three networks have advised all their affiliates of the series. It's priced at \$25 a set and is available at local BBB offices.

Agency expansion move ▪ Kudner Agency Inc., New York, has moved to larger quarters at 605 Third Avenue, occupying the eighth and ninth floors. Kudner had been at 575 Madison Avenue for the past 12 years.

AFA seminar ▪ Advertising Federation of America's fifth annual seminar in marketing management and advertising will be held at Harvard University June 30-July 12. Fee is \$590. For information, contact Professor George T. Clarke, AFA, 655 Madison Avenue, New York 21.

Business briefly...

Xerox Corp., Rochester, N. Y., will sponsor a repeat of NBC News's *The Kremlin* Tuesday, June 4 (7:30-8:30 p.m. EDT). Xerox also sponsored the original May 21 telecast, which was reported to be the most expensive TV documentary ever produced. The cost: about \$250,000. Agency: Papert, Koenig, Lois Inc., New York.

Tidewater Oil Co., through Grey Advertising, Beverly Hills, Calif., has doubled its advertising on ABC Radio



Nine times out of ten, discretionary income is spending money — and there's 27% more of it (on the national average) in Ohio's Third Market. No medium — but none — covers it as thoroughly as WHIO-TV, AM, FM. George P. Hollingbery will be pleased to tell you more.

Additional morsel for thought:

Good Labor-Management Relations. Less idleness through work stoppages than any city its size, last ten years. (Source: Dayton Area Chamber of Commerce.)

Associated with WSB, WSB-TV, Atlanta, Georgia, WSOC, WSOC-TV, Charlotte, North Carolina and WIOD, Miami, Florida



DAYTON, OHIO • WHIO • AM • FM • TV

COMMERCIAL PREVIEW: Artra cosmetics starts second series



Bettye Mason applies Artra beauty base during one of the commercials.

Pharmaco Inc., of Kenilworth, N. J., has begun its second flight of commercials using all-Negro talent. The spots for Pharmaco's Artra cosmetics line are used on *TV Gospel Time*, a weekly half hour program with all-Negro talent, shown in 24 East, South, Southwest and Midwest markets.



Patricia Ann McCoo demonstrates Artra hair dressing and conditioner product.

Among models used in the commercial series are Marlene Rankin, 1960 homecoming queen at Ohio State University; Bettye Mason, who has appeared in USO and summer stock shows, and Patricia Ann McCoo, a ballerina.

Pat Connell, the announcer and Miss Mason, who has appeared for



Marlene Rankin and Bob Anderson dance in Artra moisture cream spot.

another Pharmaco product, are the only members of the group with prior experience in TV commercials.

The spots, shot at Wilding Inc., Chicago, are for five Artra products, skin cream, soap, hair dressing and conditioner, moisture cream and medicated foundation cream. Agency is Tucker Wayne Co., Atlanta.

West by assuming full sponsorship of *Weekend West* of which it was originally co-sponsor, starting June 1. The five-minute human interest program is broadcast four times Saturday and four times Sunday between 9:30 a.m. and 4:30 p.m. Tidewater promotes its Flying A Paris contest on the shows.

Goodyear Tire & Rubber Co., through Young & Rubicam, and **Wilson Sporting Goods Co.**, through Campbell-Mithun, will sponsor NBC-TV's coverage of the final day of the United States Golf Association Open Tournament Saturday June 22 (4:30-6 p.m. EDT) from Brookline, Mass.

The Marathon Oil Co., through Camp-

bell-Ewald, Detroit, has signed for 52 weeks on Storer Broadcasting Co.'s WSPD-TV Toledo, Ohio, as sponsor of a 40-second news summary five nights a week in prime time. The show, developed by WSPD-TV and Campbell-Ewald, is being placed in 11 Midwest markets, according to Jack Phillips, Marathon advertising manager.

Pabst Brewing Co. (through Kenyon & Eckhardt), **Goodyear Tire and Rubber Co.** (Young & Rubicam), **P. Lorillard (Grey)** and **Georgia-Pacific Corp.** (McCann-Erickson) will sponsor CBS-TV's coverage of the Professional Golfers Association (PGA) tournament. The tournament's last two days will be aired Saturday, July 20 (5-6 p.m. EDT), and

Sunday, July 21 (4:30-6 p.m. EDT), and if a playoff is necessary, coverage will be carried 5-6 p.m. Monday.

RADIO BUSINESS UP

Gallagher surveys radio management

Radio's gross billings are on the increase. Of 1,003 station executives responding to a questionnaire, 77.3% said their gross for 1963 would be an average of 18.8% higher than 1962. Only 6.3% predicted the billings would drop an average of 7.6% and 16.4% said they would be constant. The figures were published by *The Gallagher Report*, a New York media-advertising newsletter.

The majority of stations said their 1962 gross income was between \$25,000 and \$199,999 with 45.6% falling in the \$25,000 to \$99,999 category and 28.6% from \$100,000 to \$199,999. Only 5.1% reported gross of less than \$25,000 and 1.9% reported more than \$1 million.

Little more than a third of the executives (35.4%) planned to increase their rates during the year an average of 13%, while 63.2% said they would keep the same rates. Only 1.4% said their rates would drop, but that average was 14.0%.

Ratings services and the National Association of Broadcasters were represented in the survey and broadcasters had many opinions on both.

Slightly more than half the stations

'Yearbook' ad draws Nigerian pen pal

A key advertising agency executive in New York got himself an offer to be a pen pal of Lateforce Abbey, a 17-year-old student in Lagos, Nigeria. The pathway for the student: an advertisement in *BROADCASTING Magazine* for the *BROADCASTING YEARBOOK*.

Arthur S. Pardoll, associate media director of Foote, Cone & Belding, New York, was one of several agency executives whose testimonials for the *YEARBOOK* appeared in an advertisement. He recently received the letter from Nigeria enclosing a clipping from the advertise-

ment and with a notation that "the full name and address" were obtained through cross-reference of the *YEARBOOK's* agency listings.

Offered as friendship tokens: "Ebony carving knives, wallet made of animal's skins, dagger knife, handbag made of animal skin, slippers of camel skin." Mr. Pardoll wrote the youthful correspondent, explaining his agency and family responsibilities prevented him from regular correspondence but adding that another New York employe of Foote, Cone & Belding was writing the Nigerian as a pen pal.



COVERAGE * First in the 17th market*... PROVIDENCE
... the whole market. One million homes ...
three states ... one billion consumer dollars. WJAR-TV... 100% reach ...
continuing leadership in a 3-station market. And ... the people are fine.
Come on in.

*Television Magazine March 1963

WJAR-TV

NBC ——— REPRESENTED BY EDWARD PETRY & COMPANY, INC.
OUTLET COMPANY STATIONS IN PROVIDENCE — WJAR-TV, FIRST TELE-
VISION STATION IN RHODE ISLAND — WJAR RADIO IN ITS 40th YEAR



Volume 7 from Seven Arts' great library of "Films of the 50's" is now available for TV.

Among these new TV "money-makers of the 60's" are such show stoppers from Twentieth Century-Fox as "Desk Set," "Will Success Spoil Rock Hunter," "Hatful Of Rain," "Mr. Belvedere Rings The Bell," "Oh Men, Oh Women," John Steinbeck's "The Wayward Bus," "Siege At Red River," "House On Telegraph Hill," "The Best Things In Life Are Free" and "Between Heaven and Hell."

Stars? They shine aplenty in Volume 7! Spencer Tracy, Katharine Hepburn, Anthony Quinn, Marilyn Monroe, Tony Randall, Loretta Young, David Niven, Jayne Mansfield, Vincent Price, Barbara Stanwyck, Ernest Borgnine, Dorothy McGuire, Richard Widmark, Virginia Mayo, Tyrone Power, Jeanne Crain, Clifton Webb, Thelma Ritter, Tom Ewell, Ginger Rogers, David Wayne, Joan Collins, Victor Mature, Gene Tierney, and many, many others.

For a complete listing of the 50 films contained in Seven Arts release of Volume 7 contact your nearest Seven Arts salesman at the offices listed at right.

VOLUME

SEVEN ARTS

SEVEN



**SEVEN ARTS
ASSOCIATED
CORP.**

A SUBSIDIARY OF SEVEN ARTS PRODUCTIONS, LTD.

NEW YORK: 200 Park Avenue 972-7777

CHICAGO: 4630 Estes, Lincolnwood, Ill. ORchard 4-5105

DALLAS: 5641 Charleston Drive ADams 9-2855

LOS ANGELES: 3562 Royal Woods Drive, Sherman Oaks, Calif.
STate 8-8276

TORONTO, ONTARIO: 11 Adelaide St. West EMpire 4-7193

Winners in American TV Commercials Festival competition

Listed below are the winners in the fourth annual American TV Commercials Festival as announced May 24 in New York (AT DEADLINE, May 27).

Each listing includes, in order, the product advertised, the commercial's name, the advertiser, agency and production company.

Best—overall series: Goodyear Tires—"Go, Go Goodyear"; Goodyear Tire & Rubber Co.; Young & Rubicam; VPI Productions.

Best—apparel: Scotchgard—"Raincoat"; Minnesota Mining & Mfg.; MacManus, John & Adams; MGM Telestudios.

Best—appliances (Home): G.E. Can Opener—"Brand New"; General Electric; Maxon; Elektra Films.

Special citation—office appliance: Xerox—"Chimp"; Xerox Corp.; Papert, Koenig, Lois; Elliot, Unger & Elliot.

Best—automobiles: VW Station Wagon—"Box"; Volkswagen of America; Doyle Dane Bernbach; VPI Productions.

Special citation—best trucks: Chevrolet—"Egg Demonstration"; Chevrolet Div., General Motors; Campbell-Ewald; Ty Thysen, Hollywood.

Best—auto accessories: Goodyear Tires—"Go, Go Goodyear"; Goodyear Tire & Rubber Co.; Young & Rubicam; VPI Productions.

Best—baked goods and confections: Laura Scudder Potato Chips—"Old Lady"; Laura Scudder Div., Pet Milk Co.; Doyle Dane Bernbach; Elliot, Unger & Elliot.

Best—baking mixes: Pillsbury Pancakes—"White On White"; The Pillsbury Company; McCann-Marschalk; Robert Lawrence Productions.

Best—banks and financial: Chase Manhattan—"New York Is People"; Chase Manhattan Bank; Ted Bates; Sarra Inc.

Best—bath soaps and deodorants: Ivory Bar—"Susie's Bath"; Procter & Gamble; Compton Advertising; On Film Inc.

Special citation—baby products: Gentle—"Baby Bath"; The Mennen Company; Grey Advertising; Saul Bass/WCD, Hollywood.

Special citation—best-baby products: Gentle Baby Bath—"New Baby"; The Mennen Company; Grey Advertising; Saul Bass with WCD Inc.

Best—beers and wines: Jax—"What's Its"; Jackson Brewing Co.; Doherty, Clifford, Steers & Shenfield; Pelican Films.

Best—breakfast cereals: Kellogg's Raisin Bran—"Wind-Up Wanda"; The Kellogg Company; Leo Burnett; Hanna & Barbera.

Best—cleansers and waxes: Windex—

"Line-up"; The Drackett Company; Young & Rubicam; Elliot, Unger & Elliot.

Tie for best—building products: Alcoa—"School Constructions"; Aluminum Company of America; Fuller & Smith & Ross; Pelican Films.

Tie for best—building products: U. S. Plywood—"Box"; United States Plywood; Kenyon & Eckhardt; MPO Videotronics.

Best—coffee and tea: La Touraine Coffee—"Not Just a Little"; La Touraine Coffee Co.; Hicks & Greist; On Film Inc.

Best—cosmetics and toiletries: Trushay—"Five Women"; Bristol-Myers; Grey Advertising; Norman Gaines.

Special citation—best-men's toiletries: Hi Sierra—"That's My George"; The Mennen Company; Grey Advertising; VPI Productions.

Best—dairy, margarines, health drinks: Foremost Milk—"Drop For Drop"; Guild, Bascom & Bonfigli; Fred Niles Communications Centers.

Best—gasolines and lubricants: Sinclair—"Long Pullback"; Sinclair Oil Co.; Geyer, Morey & Ballard; Paramount.

Best—gift items: Polaroid—"Boy With Trumpet"; The Polaroid Corporation; Doyle Dane Bernbach; Pelican Films.

Best—women's hair preparations: Ozon Hair Spray—"Mother & Baby"; Ozon Products Inc.; Sudley & Hennessy; On Film Inc.

Best—home furnishings: Rubbermaid Bath Mat—"Sound of Safety"; Rubbermaid Inc.; Ketchum, MacLeod & Grove; Van Praag Productions.

Best—institutional: Hallmark—"Christopher Columbus"; Hallmark Cards; Foote, Cone & Belding; Robert Lawrence Productions.

Best—insurance: Liberty Mutual Business Lines—"Welder"; Liberty Mutual; BBDO; WCD Inc.

Best—laundry soaps & detergents: Ivory Flakes—"Mother Cares"; Procter & Gamble; Grey Advertising; Mickey Schwarz Productions.

Best—media & entertainment: "Madame" with Sophia Loren; Embassy Pictures; Ferro, Mohammed & Schwartz.

Best—packaged foods: Betty Crocker—"Noodles Italiano"; General Mills; Doyle Dane Bernbach; Tele-Video Inc.

Best—paper products, foils: Zee Paper Napkins—"King"; Crown Zellerbach; Doyle Dane Bernbach; Producing Artists.

Best—pet products: Gaines Gravy Train—"Dane & Ducks"; General Foods; Benton & Bowles; Sutherland Associates.

Tie for best—pharmaceuticals: Allerest—"Weeds"; Pharmacrast; Papert, Koenig, Lois; Elliot, Unger & Elliot.

Tie for best—pharmaceuticals: Excedrin—"Testimonials"; Bristol-Myers; Young & Rubicam; Audio Productions.

Best—public service: Teenage Veneral

Disease Prevention—"Rose"; New York City Public Health Dept.; Grey Advertising; Klaeger Films.

Best—retail stores: Sears-Roebuck—"Back To School"; Sears-Roebuck; Ogilvy, Benson & Mather; WCD Productions.

Best—soft drinks: Sprite—"Spice"; Fanta Beverage Co.; McCann-Marschalk; VPI Productions.

Best—toys: Goofer Gun—"Elephant"; Marx Toy Co.; Ted Bates; Filmways of California.

Best—travel and transportation: Hertz—"Suzy Parker Out West"; Hertz Corporation; Norman, Craig & Kummel; Filmex.

Best—utilities: AT&T Long Lines—"Between Planes"; N. W. Ayer & Son; Tele-Video.

Best—8-10 second ID's: Gulden's Diablo Mustard—"Hot Sandwich"; Charles Gulden Co.; Richard K. Manoff; Farkas Films.

Best—program openings and billboards: Ford Fairlane—"Lively Ones"; Ford Division, Ford Motor Co.; J. Walter Thompson; Filmways of California.

Best—premium offer: Yuban Coffee—"Glass Blower"; General Foods; Benton & Bowles; MPO Videotronics.

Best—children's market: Cracker Jacks—"School Bus . . . Candy Store"; The Cracker Jack Company; Doyle Dane Bernbach; Rose-Magwood Productions, New York.

Best—program cast commercial: Sid Caesar—"Waiting Room"; Dutch Master Cigars; Papert, Koenig, Lois; ABC-TV.

Best—Canadian market: Anacin—"Man In Office"; Whitehall Laboratories; Young & Rubicam, Toronto; Rabko TV, Toronto.

Best—French-Canadian market: Kellogg Rice Krispies—"Lucky Coin"; Kellogg Co. of Canada Ltd.; Leo Burnett Co. of Canada; Peterson Productions, Toronto.

Best—Southwest market—tie: Champlin—"Wheat"; Champlin Oil & Refining; Tracy, Locke, Dallas; Jamieson Films, Dallas.

Best—Southwest market—tie: Shamrock Equa Flow Oil—"Like Two"; Shamrock Oil & Gas Co.; McCormick Advertising, Amarillo, Tex.; Alexander Film Co., Colorado Springs, Colo.

Best—West Coast market: Harrah's—"Coming Attractions"; Harrah's, Lake Tahoe, Nev.; Hoefler, Deiterich & Brown, San Francisco; Imagination Inc., San Francisco.

Special citation: best—budgeted under \$2,000: Revere—"Stereo Tape Cartridge"; Revere Camera Co.; Erwin Wasey, Ruthrauff & Ryan; MGM Telestudios.

Special citation: best—locally-produced: Birch Bayh For Senator—"Hey Look Him Over"; Citizens For Birch Bayh; Bob Long Associates, Indianapolis; Tee Vee Films, Indianapolis.

Special citation—best black and white cinematography: Award sponsored by

(50.7%) said they favor a ratings bureau run by a tripartite board of advertisers, agencies and radio stations; 16.8% are not in favor, and 32.5% are uncertain.

The overwhelming majority of respondents said they feel there is too much emphasis on the ratings services in general (92.4%); 1.3% not enough emphasis and 6.3% just about right.

Only 54.2% of the stations subscribe to a ratings service and in all cases the majority of subscribers felt that raters' work was poor. Pulse, the largest service subscribed to, is bought by 25.9%, and 58.6% of those clients consider the firm's work poor; 5.3% call it excellent; 36.1% say it is fair.

Hooper, which is bought by 12.9%

of the stations is considered poor by 64.3% of its clients; 4.5% excellent and 31.2% fair. Nielsen is considered poor by 71.7% of the 8.4% of the stations it services; 5.2% give it an excellent rating and 23.1% call it fair.

Conlan, which is bought by 3.8% of the stations, is considered poor by 85.4% of its clients and fair by 14.6%. None of its buyers call its work excellent.

NAB membership is held by 57.2% of the respondents, but of this number only 61.6% subscribe to the NAB code. Of the stations belonging to the NAB, 75.4% feel the code is just about right; 17.1% too strict, and 7.5% too lenient. Two-thirds of the members (66.9%) feel generally favorable toward what the

NAB is doing.

The 42.8% of the stations who don't belong to the NAB had a variety of reasons for not being members. At the top of the list were the 47.9% who said dues are too high; 37.6% say the organization is dominated by large stations; 25.8% see no benefit to the station; 23% feel NAB is too nationally oriented, and 20.2% disagree with the association's policies. The remaining 15.4% give other views for not joining.

The Radio Advertising Bureau shows a smaller membership among the respondents (38%) and 41.3% of these members consider the association's work excellent; 47.0% fair, and 11.7% poor.

The FCC's "attempts to improve programming in radio" is considered bad by

Eastman Kodak Co.; Sprite Soft Drink—"Spice"; VPI Productions; Cinematographer: Leonard Hirschfeld.

Special citation—best color cinematography: Award sponsored by RCA: Ford Thunderbird—"How Would You Like"; J. Walter Thompson Co.; Cinematographer: George Folsey; Group Produs.

Special citation—best video-tape production: Award sponsored by the 3M Company; Schaefer Beer—"Bowling"; F&M Schaefer Brewing Co.; BBDO Inc.; MGM Telestudios.

Citation—best location video-tape production: Timex Watches—"Acapulco Series"; United States Time Corp.; Warwick & Legler; Telesistemo, Mexico.

Special citation—best editing: Award sponsored by Movielab Inc.; Goodyear—"Go, Go, Goodyear"; Young & Rubicam; VPI Productions; Armand Lebowitz, ed.

Special citation—best direction: Cracker Jacks—Children's & Adult Series; The Cracker Jack Company; Doyle Dane Bernbach; Rose-Magwood Productions; Howard Magwood, director.

Special citation—best animation design: Chevrolet announcement for 1963 models; Campbell-Ewald Company; Elektra Films; Abe Liss, Sam Magdoff, Jack Schnerk, Joanne Mitchell—designers.

Special citation—special effects: Trubay Hand Cream—"Five Women"; Bristol-Myers; Grey Advertising; Norman Gaines Productions & Synchrofilm.

Special citation—production effects: Chevrolet visits Venice; Campbell-Ewald; Arco Film Productions.

Special citation—use of graphics: Ford—1963 pre-announcement; J. Walter Thompson; Ferro, Mohammed & Schwartz.

Music scoring—special citation: Goodyear—"Go, Go Goodyear"; Young & Rubicam; VPI Productions; Bill Thompson, music director, Hollywood.

Special citation—music with lyrics: Ford—"Lively Ones"; J. Walter Thompson; Sid Woloshin & Jack Wohl, music composers; Jerry Jerome, arrangement and direction.

Special citation—best use of humor: Laura Scudder Potato Chips—"Old Lady"; Laura Scudder Div., Pet Milk Co.; Doyle Dane Bernbach; Elliot, Unger & Elliot.

Special citation—best copy: VW Station Wagon—"Box"; Doyle Dane Bernbach; Robert Levenson, copywriter.

Special citation—best demonstration: Chevrolet Trucks—"Egg Demo"; Campbell-Ewald; Ty Thyssen Productions, Hollywood.

Special citation—on camera spokesman: Jack Gilford for Cracker Jacks; The Cracker Jack Company.

Special citation—off camera spokesman: Alexander Scourby for Johnson & Johnson, Exedrin, Olin Mathieson and others.

Special citation—on camera spokeswoman: Joan Anderson for Purolator Oil Filter.

Special citation—off camera spokeswoman: Darlene Zito for Sprite soda,

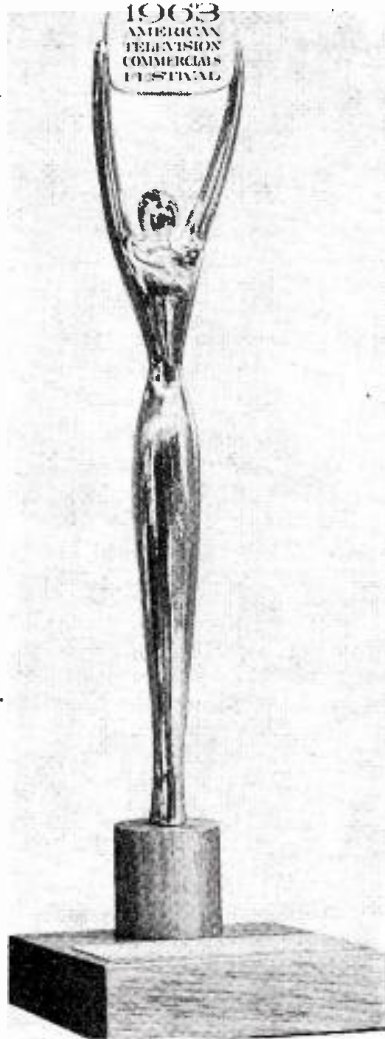

Yuban, Zest, Brylcreem and others. Festival director's citation: Gillette Safety Razor Co. and Maxon Inc. For maintaining an enviable record of originality, taste and style, with a directness of selling approach since the early days of television. While bringing to the American public an unparalleled parade of extra-special attractions, Gillette has consistently demonstrated its respect for that public and for its own role as an advertiser.

68% of the respondents; 16.1% feel the commission's work is good, and it doesn't make much difference to 15.9%.

Persuasive compliance sought by FTC member

The Federal Trade Commission should adopt new policies to "persuade businessmen" into voluntary compliance with the law, FTC Commissioner Everette MacIntyre has recommended. Speaking before the Society of Business Advisory Professions Inc. in New York, he said he would urge the agency to adopt new procedures for voluntary compliance to be used before the FTC institutes formal litigation.

Such practices "could mark the real

beginning of an effective partnership of government and business in developing a program for voluntary compliance," he said. The end result "would be a greater degree of fairness and far more effectiveness . . ." on the part of the FTC.

Commissioner MacIntyre admitted that his plan is a controversial one among the other four members of the trade commission. He also said that he is against additional delegation of authority by the agency to its staff, another move that has substantial support. "I do not believe that any businessman should be made the subject of charges in a complaint unless it has been fully considered and the commission itself has been led to believe that a violation

of law has been or is being committed," he said.

Members of the FTC should not be able to shirk responsibility "by pointing to unspecified members of the commission's staff and saying, 'There is where the error was made,'" Commissioner MacIntyre said.

Plough denies false ad claims on St. Joseph

Plough Inc. last week denied Federal Trade Commission charges that it has made false advertising claims for St. Joseph aspirin and countered that the FTC complaint is not in the public interest.

The trade commission has charged both St. Joseph and Bayer aspirin (manufactured by Sterling Drug) with false advertising because of their use of an FTC-backed medical study of five different pain killers (BROADCASTING, March 25).

Plough, Memphis-based firm which also owns five AM-FM combination radio stations, claimed that its ads were factual because the study proved that St. Joseph aspirin is less irritating to the stomach than higher priced combinations and is, in fact "a competitively better buy than any of the other pain relievers studied." The FTC proceeding, Plough and its advertising agency Lake, Spiro, Shurman Inc., Memphis, charged, seeks to withhold information from the buying public which "has a right to know the facts concerning the clinical study of pain relievers."

Radio stations owned by Plough include WMPs-AM-FM Memphis, WJJD-AM-FM Chicago, WCOP-AM-FM Boston, WCAO-AM-FM Baltimore and WPLO-AM-FM Atlanta.

Warwick & Legler drops its Revlon account

Warwick & Legler, New York, announced last week it has resigned its portion of the Revlon account, including Clean and Clear, Silicare, Natural Wonder and Contempera. Billing is estimated at \$1.5 million.

This move means there is now approximately \$6.5 million in Revlon billing that is officially unassigned. In April, Revlon reported it was withdrawing about \$5 million in business from Norman Craig & Kummel, New York (BROADCASTING, April 15).

Rep appointments . . .

■ KCHU(TV) San Bernardino, Calif.: John E. Pearson Television, New York, as national representative.

■ WEAU-AM-FM Evanston, Ill.: Mort Bassett & Co. as national representative.

■ WOMP Bellaire, Ohio (Wheeling, W. Va.): Roger O'Connor Inc., New York, as national representative.

Drop-ins end up in short-spaced grave

ADVERSE EFFECT ON UHF IS MAJOR POINT IN FCC DECISION

The FCC last week finally buried its proposal to drop short-spaced VHF channels into seven markets as a means of providing those areas with a third VHF network. The vote on the controversial issue was 4-3.

The commission held that the proposal is no longer needed to improve the competitive position of ABC with respect to CBS and NBC and that approval of the drop-ins would impede the development of UHF television.

The majority also maintained that enactment last year of the all-channel receiver legislation has considerably changed conditions in television since the commission originally proposed the drop-ins two years ago (BROADCASTING, July 31, 1961). The commission is counting on the new law to promote the spread of UHF stations.

Solid Victory ■ Supporters of UHF TV consider the order an all-out victory, for it indicates the commission in the future will be extremely solicitous of UHF's welfare. They say the commission's position on the drop-ins

means every proposal for a VHF channel drop-in or change in location—even at standard separations—will have to be scrutinized to determine whether it will adversely affect the development of UHF.

The markets that were to have received the drop-ins are Johnstown, Pa. (channel 8); Baton Rouge, La. (channel 11); Dayton, Ohio (channel 11); Jacksonville, Fla. (channel 10); Birmingham, Ala. (channel 3); Knoxville, Tenn. (channel 8); and Charlotte, N. C. (channel 6).

The commission, in the same order as that denying the drop-ins, modified the license of KOCO-TV, now on channel 5 in Enid, Okla., to specify operation on that channel in Oklahoma City. But, the commission said, the station will be required to observe standard mileage separations and to maintain an auxiliary studio in Enid to provide local service for that community. Originally, the commission proposed moving channel 5 to Oklahoma City at sub-standard spacing.

Voting to deny the drop-ins were outgoing Chairman Newton N. Minow, his successor as chairman, E. William Henry, and Commissioners Robert T. Bartley and Robert E. Lee. Commissioners Frederick W. Ford, Rosel H. Hyde and Kenneth A. Cox dissented.

This was the same line-up by which the commission instructed the staff three months ago to draft the order denying the drop-ins (BROADCASTING, March 11).

Cox Tries ■ Commissioner Cox reportedly made a strong argument for a compromise proposal to head off outright rejection of the drop-ins. Under his plan, the drop-ins would have been approved, but successful applicants for the channels would have had to operate dual UHF-VHF stations and then surrender their VHF channels after seven years.

The commission, in originally proposing the drop-ins was concerned about the immediate need for service in the affected markets as well as ABC's need for additional VHF affiliates. And that network was the strongest supporter of the drop-in plan.

The FCC last week, however, said that while programs to assign three VHF channels to major markets have done much to rectify the competitive imbalance between the networks, "they have done little to advance a final solution of utilizing the UHF frequencies. Rather, these programs have prejudiced long-range UHF growth by removing demand for the service.

"In view of what has been accomplished to aid the network television structure and the considerations stemming from the enactment of the all-channel receiver legislation," the commission added, "the continuation of 'interim' programs cannot be justified."

By rejecting the drop-in proposal, the commission jettisoned the second part of a two-part package it proposed in 1961 as a partial solution to the UHF-VHF problem. The other part dealt with the deintermixture of eight markets through the deletion of their VHF channels to make them all-UHF.

That proposal created a storm of controversy in Congress, and the commission, then campaigning for passage of its all-channel receiver bill, promised to drop the plan if the receiver bill were passed (AT DEADLINE, March 19, 1962).

WAVE-TV and WFIE-TV

Cover 383.1 miles of the Ohio River Valley!

(in Depth as well as Width!)

WAVE-TV, Louisville
 WFIE-TV, Evansville
 WAVE Radio, Louisville
 WFRV(TV), Green Bay

ALL NBC—ALL REPRESENTED BY THE KATZ AGENCY

IF IT CONCERNS RADIO OR TELEVISION LOOK IN THE . .

1963
BROADCASTING YEARBOOK
50 directories indexing the business world of tv and radio
SIX reference works in ONE
"One-book library of television and radio information"

FACILITIES OF TELEVISION: Station profiles, call letters, channels, allocations, applications pending, catv, translators; group and news paper/magazine ownership, station sales.

FACILITIES OF AM/FM RADIO: Station directory includes executive personnel, speciality programs, reps, call letters, frequencies; Canada, Mexico-Caribbean stations.

BROADCAST EQUIPMENT/FCC RULES: Manufacturers & services, new Product Guide; awards and citations, television network map.

CODES/PROGRAM SERVICES: Tv and radio codes; program producers, distributors, production services, news services, talent agents, foreign language and negro programming by stations; broadcast audience data.

REPRESENTATIVES, NETWORKS, TRADE GROUPS including regional reps and networks; attorneys, consultants, engineers, associations; U.S. govt. agencies; news and farm directors.

AGENCIES, ADVERTISERS, BILLINGS: Leading advertisers, agencies and their billings; books and reference works; schools, major trends, events, agency financial profile 1952-61.

Designed for your specialized "must know" references, the 1963 BROADCASTING Yearbook issue is the largest (632 pages) and most complete encyclopedia-type book ever published for the business of radio-tv broadcasting and the associated arts and services. It includes 50 separate directories of basic economic technical and business facts indispensable to all working in or contacting the worlds of radio and television.

Compiled, written and edited by the same staff that produces BROADCASTING—The Business-weekly of Television and Radio —serving the business of broadcasting since 1931.

Please order now to avoid disappointment. Last year's edition sold out earlier than usual despite the increased print order.

LIMITED EDITION
\$5.00 copy

-----USE THIS COUPON TO ORDER YOUR COPY NOW.-----



BROADCASTING
THE BUSINESSWEEKLY OF TELEVISION AND RADIO

1735 DeSales Street, N.W.,
Washington 6, D. C.

1963 Yearbook and the next
52 issues of BROADCASTING Businessweekly—\$12.00

52 issues of BROADCASTING Businessweekly—\$7.00

1963 BROADCASTING Yearbook only—\$5.00

Payment Enclosed Please Bill

name title/position*

address Business
 Home

city zone state

company name

*Occupation Required

KWK LOSES ITS LICENSE

FCC reverses initial decision by 3-2 vote for 'willful and repeated' fraudulent contests

The FCC last week revoked the license of KWK St. Louis for having conducted fraudulent contests which were "willful and repeated." The commission's latest death penalty was decided by a 3-2 vote, and reversed an initial decision by Hearing Examiner Forrest L. McClenning.

The commission instigated the revocation case against KWK in November 1960. The station was charged with having conducted two treasure hunts in which the treasures were not hidden until the last day. KWK was also cited for operating a "Bonus Club" which the commission claimed caused gross inconveniences to several winners in station contests.

Hearing Examiner McClenning's initial decision, issued last fall, found that the contests had been fraudulent, but that the KWK owners were not aware that they were so. Mr. McClenning decided that the fault lay with KWK's former vice president and general manager, William Jones Jr. (Mr. Jones died in May 1962), and ruled that Andrew Spheeris, president and major stockholder, acted in good faith as soon as he discovered the misrepresentations of the contests.

tations of the contests.

The Broadcast Bureau opposed Mr. McClenning's findings, maintaining that if the KWK license were not revoked it would be a violation of the FCC's policy established when KRLA Pasadena, Calif., was revoked. The commission then established that an absentee licensee is to be held responsible for the misconduct of its station manager. Mr. Spheeris and associates also own WEMP-AM-FM Milwaukee.

Sympathy Only ■ The FCC last week said that although it may be sympathetic to the fact that a licensee can be the victim of the wrongdoings of its station employees, it has been shown that Mr. Jones was more than an employee. The commission said that he was also "an officer . . . cloaked with broad authority in the day-to-day operation of the station and the treasure hunts, in particular." The KWK ownership records, at the FCC, also show that Mr. Jones owned six shares of stock at the time of the violations.

In referring to Mr. Jones's last day hidings of the treasure hunt prizes, the FCC said "these acts of the station manager which resulted in a fraud on

the public were willful and repeated as well as deliberate and intentional . . . justifying revocation." The commission said that KWK is "legally responsible" for the actions of Mr. Jones.

"The nub of the controversy," the commission said, is whether the facts in the case warrant revocation. The commission concluded that the fraudulent treasure hunts alone provide the grounds. The agency would not grant an original application if it felt that such use of a station would be made, nor would it be in keeping with the terms of a license, the FCC said.

In reference to the hardships caused by KWK's Bonus Club to persons who won a "millionaire's vacation" the commission again concluded that the licensee was at fault. The commission noted that KWK had been warned by the St. Louis Better Business Bureau that Trans Continental Airline Agency, which handled the vacation trips, had a reputation for flight delays, lost baggage and refusing to refund unused tickets. The commission said Mr. Spheeris was aware of this, and that one "vacation" was given after the station had received complaints from a former prizewinner.

Cooperation Questioned ■ KWK had argued that for similar offenses WNOE New Orleans had only been given a fine, and that KWK should get the same. However, the commission decided that KWK's case is "more severe" and that WNOE cooperated with the FCC during the latter's investigation. "However, we are not convinced that KWK's cooperation extended beyond what Mr. Spheeris believed to be desirable," the commission said. It has been found, the commission said, that he held back for a month information that the treasure hunts were indeed fraudulent.

In any case the commission said, "the forfeiture provisions of the Communications Act are not available to us here." Commissioners Rosel H. Hyde and Robert E. Lee, in their joint dissent to the revocation, said that KWK's violations were prior to the 1960 amendment of the Communications Act, which allows the FCC to fine stations as much as \$10,000, but that they felt the commission could give a fine in this case. The commissioners noted that the amendment established a one year statute of limitations, but said the commission could fine KWK if the station waived its right to it. They said it would give the FCC "an opportunity of extending more lenient treatment to the licensee than the gravity of revocation.

"We, therefore, believe that the commission should invite the licensee to submit its views with respect to possible forfeiture," Commissioners Hyde and Lee concluded. Robert M. Booth Jr., KWK attorney and former officer,

Dodd orders extra copies of JD report

Senator Thomas J. Dodd (D-Conn.) hasn't told the public what's in his juvenile delinquency subcommittee's report on television, but he's asked the Senate to publish an extra 4,000 copies of the 957-page hearing transcript released last month.

Committees are entitled to print 1,000 copies of their hearings with no questions asked, but for extra copies it's necessary to ask permission, which is usually granted.

The senator hasn't said how great the public demand is for copies of these hearings, which cover June and July 1961 and January and May 1962, nor has he given any new indication when his controversial report will be made available.

His last utterance on that was reported in an interview in a Florida newspaper which said April 23: "Father of six children, Senator Dodd says his committee will report in 30 days what they found and what they propose to do about TV's role in mounting crime."

He predicted "his committee's report will 'sing' the industry," the

Florida account said. "They promised us they'd clean up TV 10 years ago. They only did worse. We do not propose to allow them to do it again," the article said.



Senator Dodd
Potential best seller?



*How to suggest freshness—
quickly, lastingly.*
WHAT'S MISSING?



*The magic of a little girl. What
could be added . . . to show softness,
to create eye-appeal?*

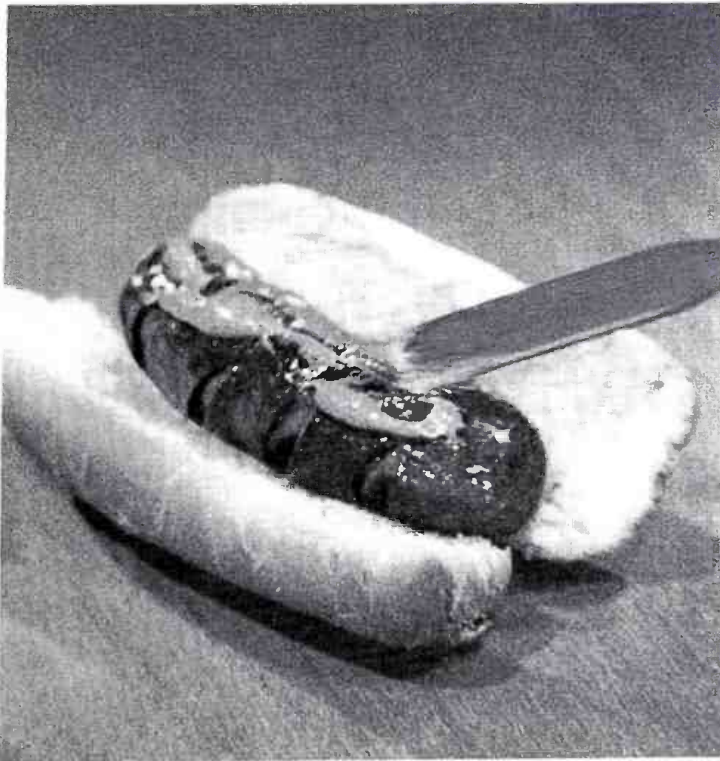

*What would you add in this picture
to stimulate added appetite-appeal,
accelerate product-sell?*

*What's missing in
these shots from
TV commercials?*

Turn the page and see . . .





Color —soft, cool green—sells the freshness for this cigarette. Links TV advertising to the package, to the point-of-sale . . . to the color idea.



Color —Here again color makes the difference . . . brings out the gentle softness of the tissue, fixes the product and package firmly in the housewife's mind.



Color and appetite . . . warm tones of yellow, red and brown make the story complete. Color in TV advertising turns prospects into customers.

Color's the answer!

Just count the ways you profit from using color:

1. Stronger trade-name identification
2. More direct product tie-in
3. Your best prospects see you at your best
4. Less cost increase for color than in print media
5. Black-and-white viewers see even better pictures

And, your commercials need color because opportunities to use it effectively are increasing, station by station, as more and more TV sets go COLOR TV.

For more about COLOR—why you should use Eastman film—why you should film all your commercials in color, even for black-and-white transmission, get in touch with: Motion Picture Film Department, **EASTMAN KODAK COMPANY**, Rochester 4, N.Y.

Or—for the purchase of film: **W. J. German, Inc.**, Agents for the sale and distribution of EASTMAN Professional Film for Motion Pictures and Television, Fort Lee, N.J., Chicago, Ill., Hollywood, Calif.

Salem Cigarettes: Advertiser: R. J. Reynolds Tobacco Co. Producer: WCD, Inc. Advertising Agency: William Esty Company, Inc. **Scott Soft-weve Tissue:** Advertiser: Scott Paper Company. Producer: Ansel Film Studios, Inc. Advertising Agency: J. Walter Thompson Company. **Gulden's Mustard:** Advertiser: American Home Products. Producer: Gray-O'Reilly Productions. Advertising Agency: Richard K. Manoff, Incorporated.

For COLOR . . .



General Sarnoff wants Comsat act amended

David Sarnoff, chairman of RCA, has recommended that the Communications Satellite Act be amended to permit the corporation to buy up all existing international communications companies so that it will have a revenue base to operate from.

In a private letter to Comsat Chairman Leo D. Welch, written last April but made public last week after excerpts were printed in Drew Pearson's newspaper column, General Sarnoff warned that the forthcoming transistorized cable, announced recently by AT&T, may very well postpone by several years the economic breakeven point of space satellite communications.

The transistorized cable, announced by AT&T Chairman Frederick Kappel and AT&T Engineering Vice President James E. Dingman earlier this year, will be able to handle 720 telephone circuits, nearly 10 times the capacity of present trans-Atlantic cables, and one television circuit.

Not only is AT&T working on this project, General Sarnoff pointed out, but so are engineers in several other countries, all with a high density of

overseas communications traffic.

In view of this, General Sarnoff said, the Comsat organization should be changed into a U. S. "flag" communications carrier, handling all overseas communications—voice, ra-



General Sarnoff
Comsat economics

dio, TV, data, telegraph and facsimile. In this way, he said, Comsat will have operating revenues that in 1962 amounted to \$160 million, with estimated overall revenues of \$350 million in 1970. It will also, he stressed, enable Comsat to deal with foreign communications administrations, almost all government owned, on a more equal basis.

Although neither AT&T nor Comsat officials would comment on the letter, it was pointed out that the space communications corporation was established on the assumption that in a decade present radio and cable overseas communications facilities would be badly strained to keep up with the projected traffic. It was also noted that one of Comsat's objectives is to serve as a communications link for newly developed countries, as well as those now heavier users of international communication facilities.

It was stressed also, that the AT&T transistorized cable development is still that, under development. When and how it may be used is not known yet, it was emphasized.

said last week that the station would appeal the revocation.

The commission's final decision came only three weeks after the oral argument following Mr. McClenning's initial decision, so that former Chairman Newton N. Minow could participate. Commissioners E. William Henry and Frederick W. Ford joined Mr. Minow in voting for revocation. Commissioners Kenneth Cox and Robert T. Bartley did not participate.

KWK was given until July 29 to conclude its affairs.

Intervention is not censorship synonym

Government intervention in radio-TV programming is not necessarily censorship, according to FCC Chairman E. William Henry.

"It is the duty of the FCC to aim at broadening the base of expression by giving more choice, more controversy and more fresh ideas," Chairman Henry said in an interview with Paul Martin, Washington bureau manager for the Gannett newspapers.

He said that he is "unalterably opposed to censorship which I consider to be stifling of freedom of expression." Mr. Henry, who took over as FCC chairman today (June 3), said the FCC should improve its examination of lic-

ense renewal applications and be as strict as money and personnel "will permit in going over with a fine tooth comb whether stations have lived up to their promises."

Speaking to the Gannett organization (owners of WHEC-AM-TV Rochester, WINR-AM-TV Binghamton and WENY Elmira, all New York, and WDAN Danville, Ill.), Chairman Henry said that "all things being equal" among applicants, a newspaper should not be granted a broadcast license.

As a result of the all-channel bill, he said, the only course left open to the FCC is to actively promote UHF intermixed with VHF. There is a psychological factor which has branded UHF as a low grade service that must be overcome, he said. The FCC, he said, must change its rules to aid UHF.

Canon 35 Advocate ■ As a lawyer, Chairman Henry favors Canon 35, which bans microphones and cameras from courtrooms. Radio-TV access to congressional hearings and floor debate is a matter for Congress to decide, he said.

The young Memphis attorney noted that the FCC will "watch closely" the industry's efforts to cure the ratings situation. The FCC, he said, has accepted ratings as a useful tool for broadcasters and that the industry "deserves a chance to right itself and come

up with its own solutions."

On the equal time provision of the Communications Act, Chairman Henry said that he would favor suspending the law for candidates for Congress and governor as well as President and vice president. The section (Sec. 315) should not be repealed, however, he said. In general, he stressed, stations have not abused the act's fairness doctrine and licensee's themselves should be permitted to be the judge on fairness matters with the FCC as arbitrator.

Commission denies short-spacing plea

Short-spaced VHF TV channels in Columbia, S. C., were vetoed by the FCC last week, and at the same time the commission announced a proposed shift of channels in Piqua and Dayton, both Ohio. Both actions followed the FCC decision to deny seven short-spaced VHF drop-ins (see page 44).

WIS-TV (ch. 10) and WNOK-TV (ch. 19), both Columbia, had asked the assignment of channel 8 to that city, and WCCA-TV (ch. 25) Columbia had requested channel 5. The requests were denied, the commission said, because the assignments would not have met the minimum mileage separation requirements.

The FCC invited comments on its

Loevinger calls for 'public debate' on FCC and its programming

Assistant Attorney General Lee Loevinger, who is due to be appointed to the FCC, feels one of the key questions confronting the commission is the extent to which it can go into the area of TV programming without engaging in censorship. He would like to see more public debate on this question.

Mr. Loevinger said last week he doesn't think the commission has overstepped limits of the constitutional prohibition against interference with free speech. But he added that the commission should be acutely aware of the dangers involved before taking any action affecting programming.

Most members of the public, he said, are aware of former FCC Chairman Newton N. Minow's "vast wasteland" speech and "its implicit exhortation to improve programming." But he said "the question of whether it's legitimate" for a member of the commission to concern himself with "the quality of programming hasn't been adequately debated" in public.

He said that while the trade press may have opposed Mr. Minow's position, the debate "hasn't reached the public prints."

Mr. Loevinger, who has been nominated by President Kennedy to serve the remaining five years of Mr. Minow's commission term, said he has not yet had an opportunity to formulate his views on the issues

confronting the commission. **Free Speech Crucial** - But he said the question of free speech is crucial. And although there may be "legitimate means" by which the commis-



Commissioner-to-be Loevinger

sion can concern itself with programming, he said, "this must be done with the full knowledge of the dangers involved."

Mr. Loevinger expressed his view in expanding on comments he made in an interview broadcast over WHAM Rochester, N. Y., on May 25. In that interview he said he believes that "government generally shouldn't interfere with the substance of things that are said or expressed or communicated—free speech if you like."

But Mr. Loevinger, who has headed the Justice Department's antitrust division since 1961, made it clear he doesn't favor a laissez-faire approach to broadcasting. He said radio and television are "quasi monopolies existing by virtue of government grants." The government, he added, "must use some means to insure that these monopolies do employ their powers and their grant in the public interest."

He said his "present inclination" is that regulation in the public interest can best be accomplished by attention "to the economic structure of the radio and television industry."

"In other words, I believe that diverse and independent ownership is infinitely better than any form of censorship."

Mr. Loevinger will appear before the Senate Commerce Committee tomorrow (Tuesday) for a hearing on his nomination to the commission.

proposed shift of channel 44 from Piqua to Dayton and assignment of channel 57 to Piqua. Taft Broadcasting Co. requested the reassignment of the UHF channels. The commission denied a petition by WWLP(TV) (ch. 22) Springfield, Mass., asking for the assignment of channel 38 to Dayton, since it would be incompatible with the FCC's UHF allocation plans. In the future, however, if interest in more UHF operations in Dayton warrants, another channel may be assigned, the FCC said.

Commissioners Hyde, Ford and Cox concurred in the Columbia actions, while Commissioner Cox dissented to the Ohio decisions.

McGee sees TV improvement

"Great strides" in improving the quality and quantity of TV programs have been made by some stations and broadcasters, according to Senator Gale McGee (D-Wyo.). Commenting on the Senate floor about the resignation of

Newton N. Minow as FCC chairman and the current status of programming, the senator singled out WLOS-TV Greenville-Asheville, N. C.-Spartanburg, S. C. for "noticeable efforts to present responsible and informative programming." Senator McGee, a member of the Senate Commerce Committee, cited seven documentaries produced in the first five months of this year by the station as being illustrative of "what can be done by responsible broadcasters."

FCC gives Wentronics conditional approval

The FCC last week granted the application of community antenna operator Wentronics Inc. to add another microwave channel to its system in Casper, Wyo. The grant was conditioned to a voluntary acceptance by Wentronics of the restrictions proposed by CATV systems by the commission's pending rulemaking (BROADCASTING, April 29).

The rulemaking would restrict a

CATV operation from duplicating a local station's programming, within its grade A contour, for 30 days before or after the local station's broadcast. The local station is required to give a 30-day, advance notification to the CATV operators. The CATV also would be required to carry the signal of the local station, if so requested, "without any material degradation in quality," the FCC said.

WRLP(TV) petition dismissed

The FCC last week dismissed a petition by WRLP(TV) Greenfield, Mass., which had asked for a reconsideration of the commission's Jan. 30 grant of a UHF translator station in Athol, Mass., to rebroadcast programs of WBZ-TV Boston.

The FCC, in denying the request, said that Millers River Translators Inc., owner of the translator, has received "adequate rebroadcast consent" and that WRLB had failed to show that it provides service to Athol.

93% SHARE IN A 4 STATION MARKET

On Sunday, May 12, the San Francisco Giants-Los Angeles Dodgers baseball game on KTVU reached a 93% share of audience! This amazing audience domination was reported by ARB who conducted a 2½-hour coincidental survey during the afternoon game on the 12th and the evening games on May 10 and 11. The average ratings listed below reveal that KTVU had an audience as large, or larger than, all the competition combined for the three telecasts.



PHOTO BY MODERNAE

Average ratings and share... ARB coincidental surveys

Friday, May 10 • 8:00-10:30 P.M.			Saturday, May 11 • 8:00-10:30 P.M.			Sunday, May 12 • 1:00-3:30 P.M.		
KTVU BASEBALL	28 rating	52% share	KTVU BASEBALL	28 rating	50% share	KTVU BASEBALL	27 rating	93% share
Station X	8 rating	15% share	Station X	10 rating	18% share	Station X	0.1 rating	0% share
Station Y	11 rating	20% share	Station Y	11 rating	19% share	Station Y	1 rating	3% share
Station Z	7 rating	13% share	Station Z	6 rating	11% share	Station Z	1 rating	3% share
			Other	1 rating	2% share			

All ratings based on 2-1/2 hour coincidental surveys.

The Nation's **LEADING**
Independent TV Station



SAN FRANCISCO • OAKLAND

Represented nationally by H-R Television, Inc.

Emergency preparedness will be better

SYLVESTER PROMISES SHORT-OF-WAR CHECKLIST

The Pentagon's information chief promised a House information subcommittee last week that his people will be better prepared to accommodate the needs of newsmen if the nation should again face another short-of-war emergency such as last fall's Cuban crisis.

Arthur Sylvester, assistant secretary of defense for public affairs, said in closed-door sessions of the Foreign Operations and Government Information Subcommittee Tuesday (May 28) that his office will issue an internal checklist for use by military and civilian information officers in emergency situations.

The subcommittee recalled Mr. Sylvester for a series of executive sessions late last month (the first closed hearings in its eight-year history), following his earlier appearances in its investigation of news control and other government information problems (BROADCASTING, May 27).

Representative John E. Moss (D-Calif.), chairman, said he thought the hearing had shown that the Kennedy Administration did its best to keep the public informed during the Cuban flareup, but he took issue with Defense Department actions on at least two points. Republican members of his group went further in their criticism.

Closed Hearing — The subcommittee has tentatively scheduled a closed hearing Wednesday (June 5) to discuss with the Office of Emergency Planning guidelines for newsmen in short-of-war situations. The office has plans for news handling in all-out war (BROADCASTING, May 8, 1961), but a question exists

whether it has authority to work up plans for short-of-war emergencies.

Representative Moss and several of his subcommittee colleagues disapproved of the Defense Department's Cuba actions in forbidding newsmen to go to the U.S. Naval Base at Guantanamo Bay, or to board U.S. warships carrying troop reinforcements.

Moreover, the subcommittee agreed that the department should rescind its Oct. 27, 1962 memorandum which requires its personnel to report their contacts with newsmen to Mr. Sylvester's office.

Representative Ogden R. Reid (R-N. Y.), former editor of the *New York Herald-Tribune*, said the memorandum is "repugnant" and "inhibits access to the news." A news media panel cited the memorandum to the subcommittee when it listed its grievances about news problems earlier this year (BROADCASTING, March 25).

Representatives Reid and George Meader (R-Mich.), ranking GOP subcommittee member, said they felt the administration did not do all it should have in providing information of the Cuban affair. The complaints of the media panel have not been adequately answered by the administration, Representative Meader said.

Commenting on Representative Moss' statement, the Michigan member said, "I don't see how he can say they told all they could" to the American people when he (Moss) may not know himself what the administration knows about the Cuba situation.

Census Bureau figures

The House subcommittee investigating ratings has been told by the Bureau of the Census just how much it costs the government to complete interviews for the monthly survey of unemployment which the bureau processes for the Labor Department.

Interviews cost the bureau an average of \$2 apiece in the field, but once tabulating, supervising and overhead costs are added, the final figure is closer to \$4.50 each, said Dr. Conrad F. Taeuber, assistant director of the bureau.

The figure was requested during testimony by bureau witnesses three weeks ago when the subcommittee was seeking information on bureau standards and procedures in comparison with those of research firms already investigated by the subcommittee (BROADCASTING, May 20).

KXTV(TV) gets renewal; FCC denies objections

The FCC has renewed the license of KXTV(TV) Sacramento, Calif., and denied a petition opposed to the renewal filed by The Citizens for Better Broadcasting Committee of that city.

The committee's petition had based its plea against renewal on the station's alleged dearth of local live programming. This programming constituted only 3.8% of the station's offerings during the composite week in the renewal application, but the commission noted that KXTV had been deprived of 40 production personnel by a strike. The National Association of Broadcast Employees and Technicians and the American Federation of Television and Radio Artists called a joint strike in September 1960, shortly before the composite week was compiled.

KXTV claimed that with a rebuilt staff it presently carries and will continue carrying about twice the local live programming reflected in its application. The station also alleged that two of the officers of objecting committees were also officers of the striking unions.

In granting the renewal, the FCC sent a letter to the committee explaining that KXTV's local live programming had necessarily been cut by the strike, that the station has since bolstered such offerings and that key employees of the station were active in community affairs and had "maintained a continuing awareness of the tastes, needs and interests of the people of its listening area. . . ."

Price cooperation is not price fixing

A House committee hearing on cooperative price advertising has helped clarify the Federal Trade Commission's recent contention that such advertising would be price fixing.

That's the thinking of Representative Joe E. Evins (D-Tenn.), chairman of the Select Committee on Small Business, which brought the FTC and other parties in the issue to Capitol Hill to discuss the controversial advisory opinion. The opinion set off distress cries from small businessmen, mostly retail druggists and grocers, who said the advisory discriminated in favor of large chain stores which were free to use manufacturers' cooperative advertising money while the small merchants were not (BROADCASTING, May 13).

Representative Evins has said

that the FTC's testimony implies that the agency will not proceed in cases where merchants cooperate on prices only for advertising purposes. This is expected to be borne out in the committee's report this week.

The counsel for a retail druggists group which requested the FTC ruling has subsequently advised its clients to proceed with plans for joint advertising with prices.

The Senate, however, is not through with the subject. Its small business unit plans a hearing of its own and intends to ask the Small Business Administration to comment on advertising problems small merchants face. Five senators are backing a resolution calling on the FTC to hold off any action in this field until Congress can study the matter.



Why view on a screen . . . what they'll see on the tube!

A tv commercial viewed on the conference room movie screen may look to be a sharp winner . . . yet turn out to be a dull also-ran on the tv tube. Remember that, next time someone invites you to "screen" a tv commercial. And remember that what you'll see is a far cry from the cropped, out-of-time-phase image that comes through on tv. Like to see your tv films as others see them? View them on a tv monitor. We hope the results will help you realize why more commercials and shows every day are being carried on SCOTCH® BRAND Video Tape!

Tape provides an electronic original, expressly designed for tv viewing. This is no make-do electronic copy of an essentially

optical original. Every image is completely compatible with the tv set in the home.

Don't take anyone's word for it—prove it! Bring a film you're proud of to a tv station or tape production house and monitor it. Then view a video tape side-by-side on another monitor. You'll see at once the unique live quality that "SCOTCH" Video Tape offers. Other plusses: a virtually unlimited array of special effects by pushbutton, immediate playback, no processing costs or delays—either black-and-white or color. Write for brochure on tape editing. 3M Magnetic Products Division, Dept. MBX-63, St. Paul 19, Minn.



"SCOTCH" IS A REGISTERED TRADEMARK OF MINNESOTA MINING & MANUFACTURING CO., ST. PAUL 19, MINNESOTA. EXPORTS: 99 PARK AVENUE, NEW YORK, CANADA: LONDON, ONTARIO ©1963, 3M CO.

Magnetic Products Division **3M** COMPANY

Charlie Walker as a statue of liberty?

OFF-COLOR DJ FIGURES IN FREEDOM TEST CASE

Is it possible that Charlie Walker, the erstwhile barnyard humorist of WDKD Kingstree, S. C., is going to go down in history as the saviour of broadcasting's freedom?

May be.

Rallying to the side of E. G. Robinson Jr., embattled licensee of WDKD, is the American Civil Liberties Union.

The ACLU has asked Harry Plotkin, former assistant general counsel of the FCC, to prepare a brief to be submitted as a friend of the court in the WDKD case. WDKD appealed the FCC's order last year revoking its license to the U. S. Court of Appeals for the District of Columbia. The case will probably be argued in October.

The nub of the ACLU's concern, it's understood, is that the FCC is attempting to censor programming and therefore is violating the First Amendment to the Constitution as well as Section 326 of the Communications Act. The First Amendment guarantees free speech; Section 326 prohibits the FCC from censoring any radio program.

When the FCC denied WDKD's license renewal, it found that Mr. Robinson not only made misrepresentations to the commission, but also permitted disc jockey Charlie Walker to broadcast programs that were "coarse, vulgar, suggestive and susceptible of indecent double meanings" (BROADCASTING, July

30, 1962). After failing in his request to the FCC for reconsideration, Mr. Robinson filed his appeal in the Washington appeals court.

It is the second count of the FCC's death sentence that has sparked interest in the Kingstree case and may make it a bellwether in broadcast law.

Mustn't Touch ■ The commission refused to accept the contention of Mr. Robinson's attorney, Harry J. Daly, that the Walker "humor" must not be considered by the communications agency in the license renewal proceedings. Mr. Daly urged that unless it were found obscene or profane and therefore liable to criminal penalties, the broadcasts should not be an issue in its renewal hearings. Obscenity and profanity on the air are covered in the U.S. Criminal Code.

The commission refused to accept this viewpoint. In its reply to this point, the commission said:

"Radio could become predominantly a purveyor of smut and patent vulgarity —yet unless the matter broadcast reached the level of obscenity" the FCC would be powerless to act.

As part of its obligation to consider the public interest, the FCC said, it must act. It found the broadcasts not in the public interest.

It is this contention by the FCC, many lawyers feel, that is treading close

to censorship. It is their feeling that this must be cut down quickly before the philosophy can be used to justify other incursions in the field of broadcast programming.

Mr. Robinson is represented in the appeal by the Washington law firm of McKenna & Wilkinson.

Moot Court ■ The Kingstree case has already won fame of a sort. It was chosen for the Ames competition at Harvard Law School earlier this year. This is a school-wide contest in which all of Harvard's 400 law students participate. Through "clubs" the students brief a current legal case and argue it before guest judges. The contest is judged basically on the forensic ability of the students, not on the merits of the case.

In the finals, held in Cambridge in April, a distinguished trio of jurists, sitting as the guest panel, awarded the accolade to the law students representing the FCC. The panel: Associate Justice of the U. S. Supreme Court Byron R. White, and Circuit Judges Elbert P. Tuttle, fifth circuit, and Sterry R. Waterman, second circuit. They found that the students representing the FCC had more ably presented their case than those representing WDKD.

In a separate action, the protagonist of the case, Charlie Walker, was indicted by a federal grand jury under the obscenity statute in Florence, S. C., last year. His trial is expected to take place this fall.

Harris turns down offer to run station for a day

The Chairman of the House Commerce Committee, critical of broadcasters who run too many commercials and who do not provide a diversified programming service, has declined an invitation to run a radio station in his district for one day.

Representative Oren Harris (D-Ark.) told W. N. McKinney, president and general manager of KELD El Dorado, Ark., "I have no intention of telling the radio industry what they should program and how they should run their business."

Mr. McKinney fashioned his invitation after reading a report of the congressman's remarks before the Washington Ad Club last month (BROADCASTING, May 13). He asked "just what constitutes 'in the public interest'" and suggested the congressman collect a group "of these people who you quote as saying that radio is not operating in the public interest. . . . I would like for them

to take just one broadcast day on my radio station and program it from 5:30 a.m. until midnight. Just one day out of 365!"

Representative Harris replied, "It is no answer for me, inexperienced in the operation of such a facility or planning programs, to be involved [sic] to assume responsibility for even one day. This is somewhat naive in my judgment to make it my business to describe to the industry what is balanced programming."

Radio's "contribution to the American people . . . has meant much more than the average person realizes to our progress and development," Representative Harris wrote Mr. McKinney. "In a way my statement was critical but it was more intended as a challenge," he continued. He is working to help broadcasting remain in private hands, Representative Harris said. "As a matter of fact," he replied, "I am giving

much time and effort toward policies and procedures that will permit the industry to operate in the best interest and utilize the ingenuity that I know the industry has."

Insofar as what "public interest" may be, Representative Harris said the term is in the Communications Act. It has been "administered and construed all these years . . . [and] has been interpreted by the courts and if the industry does not know [what it means] by this time, with long years of experience, I think someone had better start doing their homework."

The congressman had said he thought radio's steady diet of "music of various kinds, interspersed with news and advertising . . . constitutes some waste, unfortunately, of precious spectrum space." He also complained of too many commercials and said that radio "does not provide service at its full potential."

The Burden of Responsible Programming



It seems just about unanimous now. ■ A month ago, a distinguished panel of *opinion leaders* and *critics* singled out NBC for numerous and significant Peabody Awards. Previously, the *nation's viewers* selected a wide range of NBC programs and personalities as their favorites in the TV Guide Awards. ■ And just a few days ago, *our colleagues* in the television industry presented us with a dazzling array of Emmy Awards—headlined by the naming of “The Tunnel” as “The Program of the Year.” “The Tunnel” was also honored as the best documentary, and NBC News correspondent Piers Anderton received the award for the best international reporting for his work on that program. We also want to add our appreciation for the other NBC Emmy winners: Shirley Booth of “Hazel”; Trevor Howard for his performance in “The

Invincible Mr. Disraeli” (O. Tamburri won an award for camera work in the same program); Robert Russell Bennett for his original music in Project 20’s “He Is Risen”; the “Huntley-Brinkley Report” and “David Brinkley’s Journal”; “Walt Disney’s Wonderful World of Color” (honored for the series itself, as well as the art direction by Carroll Clark and Marvin Davis); “The Andy Williams Show”; and a Trustees’ Award to the late Dick Powell. ■ NBC’s winners this year cover the complete broadcast spectrum, from on-the-spot reporting of great events to unalloyed entertainment. In all, they typify the diverse programming of the entire NBC schedule.



CONGRATULATIONS, TOO, TO THE PROGRAMS AND TALENTS SINGLED OUT ON THE OTHER NETWORKS: “THE DICK VAN DYKE SHOW,” “THE DEFENDERS,” “JULIE AND CAROL AT CARNEGIE HALL,” “G-E COLLEGE BOWL” AND THE “ANDY GRIFFITH SHOW” ON CBS; “BEN CASEY” AND “NAKED CITY” ON ABC

FCC charged with unfair action in AM freeze

COURT HEARS ARGUMENT OF PROSPECTIVE APPLICANTS

The FCC's AM freeze, imposed a year ago on new applications for standard broadcast applications, was attacked last week before three judges of the U. S. Court of Appeals in Washington.

Nine prospective applicants, who unsuccessfully sought to file in the immediate days following the commission's freeze date, charged that (1) they didn't receive the proper advance notice, (2) a freeze requires a rulemaking proceeding and cannot be done by fiat, (3) the refusal of the FCC to accept their applications discriminates against them because applications on file before the May 15, 1962, cutoff date are being processed. Some of the applicants appealing are in conflict with some of the applications being processed, it was pointed out.

One example of the alleged unfairness of the commission's action, it was pointed out, is that early in May the FCC announced routinely the list of pending applications scheduled to be processed during the month. It listed May 25 as the deadline for any new applications which might be in conflict with these on the processing line list. Some of the prospective applicants relied on this May 25 deadline, and found themselves frozen out.

A hint of ex parte conduct was raised in a reference to the "meeting" between then FCC Chairman Newton N. Minow and President LeRoy Collins of the National Association of Broadcasters. This resulted in the FCC's recent proposal to establish an AM-FM-to-population ratio table to control radio "overpopulation" (BROADCASTING, May 20).

Move Defended ■ The FCC's action was defended by Assistant General Counsel Daniel Ohlbaum who explained that the decision to refuse new AM applications was based on a study that showed no major effect on the structure of AM broadcasting would take place if pending applications were processed, but would if new applications were permitted to be filed.

Stressing the "chain reaction" effect in AM application processing, Mr. Ohlbaum also argued that the commission's decision resulted in the fairest manner of handling the situation.

He also argued that the move was not substantive (requiring a rulemaking proceeding), but procedural only.

Mr. Ohlbaum was on the receiving end of a number of questions by the circuit judges, primarily as to why the FCC didn't stop all processing while it looked into the AM allocations picture. There was also one suggestion from the bench that the commission permit applications in conflict with pending applica-

tions to be filed so that the facilities at stake not be foreclosed.

Hearing the case were Chief Judge David L. Bazelon and Circuit Judges George T. Washington and Walter M. Bastian.

Ratings firms ask court to drop fraud suits

The A. C. Nielsen Co. and The Pulse Inc., defendants in separate \$250,000 fraud actions by WAME Broadcasting Co., Miami, have asked that their cases be dismissed for failure to show cause of action.

The suits, believed to be the first court cases to grow out of a congressional investigation of broadcast research practices, were filed in April by WAME Miami in the circuit court of Dade county, Fla. (BROADCASTING, May 6). Both complaints claim the ratings firms misrepresented their Miami metropolitan area reports between 1959 and 1962.

A motion by Pulse attorneys to dismiss the Pulse suit will be heard in Miami Aug. 1, it was learned last week.

Attorneys for the Nielsen company were successful in having the action removed to the U. S. District Court; however WAME will ask that the case be returned to the state court so that its attorneys can litigate Pulse and Nielsen in the same jurisdiction.

VHF channel requested for Fort Smith, Ark.

The KWHN Broadcasting Co., licensee of KWHN Fort Smith, Ark., last week requested that the FCC institute a rulemaking to reassign channel 9 to that city, deleting it from Hot Springs. KWHN proposed that channel 64 be substituted for channel 9 in Hot Springs. KWHN would apply for the channel.

KFOY-TV Hot Springs is on channel 9, KWHN noted, but said that Hot Springs is economically over-shadowed by its proximity to Little Rock. The population of Hot Springs has fallen in the last few years, KWHN said, while that of Fort Smith has been growing and can presently support more than one VHF operation.

KWHN said that KFSA-TV (ch. 5) Fort Smith, the only TV station in that city, is owned by Donald W. Reynolds, who also owns KFOY-TV. Mr. Reynolds also owns the *Fort Smith Times Record* and *Southwest American*, Fort Smith's only daily and Sunday newspapers, KWHN said, and contended that Mr. Reynolds has a virtual monopoly of communications media in the area. Reassignment of channel 9 to Fort Smith would al-

leviate any such monopoly, KWHN said.

KWHN also requested that the FCC deny an application by KFOY-TV to reduce the station's visual power from 30.1 kw to 2.63 kw. KWHN said that this will merely make it easier for Mr. Reynolds to lower the cost of maintaining his monopoly.

The Fort Smith AM suggested that the commission could instigate a de-intermixture proceeding such as the agency did in Bakersfield, Calif. In the Bakersfield case the FCC succeeded in modifying the license of KERO-TV to specify channel 23 rather than channel 10 (BROADCASTING, Nov. 19, 1962).

Stratton wants FCC to intercede with NBC

Representative Samuel S. Stratton (D-N.Y.) has asked the FCC to help him in his effort to confront Senator Kenneth B. Keating (R-N.Y.) in a televised debate on Cuba.

The congressman said last week that NBC has denied his request for an opportunity to refute some of the "grave charges . . . on the competence of our intelligence community" made by the senator on *Meet the Press* May 12.

Citing 1959 amendments to Section 315 of the Communications Act, Representative Stratton told the FCC that NBC is obligated "to afford reasonable opportunity for the discussion of conflicting views on issues of public importance."

He said William R. McAndrew, executive vice president, NBC News, had explained that four officials of the Kennedy administration have appeared on the program since the Cuban crisis last October and had given ample expression to the administration's point of view.

Representative Stratton argued that only one of these appearances was after January 31, the date of what he considered Senator Keating's most serious charges on Cuba. The subject had not been covered satisfactorily in that appearance or by questioning of the senator last month, he said.

Representative Stratton said the network had invited him to debate with the senator on the *Today* show in March, but when the GOP senator would not agree to the joint appearance, Senator John Stennis (D-Miss.) was substituted. NBC had indicated he would be invited back, Representative Stratton said, but he's still waiting.

When he saw Senator Keating "get away with murder" on *Meet the Press*, he asked NBC for an opportunity "to disprove the senator's claim" on equal facilities or to debate him on the air.

Representative Stratton has been recently discussed as a Democratic opponent to Senator Keating, who is up for re-election next year.

Sound Control with Sony



PROFESSIONAL COMMAND OF SOUND FOR EVERY RECORDING AND BROADCAST SITUATION

Sony CR-4 Wireless Microphone—The perfect transistorized microphone and pocket-size transmitter for active singer/dancers and TV performers to give complete freedom from entangling cables and obstructing mike stands. Mike and transmitter together weigh only 13½ ounces. Complete with transmitter, receiver and carrying case: \$250.

Sony EM-1 Newscaster Portable—A full track, all transistorized portable recorder designed for rugged service and dependable performance in remote locations. Meeting NARTB specifications, the EM-1 is ideal for on-the-spot interviews and sound recording. • Governor controlled, constant speed spring wound motor • Rewind while recording • 13¼ pound weight. Complete with microphone and accessories: \$495.

Sony MX-777 Stereo Mixer—A six chan-

nel all transistorized self powered stereo/monophonic mixer featuring: 4 balanced microphone inputs, 2 balanced hi-level inputs and 2 balanced recorder outputs. Other features include individual level controls and channel 1 or 2 selector switches, cannon XL receptacles and switch for bridging of center staging solo mike. Complete with carrying case: \$175.

Sony C-37A Condenser Microphone—Remarkably smooth and uncolored natural response through the full range of recorded frequencies has earned the C-37A the title of "world's most perfect microphone." • Adjustable for omni-directional or uni-directional • Frequency response ±2 db 20-18,000 cps • Signal to noise—more than 55 db for signal of 1 micro-bar at 1000 cps. Complete with CP-3 Power Supply, carrying case and 30 feet of cable: \$295.

Sony C-17B Condenser Microphone—A miniaturized, uni-directional companion to the famous Sony C-37A Microphone. With outstanding background isolation characteristics, the uni-directional cardioid pattern is ideal for TV, night club and solo voice stereo recording application. The slim 1½" diameter size minimizes visual problems. Complete with CP-3 Power Supply, carrying case and 30 feet of cable: \$350.

Sony CP-3 Power Supply—For the C-37A and the C-17B microphones, the CP-3 features: Switch for 3 positions of low frequency attenuation; special high cut filter switch for all frequencies above 10,000 cps.

For more complete specifications and name of nearest dealer, write Superscope, Inc., Dept. 3, Sun Valley, California.

In New York, visit the Sony Fifth Avenue Salon, 585 Fifth Avenue.

All Sony Stereorecorders are Multiplex Ready!

SUPERSCOPE

The Tapeway to Stereo

But what did Minow do in his spare time?

Newton N. Minow, in his last week as chairman of the FCC, had what was probably the busiest week in his 27-month Washington sojourn.

During the week he: (1) appeared on *David Brinkley's Journal* Monday on NBC-TV; (2) presided on Monday, Tuesday and Wednesday over three full FCC meetings, which made several important decisions (see stories, page 31, 44, 46); (3) visited on Wednesday with President Kennedy at the White House; (4) attended a going-away party given by FCC staff members (also on Wednesday) (see picture); (5) was the subject of a statement on the floor of the House of Representatives by Oren Harris (D-Ark.), chairman of the House Commerce Committee; (6)

with Mrs. Minow, celebrated his 14th wedding anniversary on Wednesday, and (7) probably did a little packing, in between his other activities, in preparation for his return to Chicago and a new position with Encyclopaedia Britannica Inc.

In his TV appearance Mr. Minow said television must "divorce the advertiser [from] the editorial department" if it is to be completely independent.

He reasserted his belief in the soundness of the so-called "magazine concept," under which advertisers would sponsor the commercials but not the programing.

Mr. Minow acknowledged that such a system would probably need exceptions to permit "full sponsor-

ship of certain programs." He cited the *Hallmark Hall of Fame* as an example. The important thing, he said, is that advertisers "should have nothing to do with editorial judgment or editorial decisions."

Under questioning by Mr. Brinkley, the retiring FCC chairman also reviewed his philosophy on a wide range of other subjects including service to minority-interest groups, educational television, so-called censorship, editorializing and programing on controversial issues, "concentration" of power in the networks and children's programs.

Mr. Minow suggested that educational television "should take one subject and devote itself to it, and make or break its reputation on it." He suggested that ETV do "the great course in American history" and enlist the assistance of Presidents Kennedy, Eisenhower, Truman and Hoover in preparing and presenting the program.

He said that if he owned a commercial station in a major market, he would operate it with the aim that "I would get rich in perhaps three years instead of one."

Representative Harris, who has frequently taken strong issue with the FCC and some of Mr. Minow's policies, had friendly words for the retiring commission chairman in his House statement. He said Mr. Minow's "vast wasteland speech" succeeded in calling to the attention of the American people a vast public problem which to a large extent is still with us. . . .

"Many persons have labeled Mr. Minow a controversial person," the congressman continued. "No doubt he has created controversy or as I rather would describe it—he has brought about a dialogue which still continues on how broadcasters are to perform in the public interest. . . . Far from being given to controversy we have found Mr. Minow most cooperative in working for solutions of difficult and complex issues in the field of communications."

Mr. Minow "is owed a debt of gratitude by the American people for helping our democracy to identify an important public problem," Representative Harris said.

Mr. Minow's new job is vice president and general counsel of Encyclopaedia Britannica Inc., reportedly at a salary of \$75,000 a year plus additional benefits. His resignation from the FCC to take the Britannica post became effective June 1.



Last Wednesday was a busy day for the departing FCC Chairman Newton N. Minow. He (l) presided over his last meeting as chairman; (2) with his family, called on President Kennedy; (3) was honored at a party given by FCC staff members, and (4) celebrated his 14th wedding anniversary. With Mrs. Minow and daughters Nell, 11, Martha, 8, and Mary 4, looking on, Mr. Minow (left in photo above) received from the new chairman, E. William Henry

(r) farewell gifts from the commissioners and FCC staff. These included a gavel and base, the chair Chairman Minow used and a plaque detailing the FCC accomplishments while he was chairman. Mr. Minow told the approximately 200 guests at his going-away party that he hoped to return to "public service." He resigned from the commission to become executive vice president-general counsel of Encyclopaedia Britannica Inc.

Section 315 fans to give their views

Several members of the House Commerce Committee who don't think Section 315 of the Communications Act should be suspended at all will be represented by minority views in a report which was being prepared last week.

The full committee has given its blessing to a proposed suspension of equal time requirements for the presidential and vice presidential races in 1964 (BROADCASTING, May 27), but a small group of members—including the ranking men of both parties—oppose the idea.

In their section of the report they are expected to point out that broadcasters were warned once before that they should not use a suspension of Section 315 as a lever for eventual repeal of the equal time law. This warning was made in 1960, but no sooner did this year's hearing on equal time suspension open than two network presidents used the session as a forum to advocate outright repeal of Section 315, the minority says (BROADCASTING, March 11).

At least four members of the committee have been identified with these views: Representatives John Bell Williams (D-Miss.), ranking Democrat; John B. Bennett (R-Mich.), ranking Republican; Samuel L. Devine (R-Ohio) and J. Arthur Younger (R-Calif.).

Many other members feel the limited suspension is about as much tampering with the equal time safeguard as they can tolerate.

Next stop for the legislation is the Rules Committee which will decide whether and when to let it go to the floor.

These congressmen also have been critical of broadcasting editorials, especially as they apply to politics and other areas of controversy. Representative Walter E. Rogers (D-Tex.), chairman of the Communications Subcommittee, already is on record in favor of a hearing on editorializing and has said he hopes to hold it sometime this summer, possibly in July (BROADCASTING, May 27). No bills on the subject had been offered up to last week, but Representative Rogers said his subcommittee would be glad to hear the views of any member interested in such legislation.

The Senate hasn't been publicly active in political broadcasting problems so far this year. It's waiting for the FCC's report on Section 315 experience from the 1962 elections. But the committee's Freedom of Communications Subcommittee produced a six-volume report last year, and one of its recommendations urged the FCC to

provide some ground rules on political editorializing (BROADCASTING, April 23, 1962).

The subcommittee offered some suggestions of its own which were intended to give persons who were subjects of editorials an opportunity to know what was said about them and to reply. The suggestions added up to equal time for editorials.

It is expected that these suggestions were in the back of some congressmen's minds when they drafted their minority views, but an outright ban on such editorials might sit well with them, too.

FCC lifts CP for WHYZ-TV Duluth, Minn.

The character qualifications of principals in WDUL Television Corp. again played a determining role in the company's fortunes, as the FCC last week denied WDUL's application for additional time to construct its WHYZ-TV Duluth, Minn., and so terminated its existing construction permit.

A WDUL application for a modification of its CP was denied last July (BROADCASTING, July 30), when the commission held that "the applicant's

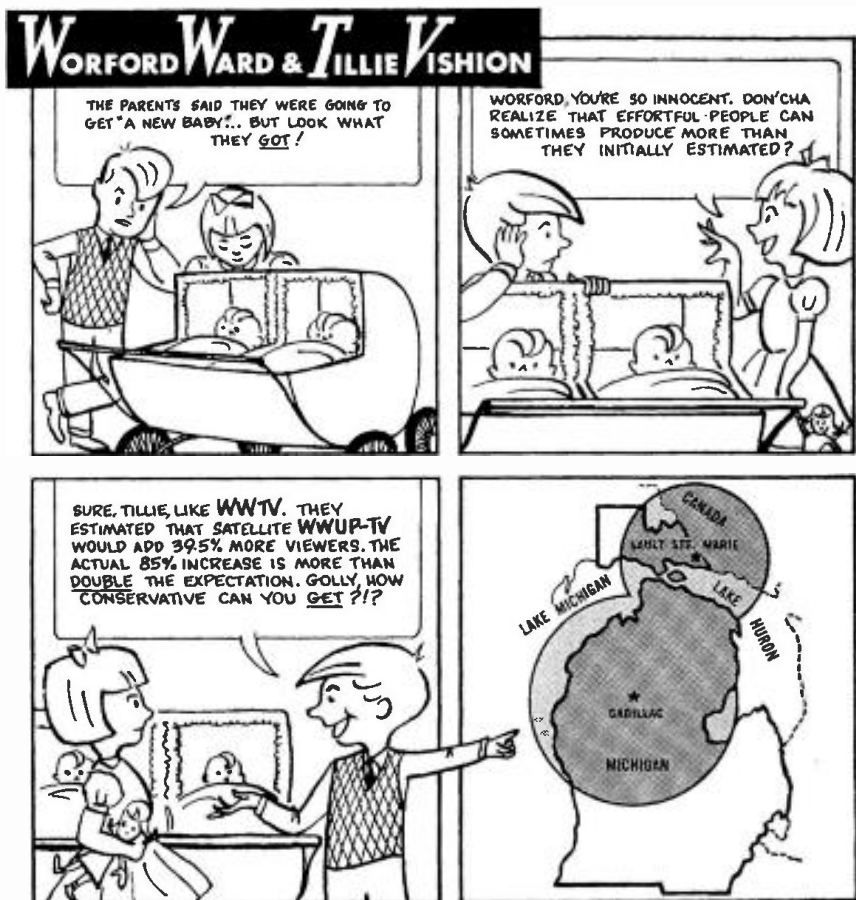

DOUBLED THE EXPECTATION!

Last summer when our WWUP-TV satellite at Sault Ste. Marie went on the air, we estimated we'd increase our market and audience by 39.5%. But then the Nov., '62 ARB showed an 85% increase.

ARB also says that we now cover an area with 492,100 TV homes—actually about three times more population than Atlanta!

Have you discovered Upstate Michigan? It's America's greatest "sleeping market." It includes nearly a million people. Its retail sales are nearly a BILLION DOLLARS. If you want an increase in your Michigan sales, use a few extra television dollars *Upstate*, where they face a lot less competition! Ask Avery-Knodel for the facts.

The Folger Nations

RADIO
 WZZM KALAMAZOO-GIFTSLE CREEK
 WZZM GRAND RAPIDS
 WZZM-FM GRAND RAPIDS-KALAMAZOO
 WZZM-FM CADILLAC

TELEVISION
 WZZM-TV GRAND RAPIDS-KALAMAZOO
 WWTV CADILLAC-TRAVERSE CITY
 WWUP-TV SAULT STE. MARIE
 KALAMAZOO-TV KALAMAZOO
 MICHIGAN-TV GRAND ISLAND, ILL.

WWTV/WWUP-TV

CADILLAC-TRAVERSE CITY / SAULT STE. MARIE

CHANNEL 9 / CHANNEL 10
 ANTENNA 1640' A. A. T. / ANTENNA 1214' A. A. T.
 CBS • ABC / CBS • ABC

Avery-Knodel, Inc., Exclusive National Representatives

Newton's aware there's Somebody up there

"My God."

Zsa-Zsa Gabor couldn't get away with it, but Newton N. Minow did.

The expletive was "blooped" out by NBC-TV when Miss Gabor used it in a taped interview for the *To-night* show about 10 days ago. It was left untouched when the retiring FCC chairman used it in a taped interview for *David Brinkley's Journal* last week (see page 58).

But Mr. Minow's exclamatory challenge to section 4, paragraph 5 of the NAB television code was not entirely unquestioned. NBC staff executives had fun speculating whether it would be allowed to stand.

Mr. Minow used the phrase in quoting himself. He said a broad-

caster once told him that a study had shown that television "hasn't affected [children] at all." Mr. Minow said his reply was: "My God, I can't think of a worse indictment of television than that."

The NBC standards division usually "bloops" such utterances—that is, deletes them from the audio—in entertainment programs, where its jurisdiction is centered. The Brinkley program, presented by NBC News, is under the control of the news division.

The NAB code's "general program standards" provide that "reverence is to mark any mention of the name of God, His attributes and powers."

derelictions and misconduct" and "willful misrepresentations" in connection with an unauthorized transfer of control had disqualified its application. (The FCC at that time also judged the company unfit to be a licensee, but it later relented.) The commission maintained that its decision still stood and that "we likewise now conclude for these same reasons" that additional time should not be granted.

The commission added, however, "we emphasize the fact that the conclusion here reached is based upon the misconduct of the principals in the stewardship of the Duluth permit here under construction. Any bearing this conclusion may have upon the licensee qualifications of WDUL's principals as individuals at other times and places may be considered if and when appropriately raised in other proceedings."

FCC horse racing rule not to be retroactive

The FCC's proposed rulemaking on the broadcast of horse race information (BROADCASTING, April 15 et seq.) will not retroactively endanger licensees at renewal time if they have toed the present mark, it was explained in a letter, released last Tuesday but dated a week before, from FCC Chairman Newton N. Minow to Senator Warren G. Magnuson (D-Wash.).

The legislator—chairman of the Senate Commerce Committee and also chairman of the Senate Appropriation Committee's Independent Offices Subcommittee, which doles out money to the FCC—had asked whether the presently legal pony programming carried by some stations might, in light of the proposed rules, hamper their efforts to renew their licenses.

Mr. Minow replied, "The proposed

rules are, of course, not in effect at the present time, and, as I indicated in my previous letter to you, the commission has reached no conclusions with respect to them." Noting that the proposed rulemaking is a controversial one, he added, "any licensee who conscientiously adheres to our 1961 policy statement [BROADCASTING, Nov. 27, 1961] pending finalization of the rulemaking proceeding, need have no fear of being penalized at renewal time. . . ."

Paterson applicants face hearing for ch. 37

The FCC has designated for comparative hearing the applications by four parties to operate channel 37 in Paterson, N. J. The four applicants are: Spanish International Television Co.; Progress Broadcasting Corp.; Bartell Broadcasters Inc., and Trans-Tel Corp.

The commission also made WPX(TV) New York a party to the proceeding. WPX has charged that Trans-Tel's application, if granted, would cause economic injury to the station.

There will be no final authorization made for channel 37, the commission said, until it makes a decision on the rulemaking to prohibit the use of channel 37 within a 600 mile radius of the University of Illinois' radio astronomy observatory in Danville (BROADCASTING, May 6). The channel 37 rulemaking would also restrict use of that channel, outside of the 600 mile radius, for television broadcasting between midnight and 7 a.m. The rulemaking if put into effect would be valid until January 1968.

Trans-Tel has suggested that the FCC drop-in a short-spaced channel 14 in Paterson in place of channel 37. Progress Broadcasting said it felt the rulemaking struck a fair balance of use of

channel 37 by researchers and broadcasters. Radio astronomers, however, were not satisfied with the FCC's rulemaking, and felt there is a need for a nationwide reservation of the channel (BROADCASTING, April 29).

FCC Chairman Newton Minow dissented to the commission's action, supporting the contention that channel 37 should be reserved on a nationwide basis for radio astronomy. Chairman Minow suggested that a substitute channel be found for use in Paterson. Chairman-designate E. William Henry warned the applicants for channel 37 that because their applications were set for hearing, they were extended no rights to the channel as such.

USIA reports increases in Voice's audience

The Voice of America's free world listening audience increased by more than 25% last year, the U. S. Information Agency has reported. Facing some measurement problems (gaps in information and troubles in precise measurement), the agency describes its figures as estimates. While the Voice audience increased by more than one-fourth, the overall audience in the noncommunist areas increased by about 12%, the agency said. The largest increase was in Latin America, up more than 50% over 1961.

The Voice's average daily audience now ranges from 17 to 26 million people, but more than twice that number listens to the broadcast service's programs during any given week. About 5 million listeners in the daily audience hear their programs in English; the remaining listenership is divided among 35 other languages.

The Voice's Communist area audience averages from 5 to 10 million daily and twice that weekly, USIA reported.

Sacramento pay TV denial sought in

Camellia City Telecasters last week asked the FCC to deny the application of KVUE(TV) Sacramento and Melco Pay TV Co. to conduct a three-year pay TV test in that city. Camellia said that a grant of such an application would be unfair to its competitive status with KVUE's renewal application for the channel 40 facility.

Capitol TV Co., licensee of KVUE, and Melco applied for the subscription television test this spring (BROADCASTING, April 22). Melvyn E. Lucas, who developed the proposed system, heads both of the companies.

Camellia told the commission that if the pay TV test is conducted, KVUE would be given a comparative advantage



It's a fact...
G. E.'s 7629 and 8092
image orthicons are
highly sensitive,
long-lived tubes...
up to 9000 hours and more...

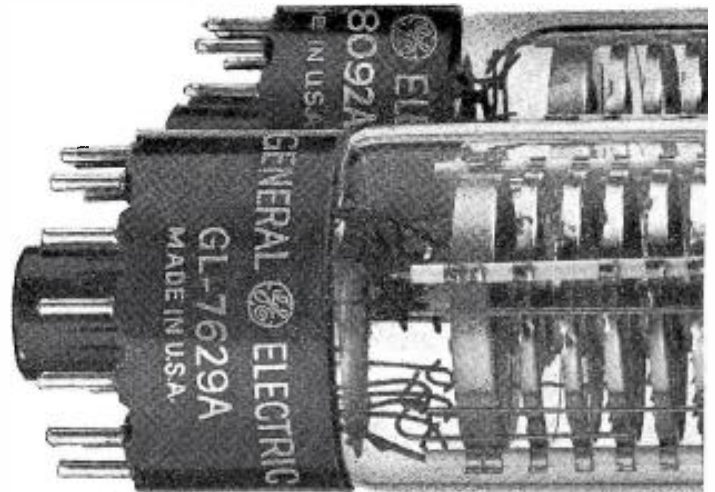
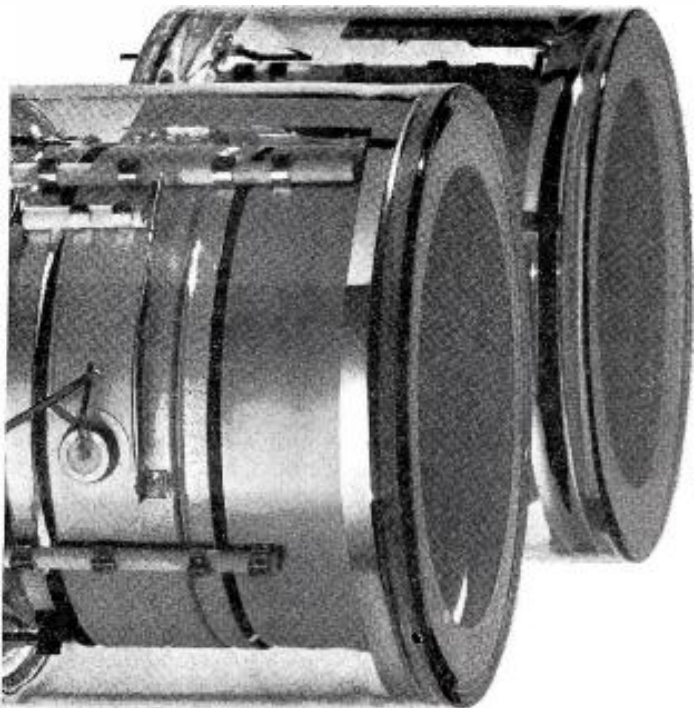

signal-to-noise ratios,
however, were a bit low...

(36:1 and 34:1 average)

Now, in the "A"
versions, we've quieted
them down...

(to 48:1 and 37:1)

HOW? . . . with design improvements utilizing semiconductor target material. G. E.'s new I.O.'s are designated the GL-7629A and GL-8092A . . . why don't you try one in your camera? In fact, try the whole line of newly improved G-E image orthicons: G-E Type GL-5820A, S:N—48:1/GL-7293, S:N—45:1/GL-7629A, S:N—48:1/GL-8092A, S:N—37:1/GL-8093, S:N—55:1. For your free facts folder, containing data and application notes on the expanding line of G-E image orthicons and vidicons, write to General Electric Company, Room 8005A, Owensboro, Kentucky, or call your nearest G-E Industrial Tube Distributor, today!

Progress Is Our Most Important Product

GENERAL  ELECTRIC

on programing considerations. Camellia said it would have only a proposed program schedule to show. Camellia noted that its application to compete with KVUE's renewal was already on file at the time the channel 40 station and Melco filed the pay TV test request.

The application for the test doesn't meet the commission's requirements, Camellia contended. It failed to show that Melco and KVUE do not have "an exclusive contract" nor does it give the principals of Melco, Camellia said. Camellia questioned Melco financial qualifications to operate the proposed test as well as KVUE's ability to keep operating. Camellia noted that KVUE has not been on the air since March 19, 1960, and said that renewal of its license is doubtful.

Legalties of space probes

A panel discussion on the legal problems of space exploration is scheduled for tomorrow (June 4) by the Federal Bar Association.

The meeting, to be held at 8 p.m. in the National Lawyers Club, Washington, will hear T. A. M. Craven, former FCC commissioner and now special consultant to the FCC on space communications; Max D. Paglin, FCC general counsel; George Feldman, a director of the Communications Satellite Corp., and J. Henry Glazer, National Aeronautics and Space Administration.

The panel will be moderated by Kenneth Finch, FCC attorney who is chairman of the space subcommittee of the International Law Committee of FBA.

Network study printed

The FCC has announced that its Office of Network Study report on *Television Network Program Procurement*, is available to the public through the Government Printing Office, Washington 25, D.C. The report costs \$1.25 a copy, and was printed by the House Committee on Interstate and Foreign Commerce, the commission said.

The network report was made public last December and advocated several

Mr. Henry's calendar

E. William Henry, who has replaced Newton N. Minow as chairman of the Federal Communications Commission will be interviewed by Harry Reasoner on CBS-TV's *Portrait* program June 5 (7:30-8 p.m. EDT). The interview will be conducted at Chairman Henry's home in Washington. Mr. Henry will be asked to discuss his life and career leading to his recent appointment. Chairman Henry also has accepted a "major" speaking engagement in New York on Sept. 24. Mr. Henry will appear before the International Radio & Television Society, according to IRTS's new president, Sam Cook Digges of CBS Films Inc.

stringent rules to control network program practices (BROADCASTING, Dec. 3, 1962).

KFAB wants ruling on emergency service

KFAB Omaha has asked the FCC for "an advisory ruling" on a plan to provide an emergency locating service to the doctors of the Omaha area. The service, which would aid in contacting doctors for emergency calls, would be handled in cooperation with the Omaha Physicians Bureau, KFAB said.

The station requested a ruling from the commission that it would not be liable to any penalties for conducting an unauthorized point-to-point communications service.

KFAB described the proposed service as a "back-up" measure for the answering service which is available to area physicians. The answering service provides a code number for each member physician, KFAB said, and in cases where the answering service failed to contact a needed doctor, and the sta-

tion was requested to do so, it would broadcast the code number of the doctor. Such bulletins would be labeled public service announcements, KFAB said, and would not use the name of the doctor.

Line rate hike Aug. 1; news services exempt

New wire rates, higher for leased telegraph lines and lower for leased telephone lines, will take effect Aug. 1, the FCC ruled last week. But the commission said that charges for news services, used by radio stations and networks as well as by the press, will not be changed until a separate study is made.

A rate hike was originally ordered for news services, too, in a final decision of Jan. 28. The commission stayed the decision March 13 in order to consider appeals.

Last week's action noted that rate increases for news outlets "would impair the widespread dissemination of news information." The FCC added: "In view of the authority given the commission to establish a separate press class of service with charges which may be different from the charges for other classes of service, and in view of the public interest in widespread dissemination of news information, we conclude it is appropriate to withhold a determination at this time."

UHF for Los Angeles ETV?

Community Television of Southern California, an organization devoted to obtaining an educational TV for Los Angeles, has filed a notice of intent to apply for UHF channel 28 with the FCC. But it does not intend to drop plans to acquire one of the seven commercial TV stations now operating in Los Angeles.

Rose Blyth, executive secretary, said "Channel 28 is the last UHF channel available in this area. We have always known that we would need more than one channel to provide the kind of service that is needed and have planned from the beginning for the eventual addition of a UHF facility to the VHF station with which we hope to launch our educational programing sometime in 1964. So going after channel 28 was just a matter of protecting ourselves."

Breakthrough in Ohio senate

The Ohio senate has extended floor privileges to 27 members of the Ohio Radio-TV Correspondents Association.

The senate resolution allows newsmen access to the floor to interview legislators and otherwise gather news. The correspondents, however, are still barred from taking any broadcast equipment on the floor, except by "express permission" of the senate's Committee on Rules.

*More than a decade of Constructive Service
to Broadcasters and the Broadcasting Industry*

HOWARD E. STARK

Brokers—Consultants

50 EAST 58TH STREET

NEW YORK, N. Y.

ELBORADO 5-0405

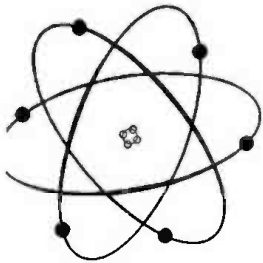

PROGRESS REPORT NUMBER 15 ON ATOMIC ELECTRIC POWER

An engineer at a new investor-owned atomic electric power plant checks out ports in the nuclear reactor head.

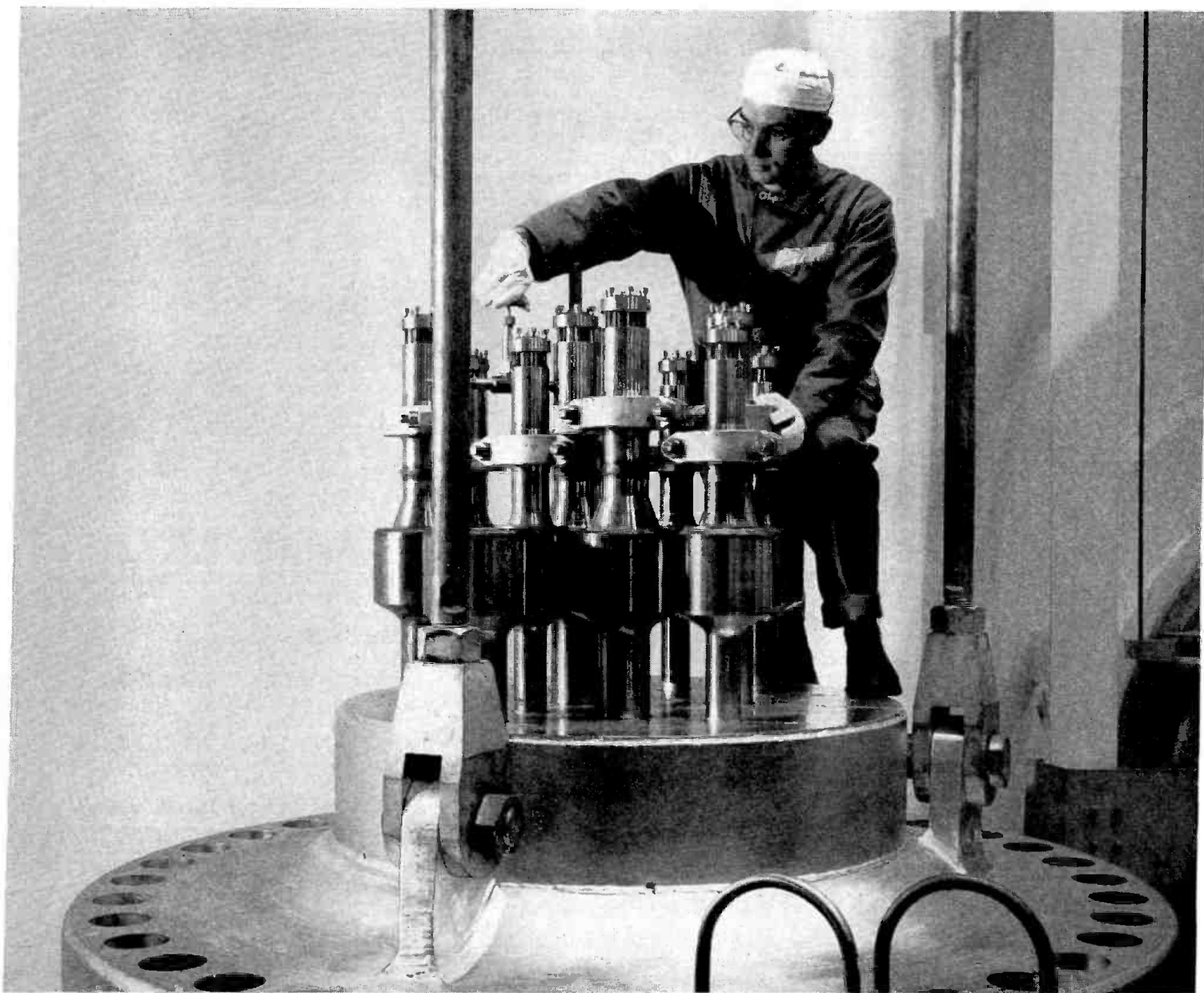

**125 COMPANIES...
25 ATOMIC POWER PROJECTS...
\$1,000,000,000 PROGRAM**

There's a big job being done by America's investor-owned electric light and power companies to get electricity from the atom. It's a \$1 billion program. Power companies from all over the nation—125 of them—are now participating in 25 atomic electric projects. All this is just one part of the investor-owned electric companies' continuing research and development program to make sure America will always have plenty of low-cost electric power.

Investor-Owned Electric Light and Power Companies... serving more than 140,000,000 people across the nation
Sponsors' names on request through this magazine

Union negotiation headache time ahead

SIX GROUPS WILL SEEK NEW PACTS IN '63; THREE MORE EARLY IN '64

The maintenance of jobs, wage increases and royalty or reuse payments loom as the key union demands in 1963 as networks and other broadcast industry groups head into a strenuous stretch of contract talks, starting this summer and extending through the fall and winter.

Six crucial negotiations are scheduled during 1963, and three other contract talks, which will be influenced by the course of settlements this year, are slated for the early part of 1964.

Industry officials have held discussions on new agreements with the Writers Guild of America and the Screen Directors International Guild for the past several months, and have reached tentative agreements, pending the framing of contract language and ratification by members.

But this is only the beginning. While applying the finishing touches to the SDIG and WGA contracts, negotiators have a back-breaking timetable through next February, involving talks with the International Brotherhood of Electrical Workers, the American Federation of Television & Radio Artists, the Screen Actors Guild, the National Association of Broadcast Employees & Technicians and the American Federation of Musicians.

"You can safely say we are moving into our 'headache period,'" one network executive observed last week.

The wage issue crops up traditionally in labor negotiations, and the broadcasting field is no exception. It is difficult to forecast a percentage increase that will apply to all unions, but a knowl-

edgable source indicates that 5% (plus fringe benefits), is a reasonable estimate.

Job Factor ■ The maintenance of jobs is expected to be a crucial factor in forging contracts with the technical unions, particularly IBEW at CBS and NABET at NBC and ABC, and with the AFM and Local One of International Alliance of Theatrical Stage Employes at the three networks.

These unions have been grumbling for years that automation and improved working procedures are displacing union employes, and the job retention issue is expected to take on heightened significance this year. IBEW will be negotiating with CBS this summer, and lurking in the background will be the specter to the union of the new CBS Broadcast Center on New York's West Side, now under construction at a cost of more than \$14 million.

"We hear this center is virtually 100% automated," an IBEW official commented. "We realize the network will be trying to reduce technical forces and it is up to us to save jobs."

The extent to which CBS is successful in paring its technician staff this summer will undoubtedly have repercussions on the NABET negotiations with ABC and NBC next January. CBS officials were willing to acknowledge last week that the network's new center, which an IBEW executive said originally was called the "hard core center," will be "highly automated." But he declined to discuss the possible effect it will have on the employment of engineers and technicians.

The third key item in labor negotiations is expected to be so-called extra payment, applicable to the talent unions (the Writers Guild, AFTRA, SAG and the AFM). These unions are aiming to broaden their pay benefits for performers from royalties (based on a percentage of gross sales) or reuse payments (based on the number of times a program or commercial is used). These benefits are part of many of the existing contracts, but the talent unions are seeking to expand their intake in this area.

Lurking in the shadows of negotiation—but unmistakably present—is the threat of strikes. In the past year, strikes by unions in other industries have been more frequent. In broadcasting, management is concerned mainly with effects of strike action by the technical rather than the talent unions. The rationale is that a prolonged strike by technicians could more seriously hamper operations.

The significance that networks attach to technical union negotiations can be adduced by this development: The networks already are sending hundreds of their executives to training schools to be prepared for any contingency (box, page 65). This move paid off for management in recent years when CBS became involved in a strike with IBEW and NBC with NABET. Executives-turned-technicians manned cameras, control boards, dollies and other equipment, and kept the networks operating for periods up to 19 days.

A Status Report ■ Though management and union officials traditionally are reluctant to discuss proposals, strategy or tactics planned for contract talks, background interviews with officials from both sides and with some outside observers over the past few weeks provided the basis for the following status report for each labor organization:

Writers Guild of America ■ The East Coast branch of WGA has been negotiating with the three networks for a new contract for both free lance and staff writers in non-entertainment programs (news, documentary, continuity). The contract has not yet been ratified, but it is reported the union has gained a basic 5% increase in wages and fees. Present top minimum scales for staff writers: \$195 weekly plus commercial fees and overtime at ABC and CBS; \$214 at NBC but no overtime pay.

The old contract expired on March 31 and agreement on a new contract

Plans to syndicate KYW-TV program canceled

Plans to syndicate the *Mike Douglas Show*, a 90-minute daytime live talent program carried on KYW-TV Cleveland, to four other Westinghouse Broadcasting Corp. TV stations have been canceled because of KYW-TV's inability to reach agreement with the American Federation of Television & Radio Artists on a waiver of fees and two other issues.

A memo distributed to the KYW staff on May 24 and released generally last week stated that the Cleveland local of the union never had offered more than a conditional waiver for 90 days, while the station

needed a permanent waiver. In addition, in return for the waiver, the union had insisted on demands that went beyond its contract with the station, the memo stated. These were said to include payment to announcers of fees for off-camera announcements and for contribution of 5% to the union's pension and welfare fund on all income earned by staff and free-lance members, rather than present 5% on gross scale income only.

AFTRA's demands, a KYW-TV official said, make the syndication of the *Mike Douglas Show* "impossible."

Nonunion technicians prepare for strike emergency

The networks are concerned mainly with the effects of a strike by the technical unions—the International Brotherhood of Electrical Workers at CBS and the National Association of Broadcast Employees & Technicians at NBC and ABC. One solution: send executives and other nonunion employees to a technical training school.

In preparation for coming negotiations with the technical unions (story, p. 64), the networks are sending some of their nonunion workers at main locations throughout the country to a technical school in the area. In New York network staffers are now training at RCA Institutes in Times Square, learning various technical operations, such as operating cameras and audio boards and (see photo) learning the intricacies of film transmission.

Network officials decline to discuss details but it is estimated that approximately 250 staffers from each network are undergoing technical training. One technical union leader commented last week: "We regard the existence of these 'scab schools' as a sign that networks are not ready to bargain in good faith."

A former NBC staffer who attended such a school in 1959 told

BROADCASTING that training was under a unit system. A unit of 10 men was sent to school for 12 weeks, three hours a week. Each man learned a specific skill—cameraman, sound boom operator, dolly pusher and so on. When NABET called a "wildcat strike" in late April 1959, each

unit was assigned to specific shows. He noted that these executives-turned-technicians were sufficiently proficient to telecast the Emmy Awards presentation that year in color. He recalled that he received a bonus of \$200 at the conclusion of the 19-day walkout.

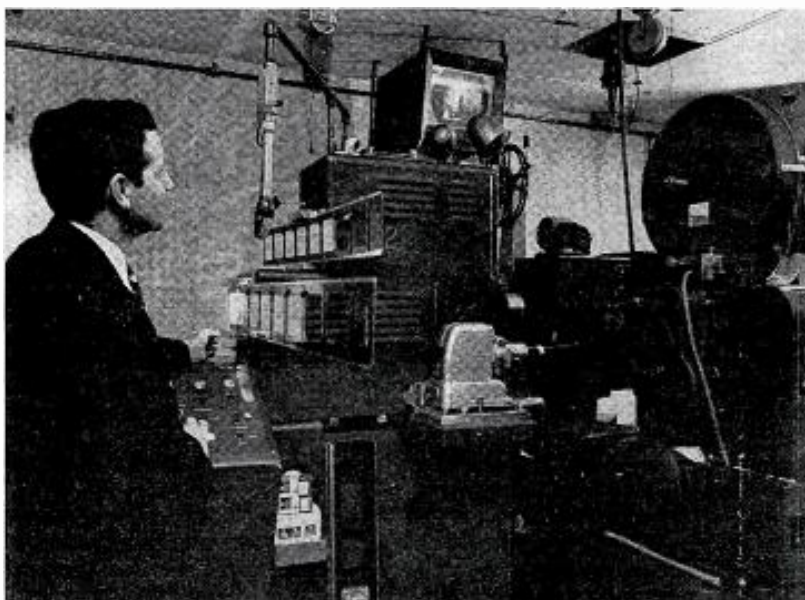

Network executives study technical operations

reportedly was held up largely because of the guild's position on a new formula to cover programs rerun in the U. S. and shown abroad. A union official noted that the question of deferred compensation is vital to the writer today and the framing of an appropriate contract provision acceptable to both management and the WGA formed the basis for considerable discussion. The new contract, which is expected to be signed within the next few weeks, will run for two-and-a-half years, retroactive to March 31. It covers almost 300 staff writers at the networks and approximately 800 free-lance writers.

Screen Directors International Guild ■ The union recently reached a tentative agreement with the Film Producers Association of New York, but a contract will not be signed for several weeks pending ratification by union members. SDIG is understood to have gained additional fringe benefits and an estimated 5% boost over its present pay scale. The directors, who work on film commercials, documentaries and theatrical films in New York, now earn basic wages of \$390 a week for a five-day week if they are hired for 26 weeks or more; \$465 weekly if they are employed for six weeks to 26 weeks; \$540

for one week's work, and \$135.50 for one day.

The union had sought but reportedly did not obtain benefits in certain "working conditions" areas, including payment for preparation of work and for performing assignments in premium time (weekends and holidays).

International Brotherhood of Electric Workers ■ This negotiation involving CBS shapes up as the critical one on the broadcasting scene this year. In view of its projected move in 1964 to its new Broadcast Center, which is highly automated, the network undoubtedly will seek a contract that will provide for flexibility in the size of IBEW crews. The union is bound to press for maintenance of staffs.

One source close to the union commented: "The union knows it's going to lose jobs. But it's going to fight hard to save as many jobs as it can."

The top minimum scale for most technicians at CBS is \$200 a week. The union is expected to seek initially a possible 20% increase in wages, but the feeling is that it would accept an added 5% if it gained other concessions. These are said to be various devices that will help save jobs, such as a four-day week, a six-and-a-half-hour

day, and guaranteed employment for workers with seniority.

Approximately 1,100 engineers and technicians employed in New York, Chicago, Hollywood and other cities are represented at CBS by IBEW. The dwindling of technician jobs is summed up by an IBEW official in this way: "We now have about 575 men working at CBS in New York. At one time we had more than 800 men."

Job Decline ■ Several factors have contributed to the decline of jobs. One is the cut-back in live programming; another is improved working procedures devised out of experience, and the third is the introduction of automated equipment.

Len Bader, international representative of IBEW in New York, declined to discuss details of the coming negotiations but did reveal that the present contract concept is "outmoded" in view of the "changed conditions in the industry today." He claimed that the use of tape at the networks and the impact it has had on working procedures are not reflected in the contract. The basic pact, he said, was formulated in 1950 when the bulk of the programming was live. The union, Mr. Bader indicated, will aim for changes in working pro-

TvQ's top 10 for April, by age

Rank	Program	Total audience TvQ*	Age groups				
			6-11 TvQ*	12-17 TvQ*	18-34 TvQ*	35-49 TvQ*	50 + TvQ*
1	Beverly Hillbillies (CBS)	55	81	68	53	47	46
2	Bonanza (NBC)	48	43	55	45	43	53
3	Red Skelton Hour (CBS)	46	74	54	42	42	39
4	Doctor Kildare (NBC)	43	54	46	42	36	46
4	Saturday Night Movies (NBC)	43	46	59	48	36	31
6	Combat (ABC)	42	55	56	41	38	25
7	Disney World of Color (NBC)	41	64	46	33	35	37
8	Andy Griffith (CBS)	40	49	36	34	40	43
9	Monday Night Movies (NBC)	39	41	46	41	35	32
10	Gallant Men (ABC)	38	53	55	33	33	26
10	Gunsmoke (CBS)	38	57	42	29	35	39
10	Hazel (NBC)	38	56	38	29	29	44

*Percentage of those who are familiar with program and say it is one of their favorites.
Copyright Home Testing Institute, Inc., 1963

cedures that will recognize the pre-eminence of tape production of programs, but he declined to elaborate.

The present contract is for two-and-one-half years, starting Feb. 1, 1961.

National Association of Broadcast Employees & Technicians ■ The three-year contract with NBC and ABC expires Jan. 31, 1963. In general, pacts signed by IBEW and NABET are similar, though a rivalry exists between them and each claims it sets the pattern for the other. The basic top wage is slightly higher at NBC and ABC—\$202 a week—as compared to \$200 at CBS.

Both network and union officials reported last week that negotiations are too distant to form concrete plans. But they agree that the same basic conditions to be discussed in the IBEW-CBS talks will prevail in the NABET-NBC-ABC conferences. There are approximately 1,200 NABET members at NBC and 1,000 at ABC.

"NBC and ABC will be staying at the same old premises," a union official observed. "But they can install the same equipment and devise the same working methods as CBS at its new center. Of course, automation is the big problem. Though we all have to learn to live with it, management must realize it has responsibilities to its workers too."

Screen Actors Guild-American Federation of Television & Radio Artists ■ A negotiation in which advertisers have expressed keen interest is the coming joint talks with SAG and AFTRA on codes governing TV commercials. For the first time, negotiations with these talent unions will be headed by a group of agency and advertiser officials, rather than network executives.

The present three-year contract, which expires on Nov. 15, was formulated by the unions and the networks, accompanied by violent protests from agencies and advertisers. They claimed that networks accepted fairly modest boosts in wages and fees on network programs and commercials, and steep

increases in spot commercials. Accordingly, the networks have passed the negotiation reins to the advertisers and agencies in the commercials area.

The principal bone of contention is the reuse formula for spot TV commercials. Advertisers have contended that it has resulted in higher costs, and a joint American Association of Advertising Agencies—Association of National Advertisers study of the SAG-AFTRA residual formula is expected to confirm this contention. The study is expected to be completed within a month.

Neither the unions nor management will discuss projected proposals. A SAG official last week reported that its members earned approximately \$25 million on commercials in 1962, representing the initial fee for making the spot and residuals from reuse of the commercial. He claimed that a comparison could not be made with prior years because the figure was computed from performers' contribution to the pension and welfare fund, which went into effect in 1962.

In addition, AFTRA will negotiate separately with networks on scales for performers appearing in live and taped programs plus staff announcers.

One area that is expected to be discussed searchingly is a "more realistic" formula for programs sold abroad. The effect of the present contract, which calls for certain percentages of the original fees to performers on programs sold in foreign countries, has been to keep the overwhelming proportion of so-called "prestige" music-variety, classical music and other taped shows off foreign airwaves because producers and networks claim the fees are exorbitant. As a result, the bulk of U. S. programs exported abroad are films, on which there is currently no overseas pay.

Local One, International Alliance of Theatrical Stage Employees ■ This contract with New York stagehands and associated employes at the three networks expires next Dec. 31. One union

official characterized the problem of Local One with this terse remark: "We're losing jobs all the time."

Neither the union nor the networks would reveal employment figures, but it is estimated there are about 225 IATSE members on staff and 350 who work on a casual basis. One union official claimed that at one time there were almost twice the number there are today, but network officials insist the reduction has not been that steep. The union says the reduction in the number of stagehands results from improved working procedures and a decline in live programs at the networks, along with an increase in the number of filmed and taped shows. The taping of a program, a union official noted, speeds up the production process, and the practice of pre-taping has virtually "wiped out" employment during the summer of stagehands employed on a casual basis.

The union's main objective is to maintain a maximum number of employes on the staffs of the three networks. The top basic scale for stagehands is \$151.36 per week.

American Federation of Musicians ■ The main issue with musicians also is job retention. Networks and stations which still employ staff musicians contend there is relatively scant use today for regularly employed musicians, and the networks are expected to emphasize this stand next February when the present five-year pact expires.

The three networks employ approximately 350 musicians on staff in New York, Chicago and Hollywood. This figure does not include musicians who are hired for special or regular programs by networks or independent producers. The weekly wage rate is \$242 in New York and slightly lower in Chicago and Los Angeles.

The outlook is that the networks will be able to effect some reductions in staff musicians quotas. There is precedence for this in the last negotiations when the Chicago staff for each network was reduced by 20 musicians over a four-year period. The most vulnerable local is in New York, where each network employs 65 musicians.

Hayward gets rights

Leland Hayward Productions Inc. has purchased rights from British Broadcasting Co. to produce for American television the topical English TV satire, *That Was the Week That Was*. Marshall Jamison will serve as executive producer and William Harbach producer-director of the 30-minute weekly show whose format will be restyled to be a commentary on American events with occasional excerpts from the BCC show where pertinent to American life. The program package is represented by General Artists Corp.

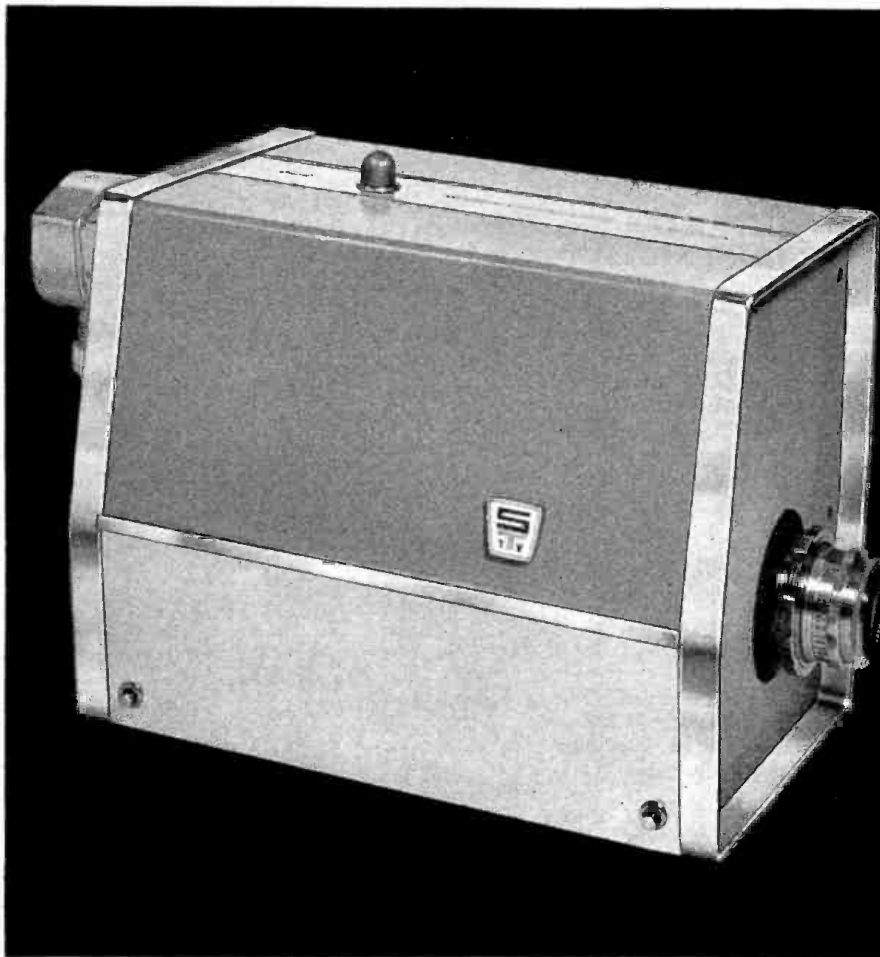

New SOLID STATE FILM CAMERA SYSTEM

Performs like
it looks—
GREAT!

■ The first look tells you Tarzian's smartly-styled FULLY Solid State Film Camera is big on quality. Swing up the quick-opening side panels and you'll see the quality runs clear through. Especially designed for television film and slide pick up, the 1500F/A camera system uses a 1.5" image pick up tube, is entirely solid state—including the preamplifier—and is designed to mount on any standard multiplexer. All circuitry is immediately accessible on plug-in printed circuit cards. New advances in solid state circuit design deliver better than 1% sweep linearity, 1.5% geometric distortion . . . and greater than 46 DB S/N.* And, of course, the camera system takes advantage of the superior qualities of 35 mm optics.

Find out how easy it is to put this finest of film camera systems into your studio—call or write:

*0.4 μ amp Beam current—F8 lens stop opening

Broadcast Equipment Division
SARKES TARZIAN, INC.
east hillside drive • bloomington, indiana



CBS, NBC in dead heat in Emmy race

CONTROVERSIAL DOCUMENTARY HONORED AS 'PROGRAM OF THE YEAR'

CBS-TV and NBC-TV shared in total Emmy awards on May 26. The two networks received 12 each in the various categories for outstanding TV program work. ABC-TV won three awards.

The telecast itself started at 10 p.m. on NBC-TV but didn't conclude until 11:50 p.m. EDT, 20 minutes past the scheduled sign off.

Aside from a count of awards by network, the attractions and performers selected acclaimed the following:

The Tunnel on NBC-TV, awarded the statuette as the outstanding program of the year, not only was a documentary but also a controversial program that the State Department asked be kept off the air because of the delicate international situation (the program, depicting the digging of a tunnel from East to West Berlin as an escape route for refugees, finally went on the air in December 1962, after a rescheduling).

A top comedy show—*Dick Van Dyke* on CBS-TV—received awards as the standout in several categories. This was true also of Carol Burnett and her appearances in specials on CBS-TV, of *The Defenders* (CBS-TV), of a *Ben*

Casey episode on ABC-TV and of a Hallmark production on Disraeli (NBC-TV).

The first station to be presented a national Emmy in a new category was WCBS-TV New York for its production of *Superfluous People*. The first international award went to Granada Television Network (United Kingdom) for *War and Peace*.

Also cited by the National Academy of Television Arts and Sciences, which presents the awards, were AT&T for Telstars I and II; Dick Powell (posthumous), and President Kennedy for his recognition of TV and participation in telecasts of importance.

As in the past seasons, the Emmys were conferred at simultaneous three-city, black-tie dinner presentations in New York, Hollywood and Washington. Following a pattern, ATAS voting selected a mixture of culture, drama, high-level information and regular entertainment.

It was noted that this was the second straight year that the telecast ran 20 minutes over the 90-minute allotted time. Procter & Gamble, through Grey Advertising, sponsored two-thirds of the program and the other third was picked up by Libby, McNeill & Libby, through J. Walter Thompson.

Estimates placed the "per minute" audience at approximately 30 million.

The official awards list covers presentations of any length, live, taped or filmed. Classifications included cinematography for TV, electronic camera work, film editing for TV and engineering or technical excellence.

The awards list:

PROGRAM OF THE YEAR

(That program, created originally or fully adapted for television, which is considered to be the most outstanding presentation during the awards period. Such a program may be either one of a series or an individual presentation, either entertainment, public service or coverage of a newsworthy event, but may not include a duplicate or an approximate duplication of a presentation previously used in another medium.)—*The Tunnel*, Dec. 10, 1962 (NBC).

PROGRAMS

Humor (regular or special program, or series)—*The Dick Van Dyke Show* (CBS).
Drama (regular or special program, or series)—*The Defenders* (CBS).

Music (regular or special program or a series)—*Julie and Carol at Carnegie Hall*, June 11, 1962 (CBS).

Variety (regular or special program, or a series)—*The Andy Williams Show* (NBC).
Panel, quiz, or audience participation (regular or special program, or a series)—*G-E College Bowl* (CBS).

Children's (regular or special program, or a series)—*Walt Disney's Wonderful World of Color* (NBC).

Documentary *The Tunnel*, Dec. 10, 1962 (NBC).

News (regular or special program, or a series)—*Huntley-Brinkley Report* (NBC).

News commentary or public affairs (regular or special program, or a series)—*David Brinkley's Journal* (NBC).

International reporting or commentary

(Overseas origination—person or program)—Piers Anderton, Berlin correspondent, NBC—for *The Tunnel*—Dec. 10, 1962 (NBC).

ACTING PERFORMANCES

Actor in a leading role (single performance)—Trevor Howard, "The Invincible Mr. Disraeli" on *Hallmark Hall of Fame*, April 4, 1963 (NBC).

Actress in a leading role (single performance)—Kim Stanley, "A Cardinal Act of Mercy" on *Ben Casey*, Jan. 14 and 21, 1963 (ABC).

Actor in a series (lead) (continued performance only)—E. G. Marshall, *The Defenders* (CBS).

Actress in a series (lead) (continued performance only)—Shirley Booth, *Hazel* (NBC).

Actor, in a supporting role (regular or special)—Don Knotts, *The Andy Griffith Show* (CBS).

Actress in a supporting role (regular or special)—Glenda Farrell, "A Cardinal Act of Mercy" on *Ben Casey*, Jan. 14 and 21, 1963 (ABC).

In a variety or musical program or series (regular or special program)—Carol Burnett, *Julie & Carol at Carnegie Hall*, June 11, 1962 (CBS) and *Carol and Company*, Feb. 24, 1963 (CBS).

ACHIEVEMENT

In composing original music for television—Robert Russell Bennett, "He Is Risen" on *Project 20*, April 15, 1962 (NBC).

In art direction and scenic design—Carroll Clark and Marvin Aubrey Davis, *Walt Disney's Wonderful World of Color* (NBC).

Writing in drama—Robert Thom and Reginald Rose, "The Madman" on *The Defenders* Oct. 20 and 27, 1962 (CBS).

Writing in comedy—Carl Reiner, *The Dick Van Dyke Show* (CBS).

Directorial in drama—Stuart Rosenberg, "The Madman" on *The Defenders* Oct. 20 and 27, 1962 (CBS).

Directorial in comedy—John Rich, *The Dick Van Dyke Show* (CBS).

Cinematography for television—John S. Priestley, *Naked City* (ABC).

Electronic camera work—"The Invincible Mr. Disraeli" on *Hallmark Hall of Fame*, April 4, 1963 (NBC).

Film editing for television—Sid Katz, *The Defenders* (CBS).

THE STATION AWARD

Superfluous People, WCBS-TV New York City.

THE INTERNATIONAL AWARD

War and Peace, Granada Television Network Ltd., Great Britain.

TRUSTEES AWARDS

The American Telephone and Telegraph Company—"For conceiving and developing Telstar 1 and Telstar 2. The launching of these satellites into the skies has spanned the oceans with a measureless gift—the promise of instant television communication between the peoples of the world."

Dick Powell—"In grateful memory of his conspicuous contributions to and reflections of credit upon the industry as an actor, director, producer and executive; and for his consistent and unselfish cooperation with and support of the academy."

TRUSTEES CITATION

"This citation is presented to the President of the United States . . .

"Because you initiated and have continued to make your news conferences available to television . . .

"Because this willingness to expose to the public the thoughts and feelings of your office was further reflected in a specially scheduled news conference as part of the first Telstar broadcast . . .

"Because by participating in the program *Conversation with the President* a new dimension was reached in communication between the White House and the people . . .

"For these reasons . . .

"And in honor of your continued recognition of television's importance to the dialogues of a free society . . . this citation is extended by the Board of Trustees of The National Academy of Television Arts and Sciences to the President of the United States, John Fitzgerald Kennedy.



WSLS-TV, Roanoke
sells Virginia's
NO. 1 TV Market. *

* Source - Television Magazine

K THE KATZ AGENCY, INC.
National Representatives

High mortality rate

The mortality rate of new television programs this current season which won't be around come next fall is the highest so far—72%—a study made by Foote, Cone & Belding, Chicago, disclosed last week. Of the 32 new shows which began last fall, a total of 23 won't be back next season, the agency said. FC&B's study of the past 10 years found the previous program mortality high was 66% in the 1959-60 TV year. Ten-year average death rate: 57%.

CBS Radio drops N.Y. Philharmonic

CBS Radio has terminated its 33-year seasonal broadcasts of the New York Philharmonic concerts. The current concert season ended with the performance of May 26. The orchestra was notified the network would not continue the broadcasts another season by CBS Radio President Arthur Hull Hayes.

Mr. Hayes said the broadcasts have been declining in audience over the years. He attributed the drop to several factors, among them the changing nature of network radio program service to principally news and information. He also attributed the drop to broadcast pickups by stations of regional concerts, delayed tapings, and to a growing supply of concert music to the public through recordings and network telecasts.

It was noted that the Philharmonic Society has received \$90,000 a season for radio rights to the weekly concert plus additional payments which up the approximate total cost to CBS Radio to \$155,000 a year. An increment study over a ten-year period on CBS Radio-owned stations found a 72.6 percent drop in audience, it was reported.

WNYC-AM-FM-TV New York, municipally owned and operated stations, offered their facilities for broadcast in New York. They also would tape the concerts for sales to stations elsewhere in the U. S. in the hope of defraying the expected financial loss to the Philharmonic Society.

Country Music Week planned

Preparation of the third annual National Country Music Week, Oct. 27-Nov. 2, is underway by the Country Music Association. CMA's president, Gene Autry, has appointed three regional co-chairman: Roy Horton, chairman in the East; Steve Sholes in the

West, and Bob Pampe in Canada. Ken Nelson will be responsible for the production of a special promotion disc to be sent to radio stations in the U.S. and Canada.

Overseas Press Club presents TV awards

NBC News won top honors in three categories at the annual presentation of awards for journalistic excellence of the Overseas Press Club of America in New York last week. Two first place awards went to CBS News and one to ABC News at the club's 24th annual awards dinner.

NBC News winners were *The Tunnel* for "the best television reporting from abroad," Scott Berner for "best photographic reporting (motion picture) from abroad," and Peter Dehmel and Klaus Dehmal for "superlative photography requiring exceptional courage and enterprise abroad."

CBS News' Alexander Kendrick received the award for "best interpretation of foreign affairs, radio." The television award in this category went to CBS News for its production of "East Germany—The Land Beyond The Wall," one of the *CBS Reports* series.

ABC News' Sidney Lazard was named winner for "best radio reporting from abroad."

Citations were presented to NBC News' Piers Anderton and Joseph Harsch; ABC News' Charles Arnot, Howard K. Smith and the ABC News Special Projects Division for *Meet Comrade Student* and to CBS News for its production *So That Men Are Free*.

Faulk's life to be filmed

Tandem Productions, Hollywood, announced last week it will produce a motion picture in 1964 depicting the life of John Henry Faulk, radio and television personality. Mr. Faulk won a \$3.5 million judgment for libel last year in a case involving "blacklisting" in the broadcast field.

Tandem said it has acquired the motion picture rights to a book Mr. Faulk now is writing. It will be published by Simon & Schuster in January 1964.

Film sales . . .

The 12-Hour Grind (Triangle Stations): Half-hour color film of Sebring, Fla., auto race, sold to: WPIX(TV) New York; WLWC(TV) Columbus, Ohio; WJRT(TV) Flint, Mich.; WDAF-TV Kansas City, Mo.; WNEP-TV Scranton-Wilkes-Barre, Pa.; WAGA-TV Atlanta; WTTV(TV) Indianapolis; WGR-TV Buffalo; KERO-TV Bakersfield, Calif.; KFMB-TV San Diego; WPTA(TV) Fort Wayne, Ind.; WSM-TV Nashville; WMCT(TV) Memphis; KPRC-TV Houston; KXTV(TV) Sacramento, Calif.; and KRON-TV San



Gates 12 and 16-inch turntables are designed for continuous 24-hour commercial service. No programming load too great for these rugged Professionals.

CB-500

16-inch turntable chassis with synchronous motor.

\$250.00



CB-77

12-inch turntable chassis with synchronous motor.

\$230.00

FEATURES:

- Exclusive "hub drive" effectively isolates motor vibration from turntable surface, resulting in lower noise and rumble.
- Low speed synchronous motor (600 RPM) reduces motor noise.
- Extra heavy aluminum castings used for base plate. Turntable platter is precision machined and balanced.
- Three speeds—78, 45 and 33 $\frac{1}{3}$ RPM.
- Entire chassis floats on foam rubber cushion to isolate floor and desk vibrations.
- Chrysler oilite bearings at all major friction points. Fingertip speed shift has monoball self-aligning bearings. Operation is silent, smooth and trouble-free.
- Silent, illuminated mercury switch.
- Built-in stroboscope.

SHIPMENT FROM STOCK

CB-500 (16") \$250.00

CB-77 (12") \$230.00

Prices are FOB Quincy, Ill.

GATES

GATES RADIO COMPANY
Subsidiary of Harris-Intertype Corporation
QUINCY, ILLINOIS

Offices in: HOUSTON, NEW YORK,
LOS ANGELES, WASHINGTON, D.C.

Francisco. Schaefer Beer, via BBDO, and Eldon Toy, via Don Kemper, will sponsor program in six Triangle markets: WFIL-TV Philadelphia; WFBG-TV Altoona, WLYH-TV Lebanon, both Pennsylvania; WBNF-TV Binghamton, N. Y.; WNHC-TV New Haven, Conn. and KFRE-TV Fresno, Calif. Now in 24 markets.

Trails West (Robeck & Co.): Sold to WOR-TV New York; WLKY(TV) Louisville, Ky.; KTVH(TV) Hutchinson-Wichita, Kan.; WAFB-TV Baton Rouge; WCTV(TV) Tallahassee, Fla.-Thomasville, Ga. and WNEM-TV Saginaw-Bay City, Mich. Now in 100 markets.

Program notes . . .

War is heck ■ Desilu Sales Inc. has announced the acquisition of *The World at War*, a first run syndication series. *The World at War* consists of 13 half hours of film footage—from U. S., British, Canadian, Japanese, German and Italian sources—of World War II. Produced by the Canadian National Film Board, the series will be distributed beginning this summer.

Quiz for 'Jerrod' ■ *People Will Talk*, an audience-participation game show

Sarnoff to speak

The initiation of a new weekly series on NBC Radio, "*Toscanini—The Man Behind the Legend*," will be marked by an intermission talk by Brigadier General David Sarnoff, RCA board chairman, when the show begins Wednesday, June 5 (9:05-10 p.m. EDT). It was General Sarnoff, then NBC board chairman, who was instrumental in bringing Mr. Toscanini out of retirement in 1937 and launching the 17-year series in which the Italian conductor participated with the NBC Symphony on radio and recordings.

starring Dennis James, will replace *Ben Jerrod*, a new series this season in the NBC-TV daytime schedule. The quiz, produced by Four Star Television, will be seen beginning July 1 (Monday-Friday, 2-2:25 p.m. EDT).

Free films for TV ■ The Broadcast Information Bureau reports that there has

been an increase of 10% in the number of available public relations films intended for TV and a 7% increase in the number of organizations underwriting this type of film. Information on public relations film is incorporated in the 10th edition of the *TV Free Film Source Book* released to subscribers by BIB. The bureau reports that between the release of its 1962 and 1963 volumes, 953 public relations films were added and 622 dropped.

'Hedda Gabler' set

CBS-TV last week set Dec. 9, 1963, as the date it will schedule the 90-minute *Hedda Gabler*, the Henrik Ibsen play that the network taped for TV using BBC studio facilities in London a year ago. The program appeared on BBC on Dec. 28, 1962.

Desilu extends GAC sales pact

Desilu Productions has extended the contract of General Artists Corp. to serve as exclusive sales agency for Desilu's network television sales through the sales season for the 1964-65 broadcast season.

THE MEDIA

RATINGS MONKEY BUSINESS

American Research Bureau voids Green Bay survey after station asks diary keepers to reveal selves

The May-June American Research Bureau survey of metropolitan Green Bay, Wis., was voided by ARB last week because of a station's admitted attempt to "insure the accuracy of the survey."

ARB stopped the regularly scheduled survey, which was to have been published in mid-July, when it learned that WLUK-TV Green Bay had broadcast announcements requesting ARB diary keepers to call the station. According to field representatives of the ratings firm, the station began running the announcements Friday evening (May 24), one week after the four-week survey began.

Canceling Spots ■ On Wednesday (May 29), Norman M. Postles, secretary-treasurer of M & M Broadcasting Co., licensee of WLUK-TV, notified ARB that the station was discontinuing the announcements immediately. Mr. Postles said he would go to ARB headquarters in Beltsville, Md., this week to meet with Ralph Crutchfield, station sales manager for ARB, and negotiate for a new survey of the Green Bay market at WLUK-TV's expense.

John H. Borgen, general manager of WLUK-TV, said the spots consisted of a

"bulletin" slide with voice-over: "If you have received an American Research Bureau television survey book in the mail this past week, please call WLUK-TV at Hemlock 2-6468. We have an important message and surprise for you."

ARB reported that callers were told the gift would be some scratch paper and a pen and that the station would also send a letter explaining the importance of the diary and telling how to fill it in.

Mr. Postles said the station's move was an attempt "to make the survey as accurate as possible. We are advising people we have talked to, to be most careful, most complete in preparing their diaries."

According to the two most recent ARB surveys in the Green Bay area, (November-December 1962 and February-March 1963), WLUK-TV finished third on overall share in the three-station market. The November-December survey gave WBAY-TV a share of 53, WFRV(TV) a 25 and WLUK-TV a 22. In the February-March survey, WBAY-TV had a share of 49, WFRV a 32 and WLUK-TV a 20.

ARB said voiding the survey would cost the firm about \$3,000, in rebates to station clients. The ratings firm said this was not the first time a station had interfered in the conduct of a survey.

During its February-March survey of the Abilene-Sweetwater, Tex., metro area, ARB ran into a similar situation. In its published report of that survey ARB included a "special notice" stating: "During the last two weeks of the February-March survey period . . . KPAR-TV televised several daily spot announcements consisting of pictures of an ARB diary and a Nielsen diary, with the request that any person keeping such a diary report to the station in person so that the 'registration number' of the diary could be 'checked.' The station offered \$5 to all persons who brought in diaries to the station. In order to determine the magnitude of the response to the announcements and to evaluate the effect (if any) these announcements may have had in influencing diary keepers, ARB reinterviewed all persons who had returned metro diaries for the weeks March 1-7 and March 8-14. These reinterviews disclosed the fact that 12 diary keepers had taken diaries to the station and had collected the \$5 offered. These diaries were located and eliminated from the data used in the preparation of the Abilene/Sweetwater report. However, the results of the reinterviews and an evaluation of the 12

diaries eliminated revealed no indication of pressure on the part of the station to alter the recorded viewing or the viewing habits of the persons keeping the diaries."

Not The Same ■ ARB said it could not apply the Sweetwater/Abilene techniques to the Green Bay situation because WLUK-TV had begun its announcements so early in the survey. Mr. Borgen said the station had aired the announcements on a run of schedule basis, with most being aired in the morning hours.

Asked how WLUK-TV was logging the announcements, Mr. Postles would not comment.

An official of another Green Bay station reported that an ARB diary-keeper from Appleton, Wis., who apparently had seen the WLUK-TV announcement, called his station asking for her "important message" and gift. He said the call was referred to WLUK-TV.

Mr. Crutchfield said the survey had to be voided since the diary-keepers who responded to the television announcements had become "atypical," having spoken with an official of one of the stations.

ARB plans to send a special bulletin and letter to all agencies and clients telling them why the survey isn't being published.

The survey firm's officials were apprehensive of consequences if the station practices in Green Bay and Sweetwater/Abilene were to spread. "If 30 stations started doing it," an ARB official said, it could affect the national sweeps.

Media reports...

WLS to editorialize ■ WLS Chicago has started a new editorial policy with initial series titled "Smut On Our Newsstands." The ABC-owned outlet will air editorials as occasion demands. A single issue will be treated continuously for a month or more and many times daily if necessary. Newsman Bernard Miller will prepare and voice the editorials approved by WLS President Ralph Beaudin and editorial board.

New quarters ■ KRHM-FM Los Angeles has moved to new quarters at 301 S. Kingsley Drive, Los Angeles 5. Telephone remains Dunkirk 5-7421. Continental/International Productions, subsidiary of KRHM-FM, has also moved to the new address.

New salesmakers ■ Effective June 15, KILO Grand Forks and KDLR Devils Lake, both North Dakota, will join the North Dakota Salesmaker Group. Their regional representative will be Dean & Slaughter Inc., Minneapolis.

Macfadden-Bartell purchase ■ The Macfadden-Bartell Corp. has purchased

True Confessions and *Motion Picture* magazines from Fawcett Publications for an estimated \$2 million. Macfadden-Bartell also owns WADO New York; WOXY Milwaukee and KCBQ San Diego and Telecuracao, a television station in the Netherland Antilles. It is also the majority stockholder of Macfadden Teleglobe Denver, franchise holder for the Teleglobe system of subscription television proposed to be operated over the facilities of KCTO(TV) in that city.

Colleges get \$116,000 CBS Foundation grants

CBS Foundation Inc. has announced grants to institutions of higher education totaling \$116,000 for 1963. Seven \$3,000 unrestricted grants will be presented to six institutions honoring graduates of those schools who are now CBS executives. The balance will be distributed to 11 colleges and college associations.

The seven CBS executives recognized and their alma maters: Frank Beazley, general sales manager, WCAU-TV Philadelphia, Stanford University; Willard Block, international sales manager, CBS Films Inc., Columbia University; Blair Clark, general manager and vice president CBS News, Harvard University; Ralph Daniels, national sales manager, KNXT(TV) Los Angeles, Pomona College; David Fuchs, director, market development, CBS-TV, Yale University; John McCrory, assistant sales manager, KMOX-TV St. Louis, Fordham University and Renville McMann, director of engineering, military and industrial systems, CBS Laboratories, Yale University.

The CBS Foundation has given over \$1.5 million to colleges and universities since organization of its educational grants program in 1954.

Broadcasters-print men meet under UPI banner

United Press International, believing that broadcasters and newspapermen can learn a lot from each other, held a combined meeting of the UPI Newspaper Editors and Broadcasters of Wisconsin in Milwaukee May 24-25.

Richard Leonard, managing editor of the *Milwaukee Journal* and president of the UPI Newspaper Editors, noted that the meeting was held "because we both have problems that have a common solution."

Bill Garry, president of the Radio-Television News Directors Association, drew special attention to the joint crusading efforts of WBBM-TV Chicago and the *Chicago Daily News*. The two media recently joined hands to illuminate Chicago's slum problems (BROADCASTING, May 27).

We're proud of our Stainless TALL TOWER*

... say these leading broadcasters



ROBERT C. LUKKASON
General Manager

KCND-TV
PEMBINA, N. D.



CLIFF THOMFORDE
Technical Director

* 1454 feet

If you're planning towers of any kind, take advantage of STAINLESS' experience in designing and fabricating the world's tallest structures.



Get your free book describing these installations.

Stainless, inc.

NORTH WALES • PENNSYLVANIA
In Canada: Walcan, Ltd., Carleton Place, Ont.

Radio code board meets—and talks

PROPOSED CHANGES IN TIME STANDARDS ARE PLACED ON THE TABLE

There will be no immediate changes in the commercial time standards contained in the radio code of the National Association of Broadcasters, the radio code board decreed last week.

The code board, meeting for one and one-half days in Washington, tabled for the present all proposed changes in the time standards (BROADCASTING, May 27). In other actions, the code board:

- Adopted a statement alleging that incorporation of the time standards into government rules "would spell the doom of self-regulation in broadcasting."

- Approved in principle the recommendation of NAB Code Authority Director Robert D. Swezey for a broadcasting-advertising study of the entire problem with emphasis on the "quality" of commercials.

- Heard a report from Charles

casting and the commission if it failed to speak frankly and directly to the issues involved," the code board said.

If the government threat is carried out, the statement continued, "from that day forward a most significant determinant of a station's contribution to its community would be the numerical clocking by the government of minutes and seconds of advertising." This, the board said, would be a "fruitless result."

The radio and TV codes are a very creditable example of industry self-regulation, the code board said, constituting patterns of program and commercial practices which, when observed, substantially affect the financial income of subscribers. A fair appraisal shows that broadcasters' voluntary support of the codes has been respectable, the board maintained.

Facts and Figures ▪ TV code sub-

The board said that it has become "increasingly aware" that no quantitative measure of the amount of commercials without regard to content, quality and techniques of production can serve as a measuring stick for advertising. Alluding to Mr. Swezey's recommended study, the board said that a more realistic and meaningful gauge must be developed. "But if industry efforts toward that end are to be productive," the board said, "they must not be constrained by government fiat." The board concluded:

"We are convinced that the adoption of the proposal would constitute an ill-considered intrusion in an area in which government dictate is not only unnecessary but unwarranted. We therefore earnestly urge the commission to withdraw the proposal and to leave this matter of the appropriate presentation of commercials to the li-



At the May 27 meeting of the radio code review board were (l to r): Robert L. Pratt, KGGF Coffeyville, Kan.; Richard O. Dunning, KHQ Spokane; Robert B. Jones Jr., WFBR Baltimore; Elmo Ellis, WSB Atlanta; Robert D. Swezey, NAB code authority director; Lee Fondren, KLZ

Denver; Richard H. Mason, WPTF Raleigh, N. C.; Herbert L. Krueger, WTAG Worcester, Mass., and Charles M. Stone, radio code authority manager. Absent from the photo: Richard M. Fairbanks, WIBC Indianapolis, and Cliff Gill, KEZY Anaheim, Calif., board chairman.

Stone, NAB radio code manager, showing that there is 91.7% compliance with the radio code (among subscribers who number some 37% of total radio stations).

- Recommended two minor changes in the code to the NAB radio board.

- Appointed a three-man "screening committee" to consider proposed changes and alternates to the present time standards.

A large portion of last week's meeting was devoted to pending proposals to relax the time standards and the FCC's threat to formally embrace in its rules the industry's prescribed commercial maximums. In view of the serious implications of the FCC rulemaking, "this board feels that it would be doing a disservice to the public, broad-

scribers now number 409, 70% of all operating stations, it was pointed out.

The present radio code and its time standards have been in effect less than three years and "in that relatively brief period have acquired 1,830 subscribers—over 37% of the much larger and diversified radio business," the board said. An increase of radio subscribers of 19% over the past year "can scarcely be termed an unhealthy rate of growth," the statement continued.

Critics of the radio code ignore its many accomplishments and persist in the allegation that it has been unsuccessful in "restraining what is loosely referred to as overcommercialism," the board charged. "Overcommercialism has never been satisfactorily defined and probably never will be."

censes of broadcast facilities who are not only competent to deal with it but who are fully cognizant of their legal and moral responsibility to do so."

Steering Committee ▪ Elmo Ellis, WSB Atlanta, who chaired last week's meeting in the absence of Chairman Cliff Gill, KEZY Anaheim, Calif., appointed the screening committee for a continuing study of time standard changes. Members of the special committee include Lee Fondren, KLZ Denver, Robert L. Pratt, KGGF Coffeyville, Kan., and Herbert L. Krueger, WTAG Worcester, Mass.

Other code board members present at last week's meeting were Richard O. Dunning, KHQ Spokane, Wash.; Robert B. Jones Jr., WFBR Baltimore; and Richard H. Mason, WPTF Raleigh,

NAB's opposition going 'through channels'

There is no "sound need" for a national meeting of broadcasters to crystallize uniform opposition to the FCC's plan to adopt the commercial time standards now encompassed in the radio-TV codes of the National Association of Broadcasters, according to NAB President LeRoy Collins.

Replying to a request by the Georgia Association of Broadcasters that the NAB call such a meeting, Governor Collins said that the NAB will develop its strategy of opposition "through normal channels."

GAB made its proposal to the national association following a May 25 "emergency" meeting of its board of directors. Jack Williams, GAB executive secretary, wrote Governor

Collins of the Georgia request and said that GAB would hold off on plans to call its own meeting of southern states to give the NAB an opportunity to act.

Five states already have pledged support of the Georgia position, Mr. Williams said. "We have no desire to splinter or oppose NAB," he told Governor Collins, "but we feel strongly that urgent action must be taken—and soon. . . Georgia broadcasters hope to have and expect NAB's leadership."

Governor Collins, in reply to GAB, said that "no one has any reason to doubt where we stand on this issue." He said NAB opposition will be developed through committee, board

and staff considerations "and will be pressed in the manner we conclude will be most effective."

The NAB president told GAB to use "your own judgment as to what meetings you stimulate, but any impression you may give . . . that NAB may not be concerned or not active in its efforts will be wholly erroneous."

NAB plans to ask the FCC for an extension of the present July 1 deadline for comments on the controversial rulemaking, NAB Vice President Howard Bell disclosed in a letter to Mr. Williams. He said the NAB board, meeting in Washington June 24-28, will go over the proposal in planning the NAB's opposition.

N. C. The ninth radio code board member, Richard M. Fairbanks, WIBC Indianapolis, did not attend.

In the face of the FCC threat to adopt the time standards, the board tabled all pending proposals to relax, amend or repeal them entirely. And, while the board was meeting, the concept of expressing commercial limitations in percentages rather than minutes, and computing on a daily rather than an hourly basis (BROADCASTING, May 27), continued to be pushed outside Washington.

No Change In Total ■ Broadcasters advocating this approach stressed that it could be adopted on a basis that would not change the permissible total of commercial content, yet would permit a redistribution of that content to accommodate the needs of most if not virtually all stations, large or small.

Thus, its supporters maintained, more stations would be "able" to subscribe to the code—and more subscribers would be able to adhere more closely to it.

In television, for example, it was estimated that this could be accomplished by amending the code to read that not more than 20% of the entire broadcast day, not more than 25% of any one hour, should be devoted to commercials.

These figures would in no way represent a relaxation of current standards, advocates emphasized.

These supporters felt that, in addition, there should be a qualitative study such as Mr. Swezey has proposed to learn more about how the nature of a commercial, as distinguished from the simple measure of its length, contributes to so-called overcommercialization. But they urged the adoption of their code revisions now, contending that

the qualitative study, no matter how desirable, should not be used as an excuse—or a reason—for deferring valid changes.

Monitoring Report ■ A random sampling of 244 radio code stations showed 91.7% compliance with limitations on commercials during 1,088 of the most-listened-to hours of the broadcast day, Mr. Stone reported. Hours covered in the monitoring were 7-9 a.m. and 4-6 p.m. during the past 10 months.

During the monitored hours, there were only 91 hours of commercial time in excess of that prescribed by the code, or 8.3% above the maximum. The 91 hours averaged to one minute, 41 seconds an hour above the time standards' allowable maximum of 18 minutes commercial time for any given hour.

Mr. Ellis said the results show "an excellent degree of compliance." He speculated that most instances of violations were inadvertent rather than a deliberate flaunting of the code.

The monitoring report showed that compliance averaged 93.8% during the evening and 89.6% from 7-9 a.m.

The code board recommended that the radio code be amended to include a specific provision against the disparagement of competitive products by advertisers. Another proposed change would state that "religious programs shall place emphasis on religious doctrines of faith and worship," excluding the present specific prohibition against the presentation of controversial or partisan views "not directly or necessarily related to religion or morality."

These proposed changes, as well as the time standards, will be considered by the NAB radio board at its June 24 meeting in Washington. The code board cannot make final changes and only recommends to the parent body.

Georgia vetoes Texas plan

The Georgia Association of Broadcasters has voted "unanimously" not to accept the invitation of the Texas Association of Broadcasters to join a proposed Federation of State Associations (BROADCASTING, May 27).

"This is an extremely poor time to further splinter the broadcasting indus-

There's Nothing Puzzling About WMAL-TV's Straw Hat Plan

It's as simple as compound interest!

From June 2 to August 31 you get a

25% BONUS IN FREE SPOTS

on all spot purchases over \$300 per week



All this plus WMAL-TV's big viewing audience all summer long—additional exposure without additional cost. Programs figured on the same basis. Frequency discount rates not affected. Check Harrington, Righter & Parsons, Inc. for full details.

wmal-tv abc

Evening Star Broadcasting Company
Washington, D. C.

Represented by:
HARRINGTON, RIGHTER &
PARSONS, INC.

try which is already rent by far too many splinter organizations," GAB wrote Jack Roth, president of TAB. Instead, Georgia suggested that Texas support its drive to create a vice presidency at the National Association of Broadcasters whose sole duty would be to work with state associations.

NAB's 'leadership' defended by Collins

LeRoy Collins, president of the National Association of Broadcasters, replied sharply last week to rising criticism of the "leadership" the NAB is providing for the broadcasting industry.

Speaking before the Connecticut Broadcasters Association, he said that some of those who criticize the NAB role of leadership "do so in apparent ignorance of the true facts. Frequently, also, the critic will provide nothing more than a vague, general emotional appeal without suggesting alternative courses of action," he charged.

While the NAB is "disturbed by some current FCC procedures," Governor Collins said, he urged that "no one heed the prophets of doom—those on the fringes of our industry who would have us believe that there is implacable enmity between the FCC and

the broadcaster. . ."

He urged those who disagree with NAB policies to work within its established framework to seek changes "rather than attempt from the outside to weaken the whole fabric of industry unity . . . Otherwise, there can be no recognizable voice of broadcasting, only a meaningless din of chaos and confusion with inevitable ultimate default and failure."

NAB's No. 1 objective is to help broadcasters to become better and stronger, Governor Collins said. The NAB has a strong government relations program to avoid federal incursion into broadcasting.

Renewal Letters ■ For the first time in public, the NAB president mentioned license renewal inquiries which the FCC is sending to TV stations questioning local live programming. "Certainly one can raise questions on this subject," he said, "but such questions should be direct and meaningful to obtain useful answers. To ask a question of a licensee in a form to indicate to some that a particular answer is desired is, I submit, improper."

The NAB president spoke specifically of two broadcasting problems with government — congressional investigation of the ratings services and the FCC's threat to adopt the NAB's com-

mercial time standards. He said the industry's ratings research plan (BROADCASTING, May 27) is a "bold and unprecedented concept that will be one of the most significant developments in the history of broadcasting." The primary objective of the plan, he said, is to assure that audience measurement services are valid, reliable and effective.

If more stations subscribe to the NAB radio and TV codes, Governor Collins said, the FCC rulemaking "would never have seen the light of day." He said this threat of government intrusion is wrong and the NAB will oppose it "with all our strength and effectiveness. Discipline is needed in this area, but this is a proper place for self discipline through our own initiative and resources, not for government stricture."

Changing hands

ANNOUNCED ■ *The following sales of station interests were reported last week subject to FCC approval:*

■ wdz Decatur, Ill.: Sold by Frank C. Schroeder Jr. to Stephen P. Bellinger, Morris E. Kemper, Joel W. Townsend, Ben H. Townsend and T. Keith Coleman for \$325,000. The buyers control wizz Streator and WRAM Monmouth, both Illinois. wdz is a 1 kw daytimer on 1050 kc with MBS affiliation. Broker was Hamilton-Landis & Associates.

■ WRIM Pahokee, Fla.: Sold by WRIM Inc. to Mr. and Mrs. John N. Traxler for \$23,000. Station is 500 w daytimer on 1250 kc. Broker was Chapman Co.

■ KDWC(FM) West Covina, Calif.: Sold by J. Kent Blanche and associates to Sherman J. McQueen and group of Southern California local businessmen for \$15,000. Station, which has been silent since July 1962, operates on 98.3 mc with 810 w. Broker was Wilt Gunzendorfer & Associates.

APPROVED ■ *The following transfer of station interests was among those approved by the FCC last week (for other commission activities see FOR THE RECORD, page 88).*

■ KTTV(TV) Los Angeles, Calif.: Sold by the Los Angeles Times-Mirror to Metromedia Inc. for \$10,390,000 (see page 75).

MAAC names permanent group on standards

MBS announced last week that the Mutual Affiliates Advisory Committee has appointed a permanent research committee to study ways and means of establishing a single-standard of radio listening measurement.

MAAC approved the move at a

Outstanding Values in Radio-TV Properties

Profitable 3 year record daytimer. Tops all ratings. Solid market. Liberal terms.

CALIFORNIA
\$275,000

Excellent daytime facility. Number 1 rating. Absentee owner will offer good terms. Fast growing market.

CALIFORNIA
\$150,000

Powerful daytimer in multiple station market. Excellent facility. Presently profitable, but needs owner-manager to realize potential. Good terms.

NEW ENGLAND
\$200,000

BLACKBURN & Company, Inc.

RADIO • TV • CATV • NEWSPAPER BROKERS
NEGOTIATIONS • FINANCING • APPRAISALS

WASHINGTON, D.C.

James W. Blackburn
Jack V. Harvey
Joseph M. Sitrack
RCA Building
Federal 3-9270

CHICAGO

H. W. Cassill
William B. Ryan
Hub Jackson
333 N. Michigan Ave.
Chicago, Illinois
Financial 6-6460

ATLANTA

Clifford B. Marshall
Stanley Whitaker
John G. Williams
1102 Healey Bldg.
Jackson 5-1576

BEVERLY HILLS

Colin M. Selph
G. Bennett Larson
Bank of Amer. Bldg.
9465 Wilshire Blvd.
Beverly Hills, Calif.
CRestview 4-8151

meeting of its 25 members in Nassau, Bahamas. Ray Anderson, research and marketing director of the Minnesota Mining & Manufacturing Co., parent company of Mutual, was named consultant to the research committee.

MAAC unanimously commended the administration of the network and its news and special events divisions for performing "a most outstanding job in serving the affiliates with a superior radio service."

The committee re-elected Victor C. Diehm, WAZL Hazleton, Pa., chairman. Other officers elected were Carter C. Peterson, WBGY Savannah, Ga., vice chairman, and Ed Breen, KVFD Fort Dodge, Iowa, secretary.

WUHY-TV gets CBS grant of \$100,000

CBS-TV continued its financial support of educational television with the announcement last week of a \$100,000 grant to assist operation of WUHY-TV, the ETV outlet for Philadelphia.

According to CBS officials, the contribution raises to \$1,350,000 the amount which the network has given in cash contributions to various ETV enterprises in the country.

WUHY-TV previously had received equipment, facilities and technical aid from CBS, and when the station's studios were hit by fire in 1960 the CBS-owned WCAU-TV in Philadelphia made its studios and facilities available to WUHY-TV then WHY-TV.

In making the gift, CBS President Frank Stanton said that CBS supported efforts to make television "a useful tool of instruction, to develop new educational techniques, and to supplement the intellectual and cultural activities of commercial television. We welcome, both the opportunity that commercial television has to learn from educational television's greater freedom to experiment and the increased competition to earn the viewer's attention," he said.

Microwave for ETV planned

An agreement to exchange educational TV programming by microwave transmission has been announced by the New Jersey Educational Television Corp. and WHY-TV Inc. of Philadelphia.

Initially the system will link NJ-ETV's proposed channel 77 Essex with WUHY-TV and later connect ETV outlets in New Brunswick, Atlantic City and Glassboro as part of the "live network." The proposed system will link the four New Jersey educational stations with each other as well as with WUHY-TV.

FCC okays sale of KTTV(TV) Los Angeles

METROMEDIA PURCHASE GIVES IT FULL TV QUOTA

The FCC unanimously approved the sale last week of KTTV(TV) Los Angeles from the Los Angeles/Times Mirror Co. to Metromedia Inc. for \$10,390,000, one of the highest prices for a broadcast property.

In approving the transfer, with Commissioner Robert T. Bartley abstaining, the commission said it was without prejudice to its avowed hope that one of Los Angeles' seven VHF stations might become an educational, non-commercial outlet. This was expressed in the FCC's 1961 notice of inquiry.

The grant was conditioned on (1) the outcome of the ex parte proceedings involving WFTV(TV) Orlando, Fla., and (2) that John P. Crisconi relinquish his stockholdings in either Metromedia Inc. or WKTV(TV) Utica, N. Y.

The Orlando case involves allegations of ex parte contacts with members of the FCC resulting in the channel 9 grant to Mid-Florida Television Corp. in 1957. John W. Kluge, president of Metromedia, was at that time a principal stockholder in the Orlando applicant. He has since disposed of his interest in that station. WFTV(TV) prin-

cipals were cleared of the off-the-record taint by the FCC after a rehearing.

Mr. Crisconi owns less than 1% of Metromedia stock and a little over 6% of the WKTV ownership. With the acquisition of KTTV, Metromedia becomes the owner of five VHF and two UHF television stations. In an attempt to overcome this technical violation of the duopoly rule (which prohibits any one entity from owning more than five VHF and two UHF television outlets), Mr. Crisconi placed his WKTV stock in a trusteeship. The commission, however, did not accept this arrangement. WKTV principals recently purchased KSYD-TV Wichita Falls, Tex. (BROADCASTING, March 18).

The transaction involves the acquisition of all the stock of the Times Mirror Broadcasting Co., licensee of the channel 11 independent. Robert W. Brechner, president and general manager of the station, will remain in charge.

Still To Come - Still pending FCC approval is Metromedia's purchase of KLAC-AM-FM Los Angeles for \$4.5 million (BROADCASTING, March 18). Only

EXCLUSIVE BROADCAST PROPERTIES!

MIDWEST —Full time radio station in large, prosperous market. This good-powered facility grossed approximately \$250,000.00 in 1962 and is capable of doing much better. Priced at \$375,000.00. **Contact—Richard A. Shaheen in our Chicago office.**

WEST —Good power and frequency provide excellent market coverage for this full time radio station. Presently running 15% ahead of 1962 gross of \$190,000.00—plus. Priced for a quick sale of \$260,000.00 cash. **Contact—John F. Hardesty in our San Francisco office.**

Hamilton-Loundis

& ASSOCIATES, INC.

John F. Hardesty, President

NEGOTIATIONS • APPRAISALS • FINANCING OF CHOICE PROPERTIES

WASHINGTON, D.C.
1737 DeSales St., N.W.
Executive 3-3456

CHICAGO
Tribune Tower
DElaware 7-2754

DALLAS
1511 Bryan St.
Riverside 8-1175

SAN FRANCISCO
111 Sutter St.
EXbrook 2-5671

RADIO • TV • CATV • NEWSPAPERS

America's Most Experienced Media Brokers

three weeks ago Metromedia announced the purchase of WCBM-AM-FM Baltimore for \$2 million (BROADCASTING, May 20).

Metromedia's broadcast holdings: WNEW-AM-FM-TV New York; KMBC-AM-FM-TV Kansas City, Mo.; WTTG(TV) Washington; KOVR(TV) Sacramento, Calif.; all VHF, and WTVH(TV) Peoria and WTVP(TV) Decatur, both Illinois and both UHF, and WIP-AM-FM Philadelphia and WHK-AM-FM Cleveland. It also owns the outdoor advertising firm of Foster & Kleiser.

Fire hits Chicago FM

WDHF(FM) Chicago expected to resume broadcasting over the weekend from temporary studios, James DeHaan, president-general manager, said Thursday. The station went off the air May 24 after a \$100,000 fire which also destroyed new stereo and automation gear waiting to be installed.

'No payola' affidavits sought by KFVB

POLLS RECORD PROMOTERS TO SEE IF THEY'RE CLEAN

About 20 record promoters have signed affidavits that they have not made gifts of more than nominal value to any employe of KFVB Los Angeles, J. Joseph Bernard, station manager, said last week. Several affidavits are coming in each day, he said, and he looks for the trend to continue until all, or the vast majority, of the city's record promoters are accounted for. Some are delaying, he said, because they represent companies with Eastern headquarters which must be checked before any local action is taken.

The affidavits are in response to a letter written May 14 by Mr. Bernard requesting all record promoters who submit records for use on KFVB that they have not engaged in any form of

payola to get their records played. The letter states that it was written as a result of an anonymous telephone call to Joseph C. Drilling, president of Crowell-Collier Broadcasting Co., owner of KFVB and other radio stations. The call, Mr. Bernard stated, charged that KFVB's record librarian, Don Anti, "demands and receives gifts of monies, clothing, extensive trips and an inordinate amount of entertainment from certain record promoters and record companies." The caller said that if Mr. Anti is not replaced, a report of his activities will be made to the FCC.

Mr. Bernard said that he too had received anonymous calls and has asked for "names, incidents and proof" without receiving any evidence to back up any of the charges. His letter quotes one of the basic CCBC policies forbidding the acceptance by staff members of any gift having a normal retail value of more than \$20 or a loan of any amount and adds that each employe signs an affidavit every three months that he has complied with this policy.

"I approach this problem with the premise that all of you are honest and above reproach in the areas mentioned. . . ." Mr. Bernard wrote the record promoters. "I therefore ask each of you in the promotion business to sign and notarize the attached form. . . . If anyone does not do so, it shall become my duty to see that he is barred from the station."

The letter was discussed at a meeting of the Southern California Record Industry Promoters and the question was raised why it was sent to them rather than to the record distributors or manufacturers. "The answer is simple," Mr. Bernard explained. "The promoters are the people we do business with, not the manufacturers or the distributors. The promoters bring the records to us and leave them for us to play and then to decide whether or not they merit use on the air for our program format."

KFVB gets about 200 records a week, submitted almost entirely by record promoters, he said. A committee made up of the program director, the music librarian and the disc jockies, listens to about 40 records of the total and decides which should go on the station's play list for the following week. "The librarian selects the records for the committee to hear. Therefore his opinion is especially important to the record people." Mr. Bernard said that he believes the anonymous phone caller is a disgruntled promoter whose records have failed to get on the KFVB play list.

There are about 100 record promot-



Petry reps for shortwave station

Some of results of first contract placed by Edward Petry & Co. as sales representative for an international broadcasting service are examined on the desk of Ralph Pennell, marketing director of Electric Storage Battery Co. International, which through Petry placed the campaign on Radio New York Worldwide (WRUL).

ESB, one of the sponsors of WRUL's coverage of the Gordon Cooper space flight, got almost 3,000 letters (average postage: 30 cents) in response to an offer of a Ray-O-Vac flashlight. With Mr. Pennell (seated)

are (l to r), Jack Duffy, Petry sales representative; David Wheeler, ESB sales representative, and Gene Mancini, ESB assistant merchandising and advertising director.

WRUL's appointment of Petry to handle sales to U. S. companies doing business overseas was announced last week. Petry meanwhile has racked up sales to Chrysler International, RCA, Champion Spark Plugs, and Voice of Prophecy. Radio New York, which was acquired Jan. 1 by the Mormon Church, is headed by Ralf Brent. It is an international affiliate of ABC Radio.

ers active in the Los Angeles area and about 60 of these belong to SCRIP. The president of SCRIP, Russ Regan of Buckeye Record Distributors, and the organization's secretary, Pamela Burns, an independent record promoter, have both signed affidavits, Mr. Bernard said. To date, he added, no one has flatly refused to sign one.

66 broadcasters enrolled for seminar

Broadcast executives, 66 strong, will invade the Harvard University campus this summer for the fourth annual executive development seminar sponsored by the National Association of Broadcasters.

James H. Hulbert, manager of the NAB department of broadcast management who is in charge of the seminar, said that no more registrations can be accepted for the July 14-26 sessions at the Harvard Graduate School of Business Administration. Station executives plan to attend from 26 states, Canada, Puerto Rico and an American newsman from England, he said.

The course is designed to develop skills in the analysis and solution of management problems and special attention will be given to competitive programing, personnel, finances and selling. Instruction will be by the "case method" technique developed by the Harvard Business School. Special research materials provided by the broadcasters and specifically tailored for the seminar will be used, Mr. Hulbert said.

A complete list of registrants follows:

- COLORADO—Lee Fondren, KLZ Denver.
- FLORIDA—Edmund Ansin, WCKT(TV) Miami; William Faber, WFLA-TV Tampa; Kenneth F. Small, WRUF Gainesville.
- GEORGIA—Charles Doss, WROM Rome; Joseph Higgins, WAI(TV) Atlanta; Virgil B. Wolf, WRDW-TV Augusta.
- ILLINOIS—Timothy Ives, WJBC Bloomington; Thomas Miller, ABC Television Spot Sales, Chicago.

- INDIANA—Hugh Kibbey, WFBM-TV Indianapolis.
- IOWA—Kenneth Hastie, WMT-TV Cedar Rapids.
- KANSAS—Robert Schmidt, KAYS-TV Hays.

LOUISIANA—Roger Davison, WJBO Baton Rouge; Paul Goldman, KNOE-AM-TV Monroe; Robert Schultis, WDSU-TV New Orleans.

MAINE—Richard Bronson, WABI-TV Bangor; Robert Maynard, WMTW-TV Portland; Donald Powers, WCSH-TV Portland; Eugene Wilkin, WGAN-TV Portland.

MASSACHUSETTS—Leslie Arries Jr. WHDH-TV Boston; Donald Thurston, WMNB North Adams.

MICHIGAN—Donald DeSmit Jr., WKZO-TV Kalamazoo; James Gross, WJIM-AM-TV Lansing; Michael Lareau, WOOD Grand Rapids; Franklin Sisson, WWJ-TV Detroit.

MISSOURI—Ray Karpowicz, KSD-TV St. Louis; Robert Wormington, WDAF-TV Kansas City.

MONTANA—Edmund Peiss, KOOK-AM-TV Billings.

NEBRASKA—Ed Hundley, KNCY Nebraska City.

NEVADA—Lee Hirshland, KOLO-TV Reno.

NEW YORK—John Dickinson, Harrington, Righter & Parsons Inc., New York; Ole Morby, Time-Life Broadcast Inc., New York; Mark Olds, WINS New York; Robert Peebles, WROW Albany; Sam Slate, WCBS New York.

NORTH CAROLINA—Victor Dawson, WFNC Fayetteville; L. G. Jones, WTOE Winston-Salem; Penn Watson, Jr., WGTM Wilson.

NORTH DAKOTA—A. L. Anderson, KFJR Bismarck.

OHIO—James Burgess, WLW Cincinnati; George Campbell Jr., Peoples Broadcasting Corporation, Columbus; Harry Crowl, WAVI Dayton; Lawrence Rogers, Taft Broadcasting Company, Cincinnati; David Stewart, WKBN-TV Youngstown; Richard Wolfe, WBNS Columbus.

PENNSYLVANIA—Arthur Carlson WSBA, York; E. J. Meehan, Jr., WPBS Philadelphia; Dan Shields, WGAL-AM-TV Lancaster.

RHODE ISLAND—Albert Gillen, WPRO-TV Providence; H. William Koster, WEAN Providence.

SOUTH CAROLINA—Bruce Buchanan WFBC, Greenville; Law Epps, WIS-TV Columbia; Charles Sanders, WSPA-AM-TV Spartanburg.

TEXAS—John O'Brien, KTON Belton; Edwin Pfeiffer, WFAA-TV Dallas; William Terry, KRBC, KACB-TV Abilene.

VIRGINIA—Harold Barre WRVA, Richmond; Harold Soldinger, WTAR-TV Norfolk; J. Glen Taylor, WAVY-TV Portsmouth.

WASHINGTON—Lincoln Miller, KIRO-AM-TV Seattle.

WISCONSIN—Arlow D. Bice, Jr., WCWC Ripon; Norman M. Postles, Superior.

Also attending will be: Dennis Barkman, CFAM Altona, Manitoba, Canada; Rod Macleish, Westinghouse Broadcasting Co., London; Harlan C. McFadden, WKAQ San Juan; Segismundo Quinones Jr., WPRM San Juan.

FOR TOWERS of all kinds CALL ROHN

For a complete line of towers ideally suited for radio, television and microwave use of all kinds, rely on ROHN.

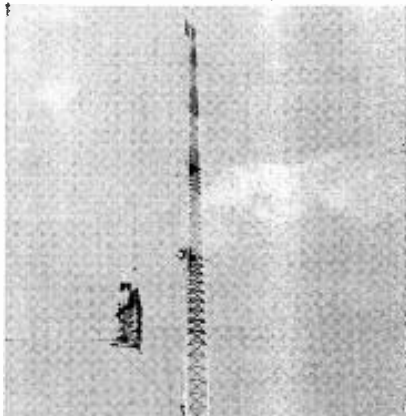

Shown above is the final installation of a 16 bay antenna atop a 485' ROHN TV broadcast tower. The installation is the WMBD-TV translator station at LaSalle, Illinois, Channel 71.

ROHN Manufacturing Co.



P.O. Box 2000
Peoria, Illinois

"Pioneer Manufacturer of
Towers of All Kinds"
ROHN Representatives world-wide.



\$1.11

an hour **STAFFS YOUR STATION** with IGM SIMPLIMATION

Get the details! Find the way to bigger audiences, lower costs, higher profits with unparalleled flexibility and consistently better sound. Write for free folder. "The Sound of Money."

IGM SIMPLIMATION,

P.O. Box 943, Bellingham, Washington.

FINANCIAL REPORTS

Tax reform would hit family-owned firms

BILL CAN ADD \$10 MILLION A YEAR TO U. S. COFFERS

High-bracket tax payers who set up personal or family-owned corporations for tax purposes—a grouping which includes some television performers and other people in broadcasting—would be affected by a tax reform proposal tentatively approved last week by the House Ways and Means Committee.

Subject to review by the committee, the proposal is aimed at catching about \$10 million in tax revenue which the

government says it loses to "incorporated pocketbooks" of the wealthy.

Under present laws corporations pay a tax rate of 7.8% on dividend income, but individuals pay from 16 to 87%, depending on their tax bracket. The first \$50 is exempt in either case.

The reforms would tighten up restrictions in this area which President Kennedy called "inadequate" in his January tax message. If adopted, the measures

would make it more difficult for a taxpayer to use a corporation as a device for avoiding full taxes on investment income without running into the punitive taxes which are levied on personal holding companies.

Chris Craft reports profit

Both television stations owned by Chris Craft Industries Inc., a diversified company which owns KPTV(TV) Portland, Ore., and KCOP (TV) Los Angeles, are operating profitably, John G. Bannister, president of the company said in a May 20 report to stockholders on first quarter earnings. KCOP, he added,

achieved a profit position for the first time in the latter part of 1962.

Three months ended March 31:

	1963	1962
Earned per share* \$	0.21	0.34
Revenues	17,468,186.00	17,803,252.00
Earnings before federal taxes	315,449.00	859,240.00
Net earnings	290,449.00	469,240.00

*Based on 1,376,872 shares outstanding as of March 31.

TV-Electronics Fund up 14.2%

Total net assets of Television-Electronics Fund Inc. increased to \$378.1 million on April 30, the mid-year of the fund's fiscal year, it was reported last week. This is a 14.2% growth in

assets from the \$331 million in Oct. 31, 1962, the end of the last fiscal year, Chester D. Tripp, president of the fund, pointed out. Net asset value per share rose to \$7.48, a gain of 17.5% from the close of the 1962 fiscal year.

Audio Devices report

Audio Devices Inc., New York, magnetic tape manufacturer, quarterly report for period ending March 31:

	1963
Earned per share	\$ 0.14
Net income before federal taxes	249,880.00
Net income after taxes	123,480.00
Total sales	1,899,050.00
Total shares outstanding	868,371

(This is Audio Devices' first issuance of quarterly reports.)

EQUIPMENT & ENGINEERING

A television system for the blind?

ELECTRIC IMPULSES ON BRAIN MAY MAKE IT POSSIBLE

A television system may someday bypass the eye and send electric impulses directly to the brain, enabling a blind person to "watch" television. This possibility was presented by Dr. Allen DuMont at the International Television Symposium in Montreux, Switzerland.

Dr. DuMont is the founder and senior technical consultant of DuMont Laboratories Division of Fairchild Camera and Instrument Corp. He said "there are outstanding electronic scientists who are convinced that we will be able, eventually, to feed electrical waves directly to the human brain . . . with such precision that in combination with the human nervous system, a blind person will actually enjoy television pictures."

Other developments in TV envisioned by Dr. DuMont:

- "There is little question that color television of a 3-dimension type will

replace present black-and-white receivers while the sound portion will be stereophonic.

- "Our better receivers will have their own tape recorder in order that particular programs can be taped.

- "Miniaturization will take over in the area of the pickup camera, so that we will have television cameras that will weigh less than a pound.

- "Interconnection from city-to-city or country-to-country will utilize lasers in combination with fiber optics, rather than presently existing coaxial cable and microwave."

FM-stereo in about half of combination sets

Almost 50% of all radio-television and radio-phonograph combination sets produced during the first quarter of 1963 were capable of FM-stereo reception, the Electronic Industries Associa-

tion has reported.

During the first three months of this year, 24,465 radio-TV combinations out of 62,816 had FM-stereo. In radio-phonograph combinations, 180,752 out of a total of 348,436 were equipped to receive stereo signals. This adds up to 205,217 combination receivers out of 411,252 total capable of receiving stereo. For all of last year, 767,539 combination receivers (nearly 46%) out of a total of 1,677,385 combinations had FM-stereo.

CBS-TV to purchase 44 Mark IV cameras

Marconi's Wireless Telegraph Co. has received what it claims is the largest single order ever placed for 4½-inch image orthicon television cameras. The order for 44 Marconi Mark IV camera channels was placed by the CBS Television Network.

The cameras, which were ordered after an extensive series of evaluation tests, are fitted with a transistorized pre-amplifier.

The new CBS television center in New York will receive 29 of the new cameras between July and November. Another six are for the new CBS News facility in Washington and nine, to be delivered in July, will be used in two studios at the network's Television City in Hollywood.

Cameras now 'lock on' to track launches

Photographers are now using television to "lock on" to space rockets so that the camera automatically follows a launch.

A compact tracking system, developed by Douglas Aircraft Co. and Admiral Co., was used three weeks ago at the Cooper launch. Motion picture cameras were mounted on top of a 19-foot van, alongside of which was a

First quarter set sales figures

Production of TV receivers with UHF spurted in March to a high of 76,481, more than any month in the last 15 months, Electronic Industries Association has reported. EIA also said that distributor television set

sales for the first quarter of this year were more than 73,000 sets above the total sales for the same period last year. Radio sales for the quarter were down by almost 300,000.

EIA first quarter reports:

Period	TV	SALES		
		(With UHF)	Radio	(FM)
Jan.-March 1963	1,641,617	1,887,894*
Jan.-March 1962	1,567,987	2,177,998
PRODUCTION				
Jan.-March 1963	1,738,781	(198,226)	4,187,540**	(264,125)
Jan.-March 1962	1,689,614	(134,647)	4,625,844	(241,736)

*Does not include auto radios.

**Includes 1,929,809 auto radios compared to 1,618,331 for same quarter in 1962. FM production does not include FM auto receivers.

vidicon TV camera trained on the Atlas missile. At launch, the Atlas's exhaust flames created an electronic "signature" for the TV cameras which automatically tracked the flight until booster burnout. Coupled to the TV camera via a servo-mechanism control was the motion picture camera.

Films from the motion picture camera were processed automatically in the van and furnished to the television pool and still photographers. The picture from the vidicon also can be video taped or used for live broadcast.

The system has been used previously to guide radar antennas at White Sands missile range in New Mexico during the hypersonic flight of the Nike-Zeus anti-missile missile; to track an Arcas rocket at Wallops Island, and to track the Delta vehicle which launched Telstar II at Cape Canaveral.

Zenith displays new color tube at parts show

Although Zenith Radio Corp. is not expected to announce the start of commercial production and technical details of its color picture tube for several weeks, a factory model of the new 21-inch three-gun shadow mask tube was on display in Chicago at the 1963 Electronic Parts Distributors show.

The new tube was described as the "blood brother" of RCA's standard color tube. It is being made under cross-licensing agreements between Zenith and RCA, it was explained.

The new color tube is being made by Rauland Corp., a Zenith subsidiary, and was on display with other Zenith-Rauland TV picture tubes at the Rauland exhibit. Rauland has supplied Zenith with color TV tubes for some dozen or more years for the set maker's own developmental purposes, a Rauland representative said.

A new UHF all-channel booster to extend fringe area home reception of UHF TV stations was introduced at the May parts show by Blonder-Tongue Labs. which claimed the unit is the first

Suits dropped

Motorola Inc. and Zenith Radio Corp., both Chicago, have agreed to dismiss suits against each other for TV receiver patent infringements, the two firms have announced. The litigation began in 1959 when Zenith charged Motorola had infringed patents covering remote control and other TV set features. Motorola subsequently filed a countersuit over a circuitry patent.

all-channel unit of its kind. Jerrold Electronics also displayed its new line of top-of-the-set UHF converters which enable existing VHF-only set owners to tune UHF too. Models tune all UHF channels 14 to 83 and range in price from \$29.95 to \$49.95.

Many of the exhibits this year also disclosed increased interest in FM stereo and citizens band radio. The parts show is sponsored jointly each year by the Electronic Industries Association, Western Electronic Manufacturers Association, Association of Electronic Manufacturers Inc. and National Electronic Distributors Association.

Teleprompter to sell manufacturing operations

Teleprompter Corp., New York, announced last week that it plans to sell the electronics manufacturing operations of the company to a private group of investors, and henceforth concentrate on its community antenna, closed-circuit and live meeting production services.

Neither the price nor the identity of the prospective purchasers was divulged. Stockholder approval of the sale will be sought at the company's annual meeting in July. The electronic manufacturing division makes the Conley continuous loop magnetic tape cartridges, Weathers high-fidelity components, and products used in broadcasting, government and education.

Teleprompter had a net loss of \$800,000 in 1961 and a net profit of \$55,000 in 1962.

Technical topics...

Tube plant ■ International Telephone and Telegraph Corp. has started construction of a \$3.5 million Electron Tube Division unit at Easton, Pa. The plant will manufacture "special purpose tubes" and include research facilities for the IT&T system.

New technical handbook ■ General Electric Co., Owensboro, Ky., has re-

leased its tenth edition of "Essential Characteristics," receiving tube, capacitor and picture tube handbook. Priced at \$1.50, the publication features several innovations from past editions. All receiving tubes with same base pin connections are listed together alongside respective basing diagrams.

Shielded containers ■ Spun construction netic containers in two sizes, 3½-inches and 20-inches, are being made available through Magnetic Shield Division of Perfection Mica Co., Chicago.

Animation equipment ■ S.O.S. Photo-Cine-Optics, New York, has introduced two new animation stands, "Tel-Anima-stand" models IA and IIA. The IIA is a portable table model with self adjusting platen, motorized vertical camera adjustment and fully rotating camera priced at \$4,500. The IA, a similar model with "zoom motor drive," is reported to be suited for titles, TV commercials and other animation production. It lists at \$3,250.

Digital gear ■ Digital display units which were part of CBS-TV's election tallying equipment are being marketed by CBS Laboratories, Stamford, Conn. The units are described as suitable for production control systems, time interval displays, tabulation and a variety of other uses.

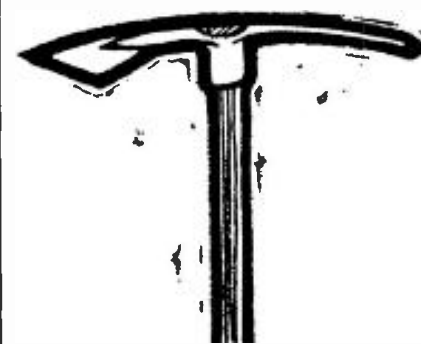

WHY SALES CLIMB ALONG THE SKYLINE

You're picking a "one-buy" TV market of over ¼ million homes with General Merchandise sales as big as the 36th metropolitan area.



P.O. BOX 2191 • IDAHO FALLS, IDAHO
CALL MEL WRIGHT, AREA CODE 208-523-6567
Call your Hollingbery office or Art Moore in the Northwest or John L. McGuire in Denver.

KOOK Billings / KFBB Great Falls / KXLF Butte
KID Idaho Falls / KBLL Helena / KLIX Twin Falls

WHIP THE HAZARD OF
LIBEL, SLANDER,
INVASION OF PRIVACY, PIRACY,
VIOLATION OF COPYRIGHT

WITH 1) Good Practices
2) Good Care
3) Good Insurance.

YOU handle No. 1 and No. 2 — WE'LL look after No. 3 with our SPECIAL and UNIQUE EXCESS POLICY, built to do it satisfactorily and quite inexpensively!

For details and rates, write

EMPLOYERS REINSURANCE CORPORATION
21 W. Tenth, Kansas City, Mo.
New York, Chicago, San Francisco,
107 William St., 175 W. 100 Bush St.,
St. Jackson St.

Radio month produces crop of promotions TRANSISTORS ARE STATIONS' FAVORITE GIVEAWAYS

Governors signed proclamations and stations developed contests to promote May as National Radio Month.

In Michigan, where Governor George Romney issued a proclamation for radio month, the Mid-State FM Network presented him with an FM stereo radio. The Connecticut proclamation, read by Governor John Dempsey, was carried by more than 30 stations in the state.

Transistor radios were presented by several stations. KTTR Rolla, Mo., gave away a transistor a day during the month. Listeners were asked to write about what the station meant to them.

At WHAM Rochester, N. Y., the station tied its 41st anniversary to the radio month promotion and offered to swap a transistor radio for any radio receiver manufactured or home-built no later than 1925. Fifty-five radios were delivered at the station's booth at the Rochester Home Show. The earliest was a 1912 Clapp-Eastman crystal set, still in working order.

WSB Atlanta ran weekly contests during the month, with winners receiving FM radios. The contests included the hours listened most and why; the best joke heard on radio; favorite radio personality, and the number of advertisers the station had during the contest's period.

In Minnesota and North Dakota, five stations operated by Bob Ingstad

worked with local chambers of commerce in presenting Fred A. Palmer, sales consultant. Mr. Palmer conducted one-day clinics in each community and spoke to high school students.

WFBR Baltimore used radio month to salute to its competitors. It allotted one day to each AM and FM in the city with a series of vignettes detailing the station's programming, community action and its principals.

The radio industry received a salute from Kiwanis International. Local Kiwanis clubs were asked to let "broadcast people know how much you appreciate the support that they have given . . . [and] the unflinching stand the broadcasters take in the sacred matter of free speech in a free land."

The Georgia Association of Broadcasters developed several events for its radio month campaign, culminating in a Miss Mobile Radio contest. Five finalists, chosen from a statewide radio promotion, were presented to the Atlanta Advertising Club on Radio Day, and the winner will be chosen at the GAB's annual convention, June 11.

The GAB used specially prepared materials to salute Law Day on May 1, with almost 2,000 spots and programs aired. During the month, the GAB announced the winner of its first \$500 radio-TV scholarship and selected its annual Prestige Award winners.

Pick a seat, any seat

A contest with only one prize has been announced by KGLM Avalon (Catalina), Calif.: all 272 seats to the June 24 evening performance of "Billy Barnes, L.A.," a revue now playing at the Coronet Theatre in Los Angeles. The listener who writes the best explanation in 50 words or less of why he wants to be entertained all by himself by the six performers in the show's cast will get the right to invite 271 guests, to sell that many tickets or to tear them up and enjoy the play in solitary grandeur.

How now, experimental cow

A "milkdown" to determine whether a cow gives more milk listening to the uninterrupted musical program segments on WAIT Chicago or to the diverse fare offered by the city's "top five" stations was undertaken May 23 by WAIT. Two cows were placed in special window stalls at a downtown department store for two weeks of public display.

One cow is wearing earphones tuned exclusively to WAIT. The other cow is listening alternately for two hour segments to each of the "top five" competitors selected by WAIT and including, alphabetically, WBBM, WGN, WIND, WLS and WYNR. Each cow will be milked twice daily during rush hours and the one producing more milk will be the winner. Promotion also includes naming the cows.

19 stations get awards for on-air promotion

Nine television stations and 10 radio stations were cited for on-air promotion of their own facilities in the Broadcasters' Promotion Association's second annual awards competition.

Judging by three advertising agency executives was based on motivation, creativity, execution of idea and contribution to industry. Serving as judges were Robert Boulware, vice president and associate media director at Fletcher, Richards, Calkins & Holden; Samuel Vitt, vice president and media director at Doherty, Clifford, Steers & Shenfield, and Bern Kanner, associate media director at Benton & Bowles.

The winners will receive engraved awards from the Broadcasters' Promo-



The Georgia Association of Broadcasters presented the finalists in its Miss Mobile Radio contest at the Atlanta Advertising Club. The girls and their sponsoring stations (l to r): Joyce Bell, WCHK Canton; June Orr, WGAU, WRFC and WDOL, all Athens; Arthur

McCoy, president of Blair Radio, featured speaker of the day; Nelle McBride, WFEH Louisville; Barry Sherman, WQXI Atlanta, GAB Radio month chairman; Genelda Odum, WGGG Gainesville, and Charlene Tarpley, WRGA Rome.

tion Association, at the group's annual seminar in San Francisco, November 17-20.

The winners:

Television (markets over 500,000): Station image: 1st—KFMB-TV San Diego; honorable mention—WHIC(TV) Pittsburgh, KTRK-TV Houston.

Special Events: 1st—WFAA-TV Dallas-Fort Worth; honorable mention—WCBS-TV New York, WTVT(TV) Tampa-St. Petersburg, Fla.

Personalities and programs: 1st—KFMB-TV San Diego; honorable mention—WTCN-TV Minneapolis-St. Paul, and WTVJ(TV) Miami.

Radio (markets over 500,000). Station image: 1st—WHAS Louisville, Ky.; honorable mention—WGBS-AM-FM Miami, WMCA New York, KCBS-AM-FM San Francisco. Special events: 1st—WIL-AM-FM St. Louis; honorable mention—KCBS-AM-FM San Francisco; WFAA-AM-FM Dallas, WABC-AM-FM New York. Personalities and programs: 1st—KCBS-AM-FM San Francisco; honorable mention—KCBS-AM-FM San Francisco, WHAS Louisville, Ky., WLS Chicago (two entries).

Radio (markets under 500,000). Station image—no winners. Special events: 1st—CJOB-AM-FM Winnipeg, Man.; honorable mention—KRNT Des Moines, Iowa.

Personalities and Programs: 1st—KOB Albuquerque, N. M.

No prizes were awarded in any category for television stations in markets of less than 500,000.

Jaycee safety drive gets radio-TV backing

A year-long traffic safety campaign will be conducted by radio and TV stations in South Dakota in conjunction with local Junior Chamber of Commerce clubs, according to Mort Henkin, KSOO-AM-TV Sioux Falls and president of the South Dakota Broadcasters Association. The drive will begin this week with the two sponsoring organizations working closely with local police departments.

The campaign will include a series of public service announcements geared to teen-age and adult driver education. Al Clark, KWYR Winner, is coordinator for radio and Tom Sheeley, KELO-TV Sioux Falls, for television.

Vicks merchandising award goes to WKDA

WKDA Nashville was announced last week as the winner of a radio merchandising contest for Vicks Vaporub. Second and third place winners were WJLD Birmingham, Ala., and WKIX Raleigh, N. C., respectively.

Thirty-three radio stations in the

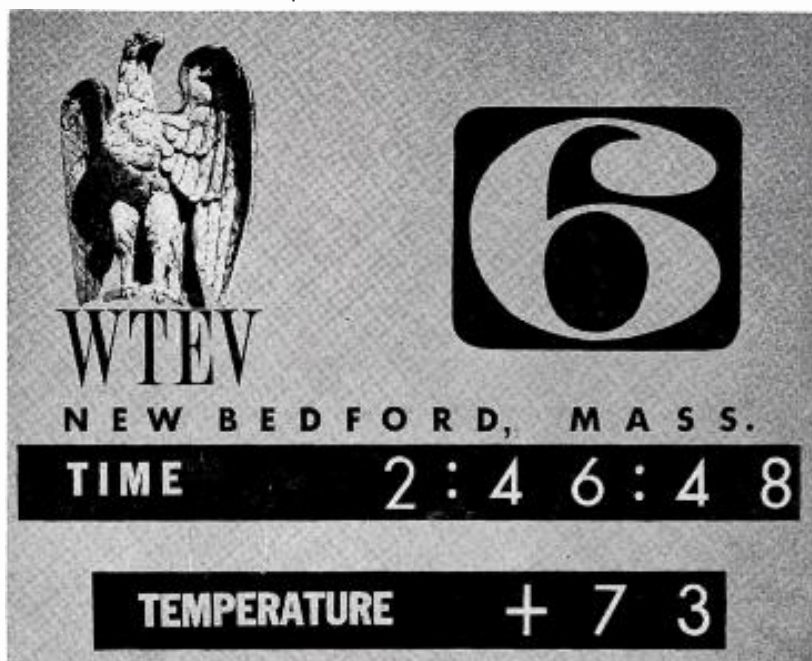

Time and temperature on TV

Each station ID on WTEV(TV) New Bedford, Mass., now includes a time and temperature report, activated by the electronic brain that automates all technical equipment at the channel 6 facility. The informa-

tion is held on the screen from 3 seconds to 10 seconds and the time flashes from second to second. WTEV's master clock is a custom-made model designed and constructed in Switzerland.

Southeast participated in the Vicks contest, which was designed to enhance consumer awareness of the product and its 11-week advertising campaign on the participating stations during the winter.

WKDA set up its own contests including a retailer display competition and several on-air consumer contests. In addition, the station helped set up displays in 20 supermarkets and conducted a one-week public service colds prevention campaign. For its efforts, WKDA won two portable television sets and a trophy. WJLD and WKIX were awarded gold plaques.

Drumbeats . . .

Close guess ■ Irene Hess, account executive at Erwin Wasey, Ruthrauff and Ryan Inc., Chicago, came within 0.002 of a mile in winning the WFBM Indianapolis Speedway Sweepstakes. The annual sweepstakes is awarded to the timebuyer who most nearly guesses the correct qualifying speed for the pole position car for the Memorial Day 500-Mile race (151.153 miles per hour this year). Miss Hess, who guessed 151.151 miles per hour, won an all-expense paid trip to Indianapolis for the race.

Pear-shaped answers ■ Media buyers

got their chance to predict listener response in a contest held by KNBR San Francisco. The station awarded a Polaroid camera and a case of pears to each of 18 winning buyers who guessed closest to the number of letters, with pear labels enclosed, sent in by KNBR listeners. At contest deadline, 16,737 letters had been received from listeners to the Pacific Coast Canned Pear Service commercials.

His and Hers ■ More than 85,000 entries were received by WKMH Dearborn, Mich., in the station's one-month Family Prize Fair. A Detroit couple was first prize winner of His and Hers 1963 Plymouth and Valiant convertibles. Portable TV sets, radios, movie cameras and watches were given to 350 other winners.

Public service report ■ A 24-page booklet, "Reflections," is being distributed by WFLA-TV Tampa, Fla. The booklet, which describes the station's public service activities during 1962, is sent to people the station feels should be interested in what WFLA-TV is doing in the community. Depending upon the individual who receives the mailing, certain types of letters go out, one of which asks the recipient his ideas as to what the station should do to better improve its service to the community.

BROADCAST ADVERTISING



Mr. Murison

Kenneth A. Murison elected executive VP of Edward H. Weiss & Co., Chicago. Mr. Murison joined Weiss in 1954 as account executive. He was elected VP and account group supervisor in 1957, member

of board of directors in 1959 and senior VP last year. He is also chairman of account management board.

H. Earl Hodgson resigns as president of Aubrey, Finlay, Marley & Hodgson, Chicago, "to resolve differing management views." Mr. Hodgson had been with agency since 1948.

David Y. Bradshaw, operations manager in television department of Young & Rubicam, New York, and **Sidney Marshall**, supervisor of TV commercial production on West Coast, elected VP's.

Robert Schulberg has closed his own agency in Los Angeles to join Guild, Bascom & Bonfigli as manager of its Los Angeles office. He succeeds **George Allen**, who will concentrate on account supervision. **Shirley Kittelson**, assistant to Mr. Schulberg, and **Jean Craig**, copywriter, also moved to GB&B.

Edson F. Allen, formerly with advertising staff of Allis-Chalmers Mfg. Co., Milwaukee, joins Klau-Van Pietersom-Dunlap, that city, as account executive.

Irving Miller, **Edwin H. Pfund** and **William E. Sprague** promoted to group managers at Ketchum, MacLeod & Grove, Pittsburgh. Messrs. Miller and Pfund, both vice presidents, had served as assistant group managers prior to their promotions. Mr. Sprague was account supervisor.

Flora L. Neumeister and **Catherine H. O'Brien** appointed copy group heads of Foote, Cone & Belding, New York.

Louis J. Nicholas, VP of Geyer, Morey, Ballard, Los Angeles, appointed manager of West Coast operations.

Sumner Fineberg joins Public Relations & Advertising Associates, Birmingham, Ala., as art director.

William Miller, formerly of Leo Burnett Co., joins McCann-Marschalk, New York, as account executive.

Orville Benskin, **Jane Mars**, **Veronica McLaughlin**, **Gene Moss** and **Bill Olofson** join Davis, Johnson, Mogul and Colombatto, Los Angeles. Mr. Benskin, account executive; Miss Mars, co-media director; Miss McLaughlin, art director, and Mr. Olofson, copy chief, all come from similar posts at Kenyon & Eckhardt, Los Angeles. Mr.

Posthumous elections

Gilbert T. Hodges and **Paul B. West** have been posthumously elected to Advertising Hall of Fame. Mr. Hodges was associated with Frank Munsey Co., *New York Sun*, and *Wall Street Journal* and was past president of Advertising Federation of America. His affiliation with *Wall Street Journal* ended with his death in 1959. Mr. West was president of Association of National Advertisers for 28 years until his death in 1960. Hall of Fame is sponsored by AFA and Advertising Club of New York. Citations will be given to members of families of two honored at annual convention of AFA in Atlanta June 17.

Moss, formerly assistant merchandising manager of Capitol Records, will be copy writer.

Jack Stanley, former creative group coordinator at J. Walter Thompson, joins Fuller & Smith & Ross, as vice president and creative director.

Edward S. Early, formerly with Lambert & Feasley, New York, joins Gardner Adv., St. Louis, as account executive. **William C. Hogan**, advertising artist for International Shoe Co., joins Gardner as art director in merchandising department.

L. E. Miller, VP and account supervisor at Ted Bates & Co., New York, re-joins Lennen & Newell, that city, as senior vice president and management account supervisor. Mr. Miller held same posts with Lennen & Newell from 1952 to 1959.



Mr. Miller

Joseph S. Hayden Jr., copy writer, named to newly created post of TV-radio coordinator for Bo Bernstein & Co., Providence and Natick, Mass., advertising and public relations agency.

Jack Walters, associate producer at ABC-TV, joins radio-TV department of Carl Byoir & Associates, New York PR firm, effective today (June 3). Mr. Walters succeeds **Ed Hymoff**, who is resigning to enter aerospace work.

Frank McDonald, formerly of Doherty, Clifford, Steers & Shenfield, joins Cunningham & Walsh, New York, as senior media buyer. Other new personnel: **Tom Della Corte**, formerly of

Geyer, Morey, Ballard, and **Robert Jeremiah**, of Lennen & Newell, named media buyers. Agency also appointed **Eleanor Accles** media supervisor; **Joseph Larsen** and **Angela Nicholais**, media buyers, and **Jay Holland**, media assistant.

Thomas G. Armstrong, **Keith P. Fischer** and **John H. Thomas**, account supervisors at Grey Adv., New York, elected vice presidents.

Norman Reed, VP of WWDC-AM-FM Washington, elected president of Advertising Club of Metropolitan Washington, succeeding **Robert A. Bowerman** of *The Washington Post*. Among six new directors elected by club was **Tom E. Paro**, WRC-TV Washington.

THE MEDIA

Michael J. Roberts, former VP - general manager of WBC Program Sales, subsidiary of Westinghouse Broadcasting Co., joins broadcast division of Triangle Publications in newly created position of director of syndicated program sales. Mr. Roberts will make his headquarters at Triangle's offices in New York and be responsible for syndicated sales of radio-TV programs produced by Triangle stations, and for sales of Triangle program service. Triangle Stations are WFIL-AM-FM-TV Philadelphia; WNBC-AM-FM-TV Binghamton, N. Y.; WFBG-AM-FM-TV Altoona - Johnstown, Pa.; WNHC-AM-FM-TV New Haven-Hartford, Conn.; WLYH-TV Lebanon-Lancaster, Pa.; and KFRE-AM-FM-TV Fresno, Calif.



Mr. Roberts

Norman L. Posen, sales manager of wchs Charleston, W. Va., appointed general manager of KDAY Santa Monica, Calif. Both stations are owned by Rollins Broadcasting Co.

George W. Crowell appointed station manager of WMBR-AM-FM Jacksonville, Fla. Other staff appointments: **Robert W. Ward**, commercial manager; **Guy Williams**, program director; **C. Roy King**, chief engineer; **Lee Simms**, public service director; and **Bill Greenwood**, news director.

Marshall R. Nanis, regional sales manager, promoted to commercial manager of WILD Boston.

Clifford F. Fisher, sales manager of WHAM Rochester, N. Y., joins WKBW-TV Buffalo as account executive.

Stanley Levey, former labor reporter for *New York Times*, joins CBS News as correspondent specializing in labor, economics and business, effective July

29. Mr. Levey has been assigned to Washington bureau.

Oscar C. Turner, manager, promoted to director of personnel and labor relations on West Coast for NBC.

Mike Sullivan joins sales staff of WEJL Scranton, Pa.



Mr. Sailors

Don Sailors, VP in charge of sales for WING Dayton, Ohio, named VP and assistant general manager. Mr. Sailors joined WING in 1959 as local sales manager and was elected VP-sales in September 1960.

Bill McLean, air personality at KAKE-AM-TV Wichita, Kan., named program director of KAKE radio, succeeding **Doug Lyon**, who moves to station's sales staff.

Del Winger joins WTAF-TV Marion, Ind., as regional sales manager. **Donald L. Tillman** appointed program manager.

Anne Denton Blair, Washington correspondent for broadcast division of Triangle Publications and producer of *Window on Washington*, interview-type program heard on Triangle radio stations, elected president of American Newspaper Women's Club May 28.

Herbert Feinstein, former attorney for Music Corp. of America, in Beverly Hills, named host of *Look Who's Talking*, new interview program on KRON-FM San Francisco.

Dale Lutz, with WCOL-AM-FM Columbus, Ohio, since January 1962, elected vice president in charge of sales.



Mr. Lutz

Samuel S. Carey, former program director and film buyer at WRVA-TV Richmond, Va., elected VP and assistant station manager. Other WRVA-TV promotions: **James D. Freeman**, operations manager; **Sanford S. Terry Jr.**, chief engineer; **Cecil K. Spicer**, assistant chief engineer; **Don T. Johnson**, production manager; **Robert Brown**, film director.

Jonathon Kirby, former executive director of American Freedom Network, joins news staff of KFWB Los Angeles as reporter-at-large.

Pat McGuiness, veteran reporter-newscaster in Southern California radio, joins news staff of KABC Los Angeles, effective June 10. For past five years he has been with KNX Los Angeles and CBS Radio Pacific Network.

Jim Kiser, program director of KSET El Paso, Tex., joins WIS-TV Columbia, S. C., as announcer-newsman. **Joe Pin-**

Executive roster posted

L&P Broadcasting Corp., new owner of WYON and WHFC(FM) Cicero, Ill. (formerly WHFC-AM-FM), last week announced its executive roster: station manager, **Frank D. Ward**, former operations manager of WINZ Miami; commercial manager, **Lloyd Webb**, former general manager of WJOB Hammond, Ind.; operations manager, **Gwen McDonough**, former assistant program director of WYNR Chicago; production manager, **Tom Johnson**, previously operations manager at WSAF Sarasota, Fla.; technical director, **Pat Cerone**, who was chief engineer at WINZ; program director, **E. Rodney Jones**, previously with WYNR; and news director, **Mike McClellan**, formerly with WBEE Harvey, Ill. WYON's new format is all-Negro 24 hours daily.

ner, announcer at WZOK Jacksonville, Fla., joins WIS-TV to do news and general announcing assignments.

Richard Bradley, formerly of WQXR-AM-FM New York, joins news staff of WSOC-TV Charlotte, N. C.

Bill Shadel, ABC News Washington congressional correspondent, is leaving network Friday, June 7, to become professor of communications at University of Washington. Mr. Shadel joined ABC in 1957 after 14 years with CBS as newsmen. His various assignments have included coverage of Italian campaign for CBS, 1943-44, and space shot coverage for ABC in recent years.

Palmer Payne, former news director of WCOP Boston, joins WNAC, that city, as vacation staff announcer.

Chuck Mitchell, former West Coast manager for AnSCO's motion picture division and recently employed in graphic arts field as broker and sales manager, joins KGBS Los Angeles as merchandis-

ing manager.

Paul Condylis joins KHJ-AM-FM Los Angeles as Sunday disc jockey and part-time newscaster.

Harry Munyan joins WIOD Miami as community relations director.

Bob Chase, sportscaster, named public affairs director-assistant program manager of wowo Fort Wayne, Ind.

Jack Steck, director of program and talent development for WFIL-AM-TV Philadelphia, elected president of Poor Richard Club, that city.

Mike Booth joins WAMR Venice, Fla., as air personality-promotion director, replacing **Jim Hart**, who has been promoted to program director.

Duayne Trecker joins news staff of KING-AM-FM Seattle.

Howard H. Marsh, account executive at Television Advertising Representatives, New York, appointed assistant sales manager of KPIX(TV) San Francisco. Both organizations are owned by Westinghouse Broadcasting Co. Before joining TVAR in 1961, Mr. Marsh had been with Harrington, Righter and Parsons; CBS-TV Spot Sales; Peters, Griffin, Woodward.



Mr. Marsh

Richard Leader, radio manager of H-R Representatives, Los Angeles, appointed office manager. **Robert Billingsley**, television salesman, named manager of firm's TV department.

INTERNATIONAL

R. W. Bolstad, VP-treasurer of Famous Players Canadian Corp., Toronto, elected president, succeeding **J. J. Fitzgibbons**, who became board chairman. Company controls Trans-Canada Tele-meter, Toronto; owns share of CKCO-TV Kitchener, Ont., and CKMI-TV and CFCM-TV Quebec City. **Eugene E. Fitzgibbons** was elected VP for communications management, and **K. J. Easton**,

United Press International
Facsimile Newspictures and
United Press Movietone Newsfilm
Build Ratings

VP for communications operations.

John Funston, formerly of CHNS Halifax, N. S., named general manager of CKSL London, Ont.

Allen A. McMartin, mining financier, elected a director of Standard Radio Ltd., Toronto, owners of CFRB and CKFM, both Toronto, and CJAD and CJFM, both Montreal.

GOVERNMENT



Mr. Rosenbloom

Joel Rosenbloom, who had served as legal assistant to former FCC Chairman Newton N. Minow, named special assistant to Mr. Minow's successor, E. William Henry. Mr. Rosenbloom, 32, joined commission in 1957 as trial attorney in litigation division of office of general counsel. New chairman is retaining **Lillian Watson** as his confidential assistant.

Marguerite F. Hubbard, assistant chief of FCC's broadcast license division, has retired. Mrs. Hubbard, whose government service dates back to 1918, has been with commission since 1934.

PROGRAMING

David Gerber, VP of General Artists Corp. Television Division, elected senior VP. **Lester Gottlieb**, VP at NBC-TV, elected VP at GAC-TV. **Malcolm Stuart**, VP in literary division, appointed VP for creative programing for GAC-TV, and will retain literary division post. New appointments were announced by **Herman Rush**, recently appointed president of GAC-TV (BROADCASTING, May 13).



Mr. Gerber

Roy Seawright, former VP of Cascade Pictures (FATES & FORTUNES, May 27), joins MPO-TV of California, Hollywood, as producer, director-cameraman. **Don Sweeney** joins MPO's New York office as special effects cameraman. Other additions to New York staff are **Paul Kasander**, producer; **Thomas Whitesell**, TV production control; and **Cal Schultz**, editor.

Dick Berg, who joined Revue Studios in 1961 as producer of *Checkmate* series, elected VP. He will produce segments of Chrysler show hosted by **Bob Hope** during 1963-64 season.

Don W. Sharpe, recently resigned as president of television division of General Artists Corp., reappointed personal representative of **Lucille Ball** and **Desilu Production's** representative for *The*

Praise from Boys' Clubs

Memorandum: From the Boys' Clubs of America to the Federal Communications Commission.

Subject: The "invaluable contributions" the broadcasters of America have and are giving to the youth of America.

Proof: The Boys' Clubs of America presented National Association of Broadcasters' President **LeRoy Collins** with an engraved scroll for the "immeasurable assistance" radio-TV stations have given "with sight, sound and personal support" to the youth of America. In presenting the scroll, **A. Boyd Hinds**, associate national director of the youth-guidance organization, revealed that \$6 million in free air time was donated by broadcasters last year in telling the BCA story.

NAB President Collins was keynote speaker at the annual BCA convention in Toledo, Ohio.

Lucy Show. GAC is exclusive sales agency for network sales of **Desilu's** television properties.

Frank DeVol, who wrote theme for *My Three Sons*, reappointed by **Don Feddersen** as executive producer of ABC-TV series, to compose and direct scores for all 38 segments of series for its fourth year.

Edward Sargoy elected president of Copyright Society of U. S. A. **Charles B. Seton**, former secretary, and **Sidney A. Diamond**, former treasurer, elected VP's and trustees. Other new offices: **Alan Latman**, secretary; **Edward M. Cramer**, treasurer; **Morton Goldberg**, assistant secretary; and **Stanley Rothenberg**, assistant treasurer.

EQUIPMENT & ENGINEERING

Donald Spanier resigns as VP-general manager of **Harman-Kardon Inc.** (hi-fi equipment), subsidiary of **Jerrold Corp.**, Philadelphia.

Frank A. Seghezzi named manager of contracts for **Raytheon Co.'s** communications and data processing operation at **Norwood, Mass.**

Charles L. Winchester, director of advertising for **Allied Research Labs**, Glendale, Calif., joins **Eitel-McCullough Inc.** (electronic products manufacturer), San Carlos, Calif., as public relations services specialist.

Donald W. Sharp named operations manager of **ARINC Research Corp.**,

subsidiary of **Aeronautical Radio Inc.**, Washington.

Dan O'Connell, sales manager for **Taco** consumer products division of **Jerrold Electronics Corp.**, appointed marketing administrator for distributor sales division.

ALLIED FIELDS

Irving Levine, veteran entertainment industry attorney who has represented theatrical, motion picture and television interests in both New York and Hollywood, appointed special consultant and counsel for **Theatre-Vision Color Corp.**, subsidiary of **National General Corp.**, which is developing national closed circuit color TV network for theaters.

Philip Mazur, member of special tabulations department of **American Research Bureau**, division of **C-E-I-R Inc.**, Beltsville, Md., transfers to **ARB's** midwest station sales staff. Mr. Mazur joined **ARB** in June 1962. He formerly served on staffs of **WOSU-AM-FM-TV** and **WBNS-TV**, both Columbus, Ohio.



Mr. Mazur

John F. White, president of **National Educational Television and Radio Center**, elected to board of directors of **Foreign Policy Association** (nonprofit educational organization), New York. **Eric Johnston**, president of **Motion Picture Association of America**, and **Arthur B. Toan Jr.**, partner of **Price Waterhouse & Co.**, were also elected **FPA** directors.

A. Bruce Rozet, VP of **Gencom** division of **Electra Megadyne**, wholly owned subsidiary of **Capitol Records**, resigns to join **Stanford Research Institute** in Palo Alto, Calif. He will serve as senior staff member involved in corporate planning, contract negotiations, and international corporate negotiation.

Dallas W. Smythe, research professor of communications at **University of Illinois**, Champaign-Urbana, resigns to become first head of social sciences division of **University of Saskatchewan**, Regina. Dr. Smythe served as chief economist of **FCC** before moving to **Urbana** in 1948.

DEATHS

A. Fred Gibson, 34, **Carolinas' sales manager** of **wbTV(tv)** **Charlotte, N. C.**, died May 29 at his home in that city. Prior to being appointed **Carolinas' sales manager** in 1961, Mr. Gibson served four years as assistant sales manager of **wsJS-tv** **Winston-Salem, N. C.**

Osborne C. Wade, 51, air personality at **wkNE** **Keene, N. H.**, died May 22 of heart attack.

TAX MAY BE TOO MUCH

ATV says it will go out of business if revenue levy on advertising is made into law

Associated TeleVision Ltd., one of Britain's major TV companies, is prepared to go out of business if the levy on advertising revenue becomes law. The company, which made over \$14 million last year, has told the government that the levy would make it no longer worth while to continue in television. It doesn't intend to apply for broadcast license renewal next year if the levy is imposed.

Norman Collins, deputy chairman of ATV, speaking at the annual convention of the Radio & Television Retailers Association, said that the levy would result in drastic production cuts which would mean big unemployment throughout the industry.

The levy on advertising revenue would reduce profits of some companies to the level of a depressed industry. It would mean the end of the commercial network as viewers know it today, he said.

"British television would take a big step backwards," and the BBC-TV would not maintain its present standards without vigorous competition, Mr. Collins continued.

He foresees the end of the export of British TV films, adding that during the past seven years ATV had earned \$23 million from the Western Hemisphere. "If our revenue is to be slashed by a levy we could never afford the huge long term investment . . . which film making involves." If money has to be taken from the TV companies then profits should be taxed, not revenue.

Mr. Collins said that the levy will probably be scrapped before the new television bill became law.

Commercial TV companies received \$159.6 million in advertising revenue last year and spent \$98 million leaving a \$61.6 million profit. This year their revenue was expected to be about \$154 million and with the proposed levy taking \$50.4 million most of their profits would be eaten away.

Dealing with the suggestion that a profit tax is unworkable because the TV companies would attempt to evade it, Mr. Collins said, "The whole thing is an insult to the whole structure of our free enterprise society."

He said there are about 200,000 shareholders spread over the 15 companies. Unless the government thought again, a lot of money that had been invested could never be recovered.

Two local TV companies have said

that they do not intend to go out of business because of the proposed levy on advertising revenue.

Scottish Television Ltd. said, "We do not think we are in any danger and whatever happens we will not be throwing in the towel."

Anglia Television Ltd. said, "No change in Anglia's established service is contemplated."

A spokesman for the Screen Writers Guild has commented that it is opposed to the levy, "But it is strange to hear the companies squealing for all they are worth, when for the past few years they have been enjoying fat profits which have never been passed on to writers, actors and technicians."

"It is sickening that the companies, in an attempt to cut their losses, turn immediately to the creative people in the industry and threaten redundancy and cuts in expenditure."

Financial loss causes drop of local shows

Britain's newest TV company, Wales West and North Ltd., which went on the air last September, will no longer produce local shows but will carry only network programs.

WVN has about 320,000 viewers in a coastal belt from west to north Wales. Its accounts to December, representing 16 months expenses and three and a half months time sales, showed a \$445,200 loss.

The chairman, Dr. B. Haydn Williams, has resigned, but will remain on the board of directors.

British post office bans 625-line TV tests

The United Kingdom post office has banned 625-line test programs by a mobile television station owned by a TV set manufacturer. The station has already made several broadcasts.

Negotiations between the company, Pye Group Ltd., and the post office for a license have been going on for several months. Pye wants to operate the station all over the country. The post office wants to limit the four mile range broadcasts to the London area where BBC begins 625-line transmissions next April.

More publicity should be given to BBC-TV 625-line broadcasts on its new channel scheduled for next year said Michael Keegan, director of the Radio

COUGH
COUGH
COUGH
COUGH
COUGH



COUGH TOO MUCH?
SHORT OF BREATH?



BREATH?
BREATH?
BREATH?
BREATH?

COUGH
COUGH
COUGH
COUGH
COUGH



COUGH TOO MUCH?
SHORT OF BREATH?



BREATH?
BREATH?
BREATH?
BREATH?

COUGH
COUGH
COUGH
COUGH
COUGH



COUGH TOO MUCH?
SHORT OF BREATH?



BREATH?
BREATH?
BREATH?
BREATH?

Don't take chances . . . see your doctor. You may have a Respiratory Disease. Chronic RD afflicts at least 12 million Americans today. Don't take chances with its most common symptoms—chronic cough and shortness of breath. Your local Christmas Seal organization and the National Tuberculosis Association say: **See Your Doctor.**



U.S. TV can learn from European cousins

Eric Boden, an international television advertising consultant, has said in the past that "the know-how shoe has slipped onto the other foot and now it's Britain that has much to teach America" in advertising technique.

In New York recently to observe samplings of U. S. television commercials, Mr. Boden in a special interview with BROADCASTING expanded his views to mention contributions which the continental countries might make to American advertising.

A former head of Schwerin Research's Great Britain division, Mr. Boden now acts as an independent consultant, watching TV and cinema commercials by the thousands and logging miles by the tens of thousands. In 1962 he estimates he saw 7,000 commercials and journeyed 25,000 miles.

His close affiliation with European television, however, has not jaundiced his views of American advertising—indeed, he's quick to admit that much of European advertising, for one reason or another, is in the rudimentary stage. But he's just as quick to point out that a little more observation of their European counterparts might be a boon to U. S. advertisers. "Nothing strikes me

more than the lack of cross-pollination between the commercials of different countries," he said, admitting that there is "surprisingly similarity in commercials," but that the ideas have traveled mostly "in one-way traffic" from the U. S. to Europe.

Soft Sell ■ In Great Britain, the only European country which could seriously rival the U. S. for the commercialization of its television, Mr. Boden describes great progress in the matter of "soft sell" or indirect selling techniques.

"They don't need 60 seconds to create a mood," he said, "they can do it in 30 or sometimes 15 seconds. It seems that they succeed mainly because they don't try to say too much; they don't try to cram as many points as possible into a given length.

"I remember one in particular where the message was the simple identification of a soap product with the theme of mother love. Very simple, and yet sales of the product proved the commercial was successful."

Elsewhere in Europe, where commercial television is still in its infant stages, very limited or even non-existent, Mr. Boden said there are

techniques which could be applicable to U. S. advertising men.

As an example, he pointed out that nowhere is the German propensity for formalism more apparent than in its television advertising. The Germans' close attention to pictorial arrangement and graphic qualities of a commercial, have led them to effective use of split-screen or triple-split-screen devices.

Although he claims the Germans remain a bit heavy-handed, Mr. Boden added that they, too, are skillful in the shorter, crisper commercial.

Arty in France ■ France, though it doesn't have commercial television, has a counterpart in cinema advertising. Mr. Boden scores the French commercials as "maddening" and "over-sophisticated" and says that they too often are the product of an "arty" producer and a gullible advertiser, who completely bypass the agency. But he said that Americans, plagued with the continual necessity for originality, may find in France a rich source of new ideas.

Italian television advertising Mr. Boden dismissed as "surprisingly bad," explaining that the strict limitation of commercials makes prac-

and Television Retailers Assn. speaking at the group's annual convention. He complained that the new BBC television network had been considered by TV set manufacturers as a potential booster of business but it was a disappointment.

He attacked BBC's development plans for the new network which would transmit only to the London area in 1964 and in Birmingham by 1965. There was no date set for the rest of the country.

All the public knew was that there is to be a change of line standard. It must be told by BBC that a new network would soon be on the air and if it wants to tune in to it, it will need new sets and antennas.

A criticism of the "secrecy" about the new network was made by association President Cyril Butterfield who said that the choice of BBC-2 as a name was "unenterprising and unimaginative."

TV-radio advertising up

National advertising in Canada on radio and television for January was ahead of a year ago, according to Elliott-Haynes Ltd., Toronto market research organization. National radio advertising in January 1963, totaled \$1,196,811 against \$1,189,820 in Janu-

ary 1962. Television advertising in the same period totaled \$4,825,836, up from \$4,010,445. Foods and food products advertisers were the largest group in radio both January periods, while drugs and toiletries were largest group in this January period in television, replacing foods and food products advertisers the previous year.

WEST GERMAN TV Spot selling is brisk despite limitations

West German regional broadcasting organizations registered a total of 7,789 TV spots representing a sales total of close to \$7 million in February 1963. Only part of the West German total TV time is open for commercials and spots are the only type of TV advertising. There are still no sponsored shows. Spots are grouped in special daily slots while the rest of the schedule carries no advertising at all.

February figures are higher than the comparable January figures and those statistics from February 1962. Figures of February 1963 for different regional German television broadcasting organizations are as follows: Bayerisches Werbefernsehen (Munich, Bavaria)

1,094 spots, \$700,000; Werbefernsehen Berlin (West Berlin), 1,210 spots, \$550,000; Hessisches Werbefernsehen (Frankfurt, Hesse), 1,233 spots, \$625,000; Norddeutsches Werbefernsehen (Hamburg, Northern Germany), 1,227 spots, \$1,475 million; Saarlaendisches Werbefernsehen (Saarbruecken), 1,172 spots, \$350,000; Werbefernsehen Suedwest (Stuttgart and Baden-Baden), 965 spots, \$825,000; Westdeutsches Werbefernsehen (Cologne, Western Germany), 888 spots, \$2.4 million.

Television set saturation in West Germany is growing at different rates in different areas of the country. Westdeutscher Rundfunk in the heavily populated industrial area of West Germany reports a saturation of 57% in March, this year. This is the highest saturation percentage registered in West Germany. Lowest saturation percentages are reported from Suedwestfunk, Baden-Baden, and Sueddeutscher Rundfunk, Stuttgart, both in Southwestern Germany and both having a TV saturation of 35%. The same 35% figure is reported by Bayerischer Rundfunk, Bavaria.

Mountains and resulting propagation problems are given as a reason for low saturation figures in these areas. In



Eric Boden
Professional commercial watcher

tically every campaign in Italian television a successful one.

But in smaller countries, such as Portugal and Finland, he expressed admiration for their ability "to get around simple ideas effectively with a very low budget . . . there's seldom the slightest relationship between the production cost of a commercial and what it does to viewers."

other parts of West Germany TV saturation is around 40-50%. The figures are increasing at a moderate but regular pace. There is no longer a "television boom." Set makers have cut back their production rates and a larger than expected share from the total is now going into replacement set sales as VHF transmitter construction is now all but completed and new transmitters added are mostly in the UHF band. All German set models are now equipped for UHF reception.

Theatre sports network set up in Canada

A closed circuit network of nine theaters has been established by Paramount Pictures Corp., in Toronto, to present a complete schedule of professional sports events on large screen television.

International Telemeter Co., pay-TV subsidiary of Paramount, and Famous Players Canadian Corp., partly owned by the movie company, will be aligned with Trans Canada Telemeter in a four-year agreement with Toronto Maple Leafs for the presentation of hockey games at the theaters in the Toronto area. The games will be shown at the

theaters at the same time they are being telecast to Telemeter's home TV subscribers.

A seating capacity of 11,000, with tickets priced at \$1.25, \$2, \$2.50 and \$3, will be provided by the theaters.

R. W. Bolstad, president of Famous Players, pointed out that "this is only the second step in the building of a theater television network across Canada that could grow to over 100 theaters."

The nine-theater network is an outgrowth of the presentation last season of the Maple Leafs' away from home games at the College Theater in Toronto.

Canadian radio set sales up

Sales of made-in-Canada radio receivers was up during the first three months of this year compared to the same period last year, while television receiver sales for the period were down, according to the Dominion Bureau of Statistics, Ottawa. Radio receiver sales totaled 167,074 in the January-March period 1963, against 153,881 sets sold in the same period last year. Canadian-made TV set sales numbered 92,965 in the January-March 1963 period compared with 93,379 last year.

Imports of transistor radio receivers in the first eleven months of 1962 amounted to 750,760 units, while 14,900 TV sets were imported in that period.

CBC, union in deadlock

New radio and television equipment designed to streamline broadcasting operations has led to a deadlock in contract negotiations between the Canadian Broadcasting Corp. and the national Association of Broadcast Employees and Technicians. Negotiations broke off when CBC demanded a preliminary agreement on its proposal that NABET abandon its jurisdiction over the equipment. The Canadian government's Department of Labor has appointed Bruce

McRae as conciliator to mediate the dispute. The union, which represents 1,500 CBC technical employees across Canada, is seeking wage increases and adjustments which CBC estimates at 16.5%, and a reduction in the work week from 40 to 35 hours.

WAB meeting postponed

The Western Association of Broadcasters annual meeting has been delayed from June 11-13 to September 8-11. WAB, representing Canadian broadcasters of the four western provinces, will meet at Jasper Park Lodge, Jasper, Alberta.

Abroad in brief...

Canadian TV award ■ An annual television film award is being established by friends of three Canadian Broadcasting Corp. film men who were killed in an airplane crash on Feb. 25. The award, for which \$5,000 is being collected, will be in memory of CBC producer Norman Caton and CBC cameramen Charles Riegler and Len Macdonald. They were killed in a plane crash in the interior of British Columbia while filming a production for *Camera Canada*.

'English by Television' ■ The British Broadcasting Corp. has introduced a series of 39 television programs, *English by Television*, consisting of a full elementary course in English grammar. Each program runs 13-½ minutes. The series is now being shown in Finland, France, Egypt, Germany and Switzerland, and reportedly will begin shortly in Algeria, Argentina, Denmark, Indonesia, Morocco, Thailand and Uruguay. Negotiations are currently underway with several other non-English speaking countries.

FM network completed ■ Radiodiffusion-Television Francaise completed national FM radio coverage in France last week by adding 17 new transmitters to the four already in service in its French I network. Like its predecessors on FM,

SUBSCRIPTION APPLICATION

BROADCASTING *The Businessweekly of Television and Radio*
1735 DeSales Street, N.W., Washington 6, D. C.

Please start my subscription immediately for—

<input type="checkbox"/> 52 weekly issues \$7.00	<input type="checkbox"/> 104 weekly issues \$12.00	<input type="checkbox"/> Payment attached
<input type="checkbox"/> 52 issues & 1963 Yearbook \$12.00		<input type="checkbox"/> Please bill
<input type="checkbox"/> 1963 Yearbook \$5.00		

name _____ title/position* _____

address Business Home _____

city _____ zone _____ state _____

company name _____

*Occupation Required

France IV and France III, the new Paris-Inter chain will provide 95% of the continental French radio audience with high fidelity sound. The few remaining blank spots in FM coverage will reportedly be eliminated later this year with the installation of 10 more relay stations on France I and three more on France III.

Resumes service ■ The British Broadcasting Corp., which suspended in 1957 radio broadcasts to Portugal, resumed service to that country (half-hour daily) last month with world news, reviews of the British press, and comments reflecting the British point of view on world events.

RFE sets power increase to Eastern Europe

Radio Free Europe announced plans last week to double the power of its signal to its five-country East European target area.

RFE, which operates on a reported \$11 million budget, will spend approximately \$1.75 million to put four new 250 kw transmitters into operation at its main transmitting station near Lis-

More FM in Canada

There are now an estimated 463,000 homes in Canada with FM receivers, according to a tabulation of All-Canada Radio and Television Ltd., Toronto. This is estimated to be 31.5% more than in 1961. The breakdown by provinces shows that more than half the receivers, 239,000, are in Ontario, 132,000 in Quebec, 40,000 in British Columbia, 24,000 in Alberta, 14,000 in Manitoba, 6,000 in Saskatchewan, and approximately 4,000 in each of the four Atlantic coast provinces of Canada.

bon. All of the transmitters, on order from International General Electric Co., are expected to be operating by next April.

The new broadcast operation was contingent upon an agreement recently signed by the Portuguese government allowing the increased power and renewing RFE's authority to broadcast from Portugal for 10 years.

C. Rodney Smith, director of RFE, explained that effective penetration of Eastern Europe necessitated higher power because of increased man-made and natural interference. He said that jamming of RFE signals had increased 43% since 1954. The other is a four-year period of "sun spot low," an ionospheric condition which hinders sky wave transmission. RFE is dependent on sky wave transmission in reaching the Communist satellites and hopes to overcome the difficulty with increased power.

Canadian sales arm formed by CBS-TV

CBS-TV on June 1 will form a wholly owned subsidiary, CBS Television Network Sales of Canada Ltd., to direct the sale of CBS-TV programs in Canada. The board includes CBS-TV President James T. Aubrey Jr., Vice President Thomas K. Fisher and Willard Z. Estey, Canadian attorney. Officers of the new firm also are CBS-TV executives. CBS also had announced William Cooke as general manager of its subsidiary.

FOR THE RECORD

STATION AUTHORIZATIONS, APPLICATIONS

As compiled by BROADCASTING May 23 through May 28 and based on filings, authorizations and other actions of the FCC during that period.

This department includes data on new stations, changes in existing stations, ownership changes, hearing cases, rules and standards changes, routine roundup of other commission activity.

Abbreviations: DA—directional antenna. CP—construction permit. ERP—effective radiated power. VHF—very high frequency. UHF—ultra high frequency. ant.—antenna. aur.—aural. vis.—visual. kw.—kilowatts. w.—watts. mc.—megacycles. D—day. N—night. LS—local sunset. mod.—modification. trans.—transmitter. unl.—unlimited hours. kc.—kilocycles. SCA—subsidiary communications authorization. SSA—special service authorization. STA—special temporary authorization. SH—specified hours. *—educational. Ann.—Announced.

New TV stations

APPLICATIONS

*Little Rock, Ark.—Arkansas Educational Television Commission. VHF channel 2 (54-60 mc); ERP 100 kw vis., 50 kw aur. Ant. height above average terrain 1,014 feet, above ground 936.5 feet. P. O. address c/o Thurl E. Tom Tyler, 1010 West Third Street, Little Rock. Estimated construction cost \$827,971; first year operating cost \$220,500. Studio location Little Rock, trans. location Jefferson Springs. Geographic coordinates 34° 22' 12" N. Lat., 92° 10' 07" W. Long. Type trans. RCA TT-25CL, type ant. RCA TF-5CL. Legal counsel John C. Doerfer, consulting engineer Willis C. Beecher, both Washington. Principals: board of commissioners. Ann. May 22.

Roswell, N. M.—R. H. Parker. VHF channel 10 (192-198 mc); ERP 12.6 kw vis., 6.62 kw aur. Ant. height above average terrain 104 feet, above ground 186 feet. P. O. address 2nd floor, Union Fidelity Life Building, Dallas. Estimated construction cost \$152,147; first year operating cost \$180,000; revenue \$240,000. Studio and trans. locations both Roswell. Geographic coordinates 33° 23' 51" N. Lat., 104° 31' 21" W. Long. Type

trans. RCA TT-2BH, type ant. RCA TF-6AH. Legal counsel Prescott & Prescott, Dallas; consulting engineer W. B. Carr, Fort Worth, Tex. Mr. Parker, sole owner. Is VP of life insurance company. Ann. May 28.

New AM stations

ACTIONS BY FCC

Morris, Ill.—Grundy Broadcasting Co. Granted CP for new AM on 1550 kc, 250 w-D. P. O. address Louisiana, Mo. Estimated construction cost \$14,077; first year operating cost \$48,550; revenue \$53,600. Owners are theatre owners Russell and Mildred Armentrout (each 50%). Chmn. Minow and Comr. Cox not participating; Comr. Lee dissented. Jan. 15, 1962, supplementary initial decision looked toward grant. Action May 22.

Crawfordsville, Ind.—Radio Crawfordsville Inc. Granted CP for new AM on 1550 kc, 250 w, DA-N, unl. P. O. address 311 Ben Hur Building, Crawfordsville. Estimated construction cost \$9,937; first year operating cost \$42,000; revenue \$48,000. Richard E. Lindsay (16.7% of WMRI-AM-FM Marion, Ind.) owns two-thirds; Ralph J. Bitzer (33½% of KGRN Grinnell, Iowa) owns one-third. Chmn. Minow and Comr. Cox not participating; Comr. Lee dissented. Jan. 15, 1962, supplemental initial decision looked toward grant. Action May 22.

Sullivan, Ind.—Sullivan County Broadcasters Inc. Granted CP for new AM on 1550 kc, 250-w D. P. O. address, 555 South Seminary Street, Madisonville, Ky. Estimated construction cost \$11,300; first year operating cost \$36,000; revenue \$48,000. Edgar F. Arnold Sr., Elmer L. Kelley Jr., H. W. Wells and Edgar F. Arnold Jr. (each 25%), all have interest in WFMW-AM-FM Madisonville, Ky. Chmn. Minow and Comr. Cox not participating; Comr. Lee dissented. Jan. 15, 1962, supplementary initial decision looked toward grant. Action May 22.

Lynchburg, Va.—Griffith Broadcasting Corp. Granted CP for new AM on 930 kc, 1 kw-D; pre-sunrise operation with daytime facilities precluded. Estimated construction cost \$30,373; first year operating cost \$58,183; revenue \$74,553. Principals: Alfred H. Griffith Sr. (99.5%) and A. Hundley Griffith Jr. and Mildred Wright Griffith (each .25%). A. H. Griffith Sr. is attorney; A. H. Griffith Jr. is president of WBCR Christianburg, Va. April 4 initial decision looked toward grant. Action May 28.

Lake Geneva, Wis.—Southern Wisconsin Inc. Granted CP for new AM on 1550 kc, 1 kw-D. P. O. address c/o John F. Monroe

EDWIN TORNBERG & COMPANY, INC.

Negotiators For The Purchase And Sale Of
Radio And TV Stations
Appraisers • Financial Advisors

New York—60 East 42nd St., New York 17, N. Y. • MU 7-4242
West Coast—1357 Jewell Ave., Pacific Grove, Calif. • FR 5-3164
Washington—711 14th St., N.W., Washington, D.C. • DI 7-8531



PROFESSIONAL CARDS

<p>JANSKY & BAILEY Offices and Laboratories 1339 Wisconsin Ave., N.W. Washington 7, D.C. FEderal 3-4800 <i>Member AFOOE</i></p>	<p>JAMES C. McNARY Consulting Engineer National Press Bldg. Wash. 4, D. C. Telephone District 7-1205 <i>Member AFOOE</i></p>	<p>—Established 1926— PAUL GODLEY CO. Upper Montclair, N. J. Pilgrim 6-3000 Laboratories, Great Notch, N. J. <i>Member AFOOE</i></p>	<p>GEORGE C. DAVIS CONSULTING ENGINEERS RADIO & TELEVISION 527 Munsey Bldg. Sterling 3-0111 Washington 4, D. C. <i>Member AFOOE</i></p>
<p>COMMERCIAL RADIO EQUIPMENT CO. Everett L. Dillard, Gen. Mgr. Edward F. Lorentz, Chief Engr. INTERNATIONAL BLDG. DI 7-1319 WASHINGTON 4, D. C. <i>Member AFOOE</i></p>	<p>A. D. Ring & Associates 41 Years' Experience in Radio Engineering 1710 H St., N.W. 298-6850 WASHINGTON 6, D. C. <i>Member AFCEE</i></p>	<p>GAUTNEY & JONES CONSULTING RADIO ENGINEERS 930 Warner Bldg. National 8-7757 Washington 4, D. C. <i>Member AFOOE</i></p>	<p>Lohnes & Culver Munsey Building District 7-8215 Washington 4, D. C. <i>Member AFCEE</i></p>
<p>RUSSELL P. MAY 711 14th St., N.W. Sheraton Bldg. Washington 5, D. C. REpublic 7-3984 <i>Member AFOOE</i></p>	<p>L. H. Carr & Associates Consulting Radio & Television Engineers Washington 6, D. C. Fort Evans 1000 Conn. Ave. Leesburg, Va. <i>Member AFOOE</i></p>	<p>KEAR & KENNEDY 1302 18th St., N.W. Hudson 3-9000 WASHINGTON 6, D. C. <i>Member AFOOE</i></p>	<p>A. EARL CULLUM, JR. CONSULTING ENGINEERS INWOOD POST OFFICE DALLAS 9, TEXAS MEIrose 1-8360 <i>Member AFOOE</i></p>
<p>GUY C. HUTCHESON P.O. Box 32 CRestview 4-8721 1100 W. Abram ARLINGTON, TEXAS</p>	<p>SILLIMAN, MOFFET & KOWALSKI 1405 G St., N.W. REpublic 7-6646 Washington 5, D. C. <i>Member AFOOE</i></p>	<p>GEO. P. ADAIR ENG. CO. CONSULTING ENGINEERS Radio-Television Communications-Electronics 901 20th St., N. W. Washington, D. C. Federal 3-1116 <i>Member AFOOE</i></p>	<p>WALTER F. KEAN CONSULTING RADIO ENGINEERS Associate George M. Sklom 19 E. Quincy St., Hickory 7-2401 Riverside, Ill. (A Chicago suburb) <i>Member AFOOE</i></p>
<p>HAMMETT & EDISON CONSULTING RADIO ENGINEERS Box 68, International Airport San Francisco 28, California Diamond 2-5208 <i>Member AFOOB</i></p>	<p>JOHN B. HEFFELFINGER 9208 Wyoming Pl. Hiland 4-7010 KANSAS CITY 14, MISSOURI</p>	<p>JULES COHEN & ASSOCIATES 9th Floor, Securities Bldg. 729 15th St., N.W., 393-4616 Washington 5, D. C. <i>Member AFOOE</i></p>	<p>CARL E. SMITH CONSULTING RADIO ENGINEERS 8200 Snowville Road Cleveland 41, Ohio Phone: 216-526-4386 <i>Member AFOOE</i></p>
<p>J. G. ROUNTREE CONSULTING ENGINEER P.O. Box 9044 Austin 56, Texas GLendale 2-3073</p>	<p>VIR N. JAMES CONSULTING RADIO ENGINEERS Applications and Field Engineering 232 S. Jasmine St. Phone: (Area Code 303) 333-5562 DENVER 22, COLORADO <i>Member AFOOB</i></p>	<p>A. E. Towne Assocs., Inc. TELEVISION and RADIO ENGINEERING CONSULTANTS 420 Taylor St. San Francisco 2, Calif. PR 5-3100</p>	<p>PETE JOHNSON Consulting am-fm-tv Engineers Applications—Field Engineering Suite 601 Kanawha Hotel Bldg. Charleston, W.Va. Dickens 2-6281</p>
<p>MERL SAXON CONSULTING RADIO ENGINEER 622 Hoskins Street Lufkin, Texas NEptune 4-4242 NEptune 4-9558</p>	<p>WILLIAM B. CARR Consulting Engineer AM—FM—TV Microwave P. O. Box 13287 Fort Worth 18, Texas BUtler 1-1551</p>	<p>RAYMOND E. ROHRER & Associates Consulting Radio Engineers 436 Wyatt Bldg. Washington 5, D. C. Phone: 347-9061 <i>Member AFOOE</i></p>	<p>E. HAROLD MUNN, JR. BROADCAST ENGINEERING CONSULTANT Box 220 Coldwater, Michigan Phone: BRoadway 8-6733</p>
<p>PAUL DEAN FORD Broadcast Engineering Consultant 4341 South 8th Street Terre Haute, Indiana Wabash 2643</p>	<p>BARKLEY & DEXTER LABS., INC. Donald P. Wise James M. Moran Consulting, Research & Development for Broadcasting Industry & Government 50 Frankfort St. Diamond 3-3716 Fitchburg, Massachusetts</p>	<p>JOHN H. MULLANEY and ASSOCIATES A Division of Multronics, Inc. 2000 P St., N.W. Washington 6, D. C. Columbia 5-4666 <i>Member AFOOB</i></p>	<p>SPOT YOUR FIRM'S NAME HERE To Be Seen by 100,000* Readers —among them, the decision-making station owners and managers, chief engineers and technicians—applicants for am, fm, tv and facsimile facilities. *ARB Continuing Readership Study</p>
<p>Service Directory</p>	<p>COMMERCIAL RADIO MONITORING CO. PRECISION FREQUENCY MEASUREMENTS AM-FM-TV 103 S. Market St., Lee's Summit, Mo. Phone Kansas City, Laclde 4-3777</p>	<p>CAMBRIDGE CRYSTALS PRECISION FREQUENCY MEASURING SERVICE SPECIALISTS FOR AM-FM-TV 445 Concord Ave., Cambridge 38, Mass. Phone TRowbridge 6-2810</p>	<p>COLLECTIONS For the Industry ALL OVER THE WORLD TV—Radio—Film and Media Accounts Receivable No Collection—No Commission STANDARD ACTUARIAL WARRANTY CO. 220 West 42nd St., N. Y. 36, N. Y. LO 5-5590</p>

SUMMARY OF COMMERCIAL BROADCASTING

Compiled by BROADCASTING, May 28

	Lic.	ON AIR Cps.	NOT ON AIR Cps.	TOTAL APPLICATIONS for new stations
AM	3,801	43	139	384
FM	1,088	21	101	198
TV	518	60	87	121

OPERATING TELEVISION STATIONS

Compiled by BROADCASTING, May 28

	VHF	UHF	TOTAL TV
Commercial	486	92	578
Non-commercial	47	21	68 ¹

COMMERCIAL STATION BOXSCORE

Compiled by FCC, April 30

	AM	FM	TV
Licensed (all on air)	3,789	1,078	518
Cps on air (new stations)	51	28	60
Cps not on air (new stations)	128	104	84
Total authorized stations	3,968	1,210	662
Applications for new stations (not in hearing)	232	180	72
Applications for new stations (in hearing)	166	13	48
Total applications for new stations	398	193	120
Applications for major changes (not in hearing)	266	88	41
Applications for major changes (in hearing)	54	3	8
Total applications for major changes	320	91	49
Licenses deleted	0	1	0
Cps deleted	0	1	1

¹Includes 3 stations operating on unreserved channels.

Jr., 735 North Water Street, Milwaukee. Estimated construction cost \$35,473; first year operating cost \$45,000; revenue \$60,000. Owners are John F. Monroe Jr., Mary Ellen M. Schmitz and Margaret M. Zunick, each 29.4%, and Miriam B. Monroe, 11.8%, all of whom have interest in WSWW Platteville and WCWC Ripon, both Wisconsin. Chmn. Minow and Comr. Cox not participating; Comr. Lee dissented. Jan. 15, 1962, supplementary initial decision looked toward grant. Action May 22.

Madison, Wis.—Air Capitol Inc. Granted CP for new AM on 1550 kc, 5 kw-D, DA, P. O. address Herbert L. Mount, 2040 West Wisconsin Avenue, Milwaukee. Estimated construction cost \$23,973; first year operating cost \$75,200; revenue \$88,088. Owners are Herbert L. Mount (26.53%) attorney; Neil K. Searles (26.53%) former general manager WFOV Milwaukee; Frederick A. Wilmanns (13%); John E. Dickinson (13%), and Gordon D. Adams (20%). Chmn. Minow and Comr. Cox not participating; Comr. Lee dissented. Jan. 15, 1962, supplementary initial decision looked toward grant. Action May 22.

Existing AM station

APPLICATION

WJNO West Palm Beach, Fla.—CP to increase daytime power from 250 w to 1 kw and install new trans. Ann. May 22.

Ownership changes

ACTIONS BY FCC

WEAD College Park, Ga.—Granted assignment of license from College Park Broadcasting (100%) to Ruth Sills (100%), receiver in bankruptcy. No financial consideration involved. Action May 23.

WMAS - AM - FM Springfield, Mass.—Granted assignment of license from WMAS Inc. to Southern New England Broadcasting Inc., parent company of WMAS Inc. No financial consideration involved. Action May 23.

WEEL Fairfax, Va.—Granted acquisition of positive control of licensee corporation, O.K. Broadcasting Corp., from George E.

Oleson (50%) by Arthur Kellar (100% after transfer, 50% before). Consideration \$125,000. Action May 24.

APPLICATIONS

KFGT Flagstaff, Ariz.—Seeks assignment of license from E. G. Phillippi (100%) to Guy Christian (100%). Consideration \$3,000 and assumption of sales agreement. Mr. Christian is majority owner of KKAN Phillipsburg, Kan. Ann. May 28.

KHOS Tucson, Ariz.—Seeks relinquishment of positive control of permittee corporation, Grabet Inc. Radio Enterprises, by Fred L. Vance (56 2/3%) to Walter J. Stiles and Thomas J. Wallace (each 33 1/3% after transfer, 5% before); other ownership remains stable. Consideration \$7,750. Ann. May 28.

KDWC(FM) West Covina, Calif.—Seeks assignment of license from John K. Blanche and Joseph D. Worth (each 50%), d/b as Pacific-South Broadcasting Co., to Sherman J. McQueen (18.75%) and others, tr/as San Gabriel Valley Broadcasting Co. Consideration \$15,000. Mr. McQueen is VP of Foote, Cone & Belding, Los Angeles. Ann. May 22.

KWSL Grand Junction, Colo.—Seeks acquisition of positive control of licensee corporation, Mesa Broadcasting Co., (13,334 shares issued), from V. A. Buckmaster (9,375 shares) and Joe B. Sullivan (3,125 shares) by Francis C. Gibbs (13,334 after, 834 before transfer). Consideration \$17,500. Ann. May 23.

WLBE Leesburg-Eustis, Fla.—Seeks transfer of negative control from Paul A. (49.1%) and Sally H. (.9%) Husebo and Wendell F. (49.1%) and Jean T. (.9%) Husebo to P. A. and S. H. Husebo (each 50%). Consideration \$50,000. Ann. May 22.

WKRS Waukegan, Ill.—Seeks transfer of control of licensee corporation, News-Sun Broadcasting Co., from individuals to Keystone Printing Service Inc., substantially owned by same persons. No financial consideration involved. Ann. May 23.

KNDR(FM) Des Moines, Iowa—Seeks assignment of license from New Directions Broadcasting Corp. to Charles Funaro (100%), trustee in bankruptcy. No financial consideration involved. Ann. May 23.

KNIA Knoxville, Iowa—Seeks assignment of license from Mitchell Broadcasting Co. to KNIA Broadcasting Co., wholly owned subsidiary of Mitchell. No financial consideration involved.

WNVL Nicholasville, Ky.—Seeks assignment of license from Pierce E. and F. E. Lackey and Katherine Peden (each 33 1/3%), d/b as Nicholasville Broadcasting Co., to Robert P. Joseph. Consideration is assumption of debt. Mr. Joseph is general manager of WKYB Paducah, Ky. Ann. May 22.

WETT Ocean City, Md.—Seeks assignment of license from Wett Corp. to Ocean City Broadcasting Corp., owned by majority owners of Wett. Consideration is assumption of debt. Ann. May 23.

WILD Boston—Seeks assignment of license from Nelson B. Noble (100%), d/b as Noble Broadcasting Corp., to Leonard E. Walk (50%) and Bernard M. Friedman and James Rich (each 25%), tr/as Dynamic Broadcasting Inc. Consideration \$135,000. Applicant owns WAMO-AM-FM Pittsburgh and WUFO Amherst, N. Y. Ann. May 23.

KETV(TV) Omaha—Seeks assignment of license from Herald Corp. to Northwest Agencies Inc. (contingent on grant of transfer of control of Herald to Northwest). No financial consideration involved. Ann. May 23.

WTLK Taylorsville, N. C.—Seeks assignment of license from Robert B. Brown (100%) to Mr. Brown (100%) tr/as Center Broadcasting Co. No financial consideration involved. Ann. May 22.

WZIP-AM-FM Cincinnati—Seeks transfer of control of licensee corporation, Greater Cincinnati Radio Inc., from News-Sun Broadcasting Co. to Keystone Printing Service Inc.; ownership remains essentially stable. No financial consideration involved. Ann. May 23.

WDOT Burlington, Vt.—Seeks assignment of license from Fortune and Anthony Pope (each 50%), d/b as Dot Broadcasting Corp., to William A. Hunter (34%), John Hunter Jr. (20%) and others, tr/as Hunter Broadcasting Inc. Consideration \$110,000. W. A. Hunter is operations and news director of WPTZ-TV Plattsburgh, N. Y.; J. Hunter is assistant VP of trust company. Ann. May 22.

KGMJ(FM) Seattle—Seeks assignment of license and SCA from Rogan Jones (41.85% individually and control of additional 52.9% through 85.44% ownership of International Good Music Inc.) and others, d/b as KGMJ Inc., to J. Elroy McCaw (45%), A. Stewart Ballinger (35%) and H. Dewayne Kreager and Willard J. Wright (each 10%), tr/as Metropolitan Radio Corp. Consideration \$45,000. Ann. May 24.

WNAW Neenah-Menasha, Wis.—Seeks transfer of control of licensee corporation, Neenah-Menasha Broadcasting Inc., from S. N. Pickard (100%) to James A. McKenna Jr. and Hudson Broadcasting Corp. (each 45%) and Don C. Wirth (10%), tr/as WNAW Inc. Consideration \$450,000. Hudson Broadcasting, licensee of WCMB and permittee of WDTV(TV), both Harrisburg, Pa., is 80% owned by Mr. McKenna; he also owns KEVE and KADM(FM) Golden Valley, Minn., has interest in WAWA West Allis, Wis., and is partner in Washington law firm; Mr. Wirth is manager of WNAW. Also see application below. Ann. May 23.

WNAW Neenah-Menasha, Wis.—Seeks assignment of license from Neenah-Menasha Broadcasting Inc. to WNAW Inc.; contingent on grant of application above. No financial consideration involved. Ann. May 23.

Hearing cases

INITIAL DECISION

■ Hearing Examiner Herbert Sharfman issued initial decision looking toward (1) granting application of Rockland Radio Corp. for new daytime AM on 1300 kc, DA, with 500 w in Spring Valley, N. Y., conditioned that pre-sunrise operation with daytime facilities is precluded pending final decision in docket 14419, and (2) denying applications for new stations on same frequency of Rockland Broadcasting Co. with 500 w, DA, in Blauvelt, N. Y., and Rockland Broadcasters Inc., with 1 kw, DA, in Spring Valley. Action May 28.

DESIGNATED FOR HEARING

■ By memorandum opinion and order, commission designated for hearing applications of Spanish International Television Inc., Progress Broadcasting Corp., Bartell Broadcasters Inc. and Trans-Tel Corp. for new UHF TV stations on channel 37 in

Paterson, N. J. WPIX Inc., licensee of WPIX (ch. 11) New York, which opposed Trans-Tel Corp.'s application on grounds of economic injury, was made party to proceeding. Memorandum opinion also provides that no final authorization will be issued in proceeding until termination of rulemaking in Doc. 15022 which proposed to delete channel 37 from broadcast service until Jan. 1, 1968, in area within radius of 600 miles of radio astronomy site in Danville, Ill., and to restrict transmission of stations on that channel beyond 600-mile limit between hours of midnight and 7 a.m. local time until Jan. 1, 1968. Chrm. Minow dissented and issued statement; Comr. Bartley dissented and voted to defer action; Comr. Henry concurred and issued statement. Action May 23.

OTHER ACTION

By order, commission granted petition by Broadcast Bureau and extended time to June 3 to file application for review of Review Board's April 17 decision which granted application of Wilkes Broadcasting Co. for new daytime AM on 1520 kc, 5 kw, reduced to 1 kw during critical hours, in Mocksville, N. C. Action May 27.

Routine roundup

ACTIONS BY REVIEW BOARD

By memorandum opinion and order in proceeding on applications of D & E Broadcasting Co. and Great State Broadcasters Inc. for new AM stations in San Antonio, Tex., in Docs. 14587-8, granted motion by Broadcast Bureau (in which Eloy Centeno, 98% owner of stock in Great State, joins) and reopened record and enlarged hearing issues to determine (a) whether Centeno has knowingly engaged in importation of horses into U. S. in violation of Tariff Act of 1930, or has through his agents or employees accepted and transported horses which he knew, or should have known, were imported into U. S. in violation of Tariff Act of 1930; and (b) in light of evidence adduced, whether Great States has requisite character qualifications to be licensee of commission. Action of May 22.

By memorandum opinion and order in consolidated proceeding on applications of Marshall Broadcasting Co. and Wright Broadcasting Co. for new AM stations in Marshall and East Lansing, respectively, both Michigan, in Docs. 15017-8, (1) granted in part Marshall petition and enlarged hearing issues to determine facts and circumstances relating to filing of Wright application, with particular reference to whether persons named in its application are real parties in interest and whether application was filed for principal or incidental purpose of delaying or obstructing establishment of standard broadcast facility at Marshall, and whether, in light of facts adduced, Wright is qualified to be licensee of station; (2) denied Wright motion to delete hearing issue 2; and (3) made Triad Television Corp. (WALM), Albion, party to proceeding. Action May 22.

By memorandum opinion and order in proceeding on application of Pinellas Radio Co. for new AM in Pinellas Park, Fla., in Doc. 14692, (1) denied petition by Cherry Broadcasting Co. (WDBO), Orlando for enlargement of issues, and (2) dismissed as moot motion by WDBO to strike paragraph in Pinellas April 19 opposition. Action May 22.

By memorandum opinion and order in proceeding on applications of International Broadcasting Corp. and Mauricio Alvarez-Martin for new AM stations in Carolina, P. R., approved agreement whereby International would reimburse Alvarez-Martin in return for his withdrawal; dismissed application with prejudice; and retained in hearing status International application. Action May 22.

In proceeding on application of Beamon Advertising Inc. for new AM in Dangerfield, Tex., in Doc. 14964, granted its petition and extended to June 3 time to file opposition to Mt. Pleasant Broadcasting Co. petition to enlarge issues. Action May 22.

Scheduled oral argument for June 25 in proceeding on AM application of Birch Bay Broadcasting Inc. (KARI), Blaine, Wash. Action May 22.

ACTIONS ON MOTIONS

By Chief Hearing Examiner
James D. Cunningham

Granted petition by Broadcast Bureau and extended time from May 27 to June 3 to file proposed findings of fact and con-

clusions and, on own motion, extended time to June 24 to file replies in consolidated AM proceeding on applications of Salem Broadcasting Co. (WJBD), Salem, and Leader Broadcasting Co., Edwardsville, respectively, both Illinois. Action May 27.

Designated Examiner Forest L. McClenning to preside at hearing in proceeding on application of Hershey Broadcasting Inc. for new AM in Hershey, Pa.; scheduled prehearing conference for June 25 and hearing for July 17. Action May 24.

On own motion, and with agreement of Marshall Broadcasting Co. and Wright Broadcasting Co. for new AM stations in Marshall and East Lansing, respectively, both Michigan, in Docs. 15017-8, revised certain procedural dates and ordered hearing on July 9 as scheduled. Action May 24.

Ordered that Examiner David I. Kraushaar, in lieu of Examiner Asher H. Ende, will serve as presiding officer in proceeding on applications and Sands Broadcasting Corp., Hoosier Broadcasting Corp., and Independent Indianapolis Broadcasting Corp. for new AM stations in Indianapolis. Action May 22.

Ordered that Examiner Millard F. French, in lieu of Examiner Asher H. Ende, will serve as presiding officer in proceeding on application of Bigbee Broadcasting Co. for new AM in Demopolis, Ala. Action May 22.

Designated Examiner Thomas H. Donahue to preside at hearing in proceeding on AM application of James S. Rivers Inc. (WJAZ), Albany, Ga.; scheduled prehearing conference for June 21 and hearing for July 30. Action May 21.

Designated Examiner Arthur A. Gladstone to preside at hearing in proceeding on application of O. L. Withers for new AM in Woodburn, Ore.; scheduled prehearing conference for June 24 and hearing for July 29. Action May 21.

Designated Examiner Isadore A. Honig to preside at hearing in proceeding on AM application of O. K. Broadcasting Corp. (WEEL), Fairfax, Va.; scheduled prehearing conference for June 27 and hearing for July 25. Action May 21.

By Hearing Examiner Basil P. Cooper

Pursuant to agreements reached at May 22 prehearing conference in proceeding on AM application of Wells, Waller & Ballard Inc. (KEBE), Jacksonville, Tex., continued June 25 evidentiary hearing to June 27. Action May 22.

By Hearing Examiner Thomas H. Donahue

Granted petition by Broadcast Bureau and extended from May 20 to May 24 time to file proposed findings and conclusions in proceeding on AM applications of Smackover Radio Inc., Smackover, and Magnolia Broadcasting Co. (KVMA), Magnolia, both Arkansas. Action May 21.

In proceeding on AM application of Beardstown Broadcasting Inc. (WRMS), Beardstown, Ill., (1) granted applicant's petition for leave to amend so as to either eliminate or render nominal matters now designated for hearing, (2) accepted for filing amendment to which petition relates, (3) removed amended application from hearing and returned to processing line, and (4) cancelled May 22 conference and June 24 hearing. Action May 21.

By Hearing Examiner Millard F. French

In proceeding on application of Brush Broadcasting Co. for new AM in Wauchula, Fla., continued May 22 date for further exchange of exhibits to date ten days subsequent to receipt by parties of transcript of testimony taken in Wauchula. Action May 21.

By Hearing Examiner Walther W. Guenther

On own motion, scheduled further hearing conference for May 31 in proceeding on application of Bay Shore Broadcasting Co. for new AM in Hayward, Calif. Action May 24.

By Hearing Examiner Isadore A. Honig

By order formalized certain procedural agreements reached at May 21 prehearing conference in proceeding on AM application of Delaware Valley Broadcasting Co. (WAAT), Trenton, N. J., scheduled certain procedural dates, ordered hearing to commence as scheduled June 24, and, on own motion, relieved Delaware Valley of its obligation to exchange copies of its proposed exhibits with Federal Aviation Agency. Action May 21.

By Hearing Examiner Jay A. Kyle

Granted petition by Broadcast Bureau and extended time from June 3 to June 12 to file proposed findings in proceeding on application of Geoffrey A. Lapping for new AM in Blythe, Calif. Action May 27.

Granted request of Redding-Chico Television Inc. and ordered that lists of witnesses it desires shall be furnished Northern California Educational Television Association Inc. on June 10, and continued June 3 hearing to June 17 in proceeding on their applications for new TV stations on channel 9 (Northern Calif. would operate noncommercially), in Redding, Calif. Action May 27.

Pursuant to May 20 hearing conference in proceeding on application of Geoffrey A. Lapping for new AM in Blythe, Calif., scheduled further hearing for May 31 in Washington. Action May 20.

By Hearing Examiner Forest L. McClenning

Granted petition by Port Chester Broadcasting Co. for leave to amend its application for new AM in Port Chester, N. Y., to change proposed hours of operation from unil. time to daytime only. Action May 22.

Granted petition by Abacoa Radio Corp. and continued certain procedural dates, and rescheduled July 16 hearing for July 23 in proceeding on its application and that of Ponce Broadcasting Corp. for new AM stations in Arecibo and Cayey, respectively, both Puerto Rico. Action May 21.

Granted motion by Big Bear Lake Broadcasting Co. and continued May 23 prehearing conference to June 24 in proceeding on its application for new AM in Big Bear Lake, Calif. Action May 21.

By Hearing Examiner
Chester F. Naumowicz Jr.

By order, formalized certain agreements reached and rulings made at May 23 and 24 hearing sessions in proceeding on AM application of Denver Area Broadcasters (KDAB), Arvada, Colo., scheduled certain procedural dates and ordered hearing to reconvene on July 9. Action May 27.

Granted petition by Broadcast Bureau and extended from May 24 to June 4 time to file proposed findings in proceeding on application of William S. Cook for new AM in Colorado Springs. Action May 24.

Upon request by Broadcast Bureau, continued Sept. 10 hearing to Oct. 2 in Cheyenne, Wyo., in proceeding on applications of Charles W. Stone for renewal of license and for change of facilities of KCHY Cheyenne, and Fort Broadcasting Co. for renewal of license of KDAC Fort Bragg, Calif., in Docs. 14816 et al. Action May 24.

In proceeding on AM application of Southwestern Broadcasting Co. of Mississippi (WAPP), McComb, Miss., continued May 27 hearing to May 28. Action May 22.

By Hearing Examiner Herbert Sharfman

Granted motion by Coastal Broadcasters Inc., Herndon, Va., and extended time from May 22 to May 29 for preliminary exchange of engineering exhibits in proceeding on its AM application, et al., in Docs. 14873 et al. Action May 27.

Upon request by Broadcast Bureau and without objection by other parties in revocation proceeding against Martin R. Karig (WIZR), Johnstown, N. Y., and other Karig and related applications in Docs. 14817 et al., further extended from May 24 to May 28 time to file initial proposed findings and from June 7 to June 11 for replies. Action May 24.

By Hearing Examiner Elizabeth C. Smith

Granted petition by Chesapeake Broadcasting Corp. (WASA), Havre de Grace, Md., and continued certain procedural dates and rescheduled June 5 hearing for June 24 in proceeding on its AM application and that of Accomack-Northampton Broadcasting Inc. (WESR), Tasley, Va. Action May 27.

Granted petition by Broadcast Bureau and extended time from June 7 to June 17 to file proposed findings and conclusions, and to July 5 for replies in proceeding on applications of Valparaiso Broadcasting Co. and Porter County Broadcasting Co. for new AM stations in Valparaiso, Ind. Action May 24.

Received in evidence exhibit 23-A of Porter County Broadcasting Co. and closed

Continued on page 97

CLASSIFIED ADVERTISEMENTS

(Payable in advance. Checks and money orders only.) (FINAL DEADLINE—Monday preceding publication date.)

- SITUATIONS WANTED 20¢ per word—\$2.00 minimum • HELP WANTED 25¢ per word—\$2.00 minimum.
- DISPLAY ads \$20.00 per inch—STATIONS FOR SALE, WANTED TO BUY STATIONS and EMPLOYMENT AGENCIES advertising requires display space.
- All other classifications 30¢ per word—\$4.00 minimum.

• No charge for blind box number. Send replies to *Broadcasting*, 1735 DeSales St., N.W., Washington 6, D. C.

APPLICANTS: If transcriptions or bulk packages submitted, \$1.00 charge for mailing (Forward remittance separately, please). All transcriptions, photos, etc., sent to box numbers are sent at owner's risk. BROADCASTING expressly repudiates any liability or responsibility for their custody or return.

RADIO

Help Wanted—Management

Southern California, immediate opening for solid salesman, capable of management, with top station multiple chain. Good starting salary. Box G-12, BROADCASTING.

Managers, small and major market manager vacancies in established eastern group operation. . . Prime consideration to successful sales managers with programing community service appreciation, excellent character and ambition to advance. Send full details. Box G-235, BROADCASTING.

Sales manager or salesman with qualifications, large midwest market. Box G-291, BROADCASTING.

Southwest manager for small single market station. Strong on sales, first phone, some investment preferred. Rapidly growing market. Salary, profit sharing opportunity. Good references essential. Box H-18, BROADCASTING.

Immediate opening for general manager of a Texas station. The opportunity is waiting for the right man. Send background and full information in first letter to Box H-25, BROADCASTING.

Manager sales manager upper midwest city of 30,000. Competitive. Agriculture important to market. Compensation geared to profits. Send resume to Box H-69, BROADCASTING.

Sales

Columbus, Ohio . . . Immediate opening for good salesman, management experience or ready. Top independent. Growing chain, good salary plus. Please write fully. Box G-13, BROADCASTING.

Announcer for established, successful good music station San Francisco Bay area. First class license essential. Good voice important. Send tape. Knowledge of classical music, ability to handle news helpful. Permanent position with definite management potential. Maintenance not important. Good board performance essential. Ideal living conditions. Good salary for right man. This is addition to present staff. Must have minimum two year experience on quality station. No beginners. Give full details including educational background first reply. Preference to Northern California resident. Box G-199, BROADCASTING.

Michigan regional in medium market. Opening for salesman with year or more small or medium market experience who wants to move to larger market and larger income. Replies confidential. Give full details and photo. Box G-258, BROADCASTING.

Rockford Illinois metropolitan market has lucrative position for experienced radio salesman, full of ideas and energy. Opportunity for real solid income with a solid established operation. Family man preferred. Guarantee, 20% commission, car allowance. All replies confidential. Box G-310, BROADCASTING.

Salesman-announcer to operate remote studio in county seat town of 5000. Midwest. Send resume and tape. Box G-368, BROADCASTING.

Salesman announcer. Not necessarily executive type just hard worker. \$600 per month plus commission total station gross for right man. Box H-59, BROADCASTING.

Help Wanted—(Cont'd)

Sales

Expanding sales force. Need young fast-moving, intelligent salesman. Must have implicit faith in prolific presentation or spec sales tapes. No phone calls. Mail resume, in confidence to, Bill Gallagher, Jr., General Sales Manager, WPIK, Virginia Theatre Building, Alexandria, Virginia. WPIK serves the greater Washington D. C. area with adult programing.

Announcers

Experienced staff announcer for Maryland independent. Mature voice, good references, necessary. Send air check and resume. Box G-250, BROADCASTING.

Newsman to gather, write, and air local news. Midwest. \$110/week tape, resume and photo to Box G-255, BROADCASTING.

Want stable combo man who can enjoy small town. Alabama regional station, emphasizing quality. Want man with knowledge of RCA equipment, and good voice. Send resume, picture, tape, references and salary needs to Box G-317, BROADCASTING.

First phone engineer-announcer. Chicago fm station maintenance-announcing required. Send tape-resume. Box G-347 BROADCASTING.

New eastern seaboard daytimer needs experienced announcer-engineer with first phone. Box G-357, BROADCASTING.

Needed: Experienced announcer and control board operator for Western North Carolina station, news, all types music. Box G-358, BROADCASTING.

Experienced announcer newsman for New Jersey independent. Salary commensurate with ability. Box G-362, BROADCASTING.

Experienced announcer for 5000 watt network station in western state. \$90 per week to start, with fringe benefits. Give complete details of yourself and tape in your first letter. Box H-56, BROADCASTING.

A Broadcast journalist with a mature voice who is skilled at gathering, writing, and broadcasting radio news. Hard, challenging work. Box H-62, BROADCASTING.

Wisconsin early morning first phone, permanent position for farm oriented announcer with good voice. Box H-70, BROADCASTING.

Good announcer with first phone for network station in Idaho. Starting salary according to ability. Our staff knows of this ad. Box H-57, BROADCASTING.

Experienced radio announcer for midwest radio tv operation. Air resume and tape. Box H-77, BROADCASTING.

Experienced, dependable announcer. Send tape, resume, photo, salary. KLIC, Monroe Louisiana.

KLIX, a 5000 watt network station in Twin Falls, Idaho needs an experienced announcer. Contact William R. Vogel, WGNS, Murfreesboro, Tennessee.

Newsman with 1st phone for metro east coast indie. No maintenance. Basis plus talent. Heavy emphasis on local news. Send tape and background to Box H-6, BROADCASTING.

Help Wanted—(Cont'd)

Announcers

Outstanding midwest market wants you! Benefit loaded station needs most happy fellow to meet and beat tough competition. Maturity is fine, experience essential. Rush tape, background information and salary expected. Box H-4, BROADCASTING.

Need two. Announcer \$412 per month. Newsman \$450 per month. KBRZ, Freeport, Texas.

Opportunity married staff announcer. Outline experience. RADIO KFRO, Longview, Texas.

Experienced announcer dependable know pop and country music, strong on news and commercials. Willing to adjust top operation and area. (Know it alls and smart alecks need not apply.) Immediate position contact Jim Risner Owner, Manger, KRMS, Osage Beach, Mo.

On air newsman with thorough news background. 40 hours. Opening in August. Send complete information, recent photo and salary requirement in first letter to Michael Dillon, PGM. Dir. KOB Radio, 1430 Coal SW, P. O. Box 1351, Albuquerque, New Mexico.

KWTK radio wants two mature, experienced announcers for adult music, locally oriented news and sports operation. Prefer men with southwest background. Some tv also. Send tape, letter and recent photograph to Frank Fallon, P. O. Box 7128, Waco, Texas.

Immediate opening at station KOH, Reno and KBEE, Modesto. First FCC ticket required. Permanent position, excellent company benefits. Apply in person or send detailed resume to station managers or personnel department, McClatchy Broadcasting Co., 21st and Q, Sacramento, California.

Suburban Chicago. Combo first class. Permanent. Tape complete information now. WEAW, Evanston, Illinois.

New Jersey experienced announcer newsman for adult music station. Send preliminary tape, resume. Interview required. WHTG, Rt. 1, Asbury Park.

Announcer news. 1st ticket. No maintenance. Daytime mutual, good opportunity with growing organization. Salary open. Send tape and resume to WJUD, St. Johns, Michigan.

First opening in four years. Middle of road, with ambition leading toward management. First phone preferred. Salary open. Send tape, resume, and references to Boyce Hanna WADA, Shelby, North Carolina.

Immediate need for 1st class radio engineer. State salary requirements and qualifications other phases or radio. Write Dwight Snyder, Manager, WCKM, Winnsboro, South Carolina.

Modern Negro disk jockey for morning spot. Must be able to do bright, tight production show. A growing station in one of the top markets. First class license preferable, not necessary. Good pay. Please send tapes and resumes to James Psihoulis, WZUM, Pittsburgh, 5, Pa.

Immediate opening for morning man, capable on news, sports and announcing. Send tape, and resume, WDDY, Gloucester, Virginia.

DJ's learn the professional way to introduce a record. 300 interchangeable, intelligent intros by excellent writers for vocals and instrumentals. \$3.95 Broadcast Intros, 975 North 35th, Milwaukee 8, Wisconsin.

Help Wanted—(Cont'd)

Technical

Growing chain wants capable First Class engineer for Phila. area station. Ideal atmosphere for good man. Many fringe benefits. Personal interview essential. Tell all, including salary requirements to Box G-340, BROADCASTING.

Chief engineer midwest directional AM. Some announcing ability and production experience preferred. Box H-28, BROADCASTING.

Kentucky daytimer needs first class engineer. State salary requirements and earliest available date. Box H-63, BROADCASTING.

An opportunity in Phoenix, Arizona for a sound recording technician. Must have wide experience recording on tape, disc and film, mixing, dubbing and technical background in recording techniques, understanding and know how of recording problems. Background in radio, television recording and motion pictures, with administrative and executive abilities to head and develop sound recording facility of expanding industrial motion picture producer. Box H-76, BROADCASTING.

Engineer announcer capable of assuming complete responsibilities of studio engineer, and, willing to work with our transmitter engineer. Also must carry some air work. Send complete resume, tape, and references to KPEG, E. 3810 Boone, Spokane 24, Washington.

Engineer. Some experience. Salary open. WVOS, Liberty, New York.

Top chief engineer position available immediately in Puerto Rico, for going successful tv am fm operation. Will meet salary requirements of right individual. Apply by letter sending resume of experience and other details to Mr. F. Pons c/o Lamborn 99 Wall Street, New York 5.

Southern California major metro area adult kilowatt must have competent engineer who can handle all maintenance and repairs and who has good air personality with plenty of announcing experience. Do not apply unless able to handle all engineering chores. Bonus pay for best announcer. Climate free. Call Ron Zimmer. Area Code 714. Phone number 686-0260.

Chief engineer announcer. Non directional 1 kw CBS affiliate. Light air shift. Resume and salary requirements to KBIZ, Ottumwa, Iowa.

Need transmitter engineers in Wichita Falls Lawton area. Permanent positions. State salary requirements and experience. Box 1053, Wichita Falls, Texas.

Two engineers with first phone, one for chief, salary open. Contact Richard Wright, WTTF, Tiffin, Ohio.

Production—Programing, Others

Number one midwest independent is looking for an experienced production announcer, creative and capable of writing agency type copy. Send written examples, tape, salary requirements, and complete resume to Box H-32, BROADCASTING.

Wanted director of programing to take charge of model all new FM operation in Kenosha Wisconsin. Contact Bill Lipman, WLIP.

Sports director, some staff. Considerable play by play. KHAS, Hastings, Nebraska.

Louisiana, experienced announcer for morning shift on adult, popular music station. Call collect, manager KSYL-NBC, Hillcrest 2-6611, Alexandria, Louisiana.

Help Wanted—(Cont'd)

Production—Programing, Others

WTAR Radio-television Norfolk is expanding public affairs and news department. Immediate need for experienced radio television newsmen. Emphasis on imaginative reporting plus solid writing and editing abilities. Opportunity for creative work in news and public affairs documentary programing in southeast's fastest growing area. Contact Clayton Edwards, News Director, WTAR, 720 Boush Street, Norfolk, Virginia. Telephone: 625-6711.

RADIO

Situations Wanted—Management

Broadcaster, 27 married. 10 years experience. Award winning newscaster, programmer, production, continuity. Limited sales. Desires small station operations directorship. References excellent. Box G-335, BROADCASTING.

13 years broadcasting experience. Past station manager. 32, family, college grad. First phone. Box G-359, BROADCASTING.

General manager. Large market. For sale a pretty fair track record built on ability, hard work, a lot of luck and via not too many pasture changes. Box H-1, BROADCASTING.

Experienced Carolina manager-salesman desires association with growth and stability station in Virginia or two Carolinas. Box H-11, BROADCASTING.

Management or pd with management future, for hard work and ability. 8 years experience management, programing, announcing, continuity, sales, all references. College veteran family. 30. Box H-14, BROADCASTING.

Attention S. C. or Ga., Alabama, Florida stations. Working manager strong on local, regional sales, promotions. 17 years 7 management desires small or medium market. Best references. Box H-15, BROADCASTING.

Manager, midwest preferred. Radio experience small market to #2, includes programing net owned 50 kw launching cps. Former owner. Adult operations only. Box H-19, BROADCASTING.

Not distress merchandise. Honest, sharp, hard working radio tv executive with unusual flair for creative sales. 6 years multiple station experience prior to present radio management post. Property sold. Considering all offers. Final decision will depend on owner's reputation. Your references must be as excellent as mine. Confidential. Box H-30, BROADCASTING.

Experienced manager currently operating successful station in competitive market. Strong on sales, programing, promotion. Looking for advantageous change in medium sized market. No time urgency. Let's get acquainted. Box H-31, BROADCASTING.

Currently manager, seek manage or operations manager position. Young, aggressive—10 years experience. Good record as program director, news director, sales manager and manager. Small or medium market. Box H-43, BROADCASTING.

Sales

D.J. wants to swing. 1 year middle of the road experience. Single. Box G-326, BROADCASTING.

Top flight executive level broadcast salesman available. Eastern college graduate package goods and retail sales oriented, manufacturer and agency advertising background. Knows tv and radio production. New York and Boston business experience 38 years old leader of family of five needs late teen financial prospect in northeast location. Aggressive direct sales type. "You don't need an advertising agency—I am one." However also effective with agency execs. No cut rate—priced to sell for you fast. Currently with top 50,000 watt radio New York. For further names, places and sales success status, Box H-78, BROADCASTING.

Situations Wanted—(Cont'd)

Announcer

D.J./announcer wants to locate permanently. 6 months experience middle of the road. Tight board, young, married, dependable. Also like to do record hops. Available June 15. Minimum \$75. Box G-350, BROADCASTING.

5 years experience. DJ announcer, morning man. Northeast, family man. 31. Box G-363, BROADCASTING.

Happy, energetic rock sound. Pied piper teen rockers in small market. Modern delivery. Best references. Box G-197, BROADCASTING.

Disc jockey newscaster, young, experienced, can do play by play baseball. Will locate anywhere for right offer. Box H-10, BROADCASTING.

Graveyard shift open? Young, versatile announcer seeking night work. Hard worker, dependable, ambitious. Commercial background. Good play by play man. Three years managerial experience in college. No tape collectors. Interview a must. Prefer midwest. Any format. Best of references. Can relocate June 10. Box H-13, BROADCASTING.

This morning personality maintains a number one rating with middle music policy against all types of competition. Something a little different. Box H-16, BROADCASTING.

Experienced announcer/dj dependable, versatile, young, single. Authoritative news, knows top 40 and middle of road. Box H-17, BROADCASTING.

Experienced top 40 personality with emphasis on production skills. College background, tight, fast, swinging production. News experience, want larger market. Box H-22, BROADCASTING.

Fast, smooth, funny pro wants to spend a long time with a solid, responsible organization in medium to major market with major university. My ad lib is my product. Lots of good background, references and love for money. Educated. No problems. Box H-24, BROADCASTING.

Personality dj, first phone, tight production, ready to move up. Box H-27, BROADCASTING.

Announcer, 21 single, ½ year experience. Phone 313-838-6418.

Boston. Experienced announcer desires position while attending college. Box H-33, BROADCASTING.

Seasoned announcer, sixteen years radio-tv. Congenial personable, authoritative. Box H-34, BROADCASTING.

Personality. First phone. Best references. Available immediately. Box H-36, BROADCASTING.

Professional attitude, experienced radio/tv announcer/interviewer/dj. Limitless ambition. College graduate, married. Desire combination radio/tv position medium eastern market. Box H-41, BROADCASTING.

Desire to relocate in Arizona. 12 year veteran of radio as dj personality writer, producer and pd. Box H-45, BROADCASTING.

West coast only: Major midwest market dj 1st phone. Nine years experience all phases. Wants tight top tune swinger. Married, family references. Phone 305-342-0609, or write. Box H-46, BROADCASTING.

Sportscaster you don't want me, I'm not an alcoholic. I believe in mature, conscientious work, loyalty to my employer; in working at my profession instead of playing politics on a golf course. Ten years radio and tv major college football and basketball. Two years professional basketball, three years major league baseball and top references. What's happened to the industry? Aren't these qualifications wanted today? If so, I'm available July first. Box H-50, BROADCASTING.

Situations Wanted—(Cont'd)

Announcers

Looking for reliable experienced announcer? I'm your man! 15 years in radio and television. Now doing both. Need growing market. Box H-51, BROADCASTING.

Florida any price. Top sports, good news-music. 7 years experience. Box H-54, BROADCASTING.

Male dj seeks girl partner for comedy radio show. Minimum 3 years experience. Must be funny, funny, funny! Voices helpful. Phone No. DR 6-7261 (area code 201) or tape to Box H-64, BROADCASTING.

Energetic, enthusiastic young man wants job with strong, small outfit. Runs tight board, works hard. Available immediately. Prefers midwest, but will travel. Air checks resume, references. Box H-65, BROADCASTING.

Young man, 21, married announcer and dj, good voice; ½ year experience, programs, C & W, R & B, top 40 material. Seeks day hours. Desire to move up. Will move. Box H-66, BROADCASTING.

What is my forte? A casual, nostalgic "man next door" show. Voice to go along. Now in large market. Desire to relocate. All offers considered. \$110 minimum. Box H-72, BROADCASTING.

Dick Reynolds . . . want small market anywhere. Some experience. References, tapes, any music. News, tight, bright, hard worker. Some college. Available now. Call—313-234-8049. Or write 314 Josephine, Flint, Michigan.

First class combo man, wants change. Prefer central or eastern North Carolina. Ready by June 30. Write P. O. Box 1096, Elizabethtown, North Carolina.

Announcer, dj excellent on news, young, personable, ambitious. Will locate anywhere. Broadcasting school graduate. Tape available. Robert Bartels, 930 South Michigan Hotel, Chicago 5, Illinois.

Sparkling first phone morning man. Presently chief engineer and chief announcer. 10 years experience all phases. Interested in learning sales your way. Box H-74, BROADCASTING.

Ben Casey can't perform your operation as well as I can. Experience, tight board, showmanship. Box H-75, BROADCASTING.

Announcer d.j. experienced. Bright happy personality. Authoritative news. Willing to travel. Box H-79, BROADCASTING.

Technical

Presently tv chief. Available immediately. 10 years experience. Looking for security. Prefer no announcing. 4021 South Grand Blvd. Spokane 36, Washington MA-4-1656.

First phone, beginner, career type, afternoons, Kansas City vicinity, GL 2-8063. Box G-85, BROADCASTING.

First phone. Transmitter position. Some fm exp. Western states area, will consider others if good opportunity. Box G-344, BROADCASTING.

Engineer, first phone, experienced, seeks summer position N.Y.C. area. Box H-7, BROADCASTING.

Transmitter technician first phone, about to retire wants part time job. New Jersey or central Ohio. Box H-9, BROADCASTING.

First phone announcer. Some college and technical school training. Prefer large or medium size city. Box H-20, BROADCASTING.

Engineer announcer nine years experience maintenance news, country music wants position Louisiana, east Texas, Arkansas, Oklahoma. 665-5221 Denhan Springs, Louisiana. Nights. Hamp Clark,

Situations Wanted—(Cont'd)

Technical

Am presently a member of one of nation's metropolitan radio/television news staffs, writing, airing local news, doing beep, soft, phone shows, specials. Seek better personal situations, or change including entertainment variety. Will visit sincere parties. Box H-49, BROADCASTING.

Chief engineer. Will assume complete responsibility for technical operation of am-fm-tv station, or group of stations. Experienced to 50 kw with directional antenna systems. Now on east coast, will relocate. Prefer salary with stock arrangement. Box H-80, BROADCASTING.

Former field engineer for a well known consultant. Experienced in all phases of studio and transmitter engineering. Seeking a position as field engineer, working chief, or in construction and maintenance. Box H-37, BROADCASTING.

Situation wanted as engineer in small tv, fm or am station in western Montana, Idaho or eastern Washington. First class FCC with 12 years experience. Resume will be furnished. 2135 Martin Avenue, Dayton 14, Ohio.

Chief 11 years experience, all phases including sales. Good announcer. Directional am and fm, constructed 4 stations. Run middle of the road show, know classics. Last two years in Chicago radio. Call anytime before 3 p.m. Walt Adams 312-662-0515. 2020 Linden, Waukegan, Illinois.

Production—Programing, Others

"Experienced news director with radio and television experience. Looking for right opportunity. Good credit, good references, college, sober, single. Needs job now. Will travel. Dick Harris 5628 16th Ave. S. Minneapolis, Minn. Phone 612-TA-4-2507.

Key man for locked door! 15 years major markets drive time personality, creative, production program director. Desires responsible position. Employed. Box G-307, BROADCASTING.

Program director. Airman loves long hours, broadcasting money. 14 years experience. Top references New England Middle Atlantic. No rock. Immediate move. Box H-73, BROADCASTING.

College grad., married, 5 years experience. Can do writing, tight morning shift, intelligent strong news. Character voiced commercials, promotion minded and likes to sell good sound. Not a drifter. Box H-55, BROADCASTING.

News director. College radio tv major. 3 years experience, gathering, writing, airing. Family man seeking permanency in larger city, 100,000 plus. \$135 minimum. Box H-87, BROADCASTING.

TELEVISION**Help Wanted—Announcers**

Announcer. Experienced. Southwest leading network. Above average talent opportunities. Excellent benefits. Send resume, pic, tape or VTR. Box H-52, BROADCASTING.

Newsman experienced to head tv news department. Position available immediately. Call Len Cane, WPTZ-TV, Jordan L-5555, Plattsburgh, New York.

Technical

First phone engineer for studio operation and maintenance. Immediate opening southeastern city 50,000. Experience desirable, not essential. Box H-21, BROADCASTING.

Help Wanted—(Cont'd)

Technical

Supervisory engineer small tv station in midwest performer, children's program. E. M. Sears, Personnel Manager, Sarkes Tarzian Inc., E. Hillside Drive, Bloomington, Indiana.

Florida-chief engineer experienced in studio, transmitter, and vtr operation and maintenance. Needed soon for etv station. Channel 7, Box 7, Jacksonville, Florida. Phone 389-3674.

Production—Programing, Others

Producer director . . . fully experienced, well trained tv producer director; full time position with established etv stations. College graduate, M.A. or work towards it, preferred. Contact Otto Schlaak, Manager WMVS, Milwaukee, Wisconsin.

Television artist wanted by station located in N.E. Should be experienced in all phases of art work utilized in tv slides, set design, and construction requirements newspaper ads sales, promotion presentations etc. This is a fine opportunity for a person who is creative and looking for a challenge. Send resume to Box H-5, BROADCASTING.

Continuity director. Must know station operations. Capable of taking over in highly competitive s.w. market. Salaried. 400 month. Box H-53, BROADCASTING.

TELEVISION**Situations Wanted—Management**

Advertising and promotion manager. Experienced young man, college grad, vet, offers you creative advertising talent plus practical experience with all major media. He's looking for a station that believes strongly in merchandising and where responsibility and hard work provide a challenge. For resume, references, write: Box H-42, BROADCASTING.

Operations manager: Presently employed. Thirteen years experience medium major market tv. Seeking change for valid reasons. Capable, ambitious, strong engineering and administrative background; directing programing, production FCC, Labor negotiations, etc. For resume write. Box H-48, BROADCASTING.

Announcers

Newsman writer announcer available immediately. 14 years experience New England. Middle Atlantic references. Box H-61, BROADCASTING.

Versatile, ambitious radio tv announcer desires more lucrative market. College grad, married. 7 years experience. Strong on news and play by play. TV sales experience. Will relocate anywhere. Box H-68, BROADCASTING.

Professional tv announcer — experience sales, traffic, design, production, presently have nine top rated live shows per week with Canadian network station. Commercials scripted and ad lib. Wish to relocate with view to responsible management position. Married. Three children. Brochure. film on request. Box G-338, BROADCASTING.

Technical

Have you opportunity for engineer with 12 years television experience including color, planning, construction? Last 4 years asst. chief. Box G-364, BROADCASTING.

Midwest, 1st phone. 4 years am and fm announcing experience. Dependable, married. Box H-35, BROADCASTING.

Former field engineer for a well known consultant. Experienced in all phases of studio and transmitter engineering. Seeking a position as field engineer, working chief, or in construction and maintenance. Box H-37, BROADCASTING.

Situations Wanted—(Cont'd)

Technical

Assistant studio maintenance supervisor for last 8 years seeks relocation for greater opportunity, 11 years tv experience. Good references. Box H-40, BROADCASTING.

Assistant chief wishes to relocate. Experience, administrative, construction, maintenance, proof of performance, video tape, color, remotes, etc. Sharp. Box H-71, BROADCASTING.

Production—Programing, Others

Experienced, employed television announcer, newsman. Desires advancement; announcer, news, programing, married. Box H-44, BROADCASTING.

News director. Highly successful major market record. Top rated on the air delivery, proven administrative ability, award winning news photographer. Extensive special events and public affairs programing experience. Best references include current employer. Kine available. Box H-12, BROADCASTING.

For Sale

Equipment

Gates 250 C-L used working when removed from service. Gates Model 2700 limiter (modified as is, used). Gates model 25A automatic frequency control unit. Two each 1400 kc Biley crystals (in ovens). Total price for all \$450. Box H-58, BROADCASTING.

One surplus 3M video splices available. One or two splices in an hour reel. Unable to use due to client requiring unspliced tape. Box H-60, BROADCASTING.

Ampex VR-1000 spare parts. Send for list. Karl Troeglen, KCMO, Broadcasting, Kansas City, Mo.

Used UHF 1 kw RCA Transmitter excellent condition, immediate delivery, a bargain. WCET, 2222 Chickasaw Street, Cincinnati 19, Ohio.

Tower Stainless type G-17 Guyed, Galvanized 200 feet with lighting, 1 choke, PE Cell. 6 years old. Down, ready to ship. \$750 KPER, Gilroy, California.

1000 watt Western Electric transmitter model 443-A-1. Now tuned to 1050 kc. Good working condition. Best offer. WPAG, Ann Arbor, Michigan.

Xmission Line; Teflon insulated, 1½" rigid, 51.5 Ohm flanged with bullets and all hardware. New—unused. 20 foot length for \$40.00. Quantity discounts. Stock list available. Sierra-Western Electric, 1401 Middle Harbor Road, Oakland 20, California. Telephone 2-3527.

Television / radio transmitters, monitors cameras, microwave tubes audio monitors. Electrofind, 440 Columbus Ave., N. Y. C.

Two Dumont TA-124-A cameras, working condition, less tripods and tilt heads. Best offer. Box G-331, BROADCASTING.

One G.E. color film scanner, new '58. Includes two Eastman-Kodak model 300 continuous motion projectors in excellent condition. Also includes a dual 8 slide disc slide system. Also includes preview facilities for film and slides. Is currently in regular use and well maintained. Ideal way to get into color film and slides inexpensively. \$27,500. Box H-8, BROADCASTING.

¾" Coaxial cable, Andrew Heliax. Black sheath covered. Never used. 85¢ per foot box El Cajon Electronic Engineering, P. O. Box 012, San Diego 15, California.

Eighty five 20 ft. sections of Prodelin UHF 3½ inch transmission line. Good condition. Make offer. R. V. Goyette, KARD-TV, 833 North Main, Wichita, Kansas.

Film scratches and dirt showing on your tube? A lot of stations got rid of them by using Piclear—You can too. Piclear, Inc., 450 Weaver Street, Larchmont, N. Y.

For Sale

Equipment

Complete Gates RCM20 remote control system, including meters, shunts, motors, \$500. Windcharger 350 foot guyed tower, lighted, best offer, you dismantle. WAAA, Winston-Salem, North Carolina.

Commercial crystals and new or replacement crystals for RCA, Gates, W. E. Bliley and J-K holders, regrounding, repair, etc., BC-604 crystals and Conelrad. Also A. M. monitor service. Nationwide unsolicited testimonials praise our products and fast service. Edison Electronic Company, Box 96, Temple, Texas.

Factory reconditioned tape cartridge equipment with full 90 day guarantee. Cartridge playbacks priced at \$225 and recording amplifiers at \$165, (24) P-150 and P-190 series, (9) A-150 and A-190 series. The following equipment is available in like-new condition: (1) MaCarTa Carousel @ \$975; (1) RCA Cartridge Recording Amplifier @ \$300; (1) RCA Tape Cartridge Playback @ \$450. Also, recently traded, the following RCA Magnetic Disc equipment. Make an offer. (2) BQ104 Disc Changers; (2) BQ51A Disc Recorders; (3) Disc Changer Remote Selectors; (2) Disc Erasers. Automatic Tape Control, Inc., Bloomington, Illinois, Phone 309-825-2078.

Thermometer, remote electrical: used by over 100 stations, enables announcer to read the correct outside temperature from mike position. Installed in less than an hour. Send for brochure. Electra-Temp. Co., Box 6111, San Diego 6, Calif.

WANTED TO BUY

Equipment

Will buy or trade used tape and disc recording equipment—Ampex, Concertone, Magnecord, Presto, etc. Audio equipment for sale. Boynton Studio, 10 B Pennsylvania, Tuckahoe, N. Y.

Need 5 or 6 layer super turnstile antenna and 25 kw vestigial sideband filter for television channel 2. Write stating make, model, condition, and prices. Box G-321, BROADCASTING.

Audio limiter. Send description and price to J. Deneufville, WGLM, Richmond, Indiana.

All equipment between the microphone and the 150 foot tower necessary to build a 250 watt station. Gates transmitter preferred. What do you have? Cash available. Box C-23, BROADCASTING.

New or used heads for Ampex 450-A or 450-B. Used heads must be in good condition. Box G-94, BROADCASTING.

Tower wanted. Approximately 450 feet, self supporting. Bill Angle, Box 55, Greenville, North Carolina.

BUSINESS OPPORTUNITY

Unlimited funds available for radio and television properties. We specialize in financing for the broadcasting industry. Write full details to Box 205A, BROADCASTING.

Miscellaneous

Capital needed: Reliable, experienced and successful radio station owner wants to borrow \$500,000 to purchase 3rd radio station and is seeking best terms. Excellent bank credit. Good collateral. Box H-39, BROADCASTING.

Philadelphia announcers; tape your spots. Hagerty and Taylor Productions, 2321 West Lehigh, Philadelphia 32, Pennsylvania.

Bingo cards personalized advertising, your message front and back. Many colors, sizes, prices. Controls and calculations for promotions. Television, radio, newspaper, etc. Buy direct—save. Forsyth Manufacturing Company 1930, West 41st Ave., Phone 433-7044, Denver 11, Colorado.

Miscellaneous—(Cont'd)

30,000 Professional Comedy Lines! Topical laugh service featuring deejay comment, introductions. Free catalog. Orben Comedy Books, Atlantic Beach, N. Y.

"Quick Quips" Jokes, one-liners, comedy, ad-libs for deejays. Also "Disc Hits," record info. \$5.50. Del Mar Radio Features, P.O. Box 61, Corona Del Mar, California.

Helicopters for lease yearly, for traffic time newsphoto, promo. Very reasonable. Tax deductible. Box E-33, BROADCASTING.

SCA background music service facilities for lease in Terre Haute, Indiana. Write P. O. Box 433.

Broadcast Comedy is listed in the new "Comedy Guide" of "talk" comedy. Write for free 24 page booklet on your letterhead. Show-Biz Comedy Service (Dept. B), 65 Parkway Court, Brooklyn 35, New York.

INSTRUCTIONS

FCC first phone license preparation by correspondence or in resident classes. Grantham Schools are located in Hollywood, Seattle, Kansas City and Washington. Write for our free 40-page brochure. Grantham School of Electronics, 1505 N. Western Ave., Hollywood 27, California.

Elkins Radio License School of Chicago—Six weeks quality instruction in laboratory methods and theory leading to the F.C.C. First Class License, 14 East Jackson St., Chicago 4, Illinois.

Announcing programming, console operation. Twelve weeks intensive, practical training. Finest, most modern equipment available. G. I. approved. Elkins School of Broadcasting, 2603 Inwood Road, Dallas 35, Texas.

Elkins training now in New Orleans for FCC First Class License in 6 weeks. Nationally known for top quality theory and laboratory instructions. Elkins Radio School, 333 Saint Charles, New Orleans, Louisiana.

Be prepared. First class F.C.C. license in six weeks. Top quality theory and laboratory training. Elkins Radio License School of Atlanta, 1139 Spring St., N.W., Atlanta, Georgia.

FCC first phone license in six weeks. Guaranteed instruction in theory and laboratory methods by master teachers. G. I. approved. Request free brochure. Elkins Radio License School, 2603 Inwood Road, Dallas, Texas.

Jobs waiting for first phone men. Six weeks gets you license in only school with operating 5 kw station. One price includes everything, even room and board. Can be financed. American Academy of Electronics, WLIQ, Sheraton Battle House, Mobile, Alabama.

San Francisco's Chris Borden School teaches you what you want: 1st phone and "modern" sound. Jobs a plenty. Free placement. Illustrated brochure. 259 Geary Street.

Since 1937 Hollywood's oldest school devoted exclusively to Radio and Telecommunications. Graduates on more than 1000 stations. Ratio of jobs to graduates approximately six to one. Day and night classes. Write for 40 page brochure and Graduate placement list. Don Martin School of Radio and Television Arts & Sciences, 1653 North Cherokee, Hollywood, California.

"Do you need a first phone? Train for and get your FCC first class license in just five (5) weeks with R.E.I. in beautiful Sarasota! Affiliated with modern commercial station. Free placement. Write: Radio Engineering Institute of Florida, Commercial Court Building, P. O. Box 1058, Sarasota, Florida."

INSTRUCTIONS—(Cont'd)

Announcing, programing, first phone, all phases electronics. Thorough, intensive practical training. Methods and results proved many times. Free placement service. Allied Technical Schools, 207 Madison, Memphis, Tennessee.

FCC license in six weeks. Total cost \$285. Our graduates get their licenses and they know electronics. Houston Institute of Electronics, 652 M and M Building, Houston, Texas. CA 7-0529.

Train now in N.Y.C. for FCC first phone license. Proven methods, proven results. Day and evening classes. Placement assistance. Announcer Training Studios, 25 W. 43rd, N. Y. OX 5-9245.

Since 1946. Original course for FCC first phone operator license in six weeks. Over 420 hours instruction and over 200 hours guided discussion at school. Reservations required. Enrolling now for classes starting July 10, October 9. For information, references and reservations, write William B. Ogden Radio Operational Engineering School, 1150 West Olive Ave., Burbank, California.

Special accelerated schedule. The Los Angeles Division of Grantham Schools is now offering the proven Grantham first class license course in a special accelerated schedule. Taught by a top notch instructor, this class is "success tested" for the man who must get his first phone in a hurry. The next starting dates for this accelerated class are July 8, and September 9th. For free brochure, write: Dept. 3-B, Grantham School of Electronics, 1505 N. Western Ave., Los Angeles 27, California.

Help Wanted

Announcers

\$14,000 MINIMUM

For
GREAT RADIO PERSONALITY

For
GREAT STATION

In
GREAT MARKET

Tape, photo, and story to:
Box G-232, BROADCASTING

Technical

"Chief Engineer Wanted" for WFMT, Chicago's fine arts duPont-Peabody award FM station. Top experience required in high power, stereo, and audio. Bernard Jacobs, Station Manager, 221 North La Salle Street Chicago 1, Illinois. State 2-5668.

TELEVISION

Help Wanted—Announcers

NEWSCASTER-NEWSMAN

Major eastern market TV station with large & aggressive news operation is seeking an on the air newscaster with solid journalistic background. Minimum guarantee \$10,000 per year with opportunities for more. Send S.O.F. or Video Tape with resume.

Box H-29, BROADCASTING

Sales

SALES MANAGER

For Midwest UHF station in VHF market. No conversion problem for fast growing station. Need hard worker and sales leader.

Box G-218, BROADCASTING

RADIO

Situations Wanted—Announcers

Ambitious first phone announcer with creative ideas. College graduate, twenty four years old, married. Interested in working with a top flight station. Willing to relocate. Excellent credit rating. Presently employed; desires to move up.

Box H-23, BROADCASTING

Employment Service

MOVE UP?

ALL BROADCAST PERSONNEL PLACED
MOST MAJOR U. S. MARKETS
MINOR-MARKET MIDWEST SATURATION
WRITE FOR APPLICATION NOW
BROADCAST
EMPLOYMENT SERVICE
4825 10th Ave. So. Minneapolis 17, Minn.

For Sale

Equipment

- 1 890 ft. Blaw Knox Tower
- 70 lb. sq. ft. windload-guyed.
- 1 12 Bay Super Turnstile
- Channel 10 Antenna
- 1 TT 50 AH Transmitter
- Channel 10
- 1 TS 21 Switcher
- 12 input -6 output.
- 2 TG 2A Sync. generators.

• Also other equipment available-list upon request. Public Service Television Corp., P. O. Box NAL, Airport Mail Facility, Miami 59, Florida, Telephone Newton 3-6311, Extension 345.

RCA Type OR-1 Portable Disc Recorder and Playback with 72-DX Recording attachment (78 & 33 RPM).....\$400
Ampex Model 400 7 1/2/15 IPS tape recorder with portable case.....250
Berlant Concertine BRX-30 Rackmount recorder, 7 1/2/15 IPS.....200
General radio type 733-A, 400 cycle Oscillator.....25
General radio type 731 -A AM Modulation monitor.....25
RCA Type SK-50 Variable microphone (30-150-250).....40
National SW-54 receiver, used with home built Conelrad Alarm unit. (AVC operated).....25
Rack Mounted ON-AIR monitor (home built).....15
2 GeeCo ON-AIR Lights @ \$10.00.....20
Police Alarm FM monitor.....5
Gordon "BUD" Pentz, KWBE, Beatrice, Nebraska. Phone CO 3-2388.

For Sale—(Cont'd)

Equipment

We are cleaning house.
Schafer 1200 GMA Automation System (\$18,300 new) used, reconditioned \$12,800
Schafer 400-RA Remote Control System (\$1,795 new) used, reconditioned 1,295
Schafer Automation System, Model 60, used, as is, Good Condition 3,500
GE Unifvel, used, as is 75
GE Unifvel, new 150
Gates Extension Meter Panel for MO2890 Freq. Monitor, as is 75
Rust 10 function Remote Control System, as is 500
Collins Limiter 26U1, like new 300
Miratel Air Alert Conelrad Receiver, as is 25
Ampex PR-10 Recorder with 4 channel mixer, as is 400
Ampex 354 Stereo Recorder, used 1,250
Hewlett Packard 200B audio oscillator, used 100
Seeburg 200 LU, used, as is 400
ATC PB-1-190 Cartridge Recorders, used 400
ATC Record Amplifiers, new 300
Eico 160K Kit Tape Deck, new 50
FIRST COME, FIRST SERVED . . .
Send check with order. Schafer Electronics, 235 S. Third Street, Burbank, California. Telephone: Area Code 213, 845-3561.

Miscellaneous

A Great Radio Salesman

Now you can have your own newsletter, telling the importance of radio to prime accounts, potential and opinion-makers in YOUR CITY. A great local promotion, designed for timely monthly mailing. Personalized with your station imprint. A prestige promotional publication. Low \$49.50—it can be your most effective salesman. Write, wire today for samples and prices.

RADIO REPORTS NEWSLETTER

1186 Arlington Ln. (ALdine 2-9191)
San Jose 29, California

Colorful Combination

RADIO MARKET SHEETS and COVERAGE MAPS

Address Radio Dept. on your letterhead for FREE information and samples.

EVEREADY ADVERTISING

1817 Broadway • Nashville 4, Tenn.

BUSINESS OPPORTUNITY

UNIQUE OPPORTUNITY

For the first time in the history of the broadcasting industry, a franchise offer is being made in one of the most basic and vital facets of the business—never before opened to outsiders. The franchiser is one of the best known companies in our field: the name will be instantly recognizable to you. Qualified franchisees will have an immediate assured income following a modest investment, and the cherished opportunity to be in business for themselves. Applicants must be responsible members of their communities, and broadcast professionals, heavy in sales background. Only 20 men in the nation will qualify—one each in the following major markets: Boston, Minneapolis, Dallas, Memphis, San Francisco, Seattle, Pittsburgh, Atlanta, St. Louis, Denver, Houston, Richmond, Kansas City. Reply today: this is the opportunity of a lifetime.
Box H-81, BROADCASTING

WANTED TO BUY

Stations

Wanted Radio Station In Arizona-New Mexico-Colorado

Marketing & Advertising Consultant experienced in radio station operation and management wants to buy, or buy into single market operation with future. Principals only contact.

Box H-47, BROADCASTING

WANTED

Station in N. E.; prefer long pay-out or 10-20,000 down plus pay-out. Seek challenging situation with small loss or small profit.

Robert Price
500 Fifth Avenue
New York 36, New York

For Sale

Stations

CONFIDENTIAL NEGOTIATIONS

For Buying and Selling
RADIO and TV STATIONS
in the eastern states and Florida
W. B. GRIMES & CO.

2000 Florida Avenue, N.W.
Washington 9, D. C.
DECATUR 2-2311

Florida-North

Daytime-history earning-priced realistically.

Associated Media Brokers
Suite 328 Bayview Building
Fort Lauderdale, Florida
Phone LOgan 6-7843

Bob Flynn Myles Johns

THE PIONEER FIRM OF TELEVISION AND RADIO MANAGEMENT CONSULTANTS ESTABLISHED 1946

Negotiations Management
Appraisals Financing
HOWARD S. FRAZIER, INC.
1736 Wisconsin Ave., N.W.
Washington 7, D. C.

Florida-South

Absentee owned—station has great potential for owner operator—liberal terms.

Associated Media Brokers
Suite 328 Bayview Building
Fort Lauderdale, Florida
Phone LOgan 6-7843

Bob Flynn Myles Johns

FOR SALE

500 W Daytimer in Southeast coast town. \$50,000 with 29% down. Balance at 6% over 5 years.

Box G-370, BROADCASTING

For Sale—(Cont'd)

Stations

Florida-Central

Daytime-non-directional-\$15,000 down to qualified buyer—excellent terms.

Associated Media Brokers
Suite 328 Bayview Building
Fort Lauderdale, Florida
Phone LOgan 6-7843

Bob Flynn Myles Johns

Ky.	single	daytimer	\$68M	terms
S. E.	small	fulltime	22M	cash
S. E.	small	power	90M	cash
N. C.	metro	daytimer	125M	50%
Fla.	metro	daytimer	260M	29%
S. E.	major	daytimer	238M	65M
S. E.	profitable	UHF-TV	2MM	cash
And others				

CHAPMAN COMPANY
2045 Peachtree Rd. N.E., Atlanta 9, Ga.

To buy or sell Radio and/or TV properties contact.

PATT McDONALD CO.
P. O. BOX 9266 - GL 3-8080
AUSTIN 17, TEXAS

STATIONS FOR SALE

EASTERN REGIONAL Daytime. Priced at \$85,000. \$30,000 down.

CALIFORNIA. Exclusive. Daytime. Priced at \$30,000. Terms possible, if you qualify.

JACK L. STOLL & ASSOCS.
Suite 600-601 6381 Hollyw'd Blvd.
Los Angeles 28, Calif. HO 4-7279

Florida-Major Market

Fulltime—Florida's fastest growing area—profitable—priced realistically—good terms to qualified buyer.

Associated Media Brokers
Suite 328 Bayview Building
Fort Lauderdale, Florida
Phone LOgan 6-7843

Bob Flynn Myles Johns

SOMETHING TO BUY OR SELL?

**For Best Results
You Can't Top A
CLASSIFIED AD**

in

BROADCASTING
THE BUSINESSWEEKLY OF TELEVISION AND RADIO

Continued from page 91

record in proceeding on its application and that of Valparaiso Broadcasting Co. for new AM stations in Valparaiso, Ind. Action May 20.

BROADCAST ACTIONS by Broadcast Bureau Actions of May 27

WNBT Wellsboro, Pa.—Granted license covering installation of old main trans. as aux. trans.

KHEP Phoenix, Ariz.—Granted CP to make changes in ant. system (increase height).

Tillamook TV Translators Inc., Tillamook, Ore.—Granted CPs to replace expired permits for new UHF translator signal booster station no. 1 for K7IAL, K76AM, and K79AE.

KJWH Camden, Ark.—Granted mod. of CP to move ant.-trans. site and change type trans.

WVLN Olney, Ill.—Granted request and cancelled CP to increase power, install new trans. and make changes in DA system.

KRGN(FM) Las Vegas—Granted SCA on sub-carrier frequency 67 kc.

KVEN-FM Ventura, Calif.—Granted mod. of SCA to change from 67 and 29 kc to 41 and 67 kc and make changes in equipment.

Actions of May 24

WSIX-FM Nashville—Granted CP to install new ant.; increase ant. height to 1,110 feet; ERP to 100 kw; and make changes in ant.-system.

WCIU(TV) Chicago—Granted mod. of CP to change ERP to vis. 185 kw; aur. to 100 kw; ant. height to 650 feet; change trans. and studio locations; type trans. and ant., and make changes in ant. structure and equipment.

Following were granted extensions of completion dates as shown: WGAL-TV (aux. trans.) Lancaster, Pa., to June 15; *WVAN-TV Savannah, Ga., to Oct. 1, and *KNME-TV Albuquerque, N. M., to Nov. 28.

Actions of May 23

KIDD Monterey, Calif.—Granted mod. of license to change studio location and operate trans. by remote control; conditions.

WMFD Wilmington, N. C.—Granted mod. of license to operate trans. by remote control; conditions.

KFGT Flagstaff, Ariz.—Granted authority to remain silent for period ending June 30.

KBPS Portland, Ore.—Granted authority to remain silent for period beginning June 1 and ending Sept. 22.

Actions of May 22

*KVCR(FM) San Bernardino, Calif.—Granted CP to increase ERP to 810 w; change ant.-trans. location (coordinates only—no change in description); make changes in ant. system (FM ant. to be mounted on KVCR-TV tower); ant. height 300 feet.

KSEA(FM) San Diego—Granted mod. of CP to increase ERP to 25 kw (horizontal), 10 kw (vertical); ant. height to 220 feet; change main studio, remote control and ant.-trans. site; change type trans. and ant.; and ant.-system.

WGRV-FM Greeneville, Tenn.—Granted mod. of CP to increase ERP to 4.6 kw; decrease ant. height to 225 feet; and make changes in ant.-system.

WWOL-FM Buffalo—Granted extension of completion date to Nov. 24.

Action of May 17

Norton Chamber of Commerce, Norton, Kan.—Granted CP for new VHF TV translator station on channel 4 to translate programs of KAYS-TV (ch. 7) Hays, Kan.

Action of May 16

Laughlin Peak TV Assn., Willits, Calif.—Granted CP for new VHF TV translator on channel 9 to translate programs of KRON-TV (ch. 4) San Francisco.

Rulemakings

TERMINATED

WWLP(TV) Springfield, Mass.—Petition to amend table of allocations by deleting channel 38 from Connersville, Ind., and reassigning same channel to Dayton, Ohio.

PETITION FOR RULEMAKING FILED

Symphony Network Association Inc.—Requests institution of rulemaking proceeding so as to assign channel 72 to Birmingham, Ala. Received May 22.

What can one company do to improve audience measurement?



INTENSIFY METHODS RESEARCH!

A good research service doesn't just happen. It takes months — sometimes years — of development and continuing refinement and improvement. It takes meetings and component testing and more meetings and more testing to reach out for solutions to some of the problems of audience research. We may never solve them all to perfection.

Now, at ARB, this activity is being intensified, particularly in our search for possible biases and sources of error both in sample selection and in recording within the sample homes. This pursuit strikes at what is currently the most important area for improvement in audience research.

This operating philosophy of research and development has always been a part of ARB. It had a great deal to do with our decision to double samples. It accounted for the recent completion of a comprehensive study, The Influence of Non-Cooperation in the Diary Method of Television Audience Measurement, soon to be published in book form.

There have been other advancements which you have seen reflected in the service offered by ARB over the years. There will be more.

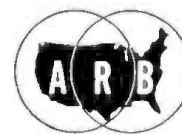

**AMERICAN
RESEARCH
BUREAU**

DIVISION OF C-E-I-R INC.

BROADCASTING, June 3, 1963

OUR RESPECTS to Basil Francis Grillo

He moved from accountant to top TV producer

The jumping frogs of Calaveras county, whose prowess was immortalized by Mark Twain and is annually tested in the competitions at Angel Camp, Calif., may have provided the inspiration that turned an Angels Camp boy, Basil Francis Grillo, from an accountant into one of television's top producers with the title of president of Bing Crosby Productions. But if there is any astonishment at this mammoth leap, it is not shared by Mr. Grillo.

"Look closely at the producers in Hollywood television," he said last week. "You'll find very few who started out as producers. Very few actors become producers, very few writers. Most creative people are not businessmen and if you don't have a good business operation you're not going to have a very long life in television production.

Please Yourself ■ "For 20 years I've been responsible for saying 'We'll do it' or 'We won't' and I'd better have some taste and judgment or I'd be in a lot of trouble. I'm not a creative man, but I know what I like and that's the only sound basis for making any decision. You can't do more than guess about what someone else will like and if your taste is a reasonable representation of the general public's you'll be OK. If not, you'd better get out of TV production fast, because if you don't you'll damn soon be forced out."

The success of BCP's *Ben Casey* leaves little doubt about Basil Grillo's ability to please the public taste as well as his own. And Mr. Grillo has high hopes for *Breaking Point*, a series of psychological dramas to start this fall on ABC-TV, the same network that broadcasts *Ben Casey*.

Program production today takes up about 90% of Basil Grillo's time, but in the nearly 20 years he has been associated with Bing Crosby, he has gotten him in and out of scores of ventures including real estate, savings and loan associations and broadcast properties, as well as records, radio and TV programs and tape recording.

The Crosby association with tape recording goes back to the World War II years, when Bing's records were dubbed into broadcasts for Armed Forces Radio. The singer was fascinated by the idea of recording his radio programs at the time most convenient to him and to get away from having to show up at the broadcasting studio every week at the same time to do his programs live. In 1946, ABC agreed to let him try it.

Discs to Tape ■ "We started out recording the shows on acetate discs," Mr. Grillo related, "but after a transfer or two we began running into too great a

loss in quality. We tried all kinds of recording speeds. We tried recording on wire. Then Jack Mullin, our recording engineer, came in with some German tape and a recorder he had brought back after the war. The result was so good we began using tape for our shows in the fall of 1947.

"But after a couple of months of continuous use the recorder began to show signs of wear, so Mullin asked some of his classmates from Stanford, who were working at Ampex, whether they could build new tape recorders for us."

They could and did. The machines worked splendidly and Bing Crosby Enterprises became the sales agent for Ampex until 1955. BCE was also active in video tape development but after Ampex had become the first to develop a practical unit for broadcast use, BCE sold its tape operations to Minnesota Mining & Manufacturing.

Basil Grillo left his native Angels Camp (Oct. 8, 1910, was his birthday) at an early age; grew up in San Francisco and was graduated from the University of California at Berkeley, where he was a top miler, in the mid-depression year, 1932. For the next 10 years he had a variety of jobs—salesman, credit manager, tax auditor, CPA. He was associated with the accounting firm, Andrew Anderson & Co., in 1944, when on the recommendation of Mr. Crosby's tax attorneys, he was hired to organize Bing Crosby Enterprises.

Bing's Big Business ■ "Up to that

time Bing had been a performer, receiving a salary for his radio and motion picture work, a royalty from his records. Now, BCE began packaging his radio shows and movies. We set up a record company, co-owned with Decca. We got into tape. And as a result of a golf game Bing had with Jock Whitney, we got into frozen orange juice. Mr. Whitney was telling Bing about Minute Maid orange juice, a product of Vacuum Foods, a Whitney company. Bing said he'd like in, so he did the company's 15-minute radio shows and got the West Coast franchise, which we operated for several years until they bought it back."

In the early 1950's Bing Crosby Enterprises went into the TV film business, producing *Fireside Theatre*, TV's first half-hour anthology series, for Procter & Gamble. "We made 52 shows for them and had the next-to-top rating, right behind Milton Berle. Now, a dozen years later, P&G is one of *Ben Casey's* sponsors and will be in on *Breaking Point*."

BCE decided early to get into TV station ownership as well as program production. "We filed for Yakima, Tacoma, Spokane, Seattle; then the freeze came. When it was over, Ed Craney, radio station operator who had also filed for TV in Spokane, suggested we go in together instead of competing for the grant. After 45 minutes I agreed. He went back home; I drew up the agreement and sent it to him; he signed it and sent it back. It was the greatest relationship I've ever had. No argument, no fuss. We wanted to do business together and we did. We got one of the first post-freeze grants and built the station (KXLY-TV). Later on we sold it."

Bing Crosby was also part of a group which purchased KCOP(TV) Los Angeles, subsequently transferring the station to NAFI Corp. (now Chris Craft Industries) on a stock deal. He was co-owner of KMBY Monterey, Calif., with John Cohan who bought out his interest and subsequently defeated the Crosby bid for a CATV license there.

A man of many interests, Basil Grillo has learned French, Spanish and Italian ("I can read them but I'll never be a linguist") and studied history and other subjects in evening classes, perhaps to keep from getting bogged down in business worries. He keeps slim and trim with golf, hunting and fishing.

He and his wife, the former Jane Nunn, live in Encino in the San Fernando Valley. They have three sons: Gary, 27, an assistant director; Basil, 23, broker, and Michael, 15.



Basil Grillo
Knows what he likes

Facts of life—or death

THE most pressing problem now confronting radio and television broadcasters is that of deciding how to resist the FCC's proposal to adopt, as part of its own regulations, the advertising time restrictions of the National Association of Broadcasters' radio and television codes. To judge by the statement issued last week by the NAB's radio code board, the problem may be bigger than the broadcasters can handle.

The radio code board came out in opposition to the FCC's plan, but with arguments that would lose a debate in any responsible forum.

The radio code is a model of self-regulation, said the board. In the past year its subscriber list increased 19%, never mind the disagreeable fact that less than 4 out of 10 existing stations are subscribers or that at the present break-neck rate of growth it would take 10 years to enfold in the code the more than 3,000 stations that are still outside it.

Critics are unkind in saying that the code has failed to prevent over-commercialism. The truth is that nobody can define over-commercialism, said the radio code board, and the time allocated to commercials may be an unimportant factor in audience response.

What the radio code board was evidently trying to do was to eulogize the code as a living document of unquestionable merit—and at the same time to begin disentangling itself from the only troublesome section of the code, its commercial standards. Onlookers are not apt to be impressed. The cry, "I love you; be mine," lacks a ring of sincerity when uttered by a husband to the wife he is escorting to divorce court.

In a sense, however, the statement of the radio code board may serve a useful purpose. It betrays the futility of trying to glorify a system that has never worked and cannot be made to. It does so in time for the television code board, which meets June 10 in New York, and the main boards of the NAB, which meet later this month in Washington, to recognize its weaknesses.

The only defense that the broadcasters can hope successfully to use is that of facing up to facts, however embarrassing they may be to certain broadcast leaders who have been personally identified with the writing and enforcement of the codes. The facts are that a majority of radio stations and a good many television stations have found it impossible to abide by the commercial standards of the codes—and would find it no more possible to survive if the same standards were imposed by the government.

If the FCC adopted those standards, it would force some stations out of business and turn others into loss operations. We cannot imagine that any FCC, no matter how tough-minded its majority, wants to start signing station death warrants in bushel lots.

Exit Mr. Minow

AN era ended today. It was a short era that lasted 27 months, but it left an impression that will be deeply etched in the history of broadcasting.

Today the FCC is presided over by E. William Henry who at 34 is the youngest head of an important agency in a government that largely is populated by young men. The gavel was handed him by Newton N. Minow who at 37 is one of the youngest men ever to retire from high government office.

Mr. Minow made an important office more important. In his 27 months he was certainly the most controversial and colorful chairman the FCC has ever had. Whether he left

the FCC better than he found it depends upon where one happens to sit. He was the darling of the bureaucrats, the educators and many politicians. He was anathema to the majority of broadcasters, even though some privately may have given him lip service in commending his campaign of goading and needling.

Mr. Minow's campaign succeeded in its obvious mission of frightening broadcasters. His legacy includes the imposition of fines and forfeitures, suspensions and short-term licenses, filing fees and poison pen letters to licensees at renewal time.

Instead of encouraging stability, the crusade has brought unrest. If these conditions had existed after World War II, we venture there would have been few companies willing to risk investments of millions for speculative television services.

In radio's early days there were complaints about the sameness and dullness of programs and about overcommercialism. That was while Chairman Henry and Mr. Minow were somewhere between diapers and their first pair of long pants. That also was before radio became a serious competitor of newspapers and magazines. It wasn't big enough to be shot at. Politicians didn't understand this complicated gadget.

Conditions changed. Everybody became an expert. Broadcasting attracted outside investors and was labeled big business. A presidential election was won by the Great Debates. Broadcasting suddenly had become too important to be left to the interplay of free enterprise.

It was in that climate that 35-year-old Newton Minow assumed the chairmanship on March 2, 1961. It must be assumed he has carried out the mandates of the administration. Mr. Henry promises that his stewardship will be just as tough. Those around him—particularly the staff-level executives—say he will be tougher.

We wish Mr. Minow success in his new work as a corporate officer and chief counsel for William Benton's prospering Encyclopaedia Britannica enterprises. At EB he will be working with President Maurice Mitchell, famed for "Mitch's Pitch" in the pre-television era of radio broadcasting and one of the best salesmen the air media have produced.

Back at the FCC it seems the script calls for more shooting. If the aim is to improve broadcasting's end product, the proper course would be to encourage stability in broadcasting ranks. Longer licenses would be one simple way of going about it.



Drawn for BROADCASTING by Sid Hix
"It's called the television concept. . . . In summer we rerun the stuff we published last winter!"

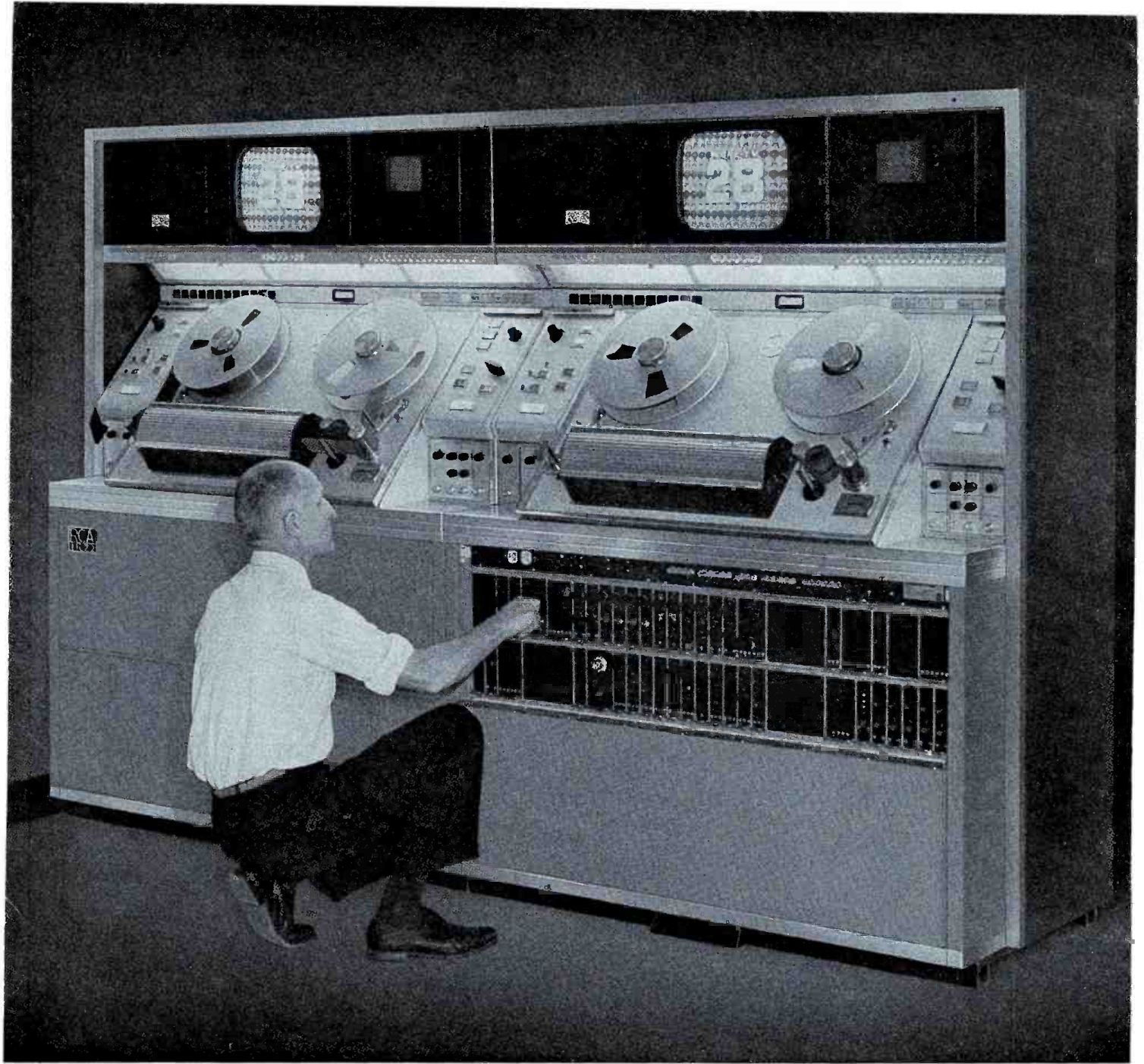

TAPE DUO DELUXE AT WBRE

"A Prestige Builder with Our Customers"

This is the look of leadership for the years ahead—new excellence of design and brilliant performance. With two TR-22 Deluxe TV Tape Recorders, this station can record on one unit while on air with the other. The two units occupy the space of a previous single tape unit.

Fully transistorized design does away with the problems of power and heat, reduces maintenance, and

assures a new standard of excellence. Clients are impressed with the efficient "look," the quality of performance, the increased versatility. It's a prestige builder with customers. Your own studio can benefit from this symbol of the finest in TV Tape.

See your RCA Representative. Or write RCA Broadcast and TV Equipment, Building 15-5, Camden, N.J.



The Most Trusted Name in Television

Sheer delight to have on

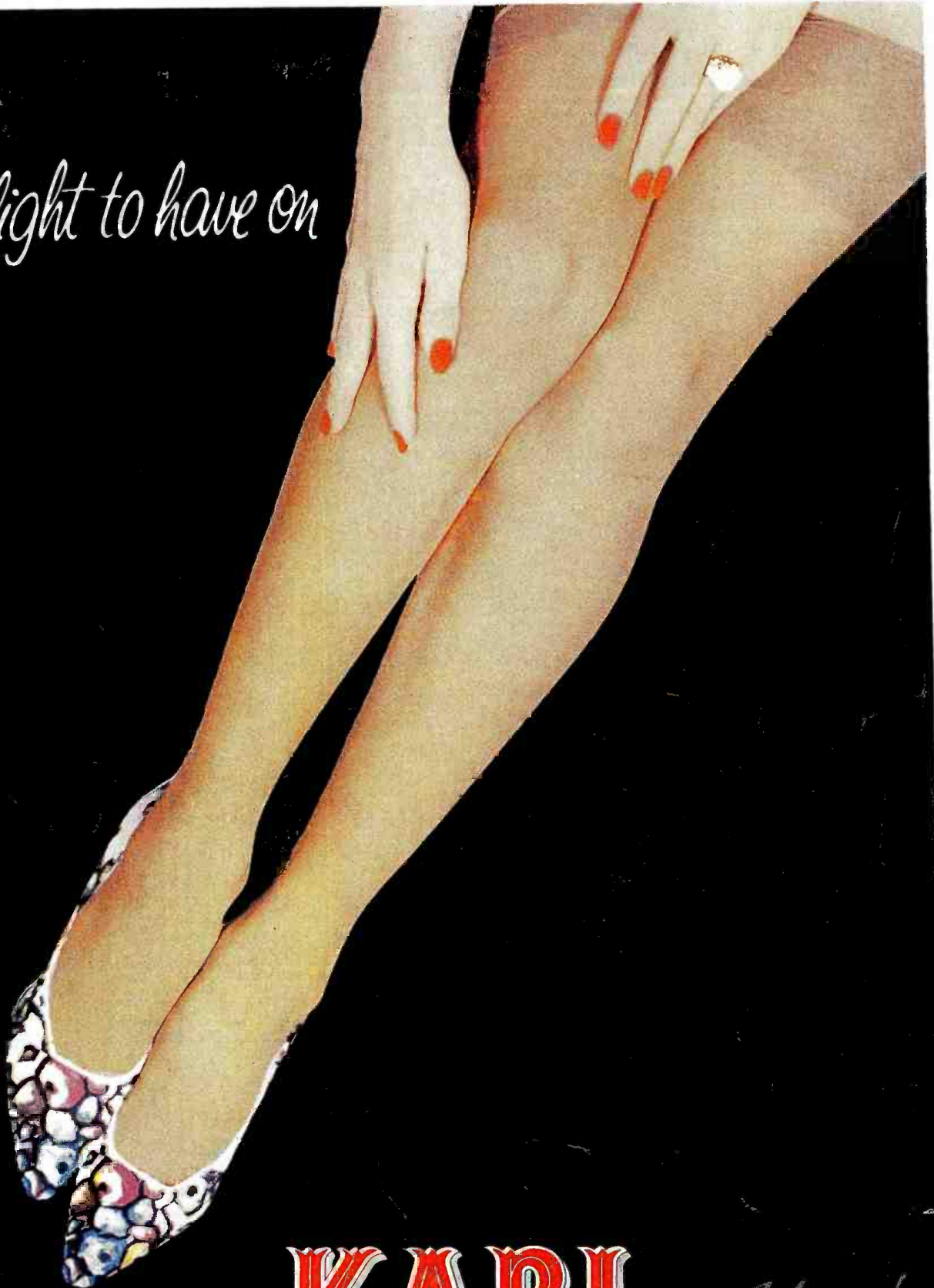

KABL

Music

THE *McLendon* STATION FOR SAN FRANCISCO