

ELECTRONIC

design

ELECTRONIC
design



Specifically designed to meet military electronic requirements, these hermetically sealed thermostats have a very high leakage resistance between contact circuit and shell. Their response rate, about the same as that of a laboratory thermometer, is not slowed down by hermetic sealing. The internal construction of the unit is shown in the sketch above.

July 1954

FREED Instruments & Transformers

Famous For

QUALITY • DEPENDABILITY • ACCURACY



No. 1030
Low Frequency
"Q" Indicator



No. 1020B
Megohmmeter



Decade
Inductors



No. 1040
Vacuum Tube Voltmeter



No. 1210
Null Detector &
Vacuum Tube Voltmeter



No. 1010
Comparison Bridge



No. 1110A
Incremental Inductance
Bridge

FREED MILITARY PULSE TRANSFORMERS IN STOCK FOR IMMEDIATE DELIVERY

HERMETICALLY SEALED PULSE TRANSFORMERS for use in blocking oscillators, low level interstage coupling, and modulator outputs. Made in accordance with MIL-T-27 specifications. These pulse transformers are designed for maximum power, efficiency and optimum pulse performance. Balanced coil structures permit series or parallel connection of windings for turn ratios other than unity. Pulse characteristics, voltages and impedance levels will depend upon interconnections made.



DM-12



DM-18



DM-8



DM-01

CATALOG NUMBER	APPLICATION	PULSE VOLTAGE KILOVOLTS	PULSE DURATION MICRO-SECONDS	DUTY RATIO	TEST VOLTAGE KV., RMS	CHARACTERISTIC IMPEDANCE OHMS	CASE SIZE
MPT-1	Blocking oscillator or interstage coupling	0.25/0.25/0.25	0.2-1.0	.004	0.7	250	DM-12
MPT-2	Blocking oscillator or interstage coupling	0.25/0.25	0.2-1.0	.004	0.7	250	DM-12
MPT-3	Blocking oscillator or interstage coupling	0.5/0.5/0.5	0.2-1.5	.002	1.0	250	DM-18
MPT-4	Blocking oscillator or interstage coupling	0.5/0.5	0.2-1.5	.002	1.0	250	DM-18
MPT-5	Blocking oscillator or interstage coupling	0.5/0.5/0.5	0.5-2.0	.002	1.0	500	DM-12
MPT-6	Blocking oscillator or interstage coupling	0.5/0.5/0.5	0.5-2.0	.002	1.0	500	DM-12
MPT-7	Blocking oscillator, interstage coupling or low power output	0.7/0.7/0.7	0.5-1.5	.002	1.5	200	DM-18
MPT-8	Blocking oscillator, interstage coupling or low power output	0.7/0.7	0.5-1.5	.002	1.5	200	DM-18
MPT-9	Blocking oscillator, interstage coupling or low power output	1.0/1.0/1.0	0.7-3.5	.002	2.0	200	DM-18
MPT-10	Blocking oscillator, interstage coupling or low power output	1.0/1.0	0.7-3.5	.002	2.0	200	DM-18
MPT-11	Blocking oscillator, interstage coupling or low power output	1.0/1.0/1.0	1.0-5.0	.002	2.0	500	DM-01
MPT-12	Blocking oscillator, interstage coupling or low power output	0.15/0.15 0.3/0.3	0.2-1.0	.004	0.7	700	DM-8

SEND FOR COMPLETE CATALOG OF
FREED INSTRUMENTS AND TRANSFORMERS

Staff

Edward E. Grazda	Ed tor
M. Mandell	Associate Ed tor
M. J. Friday	Assistant Ed tor
R. Graham	Assistant Ed tor
P. L. Canfield	Editorial Assistant
N. Asto	Production Manager
E. Dadinis	Assistant Production Manager
H. W. Schlager	Business Manager
J. B. Gilchrist	Circulation Manager

Co-Publishers

T. Richard Gascoigne
James S. Mulholland, Jr.

Advertising Representatives

New York: T. Richard Gascoigne,
James S. Mulholland, Jr.,
Blair McClenachan
127 East 55th St.,
New York 22, N. Y.
PLaza 3-8677

Chicago: Thomas P. Kavooras
664 No. Michigan Ave.
Chicago 11, Ill.
SUperior 7-8054

Los Angeles: Robert E. Ahrens Dorf
1140 Wilshire Blvd.
Los Angeles 17, Calif.
MADison 9-2681

Circulation Policy

ELECTRONIC DESIGN is circulated only to qualified electronic design engineers of U. S. manufacturing companies, industrial consultants, and government agencies.

If design for manufacturing is your responsibility, you qualify for a subscription without charge provided you send us the following information on your company letterhead: your name and title; your company's name, address, and main product. Electronic, research, development, project, electrical, and chief engineers are typical qualifying titles.

If you have a design responsibility not indicated by your title, add a description of those responsibilities.

Any job change requires requalification.

Hayden Publishing Company, Inc.
127 East 55th Street
New York 22, New York

Back issues of **ELECTRONIC DESIGN**, when available, may be obtained at a charge of \$1.00 per copy.

◀ CIRCLE ED-1 ON READER-SERVICE CARD

FREED TRANSFORMER CO., INC.

1727 WEIRFIELD ST. (RIDGWOOD) BROOKLYN 27, N.Y.

JUL 22 1954

ELECTRONIC

design

Vol. 2
No. 7
July 1954

Contents

Cover	(see page 16)
Editorial	4
Engineering Review	5
Features	
Choosing Wire Insulation, by John Holland	14
Hermetically Sealed Thermostats	16
Transistor Data Chart	20
Plug-In Transistor Circuits	22
High-Output Crystal Photocell	24
Voltage Sensitive Capacitors	26
Single-Gun Color TV Picture Tube	28
Laboratory Phase Comparator, by S. Feinstein	30
Accurate Voltmeter	32
Design Forum	
Multi-Channel Amplifier Test System	18
Departments	
New Products	34
New Literature	64
Patents	72
Books	76
Advertisers' Index	78



ELECTRONIC DESIGN is published monthly by Hayden Publishing Company, Inc. at 127 E. 55th Street, New York 22, N. Y., T. Richard Gascoigne, President; James S. Mulholland, Jr., Vice-President & Treasurer; and Ralph E. Marson, Secretary. Printed at Publishers Printing Company, New York, N. Y., ELECTRONIC DESIGN is circulated monthly without charge to men in the electronic industries who are responsible for the design and specification of manufactured devices, including development and design men of consulting laboratories and government agencies. Acceptance under section 34.64 P. L. & R. authorized. Copyright 1954 Hayden Publishing Company, Inc. 24,000 copies this issue.



we like people... but...

... we know that "to err is human". In this dynamic day of automation, there is no room for error. Potter instruments provide low-cost, high-speed, exact process control without the human "error factor". And everybody benefits.

There is a Potter instrument for controlling your industrial process. Our engineers will show you how to apply counting techniques to automatize any multiple-sequence machine operation involving control of such phenomena as weight, length, time, quantity, and rpm.

THE DUAL PREDETERMINED ELECTRONIC COUNTER (Model 244) illustrated here recycles automatically and instantaneously. Rugged electrical and mechanical design assure unattended operation over long periods of time with minimum maintenance.



Write today for further information. See how you can save time and money and improve production at the same time.

POTTER INSTRUMENT CO., INC., 115 Cutter Mill Road, Great Neck, N.Y.



CIRCLE ED-2 ON READER-SERVICE CARD FOR MORE INFORMATION

ADD THE KNOW-HOW AND EXPERIENCE OF DAVEN'S
RESEARCH DESIGNERS AND ENGINEERS TO YOUR STAFF... **FREE!**

Write today for your copy of the
Most Complete Catalog Ever Offered on

PRECISION wire wound RESISTORS

Thousands of engineers have already received their FREE copy of this important 32-page catalog, packed with latest data on all types of Daven Precision Wire Wound Resistors. It's the most complete catalog ever presented on Resistors... an accumulation of 25 years of extensive designing and manufacturing experience in the resistor field, catering to the precise, varied demands of the electronics industry.

The catalog is divided into sections starting with broad general data on all Daven types and continuing into complete detailed specifications of each resistor category. It contains much previously unpublished basic design information and includes new charts and data on Sealed-Ohm Resistors, Hermetically Sealed Units, Encapsulated and Sub-Miniature Resistors. MIL, JAN and other government ratings and types are listed and cross referenced.



Write today for your FREE copy of this 32-page presentation on Super-Davohm Wire Wound Resistors.

THE **DAVEN** CO.

169 Central Avenue, Newark 4, N. J.

WORLD'S LARGEST MANUFACTURER OF ATTENUATORS

Editorial . . .

The Time Is Ripe

The Transistor Data Chart on pages 20 and 21 shows that great progress is being made in making transistors commercially available. In the July 1953 issue, we ran a similar table which listed only 36 types made by nine manufacturers. The present table includes 132 types made by 17 manufacturers, which is quite an increase for one year.

Besides having more types with higher power and temperature ratings to work with, the electronic designer now faces a brighter transistor picture in other respects.

For one thing, transistors are much more reliable than they were a year ago. Raytheon Manufacturing Co. reports that the rate of field returns versus the rate of shipments for hearing aid transistors has been about 1% since last November. This figure is especially significant when it is realized that they have about $\frac{3}{4}$ million junction transistors in hearing aid service. Radio Receptor Co., Inc., reports that in a computer application, 450 of their junction transistors have run for 2300 hours with no failures, and 128 units ran for 4650 hours with only one failure. This is only one failure in over one million transistor-hours of operation.

The lower cost of transistors is another pleasing note. In quantity lots, the average price of most junction transistors is about \$5.00, and many types can be bought for less. We have even seen point-contact transistors advertised for as low as 90¢ in production quantities.

With availability, reliability, and cost factors becoming so favorable, the time is ripe to begin applying transistors to commercial equipment. So far, less than a dozen commercial applications of transistors have been announced. The field is wide open for fresh, bold design thinking.

◀ CIRCLE ED-3 ON READER-SERVICE CARD

ELECTRONIC DESIGN • July 1954

Engineering Review...

"Stacked" Element Tube . . . An extremely rugged vacuum tube that is readily adaptable to automatic production has been developed by Sylvania Electric Products, Inc. Known as the "stacked tube", it also offers considerable size reduction, higher operating temperatures, and great stability under wide temperature fluctuations as compared to conventional miniature tubes.

In assembling the tube, the elements are stacked on two small pins. Ceramic spacers, which also insulate the elements from the structural pins, separate the elements. When the stack is completed, the small pins are electrically riveted. Ruggedness is gained by using these ceramic spacers instead of conventional mica separators, which have a tendency to spall and flake under vibration and shock.

The spacers are the critical factors in determining element spacing and, therefore, tube characteristics. This means that production machinery can be easily adapted to making other tube types by substituting spacers of different thicknesses. Multi-grid or multi-purpose tubes can be made just as easily as triodes by adding a grid or another cathode, grid and plate, respectively, plus spacers of the proper thicknesses.

The envelope is made of ceramic material to withstand severe environmental conditions, but the "stack" also fits into a standard, miniature glass envelope.

The ceramic material used for the envelope and base is aluminum oxide. Sealing the envelope and base together is a single-step process. Since no mica is used in the mount, the tube can be sealed under temperatures of about 950°C , substantially higher than mica can withstand. In addition to sealing the tube, this process provides a high "baking out" temperature which sealing glasses could not withstand. The finished tubes have less gas to begin with, and, therefore, have a longer gas-free life.

The rugged ceramic envelope can stand wide temperature changes. For example, tubes of this type have been placed in liquid nitrogen at -195°C and then immersed in boiling water at $+100^{\circ}\text{C}$ without fracture. Tubes have also been thermally cycled from room temperature up to 450°C repeatedly without damage. The tubes can also operate at much higher plate temperatures than conventional miniature tubes.

The tube can be strapped directly to the equipment chassis, or it can be socketed. Lead wires can also be soldered directly to the pins.

The tube was developed by the Sylvania Research Laboratories under a development contract with the U.S. Navy's Bureau of Ships. Limited quantities are now being made at the company's Product Development Laboratories, Kew Gardens, L. I., N. Y. The stacked tube was devised to meet military needs for rapid manufacturing of large numbers of reliable tubes. In addition, it does not use mica, which is only available in the high-quality grades required for tubes from foreign sources.

In the exploded view of the stacked tube, the parts shown from left to right are: the ceramic base, the structural pins, a plate plus ceramic spacers, a grid plus spacers, the cathode plus supports (the filament is below the cathode), another grid, and a second plate. The assembled stack is shown in the middle of the photograph between a ceramic envelope and a completed tube.

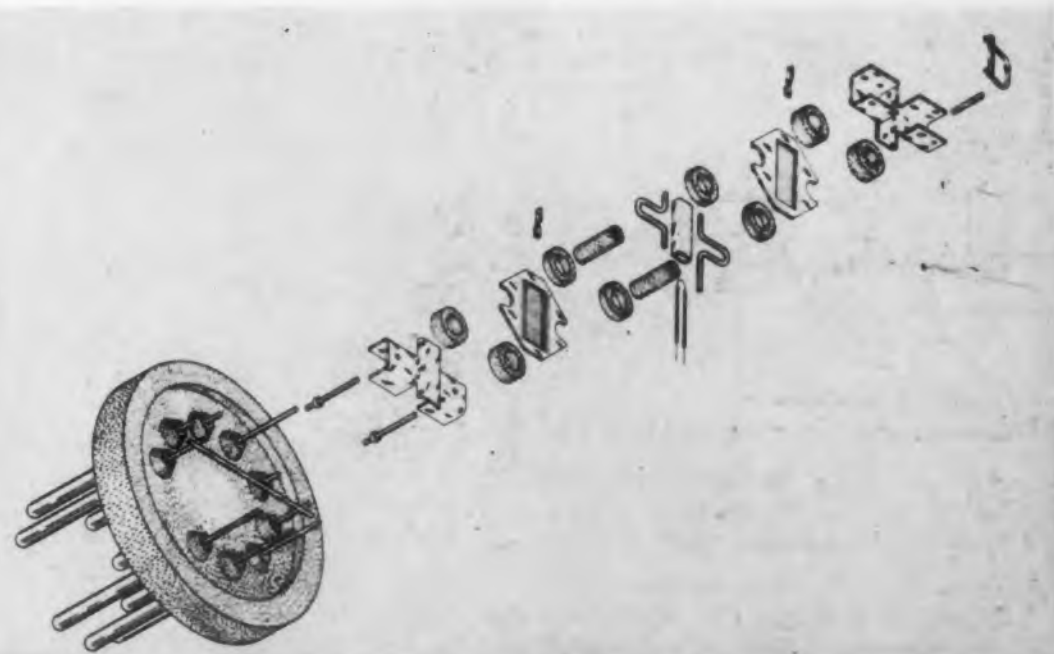

Humidity Determiner . . . A new device determines relative humidity by measuring the resistance of a carbon film. It is based on a polystyrene plastic strip coated with carbon powder in a water-sensitive binding compound. Time lag has been reduced to less than a second at room temperatures. This type of hygrometer is essentially independent of temperature from 0° to 40°C .

The resistance of the carbon-film hygrometer increases with relative humidity by electronic rather than electrolytic conduction. When humidity is low, the current passing through the carbon meets very little resistance because the carbon particles are close together. When the air in the test area is moist, the binder absorbs water and the carbon particles are forced apart. Now the resistance of the carbon-film is greater because the carbon particles are farther apart. By measuring this resistance, an accurate relative humidity reading can be obtained.

The instrument was developed by Walter J. Smith of Arthur D. Little, Inc., 30 Memorial Drive, Cambridge, Mass., for the U.S. Signal Corps. Earlier work on the device was done by the Eastman Kodak Co., Rochester, N. Y. This type of hygrometer has already been used on Radiosondes carried by weather balloons to measure accurately the humidity of the atmosphere at various altitudes.

Engineering Review . . .

British Instruments . . . Among the new instruments displayed at the recent British Industries Fair is an oscilloscope utilizing a four-gun cathode-ray tube, one gun more than most color-TV picture tubes. Four waveforms representing related events can be displayed simultaneously on a common time base.

Designated the E45 Minirack, this instrument has four direct-coupled driver amplifiers and a time-base and time-marker oscillator. Manufactured by Southern Instruments, Ltd., Camberley, Surrey, England, it

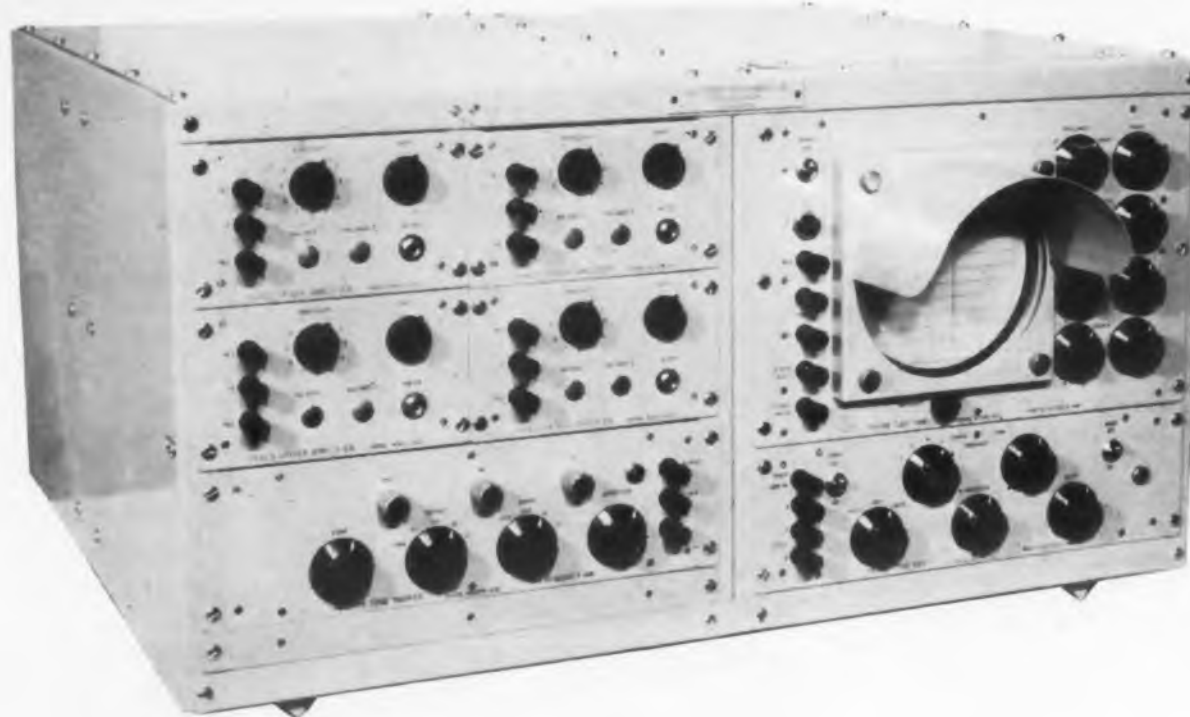

Photographs of transient waves displayed on the screen of the 4-gun cathode-ray-tube oscilloscope shown above, right, can be immediately processed in the auto-developer shown above. Both instruments were displayed at the recent British Industries Fair.

handles inputs to about 100kc. It is shown in the photograph below.

This same firm has also developed the M732 auto-developer for processing oscilloscope photographic records in daylight. This machine will develop, fix and dry any length of photographic paper from a few inches up to hundreds of feet and any width up to 120mm. It operates without a darkroom, so that oscilloscope records taken on remote sites, ships, aircraft or vehicles can be studied immediately. The device is illustrated at the left.

Another instrument is the "Wide-Strip" electronically operated potentiometer temperature recorder, which records six temperatures in different colors on a single chart. It is manufactured by Ether Ltd., Tyburn Road, Erdington, Birmingham, England.

Easily Installed Paging . . . A new paging system superimposes audio frequency pulses on regular alternating-current power wiring. Circulating personnel can carry portable paging units that can be plugged into the nearest power outlet to receive either an audio or visual signal. Manufactured by International Business Machines Corporation, New York, the system utilizes four carrier frequencies and is made in 10 to 90 paging code capacity sizes.

Jet Engine Tester . . . A new electronic jet engine tester checks the critical instruments recording engine performance without requiring that the engine be run or that the instruments be disconnected. A special probe with a self-contained heat source and thermocouples that fit over the thermocouples in the engine is the basis for the tester. The heat source develops precisely controlled temperatures up to 900°C.

Known as the "Jetcal", the device is manufactured by the B & H Instrument Company, Fort Worth, Texas. It also checks the fire warning and wing anti-ice systems. An accuracy of $\pm 4^\circ\text{C}$ is maintained at engine test temperatures in the range from 600°C to 800°C.

Electronic Weight Control . . . "Off-weight" cigarettes are automatically rejected by an electronically-controlled cigarette-making machine that insures a more uniform product. A combination of electronic, nuclear, and mechanical means adjusts the amount of tobacco going into each cigarette.

A dielectric detector measures the deviation from the correct average weight of each cigarette, while a radio-isotope beta gage measures the cigarette's density. Known as the "Microfeed", the device was developed by the American Machine & Foundry Co., 261 Madison Ave., New York 16, N. Y.

Closed-Circuit Color TV . . . Closed-circuit color TV is now available for the same uses as monochrome closed-circuit television. Two types of receivers may be used. One, for small groups, is similar to the home-type TV console. The other, featuring a specially designed optical system, projects the image free from registration problems, on a six-foot screen.

All equipment except the camera may be located remote from the scene being televised. Color TV has obvious advantages over monochrome TV for many industrial or educational uses. Examples are steel-making and surgical training. A number of medical schools are utilizing television to expand and improve teaching techniques.

The system is being produced by the General Electric Company, Syracuse, N. Y., utilizing the field-sequential method under a licensing agreement with the Columbia Broadcasting System.

Picture Storage Tube . . . Developed for viewing radar displays in daylight, a recently disclosed cathode ray tube can retain for several minutes a half-tone picture so bright that it can be viewed even in brilliant sunlight. The relatively dim images on radar screens must be hooded to be observed. Even under a hood, the viewer may have to wait for a few minutes before his eyes become adapted to the low light level of the screen.

The new tube was devised at the RCA Research Laboratories, Radio Corporation of America, Princeton, N. J. Proposed uses for the storage tubes are in airborne facsimile systems, oscilloscopes and telemetry, or wherever a bright picture of brief or transient pictorial data needs to be retained for human viewing or photographing. The tubes might be valuable in TV.

The tube has three electron guns. One of these,
ELECTRONIC DESIGN • July 1954



Capacitor Size Reduced

Savings in volume and weight by using Mylar film are illustrated above. The capacitors at the left are made with Mylar insulation. Their paper-insulated equivalents with the same ratings are on the right.

similar to the gun in standard kinescopes, "writes in" the picture signal. The second gun floods the screen with a shower of electrons. The third is for erasing the stored picture when it no longer needed.

The writing beam scans a special storage grid mounted roughly one tenth of an inch behind the phosphor screen. This grid is a fine-mesh screen with 160,000 openings per square inch supporting a thin insulating film. As the writing beam scans the insulating film, it builds up local electrical charges that vary in intensity with the picture signal.

The flooding beam, which actually produces the picture, will then pass through the charged openings on the grid in an amount proportional to the charges that have been built up by the writing beam. The erasing beam alters the charges on the grid in such a way that the flooding beam is blocked at all points, causing the picture to disappear.

In its present form, the tube has a 4-inch diam viewing screen that can present an image of hundreds of foot-lamberts in the high lights. The tube needs considerably less anode voltage than a kinescope, principally because of the tube's ability to light every spot on the viewing screen continuously instead of intermittently.

For more information on developments described in "Engineering Review", send inquiries directly to the address given in the individual item.



TRANSFORMERS for...

RADIO • TELEVISION • MILITARY • SPECIAL APPLICATIONS

MODULATION TRANSFORMER



PLATE TRANSFORMERS
MODULATION TRANSFORMERS
REACTORS
FILAMENT TRANSFORMERS
UNITIZED RECTIFIERS
PULSE TRANSFORMERS
CHARGING REACTORS

OIL, ASKAREL
DRY TYPE, (CLASS A, B & H)

PER { MIL-T-27 }
RETMA } SPEC.

PLATE TRANSFORMER



FILAMENT TRANSFORMER



HIPERCORE CORES

for smaller, lighter, low loss transformers. Write for Bulletin SR 205 listing standard cores, weights, dimensions, performance and prices.

CHARGING REACTOR



PULSE TRANSFORMER



Moloney quality, backed by 58 years of transformer experience, is designed and built into each unit.

This engineering background and experience enables Moloney to produce transformers that offer the maximum in reliability, endurance and efficiency at a minimum of size and weight.

Write for Specialty Transformer Bulletin ST 3505.

LV PLATE TRANSFORMER



MOLONEY ELECTRIC COMPANY

SALES OFFICES IN ALL PRINCIPAL CITIES - FACTORIES, ST. LOUIS, MO. - CHICAGO, ILL. - SAN DIEGO, CALIF.



CIRCLE ED-4 ON READER-SERVICE CARD FOR MORE INFORMATION

ANOTHER RAYTHEON FIRST!

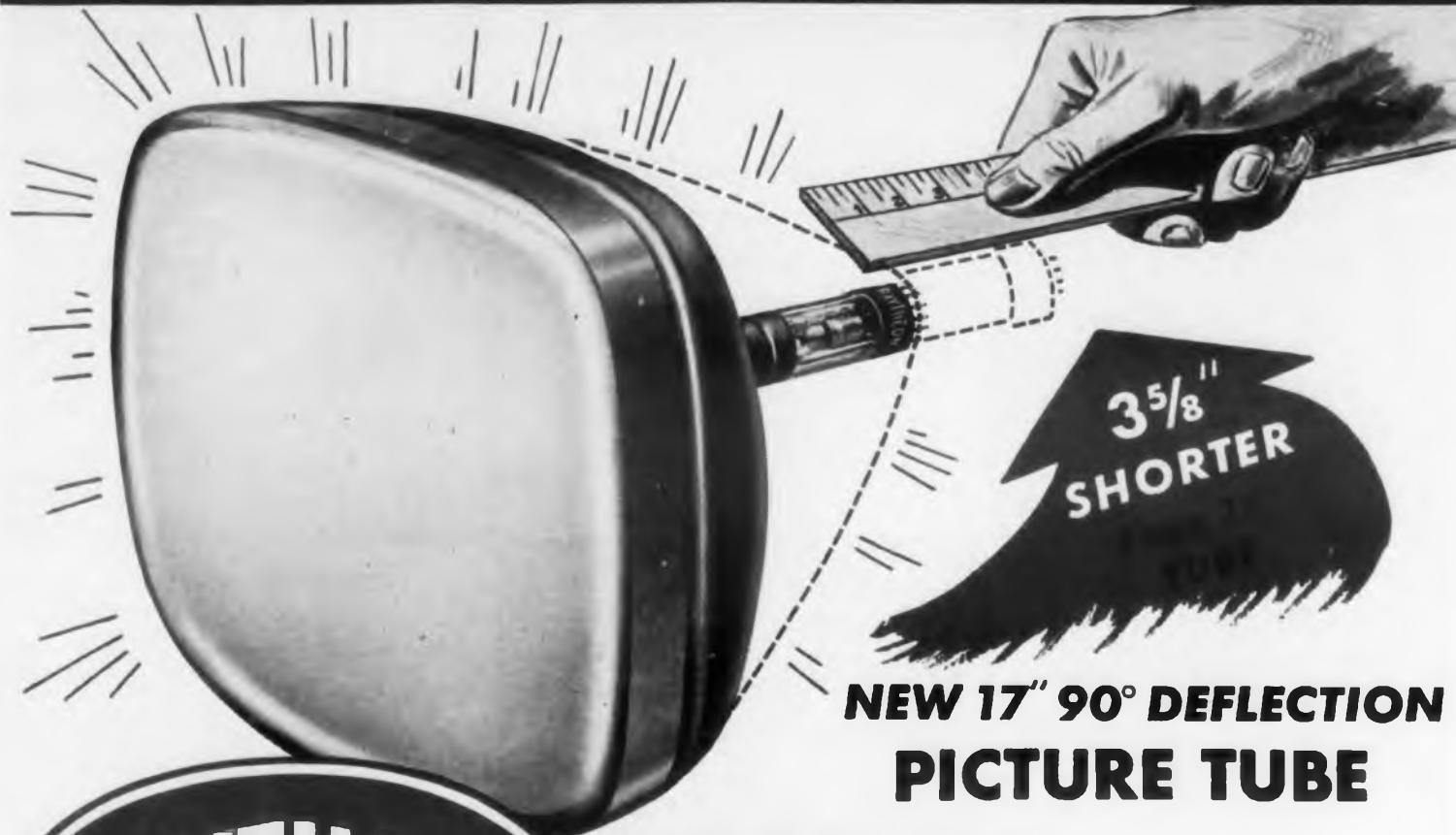

**NEW 17" 90° DEFLECTION
PICTURE TUBE**

RAYTHEON 17AVP4

Raytheon leads the way to smaller, light weight, more compact, television receivers with the amazing new 17AVP4 monochrome picture tube. It is $3\frac{5}{8}$ inches shorter in overall length and approximately 4 pounds lighter than present 17 inch tubes. The type 17AVP4 incorporates a new 90° deflection angle bulb, a 1 inch shorter neck length and achieves maximum compactness with conventional viewing area. The 17AVP4 has electrostatic focus, magnetic deflection and features the same crisp, clean picture that makes all Raytheon Picture Tubes outstanding for quality.

This important new Raytheon tube, developed and produced at Raytheon's new modern picture tube plant at Quincy, Massachusetts is one more reason why you can standardize on Raytheon Picture Tubes with complete confidence that you are giving your customers the very latest and best.

Remember, Raytheon Picture Tubes are Right for Sight, Right for you, and always New. Buy them through your nearest Raytheon Sales Representative.

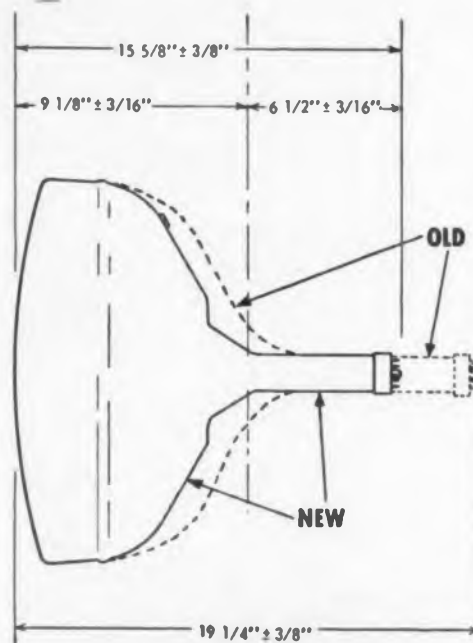

RAYTHEON

RAYTHEON MANUFACTURING COMPANY

RAYTHEON MAKES ALL THESE:

CIRCLE ED-5 ON READER-SERVICE CARD FOR MORE INFORMATION

Engineering Review . . .

Tube Element Checking . . . A new method of checking the alignment and spacing of tube elements has been developed. First the tube is immersed in clear, liquid plastic. Then its submerged glass tip is cracked off with pliers. Since there is a vacuum inside the tube, atmospheric pressure forces in the liquid plastic to fill the envelope. Baking hardens the plastic in about two hours, without disturbing the elements. The envelope is then cracked away, and the plastic-encased parts are sliced into $1/4$ " thick sections for microscopic study.

The inspection method, developed at the General Electric Company plant at Owensboro, Ky., replaces earlier, unsatisfactory tests; breaking open the glass and cutting out the parts could move or distort them, making the inspection valueless.

Meetings

August 25-27: *1954 Western Electronic Show and Convention*, Pan-Pacific Auditorium and Ambassador Hotel, Los Angeles. For information, write to WESCON, 344 North La Brea Ave., Los Angeles 36, Calif.

September, 1954: *International Scientific Radio Union*. Amsterdam, The Netherlands.

September 1-16: *Golden Jubilee Meeting of the International Electrotechnical Commission*, University of Pennsylvania, Philadelphia, Pa.

September 13-24: *First International Instrument Congress and Exposition*, Commercial Museum and Convention Hall, Philadelphia, Pa. For information, write to A. H. Peterson, Mellon Institute, Pittsburgh 13, Pa.

September 15-17: *Symposium on Information Theory*, Massachusetts Institute of Technology, Cambridge 39, Mass. Sponsored by the Professional Group on Information Theory, IRE, and others. For information, write to Dr. R. M. Fano, Research Laboratory of Electronics, M.I.T.

September 16-18: *Joint Electron Tube Engineering Council, General Conference*, Chalfonte-Haddon Hall, Atlantic City, N. J.

October 4-6: *National Electronics Conference*, Hotel Sherman, Chicago, Ill.

October 11-15: *AIEE Fall General Meeting*. Morrison Hotel, Chicago, Ill. For information, write to AIEE, 33 West 39th Street, New York 18, N. Y.

October 12: *Ferromagnetism Conference*: Naval Ordnance Laboratory, Silver Spring, Md. For information, write to L. R. Maxwell, U.S.N. Ordnance Laboratory, Silver Spring, Md.

ELECTRONIC DESIGN • July 1954

Protected Foreign Investments . . . Protection against currency inconvertibility given an American manufacturer will result in the production of electronic equipment in Germany and Italy under licenses from the American firm, according to the Foreign Operations Administration, Washington, D. C. The F.O.A. has offered the protection for profits under the Government's investment guaranty program that fosters participation of American private enterprise in the build-up of the free countries' economies.

Raytheon Manufacturing Company, Waltham, Mass., is licensing Atlas-Werke, Bremen, Germany, to manufacture commercial radar equipment and a device for measuring water depths electronically. In Italy, F.I.R.A.R. of Genoa will manufacture magnetron tubes for radar sets and klystron tubes for use in u-h-f communications equipment. Raytheon will train engineers from the Italian firm in addition to supplying technical information.

October 13-17: *1954 Annual Convention, Audio Engineering Society*, Hotel New Yorker, New York, N. Y. For information, write to C. J. LeBel, P. O. Box 12, New York 11, N. Y.

October 26-28: *National Conference on Tube Techniques*. Western Union Auditorium, 60 Hudson St., New York 13, N.Y. Sponsored by Working Group on Tube Techniques, Dept. of Defense. Papers should be submitted to Dr. Harold Jacobs, Thermionics Branch, Evans Signal Laboratory, Belmar, N.J. For information, write to Harold J. Sullivan, Advisory Group on Electron Tubes, 346 B'way, N. Y. 13, N.Y.

November 4-5: *East Coast Conference on Airborne and Navigational Electronics*. Sheraton-Belvedere Hotel, Baltimore, Md. For information, write to IRE, 1 East 79th Street, New York, N.Y.

November 10-11: *Conference on Electronic Instrumentation and Nucleonics in Medicine*. Morrison Hotel, Chicago, Ill. For information, write to AIEE, 33 West 39th Street, New York 19, N. Y.

November 29-December 3: *First International Automation Exposition*, 242nd Coast Artillery Armory, New York, N. Y. For information, write to First International Automation Exposition, 845 Ridge Ave., Pittsburgh 12, Pa.

December 8-10: *Eastern Computer Conference*, Bellevue-Stratford Hotel, Philadelphia, Pa. For information, write to AIEE, 33 West 39th St., New York 19, N.Y.

January 17-19: *High Frequency Measurements Conference*, Hotel Statler, Washington, D.C. Sponsored by AIEE and IRE. For information, write to AIEE, 33 West 39th St., New York 19, N.Y.

Bomac

REFERENCE CAVITIES

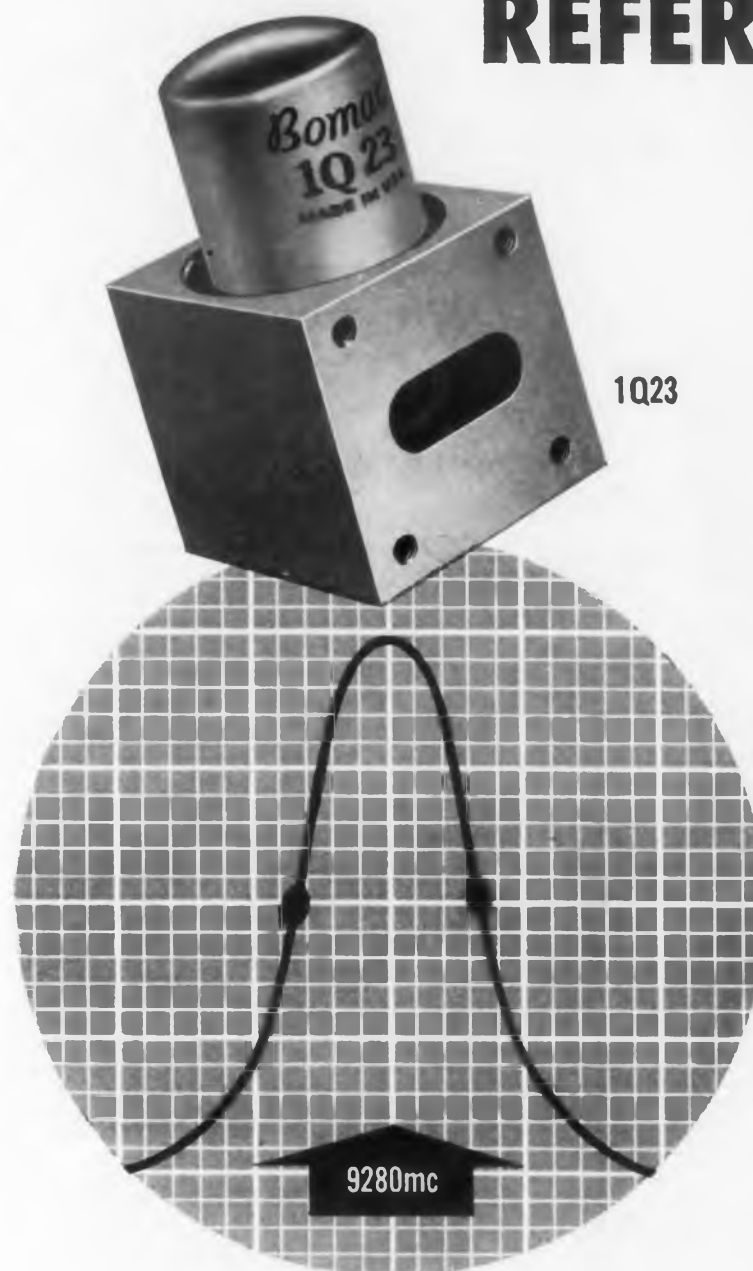

Bomac has developed a line of high-precision Reference Cavities covering six different frequencies. Essentially, Bomac cavities are fixed-frequency, vacuum-sealed, transmission-type tubes. They are used primarily as frequency determining references, and frequency stabilizers in radar beacon applications. The performance and stability of Bomac Reference Cavities over a wide range of temperatures is far superior to many other commercial cavities. Stability of the resonant frequency is maintained under severe conditions of shock and vibration by a unique cushioning arrangement that prevents excessive movement of the tube within the block.

RESONANT FREQUENCY (mc)	9280 ± 0.5 mc
VIBRATION 10 G's	± 0.1 mc
SHOCK 50 G's	± 0.1 mc
AVERAGE Q	2100
INSERTION LOSS	4.0 db - 6.0 db
TEMPERATURE COMPENSATION	
Room Temp. to 100°C	± 0.3 mc
Room Temp. to 0°C	± 0.3 mc
Room Temp. to -55°C	± 1.0 mc
ATMOSPHERIC PRESSURE	
To 45 psi (abs.)	± 0.15 mc
To 5 in. hg. (abs.)	± 0.15 mc
ALTITUDE RATING	50,000 ft. (max.)

CAVITIES FOR OTHER FREQUENCIES

1Q22 — 9250 mc	6040 — 9308 mc
1Q24 — 93.10 mc	6041 — 9312 mc
5846 — 9280 mc	

MATCHED CAVITIES — For special applications, matched cavities are now available. We invite your inquiries regarding special applications for our reference cavities.

We invite your inquiries regarding

- ENGINEERING
- DEVELOPMENT
- PRODUCTION

Bomac Laboratories, Inc.

BEVERLY, MASSACHUSETTS

GAS SWITCHING TUBES · DIODES · HYDROGEN THYRATRONS · DUPLEXERS · MAGNETRONS · MODULATORS ·

Catalog on request. Write (on your company letterhead) Dept. ED-7 BOMAC Laboratories, Inc. Beverly, Mass.

CIRCLE ED-11 ON READER-SERVICE CARD FOR MORE INFORMATION

A Hi-Temperature Tested Germanium Diode

The new Hughes type 1N198

Temperatures inside operating equipment usually climb well above the equipment ambient temperature. At these elevated temperatures, you need components with *known* characteristics. Most germanium diodes are tested at room temperature and, as operating temperatures rise, their performance deteriorates. But the new Hughes Type 1N198 is a *realistic* germanium point-contact diode.

*That's because this diode is tested 100% at 75°C—*which is just about as hot as most electronic equipment gets in operation. In addition, samples of the 1N198 are regularly subjected to all standard tests at 25°C. This means that you can use these hi-temperature tested diodes with confidence, can design equipment to take full advantage of the fact that *electrical characteristics at the higher temperatures are specified.*



Type
1N198
Electrical
Characteristics

at 75°C

Forward Current at 1V dc 5 mA (Min.)

Reverse Current at -10V dc 0.075 mA (Max.)

Reverse Current at -50V dc 0.250 mA (Max.)

at 25°C

Forward Current at 1V dc 4 mA (Min.)

Reverse Current at -10V dc 0.010 mA (Max.)

Reverse Current at -50V dc 0.050 mA (Max.)

Like all Hughes Diodes, the hi-temperature tested 1N198 is fusion-sealed in a one-piece, gas-tight glass envelope which is impervious to moisture or other external contaminating agents. The complete Hughes line of fusion-sealed germanium diodes comprises standard RETMA, JAN, and many special types. We'd like to send our Bulletin SP-2A, which lists and describes these diodes, to you. Just send for your copy, or for additional details concerning the new Type 1N198.

Hughes

SEMICONDUCTOR SALES DEPARTMENT

Aircraft Company, Culver City, Calif.



New York Chicago

Engineering Review . . .

Parachute Test System . . . By means of an f-m transmitter mounted inside a dummy, strain test data produced when the dummy is dropped by experimental parachutes is transmitted to recording instruments on the ground in a system developed to test the new parachutes demanded by faster aircraft and airborne tactics. The telemetering system was devised by M. L. Greenough, C. C. Gordon, and associates of the National Bureau of Standards, Washington 25, D. C., for the Navy Bureau of Aeronautics. The strain-gage equipped dummy is shown at the right.

The strain gages are arranged to read tension in the various harness straps. An inductive-commutator arrangement excites one gage at a time. Seven measurement channels and a calibration channel are provided. At the ground station, a spot on the face of a cathode-ray tube moves up and down with the amplitude of the modulating signal. This spot is recorded on continuously moving photographic film.

Modulation of the transmitter with the signal from one channel at a time is accomplished by means of a "coder" of novel design. The coder supplies a series of time-sequential pulses to eight resistance bridges—one for the altimeter, one for each of six tensiometers, and one fixed bridge for calibration. One hundred pulses per second are received at each bridge.

The bridge-unbalance signals are first amplified then converted to amplitude modulation of a 15kc subcarrier. This subcarrier in turn frequency-modu-

The "Color Multi-Scanner" shown below is composed of three basic parts: the flying spot scanner, the color "Cinecon" pickup units (which look like motion picture projectors), and the color slide changer pickup unit (the large enclosure at the right).



CIRCLE ED-6 ON READER-SERVICE CARD FOR MORE INFORMATION

an f-m
est data
experi-
instru-
to test
aft and
devised
iates of
ton 25,
es. The
right.
nsion in
mutator
en mea-
are pro-
uce of a
e ampli-
recorded

al from
ns of a
a series
ridges—
ometers,
undred
e.

mplified
a 15kc
y-modu-

posed of
r "Cine-
re pro-
he large



lates the 217Mc transmitter by means of a reactance-tube modulator. The ground-station receiver gives an output that is identical with the a-m 15kc subcarrier in the airborne unit. Demodulator and filter circuits convert this output signal to a waveform identical to the original bridge-unbalance signals.

The airborne transmitter has an output of about 0.75w and a range of 2 to 10 miles. Seven tubes are required for the entire airborne unit. The battery pack, which provides 7.2v at 1amp and 190v at 80ma, is tailored for about 1 hour of service.

Color Film Scanning for TV . . . Most of the 16mm technicolor motion picture film produced during the past 10 years can be scanned by a newly developed system for TV stations affording picture quality equal to or better than "live" color pickups. The device also handles monochrome film and slides and color slides. Known as the "Color Multi-Scanner," it is shown in the photograph at the left.

Manufactured by Allen B. Du Mont Laboratories, Inc., 750 Bloomfield Ave., Clifton, N. J., the unit includes a feature known as the "Electronic Color Masker" that controls brightness and color saturation. This control provides a means correcting variations in the film. The system was evolved out of this firm's monochrome Multi-Scanner.

For specialized electronic equipment... check Western Gear

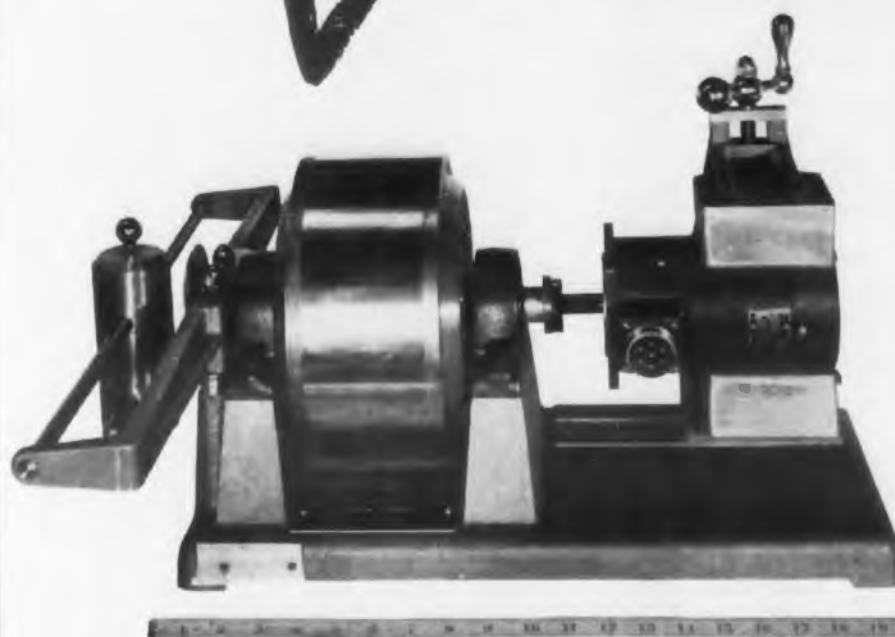

Dyna-Chek provides tested and proven accuracy in measuring the output of fractional and integral horsepower motors —

Model DM4 up to 1HP in continuous duty, and Model MDM for 1/10 HP or less. Manufactured by Mission-Western Engineers, Inc.,* Dyna-Chek provides a simple and convenient method of motor testing. Two types of broad range speed measuring equipment available as extra accessories, both supplying a high degree of accuracy. For information, address Mission-Western Engineers, Inc., 132 W. Colorado, Pasadena 1, Calif.



HIGH PRECISION GEARS and precision fine pitch

gearing from 200 to 6 diametral pitch and dimensions from .125" to 10" diameter. Western Gear Works makes available complete engineering and manufacturing facilities for the application of high precision gearing and gear drives in electronics equipment. For assistance without obligation write Executive Offices, Western Gear Works, P.O. Box 182, Lynwood, Calif.

* An affiliate of Western Gear Works, since 1888 a leader in the mechanical power transmission field.



PLANTS AT LYNWOOD, PASADENA, BELMONT, SAN FRANCISCO (CALIF.), SEATTLE, HOUSTON — REPRESENTATIVES IN PRINCIPAL CITIES

CIRCLE ED-8 ON READER-SERVICE CARD FOR MORE INFORMATION

Engineering Review

Medical Electronics . . . A method of locating kidney stones and other foreign matter in the body with the help of small sound transducers was revealed at the recent Summer and Pacific General Meeting of the AIEE by R. Stuart Mackay of the University of California Medical School.

The transducers are mounted on forceps or other surgical instruments used to remove foreign substances in the body. The necessary amplifier is easy to construct since a tendency toward hum can be removed by limiting the low-frequency response. This does not limit the useful signal, which is mostly in the higher Fourier components.

Arctic Lubrication . . . A new oil that lubricates at -100°F is expected to eliminate one of the greatest obstacles to successful arctic military operations. The lubricant was developed by Elgin National Watch Company, Elgin, Ill.

Computer Controlled Utility . . . New York City's huge electric power system is now automatically controlled by computer equipment. Consolidated Edison Company, a 3,000,000kw system with nine generating plants, has solved the problem of system load pick-up through the use of computers that automatically signal load variation to the principal generating stations, each of which responds automatically.

The computer equipment compares station loads with preset loading schedules and satisfies short-time load swings on the basis of available capabilities and satisfies sustained load changes in compliance with economical loading requirements.

Research Gains . . . Half of all employment in the United States is based on products coming from research laboratories—as contrasted with only a third in 1939, according to the *Industrial Research Newsletter* of the Armour Research Foundation, Chicago 16, Ill.

CIRCLE ED-9 ON READER-SERVICE CARD

GERMANIUM DIODE INTERCHANGEABILITY CHART



Type & Mfr.	Q-E Requirement	Minimum Forward C _r @ +1V. (MA)	Peak Inverse Voltage (Volts)	Peak Reverse Current (Microamps)	Maximum Reverse Voltage (Volts)	Remarks
1A (TP)	None	60	5	100 @ -5V. 50 @ -15V.	100 @ -5V. 50 @ -15V.	Gold bonded diode
1B (TP)	None	30	15	100 @ -5V. 50 @ -15V.	100 @ -5V. 50 @ -15V.	Gold bonded diode
1C (TP)	None	30	15	100 @ -5V. 50 @ -15V.	100 @ -5V. 50 @ -15V.	Gold bonded diode
1D (TP)	Cr	15	15	60% Rect. Eff. @ 100 Mc.	60% Rect. Eff. @ 100 Mc.	Gold bonded diode
1E (TP)	G7C	5	5	75% Rect. Eff. @ 100 Mc.	75% Rect. Eff. @ 100 Mc.	UHF mixer See Note 6
1F (TP)	G7G	5	5	60% Rect. Eff. @ 100 Mc.	60% Rect. Eff. @ 100 Mc.	Harmonic diode Silicon micro-wave diode
1N34 (S,K,RR)	1N4B	4.0	75	50 @ -10V.	50 @ -10V.	
1N34A (S,K,RR)	1N4B	4.0	75	50 @ -10V.	50 @ -10V.	
1N35 (S,K,RR)	1N52	4.0	75	30 @ -10V.	30 @ -10V.	
1N35A (S,K,RR)	1N52	4.0	75	30 @ -10V.	30 @ -10V.	
1N36 (S,K,RR)	1N52	4.0	75	30 @ -10V.	30 @ -10V.	
1N36A (S,K,RR)	1N52	4.0	75	30 @ -10V.	30 @ -10V.	
1N37 (S,K,RR)	1N52	4.0	75	30 @ -10V.	30 @ -10V.	
1N37A (S,K,RR)	1N52	4.0	75	30 @ -10V.	30 @ -10V.	
1N38 (S,K,RR)	1N52	4.0	75	30 @ -10V.	30 @ -10V.	
1N38A (S,K,RR)	1N52	4.0	75	30 @ -10V.	30 @ -10V.	
1N39 (S,K)	None	3.0	925	900 @ -100V. 800 @ -200V.	900 @ -100V. 800 @ -200V.	Small area diode
1N40 (S)	1N75	9.5	195	50 @ -10V. 50 @ -10V.	50 @ -10V. 50 @ -10V.	Computer type
1N41 (S)	1N75	9.5	195	50 @ -10V. 50 @ -10V.	50 @ -10V. 50 @ -10V.	Computer type
1N42 (S)	1N75	9.5	195	50 @ -10V. 50 @ -10V.	50 @ -10V. 50 @ -10V.	Computer type
1N43 (WE)	1N75	9.5	195	50 @ -10V. 50 @ -10V.	50 @ -10V. 50 @ -10V.	Computer type
1N44 (WE)	1N75	9.5	195	50 @ -10V. 50 @ -10V.	50 @ -10V. 50 @ -10V.	Computer type
1N45 (WE)	1N75	9.5	195	50 @ -10V. 50 @ -10V.	50 @ -10V. 50 @ -10V.	Computer type
1N46 (WE)	1N75	9.5	195	50 @ -10V. 50 @ -10V.	50 @ -10V. 50 @ -10V.	Computer type
1N47 (WE)	1N75	9.5	195	50 @ -10V. 50 @ -10V.	50 @ -10V. 50 @ -10V.	Computer type
1N48 (WE)	1N75	9.5	195	50 @ -10V. 50 @ -10V.	50 @ -10V. 50 @ -10V.	Computer type
1N49 (WE)	1N75	9.5	195	50 @ -10V. 50 @ -10V.	50 @ -10V. 50 @ -10V.	Computer type
1N50 (S)	1N75	9.5	195	50 @ -10V. 50 @ -10V.	50 @ -10V. 50 @ -10V.	Computer type
1N51 (S)	1N75	9.5	195	50 @ -10V. 50 @ -10V.	50 @ -10V. 50 @ -10V.	Computer type
1N52 (S)	1N75	9.5	195	50 @ -10V. 50 @ -10V.	50 @ -10V. 50 @ -10V.	Computer type
1N53 (S)	1N75	9.5	195	50 @ -10V. 50 @ -10V.	50 @ -10V. 50 @ -10V.	Computer type
1N54 (S)	1N75	9.5	195	50 @ -10V. 50 @ -10V.	50 @ -10V. 50 @ -10V.	Computer type
1N55 (S)	1N75	9.5	195	50 @ -10V. 50 @ -10V.	50 @ -10V. 50 @ -10V.	Computer type
1N56 (S)	1N75	9.5	195	50 @ -10V. 50 @ -10V.	50 @ -10V. 50 @ -10V.	Computer type
1N57 (S)	1N75	9.5	195	50 @ -10V. 50 @ -10V.	50 @ -10V. 50 @ -10V.	Computer type
1N58 (S)	1N75	9.5	195	50 @ -10V. 50 @ -10V.	50 @ -10V. 50 @ -10V.	Computer type
1N59 (S)	1N75	9.5	195	50 @ -10V. 50 @ -10V.	50 @ -10V. 50 @ -10V.	Computer type
1N60 (S)	1N75	9.5	195	50 @ -10V. 50 @ -10V.	50 @ -10V. 50 @ -10V.	Computer type
1N61 (S)	1N75	9.5	195	50 @ -10V. 50 @ -10V.	50 @ -10V. 50 @ -10V.	Computer type
1N62 (S)	1N75	9.5	195	50 @ -10V. 50 @ -10V.	50 @ -10V. 50 @ -10V.	Computer type
1N63 (S)	1N75	9.5	195	50 @ -10V. 50 @ -10V.	50 @ -10V. 50 @ -10V.	Computer type
1N64 (S)	1N75	9.5	195	50 @ -10V. 50 @ -10V.	50 @ -10V. 50 @ -10V.	Computer type
1N65 (S)	1N75	9.5	195	50 @ -10V. 50 @ -10V.	50 @ -10V. 50 @ -10V.	Computer type
1N66 (S)	1N75	9.5	195	50 @ -10V. 50 @ -10V.	50 @ -10V. 50 @ -10V.	Computer type
1N67 (S)	1N75	9.5	195	50 @ -10V. 50 @ -10V.	50 @ -10V. 50 @ -10V.	Computer type
1N68 (S)	1N75	9.5	195	50 @ -10V. 50 @ -10V.	50 @ -10V. 50 @ -10V.	Computer type
1N69 (S)	1N75	9.5	195	50 @ -10V. 50 @ -10V.	50 @ -10V. 50 @ -10V.	Computer type
1N70 (S)	1N75	9.5	195	50 @ -10V. 50 @ -10V.	50 @ -10V. 50 @ -10V.	Computer type
1N71 (S)	1N75	9.5	195	50 @ -10V. 50 @ -10V.	50 @ -10V. 50 @ -10V.	Computer type
1N72 (S)	1N75	9.5	195	50 @ -10V. 50 @ -10V.	50 @ -10V. 50 @ -10V.	Computer type
1N73 (S)	1N75	9.5	195	50 @ -10V. 50 @ -10V.	50 @ -10V. 50 @ -10V.	Computer type
1N74 (S)	1N75	9.5	195	50 @ -10V. 50 @ -10V.	50 @ -10V. 50 @ -10V.	Computer type
1N75 (S)	1N75	9.5	195	50 @ -10V. 50 @ -10V.	50 @ -10V. 50 @ -10V.	Computer type
1N76 (S)	1N75	9.5	195	50 @ -10V. 50 @ -10V.	50 @ -10V. 50 @ -10V.	Computer type
1N77 (S)	1N75	9.5	195	50 @ -10V. 50 @ -10V.	50 @ -10V. 50 @ -10V.	Computer type
1N78 (S)	1N75	9.5	195	50 @ -10V. 50 @ -10V.	50 @ -10V. 50 @ -10V.	Computer type
1N79 (S)	1N75	9.5	195	50 @ -10V. 50 @ -10V.	50 @ -10V. 50 @ -10V.	Computer type
1N80 (S)	1N75	9.5	195	50 @ -10V. 50 @ -10V.	50 @ -10V. 50 @ -10V.	Computer type
1N81 (S)	1N75	9.5	195	50 @ -10V. 50 @ -10V.	50 @ -10V. 50 @ -10V.	Computer type
1N82 (S)	1N75	9.5	195	50 @ -10V. 50 @ -10V.	50 @ -10V. 50 @ -10V.	Computer type
1N83 (S)	1N75	9.5	195	50 @ -10V. 50 @ -10V.	50 @ -10V. 50 @ -10V.	Computer type
1N84 (S)	1N75	9.5	195	50 @ -10V. 50 @ -10V.	50 @ -10V. 50 @ -10V.	Computer type
1N85 (S)	1N75	9.5	195	50 @ -10V. 50 @ -10V.	50 @ -10V. 50 @ -10V.	Computer type
1N86 (S)	1N75	9.5	195	50 @ -10V. 50 @ -10V.	50 @ -10V. 50 @ -10V.	Computer type
1N87 (S)	1N75	9.5	195	50 @ -10V. 50 @ -10V.	50 @ -10V. 50 @ -10V.	Computer type
1N88 (S)	1N75	9.5	195	50 @ -10V. 50 @ -10V.	50 @ -10V. 50 @ -10V.	Computer type
1N89 (S)	1N75	9.5	195	50 @ -10V. 50 @ -10V.	50 @ -10V. 50 @ -10V.	Computer type
1N90 (S)	1N75	9.5	195	50 @ -10V. 50 @ -10V.	50 @ -10V. 50 @ -10V.	Computer type
1N91 (S)	1N75	9.5	195	50 @ -10V. 50 @ -10V.	50 @ -10V. 50 @ -10V.	Computer type
1N92 (S)	1N75	9.5	195	50 @ -10V. 50 @ -10V.	50 @ -10V. 50 @ -10V.	Computer type
1N93 (S)	1N75	9.5	195	50 @ -10V. 50 @ -10V.	50 @ -10V. 50 @ -10V.	Computer type
1N94 (S)	1N75	9.5	195	50 @ -10V. 50 @ -10V.	50 @ -10V. 50 @ -10V.	Computer type
1N95 (S)	1N75	9.5	195	50 @ -10V. 50 @ -10V.	50 @ -10V. 50 @ -10V.	Computer type
1N96 (S)	1N75	9.5	195	50 @ -10V. 50 @ -10V.	50 @ -10V. 50 @ -10V.	Computer type
1N97 (S)	1N75	9.5	195	50 @ -10V. 50 @ -10V.	50 @ -10V. 50 @ -10V.	Computer type
1N98 (S)	1N75	9.5	195	50 @ -10V. 50 @ -10V.	50 @ -10V. 50 @ -10V.	Computer type
1N99 (S)	1N75	9.5	195	50 @ -10V. 50 @ -10V.	50 @ -10V. 50 @ -10V.	Computer type
1N100 (S)	1N75	9.5	195	50 @ -10V. 50 @ -10V.	50 @ -10V. 50 @ -10V.	Computer type
1N101 (S)	1N75	9.5	195	50 @ -10V. 50 @ -10V.	50 @ -10V. 50 @ -10V.	Computer type
1N102 (S)	1N75	9.5	195	50 @ -10V. 50 @ -10V.	50 @ -10V. 50 @ -10V.	Computer type
1N103 (S)	1N75	9.5	195	50 @ -10V. 50 @ -10V.	50 @ -10V. 50 @ -10V.	Computer type
1N104 (S)	1N75	9.5	195	50 @ -10V. 50 @ -10V.	50 @ -10V. 50 @ -10V.	Computer type
1N105 (S)	1N75	9.5	195	50 @ -10V. 50 @ -10V.	50 @ -10V. 50 @ -10V.	Computer type
1N106 (S)	1N75	9.5	195	50 @ -10V. 50 @ -10V.	50 @ -10V. 50 @ -10V.	Computer type
1N107 (S)	1N75	9.5	195	50 @ -10V. 50 @ -10V.	50 @ -10V. 50 @ -10V.	Computer type
1N108 (S)	1N75	9.5	195	50 @ -10V. 50 @ -10V.	50 @ -10V. 50 @ -10V.	Computer type
1N109 (S)	1N75	9.5	195	50 @ -10V. 50 @ -10V.	50 @ -10V. 50 @ -10V.	Computer type
1N110 (S)	1N75	9.5	195	50 @ -10V. 50 @ -10V.	50 @ -10V. 50 @ -10V.	Computer type
1N111 (S)	1N75	9.5	195	50 @ -10V. 50 @ -10V.	50 @ -10V. 50 @ -10V.	Computer type
1N112 (S)	1N75	9.5	195	50 @ -10V. 50 @ -10V.	50 @ -10V. 50 @ -10V.	Computer type
1N113 (S)	1N75	9.5	195	50 @ -10V. 50 @ -10V.	50 @ -10V. 50 @ -10V.	Computer type
1N114 (S)	1N75	9.5	195	50 @ -10V. 50 @ -10V.	50 @ -10V. 50 @ -10V.	Computer type
1N115 (S)	1N75	9.5	195	50 @ -10V. 50 @ -10V.	50 @ -10V. 50 @ -10V.	Computer type
1N116 (S)	1N75	9.5	195	50 @ -10V. 50 @ -10V.	50 @ -10V. 50 @ -10V.	Computer type
1N117 (S)	1N75	9.5	195	50 @ -10V. 50 @ -10V.	50 @ -10V. 50 @ -10V.	Computer type
1N118 (S)	1N75	9.5	195	50 @ -10V. 50 @ -10V.	50 @ -10V. 50 @ -10V.	Computer type
1N119 (S)	1N75	9.5	195	50 @ -10V. 50 @ -10V.	50 @ -10V. 50 @ -10V.	Computer type
1N120 (S)	1N75	9.5	195	50 @ -10V. 50 @ -10V.	50 @ -10V. 50 @ -10V.	Computer type
1N121 (S)	1N75	9.5	195	50 @ -10V. 50 @ -10V.	50 @ -10V. 50 @ -10V.	Computer type
1N122 (S)	1N75	9.5	195	50 @ -10V. 50 @ -10V.	50 @ -10V. 50 @ -10V.	Computer type
1N123 (S)	1N75	9.5	195	50 @ -10V. 50 @ -10V.	50 @ -10V. 50 @ -10V.	Computer type
1N124 (S)	1N75	9.5	195	50 @ -10V. 50 @ -10V.	50 @ -10V. 50 @ -10V.	Computer type
1N125 (S)	1N75	9.5	195	50 @ -10V. 50 @ -10V.	50 @ -10V. 50 @ -10V.	Computer type
1N126 (S)	1N75	9.5	195	50 @ -10V. 50 @ -10V.	50 @ -10V. 50 @ -10V.	Computer type
1N127 (S)	1N75	9.5	195	50 @ -10V. 50 @ -10V.	50 @ -10V. 50 @ -10V.	Computer type
1N128 (S)	1N75	9.5	195	50 @ -10V. 50 @ -10V.	50 @ -10V. 50 @ -10V.	Computer type
1N129 (S)	1N75	9.5	195	50 @ -10V. 50 @ -10V.	50 @ -10V. 50 @ -10V.	Computer type
1N130 (S)	1N75	9.5	195	50 @ -10V. 50 @ -10V.	50 @ -10V. 50 @ -10V.	Computer type
1N131 (S)	1N75	9.5	195	50 @ -10V. 50 @ -10V.	50 @ -10V. 50 @ -10V.	Computer type
1N132 (S)	1N75	9.5	195	50 @ -10V. 50 @ -10V.	50 @ -10V. 50 @ -10V.	Computer type
1N133 (S)	1N75	9.5	195	50 @ -10V. 50 @ -10V.	50 @ -10V. 50 @ -10V.	Computer type
1N134 (S)	1N75	9.5	195	50 @ -10V. 50 @ -10V.	50 @ -10V. 50 @ -10V.	Computer type
1N135 (S)	1N75	9.5	195	50 @ -10V. 50 @ -10V.	50 @ -10V. 50 @ -10V.	Computer type
1N136 (S)	1N75	9.5	195	50 @ -10V. 50 @ -10V.	50 @ -10V. 50 @ -10V.	Computer type
1N137 (S)	1N75	9.5	195	50 @ -10V. 50 @ -10V.	50 @ -10V. 50 @ -10V.	Computer type
1N138 (S)	1N75					

● General Electric is the only company that manufactures a full line of Germanium products: gold bonded, hermetically sealed, welded and power diodes, transistors, rectifiers . . . more than 80 separate types. No matter what your electronic

or electrical circuitry design problem is, call on G. E. first.

For detailed information on any of these G-E products or a free file copy of the above chart, write: General Electric Company, Section X7474, Electronics Park, Syracuse, N. Y.



GENERAL ELECTRIC

Industry Aiding Education . . .

Again affirming the close ties of the electronics industry to the nation's engineering schools, Servomechanisms, Inc., Westbury, N. Y., and Technology Instrument Corp., Acton, Mass., have donated valuable control equipment to the electrical engineering department at Rensselaer Polytechnic Institute, Troy, N.Y.

To be used for both research and instruction, the up-to-date units are sufficient for setting up 12 different complete automatic control systems. The apparatus includes 300 precision gears of varying sizes, 12 linear potentiometers, 12 servo motors, 12 amplifiers, 12 power supplies, 130 bearing blocks, and other associated gear. It is worth over \$14,000.

Nuclear Reactor Controls . . . The recently announced marketing of control equipment for low-cost experimental neutron chain reactors is another step towards producing commercial electric power from atomic energy. The controls, designed by the Oak Ridge National Laboratory, are made by Radiation Counter Laboratories, Inc., 5122 West Grove St., Skokie, Ill.

Electronic Business Failures . . .

Business failures of manufacturers of electronic equipment and components during the year ending May, 1954 more than doubled the number of producers experiencing financial difficulties in the corresponding period a year earlier. According to the annual report of the Credit Committee of the Radio-Electronics-Television Manufacturers Association, 777 14th Street, N. W., Washington, D. C., 33 such manufacturers failed in the year ending May, 1954 compared with 16 in the previous corresponding period.

Since 1945, 170 electronic manufacturers have had serious financial problems. About 35 of the 170 are operating today. Of the 33 producers who failed during the past year, more than half were less than seven years old. With respect to distributors of electronic parts, the credit report stated that of more than 1300, only eight had financial difficulty.

◀ CIRCLE ED-9 ON READER-SERVICE CARD

Choosing Wire Insulation For High Temperatures

By John Holland

Chief Engineer, Hitemp Wires, Inc.

Mineola, L. I., N. Y.

DESIGNERS of electronic devices must often select an insulated wire to meet a particular set of conditions—operating temperature limits, electrical characteristics, miniaturization requirements, space factor, moisture and abrasion resistance, and the like. In some applications (for example, magnet wire for Class A commercial use) these conditions are not too rigid. In others, particularly in the Class H range, the problems become more difficult.

To simplify the problem of selecting wire insulation for elevated temperature applications, much of the available data has been correlated and assembled in tabular form as shown below in Table 1.

Although five different types of magnet wire are listed, we generally recommend one of the following for high-temperature service:

1. *Silicone Resin*—Introduced only recently, this is an intermediate insulation whose operating temperature range is between Class A and Class H. The Dow Corning 1360 enamel, for example, is a tough, hard-baked film with excellent resistance to abrasion and thermoplastic flow up to 180°C.

2. *Polytetrafluoroethylene Resin*—For Class H applications, or where chemical resistance or electrical stability are design factors. The properties charted are for the DuPont resin trade-named "Teflon". Because of its fairly soft and elastic nature, Teflon requires special handling. However, if sharp edges are eliminated and proper winding tensions are established, it will handle satisfactorily.

Table 1. A comparison of five high temperature wire insulating materials.

Characteristics	Temprite-X (Modified Teflon)	Teflon (As supplied by Mfr)	Silicone Enamel-DC1360	Formvar (Vinyl Acetal)	Plain Enamel
Upper Temp. Limit	+250°C	+250°C	+180°C	+105°C	+80°C
Lower Temp. Limit	-100°C	-100°C	-40°C	-40°C	-40°C
Dielectric Strength	Excellent	Very Good	Very Good	Good	Good
Dielectric Constant (60cy—30,000Mc)	2.0—2.05*	2.0—2.05*	Inferior	Inferior	Inferior
Power Factor (60cy—10,000Mc)	0.0002*	0.0002*	Inferior, about 0.006—0.007	Inferior	Inferior
Space Factor	Excellent	Excellent	Excellent	Excellent	Excellent
Solvent Resistance	Excellent	Excellent	Fair	Fair	Poor
Abrasion Resistance**	Good	Fair	Very Good	Excellent	Good
Thermoplastic Flow	Good	Fair	Excellent	Excellent	Good
Crazing Resistance**	Excellent	Very Good	Fair	Fair	Fair
Flame Resistance	Excellent	Excellent	Fair	Poor	Poor
Fungus Resistance	Excellent	Excellent	Good	Good	Poor
Moisture Resistance	Excellent	Excellent	Good	Good	Good
Continuity of Insul**	Excellent	Excellent	Good	Good	Good
Arc Resistance	Excellent	Excellent	Good	Good	Good
Flexibility	Excellent	Very Good	Good	Good	Good

*Stable at temperatures up to 250°C

**See text for test procedure or explanation

3. *Modified Polytetrafluoroethylene Resin*—Resembles the manufacturer's original product in almost every respect, but has improved abrasion resistance, thermoplastic flow and flexibility. This insulation is called "Temprite-X".

At the present time there are no government specifications for either Teflon or Silicone-insulated magnet wire, although a tentative NEMA specification is currently being written for the Teflon type. Therefore it was necessary to establish quality-control and field service engineering standards before the insulations could be evaluated. This was done by testing in accordance with the requirements of JAN-W-583 which covers resin insulated (film type) wires. Using these JAN standards as a base, the following modifications were used to make the tests valid:

Type of Test	Teflon & Temprite-X	Silicone 1360
Flexibility	Preconditioning for 1 hour at +250°C	No modification required
Abrasion Resistance	Decreased abrasion scrape load by about 50%	No modification required
Heat Shock	Conditioning temperature of +250°C for one hour	Conditioning temperature of +225°C for one hour
Heat Aging	Conditioning temperature of +260°C for 168 hours	Conditioning temperature of +200°C for 168 hours
Thermoplastic Flow	Test Load reduced from 1000 grams to: 800gm (14-24 AWG) 500gm (25-28 AWG) 300gm (29-32 AWG) 100gm (33-37 AWG) 60gm (38-40 AWG) 20gm (41-44 AWG)	No modification required
Solvent Resistance	No modification required (no known commercial solvent)	No modification required
Dielectric Strength (Twist Test)	No modification required	No modification required
Continuity of Film	DC Test Voltage increased: From AWG To 110V 14-24 200V 75 25-29 150 60 30-34 100 30 35-40 60 — 41-44 30	No modification required

These modifications enabled our technicians to evaluate the basic properties of the material under test in the laboratory. The results, in this instance, were obtained for magnet wire. They are realistic for all practical purposes until final specifications are written by military or other organizations.

When using the test data given in the table to establish safe design limitations, the following points should be kept in mind:

Thermal Limitations—Ratings given are conservative, in accordance with good engineering practice, and are based on a 168-hour test without degradation

of the insulation. However, a much lower temperature limit than the one indicated for Silicone on the chart prevails if this resin is to be used in a hermetically sealed enclosure.

When confined at elevated temperatures, vapor migration and consequent loss of weight lowers the electrical properties of Silicone resin. In the case of vinyl acetal, the upper temperature limit of 105°C should be carefully adhered to when the insulation is being used in rotating equipment—since stresses induced in the winding may lower the service life.

Dielectric Strength—Conventional usage rates this property in volts per mil of insulation thickness. However, this value can be misleading because the rating varies with wire size. A heavy insulation does not give proportional results. For example, using the same insulation, the volts/mil rating of 14 AWG might be 600; but for 40 AWG it might be as high as 3000. Obviously dielectric strength is not a straight line function as insulation thickness increases. In addition, any change in the relative humidity of the test chamber affects the final result.

To overcome these shortcomings, tabled values of dielectric strength were determined by conducting a standard twist test in an air-conditioned laboratory. Ideal test conditions were found at room temperatures of 68°–72°F and relative humidity of 50-65%. The tests showed that "Temprite-X" construction provided about a 10% increase in dielectric strength over regular Teflon, and that vinyl acetals showed evidences of electrical degradation which is generally proportional to time and temperature.

Abrasion Resistance—This test was run on a General Electric Company scrape tester as follows:

Insulation	Test Load-Grams	Scrapes To Failure
No. 26 Heavy Teflon	150	56
" " " Temprite-X	150	74
" " " Silicone 1360	440	26
" " " Vinyl Acetal	440	32

Crazing Resistance—Brittleness and subsequent crazing are encountered when designing close to the upper temperature of Class A or Class B. Organic films tend to harden with aging, therefore windings embrittled under these conditions may tend to craze and crack when subjected to centrifugal forces found in motor windings. (Teflon does not harden near its upper temperature limit).

Continuity of Insulation—Tested on equipment designed in accordance with the JAN specification cited above. The standard calls for no more than 15, 10, 5, and 1 pin-hole breaks in insulation per 100 feet of wire for single, heavy, triple, and quad thicknesses, respectively. Both types of Teflon insulation far exceed this requirement, since no solvent is used in processing this type of wire, as is the case for silicones and vinyl acetals.



Arnold Pulse Transformer Cores are individually tested

under actual pulse conditions



WAD 5238

**WRITE
for your
COPIES**



"MAGNETIC MATERIALS CATALOG"

General information on all Arnold magnetic materials: permanent magnets, tape-wound and powder cores, types "C" and "E" cut cores, etc.

"ARNOLD SILECTRON CORES"

52 pages of valuable data covering a complete range of core shapes, sizes, tape gauges, etc.

ADDRESS DEPT. ED

The inset photograph above illustrates a special Arnold advantage: a 10-megawatt pulse-testing installation which enables us to test-prove pulse cores to an extent unequalled elsewhere in the industry.

For example, Arnold 1 mil Silectron "C" cores—supplied with a guaranteed minimum pulse permeability of 300—are tested at 0.25 microseconds, 1000 pulses per second, at a peak flux density of 2500 gauss. The 2 mil cores, with a guaranteed minimum pulse permeability of 600, receive standard tests at 2 microseconds, 400

pulses per second, at a peak flux density of 10,000 gauss.

The test equipment has a variable range which may enable us to make special tests duplicating the actual operating conditions of the transformer. The pulser permits tests at .05, .25, 2.0 and 10.0 microsecond pulse duration, at repetition rates varying anywhere from 50 to 1000 pulses per second.

This is just another of Arnold's facilities for better service on magnetic materials of all description.

● Let us supply your requirements.

THE ARNOLD ENGINEERING COMPANY

SUBSIDIARY OF ALLEGHENY LUOLUM STEEL CORPORATION

General Office & Plant: Marengo, Illinois

DISTRICT SALES OFFICES . . . New York: 350 Fifth Ave.

Los Angeles: 3450 Wilshire Blvd.

Boston: 280 Berkeley St.



CIRCLE ED-12 ON READER-SERVICE CARD FOR MORE INFORMATION

MIL-T-27 Power and Audio
 MS (Military Standard)
 MIL-T-27 400 Cycle
 Pulse Transformers
 Molded Toroidal Inductors
 High Fidelity Transformers
 Transistor Transformers
 Link Replacements



You'll find them all in the new

CHICAGO

CATALOG
 of

the World's Toughest Transformers

These are just a few of the popular types of transformers for military, new equipment, general replacement, control and power circuit applications listed in CHICAGO's new Catalog . . . over 500 transformers, with complete physical and electrical specifications on each unit.

And more important—they are all *in stock* for quick delivery from your local CHICAGO distributor.

**Write Now FOR YOUR FREE COPY
 OF THIS VALUABLE REFERENCE.**

Ask for Catalog CT-554

CHICAGO STANDARD TRANSFORMER CORP.

3501 ADDISON STREET • CHICAGO 18, ILLINOIS



EXPORT SALES:
 Roburn Agencies, Inc.,
 431 Greenwich Street,
 New York 13, N. Y.

CIRCLE ED-13 ON READER-SERVICE CARD FOR MORE INFORMATION

Hermetically Sealed Thermostats

BY MAKING the enclosure itself the thermally responsive element, the C8 Series Electrical Thermostats shown on the cover afford high stability, rapid response, and great resistance to shock. Especially designed for use in military electronic applications, the units have high leakage resistance and can stand temperature extremes over their entire range, from -100°F to 300°F , without damage or change in temperature setting. Each mounting type of the basic mechanism is available with an external setting adjusting arm which does not break the glass-to-metal hermetic

Fig. 1. Cross-section of the non-adjustable-type thermostat.

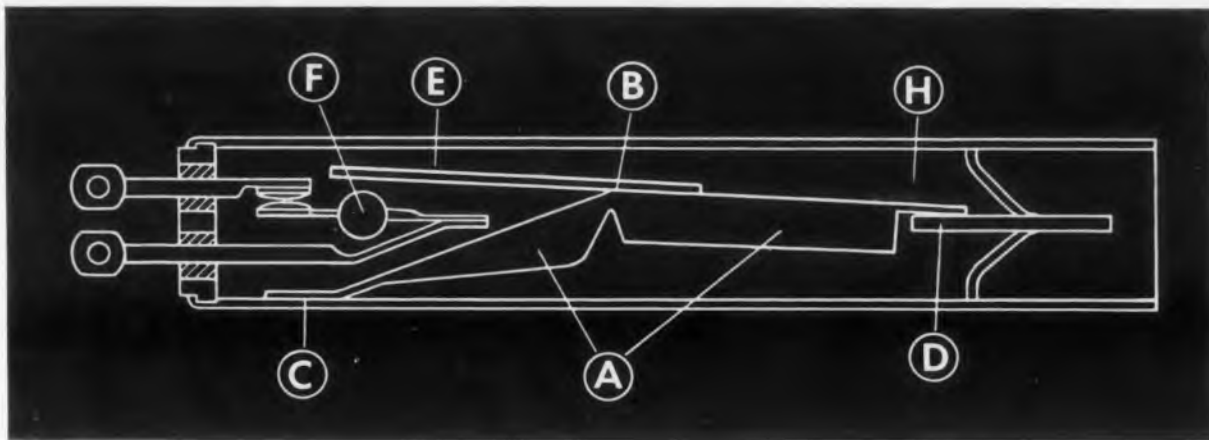

seal. One of the adjustable types is shown in Fig. 2.

They are suitable for direct control of moderate loads, for control of heavier loads through relays, and for over- and under-temperature indication, alarm, or cut-off service. Suggested applications are to control crystal ovens or other constant-temperature zones, to control stand-by heaters, to control pre-heating of equipment to a temperature at which it will start properly, and to control the cooling of large transmitting tubes. In many applications, the use of a small capacitor connected across the contacts improves action markedly. The units are manufactured by G-V Controls, Inc., 28 Hollywood Plaza, East Orange, N. J.



Fig. 2. Two of the C8 Series thermostats. The right one is adjustable.

The encasing brass shell of the thermostat, which is in direct contact with the controlled medium, expands and contracts with temperature change. Referring to Fig. 1, the invar member, the "dog-leg" shaped component (A), does not expand with temperature change. The left end (C) of this invar member is welded to the shell and the right end is connected by member (D) to the other end of the shell. When the shell expands, the pivot point (B) moves downward. This motion is multiplied by the extension arm (E), which bears against the round glass insulating bead (F) and opens the contacts.

The electrical structure is built entirely on the hermetic header of the thermostat. Current carrying parts are short. Load currents are not carried by or near thermally responsive elements, thus reducing self-heating effects.

To change the temperature setting of the unit, the adjusting tongue, which extends outside the hermetically sealed space, is deflected with respect to the shell's axis. This action raises or lowers the temperature at which the contacts open and close.

The temperatures at which the non-adjustable types act are factory set. Where the required response does not change with the life of the equipment in which the unit is installed, a handy specification procedure is to order some of the adjustable models for prototypes. Once the best response temperature is determined by test, the non-adjustable type can be ordered for production units.

With moderate heater loads, the units will control within $\pm 5^\circ\text{F}$, but when used as a temperature-indicating or alarm device, repetitive operation within $\pm 1^\circ\text{F}$ can be expected. The response times of the unit are approximately the same as that of a laboratory thermometer. The nominal rating of the palladium-silver contacts is 5amp, 115v a-c. The spst contacts can be specified to open or close on rising temperature. For more information,

CIRCLE ED-303 ON READER-SERVICE CARD

ELECTRONIC DESIGN • July 1954

In Oven Heat
or Arctic Cold



SILASTIC stays elastic

... gives you new freedom in the design of products ranging from traction motors to domestic steam irons, from aircraft engines to electric ranges.

- For example, "Cooking without looking" on electric ranges is made possible by an "electronic eye" embedded in a diaphragm of Silastic.*
- Load restrictions on diesel-electric locomotive motors have been removed by insulating field coils with Silastic R Tape; service life has been more than doubled.
- Aircraft limit switches protected by diaphragm-type wobbling seals of Silastic remain operable after long exposure to weather and temperatures below -100°F .
- Silastic gaskets and seals withstand hot oil at 450°F in aircraft engines; save 90% of the flight delays previously caused by pushrod packing leakage.

You no longer have to consider rubbers as transient materials useful over a very limited temperature span. Silastic, the Dow Corning silicone rubber, is serviceable over a span of more than 600 Fahrenheit degrees and after years of weathering. It retains its dielectric and physical properties including high thermal conductivity and low moisture absorption at temperatures from -100 to 500°F .

* T. M. REG. U. S. PAT. OFF.

Mail Coupon Today for data on the properties, performance and applications of Silastic.

first in Silicones

DOW CORNING CORPORATION

MIDLAND, MICHIGAN

Canada: Dow Corning Silicones Ltd., Toronto England: Midland Silicones Ltd., London
France: St. Gobain, Paris

Branch Offices in:
ATLANTA
CHICAGO
CLEVELAND
DALLAS
DETROIT
LOS ANGELES

NEW YORK
WASHINGTON, D. C.
(SILVER SPRING, MD.)

Dow Corning Corporation, Dept. DA-19, Midland, Michigan

Please send me:

- Table of Typical Properties and Applications of Silastic
 List of Silastic Fabricators
 32-page booklet entitled "What's a Silicone?"

NAME _____ TITLE _____

COMPANY _____

ADDRESS _____





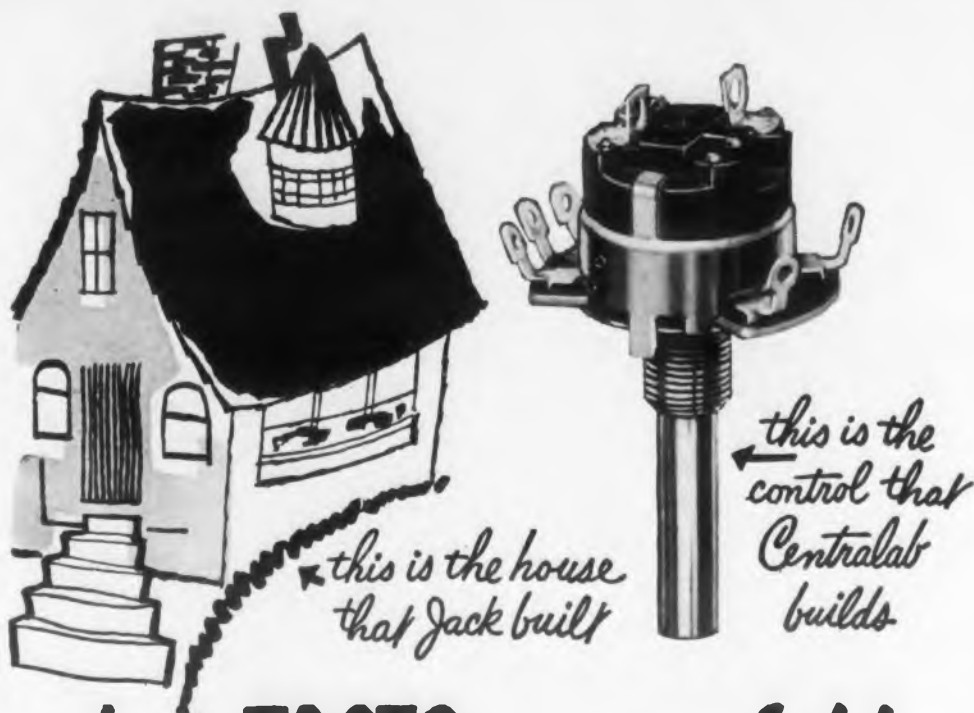









CITY _____ ZONE _____ STATE _____

CIRCLE ED-14 ON READER-SERVICE CARD FOR MORE INFORMATION



but **FACTS**...not fable

make the Model 2 Radiohm[®] industry's finest control
here's how it goes together...

SWITCH  ... COVER  ... STOP  it's positive. also provides superior switch shielding. Laminated phenolic SHOE  resists humidity. Double wiping CONTACT SPRING  for noiseless rotation. TERMINALS  ... velvet-smooth RESISTOR  available in 14 standard tapers. CENTER TERMINAL-COLLECTOR, specially treated for smooth take-off.  BASE  laminated phenolic for high humidity insulation. GROUND PLATE  ... BUSHING  accurately finished to close tolerances for smooth shaft rotation. RETAINING RING  ... SHAFT  available in round, flatted, slotted, split-knurl, and finger-tip knurl. ALL ASSEMBLED  the Model 2 is only 15/16" in diameter, rated at 1/2 watt.

VARIETIES AVAILABLE: single or twin, concentric shafts, plain or switch type, with or without taps; control and rotary tap switch combinations.

MANY SWITCH TYPES—Line switches rated 5 or 8 amps @ 125 volts a-c. Six switching combinations for real production flexibility.

NOW! Write for bulletins 42-164 and 42-157. Get all the facts and you'll specify Centralab.

Centralab

A Division of Globe-Union Inc.
952-G E. Keefe Avenue • Milwaukee 1, Wisconsin
In Canada: 804 Mt. Pleasant Road, Toronto, Ontario

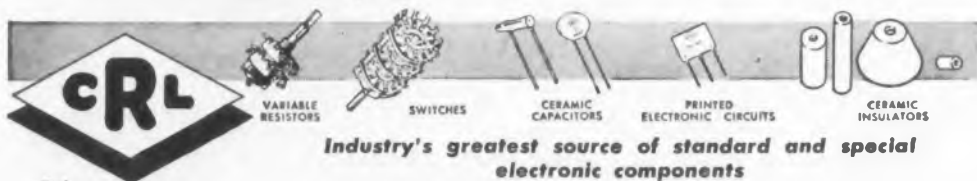

B-4

CIRCLE ED-15 ON READER-SERVICE CARD FOR MORE INFORMATION

Multi-Channel Amplifier Test System

GREAT flexibility for use has been designed into the Model 119 Amplifier System, shown on these pages. The engineer using this equipment can operate it remotely or trust its operation to technicians with minimum training. The photographs on these pages show how the designers of this instrument achieved ease of operation, installation and servicing, and included self-protective features.

Providing a complete static and dynamic measuring system for voltages at 0 to 1000cy, the system is manufactured by Heiland Research Corporation, 130 East Fifth Ave., Denver 9, Colo. Less than 0.5mv rms input signal can give full-scale output for wide-amplitude oscillograph readings. The system's six amplifiers were designed for use with this firm's fluid-damped galvanometers, but they may also be used with the more sensitive electromagnetically damped galvanometers.

The system is contained in two separate enclosures, which may be firmly fastened together as shown in Fig. 1. The units can be mounted in a standard 19" relay rack by using rack mount adaptors, which are available as accessories. Rubber feet are provided for placing them on a table, either side by side or stacked. Shock or vibration mounts for each case or for the two cases stacked together are available.

The Model 119 system utilizes a highly stable 5000cy carrier frequency. The oscillator's tuning fork is temperature-compensated to 20 parts per million per degree Centigrade. The system may be turned on and off and the channels may be calibrated simultaneously by remote control. Phone jacks are provided at various points in the circuit to enable oscillograph checks of wave forms to be made. The cases are made of lightweight cast aluminum.

CIRCLE ED-305 ON READER-SERVICE CARD

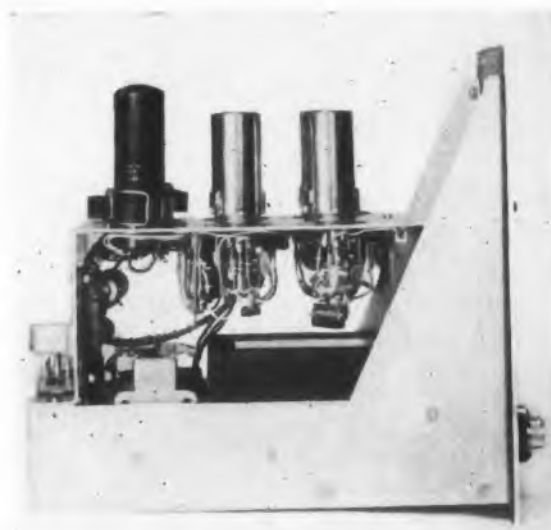

Fig. 2. The oscillator subassembly. All components are readily accessible for servicing due to the use of turret sockets.

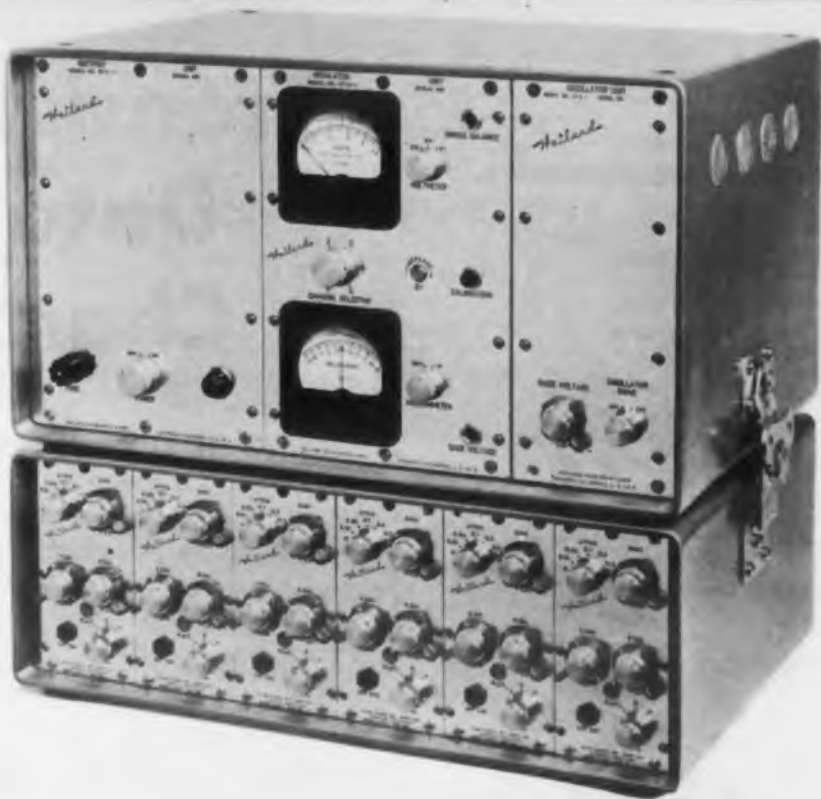
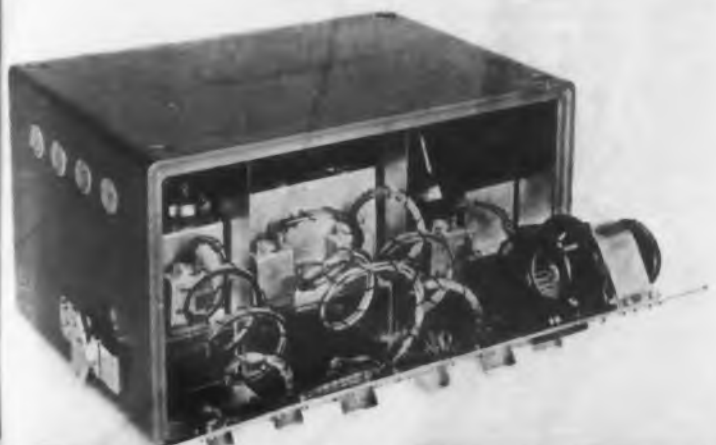

Fig. 1. The complete amplifier system. The power-supply-oscillator case (top) is locked to the amplifier case by connecting hardware. All operation and control is from the front panels. The controls lock in position either by detent action or by use of locking levers. Notice the two phone jacks in the regulator (middle, upper) panel where an oscilloscope can be inserted to check the waveforms during operation.

Fig. 3. The back of the amplifier case. The bridge circuit is etched into the panel. Connectors for all cables have been selected so that it is impossible to connect them to the wrong terminal.



Fig. 4. The back of the power-supply-oscillator case opened. The cable bunches are made long enough to operate each subassembly outside the case for servicing purposes. This case has an oscillator-synchronizing receptacle to connect to other oscillator units when two or more Multichannel Amplifier Systems are being used simultaneously for the purpose of keeping the outputs of all oscillators at the same frequency.



highly
oscil-
npen-
egree
ed on
rated
Phone
n the
ks of
made

RD

Kearfott developed RATE GYROS in production

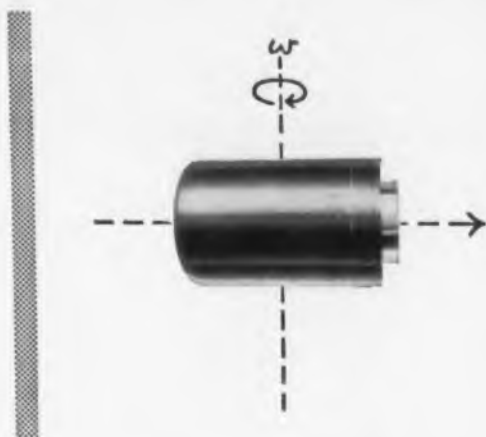

Eight basic rate gyros developed and produced by Kearfott are available for rate measurement, rate integrating or rate cutout applications.

SPRING RESTRAINED RATE GYROS

Max. Measuring Rate 12°/sec. to 720°/sec.

Type	Max. Output Null Ratio	Ratio Max. to Min. Input Rate	Dimensions	Weight
STANDARD	300:1	1000:1	2 3/8" x 3 7/8"	2 lbs.
HIGH SENSITIVITY	1000:1	2000:1	2 5/16" x 4 1/4"	4 1/2 lbs.
MINIATURE	1000:1	1500:1	2" x 3 5/16"	1 lb.

FLOATED RATE INTEGRATING GYROS

Type	Damping Ratio	Dimension	Weight	Drift Standard Deviation
HIGH ACCURACY	.3	6" x 3 3/4"	6.4 lbs.	.1°/hr.
MINIATURE	1	2" x 3 21/32"	1 3/8 lbs.	1/3 millirad/sec.

GYRO ACTIVATED RATE SWITCHES

Type	Cutout Rate	Dimensions	Weight
STANDARD	25°/sec.	3 1/2" x 5 3/32"	3 3/4 lbs.
MINIATURE	25°/sec.	3 1/2" x 4 3/16"	2 3/4 lbs.
SUBMINIATURE	15°/sec.	2" x 3 5/16"	3/4 lbs.

Kearfott Gyros are hermetically sealed in a dry inert gas and feature high pickoff output thus eliminating bulky external amplifiers.

Additional data and prices will be sent on request

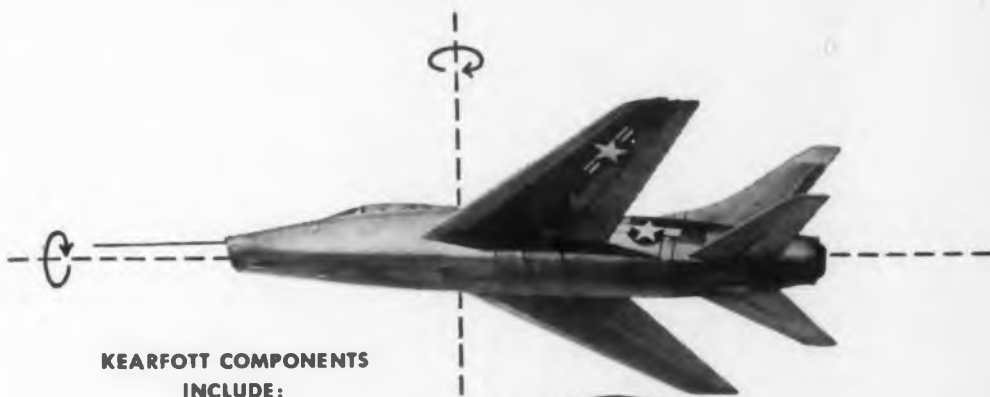

KEARFOTT COMPONENTS INCLUDE:

Gyros, Servo Motors, Synchros, Miniaturized Servo and Magnetic Amplifiers, Tachometer Generators, Hermetic Rotary Seals, Aircraft Navigational Systems, and other high accuracy mechanical, electrical and electronic components.

Visit the Kearfott display at the Western Electronic Show and Convention, August 25-27 at the Pan-Pacific Auditorium, Los Angeles, California.



KEARFOTT COMPANY, INC., LITTLE FALLS, N. J.

Sales and Engineering Offices: 1378 Main Avenue, Clifton, N. J.

Midwest Office: 188 W. Randolph Street, Chicago, Ill. South Central Office: 6115 Denton Drive, Dallas, Texas

West Coast Office: 253 N. Vinedo Avenue, Pasadena, Calif.

A GENERAL PRECISION EQUIPMENT CORPORATION SUBSIDIARY

CIRCLE ED-16 ON READER-SERVICE CARD FOR MORE INFORMATION

Transistor Data Chart

Manu- facturer	Type No.	Class	Maximum Ratings			Typical Operation										Application		
			V _e (Volts)	I _c (MA)	W _c (MW)	I _c (MA)	V _c (Volts)	I _c (MA)	α	PG (DB)	PO (MW)	NF (DB)	F _{co} (Mc)	C				
Junction Transistors																		
A	OC70	P-N-P	-4.5	-10	6(45°C)		-2	0.5	30					10	GE	Audio		
	OC71	P-N-P	-4.5	-10	6(45°C)		-2	3	47					10	GE	Audio		
	O80C	P-N-P	-30	-10	50(45°C)		-2	0.5	30					10	GE	Audio		
	O81C	P-N-P	-30	-10	50(45°C)		-2	3	47					10	GE	Audio		
CBS	2N36	P-N-P	-20	-8	50	1	-6	-1	45	40(a)				21	GE	Hi-gain amp.		
	2N37	P-N-P	-20	-8	50	1	-6	-1	30	36(a)				18	GE	Hi-gain amp.		
	2N38	P-N-P	-20	-8	50	1	-6	-1	15	32(a)				16	GE	Low-gain amp.		
	HA-1	P-N-P	-20	-8	50		-3	-0.5	30	37(a)				12	GE	Hearing aid		
	HA-2	P-N-P	-20	-8	50		-3	-0.5	30	37(a)				27	GE	Hearing aid		
	HA-3	P-N-P	-20	-12	50		-3	-2.5	35		3(b)				GE	Hearing aid		
GE	2N43	P-N-P	-45	-50	150(25°C)	1	-5		0.98	39(c)				22	1	GE	Hi-gain amp.	
	2N44	P-N-P	-45	-50	150(25°C)	5	-20		0.95	33(d)	40			22	1	GE	Low power	
	2N45	P-N-P	-45	-50	150(25°C)	5	-20		0.92	30(e)	40			22	1	GE	Low power	
GP	RD-2517A	N-P-N	30	10	50(25°C)	-1	4.5	1	0.93	38				20	1	GE	Amp., switch	
	RD-2520A	N-P-N	30	10	50(25°C)	-1	4.5	1	0.98	40				20	2.5	GE	Amp., switch	
	RD-2521A	N-P-N	40	10	50(25°C)	-1	4.5	1	0.98	47				20	2.5	GE	Military	
	RD-2525A	N-P-N	25	5	25(25°C)	-1	4.5	1	0.99	47				20	5.0	GE	Amp., switch	
H	J-1	P-N-P	-40	-10	150	1	-6		0.97					11	1	GB	Low power	
	J-2	P-N-P	-40	-10	150	1	-6		0.94					22	0.5	GB	Low power	
	J-3	P-N-P	-40	-10	150	1	-6		0.90					33	0.5	GB	Low power	
MH	2N57	P-N-P	-60	800	2000(70°F)		28	350		20(f)	5000				0.02	GE	Power	
NU	T34D	P-N-P	-27	12	47(25°C)	1	-4.5	1	66	39(g)				20		GE		
	T34E	P-N-P	-27	12	47(25°C)	1	-4.5	1	21	38(f)				24		GE		
	T34F	P-N-P	-27	12	47(25°C)	1	-4.5	1	20	36(f)				28		GE		
P	2N47	P-N-P	-35	-20	50(25°C)	1	-5	-1	0.98					15			Hearing aid	
	2N49	P-N-P	-35	-20	50(25°C)	1	-5	-1	0.98					12			Hearing aid	
	2N62	P-N-P	-35	-20	50(25°C)	1	-5	-1	0.98					15			Medium power	
RCA	2N34	P-N-P	-25	-8	50	1	-6	-0.01	0.98	40(g)						GE	Audio amp.	
	2N35	N-P-N	25	8	50	-1	6	0.01	0.98	40(g)						GE	Audio amp.	
RR	RR14	P-N-P	-25		70(50°C)	-0.5	-1.5			36(a)				19		GE		
	RR20	P-N-P	-25		70(50°C)	-0.5	-1.5			40(a)				19		GE		
	RR21	P-N-P	-25		70(50°C)	3	-1.5							19		GE		
	RR34	P-N-P	-25		70(50°C)	0.5	-1.5			32(a)				19		GE		
	RR38	P-N-P	-25		70(50°C)	-3	-1.3			28(h)		1				GE		
	RR80YD	P-N-P	-6	-5	40(50°C)		-1.3	(al)	50(ak)	30(ai)				16(ak)		GE	Hearing aid	
	RR80RD	P-N-P	-6	-5	40(50°C)		-1.3	(al)	50(ak)	30(ai)				24(ak)		GE	Hearing aid	
	RR80BD	P-N-P	-6	-5	40(50°C)		-1.3	(am)	50(ak)	25(aj)				24(ak)		GE	Hearing aid	
	RR83	P-N-P	-25		50(50°C)	1	-4.5		40					24	0.7			
	RR87	P-N-P	-25		70(50°C)	1	-4.5		24					24	0.5			
	2N34	P-N-P	-25		70(50°C)	1	-6		40	40(g)							GE	
	2N36	P-N-P	-25		70(50°C)	1	-6		45	40(a)							GE	
	2N37	P-N-P	-25		70(50°C)	1	-6		30	36(a)							GE	
	2N38	P-N-P	-25		70(50°C)	1	-6		15	32(a)							GE	
	2N39	P-N-P	-30		50(50°C)	1	-4.5	1		39(g)				24			GE	
	2N40	P-N-P	-30		50(50°C)	1	-4.5	1		38(g)				24			GE	
	2N42	P-N-P	-30		50(50°C)	1	-4.5	1		36(g)				24			GE	
RAY	CK721	P-N-P	-22	-10	33(30°C)	1	-6		45	41(i)				22	0.8	GE	Gen. purpose	
	CK722	P-N-P	-22	-10	33(30°C)	1	-6		12	36(j)				30	0.8	GE	Gen. purpose	
	CK723	P-N-P	-22	-10	33(30°C)	1	-6		22	39(k)				25	0.8	GE	Gen. purpose	
	CK725	P-N-P	-22	-10	33(30°C)	1	-6		90	42(l)				20	0.8	GE	Hi-gain audio	
	CK727	P-N-P	-6	-10	30(35°C)	0.5	-1.5		35	36(m)				12	0.8	GE	Low noise	
	2N63	P-N-P	-22	-10	33(30°C)	1	-6		22	39(k)				25	0.8	GE	Audio	
	2N64	P-N-P	-22	-10	33(30°C)	1	-6		45	41(i)				22	0.8	GE	Audio	
	2N65	P-N-P	-22	-10	33(30°C)	1	-6		90	42(l)				20	0.8	GE	Audio	
S	2N34	P-N-P	-25	-8	50	1	-6		40	40(g)						GE	Amp.	
	2N35	N-P-N	25	8	50	-1	6		40	40(g)						GE	Amp.	
	2N68	P-N-P	-25	-8	2000	125	-12	125		710(m)						GC	Power	
TI	200	N-P-N	30	5	50(25°C)	-1	5		9	37(j)				26	0.9	GE	Hi-gain audio	
	201	N-P-N	30	5	50(25°C)	-1	5		19	40(j)				23	1.1	GE	Hi-gain audio	
	202	N-P-N	30	5	50(25°C)	-1	5		49	43(o)				20	1.3	GE	Hi-gain audio	
	206	N-P-N	30	5	50(25°C)	0.5	2.5		35					14		GE	Hearing aid	
	207	N-P-N	30	5	50(25°C)	0.5	2.5		19	29				21		GE	Hearing aid	
	208	N-P-N	30	5	50(25°C)	-10	2.5		19	26						GE	Hearing aid	
	300	P-N-P	-30	-10	50(25°C)	1	-5		9								Audio amp.	
	301	P-N-P	-30	-10	50(25°C)	1	-5		19								Audio amp.	
	X-2	N-P-N	35	75	80(25°C)		22.5	40	9	22.7(p)	500				0.225	GE	Low level audio	
																	Power	

COMMERCIALLY available transistors are listed on the chart shown on these pages. This is the second such compilation (*ED, July, 1953, p. 11*). Transistors being produced for military consumption only or those made for special users are not included. The data were obtained from information furnished by the manufacturers. For specifications for specific applications, the individual manufacturer should be consulted. The following companies are listed as sources of transistors.

- AAmperex Electronic Corp., 230 Duffy Ave., Hicksville, N. Y.
 CBSCBS-Hytron, Division of Columbia Broadcasting System, Danvers, Mass.
 GEGeneral Electric Co., Electronics Park, Syracuse, N. Y.
 GPGermanium Products Corp., 26 Cornelison Ave., Jersey City 4, N. J.
 HHydro-Aire, Inc., 3000 Winona Ave., Burbank, Calif.
 MHMinneapolis-Honeywell Regulator Corp., 2747 Fourth Ave. S., Minneapolis, Minn.
 NUNational Union Radio Corp., Johnsville Rd., Hatboro, Pa.
 PPhilco Corp., Government & Industrial Div., 4700 Wissahickon Ave., Philadelphia 44, Pa.
 RCARadio Corporation of America, Tube Dept., Harrison, N. J.
 RRRadio Receptor Co., 251 W. 19th St., New York 11, N. Y.
 RAY ...Raytheon Manufacturing Co., 55 Chapel St., Newton, Mass.
 SSylvania Electric Products Co., 1740 Broadway, New York 19, N. Y.

Footnotes

- (a) Z_s (source impedance) = 1000;
 R_l (load resistance) = 30,000.
 (b) Z_s = 1000; R_l = 1200.
 (c) Z_s = 600; R_l = 4000.
 (d) Z_s = 220; R_l = 4500.
 (e) Z_s = 125; R_l = 4500.
 (f) Operated push-pull, Class B2.
 (g) Z_s = 500; R_l = 30,000.
 (h) Z_s = 500; R_l = 350.
 (i) Z_s = 1500; R_l = 20,000.
 (j) Z_s = 500; R_l = 20,000.
 (k) Z_s = 800; R_l = 20,000.
 (l) Z_s = 2700; R_l = 20,000.
 (m) Z_s = 1000; R_l = 20,000.
 (n) Z_s = 50; R_l = 24.
 (o) Z_s = 1250; R_l = 20,000.
 (p) Operated push-pull, Class B. Load = 1000.
 (q) Z_s = 50; R_l = 1000.
 (r) With heat sink.
 (s) R_l = 4500; distortion = 6%.
 (t) Z_s = 500; R_l = 50,000.

- TITexas Instruments, Inc., 6000 Lemmon Ave., Dallas 9, Texas
- TPTransistor Products, Inc., Snow & Union Streets, Boston 35, Mass.
- TRTransitron Electronic Corp., 403 Main St., Melrose 76, Mass.
- TSTung-Sol Electric Inc., 95 Eighth Ave., Newark 4, N. J.
- WWestinghouse Electric Corp., Electronic Tube Div., P. O. Box 284, Elmira, N. Y.

The column headings at the top of the chart stand for the following parameters:

- V_c Collector voltage
- I_c Collector current
- W_c Collector dissipation
- I_e Emitter current
- α the "alpha" or current amplification factor
- PG Power gain
- PO Power output
- NF Noise factor
- F_{co} Frequency cutoff
- C Type of circuit for which the characteristics are listed: "GE" being grounded emitter connection, and "GB" being grounded base connection.

Since the temperature at which collector dissipation is measured is pertinent, that temperature is listed in parentheses where available beside W_c in the chart.

For certain transistors intended for switching circuits, rise times (T_r) and cutoff times (T_c) are listed instead of other characteristics.

In addition to the transistors listed, photo transistors are produced by Radio Receptor (Type *RR66*), Texas Instruments (Type *800*) and Transistor Products (Type *X-25*).

Most of the transistors are hermetically sealed. A smaller number are plastic encapsulated, and a few of the latter are both plastic encapsulated and hermetically sealed. The plastic encapsulated types are usually in metal enclosures.

For reprints of this chart,

CIRCLE ED-325 ON READER-SERVICE CARD

- (u) Operated push-pull, Class B, Load = 2000.
- (v) $Z_s = 25$; $R_1 = 9000$.
- (w) Osc. frequency.
- (x) Each emitter.
- (y) $Z_s = 425$; $R_1 = 17,500$.
- (z) $Z_s = 500$; $R_1 = 10,000$.
- (aa) At 50Mc.
- (ab) $Z_s = 500$; $R_1 = 15,000$.
- (ac) $T_r = 0.2\mu\text{sec}$.
- (ad) $T_r = 0.10\mu\text{sec}$.
- (ae) Selected for maximum gain and uniform collector characteristics.
- (af) $T_r = 0.15\mu\text{sec}$.
- (ag) $T_r = 1.0\mu\text{sec}$ (max.).
- (ah) Class A operation, 10% distortion, $Z = 600$, $R = 5000$.
- (ai) $Z_s = 2000$; $R_1 = 18,000$.
- (aj) $Z_s = 1500$; $R_1 = 300$.
- (ak) Measured at $V_c = -4.5v$.
- (al) 0.3 — 0.5ma.
- (am) 1.65 — 2.2ma.

* New data under preparation by manufacturer.

Manufacturer	Type No.	Class	
TP	X-22*	N-P-N	
	X-23*	N-P-N	
	X-27*	N-P-N	
	X-78C*	P-N-P	
	X-78B*	P-N-P	
	X-78E*	P-N-P	
	X-102*	P-N-P	
	TR	2N34	P-N-P
		2N36	P-N-P
		2N37	P-N-P
2N38		P-N-P	
2N43		P-N-P	
2N44		P-N-P	
2N45		P-N-P	
2N63		P-N-P	
TS	DR-100	P-N-P	
	DR-101	P-N-P	
	DR-102	P-N-P	
	DR-108	P-N-P	
	DR-109	P-N-P	
	DR-110	P-N-P	
	W	2N54	P-N-P
2N55		P-N-P	
2N56		P-N-P	
Silicon Transistors			
TI	900	N-P-N	
	901	N-P-N	
	X-15	N-P-N	
Tetrode Transistors			
GP	RDX-300	N-P-N	
	RDX-301	N-P-N	
	RDX-302	N-P-N	
S	3N21	Pt. Cont.	
TI	700	N-P-N	
Point Contact Transistors			
A	OC50		
	OC51		
CBS	PT-2A		
	PT-2S		
H	A-0		
	A-1		
	A-2		
	A-3		
	S-0		
	S-1		
	S-2		
RCA	2N32		
	2N33		
S	2N32		
TI	102		
	103		
TP	2A		
	2C		
	2D		
	2E		
	2G		
	2H		
	2L		
	2N32		
	2N33		
	2N50		
2N51			
2N52			
2N53			
W	WX3347		
	WX4811		
	WX4812		

Maximum Ratings			Typical Operation								Application		
V _c (Volts)	I _c (MA)	W _c (MW)	I _c (MA)	V _c (Volts)	I _c (MA)	α	PG (DB)	PO (MW)	NF (DB)	F _{ro} (Mc)		C	
40	5	50	1	4.5		0.9						GB	Amp.
40	5	50	1	4.5		0.95						GB	Amp.
40	5	50	1	4.5		0.8						GB	Amp.
45	50	1000	150	35	40		10	600		0.01		GC	Power amp.
45	50	1000	150	35	40		10	600		0.01		GB	Power amp.
45	50	1000	150	35	40		10	600		0.01		GE	Power amp.
45	50	500	75	35	25		10	300		0.01		GC	Power amp.
-25	-20	125	1	-6	-1	55	41(a)		20	0.8		GE	Hi-gain amp.
-25	-20	125	1	-6	-1	60	41(a)		20	0.8		GE	Hi-gain amp.
-25	-20	125	1	-6	-1	38	37(a)		22	0.6		GE	Amp.
-25	-20	125	1	-6	-1	22	35(a)		24	0.5		GE	Gen. purpose
-45	-50	375(r)	1	-6	-1	50	40(a)		20	0.7		GE	Medium power
-45	-50	375(r)	1	-6	-1	22	37(a)		22	0.5		GE	Medium power
-45	-50	375(r)	1	-6	-1	19	33(a)		22	0.4		GE	Medium power
-45	-20	125	1	-6	-1	22	38(a)		18	0.5		GE	Gen. purpose
-25	-20	125	1	-6	-1	45	39(a)		16	0.7		GE	Medium gain
-25	-20	125	1	-6	-1	90	42(a)		15	1		GE	Hi-gain
-15	-20	50	0.5	2.5	-0.5	35	38(q)		15			GE	Subminiature
-45	-1000	10,000(r)	100	-20	-100	20	30(q)	800		0.2		GE	Hi-power
-45	-100	750(r)	1	-6	-1	50	40(a)		20	0.8		GE	Hi-power, hi-freq.
-10	8	30		-1.5	-1	25	30(a)		10	1		GE	Low noise amp.
-25	8	30		-1.5	-1	15	25(a)		30	1		GE	Gen. purpose
-10	8	30		-1.5	-2	30	30(s)		20	1		GE	Amp.
-10	8	30		-6	-1	15	25(a)		30	1		GE	Gen. purpose
-10	8	30		-1.5	-1	30	30(a)		20	1		GE	Amp.
-25	8	30		-15	-1	100	40(a)		30	1		GE	High alpha
-45	-10	200(25°C)		-6	-1		40(t)			0.5		GE	Low power amp.
-45	-10	200(25°C)		-6	-1		39(t)			0.5		GE	Low power amp.
-45	-10	200(25°C)		-6	-1		38(t)			0.5		GE	Low power amp.
30	10	50(100°C)	-1	5		0.90			23	2			Audio amp.
30	10	50(100°C)	-1	5		0.90			23	2			Audio amp.
50	100	500(85°C)	45	35			14	1000(u)					Power
25	5	50		22.5			16.5(v)			60(w)		GB	Osc., amp., switch
25	5	50		22.5			14(v)			30(w)		GB	Osc., amp., switch
25	5	50		22.5			12(v)			15(w)		GB	Osc., amp., switch
-60		100	1(x)	-45		2.5						G3	Switch
30		50(25°C)	-1	5		0.95						GE	AGC circuit
-30	-12	120(40°C)	1.5	-5		2.1			43	1		GB	Amp.
-50	-15	100(55°C)	1	-30		2.2				1.5		GB	Switch
-40	-10	100	0.5	-30	-1.2	1.85	18(y)		55	2		G3	Amp.
-40	-10	100	0.5	-30		1.85				2		GB	Switch
-20	8	50	0.3	-8		2				3		GB	Amp.
-20	8	50	0.3	-8		2				2		GB	Amp.
-20	8	50	0.3	-8		2				1		G3	Amp.
-20	8	50	0.3	-8		2				0.3		GB	Amp.
-40	8	50	T _r = 0.2 μsec; T _c = 1 μsec									GB	Switch
-40	8	50	T _r = 0.5 μsec; T _c = 2 μsec									GB	Switch
-40	8	50	T _r = 1 μsec; T _c = 6 μsec									G3	Switch
-40	-8	50	0.5	-25		2.2	21(z)			0.9		GB	Pulse
-8.5	-7	30	0.3	-8	-3.3			1(aa)					H-F osc.
-40	-8	50	0.5	-25		2.2	21(z)					GB	Switch
-25	-15	75(25°C)	T _r = 0.2 μsec; T _c = < 2 μsec										Switch
-25	-15	75(25°C)	T _r = 0.2 μsec; T _c = > 2 μsec										Switch
-50	-8	120	1	-30		1.5	22(ab)					GB	Amp., osc.
-50	-8	100	2	-15		2						GB	Switch
-50	-8	100	1	-30		1.5	22(ab)			2(ac)		GB	Amp., osc.
-50	-8	100	1	-30		1.5	22(ab)					GB	Amp.
-50	-	120	2	-15		2				10(ad)		GB	Switch
-50	-8	100	1	-30		2	22(ab)			(ae)		GB	Amp.
-50	-	50	1	-15		2.2	22			5		GB	Switch
-40	-8	50	0.5	-25		2.2	21(j)			2.7		GB	Switch
-8.5	-7	30	0.3	-8.5		2.3	22(j)			3(ac)		GB	Switch
-15	-1	50	2	-15		2	22,ab)			3(ac)		GB	Switch
-50	-8	100	8	-7		2.2	(ad)					GB	Switch, osc.
-50	-8	120	1	-30		1.5	22(ab)			1		GB	Amp., osc.
-50	-8	120	2	-15		2				5(ad)		GB	Switch
-40	-10	100	1.5	-20	-5	2	15(ah)		25	2		GB	Amp.
-40	-10	100				2.2(ag)							Switch
-40	-10	100	0.5	-20	-2.5	2	20			10		GB	Amp.

Plug-In Transistor Circuits



PLUG-IN Transistor Circuits, known as "Lee-Pacs", that offer savings in both the development and manufacture of transistorized equipment are available in five basic circuit types. All mounted on a standard 9-pin base in the same size can, shown in phantom in Fig. 1, the units include an audio amplifier, a cathode follower, two pulse generators, and a sine wave oscillator. The circuits for the various types are shown in Figs. 2-5. The units all weight about 1 oz.

The audio amplifier, Stock No. LPQA-14-001-1, has an input impedance of 60 ohms and an output impedance of 10,000 ohms. Power out at 1kc with an input signal of 0.04v peak-to-peak is 1/2mw. Direct

current bias power is 36mw. There is less than 1/2db change in output with $\pm 15\%$ change in bias.

The cathode follower, Stock No. LPHK-14-002-1, has an input impedance of 9000 ohms for a load impedance of 1000 ohms. Power output with 4v peak-to-peak input signal (the maximum) is 2mw. Direct current bias power is 5mw. The unit's frequency response is flat from 20cy to nearly 10kc.

Both pulse generators (Stock Nos. LPJG-34-001-1A and LPJG-23-001-1) require 27mw d-c power input with a load resistance of 270 ohms. The first type has a pulse frequency range of 10,000 to 50,000 pulses per sec for a pulse width of about 1 μ sec. The second

type has a pulse frequency range of 500 to 10,000 pulses per sec for a pulse width of about 6 μ sec. Frequency for both types varies less than -4% for a -20% change in bias voltage.

Any frequency between 50cy and 100kc can be specified for the sine-wave oscillator, Stock No. LPSM-14-004-1. Power output is 2.25mw for a d-c power input of 200mw.

The physical dimensions of the units are 2-3/16" x 29/32" x 29/32". These plug-in devices are manufactured by Lee Laboratories, Genesee, Pa., who plan to introduce other circuits of this size.

CIRCLE ED-307 ON READER-SERVICE CARD FOR MORE INFORMATION

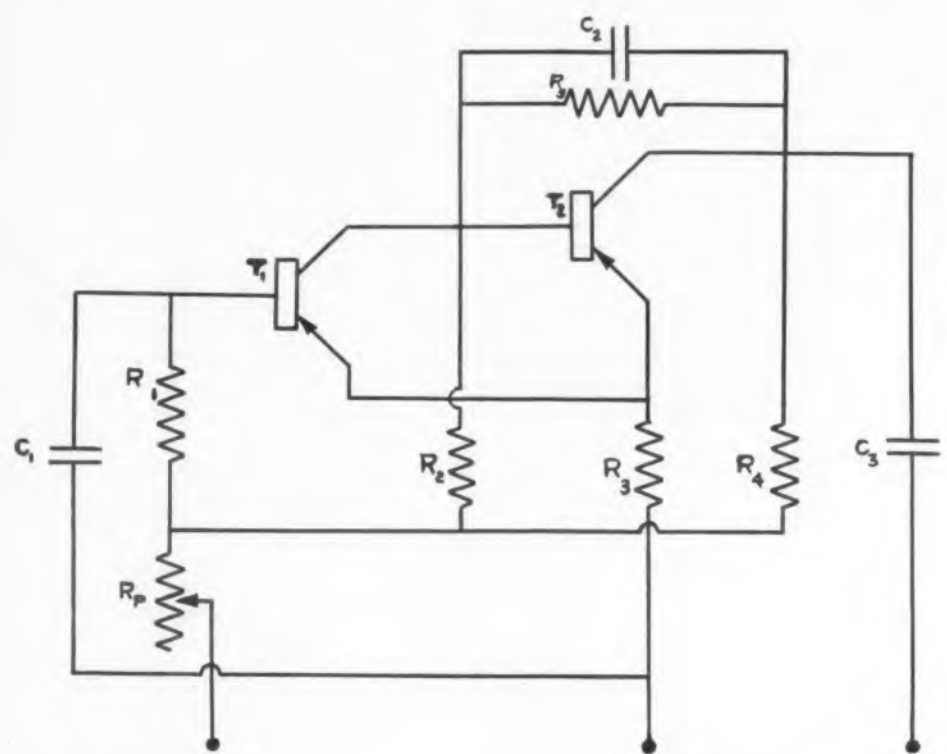

Fig. 2. This sine-wave oscillator circuit can be specified for any frequency from 50cy to 100kc.

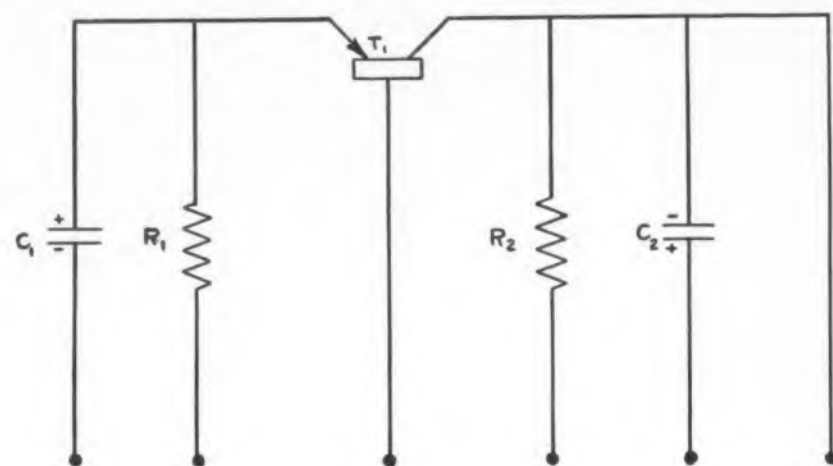

Fig. 4. The frequency response of this cathode-follower circuit is flat from 20cy to nearly 10kc.

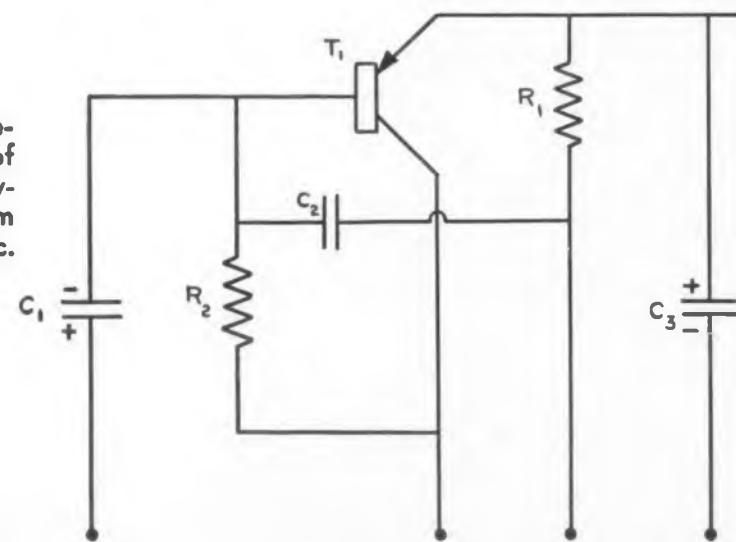

Fig. 3. The physical appearance of this audio-amplifier circuit is shown in Fig. 1, above and right.

Fig. 1. Front (left) and back (below) views of a "Lee-Pac" with the enclosure in phantom.

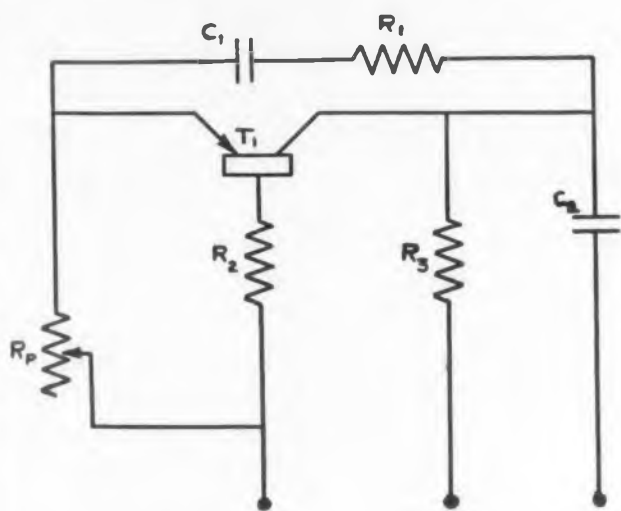
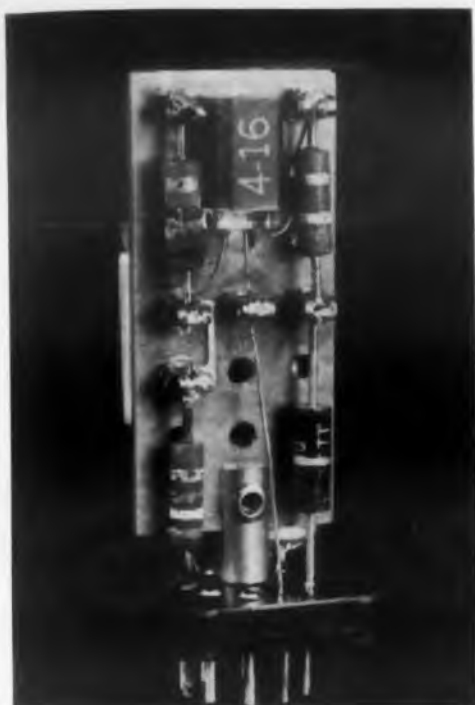
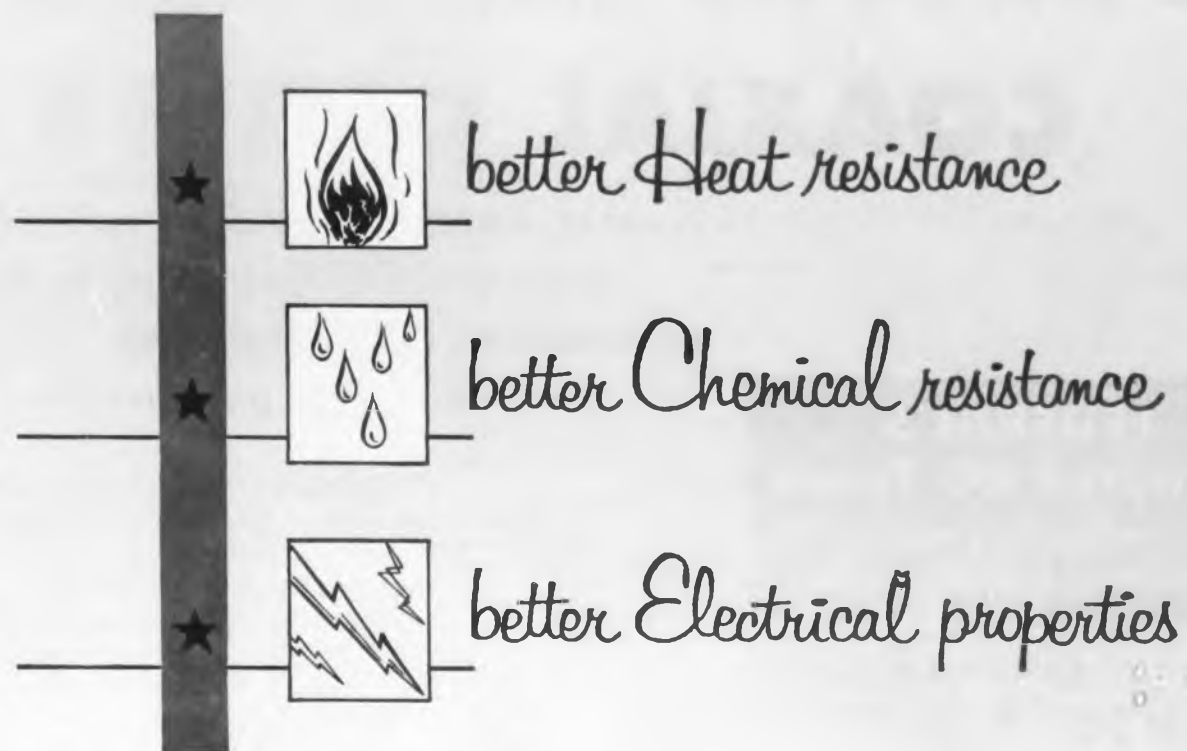

Fig. 5. Circuit for both pulse generators. The plug-in units weigh only 1 oz, making them useful in applications where weight saving is important.

Important news!

EPON[®] resin 828 with new Curing Agent CL gives



IF YOU are among the many users of Epon resin 828 for casting, laminating or other structural applications—you will welcome this new development of Shell Chemical's continuing research program.

Curing Agent CL* produces Epon resin polymers with improved mechanical and electrical properties at temperatures as high as 300° F. After three hours' immersion in boiling water or acetone, glass cloth laminates of

Epon resin 828 and Curing Agent CL retained more than 95% of their initial dry flexural strength. And with Curing Agent CL you can use the "B-stage," or pre-curing, process—permitting dry layups and specialized casting techniques.

Your request will bring you a sample of Epon resin 828 and Curing Agent CL for evaluation, as well as a copy of Technical Bulletin SC:54-10. Write for them—today.

Curing Agent CL is Shell Chemical Corporation's name for metaphenylene diamine. We do not manufacture Curing Agent CL. It is available in commercial quantities from E. I. du Pont de Nemours & Company and National Aniline Division, Allied Chemical & Dye Corp.

*A development of Shell Chemical laboratories. Patent applied for.

SHELL CHEMICAL CORPORATION

CHEMICAL PARTNER OF INDUSTRY AND AGRICULTURE

380 Madison Avenue, New York 17 • 100 Bush Street, San Francisco 6
Atlanta • Boston • Chicago • Cleveland • Detroit • Houston • Los Angeles • Newark • St. Louis
IN CANADA: Chemical Division, Shell Oil Company of Canada, Limited • Montreal • Toronto • Vancouver

CIRCLE ED-18 ON READER-SERVICE CARD FOR MORE INFORMATION



THE CHOICE FOR **MARINE**
APPLICATIONS



Federal QUALITY-CONTROLLED COAXIAL CABLES

... serve on the Seven Seas with the same dependability they bring to ALL transmission requirements of communications and industry!

**FEDERAL'S
Armored RG Types**
Outstanding for ruggedness,
efficiency and reliability

RG-10/U • RG-12/U • RG-18/U
RG-20/U • RG-35/U • RG-74/U
RG-79/U



RG-18/U



RG-12/U



RG-79/U

Remember: Federal is the manufacturer of "America's most complete line of solid dielectric cables." Tell us your needs!



AVIATION

On ships at sea ... plowing through all kinds of weather ... from sub-zero regions to the tropics!

That's where coaxial cables receive the supreme test of *dependability* ... operating radar, direction finders, Loran, RF power and general communications ... safeguarding human life and valuable cargoes!

Marine applications are only one of the many fields where Federal quality-controlled coaxial cables are the choice of designers and engineers for *trustworthy transmission*!

In aviation, industry, broadcasting, TV, test, experimental, pulse or special purpose ... for HF, VHF or UHF anywhere ... you'll find the best in *quality and performance* in Federal's RG types. Write us today about your specific requirements, to Dept. D-135.



BROADCASTING



TEST EQUIPMENT

YOURS FOR THE ASKING: Federal's new 28-page buying guide contains a world of information on Federal quality-controlled wires and cables, plus numerous tables and diagrams. For your free copy write to the department above.



RADAR, PULSE,
EXPERIMENTAL EQUIPMENT
AND SPECIAL TYPES



INDUSTRIAL

High-Output Crystal Photocell

ABOUT one million times as sensitive as the conventional vacuum tube photocell, the Crystal Photocell Type CL-1 shown in Fig. 2 has an output at low-light levels sufficient to fire a cold-cathode discharge tube or operate a meter-type or electrostatic relay. At high light levels the output can operate conventional sensitive magnetic relays.

The sensitive semiconductor element is a very pure cadmium sulphide crystal. It responds to light over the entire visible spectrum, having maximum response near the green portion. It also exhibits considerable response to near infrared, hard X-ray, and gamma-ray radiation. The action of the crystal is one of photoconductivity, the resistance being an inverse function of light and extremely high in the absence of illumination. Since the cell conducts substantially the same on both polarities of voltage, it may be used to modulate an alternating current.

The crystal is imbedded 1/8" from one end of a transparent plastic cylinder 1/4" in diam and 1/2" long. The crystal end of the cylinder is unpainted, thus providing a window for light. Tinned copper leads extend from the other end. These leads may be used for soldering directly or cut off short for socket pins. This design results in a small, rugged, moisture-proof unit. The photocell is manufactured by the Clairex Corp., 50 W. 26th St., New York 10, N. Y.

Modifications of the standard type can be specified. Photocells having higher sensitivity, of different sizes, or with a plastic lens incorporated are available.

Typical static characteristics of the unit are shown in Fig. 1. Its median characteristics are as follows: sensitivity of 100 μ amp at 100v and 2 foot-candles; dark current of 0.05 μ amp at 100v; output with frequency decreases 6db per octave throughout the audio range for modulated light (The cell may be compensated for flat response by a single high-pass RC network.); effective time constant to modulated light is an inverse function of illumination—at 1 foot-candle it is about 0.05sec. The maximum voltage rating of the unit is 250v. Maximum power dissipation is 50mw.

Fig. 4 shows a basic schematic in which direct relay operation may be obtained from the output of the CL-1 Photocell. Light from a 5 candlepower source



Federal Telephone and Radio Company

A Division of INTERNATIONAL TELEPHONE AND TELEGRAPH CORPORATION
SELENIUM-INTELIN DEPARTMENT Dept. D-135 100 KINGSLAND ROAD, CLIFTON, N. J.
In Canada: Federal Electric Manufacturing Company, Ltd., Montreal, P. Q.
Export Distributors: International Standard Electric Corp., 67 Broad St., N. Y.

CIRCLE ED-19 ON READER-SERVICE CARD FOR MORE INFORMATION

GET YOUR DC
from AC with dependable, long-life Federal Selenium Rectifier Power Supplies.

is directed in a parallel beam by the collimating lens to the collecting lens, which further directs it to the crystal element of the device. Alternate passage and interruption of the light beam will cause the relay to operate and release. Such an arrangement is applicable to automatic door openers, industrial control devices, counters, machinery safeguards, etc.

A circuit employing the unit to trigger a cold cathode gas discharge triode is shown in Fig. 6. The gas discharge triode in turn operates a thermal delay relay. This circuit may be employed, for example, to switch on signs, lights, etc., at dusk and turn them off at dawn. The sensitivity of the circuit may be set by adjusting the 10 megohm rheostat to obtain actuation at one foot-candle incident illumination. No lens is required. In this circuit the photocell is operated by alternating current.

A circuit providing fast operation of a relay, mechanical counter, or other load at low light levels is shown in Fig. 3. The R-C combination in the cathode of the 6C4 triode equalizes the time constant of the CL-1. For operation at one foot-candle C_1 should be about 10mfd, while at 0.1 foot-candle 100mfd, would

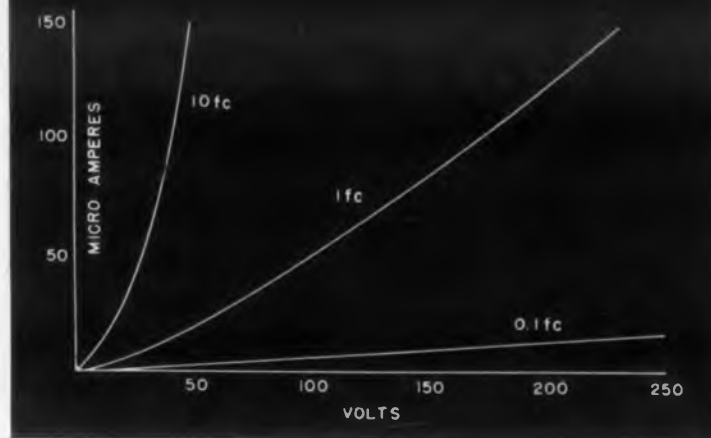

Fig. 1. Static characteristics of the photocell for various illuminations (in foot-candles).

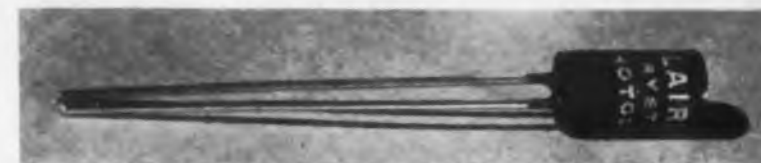

Fig. 2. The Type CL-1 Crystal Photocell

be an appropriate value. No lens is required.

In the circuit diagram of Fig. 5, the NE-48 glow tubes are employed in a basic flip-flop circuit which operates by virtue of the difference between the starting and operating voltages of the glow lamp. The circuit is triggered by discharge of the 0.25mfd condenser through the NE-2 tube. The condenser is charged by current through the photocell resulting from an impulse of light. The one megohm potentiometer controls the sensitivity and is adjusted accord-

ing to the light intensity. No lens is required. Each successive impulse of light triggers the circuit so that the relay is alternately actuated.

Such a circuit might be used, for example, as an indication of the entrance and exit of a person into a room. A person interrupting the light beam on entering would actuate an indicator or put on a light. When the beam is interrupted on leaving, the indicator or light would be turned off. For more information,

CIRCLE ED-308 ON READER-SERVICE CARD

Fig. 3. Time compensated circuit.

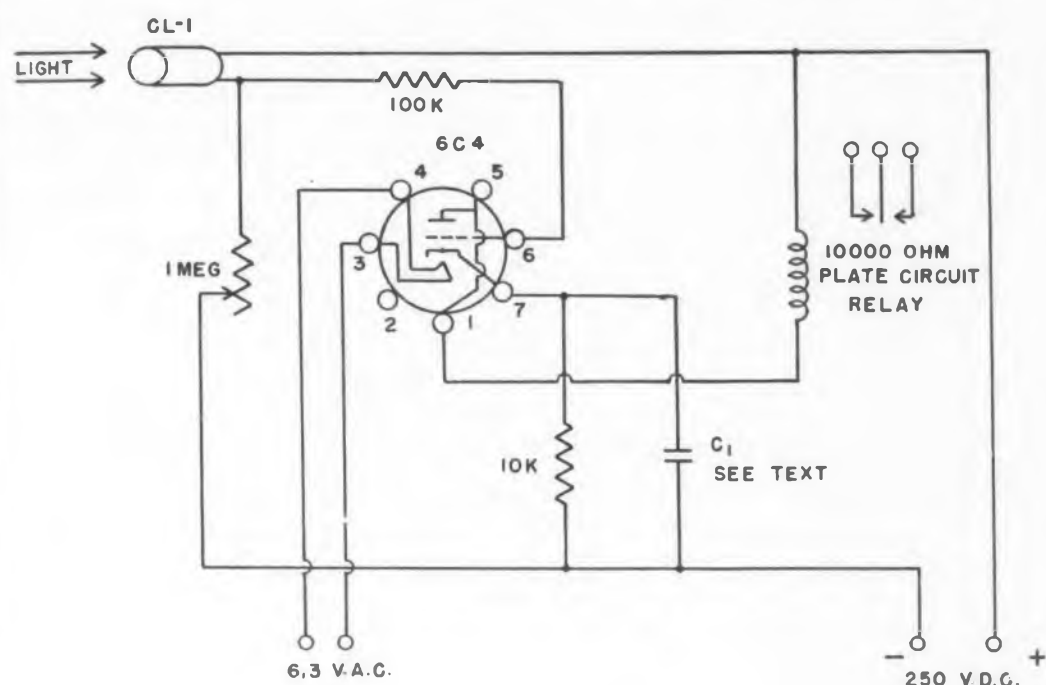

Fig. 4. Direct actuation circuit.

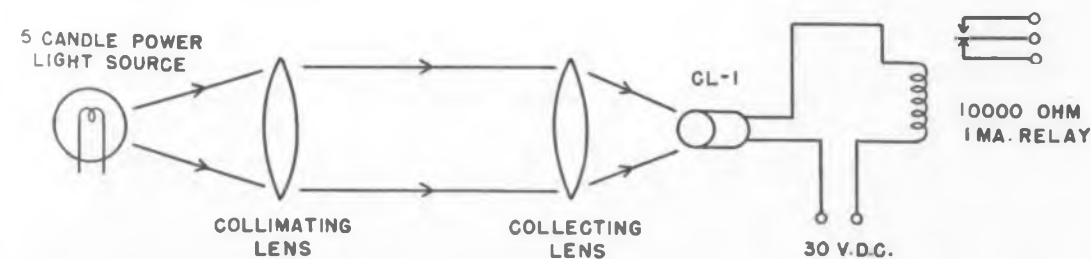

Fig. 5. Light impulse circuit.

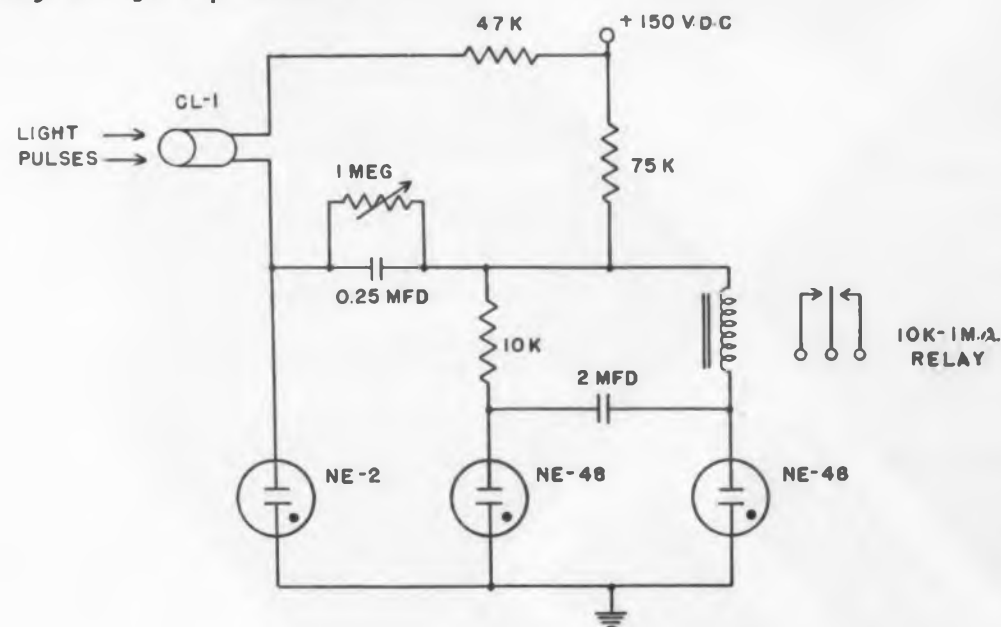
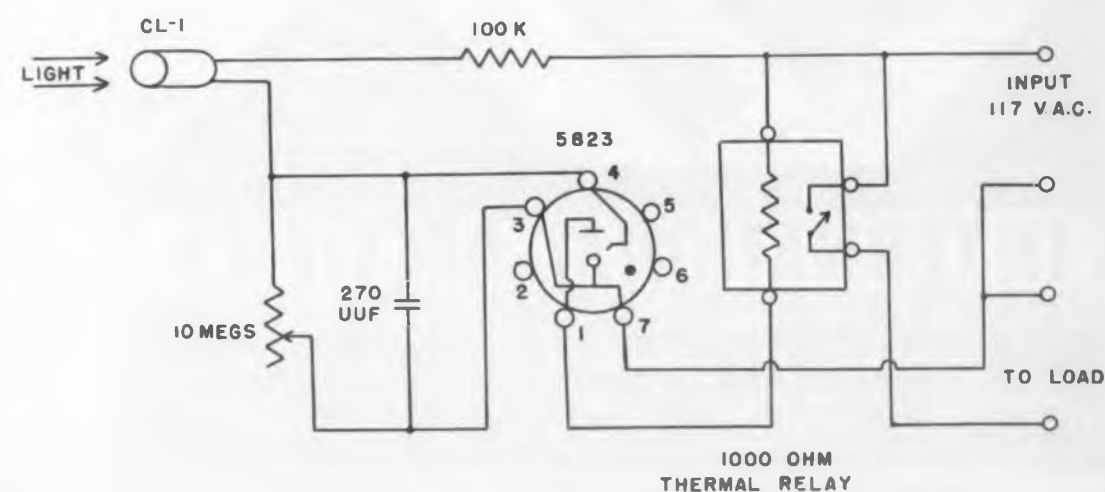

Fig. 6. Darkness switch circuit.



INTERNATIONAL RECTIFIER

C O R P O R A T I O N



EL SEGUNDO
CALIFORNIA

POWER RECTIFIERS

RATINGS TO 250 KW
POWER FACTOR 95%
EFFICIENCY TO 87%

Write for
BULLETIN
C-349

Selenium Rectifiers

widest range
in the
industry

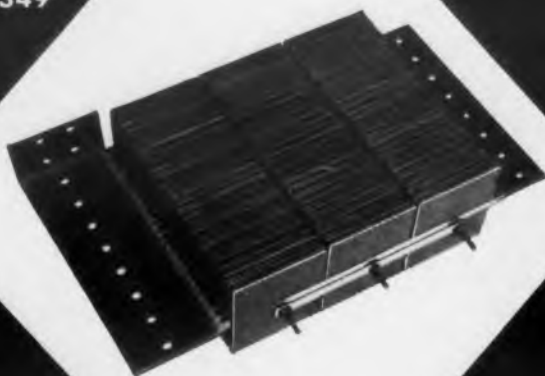

HI-VOLTAGE CARTRIDGE TYPES

Case Diam.: $\frac{1}{4}$ " to $1\frac{1}{4}$ "
Length: $\frac{1}{2}$ " to 12"
DC Output: 20v to
200,000 v at
1.5 ma to 60 ma

Write for
BULLETIN
H-1

ALL TYPES MANUFACTURED TO YOUR INDIVIDUAL SPECIFICATIONS



PROMPT
DELIVERIES
ON PRODUCTION
QUANTITIES

INTERNATIONAL RECTIFIER

C O R P O R A T I O N

1521 E. Grand Ave., El Segundo, Calif. • Phone: ORegon 8-6281
CHICAGO: 205 W. Wacker Drive • Phone: Franklin 2-3889
NEW YORK: 501 Madison Avenue • Phone: Plaza 5-8665

CIRCLE ED-20 ON READER-SERVICE CARD FOR MORE INFORMATION

Voltage Sensitive Capacitors

Fig. 1. Characteristic curves of the two types of voltage-sensitive capacitors.

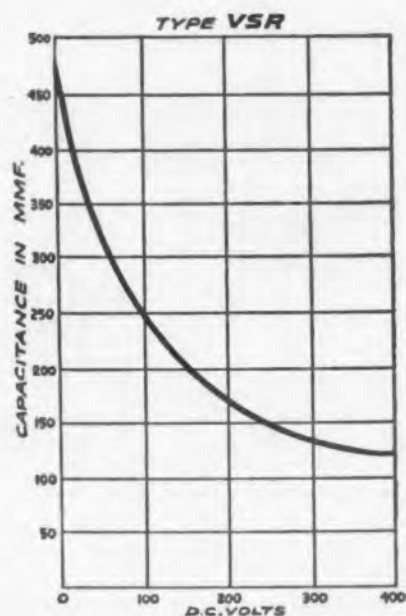
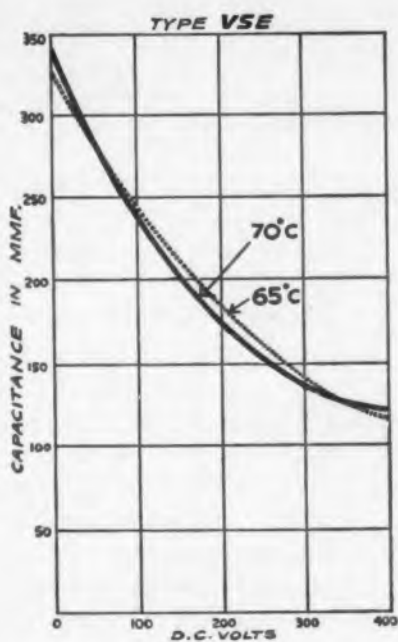

CAPACITANCE changes as great as 70% can be obtained by varying the potential applied to a new type of subminiature, ceramic, voltage-sensitive capacitor. This characteristic makes it useful for a wide variety of applications such as tuning and frequency control, frequency modulation, harmonic generation, dielectric amplifiers, in variable frequency filters, in sweep circuits, etc.

The capacitors derive their voltage-sensitive property from a special ceramic dielectric material. Since the units are also sensitive to temperature variations, two types have been developed: Type VSR units, whose voltage sensitivity is greatest at room temperature (20°C to 25°C), and Type VSE, whose voltage sensitivity is a maximum at about 70°C. The latter units are intended for use in a controlled environment, such as a crystal-type oven, to eliminate variations caused by changes in ambient temperature. The capacitors are products of the Mucon Corp., 9 St. Francis St., Newark 5, N. J.

The curves in Fig. 1 show how the capacitance changes with applied voltage. For the type VSR unit, applications of 100v, 200v, and 400v decreases the capacitance approximately 45%, 60%, and 70%, respectively. The type VSE unit, somewhat less voltage sensitive, decreases in capacitance by about 30%, 50%, and 63% when 100v, 200v, and 400v, respectively, is applied.

Physically, the capacitors are quite small. Body sizes start at approximately 1/8" square by 0.080" thick. The leads are normally No. 26 gage tinned copper wire arranged axially. For values above

Fig. 2. Amplifier tuning circuit (left) and an f-m oscillator circuit (right).

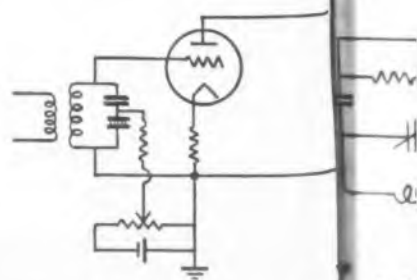

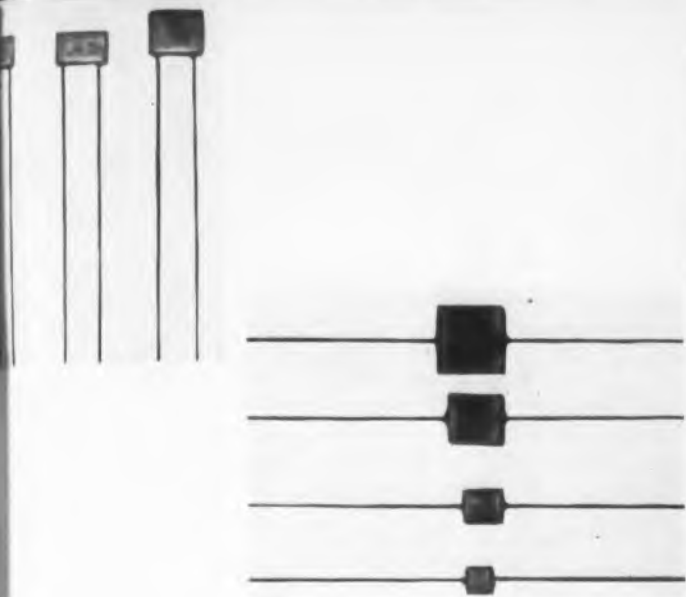

1000mmfd, radial leads are obtainable. Capacitance values of about 400mmfd to 0.01mfd are normally obtainable, and larger sizes are readily produced by paralleling ceramic plates in a single unit.

Four application possibilities are shown below for these units. These include use of the voltage-sensitive capacitor as a tuning element in an amplifier (Fig. 2, left), in a frequency-modulated oscillator application (Fig. 2, right), and in simple parallel and series tuned circuits as indicated in Fig. 3. These represent only a few of the circuit possibilities. In more elaborate control arrangements, the d-c voltage applied to the voltage-sensitive capacitor could be obtained from a voltage divider-selenium rectifier network instead of a battery as shown. For more information on these units,

CIRCLE ED-309 ON READER-SERVICE CARD

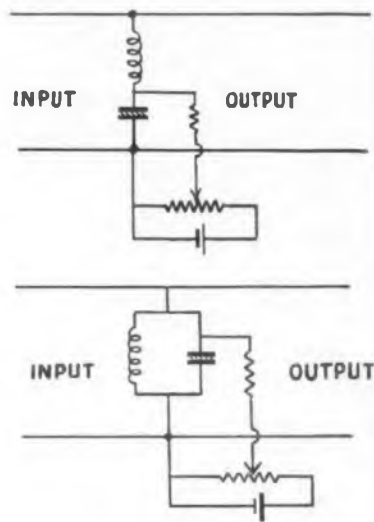
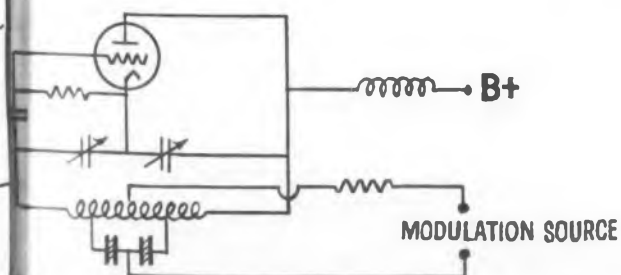

Fig. 3. Series (above) and parallel (below) tuned circuits employing voltage-sensitive capacitors.



New Instruments and Components to Aid in Design and Reduce Costs

by

TECHNITROL

Unique Variable Pulser is Valuable Laboratory Aid

The Technitrol Variable Pulser is a reliable, versatile instrument which converts the output of a laboratory oscillator into a series of pulses.

One use has been as a low pulse rate device to study the response of components and networks to isolated pulses. Another use has been as a variable pulse rate source to study P.R.F. sensitivity. Still another use has been as a constant high frequency source for a temporary clock pulse generator.

Characteristics

- Wide range of frequencies from 2 cps. to over 2.0 mcs.
- Pulse characteristics optimized with rise and fall times approximately 0.04 μ s. and 0.06 μ s. respectively.
- Duration of pulse variable from 0.2 μ s. to 5.0 μ s. in steps of 0.1 μ s.
- Accurate, stable pulse duration controlled by electric delay lines.
- Amplitude continuously variable without distortion from 0 to 45 volts.
- Trigger pulse precedes output pulse to synchronize oscilloscopes, etc.

Tiny Encapsulated Pulse Transformers Wound to Your Requirements

Technitrol Pulse Transformers are wound on ferrite cores and cast in resin to form a $\frac{3}{4}$ " sealed unit.

Type TE has 2-inch pigtail leads of No. 20 wire. Type TP has 7-pin plug-in for miniature tube sockets. Lends itself admirably to printed circuits where holes can be drilled in the circuit board, the transformer plugged into these and the pins soldered to the circuit leads on the side opposite the body of the transformer.

MORE INFORMATION ON REQUEST

TECHNITROL ENGINEERING COMPANY
2751 N. 4th St., Philadelphia 33, Pa.

- Send Bulletin
- 186 Variable Pulser
 - 166 Pulse Transformers
 - 174 Delay Lines

Write Dept. D-7

NAME _____
COMPANY _____
ADDRESS _____
CITY _____ ZONE _____ STATE _____

Very Compact Delay Lines Designed to Fit Your Need

A Technitrol Delay Line—with not more than $\frac{1}{4}$ " diameter and $6\frac{1}{4}$ " length, or in a package—will be designed for your particular circuit application. A variety of mountings offers you a wide choice.

- Delay: 0.01 to 1.6 μ s.
- Characteristic Impedance: 400 to 2500 ohms.
- Wide Frequency Response: 0.5 μ s. at 1200 ohms.
3 db down at 5 mcs
6 db down at 8 mcs
10 db down at 10 mcs
- Continuing intensive research and development is expected to make available even greater band-widths.
- Linear Phase: to 9 mcs and beyond

CIRCLE ED-21 ON READER-SERVICE CARD FOR MORE INFORMATION



is **CORROSION RESISTANCE**

... your problem?

Long experience in the development of precision instruments enables Ketay to manufacture Synchros, Servos and Resolvers to meet the cycling humidity requirements of MIL-E-5272

As a leader in the use of corrosion resistant materials in Synchros, Servos, Resolvers, Control Equipment and related instruments, Ketay has enormously broadened their usefulness for both the government and industry.

Ketay has built an outstanding record as originators of units to meet individual specifications. Ketay engineers will be glad to discuss your requirements.

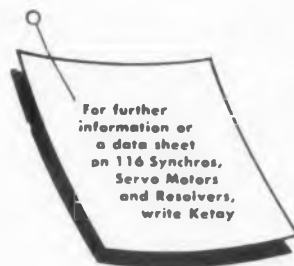

Ketay

MANUFACTURING CORP.

Executive Offices 555 Broadway, New York 12, N. Y.
Pacific Division, 12833 Simms Avenue, Hawthorne, California

New York Division • Kinetix Instrument Division • Pacific Division
Electronic Instrument Division • Research & Development Division

CIRCLE ED-22 ON READER-SERVICE CARD FOR MORE INFORMATION

CORROSION RESISTANT UNITS

Ketay offers a complete line of Corrosion Resistant Instruments, four of which are pictured above. From left to right they are:

● Synchro, Size 23, Frame O.D. 2.250", 26 V and 115 V 400 & 60 Cycles. (Transmitter, Receiver, Resolver, Differential, Control Transformer) Also available in same frame size: Servo Motor—115 V 60 Cycles.

● Synchro, Size 15, Frame O.D. 1.437", 26 V and 115 V 400 Cycles. (Transmitter, Receiver, Resolver, Differential, Control Transformer) Also available in same frame size: Servo Motor Mk 7—115 V 400 Cycles.

● Synchro, Size 11, Frame O.D. 1.062", 26 V and 115 V 400 Cycles. (Transmitter, Receiver, Resolver, Differential, Control Transformer) Also available in same frame size: Servo Motor Mk 14—115 V 400 Cycles.

● Synchro, Size 10, Frame O.D. .937", 26 V 400 Cycles. (Transmitter, Receiver, Resolver, Differential, Control Transformer) Also available in same frame size: Servo Motor—26 V 400 Cycles.

**SYNCHROS • SERVO MOTORS
RESOLVERS • MAGNETIC AMPLIFIERS
AIRBORNE INSTRUMENTS
AUTOMATIC CONTROL SYSTEMS**

Single-Gun Color TV Picture Tube

RECTANGULAR instead of round faced, the "Chromatron" PDF 21-3, a tri-color picture tube for TV receivers shown in Fig. 1, is now available in sample quantities. Featuring a single-gun construction, the tube utilizes the same deflection yoke and focus coils as monochrome tubes. It provides fringe-free color and black-and-white pictures on a 159.5 square inch screen.

The tube is only 25" long. Its diagonal deflection angle of 65° is comparable to that of monochrome tubes. The tube does not require color-purifying or static and dynamic convergence equipment, thereby reducing production and maintenance costs.

Developed and produced by Chromatic Television Laboratories, Inc., 1501 Broadway, New York 36, N. Y., the "Chromatron" is a post-deflection-focusing-type tube. The color phosphors are deposited on the screen in strips instead of dots as in other newly developed picture tubes. Instead of a shadow mask or similar mechanical screening structure in front of the phosphor screen, the Chromatron utilizes a complex, interwoven grid structure to deflect the electron beam to the proper color strips. This grid structure allows 85% of the electrons in the beam to reach the screen, thereby reducing the problem of overheating. There is no serious radiation problem with this tube.

The tube is available for design and development work and the manufacturer is offering production licenses. The envelope illustrated will accommodate a picture size up to 210 square inches.

Heater requirements of the tube are 6.3v, at 0.6amp. Referring to the basing diagram shown in Fig. 2., typical operation of the tube calls for an anode voltage of 18,000v, d-c, a grid No. 3 voltage of 3.500 to 6000v, d-c a color deflector voltage of



Fig. 1. The rectangular-picture "Chromatron" which employs a single-gun construction.

400v peak, a seeker voltage (the d-c potential between the color deflectors and grid No. 3) of 150 to 600v, d-c, a grid No. 2 voltage of 300v, d-c, a grid No. 1 voltage (for visual extinction of the focused spot) of -50 to -105v, d-c, and a focusing coil current of 55 to 85ma, d-c. For more data on the "Chromatron" color TV picture tube,

CIRCLE ED-310 ON READER-SERVICE CARD

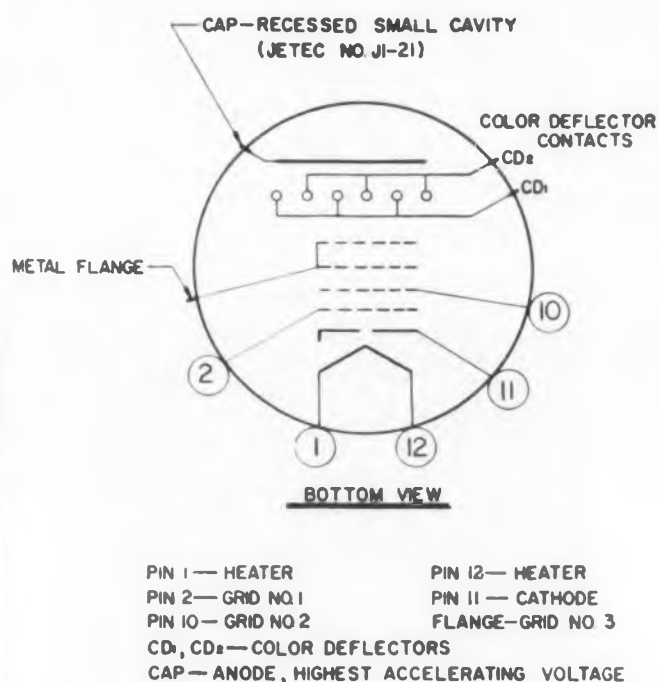

Fig. 2. Basing diagram for the new single-gun color TV picture tube.



FX-104



*Big things are happening at Lockheed.
That's why:*

Lockheed in California increases engineering staff

Diversification at Lockheed is again resulting in more and better careers for engineers.

Already 11 models are in production — huge luxury airliners, transports, trainers, bombers, radar search planes.

Now Lockheed has new aircraft of the future coming up — the XF-104, a lightweight jet fighter; the XFV-1, a vertical rising plane; the Universal Trainer, a versatile new jet fighter-trainer. In addition, continuing development on the Super Constellation and other classified activities require a larger staff.

These new development projects offer engineers outstanding opportunity for achievement and promotion. To engineers who seek that opportunity, Lockheed offers:

1. **Increased pay** rates now in effect
2. **Generous travel** and moving allowances
3. **An unusually wide range** of extra employe benefits.
4. **The chance for you** and your family to enjoy life in Southern California.

Lockheed invites inquiries from Engineers who seek opportunity for achievement. Coupon below is for your convenience.

Lockheed
AIRCRAFT CORPORATION
BURBANK • CALIFORNIA

Lockheed has career openings for:

Servomechanisms and Autopilot Research Engineers

with a degree in Electrical Engineering and experience in research and testing of servomechanisms and autopilots.

Aircraft Design Engineers

for structural, mechanical or hydraulic design. To qualify, you need an engineering degree and experience in above or related fields.

Aerodynamicists

with a degree in Aeronautical Engineering and experience in sonic and supersonic performance and stability control.

Thermodynamicists

with a degree in Aeronautical or Mechanical Engineering and extensive experience in aircraft thermodynamics.

Aircraft Maintenance Design Engineers

for expert advisory guidance in maintenance design aspects. To qualify, you need extensive aircraft maintenance design experience, military or commercial. This position commands a high salary.

Electro-Mechanical Design Engineers

for important research and development on servomechanisms, autopilots and flight simulation. To qualify you need a degree in Electrical Engineering and at least two years' experience.

Electrical Design Engineers

with a degree in Mechanical or Electrical Engineering and experience in 1) aircraft circuit development and electrical design or 2) experience in design of electrical and electronic equipment installation.

Mr. E. W. Des Lauriers, Dept. ED-7

Lockheed Aircraft Corporation
1708 Empire Avenue, Burbank, California

Dear Sir:

Please send me your Lockheed brochure describing life and work at Lockheed in Southern California.

My name _____

I am applying for . . . (name position in this advertisement which fits your training and experience)

My street address _____

My city and state _____

CIRCLE ED-23 ON READER-SERVICE CARD FOR MORE INFORMATION



PHOTOGRAPH ANY SCOPE PATTERN

with the **FAIRCHILD** Oscillo-Record Camera

The Fairchild Oscillo-Record camera will accurately record continuously varying phenomena as well as single transients and stationary patterns. Continuously variable electronic control of the film speed from 1 to 3600 inches per minute allows you to select the optimum speed for the greatest clarity and detail, without film waste. The entire length of the 35 mm. film (100, 400 or 1,000 feet) can be run off continuously at any speed. The film is sprocket-driven so there is no slippage at any speed.

The Oscillo-Record camera mounts directly on the top of the scope. No tripod is needed and the oscilloscope controls are always accessible.

FOR IMMEDIATE EVALUATION of individual exposures the Fairchild-Polaroid® Oscilloscope Camera is economical, fast, and convenient. The trace reads from left to right, and is exactly one-half size. Each 3¼" x 4¼" Polaroid print (available in only 60 seconds) records two separate images.

For more information, write *Fairchild Camera and Instrument Corporation, Robbins Lane, Syosset, L. I., N. Y., Department 120-21G.*

FAIRCHILD

OSCILLOSCOPE RECORDING CAMERAS

CIRCLE ED-24 ON READER-SERVICE CARD FOR MORE INFORMATION

Laboratory Phase Comparator

By S. Feinstein

Servomechanisms, Inc., Westbury Division, New York

Fig. 1. One version of the laboratory phase comparator.



Fig. 2. The bottom plate removed to show construction.

Fig. 3. Typical component values for the comparator circuit are $R = 6890$ ohms, $C = 0.1\text{mfd}$ and $r = 5000$ ohms.

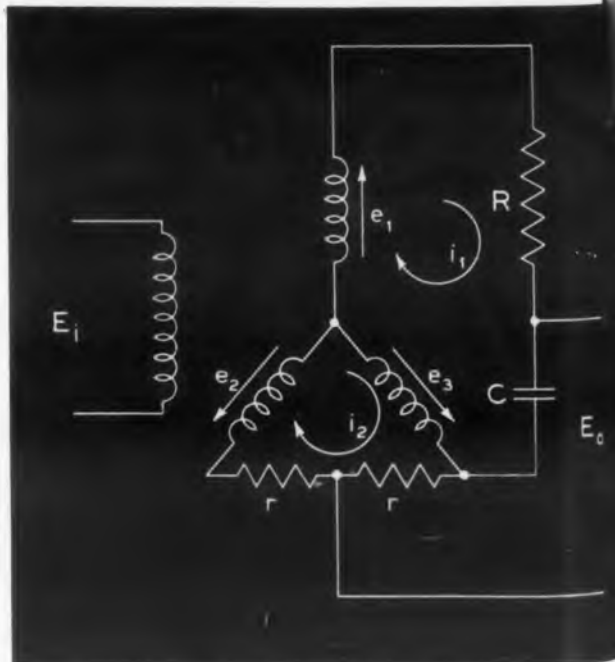

RAPID, accurate measurement of phase differences can be accomplished by means of the relatively simple and inexpensive test equipment described here. Although phase meters may be purchased, they are relatively expensive and unwieldy. The small, inexpensive, versatile, and rather accurate phase shifter shown in Fig. 1 was put together using an ordinary synchro which is available in most design laboratories.

This phase shifter has the following features:

1. It is self-calibrating, using a single adjustment.
2. It may be used at frequencies from 60cy to over 500cy.
3. Its zero phase-shift point remains unchanged with frequency.
4. Its phase shift varies linearly with rotor rotation; therefore, it uses a simple circular scale calibrated from 0 to 360°.
5. The output is isolated from the input.

The phase comparator is normally used in the following manner: A common excitation voltage source (usually the 6.3v filament input) is used to excite the phase shifter and the network under test. (The network may require that a resistive voltage divider be used to reduce the input.) The outputs of the phase shifter and the network are used to form a Lissajous pattern on a scope. The phase shifter is set for a zero phase-shift pattern, and the phase shift of the network is read directly on the phase shifter scale.

It may be of interest to derive the equations defining the operations of the circuit as shown in the simplified schematic. The following reasoning is involved:

1. e_1 , e_2 , and e_3 are functions of ϕ , the angle between the rotor and stator windings.
2. If we assume the internal impedances of voltage sources e_1 , e_2 , and e_3 are negligible compared to R , C and r , we may write i_1 and i_2 in terms of these voltages and constants.
3. This, then, allows E_o to be expressed in terms of these voltages and hence as a function of ϕ .
4. Expressed mathematically we wish to establish the relationship $E_o/E_i = |K| / \pm \phi \pm \theta_c$ where θ_c is a constant angle and K is a constant of proportionality.
5. It can be shown that the above relation holds when $R\omega C = \sqrt{3}$, and that if R is a rheostat and at a given frequency is adjusted so that $R\omega C = \sqrt{3}$, a scope will show that the amplitude of the output will remain constant as the phase angle is varied. Once we have established the proper R for constant amplitude, we will have also produced a linear phase shifter. Note also that $\theta_c = \tan^{-1}\sqrt{3}$ is a constant at any frequency once R is adjusted. Thus, the phase shifter zero point remains unchanged.

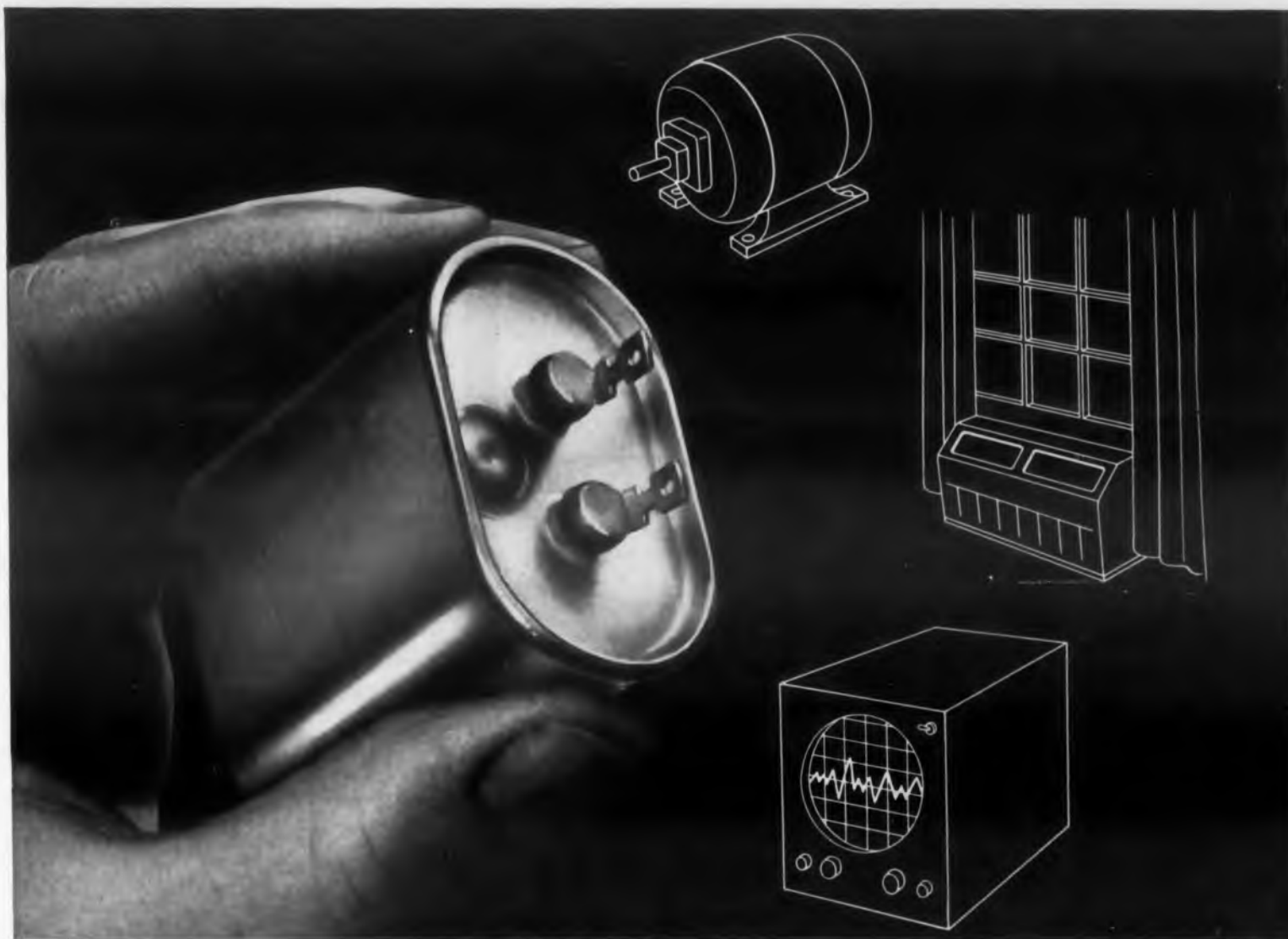

Save space and weight in electronic equipment with versatile G-E drawn-oval capacitors

LONG RELIABILITY. G-E drawn-oval fixed paper-dielectric capacitors have been manufactured for fluorescent lamp ballasts and air-conditioning equipment for ten years. They also offer the important advantages of smaller size, lighter weight, and substantial cost reductions to the electronics industry. So, if you're using a fixed paper-dielectric capacitor in your electronic equipment consider the advantages offered by G-E drawn-ovals.

WIDE RANGE OF RATINGS. Ratings range from 1 to 15 uf at 600 to 1500 volts dc, or 330 to 660 volts ac. A wide choice of mounting arrangements makes G-E drawn-ovals ideally suited for quality electronic equipment, controls, and other applications where capacitors meeting the electrical and mechanical requirements of MIL-C-25A specifications (except for case dimensions and markings) are desirable.

UP TO 20% COST REDUCTION. Prices range from 10 to 20% below those for similarly rated rectangular capacitors. Savings in size and weight amount to as much as 30% in some case styles. A double rolled seam attaches cover to drawn steel case, producing a lighter, yet stronger, capacitor.

CHOICE OF MOUNTINGS AND TERMINALS. Mounting versatility is provided by a choice of three bracket styles for upright, inverted, or side mounting to suit individual application requirements. Units are also available with either eyelet (pictured above), fork type, or quick-connect (solderless) terminals.

For more information on G-E drawn-oval capacitors, their ratings, dimensions, and prices, contact your G-E apparatus sales representative or write for Bulletin GEA-5777, to General Electric Co., Section 442-10, Schenectady 5, N. Y.

Progress Is Our Most Important Product

GENERAL  ELECTRIC

CIRCLE ED-25 ON READER-SERVICE CARD FOR MORE INFORMATION



The Edison Control Relay Amplifies Power 500,000 Times

New Edison Control Relay Amplifies Power 500,000 Times

New Edison Control Relay Amplifies Power 500,000 Times

New Edison Control Relay Amplifies Power 500,000 Times

New Edison Control Relay Amplifies Power 500,000 Times

New Edison Control Relay Amplifies Power 500,000 Times

New Edison Control Relay Amplifies Power 500,000 Times

New Edison Control Relay Amplifies Power 500,000 Times

Edison Control Relay Amplifies Power 500,000 Times

Control Relay Amplifies Power 500,000 Times

Relay Amplifies Power 500,000 Times

Amplifies Power 500,000 Times

Because there is an amplification factor of approximately 500,000 between the input power to the operating coils and the load capacity of its own contacts, Edison's Magnetic Control Relay actually eliminates the need for electronic boosting—operates *directly* from a thermocouple, photocell, or from vacuum tube currents. Yet this precision instrument stands up even under the shock and vibration of aircraft service.

Designed and developed in the world-famous Edison Laboratory, this small relay has features of particular interest to designers of electronic equipment.

Low power operation—Standard types operate at as low as 30 microamperes—do not drain

power from other circuit components, such as gyro motors.

Versatility—Coils can be supplied with resistances from 0.5 to 20,000 ohms. Differential operation is made possible by separate connections from each coil with polarized operation as an inherent characteristic.

Stability—Test relays have exceeded 8,000,000 cycles without calibration change.

Rugged Movement—Dissipates overloads up to 10,000 times normal operating input—withstands 50 g shock in all planes (unenergized).

Contacts—Platinum-iridium wire, either SPST or SPDT, with capacity of 1/3 ampere at 28 volts d.c. non-inductive.

Write us—especially if you are now using a single-stage electronic amplifier—for more complete information.

Thomas A Edison

A GREAT NAME CONTINUES GREAT NEW ACHIEVEMENTS

Thomas A. Edison, Inc.

INSTRUMENT DIVISION • 55 LAKESIDE AVENUE • WEST ORANGE, NEW JERSEY

Fig. 1. Closeup of the face of the voltmeter showing an unknown voltage of $7.624 \times 10 = 76.23\text{v}$ read from the attenuator.



Accurate Voltmeter

EXTREMELY low d-c voltages can be measured with speed, accuracy, and minimum loading with the Model LVM laboratory standard voltmeter. Shown in Fig. 3, this self-contained, portable instrument will replace in almost all applications an assemblage of laboratory potentiometer, voltbox, galvanometer, external battery and standard cell. Construction of the indicator and movement is such as to afford protection from overloads as great as 100,000%.

Typical applications include measurement of standard cells, diodes and transistors, computer voltages, and power supply regulation. The instrument can also be used to calibrate meters, transducers, strain gages and thermocouples. As a

Fig. 2. Block diagram of the unit.

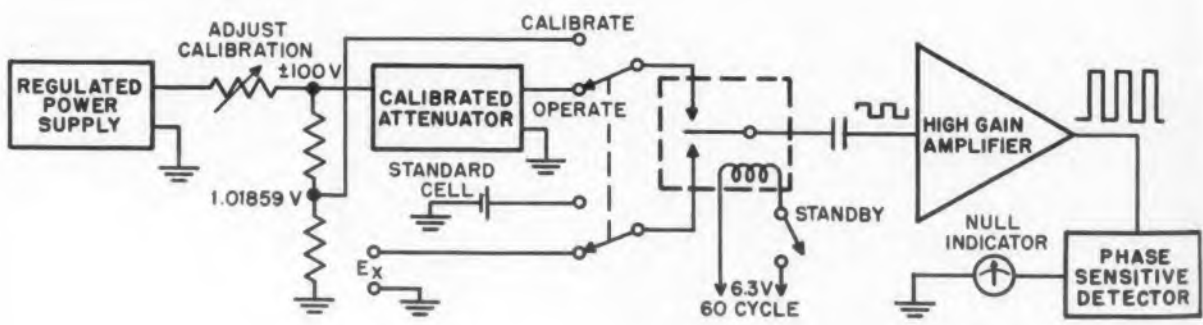

nullmeter, its sensitivity is greater than $5\mu\text{v}$. It may be used as a comparison bridge to measure resistive differences to an accuracy of 0.01%. As a current meter, accurate readings are possible in the millimicroampere range.

The unit is a nulling voltmeter consisting essentially of a highly stabilized power supply, an accurately calibrated attenuator, a high-gain chopper amplifier and a sensitive null indicator as shown in Fig. 2. In operation, the voltage to be measured

Fig. 3. Portable version of the Model LVM-5 laboratory voltmeter.



is applied to one of the chopper contacts. The attenuator, which is across the regulated supply, has its output applied to the other chopper contact. The 60cy square wave that then appears on the chopper arm is amplified and fed to a phase-sensitive detector. The resultant d-c voltage viewed on the zero-center null indicator causes a deflection to the right for too high an attenuator setting. When the indicator is zeroed, the two voltages on the chopper contacts are equal, and the value of the unknown may be read directly from the setting of the attenuator. Such a reading is shown in Fig. 1.

The range of the unit is 0-100v d-c, positive or negative grounded. The effective scale length is 114 ft. Linearity is better than 0.05% on any one range, 0.1% overall. The input current is less than 10^{-11} amp. Absolute accuracy is 0.1% of the reading.

Two versions of the instrument are available. Model LVM-5 is a portable unit 10-7/8" wide x 9-5/16" high x 11" deep. Model LVM-5R is designed for rack mounting. It is 19" wide x 7" high x 12" deep. The instruments are manufactured by the Computer Company of America, Division of Bruno-New York Industries Corp., 149 Church St., New York 7, N. Y.

The internal power supply is designed to furnish $100v \pm 0.05%$ across the attenuator. The attenuating network across the 100v line consists of fixed resistors and a precision 10-turn potentiometer in a Thomson-Varley circuit. The resolution of this attenuator is such that for settings between 0 and 1v, each of the 1000 divisions on the potentiometer dial represents $100\mu v$. All resistors and the potentiometer in the network are matched to within 0.025%. The 1000 hr minimum operating life of the low-noise-level chopper is greatly extended by use of a "Standby Switch". For more information,

CIRCLE ED-312 ON READER-SERVICE CARD

NEW AMP

PATENTED "F" CRIMP

TAPER PINS

FOR WIRING

AN TYPE CONNECTORS



IMPROVE RELIABILITY

SAVE TIME REDUCE COST

Now AN type connectors can be wired 5 to 10 times faster **with even superior performance reliability**. There are no cold solder joints, burned insulation, embrittled wire and breakage at solder cups or short circuits due to loose strands and excess solder.

For many years the Aircraft, Electronics and Communication industries have awaited this new and simpler method, since the soldering of wires to conventional AN connector contacts is a slow and painstaking process involving much skill and repeated inspection checks.

With AMP's new Taper Technique, a special AMP Patented "F" Crimp Taper Pin is attached to the wires by high speed automatic machines. This pin is then installed in the connector with one easy and positive stroke of AMP's new "measured energy" CERTI-LOK insertion tool. The result is uniformly better connections, produced in much less time with tremendous cost savings.

Tests prove that AMP Taper Pins provide a greater degree of uniformity than soldered connections. Reliability is actually increased because the possibility of human error in assembly has been greatly reduced.

Leading Connector manufacturers are now supplying AN and other types of multiple contact connectors for use with AMP Taper Pins. Write today for further information.

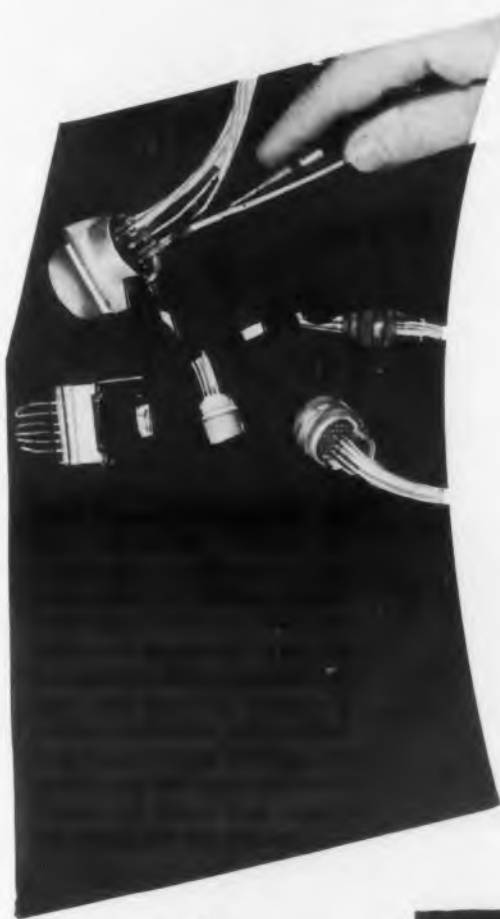

AMP Trade-Mark Reg. U.S. Pat. Off. © AMP



CIRCLE ED-27 ON READER-SERVICE CARD FOR MORE INFORMATION

NOW... ALL STANDARD

AMRECON[®] RELAYS

with
hermetically-
sealed enclosures



**In Current Ratings up to 25 amp a-c or d-c,
and in All Standard Voltages**

Now you can specify any standard Amrecon relay for applications requiring complete relay protection. These high-quality relays can be obtained hermetically sealed in seamless steel enclosures which are first exhausted and then filled with a dry inert gas. The entire assembly is highly resistant to vibration and shock. Amrecon hermetically-sealed relays are available with either plug-in or solder terminals. For your special or unusual relay applications, let Amrecon's experienced engineers help you work out the best solution.

WRITE FOR
FREE CATALOG AND
DESCRIPTIVE BULLETIN R-10



**AMERICAN
RELAY & CONTROLS, Inc.**

3643 Howard St., Skokie, Illinois
(Suburb of Chicago)

A Subsidiary of **OHMITE[®] MANUFACTURING COMPANY**

CIRCLE ED-28 ON READER-SERVICE CARD FOR MORE INFORMATION

34

New Products . . .

Transformers and Chokes

Miniature, Hermetically Sealed Types



Suitable for use in circuitry such as transistor or geophysical applications, these miniature, hermetically sealed transformers and chokes measure only 3/4" x 15/16" x 1-7/8" high. Available in both standard steel and mu metal, they are classified into the following groups: input, 500 (125) ohms to 150,000 ohms CT, primary inductance 8.5h $\pm 5\%$; output, 20,000 ohms CT to 16/8/4/2 ohms, primary inductance 1200h; inductors, 1500h, with two, 2% taps.

Special designs are available up to 10w, 400cy power transformers, audio transformers, and inductors with ratings similar to those shown above. Audio Development Co., Dept ED, 2833 13th Ave., South, Minneapolis, Minn.

CIRCLE ED-29 ON READER-SERVICE CARD FOR MORE INFORMATION

Tetrode Transistors

Operate in Megacycle Range

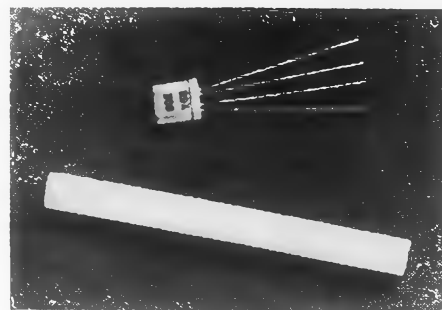

Three high-frequency, grown-junction Tetrode Transistors, Types RD-X300, RD-X301 and RD-X302, are intended for use in high frequency oscillators and amplifiers at frequencies above the limits of grown-junction transistor triodes.

In tetrode oscillator circuits, maximum frequency of operation of the three units is 10-20Mc, 20-35Mc, and above 35Mc, respectively. At 20°C ambient, all three units have maximums of: 30v collector voltage, 5ma collector current, 50mw collector dissipation, and 5ma base-to-base current. Germanium Products Corp., Dept ED, 26 Cornelison Ave., Jersey City, N. J.

CIRCLE ED-30 ON READER-SERVICE CARD FOR MORE INFORMATION

Miniature Counter

High-Speed Electromagnetic Type



The dynamical-ly balanced mechanism of the C-100 electromagnetic impulse counter effectively prevents miscounts due to shock or vibration, making it suitable for mobile applications. The unit, with four dials (non-reset) reading up to 9999, is only 1-5/8" x 1-1/32" x 57/64" in size and weighs less than 1-3/4oz.

It counts at speeds up to 40cy per sec, on actuation by interruption of a 28v d-c circuit. Unimax Switch Division, Dept. ED, The W.L. Maxson Corp., 460 West 34th St., New York 1, N.Y.

CIRCLE ED-31 ON READER-SERVICE CARD FOR MORE INFORMATION

D-C Magnetic Amplifier

Operates from 200 μ w Signals



With this magnetic amplifier, the output of a low level d-c device, such as a thermocouple, phototube, strain gage, or thermistor bridge, can be amplified sufficiently to operate an insensitive meter or relay. Known as the Type 806, the amplifier will operate from input signals as low as 200 μ w and will provide an output of 0.05w of reversible polarity to a 50 ohm load. A power gain of approximately 300,000 can be obtained.

The unit is completely self-contained and requires no additional rectifiers or power supply. It operates from 115v, 60cy, single phase. Two feedback windings are provided and may be connected externally. Polytechnic Research & Development Co., Inc., Dept. ED, 55 Johnson St., Brooklyn, N. Y.

CIRCLE ED-32 ON READER-SERVICE CARD FOR MORE INFORMATION

ELECTRONIC DESIGN • July 1954

Resistive Networks

Embedded in Epoxy Plastic



These hermetically sealed resistive networks, embedded in epoxy plastic, are offered in a large number of terminal types, including plug-in and low and high voltage insulator types. They are available in resistances from 0.1 ohm to 15 megohm, with accuracies from 1% to 1/40th of 1%. The designs meet and surpass many applicable MIL specs.

The networks are made to customer requirements to fill specific space limitations. Cinema Engineering Co., Division of Aerovox, Dept. ED, 1100 Chestnut St., Burbank, Calif.

CIRCLE ED-33 ON READER-SERVICE CARD FOR MORE INFORMATION

Photo Transistor

Covers Visible Spectrum

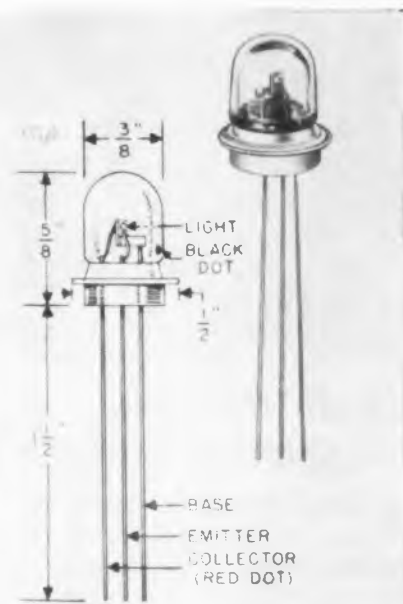

Although developed for use in automobile headlight dimmers, the miniature p-n-p photo transistors, Type RR66, will be equally useful in a wide variety of industrial control applications. The light sensitive element is hermetically sealed within a glass bulb and is connected to three leads that emerge from a glass header.

The spectral response covers the visible range and extends far into the infra-red region, so that it is especially useful in black light applications. The unit features an available base connection that permits thermal stabilization in modulated light applications. The bulb diameter is 3/8" and overall height is 5/8". Radio Receptor Co., Inc., Dept. ED, 251 West 19th St., New York 11, N. Y.

CIRCLE ED-34 ON READER-SERVICE CARD FOR MORE INFORMATION

Attenuation Networks

Feature Plug-in Pads



The 690 Series of "Plug-In" attenuation networks combines a wide range of attenuation with a plug-in feature for adjusting input and output impedance.

Impedance can be changed to any value by substituting plug-in pads of the impedance desired.

The networks have a rugged, flexible design. They are available in either "T" or "balanced H" circuits. A range of 110db in 1db steps can be obtained on the two-dial series, or a range of 111db in 0.1db steps on the three-dial series. A special card-type, non-inductive winding is used, giving a frequency range of 0-50kc. These units may be used above 50kc with only a slight decrease in accuracy. Resistor units are calibrated to $\pm 1.0\%$ accuracy and operate at a +20db (0.6w) maximum input level.

To insure low contact resistance and uniform contact pressure, patented "knee-action" switch rotors are used. Silver-alloy rotors, slip-rings, and contacts insure good electrical performance. The networks are available in a wide range of impedance and loss. Daven Co., Dept. SX, 191 Central Ave., Newark, N.J.

CIRCLE ED-35 ON READER-SERVICE CARD FOR MORE INFORMATION

Electrolytic Capacitors

Three Low-Cost Types



Three types of low-priced "Unecap" Electrolytic Capacitors are now available from this firm. They include the "Unecap", a wax-impregnated cardboard tube

with a mounting strap. This type has insulated, flexible, color-coated leads, striped for easy soldering. It is good for 80°C operation and made in single, dual, triple, and quadruple combinations.

The "Super Cap" is an hermetically sealed unit in an aluminum can with an insulating sleeve, marked for easy identification. The "Twist Prong Can" is a compact unit in hermetically sealed, aluminum grounded cans, available in 1" and 3/8" diameters, in single, dual, triple, and quadruple units. Every "Unecap" capacitor is individually tested. The firm can also provide special capacitor units. United Electronic Mfg. Corp., Dept. ED, 542 39th St., Union City, N. J.

CIRCLE ED-36 ON READER-SERVICE CARD FOR MORE INFORMATION

NEW LOWCOST Miniature Capacitors



- Plastic film dielectric
- Very High resistance
- Low dielectric absorption
- Very Low cost
- Temperature range — 70°C to 140°C
- Smaller than the smallest
- Extremely long life
- Voltage 100 to 1000 volts
- Capacitance .001 to 1 mfd.
- Will withstand severest environmental tests.

We invite your inquiries. Ask for our complete catalogue on your company letterhead.

- Plastic Film Capacitors ● High Voltage Power Packs ● Pulse Forming Networks



Plastic Capacitors, Inc.
2511 W. MOFFAT STREET, CHICAGO 47, ILLINOIS

CIRCLE ED-37 ON READER-SERVICE CARD FOR MORE INFORMATION



**THERE'S
NO CATCH**

TO

Koiled Kords

SAYS

STROBO RESEARCH

"A great convenience, a tremendous impetus to sales", says Edward Farber, of Strobe Research, Milwaukee. Koiled Kords are now used on all the STROBOFLASH® units made by this company and Mr. Farber claims the retractile cord "adds that certain additional look of quality and efficiency."

On all electrical equipment that moves, Koiled Kords eliminate long trailing wires. They are safe, long lasting, convenient and attractive. Whether your problems concern consumer or industrial products, Koiled Kords may prove a tremendous asset.

Write for booklet 1052-G that shows many applications for Koiled Kords. It's free and full of ideas.

Koiled Kords
INCORPORATED

BOX K, NEW HAVEN 14, CONN.

CIRCLE ED-38 ON READER-SERVICE CARD FOR MORE INFORMATION

36

New Products . . .

Servo Potentiometers

Linearity is $\pm 0.05\%$

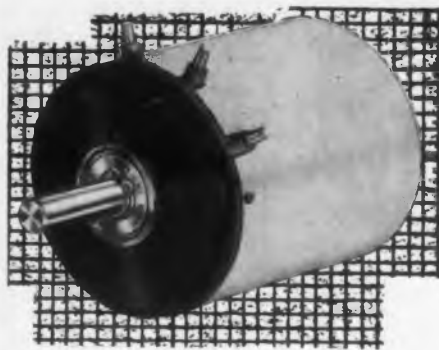

The Type M10T 10-turn servo potentiometers have an independent linearity of $\pm 0.05\%$ of total resistance with $\pm 0.25\%$ or better available on special orders. An effective electrical

angle of $3600^\circ +1^\circ, -0^\circ$ provides high resolution throughout the range of resistances available. Precious metal contacts assure dependable low-noise contact throughout a long life. The unit is suited to applications in computers, servomechanisms, and instrumentation requiring the highest linearity, resolution and mechanical precision.

The units meet applicable military specifications for corrosion resistance, humidity, salt spray, shock, and vibration. The potentiometers are available in standard resistance values from 1000 to 10,000 ohms with tolerances of $\pm 5\%$. Power dissipation is 5w at 40°C derated to zero at 80°C . Maximum starting torque is 1.3 in-oz at 20°C . The units are 2" diam x 2" long and weigh 5 oz. Technology Instrument Corporation, Dept. ED, Acton, Mass.

CIRCLE ED-39 ON READER-SERVICE CARD FOR MORE INFORMATION

Transformers

For Instrument Power Supplies



to limit stray magnetic fields, which makes them suitable for use in extremely sensitive equipment.

Multiple static shields have also been incorporated into the design to limit capacitive coupling. Triad Transformer Corp., Dept. ED, 4055 Redwood Ave., Venice, Calif.

CIRCLE ED-40 ON READER-SERVICE CARD FOR MORE INFORMATION

**reduce
noise
error over
99%**

mininoise®
ACTUAL SIZE!

Mininoise Cable, made only by Microdot, is ideal for low signal levels and high impedance terminations. In every applicable case, Mininoise reduces noise 99%!

WRITE for data on Mininoise cable and Microdot coax assemblies.

MICRODOT
1826 FREMONT STREET
50 PASADENA • CALIF.



CIRCLE ED-41 ON READER-SERVICE CARD FOR MORE INFORMATION

Every Use:
of
**SOLDERING
LUGS
•
TERMINALS
•
SMALL
STAMPINGS**



**CAN PROFIT through MALCO'S
Low Cost, Quantity Production**

We manufacture a complete line of standard and custom-made solder and solderless lugs, terminals, corona rings, and small stampings for radio, television, industrial and military electrical/electronic use.

Precision tooling and rigid quality control insures tolerances to your most critical specifications. High production techniques, plus over 1000 different standard parts permit prompt delivery at lowest possible unit cost.

Let us know your requirements.
Request our new 38-page
convenient reference catalog.



Malco TOOL and MANUFACTURING CO.
4027 W. LAKE ST., • CHICAGO 24, ILLINOIS

CIRCLE ED-42 ON READER-SERVICE CARD FOR MORE INFORMATION

ELECTRONIC DESIGN • July 1954

Testing with variable A-C voltage?

THE OLD WAY: Collect 1. A variable transformer

2. A voltmeter
3. Connection leads and then connect

THE NEW WAY:
Get all at once in a

VOLTBOX

A-C POWER SUPPLY



Here's your variable a-c voltage test gear all ready in a compact, cast-aluminum, portable unit that includes:

- A POWERSTAT variable transformer
- A direct reading voltmeter
- Three output receptacles
- Two Superior 5-WAY binding posts
- An "on-off" switch and line-load meter switch
- A renewable fuse and 6-foot cord-plug

Save your own valuable time and do a better job with a VOLTBOX a-c power supply.

The SUPERIOR ELECTRIC Company
1707 CLARKE AVENUE, BRISTOL, CONN.

CIRCLE ED-43 ON READER-SERVICE CARD FOR MORE INFORMATION

Digital Differential Analyzer Has Capacity of 60 Integrators



The Digital Differential Analyzer utilizes the decimal numbering system in both programming and in calculating solutions, making it extremely easy to operate. The fundamental operation of this computer is the numerical integration of any variable with respect to any other variable, linear or non-linear, which generates a third variable. Integrators may also be coded to perform addition, multiplication, division, comparison, limiting, decision, and servo operation. The computer has a capacity of 60 integrators.

Among the problems easily handled by the machine are the numerical solution of linear and non-linear differential equations, or simultaneous sets of such equations. It may be employed to solve integral equations, split-boundary value problems, and individual or simultaneous sets of linear or non-linear algebraic and transcendental equations. The computer also may be applied as a numerical simulator of certain physical phenomena. It can operate at a speed of 100 or 200 iterations per second.

Automatic programming is by punched tape prepared by electric typewriter, or the computer can be manually coded through the operation of the monitor control panel. Decimal solutions are displayed in both tabulated and graphical form. The recording of solution data on punched tape makes it available for later use in other computations. Graphical information and tabulated data may be used by the computer during computations. Bendix Computer Div., Dept. ED, 5630 Arbor Vitae St., Los Angeles 45, Calif.

CIRCLE ED-45 ON READER-SERVICE CARD FOR MORE INFORMATION

Mirror Coating Resists Corrosion

A new type of instrument mirror coating has a hardness close to that of the harder precious metals and a reflectivity equivalent to pure aluminum in all ranges of the spectrum. The coating is equally good for first or second surface mirrors, and may be cleaned repeatedly without damage.

As one measure of its durability, an open flame produces no apparent effect. Houston Technical Laboratories, Dept. ED, 2424 Branard, Houston, Texas.

CIRCLE ED-46 ON READER-SERVICE CARD FOR MORE INFORMATION



There's Nothing Safer
than a Rocking Chair

... Unless You Put It
in the Wrong Place.



Solder is the bond that is used to seal metal to metal in the hermetic closure of electrical components. For many hundreds of applications its limited structural strength is good enough.

But what about parts that must fly at sub-zero temperatures and withstand vibration and changing pressures—and on their continued functioning hangs human life.

An extremely favorable ratio of weight to strength is not the only factor that makes Fusite glass-to-steel hermetic terminals so fit to fly.

Because they lend themselves so readily to welding, you need not count on solder alone to hold the terminal in place. The tiny dimples on the illustrated terminal and lid are actually spot welds which give additional structural strength to help keep a part functioning after a solder seal has disintegrated.

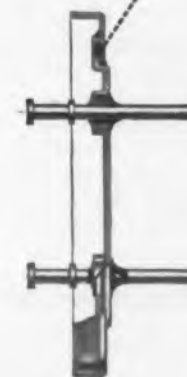

During assembly these welds serve to hold the terminal in place if the solder softens under the heat of sealing lid to container.

We are equipped to weld the Fusite terminal of your choice into your lid. If you wish to do your own welding our engineers are at your service.

Would you like to see samples?

Write Dep't. L3



THE FUSITE CORPORATION
6000 FERNVIEW AVENUE
CINCINNATI 13, OHIO

CIRCLE ED-47 ON READER-SERVICE CARD FOR MORE INFORMATION

Versatility

with a
GREEN
ENGRAVER

ENGRAVES

PANELS

DIALS

PLATES

Mark your own symbols, numbers, lettering, on your small parts, tools, identification and name plates . . . easily, simply, quickly . . . tracing from a master with the GREEN ENGRAVER. Widely used in electronic and plastic fields, in machine tool shops and wherever permanent marking is needed. The GREEN ENGRAVER engraves equally well on metals, plastic, wood, hard rubber and glass. Routs Models Profiles Engraves Etching attachment and other special equipment for industrial uses are available. Fact-filled folder on request showing how economies in costs, labor and time are achieved with the GREEN ENGRAVER.



GREEN

INSTRUMENT COMPANY
361 PUTNAM AVE., CAMBRIDGE, MASS.

CIRCLE ED-44 ON READER-SERVICE CARD FOR MORE INFORMATION

ELECTRONIC DESIGN • July 1954

Berkeley

Decimal Counting Units

give you

- ★ Absolute counting accuracy
- ★ Counting rates to 1,000,000 per second
- ★ Direct reading in digits
- ★ Control signal at any preset count if desired
- ★ Proved reliability—more than 50,000 in use
- ★ Compact plug-in design, easily replaceable
- ★ Any desired count capacity by cascading, or driving mechanical register
- ★ Instantaneous reset without missing a count

For These Typical Applications

Measurement and control of: packaging, sorting by count, weight or size...cutting to width or length...rotary or linear motions or speeds...frequency, velocity, pressure, temperature, flow, viscosity, nuclear radiation, etc.



COUNTING OR COUNTER-CONTROLLER TYPES AVAILABLE

← **DECIMAL COUNTING UNITS**... four models, with count rates of 40,000, 100,000, 350,000 or 1,000,000 cps. Overall dimensions from $1\frac{3}{8}'' \times 5\frac{1}{2}'' \times 5\frac{1}{2}''$ for lower count rate units to $3\frac{1}{4}'' \times 5\frac{1}{2}'' \times 5\frac{1}{2}''$ for 1,000,000 cps. unit. Operate over wide voltage range. Low current models and special units to suit various requirements available promptly.



← **COUNTER-CONTROLLER UNITS**... produce electrical output signal when any desired pre-set count is reached. Similar to counting units in design and construction; maximum count rate, 40,000 per second. Output actuates relays, signal devices or servomechanisms. Dual preset type (output at any two preset counts) available; first signal can be used to warn of approaching limit, slow down operation preparatory to second "stop" signal, etc.

ENGINEERING ASSISTANCE AVAILABLE

As the pioneer in development of decimal counting devices since 1946, BERKELEY has an unsurpassed fund of experience and knowledge to offer. Representatives in 20 U. S. and Canadian cities. Write today for technical bulletins and specific application data; address Dept. D7.

M-35

Berkeley

division

BECKMAN INSTRUMENTS INC.
2200 WRIGHT AVE., RICHMOND, CALIF.

CIRCLE ED-48 ON READER-SERVICE CARD FOR MORE INFORMATION

New Products . . .

Germanium Diodes

Offered in 19 Standard Types

Type 1N Series Germanium Diodes are designed with a functional hexagonal body that is tapered to indicate direction of current flow. They are point contact crystal diodes, made to insure a low cost unit offering dependable service and long life.

The diodes are protected against humidity by their



brown, molded housing, and, aided by an electrically inert material that fills the entire cavity and seals out all moisture, they are able to withstand severe mechanical shock. Available in 19 standard types, they are adaptable to a large variety of circuit applications in electronic equipment. International Resistance Co., Dept. ED, 401 North Broad St., Philadelphia 8, Pa.

CIRCLE ED-49 ON READER-SERVICE CARD FOR MORE INFORMATION

Protective Relay

Controls Power Source

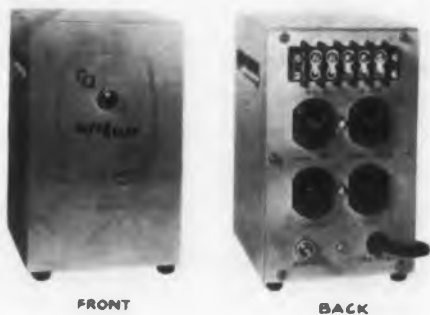

The "Super Relay" controls loads up to 15amp a-c with an input current of less than $5\mu\text{amp}$. The sensing device may be a contactor, such as a precision thermo-regulator, normally open or closed; or a standard phototube, normally illuminated or dark, that may energize or de-energize the relay, which in turn may either close or open the load circuit. The proper selection of control and output circuits, which are in the unit, permits the desired phase of control with completely fail-safe operation of any device. Infrared lamp loads, for example, may be controlled with provisions for marginal heat operation.

The control device and cabinet are isolated from the a-c power line. D-C vacuum-tube circuitry provides maximum stability as well as provision for external delay circuits if needed for optimum control characteristics. The relay operates on 115v a-c. It measures 6-1/2" x 4-1/4" x 4-1/4" and is finished in baked gray enamel. Chicago Apparatus Co., Dept. ED, 1735 N. Ashland Ave., Chicago 22, Ill.

The control device and cabinet are isolated from the a-c power line. D-C vacuum-tube circuitry provides maximum stability as well as provision for external delay circuits if needed for optimum control characteristics. The relay operates on 115v a-c. It measures 6-1/2" x 4-1/4" x 4-1/4" and is finished in baked gray enamel. Chicago Apparatus Co., Dept. ED, 1735 N. Ashland Ave., Chicago 22, Ill.

CIRCLE ED-50 ON READER-SERVICE CARD FOR MORE INFORMATION

NEED A MAG-AMP?



SEE A C-A-C MAN



MAGNETIC AMPLIFIERS

Designed and Produced
to Fit YOUR Application

Toroidal construction and quality materials provide: high gain per stage—fast, stable response—long, maintenance-free life—extreme ruggedness.

Designs to allow: multiple, electrically isolated input and output windings—line frequencies 60 cycles, 400 cycles and higher—operating temperatures -55°C to $+100^{\circ}\text{C}$ —hermetic sealing to military specifications.

SEE YOUR CAC MAN

NEW YORK—Harold Gray Assoc.—LA. 4-4258
286 Fifth Ave., New York, N. Y.
PHILADELPHIA—Charles R. Hile Co.—Elgin 6-2266
Hillview Rd., Box 144, Paoli, Pa.
BALTIMORE—Charles R. Hile—Boulevard 1202J
L. G. Korman; 5006 Kenwood, Baltimore 6, Md.
CHICAGO—Gassner & Clark Co.—Rogers Pk. 4-6121
6349 N. Clark, Chicago, Ill.
KANSAS CITY—E. W. McGrade Co.—Delmar 9242
6315 Brookside Plaza, Kansas City, Mo.
LOS ANGELES—Samuel O. Jewett—State 9-1214
13537 Addison St., Sherman Oaks, Calif.
HAMBURG—Cooper-Morgan, Inc.—Emerson 3405
P. O. Box 152, Hamburg, N. Y.
SYRACUSE—Naylor Electric Co.—2-3894
State Tower Bldg., Room 317, Syracuse 2, N. Y.
MERIDEN—Henry Lavin Assoc.—7-4555
(Henry Lavin) P. O. Box 196, Meriden, Conn.
NEEDHAM—Henry Lavin Assoc.—3-3446
(Robt. V. Curtin) 82 Curve St., Needham, Mass.
CLEVELAND—Ernie Kohler Assoc.—Olympic 1-1242
8905 Lake Ave., Cleveland 2, Ohio

COMMUNICATION ACCESSORIES CO.
Hickman Mills, Missouri

CIRCLE ED-51 ON READER-SERVICE CARD

Magnetic Shift Registers

Operate at 125kc

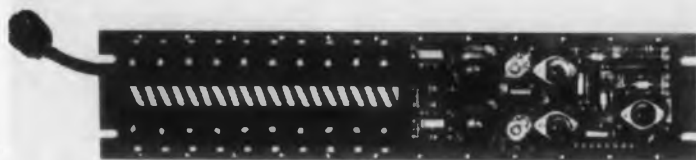

Four models of magnetic shift registers are offered for computer or other electronic system applications. These units are completely self-contained operating assemblies, requiring only normal power supply voltages and a source of clock pulses, in addition to the input information. Information rates of 125kc may be handled.

Each shift register contains 20 plug-in magnetic core elements arranged to store 10 bits of information. Because the output of one unit directly provides the input to another, the registers may be ganged serially to provide as large a binary storage system as may be required. Units may also be operated in parallel from the same timing source to provide storage for coded decimal numbers.

The four different models (SR2, SR3, SR4, and SR5) are offered to provide various combinations of serial or parallel read-in and read-out. Use is made of both printed wiring and conventional component board construction to insure maximum reliability, simplicity, and serviceability. The chassis mounts in standard relay racks. Magnetics Research Co., Dept. ED, 142 King St., Chappaqua, N.Y.

CIRCLE ED-53 ON READER-SERVICE CARD FOR MORE INFORMATION

Deflection Yokes

For Radar Systems



These high-precision radar deflection yokes include rotating and stationary types for PPI and rectangular displays. High performance core materials such as Mu metal and "Molly Permalloy" are used. Specifications also include a wide range of inductances using complex winding distributions with high voltage insulations.

High efficiency, superior linearity, and perpendicularity with low distributed capacitance are the outstanding features of these yokes. Constantine Engineering Laboratories, Dept. ED, P.O. Box 471, Mahwah, N.J.

CIRCLE ED-54 ON READER-SERVICE CARD FOR MORE INFORMATION



MINIATURE



MOLDED



T LINE



TOROIDS



MILITARY

CIVILIAN

KENYON TRANSFORMERS

Meet All Government and Commercial Requirements
Inquiries Invited



KENYON TRANSFORMER CO., INC.

840 Barry St., New York 59

CIRCLE ED-52 ON READER-SERVICE CARD

ELECTRONIC DESIGN • July 1954

P?
MAN

FIERS

uced
tion

quality mo-
er stage-
, mainte-
ggedness.

Electrically
windings-
00 cycles
temperatures
magnetic seal-

AN

258

in 6-2266

1202J
ore 6, Md.
Pk. 4-6121

har 9242
D.
9-1214
lif.
on 3405

e 2, N. Y.

Conn.

am, Mass.
ic 1-1242

ES CO.

ri

ICE CARD

uly 1954

ATTENTION TIP JACK BUYERS . . .

JOHNSON NYLON TIP JACKS*

Low capacity to panel — high DC breakdown

*Patent Pending

SPECIFICATIONS

DC breakdown, 11,000 volts
Nominal capacity to $\frac{1}{8}$ " panel,
2.0 mmf.

Mating pin, .081 diameter
Mounting hole required, $17/64$ "
Head diameter, $\frac{3}{8}$ "
Insulating hardware required,
NONE

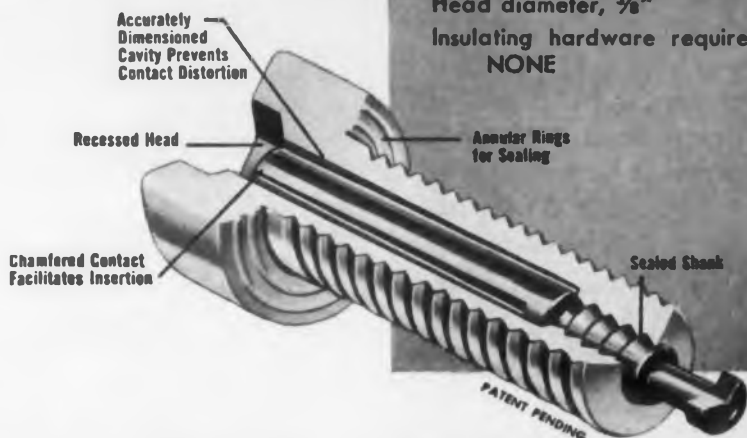

Made of tough, low-loss nylon, these JOHNSON tip jacks are completely insulated and impervious to heat damage up to 105° Centigrade. Injection molded, they will not split or chip even under rapid or extreme temperature changes. With a leakage resistance of 2000 megohms, JOHNSON Nylon Tip Jacks were subjected to 100% relative humidity for seven days, and at the end of this accelerated humidity test still retained a leakage resistance of more than 700 megohms. Machined beryllium copper contacts are silver plated and chamfered for speedy insertion. Extremely low contact resistance; live spring action eliminates fatigue failure — will not take a set. Available in 11 bright colors, JOHNSON Nylon Tip Jacks are ideally suited to coded application. Recommended for aircraft and military use, all materials meet JAN and MIL specifications.

For price quotations and samples of these outstanding Nylon Tip Jacks send your request on company letterhead.



E. F. JOHNSON COMPANY

CAPACITORS • INDUCTORS • SOCKETS • INSULATORS • PLUGS • JACKS • KNOBS • DIALS AND PILOT LIGHTS

344 SECOND AVENUE SOUTHWEST • WASECA, MINNESOTA

CIRCLE ED-55 ON READER-SERVICE CARD FOR MORE INFORMATION

New Products . . .

Speaker Magnets

Have High Energy Product

The RETMA Standard No. 9 loud-speaker magnet is available with a minimum energy product of over 6 million BH max. It is made of "Hyflux Alnico V HE." It makes possible a high sound level, a better transient response, and true reproduction of sound. Indiana Steel Products Co., Dept. ED, Valparaiso, Ind.

CIRCLE ED-313 ON READER-SERVICE CARD

Copper-Plastic Laminate

For Printed Circuits

A copper-to-polyester-glass-mat sheet laminate known as "Estoglas" offers excellent physical and electrical properties. The low power factor of the laminate makes it especially valuable as a base for etched circuits.

The laminate has a resin of electrical-grade polyester and a filler of random-mat glass fibers, giving it uniform strength in all directions. The tensile and flexural strengths are in the neighborhood of 24,000psi. Standard sheet size is 24" x 36" in various thicknesses from 0.044" up, and are clad on one or both sides with 1 oz, 2 oz, or 3 oz copper. Dielectric constant at 1kc is 3.62. Plastilight, Inc., Dept. ED, 481 Canal St., Stamford, Conn.

CIRCLE ED-314 ON READER-SERVICE CARD

Pipe Markers

Stick to Pipes at 300° F

These self-sticking pipe markers can be used to identify the pipes carrying cooling liquids to big transmitter tubes or other equipment operating at extremes of temperature. They stick to pipes at continuous temperatures from -300°F to +300°F.

Mounted on dispenser cards, the markers do not require moisture to apply. W. H. Brady Company, Dept. ED, 727 West Glendale Ave., Milwaukee 12, Wis.

CIRCLE ED-315 ON READER-SERVICE CARD

40

ELECTRONIC COMPONENTS*

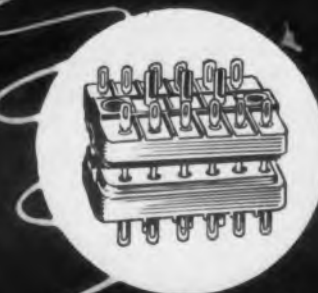

***PRECISION PRODUCED FOR
OVER FIFTEEN YEARS**

**TUBE SOCKETS
PRINTED CIRCUITS
RECEPTACLES - PLUGS
CONNECTORS
TERMINAL BLOCKS
COMMERCIAL AND
JAN TYPES**

National

**FABRICATED
PRODUCTS
INC.**

NATIONAL FABRICATED PRODUCTS, INC.

2650 W. BELDEN AVENUE

Dickens 2-2650

CHICAGO 47, ILLINOIS

CIRCLE ED-316 ON READER-SERVICE CARD FOR MORE INFORMATION

ELECTRONIC DESIGN • July 1954

SILICONDUCTORS*

TRADE-MARK

®

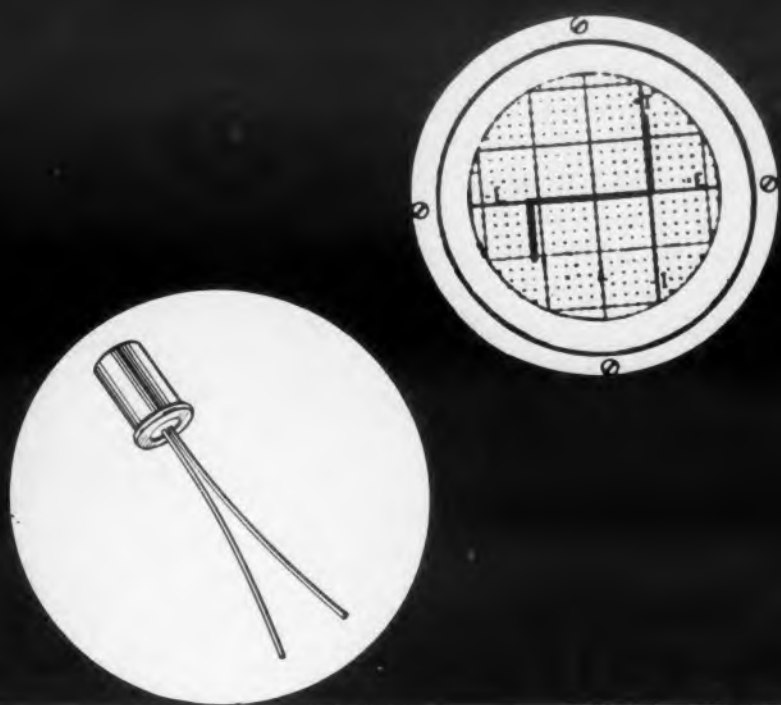

*SINGLE CRYSTAL SILICON JUNCTION DIODES

BROAD RANGE
IN137A & IN138A

IN200 TO IN217

18 TYPES IN 10%
VOLTAGE RANGES
FROM 5 TO 270 VOLTS

AS

VOLTAGE REGULATORS

HIGH BACK IMPEDANCE RECTIFIERS

ALSO

MATCHED PAIRS & QUADS

IN PRODUCTION QUANTITIES FOR IMMEDIATE DELIVERY

NATIONAL SEMICONDUCTOR PRODUCTS

DIVISION OF NATIONAL FABRICATED PRODUCTS, INC.

930 PITNER AVENUE

DAvis 8-0800

EVANSTON, ILLINOIS

CIRCLE ED-316 ON READER-SERVICE CARD FOR MORE INFORMATION

LICENSED BY WESTERN ELECTRIC CO., INC.



Nameplates

Adhesive Backed

Known as "Foileal", these nameplates are made of adhesive-backed metal foil and require no fasteners for attachment. They are as permanent as conventional nameplates.

The nameplates are adaptable to curved surfaces and are made in a variety of colors. They meet MIL-P-6906 Specifications. Miller Dial & Name Plate Co., Dept. ED, 4400 North Temple City Blvd., El Monte, Calif.

CIRCLE ED-317 ON READER-SERVICE CARD

Magnetic Tape

Has Long Life

A new magnetic recording tape is unconditionally guaranteed never to break or curl when it is used under normal conditions of recording and playback. Known as "Lifetime" Tape, it will not shrink, stretch, or dry out. It stands extremes of temperature and humidity.

Made on a base of "Mylar", it is available in splice-free reels of 600, 1200, and 2400 feet. Reeves Soundcraft Corp., Dept. ED, 10 East 52nd St., New York, N.Y.

CIRCLE ED-318 ON READER-SERVICE CARD

Cold-Flow Parts

Available in All Metals

A free sample box contains two of the many intricate parts produced by the "Cold-Flow" technique. "Cold-Flow" is a cold forging method for forming parts in all metals.

The two sample brass parts, a terminal post and a contact point, illustrate the close dimensional control on difficult shapes, improved surface finish and increased surface hardness due to the process.

The technique evenly fans out the metal grain and eliminates severed fibres. Tensile and sheer strengths are improved. Because parts are produced from wire rather than bar stock, material waste from machining is eliminated. Camcar Screw & Mfg. Corp., Dept. ED, 604 18th Ave., Rockford, Ill.

CIRCLE ED-319 ON READER-SERVICE CARD

new approach to

THERMAL RELAY DESIGN

G-V TIME DELAY RELAYS

- Hermetically Sealed
- Still Adjustable
- Amazingly Rugged
- Thoroughly Dependable



G-V ENGINEERING OFFERS A NEW APPROACH TO THERMAL RELAY DESIGN

- Stainless steel mechanism welded into a single integral structure and supported at both ends for unequalled resistance to vibration and shock
- Heater built inside expanding member for maximum efficiency and protection
- Rolling contact action for positive operation
- Easy adjustability where desired
- Precise operation never before available in thermal relays
- Time ranges: 3 seconds to 5 minutes
- Hermetically sealed in metal shell
- Heater voltages up to 230 volts
- Fully temperature compensated
- Suitable for military and industrial use
- Unequalled for ruggedness and precision

U. S. and Foreign Patents Pending

G-V
CONTROLS INC.

The stainless steel structure of G-V Thermal Relays, encased in a metal shell, delivers dependable, trouble-free performance under the most severe operating conditions . . . proved in commercial and military service for three years.

Thermal Relays are the simplest, smallest, lightest, most economical means of introducing a substantial delay into an electrical circuit.

G-V Relays offer performance never before available.

Why not find out by writing today how they can help you. G-V Controls are Thermal Relay specialists. They originated the 7-pin miniature and now make more of these than all other producers combined.

Only G-V offers complete technical data and helpful engineering cooperation on THERMAL TIME DELAY RELAYS.

Write for bulletin and help with your particular problems.

18 Hollywood Plaza
East Orange, New Jersey

Greatly expanded production facilities assure prompt deliveries.

CIRCLE ED-56 ON READER-SERVICE CARD FOR MORE INFORMATION

New Products . . .

Polar Relay

High Speed, Sensitive Unit



A new polar relay features exceptional sensitivity for high-speed pulse repeating and dependable performance where low

current is transmitted over long lines. Known as the "PTW Polar Relays," this unit has performed billions of operations without readjustment. No critical adjustments are necessary; spacing of contacts takes only a simple set-screw regulation.

The relay meets the speed and sensitivity requirements for teletypewriters and is recommended for line current direction indication or as a differential relay in a Wheatstone Bridge type of control. The unit has an easily removable snap-on cover and measures only 2-7/16" x 2-1/4" x 3-5/16". Electric Sales Corp., Dept. ED, 1033 West Van Buren, Chicago 7, Ill.

CIRCLE ED-57 ON READER-SERVICE CARD FOR MORE INFORMATION

Precision Frequency Regulator

For Aircraft Inverters

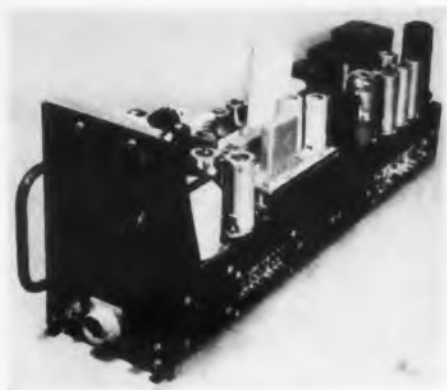

The Model M-1087 Precision Frequency Regulator and Inverter Assembly is used for high precision rate gyros, and fire control and navigational system motors and servos requiring accurate frequency regula-

tion. The control unit is adaptable to inverters of different sizes, ratings, and manufacture. It is shown with its cover removed.

Average frequency control of $400 \pm 0.1\text{cy}$ and instantaneous control of $\pm 1\text{cy}$ at the same frequency are featured. Providing output voltage of 110-120v a-c, single or three phase, the assembly operates without a separate power supply.

The control unit has dimensions of 22" x 5" x 7-3/4" and weighs 28-1/2 lb, while the inverter unit size and weight depend on the particular make. The W. L. Maxson Corp., Dept. ED, 460 W. 34th St., New York 1, N. Y.

CIRCLE ED-58 ON READER-SERVICE CARD FOR MORE INFORMATION



presents

A NEW IDEA IN Flexible Plastic TUBING CLAMPS

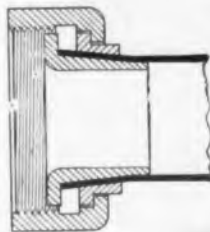

for use with AN TYPE CONNECTORS

This unique tubing clamp provides an inexpensive method to protect open wiring used in connection with a standard AN TYPE CONNECTOR.

It is an *easy and quick* way to attach flexible plastic tubing to a connector—*without the use of hand tools*. When used in conjunction with a gasketed adapter, a waterproof joint is provided between connector and tubing.

Material—aluminum. Sizes to accommodate tubing from 1/4-in. I.D. to 2-in. I.D AN plug sizes 12S to 48.

Write for Catalog data.



H. H. BUGGIE, Inc.
726 STANTON STREET
TOLEDO 4, OHIO

CIRCLE ED-59 ON READER-SERVICE CARD

It pays to choose crystals from the world's most complete line!

Whether your crystal requirement involves extreme miniaturization, stability, unusual frequencies, weight reduction or maximum protection against moisture, temperature changes, shock or vibration, Standard Piezo has the answer . . . fully tested and proved in the world's most critical military, aviation, commercial, and industrial services.

STANDARD PIEZO COMPANY
Carlisle, Pa.



NEW 20-PAGE
CATALOG ON
REQUEST

STANDARD PIEZO CRYSTALS

... by the Pioneers of Modern
Crystal Development



CIRCLE ED-60 ON READER-SERVICE CARD

ELECTRONIC DESIGN • July 1954

Toggle-Switch Boot For High Pressure Service

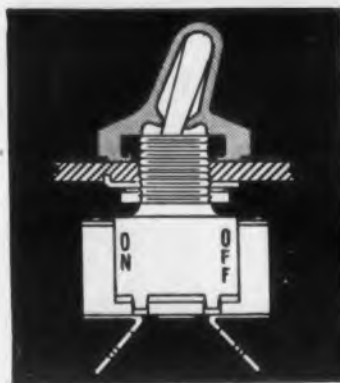

The Model 5030 "Hexseal" is a miniature toggle-switch boot for high pressure service. When installed on the exterior of a panel in place of a conventional lock-nut, it provides both hermetic sealing and fastening. The design incorporates a gasket rib, molded as an integral part

of the boot, which seats against any panel surface to keep out moisture, dust, or combustible vapors.

"Hexseals" are made of silicone rubber, chemically bonded to a threaded insert. They meet vibration and weather requirements of MIL Spec E-5272A, and surpass the requirements of MIL Spec B-5423. Operating temperature range is from -80° to $+500^{\circ}$ F, and the material remains unaffected by acids, ozone, or saltwater atmosphere.

The boot is of single unit construction, requiring no assembly. Absolute sealing is obtained by hand tightening. For production applications, a standard hex socket wrench is recommended. Dimensions are $1/2$ " overall height with $7/16$ " between flats. The unit accommodates a toggle bat $3/8$ " high, with mounting thread $1/4-40$. The color is gray with other colors available on special order. Automatic & Precision Mfg. Co., Dept. ED, 252 Hawthorne Ave., Yonkers 5, N. Y.

CIRCLE ED-61 ON READER-SERVICE CARD FOR MORE INFORMATION

Electrical Counter With Instantaneous Reset



An expansion of the Sodeco line of mechanical reset counters, these electrical reset counters are available in four or five-digit models. Standard models have a counting speed of up to 10 impulses/sec. Special models are available with speeds up to 25 impulses/sec. Resetting to zero is accomplished in only 0.4sec, and, if necessary, the reset voltage may be different from the impulse voltage.

The counters are available for flush mounting and measure only $1-3/8$ " x $2-3/8$ " x $4-3/8$ ". They are available with or without housings. Landis & Gyr, Dept. ED, 45 W. 45th St., New York 36, N.Y.

CIRCLE ED-62 ON READER-SERVICE CARD FOR MORE INFORMATION

*Career-chance
of a lifetime for*

Senior ELECTRONIC Engineers

*in Lockheed's expanding
Missile Systems Division*

Recently formed from other Lockheed engineering organizations, the Missile Systems Division has a few openings for highly-qualified engineers in various phases of electronics.

The Division's expansion program — along with the type of work involved in its contracts — makes these openings outstanding opportunities for achievement. Engineers who qualify have probably worked on missile, radar-computer, counter-measure, IFF, AMTI or similar projects.

Lockheed has openings for:

- **Senior Electronic Engineers** with experience in the development, packaging, and specification of small, rugged components including resistors, capacitors and all types of magnetic parts.
- **Senior Servomechanisms Engineer** with circuit, auto-pilot or electro-mechanical experience (aircraft or missile experience preferred).
- **Senior Electronic Design Engineers** with experience in sub-miniature packaging techniques. Previous experience with potted plug-in units, etched and printed circuits is desirable.
- **Senior Electronic Engineers** with development and analysis experience in one or more of the following fields.

- A. Guidance systems analysis
- B. Microwave antennas
- C. Radome design
- D. Microwave transmitters
- E. Advanced packaging techniques
- F. Waveguide components
- G. Component specification
- H. IF receivers and FM discriminator circuits

- I. Synchronization and timing circuits
- J. Memory circuits (tubes, magnetic drums, delay lines, etc.)
- K. High voltage power supply and CRT display circuits
- L. Analogue computers
- M. Video pulse, delay, gating, range and range rate tracking circuits

In addition to outstanding career opportunities, the Missile Systems Division offers you excellent salaries commensurate with your experience, generous travel and moving allowances, an unusually wide range of employee benefits and a chance for you and your family to enjoy life in Southern California.

Coupon below is for your convenience.

L. R. Osgood Dept. ED-M-7

LOCKHEED MISSILE SYSTEMS DIVISION

7701 Woodley Avenue, Van Nuys, California

Dear Sir: Please send me information on the Missile Systems Division.

name

field of engineering

street address

city and state

CIRCLE ED-63 ON READER-SERVICE CARD FOR MORE INFORMATION



MICROMAG

Static Magnetic
Low Level
DC Converter

All Magnetic
Drift Free
High Sensitivity
No Bias Required



MODEL MH-1

Actual Size

A new line of MICROMAG magnetic DC converters... that produce phase reversing AC output (sinusoidal) voltage in response to a polarity reversing DC input voltage. Fully magnetic design eliminates use of vacuum tubes and all moving parts. It is an extremely rugged, reliable and highly stable component of compact configuration. Exhibits very constant conversion gain over a wide ambient temperature range.

APPLICATIONS: Converters for strain gauges, photocells, thermocouples, summing amplifiers, null detectors, control and measurement instruments. Numerous applications in place of mechanical choppers.



FOR COMPLETE TECHNICAL DETAILS...WRITE SALES DEPT.



MAGNETIC RESEARCH CORP.
318 KANSAS STREET • EL SEGUNDO, CALIFORNIA

VISIT BOOTH #645 • WESCON SHOW • PAN PACIFIC • LOS ANGELES •
CIRCLE ED-64 ON READER-SERVICE CARD FOR MORE INFORMATION

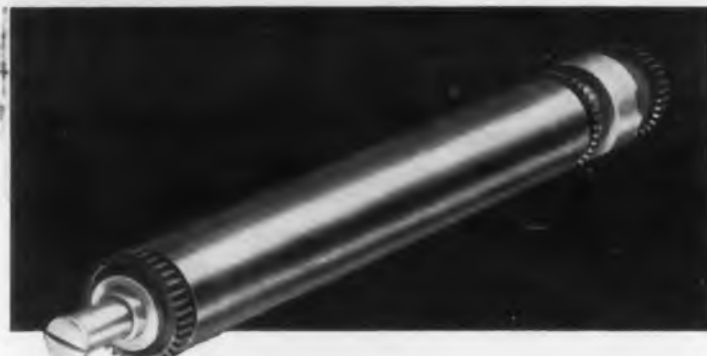

OUT OF AN IBM BUSINESS MACHINE POPS THIS TUBING IDEA FOR YOU

This is the contact roll of an IBM Collator—which performs electronic sleight-of-hand with 240 punched cards per minute! Steel fingers that sort the cards give the roll a high-speed workout. And it must resist corrosion and be a good electrical conductor. IBM employs Superior WELDRAWN* Beryllium Copper and low carbon steel composite tubing for the roll because it meets tight specifications for wear resistance, peak hardness and conductivity. Chances are this tubing—or one of our more than 55 other analyses—will meet your requirements for equally critical applications. Send for free Technical Bulletin #7-2 and tell us about your tubing needs.

*Reg. U.S. Pat. Off.

All analyses .010" to 3/4" O.D.
Certain analyses in light walls up to 2 1/2" O.D.

SUPERIOR TUBE COMPANY
2050 Germantown Ave., Norristown, Pa.

Superior Tube

THE BIG NAME IN SMALL TUBING

CIRCLE ED-65 ON READER-SERVICE CARD FOR MORE INFORMATION

44

New Products...

Epoxy Resin

Heat Distortion Temperature over 150°C

A new high heat distortion temperature epoxy material, designated as Hysol 6000HD, has a heat distortion temperature over 150°C. It is supplied in sheets, rods, and tubes. Custom castings can be made to specification.

Hysol 6000HD has excellent electrical properties, good machinability, and low water absorption. It is amber colored. The heat distortion temperatures were determined in accordance with ASTM D648-45T. Houghton Laboratories, Inc., Dept. ED, 322 Bush St., Olean, N.Y.

CIRCLE ED-66 ON READER-SERVICE CARD FOR MORE INFORMATION

Circular Connectors

Hermetically Sealed



The distinguishing feature of the VR and VP Series of miniature, hermetically sealed circular connectors is a "Kovar" type glass seal fused to the base of each contact and to the precision machined steel body. This improvement makes the connectors especially adaptable to missile-type cabling, radar equipment, and other applications where pressurized or vacuum-type equipment is used.

Connectors are available with one to nine contacts, depending upon application. Positive indexing, plus a band lock that can be engaged by touch, assures simple and accurate joining of plug and receptacle under all conditions. This positive-acting lock also prevents uncoupling, even when subjected to severe vibration. The female section is equipped with hood and cable clamp.

Contacts are gold-plated over silver, giving maximum conductivity, soldering ease, and resistance to corrosion. Breakdown voltages for VR receptacles are high. Types with one to four contacts have a 1200v d-c breakdown at sea level under normal conditions, and 250v d-c at 70,000 ft. Types with five to seven contacts have a d-c breakdown of 2500v at sea level, and 500v at 70,000 ft. The nine-contact type has 1200v d-c breakdown at sea level and 200v d-c at 70,000 ft. Current rating for all connectors is 5amp. Approximate weight of plug and connector is 0.57 oz. Viking Electric, Dept. ED, 1061 Ingraham St., Los Angeles 17, Calif.

CIRCLE ED-67 ON READER-SERVICE CARD FOR MORE INFORMATION

NEW

SUB-MINIATURE UNIMAX® SWITCH

Type U S M



ACTUAL SIZE

for easy wiring in miniaturized apparatus.

- Sturdy, standard flat terminals are widely spaced for rapid wiring and easy soldering.
- Case size 25/32" x 23/64" x 1/4".
- Long life.
- Available in plain or leaf-actuator style.
- Rated 5 amperes at 125/250 volts, a-c. or 2 amperes at 30 volts d-c.; SPDT.

Write for data sheet.

UNIMAX SWITCH

DIVISION OF THE W. L. MAXSON CORPORATION
460 WEST 34th ST. NEW YORK 1, N.Y.

CIRCLE ED-68 ON READER-SERVICE CARD FOR MORE INFORMATION

Fielden PROXIMITY METER

CAPACITANCE GAUGE



- * Precision testing of concentricity, thickness micrometry of production samples, finishes, insulation, strain and torque measurement; also dielectric analysis of gases, liquids or solids.
- * No contact with specimen or sample is necessary.

- * Broad versatility for both static and dynamic testing.
- * High stability for either long or short test periods. Sensitivity exceeds 0.01 mfd.
- * Frequency response flat within ± 1db from 100 to 20,000 CPS.

The Fielden Proximity Meter-Capacitance Gauge provides a new, highly accurate means of measuring, comparing, or monitoring dimensions and distortions impossible to attain by mechanical means now available. For example, variations of 0.01 of a micro-inch are easily detected. Wear or damage to either electrode gauging head or sample is impossible, since no physical contact is made with the specimen. Applications are extremely broad. They range from dielectric analysis of moisture, composition, or contamination—to concentricity comparisons of turbine shafts—or biological specimen studies in the laboratory. For further data on this unusual instrument write today to Dept. Q.



Robertshaw-Fulton

CONTROLS COMPANY

FIELDEN INSTRUMENT DIVISION
2920 N. 4th St., Philadelphia 33, Pa.

CIRCLE ED-69 ON READER-SERVICE CARD FOR MORE INFORMATION

ELECTRONIC DESIGN • July 1954

Curtis Terminal Blocks
Make Better Connections
Economically—Quickly.
A type for every purpose.

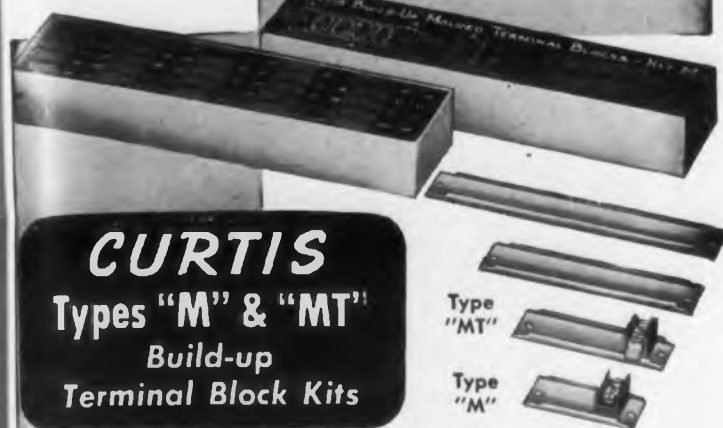

CURTIS Types "M" & "MT" Build-up Terminal Block Kits

You Build Them to Your Needs

Write for Bulletin
DS-122. Also, ask
about wide selection
of other Curtis
Blocks available.

Both the "M" and "MT" Blocks built from these kits are identical to the factory assembled blocks of the same types. The only difference between the "M" and "MT" kits is the marking tag for circuit identification provided with the "MT" kit. They have been put in kit form to save you time on engineering, research, maintenance and repair work. They can be assembled in blocks of 2, 3, 4, 5, 6, 8, 10 and 12 terminals from the parts furnished. Rated 300 volts, 15 amperes.

CURTIS DEVELOPMENT & MFG. CO.

3236 North 33rd Street, Milwaukee 16, Wisconsin

CIRCLE ED-70 ON READER-SERVICE CARD FOR MORE INFORMATION

ANOTHER NEW FAIRCHILD POTENTIOMETER



TYPE 745 10-TURN HELICAL

Designed for use in high speed computers, guided missiles, etc., the Type 745 features high electrical accuracy (linearity $\pm 0.025\%$) and a resistance range from 100 to 300,000 ohms. This 10-turn helical potentiometer weighs 7 ounces and meets rigid government requirements for resistance to humidity, salt spray, altitude, temperature, vibration, shock, sand and dust, and fungus. The Type 745 is 2" in diameter and 2-5/32" long from the front of the servo flange to the end of the case. Mechanical and electrical rotation is 3600° ($\pm 2^\circ-0^\circ$) with a starting torque of 1 oz.-in.

SAMPLES AVAILABLE ON ORDER

The Type 745 is another reason why Fairchild can help you solve all your precision potentiometer problems. For more information write Fairchild Camera & Instrument Corp., Potentiometer Division, 225 Park Avenue, Hicksville, L. I., N. Y., Department 140-49N.



CIRCLE ED-71 ON READER-SERVICE CARD FOR MORE INFORMATION

ELECTRONIC DESIGN • July 1954

D-C Voltmeter

Employs Adjustable Reference Voltage

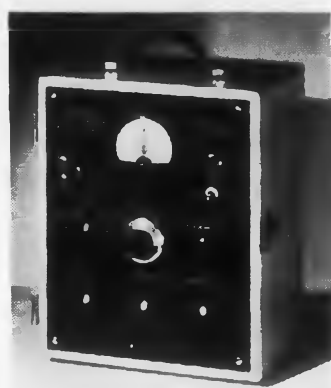

The Model 124 Precision D-C Voltmeter produces an accurate, adjustable reference voltage for comparison with the voltage to be measured. Equality of the two voltages is indicated on a null-indicating meter. Voltages between 0-510v can be measured.

The produced reference voltage is indicated on dials associated with the adjustments of the voltage. Two adjustments are made in steps of 100v and 10v, and a third is made on a multi-turn potentiometer with a vernier dial; the vernier subdivides either of the other two steps into 1000 divisions each. Fractions of a division may be estimated.

The voltmeter has a stable regulated power supply circuit for use as the interval voltage source. An additional position on the 10v decade switch permits overlapping ranges so that voltages exceeding a multiple of 100v may be measured in two different positions of the decade switch; this feature also permits extension of the useful range beyond 500v.

The voltmeter is available for relay rack mounting and, on special order, the terminals of the reference voltage may be connected to a receptacle on the front panel to by-pass the null indicator. Furst Electronics, Dept. ED, 3322 W. Lawrence Ave., Chicago 25, Ill.

CIRCLE ED-72 ON READER-SERVICE CARD FOR MORE INFORMATION

Thyratron Tubes

For Electronic Control Use

These two standard thyratron tubes are specifically designed for electronic control purposes, such as the speed of d-c motors, counting and sorting devices, regulation of current and voltage, and switching. Designated as Amperex types "AX-5544" and "AX-5545", they are directly interchangeable in every respect with RETMA tubes bearing the same designation.

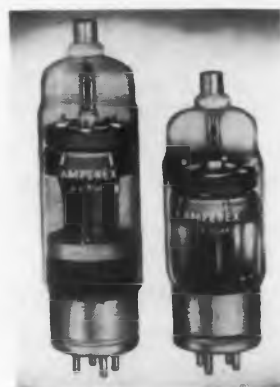

Both tubes are three-electrode, Xenon-filled thyratrons, with negative control characteristics. The inert gas filling allows reliable operation at maximum ratings over a wide temperature range. Amperex Electronic Corp., Dept. ED, 230 Duffy Ave., Hicksville, L.I., N.Y.

CIRCLE ED-73 ON READER-SERVICE CARD FOR MORE INFORMATION

ONE PIECE TUBULAR DESIGN
UP TO
2,000,000 CM

HYLUGS : HYLINKS



For dependable, rapid termination of wire and cable. Easily installed with matched Burndy tooling.

For making solderless end-to-end connections. Installed rapidly with Burndy indenting tools.

Ask your Burndy Distributor

BURNDY
NORWALK • CONNECTICUT

CIRCLE ED-74 ON READER-SERVICE CARD FOR MORE INFORMATION

the NEW
miniature ALL-METL
BARRY B MOUNT



for all-temperature vibration protection
of airborne equipment

These new isolators are the latest addition to the famous Barry ALL-METL line. They are specifically designed to help you meet miniaturization demands under toughest environmental conditions.

- Perfect operation from -60°C to $+200^\circ\text{C}$.
- Weight only $\frac{1}{2}$ ounce per unit isolator.
- Free height only $1\frac{1}{4}$ "—bottomed height $25/32$ "
- Load ratings from 0.1 to 3.0 lb. per unit.
- Meet all relevant requirements of JAN-C-172A.
- Ruggedized models for equipment to meet shock tests under AN-E-19, MIL-E-5272, MIL-T-5422.
- Available for 2 or 4-hole mounting.



For complete information, ask for your free copy of the new Barry Product Bulletin 542, containing full installation and performance data. And for greatest benefits with these new isolators, let our Field Engineering Service help in the early stages of your equipment design. Write directly to The Barry Corporation, 775 Pleasant Street, Watertown, Massachusetts, or get in touch with your nearby Barry representative.

CIRCLE ED-75 ON READER-SERVICE CARD FOR MORE INFORMATION

for really **ACCURATE**
Voltage Regulation



Type 1570-A Automatic
Voltage Regulator



Holds Voltage Output Constant to $\pm 0.25\%$
Extra Fast Response of 0.1 Sec. per Volt
Handles up to 50 Amps. (6 KVA)

Consists of a VARIAC® continuously-adjustable autotransformer, a servomechanism circuit which samples output voltage and a servo-motor which drives the VARIAC to correct for line variations. For really ACCURATE line voltage regulation this is the answer.

Type 1570-ALM (115 v) or Type 1570-AHM (230 v)
Automatic Voltage Regulator . . . \$470.00

Write for the July 1954 G-R EXPERIMENTER
for Complete Details

GENERAL RADIO Company

275 Massachusetts Avenue, Cambridge 39, Mass., U.S.A.
8055 131st St., Silver Spring, Md. WASHINGTON D. C. 90 West St. NEW YORK 6
920 S. Michigan Ave. CHICAGO 5 1000 N. Seward St. LOS ANGELES 38

CIRCLE ED-76 ON READER-SERVICE CARD FOR MORE INFORMATION

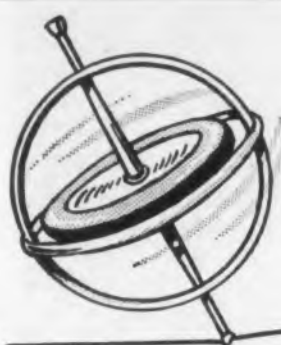

CASTELL
push button
LOCKTITE
lead holder has
PERFECT BALANCE

Perfect balance makes Push Button
CASTELL LOCKTITE Holder the king of its class.

Exclusive collet holds lead in **bull dog**
grip, preventing slipping or turning.

No graphite dust stains your fingers
—because with one-hand push-button
action you extend and retract the lead.
No need to touch graphite. Comfortable
“wood-pencil” feel—not metallic.

Equipped with easily-replaced clutch,
giving your LOCKTITE indefinite life.

Imported CASTELL 9030 Lead inserted
in your LOCKTITE Holder gives you the
combination for brilliant results on your
drawing board. Ask your Dealer for both—
LOCKTITE Holder and Imported CASTELL 9030
Lead in 19 degrees, 7B to 10H.

AW. FABER-CASTELL
PENCIL COMPANY, INC., NEWARK 3, N. J.

CIRCLE ED-77 ON READER-SERVICE CARD FOR MORE INFORMATION

New Products . . .

Lacing Cord and Tape
Teflon-Impregnated

“Nebroce” lacing cord and tape, especially suited to high-temperature applications consists of high-grade, continuous-filament “Fiberglas” thoroughly impregnated with a uniform film of “Teflon”. Applications are in tying coils, motor windings, and harness lacings that are to be impregnated with high-temperature varnishes.

The Teflon coating also serves as a lubricant, thus preventing single filaments from severing each other when cords are flexed or knotted. The new product withstands temperatures from -90° to 260° C, has high tensile strength, is non-inflammable, will not support fungus growth, and is chemically inert to all known commercial solvents.

“Nebroce” is furnished in a wide range of sizes and colors. Cordage is available from stock in sizes from 0.0046” to 0.076” diam. Tape comes in widths from 3/32” to 1/2”. Other sizes can be specified. Hitemp Wires, Inc., Dept. ED, 26 Windsor Ave., Mineola, New York.

CIRCLE ED-78 ON READER-SERVICE CARD FOR MORE INFORMATION

Quick-Action Vise
Jaw Space up to 5 ft



The “AVA”
Quick-Action Vise
clamps work tightly
by spring pressure.
It can be held while
working, and also serves
as a clamp. Portable

or attachable, it can be used for holding parts and jiggling, and for assembly, welding, soldering, and many other operations. Vises are available from 6” to 60” (space between jaws when wide open), in multiples of 6”

Type 108 aluminum castings with 3/4” cold rolled tubing are used to make the design light and strong. Two lever springs give from a slight squeeze up to 300 lb pressure when jaws are flipped closed. One jaw, with lever lock, bolts to the tube. The other acts on a double-spring action that assures quick lock. The user can alter shapes with the addition of rubber sleeves to the jaws and clip-on plates of plastic, copper, etc. Any size or shape enlargement plates can be added by drilling and bolting to the parent jaw. Evanson Equipment Co., Dept. ED, 33 Warren St., Newark 2, N. J.

CIRCLE ED-79 ON READER-SERVICE CARD FOR MORE INFORMATION

A Full Line

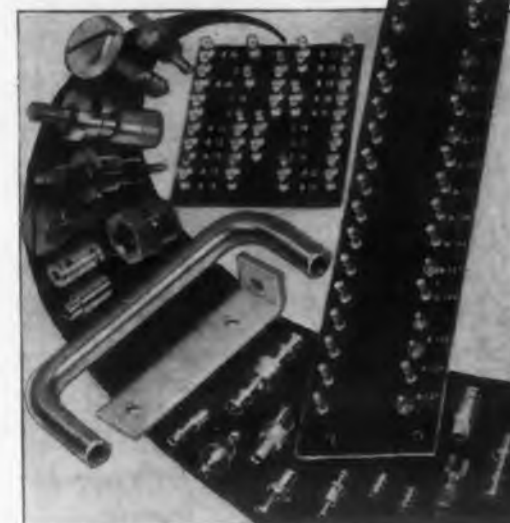

- Terminal Lugs ● Insulated Terminals ● Electronic Hardware
- Handles ● Captive Screws
- Brackets ● Dial Locks ● Spacers
- Shaft Locks ● Binding Posts

Completely assembled terminal boards to meet all government specifications.

Immediate delivery from stock or to order on all items.

Write for Catalog

CITATION PRODUCTS CO.
233 EAST 146th ST., NEW YORK 51, N. Y.

CIRCLE ED-80 ON READER-SERVICE CARD FOR MORE INFORMATION



Helipot technical paper
a Helipot Technical Information Service

Characteristics of Precision Servo Computer Potentiometers

by D. C. Duncan
General Mgr., Helipot Corp.

Presented at A. I. E. E. Conference on Feedback Control Systems

Write today for your free copy of this Technical Paper. Ask for Data File 707

Helipot first in precision potentiometers
Helipot Corporation/South Pasadena, California
a division of BECKMAN INSTRUMENTS, INC.

CIRCLE ED-81 ON READER-SERVICE CARD FOR MORE INFORMATION



ENGINEERS
ARE DEMANDING
MILWAUKEE

RIBWOUND RESISTORS

SIZES FROM 50 TO 2000 WATTS
FIXED • ADJUSTABLE • TAPPED

MILWAUKEE'S production has stepped up to meet demand for RIBWOUNDS! These are MILWAUKEE'S answer to space-saving applications where high wattage and low resistance is required. Accurate — built for high performance.

Write, wire or phone today for quotations—samples.

All other types of wire wound resistors are available — specials are made to your specifications.

MILWAUKEE RESISTOR CO.

170 W. Virginia Street, Milwaukee 4, Wisconsin

CIRCLE ED-82 ON READER-SERVICE CARD FOR MORE INFORMATION

3 Soldering Operations in 1 Easy as ABC

with

KESTER "SOLDERFORMS"

A Solder screws and stud to can cover.
"Solderform" Disc & Rings 5% Silver
—95% Lead Alloy. Melting Point 680°F.

B Solder glass terminals to cover.
"Solderform" Rings 63% Tin—37%
Lead Alloy. Melting Point 361°F.

C Hermetically seal cover on can.
"Solderform" Ring 28.5%
Bismuth—28.5% Tin—43%
Lead Alloy. Softening Point 250°F.

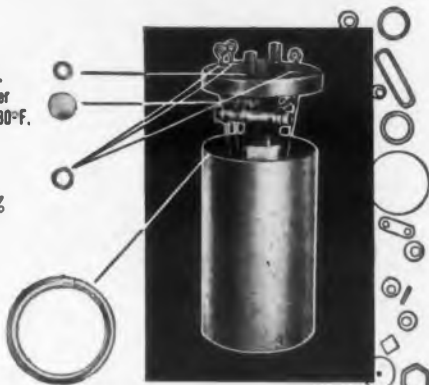

Here's a typical example of a tough resistance soldering job involving progressively lower melting temperatures. Kester "Solderforms" made sure this high precision oscillator coil came through every test successfully.

WRITE TODAY for free "Solderform" samples and literature.

KESTER
SOLDER COMPANY

4266 Wrightwood Avenue • Chicago 39, Illinois
Newark 5, New Jersey • Brantford, Canada

CIRCLE ED-83 ON READER-SERVICE CARD FOR MORE INFORMATION

ELECTRONIC DESIGN • July 1954

Transmitting Triode

Operates up to 200°C and 400g



The Type GL-2C39B is a metal-and-ceramic vhf-uhf "lighthouse" transmitting tube with a construction allowing operating temperatures up to 200°C and shock resistance up to 400g. The tube can be used in new equipment, or as a direct replacement for the GL-2C39A in grounded-grid, class C power amplifier, oscillator, or frequency-multiplier circuits up to 2500Mc. It is a high-mu triode.

Features include an oxide-coated indirectly heated cathode and an anode capable of dissipating 100w with forced air cooling. It has parallel-plane construction, disk seals, and silver-plated external metal parts. The tube easily withstands the stress of insertion into and removal from its cavity.

Maximum ratings, in class C telegraphy as an r-f amplifier and oscillator (key-down conditions per tube without amplitude modulation) are: d-c plate voltage, 1000v; d-c cathode current, 125ma; d-c grid voltage, —150v; d-c grid current, 50ma; peak positive r-f grid voltage, 30v; peak negative r-f grid voltage, —400v; plate dissipation, 100w; grid dissipation, 2w. General Electric Company, Tube Div., Dept. ED, Schenectady 5, N.Y.

CIRCLE ED-84 ON READER-SERVICE CARD FOR MORE INFORMATION

Wiring Template

For JAN-STD-15 Symbols



This template, designed by the electrical engineering department of Lockheed Aircraft Co., permits the rapid drawing of electronic symbols conforming to specification JAN-STD-15. The sizes

of the symbols are in multiples of 0.2", standard to the minimum line spacing allowed under JAN-STD-15.

The straight edges, circles, corners, etc., of the template permit it to be used as a general electronic template in addition to its specialized use in wiring diagrams. Made of 0.30" matte finish plastic, all cut-outs are milled for precision smoothness. Overall size is 7" x 6-1/8". Rapidesign, Inc., Dept. ED, Box 592, Glendale, Calif.

CIRCLE ED-85 ON READER-SERVICE CARD FOR MORE INFORMATION

FASTER, MORE ACCURATE INSPECTION WITH

FLASH-O-LENS Illuminated Magnifiers



In industrial inspection departments, on production lines, in foundries and laboratories, wherever close visual inspection is important, FLASH-O-LENS gets the job done better, faster. FLASH-O-LENS spots minute defects by spotlighting the area it magnifies.

Battery models, powered by standard flashlight cells, and AC-DC plug-in models are available with 5, 7, 20 or 40 power precision lenses to meet a wide range of inspection needs. Prices start from \$10.65.

WRITE TODAY for literature showing applications, types, prices.

E. W. PIKE & COMPANY, Inc.

492 NORTH AVENUE

ELIZABETH 3, N. J.

CIRCLE ED-86 ON READER-SERVICE CARD FOR MORE INFORMATION

MIGHTY MIDGETS!

CANNON MINIATURE D. C. SOLENOIDS



APPROXIMATELY 1 1/2" x 1/4"

POWERFUL! RELIABLE! MANY USES! LOW COST!

Here's YOUR answer to small traction problems. May be used to operate keyboards, light springs, control board signal flags, and door latches. Conventional design. Wide range of d. c. voltages. Self-lubricating Nylon bobbin. Side leads. Design variations available to meet YOUR specific problems. Write TODAY for full information!

CANNON PLUGS

Please Refer to Dept. 143
CANNON ELECTRIC COMPANY, 3209 Humboldt St., Los Angeles, California
Factories in Los Angeles; East Haven; Toronto, Canada; London, England.
Representatives and distributors in all principal cities.

CIRCLE ED-87 ON READER-SERVICE CARD FOR MORE INFORMATION

Metron BANTAM SPEED REDUCERS

- Complete!
- Compact!
- Adaptable!

The New Bantam combines power capacity and toughness with small size.

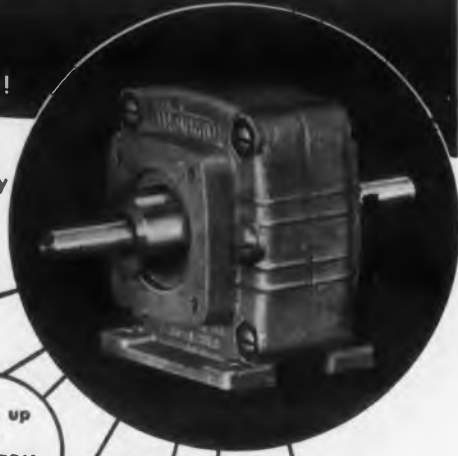

Save design, production, and assembly costs by using ready-to-go Bantams as package components in your product.

Write for Data Sheet 10 and 11 for details

Metron INSTRUMENT COMPANY
450 Lincoln St. • Denver 3, Colorado

CIRCLE ED-88 ON READER-SERVICE CARD FOR MORE INFORMATION

New Products ...

Cathode Follower

For General Purpose Instrumentation



The Model TG-1 Multi-Channel Cathode Follower combines compactness and sturdiness with simplicity and ease of operation. For general purpose instrumentation work, it is capable of handling both a-c and d-c signal circuits wherever high to relatively low impedance transformation is required.

The unit has four channels, individual input and output terminals, d-c balance control, two separate regulated power supplies, low noise, and high stability. Weight is only 8 lb, and size is 5" x 6" x 9". It takes 105-125v, 50-60cy, 35w. Single channel gain (no load) is 0.89; output resistance, 4800 ohms; input capacity, 15mmfd; output capacity, 40mmfd; signal input (no load) maximum, 170v peak. Channel-to-channel interaction is 1% (adjacent channel) and 0.1% (non-adjacent).

The unit is also available for standard rack or panel mounting. G. W. Associates, Dept. ED, P.O. Box 2263, El Segundo, Calif.

CIRCLE ED-90 ON READER-SERVICE CARD FOR MORE INFORMATION

Teflon Adhesive

Holds to 200°C

This pressure sensitive adhesive, designated Flexrock No. 80, was developed for bonding Teflon to itself and other materials. It will hold Teflon to metals, glass, paper, or other plastics. It has good acid and alkali resistance, good dielectric strength, excellent heat stability and low temperature characteristics.

Teflon to Teflon peel strengths of approximately 2 lb per inch of width and shear strengths of 12 to 15psi are developed. It retains usable pressure sensitive characteristics from 55°C to 200°C. Although it becomes thermoplastic at temperatures over 150°C, it retains its effectiveness as a bonding agent.

The adhesive is suitable for application by brushing or knife coating. It may be sprayed or dipped by thinning to suitable viscosity. Flexrock Company, Packing Division, Dept. ED, 3608-B Filbert Street, Philadelphia 1, Pa.

CIRCLE ED-91 ON READER-SERVICE CARD FOR MORE INFORMATION

It's the Principle ...

Relay Basic Unit
A-1105



This structure is the principle contained in 3 AN approved Hermetically Sealed type relays, manufactured by Electrical Products Corporation.

Used for control of vital airborne electronic equipment, it is unusually rugged and provides exceptional resistance to shock, vibration and acceleration.

Has balanced rotary armature with unique, close-coupled contact linkage for speedy, low-inertia operation.



A-1104
(AN-3306-1)



A-51-108
(AN-3311-1)



A-1106
(AN-3307-1)

SPECIFICATIONS:

Nominal Coil Voltage 24-28 VDC
Dimensions 1 1/8 x 1 3/8 x 1 1/8 inches
Weight 3 ozs.
Contacts DPDT
Rated (Resistive and Inductive) 10 amps.
Also available in other enclosures.

Electrical Products offers:

*Uniformly high quality by rigid inspection and testing.

*Extra rugged construction on all type Relays.

Send for Brochure and Specifications on our complete line.



Electrical Products CORP.

1100 North Main Street, Los Angeles 12, California

CIRCLE ED-92 ON READER-SERVICE CARD FOR MORE INFORMATION

is this your
timing
problem?



Sorry...
A. W. HAYDON CO.
can't help you.

Only instruction, practice, and patience can improve your score!

But...if your problem is
PRECISION TIMING

you may save time, trouble and money by investigating what our timing engineers have done for others. Our A.C. and D.C. achievements may already include the solution of your most complex problem. Why not find out?

Send for
latest
catalog
manual



A.W. HAYDON
COMPANY
227 NORTH ELM STREET
WATERBURY 20, CONNECTICUT
Design and Manufacture of Electrical Timing Devices

CIRCLE ED-89 ON READER-SERVICE CARD FOR MORE INFORMATION

FORD
Helical Type
Precision
Potentiometers



Multipot

THE
MARK OF
QUALITY

Electrically Quiet —
Mechanically Smooth —
Four basic types featuring the
finest of materials and crafts-
manship:

1. Standard Series, 1 1/2" dia.
2. "A" Series, 1" dia.
3. "B" Series, 1" dia. x 1" long.
4. "HN" Series, HERMETICALLY SEALED, 1" dia. x 1-9/16" long.

Above dimensions - are for 10-
turn units. Any Multipot may
be supplied with any rotation
from 320° to 3600°. Resistances
from 1 ohm to 400,000 ohms.
Send for Catalog.

FORD ENGINEERING COMPANY
UPLAND, CALIFORNIA
PHONE YUKON 322-321

CIRCLE ED-93 ON READER-SERVICE CARD FOR MORE INFORMATION



GUIDE TO VOLTAGE SPEED CURRENT SERVO CONTROL

ON REQUEST

This new 12-page illustrated bulletin describes the wide variety of control situations to which the REGOHM electro-mechanical controller is adaptable.

Learn how REGOHM will provide sensitivity, speed of response and system stabilization under severe operating conditions in your control system.

Circuit diagrams illustrating the many applications of this versatile, automatic controller, are given.

Text and illustrations describe the functions, design advantages, operation and control characteristics of this small size, lightweight, plug-in device.

Write for Bulletin 505.00. Address Dept. G, Electric Regulator Corporation, Norwalk, Conn.

REGOHM



CIRCLE ED-94 ON READER-SERVICE CARD FOR MORE INFORMATION

Terminal Boards Custom-built or standard

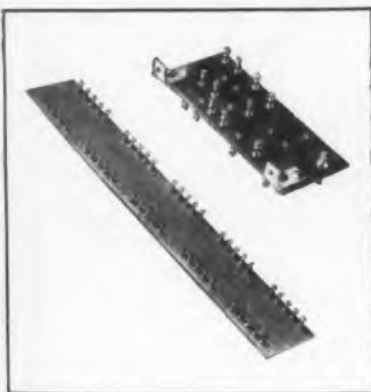

Whatever your needs, you can rely on C.T.C. to give you terminal boards that meet your specifications — and that are guaranteed by quality manufacturing.

We design and fabricate special boards of cloth, paper, or glass laminates (phenolic, melamine, epoxy or silicone resin) imprinted as required — rubber stamp, silk screen, hot stamp or engraving. Boards are lacquered or varnished to specifications MIL-V-173 and JAN-T-152. Terminals, feed-throughs, hardware and all other fixtures meet all applicable government specifications. We welcome sub-contracts for electronic parts and assemblies. Standard type boards are also available — in cotton fabric phenolic, nylon phenolic or grade L-5 silicone impregnated ceramic.

Boards and assemblies are furnished in any quantity. Write direct for complete information on the type of boards you need. Cambridge Thermionic Corporation, 457 Concord Ave., Cambridge 38, Massachusetts.

CIRCLE ED-95 ON READER-SERVICE CARD FOR MORE INFORMATION

ELECTRONIC DESIGN • July 1954

Electronic Volt-Ohmmeter Multi-Range, Long Scale Design



This multi-range electronic Model 225 Volt-Ohmmeter is designed around a 9" internal pivot meter. It has extra long scales, minimizing reading errors and permitting use of the equipment at a practical working

distance. Included are accurate peak-to-peak scales for measurement of complex waveforms, a "zero center" scale for galvanometer applications, and a new single unit probe for both a-c and d-c measurements through the use of a slide switch.

When functioning as a d-c voltmeter, it has ranges of 0-1.5v, 0-3v, 0-12v, 0-30v, 0-120v, 0-300v, and 0-1200v, either positive or negative. Input resistance is 10 megohm with the new probe. When functioning as an ohmmeter, it has ranges of x1, x10, x100, x1000, x10,000, x100,000, and x1 megohm; readability is 0.2 ohms to 1000 megohms. When functioning as an a-c voltmeter, it has seven a-c rms ranges: 0-1.5v, 0-3v, 0-12v, 0-30v, 0-120v, 0-300v, and 0-1200v; and seven a-c peak-to-peak ranges: 0-4v, 0-8v, 0-32v, 0-80v, 0-320v, 0-800v, and 0-3200v.

Frequency characteristics are flat from 40cy to 3.5Mc. The instrument is housed in a blue "Hammer-tex" steel case measuring 16" x 13" x 7" deep. Hickok Electrical Instrument Co., Dept. ED, 10525 Dupont Ave., Cleveland 8, Ohio.

CIRCLE ED-96 ON READER-SERVICE CARD FOR MORE INFORMATION

Metal Laminate Extremely Flexible

A new process bonds vinyl plastic on metal sheeting—steel, aluminum, magnesium, or copper. The resulting material, called "Metal Laminate", is post-formed into the finished product. This coating is extremely resistant to abrasion and corrosion.

The laminate is extremely flexible. It may be bent, drawn, stamped, crimped, or punched without destroying either the vinyl or its bond. Seams may even be welded to form air-tight enclosures. After welding is completed, minor repairs to the vinyl at the point of the weld completely reconstitutes the liner and lamination.

Because of its superior wearing qualities, the laminate practically eliminates refinishing costs for the life of the product. It is available in a great variety of patterns and colors. Metal Laminate Division, Dept. ED, O'Sullivan Rubber Corp., Winchester, Va.

CIRCLE ED-97 ON READER-SERVICE CARD FOR MORE INFORMATION



Here's the Precision Switch that Gives You Extra Features at No Extra Cost

- **LONG MECHANICAL LIFE**

Carries life rating of 10,000,000 mechanical operations with precise repeatability of entire life of switch.

- **HIGH CAPACITY**

UL rated at 10 amps, 125/250 v. ac or 30 v. dc. Wiping action of contacts reduces arcing for long electrical life.

- **SMALL SIZE**

Durable plastic case measures only 1 1/4" long, 1/2" wide and 1/2" high, permitting more compact designs and mounting arrangements.

Send for details in Specification Sheet STS-7



ELECTRO-SNAP SWITCH AND MFG. CO.
4224 West Lake Street, Chicago 24, Illinois



CIRCLE ED-98 ON READER-SERVICE CARD FOR MORE INFORMATION

Laminated
INSUROK[®]
PLASTICS

**SHEETS
RODS, TUBES
PUNCHINGS
GEAR BLANKS
FABRICATED
PARTS**

*All NEMA and
other Special Grades*

Write for
Descriptive
Folder

The **RICHARDSON COMPANY**

FOUNDED 1858

2682 Lake St., Melrose Park, Illinois (Chicago District)

CIRCLE ED-99 ON READER-SERVICE CARD FOR MORE INFORMATION



Miniature Metal Tubing

for the
**ELECTRONIC
INDUSTRY**

● Looking for a good source of miniature and sub-miniature metal tubing? Uniform Tubes has been drawing fine, seamless tubing for over 20 years, furnishing O.D.'s down to .010"; walls down to .0010"; and tolerances as close as .00025"—in metals of almost any desired analysis. We helped pioneer the development of miniature tubing components for transistors and other advanced electronic equipment. Write for information or quotation. You'll like our prices and our 3-4 weeks delivery.



UNIFORM TUBES, INC.
LEVEL ROAD, COLLEGEVILLE 2, PENNSYLVANIA
Offices in principal cities

CIRCLE ED-100 ON READER-SERVICE CARD FOR MORE INFORMATION

There's always room for a Fenwal Miniature THERMOSWITCH® control



SEND FOR BULLETIN

Designed for:
CRYSTAL OVENS
GUIDED MISSILES
WAVE GUIDES
RADAR • COMPUTERS
ANTENNAS

and many others where temperature control is vital and space is at a premium, the new Fenwal Miniature THERMOSWITCH units are real problem solvers.

Bringing you advantages never before found in so small a control, these rugged little devices are extremely sensitive to temperature variations and positive in action. Adjustable anywhere within the range of 0°F to 200°F, they maintain normal control characteristics under vibrations ranging up to 5 G's.

For details on how you can get maximum dependability of temperature control in minimum space, send for your copy of the Miniature THERMOSWITCH Control bulletin.

Write Fenwal Incorporated, 97 Pleasant St., Ashland, Mass.



THERMOSWITCH®
Electric Temperature Control and Detection Devices
SENSITIVE...but only to heat

CIRCLE ED-101 ON READER-SERVICE CARD FOR MORE INFORMATION

New Products . . .

Interval Generator Has 1 μsec to 1 sec Range

Designed for testing and calibrating systems that rely on precise time measurements, this unit tests or generates time intervals and delays from 1μsec to 1sec. The Model 564 has a built-in time-base oscillator that uses a temperature controlled 1Mc crystal for long term frequency stability. Indication is by



means of neon lamps arranged to give six-digit readings directly in μsec.

Intervals of the order of seconds are generated with better than 0.0001% accuracy. Manual or automatic reset may be used; with automatic resetting, the instrument recycles itself to produce trains of accurately spaced pulses. A separate amplifier and shaper unit is provided for application where an external time base source is used for simulating target delays selectable directly in feet or yards. Potter Instrument Co., Dept. ED, 115 Cutter Mill Road, Great Neck, N.Y.

CIRCLE ED-102 ON READER-SERVICE CARD FOR MORE INFORMATION

Output Transformer Gives Ultra-Linear Operation



The BO-13 high-fidelity output transformer, specially designed for ultra-linear operation, features "sealed-in-steel" construction. It is highly compact, with its drawn steel case measuring 3-11/16" x 3-5/16" x 4-11/16" high. It has pin-type terminals and is provided with studs for flush chassis mounting. The unit is designed especially to convert high-fidelity amplifiers to ultra-linear operation. Chicago Standard Transformer Corp., Dept. ED, 3501 W. Addison St., Chicago 18, Ill.

CIRCLE ED-103 ON READER-SERVICE CARD FOR MORE INFORMATION

Specify PRECISION-ENGINEERED SERVO MOTORS

RELIABLE PERFORMANCE
RUGGED CONSTRUCTION



In the operation of—

- GUNFIRE CONTROLS
- ROCKET CONTROLS
- GUIDED MISSILES
- AIRCRAFT CONTROLS
- INDUSTRIAL CONTROLS

G-M Servo Motors can be supplied to meet rigid military specifications with regard to humidity, temperature range, vibration and altitude. Avail-

able in 2, 4 or 8 pole construction and for frequencies from 60 to 400 cycles.

Write today for complete information.

Another product of  **LABORATORIES • Inc.**

4284 NORTH KNOX AVENUE, CHICAGO 41, ILLINOIS
CIRCLE ED-104 ON READER-SERVICE CARD FOR MORE INFORMATION

FAST, ACCURATE PINNING OF PRECISION SHAFTS WITH TRADEMARK

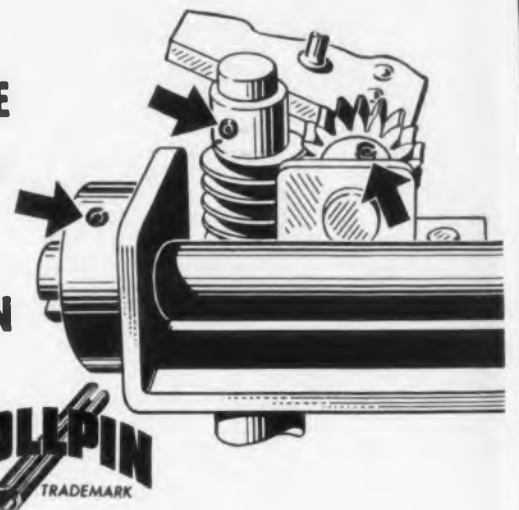

Rollpin speeds production alignment of close tolerance shafts. The slotted, hollow steel spring pin, with chamfered ends, is simply pressed or driven into holes drilled to normal production tolerances. It compresses as driven, is self-locking and vibration-proof. Rollpin is light, easily removable, reusable and has a shear strength greater than a solid pin of the same diameter. Diameters from 1/16" to 1/2".

Rollpin, in place of rivets, set screws, dowels and stop pins can cut production costs as much as 90%. For detailed information on any electronic fastening problem, write: Elastic Stop Nut Corporation of America, 2330 Vauxhall Road, Union, New Jersey. Address Dept. R26-757.



**ELASTIC STOP NUT CORPORATION
OF AMERICA**

2330 Vauxhall Road, Union, N. J.

DESIGN HEADQUARTERS FOR SELF-LOCKING FASTENERS

CIRCLE ED-105 ON READER-SERVICE CARD FOR MORE INFORMATION

ELECTRONIC DESIGN • July 1954

Need a complete complement* of High Voltage Capacitors for developmental color TV?

Leaders for over two years in experimentation with component parts for color TV, Jeffers Electronics has developed this first complete complement of high-voltage capacitors.

Drawings and additional technical information furnished on request. Complete kits of high-voltage capacitors listed below available at nominal cost.

Each kit includes the following units:

No. per kit	Capacity	Voltage Rating
1	10,000 MMFD	6KV
1	2,000 MMFD	30KV
1	500 MMFD	30KV
2	1,000 MMFD	10KV
3	1,200 MMFD	15KV

*Typical quantities proposed

Other Divisions: Speer Resistor
International Graphite & Electrode



CIRCLE ED-106 ON READER-SERVICE CARD FOR MORE INFORMATION

Cathode Ray Tube Easily Read in Bright Daylight



This small cathode ray tube has a 5" face, a heater power consumption of only 1.26w, and an overall length of only 7-1/2". It has special features that make it easily readable in bright daylight. The tube comes with vari-

ous phosphors making up 5ALP series.

The tube has a standard 9-pin miniature base. It uses magnetic focus and deflection, and produces beam currents on 0.5-1.0ma under normal operations. It can be designed into airborne or small, compact equipment, or can be used where strong, surrounding light levels are encountered. Maximum ratings include: heater voltage (a-c or d-c), 6.3v; anode voltage, 10kv; grid voltage (negative), 250v, (positive) 0v; grid resistor, 1.5 megohm. Tube neck diameter is 0.87". National Union Radio Corp., Dept. ED, 405 Lexington Ave., New York 17, N. Y.

CIRCLE ED-108 ON READER-SERVICE CARD FOR MORE INFORMATION

Resistance Instrument With Dual-Null Indicator



Compact enough to be held in the hand, this test instrument for resistance measurement features a dual-null indicator incorporated into a Wheatstone bridge circuit with a range from 5 ohms to 50-megohms. The instrument accurately determines resistance values within seconds; no recalibration is ever required. Known as the "Signal-Glow" Model R-10, the unit has no batteries and weighs only 1 lb 12 oz.

The case measures 3-3/4" x 6" x 2". The face is arranged with a large scale marked 5-10,000 ohms with a center point knob. The direction of the null is made apparent at a glance by the lighting of either of a pair of neon lamps. There is a 3-position multiplier switch for precise readings in three ranges: 0.01, 1, and 100 times scale. Two pin-type test terminals and a power on-off switch are also on the face. A 5' power line with standard plug and a pair of 18" test leads with pin prods on clips complete the instrument. It may be plugged into any 115v 50-60cy outlet. Industrial Development Laboratories, Dept. ED, 17 Pollock Ave., Jersey City 5, N. J.

CIRCLE ED-109 ON READER-SERVICE CARD FOR MORE INFORMATION

STAINLESS STEEL
RIGHT OFF THE SHELF

ALL TYPES OF
STAINLESS STEEL
FASTENINGS

WRITE, WIRE or
PHONE FOR YOUR CATALOG
Today

**Star Stainless screws have
CLEAN, BRIGHT-AND-SHINY HEADS**

Star STAINLESS SCREW CO.
Armory 4-1240
240 Union Avenue • Paterson 2, N. J.
Direct New York Telephone: Wisconsin 7-9041

- BOLTS & CAP SCREWS**
- SOCKET, SET & CAP**
- NUTS, WASHERS**
- MACHINE SCREWS**
- SHEET METAL SCREWS**
- WOOD SCREWS**
- PIPE FITTINGS**

- Class 3 Screws
- AN Drilled Fillister Heads
- AN WASHERS
- Studs, Standard & Special
- Special Screw Machine Products

CIRCLE ED-110 ON READER-SERVICE CARD FOR MORE INFORMATION

C.O.U.N.T.S
ELECTRICALLY

RING A BELL

LIGHT A LIGHT

STOP or START a MACHINE

DURANT Electric 'SP' PREDETERMINED COUNTER

DURANT Electric 'SP' PREDETERMINED COUNTER

(COUNTS ELECTRICALLY and CLOSES SWITCH AT END OF PRE-SET COUNT) Eliminates costly over-runs or time consuming under-runs. Actuated by Photo Electric Cell, Tube, Relay, or Contact Switch. Counter can be located where desired. Predetermined count may be set at any figure to 99,999. Hundreds of applications in all phases of production and instrument work.

SMALL • COMPACT • RUGGED • FAST • ACCURATE

DURANT MANUFACTURING CO.
1993 N. Buffum St. 193 S. Water St.
Milwaukee 1, Wis. Providence 3, R. I.
Representatives in Principal Cities

PRODUCTIMETERS

Count Everything



CIRCLE ED-107 ON READER-SERVICE CARD FOR MORE INFORMATION

ELECTRONIC DESIGN • July 1954

RESINITE

GIVES YOU THE HIGHEST INSULATION RESISTANCE OF ANY RESINATED PRODUCT

INSULATION RESISTANCE (READINGS TAKEN UNDER HUMIDITY)

TEMPERATURE 100-102° F
RELATIVE HUMIDITY 85 TO 94%
AS VAC

Tests conducted on .253 I.D. x .283 O.D. tubes used on coil forms for television receivers.

Performance data—compiled from laboratory tests, actual field operations and reports from manufacturers—prove the outstanding operating characteristics of Resinite. In volume resistivity... low moisture absorption... excellent thermal properties... low power factor... and resistance to voltage breakdown... Resinite outperforms all other resinated products.

Resinite Coil Forms are available with inside or outside threads — slotted, punched or embossed. Special three-row threaded design permits axial pressure in excess of 25 lbs. Torque controllable to + or - 1 inch oz.

RESINITE 8104—very high dielectric properties under extreme humidity.

RESINITE "AC"—very high dielectric properties—completely immune to electrolytic corrosion.

RESINITE 104—for stapling, severe forming and fabricating.

Write today for Full Details and Technical Information

RESINITE CORPORATION
DIVISION OF PRECISION PAPER TUBE

2035C West Charleston Street, Chicago 47, Illinois
79 Chapel Street, Hartford, Conn.

CIRCLE ED-111 ON READER-SERVICE CARD FOR MORE INFORMATION

trifles make PERFECTION . . .
 but PERFECTION is no trifle
3 1/2 oz. of perfection
 . . . is VITAL to 61 TONS of
 MAGNIFICENT PERFORMANCE

#1 In a Series of
 Tremendous Trifles

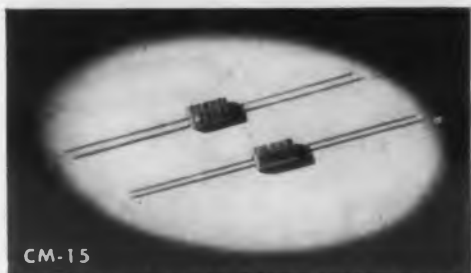

CM-15

Smallest Molded Mica Capacitors 9/32" x 1/2" x 3/16"

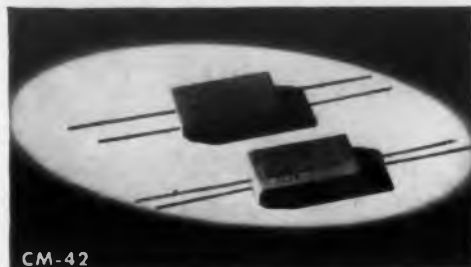

CM-42

Made to Meet All MIL-C-5 Requirements. Largest Molded Mica Capacitors of Wire Terminal Type 13/16" x 1 1/2" x 5/16"

Jobbers and distributors are requested to write for information to Arco Electronics, Inc., 103 Lafayette St., New York. Large stocks on hand—spot shipments for immediate delivery. Sole Agent for Jobbers and Distributors in the United States and Canada.



WRITE FOR FREE SAMPLES AND CATALOG ON YOUR FIRM'S LETTERHEAD

When the mighty giants of the air lift their massive wings to fly, a thousand and more "tremendous trifles" instantly go to work in harmonious unison to give life and power. It is the perfection of these "trifles" that makes possible the magnificent performance of today's luxurious air liners.

The EL Menco Capacitor — CM-15 — is one of these "tremendous trifles" that plays such a vital part in the efficient operation of aircraft communication.

EL Menco IS THE ONE OUT OF MANY CHOSEN FIRST

Whether you use our high capacity CM-42 (10-25,000 mmf) or our midjet low capacity CM-15 (2-525 mmf) you have guaranteed assurance of job-tested, job-rated capacitors — tremendous trifles of perfection so vital to the magnificent performance of YOUR product.

ELECTRO MOTIVE is now supplying special silvered mica films for the electronic and communication industries — just send us your specifications.

MOLDED
 MICA

El-Menco
 CAPACITORS

MICA
 TRIMMER

Foreign and Electronic Manufacturers Get Information Direct from our Export Dept. at Willimantic, Conn.
 THE ELECTRO MOTIVE MFG. CO., INC. WILLIMANTIC, CONN

CIRCLE ED-112 ON READER-SERVICE CARD FOR MORE INFORMATION

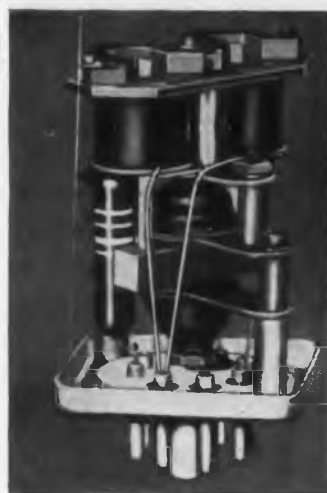

Here is a pair of "Problem-Solvers"
 For Designers of Electrical Control Systems
FRAHM® REED RELAYS ▶
 ◀ **FRAHM® OSCILLATORS**

Frahm Resonant Reed Relay is an electro mechanical device which responds to an alternating signal having frequency and amplitude values that lie within specified bands. A number of control signals over a single circuit is possible with all types of communication circuits, including radio. A signal is transmitted either on a wire line, or as a modulated carrier to some remote location

where it operates a reed relay to indicate the control function at that point. Since each reed relay will respond only to a narrow band of frequencies, it is possible to operate a number of relays simultaneously by making use of an equal number of source generators arranged so that none of the operating frequency bands overlaps. In a range of 200 to 500 cycles it is possible to operate up to 16 channels with no interference.

Frahm Oscillator controls are miniature tuning forks for use in electronic oscillators to provide stable output frequencies. By their use good sine wave signals with output better than 1 volt can be obtained. They are available for any frequency in the range of 50 to 1000 cps with accuracies better than 0.2%. A series of standard units is available to match the standard Frahm Reed Relays.

JAMES G. BIDDLE CO.

• ELECTRICAL TESTING INSTRUMENTS
 • SPEED MEASURING INSTRUMENTS
 • LABORATORY & SCIENTIFIC EQUIPMENT

1316 ARCH STREET
 PHILADELPHIA 7, PA.

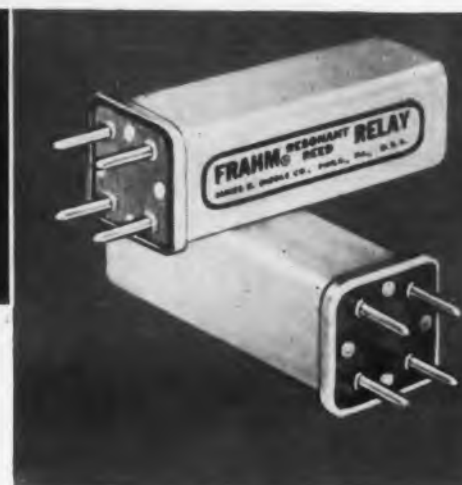

Frahm Reed Relay and Oscillator combinations may be used for controlling, signalling, monitoring, and protection and frequency matching. Check coupon for new bulletin on Frahm Relays and Frahm Oscillator Controls.

James G. Biddle Co. 8-407
 1316 Arch St., Phila. 7, Pa.
 Gentlemen:
 Please send me Bulletin 33-ED—Frahm Relays
 Bulletins 34-10-ED—Frahm Oscillators

NAME _____
 JOB FUNCTION _____
 COMPANY _____
 ADDRESS _____

CIRCLE ED-113 ON READER-SERVICE CARD FOR MORE INFORMATION

New Products . . .

Potentiometer
 Has 1/2 amp dpdt Switch

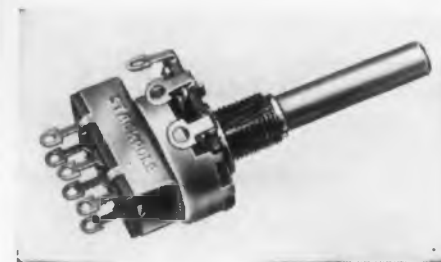

This Type LRSS-150 miniature potentiometer has a dpdt slide switch that operates at either extreme of shaft rotation. The unit is particularly

useful as a combined tone control and changeover switch for a variety of functions such as changing from a-m to f-m reception, standard to shortwave band switching, high-gain to low-gain input switching in phonographs and preamplifiers, or as a sharp tune to broad tune i-f bandwidth switch in a-m or f-m receivers.

This 0.5w control can be supplied with a U.L. approved fibre-insulated metal switch for protection against accidental contact with exposed terminals as well as some reduction in hum pickup when the switch is used in low-level audio circuits. Approved switch rating is 0.5amp at 125v a-c or d-c. Electronic Components Div., Dept. ED, Stackpole Carbon Company, St. Marys, Pa.

CIRCLE ED-114 ON READER-SERVICE CARD FOR MORE INFORMATION

Power Supply
 High Voltage Plug-In Type



The Model 123 "Photomultiplier" Power Supply, the latest in this firm's line of "Uniplugs", should be useful in scintillation counters, Geiger counters, and other circuits requiring a well-regulated, high-voltage, low-current power supply.

Output voltage is 800v or 1000v d-c, adjustable over a range of $\pm 25v$ from the mean value. Output current is 1.5ma maximum, though the unit can be adjusted to supply up to 3ma. Regulation is less than 0.4% with 1ma load shift, and less than 0.1% with a 10v line voltage shift. Output ripple is less than 100mv rms. Input is 105v to 125v a-c, 60cy. Size is 3-3/4" x 3-1/2" x 6-3/4" seated height. The supply is assembled in a drawn, enameled-steel case with a double octal plug base. Net weight is 3-1/2 lb. C. J. Applegate & Co., Dept. ED, 1816 Grove St., Boulder, Colo.

CIRCLE ED-115 ON READER-SERVICE CARD FOR MORE INFORMATION

ELECTRONIC DESIGN • July 1954

Casting Resin

Stands Temperature Extremes

A low-loss, low-dielectric-constant, casting resin known as "Stycast TP-M" is useable over an extremely wide temperature range even when large inserts are embedded. It is a thermosetting material.

With frequencies of from 60 to 10^{10} cps, the dielectric constant range of the cured resin is from 2.36 to 2.38 while the dissipation factor is below 0.0009. Dielectric strength is 450v per mil and the volume resistivity is above 10^{13} ohms-cm³.

The physical properties of the cured material are as follows: specific gravity, 1.05; tensile strength, 5000psi; compressive strength, 8000psi; modulus of elasticity, 3.0×10^5 psi; water absorption, 0.5% gain at 25°C in 24 hours; temperature range -70°C to 125°C; color opaque white; machinability, good. Emerson & Cuming, Inc., Dept. ED, 869 Washington St., Canton, Mass.

CIRCLE ED-157 ON READER-SERVICE CARD

Directional Radomes

Made in Any Shape

These directional radomes, utilizing a new wall construction (type "B") permit the transmission of microwaves at any angle of incidence with alteration of polarization, and with or without change or direction, whichever is desired. Special radomes, with practically any type configuration, can be designed and manufactured with this material.

The type "B" construction is a sandwich of thick low-dielectric skins with a thin high-dielectric core. It is rugged and durable. With this construction, radomes have been designed with negligible cross-talk and extremely low reflection. This wall material allows extreme streamlining configuration such as ogives and cones, thus opening up possibilities of new aerodynamic concepts for airborne vehicles. McMillan Laboratory, Incorporated, Dept. ED, 28 Central Street, Ipswich, Mass.

CIRCLE ED-158 ON READER-SERVICE CARD

CIRCLE ED-159 ON READER-SERVICE CARD
ELECTRONIC DESIGN • July 1954



G.E. designs 400-cycle alternator to meet demanding guided-missile requirements

Another example of G-E motors for aircraft

NEWLY DEVELOPED to withstand the tremendous range of shock, temperature and atmospheric conditions encountered in guided-missile applications, this explosion-resistant 400-cycle alternator meets rigid environmental and military specifications (MIL-E-5272, procedure 1). Rated up to 1500 volt-amperes, 12,000 rpm, for output of 115 volts, this unit is designed to be driven by a wide variety of d-c, a-c, turbine, and jet-air drives.

RIGID TESTING assures that this alter-

nator—and all G-E aircraft and armament motors—meet specifications regarding altitude, shock, temperature, vibration, humidity, sand and dust, and centrifugal force.

YOUR SPECIFICATIONS are all that G-E motor engineers need to begin applying their years of experience to your aircraft and armament problems. Contact your G-E Apparatus Sales Office today. Or write: General Electric Co., Section 704-29, Schenectady 5, New York.

GENERAL  ELECTRIC

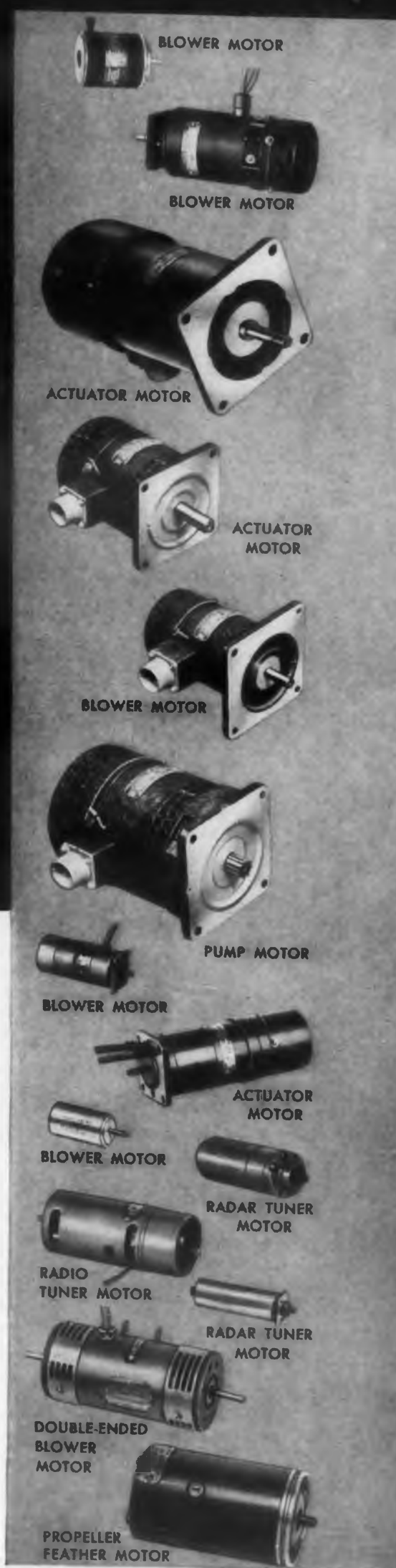

A few of the hundreds of aircraft and armament motors designed and built by General Electric.

NEW SIGMA RELAY DESIGNED FOR MODEL AIRPLANE REMOTE CONTROL

The new Sigma 26F 8000-CDS Relay was designed to provide certain advantages over the 4F, now a popular remote control relay. How well this objective has been realized remains to be seen. On paper, however, it looks like this:

Coil resistance 8000 Ohms \pm 10%
at 20°C

Pull-on current 0.6-0.7 ma dc
(Factory setting. What you do is
your own business)

Difference between pull-on and
drop-out 0.1-0.2 ma dc

Weight 2 oz.

Shock immunity 100 G
(without damage)

As compared to the 4F, the 26F is slightly smaller, $\frac{1}{4}$ ounce lighter and is more resistant to vibration and shock. Its major hope is the lower operating current and differential which means longer battery and tube life. Cost is slightly more than the 4F.



SIGMA
SIGMA INSTRUMENTS, INC.
PEARL STREET, SO. BRAINTREE, BOSTON 85.

APPEARING IN MODEL AIRPLANE NEWS

Model airplane enthusiasts use miniature radio transmitters and receivers for remote control of models in flight. An important component of the receiver is a sensitive relay. For years the Sigma type 4F has been a favorite for this purpose — by chance rather than by design.

Normally we wouldn't bother with a *special* design for such an application, but some of our boys play with model airplanes and the rather lavish praise that model airplane magazine editors have had for the 4F made us think it about time to design one that *we* could really feel was good for models.

We justify this sort of thing by recalling that these people grow up and get jobs (where they *may* specify relays).

SIGMA

SIGMA INSTRUMENTS, INC., 91 PEARL STREET, SO. BRAINTREE, BOSTON 85, MASS.

CIRCLE ED-118 ON READER-SERVICE CARD FOR MORE INFORMATION

New Products . . .

Fuse and Lamp

Lights Up When Fuse Burns Out



The "Fuse-Lamp" consists of a fuseholder of solid construction, a complete neon pilot light assembly with built-in resistor, and a

neon glow lamp. Valuable for any type of fused equipment, its lamp lights up immediately if the fuse burns out, permitting a damaged fuse or circuit to be found at once.

Built for rugged use, the product will work under tropic conditions. The neon lamp is guaranteed for 10,000 actual working hours. No current is used under normal conditions; current is used only when the circuit is broken and the lamp lights up.

The "Fuse-Lamp" mounts in a 27/32" hole and extends only 2". Net weight is 1-1/4 oz. It is available in ranges from 2-1/2v to 4-1/2v a-c d-c, to 200-500v a-c d-c. In the lower ranges, incandescent lamps are supplied.

The "Fuse-Lamp" is manufactured by H. Schurter AG of Lucerne, Switzerland, represented in the United States by L. Keller, Dept. ED, 3547 N. Wilton Ave., Chicago 13, Ill.

CIRCLE ED-119 ON READER-SERVICE CARD FOR MORE INFORMATION

Vacuum-Tube Voltmeter

Covers 500 μ v to 500v RMS Range



The Model 442 Voltage Meter is calibrated in both a-c voltage and decibels. It covers a voltage range from 500 μ v to 500v rms over a frequency range of 15cy to 250ke, including an amplifier which can be externally used, having a voltage gain of 1600 (63db). The scale is logarithmic and calibrated from 0.5v to 5.0v; the db range is from -5 to +17, based on zero

db, equalling 1mw in 600 ohms.

Instrument accuracy is $\pm 2\%$ from 15cy to 250ke. Stability is $\pm 1\%$ over line variation from 105v to 125v a-c. Power supply requirements are 117v $\pm 10\%$, 50cy to 400cy. Power consumption is approximately 31w. Input impedance is 2 megohm shunting 25mmfd.

The unit is housed in a metal cabinet that measures 5-3/4" x 11-11/16" x 5-13/16". Specialty Assembly & Packing Co., Inc., Dept. ED, 79 Clifton Pl., Brooklyn 38, N. Y.

CIRCLE ED-120 ON READER-SERVICE CARD FOR MORE INFORMATION

teflon*

... and We Can Deliver!



EXTRUDED & MOLDED ROD and TUBE Small Machined Parts! Sheets!

Heavy demand has put many TEFLON fabricators in a "back ordered" condition. The effect — stymied or crippled production on your end.

At FLEXROCK we have licked this problem. New TEFLON producing equipment has been added. We have substantially increased capacity. We can't take on all things just yet. But soon we will be ready to "throw the book at you" with a complete range of TEFLON services. RIGHT NOW we are set to ship you TEFLON Rod and Tube, extruded or molded. Sheets, and small parts — no matter how intricate — machined from Rod and Tube. We can promise good delivery — yes, FAST DELIVERY . . . with closest possible tolerances on your small parts. Tell us your needs — we will be happy to quote delivery and price.

*DuPont trade-mark for tetrafluoroethylene resin



SEND US YOUR "SPECS" LET US QUOTE!

FLEXROCK COMPANY
3608-B Filbert St., Phila. 1, Pa.

We are enclosing sample, specs, and quantity for our TEFLON requirements. Please furnish quotation.

Please send us your TEFLON Bulletin including stock list.

Name

Company

Address

City Zone State

CIRCLE ED-121 ON READER-SERVICE CARD

Resistors

Wire-Wound Encapsulated Types



This line of "Riteohm" encapsulated, wire-wound precision resistors exceeds the requirements of MIL-R-93A, Amendment 2, at 125°C ambient. The units have an enameled alloy re-

sistance wire non-inductively pie-wound on a rigid steatite bobbin, which holds the windings in place and resists mechanical movement. The wire is welded to the terminals, providing permanent electrical connections, important in eliminating noise and instability.

The entire assembly is encapsulated in a resin with a coefficient of expansion closely matching that of bobbin, wire, and terminals. The design provides an extremely stable resistor practically immune to moisture, vibration, and mechanical damage.

Resistors are offered with axial leads (Type 85) or lug terminals (Type 86). Wattages are 1/4w, 1/3w, 1/2w, 3/4w, and 1w (125°C ambient). Resistance values are available up to a maximum of 1,950,000 ohms, with tolerances available as close as $\pm 1\%$. Axial lead types are in eight sizes from 3/8" to 1" long (excluding leads) and 5/16" to 1/2" diam; the lug type is in three lengths from 1/2" to 1", with a 9/16" diam. Ohmite Manufacturing Co., Dept. ED, 3664 Howard St., Skokie, Ill.

CIRCLE ED-122 ON READER-SERVICE CARD FOR MORE INFORMATION

Teflon Spaghetti

Stable to 525°F

Teflon spaghetti that will not melt, burn or decompose while soldering a joint next to it is available in a wide range of sizes for insulating wire conductors, bus leads, sub-miniature tube pins, etc. The new product has all the other valuable characteristics of Teflon such as very high surface resistivity, high dielectric strength, low moisture absorption and high resistance to chemicals, weather and fungi.

For color coding, the tubing is produced in its natural white color, black, brown, red, green, blue and yellow. It is made in a full range of internal diameters corresponding to AWG gages 24 to 8. The material is completely stable at temperatures up to 525°F. Teflon meets Class H, AIEE standards for maximum hot spot insulation temperatures. Its dielectric strength drops only slightly at 400°F. The Polymer Corporation of Pennsylvania, Dept. ED, Reading, Pa.

CIRCLE ED-123 ON READER-SERVICE CARD FOR MORE INFORMATION

ELECTRONIC DESIGN • July 1954



inside story
of the
BLUE-POINT[®]



how astron builds
CAPACITORS
with "real quality"

Finest all-purpose molded plastic paper tubulars ever made — impervious, attractive shell and seal give positive moisture, heat protection in hot and humid climates... completely revolutionary BLUE-POINT seal for dependability, vibration resistance, firmly secured lead-wires... continuous operation at 85°C without derating... new solid thermosetting impregnant insures high capacitance stability, low power factor and high insulation resistance over entire -40°C to +85°C temperature range... seal and shell are unaffected by hot soldering irons... New ASTRON concepts of capacitor design produce the individually tested BLUE-POINT.

Increase your design versatility.
Write today for bulletin AB-20B for free technical information.

ASTRON
CORPORATION

Export Division: Rocke International Corp.
13 E. 40th St., N. Y. C.
In Canada: Charles W. Pointon
6 Alcina Ave., Toronto 10.



255 GRANT AVENUE, EAST NEWARK, N. J.

CIRCLE ED-124 ON READER-SERVICE CARD FOR MORE INFORMATION



JEFFRIES

means years of Transformer

"KNOW HOW"

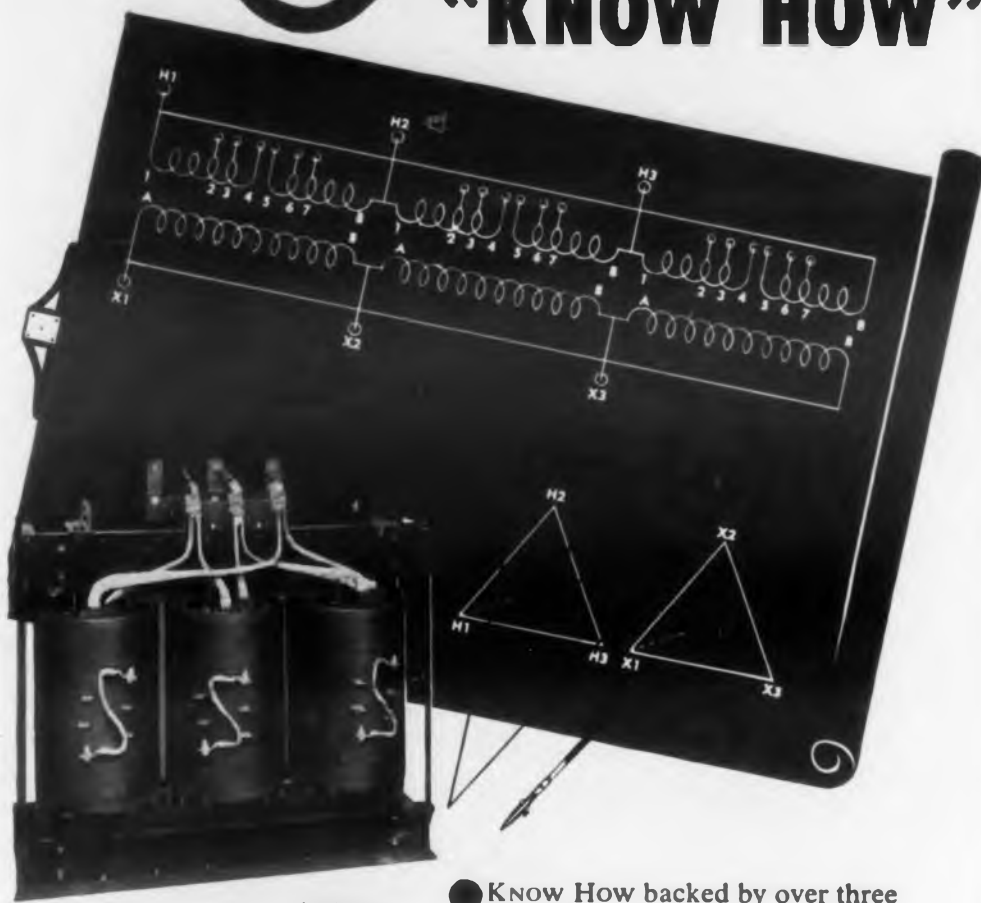

INTERNAL
CONSTRUCTION
500 KVA 3 PHASE

● **KNOW HOW** backed by over three decades of experience in design and construction to produce the best possible dry type transformers... transformers that provide maximum operating economy with minimum upkeep... efficient, quiet performance with absolute reliability... eliminate long secondary conduit or bus runs because they can be installed at the load center... have low initial cost and eliminate specially constructed vaults... require no oil filtering or changing... and have Underwriters' Laboratory Approval.



COMPLETE UNIT
300 KVA 3 PHASE

Available from 5 VA to 1000 KVA in all voltage classifications up to 15 KV in standard sizes or built to specifications. JEFFRIES Engineers will be glad to discuss your requirements.

Write for additional information and illustrated catalog



JEFFRIES TRANSFORMER CO.
SUBSIDIARY OF LEACH CORPORATION
1710 East 57th Street, Los Angeles 58, California
Phone LOgan 8-3436

MANUFACTURERS OF DRY TYPE TRANSFORMERS & ELECTRICAL WINDINGS

CIRCLE ED-125 ON READER-SERVICE CARD FOR MORE INFORMATION

New Products . . .

Balanced Modulator For Pulse Applications



The Type 1000-P7 balanced modulator has a modulation-frequency response flat from d-c to 20Mc, thus making it suitable not only for short pulses but for any wide-band modulation.

The usable carrier-frequency range extends from 60Mc to 2300Mc, and 100% amplitude modulation can be obtained throughout this carrier range. Double-sideband suppressed-carrier modulation, and pulse modulation with 60db carrier suppression between pulses are also possible throughout the entire carrier frequency range.

Television video is handled by the modulator even through the u-h-f television band. Other applications include tests on microwave relay systems using multiplex pulse-code modulation, on omni-range and DME equipment, on telemetering circuits, and on high-resolution radar. General Radio Co., Dept. ED, 275 Massachusetts Ave., Cambridge 39, Mass.

CIRCLE ED-126 ON READER-SERVICE CARD FOR MORE INFORMATION

Servo Motor Low Inertia, Induction Type



This precision-built, 2-phase, 2-pole induction servo motor with double-ended shaft has a low-inertia squirrel-cage rotor designed to eliminate cogging at low speeds. Designated as Type DPJJD-764-38, it

provides a high torque-to-inertia ratio, low starting voltage, and linear torque-speed characteristics with maximum torque at stall. It can be wound with two or four poles.

Characteristics at 60cy include: 5w output, 5 oz-in stalled torque, and 5000 ohm control-phase stalled impedance. Weight is 23 oz. The unit can be made to operate from a single phase source by splitting the phase with a capacitor. It is available for 400cy operation, or can be designed to meet specifications. Electric Indicator Co., Inc., Dept. ED, Springdale, Conn.

CIRCLE ED-127 ON READER-SERVICE CARD FOR MORE INFORMATION

A Revolutionary New Relay Development

of utmost importance to electrical
and electronic design engineers

The Mullenbach Capaswitch uses an entirely new and different concept in relay design to transfer the contacts; provides extreme sensitivity, low power requirements, high current-carrying capacity.

The revolutionary new Capaswitch is basically an ultra-sensitive relay with unusual current carrying capacity. It will perform all of the jobs of conventional magnetic-coil relays, within the same current carrying capacity, plus many jobs that magnetic-coil relays cannot do. However, in design it departs radically from conventional relays. Instead of the usual electromagnetic armature, a unique electrostrictive capacitive element provides the mechanical energy to open and close the contacts. Only 0.5 milliwatt-seconds of operating power (150 volts d.c.) is required to close the contacts. To keep them closed requires less than 0.1 milliwatt, or less than one-hundredth the power required to keep a conventional magnetic-coil relay closed! This low power requirement opens up a vast new field of applications, eliminating need for much pre-amplified equipment.

How the Capaswitch works—Application of an actuating voltage creates a bending moment in the electrostrictive capacitive element, closing the contacts. Removal of the actuating voltage and discharge of the electrostatic element through external circuits or through a resistor, removes the bending moment, opening the contacts.

Time Delay Function—If appropriate resistances are applied in the circuit, the Capaswitch will function as a time delay relay to open or close the contacts. For longer time delays a larger condenser may be paralleled to the capacitive element.

Pulse Characteristics—Initial closing time of the Capaswitch is 10 milliseconds. However, it can be actuated by pulses as short as 10 microseconds or less. The electrostatic element may also be used to store low power pulses until sufficient voltage has been accumulated to operate the relay. However, present models cannot be used for accurate counting.

Available now—Until recently the Capaswitch has been available only in limited quantities. Now, however, stepped-up production schedules assure increasing supplies.

OVERALL DIMENSIONS:

Length: 3½"
Width: 1-7/16"
including solder terminals
Depth: 11/16"
Weight: 1.7 ounces

THE MODEL A-150 CAPASWITCH

a single pole, double throw relay, rated at 1 amp., 110 v., A.C. non-inductive load. Normal operating voltage 150 volts D.C.



Write today
for complete
specifications
and prices!



Mullenbach

ELECTRICAL MANUFACTURING CO.
Established in 1927

2300 East 27th Street • Los Angeles 58, Calif.

CIRCLE ED-128 ON READER-SERVICE CARD
ELECTRONIC DESIGN • July 1954

Ceramic Capacitors

Disc Type

Featuring thicker dielectric, the new Series ACD ceramic disc capacitors for alternating-current operation are especially intended for electric-razor noise suppression and for certain TV by-pass applications.

Other features of the units include a power factor (initial) of 1.5% max at 1000cy and 2.5% max after humidity; and an initial leakage resistance better than 7500 megohms and greater than 1000 megohms after humidity. Hi-Q Division, Dept. ED, Aerovox Corporation, Olean, N. Y.

CIRCLE ED-129 ON READER-SERVICE CARD

Reprocessed Teflon

Rods, Tubing, Bars, Cylinders

This new plastic product, trademarked "Fluoroplast", is 100% tetrafluoroethylene ("Teflon") reprocessed from virgin material waste. It has the purity and possesses most of the outstanding properties of the virgin material.

It is offered in molded bars and cylinders and extruded rods and tubing at prices sufficiently lower than other fluorocarbon plastics to extend the uses of these materials. Fluoroplast is generally colored green for identification. United States Gasket Co., Dept. ED, Camden 1, N.J.

CIRCLE ED-130 ON READER-SERVICE CARD

Plastic Tape

Dielectric Strength of 10kv

"Scotch" plastic electrical tape is now available in a new convenient roll size 3/8" wide. It combines handy size with the excellent insulation and holding qualities of the standard tape. Because of its thin, 7-mil backing and narrow width, the tape provides a higher degree of conformability.

Among the features of the tape are a high dielectric strength of 10kv and excellent resistance to water, oils, acids, sunlight and weather. Minnesota Mining and Manufacturing Co., Dept. ED, 900 Fauquier St., St. Paul 6, Minn.

CIRCLE ED-131 ON READER-SERVICE CARD

CIRCLE ED-132 ON READER-SERVICE CARD

ELECTRONIC DESIGN • July 1954

8 Dependable Solutions TO HERMETIC SEALING PROBLEMS...

E-I HERMETICALLY
SEALED
AND MINIATURE



MULTIPLE HEADERS—Vacuum tight, cushioned glass construction. Strain-free, tin dipped for easy soldering and silicone treated for maximum dielectric strength.



SEALED TERMINALS—Featuring cushioned glass construction, high thermal shock resistance. Available in economical preferred types and special designs.



END SEALS—For condensers, resistors and other tubular components. Completely strain-free and provide a permanent hermetic seal. Standardized, economical types.



COMPRESSION TYPE HEADERS—Super rugged, absolutely rigid, practically indestructible multiple headers. Exclusive E-I development offers greatly increased resistance to shock and vibration.

*PATENT PENDING
ALL RIGHTS RESERVED

E-I Hermetically-Sealed Terminals and Miniature Closures are available to solve practically every electrical and electronic sealing problem. Recommendations on specific applications and samples will be sent promptly on receipt of your specifications or sketches. There is no obligation.

OCTAL HEADERS—Plug-in and multiple types. Feature new principle of hermetic sealing. Solid metal blanks assure maximum mechanical strength and rigidity.



TRANSISTOR CLOSURES—For transistors and other components requiring hermetic sealing. Available in standard types or custom design to specifications. Cases supplied round, rectangular or square.



LUG-TYPE, LEAD-THRU INSULATORS—For "bath tub" condensers, transformers, other applications requiring voltage ratings from 2000 to 4000 (rms.). Compression sealed, super rugged. Inside or outside mounting.



COLOR-CODED TERMINALS—Feature glass inserts in standard, easily identified RMA color codes. Coloring is in the glass.



New Catalogs on Request—Illustrated literature on any of the above is available without obligation. Call or write for new bulletins, today!



DIVISION OF AMPEREX
ELECTRONICS CORPORATION

ELECTRICAL INDUSTRIES

44 SUMMER AVENUE, NEWARK 4, NEW JERSEY



**MAKES
IT...**

TEFLON and DILECTO METAL CLADS

WITH BETTER BOND STRENGTHS

For superior metal clad stock for printed circuits, with either a high heat resistant Teflon glass-base core, or a Dilecto paper grade core that is easy to punch, see C-D-F. These average test values show how C-D-F's laminating know-how pays off with better, dependable bond strengths:

	Lbs. pull per 1" width
XXXXP-26 plus .00135" copper	5 to 8
XXXXP-26 plus .0027" copper	7 to 10
XXXXP-26 plus .0015" aluminum	9 to 12
GB-112 Teflon plus .00135" copper	6 to 9

Teflon is a Du Pont trademark.

GET THE FACTS: Write for technical bulletin 35 with complete information on C-D-F metal clad stock; Teflon folder T-52 with samples; C-D-F general catalog and plastics machining notebook.

Continental-Diamond Fibre

CONTINENTAL-DIAMOND FIBRE CO., NEWARK 107, DELAWARE

CIRCLE ED-134 ON READER-SERVICE CARD FOR MORE INFORMATION

New 300-watt Vitrohm ring rheostat with exclusive "twin-shoes"



Ward Leonard's exclusive sintered self-lubricating twin-shoe construction insures uniform contact pressure, plus unusually smooth and trouble-free operation.

Other features of the new 6" Vitrohm ring rheostat eliminate backlash, insure contact pressure, prevent arm over-travel or radial motion. It takes less back-of-panel space, too.

Write for Bulletin 1116, Ward Leonard Electric Company, 77 South St., Mount Vernon, N.Y. 4.13

WARD LEONARD ELECTRIC CO.

Result-Engineered Controls Since 1892

RESISTORS • RELAYS • MOTOR CONTROLS • CHROMASTER



CIRCLE ED-135 ON READER-SERVICE CARD FOR MORE INFORMATION

New Products . . .

Pulse Transformers Hermetically Sealed Subminiatures

These subminiature pulse transformers utilize advanced pulse-winding techniques and high-permeability pulse cores. They can be made to meet specification MIL-T-27 on special order.



The PM1A is hermetically sealed in a 7/8" diam flanged case 15/16" high. It has 1 to 3-1/2μsec pulse width, 5% droop, 0.06μsec rise time, and the winding ratios are 200 ohm/200 ohm, 100v:100v.

The PM1B is similar to the PM1A and rated 0.3 to 1μsec. Atlantic Transformer Corp., Dept. ED, 30 Hynes Ave., Groton, Conn.

CIRCLE ED-136 ON READER-SERVICE CARD FOR MORE INFORMATION

Switch

Handles Eight Primary Circuits

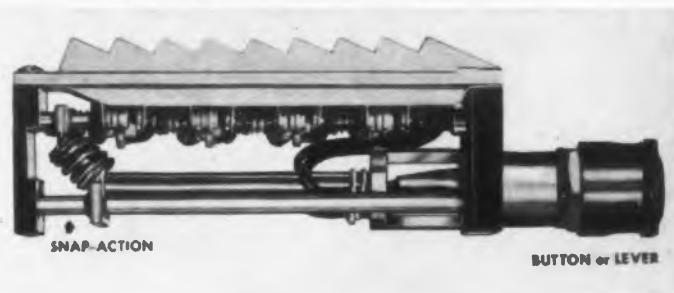

To operate this 8pdt switch, it is only necessary to push a button or throw a lever, whereupon this master unit switches on or disconnects eight primary circuits for complete control of multiple operations on a wide variety of equipment.

Constant contact pressure (4 oz per point) is maintained throughout the stroke until positive snap action occurs in either direction. There is no dead center. Contacts handle 5amp 28v d-c inductive; 10amp 115v d-c non-inductive; 60-400cy. The switch is built to exceed ANS-63, to resist shock and vibration, and to operate at -65° to +160°F. It is designed for easy multiple wiring to each terminal.

The unit mounts on a 1-1/2" x 1-1/4" panel area, requiring no more space than two toggle switches. Weight is approximately 8 oz. The sand- and dust-tight enclosure is easily removed for inspection. The switch is available with an auxiliary "push-to-test" spdt circuit and dial light. Guardian Electric Manufacturing Co., Dept. ED, 1621-E W. Walnut St., Chicago 12, Ill.

CIRCLE ED-137 ON READER-SERVICE CARD FOR MORE INFORMATION

Where SHOCK and VIBRATION
are a Problem . . .

ENGINEERS CHOOSE the rugged Phil-trol 27 RELAY

For
AVIATION
and
ELECTRONIC
INDUSTRIES



TYPE 27QA-3 POLE

FRONT
BACK

ENCLOSED

Proved performance of Phil-trol 27 Relays in many vitally important applications has built great demand for this sturdy, sensitive and highly efficient relay. For instance, they are used for: propeller pitch control . . . cabin pressure and temperature control . . . guided missiles . . . computers . . . communication equipment . . . and many other electronic devices.

Phil-trol 27 Relays have unusual features like two-coil construction, which allows greater operating force for a given power input, and also completely eliminates magnetizing force losses at the armature hinge. The rigid frame and balanced armature design provides stability under conditions of high acceleration, severe vibration or shock.

For complete details on all of the many Phil-trol Relays available, write for the new Catalog.

Phil-trol

IS THE REGISTERED TRADEMARK OF

PHILLIPS CONTROL CORP.

Dept. ED

JOLIET, ILLINOIS

A THOR CORPORATION SUBSIDIARY

OFFICES IN ALL PRINCIPAL CITIES

Phil-trol Type 27 Relays are available in 1, 2, 3, 4 or 5 pole, single or double throw. Operating voltage up to 230 D.C., resistance up to 13,400 ohms, minimum operating current is .001 amps. Available enclosed in dust cover or hermetically sealed.

CIRCLE ED-138 ON READER-SERVICE CARD FOR MORE INFORMATION

it's
NEW!

it's
PORTABLE!

it's
ECONOMICAL!

Dectron
**DS-660
FREQUENCY
METER**

Designed for portability and low-cost as well as accuracy, the newly developed DS-660 will count and display any electrical or mechanical event which can be converted into a varying voltage of sufficient amplitude - from 10 to 100,000 events per second. Derives its time base from the 60 cycle line - which determines the accuracy - approximately .1%. Here is new and amazing reliability and circuitry available in one unit.

FEATURES:

- SELF CHECKING
- AUTOMATIC AND MANUAL RESET
- DISPLAY from 1 to 10 SECONDS
- LIGHTWEIGHT - only 16 lbs.
- UTILIZES STANDARD PLUG-IN DECADES
- BASIC UNIT READS OUT TO 10 KC (4 decades)
- AIR COOLED (Fan)

Write TODAY for full technical information

THE Dectron CORPORATION, Dept. 76
5420 VINELAND AVE., NO. HOLLYWOOD, CALIF.

CIRCLE ED-139 ON READER-SERVICE CARD FOR MORE INFORMATION

ELECTRONIC DESIGN • July 1954

Need **VOLUME**
on Small Parts
Like
These?



Investigate **MULTI-SWAGE**

Economy Way to Get Volume!

If it's **VOLUME** you need on small tubular metal parts similar to these, be sure to look into Bead Chain's **MULTI-SWAGE** Process. Send the part (up to $\frac{1}{4}$ " dia. and to $1\frac{1}{2}$ " length) and your specs for a quotation. Chances are you'll find a new way to effect important savings.

Much Cheaper Than Solid Pins

Many prominent users of solid pins for electronic and mechanical purposes have cut costs by switching to Multi-Swaged tubular pins . . . without sacrificing strength or accuracy. Often this is possible to accomplish.

Typical Applications —

As terminals, contacts, bearing pins, stop pins, male-female connections, etc., in a wide variety of electronic and mechanical products:—Toys . . . Business Machines . . . Ventilator louvers . . . Radio and Television apparatus . . . Terminal-boards . . . Electric Shavers . . . Phono Pick-ups, etc. For **DATA BULLETIN**, write to



The **BEAD CHAIN** Mfg. Co.

58 Mountain Grove St., Bridgeport 5, Conn.

Manufacturers of **BEAD CHAIN**—The linkless chain of a thousand uses, for fishing tackle, novelty, plumbing, electrical, jewelry and industrial products.

CIRCLE ED-140 ON READER-SERVICE CARD

Frequency Calibrator

Utilizes WWV Signals

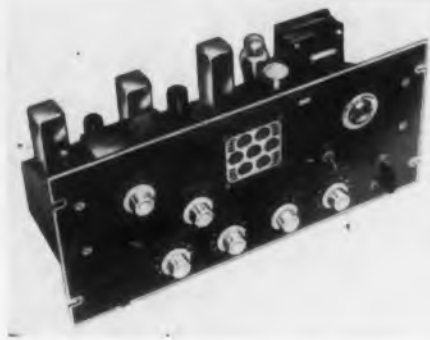

The RH-10 is an improved frequency calibrator utilizing transmission from the U. S. Bureau of Standard's station WWV. It makes use of WWV's primary frequency standards for checking

and setting audio frequencies, radio frequencies, and timing devices.

The 11-tube calibrator is pre-tuned to receive the 5Mc and 10Mc WWV signals. Selection is by means of a switch. A 4-position selector switch permits reception of standard WWV signal, 440cy modulation, 600cy modulation, or beat carrier (audio frequencies below 400cy). The circuit design affords: sensitivity exceeding $1.0\mu\text{v}$ on any band, with high antenna input impedance for single wire or tuned doublet; selectivity 10db at 5kc off resonance; image rejection better than 50db; and local oscillator voltage regulation to minimize drift.

The calibrator has a tuning eye to facilitate accurate tuning and comparison for fundamentals and harmonics of r-f sources with the WWV signal. It has controls for fine tuning, master audio gain, panel speaker volume, and audio output level. R-F and audio output terminals are on the front panel. The unit is available in a standard rack panel with dust cover. It is rated for 105-125v, 50/60cy. Browning Laboratories, Inc., Dept. ED, 750 Main St., Winchester, Mass.

CIRCLE ED-141 ON READER-SERVICE CARD FOR MORE INFORMATION

Contact Kits

Contain Rivets and Buttons

These two Electrical Contact Kits, Models K11 and K12, contain standard silver rivets and electrical welding contact buttons, respectively.

Each kit contains the following metal strips for fabrication of contact parts and supporting members: 0.005" coin silver overlay on grade C phosphor bronze 0.015" overall (spring temper); 0.015" fine silver on commercial bronze 0.045" overall (half hard temper); 0.015" fine silver striped commercial bronze 0.045" overall (hard temper); grade C phosphor bronze double-clad on copper 0.012" overall, 25/50/25 thickness ratio (spring temper); beryllium copper 0.010" thick (half hard temper).

Dimensional working drawings on vellum are included for duplication on the designer's drawings. Metals & Controls Corporation, General Plate Div., Dept. ED, Attleboro, Mass.

CIRCLE ED-142 ON READER-SERVICE CARD FOR MORE INFORMATION

ELECTRONIC DESIGN • July 1954

TUNG-SOL®

5881



BEAM POWER AMPLIFIER

for the ultimate in reliability where the 6L6 is called for . . .

Absolute reliability!

There, in two words, is the net result of all the engineering which TUNG-SOL has put into the 5881. This completely new tube is designed to operate in circuits for which the 6L6 is specified and is completely interchangeable wherever the 6L6 is now in use. Full utilization of the design and production techniques which have proved themselves over the past 15 years, has created this exceptionally reliable tube.

The 5881 is manufactured under laboratory conditions accompanied by the most severe tests. It is rugged both mechanically and electrically, with tremendous overload capacity. The 5881 maintains high efficiency throughout its life and provides low cost operation through reduced maintenance.

Where reliable service is essential in audio circuits, the TUNG-SOL 5881 is a "must." Order it from your regular TUNG-SOL supplier.

The TUNG-SOL engineering which has produced the 5881 is constantly at work on a multitude of special electron tube developments for industry. Many exceptionally efficient general and special purpose tubes have resulted. Information about this and other types are available on request to TUNG-SOL Commercial Engineering Department.



Tung-Sol Electric Inc., Newark 4, N. J.

Sales Offices: Atlanta, Chicago, Columbus, Culver City (Los Angeles), Dallas, Denver, Detroit, Newark, Seattle.

TUNG-SOL makes All-Glass Sealed Beam Lamps, Miniature Lamps, Signal Flashers, Picture Tubes, Radio, TV and Special Purpose Electron Tubes and Semiconductor Products.

TUNG-SOL ELECTRON TUBES

CIRCLE ED-143 ON READER-SERVICE CARD FOR MORE INFORMATION

WHAT ARE YOU LOOKING FOR in a paper tubular capacitor?

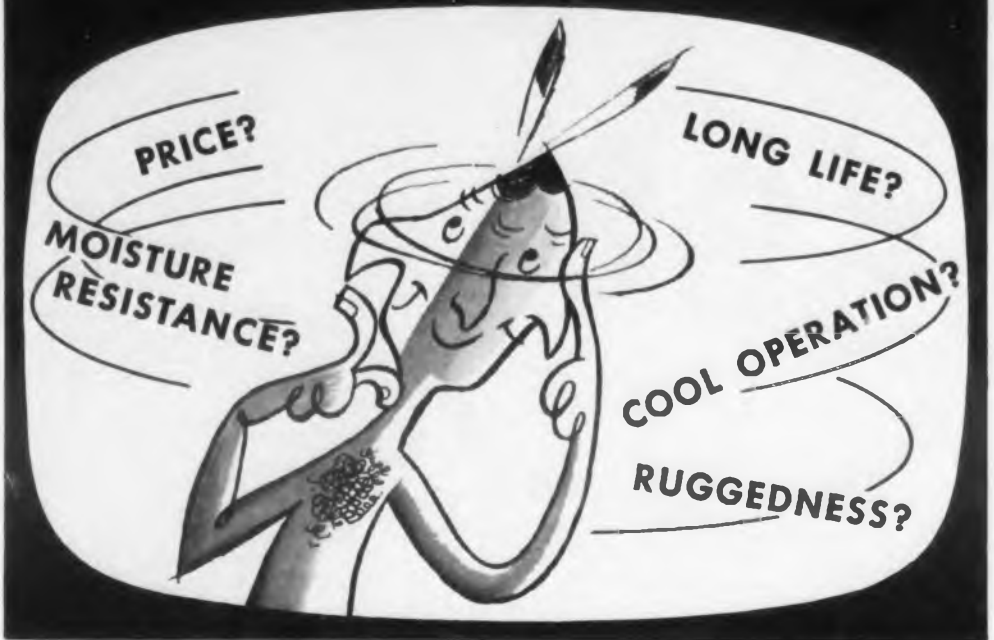

No matter what your particular applications problem in paper tubular capacitors—Sangamo can meet your need. You can choose from the following types:



TELECHIEF—The *premium* tubular. Molded in Humiditite . . . the Telechief offers amazing moisture resistance—satisfactory high temperature operation up to 85° C. (Contact our engineers about operating problems in the 100°—125° C range).

REDSKIN—An industry standard. Gives dependable *long life* operation at 85° C. The thermo-setting plastic case stands rough handling and the especially designed, flexible leads resist breakage—they can't pull out.



CERAMICHIEF—A ceramic-encased paper tubular. Here's quality at a price. Try it for high moisture resistance—long life. Wax, Resinex, or Mineral Oil impregnated. 85° C operation. The Ceramichief is ideal for plastic imbedment circuitry.

BUCKSKIN—An economical cardboard-encased paper tubular. Gives full Sangamo quality in applications where costs are a problem. Wax, Resinex, or Mineral Oil impregnation. Built to pass requirements of RTMA Spec. REC-118A.



P.S. For extremely critical applications—don't overlook Sangamo Types SA through SM. These hermetically-sealed, metal cased tubulars are built to MIL-C-25A Specs. Engineering Bulletin SC54-10 gives full information.



SANGAMO ELECTRIC COMPANY

SC54-10

MARION, ILLINOIS

CIRCLE ED-144 ON READER-SERVICE CARD FOR MORE INFORMATION

New Products . . .

Subminiature Switch

Snap-Acting Type



The subminiature, snap-acting switch, Type USM, is designed to overcome the difficulties of making electrical connections

within the space limitations of miniaturized equipment. Flat terminal lugs, widely separated in the switch base, have holes so located that wires up to No. 18 can be easily hooked into the terminals from any direction for single or ganged-switch installations.

The switch terminals are plated for rapid soldering. The unit is available in plain or leaf-actuator styles. It is rated for spdt operation at 5amp, 125/250v a-c or 2amp, 30v d-c. Its size is 25/32" x 23/64" x 1/4". Unimax Switch Division, Dept. ED, The W.L. Maxson Corp., 460 West 34th St., New York 1, N.Y.

CIRCLE ED-145 ON READER-SERVICE CARD

Beam Power Amplifier

Hard Glass Miniature Tube



This beam power amplifier, Type 6094, is designed to replace the 6AQ5 and other similar types. Each tube is run-in tested and aged under vibration with all operating voltages applied for 45 hours. This unit is designed for use in equipment in which high ambient temperatures and high levels of vibration, shock, and other accelerations are encountered.

A hard glass (nonex) bulb and stem with tungsten pins are used. This, along with a careful exhaust to a very low vacuum, permits operation of the Type 6094 at bulb temperatures up to 300°C. These tubes have a cathode type structure with ceramic heater insulation and a coil type heater, permitting operation at high heater-cathode voltages. The unit has a 9-pin miniature button base and can operate at altitudes up to 80,000 ft. Bendix Aviation Corp., Dept. ED, Red Bank Division, Eatontown, New Jersey.

CIRCLE ED-146 ON READER-SERVICE CARD

Miniature Relay

Compact Telephone-Type Unit



Intended for applications where space is limited, this d-c unit is only 0.94 cu in in size and weighs 1.2oz. High efficiency is assured by using only one air gap in the magnetic assembly and

a retaining spring which maintains the armature rigidly in place in three major axes. Welded crossbar contacts are employed, insuring positive alignment of contacts at all times.

Any class of high temperature insulation can be wound on the nylon bobbin. Since the insulation is inorganic, there is no gassing, condensation or bubbling. Ceramic bumpers are fastened to the blades mechanically, and failures resulting from the use of cement are eliminated.

The unit is sensitive, operating at 90mw or less. Current rating is 3amp resistive and 1 amp inductive at 26-1/2v d-c. Ambient temperature ranges are -55°C to +85°C on standard coil and -55°C to +125°C on Teflon coil. The unit has a life expectancy of 1,000,000cy minimum with crossbar contacts, and is available in open types and hermetic enclosures. Advance Electric & Relay Co., Dept. ED, 2435 N. Naomi St., Burbank, Calif.

CIRCLE ED-147 ON READER-SERVICE CARD

Transistor Kit

For Experimental Work

This inexpensive kit includes all the components necessary to permit a designer to gain basic knowledge of transistor circuitry through actual experimentation. The kit includes electrolytic capacitors, coils, a potentiometer, one germanium diode, a chassis, terminal strips, wire, resistors, condensers and two transistors.

A simple instruction book covers the physics of transistors and contains experiments for a one-stage audio amplifier, a two-stage R-C coupled audio amplifier, an audio oscillator, an r-f oscillator, a signal tracer, a tuned signal tracer, etc. Precise Development Corp., Dept. ED, Oceanside, L.I., N.Y.

CIRCLE ED-148 ON READER-SERVICE CARD

ELECTRONIC DESIGN • July 1954

Plate Circuit Relay

For Current and Voltage Sensing

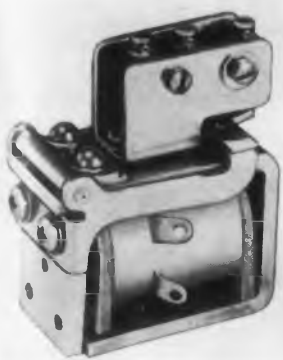

This series of relays is suitable for plate circuit use and current and voltage sensing applications. The units incorporate the use of snap switches to provide positive and instantaneous on-off

switching action. This line is divided into two groups: precision types for high accuracy, identical repeatability, and resistance to shock and vibration; and those for on-off duty applications where requirements are less critical.

Shown is Type RL-516 which has a 6400 ohm coil. This unit pulls in at 4ma, drops out at 2ma; and, with a detent resistor, pulls in at 4ma and drops out at 3.95ma. Coil resistance is up to 18,000 ohms, and sensitivity goes as low as 80mw. These units are also available in 1 pole, 2 pole, 3 pole, and more for special applications. Joseph Pollack Corp., Dept. ED, 81 Freeport St., Boston 22, Mass.

CIRCLE ED-149 ON READER-SERVICE CARD

Quartz Crystals

Subminiature Types



Type 42 Crystals are highly stable subminiature quartz crystals for frequency control of commercial and military aircraft transmitters and receivers. They are designed for switch deck mounting. The units are comparable to military types CR-23/U and CR-32/U and are available for all frequencies from 15 to 100Mc.

The plated quartz crystal unit is especially mounted for resistance to high shock and vibration. The assembly is hermetically sealed in a nickel-plated copper container filled with dry nitrogen. The complete unit measures only 0.455" x 0.420" wide x 0.175" thick, exclusive of leads. Standard Piezo Company, Dept. ED, 265 E. Pomfret St., P.O. Box 278, Carlisle, Pa.

CIRCLE ED-150 ON READER-SERVICE CARD

This is the **GREATEST READERSHIP:**

4,500

design engineers

of **20,000**

circulation

ACT

not only read but

Every month the equivalent of 22% of the circulation writes manufacturers for more data on products seen in **ELECTRONIC DESIGN**. This is nothing new. It's been happening ever since the first issue.

The 20,000 subscribers are all electronic design engineers who are designing electronic devices for mass manufacture. Their prime interest is the latest technical news of components, materials and test equipment, which they find in readily usable form in **ELECTRONIC DESIGN**.

ELECTRONIC DESIGN is the only publication concentrating its editorial and circulation in the electronic original equipment market.

Your electronics advertising will be read when it appears in **ELECTRONIC DESIGN**.



Winchester Electronics

ONE SOURCE OF Printed Circuit CONNECTORS

for ALL
your needs...

"K2"



3-Contact

"K3"



3-Contact

For
individual
or
combination
use.

"K"

2, 3, 4, 10, 15, 18 & 22 5-Amp. Contacts
2500 vDC Breakdown Voltage

**3 CONNECTOR
STYLES**

**2 to 37
CONTACTS**

**5 TERMINAL
TYPES**

**2 CONTACT
SPACINGS**
(3500 or 2500 vDC
Breakdown Voltage)

**2 CONTACT
WIDTHS**
(5-Amp. or 3-Amp.
Rating)



Type "T" for
Riveting to
Circuit Card



Type "S" with
Solder Cup

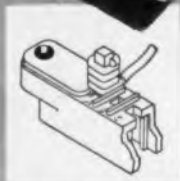

Type "W" for
"Wire-Wrap"

"KM"

14, 21, 31 & 37 3-Amp. Contacts
2500 vDC Breakdown Voltage

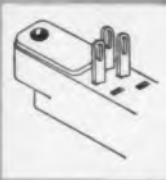

Slotted Eyelet will
take 3 #20 wires.

"KKM"

4, 10, 12, 15, 18 & 22 3-Amp. Contacts
2500 vDC Breakdown Voltage



for
"Wire-Wrap"

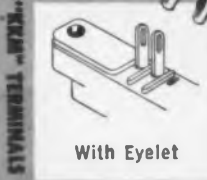

With Eyelet

"KKM" is ideal for low-cost commercial applications... mechanically interchangeable with comparable "K" type.

These precision "printed circuit" connector receptacles and many variants of them, or others to your specifications, are the accepted standard... for quality, compactness, ruggedness, light weight and dependability.

Wire or write for catalog of these and other types or advise us of your special requirements.

**Winchester Electronics, Inc. Products
and Designs are Available Only
from Winchester Electronics, Inc.**

West Coast Branch:

1729 Wilshire Blvd., Santa Monica, California

**Winchester
Electronics**

INCORPORATED

GLENBROOK, CONN., U.S.A.

CIRCLE ED-153 ON READER-SERVICE CARD FOR MORE INFORMATION

New Products . . .

Double-Break Switches Control Two Isolated Circuits



The "TB" Series of double-break switches are designed to control two isolated circuits. By use of a snap-action spring,

almost simultaneous break and make of both contacts is accomplished, in both the normally closed and normally open circuits.

These small-sized units (1/2" x 1/2" x 1-1/4") are especially useful on reversing circuit applications where space is at a premium. Two screw terminals (one normally open and one normally closed) extend from either end of the phenolic case. The terminals are plated for soldering for applications where the switch is used without the screws. Two 0.101" diam holes on a 0.520" center are provided for mounting the switch in a fixed position. The switches will switch 10amp at 125v or 250v a-c, and 10amp at 30v d-c, inductive. Micro Switch, Division of Minneapolis-Honeywell Regulator Co., Dept. ED, Freeport, Ill.

CIRCLE ED-154 ON READER-SERVICE CARD FOR MORE INFORMATION

Electronic Timer Delays Stop or Start



The "Tele-Trol" timer is continuously variable from 0 to 10sec and immediately re-cycles when triggered. Because it is of the accumulative type, the re-cycle time is added to the balance of the previous cycle if triggering occurs before shut-off is reached.

The timer handles a 30amp non-inductive load at 125v, a-c. It operates on 110v, single-phase, but models are available for 220v or 440v, 3-phase operation. Overall size is approximately 3" x 4" x 5". The unit furnishes an accurate means of delaying shut-off or start on a wide variety of equipment, such as work-feeding devices and other equipment utilizing electric motor drives. Benchmaster Mfg. Co., Dept. ED, 1835 W. Rosecrans Ave., Gardena, Calif.

CIRCLE ED-155 ON READER-SERVICE CARD FOR MORE INFORMATION

**YOU CAN'T
SHAKE 'EM LOOSE!
BUT YOU CAN COOL 'EM OFF...**



With BIRTCHER

KOOL KLAMPS

BIRTCHER KOOL KLAMPS will help keep your subminiature tubes COOL... and hold them firm and secure, regardless of how they are shaken, or vibrated.

KOOL KLAMPS are made of a specially developed heat treatable alloy 99 1/2% pure silver of high thermal conductivity.

KOOL KLAMPS under certain conditions are able to reduce bulb temperatures as much as 40° C.

KOOL KLAMPS have proved of particular value in miniaturized electronic equipment.

Where heat conditions are less critical, beryllium copper KOOL KLAMPS are available.

The BIRTCHER CORPORATION

4371 Valley Blvd.
Los Angeles 32, California

Dept. ED-7-4

Please send Bulletin which describes and illustrates Kool Klamps in detail.

Company
Attention of
City State

CIRCLE ED-156 ON READER-SERVICE CARD

Communication Engineers

with
experience in
the fields of

**Systems
Engineering
Information
Theory
Circuit
Development
Electro-
mechanical
Development
Equipment
Engineering**

THE OPENINGS

Advancements in the fields of wave propagation, translation of information, communication theory, circuit techniques and equipment miniaturization have created a number of new openings for qualified engineers in the Hughes Advanced Electronics Laboratory.

AREAS OF WORK

The communication group is concerned with the design and development of unique radio communication systems and with exploiting new radio communication techniques. Specialists in propagation phenomena, antenna systems, network theory, magnetic recording, wide-band amplification, and intricate electromechanical devices are active in this program.

Assurance is required that relocation of applicant will not cause disruption of an urgent military project.

Hughes

**RESEARCH AND
DEVELOPMENT
LABORATORIES**

*Scientific
and Engineering
Staff*

CULVER CITY,
LOS ANGELES
COUNTY,
CALIFORNIA

Thyratron Tube For Industrial Uses



This panel mounting, high-current thyratron rectifier is designed for use in a wide variety of industrial electronic equipments, such as in motor speed control, welding control, and regulated rectifier applications. Designated as the NL-760P, it carries 6.4amp d-c and has a peak rating of 77amp. It has a bracket base for panel mounting.

The tube is gas-and-mercury filled for quick starting and constancy of characteristics within wide temperature limits. Other ratings are: filament voltage—2.5v; filament current—21amp; and peak inverse voltage—1250v. National Electronics, Inc., Dept. ED, 628 North St., Geneva, Ill.

CIRCLE ED-172 ON READER-SERVICE CARD FOR MORE INFORMATION

Carbon-Film Resistors Encapsulated in Glass



Glass-encapsulated and inert gas filled carbon-film resistors are offered in three types. They provide satisfactory operation under

extreme conditions of humidity and high ambient temperature, plus great stability, long life, and improved electrical characteristics.

The resistors are designed for use where greater than usual wattage dissipation or higher voltage applications are desired. In addition, they are especially recommended for focus and convergence strings in color TV, for electronic counters, radar, sonic devices, and avionic equipment.

Model RX3 is recommended for applications requiring up to 15kv; it is a high voltage resistor. Other units are high wattage resistors. Type RX4 has a resistance range from 200 ohms to 200 kilohms and dissipates up to 5w, while Type RX5 has a rating of 200 ohms to 650 kilohms, and is capable of loads up to 10w. Depending upon the application, tolerances can be furnished from a maximum of $\pm 10\%$ to a minimum of $\pm 1\%$. Operating temperature is -65° to $+225^{\circ}\text{C}$. Components Division, Viotoren Instrument Co., Dept. ED, 3800 Perkins Ave., Cleveland, Ohio.

CIRCLE ED-116 ON READER-SERVICE CARD FOR MORE INFORMATION

New WHAT'S IN SCOPE ...for RADAR?



CUBIC'S New VSWR INSTRUMENTATION SYSTEM for continuous . . . automatic . . . measurement of VSWR

The New Model 620 is CUBIC'S contribution to higher efficiency and higher economy in that new RADAR design you may be planning. Designed for field and production use—where frequent VSWR measurements of radar, and other amplitude modulated microwaves are required, it has certain important features entirely new:

- Measurement of VSWR is continuous and automatic over two calibrated ranges, covering ratios 1.02 to 1.2, and 1.2 to ∞ .
- Can be used with CUBIC'S matched directional coupler—permanently or temporarily installed in waveguide run.
- Available too as JAN AN/UPM-12 Military version.
- And available in Model 621, for VSWR measurements at signal generator levels.
- For x-band only, at present. RF components will be ready shortly for operation on S thru Ku band.

New designs make new demands. CUBIC engineers are constantly conducting research to develop new products to enable those new Electronic designs—still on the drafting boards, to become reality. In this connection, our Engineering and service departments are always at your disposal on any Electronic problem.

Write for latest edition of our catalog of microwave instruments



CUBIC
CORPORATION

ELECTRONIC EQUIPMENT
RESEARCH...DEVELOPMENT
SAN DIEGO, 6, CALIFORNIA

CIRCLE ED-117 ON READER-SERVICE CARD FOR MORE INFORMATION

NEW TAYLOR 3C full wave rectifier



This new Taylor heavy-duty xenon filled rectifier provides unusual dependability and long life in power supply applications.

As always, Taylor is producing tubes of superior quality and outstanding performance for industrial and commercial applications. We invite your inquiry on standard or special tube types.

Announcing . . .

NEWARK
ELECTRIC COMPANY

223 W. Madison St., Chicago 6, Ill.
Authorized distributor stocking full line of Taylor Replacement Tubes.

WRITE FOR LITERATURE ON FULL XENON TUBE LINE

Taylor HEAVY CUSTOM BUILT DUTY **Tubes**

TAYLOR TUBES INC., 2312-18 WABANSIA AVE., CHICAGO 47, ILL.

Canada: Atlas Radio Corp., Ltd.
560 King St., W., Toronto 2-B
Cable: ATRADCO

Export: Royal National Company
75 West St., New York 6, N. Y.
Cable: NATVARNCO

CIRCLE ED-161 ON READER-SERVICE CARD FOR MORE INFORMATION

New! Torwico TINYMAX transformers for 400 cycle applications

*Output—6 V.A. *Regulation—10%
*Size—Dia. 1", Ht. 3/4"
*Weight—1 1/2 ounces

Now, to meet the demand for smaller but highly efficient miniature transformers, Torwico has designed the Tinymax Series. Compact, light and durable, these miniatures are ideal for airborne use. Typical of the Tinymax series are the following electrical and dimensional characteristics:

TW-6 — Electric Rating: Input—115v, 400c; Power Output—6 VA; Regulation—10%; Heat Rise—40°C, Class "A". Mechanical Measure: 1 in. x 3/4 in., weighs 1.5 oz.

TW-3 — Electric Rating: Input—115v, 400c; Power Output—3 VA; Regulation—15%; Heat Rise—40°C, Class "A". Mechanical Measure: 1 in. x 9/16 in., weighs 1 oz.

Meets MIL-T-27 Specifications.

We are prepared to design and produce TINYMAX transformers to your specific requirements.

Write today...
for full
information.

TORWICO ELECTRONICS, INC.

963 Frelinghuysen Avenue, Newark 5, New Jersey

CIRCLE ED-162 ON READER-SERVICE CARD FOR MORE INFORMATION

New Literature . . .

Transistor Bibliography 163

Entitled "Guide to Transistor Literature", this 54-page bibliography is divided into sections on theory, characteristics, types, applications, production and testing, and general information. Foreign articles and books from Germany, Great Britain, Japan and Russia are included in the listings. A 5-page subject index is also given. The Glenn L. Martin Company, Presentations Section, Engineering Division, Baltimore 3, Md.

Shielded Enclosures 164

A new booklet, entitled "Evaluating Shielded Enclosures", by Richard B. Schulz, is aimed at eliminating much of the uncertainty and confusion which have made the intelligent purchase of shielded enclosures difficult. It reduces the major factors involved in shielded enclosure specification to their basic engineering equivalents, and compares and evaluates them. In addition to clarifying important points of conflict, the author covers filters and filter performance, structural factors, component contacting, and air inlets. A checklist of questions applicable to any enclosure purchase and designed to place all enclosures considered by the buyer on a common base of comparison is also provided. Ace Engineering and Machine Co., 3644 North Lawrence Street, Philadelphia 40, Pa.

Custom Made Components 165

A 6-page folder (No. 53P) illustrates and describes this company's line of custom-made transformers, reactors, chokes, special windings, and electronic devices is currently available. It incorporates a useful checklist for anyone considering electrical or electronic components. The Electran Manufacturing Co., 1901 Clybourn Avenue, Chicago 14, Ill.

High Potential Testing 166

A 2-page bulletin (No. 14-1) outlines the advantages of d-c high potential testing over conventional a-c methods, and describes typical applications. Standard d-c "Hypot" high-voltage test units are covered in detail, and engineering service and features available on models in the 45kv and above range are presented. Associated Research, Inc., 3758 West Belmont Avenue, Chicago, Illinois.

Microwave Tubes 167

A 6-page, 2-color brochure discusses the principles and applications of microwave gas control tubes, traveling wave tubes, and backward wave oscillators. Applications covered include electronic switches, modulators, phase shifters, attenuators, and gas tube detectors and gyrators. Roger White Electron Devices, Inc., Route 17 and Erie R.R., Ramsey, N.J.

Aluminum Parts Design 168

A new 16-page illustrated booklet called the Alcoa Impact Fact Book, covering the significant facts necessary to design products as impact extrusions has been made available by this concern. These impacts are one piece, seamless, semi-hollow or solid parts with forged bases and one or more extruded side walls. The parts may have round, square, rectangular, or oblong cross sections with ribbed, beaded or fluted side walls, and bases containing bosses, lugs, and other projections or recesses. Aluminum Company of America, 724 Alcoa Building, Pittsburgh 19, Pa.

Sound Products 169

A 20-page illustrated catalog lists this company's latest line of sound equipment. The booklet is divided into sections dealing with such products as microphones, amplifiers, speakers, intercommunications equipment, television Antenaplex systems, and unit-built cabinets and racks. Each section presents a list of products designed to meet needs from portable systems to large sound installations. Descriptions of each model include special features, uses, specifications, and illustrations. Radio Corporation of America, Sound Products Section, Camden, N. J.

Abrasion-Cutting Device 170

An abrasive device known as the Model C "Air-brasive" unit, which can be used for precision cutting, drilling, etching, and light deburring, is described in this bulletin (No. 5307). The cutting action is performed by a fine stream of gas-propelled abrasive particles traveling at near supersonic speeds directed at the work through a small orifice nozzle. Lines as fine as 0.008" can be cut. S. S. White Industrial Division, 10 East 40th St., New York 16, N. Y.

Recording Controllers

171

A new line of process instruments including potentiometric and a-c bridge recorders and recording controllers is described in this company's Bulletin GED-2100. The book illustrates fully the "magnetic standard" employed in the potentiometric system and the "bridge-balancing unit" in the a-c bridge system. These components combine with advanced measurement circuitry and proven control methods to present a new engineering approach to sustained standardization, reduced maintenance, long-term accuracy and precision, increased chart readability, and protection of processes against damage from component failure. General Electric Co., Schenectady 5, New York.

Taps and Dies

An 8-page illustrated folder covers small taps, dies, screws, drills, gages and punches for the instrument manufacturer. It supplies important data on threads from 56 to 160 per inch and contains tables of related information such as sizes of small wire gage numbers, tap and clearance drills, etc. Suggestions for checking thread sizes are also included, and prices for the stock items are listed. Write direct to J. I. Morris Company, 394 Elm Street, Southbridge, Mass.

Silastic Data

173

A 4-page brochure compiles references to 30 of the most popular stocks and pastes to help the user select the "Silastic" silicon rubber best suited to his needs. Designated Silastic Facts 9-334, it briefly describes each raw stock, giving its outstanding characteristics, useful temperature range, suggested applications, and recommended fabrication methods. Also listed are the typical properties of finished parts fabricated and cured as recommended from each of the 30 stocks and pastes. Included are specific gravity, Shore A durometer, tensile strength, percent elongation, and resistance to compression set. Dielectric constant is given as well as dielectric strength and power factor at 100 and 1,000,000cy. Dow Corning Corp., Midland, Mich.

Miniature Computing Differential

174

A 2-page, 2-color bulletin illustrates and fully describes a new 1/8" mechanical computing differential, the latest and smallest addition to this firm's line of ultra-precision single spider gear differentials. Engineered to high military and commercial standards, the unit performs additive and subtractive operations in a working circle of 1.000" maximum diam. Data on speeds, temperatures, and construction are provided, as well as performance curves and detailed specifications. Ford Instrument Co., Division of the Sperry Corporation, 31-10 Thomson Avenue, Long Island City 1, N. Y.

Antenna Selector

175

Communications systems designers will find this 7-1/2" diam circular slide rule valuable. On one side of the selector is a parabolic microwave antenna computer giving power and db gain as a function of wavelength and reflector diameter on a 12-1/2" scale. The gain values were computed on an overall efficiency of 55%. This side includes another set of 19" scales for conversion of frequency into centimeters and inches. It is also handy for converting centimeters into inches. The range of parabolic reflector diameters runs from 4" to 144".

The other side of the selector shows FCC frequency allocations from 30Mc through the 30,000Mc upper limit of the K band as of February 1, 1954. Condensed specifications for 17 of this firm's antennas located in each of the frequency bands appear simultaneously with the allocation data. Gabriel Electronics Division, The Gabriel Company, Endicott St., Norwood, Mass.

Magnetic Cores

176

A line of single-phase, 3-phase, and ring-type "Hipersil" cores is listed in this 2-color, 48-page catalog (Section No. 44-035). These magnetic cores are made of highly grain-oriented, cold-rolled, silicon-iron alloy laminations. The saturation flux density is about 20,000 gauss. The catalog includes 19 graphs with curves of the various characteristics for the different lamination thicknesses. Westinghouse Electric Corp., Transformer Division, P. O. Box 231, Greenville, Pa.

Selenium Rectifiers

177

A 24-page catalog describing both radio and industrial selenium rectifiers has been issued recently. It is fully illustrated with voltage curves, circuitry, tabular material and product applications, and presents an expanded tabulation of power rectifiers up to 260v input and 30amp. Among the rectifiers described are special ones for magnetic amplifier application, hermetically sealed and high temperature types, and embedded stacks. Radio Receptor Co., Inc., Seletron and Germanium Division, 251 West 19 Street, New York 11, N. Y.

Titanium Tubing

178

Properties, applications, and advantages of titanium tubing are presented in detail in an 8-page illustrated booklet (Bulletin No. 42). Topics covered include research and development of the product, available tube sizes, tubing tolerances, chemical analysis, and finishes. There is also an informative section on processing and fabricating characteristics of titanium tubing. Superior Tube Company, 1521 Germantown Ave., Norristown, Pa.

AVAILABLE FROM STOCK FOR IMMEDIATE DELIVERY

acrylic rods and tubes

SIZES AVAILABLE

RODS

1/8"	9/16"
3/16"	5/8"
1/4"	3/4"
5/16"	7/8"
3/8"	1"
7/16"	1 1/8"
1/2"	1 1/4"

TUBES

1/16" wall	1/8" wall
1/4" O.D.	1/2" O.D.
5/16" "	5/8" "
3/8" "	3/4" "
1/2" "	7/8" "
5/8" "	1" "
3/4" "	1 1/4" "
7/8" "	1 1/2" "
1" "	1 3/4" "
1 1/4" "	2" "

CLEAR CRYSTAL METHYL
METHACRYLATE—Rods
and tubes for industrial,
novelty, display, models
and all other fields.

Write for price lists and samples today

Special sizes
to order

ACE PLASTIC COMPANY
Precision Extruders and Fabricators

91-58 VAN WYCK EXPRESSWAY • JAMAICA 35, N. Y.

CIRCLE ED-179 ON READER-SERVICE CARD FOR MORE INFORMATION

FREE!
BOOKLET
AND
SAMPLES

LEARN HOW
SHAKEPROOF®
Plasti-Rivets
CUT ASSEMBLY COSTS!

These ingenious new plastic fastenings drive from one side—simplify blind fastening problems—resist vibration loosening and corrosion. Available in a wide variety of thermo-plastic materials, in a wide choice of colors, sizes and standard or special types.

Send for **FREE**
Testing Samples to-day!

SHAKEPROOF®
"Fastening Headquarters"

DIVISION OF ILLINOIS TOOL WORKS
St. Charles Road, Elgin, Illinois
Offices in principal cities

CIRCLE ED-180 ON READER-SERVICE CARD FOR MORE INFORMATION

FORD INSTRUMENT COMPANY



PRECISION

CAMS

- offered in a variety of types
- with tolerances to $\pm 0.0005''$
- for wide range of computing and motion applications

Whatever your computing or motion application, Ford Instrument can make the cam to meet your exacting needs... 3-D Cams, grooved flat cams, external flat cams, grooved cylindrical cams. Our unique cam-producing facilities guarantee a "custom" job every time. Check us today.

WRITE FOR ILLUSTRATED CAM BROCHURE. COMPLETE DETAILS ON ALL TYPES. ADDRESS BOX ED.



FORD INSTRUMENT COMPANY

DIVISION OF THE SPERRY CORPORATION
31-10 Thomson Avenue, Long Island City 1, N.Y.



25

CIRCLE ED-160 ON READER-SERVICE CARD FOR MORE INFORMATION

INTRODUCING - the new CHATHAM TYPE 6337 LOW-MU POWER TRIODE



.. an outstanding
regulator tube
for DC power
supply units

PLATE SUPPLY—225 volts
BIAS RESISTOR—100 ohms
AMP. FACTOR—2.7
PLATE RESISTANCE—60 ohms
PLATE DISSIPATION—80 watts
TRANSCONDUCTANCE—
45,000 μ mhos
PLATE CURRENT—450 ma
HEATER VOLTS—6.3 (AC or DC)
HEATER AMPS—7.25

Featuring:

- LOW MU, HIGH PERVEANCE
- PLATE CURRENT HELD WITHIN $\pm 10\%$
- COMPACT PHYSICAL DESIGN
- WITHSTANDS 500 G SHOCK

Specifically designed as a regulator tube, Type 6337 features plate current held within $\pm 10\%$, and complete absence of plate current drift. A hard glass envelope and a button stem that strengthens the mount, provide high immunity to extreme shock and vibration. Wide inter-lead spacing practically eliminates electrolysis. These and many other special features make the Type 6337 a tube of utmost dependability in critical regulating circuits. Write today on company letterhead for data sheets.



CHATHAM ELECTRONICS CORP.

Executive and General Offices: LIVINGSTON, NEW JERSEY
Plants and Laboratories: NEWARK and LIVINGSTON, NEW JERSEY

CIRCLE ED-181 ON READER-SERVICE CARD FOR MORE INFORMATION

New Literature . . .

Production Facilities 182

A six-page foldout summarizes the company's facilities for production of acoustic devices, miniaturization of custom printed circuitry, plastic molding, coil winding, transformers, and electronic component assemblies. In addition to the usual equipment for electronic manufacture, the company has a model shop which makes models of all parts and assemblies prior to manufacture. This shop is especially skilled at small intricate parts and quick fabrication of temporary plastic molds for pilot runs. Telex, Inc., Dept. DE, Telex Park, St. Paul, Minn.

Push Button Latches 183

In a 42-page, 2-color bulletin, full details of a new push-button flush latch development are given in detail. Drawings and illustrations of complete assembly and installation are included, as well as procurement information and parts listing. Applications for commercial, industrial, marine and aircraft designs are presented with complete materials specifications. Hartwell Company, 9035 Venice Blvd., Los Angeles 34, Calif.

Vibration Isolators 184

An illustrated 4-page brochure lists the advantages of the new LM-3 and LM-5 series in the company's line of vibration isolators. It covers improvements in the installation and leveling of heavy machines without bolting or shims, increased plant mobility, reduced maintenance costs, and lessening of the noise level. The Barry Corporation, Dept. L&L, 1100 Pleasant Street, Watertown, Mass.

Color TV Components 185

Components for operation of the 15GP22 color TV picture tube and typical circuits utilizing them are given in this 19-page brochure (Form No. 1CE-115). The components include a deflecting yoke, purifying coil, beam positioning magnets, and various associated transformers. Deflection, high-voltage, focus and convergence circuits are shown. RCA Tube Department, Radio Corp. of America, Harrison, N.J.

Markers and Labels 186

A 4-page bulletin (No. 132) presents, in three colors, actual-size illustrations of pressure sensitive markers and labels tailor-made for special applications. Data on label sizes, wording, colors available, shapes, trademark cuts, and label materials are provided. A Dispenser Card containing special labels is sent along with the bulletin. W. H. Brady Co., Dept. 140, 727 W. Glendale Ave., Milwaukee 12, Wis.

Transistor Curve Tracer 187

This folder describes the Model 200A Transistor Curve Tracer. The instrument displays the collector and transfer family of curves for a transistor on an oscilloscope. Rapid and simple determination of transistor parameters can be accomplished. Magnetic Amplifiers, Inc., 632 Tinton Ave., New York 55, N.Y.

Magnetic Clutches 188

A 12-page, 3-color bulletin provides complete information on a compact electromagnetically operated mechanical coupling. Average engage time is 10 milliseconds. Operating speed is from 0 to over 1000rpm. Specifications for both crown tooth drive and plate drive units are provided as well as application, performance, and dimensional data. Reeves Instrument Corp., 215 E. 91st St., New York 28, N.Y.

Data Recording Equipment 189

A 4-page condensed catalog describes the various components which make up Oscillograph Consolettes. These instruments consist of multiple channel oscillograph recorders and a choice of high and low gain d-c, a-c, or universal carrier amplifiers. Many combinations of equipment are possible. Edin Co., Inc., 207 Main St., Worcester 8, Mass.

Power Supplies 190

A 36-page catalog describes, illustrates, points out features, and presents specifications of a wide variety of power supplies, in classes from 0-300v to 0-600,000v. Another section is devoted to instruments, including kilovoltmeters, microammeters, rheostats, and portable projection type oscilloscopes. Beta Electric Corp., 333 E. 103rd St., New York 29, N. Y.

DESIGN and PRODUCTION NEWS

FOR ELECTRICAL AND ELECTRONIC ENGINEERS

Published by TECHNICAL SERVICE, Chemical Manufacturing Division, The M. W. KELLOGG Company

JUNE - JULY, 1954

New Cap Connectors of KEL-F[®] Polymer Widen Tube Service Range... Cut Altitude, Moisture "Arc-Over"!

Exceptional moldability of KEL-F and special equipment permit the "insert" molding of grid cap leads and resistors into a one piece insulated jacket. Conventional wire holes are eliminated, preventing insulation "pull back". Zero moisture absorption of KEL-F polymer and the elimination of wire holes precludes moisture collection which formerly caused "arc over" under high humidity.

The high insulation resistance and dimensional stability of KEL-F polymer over a wide temperature range (minus 320°F to plus 390°F) permits use of these connectors in critical installations subjected to extremes of temperature.

Alden Products Company, Brockton, Mass., uses KEL-F trifluoro-chloroethylene and a special molding technique to produce an entire series of connectors. Variety includes top- or side-connected leads, with or without resistors.

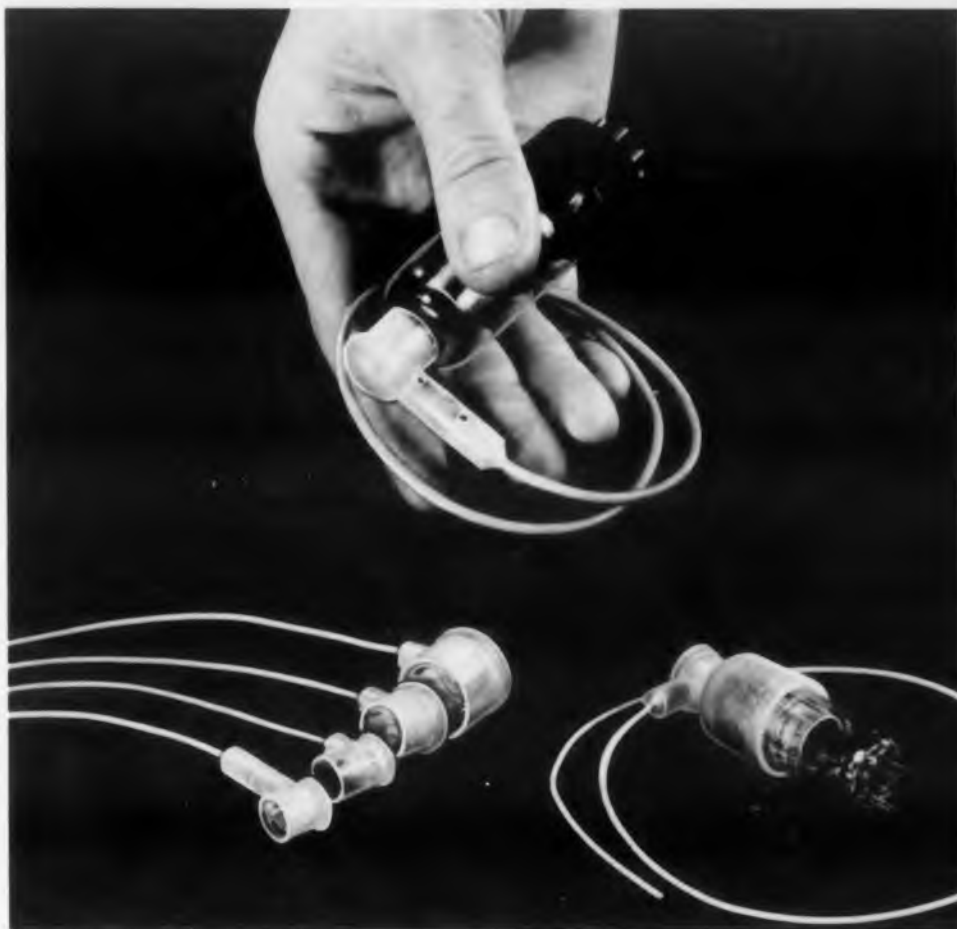

For further information ask for Application Report E-124

**NEW LOWER PRICES
FOR "KEL-F" POLYMERS
OPEN UP MANY
NEW APPLICATIONS
POSSIBILITIES!**

This is the fourth important price reduction since the introduction of KEL-F polymer products in 1948. It cuts prices up to 25% in ton lots, and as much as 42% for small quantities nominally used for experimental work.

The reduction is made possible by the rapidly expanding acceptance of KEL-F polymers and the manufacturing economies achieved in Kellogg's new production facilities.

NEW PRICE SCHEDULE—Effective May 17, 1954

	High Density	Low Density	Plasticized
1-99 pounds	\$10.00	\$9.50	\$11.00
100 - 1999 pounds	9.50	9.00	10.50
2000 pounds and over	9.00	8.50	10.00

P.O.B. Jersey City

KEL-F

TRIFLUORO
CHLORO
ETHYLENE
POLYMERS

KEL-F

MOLDING
POWDERS

KEL-F

FLUORO
CHLORO
CARBON
PLASTIC

KEL-F

DISPERSION
COATINGS

KEL-F

TRIFLUORO
CHLORO
ETHYLENE
POLYMERS

KEL-F

OILS
WAXES
GREASES

"Spaghetti", Flexible in Sub-sub-zero Temperature, Protects Against Oils, Chemicals and Moisture!

This smooth extruded "spaghetti" sleeving for aircraft wiring made of KEL-F polymer, is in a class by itself. Not only does it have a high dielectric strength of from 2500 to 5000 volts per mil, and excellent arc resistance, but it will stay pliable and resist cracking and splitting even after prolonged use at temperatures from minus 140° to 300°F. The unique physical and chemical properties of this fluoro-chloro-carbon plastic permits the lightweight but tough sleeving to remain unaffected under constant exposure to chemicals, oils, or aircraft fuels.

Resistoflex Corporation of Belleville, N. J., manufactures several grades of "spaghetti" and rigid sleeving, made from KEL-F polymers, under the name Fluoroflex "C"***.

*** Trade mark of Resistoflex Corporation
For further information ask for
Application Report E-105*



Recent Significant KEL-F Polymer Developments...

"Lug" type pressure rupture discs now use extruded film not only to protect discs against corrosion damage, but as pressure and vacuum seals.

Wavemeter test probes (microwave control) use molded insulation for consistent performance in high humidity and under thermal cycling.

Heater coils and plates for severe chemical service are protected with "baked on" coatings of KEL-F polymer dispersions.

Indexed commutators for computers now consist of a molded plastic cylinder with intricate conductive inserts. High dielectric and non-carbonization of polymer improves performance.

Be sure you have the latest BUYERS GUIDE SUPPLEMENT...including new sources for KEL-F polymer parts and services!

For complete information regarding any item mentioned in DESIGN AND PRODUCTION NEWS, ask for detailed APPLICATION REPORTS, write

**Technical Service
CHEMICAL
MANUFACTURING
DIVISION
THE
M. W. KELLOGG
COMPANY**

*P. O. Box 469, Jersey City 3, N. J.
or offices in Boston, Chicago, Dayton,
Los Angeles and New York*



KEL-F

TRIFLUORO
CHLORO
ETHYLENE
POLYMERS

KEL-F

MOLDING
POWDERS

KEL-F

FLURO
CHLORO
CARBON
PLASTIC

KEL-F

DISPERSION
COATINGS

KEL-F

TRIFLUORO
CHLORO
ETHYLENE
POLYMERS

KEL-F

OILS
WAXES
GREASES

Molders & Fabricators of the Month

Leading molders, extruders and fabricators specialize in the production of materials and parts made of "Kel-F"... each month this column will spotlight several of these companies with their principal services and products.

International Resistance Company

Philadelphia, Pa.

Extrusion, Compression, Transfer & Injection Molding
Terminals, Resistors, electronic components
Extruded Rod & Tube
Molded Rod, Tube & Sheet

Surprenant Manufacturing Company

Clinton, Mass.

Extrusion
Insulated Wire
Extruded Rod, Tube & Spaghetti
Tape, Strip & Monofilament

Tri Point Manufacturing & Developing Co.

Brooklyn, N. Y.

Machining

The United States Stoneware Company

Akron, Ohio

Corrosion Control
Dispersion Coating

Tape Wound Cores 192

A spiral-bound, 20-page catalog, entitled "Performance-Guaranteed Tape Wound Cores" covers the physical and magnetic constants of over 100 standard sizes of toroidal cores. Construction descriptions include hydrogen annealing, tape winding, and protective boxing. A table of basic physical constants of common magnetic materials, and one on trade names of similar materials together clarify some of the confusion which has arisen from the use of various trade names for similar materials. Production core testing and the company's core matching service are described, and the catalog concludes with 10 pages of curves. Magnetics, Inc., Butler, Penna.

Voltmeters 193

Technical Bulletin No. 197 describes circuitry, range, application, and operating techniques for four of this firm's frequency-selective voltmeters. In addition to detailed information on Models 101A, 103A, 104, and 108A, the brochure covers other carrier-frequency-measuring equipment, including Model 121 wave analyzer and Model 122 line bridging transformer. Sierra Electronic Corp., Dept. P, 1050 Brittan Avenue, San Carlos 2, Calif.

Relays and Actuators 194

Multi-contact, power, and hermetically sealed relays and actuators are each listed and described in separate sections of this 50-page catalog. Characteristic curves are given for many of the units. Phillips Control Corporation, Joliet, Ill.

Vacuum Pump Care 195

Many practical tips on installation, operation, and maintenance of vacuum pumps and vacuum systems are contained in "How To Care For Your Vacuum Pump", a 16-page illustrated handbook. The manual covers the proper way to make leakproof connections in vacuum piping layouts, recommended types of gages, valves, fittings, and gaskets, trouble shooting procedures, and a check list of do's and don'ts to insure long life of vacuum systems. F. J. Stokes Machine Co., 5500 Tabor Road, Philadelphia 20, Pa.

Subminiature Relays 196

This is the latest catalog listing this firm's line of subminiature relays designed to meet severe environmental conditions. Sealed and open-construction types are included. The resistance, voltage and current ratings for each of the different coils supplied with each type of relay are given in tabular form. Neomatic, Inc., 9010 Bellanca, Los Angeles 45, Calif.

Wire Insulating Extruder 197

A compact packaged machine for putting Teflon on wire is described in a 6-page, 2-color folder. It describes the development of the machine and contains detailed instructions for installation, loading, and operation. Complete illustrations of the push-button control panel and specifications for the machine are included. Jennings Engineering, Inc., 3457 Chestnut Street, Philadelphia 4, Pa.

Clutches and Brakes 198

A line of small electro-magnetic brakes and clutches is described in this 9-page bulletin. A miniature clutch with a torque of 8 oz-in is also described. A description of this firm's eddy current dynamometer is also given. This instrument has three torque ranges, the lowest being 0-2 in-oz. Magtrol, Inc., P.O. Box 29, 533 S. Niagara St., Tonawanda, N.Y.

Investment Castings 199

An 8-page booklet deals with some typical small part problems of intricate form, wear resistance, corrosion resistance, and heat and oxidation resistance which confront manufacturers. Using four different parts as examples, the brochure describes the problems and illustrates how they can be solved by the investment casting process. By clarifying the method by which the investment casting process fits into the production of finished products, the brochure opens new fields in design and manufacture, illustrating parts requiring non-machinable materials that can be investment cast to tolerances that require no secondary finishing operations. Facilities and engineering services available to designers and manufacturers are also included in the booklet. Vascaloy-Ramet Corp., Waukegan, Wis.

Arga E-X-P-A-N-D-E-D SCALE A. C. VOLTMETER



Conventional
4½" Scale

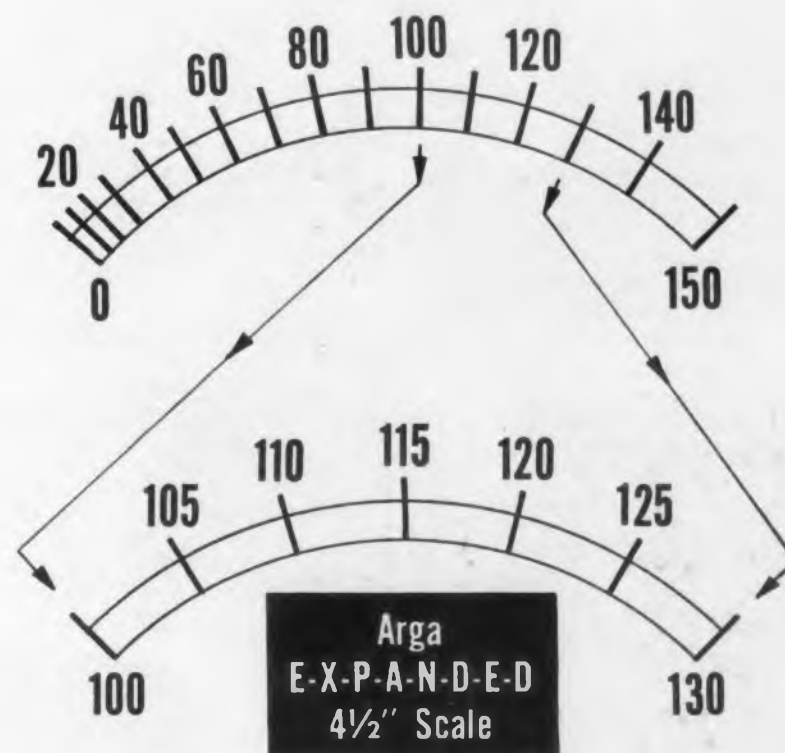

SPECIFICATIONS

ACCURACY — ½% input voltage
FREQUENCY RANGE — 50-2000 cps
BASE VOLTAGE — 115, 120, 208, 230 volts
SPAN — ±5, ±10, ±15 volts
SIZE — 3½" or 4½"—Panel Mounting
SHAPE — Round or Square

Write for Data File 5-116

Arga *division*

BECKMAN INSTRUMENTS, INC.
SOUTH PASADENA 1, CALIFORNIA

CIRCLE ED-202 ON READER-SERVICE CARD FOR MORE INFORMATION

**X-Y PLOTTER
AND RECORDER**



LIBRASCOPE, INCORPORATED

**RECORDS
TWO INDEPENDENT
VARIABLES FROM
ANALOG OR DIGITAL
INPUTS**

A compact, desk-size unit designed for general purpose graphic recording from analog or digital inputs with standard Librascope converters or special modifications engineered to customer requirements. Unique pen travel, fast and dependable. Full chart visibility allowing curve generation to be observed at all times. Write for detailed catalog information.

Mechanical and electrical analog computers, digital computers, input-output devices and components.

Computers and Controls

LIBRASCOPE

A SUBSIDIARY OF GENERAL PRECISION EQUIPMENT CORPORATION

1607 FLOWER ST., GLENDALE, CALIF.

CIRCLE ED-205 ON READER-SERVICE CARD FOR MORE INFORMATION

**UNIVERSAL
meets exacting
DESIGN
REQUIREMENTS**

in

TOROIDAL COILS

Our specially designed machines now wind Toroidal Coils quicker and with more accuracy than other standard methods. Universal Toroidal Coils in any size wire to your specifications—are economical in materials and possess the smallest external leakage field of all other shapes.

Universal Toroids wound to Mil-T-27 specs.

Wire sizes #42 (.00249 mils) to #10 (.1019 mils).

Excellent Delivery in small or large quantity.

Engineering Service Available.

"ACCURACY IS A UNIVERSAL WORD"

UNIVERSAL  **MANUFACTURING COMPANY, INC.**
DEPT. E.D. HILLSIDE AVE. HILLSIDE, N. J.

CIRCLE ED-206 ON READER SERVICE CARD FOR MORE INFORMATION

New Literature . . .

Germanium Crystals

"Industrial Uses for Germanium Crystals" is the title of a 42-page booklet devoted to applications of germanium crystals of particular use to industry. The four chapters of the tract cover: relays and relay applications; timing circuits; power supply applications; and applications to industrial instrumentation. Price is 25 cents. Write direct to Sylvania Electric Products, Inc., 1740 Broadway, New York 19, N. Y.

Name Plate Design 208

Tips on name plate design and selection are provided in this 12-page booklet. It covers purposes of the name plate identification desired, appropriate sizes and shapes, variety of metals available, types of processes and finishes available, methods of reproducing designs on plates, types of lettering, and fastening of name plates. L. F. Grammes and Sons, Inc., Allentown, Pa.

Instruments

Complete basic information on this concern's line of mechanical industrial instruments is given in a new 50-page, two-color catalog (M-2-A). Items covered are: fixed stem and distant reading dial thermometers; temperature and pressure recorders, non-indicating controllers, indicating and recording controllers; accessories; and diaphragm motor valves. Price lists and circular recorder charts are also included. Write direct to Weston Electrical Instrument Corp., 614 Frelinghuysen Ave., Newark 5, N. J.

Wires and Cables 209

A 36-page illustrated catalog provides descriptions and complete specifications on the concern's entire line of hook-up and lead wires and cables for use in the electronics field. Tables and charts, as well as special wire, cable cord and harness assemblies to individual specifications are also included. Lenz Electric Manufacturing Co., 1751 No. Western Ave., Chicago 47, Illinois.

Selenium Rectifiers 211

This 24-page illustrated booklet contains much information useful to the design engineer who uses rectifiers. Standard cell sizes and ratings; typical circuits, applications, and characteristics; operation of rectifiers at higher than normal temperatures; and formulas are included. Fansteel Metallurgical Corporation, North Chicago, Ill.

Delay Lines 212

This 2-page bulletin describes Distributed Constant Delay Lines for IFF, color TV, and many other military and commercial applications. Design features are described. A table lists 12 typical delay lines, with complete technical data. Three delay lines and two hermetically sealed containers are illustrated. Electrometric, Inc., Woodstock, Ill.

Heat Flow Transducer 213

A 2-color illustrated leaflet describes the company's Model 200 Series Thermopile Heat Flow transducers. The text outlines how closely concentrated thermocouple junctions provide an output high enough for direct driving of indicating or recording meters, thereby suiting the transducers to applications involving portable instrumentation and uses outside standard power availability. Cross section drawings, output calibration curves, and specifications giving data on sensitivity, response, internal resistance and dimensions are also included. Beckman & Whitley, Inc., 1085 East San Carlos Ave., San Carlos, Calif.

Conductivity Measurements

An 87-page circular, "Effective Radio Ground-Conductivity Measurements in the United States" was prepared by the National Bureau of Standards. It contains 84 maps with the results of measurements in the broadcast band. Over 7000 radials are shown on the maps. The study showed little association of effective ground-conductivity with soil type. Previous maps have been prepared on the assumption that the values of conductivity are closely associated with soil type. Price of the circular is 65 cents. Order direct from Government Printing Office, Washington 25, D. C.

Batteries

215

Silver-zinc rechargeable batteries are described in this 2-color folder with a voltage vs time chart shown for each of the seven types available. These batteries operate at great extremes of temperature and feature a flat voltage curve. American Machine & Foundry Co., Contract Div., 261 Madison Ave., New York 16, N.Y.

Capacitors

216

A complete line capacitors including electrolytic, paper, and metallized paper types are described in this 49-page catalog (No. AC-4). Detailed sections on selection specifications for each type, respectively, are also included. A discussion of this firm's line of filters is also given. Astron Corporation, 255 Grant Avenue, East Newark, N.J.

Plastic Machining

217

A precision machining service for plastic components is described in this 4-page folder. Among the plastics processed by this firm are Teflon, Formica, Kel-F, and Nylon. Tri-Point Mfg. & Development Co., 401 Grand St., Brooklyn 11, N.Y.

Metal Fasteners

218

Screws, washers, bolts, and nuts are listed with prices per gross in this 42-page catalog (No. C). A chart of decimal equivalents of fractions of inches is included. Admiral Screw Company, 2511 W. Moffat Street, Chicago 47, Illinois.

Design Service

219

This 11-page brochure describes the engineering, research, development, design, and testing services available from this consulting firm. Specialists in fluid mechanics, electro-mechanics, controls, vibrations, instrumentation, and gearing are on the staff. Barnes & Reinecke, Inc. 234 East Ohio St., Chicago 11, Illinois.

CIRCLE ED-220 ON READER-SERVICE CARD ►
ELECTRONIC DESIGN • July 1954

*Save assembly time . . .
with quality-controlled ceramics*

made of

ALSiMAG[®]

Your line workers will appreciate the ease and speed with which they can assemble ALSiMag ceramics. Your production planning staff will be well pleased with the excellent quality as well as the rapid delivery of these parts.



Physical dimensions and tolerances are checked at every key stage of manufac-

ture by thoroughly trained Quality Control inspectors to insure shipment of a superior product.

Four large, completely equipped plants assure you of hundreds—or hundreds of thousands—of ALSiMag precision made parts when you want them.

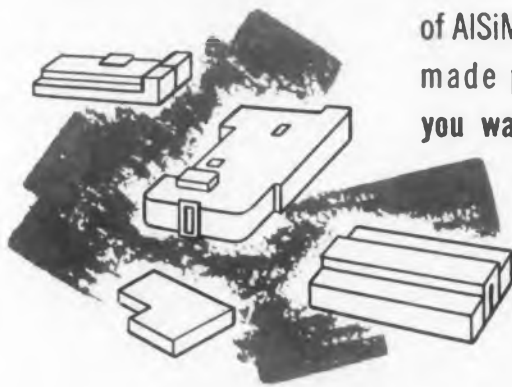

You can confidently specify ALSiMag ceramics—backed by over fifty years of specialized experience in the technical ceramics field.



53RD YEAR OF CERAMIC LEADERSHIP
AMERICAN LAVA CORPORATION
A Subsidiary of Minnesota Mining and Manufacturing Company
CHATTANOOGA 5, TENNESSEE

OFFICES: METROPOLITAN AREA: 671 Broad St., Newark, N. J., Mitchell 2-8159 • SYRACUSE, N. Y.: 647 S. Warren St., Phone 74-4889 and 74-4880 • CLEVELAND: 5012 Euclid Ave., Room 2007, Express 1-6685 • NEW ENGLAND: 1374 Mass. Ave., Cambridge, Mass., Kirkland 7-4498 • PHILADELPHIA: 1649 N. Broad St., Stevenson 4-2823 • ST. LOUIS: 1123 Washington Ave., Garfield 1-4959 • CHICAGO: 228 N. LaSalle St., Central 6-1721 • SOUTH WEST: John A. Green Co., 6815 Oriole Dr., Dallas 9, Dixon 9918 • LOS ANGELES: 5603 N. Huntington Dr., Capitol 1-9114 • SOUTH SAN FRANCISCO: 320 Shaw Rd., Plaza 6-0800 • PITTSBURGH: 911 Plaza Bldg., Atlantic 1-2075



*a new achievement in
fast-print oscilloscope
recording . . .*

Simple to Operate. Uses standard Polaroid® magazine and fast self-developing film. Delivers finished black field print in 60 seconds. **Automatically Records** 3 to 16 traces per print. Provides full size image on 3" scope, half-size image on 5" scope. No reversal of image.

The Aremac Automatic **RECORDOSCOPE 1185**

A fully automatic oscilloscope camera that reduces engineering time and costs . . . improves results.

Slippery Camera Mount with swing-a-way adapter hood. Camera easily swung aside when not in use. Prevents data card exposure. Available in 35 mm camera and service several 2 and 5" scopes of different makes when provided with adapter mounts and hood. Can be interchanged in seconds. Exposure plus automatic movement to next trace position can be accomplished in three ways: (1) manual shutter release, (2) cable release, (3) remote operating switch.

Manual RECORDOSCOPE

The manually operated version of the RECORDOSCOPE 1185 offers many of the precision engineered advantages found in the companion automatic model. Though basically designed for manual release and advance of film, this camera can be factory modified for automatic operation.



*POLAROID is the registered name of the Polaroid Corporation



The Aremac **RECORDOSCOPE 1073** *a 35 MM Synchronous Camera for Continuous Motion or Single Frame Oscilloscope Recording*

The Aremac 1073 Recordoscope is a compact self-contained unit mounting an f/2 six-element 50 mm lens and special 400 foot Aremac powered magazine. Shutter interlock system prevents film motion when shutter is closed. Synchronous film speeds range from 256"/sec. to 1/8"/sec. in 12 steps of 2:1 ratio. The camera can be stopped and restarted with practically instantaneous speed synchronization. Periscope mounts camera vertically. Provision for automatically illuminated data cards and strobe contacts.

Write for Complete Technical Data on AREMAC Cameras Today.

Aremac ASSOCIATES

MANUFACTURERS OF MECHANICAL & OPTICAL INSTRUMENTS
329 WEST WASHINGTON STREET • PASADENA 3, CALIFORNIA

CIRCLE ED-273 ON READER-SERVICE CARD FOR MORE INFORMATION

New Literature ...

Germanium Products 274

This firm's complete line of germanium diodes and germanium transistors is described in an 8-page catalog (Bulletin G-23). Fully illustrated with charts, voltage curves and diagrams, the brochure covers 32 different germanium diodes, including four JAN types, nine hermetically sealed, p-n-p junction transistors, and supplies product applications for each. Radio Receptor Co., Inc., Sales Dept., 251 West 19 Street, New York 11, N. Y.

Pulse Transformers 275

A new catalog lists the electrical and physical characteristics of 33 blocking oscillator or regenerative driver pulse transformers. Pulse voltage, pulse duration, maximum duty ratio, load impedance, rms test voltage, induced voltage, and d-c resistance are listed for each type. Utah Radio Products Co., Inc., 1123 East Franklin St., Huntington, Ind.

Klystrons and Magnetrons 276

Two 4-page bulletins, entitled "Characteristics of Magnetrons" (No. 2867) and "Characteristics of Klystrons" (No. 2868) list the company's magnetrons and klystrons. They include information on frequency band, maximum ratings, and typical operation conditions. Klystrons oscillating at 600Mc to 51,800Mc, and magnetrons oscillating at 1220Mc to 24,250Mc are listed. Power Tube Division, Raytheon Manufacturing Co., Waltham 54, Mass.

Relay Catalog 277

A new 44-page, 2-color, spiral bound catalog lists standard stock relays and also suggests some of the many modifications that can be made to accommodate special requirements. Details include characteristics, schematics, and dimensions. The catalog is in five sections listing types of relays as follows: midgets, circuit controls, special purpose, radio and high frequency, aircraft relays and contactors. Leach Relay Co., Division of Leach Corporation, 5915 Avalon Blvd., Los Angeles 3, Calif.



SMALL PLASTIC PARTS



GRC

INJECTION MOLDING TECHNIQUES OFFER WIDE FLEXIBILITY AT IMPORTANT SAVINGS!

Gries tiny thermoplastic parts meet simple or intricate specifications precisely, uniformly, and economically. We mold all thermoplastics! Nylon, Kel-F, acetates, polystyrene, polyethylene, etc. Quantities of 25,000 to millions.

NYLON A SPECIALTY!

Gries' unique special molding facilities make the most of nylon's unique advantages—at the least cost

AUTOMATIC INSERT MOLDING.

Exclusive facilities for individual or continuous inserts; finished parts produced automatically—without manual labor of any kind!

MAXIMUM SIZE:

.025 oz. 1" long

NO MINIMUM SIZE!



Write today for samples and informative bulletins; send prints for quotations.

GRIS REPRODUCER CORP.

World's Foremost Producer of Small Die Castings
40 Second St., New Rochelle, N. Y. • NEW Rochelle 3-8600

CIRCLE ED-278 ON READER-SERVICE CARD FOR MORE INFORMATION

ELECTRONIC DESIGN • July 1954

Power

In a
When
compan
ucts for
ies syst
and cor
ards an
matic t
starting
delay r
Informa
subjects
lighting
ment fo
matic
Orange

Comp

Comp
servo sy
brochu
electro-
gent se
a posit
plifiers
Contro
N. E.,

ELECT

Power Controls

In a 30-page booklet (No. 528) entitled "When Normal Power Fails . . .", this company compiles their services and products for use on the power side of electronics systems. It discusses devices designed and constructed to meet RETMA standards and also covers such controls as automatic transfer switches, engine-generator starting units, differential relays, time delay relays, and complete control panels. Information is also given on such related subjects as current surge tests, adequate lighting, relay protection, auxiliary equipment for engine generator controls. Automatic Switch Co., 391 Lakeside Ave., Orange, N. J.

Computer Components

Computer components and packaged servo systems are catalogued in this 8-page brochure. Among these products are an electro-mechanical integrator, an arc tangent solution system, a two-speed system, a position servo potentiometer, servo amplifiers, and magnetic amplifiers. Feedback Controls, Inc., 503 Rhode Island Ave., N. E., Washington 2, D. C.

279

Tube Cooling Units

An 8-page aviation products bulletin (No. 320) includes a listing of cooling units for tubes. Designed expressly to meet military requirements for cooling radar and electronic tubes, they come in four models. Eastern Industries, Inc., New Haven, Conn.

Vibration Isolators

Bulletin 538 presents in four pages detailed technical and application information on the concern's Series 670 and Series 297 Barrymounts. The units are shock and vibration isolators designed to reduce shock and noise caused by impact-type machines, and vibration and noise caused by heavy rotating and reciprocating machines. The isolators are available in seven load ratings, covering the range from 500 to 4400 lb per unit isolator. Included in the bulletin is information on dimensions, and loads, installation procedures, variation of natural frequency with load, percent isolation of vibration for various frequencies and applied loads, and performance under shock. The Barry Corporation, 875 Pleasant Street, Watertown 72, Mass.

281

282



Microwave
Assemblies,
Radar Components,
and Precision
Instruments
manufactured and
designed to your
Specifications.

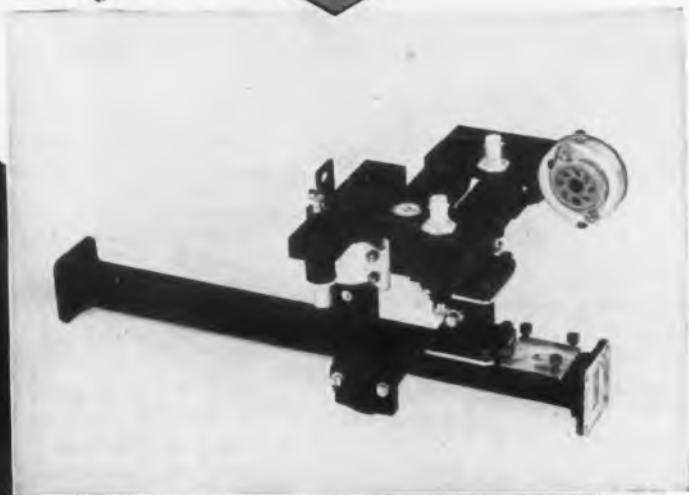

N.R.K. MFG. & ENGINEERING CO.

4601 WEST ADDISON STREET • CHICAGO 41, ILL. • Spring 7-2970

CIRCLE ED-283 ON READER-SERVICE CARD FOR MORE INFORMATION

Famous DeWalt[®] Home Power Shop relies on Sterling Relays

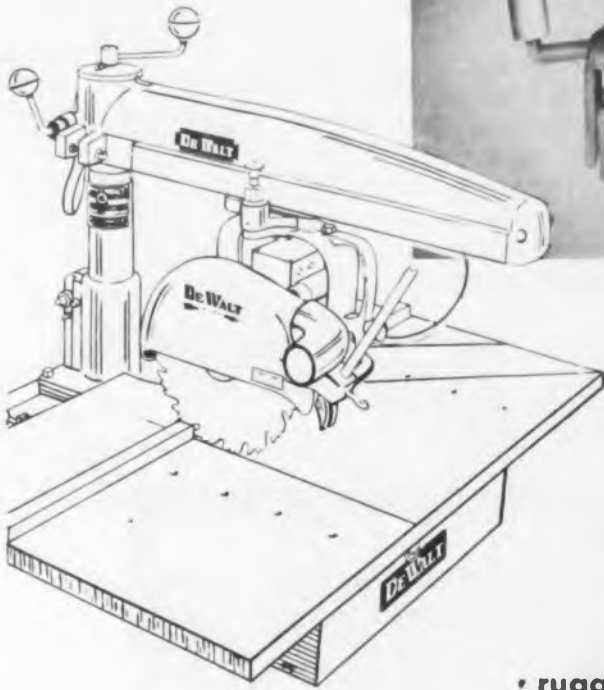

- for resistance to vibration • fast operation
- low loss while on the line • small size
- rugged construction • low cost
- years of trouble-free service

Dependable DeWalt power tools need rugged, dependable components. So it's little wonder that Sterling Relays are built into DeWalt equipment. DeWalt, like hundreds of other manufacturers, has found you can't beat Sterling quality or service for standard and specialized work. Sterling experience and AMF engineering know-how give you a product to meet your most rigid specifications.

General Specifications, Sterling MS Relay

- Cut-out, operate, 125 V.A.C., Nominal 120-130 V. • Cut-back, drop out, 60 V.A.C., Nominal 50-70 V. • Wide, adjustable differential • Large high-pressure silver contact, $\frac{3}{8}$ " diam. • Overall size, $2\frac{1}{4}$ " x 2" x $1\frac{3}{8}$ " diam. • Weight, app. 4 oz. • Mounting, 2 or 4 #6-32 tapped holes • Operates in any position

Whatever YOUR relay requirement, you'll be glad you checked with Sterling. Write Sterling Engineering Co., Laconia, N. H.



They're relays YOU can rely on!

AMF Products are better...by design
AMERICAN MACHINE & FOUNDRY COMPANY

STERLING ENGINEERING CO
54 Mill St., Laconia, N. H.

Please send your 28-page Sterling Relay catalog to

NAME _____

POSITION _____

FIRM _____

ADDRESS _____



NOW! SPECIFICATION STRIPING ON TEFLON HOOK-UP WIRE... ANOTHER TENSOLITE "FIRST!" New TENSOLON high temperature Teflon insulated hook-up wire is striped with one broad and one or two narrow stripes for circuit identification. Teflon inks fused into the insulation make sequence of colors easily distinguishable. Striping conforms to commercial (GEN-104) and military (MIL-W-76A) specifications for color coding. Wire sizes available from No. 26 to No. 10 AWG with 819 different striping combinations possible. Insist on TENSOLON when specifications call for...

Breaking The Temp Barrier!

TENSOLON
TEFLON[®] INSULATED
WIRE & CABLE

Tensolite has complete fabricating facilities for solving your high temperature wire problems —

- PARALLEL WRAPPED TEFLON
- SPIRAL WRAPPED TEFLON
- EXTRUDED TEFLON
- SPIRAL STRIPING WITH
TEFLON INKS

Watch Tensolite for progress in electronic wiring — inquiries are invited.

NEW! 16 pages of specifications and data covering the complete Tensolite line; a note on your letterhead will bring your copy promptly.



Tensolite

INSULATED WIRE CO. INC

© Du Pont

TARRYTOWN, NEW YORK — TARRYTOWN 4-2300

Tensolite products include: TENSOLON — Teflon Hook-up Wire to MIL-W-16878A and Miniature Teflon Jacketed Cables; TENSOLEX—Vinyl Insulated Wires to JAN-C-76, MIL-W-76A, MIL-W-16878A; TENSOLITE — Super-flexible Constructions including Phonograph Pick-up Cables and Hearing Aid Cordage.

CIRCLE ED-285 ON READER-SERVICE CARD FOR MORE INFORMATION

Patents . . . By John Montstream

Phase Shift Oscillating System . . .

Patent No. 2,662,183. Jack E. Bridges, Chicago, Ill. (Assigned to Radio Corporation of America).

The patent describes a new phase-shift oscillating system that has general application, although it is particularly useful as the local oscillator for the horizontal or line sweep generator of a television receiver. An automatic frequency control system maintains the local oscillator in step with the incoming horizontal or line sweep synchronizing signal. The prior systems operate successfully, but require the use of large coils or transformers, which are relatively expensive and bulky. This system uses components that are relatively inexpensive and occupy much less space.

The operation of the oscillator shown in Fig. 1 is better understood from a consideration of the vector diagram shown in Fig. 2. Suppose that a sinusoidal signal e_{p1} is applied to the control grid (22) of tube 10. An amplified output signal e_{p1} of opposite phase is produced across load resistor 14. This signal is fed back directly to grid 22 through a phase shift network (21) and the output signal e_{f1} from the network, is shown as 90° out of phase. The component e'_{f1} of this signal which appears on control grid 22 is utilized with

a component signal e'_{f2} as will be described to produce oscillation.

Signal e_{p1} is also applied to control grid 18 of tube 11 through a coupling capacitor (19) where it appears as signal e_{p2} across grid-cathode resistor 20. The resultant signal e_{p2} across load resistor 16 of tube 11 is out of phase with its input signal and is fed back to control grid 22 of the first tube (10) through a phase shift network (24) and resistor 25. Output signal e_{f2} of the phase shift network applies a component thereof e'_{f2} to control grid 22. The two feed back signals e'_{f1} and e'_{f2} are of such magnitude and phase as to equal in magnitude the input signal e_{p1} so that the proper conditions exist for oscillation.

The phase-shift networks 21 and 24 are capacitors and resistors, there being three different networks illustrated in the patent including one particularly designed for use in a television circuit. The two phase-shift networks of the system may be of the same variety, that is, phase advancing or phase retarding, or they may be different. The frequency is preferably controlled by varying the magnitude of the feed back voltage e'_{f1} although control may be exercised by varying the magnitude or phase or both the magnitude and phase of either of the feed back voltages.

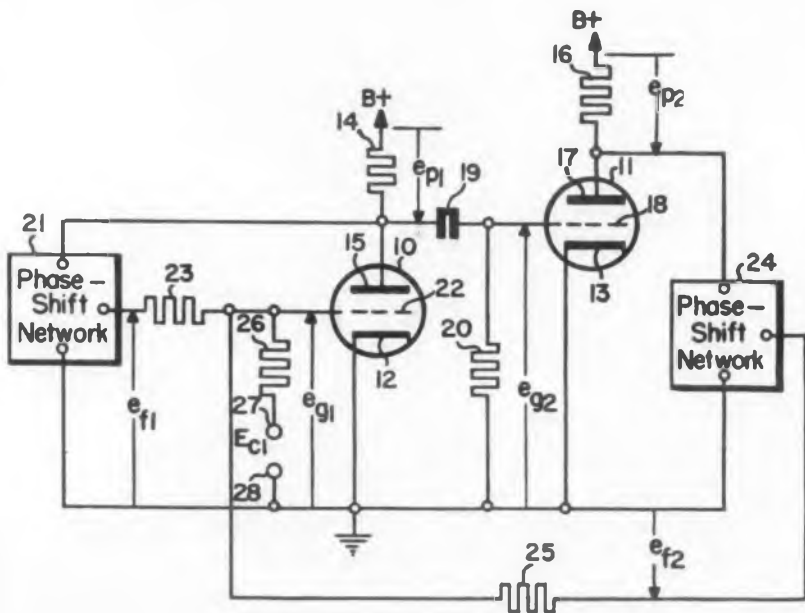

Figs. 1 and 2. The phase-shift oscillator (left) and its explanatory vector diagram (below).

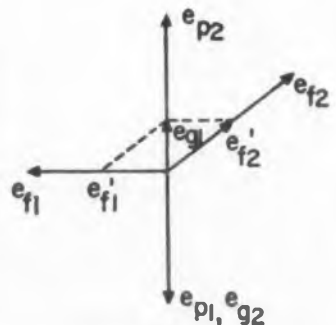

Semiconductor Signal Translating Device . . . Patent No. 2,655,610. Jewell J. Ebbers, Whippany, N. J. (Assigned to Bell Telephone Laboratories, Inc.).

This patent considers means of controlling the operating characteristics of junction type transistors. Such characteristics include the current-voltage relationships, the effective current multiplication factor, collector saturation current, and the transference of the transistor from open to closed circuit conditions.

One application of the unit is shown in Fig. 3. Junctions J_1 and J_3 are of low resistance and J_2 is of high resistance. The terminal E is the emitter, C the collector and B the base terminal. The input signal

is applied between E and E_1 . Resistor 21 represents the load. Resistor 24 controls the unit's characteristics.

By varying resistor 24 from 1000 to 10,000 ohms, the multiplication factor varies from 2 to 70 with the factor leveling off at higher and lower values of resistance. This characteristic is plotted on a graph. Other graphs are included in the patent.

By using other circuitry and an asymmetric diode or diodes, or a point contact at an emitter connection, a wider range of selection of operating characteristics may be secured. For example, the unit may be designed to control the slope and sign of the operating characteristic. The patent also describes how the unit may be designed for switching operating.

Fig. 3. A circuit for controlling the characteristics of junction transistors.

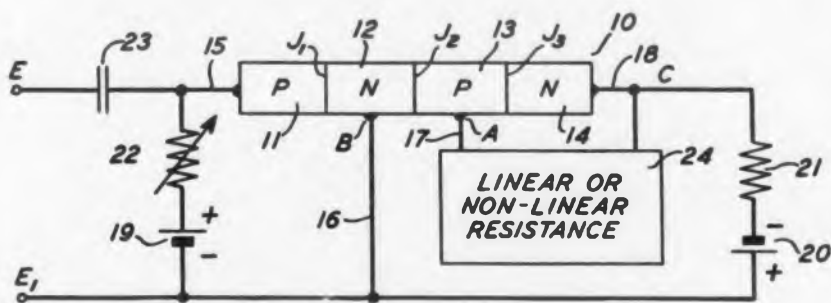

You asked for them . . . they're here . . .

G.E.'s IMPROVED TV SWEEP TUBES

AT NO PRICE INCREASE!

- Cooler operation! New king-size bulb has 89% more glass surface area.
- 6,000 v peak pulse plate voltage rating, against 5,500 v for prototypes 6BQ6-GT and 25BQ6-GT! Internal tube arcing is greatly reduced.
- Special high-melting-point solder is used for the plate cap-terminal. Prevents loosening of terminal when tube is removed for testing.
- Same basing layout as prototypes. New tubes are fully interchangeable with the old.



You can SEE the improvement over prototypes (left)

Ask for complete information! General Electric Company,
Tube Department, Schenectady 5, New York

GENERAL ELECTRIC

162-189

CIRCLE ED-286 ON READER-SERVICE CARD FOR MORE INFORMATION

ELECTRONIC DESIGN • July 1954

This Story is full of Holes

1808 to be ACCURATE

WHEN the W. L. Maxson Corp. needed gear train panels for their computing machines, *Universal* got the nod for one important reason! Notwithstanding our years of experience and an enviable record for producing precision work—this job came to us primarily because we had the equipment* to do the job best!

Working to tolerances of $\pm .0005$ between holes, and tolerances of $\pm .0002$ on the holes themselves, interior of holes finished to 4 to 6 micro-inches, this precision boring operation on 24 ST aluminum sheets, is just one of the many jobs of its kind constantly "in work" at our plant.

**The Jig Boring Machine that handled this job, employs an optical measuring system instead of the usual threaded spindle, this machine attains an accuracy undreamed of in other machines.*

"Accuracy Is A
UNIVERSAL Word"

Our Engineering Staff is Available to Help You. Send specifications or blueprint for quotation.



CIRCLE ED-287 ON READER-SERVICE CARD FOR MORE INFORMATION

GOLD INLAY KNOBS IN ANY QUANTITY!

... and Never a Tool Charge

NEW *Gee-Lar* GOLD INLAY KNOBS

You can get beautiful gold inlay knobs, pointers, instrument controls . . . thousands of styles and varieties . . . in any quantity from GEE-LAR—The House of Knobs. They're available in both knurled and spring types, in either walnut or ivory backgrounds. For faster service and lower cost . . . plus the widest selection . . . get your Gold Inlay Knobs from GEE-LAR!

WRITE TODAY
for Gee-Lar Catalog
IT'S FREE!



THE HOUSE OF KNOBS

GEE-LAR MANUFACTURING COMPANY

824 Elm Street •

Meriden, Conn.

CIRCLE ED-288 ON READER-SERVICE CARD FOR MORE INFORMATION



PHOTOCIRCUITS, INC. selects *NEW HUBBELL Interlock* SUB-MINIATURE CONNECTORS FOR WIRING PRINTED CIRCUITS!



Made for each other! Hubbell Interlock's sub-miniature connectors make wiring of printed circuits fast and safe. Note how Interlock Type "C"

Connectors pass through set-in eyelets from back and lock automatically on opposite side. Eyelets manufactured by United Shoe Machinery Corp. Eyelet setting machines are available.

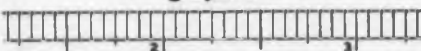

Hubbell Interlock sub-miniature Type "C" Connector. Simplicity of design is the key to its constant low contact resistance and ease of installation.

Hubbell Interlock's latest development, the sub-miniature Type "C" Connector, featuring low contact resistance, automatic locking — quick disconnect wiring, found immediate application to another recent advancement in the electronic field — the "printed" circuit. The tiny connectors met every requirement for wiring the illustrated rotary switch plate circuit manufactured by Photocircuits, Inc. of Glen Cove, N.Y. Their automatic locking — quick disconnect feature eliminated difficult soldering and made possible fast, easy wiring maintenance. The exclusive Hubbell Interlock mechanism assured a vibration-proof, constant low contact resistance.

For Difficult Wiring Problems Requiring Sub-Miniature Connectors, Our Development Laboratory Will Cooperate With Your Engineers To Adapt Interlock For Your Specific Applications.

HARVEY HUBBELL, INC.

Interlock Dept., Bridgeport 2, Conn.



CIRCLE ED-289 ON READER-SERVICE CARD FOR MORE INFORMATION

Patents . . .

Ultrahigh Frequency Resonator . . .
Patent No. 2,660,667. Arnold E. Bowen, Redbank, N. J. (Assigned to Bendix Aviation Corporation).

In the simple magnetron resonator shown in Fig. 4, a partition is inserted into an evacuated wave guide to form a partial obstruction to the passage of waves. The resonator may serve many different purposes in a wave guide, some of which are: as a combination resonator and radiator for an oscillation generator; a filter; a frequency selective coupling; an absorber of waves of a resonant frequency; as a transmitter of waves between connecting wave guides; or as a radiator of waves into space. A wave guide system may also be tuned by adjusting the position of the partition which forms the resonator.

The partition (4) is a disc with an aperture consisting of two round holes (5 and 6) joined by a slot (7). The sides of the slot (8 and 9) form anodes. The capacity between surfaces 8 and 9 is in parallel with the inductive loops formed by the circular surfaces of holes 5 and 6. Filament 10 located between anodes 8 and 9 and a pair of magnets (16 and 17) placed outside the waveguide provides a constant magnetic field between the anodes.

In operation, electric charges alternate between anodes 8 and 9 at an ultrahigh frequency determined by the dimensions of the surfaces. Energy is radiated from the slot towards both ends of the waveguide. The energy radiating towards the conducting plate (3) is reflected back towards the partition to reinforce the energy radiating towards and through a dielectric window (2) into space or into a waveguide as requirements dictate.

Fig. 4. An ultrahigh frequency resonator.

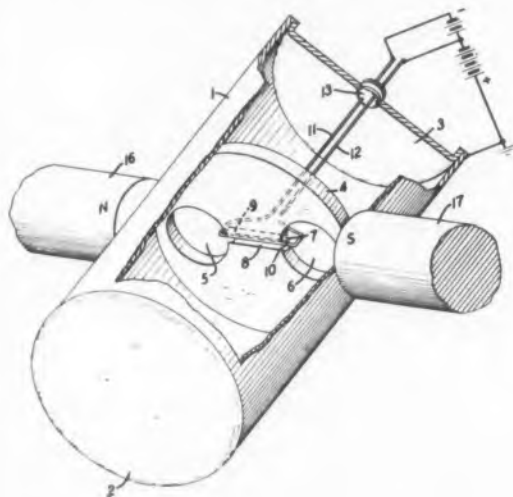

Linear Sawtooth Generator . . . *Patent No. 2,661,420. Thomas E. Woodruff, Redondo Beach, Calif. (Assigned to General Electric Company).*

The circuit shown in Fig. 5, provides a linear sawtooth output for a low repetitive rate and a wide voltage range.

The circuit includes a capacitor (1) that charges exponentially, the charge being supplied from a B battery through tubes 5 and 4 and cathode resistor 3. Terminal 6 of the capacitor increases in potential as the charging proceeds and controls the potential on grid 13 of cathode follower tube 8 with cathode resistor 12. The linear sawtooth wave is secured from terminal 14. As the potential at terminal 6 rises, the potential on grid 13 increases so that current flow through tube 8 increases. This in turn increases the potential across the output cathode resistor 12 and, therefore, at terminal 14.

Tubes 5 and 15 make up a voltage regulator. As the current through resistor 12 increases with the increase in potential at terminal 6 as capacitor 1 charges, the potential across the cathode resistor 12 increases. This increases the negative bias on control grid 20 of tube 15. Current flow through the tube decreases and the potential of anode 21 as well as that of the control grid 22 of tube 5 increases and results in a decreased potential drop across the tube 5. As a result of the voltage regulator action, the potential increase at terminal 14 is a linear within 1% over a range of 0 to 150v. Greater linearity may be secured from the circuit by inserting tube 25 and its anode load resistor in parallel with tube 4. The capacitor 1 is discharged, thereby terminating the sawtooth wave through thyatron 32, which is triggered by a positive pulse applied to grid 36.

Fig. 5. A linear sawtooth generator.

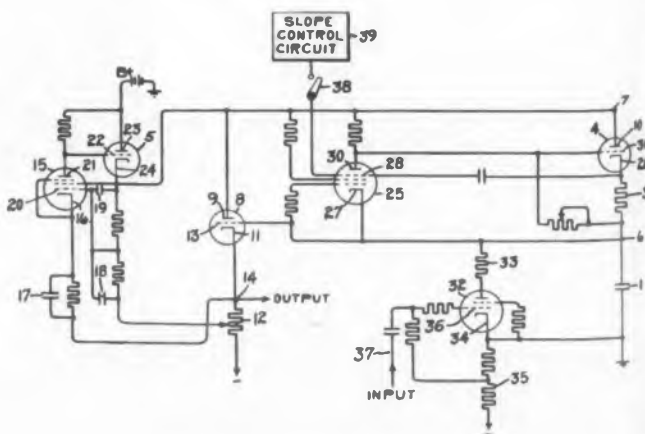

Bidirectional
Patent No.
Madison, N
Laboratori

In the tr
the input
electrode.
circuit value
though the
impedance.
delivered to
input sign
impedance

By anot
values, the
the input
tially zero
useful fo
devices in

Fig. 6. A constant-output voltage transformer circuit.

Bidirectional Transistor Amplifier . . .
Patent No. 2,659,774. Harold L. Barney, Madison, N. J. (Assigned to Bell Telephone Laboratories, Inc.).

In the transistor circuit shown in Fig. 6, the input signal is applied to the collector electrode. By proper selection of the circuit values, the circuit will function as though the output has substantially zero impedance, that is, the output voltage delivered to the load is dependent on the input signal but independent of the load impedance.

By another suitable selection of circuit values, the circuit may be operated so that the input impedance presented is essentially zero. This condition is particularly useful for inserting current-measuring devices into a network (for example, an

oscillation circuit) with or without a minimum of disturbing effect on the network.

Again, with proper selection of parameters, the circuit will give equal amplification in both directions without switches, which is useful in telephone circuits. The inventor described another bidirectional circuit utilizing an inverted grounded emitter transistor in Patent No. 2,659,773 (see *ED May, 1954, p. 72*).

In the circuit shown, the input signal (11) is applied to the collector electrode (4), operating on a negative bias of from 40 to 100v from the battery (5). The base electrode is common to the input and output circuits. The output is connected with the emitter (3), which works best on low-voltage bias with respect to the grounded base.

Fig. 6. A constant-output-voltage transistor circuit.

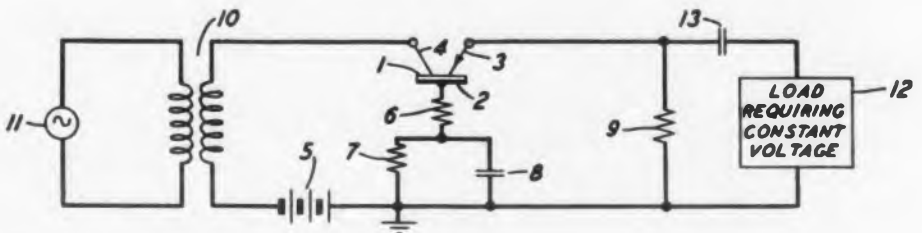

ALTIVAR

FOR HI-ALTITUDES

Constant cooling efficiency at high altitudes can now be realized with brushless induction motors of the ALTIVAR type, pioneered by ROTRON. Blowers and fans thus fitted will move 2 to 10 times more volume of cooling air at altitudes than at sea level.

Of the 240 different types of fans and blowers presently listed in ROTRON'S ring-binder catalog (sent free to potential customers on letterhead request) many are now listed with these new ALTIVAR motors, and many more are assembled to order.



ALTIVAR



HI-ALTITUDE NOMOGRAMS, just published by ROTRON, will assist you in solving intricate high-altitude cooling calculations. If you are not on our catalog mailing list, send us your letterhead request for a free copy.

* REGISTERED U. S. PAT. OFF.



ROTRON MANUFACTURING CO., INC.

7 SCHOONMAKER LANE

WOODSTOCK, N. Y.

CIRCLE ED-290 ON READER-SERVICE CARD FOR MORE INFORMATION

**"HOW SMALL
CAN YOU GET?"**

**. . . is a thought
our engineers
like to play with**



Since **WHEELER** has had long experience in manufacturing precision-controlled insulated magnet wire so fine you can barely see it, it is only natural that our engineering people have been working with miniature and sub-miniature coil and transformer units from the inception of miniaturization.

The important **NEW TINY-MITE** series of transformers is one result of this work. **Tiny-Mite Transformers**, with unusually excellent typical characteristics, are ideal for use in transistor and printed circuits, control, guided missile, and similar applications where space, weight, and size are prime factors.

Tiny-Mite Transformers are assembled with nickel alloy laminated cores, with fine wire coils wound on nylon bobbins. Windings are terminated with special care and technique to insure maximum protection to leads.

Tiny-Mite Transformers are varnish-treated and can be supplied open frame with 3" color coded leads, or in metal shells, hermetically sealed, and with #22 tinned leads soldered to header terminals to facilitate assembly.

Tiny-Mite Engineering Data Sheets are available on request to **Wheeler** — producers of fine gauge magnet wire, specialized coils, and transformers. Your own special needs can almost certainly be met by standard units in this new series, or by possible modifications. We will welcome your inquiry.

THE WHEELER INSULATED WIRE COMPANY, Inc.

Division of The Sperry Corporation
1131 East Aurora Street, Waterbury 20, Connecticut



WHEELER

WHEELER MAKES THESE PRODUCTS A *Specialty*

12WH54

CIRCLE ED-291 ON READER-SERVICE CARD FOR MORE INFORMATION



1 MFD. 2" x 2" x 1"



0.5 MFD. 1 1/4" x 1 1/4" x 1 1/2"



0.25 MFD. 1 1/4" x 1 1/4" x 7/8"



0.1 MFD. 1 1/4" x 1" x 7/8"



0.05 MFD. 1 1/4" x 7/8" x 1 1/16"

ULTRA-HIGH PRECISION POLYSTYRENE CAPACITORS

as low as 0.1%
tolerance in most values

CAPACITANCE AVAILABLE—0.05 to 10.0 MFD.
VOLTAGE AVAILABLE—100 to 400 VDC
INSULATION RESISTANCE—10⁹ MEG./MFD.
TEMP. COEFF.—100 P.P.M. per °C (—20° to 140°F)
DIELECTRIC ABSORB.—.015%
DISSIPATION—.0002

**Special Values to
Close Tolerances—Our Specialty**

Write for New, Complete Catalog to Dept. 1B

SOUTHERN ELECTRONICS CORP.

239 W. Orange Grove Avenue, Burbank, Calif.

CIRCLE ED-292 ON READER-SERVICE CARD FOR MORE INFORMATION

Finest CLOSELY-REGULATED PRECISION DC POWER SUPPLIES

HIGH VOLTAGE—HIGH CURRENT



Write for Technical Bulletin—Contains
Complete Engineering Specifications

Phone LOgan 8-4771

CIRCLE ED-293 ON READER-SERVICE CARD FOR MORE INFORMATION

CONTROL: Magnetic Amplifier.
OUTPUT: 6 to 500 VDC at 5 to 200
Amps. continuous.
RIPPLE: As low as 0.01% RMS.—or
to customer's specification.
REGULATION—Steady State. ±0.15%
no load to full load.
Dynamic. ±0.2% under ex-
treme load or line change.
PRECISE REGULATION. . . for Laboratory
or Production work.

Designed to meet the most exacting
requirements of the Electronics
industry, INET Precision Power
Supplies combine the long-life per-
formance of selenium rectifiers with
the rugged dependability of mag-
netic amplifier controls.

PROTECTED . . . Engineered for long,
trouble-free operation, Units are
fully protected against overloads
and static elements eliminate main-
tenance.

**COMPACT—Simple to Install and
Operate . . .**

Requires minimum space, housed in
steel cabinets with meters and con-
trols mounted for quick visibility
and operation. Available in wall,
floor-standing or caster mounted
models.



Division of
LEACH CORPORATION

4441 Santa Fe Avenue
Los Angeles 58,
California

Books . . .

Fundamentals of Transistors . . . By Leonard Krugman, 140 pages, paper bound. John F. Rider Publisher, Inc., 480 Canal St., New York 13, N.Y. \$2.70.

Although written for the technician and amateur, this volume makes a handy and concise introduction to transistors for any engineer approaching the subject for the first time. The basic physics of semiconductors are considered without delving into advanced physical and mathematical concepts.

Individual chapters are devoted to basic semiconductor physics, transistors and their operation, the grounded base transistor, grounded emitter and grounded collector transistors, transistor amplifiers, transistor oscillators, and transistor high-frequency and other applications. Each chapter is well illustrated with circuit diagrams and equivalent circuits.

The chapter on amplifiers includes sections on phase inverters, gain controls, cascade operation, and complementary-symmetry circuits. A discussion of printed circuit techniques as applied to transistors is included in the last chapter. A list of common transistor symbols is also given. The author is a member of the Signal Corps Engineering Laboratories.

Proceedings of a Conference on the Utilization of Scientific and Professional Manpower . . . 197 pages. Columbia University Press, New York 27, N. Y. \$3.50.

Management concerned with gaining greatest use of engineering personnel in an era of increasing shortages of engineers and with recruiting new engineers will find this book of interest. The individual engineer will find the discussion of his relationship to management most illuminating. The volume contains the proceedings of a Conference on the Utilization of Scientific and Professional Manpower. This conference of national, industrial, and other leaders was sponsored by the Na-

tional Manpower Council, which was established in 1951 under a Ford Foundation grant to provide a continuing appraisal of manpower problems.

The book is divided into three parts: Major Aspects of Utilization Problems; The Utilization of Engineering, Medical and Teaching Personnel; and Approaches to Improved Utilization. Engineering manpower problems are considered in about one-third of the middle and longest part.

The Conference raised many questions and answered few of them, but it approached them in a flexible and analytical manner that should appeal to engineers. Among these questions were: how to keep personnel in research and development by providing salaries and status to match those of sales and administrative posts, what sort of education for engineers, i.e., many specialties vs a broad, general, scientific background, and how to utilize and integrate technicians to support the efforts of research and development engineers.

Ten Founding Fathers of Electrical Science . . . By Bern Dibner, 48 pages. The Burndy Library, Norwalk, Conn. \$1.00.

Although the practicing electrical engineer need hardly know more than the latest theories, techniques and formulae to accomplish his task, a knowledge of the historical development of electrical science should bolster pride in profession and thereby make him a better engineer. This selection of short biographies of the great pioneers in the field is good historical reading which should also stimulate the engineer by its record of insight, perseverance, and courage.

Rare old woodcuts of contemporary portraits and actual original circuit diagrams are among the 21 illustrations of the work of Gilbert, de Guericke, Franklin, Volta, Ampere, Ohm, Gauss, Faraday, Henry, and Maxwell. This handsomely printed volume is recommended for the home libraries of all engineers.

Coil WI
125 pag
Palsaki
\$6.50.

Profu:
winding
ground f
coils. W
of coils,
methods
multi-lay
universa
An ap
glossary
industry
cals, an
ography
included

Standar
Paper l
dards A
York 17

This
ground
America
Proceed

Coil Winding . . . William Querfurth.
 125 pages. Geo. Stevens Mfg. Co., Inc.,
 Pulsaki Road at Peterson, Chicago 30, Ill.
 \$6.50.

Profusely illustrated, this book on coil winding will provide a valuable background for engineers who design or specify coils. Written primarily for the producer of coils, the book describes the four main methods of coil winding: single layer, multi-layer, universal, and progressive-universal.

An appendix is included with a valuable glossary of terms used in the coil-winding industry, tables of wire sizes and reciprocals, and coil winding formulae. A bibliography on coil design and winding is also included.

Standards in a Changing World . . .
 Paper bound, 72 pages, American Standards Association, 70 E. 45th Street, New York 17, N. Y. \$3.00.

This book provides an excellent background on the work and objectives of the American Standards Association. It is the Proceedings of the Fourth National Stan-

dardization Conference and the Thirty-fifth Annual Meeting of the ASA.

In addition to reprinting various addresses at the Conference, reports of panels on standards for purchasing, "Factors Involved in Organizing a Standards Department," and an "Industrial Noise Symposium" are also included.

American Standard Letter Symbols for Acoustics . . . Prepared by the Sectional Committee on Letter Symbols, American Society of Mechanical Engineers. 12 pages. 29 West 39th St., New York 18, N. Y. \$1.00.

Engineers, scientists, technicians, and all others engaged in acoustical measurements or the publication of articles on acoustics will find this compilation of letter symbols valuable. More than 100 symbols are listed, and an appendix listing the symbols in alphabetical order is also included in the booklet.

Prepared under the procedures of the American Standards Association, this work should promote the wide acceptance of these American standard symbols.



- SUB-MINIATURE
- ANTI-VIBRATION
- SUPER-RUGGED

WIDE SELECTION OF RELAY TYPES...

Sensitive from .010 watts. Hi temperature and temperature compensated. Fast operate or time delay. Frequency tuned (vibrating reed type).

Designed to meet or exceed
 MIL R 5757B

Vibration: Withstands to as high as 20 Gs to 1000 cycles per second. Temperature range: -65° to 200°C. Life: Into the millions of operations. Open or hermetically sealed. Optional plug-in or solder terminals. Variety of mounting arrangements. High contact current.

SEND FOR CATALOG AND ENGINEERING DATA

NEOMATIC INC.

9010 BELLANCA • LOS ANGELES 45, CALIF. • OREGON 83814

CIRCLE ED-295 ON READER-SERVICE CARD FOR MORE INFORMATION

DEPEND ON

DALOHM



Deposited Carbon Resistors

For

ACCURACY and STABILITY!

DC-1/4 —
1/4 Watt

*For Miniature Installations

Dalohm deposited carbon resistors are manufactured under rigid controls to deliver matchless performance and economy in any high-low resistance range.

Dalohm resistors are sealed against moisture with special silicone coating having high di-electric strength, excellent thermal conductivity, and high

resistance to abrasion.

From 1 Ohm to 200 Megohms, depending on type.

Temperature coefficient 200 PPM per degree C for lower resistance ranges up to 500 PPM per degree C for higher ranges.

1% accuracy. 2%, 5%, and 10% tolerances also available.

Write, Wire or Call

1328 28th Ave.

Phone 2139

DALE PRODUCTS, INC. Chicago, Illinois, U.S.A.

CIRCLE ED-296 ON READER-SERVICE CARD FOR MORE INFORMATION

LESS LEAKERS with NICORO BRAZING ALLOY



A Wesgo developed nickel bearing gold-copper alloy that possesses—

- ★ Improved wetting and flow characteristics
- ★ Greatly diminished tendency toward brittleness
- ★ Smaller grain size
- ★ Higher tensile strength

Vacuum tube manufacturers report a material reduction in number of leakers when conventional gold-copper alloys are replaced by Nicoro.

Write for circular on Nicoro and other Wesgo brazing alloys.

WESTERN GOLD & PLATINUM WORKS

589 Bryant

• San Francisco 7, Calif.

CIRCLE ED-297 ON READER-SERVICE CARD FOR MORE INFORMATION

1. Tubular Button Seals for rectifiers, condensers, filters and other components.
2. Crystal Holders—wire and pressure mounted.
3. Individual Terminals and Feed Throughs for relays, transformers, networks, and general applications.
4. Terminal Strips for transformers and general applications.
5. Stand-Off Terminals for chassis work.
6. Multi-Terminal Headers—all glass and individual bead design . . . for relays, networks, transformers.
7. Transistor and Diode Enclosures.
8. AN Connectors.
9. Rectangular Plugs and Connectors.
10. Polarized Plugs.
11. Refrigerator Seals.



HERMETIC SEAL PRODUCTS CO.

39 South Sixth St., Newark 7, N. J.

Engineering and design service to aid in selecting best possible glass-metal seals for every application as well as application engineering.

Hermetic SEAL

GLASS-METAL HEADERS For Every Electronic Use

The prime source for variety in size, configuration and shape—quality performance and thoroughly acceptable cost to you. Special terminals for any purpose. In VAC-TITE® Compression Seals as well as conventional lower designs.

VAC-TITE is HERMETIC's vacuum-proof, compression-constructed, glass to metal seal. In addition to special shapes, every standard glass seal at .300 O.D. and .500 O.D., multi-terminal headers and a large variety of individual terminals are available in VAC-TITE Compression Seal.

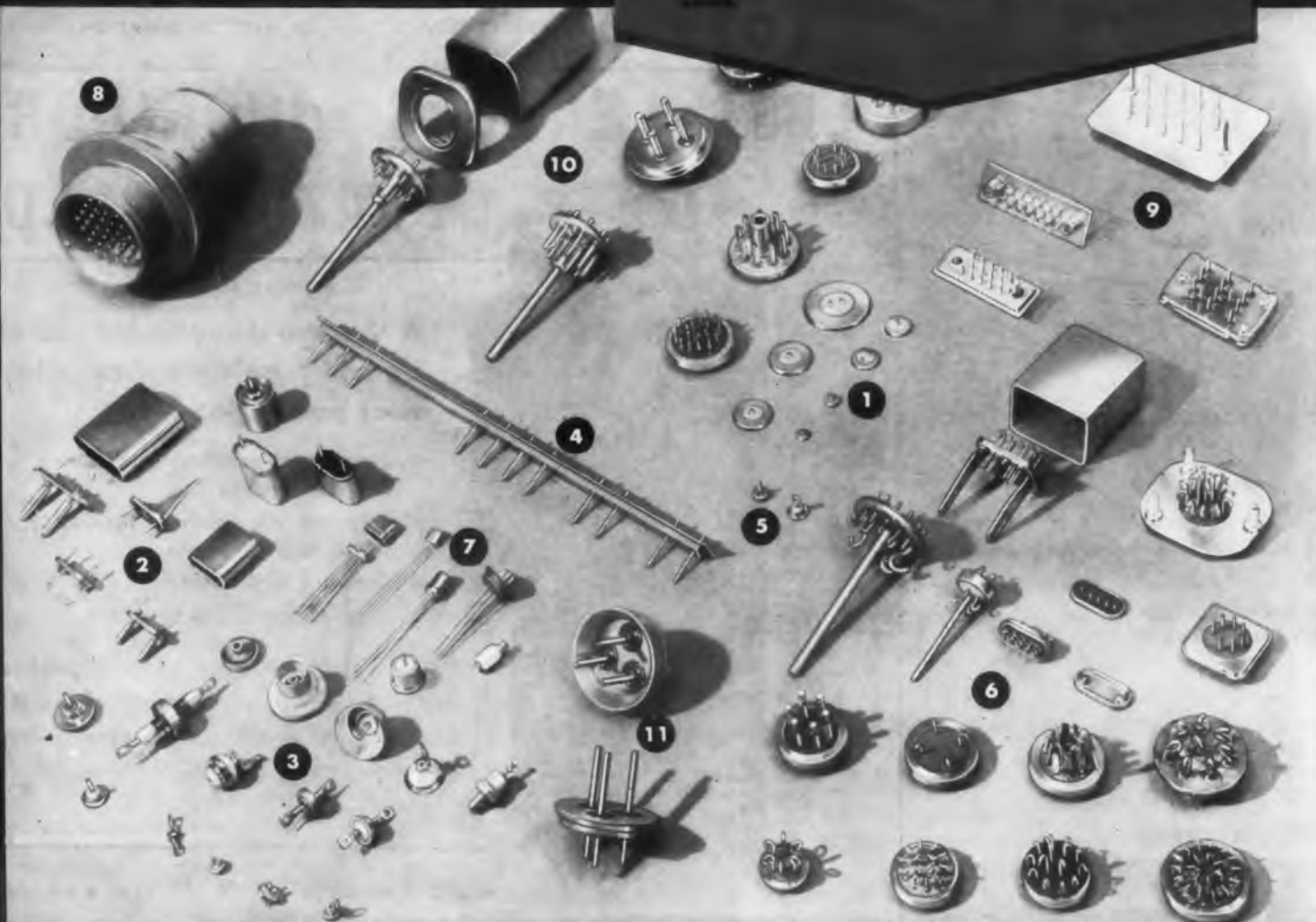

FIRST AND FOREMOST IN MINIATURIZATION

CIRCLE ED-298 ON READER-SERVICE CARD FOR MORE INFORMATION

Inquiry No.	Advertiser	Page
179	Ace Plastic Co.	65
27	Aircraft-Marine Products, Inc.	33
220	American Lava Corp.	61
28	American Relay & Controls, Inc.	34
273	Aremac Associates	70
202	Arga Div. of Beckman Instruments, Inc.	67
12	Arnold Engineering Co., The	15
124	Astron Corp.	55
75	Barry Corp., The	45
140	Bead Chain Mfg. Co., The	59
48	Berkeley Div. of Beckman Instruments, Inc.	38
113	Biddle, James G. Co.	52
156	Birtcher Corp., The	62
11	Bomac Laboratories, Inc.	9
59	Buggie, H. H., Inc.	42
74	Burdy Engineering Co.	45
95	Cambridge Thermionic Corp.	49
87	Cannon Electric Co.	47
15	Centralab, Div. of Globe Union Inc.	18
181	Chatham Electronics Corp.	66
13	Chicago Standard Transformer Corp.	16
80	Citation Products	46
51	Communication Accessories Co.	38
134	Continental-Diamond Fibre Co.	58
117	Cubic Corp.	63
70	Curtis Development & Mfg. Co.	45
296	Dale Products, Inc.	77
3	Daven, Co., The	4
139	Detectron Corp., The	58
14	Dow Corning Corp., The	17
107	Durant Mfg. Co.	51
26	Edison, Thomas A., Inc.	32
105	Elastic Stop Nut Corp. of America	50
94	Electric Regulator Corp.	49
132	Electrical Industries	57
92	Electrical Products Corp.	48
112	Electro Motive Mfg. Co., Inc.	52
93	Electro-Snap Switch & Mfg. Co.	49
77	Faber-Castell, A. W. Pencil Co., Inc.	46
71	Fairchild Camera & Instrument Corp.	45
24	Fairchild Camera & Instrument Corp.	30
19	Federal Telephone & Radio Co.	24
101	Fenwal Inc.	50
69	Fielden Instrument	44
121	Flexrock Co.	54
93	Ford Engineering Co.	48
160	Ford Instrument Co.	66
1	Freed Transformer Co., Inc.	2
47	Fusite Corp., The	37
104	G-M Laboratories, Inc.	50
56	G-V Controls, Inc.	42
288	Gee-Lar Mfg. Co.	74
25	General Electric Co., Apparatus Sales	31
159	General Electric Co., Apparatus Sales	53
9	General Electric Co., Electronics Div.	12
286	General Electric Co., Tube Dept.	73
76	General Radio Co.	46
44	Green Instrument Co., Inc.	37
278	Gries Reproducer Corp.	70
89	Haydon, The A. W., Co.	48

No.	Advertiser	Page
89	Harvey Hubbell, Inc.	74
81	Helipot Corp.	46
98	Hermetic Seal Products Co.	78
6	Hughes Aircraft Co.	10
	Hughes Research & Development Labs	63
65		
93	Lot, Div. of Leach Corp.	76
20	International Rectifier Corp.	26
99	International Resistance Co.	79
70		
25	Jeffries Transformer Co.	56
67	Johnson, E. F., Co.	39
15		
55		
16	Kearfott Co., Inc.	19
7	Kellogg, The M. W. Co.	10
45		
52	Kenyon Transformer Co., Inc.	39
59		
83	Kester Solder Co.	47
38		
22	Ketay Mfg. Corp.	28
52		
38	Koiled Kords, Inc.	36
62		
9		
205	Librascope, Inc.	68
42		
23	Lockheed Aircraft Corp., Missile Systems Div.	29
45		
63	Lockheed Aircraft Corp., Missile Systems Div.	43
49		
64	Magnetic Research Corp.	44
47		
42	Malco Tool & Mfg. Co.	36
88	Metron Instrument Co.	48
18		
41	Microdot, Div. of Felts Corp.	36
66		
82	Milwaukee Resistor Co.	47
16		
4	Moloney Electric Co.	7
46		
28	Mullenbach Electrical Mfg. Co.	56
38		
58		
83	NRK Mfg. & Engineering Co.	71
63		
116	National Semi-Conductor Products	40
45		
95	Neomatic, Inc.	77
77		
38	Phillips Control Corp.	58
4		
86	Pike, E. W., & Co.	47
58		
37	Plastic Capacitors, Inc.	35
17		
2	Potter Instrument Co., Inc.	3
51		
100	Radio Corp. of America, Tube Dept.	80
32		
5	Raytheon Mfg. Co.	8
50		
11	Resinite Corp., Div. of Precision Paper Tube	51
49		
99	Richardson Co., The	49
57		
290	Rotron Mfg. Co., Inc.	75
48		
44	Sangamo Electric Co.	60
52		
80	Shakeproof, Div. of Illinois Tool Works	65
49		
18	Shell Chemical Corp.	23
18		
Sigma Instruments, Inc.	54	
292	Southern Electronics Corp.	76
106		
Speer Carbon Co., Jeffers Electronics Div.	51	
30		
60	Standard Piezo Co.	43
24		
110	Star Stainless Screw Co.	51
50		
284	Sterling Engineering Co.	71
44		
43	Superior Electric Co., The	37
54		
65	Superior Tube Co.	44
48		
66		
61	Taylor Tubes, Inc.	64
2		
21	Technitrol Engineering Co.	27
37		
285	Tensolite Insulated Wire Co., Inc.	72
462		
Torwico Electronics, Inc.	64	
50		
43	Tung-Sol Electric, Inc.	59
42		
400	Uniform Tubes, Inc.	50
74		
68	Unimax Switch, Div. of The W. L. Maxson Corp.	44
31		
287	Universal Mfg. Co., Inc.	73
53		
206	Universal Mfg. Co., Inc.	68
12		
73		
35	Ward Leonard Electric Co.	58
46		
8	Western Gear Works	11
37		
97	Western Gold & Platinum Works	77
70		
91	Wheeler Insulated Wire Co., Inc., The	75
48		
53	Winchester Electronics, Inc.	62

NOW

3 new wire wound resistors

IRC's new power wire wounds are lower cost per watt than any other power type.

At 4, 7 and 10 watts, they offer savings of several cents each in any application requiring compact, low cost, efficient power resistors. Types PW-4, PW-7 and PW-10 resistors assure safe operation in circuits where stability and low wattage dissipation are needed.

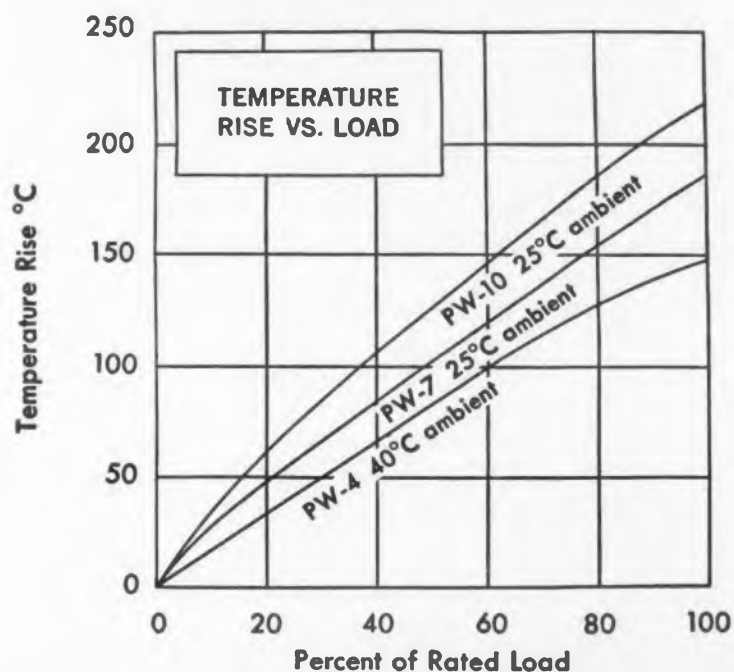

4 WATT

Type PW-4 allows safe operation with hot-spot temperatures up to 165°C. Fully insulated housing will not burn or support combustion.



7 WATT

Types PW-7 and PW-10 allow safe operation with hot-spot temperatures up to 275°C.



10 WATT

UNUSUAL DESIGN AND ASSEMBLY TECHNIQUE PROVIDES LOWER COST PER WATT.

SEND COUPON FOR DATA BULLETINS

Voltmeter Multipliers • Boron & Deposited Carbon Precistors • Insulated Composition Resistors • Power Resistors • Volume Controls • Low Wattage Wire Wounds •

Wherever the Circuit Says

Precision Wire Wounds • Ultra HF and Hi-Voltage Resistors • Selenium Rectifiers • Insulated Chokes • Hermetic Sealing Terminals •

INTERNATIONAL RESISTANCE CO.

Dept. D, 401 N. Broad Street, Philadelphia 8, Pa.

In Canada: International Resistance Co., Ltd., Toronto, Licensee

Please send Bulletin P-1 on PW-4 Resistors

Bulletin P-2 on PW-7 and PW-10 Resistors.

Name _____

Title _____

Company _____

Address _____

City _____ State _____

CIRCLE ED-299 ON READER-SERVICE CARD FOR MORE INFORMATION

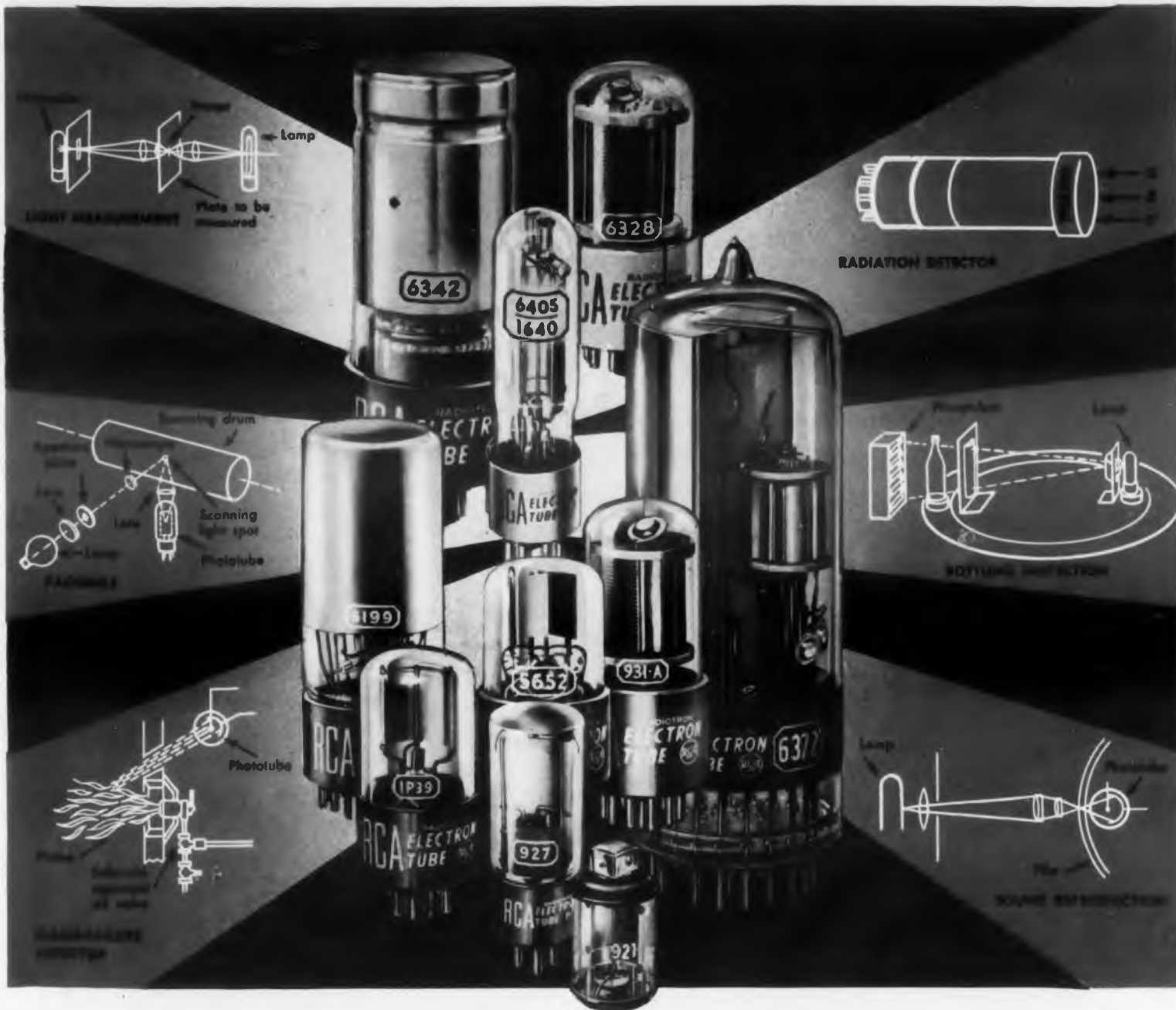

In photo-electronics ...it's RCA Phototubes for your needs

RCA—pre-eminent in the design and development of phototubes—offers a full line of high-quality phototubes to meet your needs in designing light-actuated devices. This line of phototubes includes a wide selection of gas types (for sound-on-film and relay work)—vacuum types (for high-speed work and precision measurements)—and multiplier types (for applications where extremely high sensitivity is important).

RCA phototubes are available in a variety of spectral responses, physical shapes, and sizes. For help on phototube equipment design problems—write RCA Commercial Engineering, Section G-18-Q, Harrison, N. J. Or call the RCA Field Office nearest you:

(EAST) Humboldt 5-3900
415 S. 5th St., Harrison, N. J.
(MIDWEST) Whitehall 4-2900
589 E. Illinois St., Chicago, Ill.
(WEST) Madison 9-3671
420 S. San Pedro St., Los Angeles, Cal.

Check your application—select your phototube	
Application	RCA Phototube Types
Sound Reproduction	IP40, 920, 927
Light and Color Measurements	IP21, IP22, IP28, IP29, IP39 917, 919, 926, 931-A, 935, 6217
Relay Applications	IP39, IP40, IP41, IP42, 917 919, 921, 922, 925, 931-A 6328, 6405/1640
Scintillation Counting	IP21, 931-A, 5819, 6199 6342, 6372
Facsimile	934, 5652

Visit the RCA Exhibit at the Western Electronic Show and Convention, Los Angeles—August 25-26-27



RADIO CORPORATION of AMERICA
ELECTRON TUBES
HARRISON, N. J.

CIRCLE ED-300 ON READER-SERVICE CARD FOR MORE INFORMATION

Postmaster: Form 3547 Requested

HAYDEN PUBLISHING COMPANY, INC.
127 East 5th Street, New York 22, N. Y.

ELECTRONIC
design