

ICD08635

POPULAR COMMUNICATIONS

DECEMBER 1991 \$2.95

\$3.95 CANADA

DX On The Crowded Broadcast Band

Also in this issue:

- **WWII Radio Propaganda**
- **The Secret World of Scanners**
- **We Review: The JRC NRD-535**
- **Special QSL's From HCJB!**



Plus: Car Phones, CB, Ham Radio & More

TAKE THE WORLD ON THE ROAD

WORLDWIDE RECEIVERS FROM ICOM

IC-R1 HANDHELD RECEIVER

The smallest wideband handheld available today, the IC-R1 continuously covers 100kHz-1300MHz with AM, FM and wide-band FM modes. This tiny receiver goes anywhere you go, measuring just 1.9"W x 4.0"H x 1.4"D.

Easy operation is a snap with the IC-R1's Dual Frequency Selection (direct keyboard and rotary tuning). 100 memories and a 24-hour clock complete the world's smallest full-featured handheld receiver.



IC-R100 MOBILE RECEIVER

Whether you're at home or in your car, the IC-R100 gives you continuous coverage from 100kHz-1856MHz in AM, FM and wide-band FM modes. Monitor VHF air and marine bands, emergency services, government and amateur stations. 121 fully programmable memory channels, multiple scanning systems and a built-in backup lithium battery.



IC-R72 BASE RECEIVER

The IC-R72 continuously receives 100kHz-30MHz in SSB, AM and CW modes with exceptionally high sensitivity. An optional U-E provides FM reception. The IC-R72 incorporates a noise blander, five scanning systems, internal backup battery and built-in clock with Icom's DDS System. The IC-R72 boasts a 100dB wide dynamic range while an easy to access keyboard provides convenient programming versatility... superb for shortwave listeners!



See our complete line of quality receivers at your local authorized ICOM dealer.

CORPORATE HEADQUARTERS:
ICOM America, Inc., 2380-116th Ave. N.E.
Bellevue, WA 98004
CUSTOMER SERVICE HOTLINE
(206) 454-7619
CUSTOMER SERVICE CENTERS:
18102 Skyhawk South, Suite 52-B
Irvine, CA 92714
1777 Phoenix Parkway, Suite 201
Atlanta, GA 30349
3071 - #5 Road, Unit 9
Richmond, B.C. V6X2T4 Canada
2380-116th Ave. N.E. Bellevue, WA 98004
All stated specifications are subject to change without notice (obligation). All ICOM radios significantly exceed FCC regulations limiting spurious emissions. R1991

For full details call the ICOM Brochure Hotline at 1-800-999-6877.



HAPPY HOLIDAYS from Electronic Equipment Bank

SONY ICF5W77



From the genius of Sony, the world's most advanced portable Receiver. Factory programmed, 100 of the most popular SWL stations which you can reprogram yourself.

- 15-30MHz AM/CW/SSB
 - 76-108MHz FM (Stereo)
 - Station Name Tuning
 - 160 Memory Pre-set
 - Synchronous Detection
 - Wide-Narrow Filters
 - Multi Function Scan
 - Multi Function Clock/Alarm
 - 120VAC Adapter Incl.
 - 10.8x6.8x1.8 in. Wt. 52oz.
- List \$624.95 **EEB \$499.00** - sh.

It's Time To Upgrade!

SONY ICF2010



Big Receiver performance in a portable, take with you package. Thousands of satisfied users make the ICF2010 Sony's Biggest Seller!

- 15-30MHz AM/CW/SSB
 - 76-108MHz FM Band
 - 116-136MHz Air Band
 - Synchronous Detection
 - 32 Program Memories
 - Direct Keyboard Entry
 - Multi Scan Functions
 - Multi Clock Functions
 - 4.5 VDC (3D) & (2) AA not incl.
 - 120VAC Adapter Incl.
 - 6.25x11.3x2.2 Wt 48 oz.
- List \$429.95 **EEB \$349.95** + sh.

A True Classic!

SONY ICF5W7600



This is our number one selling mid-sized portable. Explorers and travelers will love the versatility of the ICF SW7600.

- 15-30MHz AM/CW/SSB
 - 76-108MHz FM Band
 - 10 Station Memory
 - Full SW Coverage .1-30mhz
 - Dual Conversion
 - AN61 Antenna Incl.
 - Clock, Timer, Alarm
 - AM/SSB/FM/FM Stereo
 - Direct Keyboard Entry
 - Power (4) AA Not Incl. AC adptr. incl.
 - 7 1/4 x 4 3/4 x 1 1/4 wt. 22 oz.
- List \$399.95 **EEB \$219.95** + sh.

#1 Compact Portable!

SONY TCM38V



Turns your scanner into a logging receiver. Let the TCM38V run unattended. Play back later. You won't miss any action.

- Logging cassette recorder
 - CH1 audio. ch 2, time date
 - Records date, time & play back to LCD readout
 - Ideal for scanner monitorin
 - VOR voice audio auto start
 - Auto record level
 - Built in microphone or Ext.
 - Power (2) AA not incl.
 - Opt. AC adapter PA3N 13 \$9.95
 - 3 1/2 x 5 1/4 x 1 1/4 wt. 10 oz.
- List \$129.95 **EEB \$99.95** + sh.

NEW Innovative Recorder!

JRC NRD535D



The NRD515 then 525 now 535D. Each generation has introduced state-of-the-art features to satisfy the most discerning listener.

- 1-30MHz AM/CW/SSB/FM
 - New Exalted Carrier
 - New Selectable Sidaband (ESS)
 - Phase Lock Detection
 - Variable Bandwidth Control (BWC)
 - Tuning Steps 1Hz DDS (10Hz readout)
 - 100dB Dynamic Range
 - 200 station memory
 - RTTY Demod Option
 - 4 Filter Position 3 Supplied .1, 2.6kHz
 - 13x5x11 in. Wt. 20lbs.
- List \$1999 **EEB \$1599** + sh.

ICOM R71A



Setting World Standards! Versatile, Reliable, Rugged. Our Top Selling Desktop Receiver!

- 1-30MHz AM/CW/SSB Opt. FM
 - Pass Band Tuning
 - 100dB Dynamic Range
 - Filters 6 & 2.4kHz Opt. CW 500Hz
 - 120/240 VAC Opt. 12VDC
 - 32 Programmable memories
 - Dual VFO
 - Multi Scan Functions
 - IR. Remote Option
 - Computer Control Option
 - Many EEB Filters & other Options
 - 11.3x4.3x10.9 in. Wt. 16.5 lbs.
- List \$999 **EEB \$849.95** + sh.

DRAKE R8



Getting Rave Reviews From The Experts! EEB welcomes Drake back to the shortwave market. The R8 promises to be a big hit with the serious listeners.

- 1-30MHz AM/CW/SSB
 - VHF Opt. 35-55/108-174MHz
 - 100 Memory Channels
 - Synchronous Detection
 - 5 filters .5, 1.8, 2.3, 4, 6 kHz
 - All Mode AM, CW, SSB, RTTY, FM
 - Band Pass Tuning
 - RS232 Serial Interface
 - Dual Antenna Inputs
 - 13.2x13x5.25 in. Wt. 13lbs.
- EEB \$979.00** + sh.

FREE in U.S.A.
NEW 1992 CATALOG



- All New expanded SWL
- New Amateur Section
- Enlarged Scanner Section
- New Specialty Section
- Expanded Book Section

This is our largest catalog ever! If you received our 1991 catalog your on our mailing list. Watch for your copy! If you never received an EEB catalog call-write or FAX (703-938-6911) today! Our Catalog is free in U.S. \$1.00 in Canada/Mexico. All others are \$3.00.

POPULAR COMMUNICATIONS

DECEMBER 1991

VOLUME 10, NUMBER 4



24



52

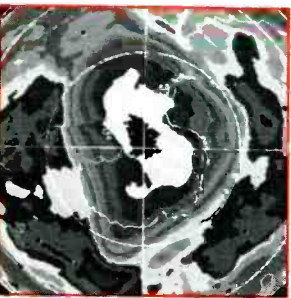

70



16

FEATURES

- Mediumwave DX'ing In The 1990's** 9
How To Hear Interesting DX On Today's Crowded Broadcast Band *By Karl D. Forth*
- The Secret World Of Scanners** 12
Drug Smugglers, Wireless Microphones, Military Surveillance, Foreign Governments—Hear Them Once You Know Where To Listen! *By Chuck Robertson*
- Psychological Warfare Broadcasts During WWII** 16
Did They Get Through? Were They Useful? Here's What A German Intelligence Officer Thought! *By Alice Brannigan*
- Books You'll Like** 21
Cyberpunks, Breaking The Codes Behind Toll-Free Numbers, and RTTY News *By R. L. Slattery*
- The Radio Animal: Still Hiking Up The Jolly Roger** 24
The Public Just Loves This Pirate, The FCC Doesn't *By Andrew Yoder*
- POP'COMM Reviews: The New JRC NRD-535 Communications Receiver** 29
By Pop'Comm Staff
- Build A DF Antenna** 32
A Simple Receiving Antenna With Directionality For HF *By Hank Olson, W6GXN*

COLUMNS

- CB Scene 34
You Should Know 38
How I Got Started 42
Emergency 43
RTTY 44
Ham Column 48
Clandestine Communique 51
Listening Post 52
Telephones Enroute 57
Pirates Den 59
Communications Confidential 60
Broadcast DXing 64
Washington Pulse 68
Satellite View 70
Scanning VHF/UHF 72

DEPARTMENTS

- Beaming In 4
Mailbag 6
New Products 30
Worldband Tuning Tips 40
Communications Shop 77

This month's cover: Transmitter engineer Everett Lawson at the base of Nashville, TN WSM 150-ton antenna. Photo by Larry Mulvehill.

EDITORIAL STAFF

Tom Kneitel, K2AES/KNY2AB, Editor
Jeanine M. O'Connor, Associate Editor

CONTRIBUTING EDITORS

Gerry L. Dexter, Shortwave Broadcast
Robert Margolis, RTTY Monitoring
Gordon West, WB6NOA, Emergency
Don Schimmel, Utility Communications
Edward Teach, Alternative Radio
Harold A. Ort, Jr., Military Consultant
Janice Lee, Radar Detectors
Chuck Gysi, N2DUP, Scanners
Roger Sterckx, AM/FM Broadcasts
Harry Helms, AA6FW, Thoughts and Ideas
Donald Dickerson, N9CUE, Satellites
Kirk Kleinschmidt, NT0Z, Amateur Radio

BUSINESS STAFF

Richard A. Ross, K2MGA, Publisher
Donald R. Allen, N9ALK, Advertising Mgr.
Emily Kreutz, Sales Assistant
Dorothy Kehrwieler, General Manager
Frank V. Fuzia, Controller
Catherine Ross, Circulation Director
Melissa Kehrwieler, Data Processing
Carol Minervini, Data Processing
Denise Pyne, Customer Service

PRODUCTION STAFF

Elizabeth Ryan, Art Director
Barbara Terzo, Assistant Art Director
Susan Reale, Artist
Dorothy Kehrwieler, Production Manager
Emily Kreutz, Production
Pat Le Blanc, Phototypographer
Florence V. Martin, Phototypographer
Hal Keith, Technical Illustrator
Larry Mulvehill, WB2ZPI, Photographer

A publication of

 CQ Communications, Inc.
76 North Broadway
Hicksville, NY 11801-2953 USA.

Offices: 76 North Broadway, Hicksville, NY 11801. Telephone 516 681-2922. FAX (516) 681-2926. Popular Communications (ISSN 0733-3315) is published monthly by CQ Communications, Inc. Second class postage paid at Hicksville, NY and additional offices. Subscription prices: Domestic—one year \$19.95, two years \$38.00, three years \$57.00. Canada/Mexico—one year \$22.00, two years \$42.00, three years \$63.00. Foreign—one year \$24.00, two years \$46.00, three years \$69.00. Foreign Air Mail—one year \$77.00, two years \$152.00, three years \$228.00.

U.S. Government Agencies: Subscriptions to Popular Communications are available to agencies of the United States government, including military services, only on a cash with order basis. Requests for quotations, bids, contracts, etc. will be refused and will not be returned or processed.

Entire contents copyright ©1991 by CQ Communications, Inc. Popular Communications assumes no responsibility for unsolicited manuscripts, photographs, or drawings. Allow six weeks for change of address or delivery of first issue. Printed in the United States of America.

Postmaster: Please send change of address to Popular Communications, 76 North Broadway, Hicksville, NY 11801.

UNIVERSAL SHORTWAVE

Monitor More With Advanced Equipment From Universal!

COMMUNICATIONS RECEIVERS

Japan Radio NRD-535D



Triple conversion power with ECSS, Bandwidth Control and 3 filters included. The new standard in HF receivers. **Under \$1600... CALL**

Japan Radio NRD-525

Affordable high-end performance and features. In stock. \$1129.95 (+\$12 UPS)

Drake R-8

A state-of-the-art receiver for the 90's. Five bandwidths, Syncro., etc **Under \$1000... CALL**

Kenwood R-5000

A powerful receiver for the serious DXer. An exceptional value. \$899.95 (+\$11 UPS)

Kenwood R-2000

Many features: mems., scan, sweep, FM mode, 24 hr. clock etc. \$649.95 (+\$10 UPS)

PORTABLE RECEIVERS

Panasonic RFB-45



Keypad, 18 memories, scan and search functions, S.S.B., fine tuning knob, clock-timer, S-METER, etc. \$169.95 (+\$5 UPS)

Sony ICF-2010

Super high performance and features. VHF air too. \$359.95 (+\$5 UPS)

Magnavox AE3805BK

A digital radio at an analog price. Covers 3.2-7.3 & 9.5-21.7MHz \$99.95 (+\$4 UPS)

Grundig Satellit 500

Hi-tech with beautiful fidelity and style. Synchronous tuning. \$539.95 (+\$5 UPS)

Note: Radios listed above are all LW-MW-SW-FM digital. Contact us for other models

SPECIAL RECEIVERS

Icom R-9000



Solid all-mode coverage from .1 to 1999.8 MHz. Multi-function CRT with spectrum analyzer. The ultimate receiver! **CALL FOR PRICE.**

SHORTWAVE ANTENNAS

Alpha Delta DX-SWL Sloper

MW +120-13 meter bands (60')..... \$67.95+\$4

Alpha Delta DX-SWL Sloper-Short

90-13 meter bands (40')..... \$57.95+\$4

Eavesdropper Specify twin lead or coax type 9 SW bands (60-10 meters)..... \$74.95+\$4

McKay Dymek DA100D Active Antenna

The Cadillac of active antennas! .. \$179.95+\$4

B&W ASW-90 Full Coverage Dipole

Covers 3.5-30 MHz solid! SO239 .. \$89.95+\$4

Note: Many more antennas available. See catalog.

MULTI-MODE CONVERTERS

Universal M-7000



The Universal M-7000 will permit you to intercept and decode Morse code, various forms of RTTY, FDM and FAX. Simple connections to your receiver and video monitor will enable you to monitor with the most sophisticated surveillance decoder available. No computer is required. **See** the world of shortwave excitement you have been missing. Requires 115/230 AC 50/60 Hz. With video fax and real time clock only \$1159.00 **Please write for full details.**

- ◆ Morse Code (CW)
- ◆ Regular Baudot RTTY
- ◆ Bit Inverted & Var. Baudot
- ◆ ASCII Low & High Speed
- ◆ Sitor Mode A & B
- ◆ ARQ-M2 & M4 (TDM)
- ◆ ARQ-E and ARQ-E3
- ◆ FEC-A and FEC-S
- ◆ SWED-ARQ and ARQ-S
- ◆ VFT Modes (TDM)
- ◆ Russian 3rd Shift Cyrillic
- ◆ Facsimile (FAX) AM/FM
- ◆ Packet 300 & 1200 AX.25
- ◆ Remote Terminal
- ◆ Literal & Databit Modes
- ◆ Variable & Standard Shift
- ◆ Automatic Tuning
- ◆ Diversity Reception

MULTI-MODE CONVERTERS

Universal M-900



Here is a compact, easy to use decoder that copies all the most important shortwave transmission modes. The M-900 covers Morse code for monitoring hams, ships and coastal stations. Baudot RTTY is included for decoding weather and international press broadcasts. Both Sitor A and Sitor B are supported for monitoring the extensive maritime and diplomatic traffic. Facsimile (to the printer only) lets you receive maps and pictures from around the world. Requires 12 VDC @.8A Text output to video monitor. \$499.95 (+\$8)

- ◆ Morse Code (CW)
- ◆ Regular Baudot RTTY
- ◆ Sitor Mode A (ARQ)
- ◆ Sitor Mode B (FEC)
- ◆ FEC-A
- ◆ Facsimile (FAX) FM
- ◆ Variable & Standard Shift

M-900 System Components

A complete M-900 system would require:

- ▶ Universal M-900
 - ▶ 12 VDC Power Supply
 - ▶ Your SW Receiver
 - ▶ Video Monitor
 - ▶ Parallel Printer
 - ▶ Cables for above
- Please write to Universal for full information on the M-900 and the above optional items.

COMMUNICATIONS BOOKS

Passport To Worldband Radio

By L. Magne. Graphic presentation of all SWBC stations. Equipment reviews too. \$16.95 \$13.90

Shortwave Receivers Past & Present

By F. Osterman. Your guide to 200 receivers with new-used value, specs, features. \$8.95

Aeronautical Communications Handbook

By R. Evans. A mammoth book on all aspects of shortwave aero listening. 266 pages. ... \$19.95

Complete SWL's Handbook Third Edition

By Bennett, Helms, Hardy. Nearly 300 pages on all aspects of SWL'ing. \$16.95

Guide To Utility Stations

By J. Klingenfuss. The definitive guide to utility stations- CW, SSB, FAX and RTTY. \$33.95

Easy-Up Antennas for Listeners & Hams

By E. Noll. Low cost, easy to erect antennas for LW, MW, FM, SW, SCAN and HAM. ... \$16.95 \$13.90

World Radio TV Handbook

All SWBC stations by country with schedules, addresses, power, etc. Reviews too. ... \$19.95

✓ Please add \$1 per title for shipping.

COMMUNICATIONS CATALOG

Universal now offers a new combined communications catalog covering shortwave, amateur and scanner equipment. There is also an unbeatable selection of antennas, books, parts and accessories. This huge 92 page (8 1/2" by 11") publication covers everything for the radio enthusiast. With prices, photos and full descriptions.

Available **FREE** by fourth class mail or \$1.00 by first class mail.

STORE HOURS

Monday - Friday 10:00-5:30
 Except Thursday 10:00-8:00
 Saturday 10:00-3:00

• We ship worldwide • In business since 1942!
 • Visa, MC, Discover • Used equip. list available
 • Prices & specs. are subject to change.

Universal Radio

1280 Aida Drive Dept. PC
 Reynoldsburg, Ohio 43068 U.S.A.
 Ohio: 614 866-4267 Toll Free: 800 431-3939

**AUSTIN AMATEUR
RADIO SUPPLY**

Friendly Service
Texas Style!

1-800-423-2604



**Order
Now!**

SONY



ICF-SW77 • ICF-2010



ICF-SW7600



**The
World
In
Your
Pocket!**

ICOM



IC-R1



IC-R100

**Bring
The
World
To
Your
Car!**

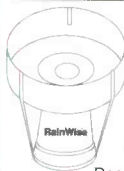

**RainWise
Remote Reading
Rain Gauge!
1/100" Read Out**

MSP \$79.95 **\$ 69.95**

Requires Two 9V Batteries-Not Included

**Super Store
Pricing!**

**AUSTIN AMATEUR
RADIO SUPPLY**

5325 North I-35
Austin, Texas 78723
512-454-2994

1-800-423-2604

At Long Last, My Time Of The Year To Shine

The last time I heard from G.L., a neighbor who lives down the road, was this past June when he and the dog warden brought home Fuzzyface, my large, shaggy mixed breed mutt. I remember it was the day we gave Fuzzyface his annual scrub down. We had let him out so he could run around to dry off. A half hour later, the dog catcher showed up to say that G.L. summoned him to complain that Fuzzyface hadn't wasted any time in making a beeline for his place to convince Mademoiselle Yvette, his prize show poodle, to embark upon a life of sin, shame and degradation.

My cousin Woody hasn't been seen since he showed up one day last summer to borrow my set of socket wrenches. The loan was supposed to have been for only a day or two. Woody is one sandwich short of being a complete picnic. When the Dept. of Motor Vehicles sent out organ donor cards, without hesitation Woody generously signed up to offer the carburetor, transmission, and engine block.

I never refuse Woody because he's so good natured. He works at a nearby airport as the baggage manager there for an airline. When I told him I was taking his airline on a combo DX'pedition and vacation, he insisted on personally attending to my radio gear and luggage. Meaning well, he was thoughtful enough to promptly dispatch all of my stuff to a deluxe tourist paradise far more expensive than the remote place I went.

But Christmas is upon us. That means G.L. and Woody, and many others, will be seeking an audience with me very soon. Guaranteed. There's no escaping it. As the sun grows dimmer and reaches its weakest point at the winter solstice, I'll be riding the crest of my yearly popularity.

It's because of VCR's, CD players, CB radios, FAX machines, fancy stereos, answering machines, home security systems, cordless phones, room monitors, cellulars, satellite TV systems, three-band radar detectors, deluxe scanners, world band radios, pocket computers, and other electronics gifts people so often receive or give themselves for the holidays. Nobody wants to take the time to plow through an owner's manual to learn how to program or operate them. It's easier just to ask someone else to explain it all.

I'm the only one with a ham ticket that my friends, neighbors, and relatives know. In their minds, this definitely qualifies me as

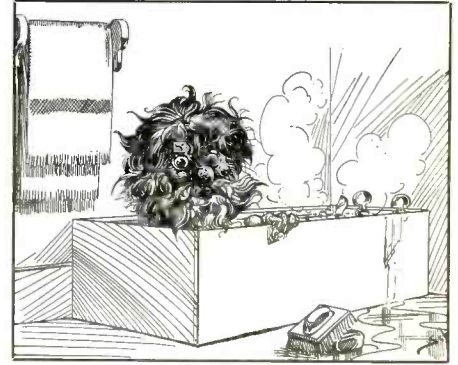

"It was the day we gave Fuzzyface his annual scrub down."



"To the delight of all, myself included, I sat there holding court . . . there was no end to the useful information I had available to dispense to the befuddled masses."

someone who can glance at any piece of electronics equipment and give them the lowdown, including a complete course of instructions in every aspect of its use. Moreover, they are certain that I can easily analyze every malfunction just from hearing their vague description, then instantly correct the problem with a few pencil taps at the right spot on the cabinet. I have always encouraged these gross misconceptions.

OK, I can bluff and wing it through the operation of any kind of radio gear. This is because of the fortunate combination of instinct and many years of experience, and most especially plenty of dumb luck. But, without going over the instruction manuals, all other modern high tech consumer products are as baffling to me as they are to

(Continued on page 50)

Now, You Can Eavesdrop On The World. Introducing the new Drake R8 Communications Receiver. It's world class, world band radio, made in the U.S.A. From Perth to the Persian Gulf, Moscow to Mozambique, local or global, you hear events *as they happen* with amazing clarity. Since 1943, Drake



has been setting the standards in electronic communications . . . and then raising them. Today, there's no better shortwave receiver than the Drake R8. **Out-Of-This-World Performance.** The new Drake R8 has more standard features than other shortwave radios. You get wide frequency range (100 KHz to 30,000 KHz), coverage of all world and local bands, and excellent dynamic range. But you also get important features you won't find on receivers costing hundreds of dollars more. A multi-voltage power supply. Pre-amp and attenuator. Five bandwidth filters and synchronous detector. Dual mode noise blanker and passband offset. Non-volatile 100 channel memory. All designed to give you the best reception with the least distortion. **Down-To-Earth Design.** The ergonomic design of the R8 gives you real ease of operation. You have convenient keypad entry, with large, legible controls. The face is bold. Uncluttered. And the liquid crystal display (LCD) is backlighted for easy reading. **Try The R8 . . . At Our Risk.** If you're not impressed by Drake's quality, performance and ease of operation, return the R8 Receiver within 15 days and we'll refund your money in full, less our original shipping charge. For more information, or to order, call **TOLL-FREE, 1-800-9-DRAKE-8**. Telephone orders may be placed on a major credit card. \$979.00 (Shipping and handling \$10 in continental U.S. Ohio residents add 6½% tax.) Call **TOLL-FREE, 1-800-9-DRAKE-8** today. You can't lose.

DRAKE

In touch with the world.

R.L. Drake Company • P.O. Box 3006 • Miamisburg, Ohio 45342 U.S.A.

CIRCLE 50 ON READER SERVICE CARD

MAILBAG

LETTERS TO THE EDITOR

Better Late . . .

In the August issue, one of your readers was complaining that he had no response from BBC Monitoring when he wrote to us for a sample copy of World Broadcasting Information. You replied that you had also written and been equally unsuccessful. I am

writing to you and your readers to apologize personally for this treatment. We received hundreds of inquiries from people who have seen our advertisements and as a general rule we try to fulfill their requests within two weeks. However, due to staff shortages a backlog of requests had built up at the end

of last year. Unfortunately to compound the problem the Gulf War then started and my department was flooded with visits from journalists from the world's media reporting on and filming the operation at Caversham. Our heightened profile due to the war also meant that even more people knew of our existence and wrote in for information, but during this time all routine work had to be put into abeyance including requests for WBI and other services. We have been trying ever since to clear the backlog of about 400 requests, starting with the oldest first. We are now employing staff to work specifically on sending out sample copies to our expanding market.

Kate Morgan,
Marketing and Sales Manager,
BBC Monitoring,
Subscriptions Office,
Caversham Park,
Reading RG4 8TZ, England

ALPHA DELTA antennas provide world-class reception solutions for our world-wide customers—and here are some of their comments

Murray Ferguson
Owairaka
Auckland
New Zealand

November 10, 1990

Dear Sir,

This is just a short letter, to let you know how pleased I am with my new Alpha Delta (DX-SLOPER 60ft) which I have just received; I bought the antenna from Gilfer Shortwave, 52 Park Avenue, Park Ridge, NJ 07656, USA. They were very helpful to me.

I have put the antenna up, according to the instructions, I was able to get to 20ft without any problems.

The receiver I have, is a JRC NRD-525, and the antenna I had was an active antenna, and the bands it covers are 49, 41, 31, 25, 19, 13 meters, but it does not even come close to the performance of the Alpha Delta Sloper; Frequencies that were very weak or barely readable, in the past, are now loud and clear, and have a very good signal strength, and also the down lead, takes away all of back ground hum, which has always been a problem in the past.

Very sincerely yours,

Murray Ferguson

L.A. Locklear
Gulfport, MS 39501

December 21, 1990

Dear Sirs,

I recently purchased a "DX-EE" antenna from Universal Radio after seeing an advertisement in Popular Communications.

As a long time SWL and DX enthusiast all I can say is WOW!

I've tried them all over the years—nothing I've tried compares to the DX-EE. I have the DX-EE running North and South with an NRD-525 and FRG-8800 with unreal results. Your antenna, the DX-EE is the quietest dipole I've ever used.

Kudos on the DX-EE! Sales should pick up on this one as I have praised it time and again to fellow SWL'ers.

Sincerely,

L.A. Locklear

Alpha Delta Model DX-SWL International Broadcast Band Sloper
(AM BDCST thru 13 mtrs-60 ft. long) **\$69.95**

Alpha Delta Model DX-EE General Coverage "Utility" Dipole
(5 thru 30 MHz-40 ft. long) **\$89.95**

At your Alpha Delta dealer or add \$5.00 for direct U.S. orders-exports quoted.



ALPHA DELTA COMMUNICATIONS, INC.

P.O. Box 51117, Phoenix, AZ 85076 • (602) 966-2200



CIRCLE 179 ON READER SERVICE CARD

The explanation is appreciated, and the excellent WBI was well worth waiting for! WBI is a weekly publication (about 20 pages) containing late information regarding the world's legit and clandestine broadcast (AM/FM/SW/TV) activities (frequencies, skeds, and stations), satellite broadcasting, and news agencies. It contains data compiled from foreign broadcast sources, foreign press items, and actual monitoring by the BBC. Its price is 350 Pounds Sterling per year, plus 20 Pounds Sterling airmail postage. Based on the present exchange rate of 1 Pound Sterling equaling US \$1.6845, in Yankee greenstamps that roughly equals \$590, plus \$33 postage. Because of its price, its primary appeal is to professional users, such as the news services, governmental agencies, publications, broadcasters, equipment manufacturers, broadcast engineers, and commercial monitoring activities. There are, however, advanced DX'ers who can find \$12 per week in their budgets to save up for the annual subscription tab. — Editor.

The BBC Monitoring Service's WBI is a good publication, but that price of 350 Pounds Sterling! When I received my sample copy and read that price, I thought it was a typo, but it's not! I guess it's safe to assume that the information is not geared toward the hobbyist. For the \$623 cost of a year's subscription to WBI, I can put a down payment on a Drake R8 or Kenwood R-5000. Or I could subscribe to POP'COMM for 31 years!

William Schmitz,
Washington, DC

ALL BAND RECEIVERS

FEATURES:

- Frequency range of 25 to 999.995 MHz
- Frequency & Mode selected via Front panel or Remote control.
- Wireless infrared remote control.
- 200 channel memory (20 channel x 10 groups).
- Scanning speed up to 35 channels per second.
- Programmable indicators & alerts include, Priority, Alarm & ON/OFF timer.
- Multi-color display for viewing ease.
- Specifically designed for Vehicular usage & mounting.

For more information
call 1-800-627-4722



SHINWA Tsushiniki Co., Ltd
12-2 Hamadayama 4-Chrome
Suginamiku Tokyo, Japan
TEL (03) 3313-1211
FAX (03) 3313-1218
TELEX: J27432 Sinwacom

**SHINWA Communications
of America Inc.**
TEL 1-800-627-4722

**SHINWA Communications
of Canada Inc.**
TEL 1-604-876-0006

**SHINWA Communications
of Latin America Inc.**
TEL 919-846-7751

SHINWA Europe AB
TEL +46 (08) 643-7510

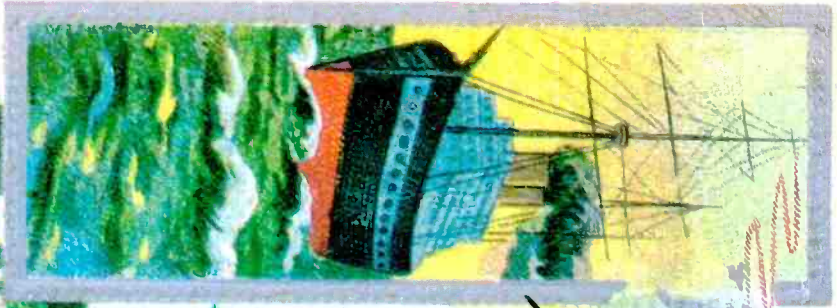

Merry Christmas to All

Debbie Miller

Dave

Allen



Tom Kneller

Virginia C. Smith

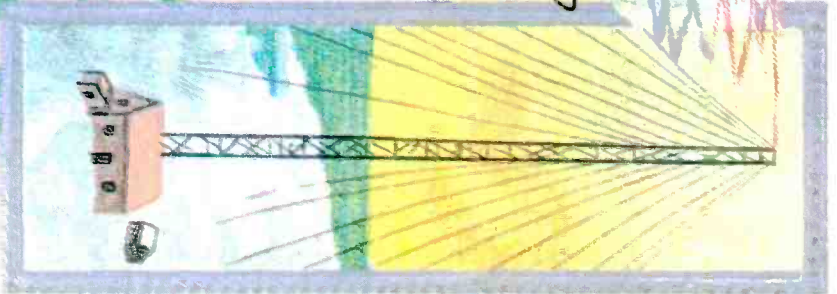

William Brown
Drill base
Kip Pugh
Ed Keenan

Barbara Terry
Marianne Krumhardt

Pat deBlasio
Garry Gandy
Linda Romanello

Joe Fale
Helen Mett

Mediumwave DX'ing In The 1990's

How To Hear Interesting DX On Today's Crowded Broadcast Band

BY KARL D. FORTH

When the medium of AM radio was new in the 1920's, everyone who had a radio was a DX'er. Everyone was interested in the new medium and what it had to offer. In 1991, those familiar frequencies between 540 and 1600 kHz may seem a little outdated when compared to microwave communications and sophisticated satellite systems; but there are still interesting programs to hear and interesting DX to try for.

The radio enthusiast interested in amateur radio or military communications may be surprised to learn that the old mediumwave band is changing. Many new stations are on the air, especially on what used to be the clear channels. Many daytime-only stations have received fulltime licenses, or switched frequencies in order to receive fulltime authorization. Other stations, due to changes in AM radio economics, have left the air. All this means new challenges in DX'ing the AM band.

Why listen to mediumwave in the first place? Talk shows on AM stations cover everything from sports to finance. Most major cities have an all-news outlet that is the best source for breaking news. The play-by-play of your favorite team is probably heard on AM. You can also hear unusual, offbeat programming from stations all over the country. For example, I recall recently tuning to a broadcast of live folk music from a small AM station in the state of Virginia. I could almost picture the band members gathered around a single large microphone.

How can a listener take advantage of changes in the band to hear new and interesting stations?

There are dozens of new stations on such clear channel frequencies as 820, 890, 1120, 1160, and 1200 kHz. Twenty years ago, there was a single station on 1200 kHz, 50,000-watt WOAI in San Antonio, Texas. Once you've heard WOAI, you have logged all of the stations in North America on 1200. The 1991 edition of the *NRC AM Radio Log* shows more than 30 domestic (United States and Canada) stations on the frequency. A number of these new stations, especially from the mid-1980's on, were heard here in Chicago, from such locations as Framingham, Massachusetts, New Castle,

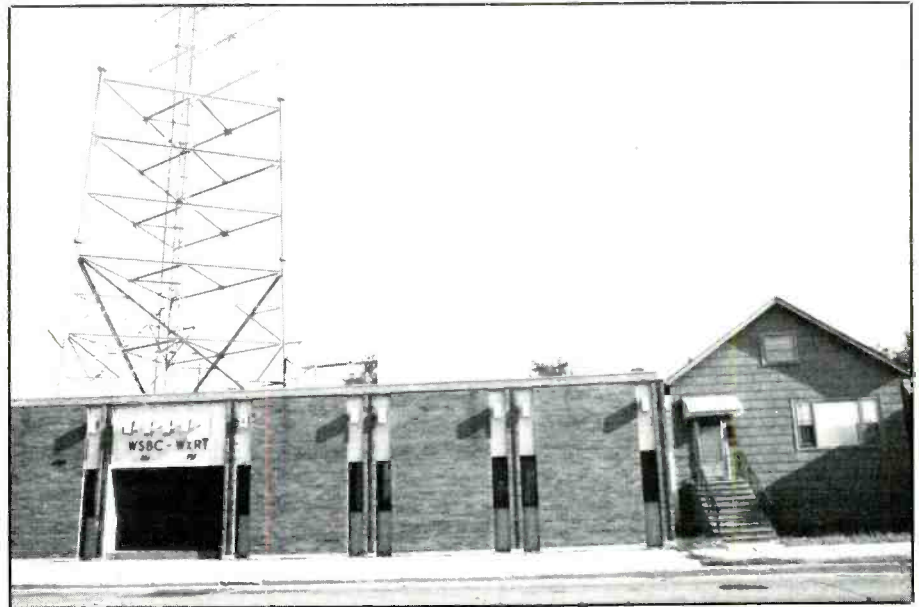

A close-up look at the WSBC-1240 studios and transmitter on Chicago's Northwest Side. Do you think the chap in the house at the right is a DX'er?

Pennsylvania, and Bolivar, Missouri. Everything was fine until the next new station, WOPA, came on the air from right here in Chicago! Now we don't hear San Antonio or anything else. You can see how this is both good and bad for DX'ing.

In addition to new AM stations to hear, the changes in the mediumwave band have also resulted in some states becoming easier to log. Wyoming, for example, is now easier to hear with KUUY-650 from Orchard Valley and KUYO-830 in Evansville. KATL-770 in Miles City has made Montana an easier log for many listeners, and WKZN-870 (now WLAM) from Gorham, Maine, made that difficult-to-hear state a bit easier to log. Sunset, sunrise and the evening hours are all good times to receive many of the new stations on the clear channel frequencies.

On the regional and local channels, the increasing number of stations and transmitter power they use have led to greater congestion which made it more difficult to hear distant stations. On the regional frequencies, many daytime-only stations have been granted low-power "post-sunset" authori-

ties. At first glance, this just adds to the congestion, but like the new stations on the clear channels, this arrangement presents some interesting opportunities.

Many stations were assigned such low post-sunset powers that they don't use them. Others use the new authority for special events. What's a special event in a place like Covington, Georgia? High school football, that's what. Try tuning in to the regional channels on Friday nights this fall and chances are you will hear stations from some unusual locations broadcasting their local high school team in action. Basketball games, track meets, etc. are also subjects for broadcasts, but Friday night football seems especially popular. It's a good opportunity to do some interesting DX'ing.

With more and more stations operating on 24-hour, 7-day-a-week schedules, when you do spot a station off the air it's best to take advantage of it. (Instead of going off the air weekly, fulltime stations may only sign off once or twice a year for maintenance.) Spend as much time as you can on the frequency that your regular dominant

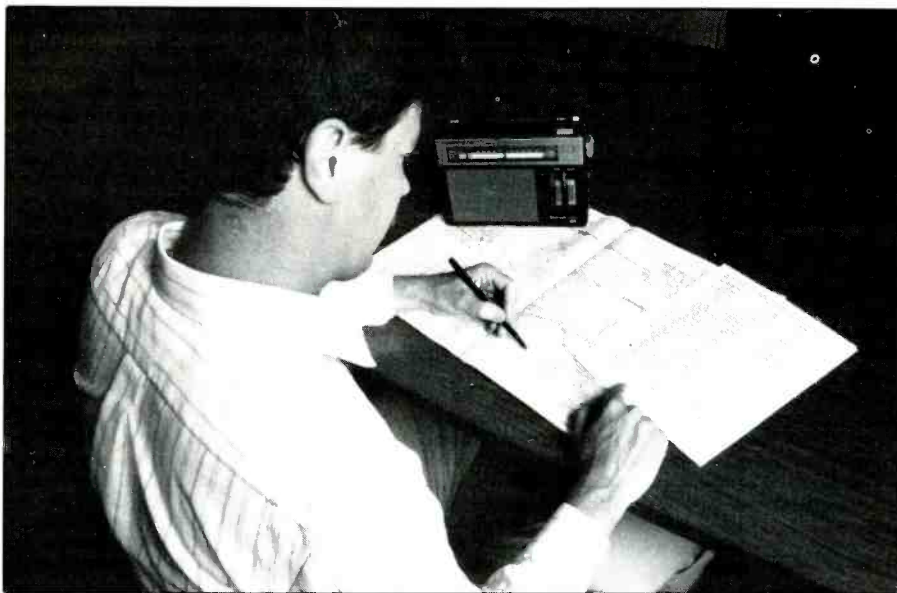

Determining targets with a page from the NRC AM Radio Log and a road atlas. Such homework can dramatically increase the mediumwave DX you hear.

station has left vacant, and on adjacent frequencies if the station off the air is a strong local.

If you don't know when the next silent period of a local station will be, why not ask them? That sounds strange, but they may have a scheduled silent period that they can notify you about (and you in turn can let other DX'ers know about it). If the chief engineer knows only a few days in advance, perhaps you can request that he mail you a postcard that you've provided. Obviously, you're going to have better luck contacting the right person at a local small-town station than you are with WCBS in New York, but it's worth a shot.

There's another type of silent period that's a little more permanent. That's when a radio station goes out of business and off the air. This used to be a rare occurrence, but now happens frequently, all over the country, in large and small cities.

Here in Chicago, one of the largest radio

markets in the United States, WPNT-820 left the air in January when its owner decided to concentrate on its FM outlet. Alert DX'ers not only heard a number of new stations on 820, but also some stations that had come on the air recently on 830 kHz.

In other cities, two stations have swapped frequencies or one station has taken over the facilities of a second that has gone off the air. When this happens, a frequency may be vacant for a few days, providing a rare "window of opportunity" to DX that channel with the local station absent.

Frequency and call letter changes are making station identification more difficult because it's harder to keep an up-to-date station log. It's also tougher to just sit on a frequency and wait for an identification, in part because of the proliferation of network programming such as Talknet. The network announcers mention the call letters of other stations on the network, so don't misidentify the station you are actually tuned to.

With crowded band conditions, it's more important than ever to recognize unusual propagation and act on it. It's equally important to know which frequencies can indicate good conditions. Some frequencies will have a strong local or nothing more than a jumble of weak signals. Others will produce different stations under different conditions. These frequencies deserve special attention, and should be checked first when beginning a DX session.

You'll notice conditions changing from day-to-day. Some days will offer very "live" conditions on mediumwave, other days will be relatively quiet. It's difficult, if not impossible, to predict when conditions will be "good" or "bad." One exception is when unusual solar activity triggers an aurora borealis. A strong aurora can often absorb signals from the north, leaving stations from the south in the clear. It's a phenomenon that's worth watching for, even with today's crowded band conditions.

Conditions are sometimes favorable for reception of foreign mediumwave stations, but the listener's location primarily determines what is heard. European stations are often heard on the East Coast. Eastern and Midwestern DX'ers can expect to hear Latin American and Caribbean stations, and West Coast listeners can receive broadcasts from the Pacific and Asia under the right conditions.

Well, now you know that you should check the clear channels and the regional frequencies at certain times. Other modes of BCB DX'ing, such as sunset skip and sunrise skip, also can produce interesting listening, but the increasing congestion on the AM band and fewer daytime-only stations are making these time periods less productive. It's also worth noting that the fall and winter months are best for both domestic and foreign BCB DX'ing.

A beginning mediumwave listener should also be aware of equipment tests, frequency checks, and DX tests. An equipment test is an unscheduled test of the station's facilities, often requiring the station to go off the air

KATL 770 / *Katl Country*

P.O. BOX 700 • MILES CITY, MT 59301 • 232-7700

KATL-770 is one of the new stations that have come on the air on the clear channels. KATL has made Montana easier to hear for many DX'ers.

To: KARL FORTH

Confirming Reception of
 WADN AM 1120 kHz
 Concord, Massachusetts
 DX Test Conducted on:
 8, Jan. 1900 - 07:00 - 07:30 UTC
 Power - 5 kw, Day Directional Pattern

73 myl, NULL

There are still interesting DX Tests for listeners to try for. The WADN-1120 test from Concord, Massachusetts, was well-heard two seasons ago.

and broadcast open carrier and test tones in the local midnight-to-dawn period. A frequency check is a type of equipment test that is scheduled and publicized in the listener club bulletins so DX'ers can try to hear the special broadcast.

The clubs do publish lists of the few frequency checks still being run, and a persistent listener looking for post-midnight tones may be lucky enough to identify an unscheduled check or other type of equipment test.

The best way to keep current with what's happening between 540 and 1600 kHz is to join the *National Radio Club* or the *International Radio Club of America*. Many listeners are members of both clubs. The NRC's *DX News* and IRCA's *DX Monitor* contain the latest station and call letter changes, loggings and reports from members, receiver reviews and technical articles, stories about radio stations, and information on frequency checks and DX tests.

Contact: National Radio Club, *DX News Magazine*, P.O. Box 5711, Topeka, Kansas 66605; or DX News Subscription Center, Ron Musco, Manager, P.O. Box 118, Poquonock, Connecticut 06064 for inquiries. New subscriptions to NRC's *DX News* are \$24. Or contact: International Radio Club of America, Ralph Sanserino, 11300 Magnolia #43, Riverside, California 92505. Membership dues for IRCA's *DX Monitor* are \$25.

The *NRC AM Radio Log* is the best reference source for station information, and the *IRCA Almanac* contains a great deal of network and other data. Both clubs also publish article reprints and other useful information.

The club bulletins provide a great deal of useful information to the active medium-wave DX'er. Loggings from other members can be used to set up a target list of stations you want to hear. Such a target list is important. You would be surprised how a little research and lot of persistence can lead to loggings considered almost impossible!

If you're new to mediumwave DX'ing, a good quality portable receiver with good selectivity will get you started. Many of the "name brand" receivers that offer the best shortwave reception are also good for mediumwave listening.

What's next for mediumwave? More congestion despite many stations going off the air, and greater DX'ing challenges. Many listeners were hoping that an extension of the AM broadcast band would provide some interesting DX opportunities. (At the 1979 *World Administrative Radio Conference* the upper limit of the AM broadcast band was extended to 1705 kHz.) The first stations were supposed to be on the air on the new channels by mid-1990. That hasn't happened, and the future of this band extension is in doubt.

The mediumwave broadcast band may not be your primary hobby band, but those familiar frequencies still have a lot to offer, and a special appeal that has lasted more than 70 years.

The Best* Just Got Better!

The Eavesdroppers™ now includes our new Zap Trapper™ Electronic Gas Tube Lightning Arrestors. Receive-only design shunts damaging transients to ground at only 1/7th the voltage buildup of the available 200 watt transmit-type arrestors, providing maximum solid state receiver protection.

Protect your investment - combine an excellent shortwave receiving antenna with the best receiver protection money can buy.



- Completely assembled and ready to use
- Only 42" overall length
- E trap circuits permit reception on all shortwave bands, 1.1-90 meters
- All connections soldered and enclosed in ultrasonically-welded, hermetically-sealed trap covers
- Includes 50' of 450 Ohm test mfg. rope

Model T includes 100' twin lead feedline

Model C includes weatherproofed center connector for your coax & coax sealant

- Either model \$79.95
- UPS for lower 48 states \$4.00
- CGD add \$3.00, IL add 7% sales tax
- Foreign shipping quoted

"The best...built like an antenna should be." -Larry Magne in *World Radio TV Handbook*

"Our best seller." -EEB in their recent ads and catalogs

"Now in use in 45 countries." -Gifer Shortwave in 1983

Antenna Supermarket

P.O. Box 563 Palatine, IL 60078 Tel (708) 359-7092 Fax (708) 359-8161

At your dealer or direct • Visa & Mastercard accepted



"AND THEY SAID IT COULDN'T BE DONE!"

THE NEW SANGEAN ATS-818CS PLL SYNTHESIZED WORLD BAND RECEIVER WITH PROGRAMMABLE CASSETTE RECORDER.

So hot it's setting the market on fire and burning up the competition.

That's because the ATS-818CS offers more features than most: high priced table top models and delivers a level of performance that blows the other portables away. Without a doubt, this is one receiver you must see and hear to believe.

Backed by our 1 year warranty of quality and workmanship, it's no wonder Sangean has become the choice of short wave enthusiasts.



The Sangean ATS-818CS features:

- All Short Wave Bands •
- Single Side Band & CW Reception •
- 45 Memory Presets •
- AM Wide/Narrow Filter •
- Dual Time Display •
- 5 Tuning Methods and more •

Call or write for more information.

SANGEAN™
AMERICA, INC.

A World of Listening
2651 Troy Ave., South El Monte, CA 91733
(818) 578-1800 FAX (818) 578-6905

The Secret World Of Scanners

Drug Smugglers, Wireless Microphones, Military Surveillance, Foreign Government – Hear Them Once You Know Where To Listen!

BY CHUCK ROBERTSON

Some people don't play by the rules. They establish their communications systems on strange, unauthorized frequencies. They use non-standard transmission modes. Generally, they run amok on the radio spectrum.

Frequency guides are useful for more orthodox communications systems, but most will do you little good in hunting down these radio anarchists. Their world is hidden to most, but knowing their tricks puts you on their track.

As the old saying goes, if you want to catch a fox, you must think like a fox. Better yet, think like a foxy scannist and capture the entire menagerie. We'll show you how.

After The Fox!

If you enjoy chasing skip stations on your scanner, and you have an ear for the unusual, sooner or later you'll cross paths with a drug runner. He's liable to use any frequency that pleases him, and any transceiver that happens to be at hand. Drug smuggling is big business, and eavesdropping on their comms can mean big excitement.

David Williams, of Birmingham, AL tells us that he was amazed that the audacity of the smugglers he heard on 35.825 MHz. They openly discussed drugs and clandestine docking locations at Bahamas locations such as Inagua and Cat Cay. From their mentions of being at Negril and Mo Bay (Montego Bay), the smuggler signals were probably skipping in from Jamaica.

On 35.465 MHz, David overheard drug runners discussing their "goods" and working out a drop at Devils Bay, which is on Virgin Gorda in the British Virgin Islands. David is a professional travel guide writer, so he knows this particular spot. He tells us that this a remote and undeveloped area with no docking facilities for ten miles. It's ideal for smugglers.!

More narco-pirates were tuned in on 33.27 MHz. These people mentioned Abaco, in the Bahamas. The ones on 33.35 MHz were discussing their destination on Great Inagua, Bahamas.

David also logged some legit Caribbean skip, like a deep sea charter ("Blue Sea") in the Cayman Islands on 35.20 MHz. He also heard a construction company in Aruba, N.W.I., on 34.40 MHz.

Back on terra firma, there are Chicago taxis on several unauthorized frequencies, including 33.14 and 33.18 MHz. The messages consisted almost entirely of X-rated four-letter words.

Other intercepts of interest from David include the Egyptian military on 37.40 MHz; a Soviet repeater on 38.725 MHz; a U.S. mil control tower in the Mideast on 31.375 MHz; an RAF activity in the U.K. on 43.15 MHz; a radiophone in Tampa, FL on 31.24 MHz; a Radio Netherlands link on 43.15 MHz; possibly Trinidad on 44.27 MHz; a taxi in New York City (Queens) on 31.24 MHz; and the Bismarck, AR police on 37.20 MHz.

David uses a Radio Shack Realistic PRO-57 and two horizontal half-wave dipoles cut to 30.50 MHz.

Paging Dr. Feelgood

Having a beeper has become more than a sign of success in street-level drug dealers, it's virtually a necessity these days, especially in metro areas. The symbol of success is the dealer who can afford the most sophisticated pager. In an effort to cut out drug trafficking, many metro high schools have now banned students from bringing beepers into the building.

Beepers have been around for thirty years, and many legitimate business people use them from locksmiths to construction workers, doctors, attorneys, repairmen, salesmen, service technicians, and delivery people. Beepers permit a business enterprise to keep in contact with its customers. This is also what made them so popular with the drug trade.

In Table 1, we list the VHF low band (except all-medical) phone-in paging station allocations used by the general public. Mostly, you'll hear general messages on these frequencies, but you're likely to hear some-

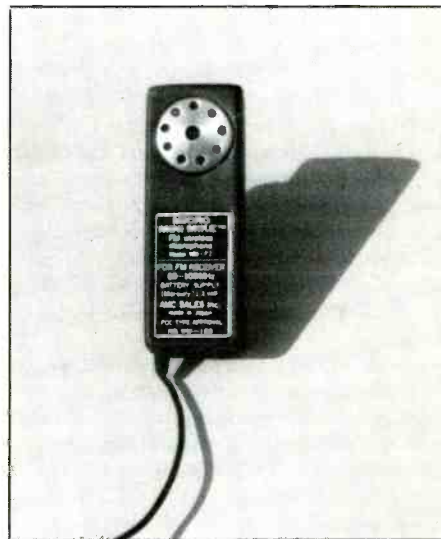

This wireless microphone operates in the 88 to 108 MHz band with WFM mode.

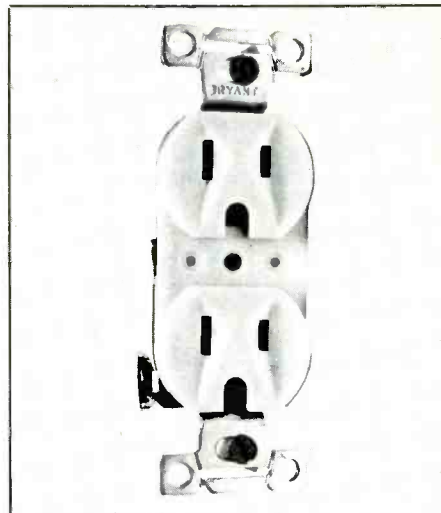

The walls can have ears! What looks like an electrical socket is actually a transmitter with a half-mile range that can broadcast every word spoken in a room. It's from Sheffield Electronics, 7223A Stony Island Ave., Chicago, IL 60649.

CHANNEL	FREQUENCY	CHANNEL	FREQUENCY	CHANNEL	FREQUENCY
PA	35.20	PN	43.20	81	931.0125
P1	35.22	P3	43.22	82	931.0375
PB	35.24	PO	43.24	83	931.0625
PC	35.26	PP	43.26	84	931.0875
PD	35.30	PQ	43.30	85	931.1125
PE	35.34	PR	43.34	86	931.1375
PF	35.38	PS	43.38	87	931.1625
PG	35.42	PT	43.42	88	931.1875
PH	35.46	PU	43.46	89	931.2125
PI	35.50	PV	43.50	90	931.2375
PJ	35.54	PW	43.54	91	931.2625
PK	35.56	PX	43.56	92	931.2875
P2	35.58	P4	43.58	93	931.3125
PL	35.60	PY	43.60	94	931.3375
PM	35.62	PZ	43.62	95	931.3625
P7	35.66	P8	43.66	96	931.3875
1	152.03	YP	152.60	97	931.4125
3	152.06	YJ	152.63	98	931.4375
5	152.09	YK	152.66	99	931.4625
7	152.12	JS	152.69	100	931.4875
9	152.15	YS	152.72	101	931.5125
11	152.18	YR	152.75	102	931.5375
13	152.21	JK*	152.78	103	931.5625
P5	152.24	JR	152.81	104	931.5875
JL	152.51	T1	152.84	105	931.6125
YL	152.54	T2	158.10	106	931.6375
JP	152.57	P6	158.70	107	931.6625
21	454.025	34	454.350	108	931.6875
22	454.050	QC	454.375	109	931.7125
23	454.075	QJ	454.400	110	931.7375
24	454.100	QD	454.425	111	931.7625
25	454.125	QA	454.450	112	931.7875
26	454.150	QE	454.475	113	931.8125
27	454.175	QP	454.500	114	931.8375
28	454.200	QK	454.525	115	931.8625
29	454.225	QB	454.550	116	931.8875*
30	454.250	QO	454.575	117	931.9125*
31	454.275	QR	454.600	118	931.9375*
32	454.300	QY	454.625	119	931.9625
33	454.325	QF	454.650	120	931.9875

*Nationwide Paging Channels

Table 1. Paging frequencies and their channel designators. Sometimes these frequencies offer some rather exotic messages, especially those relating to drug sales. Traffic is sent in voice and non-voice modes.

one calling in for a drug delivery. Be especially suspicious of circumspect or very odd sounding requests, which could be veiled references to drugs.

Hide & Sneak

While search scanning between 29.70 and 35.00 recently, my scanner stopped on 30.28 MHz at a garbled and unintelligible signal. Out of curiosity, I thought I'd switch from NFM mode through to other reception modes. When I went to AM, clear comms materialized out of the chaos. It turned out to be two Aussies extolling the virtues of different brands of local beers.

The use of AM communications on frequencies we normally regard as FM territory isn't limited to Australia. I've also unearthed several US stations that deliberately conceal their comms from casual scanner reception or co-channel users by employing AM transmissions. One is a business operation, possibly in California, that I have heard on 30.00 MHz. Ma was telling Pa, "Did you get any sales? I'm going to lock up."

Some of those New York City "gypsy

cabs" use AM, too. Listen for them on 30.76, 31.08, 31.10, 31.12, and 35.12 MHz.

If your scanner can switch to AM mode, remember to try it when you come upon a signal that sounds bizarre. Besides pirates, you'll also hear AM voice pagers, and HF band harmonics. This time of the year, foreign AM stations from around the world can be heard during daylight hours. A good indicator of VHF low band skip openings to/from South America centers around several AM mode Brazilian voice and non-voice radiopaging stations that operate in the band 35.525 to 35.975 MHz (25 kHz steps).

Sidewinding

Skip traffic is piling up on 31.48 MHz and Harvey Base is having trouble contacting its large fleet of ships at sea. This station has been mentioned here many times before. It's operated from Harvey, LA by the Gulf Fleet Marine Corp.

When Harvey Base begins having trouble contacting its widespread fleet of ships, it

NOW YOU'RE TALKING!

The Code-Free Ham License is Here

Enjoy all Amateur Radio privileges above 30 MHz without having to pass a code test. All you have to do is pass a 55-question exam on basic radio and the FCC regulations. ARRL's new book, **Now You're Talking** makes understanding what is required on the test a snap! And there are exams given all over the country every weekend.



Just think how much fun you'll have communicating through repeaters, enjoy Sporadic E skip and worldwide communications on six meters when conditions are right. There's satellite communication and you can even talk to Astronauts and Cosmonauts in orbit. Enjoy friendly local communication both direct and through repeaters. Help with disaster drills and the real thing! Sound like fun? It is! Order your copy of **Now You're Talking** below: Enclosed is \$19 plus \$4 for shipping (a total of \$23) or charge \$23 to my () VISA () Mastercard () Discover () American Express

Signature _____

Acct. No. _____

Good from _____ Expires _____

Name _____

Address _____

City _____ State _____ Zip _____ PC

THE AMERICAN RADIO RELAY LEAGUE
225 MAIN STREET
NEWINGTON, CT 06111

CIRCLE 170 ON READER SERVICE CARD

switches over to AM mode. Sometimes that does the trick. If it doesn't, Harvey will try SSB and that will often make the difference as the contacts are racked up, one after another.

The use of SSB on the scanner bands is uncommon in North America, but that's not throughout the world. In some nations, it's often encountered above 30 MHz. China, for instance, is reported to have plenty of SSB radios in operation on frequencies such as 39.27 MHz. The USSR is also reported using SSB on 32.45 and 37.76 MHz.

The Cuban Connection

Cuba has long been a way station for drug smugglers as well as a port for the Soviet Navy. Our own government has not ignored the activities in the waters surrounding Castro's island paradise.

One means of keeping track of vessels in and under the waters going to and from Cuba is by means of sonar sea buoys dropped from USAF aircraft. These devices send out sonar pulses and transmit pings by radio to US sea, air and land listening posts. By comparing the pings received from several different buoys (operating on different frequencies), it's possible to gather intelligence relating to vessel movement, size, direction, speed, and type.

During one such USAF sonobuoy drop, the frequencies were 25.41, 25.59, 32.45, 36.55, 41.90, 41.95, 48.70 and 51.50 MHz. When scanning for these, listen for the characteristic sonar ping sound, just like in submarine movies!

When the sonobuoy reaches the end of its

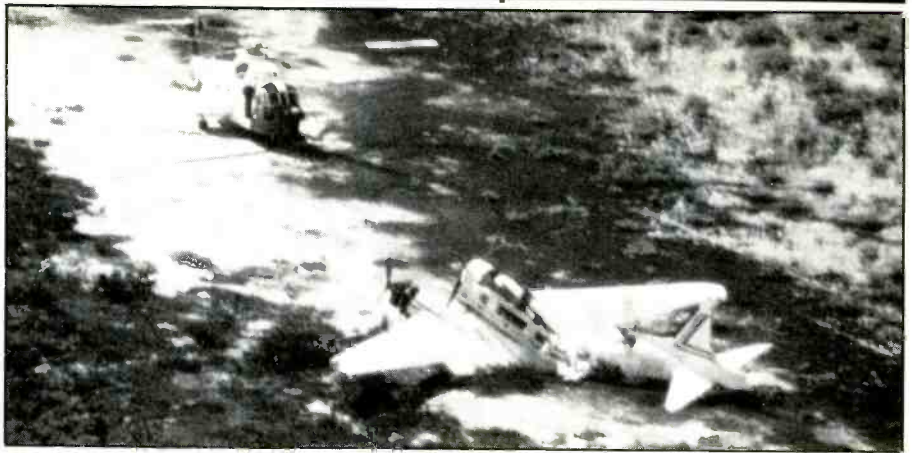

The Bahamas are a hot spot for drug smuggling activity, much of which can be heard on your scanner. Here the USCG and Bahamian police check out a suspected smuggler aircraft that crash landed on an isolated cay. (Coast Guard photo)

useful life, it automatically scuttles and sinks to the bottom.

Wireless Microphones: They're Everywhere!

Have you wondered why wireless devices (the kind that people use for eavesdropping) are turning up on just about any frequency in the radio spectrum? Can this be legal?

Well, yes, the wireless microphones are legal. The FCC allows certain very low power devices and equipment to exist like this whether the signals they radiate are unintentional or intentional. Unintentional signals might come from computers, TV sets, scanners, cash registers, word processors,

electric typewriters, industrial welding equipment, diathermy and other scientific and medical devices, etc. Intentional signals come from things like some wireless microphones, baby monitors, wireless intercoms, garage door openers, proximity detectors. Note that some intentional signal devices don't require licenses, but are still restricted to certain frequency bands (cordless phones, and 49 MHz handheld transceivers, for instance).

If you have ever driven around town with your scanner on, then you know that at certain locations a particular frequency may briefly come alive with some kind of strange sound. If you use a computer in the same room as your home scanner you may also notice that the scanner locks up on certain frequencies when the computer is in use. These are unintentional radiations, and they turn up around office buildings, factories, shopping centers, hospitals, etc.

Wireless mics are plentiful these days. Most use wideband FM (WFM) mode, so put your scanner into that mode when listening for these devices.

The Menagerie Is Open

Now that you know about some of the hiding places and odd things that can be heard, it's time to tune on that secret layer of signals that are hiding beneath the top layer of police, fire, business and other more commonplace stations. Search for the unusual and it will be there.

This should be an excellent month for long-haul DX via F2 layer skip. You might want to look through the entire 25 to 76 MHz band for signals from around the world. Starts in at sunrise and keeps on going until a couple of hours after sunset.

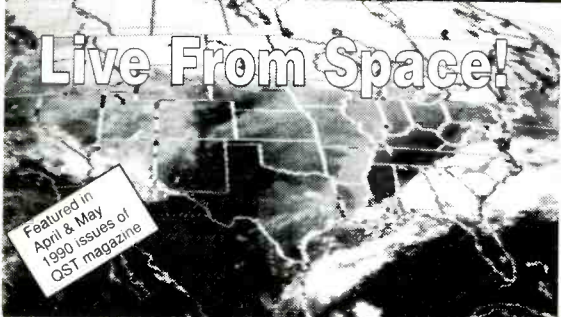

This month there will also be a secondary peak in short-hop Sporadic-E skip. Look for these openings at any hour of the day or night, bringing in stations from 450 to 1,300 miles away. The primary periods of the year for Sporadic-E are in late spring and early summer. ■



Imagine a high-resolution, high-tech scan converter that does it all. Plug it into your receiver earphone jack and decode all APT modes — WEFAX, GOES-TAP, polar satellites and HF Marine fax. Capture, enhance, save and print in gray-scale weather facsimile using your IBM-compatible computer. Achieve professional results — often surpassing the capabilities of local TV weather reporting. Latest technology for optimal noise rejection, self-test mode, advanced menu-driven software and help windows assure easy operation.

Factory-assembled and tested — \$370, includes software and user's guide.
Easy-to-assemble kit — \$240 includes software and user's guide.

OFS WeatherFAX
6404 Lakerest Ct. • Raleigh, NC 27612
(919) 847-4545

CIRCLE 157 ON READER SERVICE CARD

HASTA LA VISTA BABY!

Terminate your Search for a Handi-Counter™. We're going to blow you away with this offer!
 *\$100. off our full range Model 2810.
 *Limited time only, no discounts and no trade ins. Made in the U.S.A.

\$159.

**Don't Wait,
 This Offer Can't Last!
 Reg. Price, \$259**



- Full range -10Hz to 3GHz.
- LCD display (daylight visibility).
- True state-of-the-art technology with the high speed ASIC.
- NiCads & Charger included.
- Ultra-high sensitivity. • 4 gate times.
- Extruded metal case. • Compatible with MFJ207.

Suggested options

- TA100S: Telescoping Whip Antenna.....\$ 12.
- CC30 Vinyl Carry Case.....\$ 14.
- BL10: LED Backlight.....\$ 15.
- BL28: El Backlight for use in roomlight and low light.....\$ 45.
- BG28: Bargraph Signal Level Indicator.....\$100.
- TCXO 30: Precision ± 0.2 ppm 20 to 40°C temp. compensated time base.....\$100.

Universal Handi-Counter™ Model 3000, \$375. and Bench Model 8030, \$579. Both offer frequency, period, ratio and time interval.



OPTOELECTRONICS

Call for free catalog - Factory Direct Order Line:

1-800-327-5912

FL (305)771-2050 • FAX (305)771-2052

5821 NE 14th Ave. • Ft. Lauderdale, FL 33334
 5% Ship/Handling (Max. \$10) U.S. & Canada.
 15% outside continental U.S.A.
 Visa and Master Card accepted.

Psychological Warfare Broadcasts During WWII

*Did They Get Through? Were They Useful?
Here's What A German Intelligence Officer Thought!*

BY ALICE BRANNIGAN

Soon after World War II ended, the American military authorities in Germany came into possession of a manuscript entitled *Kriegsgeheimnisse im Aether* ("War Secrets in The Ether"), written by Wilhelm F. Flicke. Flicke had been a member of German intelligence during WWI, and worked within that structure as a radio expert until the German defeat at the end of WWII. Although his reputed opposition to the Nazi Party after 1939 supposedly got him in hot water with the political power structure during WWII, his expertise nevertheless allowed him to actively participate in monitoring, communications counterintelligence, and cryptanalysis.

Flicke's lengthy manuscript was written in 1945, immediately at the end of WWII. It is a history of the German intercept service based upon his own personal recollections, experiences, observations, and opinions. The original German-language manuscript came into the possession of the National Security Agency, and was translated into English by the NSA prior to the establishment of Executive Order 10501 of November 5, 1953. The material is therefore unclassified.

Flicke's manuscript is of historic interest, although we question and do not vouch for his "facts" (many of which seem to be fudging and pandering to the Allied victors). We certainly don't agree with more than a few of his opinions and conclusions; some are transparently ludicrous. His final summation regarding the effects of foreign broadcasting on the German people during WWII impressed us as pure fantasy. Yet, his views of propaganda broadcasting in general, nevertheless, manage to offer worthy insights from within the camp of those who "wrote the book" on the art. Keep his viewpoint in proper perspective.

Inasmuch as our December writings are always devoted to WWII, we thought that we would present you with excerpts from the chapter containing Flicke's provocative thoughts on radio broadcasting during WWII.

It is important that you keep in mind that these opinions were written soon after the

German defeat 46 years ago. They came from someone who perceived radio broadcasting from the vantage point of an observer who spent 30 years in the communications division of the German military intelligence service—a rare viewpoint for us to encounter.

Here's what Flicke reported:

The word *propaganda* has gotten a bad connotation during the last decade and a half since, unfortunately, we have had to accustom ourselves to its use, not to gain recruits for a good cause but to force upon others against their will ideas which are neither good of themselves nor useful to those upon whom they are imposed. Things have gone so far that there is a general aversion to everything connected with propaganda and an immediate resistance where propaganda is even suspected.

The different countries made use of broadcasting in different ways, and certain developments resulted in all countries on the basis of observations made. If I mention broadcast propaganda, I do so with reference to the role which broadcasting played as a means of psychological warfare.

The use of broadcasting as a means of propaganda by government originated in the Soviet Union. In this federation the enormous possibilities were recognized which centrally controlled broadcasting has for propagating specific ideas. With revolutionary revolution they set to work and created a mighty organization for the use of the government and the Communist party.

The Soviet Propaganda Machine

If we observe the type of Russian broadcast propaganda within the limits of the Soviet Union, we find that it is very primitive. However, we must not forget that Russian internal propaganda is intended for the Russian worker and peasant... and that it is calculated precisely for his concepts and his attitudes. Consequently, it has had its effects in these circles. The extent to which it

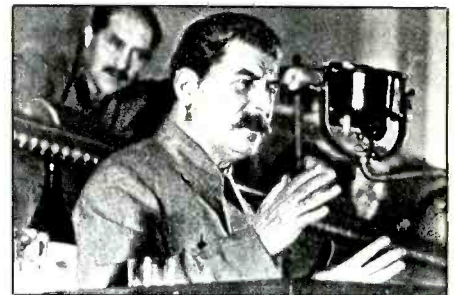

Soviet dictator Stalin's speeches were aimed so much at the Russian audiences that they bored German listeners. That's what one German intelligence analyst claimed.

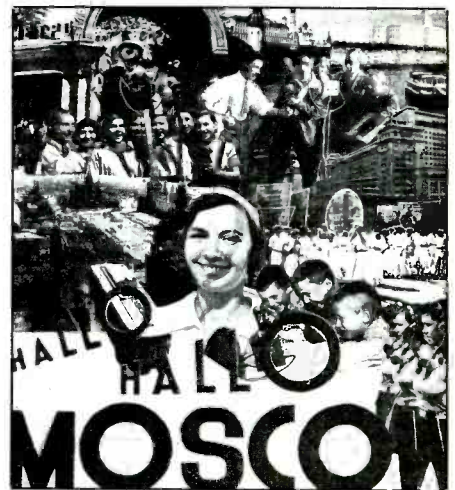

QSL sent out by Moscow's station RAN (9600 kHz) in the late 1930's. This was a major Soviet propaganda broadcaster.

achieves its aim of affecting the entire population was shown clearly during WWII.

When the Russians broadcast in the same manner in German to Germans, then they showed they knew little of the soul of the German people. Only during the course of the war did they learn to take actual conditions into account, both regarding what they

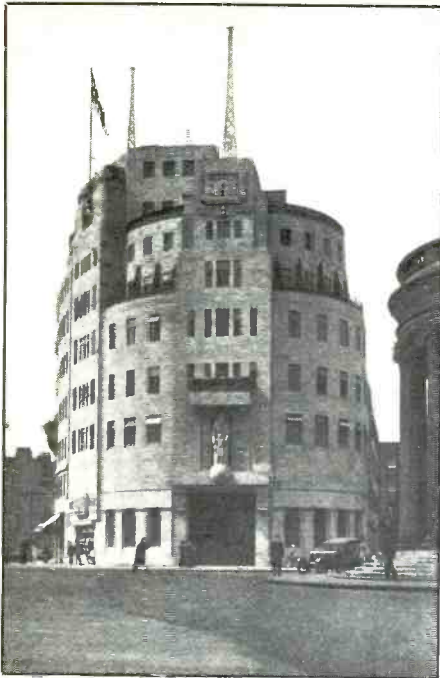

Broadcasting House, London, as it looked just before WWII. The headquarters of the BBC, the building became known throughout the world.



The BBC recorded all of Hitler's many speeches, and then picked apart his lies and contradictions in their own broadcasts to Germany. One German observer felt that this type of programming had a strong impact.

and its practical methods, coupled at times with corrections of National Socialist claims, insofar as they were applied to other countries. But that was enough to make the National Socialists denounce these broadcasts as pure propaganda and atrocious lies.

France Joins In

The British were very reserved in this matter. The French, on the other hand, were somewhat more active, and in time (beginning about 1936) the Strasbourg transmitter became the mouthpiece of liberal democratic ideas.

Indicative of the skepticism with which National Socialist propaganda was secretly viewed in Germany is the fact that the Strasbourg broadcasts were listened to by everyone who had a suitable receiver.

Even at that time people in the Ministry of War and Ministry of Propaganda in Berlin were aware that in any future war a large part of the population would regularly listen to broadcasts of other countries. But since National Socialist propaganda worked chiefly with invaded or distorted arguments, there was serious danger involved in listening to foreign broadcasts, because untruths are only effective when there is no one on the spot to disarm them by a convincing presentation of the truth.

Tuning Out Foreign Broadcasts

An attempt was made to render the German people immune to foreign broadcasts. This was done primarily by shifting the whole German broadcasting program over to wire radio. The instruments were to be so devised that it would be absolutely impossible to hear foreign broadcasts.

This was a gigantic program and considerable time elapsed before it could be realized in full. The preliminary state was represented by the so-called "people's receiver" which was planned to receive only German transmissions. When World War II broke out, wire radio was still in its early stages. It was necessary to find another way of keeping foreign broadcasts from the German people. It was decided—with characteristic National Socialist thoroughness—to use the universal cure of strict prohibition. The death penalty was fixed for listening to foreign broadcasts. They went so far as to include listening to broadcasts of allied countries under the same ban.

It has been claimed that the National Socialists were good psychologists. In general that is true. They knew perfectly well that the broadcasts of other countries would be listened to in spite of all prohibitions. But in order to reduce to a minimum the resulting dangers, they established that the maximum penalty would be for listening and passing on what had been heard. They had no choice. Their system of having everyone spied on by everyone else would see to it that listening to foreign broadcasts did not get out of hand.

must say to the German people and to how they must say it.

But in spite of everything, Russian broadcast propaganda played only a subordinate role during the war. It began to have a certain effectiveness only when captured German generals, officers and enlisted men appeared on Russian broadcasts, and addressed their messages to the German people and soldiers.

Psychological warfare had begun in Europe long before the outbreak of open hostilities. Soon after the assumption of power by

National Socialism (Nazi Party), an ardent effort was made to loudly proclaim to the world the National Socialist doctrine as a panacea for all countries and all peoples. In conjunction with other "cultural accomplishments" of National Socialism (anti-church, anti-union, anti-Semitic, concentration camps, subjugation of the press, etc.), this activity aroused opposition in all foreign broadcasts.

In reality, these were not counterpropaganda transmissions but merely efforts to discuss the validity of National Socialism

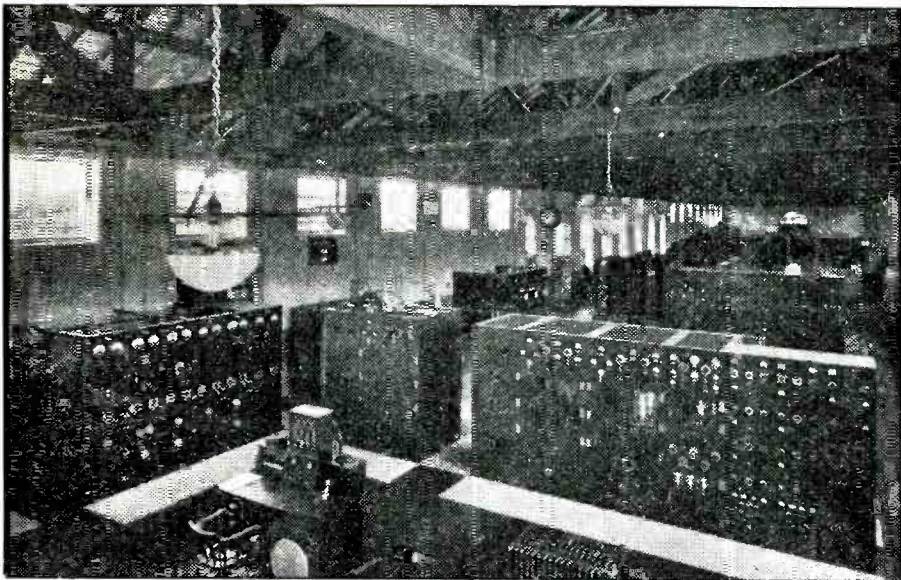

BBC transmitters at Rugby during WWII.

Immediately after the outbreak of the war the French started a violent agitation, using transmitters in Strasbourg and Paris. It was directed against the German government and its responsibility for bringing on the war. The management of this propaganda was poor. One attempted to use a clumsy instrument on a clumsy object and in so doing, caused more damage than would be suspected.

When military events turned against the French in 1940, the broadcasts on these stations became a wild scolding and, with that, lost all effectiveness. These broadcasts were listened to only with loathing and shrugging of shoulders.

The BBC Tries For German Audiences

Somewhat more clever were the BBC transmissions, but they revealed such a lack of actual conditions in Germany that the listener often had to shake his head. Had the English been asleep these past six years? Didn't they know what happened in Germany since 1933? What became of their celebrated "Secret Service"? If it hadn't learned more than appeared in the sometimes downright simple propaganda, then the British were indeed badly off. Many of the statements could be checked at once and shown to be incorrect.

There was a basic change when Brandon Bracken took over at the Ministry of Propaganda (in London). The way in which the entire style of broadcasts to foreign countries changed in about four weeks was really striking. From an unsure and tortuous path, one shifted resolutely to the only correct path under the circumstances—to the path of truthful, factual reporting. That alone was so hard and annihilating for National Socialism that any added propaganda terms, any injected propaganda purpose, could only weaken the effect. It was necessary to depict things in such detail and in such fashion that anyone could check their accuracy.

At the very time when the BBC broadcasts were making truthful reporting the foundation of their propaganda, Dr. Goebbels was proclaiming openly in Berlin, "Propaganda is never limited to the truth but is only determined by the purpose."

Truth is the enemy of distortion and the lie. Only when unadulterated truth is used as a weapon can it be effective in the long run. National Socialist propaganda relied upon the "lie of the moment;" that is to say, one boldly asserted anything and thus achieved for the moment the desired effect. If time ultimately revealed the untruth of the statement, one had accumulated meanwhile a number of new "facts" which could be trotted out with much to-do and which would so fully claim public interest that no thought would be left for the former "stupidity."

English propaganda (if we insist on using that term), under Brandon Bracken, could now afford to collect and toss back in wholesale fashion the contradictions in German

speeches, publications, press, and broadcasts. That alone was very effective. For this purpose, they recorded every speech of Hitler, Goering, Goebbels, and others, every military and political lecture, every German broadcast item, and so were able to produce, as it were, a multitude of living witnesses. That was damnably painful for German propaganda, especially as there was nothing to offer in return. Only one course remained for reducing the effectiveness of these broadcasts—that was jamming.

So now the Germans used every available means to make reception of the German language broadcasts from London impossible. They were rarely successful because the English sent out their broadcasts on as many as 10 frequencies and reception was always possible on at least one or two of them. Naturally, this varied from place to place. The jammers did not really interfere everywhere, and anyone seriously intending to hear the BBC generally succeeded (there were, of course, exceptions).

I am not asserting that the English were like lily white angels and limited themselves to 100% fact and no propaganda. By no means! They admitted sending out propaganda broadcasts, only they always separated them from straight reports. Everyone knew these things were invented, but the broadcasts were spiced with so much spirit and humor that the people liked to hear them. They had not been hewn with a broad ax like the output of Berlin's Ministry of Propaganda. They showed a cleverer hand and were well worked out.

While, in Germany, the penalty for listening to foreign broadcasts was death, the British Government did not attempt to limit listening to German broadcasts. The Germans had organized a grandiose program in the English language as an information service for listeners in England, but if anybody ever missed the mark, if any laborious effort ever reached 100% failure, it was here. It even reached the point where the British recommended listening to the German stations because what was offered provoked a shaking of heads or a compassionate smile.

I had remarked that the National Socialists were good psychologists. This was only true in respect to their own people. When dealing with other countries they displayed, without exception, a total inability to enter into the thinking of other people. For that reason, German National Socialist propaganda was usually merely a flash in the pan, unless it was supported by very practical economic interests.

American Broadcasts

The United States set up a German Language broadcast, the "Voice of America, the Voice of One of the United Nations," immediately after the beginning of the war. The broadcasts, however, were difficult to hear and found little following.

Of all of the American broadcasts in the German language, the most interesting were the addresses of the well known au-

GERMAN SHORTWAVE STATION BROADCASTING HOUSE, BERLIN

Zone III

Africa- Programme

October 1937

Call	Kc	Wave length	Time Schedule	Berlin	S. A. T.
DfL	15 110	19.85 m		8.00—8.00	7.00—9.00
DfD	15 770	25.45 m			
DfL	15 110	19.85 m		17.35—22.30	18.35—23.30
DfC	6 020	49.83 m			
DfL*	15 110	19.85 m		12.00—14.00	13.00—15.00

* only on Sunday

Announcements of programme changes and supplements will be made daily after the news

Other Transmissions of the German Shortwave Station (Berlin time)

ASIA		
DJA	31.30 m	9 560 kc
DfB	18.74 m	15 200 kc
DfC	21.45 m	13 540 kc
DfE	18.88 m	17 780 kc
DfQ	18.83 m	15 280 kc
6.05—13.00		
8.05—11.15		
14.10—17.00		
SOUTH AMERICA		
DfQ	18.83 m	15 280 kc
DfB	21.45 m	13 540 kc
DfC	18.83 m	15 280 kc
DfQ	18.83 m	15 280 kc
DfE	18.88 m	17 780 kc
17.10—18.25 (only on Sunday)		
NORTH AMERICA		
DfE	18.85 m	15 110 kc
DfB	18.74 m	15 200 kc
DfD	21.45 m	13 540 kc
DfB	18.74 m	15 200 kc
17.10—18.25 (only on Sunday)		
CENTRAL AMERICA		
DfB	18.74 m	15 200 kc
DJA	31.30 m	9 560 kc
DfB	18.74 m	15 200 kc
14.00—15.00		
22.50—4.45		

The Germans ran a heavy shortwave propaganda schedule to all areas of the world, beginning in the mid-1930's and going through the war years. (Courtesy Will Jensby, CA.)

thor, Thomas Mann. They were permeated by much spirit and knowledge, were excellent in style, and inspired by a glowing hatred of National Socialism.

Clandestines

Thusfar I have mentioned only broadcast stations which worked openly and without disguise, i.e. could be recognized by the announcer's statement as being in Moscow, London, New York, etc. But there were other transmitters which worked with the most varied disguises. If one watched carefully, however, one could always determine after a while the country in which this or that transmitter was located.

For instance, there was the *Transmitter of the SA-Fronde*. It worked in the Soviet Union and tried to give the impression that it was located in Germany and represented an opposition group within the SA. The *German People's Transmitter* was likewise in Soviet territory. It was usually easy to recognize transmitters working from the Soviet union because of the number of times *Kameraden!* occurred. Almost every second or third sentence began thus.

The so-called *Atlantic Transmitter* was listened to by many Germans. Its offerings were not always well chosen, its information not always dependable. It worked from Algiers and was the U.S.A. propaganda station for the German armed forces. The so-

COMMUNICATIONS ELECTRONICS INC.

Emergency Operations Center

has expanded to our new two acre facility and World Headquarters. Because of our growth, CEI is now your one stop source for emergency response equipment. When you have a command, control or communications need, essential emergency supplies can be rushed to you by CEI. As always, for over twenty three years, we're ready, willing and able to help. For 1992, we're introducing new products from Uniden, Shinwa, ICOM, Ranger Communications Inc., Grundig, Sangean, Magnavox and RELM.

NEW! Shinwa SR001-B

List price \$799.95/CE price \$479.95/SPECIAL
Continuous coverage from 25,000 through 999,995 MHz. If you're looking for an excellent synthesized scanner designed for mobile surveillance use, the new Shinwa SR001 scanner offers features never before offered at such a low price. When you purchase the wide band scanner from CEI, you'll get a free infrared wireless remote control that allows you to control your scanner from over 20 feet away. Selectable frequency steps of 5.0/10.0/12.5/20.0/25.0/50.0 or 100.0 KHz. are available. Dual antenna inputs terminating in an "N-type" and "BNC" connectors are included. Other features include 200 memory channels grouped in 10 banks of 20 channels, easy to read multi color LCD display, lithium battery for memory back-up, 35 channel per second high speed scanning, priority, timer and even an alarm to alert you to transmissions on your choice of one special frequency. We even include a mobile mounting bracket. The SR001 can be used for base station use with the purchase of the ACS-B 12 volt DC power supply for only \$34.95 each. A great sounding external speaker #SPE-B is available for only \$24.95.

SHINWA POCKET PAGERS

The fire department hazardous materials response teams and police department SWAT crews who need a reliable radio alerting system stake their lives on Shinwa. We offer a two-tone pocket pager with monitor feature and even a voice storage option at an affordable price. To order, we need your paging frequency as well as tone reed frequencies. For other configurations or two-way radio information, please fax us your specifications to 313-663-8888 or phone 313-996-8888.

ICOM ICR1-B

List price \$799.95/CE price \$529.95/SPECIAL
Continuous coverage from 100 kHz through 1,300 GHz. The ICOM ICR1 keeps you in touch with the world when you're on the go. The palm-size ICR1 is equipped with AM, FM and wide-FM modes to fully answer your monitoring needs. With 100 memory channels and a dual frequency selection system, you get a top-class communications receiver. Not only can you program scan searches only for signals within a specified frequency range, it's also possible to write frequencies of received stations automatically into memory. In addition, unwanted frequencies can be skipped. Order ICBC72-B battery rapid charger for \$99.95 and a BP84 1,000 ma. battery pack for \$74.95.

ICOM ICR100-B

List price \$799.95/CE price \$579.95/SPECIAL
Continuous coverage from 100 kHz through 1856 Mhz. Now you can bring a wider world of broadcasting, VHF air and marine bands, emergency services and many more communications into your vehicle. Icom's advanced ICR100 fully covers all the stations worth hearing with up to 100 memory channels and a multitude of features.

SCANNERS/CB/RADAR UNIDEN

PRO310E-B Uniden 40 Ch. Portable/Mobile CB	\$72.95
PRO330E-B Uniden 40 Ch. Remote mount CB	\$99.95
GRANT-B Uniden 40 channel SSB CB mobile	\$152.95
WASHINGTON-B Uniden 40 Ch. SSB CB base	\$229.95
PC122-B Uniden 40 channel SSB CB mobile	\$113.95
PC66A-B Uniden 40 channel CB Mobile	\$78.95
PRO510XL-B Uniden 40 channel CB Mobile	\$39.95
PRO520XL-B Uniden 40 channel CB Mobile	\$54.95
PRO535E-B Uniden 40 channel CB Mobile	\$69.95
PRO538W-B Uniden 40 ch. weather CB Mobile	\$78.95
PRO810E-B Uniden 40 channel SSB CB Base	\$174.95

UNIDEN RADAR DETECTORS

RD3000Z-B Uniden 3 band suction mount radar	\$129.95
RD2400Z-B Uniden 3 band radar detector	\$109.95
RD80-B Uniden 2 band radar detector	\$64.95
CARD-B 3 band credit card size radar detector	\$99.95
RD3XL-B Uniden 3 band radar detector	\$109.95
RD9XL-B Uniden "micro" size radar detector	\$69.95
RD27-B Uniden visor mount radar detector	\$39.95



19 PLUS-B Cobra CB radio	\$36.95
18RV-B Cobra CB radio	\$54.95
41PLUS-B Cobra CB radio	\$72.95
70LTD-B Cobra remote mount CB radio	\$99.95
19LTD-B Cobra Classic series CB radio	\$44.95
21LTD-B Cobra Classic series CB radio	\$54.95
25LTD-B Cobra Classic series CB radio	\$89.95
29LTD-B Cobra Classic series CB radio	\$109.95
146GTL-B Cobra AM/SSB CB radio	\$129.95
148GTL-B Cobra AM/SSB CB radio	\$149.95
90LTD-B Cobra Base station	\$89.95
142GTL-B Cobra AM/SSB Base station	\$199.95
2000GTL-B Cobra Deluxe AM/SSB Base station	\$379.95

COBRA RADAR DETECTORS

RD3163-B Cobra 3 band radar detector	\$109.95
RD3175-B Cobra 3 band radar detector	\$129.95
RD3173-B Cobra 3 band radar detector	\$139.95
RD3183-B Cobra 3 band radar detector	\$139.95

Bearcat 200XLT-B

List price \$509.95/CE price \$239.95/SPECIAL
12 Band, 200 Channel, Handheld, Search, Limit, Hold, Priority, Lockout Frequency range: 29-54, 118-174, 406-512, 806-956 MHz. Excludes 823,9875-849.0125 and 868,9875-894.0125 MHz. The Bearcat 200XLT sets a new standard for handheld scanners in performance and dependability. This full featured unit has 200 programmable channels with 10 scanning banks and 12 band coverage. If you want a very similar model without the 800 MHz. band and 100 channels, order the BC100XLT-B for only \$179.95. Includes antenna, carrying case belt loop, ni-cad battery pack, AC adapter and earphone. Order your scanner from CEI today.

Bearcat 800XLT-B

List price \$549.95/CE price \$239.95/SPECIAL
12-band, 40 Channel. Nothing excluded in the 800 MHz. band. Bands: 29-54, 116-174, 406-512, 806-956 Mhz. If you do not need the 800 MHz. band, order the Bearcat 210XLT-B for only \$178.95.

Magnavox® Satellite Phone

CE price \$48,880.00/Special order - allow 45 days for delivery. When war broke out in Iraq, you heard all the action because CNN had a satellite telephone. When a disaster such as an earthquake or a hurricane strikes your community and communications are disrupted, you can depend on instant reliable communications, just like CNN did using your Magnavox MagnaPhone. Inmarsat communication satellites are in geostationary orbit along the equator. They beam two-way voice and data transmissions between your satellite phone and fixed earth stations. In most instances, telephone calls are dialed directly once you have selected the satellite serving your location. No matter where you are on the planet, the MagnaPhone automatically selects the Land Earth Station (LES) nearest the destination called. This makes placing a call as easy as using a standard telephone. Dual ID numbers permit a separate Inmarsat telephone number to be used to route calls to one of the external telephone ports which could be used for a fax machine or a computer data line. For telephone, telex, fax and data communications anywhere in the world, the new MX2020P MagnaPhone is the most compact Inmarsat-A, Class 1 terminal available today. Like a cellular phone, airtime will be billed to your account. The new MagnaPhone weighs just 47 lbs (21 kg), including the antenna. Add the optional ruggedized case (only \$950.00) and it can travel as airline baggage on commercial carriers. When you arrive at your destination, installation can be done in less than 5 minutes. For more information call our Emergency Operations Center at 313-996-8888.

CIRCLE 10 ON READER SERVICE CARD

RELM UC202-B 2 Watt transceiver on 154.57 MHz.	\$114.95
RELM RH256NB-B 25 Watt VHF transceiver	\$299.95
RC12950-B Ranger Comm. 25 Watt 10 Meter xcevr.	\$229.95
MR8100-B Uniden surveillance scanner . CALL FOR PRICE	
BC55XL-B Bearcat 10 channel scanner	\$114.95
AD100-B Plug in wall charger for BC55XLT	\$14.95
PS001-B Cigarette lighter cable for BC55XLT	\$14.95
VC001-B Carrying case for BC55XLT	\$14.95
BC70XL-B Bearcat 20 channel scanner	\$159.95
BP70-B Ni-Cad battery pack for BC70XL T scanner ..	\$39.95
BC142XL-B Bearcat 10 channel 10 band scanner	\$84.95
BC147XL-B Bearcat 16 channel 10 band scanner ..	\$94.95
BC172XL-B Bearcat 20 channel 11 band scanner ..	\$124.95
BC177XL-B Bearcat 16 channel 11 band scanner ..	\$129.95
BC590XL-T-B Bearcat 100 channel 11 band scanner	\$194.95
BC760XL-T-B Bearcat 100 channel 12 band scanner	\$254.95
BC002-B CTCSS tone board for BC590/760XLT	\$54.95
BC003-B Switch assembly for BC590/760XLT	\$22.95
BC855XL-T-B Bearcat 50 channel 12 band scanner	\$199.95
BC560XL-T-B Bearcat 16 channel 10 band scanner ..	\$94.95
BP205-B Ni-Cad battery pack for BC200/100XLT	\$39.95
TRAVELLER2-B Grundig shortwave receiver	\$84.95
COSMOPLIT-B Grundig shortwave receiver	\$179.95
SATELLIT500-B Grundig shortwave receiver	\$499.95
SATELLIT650-B Grundig shortwave receiver	\$849.95
ATS800-B Sangean shortwave receiver	\$89.95
ATS803-B Sangean shortwave receiver	\$159.95
74102-B Midland emergency weather receiver	\$34.95
77116-B Midland CB with VHF weather & antenna	\$66.95
77118-B Midland CB mobile with VHF weather	\$62.95
77913-B Midland CB portable with VHF weather	\$79.95
76300-B Midland CB base station	\$92.95
NPD-B Uniden National Police Directory	\$19.95
FBE-B Frequency Directory for Eastern U.S.A.	\$14.95
FBW-B Frequency Directory for Western U.S.A.	\$14.95
RFD1-B MI, IL, IN, KY, OH, WI Frequency Directory ..	\$14.95
RFD2-B CT, ME, MA, NH, RI, VT Directory	\$14.95
RFD3-B DE, DC, MD, NJ, NY, PA, VA, WV Directory	\$14.95
RFD4 AL, AR, FL, GA, LA, MS, NC, PR, SC, TN, VI ..	\$14.95
RFD5 AK, ID, IA, MN, MT, NE, ND, OR, SD, WA, WY	\$14.95
RFD6 CA, NV, UT, AZ, HI, GU Frequency Directory ..	\$14.95
RFD7-B CO, KS, MO, NM, OK, TX Freq. Directory ..	\$14.95
PWB-B Passport to World Band Radio	\$16.95
ASD-B Airplane Scanner Directory	\$14.95
TSG-B "Top Secret" Registry of U.S. Govt. Freq.	\$16.95
TTC-B Tune in on Telephone Calls	\$14.95
CBH-B Big CB Handbook/AM/FM/Freeband	\$14.95
TIC-B Techniques for Intercepting Communications ..	\$14.95
EEC-B Embassy & Espionage Communications	\$14.95
SMHV1-B Scanner Modification Handbook/Volume 1	\$18.95
SMHV2-B Scanner Modification Handbook/Volume 2	\$18.95
LIN-B Latest Intelligence by James E. Tunnell	\$17.95
A60-B Magnet mount mobile scanner antenna	\$39.95
A70-B Base station scanner antenna	\$39.95
USAMM-B Mag mount VHF ant. w/ 12' cable	\$39.95
USA-K-B 3/4" hole mount VHF antenna w/ 12' cable ..	\$34.95

Add \$5.00 shipping for all accessories ordered at the same time. Add \$15.00 shipping per radio and \$6.00 per antenna.

BUY WITH CONFIDENCE

Michigan residents please add 4% sales tax or supply your tax I.D. number. Written purchase orders are accepted from approved government agencies and most well rated firms at a 10% surcharge for net 10 billing. All sales are subject to availability, acceptance and verification. Prices, terms and specifications are subject to change without notice. All prices are in U.S. dollars. Out of stock items will be placed on backorder automatically or equivalent product substituted unless CEI is instructed differently. Shipments are F.O.B. CEI warehouse in Ann Arbor, Michigan. No COD's. Not responsible for typographical errors.

Mail orders to: Communications Electronics, Box 1045, Ann Arbor, Michigan 48106 U.S.A. Add \$15.00 per radio for U. P.S. ground shipping and handling in the continental U.S.A. For Canada, Puerto Rico, Hawaii, Alaska, or APO/ FPO delivery, shipping charges are two times continental U.S. rates. If you have a Discover, Visa, American Express or MasterCard, you may call and place a credit card order. 5% surcharge for billing to American Express. For credit card orders, call toll-free in the U.S. Dial 800- USA-SCAN. For information call 313-996-8888 FAX anytime, dial 313-663-8888. Order from Communications Electronics today. Scanner Distribution Center™ and CEI logos are trademarks of Communications Electronics Inc. Sale dates 11/1/91 through 4/30/92 AD #101691-B Copyright © 1991 Communications Electronics Inc.

For more information call 1-313-996-8888

Communications Electronics Inc.

Emergency Operations Center

P.O. Box 1045, Ann Arbor, Michigan 48106-1045 U.S.A.
For orders call 313-996-8888 or FAX 313-663-8888



New Schedule - W2XAD - March 15th
10 a.m. to 6 p.m. EST.

M. S. Gordon Taylor

We acknowledge with thanks your communication reporting reception of our short-wave program on the above date from station W2XAF-W2XAD.

W2XAF, operating on a frequency of 9530 kilocycles or 31.48 meters, is on the air daily from 4:00 p.m. until 12:00 p.m. Eastern Standard Time.

W2XAD, operating on a frequency of 15,330 kilocycles or 19.56 meters, is on the air daily from 10:00 a.m. until 3:00 p.m. Eastern Standard Time.

Special transmissions, other than the above, will be announced at sign-off periods on both stations.

Regards
E. J. [Signature]

GENERAL ELECTRIC
SCHENECTADY, N. Y., U.S.A.

MAR 8 1942

The American broadcasts to Germany during the war, said a German intelligence officer, were weak and had no impact. This 1937 QSL is from General Electric stations W2XAF (9530 kHz) and W2XAD (15530 kHz), which evolved into station WGEO, used for such broadcasts during the war years.

called *German Freedom Station* was in the same area under the same direction.

For a time, *Gustav Siegfried Eins* made quite a stir. It was located in England and used as its theme song the same melody as the theme song of *Deutschlandsender*. Several times each evening at seven minutes before the hour this transmitter brought a talk by the Chief. The Chief's language was

raw enough to make a hard-boiled soldier at the front turn pale. He gave descriptions of the private lives of the National Socialist bigwigs. Generally these were pure fiction or at least greatly exaggerated. One of the maddest tales was his report on "Schwarze Jutta," the supposed lady friend of a German admiral and the principal heroine of the wildest goings-on. Such wild stories wearied and repelled the listener. These broadcasts did not have the least effect and people asked themselves, "if the Chief uses such language, how will the underlings talk?"

There were a huge number of other transmitters but there importance was slight.

The Importance of Foreign Broadcasts

The importance attributed to foreign broadcasts in official circles and the danger one saw in them is apparent from a decree of the Chief Signal Officer, General Gimmeler, dated 11 October 1944, regarding listening to foreign transmissions. Among other things, he said, "It is a sign of the most pitiful baseness and of the most dangerous weakness when one listens to foreign broadcasts . . . I order ruthless intervention without regard for person or rank whenever this greatest of all crimes is discovered."

Along with the type of broadcasts already described, there was one other—shall we say "active" use of radio, especially by the British. I mean the so-called special messages which were intended for agents employed in Germany. They were short and might read somewhat like, "My mother is at home," or "Vienna is in Austria," or "The first window is lighted, the second window is dark," etc. These were messages agreed upon in advance which had references to parachute drops, agent meetings, changes of frequency, and the like.

Occasionally, pieces of music were played to convey prearranged messages, primarily

in the Polish broadcasts of the BBC which were intended for the Polish resistance movement. They referred chiefly to parachute drops; these were regularly announced melodies, e.g. the soldier song *Es reiten die Ulanen . . .*, or *Oh du Mein Rosmarin, entfalte dich . . .*, or, "Die tausend Tapfern, and so on.

Role of WWII Broadcasts

Summing up the role of broadcasting as a means of psychological warfare, we can describe it as far reaching and significant. But if anyone should get the idea that the German people lost the war because they surrendered to the poison of hostile broadcast propaganda, he would be missing the point entirely. If things had worked this way, England would have had to lose the war because German broadcasts for five years were aimed at breaking down the will of the English people to resist. Or else the German people should have given in late in 1940 when British propaganda was trying to divide and infiltrate. But it merely met with resistance, just as the broadcast propaganda of Dr. Goebbels was rejected in England.

The importance of the English, Russian and other broadcasts seems to me to lie in another quarter; they helped the German people in their search for the truth, in their effort to learn the real relations of things, in its conscious and unconscious urge for spiritual recovery, in its search for a way out of the labyrinth of aberrations. If, after the outward collapse of the National Socialist reign of terror (a collapse which was inevitable), the German people showed that a vast majority had long since broken with that negative system and created conditions favorable to a positive course, then a good part of this cure may be ascribed to the critical searching of the broadcast frequencies. Broadcasting showed that it can only be an effective weapon if it uses the truth. And that is a lesson for the future.

Unquote

Thus we end the excerpts concerning WWII broadcasting contained in Wilhelm F. Flicke's manuscript, written in 1945. Our excerpts were taken directly from the original 322-page NSA translation, dated 1954. For those wishing to read the complete *War Secrets In The Ether*, a version of the Flicke manuscript was published in 1977 by Aegean Park Press. We don't know if the book is still in print, or its price. You might wish to check with Aegean Park Press (P.O. Box 2837, Laguna Hills, CA 92654) for further information.

I'll add that whatever lessons propaganda or truth broadcasting might have taught for the future, they are nothing compared to the horrible lessons Hitler's regime taught—if only they are never forgotten.

Next month we will return with our regular format of bits and pieces from here and there. Best wishes of the season to you and your family. We look forward to your joining us in January. ■

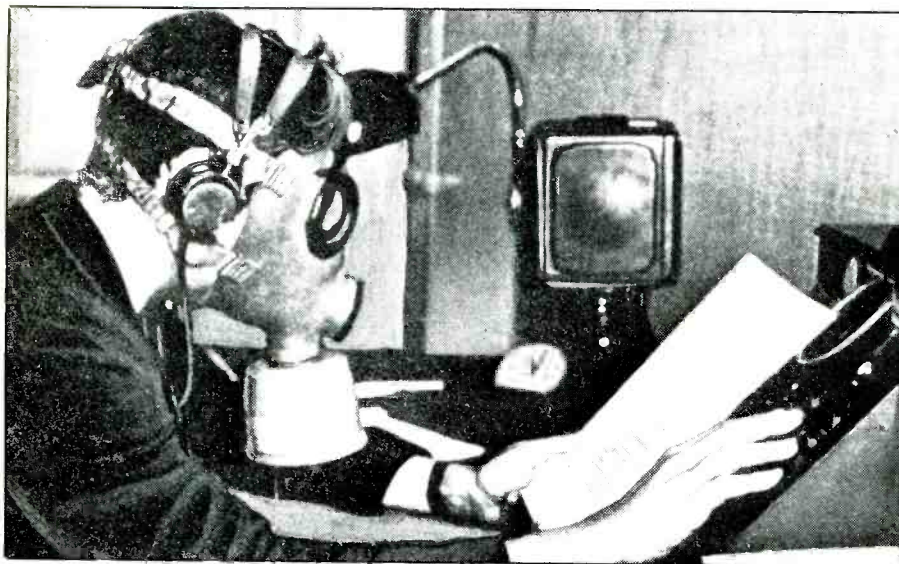

European propaganda broadcasters kept right on going throughout the war. This announcer in Rome didn't let a poison gas practice drill deter him from doing his job.

Outlaws & Hackers On The Computer Frontier

When hacker Bob Morris succeeded in hanging up an important national computer network three years ago, the incident made national headlines. It highlighted just how vulnerable the technology is that controls many of societies functions from national defense to credit reporting to the stock market. Yet, the Morris case was the public's first glimpse into a growing underground of high-tech renegades known as cyberpunks.

Reporters Katie Hafner and John Markoff, in their new book *Cyberpunk: Outlaws and Hackers on the Computer Frontier*, reveal who the cyberpunks are, the tech thrills that motivate them, and the amount of actual threat they pose in an age of complex computer networks.

The authors feel that in the 1960's and 1970's, being a hacker was a badge of honor, signifying to outsiders fanatical dedica-

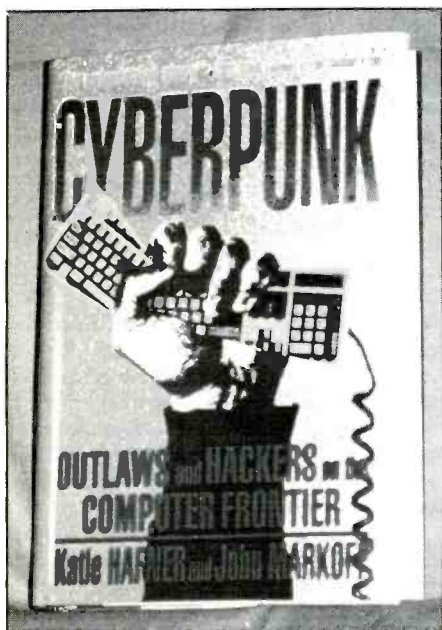

tion to an exotic technology, but which was a matter of course to the hackers themselves. The inspiration for this book came about when the authors began to see a change in the way computers were being used, with early omens of cyberpunk beginning to appear. These, they say, were young people who became so obsessed with computers that they carried their activities beyond what computer professionals considered acceptable limits of ethics and legality.

This 368-page hardcover book is the first in-depth look at this world, particularly spotlighting three hackers whose exploits have been audacious and potentially damaging.

One is Kevin Mitnick, who was successful at hacking into the top-secret software planning group at a major computer manufacturer. Embarrassed, the manufacturer had managed to limit publicity about the incident — although this book now has the whole story.

Next, Pengo is examined. He was a West German hacker who tried to get military information to sell to the Soviets. It was more of an outlaw fantasy of Pengo and his friends than a political statement, but it caused Pengo to roam through military computer networks worldwide looking for secrets. He was eventually caught because of his persistent break-ins.

Finally, Robert Morris is profiled. As brilliant as he was irresponsible, Morris inserted a potent computer virus into the national Alphanet computer network linking the Pentagon, defense contractors, and research universities.

As the authors explore the cyberpunk culture, they when and why the hacker ethos changed from one of benign intellectual fascination to one that fostered criminal behavior. They examine this preoccupation of thousands of persons whose knowledge of computers coupled with their ulterior motives has kept computer security experts swimming as fast as they can to keep their data safe.

Cyberpunk is an engrossing book; a dispatch from the frontiers of technology relating to an important issue of public concern. For persons interested in computers, communications, technology, and communications, it's doubly fascinating.

Cyberpunk is published by Simon & Schuster. You should be able to buy it at (or order it through) most bookstores. The price is \$22.95. If the bookstore has to order it for you, be sure to tell them the ISBN, which is 0-671-68322-5.

Light Reading

If you're a student, systems engineer, physicist, computer scientist, electronics hobbyist, technician, cable TV operator, or telecommunications manager, you may find it useful to have a complete reference tool or practical applications guide to fiber optic communications. With its high performance and limited space requirements, fiber optic cable is quickly taking over a large number of the jobs that were formerly the exclusive territory of copper cables.

In the 1,178-page hardcover reference entitled, *The Fiber Optics Handbook, 2nd Edition*, you'll find detailed information on the transmission medium; sources and detectors; optical cables and passive devices; optical systems; integrated optics; advanced topics in optical communication.

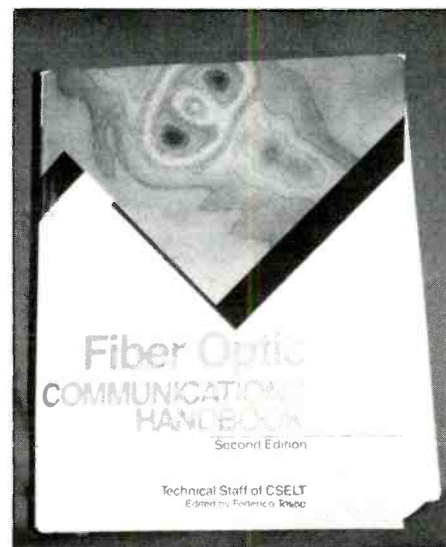

Eighty percent of the earlier edition has been completely revised, and you'll now find detailed descriptions of the latest advances in fiber optics, including: single-mode fibers; optoelectronic components; polarization aspects; nonlinear aspects; coherent systems; applications in distributed and local area networks; and more.

Also included are chapters on fabrication techniques and photonic communications.

You'll be impressed by the scope and detail of this book's coverage. It's the most up-to-date and fully comprehensive resource available to professionals and students in this rapidly expanding field. Balancing concepts, experiments, and actual hands-on practice, the reader is provided with all of the knowledge and working tools necessary to engage in competently in this exploding technology.

While there are considerable amounts of data and graphs that can be used when working with fiber optic systems, the book will also enable you to understand the fundamentals in the fascinating world of fiber optic technology.

Fiber Optic Communications Handbook, 2nd Edition, is \$89.50 from TAB Professional and Reference Books, Blue Ridge Summit, PA 17294-0850. Order book Number 3201.

The Hidden Meanings Explained

Telephone technology has taken giant strides in the past decade, with enormous expansion in toll-free 800 services, in toll 900 service, and other areas relating to long distance. To a great extent, this has been the result of many companies other than AT&T

High Performance

800MHz • CORDLESS
BABY MONITORS

FREE CELLULAR OR CORDLESS
FREQUENCY CHARTS

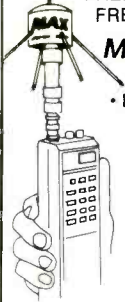

MAX 800 GROUND PLANE

- Enjoy the best possible reception
- Hear signals other antennas miss
- Astounding performance outside
- Hear 10 times more signals when mounted directly on scanner
- Use on any scanner with optional adaptor or cable

50 ft. RG6—\$35.00 Only **\$19.95**
Base Adaptor—\$15.00
Hand Held Adaptor—\$12.00

MAX CELLULAR MAG MOUNT

- Receive 800 MHz in car.
- Place on car roof and connect BNC cable to scanner
- 3dB - 14 inches high—GREAT!!

Only **\$39.95**



MAX 46-49 MHz DIPOLE

- Be amazed by number of conversations heard
- Includes 50 ft. RG-8X
- THE BEST!!

Only **\$49.95**

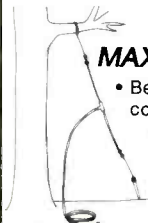

SASE for brochure
US shipping &
handling—\$4.00

MAX System™

GROUND PLANE ANTENNAS

CK-MO-MC-VISA Accepted (MA add 5% sales tax)

Send payment to: Cellular Security Group,
4 Gerring Rd., Gloucester, MA 01930
Or charge by phone: (508) 281-8892

SUPER LONG PLAY TAPE RECORDERS

12 Hour Model —
USES 120 TAPE
\$119.00*

Modified Panasonic Slimline,
high quality AC-DC provide 6
continuous hours of quality
recording & playback on each
side of cassette for 12 hours
total. Includes • Voice level
control • Digital counter,
etc. TDK - 120 Cassette
Furnished.



PHONE RECORDING ADAPTER

Records calls automatically. All Solid
state connects to your telephone
jack and tape recorder. Starts
recording when phone is lifted.
Stops when you hang up.

\$28.50*

FCC APPROVED

VOX VOICE ACTIVATED CONTROL SWITCH
Solid state. Self contained. Adjust-
able sensitivity. Voices or other
sounds automatically activate and
control recorder. Uses either re-
corder or remote mike. **\$28.50***



* Add for ship. & handling. Phone Adapter & Vox \$2.00 each
Recorders \$5.00 each. Calif. Res. add tax. Mail order, VISA,
M.C., COD's OK. Money Back Guarantee. Quantity discounts
available. Dealer Inquiries invited. Free data.
AMC SALES INC. Dept. P 9335 Lubec Street
Box 928, Downey, CA 90241
Phones (213) 869-8519 1-800-926-2488
FAX: (213) 923-1478
Mon-Fri 8-5 PAC. TIME

National 800/900 Telephone Service Code Book

A Directory of the Hidden Codes in 800 & 900
Long Distance Phone Numbers; Plus a Listing of
Long Distance Carrier Access Codes!
1,641 Listings!

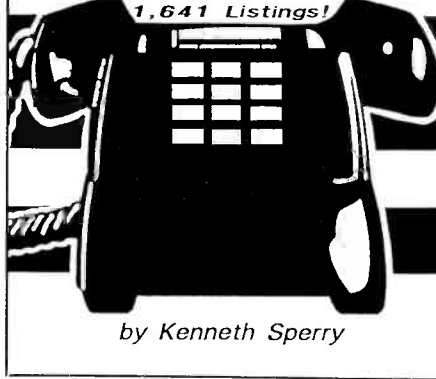

by Kenneth Sperry

entering the business of providing various
long distance and other services.

The first three digits following the "800"
in a toll-free number are actually a hidden
code that specifically identifies the particular
long distance carrier handling that call. Present-
ly there are more than 520 such "800"
codes assigned to more than 155 different
long distance carriers. Most people don't
realize this.

For example, in telephone numbers such
as (800) 321-2121, (800) 874-0981, or
(800) 292-2355, the codes 321, 874, and
292 denote that those using these numbers
are doing so via the services of AT&T. Like-
wise, numbers such as (800) 766-2255 and
(800) 888-8255 have codes that show they
are handled via MCI facilities.

Similarly, the first three digits of each
"900" telephone number are also a con-
cealed code number that identifies and re-
veals the specific carrier handling the call.
Right now, there are more than 320 such
"900" codes assigned to 86 long distance
carriers.

In addition to these codes, and perhaps
even more interesting, are the Carrier Iden-
tification Codes (CIC's). These are three-
digit telephone dial-up numbers used for di-
rectly accessing the facilities and services of
long distance carriers. At the present, there
are well over 750 CIC's assigned to nearly
600 firms.

Interestingly, "private" CIC's are even
held by states, federal agencies, military
switchboards, banks, satellite companies,
data and computer services, emergency
networks, credit card companies, radiopag-
ing services, and businesses (such as Dom-
ino's Pizza, Eastman Kodak, and others) for
their own internal communications.

Imagine if you could obtain the key that

reveals all 800 codes, 900 codes, and CIC's.
It would provide a lot of information on tele-
communications systems you use every single
day. This might effectively be put to
many professional uses, or to add to your
hobby interest in communications, or mere-
ly used to inform you of who operates these
systems.

All of these hidden codes (more than
1,600 in total), with their corresponding
meanings, are now provided in a revealing
and useful new directory called the *National
800/900 Telephone Service Code Book*,
by Kenneth Sperry. This book also has de-
scriptive text discussing and explaining 800
and 900 services, as well as how CIC's are
used to access the telecommunications fa-
cilities of long distance carriers and others.
Listings cover USA, Canada, and the West
Indies.

One example of how access codes can
come in handy was explained in a radio
commercial I heard recently while I was in
New Jersey on business. It said that persons
living in five northern NJ counties who were
calling New York City could save 10% to
30% on the cost of their calls if they dialed
"10-NJB" (10-652) ahead of the number
they were calling. I wondered why. When I
looked up it up in the *National 800/900
Telephone Service Code Book*, I learned
that 652 is the CIC code for gaining access
to "New Jersey Bell - Corridor" facilities,
also that "10" is the CIC prefix used for ac-
complishing this in "equal access" areas.

This was my first clue that there's a lot of
useful information here. Since then, I've
looked up all sorts of "800" and "900"
codes in phone numbers I have come across,
and found out who the carriers really are. I
have also tried a couple of the CIC access
codes in the book and hooked up with sev-
eral people and organizations who were
more than a little surprised to hear from me.
I would suppose that some adventuresome
soul with talent and imagination could em-
bark on many more excellent (or bogus) ad-
ventures than even Bill and Ted did.

In addition to this information, author
Sperry offers a brief discussion on the new
Unix security system designed to thwart cy-
berpunks. There are some toll-free numbers
listed, too, including one that gets a local
weather forecast throughout most of the
USA.

The *800/900 Telephone Service Code
Book*, by Ken Sperry is \$9.95, plus \$3.50
shipping (UPS to USA; 1st Class Mail to
Canada, APO, FPO, AK, HI, GU, PR, and
VI) from CRB Research Books, Inc., P.O.
Box 56, Commack, NY 11725. NY State
residents please add \$1.08 sales tax. This
book is also available from many dealers
carrying CRB's books.

RTTY Press Services

Many who DX on the RTTY bands enjoy
military, diplo, weather, maritime, and
mystery traffic. Yet, among the mainstays
on these bands are those stations around

the world sending news broadcasts and bulletins in various languages. Of particular interest to DX'ers in North America are those with scheduled RTTY news transmissions in English.

RTTY news transmissions chatter away at all hours of the day and night from the USA, France, Cuba, Germany, USSR, Japan, Poland, Argentina, Yugoslavia, Belgium, Vietnam, Philippines, Egypt, Syria, Turkey, Iraq, Libya, Iran, Greece, and many other nations. Some are from official government news agencies, others originate from commercial news services. When you copy these transmissions, you're getting the news while the stories are breaking — just as soon as local and national news media are receiving the same information for use in newspapers and on radio and TV. This gives the RTTY DX'er an advance look at news stories in-progress, even before they come out in the media.

News items include local and world events, sports, trade, and financial data.

The reference guide to these transmissions is *World Press Services Frequencies, 5th Edition*, by Tom Harrington, W8OMV. This newly updated directory lists all RTTY news transmissions according to transmitting time, according to transmission frequency, and according to country and press service. It also includes valuable general information on RTTY monitoring, including selecting equipment and getting started.

This fine information source is published

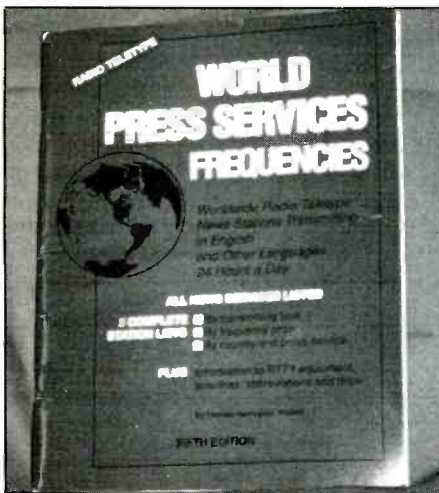

by Universal Electronics, Inc., 4555 Groves Road, Suite 13, Columbus, OH 43232. The book is \$8.95, plus \$3.00 shipping.

In Addition . . .

The *NCVA Cryptolog* is a wonderful tabloid-size newspaper issued quarterly by a worthy organization called the Naval Cryptologic Veterans Association. It's edited by Graydon A. Lewis, who is a ham and enthusiastic POP'COMM supporter. The NCVA is primarily comprised of USN vets who were involved with crypto and signals intelligence while on active duty.

The latest issue of *The NCVA Cryptolog* is Vol. 12 No. 5, and it's a beaut, being a full

three years in preparation. This is a 48-page edition filled with members' first-person codebreaking and signal intercept experiences while on duty in Alaska during World War II. Loaded with rare photos and maps, as well as stories you haven't heard or read before.

The COMINT articles by Capt. Whitlock (USN) and Capt. McIntire (USMC) alone are worth the \$16.00 price of this special edition, which we highly recommend to anybody interested in reading many exciting communications-related war experiences on the occasion of this 50th anniversary of the start of the war in the Pacific.

The special Alaskan edition can be purchased from the NCVA, 4809 Listra, Road, Rockville, MD 20853. Get your copy while they've still got a supply of them left.

We enjoyed seeing the premier copy of a new newsletter called *Scanning Wisconsin*, edited by Ken Bitter. Its name is self-explanatory, and the first issue was chock full of newsy information and frequencies of interest to Wisconsin scannists, including a product review. We'd say that here's a publication worthy of the support of Wisconsin scannists. They say they publish six times per year for a one year subscription price of \$9, or two years for \$17. Canadian orders add \$3 per year. A sample copy is \$1.50, plus 52 cents shipping/handling. Its put out by AJC Inc., W. 17912 Pearl Dr., Muskego, WI 53150-9608.

Jo Gunn Enterprises

— CB Antennas
— Mobile Antennas

— 10 Meter Antennas
— Coax

3 STAR

"Local-Groundwave-DX"
11 Meter



UPS SHIPPABLE



Specifications:
TYPE: Horz. 8 Vert. Polarization Twin Feed
GAIN: 14.5 DB
FRONT to BACK RATIO: 40 DB True
SIDE REJECTION: 40-45 DB True
BACK REJECTION: 40 DB True
WEIGHT: 28 Lbs.
LENGTH: 8 Ft.
SWR: 1:1
HORZ. to VERT. SEPARATION: 20.25 DB
WIND SURVIVAL: 100 MPH
POWER MULTIPLICATION: 40X
AUDIO GAIN: 18 DB
WIND LOAD: 2.8

HILLBILLY

"Horizontal and Vertical
10 Meter Omni"



Specifications:
FREQUENCY RANGE: 26.000-29.500
GAIN: Horizontal - 5.25 DB
Vertical - 4.75 DB
MULTIPLICATION FACTORS: Horizontal - 17 Times
Vertical - 15 Times
HORZ. to VERT. SEPARATION: 20.25 DB
POWER RATING: 2000 CW, 4000 PEP
HEIGHT: 11 Ft.
WEIGHT: 10 Lbs.
MATERIALS: 6063 T-6 Aircraft Aluminum Tubing
Requires 2 Separate Coaxial Cables for Hook-Up

Call or send \$2.00 for Complete Catalog and Pricing of Antennas.



Route 1 — Box 32C, Hwy. 82
Ethelsville, AL 35461
(205) 658-2229
FAX: (205) 658-2259
Hours: 10 am - 6 pm (CST)
Monday - Friday

DEALER INQUIRIES, PLEASE CALL

SOMERSET ELECTRONICS

Made in USA

Announces... THE MICRODEC™ 'SERIES'

NOW IT'S YOUR CHOICE! You select the Model and the features to meet your decoding and budget needs*! Each choice is fully upgradeable to the top of the line! With our new VIP50 Interface you can choose an expanded display (32x16 characters on your television) and hard copy — with or without a computer!

FEATURES:	MD100 BASIC <i>List: \$229.95</i>	MD200 PLUS <i>List: \$329.95</i>	MD300 MAXIM <i>List: \$429.95*</i>
(Compact Size: 1.3Hx5.1Wx5.3D)			
MORSE: DECODES CW WITH			
Autospeed, software filter, speed display ★		★	★
RTTY (60,67,75, 100 WPM) (major shifts) ★		★	★
RTTY (bit inversion)		★	★
ASCII (110 & 300 BAUD)	★	★	★
ASCII (bit inversion)		★	★
AMTOR/SITOR Mode A-ARQ		★	★
AMTOR/SITOR Mode B-FEC		★	★
Smart display/Intensity control		★	★
On/Off with volume		★	★
Serial Interface	★	★	★
Code Oscillator	★	★	★

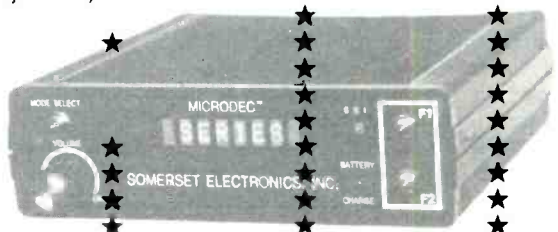

AVAILABLE OPTIONS:

Display Colors: (Green standard—no charge) Red, or Yellow (your choice) \$15.00
 NICAD Batteries for portability \$29.95 Model VIP50 Adaptor \$189.95*
 *MD300 price includes the VIP50 Interface Adaptor.

(TV Stations, phone companies, and public utilities are selecting MICRODEC™ for their operational and FCC requirements - FCC Docket 86-337.)

Call us for special introductory prices and orders at 1-800-678-7388.
Fax orders: 1-407-773-8097 • Technical assistance: 1-407-773-8097
VISA • MASTERCARD • PERSONAL CHECKS • MONEY ORDERS
SOMERSET ELECTRONICS, INC. • 1290 Hwy. A1A, Satellite Bch., FL 32937

The Radio Animal: Still Hiking Up the Jolly Roger

The Public Just Loves This Pirate, The FCC Doesn't

BY ANDREW YODER

Ask the average guy on the street, "Where's the best city in America to find the pirates?" More often than not, he'll say "Pittsburgh"—especially if you are talking to a baseball fan. Check the sports section and you will find that the Bucs had a great year in 1990.

On the other hand, if you ask the FCC the same question, they will say "Pittsburgh". But if you ask them, "Who is the leader of the Pittsburgh pirates?", they probably won't say Barry Bonds, Bobby Bonilla, or even Doug Drabek. They'll go with the Radio Animal.

The Radio Animal is not yet a "household name," but he is beginning to emerge from amongst the ranks of the pirate radio underground. Aside from being mentioned in *Popular Communications*, and other hobby radio magazines and newsletters, his pirate station has been featured in several national and regional magazines, on the evening news of a major television station in Pittsburgh, and in the limelight of a "behind-the-scenes" videotape on pirate radio.

Beginnings

Although it might appear that the Radio Animal has just broken into the scene, his pirate experience actually dates back to around 1980. Then, his love for radio drove him into experimental broadcasting. "I used to sit by the radio late at night with the lights turned off for atmosphere and listen to distant stations on the AM broadcast band. Actually, I still do," said the Radio Animal.

Gradually, the Radio Animal began to experiment with low-power hobby broadcasting. Over the years, he constructed various homemade transmitters with scrapped electronics; he added second-hand audio equipment and record albums that were either bought at yard sales or salvaged from the dumpster of the local FM rock station. "Some of my equipment was crude, but it worked," said the Radio Animal pointing to a silver, aluminum-foil covered box that served as a mixer. "I used it (the mixer) until I had the money to buy one from Radio Shack. It still works, though."

With powers as high as 60 watts output,

his local stations covered Pittsburgh even though he set the frequencies in the middle of the standard AM broadcast band. Unfortunately, the combination of unresponsive listeners and the lack of a maildrop (although he occasionally announced his home telephone number for requests) restricted the Radio Animal from receiving much feedback.

The 1987 ship-board broadcasts from Radio Newyork International (RNI) forever changed the hobby for the Radio Animal. For the first time, he learned that other radio hobbyists were experimenting with broadcasting without a license—pirating. The RNI crew inspired him to consider regional and/or national-coverage pirating.

WKND, Weekend Radio

After being persuaded by a friend, the Radio Animal initiated plans for a new station to operate on 1620 kHz and 6240 kHz, two



The Radio Animal strikes a pose in the WKND basement studio.

of the frequencies formerly used by RNI. For its initial broadcast, WKND operated on Halloween evening 1988 on 1620 kHz. The AM transmitter was home-brewed and adjustable for up to 60 watts of peak output power. In order to "push" the low-wattage



A special QSL from WKND's Halloween "Horror Jam" in 1989.

WKND

WEEKEND RADIO

Dear Free Radio Listener,

Thank you for listening, and taking the time to write to, WKND--Weekend Radio. It's always great to hear from those who listen - after all, there are more ways to communicate than just radio!

THE CONCEPT

Although WKND is mostly a hobby effort at this point, there are other reasons for our broadcasts, for example: to act on what we believe is our (and everyone's) right to use the airwaves; to be an outlet for so-called "underground" programs, or anything we would wish to transmit; to work and experiment with the technology of radio systems, just for the thrill of it, etc. Above all the idea is communication - to present our thoughts and ideas to you.

A BRIEF HISTORY

The thought that something has to be done about the state of radio has probably been with the 'Animal since the late 70's, but it took the shipboard broadcasts of Radio Newyork International in late 1987, to give us direction. After listening to their tests on 1620 KHz., WKND was born. We put the station together throughout the Summer of 1988, and made some tests. Our 'official' debut was on Halloween of '88 with a 4 hour "Horror Jam" of music, skits, and ID's. Power was 60 watts on 1620 only. Even so, the broadcast was widely heard. Early in 1989 we began transmitting on shortwave at 6240 KHz. with 25 watts output. Even though the station's range was increased, we didn't want to abandon 1620 completely, so recently we've been simulcasting on both frequencies at once!

STATION EQUIPMENT AND OPERATION

WKND is made up of both bought and built equipment. Most of the studio is bought; turntables, tape decks, mixer board, microphone, etc. However, the audio processing chain is hand built because the units were either too expensive, or not available when we needed them. Both the 25 watt and the 60 watt 1620 transmitters are homebrew. The shortwave unit is a Heathkit HX-11 CW ham transmitter that was bought at a flea market for \$10. We built and installed a regulator modulator to convert it to AM. Both lowband and highband transmitters are modulated by a home stereo used as a power amp. With this crazy array of equipment, it's no wonder we've been called a mongrel station!

WKND programs are pre-recorded or live. I personally like live better because of the spontaneity, so we've been doing more of these lately.

Well, free radio listener, I, Radio Animal THANK YOU for writing in to WKND. We wish you the best that pirate DXing has to offer, in the 90's and beyond! Tune us in again!

Yours Very Truly in the Power of Free Radio,

Radio Animal
Radio Animal

A promo sheet from WKND.

signal as far as it would go, 290 feet of aluminum wire (from a television degaussing coil) was hoisted into the air with 10 helium balloons. Amazingly, WKND was heard across the entire Northeast for this test broadcast.

During the early stage of WKND, the station operated mysteriously. Most of the broadcasts were aired around midnight Eastern time, and featured a variety of progressive/space music by Pink Floyd, Moody Blues, Count V, etc. Clashing greatly with the "regular format," songs by Michael Jackson, Rigor Mortis, Weird Al Yankovic, and others were occasionally thrown into the pot. Adding to the strange atmosphere, WKND signed on and off with the theme from *Dr. Who* (a British science fiction television program) and the announcers opted for brief IDs, rather than the long discussions that sometimes dominate pirate programming. "We felt a bit uncomfortable about saying much at that point, and besides, it added to the overall effect," said the Radio Animal.

Early in 1989, WKND suddenly flipped formats from almost no-talk space music to a strange combination of rap, heavy metal, pop, and disco music with frequent "chatter" from the announcers. The new format and the fact that the frequency was shifted to 6240 kHz (from 1621.3 kHz) fooled a number of listeners into believing that the broadcasts emanated from separate stations.

By March 1989, some of the mysteries that surrounded WKND began to dissipate when the station linked up with a maildrop in Beaver Falls, Pennsylvania (now in Blue Ridge Summit, PA). After this point, the Radio Animal responded to listeners with promo sheets and lengthy letters about the station.

In order to answer the backlog of mail and also to work on plans, equipment, and programming for the station, the Radio Animal was rarely active in the summer of 1989. "I like to take things slow and think about a situation before I just jump into it." On the bench for the summer were plans for a first anniversary Halloween show and for a high-

MFJ SHORTWAVE ACCESSORIES REMOTE ACTIVE ANTENNA

MFJ-1024 Receive strong clear signals from all over-the-world with this 54 inch active antenna that rivals long wires hundreds of feet long.

\$129.95 "World Radio TV Handbook" rates the MFJ-1024 as "a first rate easy-to-operate active antenna ... Quiet with excellent dynamic range and good gain ... Very low noise factor ... Broad frequency coverage ... the MFJ-1024 is an excellent choice in an active antenna."

Remote unit mounts outdoors away from electrical noise for maximum signal and minimum noise pickup. Mount it anywhere - atop houses, apartments, ships, buildings, balconies.

Covers 50 KHz to 30 MHz. High dynamic range eliminates intermodulation. Control unit has 20 dB attenuator, gain control. Lets you switch

2 receivers and auxiliary or active antenna. 'On' LED. 6x2x5 inches. Remote has 50 ft. coax and connector. 3x2x4 in. 12 VDC or 110 VAC with MFJ-1312, \$12.95



INDOOR ACTIVE ANTENNA

MFJ-1020A Now you'll rival or exceed the reception of outside long wires with this tuned indoor active antenna.

\$79.95 "World Radio TV Handbook" says MFJ-1020 is a "fine value ... fair price ... best offering to date ... performs very well indeed."

Its unique tuned circuitry minimizes intermod, improves selectivity, reduces noise outside the tuned band. Functions as a preselector with external antenna. 0.3-30 MHz. Telescoping antenna.

Controls are Tune, Band, Gain, On-Off/Bypass. 6x2x6 in. Use 9 Volt battery 9-18 VDC or 110 VAC with MFJ-1312, \$12.95



ANTENNA TUNER/PREAMP



MFJ-959B Don't miss rare DX because of signal power loss between your antenna and receiver.

\$89.95 The MFJ-959B provides proper impedance matching so you transfer maximum signal from your antenna to your receiver from 1.6 to 30 MHz. You'll be surprised by significant increases in signal strength.

20 dB preamp with gain control boosts weak stations. 20 dB attenuator prevents overload. Select from 2 antennas, 2 receivers. 9x2x6 inches. Use 9-18 VDC or 110 VAC with optional AC adapter, MFJ-1312, \$12.95

For your nearest dealer or to order:

800-647-1800

Order from MFJ and try it. If not satisfied return within 30 days for refund (less s/h). Add \$5.00 s/h. One year unconditional guarantee. Free catalog.

MFJ ENTERPRISES, INC.

Box 494, Miss. State, MS 39762
601-323-5869 Telex: 53-4590 MFJSTKV
MFJ ... making quality affordable

CIRCLE 156 ON READER SERVICE CARD

fidelity 1620 kHz transmitter with separate equalizers on each audio frequency band.

WKND rolled on the end of 1989 with high points as the first anniversary "horror jam" and a 1621 kHz broadcast that netted reports from as far away as Wisconsin, with only 25 watts output. Featuring a slick mix of songs (such as "Please Mr. Gravedigger," "Riders on the Storm," and "Sympathy for the Devil"), layered seasonal sound effects, public service announcements, and light talk, the Halloween WKND broadcast was also one of the station's most memorable.

Unfortunately, the Halloween broadcast was also WKND's last regular program (not including a handful of odd-frequency and 1621 kHz broadcasts that were only heard by a few listeners). Although none of the regular listeners realized it, the Radio Animal picked up a nasty habit of testing his 1620 kHz transmitters on two weeknights, back-to-back.

The FCC did spot this flaw in operations and field agents from offices in Philadelphia, Pennsylvania and Buffalo, New York were sent out to locate the station. On February 7, 1990, WKND was testing the transmitter for the second night in a row on 1620 kHz. Around midnight (local time), the Radio Animal heard a knock at the window of his basement studio. Instead of finding one of his friends at the window, the Radio Animal found John Rahtes, an agent from the FCC field office in Philadelphia.

"I was surprised," said the Radio Animal. "I didn't expect that the FCC would be at the door, especially at midnight." In the end, the bust went without incident: the Radio Animal showed the agents around the station studio, and he was fined for his activities (the fine was later reduced in light of WKND's cooperation).

At the time, the bust appeared to be the death of WKND and the end of the Radio Animal's broadcasting career. The March and April 1990 newsletters from ACE featured interviews about the WKND bust. The Radio Animal even announced his retire-

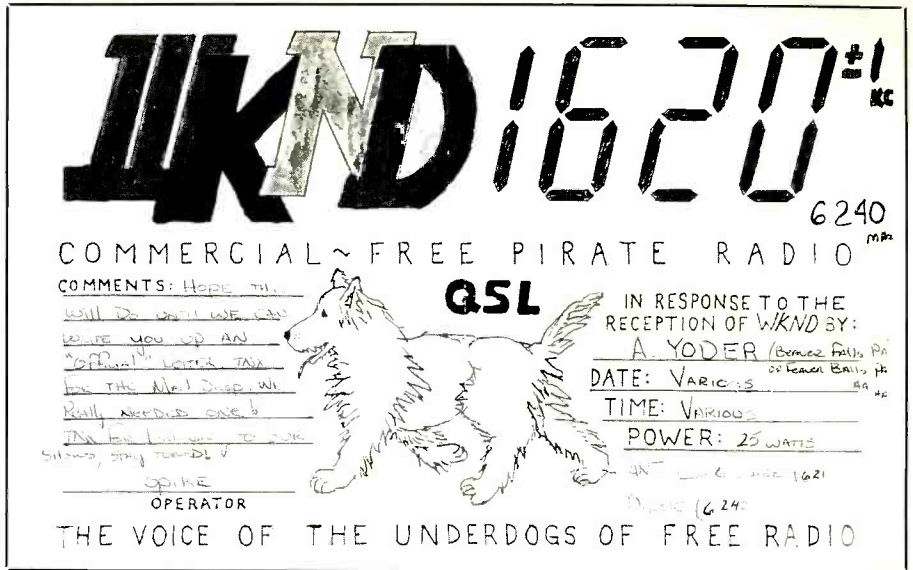

An early WKND QSL signed by Spike.

ment from the "free radio scene" and expressed his desire to find an announcing and/or production job at a commercial broadcaster. Meanwhile, other pirate activities rolled on, nearly as active as ever.

Even though the WLIS program was just a tape of the "real" pirate, the Radio Animal was served up with another reduced fine for re-airing the broadcast. Additionally, the FCC confiscated a transmitter, a mixer, a few turntables, cassettes, and other miscellaneous station materials. This bust brought WKND even more exposure. An article appeared in the *Pittsburgh Business News*, a magazine article featured the station, and the Radio Animal was interviewed for the prime time news on TV channel 11, WPXI, from Pittsburgh. "I was at a concert the next night," said the Animal, "some people recognized me and said, 'it's the guy who had the radio station.' I never had that happen to me before."

The Present And The Future

Unlike most pirate operators who drop their activities at the first hints of FCC pressure, the Radio Animal is still hiking up the jolly roger. Now, however, he avoids transmitting and instead is regularly heard as a guest on other stations. Lately, the Animal has appeared on WKZP, Action Radio, and Radio Flattus. But his two most important projects have been with the powerful Hope Radio and with Radio Wolf International.

On Hope Radio, the Radio Animal regularly presents a pirate news program that has been heard from Hawaii to Germany. "Ever since we started getting help from the Radio Animal and Phil Muzik (from KNBS), our programming has improved," said MJ, operator of Hope Radio. "Last year, we were voted as one of the worst stations in the ACE pirate poll. This year, I hope we'll be voted as the best."

The most recent project, Radio Wolf International, lumped the Radio Animal with Sparky (WKZP) and Harry A. Ness (Radio Flattus). On September 8, 1990, the group formed for a broadcast that was videotaped by the Franklin Video Group. Broadcasting from the field with a generator to power a mid-50's Johnson Viking II transmitter, the station received 50 letters from as far west as Idaho and New Mexico.

Radio Wolf International will not be returning via the transmitters of the Radio Animal, but the station will continue with a little help from friends. Likewise, his segments on the most active pirate of 1990, Hope Radio, will also continue. So, if you actively tune the shortwave "pirate bands," chances are that you will eventually run across the Radio Animal. After all, as he said, "Would ya even think someone who's been into free radio for nearly seven years could just quit like that?" Nah.

ASSOCIATED RADIO

8012 CONSER BOX 4327
OVERLAND PARK, KANSAS 66204

CALL 913-381-5900

FAX 913-648-3020

**SHORT WAVE
AMATEUR
RADIO**

New and reconditioned equipment.
BUY—SELL—TRADE—SERVICE

**CALL FOR
YOUR
LISTENING
NEEDS**



Send \$3.00 for our current catalog and wholesale sheet.

The New JRC NRD-535 Communications Receiver

The Japan Radio Co., Ltd. of Tokyo, Japan has been producing quality communications products since 1915. Historically, most of the company's marketing efforts were concentrated in the commercial and marine markets. But, some years ago the company started producing equipment for the serious shortwave listener and ham. This effort brought us the NRD-505, 515 and the 525. And, now the latest, the JRC NRD-535 receiver.

An Overview

First, the basics: The NRD-535 covers 100 kHz to 30 MHz, AM, SSB(USB/LSB), CW, RTTY, FM and FAX. The receiver operates from 100, 120, 220, or 240 VAC, 50/60 Hz, 35VA or less or 13.8VDC (nominal), 25W or less. The NRD-535's dimensions are: 13" wide x 5.5" high x 12.75" deep; weight is 20 lbs.

There is a built-in clock/timer, a line/recorder output and a built-in speaker; an optional external speaker, NVA-319, is also available. Other available options include: CMH-530 RTTY Demodulator Unit, CGD-135 High Stability Crystal Oscillator Unit, various IF Crystal Filters, and an RS-232C cable for computer control.

Sensitivity for SSB/CW/RTTY/FAX (10 dB S + N/N) is rated less than .3 uV from 1600 kHz to 30 MHz. AM sensitivity (10 dB S + N/N) is 6.3 uV below 1600 kHz, 2 uV between 1600 kHz 30 MHz. FM sensitivity is 0.5 uV above 1600 kHz. Frequency stability w/o the optional CGD-135 ± 0.5 ppm unit is ± 10 ppm short-term, ± 2 ppm long-term.

The NRD-535 is a triple-conversion design with the first IF at 70.455 MHz, second IF at 455 kHz, and the third IF at 97 kHz. The third IF is not used in the FM mode. IF and image rejection is 70 dB or better. Two-tone dynamic range is rated at 106 dB and measured at an IF bandwidth of 300 Hz. FM selectivity is rated at 12 kHz at -6 dB. In all other modes, there are a total of four filter bandwidths available: 12 kHz at -6dB, (no spec given at -60 dB); 6 kHz at -6 dB, less than 15 kHz at -60 dB; 2 kHz at -6 dB, less than 6 kHz at -60 dB; 1 kHz at -6 dB, less than 3 kHz at -60 dB.



Optional crystal filters include: CFL-231 (330 Hz at -6 dB), CFL-232 (500 Hz at -6 dB), CFL-218A (1.8 kHz at -6 dB), and CFL-251 (2.4 kHz at -6 dB).

The AGC has two selectable release times. The built-in IF notch filter attenuation is at least 40 dB.

The HF antenna inputs will accept either a 50 ohm coax or a high-impedance long-wire.

Other Features

The NRD-535 has just about everything one could ask for in a shortwave receiver. Its quiet direct digital synthesis PLL circuit eliminates much of the phase-noise complaints of earlier synthesized receivers. And, its use of the latest RF and mixer designs ensures excellent strong signal handling capability.

The PBS (passband shift) control allows for changing the center frequency of the selected IF filter by approximately ± 1 kHz without changing the bandwidth of filter. The BWC (bandwidth control) allows for continuous adjustment of the passband from 500 Hz to 2.4 kHz. These two features make this receiver a real QRM fighter!

The ECSS (exalted carrier selectable sideband) control selects a sideband, either upper or lower, which is the most immune to adjacent channel interference. This feature works only in the AM mode.

A front panel user-selectable dual-mode noise blanker, with adjustable threshold level, effectively reduces the problem of impulse ignition noise as well as longer dura-

tion pulses, such as OTHR (over the horizon radar).

Operation

It is a good idea to read the instruction manual quite well as the NRD-535 is quite a complex receiver. But, it shouldn't take you too long to get accustomed to its operation as the receiver is blessed with excellent ergonomics. The front panel control layout is very easy to use, including larger than normal control knobs. This is one receiver you don't have to have "munchkin-sized" fingers to operate.

Frequencies can be selected by four methods: 1) the main tuning knob. The tuning rate is front-panel selectable in 1 Hz, 10 Hz, or 100 Hz steps; 2) the front-panel "up-down" switch; 3) direct frequency input with front-panel keypad; and 4) the two-hundred memory channels. Each of the two-hundred memory locations permit the storage of mode, bandwidth, on/off state of the attenuator, state of the AGC, as well as the frequency of the station. The memory is non-volatile, so that even if the power fails, the memories will be retained.

You can also scan between designated memory channels or sweep between specific frequencies. The NRD-535 will scan all 200 memory channels or between only those you select. It will also sweep between two frequencies you designate. Quite a versatile tuning system. Bandwidth selection is independent of mode, as well as the AGC

(Continued on page 69)

NEW PRODUCTS

REVIEW OF NEW AND INTERESTING PRODUCTS

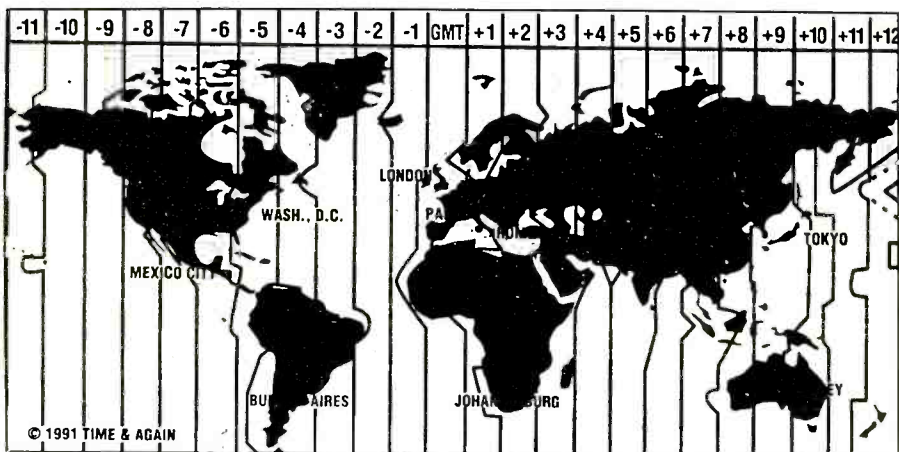

World Time Zone Map Decal

Time & Again Co. is the distributor of the World Time Zone Map decal, which can be placed on a shortwave receiver or any other object to reference international time zones at a glance. Since many shortwave receivers and other amateur radio equipment are lacking a time zone map imprinted on the case, the decal ideally fills the need.

These decals are made of a high quality

polyester and are self-adhesive for easy application to any surface. They are attractively toned with silver continents and blue oceans. The two sizes available provide for accommodation on small areas.

The prices per size are: 2¼ x 4¾ inches - \$2.00; 1½ x 3¾ inches - \$1.50, or both for \$3.00. Prices include tax. Send SASE and payment to: Time & Again, PO Box 306, Dickinson, TX 77539.



Compact HF Transceiver And A Compact HF Plus 6 Meter Transceiver!

Introducing two new HF transceivers—the all-new TS-450S HF transceiver which replaces the incredible TS-440S and the TS-690S, which will replace the TS-680S. We took TS-440S and added a whole list of new features.

Here is a list of new and different TS-450S/TS-690S features:

Direct Digital Synthesizer (DDS); fine tuning function, like the TS-850S; receiver dynamic range of 108 dB; RF power output control for all modes; choice of either with built-in automatic antenna tuner (80-10M) or without on the TS-450S; internal 80-10 M antenna tuner AT-450 optional for the TS-690S; all band, all mode operation, with general coverage receiver; 100 watts nominal output on TS-450S and TS-690S (50 W on 6 M); External Digital Signal Processor DSP-100 option/external antenna tuner AT-300 option; advanced intercept point

(AIP) which allows you to select either enhanced selectivity or reduced noise floor level; 100 memory channels, which can store everything you need for your HF operations; master/slave function, which allows you to transfer data from one radio to another. (This feature is compatible with the TS-850S) digital bar meter, and dual noise blankers.

With all these new features, this new HF radio surely looks like another Kenwood HF Winner!

For more information, contact your nearest Authorized Kenwood Amateur Radio Dealer!

Suggested retail price: TS-450S with tuner - \$1549.95, TS-450S - \$1349.95, TS-690S - \$1549.95.



PC Memory Keyer

MFJ Enterprises, Inc. announces the re-

lease of the MFJ-1268 PC Memory Keyer—a combination of IBM compatible software and hardware that turns your computer into a powerful memory keyer for \$49.95.

MFJ-1268 PC Memory Keyer hooks easily between your computer and radio. You get a total of 100 function key macros that you can easily set to send any messages or characters. You can set a macro to send a second macro at any point. Also, you can set a macro to pause a pre-set period for you to key in characters (or use paddle). You can also set them to send some characters faster or slower than others.

Many useful messages come pre-set in the macros. However, you can easily change them to say whatever you want.

Other features include incrementing serial numbering, speeds from 5-40 words per minute, variable speaker tone (or speaker off), weight adjustment, and instant access to on-line help, common CW abbreviations, Q-signals and official ARRL NTS Traffic codes.

Plus you get a full featured CW Tutor with Test Administrator that lets you give a code test on screen or printed out.

It comes with MFJ's one year guarantee.

For more information contact any MFJ dealer or MFJ Enterprises, Inc., PO Box 494, Mississippi State, MS 39762, or call (601) 323-5869, FAX (601) 323-6551, or order at 800-647-1800.

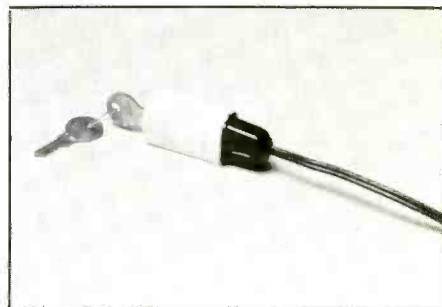

Prevents Unauthorized Use Of Equipment

The Plugbugger, available from Direct Safety Company, is a unique power cord lock for use on any two or three prong plug. It is designed to prevent unauthorized, or unwanted use of PC's, copiers and other equipment for safety or security reasons. The Plugbugger locks onto an electrical outlet plug and requires a key to release. (Price: \$9.50)

More information on the Plugbugger and other electrical safety and security devices is available in a new Master Catalog from Direct Safety Co. For a free copy, write: Direct Safety Company, 7815 S. 46th St., Phoenix, AZ 85044.



THE JAPAN RADIO CO. **NRD-535**

THE NEXT GENERATION IN HIGH-PERFORMANCE HF RECEIVERS

Once again JRC breaks new ground in shortwave receiver design. The new NRD-535 has all the features SWLs and amateurs have been waiting for. General coverage from 0.1 to 30 MHz in AM, USB, LSB, CW, RTTY, FAX and Narrow FM modes. Advanced ECSS operation for phase-lock AM reception. Variable bandwidth control (BWC). Tuning accuracy to 1 Hz possible with direct digital synthesis. 200 memory channels with scan and sweep operation. Triple Superheterodyne receiving

system. Superb sensitivity, selectivity and image rejection. Dual-width noise blanker eliminates impulse noise. Squelch, RF Gain, Attenuator, AGC and Tone controls. Optional RTTY demodulator available. 24 hour clock/timer. Easy to read vacuum fluorescent display with digital S-meter. AC and DC operation. Plus the most comprehensive computer interface found on any radio to date. Call or write today for a full color brochure, price list and dealer information.

JRC *Japan Radio Co., Ltd.*

MAIN OFFICE: Akasaka Twin Tower (Main), Akasaka 2-chome, Minato-ku, Tokyo 107, JAPAN
Tel.: (03) 584-8836 Telex: 242-5420 JRCTOK J

IN U.S.A.: 430 Park Avenue (2nd Floor), New York, NY 10022
Tel.: (212) 355-1180 FAX: (212) 319-5227 Telex: 961114 JAPAN RADIO NYK

Build A DF Antenna

A Simple Receiving Antenna With Directionality For HF

BY HANK OLSON, W6GXN

Are you "bugged" by a local source of RFI when you're trying to listen to Radio Australia on the BBC overseas service to get an "outside—USA" perspective of how things are going in the middle-east? Short of the laborious tracking down of an offending power-pole (and then convincing the local power company that you know what you're doing, so they'll fix the problem), a simpler solution could be at hand: null out the RFI with an antenna that is so simple that it almost doesn't appear to qualify as an electronic device!

The directional antenna was described in an SRI International report "Antenna For Reducing Shortwave Interference" by O.G. Villard, Jr. (W6QYT) and was prepared for VOA (January 1991). The report is user-oriented and describes how to build such an antenna and how to use it; that is, it is an operations manual as is appropriate for such a report.

Building the antenna is very simple; it is nothing but a small piece of aluminum sheet, with a 90° bent-up tab to which is screwed a short transistor-radio replacement-type telescoping whip. The antenna plate is made the same size as the small battery-operated SW receiver with which it is used to operate (see Figure 1).

My own SW battery-operated receiver is a Sony ICF-SW1 $4\frac{3}{8}'' \times 2\frac{3}{4}'' \times 1''$, so my aluminum plate is about $4\frac{3}{8}'' \times 2\frac{3}{4}''$. The plate is normally connected to the "ground" or "shell" of the radio; but even if only capacitively-coupled to the radio (with the ICF-SW1 sitting on the plate), the coupling is good enough. For convenience, the radio and its plate/whip accessory can be placed on a small plastic "lazy Susan" for ease of rotation. Then the whole integrated antenna receiver system can be placed on wooden table or bench. This allows one to easily rotate the system without actually having one's hands on it and thereby affecting the null by body capacity.

Does such a simple addition to a battery-operated SW receiver actually work, and if so, why? It is quite apparent in the use of it that it does null out interfering stations that are not in the same direction as the desired signal. The null can be as deep as 20 dB, although my particular receiver has no S-meter, and checks on an uninterfered-with SW

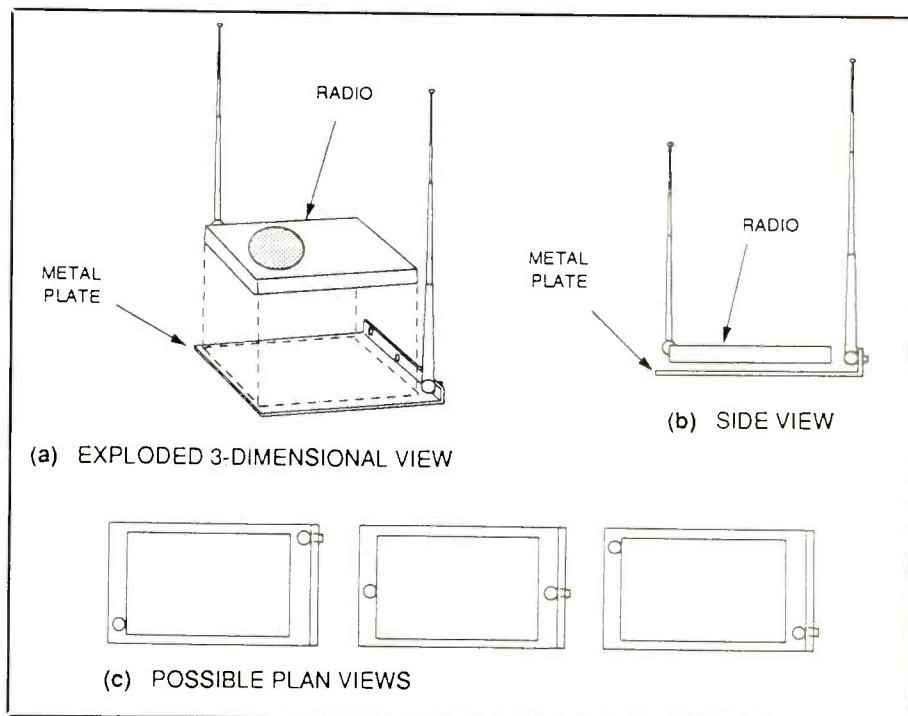

Figure 1- Perspective view.

station are hard to make because of the receiver AGC. The principle way of seeing the null is by noting the background noise increase when nulling a single signal. In the case of nulling an interfering signal, of course, the desired signal will control the AGC.

As to why this antenna works, my own interpretation of its operation is that it is one of a class of receiving antennas that have been known for many decades called "Adcock" antennas.

Traditional "Adcock" antennas are pairs of vertical balanced dipoles with equal-length balanced transmission lines between them so as to avoid azimuth errors incurred by a number of effects, most of which have to do with proximity of the earth and/or the transmission line used to feed the receiver. A really good treatise on Adcocks is given in *The Radio Engineers Handbook* by F.E. Terman, First Edition, 1943 by McGraw-

Hill (p. 880-884). Obviously this material was written when all shortwave receivers were tube-type, line-operated, and big enough to require one or two men to lift them into or out of an equipment rack. I doubt if the author could have envisioned my Sony ICS-SW1, the size of a pack of cigarettes, with no power cord, and even containing a digital synthesizer. It is precisely the new small size and freedom from external cables that allows this simple but technically elegant directional antenna to work as well as it does. Nonetheless, reference to Terman's *Radio Engineers Handbook* (if one can find a copy) is a worthwhile task, and one will note the references contained therein have names like Watson-Watt and date well back into the early 1930s.

The tiny shortwave receivers of today are only about 5 inches in their maximum dimension (about 13 cm); this is only 1/80 of the shortest wavelength in the HF band. So

our receiver is 2 or 3 orders of magnitude smaller than the wavelengths to be received, and can be considered a "point" which interferes very little with the waves received.

Because the receiver is so small compared to a wavelength, it really matters very little whether the antenna is "balanced" or not. The main point is that the voltage delivered between its antenna terminal and its "chassis" reference, are from two vertical whips with a spatial phase difference. This phase difference will contrast for each wavelength, and be less than $\lambda/2$, so the Adcock antenna principles will be in effect.

No claim is made for this antenna as a calibrated azimuth sensing device; it is simply capable of nulls that may be used to cancel interference from co-channel HF stations or noise sources. The plate should be made no larger than the radio with which it's used, and the extra whip should extend out about 6" longer than the one on the receiver. Care should be taken not to use the receiver/antenna system on or near metallic tables or benches. The system works best out-of-doors where home wiring does not interfere by causing re-radiation. Of course, no AC supply, earphones, or other external wires may be used with the radio.

In short, this easily built, simple accessory to your small battery-operated shortwave receiver can be a real help to "clear up" interference while not causing any modifications to that receiver. It is really worth a try.

YOU AINT HEARD NOTHIN...YET!

Since 1967, CRB Research has been the world's leading publisher and supplier of unique hobby and professional books and information including:

- Scanner Frequency Guides
- Shortwave Frequency Guides
- Military/Federal Communications
- Broadcast Station Registries
- Undercover Communications
- Survival Communications
- Covert Operations
- Electronic Espionage
- Surveillance
- Monitoring
- Cryptography & Codes
- Bugging
- Wiretapping
- Communications Antennas
- Electronics & Projects
- Computer Technology
- & Other Related Topics!

Ask For Big Free Catalog!

CRB RESEARCH

P.O. Box 56 Commack, NY 11725

CIRCLE 16 ON READER SERVICE CARD

UTC CLOCK

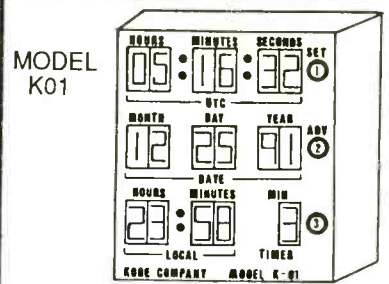

- UTC and local clock synchronized together. Set the minutes and seconds only once.
- Calendar synchronized to UTC clock
- Ten minute identification timer for hams
- Large easy to read LED display

CLOCK \$99
Postage /Handling 6

Non-Texas Total \$105
Texas Resident Sales Tax 8

Texas Resident Total \$113

Send check or Money Order to:

KODE COMPANY
Dept K1
P.O. Box 29095
Dallas, Texas 75229

SECRET FREQUENCIES

Why waste valuable time manually twisting that frequency dial looking for interesting transmissions when your computer can do it for you with RCSS™?

RCSS™ (Remote Computer Scanning System) takes full control of your radio and automatically scans the airwaves in search of those interesting "secret" transmissions. When a signal is found, RCSS™ automatically logs an entry in the database that includes the frequency, date, time of day, and the length of transmission. Other information may also be added to the record such as class of service, type of unit, call-sign, city, and other comments.

RCSS™ can run automatically while you work, sleep, or watch the game on TV. When you return, RCSS™ reports on all receiver activity that was found while you were away, enabling you to choose from among those interesting frequencies for listening. Or, if you prefer, add any standard tape recorder to automatically record the transmissions that RCSS™ finds.

RCSS™ connects to ICOM's R71A, R7000, R9000 and SASI's Seeker-301 receivers for operation. Software, interface and all required cables are included. RCSS™ is fully Microsoft Windows compatible and is the oldest software available of its type (4-years old). It's currently in use in 15 countries and being used by individuals, private corporations and Government agencies.

Watch for SASI's new Seeker 301 miniature broad band receiver and their new Spectrum-100 professional PAN adapter which is adaptable to most receivers.

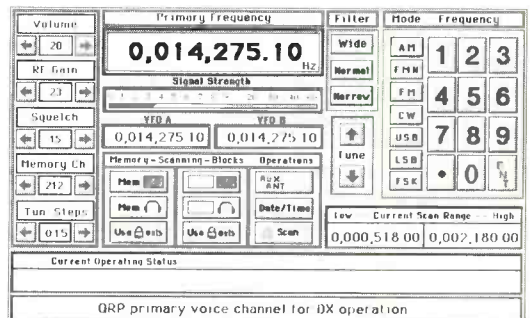

RCSS™ enables full computer control of receiver functions through the graphic user interface shown above. RCSS™ runs on IBM compatible and Macintosh computers. The NEW IBM version R9000 is shown above. Upgrades are available to registered users. A demo disk is also available for purchase. Call or Fax for more information.

SYSTEMS & SOFTWARE INTERNATIONAL LTD.

Systems & Software International is a small business and manufactures all equipment in the USA. Please contact us at: 4639 Timber Ridge Drive, Dumfries, Virginia, 22026-1059, USA, (703) 680-3559, Fax (703) 878-1460, Compuserve 74065, 1140

OEMs, Distributors and Government Agencies Take Note: RCSS™ can be customized, modified or re-engineered for special applications. Special projects are welcome.

CIRCLE 145 ON READER SERVICE CARD

27 MHz COMMUNICATIONS ACTIVITIES

There's nothing quite as vexing as facing up to the job of trying to wedge a CB installation into a vehicle when it's quite apparent that there's a severe shortage of space for the job. The very first action, in such an instance, is to look around for compact CB rigs that were intended for just such occasions.

One we kind of like is Radio Shack's Realistic TRC-415 because they packed a lot of performance into a good looking little box. The TRC-415 measures only 2 inches high, about 4½ inches across, and 6½ inches deep.

Still, within this space they've put a receiver that includes ceramic filters for increased selectivity. An ANL cuts down on noise. There's a bright LED channel display, and a 4-step LED signal/RF power meter, plus jacks for plug in mike and optional remote speaker.

The TRC-415 costs less than \$70. Check it out at any of Radio Shack's stores.

Where Have They Gone

Many readers always ask us where all of the wide assortment of CB transceiver, antenna, and accessory manufacturers have gone.

Certainly there are not as many in CB as there were fifteen years ago, but there is a dedicated group of manufacturers still furnishing equipment for CB. We publicize this equipment when the manufacturers request us to do so.

We regularly receive product information from leading manufacturers like Radio Shack, Cobra, Midland, Joe Gunn, Wilson, and Antenna Specialists. Obviously, there are other quality transceiver and antenna manufacturers in the CB field (Uniden, K-40, Valor, US Antenna, Wintenna, and Firestik just to mention a few). But we don't hear from every company with information to pass along to you. At such time as they may decide to furnish us with data on what they've got, we'll gladly tell you about their products.

CB First Deluxe Transceiver

Nothing in the world was quite as ugly as the Courier 1, made by E.C.I., of Mount Vernon, NY. On the other hand, it was the first of CB's more spectacular performers. The earliest versions of the Courier 1 probably appeared in late 1960 or early 1961, selling for about \$190.

The Courier 1 had 12 transmit channels and a 23-channel tunable receiver, plus 4 fixed-tuned channels. The triple conversion receiver had 12 tubes and 5 diodes performing 17 tube functions offering 0.1 uv sensitivity with a 6 dB noise figure. The receiver



The Realistic TRC-415 was designed for installations where space is at a premium.

had a switchable noise limiter, and adjustable RF gain. A front panel meter functioned as an S-meter and also displayed RF output in watts. The transmitter ran a 6EM5 in the final (minimum 3.4 watts output) with a 6BQ5 modulator. A universal power supply operated from 117 VAC, also 6 and 12 VDC.

Later versions, like the 1962 Courier 1AM, added extras like the ability to receive the AM broadcast band.

The Courier 1 had a unitized chassis (five separate cadmium plated units) that slid out of its all-chrome cabinet on tracks.

At a time when most CB sets offered only 3 channels and single conversion receivers or worse, this precision equipment was truly awesome in every respect. Granted, it wasn't too pleasing to the eye.

The original company owners made a fortune and sold the company many years ago. The present owners of the company that once made this equipment is Fanon-Courier Co., of California.

From Our Readers

We heard from Elie Homsy, LBN-102, one of the founders of the Lebanese DX Group. Elie tells us that the group made a DX'pedition to Cyprus recently and made many new friends over the air via their FT-747-GX and dipole. The club has about 33 members at the present, and they always enjoy reading our column.

Any readers who would like to get in touch with the LBN are invited to do so, but are requested to enclose an International Reply Coupon (IRC) for return postage. The address is: LBN DX Group, P.O. Box 166137, Beirut, Lebanon. The club suggests that letters sent to Lebanon be sent via Registered Mail to ensure delivery.

Remember Last Summer?

Now that it's cold, let's start planning for things to do when the good weather rolls around. We were reminded of this when we



What a rig the Courier 1 was! Thirty years ago it had a triple conversion receiver in an era when other CB rigs were either super-regens or single conversion.



Rocky Mountain Radio Club members set up this display of communications equipment at their picnic.

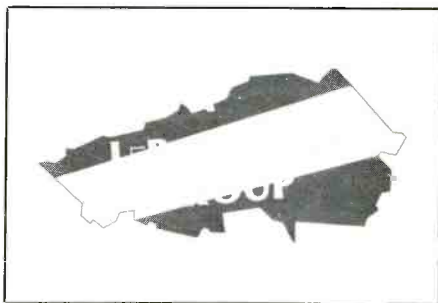

The Lebanon DX Group sends out this QSL card, which is orange, green, and white.

heard about last summer's camp out and pot luck picnic held by the Rocky Mountain Radio Club International, of Alberta.

They had a display of radio equipment for the general public to view, and it included VHF two-way radios, handhelds, and CB radios both new and from earlier years. All who attended, members and non-members alike, had a fine time and another outing will take place next summer, probably around mid-June.

If you're within visiting distance of Alberta, you might wish to consider making plans to be a part of this friendly event. For more



Chow time at the Rocky Mountain Radio Club's picnic.

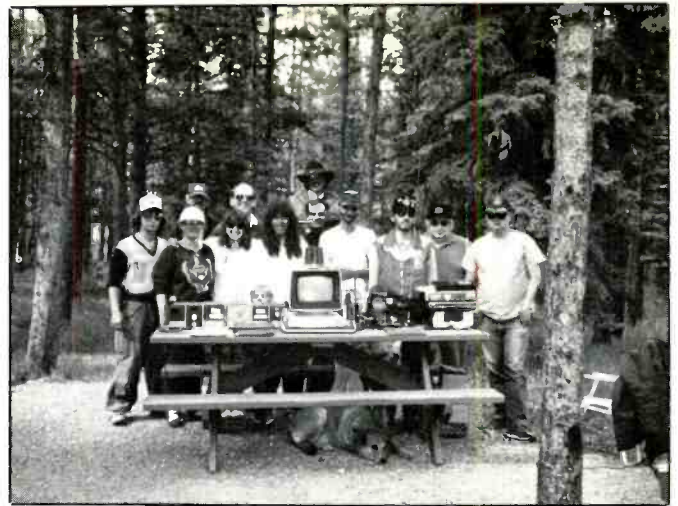

Members of the Rocky Mountain Radio Club strike a pose at their picnic last summer. Maybe next time you can join them.

information, contact the Rocky Mountain Radio Club International, 1010 8th Street S.E., Calgary, Alberta, Canada T2G 1Z4.

And, if you're too far to attend this event, you can plan something similar right in your own area. Now's the time to put on your thinking cap if you expect it to actually happen this coming summer.

In Other Mail

Douglas Stingley, of Salem, OR tells us that he's moving to Hawaii and taking along

his Cobra 2000GTL base station. He hopes that we can reassure him that there's sufficient CB activity there to make it worth bringing along the CB rig. Also, he asks about the present status of FCC enforcement of anti-skip CB regulations.

There is no shortage of local CB activity in Hawaii, and the skip rolls in on a non-stop basis. At this time the FCC doesn't appear to be working very hard at trying to enforce its anti-skip CB regulations so long as the stations stay on the authorized channels and

appear to be running legal power. Still, it's a violation of FCC Part 95 to work skip stations, even though many operators participate in the practice.

George Bandorf, KC4OUK, of Port Orange, FL wrote to tell us of a concept he has for what amounts to a restructured CB service. Although he took four pages to explain the idea, we'll see if we can skip through some of its high points for you.

The new band he would like to see extends from 26.950 to 27.950 MHz, and

Improve Your Scanning Coverage!

GRE America is proud to introduce a new family of products to enhance your scanning pleasure! First, GRE has designed the new **Super Converter 9001** for base model scanners. The 9001 converts 810 MHz - 950 MHz down to 410 MHz - 550 MHz. The 9001 is the perfect alternative to buying a new, expensive scanner covering the 800 MHz band. Next, GRE announces the new **Super Amplifier 3001** for base model scanners. The 3001 will increase gain by as much as 20 dB, and is engineered to help scanners with low sensitivity pull in weak signals. Both products use BNC connectors, (1) 9 volt battery and have an off/pass switch for returning to normal operation.



Super Converter 9001 & Super Amplifier 3001



Super Converter II



Super Amplifier



All-Band Antenna

U.S. & International Distributorship inquiries welcome. Please call GRE for further information!

Let GRE Manufacture Your Radio Products!

GRE America, Inc. is a leading OEM developer and manufacturer of radio telecommunications products such as:

- Cordless Telephones
- CB & Marine Radios
- Spread Spectrum "engines"
- Remote Monitoring Systems

If you need a high quality, cost competitive, reliable manufacturer, GRE will provide you with a free production quotation.

For more information, please call GRE at (800) 233-5973. GRE is a subsidiary of General Research of Electronics, Inc.

GRE GRE America, Inc.

GRE America, Inc.
425 Harbor Blvd., Belmont, California 94002
(415) 591-1400 Outside California: (800) 233-5973

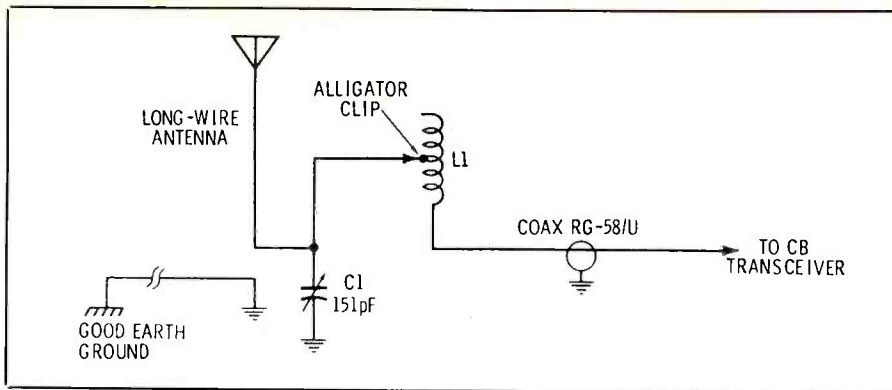

Here's how to tune up a long wire antenna for CB use.

would be open to operators who could pass a written exam similar to the Novice Class Amateur test. There would be a \$50 license fee. Hams could also operate in this band, and would have to pay the \$50 fee although would not need to pass the exam.

Operations would be 30 watts PEP, upper sideband. A sub-band for CW would be allowed. AM would be eliminated completely. No limits on skip operation. Antennas would be limited to 60 feet with unlimited gain.

This certainly is an interesting idea, even if it stands little chance of ever becoming a reality. Would we like to see it happen? Sure! Why not?

Things to Build

Every month we try to bring readers one or more small projects or things to do, and it's turned out that these are becoming very popular. Happy to oblige with more!

Norm Schnessel, of Florida, wonders if it's possible to load up a long piece of wire as a CB antenna. Why not? While it's more convenient to use a commercially made antenna, there's no reason why a wire can't be used if you want to experiment with one.

With a small tuning device (as shown in the diagram), you should be able to tune your CB rig into just about any length of wire.

The coil (L1) is 3 turns of No. 12 bus wire, 2-1/2 inch diameter, with the turns spaced a quarter-inch apart. The alligator clip attachment is located on L1 by trial and error, which is also true for the setting for the capacitor (C1), which is a 151-pf variable.

With a Field Strength Meter nearby, or an in-line Field Strength Meter, try different combinations until you eventually hit the best one for the length of wire you are using. Take your finger off the mike button while relocating the alligator clip, then press the mike button to check the reading after you have removed your hand from the clip.

Some CB rigs are just plain noise producers, picking up all sorts of outside interference and then bashing you over the head with it to the point of drowning out the other guy talking. This is especially true in mobile units.

We can't guarantee that this little trick will work for you, or on every CB rig. But it is a very old trick, and it has proven to be an effective "quick and dirty" approach to noise limiting that does work with some types of noise, at least on some CB rigs.

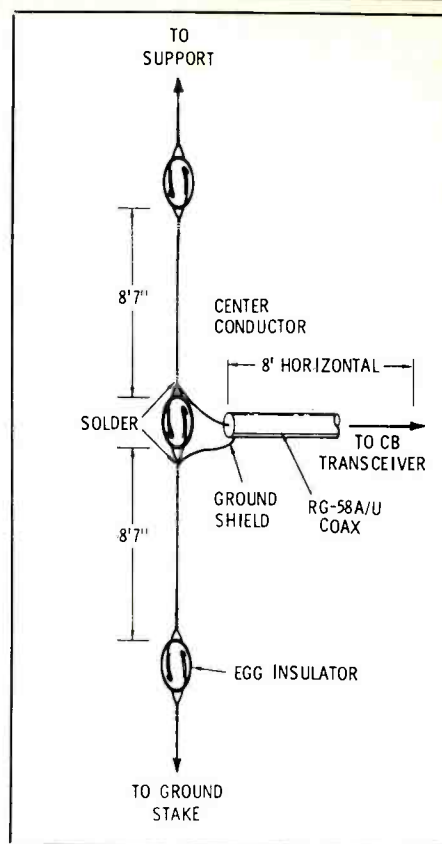

The CB dipole is a handy emergency antenna that does a reasonably good job.

All it consists of is placing a type NE-2 neon bulb across the speaker terminals of the CB rig. That's all there is to the job. If you don't like the way it works for you, take it out. The NE-2 is a cheap item and it was worth the try anyway.

Lastly, we mentioned the DX'pedition that used the CB dipole, so we thought it might be a good time to let you know how to put one together. They're good to know how to build in a pinch, like if you need a quick antenna when you least expected to.

For most purposes, consider it to be omnidirectional. Mount it as far as possible in the clear of metal objects, trees, down spouts and rain gutters, TV antennas, and any other RF absorbers that could distort the signal pattern.

Hope you have a bright Holiday. We look forward to hearing from you. Pass along your CB QSL cards (your own and/or DX cards), shack photos, CB events and news items, questions, thoughts, squawks, and ideas.

12 HOUR RECORDER



- excellent audio quality
- trouble-free metal (NOT plastic) chassis
- 6 hours per side, C120 tape
- volume AND tone controls
- AC/DC operation
- digital counter
- BUILT-IN voice activation (no external box) - add \$19*
- scanner adapter cord - \$8*

\$129*

AUTOMATIC TELEPHONE ADAPTER

- starts/stops recorder automatically
- FCC approved

\$16*



*special prices for PopComm readers

NO shipping charges on prepaid orders.
COD's OK. California residents add tax.

FREE CATALOG

VIKING INTERNATIONAL
SINCE 1971

150 EXECUTIVE PARK BLVD #4600
SAN FRANCISCO, CA 94134
PHONE: (415) 468-2066
FAX: (415) 468-2067

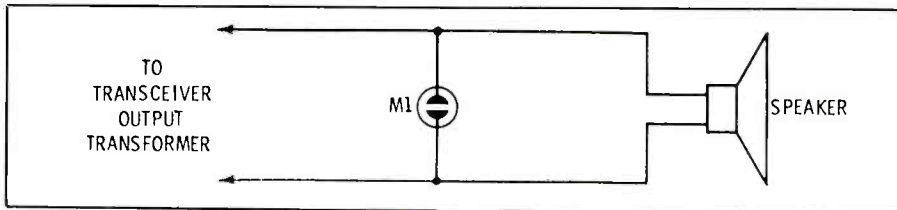

Here's a quickie noise-limiter. M1 is an NE-2 neon bulb.

CIRCLE 178 ON READER SERVICE CARD

POP'COMM's BOOKSTORE BOOK IDEAS

No Code Amateur Ticket

NOW YOU'RE TALKING by ARRL

This is THE book you need to get you're No-Code Amateur Radio license. Loaded with information. Completely prepares you for the 55 question Technician Class Amateur Radio ticket (30 questions from the Novice pool and 25 questions from the Technician pool.) Simple easy-to-understand explanations of complex questions make studying a snap. Fully illustrated. Also includes complete Novice exam study course. Get the Morse Code Training tape and you'll be set to qualify for your Novice license too. Expand your privileges to include HF CW and SSB privileges. Tested and proven study concept. ©1991 First Edition.

□ AA-NYT Softbound \$18.95
□ AR-MCT (for the Novice Code) Morse Code Tape \$9.95

SHORTWAVE RECEIVERS Past and Present edited by Fred Osterman

Put together to help the beginning SWL decide which radio to buy. Also a great reference for the experienced listener to have on hand. Full of handy facts. Includes evaluation of the radio's capabilities. © 1989

□ UE-SRPP Softbound \$8.95

QTC I Have a Message For You by "SPARKS" Ray Redwood

Memories of what it was like to be shipboard radio operator by a 40 year veteran. The author wrote this book for all of the radio operators who have ever gone to sea and to let the public know that radio operators will always be an important part of international marine commerce.

Fascinating recollections of voyages, ports, people and the many other aspects of a life at sea. Great fun reading! © 1989 1st edition 375 pages
□ RR-QTC Softbound \$8.95
□ RR-QTCH Hardbound \$14.95

M STREET DIRECTORY 1990 Edition - Complete Industry Guide to AM and FM Broadcasters US and Canada

Comprehensive listing of broadcasters. Full of helpful information for the BC SWL. Has location frequency, program formats plus much more. The book to have if you tune the broadcast bands. © 1990 640 pages

□ MST-J Softbound \$29.95

WIRELESS COMMUNICATION IN THE US, by Thorn Mayes

This fascinating history is all about the inventors, engineers and promoters that brought radio into use. Spark and ARC transmitters used shipboard and on coastal stations are described so you can almost hear and smell them. Old timers will be able to relive their past. Newcomers will learn more about the roots of radio communication. Great story. © 1989

□ WM-WCUS Softbound \$29.95

AND PART OF WHICH I WAS - Recollections Of A Research Engineer by George H Brown

George Brown was one of radio's pioneers. His career began in the Roaring 20's as a college researcher. From there, he went on to work in both radio and the development of TV technology. He is a co-author with Lewis and Epstein of one of the most definitive pieces every done on ground systems. Full of recollections of meetings with some of the most famous people in the history of radio. © 1982 revised 342 pages.

□ GHB Hardbound \$19.95

IONSOUND Ver. 3.19 by Jacob Handwerker, W1FM

Wonder when and on what frequency you'll be able to find that last DX country you need for honor roll? IONSOUND is a state-of-the-art software tool designed to predict ionospheric propagation to any part of the world. Using the latest in propagation engineering models, this handy tool is a valuable addition to the active ham's software library. Can be customized for a number of different variables. Menu driven for ease of use. Manual in an ASCII printable file is included. Math co-processor recommended but not required. IBM PCs and compatibles.

□ ION5 (5.25" disk MS-DOS Computers) \$29.95
□ ION3 (3.5" disk MS-DOS Computers) \$31.95

TRAVELER'S GUIDE TO WORLD RADIO - 1991 EDITION, English Language Broadcast Guide

Covers AM/FM/SW broadcasts for 51 major cities around the world — from Abu Dhabi to Zurich. Handy pocket book size is convenient to take when you travel. Easy-to-use format makes looking up information a snap. © 1990 128 pages

□ BB-TG Softbound \$9.95

THE WONDERFUL WORLD OF HAM RADIO: an introduction for young people. by Richard Skolnik

Written with the youngster in mind, this is a great book for the "soon to be ham." Answers many of the most often asked questions in a simple easy-to-understand format. ©1990 39 pages

□ MFJ-WWHR Softbound \$7.95

LATEST INTELLIGENCE - An international directory of codes, by James Tunnell

Finally, there's a key to the terms, phrases, acronyms, and abbreviations used by the military, law enforcement and other government agencies. Over 35,000 terms are explained and defined in a simple, easy-to-understand manner. Great for scanner ops and SWL's. Fully up-to-date. © 1991 305 pages

□ T-3531 Softbound \$16.95

WORLD RADIO TV HANDBOOK 1991 Edition

Loaded with the latest call signs, frequencies and other important information for radio and TV broadcasting around the world. Covers LF, MF, shortwave and TV services. Also has equipment reviews and other special features. ©1991. 45th Edition.

□ GL-WRTV91 Softbound \$19.95

PASSPORT TO WORLDBAND RADIO 1991 Edition

Brand new, fully revised and expanded. Now includes a bigger and better SWL's buyer's guide. Also includes all the latest broadcast schedules from countries around the world. Great reference text for Hams as well as the serious SWL and casual listener. ©1990

□ IBS-RD91 Softbound \$16.95

UNDERGROUND FREQUENCY GUIDE, by Harry Helms

The shortwave bands are filled with mysterious and unusual stations. Some are believed to send messages to spies and secret agents. Others come from drug smugglers, rebels and related clandestine groups. The only way to keep track of what is going on is to have Helm's new book. Over 500 listings with frequencies, times and broadcast formats make this a valuable book for the SWL. © 1990 86 pages

□ HH-UFG Softbound \$10.95

SPORTS AND ENTERTAINMENT FREQUENCIES, compiled by Bob Grove

Handy little book to have. Listings include the NFL, Blue Angels, Hotels and Casinos as well as press, shopping malls, and fast food restaurants. Also includes NASCAR, CART and Indy pit crew and driver frequencies! © 1991 70 pages

□ GE-SEF Softbound \$9.95

(800) 457-7373 8AM-5PM EDST CALL TOLL FREE

Shipping and handling: \$4.00 to US and Canadian address via US mail. Shipping via UPS Brown \$5.00 to US address only. COD orders add an additional \$5.00. UPS Red or Blue cost plus \$4.00 handling. All other orders shipped via US mail F.O.B. Greenville, NH, USA plus a \$4.00 handling charge. Prices subject to change.

CQ Bookstore Main St Greenville, NH 03048
Div of CQ Communications Inc C-D91

(503) 878-1441 • FAX (603) 878-1951



Popular Communications

COMMUNICATIONS GUIDE

The most up-to-date buyer's guide for communications equipment—from communications receivers and scanners, to CB radio and amateur transceivers is finally here!

Complete with articles by experts in the communications field, including Dexter, Kneitel, Helms, Gysi, Orr, Zeller, Margolis and many more, the 1992 Communications Guide is the book you've been waiting for—Here's what's inside:

An introduction to the fascinating world of communications monitoring with: illustrated articles on scanning, utility monitoring, antenna selection and construction, pirate radio, QSLing and much MORE!

AS AN ADDED BONUS, noted ham Fred Maia, W5YI tells just how easy it is to get your HAM LICENSE. In plain English, Maia explains ham radio and how YOU can become a licensed ham. In addition, a product listing with PHOTOS of amateur radio transceivers for use by Technician class licensed hams is included.

Are you interested in Citizens Band radio? An interesting article on CB radio and COMPLETE product listing with PHOTOS is included at NO EXTRA CHARGE!

The Brand NEW 1992 Communications Guide includes the latest communications products on the market with detailed specifications and photos to make your buying decision easier. We've included shortwave receivers, scanners (both base and handheld) and accessories to make your monitoring post complete.

IT'S ALL YOURS FOR JUST \$4.95. Get your copy TODAY!

For orders only
Call (800) 457-7373

8AM-5PM EDST
CQ's BOOKSTORE

Your Amateur Radio Book Source
MAIN STREET
GREENVILLE, NH 03048
Div. of CQ Communications, Inc.

For More information about an order call: (603) 878-1441
24 hour FAX Line (603) 878-1951

SHIPPING AND HANDLING

\$4.00 to US and Canadian address via US mail. Shipping via UPS Brown \$5.00 to US address only. COD orders \$10.00 UPS Red or Blue cost plus \$5.00 handling. All other orders shipped via US mail F.O.B. Greenville, NH, USA plus a \$4.00 handling charge.

DX At The Top Of The Dial

The 1600 to 1800 kHz is one of the more interesting frequency ranges around. It's home to a big grab-bag of different radio services and activities, and winter nights are the best time for DX there. It's also a place which will soon see a major change that will create multiple new DX opportunities. So what's the story?

Pirates, Parking, and Preachers

The first stop above the upper limit of the standard AM broadcast band is 1610 kHz. In the United States and Canada, many traveler's information service (TIS) stations can be heard. You're probably familiar with these; they are low-powered stations giving recorded announcements at airports, parks, tourist attractions, highways, etc. The power of these is usually five watts or less and antennas are just short whips. However, these stations can be heard over surprising distances when conditions are right. Some have been heard over 500 miles away! To have a chance for such DX, you'll need to have no TIS stations nearby, a quiet receiving location, and good receiving equipment.

If you don't hear a distant TIS signal on 1610 kHz, you'll probably nab the country of Anguilla instead. That island is home to "The Caribbean Beacon," a 50 kilowatt religious station that often puts powerful signals into all parts of North America during the evening hours. If you don't hear a station identification, you might think this is a domestic station operating off its assigned frequency, since many of its programs are the pre-recorded types heard on domestic religious broadcasters. If you do hear them, you can send your report to Box 690, Anguilla, British West Indies.

Pirate radio operators have been hanging out around 1620 kHz since the mid-1970's. This frequency is particularly favored by operators in the northeastern United States. Several of the most famous pirates of all time, such as New York's WCPR, WFAT, and WGOR as well as Pirate Radio Central of Massachusetts, have operated on 1620 kHz. If you're located along the east coast and listen late at night on weekends and holidays, you'll eventually hear a pirate or two on 1620 kHz!

Crickets, Chirpers, and Other Strange Critters

In the 1600 to 1800 kHz range you'll hear

1645	1690	1735
1650	1695	1740
1665	1705	1750
1675	1710	1765
1680	1725	1770

some signals unlike anything you can hear on the rest of shortwave. Many SWL's describe these as "crickets" because they often sound much like electronically synthesized cricket chirps. Others are a series of tones, or weird CW markers consisting of nothing more than a letter followed by some numbers. What are they?

These are actually low-powered radiolocation beacons. The "crickets" belong to radio beacons using the "Cubic Argo" radio-navigation system. Unlike other radiolocation beacons, these are not used to permanently mark an area; they are frequently moved about and seldom stay in one place for long. Cubic Argo systems are often used to mark the location of oil exploration sites or where salvage efforts are underway for sunken ships. The series of tones that are often heard are produced by a competing radiolocation system known as Decca Hi-Fix. The CW beacons with markers consisting of a single letter followed by numbers are beacons used by fishing vessels to mark the location of fishing spots.

Naturally, the closer you are to the Pacific Ocean, Atlantic Ocean, the Gulf of Mexico, or the Great Lakes, the more of these beacons you'll hear and the stronger they'll be. Forget about trying to QSL these, though, trying to find out just who is operating what and where is almost an impossible task!

Get To Know Your Neighbors Better

The area just above the AM broadcast band was the first one assigned for use by cordless phones. A decade ago, it was a lot of fun to put a multimode receiver in the FM mode and listen in on these conversations. A few years later, the FCC authorized new cordless telephone frequencies around 46 and 49 MHz, putting the 1600 to 1800 kHz range out of business for this sort of listening. Right? Wrong!!!

Freq.	Call	Location
1615	OR	Ohura, New Zealand
1620	CEP	Concepcion, Bolivia
1635	LMC	Lomincocha, Ecuador
1640	SJV	San Javier, Bolivia
1650	SOT	Reyes, Bolivia
1685	MER	Mercaderes, Colombia
1689	MH	Mount Hagan, New Guinea

It's surprising how much activity is still being heard in the old range, apparently, people haven't been upgrading to new units quite as fast as you might expect. In addition, there's quite a bit of "gray market" equipment using old frequencies still being marketed and used in larger urban areas. Gray market equipment is generally illegal for use in the U.S., often because of excessive transmitter power or unauthorized frequencies. However, a lot of it gets smuggled into the United States or is marketed as "for export only," presumably for foreign visitors to buy and take home with them. But, as a practical matter, most of it is used illegally in the United States. (Not that companies selling to the gray market are exactly shy about what they're doing; a couple have impressive displays each year at the Consumer Electronics Show in Las Vegas!)

Table 1 shows some frequencies where you can find old legal and new illegal cordless phones. From my monitoring, southern California seems to be swarming with high-power illegal units brought back by weekend shoppers in Tijuana and Calexico; I hear a great deal of Spanish and various Asian immigrant languages (such as Vietnamese) on these channels. If you're located in or near a large city, these frequencies might be worth a listen.

Grand Opening Coming Soon!

One reason you should DX the 1600 to 1800 kHz range now is because you won't have much more time to do it. In a few years, this range will be populated by AM broadcast stations as the upper end of the band is expanded to 1700 kHz.

Exactly how this new part of the AM broadcast band will be utilized isn't clear yet, although it seems likely that the FCC will opt to place regional broadcast stations (directional antennas and transmitter pow-

(Continued on page 74)

MAXIMUM RANGE MAXIMIZED SENSITIVITY

We've Carefully balanced the amount of gain used in our input amplifiers - too much or too little results in poor performance. **OPTOELECTRONICS' HANDI-COUNTERS™** with maximized sensitivity give you the maximum range for antenna pick-up.

Made in the USA



MODEL 3000
Multi-function Counter
10Hz-3GHz, 10 Digit LCD with
frequency, period, ratio, interval
& signal level bargraph...\$375.



Maximum Security Device.
Increase your frequency finding™ by 10 times the distance or more.
Tunable Preselector APS-104
\$995.

Counter Sold separately

MODEL 8030

With all the features of the 3000 plus enhanced input signal conditioning and enhanced TCXO time base \$579.



OPTOELECTRONICS

\$199.



Model 2210A
10Hz-2.4GHz Full range counter. Price includes Nicads & AC charger/adapter.

The Original Pocket-Sized LED Handi-Counter™

All of **OPTOELECTRONICS'** LED Handi-Counters™ will:

- Count frequencies above 2.4GHz.
- Have display saving Power Switch (avoids premature LED burn-out, leading cause of counter failure.)

Accept no substitutes - Look for the OPTOELECTRONICS name on the label!

Only OPTOELECTRONICS offers you MAXIMIZED SENSITIVITY.

Factory Direct Order Line

1-800-327-5912

FL(305)771-2050 • FAX(305)771-2052

5821 NE 14th Ave. • Ft. Lauderdale, FL33334 • 5% Ship/Handling (Max. \$10) U.S. & Canada. 15% outside continental U.S.A. Visa and Master Card accepted.

\$99.



Model 2300 - 1MHz-2.4GHz
Available with NiCads and AC Charger Adapter. Complete Package only....\$128.

POP'COMM'S World Band Tuning Tips

December - 1991

This PopComm feature is designed to help you hear more shortwave stations. Each month, this handy, pull-out guide shows you when and where to tune to hear a wide variety of local and international broadcasts on shortwave.

The list includes broadcasts in many languages besides English. Most of the transmissions are not beamed to North America. Keep in mind that stations make frequent changes in their broadcast times and frequencies. Changes in propagation conditions may also make some stations difficult or impossible to receive. Your own equipment and receiving location will also have a bearing on what stations you are able to hear.

Note: EE, SS, FF, etc. are abbreviations for English, Spanish, French and so on. Some frequencies may vary slightly. All times are in UTC.

Freq.	Station/Country	UTC	Notes	Freq.	Station/Country	UTC	Notes
3200	Trans World Radio, Swaziland	0400	GG/EE	4915	GBC, Ghana	0600	
3205	R. Riberao Preto, Brazil	0100	PP	4920	R. Barahona, Dominican Rep.	0300	SS
3210	R. Mozambique	0400	PP	4934	R. Tropical, Peru	1000	SS
3215	Radio Oranje, South Africa	0300	Afrikaans	4939	R. Continental, Venezuela	1000	ss
3235	R. West New Britain, P. New Guinea	1130	P'dgin	4951	R. Nacional, Angola	0000	PP
3235	R. Clube Marila, Brazil	0200	PP	4970	R. Rumbos, Venezuela	0300	SS
3250	R. Luz y Vida, Honduras	0230	SS	4975	R. del Pacifico, Peru	0200	SS
3255	BBC	0400	via Lesotho	5010	R. Garoua, Cameroon	0500	
3270	R. Namibia	0300		5020	Solomon Is. Bc. Corp	1030	
3280	La Voz del Napo, Ecuador	0300	SS	5020	ORTN, Niger	0500	FF
3300	R. Cultural, Guatemala	0230		5025	Bhutan Bc. Service	1230	
3320	R. Orion, South Africa	0245		5030	R. Catolica Nacional, Ecuador	0200	SS
3339	R. Altura, Peru	0100	SS	5035	R. Aparecida, Brazil	0030	PP
3355	R. Botswana	0400	SS	5035	RTVC, Central African Rep.	0428	sign on, FF
3360	La Voz de Nahuala, Guatemala	0200	SS	5050	R. Jesus del Gran Poder, Ecuador	0100	SS
3366	R. Rebelde, Cuba	0245	SS	5066	R. Candip, Zaire	0500	FF
3905	R. New Ireland, P. New Guinea	1100	SS	5660	R. Cutervo, Peru	0100	SS
3945	R. Vanuatu, Vanuatu	0930		5960	Radio RSA, South Africa	0400	
3980	Voice of America	0600		5965	R. Havana Cuba	0400	
3995	Deutsche Welle, Germany	0200	GG	5975	BBC	0030	via Antigua
4409	R. Eco, Bolivia	2330	SS	6005	BBC	0530	via Ascension
4457	La Voz del Tropico, Bolivia	0200	SS	6005	CFCX, Canada	0700	
4600	R. Baghdad, Iraq	0100	AA	6010	R. Mil, Mexico	0300	SS
4755	R. Educacao, Brazil	0230	PP	6010	R. Bahrain, Bahrain	0300	AA
4760	Yunan PBS, China	1230	CC	6010	R. Inconfidencia, Brazil	0000	PP
4765	RTVC, Congo	2200	FF	6015	R. Austria Int'l	0530	via Canada
4770	R. Nigeria	0500		6030	R. Globo, Brazil	2330	PP
4790	R. Atlantida, Peru	0300	SS	6040	Deutsche Welle, Germany	0100	via Antigua
4800	LNBS, Lesotho	0400	vernaculars	6055	Rdf. Rwandaise, Rwanda	0255	sign on, FF
4815	RTV Burkina, Burkina Faso	0600	FF	6075	Deutsche Welle, Germany	0230	GG
4820	La Voz Evangelica, Honduras	0300	SS	6088	R. Esperanza, Chile	0200	SS
4830	R. Tachira, Venezuela	0330	SS	6090	R. Bandeirantes, Brazil	0800	PP
4835	R. Tezutlan, Guatemala	0130	SS	6120	R. Japan	1100	via Canada
4845	RTVM, Mauritania	2330	FF	6160	CKZN, Canada	0930	
4850	CRTV, Cameroon	0430	FF/EE	6185	R. Educacion, Mexico	0800	SS
4865	La Voz del Cinaruco, Colombia	0300	SS	6210	Europeana Christian R., Italy	0600	
4865	Gansu PBS, China	1130	CC	6305	La Voz del Cid (clandestine)	0600	SS
4870	ORTB, Benin	0547	sign on, FF	6400	R. Venceremos (clandestine)	0215	SS
4885	R. Clube do Para, Brazil	0300	PP	6907	Africa 2000, Eq. Guinea	2100	SS
4890	NBC, Papua New Guinea	1230		7100	A Voz do Galo Negro (clandestine)	0045	PP
4890	ORTS, Senegal	2345	FF	7113	Lao National Radio	1130	Lao
4895	R. Brazil Central	0030	PP	7140	R. Australia	1030	
4900	La Voz de Saquisili, Ecuador	0230	SS	7145	R. Algiers, Algeria	2200	FF
4904.5	R. National, Chad	0427	sign on, FF	7190	R. Africa, Eq. Guinea	2100	

Freq.	Station / Country	UTC	Notes	Freq.	Station / Country	UTC	Notes
7200	Somali Bc. Service, Somalia	0259	sign on	11790	R. Veritas Asia, Philippines	1100	VV
7205	Voice of America	0200	via Greece	11795	UAE Radio	1600	
7215	RTV Ivoirienne, Ivory Coast	2300	FF	11805	R. Globo, Brazil	2300	PP
7235	Deutsche Welle, Germany	0400	AA, via Malta	11810	R. Jordan	0330	AA
7250	Central Bc. System, Taiwan	0800	CC	11815	Trans World R., Bonaire	1230	
7255	Voice of Nigeria	0457	sign on	11825	R. Tahiti	0345	FF/TT
7270	R. Polonia, Poland	2330		11835	R. El Espectador	2300	SS
7280	R. France Int'l	0330	FF	11840	R. Moscow	1430	Via Cuba
7315	WHRI, Indiana	0630		11845	R. Afghanistan	1800	via USSR
7345	R. Prague, Czechoslovakia	0400		11865	R. Norway Int'l	0400	NN
7355	WRNO, Louisiana	0100		11910	R. Australia	1800	
7375	R. for Peace Int'l, Costa Rica	0600		11910	R. Budapest, Hungary	0030	
7435	WWCR, Tennessee	0100		11920	R. RSA, South Africa	0445	
9022	VOIRI, Iran	0100	Farsi	11935	BSKSA	0400	AA
9115	R. Continental, Argentina	0230	SS	11940	R. Romania Int'l	0200	
9420	Voice of Greece	0200	GG	11940	R. Singapore	1100	
9435	Kol Israel	0000		11940	R. Jordan	0330	AA
9445	Voice of Turkey	2330	TT	11950	R. Havana Cuba	0000	
9445	WCSN, Maine	0200		11955	Voice of Turkey	0400	TT
9465	KFBS, Saipan	1530		11965	R. France Int'l	0100	SS
9475	R. Cairo, Egypt	0200		11980	KSDA, Guam	1400	
9486	R. Tacna, Peru	0400	SS	12000	R. Jordan	0330	AA
9520	R. Verias, Philippines	1200	II	12005	RTT, Tunisia	0430	AA
9530	KHBS, Saipan	1400		12085	R. Damascus, Syria	2110	
9535	TWR, Bonaire	0345		12095	BBC	0530	
9540	R. Nacional, Venezuela	0030	SS, others	12984	VNG, Australia	1000	time signals
9545	Solomon Is. Bc. Corp.	0730		13605	Capital Radio, via Voice of UAE	2230	
9545	R. Tirana, Albania	0530	sign on	13610	R. For Peace Int'l, Costa Rica	0200	
9555	R. Portugal, Portugal	0200	PP	13635	Swiss Radio Int'l	2130	
9560	V of Ethiopia	1300		13655	BRT, Belgium	2330	
9565	R. Universo, Brazil	0100	PP	13670	R. Canada Int'l	0245	
9570	Voice of Nigeria	0430		13675	UAE Radio	2000	AA
9575	RAI, Italy	0100		13700	R. Netherlands	2030	
9580	R. Australia	1200		13710	BRT, Belgium	2330	
9580	R. Tirana, Albania	0130		14917	R. Kiribati	0600	
9590	BBC	0030	via Canada	15010	Voice of Vietnam	2000	VV
9600	R. UNAM, Mexico	1400	SS	15020	All India Radio	1000	unid lang.
9610	Vatican Radio	0300		15030	R. For Peace Int'l	1900	
9615	Vatican Radio	2250		15090	Vatican Radio	2100	
9630	Spanish National Radio	0000		15095	R. Damascus, Syria	2110	
9635	R. Portugal	2200	PP	15110	All India Radio	0030	
9655	R. Norway Int'l	1700	NN	15110	Spanish National Radio	2000	SS
9660	R. Australia	1100		15160	WRNO, Louisiana	1500	
9670	Adventist World R., Portugal	0815		15160	R. Sofia, Bulgaria	0300	
9690	R. Beijing, China	0330		15180	R. Vilnius, Lithuania	2300	
9695	R. Sweden	0330		15185	WINB, Pennsylvania	2130	
9700	Voice of America	1730		15200	R. France Int'l	0100	SS
9700	R. New Zealand	1100		15205	Voice of America	2300	
9720	Sri Lanka Bc. Corp.	1230		15208	R. Bangladesh	1230	
9725	Adventist World R., Costa Rica	1250		15210	Radio RSA, South Africa	1700	
9735	R. Nacional, Paraguay	0000	SS	15265	Radiobras, Brazil	1800	
9735	Cyprus Bc. Corp.	2230	wknds, Greek	15310	BBC	1300	via Oman
9740	R. Beijing, China	2200		15325	R. Japan	1500	via Fr. Guiana
9745	HCJB, Ecuador	0530		15345	RAE, Argentina	2300	SS
9750	R. Korea, S. Korea	1300	KK	15345	Trans World Radio, Bonaire	1230	
9765	V. of Mediterranean, Malta	0600		15345	RTM, Monaco	1400	Berber
9780	Voice of the UAE	2200	sign on	15350	R. Luxembourg	0100	
9815	Italian R. Relay Service, Italy	0700		15365	R. Australia	1100	
9835	R. Budapest, Hungary	0200		15455	HCJB, Ecuador	1900	SSB
9860	R. Netherlands	2030		15475	Africa No. One, Gabon	1800	FF
9870	R. Austria Int'l	2230	SS	15480	FEBC, Philippines	0200	
9885	Swiss R. Int'l	1845		15485	R. Vilnius Lithuania	2300	
9800	R. Cairo, Egypt	0300	AA	15510	R. Afghanistan	1900	FF, via USSR
9910	All India Radio	0000		15560	R. Netherlands	0050	
9942	La Voz del CID (clandestine)	1330	SS	15585	R. Moscow	2300	
9965	R. Caiman (clandestine)	0200	SS	15610	Adventist World Radio/KSDA, Guam	2300	
9977	R. Pyongyang, N. Korea	1100		15640	Kol Israel	1900	
11500	R. Beijing, China	2130		15670	British Forces Bc. Service, England	0030	feeder
11570	R. Pakistan	1700		17555	R. Beijing, China	0100	sign on
11587	Kol Israel	1715	FF	17590	R. Moscow	1900	FF
11590	V of the Strait, China	1100	CC	17580	RTBF, Belgium	0500	FF
11625	Vatican Radio	0030	PP	17695	R. Netherlands	1900	
11660	R. Sofia, Bugaria	2130	PP	17730	R. Alma Ata, Kazakhstan	2130	
11670	R. France Int'l	0200	FF, via Fr. Guiana	17740	R. Yugoslavia	1200	
11710	R. Romania Int'l	0330		17770	R. Havana Cuba	2100	SS
11715	R. Beijing, China	0330	via Mali	17770	R. New Zealand	0400	
11715	KNLS, Alaska	0800	sign on	17795	RAI, Italy	0530	AA
11715	R. Korea, S. Korea	1030	via Canada	17810	FEBA, Seychelles	0400	
11720	R. Sofia, Bulgaria	0300		17810	R. Japan	2330	
11735	R. Yugoslavia	0000		17825	R. Sofia, Bulgaria	2345	
11730	BBC	0300	via Seychelles	17875	R. Sweden	1530	
11730	Spanish National Radio	0500	SS	17902	R. Nacional, Colombia	2300	SS
11755	R. Finland Int'l	2130		17950	V of Free Iraq (clandestine)	2245	AA
11760	R. Tibilisi, Georgian SSR	2000		21480	HCJB, Ecuador	1900	
11780	Voces en Libertad, Argentina	1400	SS, ex-Belgrano	21550	R. Finland Int'l	1400	
11780	R. Nacional Amazonia, Brazil	2200	PP	21690	R. Moscow	0800	RR
11790	R. Kiev, Ukraine	0000		21705	R. Norway Int'l	2200	NN
				21740	R. Australia	0200	

HOW I GOT STARTED

POP'COMM invites readers to submit, in approximately 150 words (more or less), how they got started in the communications hobby. Each month, we'll look through our file and select one to run here in the magazine.

Entries will be accepted (preferably) type-written, or otherwise clearly legible. If you have a photo of yourself taken recently, or when you got started, please include it and it will increase the chances of your letter being selected. We can't return or acknowledge material, whether or not it is used. Your story need be submitted only once, we'll keep it on file and consider it for future issues. All submissions become the property of *Popular Communications*.

Entries will be judged taking into consideration if the story they tell is interesting, amusing, or unusual. We reserve the right to make any necessary editorial changes to improve style or grammar.

Each month's winner will receive a 1-year gift subscription to (or subscription exten-



James Nelson, WB7QAP, of Yakima, Washington. Nifty array of equipment on display there.

sion if already a subscriber) to *Popular Communications*.

Address all entries to: How I Got Started, Popular Communications, 76 North Broadway, Hicksville, NY 11801.

Our Winner For December

The winner for December is James Nelson, of Yakima, Washington. James told us:

"In 1952, at age 7, I was given an old military receiver. That started my interest in SWL'ing. From 1964 to 1967, I attended the Army's S.E. Signal School at Fort Gordon, GA (MOS 293, later 31M20, Radio Relay and Carrier Operator - Microwave Equipment). After Ft. Gordon, I was stationed in Germany with the 7th Sig. Spt. 7th Army and later 32nd ADCOM.

"When I got out of military service, I drifted into CB radio, and later learned CW. I received my Novice ham ticket in 1977, and later that same year my Advanced Class. My Amateur callsign is WB7QAP, and you can find me on 15 meters CW and SSB. Hope to QSO some POP'COMM readers there!

"My equipment includes a Collins R-390A, Yaesu FT-101-E and EE, ICOM 751A, Kenwood 7730, also CB gear." ■

THE FUTURE OF AMATEUR COMMUNICATIONS

Once in a lifetime, a transceiver is introduced that's so extraordinary and innovative that it opens a totally new era in HF communications. ICOM's pacesetter IC-781 proudly exhibits that hallmark achievement with futuristic designs and features of true legendary proportions. Whether DX'ing, contesting, pioneering new interests or enjoying unquestionable top-of-the-line performance, the IC-781 is indeed today's standard of excellence!



Multi-Function Five Incht CRT. Displays frequencies, modes, memory contents, operating notes, RTT, two menu screens, plus a panoramic view of all signals in a selected range. A portion of the screen also serves as a display for data modes like RTTY, AMTOR, and PACKET.

Dual Width Noise Blanker includes MCF filter plus **level and width controls** to eliminate pulse and woodpecker noise with minimum adjacent-signal interference.

Unique Spectrum Scope. Continuously indicates all signal activities and DX pileups with your operating frequency in the center. Selectable horizontal frequency spans of 50, 100, and 200KHz for each side of the frequency you're listening to. Vertical range indicates relative signal strengths. A contesteer's dream!

Incomparable Filter Flexibility. Independent selection of wide and narrow SSB filters plus CW filters. Second and third CW IF filters are independently selectable!

Dual Watch. Simultaneously **receives two frequencies in the same band!** Balance control adjusts VFO A/B receive strength levels. You can check additional band activity, even tune in your next contact, while in QSO without missing a single word!

DX Rated! 150 watts of exceptionally clean RF output. Easily drives big amplifiers to maximum power.

Twin Passband Tuning with **separate controls for second and third IF stages!** Increases selectivity and narrows bandwidth, independently varies low and high frequency response, or functions as IF shift. **It's DX'ing Dynamite!**

A Total Communications System! Includes built-in 100% duty AC supply, high speed automatic antenna tuner, iambic keyer, semi-automatic or full QSK CW break-in to 60 wpm, Audio Peaking Filter (APF), RF speech processor, multiscanning, 105dB dynamic range, all-band/all-mode receiver with general coverage, and much more!

ICOM Dependability. The phenomenal IC-781 is built for action and backed with the most extensive warranty in the industry.

See the IC-781 at your local ICOM dealer.

ICOM
First in Communications

ICOM America, Inc., 2380 116th Avenue N.E., Bellevue, WA 98004
Customer Service Hotline (206) 454-7619
3150 Premier Drive, Suite 126, Irving, TX 75063
1777 Phoenix Parkway, Suite 201, Atlanta, GA 30349
ICOM CANADA, A Division of ICOM America, Inc.,
3071 - #5 Road, Unit 9, Richmond, B.C. V6X 2T4
All stated specifications subject to change without notice or obligation.
All ICOM radios significantly exceed FCC regulations limiting spurious emissions. 781188.

CIRCLE 175 ON READER SERVICE CARD

Mobile Command Post Battery Chargers

Most emergency command post vehicles run several batteries in parallel to keep their communications equipment on the air. There is usually a third or fourth battery specifically for engine starting. All of these need to be charged when the vehicle is not use, or when the vehicle is in prolonged use with available outside AC.

The size of the battery charger is one of the most important considerations when selecting equipment for your command post. The output amperage capability of the charger should be at least 15 percent to 25 percent of the total amp-hour capacity of all the batteries. Too often we see a 20-amp charger trying to maintain a charge on a bank of batteries when the total amp-hour capacity equals 315 amps (i.e., 3 each F-27 size batteries, 105 amp-hour battery size).

Sized correctly for this application of 3 batteries, the charger should be capable of producing between 47.25 amps to 78.75 amps which would give at least 15 amps to each battery rated at 105 amp-hour capacity.

A charger sized too small for the job will take forever to fully charge all the batteries up, and may not convert all the lead sulphate back to lead dioxide. This will seriously reduce the storage capacity of the battery.

For 3 big batteries, a good 75 amp charger will recharge the batteries much quicker, run cooler, and actually be better for the batteries. Beware of the common practice of some manufacturers to list a "double rating" for their units, such as "Model 30/20," or "Model 60/40." Reading the manuals usually interprets this to mean that the first number is an intermittent output rating, and the second number is the continuous output rating. I strongly recommend using the continuous output rating when making your choice, as this is the "real world" usage. Remember, charging a battery takes time and the continuous amperage is the thing that does the job.

Years ago, you could tell the quality of a charger by its weight, if it weighed a ton, it could probably charge up several batteries in parallel. Now there is the switching charger; a relative newcomer to the scene that is extremely lightweight.

The switching charger can offer good output regulations over a broad input range, and offers high efficiency. Some switching chargers also offer a sensed output mode that delivers full rated output current until the battery is charged to a certain voltage.



Battery charger with triple isolated outputs.

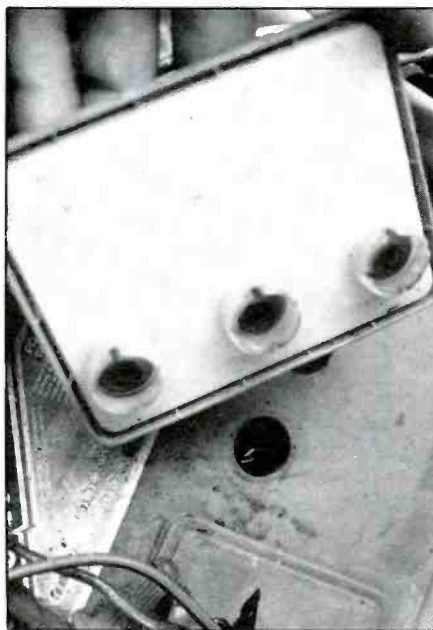

Remember to check fluid levels once a month.

The switcher then goes into a special trickle mode that will float or maintain the battery in the charge cycle. This allows the batteries to be replenished quickly, and then prevents them from being overcharged.

The switching charger raises the frequency of the line AC voltage from 60 Hz to

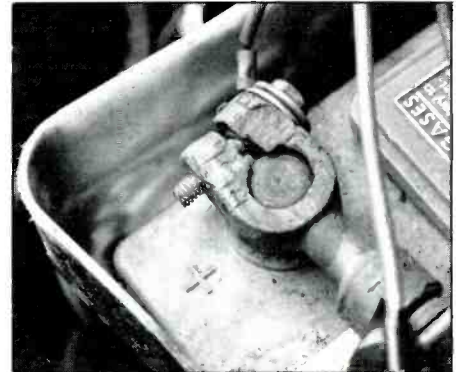

Make sure all your battery posts are clean from corrosion.



Six pounds for 10 amps per battery for 3 batteries in parallel.

20,000 to 200,000 Hz. This signal is commonly referred to as "pulse width modulated." The average of this pulse is what produces the desired output.

The AC line is isolated from the DC output for most of these chargers to prevent a source of electrolysis. This is especially important on boats. On the older linear-type of chargers, this isolation was accomplished by the input transformer. To fully isolate the AC line voltage from the DC output in a switching charger, opto-couplers are often used. These normally control the pulse width modulator circuit by light waves, thus eliminating the physical connection and accomplishing the desired isolation.

The pulse signal is then filtered to reduce
(Continued on page 74)

THE EXCITING WORLD OF RADIOTELETYPE MONITORING

POP'COMM's chief scribe, Tom Kneitel, and I were recently discussing the current situation with RTTY stations found on HF Radio. The shortwave bands seemed to have become eerily silent of RTTY signals and the poor propagation conditions of the past year were only a partial cause.

"I have also noted far fewer RTTY stations than two or three years ago running plaintext press and RY's," Tom observed. "There's lots more stuff in 850 Hz crypto than there used to be, and less stations running VFT than there were."

Pondering over his comment, I realized what he said was true. In the eight years I've been monitoring RTTY stations, I've seen the disappearance from the shortwave bands of many news agencies, including UPI, AP, AFP, DPA, Reuters and some lesser known ones, including DIPLO, which was operated by the French MFA. What ever became of ADN, which was in East Germany before the German unification?

Some weather stations have become silent, including the ones in New York City and Miami, Florida; Paris, France and Vienna, Austria. Remember coastal station WSL, Amagansett Radio, New York? It's been off the air for several years now. And the same with a station in Argentina that was seen quite often with banking deposits and withdrawals statements.

A civil war in Liberia a couple of years ago forced the shutdown of the U.S. - Liberia Radio Corp., which had a RTTY link between the Harbel, Liberia, rubber plantation, and the Firestone Tire and Rubber Co. in Akron, Ohio.

I haven't heard a thing for quite a long time from the RTTY circuit between Kitt Peak National Observatory, Tucson, Arizona, and Cerro Tololo Observatory in Chile. I guess it's gone for good, too, as well as the Smithsonian Institution circuit to Peru, Brazil and Australia.

It also seems that a number of government RTTY stations in the former Warsaw Pact nations have been shut down as those countries develop market economies. I may be wrong, but I haven't heard the weather station in Bucharest, Romania, for a long time now. What happened to it?

Yes, a lot of RTTY stations have disappeared this past decade. Some have gone to satellite transmissions, some could no longer afford operating a RTTY station, and some, such as WSL, have closed their doors forever.

And that abundance of 850 Hz crypto you mentioned? There'll be less and less of that in the next few years as many of our military bases at home and abroad are closed for good.

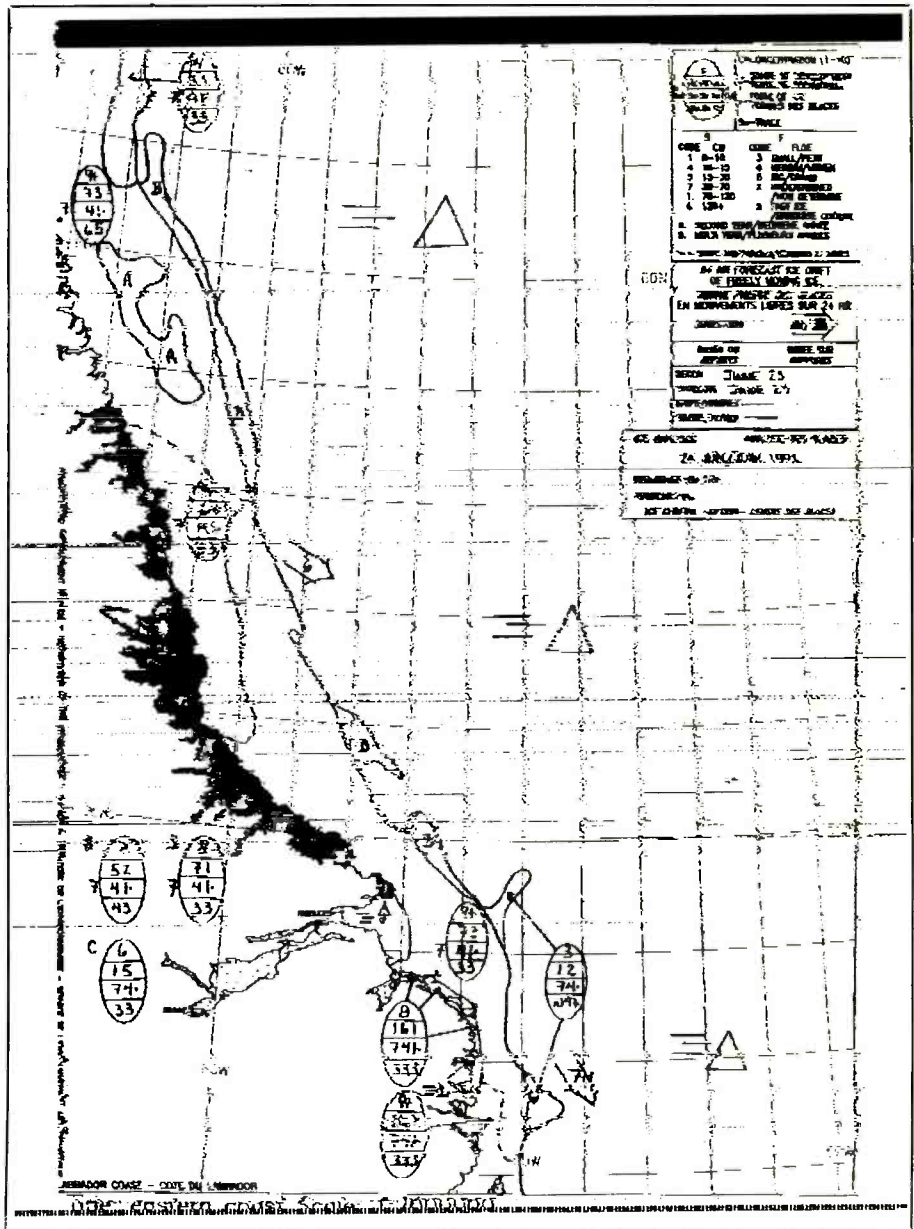

Ice chart issued by CFH, Canadian Forces Meteorological Center, Halifax, NS. (Submitted by Geoff Malta of New Jersey.)

I don't believe this to be a swan song for utility RTTY stations, especially for the diplomatic services. The newer modes of TTY transmissions, such as FEC-A, ARQ-E(3), and SI-ARQ, serve to improve long-distance communications. The more improvements that are made, the longer we'll have utility RTTY stations around to monitor.

RTTY Intercepts

4222.8: GYU, Royal Navy, Gibraltar. heard at 0150, 75 baud. (Fred Hetherington, FL)

- 4764.7:** CCS, Santiago Navrad, Chile, w wx & tfc in SS. 50 baud at 0255. (Robert Hall, RSA)
- 6496.5:** CFH, Canadian Forces Meteo. Halifax, NS, w coded wx, 75 baud at 0125. (Ed.)
- 6763.2:** "M5NLQ" w manually-typed msgs in GG to "RTA4," 50 baud at 0330. (Paul Scalzo, PQ)
- 6907.3:** Un-ID w lengthy crypto + brief & intermittent RYRY, 150 baud at 0603. (Ed.)
- 6996.9:** U.S. Army MARS stas in ARQ at 0333. (Ed.)
- 7535:** Un-ID U.S. Navy crypto between KKKK . . . and UUULLL, 75 baud at 1408. (Ed.)
- 7626:** TZH, ASECNA, Bamako, Mali, w RYRY. 50 baud at 0212. (Harold Manthey, NY) Same sta found on 7628 at 0529. (Scalzo, PQ)

TACC Телеграфное Агентство Советского Союза

Москва, Тверской бульвар, 10

25. April 1991.

Hugh M. Hawkins

U.S.A.

Dear Mr. Hugh M. Hawkins,

In answer your letter of February 12 1991: TASS really beams radio teleprinter broadcasts at the frequency 16348 kc and the time you mentioned.

We wish you further successes in your amateur radio activities.

Main Communications
Department TASS

Hugh Hawkins of Mississippi received this QSL letter from Tass, Moscow, USSR, for a news broadcast he monitored on 16348 kHz at 1800 UTC, 50 baud.

- 7720.7:** U.S. Army MARS sta AAT6USW w MARS-grams in ARQ at 1415, and in FEC at 1430. (Ed.)
- 7690:** TUH43, ASECNA, Abidjan, Ivory Coast, w RYRY, 50 baud at 0311. (Ed.)
- 7758.2:** PZP, Zanderij Aero, Surinam, w aero wx at 0100, 50 baud. (Scalzo, PQ)
- 7832:** USAF MARS stas AFA10E, AFA1FP, AFA2ER, et al, chewing the fat at 1442, 45 baud. (Ed.)
- 7863:** PWN33, Natal Navrad, Brazil, w unclas tfc, 70 baud at 0600. (Scalzo, PQ)
- 8066.7:** Un-ID Mexican military w an ARQ msg in SS at 1000. (Hetherington, FL)
- 8164.5:** 5YD, Nairobi Aero, Kenya, w RYRY at 0207, 50 baud. (Scalzo, PQ)
- 9041:** 5YE, Nairobi Meteo, Kenya, w coded wx, 100 baud at 0000. (Hetherington, FL)
- 9255.8:** SPK, Phnom Penh, Cambodia, w nx in EE, 50 baud at 1108. (Hetherington, FL)

- 9320:** Un-ID aero sta w aero wx at 0709, 100 baud. (Scalzo, PQ)
- 9374.5:** RFD49, Moscow, USSR, w crypto, foll by ID & more crypto, 2300-2305, 75 baud. (Scalzo, PQ)
- 10104.4:** 3XA, Conakry Aero, Guinea, w RYRY at 0659, 50 baud. (Scalzo, PQ)
- 10231.7:** "LYNX" w ARQ phasing sig & CW ID at 0337. (Ed.)
- 10580:** HMF46, KCNA, Bosong, North Korea, w nx in EE at 1534, 50 baud. (Harold Manthey, NY)
- 11070.5:** NNNOMOC, USMC MARS, w ARQ tfc at 0136. (Ed Deasy, VA)
- 11198.7:** "LYNX" w various selcals in ARQ & its ID in CW, at 0322. (Ed.)
- 11638:** DDK8, Pinneberg Meteo, Germany, w RYRY, 50 baud at 2049. (Manthey, NY)
- 12212.5:** YZ07, Tanjug, Belgrade, Yugoslavia, w nx in EE, 50 baud at 1047. (Ed.)
- 12241:** Un-ID U.S. Military w continuous RYRY, FDM 75 baud at 1252. (Ed.)
- 12233:** Un-ID w 5L grps, 50 baud at 1420. (Manthey, NY) It's a Cuban diplo sta somewhere, according to my loggings database—Ed
- 12490:** WTEW, the NOAA ship "Pierce," w msgs to NMN at 2241, ARQ. (Ed.)
- 12497.5:** Y5FP, The German cargo ship "Glauchau," w telexes in GG to Ruegen Radio, ARQ at 2215. (Ed.)
- 12579:** NIK, USCG, Boston, MA, w int'l ice patrol bulletin at 1219, FEC; & NMF, USCG, Boston, w hydro-lants & navareas in FEC at 0217. (Ed.)
- 12658:** LOR, Puerto Belgrano Navrad, Argentina, w plaintext wx in SS, 75 baud at 1015. (Hetherington, FL) LOR w 5L msgs at 0200. (Ed.)
- 12980:** UAT, Moscow R., USSR, w ARQ phasing sig + CW ID at 0058. (Ed.)
- 13417:** CCS, Santiago Navrad, Chile, w RYRY & SGSG, 75 baud at 1213. (Ed.)

Abbreviations Used In The RTTY Column

AA	Arabic
ARQ	SITOR mode
BC	Broadcast
EE	English
FEC	Forward Error Connection mode
FF	French
foxes	"Quick brown fox ... "test tape
QG	German
ID	identification/led
MFA	Ministry of Foreign Affairs
nx	News
PP	Portuguese
RYRY	"RYRY ... "test tape
SS	Spanish
tfc	Traffic
w/	With
wx	Weather

IMPROVE RECEPTION



ANTENNA PLUS
Only \$90

Make your receiver spring to life! Receives like the large antennas yet sits on your table! Models for ALL BANDS, SCANNER or SHORTWAVE. Strong internal 15-22db amp! 115VAC pwr. Cable to receiver. INCLUDED!
ANTENNA PLUS-1 0.5-1300MHz "All Bands" (for wide coverage rxv.)
ANTENNA PLUS-2 0.3-30MHz "Short-Wave" (peaked for SWL's)
ANTENNA PLUS-3 30-2000MHz "Scanner" (peaked for VHF-UHF)

SUPER SCANNER STICK



Only \$80
Get great scanner reception with our SUPER SCANNER STICK. Covers all scanner bands (25-1000MHz) Only 35" long. Powerful 15db booster amplifier. 25' of coax cable supplied with connector for your scanner.

SCANNER STICK Same as above but without booster amplifier \$40

SHORTWAVE ANTENNA



Brings in signals as only a large antenna can. 130' long and with four wire elements for optimum reception on all SWL bands. 0.3-30MHz. Comes with 50' coax feedline, 100' rope and a Static Bleed. MULTIWIRES-4 \$100

SIGNAL INTENSIFIER

SUPERCHARGE YOUR RECEPTION with our RFP-40! STRONGER SIGNALS for scanners, shortwave, AM-FM-TV, cable and more. 115VAC pwr. Choice of BNC, UHF or F connectors. RFP-40 \$70

LISTEN TO HOURS OF SCANNING IN MINUTES!

Our TAPE SAVER interface makes your recorder operate only when there's action on your scanner. Tape Saver TS-1 \$60

Continous US Shipping/Handling \$5, Canada, AK, HI, PR \$8 NY and MI add sales tax.

MANY MORE PRODUCTS
SEND FOR DETAILS!



ELECTRON PROCESSING, INC.
PO BOX 68
CEDAR, MI 49621 (616) 228-7020

CIRCLE 158 ON READER SERVICE CARD

SE SIGNAL ENGINEERING's High Performance CB Antennas

SUPERHAWK

\$114.95

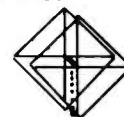

Goldenrod 45 Mobile Antenna



SPYDER A
\$35.95

WHITE LIGHTNING

\$199.95

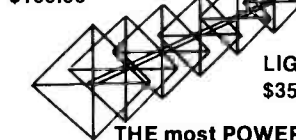

LIGHTNING 6
\$359.95

THE most POWERFUL CB base in the world today!

All SE PATENTED rotary beams are true quads and OUTPERFORM their counter parts (quad/yagi types). SE's patented SFS matching system makes SE QUADS the most technologically advanced antennas in the world today.

If your dealer doesn't have SIGNAL ENGINEERING, write or call for full specs. DEALER inquiries invited.

SIGNAL ENGINEERING

2624 Fayette Drive, Mountain View, CA 94040
(415) 948-3833

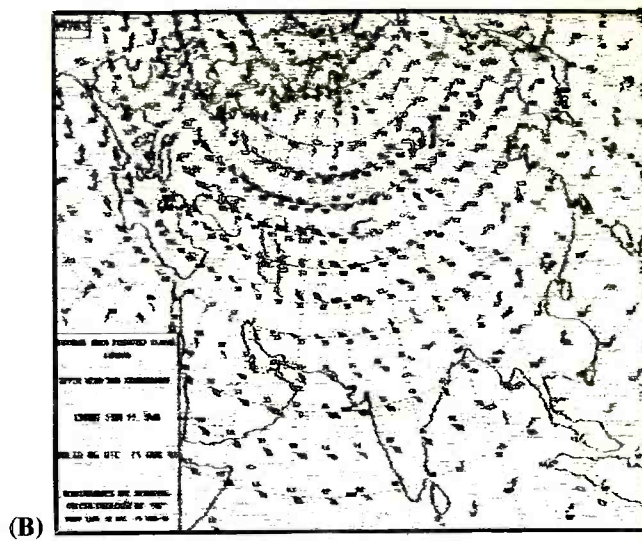
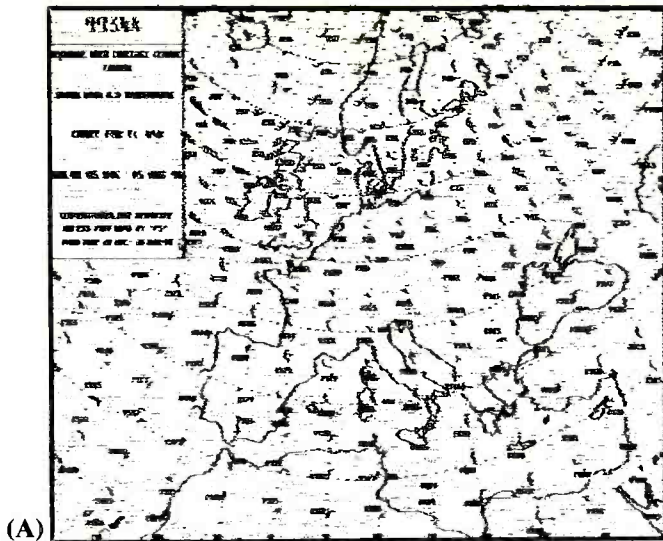

Wind temperature weather charts issued consecutively by GFE24, Bracknell Meteo, England. (A) shows Europe, and (B) Europe and Asia. (Printouts from Robert Margolis)

13526: DHJ51, Gregel Meteo, Germany, w coded wx at 0058, 100 baud. (Manthey, NY)
13530: RVW53, Moscow Meteo, USSR, w coded wx, 50 baud at 1450. (Manthey, NY)
13780: HMF35, KCNA, Jungsan, North Korea, w RYRY at 1450, foll by nx in EE at 1500. Was 50 baud and // HMF55 on 11430.. (Ed.)
13803.2: RCR78, Khabarovsk Meteo, USSR, w coded wx at 1416, 50 baud. (Ed.) Ditto at 0118. (Manthey, NY)
13863.2: SAM38, Swedish Embassy, Moscow, USSR, w 5L grps at 1356, SWED-ARQ. (Ed.)
13938.5: SNN299, MFA, Warsaw, Poland, w nx in Polish, POL-ARQ at 1249. (Ed.)
14367: BZP54, Xinhua, Beijing, China, w nx in EE at 1338, 50 baud. (Manthey, NY)
14391.5: Un-ID w encryption, ARQ-E/192 at 0203. (Ed.)
14433.5-14435: MKK, RAF, London, England, w RYI's & foxes, 50 baud at 0211. (Ed.)
14560.2: HVN, Vatican City, Vatican, idling, ARQ-M2-242/96 at 1341, & off the air at 1407. (Ed.)
14604: BAC24, PTT, Beijing, China, w RYRY & calling LZA2, 50 baud at 1417. (Manthey, NY)
14654.5: SPW, Warsaw R., Poland, w ARQ msgs in Polish at 0354. (Ed.)
14719: OST58, Oostende R., Belgium, w a tfc list & sports nx, FEC at 0122. (Ed.)
14783: Un-ID w encryption, ARQ-E/192 at 0755. (Ed.)
14823.7: CLP44, Cuban Embassy, Harare, Zimbabwe, w msgs in SS & 5F grps, 50 baud at 0729. (Ed.)
14844.9: Un-ID w a msg in FF, ARQ-E/96 at 1312. (Deasy, VA)
14926.8: RFTJ, French Navy, Dakar, Senegal, w "controle de voie," ARQ-E3/48 at 0520. (Ed.)
14930.2: AAA0USA, Fort Lewis, WA, w MARS-grams to AAB6USA, packet radio at 1243; & AAA5USB, Fort Sheridan, Highwood, IL, w an ID. Fort Sheridan is scheduled to be closed in another couple of years. (Ed.)
14932.3: APS, Algiers, Algeria, w YRYR, 50 baud at 0716. (Ed.)
14950: RWM79, APN, Moscow, USSR, w nx in AA, 100 baud at 0618. (Ed.) Ditto at 0630. (Hall, RSA)
14974.9: "RFGW," MFA, Paris, France, w 5L grps & a msg in FF, FEC-A/192 at 1545. (Deasy, VA)
14989: TNL77, ASECNA, Brazzaville, Congo, w metar's on channel A, and aero wx on channel B, ARQ-M2/96, at 0706. (Ed.) Same sta w 50-baud coded wx at 1635. (Hall, RSA)
15670: HGM36, MTI, Budapest, Hungary, w nx in SS, 50 baud at 1633. (Manthey, NY)
15838.7: VER, Canadian Forces, Ottawa, ON, w/ encryption, ARQ-M2/96, channel A, at 1627. (Ed.)
15877: "PTA" w a msg in SS & op chatter at 0208,

Autospec/68.5. (Deasy, VA)
15935: MENA, Cairo, Egypt, w nx in EE at 1700, 50 baud. (Hall, RSA) Same at 1840. (Manthey, NY)
16000: Un-ID idling, FEC-A/192 at 0011. (Ed.)
CNM69, MAP, Rabat, Morocco, w RYRY & nx in FF, 50 baud at 1525. (Manthey, NY), and at 1705. (Hall, RSA)
16107.5: HBD20, MFA, Berne, Switzerland, w 5L grps at 1620, ARQ. (Manthey, NY)
16125: Most likely French Navy w encryption & intermittent RYRY, 75 bay at 1447. Xmsn ends 1515 w RYRY + FUM (4X), FUT (1X), & DSIZ (4X). (Ed.)
16224: 3MA35, CNA, Taipei, Taiwan, heard at 1550, 50 baud. (Hall, RSA)
16265: Un-ID w short periods of crypto separated by long periods of RYRY, 785 baud at 2328. (Ed.)
16302: "DFZG," MFA, Belgrade, Yugoslavia, w nx

in SC, FEC-A/144, 2317-2324. (Ed.)
16965: ZSC, Cape Town R., RSA, w wx at 1210, 75 baud. (Hall, RSA)
17432: "DFZG," MFA, Belgrade, Yugoslavia, w nx in SC at 1345, 75 baud. (Ed.)
17454.7: Un-ID French diplo w 5L msgs, ARQ5-90/200 at 1223. Many deep fadeouts after a major solar storm. (Ed.)
17464: MFA, Bucharest, Romania, w encryption, ROU-FEC.164.5 at 1412. (Ed.)
17484.3: Un-ID w 5F grps, 75 baud at 1256. To CW 1259 for s/off. (Ed.)
17492: GYU, Royal Navy, Gibraltar, w RYI's & foxes, 50 baud at 1344. (Manthey, NY)
18035: ZRH, Cape Fisantekraal Navrad, RSA, w RYRY, 75 baud at 1200. (Hall, RSA)
18040.3: CLP1, MFA, Havana, Cuba, w 5F grps,

```

DE NIK RPT AS2
//////////////////////////////////ICE//////////////////////////////////
SUBJ: INTERNATIONAL ICE PATROL (IIP) BULLETIN
1. 091200Z JUL 91 INTERNATIONAL ICE PATROL (IIP) BULLETIN.
REPORT POSITION AND TIME OF ALL ICE SIGHTED TO COMINTICEPAT VIA CG
COMMUNICATIONS STATION NMF,NMN AND ANY CANADIAN COAST GUARD RADIO
STATION. ALL SHIPS ARE REQUESTED TO MAKE UNCLASSIFIED SEA SURFACE
TEMPERATURE AND WEATHER REPORTS TO COMINTICEPAT EVERY SIX HOURS
WHEN WITHIN THE LATITUDES 40N AND 52N AND LONGITUDES 39W AND 57W.
IT IS NOT NECESSARY TO MAKE THESE REPORTS IF A ROUTINE WEATHER
REPORT IS MADE TO NWS WASHINGTON DC. ALL MARINERS ARE URGED TO USE
EXTREME CAUTION WHEN TRANSITTING NEAR THE GRAND BANKS SINCE ICE
MAY BE IN THE AREA.
2. THE ICEBERG, GROWLER, AND RADAR TARGET POSITIONS ARE BASED ON
ESTIMATED DRIFT. DATE OF SIGHTING IS IN PARENTHESIS FOLLOWING THE
POSITION. ALL DATES ARE JUNE UNLESS OTHERWISE INDICATED.
3. ESTIMATED LIMIT OF ALL KNOWN ICE: FROM THE NEWFOUNDLAND COAST
NEAR 4735 , 5802 (CO TEAU HEAD) TO 4330N 5600W TO 4120N 4835W
TO 4650N 4010W TO 5545N 4800 THEN EASTWARD.
THE ICEBERG LIMIT NORTH OF 52N IS DERIVED FROM ENVIRONMENT
CANADA ICE CENTRE OTTAWA.
4. ESTIMATED LIMIT OF SEA ICE: FROM NEWFOUNDLAND COAST NEAR
5105N 5545W TO 5020N 5605W TO 4955N 5445W TO 5220N 5400W TO
5405N 5435W TO 5330N 5220W TO 5435N 5240W TO 5455N 5525W TO
5755N 6015W TO 6005N 6030W TO 6040N 6315W TO 6210N 6315W TO
6230N 6035W TO 6505N 5755W TO 6835N 5555N THEN NORTHWARD.
5. SOUTHERN AND EASTERN MOST BERGS ESTIMATED AT:
4229N 4846W(30), 4230N 4843W(30), 4216N 4952W(08JUL),
4713N 4130W(17), 4641N 4201W(30)
6. RADAR TARGETS ESTIMATED AT: 4230N 4845W(30), 4230N 4842W.
6. THERE ARE MANY ICEBERGS NORTH OF 4230N AND WEST OF 4300W
WITHIN THE LIMITS OF ALL KNOWN ICE GIVEN IN PARAGRAPH 3.
BT
DE NIK AR
JJJJ:

```

International Ice Patrol bulletin was issued by NIK, U.S. Coast Guard, Boston, MA. It was sent on 12579.3 kHz in FEC mode at 1219 UTC. (From Robert Margolis)

THE HAM COLUMN

GETTING STARTED AS A RADIO AMATEUR

Special Ham QSL Card To Commemorate HCJB's 60th Anniversary

If you'd like to add a rare QSL card to your collection, then be sure to take part in HCJB's amateur radio special event this month. Operators who make contact with hams from HCJB in Quito, Ecuador, will receive a one-of-a-kind QSL card, issued to coincide with HCJB's 60th anniversary. The pioneer missionary radio broadcaster has been operating since Christmas Day, 1931.

Ham operators in Quito will be on the air, making contacts worldwide for 30 hours from 4 p.m. EST (2100 UTC) Friday, Dec. 6 to 10 p.m. Saturday, Dec 7 (0300 UTC Sunday, Dec. 8). The special call sign for this event is expected to be HC60JB, and HCJB will be transmitting on 14225, 21300 and 28500 kHz (plus or minus a few kilohertz for receiving). To obtain your special QSL card, send a reception report to HCJB, Casilla 17-01-00691, Quito, Ecuador.

One of the most unusual aspects of the event is that HCJB hams will have access to some of the world's most powerful short-wave antennas, located at HCJB's international transmission site in nearby Pifo.

Keith Clukey (KC6SMW/HC1), an HCJB machinist and ham operator coordinating the event, explains: "We plan to have two hams working simultaneously on two different bands, depending on conditions. They will receive contacts in their homes in Quito and use the telephone to tap into HCJB's microwave system. The signal will then be beamed 18 miles to Pifo for broadcast around the world via our Siemens SSB transmitters.

"The reason for this elaborate system is that we can't actually receive other stations in Pifo due to interference from all the transmissions there. We have 12 high-power transmitters operating at different times and frequencies.

"The Seimens transmitters, which first went on the air in the summer of 1990, are capable of putting out 30 kW, but they will be detuned to amateur limits (1.5 kW)," Clukey continues. "However, our antennas will boost the signal strength considerably. The amount of gain will range from 18 to 25 dBI, depending on which frequency and antenna we're using at the time."

HCJB engineers have 31 antennas in Pifo at their disposal, making this one of the largest radio transmission sites in the world, and the biggest facility of its kind among religious broadcasters.

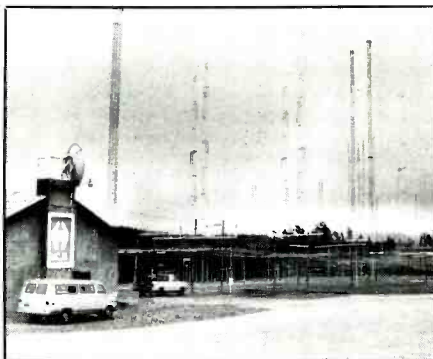

HCJB's curtain antenna array for Europe and the South Pacific overlooks HCJB's transmitter building in Pifo.

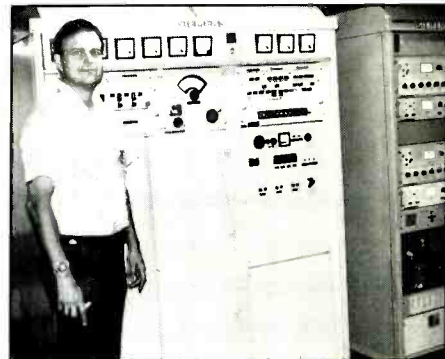

Keith Clukey, an HCJB machinist and ham radio operator, stands next to HCJB's Siemens SSB transmitters in Pifo.

Antennas to be used for the event range from a large rhombic unit (8 to 13 dBI) to 30-story-high curtain antennas with eight parallel-fed dipoles. HCJB's unique steerable antenna, capable of carrying 500 kW transmissions, will also be utilized during the event. But perhaps the most interesting antenna to be used is the cubical quad. This popular antenna design was invented by former HCJB engineer Clarence Moore in

1939. Moore came up with the innovative design to overcome problems with high-power broadcasting in the rarefied air of Quito—9,300 feet high in the +Andes. HCJB's quad antenna has 24 elements with four parallel-fed arrays, each six elements deep.

"I think there will be a good response to this special event," Clukey says. "The main thrust of the event is that ham radio opera-

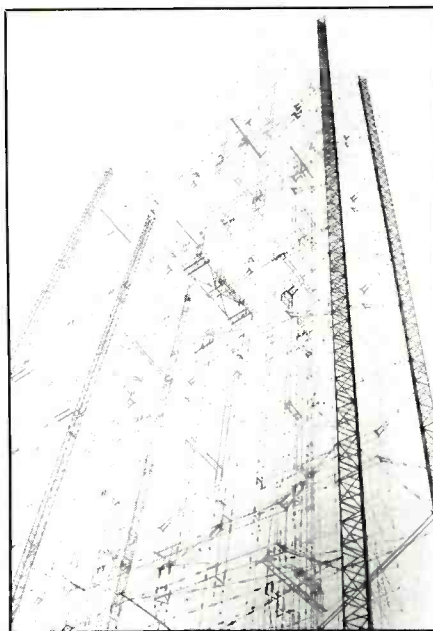

HCJB's bi-directional antenna in Pifo sends shortwave signals to Europe and the South Pacific.

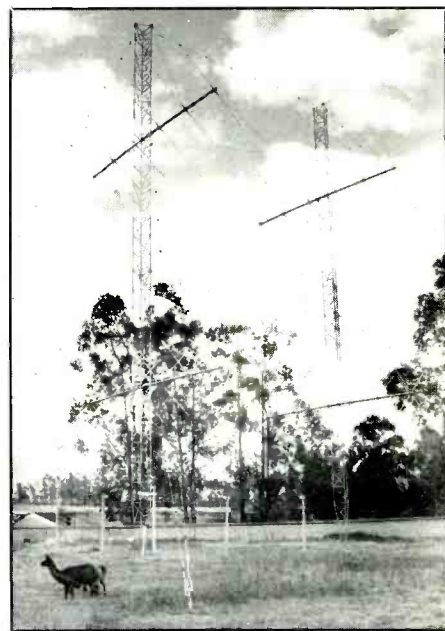

HCJB's 24-element cubical quad antenna dwarfs a pair of llamas at HCJB's international transmission site in Pifo.

tors are helping to celebrate HCJB's 60th anniversary. But we'd also like to encourage ham operators to listen to HCJB and increase their interest in the station.

"Many ham radio operators first got interested in amateur radio by listening to distant shortwave radio stations such as HCJB."

HCJB International Radio Director John Beck (HC1QH) says the event provides "yet another opportunity to make personal contact with people who are interested in our station."

He adds that numerous hams have written the station, asking how they can get into contact with ham operators at HCJB. This event answers their request as more than 18 HCJB hams are expected to take part in the special event at different times.

This will only be the second amateur radio event to be held during HCJB's 60-year history. The first took place June 11-12, 1983 during World Radio Communication Year.

Clukey adds that, "We're primarily a religious broadcaster, but we have a lot of DX programs as well as news and cultural information of general interest to all listeners."

HCJB is a ministry of World Radio Missionary Fellowship, Inc., an evangelical, interdenominational organization involved mainly in broadcasting. HCJB broadcasts around the world in more than 18 languages and 22 dialects.

By Harold Goerzen



CODE SCANNER ADVANCED MULTI-MODE DECODER Two Line, 32 Character LCD Display

Copies Morse, Baudot and ASCII Codes from your Radio! Automatic Morse Code tracking: 3-70 WPM. Built-in Code practice oscillator for hand key with readout to display. Built-in speaker. Advanced Analog and Digital filtering with AGC. Special practice mode to learn Morse characters. Compact size: 3½" x 5¾". Operates from 12 VDC or 120 VAC adapter provided. Easy hook-up to Radio speaker or headphone jack. Made in U.S.A.

Call or write for FREE brochure or order Factory Direct.

CODE SCANNER Model CSCAN \$ 189.00

Add \$6.00 shipping for continental U.S. Send check, money order, VISA or MasterCard.

Microcraft

Corporation Telephone:(414) 241-8144
P.O. Box 5130, Thiensville, Wisconsin 53092

CIRCLE 174 ON READER SERVICE CARD

YOU AIN'T HEARD NOTHIN... YET!

CRB RESEARCH

P.O. Box 56

Commack, NY 11725

Since 1967, CRB Research has been the world's leading publisher and supplier of unique hobby and professional books and information including:

- Scanner Frequency Guides
- Shortwave Frequency Guides
- Military/Federal Communications
- Broadcast Station Registries
- Undercover Communications
- Survival Communications
- Covert Operations
- Electronic Espionage
- Surveillance

CIRCLE 16 ON READER SERVICE CARD

WEFAX To The Max

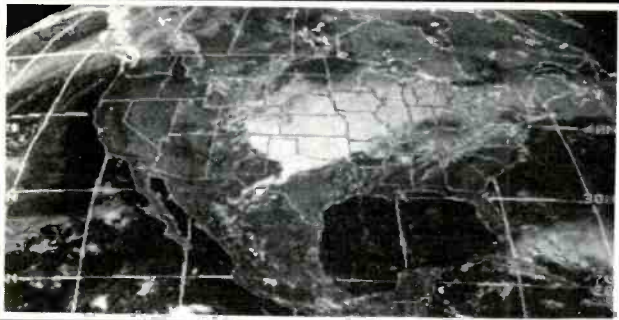

PC GOES/WEFAX 3.0 \$250

PC GOES/WEFAX 3.0 is a professional wefax image reception and analysis system for the IBM PC and compatibles. The product includes a demodulator that handles both AM and FM fax signals, advanced signal processing software, tutorial cassette, and complete 325 page reference manual. The software includes the following advance features:

Menu Driven
Start/Stop Tone Recognition
Unattended Operation
Tuning Oscilloscope
Resolution up to 1280x800x256
Programmable Colorization
Brightness and Contrast Control
Pixel Photometry and Histograms
Image Zoom, Scroll, Pan, Rotation

CGA,HGA,EGA,VGA & Super VGA
Orbital Prediction and Display
Time Lapse Frame Looping
Slide Shows
Export to PCX & GIF Files
Grayscale on all Popular Printers
Programmable IOC & Line Rates
Infrared Thermal Analysis
APT Latitude & Longitude Grids

PC HF FACSIMILE 5.0 \$99

PC HF Facsimile 5.0 is a complete reception system for shortwave FSK facsimile on the IBM PC and compatibles. The product includes an FSK demodulator, tutorial audio cassette, 250 page manual and signal processing software. The product includes many of the advanced features of PC GOES/WEFAX 3.0 but at a fraction of the price. Call or write for a complete catalog of products.

Software Systems Consulting

615 S. El Camino Real, San Clemente, CA 92672
Tel:(714)498-5784 Fax:(714)498-0568

CIRCLE 172 ON READER SERVICE CARD

THE MONITORING MAGAZINE

Computer Aided Scanning

a new dimension in communications from Datametrics



Now you can enhance your ICOM communications receiver through a powerful computer controlled system by Datametrics, the leader in Computer Aided Scanning. The system is as significant as the digital scanner was five years ago and is changing the way people think about radio communications.

The Datametrics Communications Manager provides computer control over the ICOM R7000 or R71A receiver.

Powerful menu driven software includes full monitoring display, digital spectrum analyzer and system editor.

Innovative hardware design requires no internal connections.

Comprehensive manual includes step by step instructions, screen displays, and reference information.

Extends ICOM capabilities including autolog recording facilities, 1000 channel capacity per file, and much more.

Overcomes ICOM limitations such as ineffective scan delay.

Datametrics, Inc

R7000 system \$349
R71A system \$349
Manual and demo disk \$15

Requires ICOM receiver and IBM PC with \$12K and serial port. The R71A version also requires an ICOM UX-14.

Send check or money order to Datametrics, Inc, 2575 South Bayshore Dr, Suite 8A, Coconut Grove, FL 33133. 30 return privileges apply.

CIRCLE 173 ON READER SERVICE CARD

Beaming In

(from page 4)

everybody else. Sure, I've read the manuals for the equipment I own. But that doesn't always help, either. For example, even when it's working, no matter how many times I have attempted to program my Korean Son of Sam VCR, I never fail to screw up everything.

Regardless of which late-night movie I try to record at any time on any channel, I end up with the same commercial program showing some idiot polishing a Rolls Royce and then setting fire to its hood with lighter fluid. Alternately, I get the local educational channel running a selection from their library of films, most of which cover topics like making party decorations out of fish heads. Lucky for me my VCR has spent more time in the shop being repaired than hooked to my TV set. Otherwise, I'd have the world's largest private collection of stupid cassette tapes.

The VCR's instruction book has been as useful in operating the machine as an out of town telephone directory would be. My XYL insists that, in fact, it actually is a Seoul telephone directory.

Challenges like this don't bother me in the slightest when people seek me out for tech advice. Bewildered though I may be, it's still scary to think that I'm nevertheless better at any of this than those who come around beseeching me for information. I know it's shameful of me, but it's so totally flattering that I just can't help myself.

At 9:30 on Christmas morning, the phone begins ringing with people excitedly gushing about their new electronics gifts, asking when they could drop by so they can show off the stuff, and suggesting that maybe I could also give them a few pointers on its use. The message is they don't have the slightest intention of dealing with the instruction manual. They're hoping that I will come by and explain everything off the top of my head in a five minute run-through, after which they'll be experts.

Traditionally, I have accumulated a dozen or so of these calls until 3 p.m., and then the XYL becomes the designated driver for my house calls. Everybody wants me to share their holiday feast and a bit of eggnog at each stop along the way. Anything I have to say about their equipment is on the level of my proclaiming that the "power" switch may possibly be what turns the thing on. For these paltry crumbs of information, I have the heady pleasure of basking in their profound gratitude. It's as if I had just clarified Einstein's space-time continuum. At times, my explanation has been presented to the accompaniment of so much holiday noise and commotion, so many interruptions and distractions, phones ringing and howling kids, that I figure I could have sung *Louie*, *Louie* and still received the same accolades.

Of course, the problem is that at 9 p.m. I'm only on the fourth or fifth stop of my rounds. I've already put on five pounds and don't realize that I'm attempting to fit CD's into the slots of VCR's.

One time, the house guest of a friend was a visiting dignitary from the Yamaha motorcycle works, of Tokyo. Despite a couple of futile attempts at shutting me up, I recall being inspired to provide the visitor with a lengthy, impromptu, and practically logical explanation of how to convert kilocycles into motorcycles. He was busily transcribing every word in his little notebook. Hope he was merely being courteous and didn't decide to present that brainstorm at the next Yamaha staff meeting. If he did, he's now parking Yamahas instead of being concerned with their distribution and worldwide market share.

During house calls, by the time it turns 9 p.m., I have reached the pinnacle of my joviality. Unfortunately, by then, my XYL has long since stranded me in order to return home to entertain the company we invited to arrive at 8:30.

It's why physicians no longer make house calls. A doctor can't go on a workable diet or see all of his patients until he finally stops with the house calls.

So, starting last Christmas, I stopped making house calls. Friends, neighbors and relatives who called were told to show up at our place at 3 p.m., bringing along any equipment they wanted to discuss or have explained. This time, surrounded by decorated tree and roaring hearth, we served a buffet to accompany the parade of CD's, CB's cellualars, VCR's, scanners and other wonderful gizmos. G.L., the poodle man, was there, so was Woody.

To the delight of all, myself included, I sat there holding court. I was really in my glory. As usual, there was no end to useful information I had available to dispense to the befuddled masses. The XYL claims everybody was only humoring me. For all I know, they've been doing that for years. Along with those who couldn't figure out how to use their newly-received high tech gifts, a few folks obviously showed up for no other reason than to avoid spending the holidays alone. No problem!

An old school chum who holds a sensitive position at Western Union tantalized me with the promise of coming over to offer a peek at a couple of highly classified wires he had gotten his hands on. I was to learn that one wire he had was classified as 3 inches of 14 gauge 7-strand copper antenna wire, also he showed me a strip he classified as 4 inches of 18 gauge solid conductor hookup wire. A lady from town appeared carrying a bunch of floppies in a red plastic isolation bag. She was wondering how to get a cure for their computer virus.

Another unforgettable guest was a friend who has managed to become a prominent surgeon, despite his sense of humor. He was seeking advice on his almost-com-

pleted Nobel Prize caliber medical invention, which he had brought along. This was a heart Pacemaker wired up to one of those *Clapper* gadgets that turns off electric appliances with a clap of the hands. He said its future use is guaranteed to end problems getting patients to pay past due bills sent them for his services. Some who know him figure this guy may have attended the medical school that advertises on matchbook covers.

Certainly a holiday to remember. It makes up for the other side of the year—the summer solstice, when the sun is at its strongest. That's actually the lowest point on my annual calendar, when friendly neighbors bring my dog up on morals charges, and good-natured relatives weasel me out of tools. It must be the result of an old family curse or some malevolent astrological influence.

Nobody knows what this year's holidays will bring, but I'm anxiously awaiting their arrival. The poodle guy's wife called to ask for ideas about buying G.L. an electronics gift, so I know he'll be back again. Fuzzyface always singles this fellow out of any crowd to receive his unceasing attention, and with as much gusto as provided Mademoiselle Yvette.

Cousin Woody will come around, too. He isn't beneath asking for instructions on using a flashlight or digital wrist-watch now that he knows where there's a working buffet table. Woody graduated from the Evelyn Wolf School of Speed Eating.

My hope is that your holiday will be happy, and you can also spend it in the comforting warmth of those whose company you enjoy.

There may be no better time than this holiday season to demonstrate that our cold and battered world is warmed, healed, and renewed when we reach out and share a smile with others. Seeing the humor in at least some of the many frailties of our human condition is the first step in the process.

New Age Revisited

In the September issue we showed and discussed New Age electronics products, and mentioned that they came from the catalog of Super Science, Dayton, OH. A number of readers have asked how to get in touch with Super Science.

Super Science is at PO Box 392, Dayton, OH 45409. The telephone number is (513) 298-7116.



CLANDESTINE COMMUNIQUE

WHAT'S NEW WITH THE CLANDESTINES

The resolution of the Ethiopian civil war, coupled with the end of the Mengistu government has resulted in the disappearance of several Ethiopian clandestine stations. Gone from the airwaves are *The Voice of the Ethiopian People for Peace, Democracy and Freedom*, *The Voice of the Broad Omoro Masses* and *Radio of the Ethiopian Democratic Officer's Revolutionary Movement*. *The Voice of the Broad Masses of Eritrea*, perhaps the oldest of the Ethiopian clandestines, continues its operation and now announces that it broadcasts from Asmara, Eritrea. It announces its current frequencies as 3940, 7020 and 7490. *The Voice of the Tigre Revolution* also continues to operate, announcing its location as Mekele, capital of Tigre province. North American DX'ers would seem to have a slight chance to hear this one now, at 0400-0500 on 6940 and 7820, in the Tigrigna language.

Radio SPLA, voice of the Sudan People's Liberation Movement/Army which clandestine watchers believed to be transmitting from Ethiopian facilities, apparently is, or was. Once the new regime took over in Addis Ababa *Radio SPLA* fell silent. The same is true for a lesser known anti-Sudan station, *Radio Sudan*. It's anyone's guess whether these will return, it's likely both are looking for a sympathetic host country or the means to put their own facilities on the air.

The FMLN's *Radio Venceremos* continues to be active on 6399v after a long silence on shortwave. The station is being heard around 0200 with the usual Spanish programming. You may also hear the morning transmission scheduled for 1300.

It's still not certain just who operates the replacement program for the anti-Beijing *Voice of June 4th*, which discontinued its efforts last spring. Appearing in its place is *The Voice of China*, via the facilities of the Broadcasting Corporation of China, Taiwan. The *Voice of China* now airs a 60 minute program at 2100-2200 on 15280. Supposedly, the program is produced by Chinese ex-patriots.

Here are yet more anti-Castro voices being carried on WWCR's Nashville shortwave outlet: *La Voz de la Junta Patriotica Cubana* airs at 2230-2300 and *La Voz de la Tribuna Libre* runs from 2300-2330, both on 15690. The *Patriotica Cubana* program may be from the same group which operated a station with a similar name many years back. Letters to this broadcast may be sent to Box 526852, Miami, FL 33125. The *Tribuna Libre* program has an address of PO Box 11304, Miami, FL 33111.

R. C. Watts in Kentucky reports reception



A rare clandestine QSL, especially for DX'ers in North America, Al-Quds Radio calls for a Palestinian state. Thanks to Ivan Cholakov of Bulgaria.

of *Esperanza - La Voz de los Municipios de Cuba in Exilio* between 2306 and 2356 via WWCR on 15690. This one airs Monday through Friday and is produced by the group *Municipios de Cuba*, 4600 NW 7th St., Miami, FL 33126.

UNITA's anti-Angolan *A Voz do Resistencia do Gaio Negro* continues to be heard by various clandestine hunters. It's reported on 7100 at around 2330 or later, 4880 to sign off at 2325. Programming is in Portuguese.

Watts in Kentucky reports *Croatian Radio*, Zagreb (Yugoslavia) via WHRI-7315 beginning at 0003 with news and current affairs. R. C. heard an announcement in English saying the program also airs Saturdays and Sundays on 9475. The program ended with identification in English and Croatian at 0055, then anthem to 0100 closing. First we've heard of this R. C. From your description it apparently wasn't *Radio Libertas*, the Croatian liberation program which WWRI has been running for sometime now.

The Palestine Liberation Organization's station, *Al-Quds Radio* (see illustration) is now reported to be operating on 5910 between 0600-1100 and 1300-1730. It airs a program in Hebrew at 0800, Russian at

0845 and English at 0915, otherwise all programming is in Arabic. We don't know of any loggings by North American listeners, but Ivan Cholakov in Plovdivska, Bulgaria has heard and verified the station.

The anti-Iranian station *Voice of the Mojahed* has been observed by a couple of North American monitors on 6540 with an 0130 sign on and programs in Farsi. This station is believed to be an operation of the government in Baghdad.

The CIA-affiliated, anti-Saddam *Voice of the Iraqi Opposition*, formerly the *Voice of Free Iraq*, is still on the air. Active frequencies continue to be 9570, 15605 and 17950, ex-17960. The schedule is listed as starting at 1400 and the station has been logged as late as 2230. One DX'er has had a QSL for this station, received for a report sent to the Ministry of Information in Riyadh, Saudi Arabia.

That does it for this time. Your loggings of clandestine stations, QSL information, schedules, background information and news clippings related to clandestine radio are always very welcome. Your name can be kept confidential if you wish.

Thanks for your help and, until next month, good hunting!

WHAT'S HAPPENING: INTERNATIONAL SHORTWAVE BROADCASTING BANDS

There are times when it's difficult to decide which piece of news to use as a lead item each month but this isn't one of those occasions. The choice is easy when there's a new country on the air! Radio Bahrain began shortwave broadcasts in mid-summer and is operating a 60 kW transmitter at Abu Hayan, using 6010 with programs mostly in Arabic. The schedule is a bit uncertain at this writing but may run from 1400 to 0500. Some English is also reported, ending at 2100. A couple of years ago Radio Bahrain aired a program via Radio Kuwait, but the Iraqi invasion put an end to that. Perhaps after testing the waters Bahrain decided they should have their own facility. Radio Bahrain's address is PO Box 702, Manama, Bahrain.

Incidentally, Kuwait's shortwave transmitters were destroyed by bombing during the war. New units have now been ordered and a partial shortwave service is expected to be back on in about eight months—probably spring '92, but full service isn't expected to be restored until the summer of 1993.

Another country is a step closer to getting on shortwave. Evangelist Dr. Gene Scott has announced that the government of Anguila has approved sale of the Caribbean Beacon to his University Network for \$782,187.04. That buys him 99,999 shares of stock in Caribbean Beacon (one share will remain in Anguila). At least one shortwave transmitter will be on the air from Anguila. No target date for shortwave from Anguila is known.

How's this for a bit of the unusual? Swiss Radio International has added radioteletype to their services. And, rather than being intended for reception by newspapers, radio or TV stations, this one is aimed at the general public. News and schedule information is aired on the RTTY service at 1830-1930 to Africa on 17531, 2000-2100 to Asia, 0030-0130 to South America and 0200-0300 to North America, all on 10515.

Longtime Argentine shortwave broadcaster Radio Belgrano used to be heard often in North America. More recently a days only schedule made catching this one a rare event. The company of which Radio Belgrano is a part has been sold to a private firm and now has a new name—Voces en Libertad (Voice of Liberty). It continues operating on 11781, relaying 950 kHz mediumwave between 1400-2000. So the schedule continues to make this one hard to hear in much of North America. There's some question as to whether the new owners will continue the shortwave for very long, too.

Spanish National Radio has instituted a 24 hour Spanish language world service, of which about two-thirds will be news and related programming. Although the schedule

is too involved to include here, check these frequencies, as several are in use at any given hour: 7105, 9580, 9620, 9630, 9650, 9685, 11790, 11815, 11920, 12035, 15110, 15240, 15325, 15365, 15395, 17715, 17755, 17845, 17890, 21495, 21555, 21570, 21595.

Republic of Yemen Radio has added some English to its schedule. This is scheduled at 1600-1630 on 5970 and 7190—time and frequency combos which don't do much for us here in North America.

A month or two back we told you of the demise of the USSR's long-running Radio Station Peace and Progress. It seems that wasn't the only Soviet broadcaster to meet its end. Radiostansiya Rodina, or Radio Homeland, the all-Russian language relay of various home service networks has also been discontinued on shortwave.

Guam is a no-go for High Adventure Ministries. It seems that all the wrangling over land titles and such has caused George Otis and company to give up on putting their KHBN shortwave station on Guam. They still hope to put KHBN on the air from somewhere in the Pacific, though. Perhaps in Northern Australia or one of the Pacific Islands.

Meantime, the "Hope" organization is adding a new 25 kW transmitter for the King of Hope station in Lebanon and should be active by the time you read this. The new unit is tentatively scheduled to use 11530 and simulcast the 6280 frequency.

Radio Beijing has plans to build a new "Radio Beijing Center" which will cost 'em 200 million yuan, says the Radio Beijing newsletter. It's to be located in the western suburbs of Beijing and construction should begin in about a year. They won't be ready for occupancy and broadcasting until 1995-96. Radio Beijing's current headquarters was built in 1958.

NOTES FROM THE MAIL: Bill Moser of New Cumberland, Pennsylvania says he's still teaching his "Radio World" class. The latest had 15 students, including Bill's son.

David Gasque in Orangeburg, South Carolina recommends tuning with upper or lower sideband controls engaged. He points out that it's easy to scan through a band, listening for oscillation when carriers are hit. "Using USB," says David, "I simply tune lower in frequency to the 'bottom' of the oscillation. I then switch to a narrow filter and listen or wait for the signal to improve. If using LSB, the opposite technique is used." Good advice, David. Many DX'ers tune in sideband almost exclusively.

Mrs. Robin Verhose in Spring Lake Heights, New Jersey wonders "how on earth you get an address from a station that's new." Often, Mrs. Verhose, the sta-

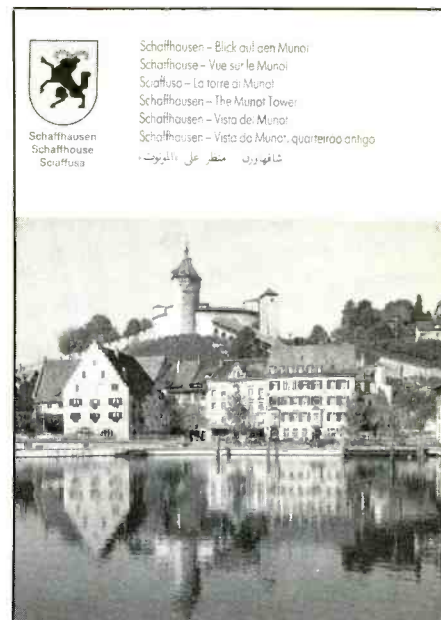

One in a series of Swiss Radio International's QSL cards which picture Swiss scenes. Thanks, J.K. Todd, Sacramento, CA.

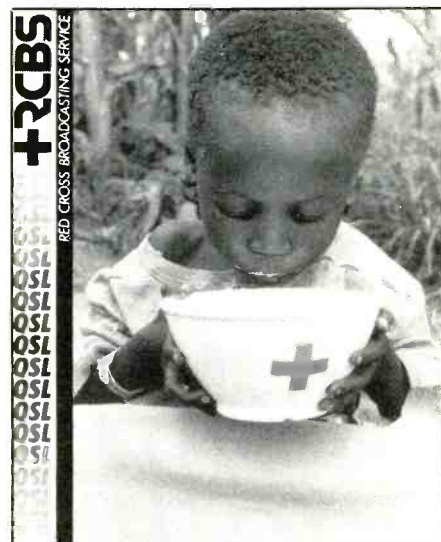

Switzerland's other station is the Red Cross Broadcasting Service. R.C. Watts, Louisville, KY, logged this while in Europe.

tion will announce an address. Or another DX'er will hear it or otherwise come across it and report it to this column or one of the club bulletins. Often you can "make up" an address that'll work just by using the station name plus the city and country in which it's located.

Mike Hawk in Omaha, Nebraska says he's been an SWL "off and on" since he was seven! Mike does a lot of mediumwave lis-

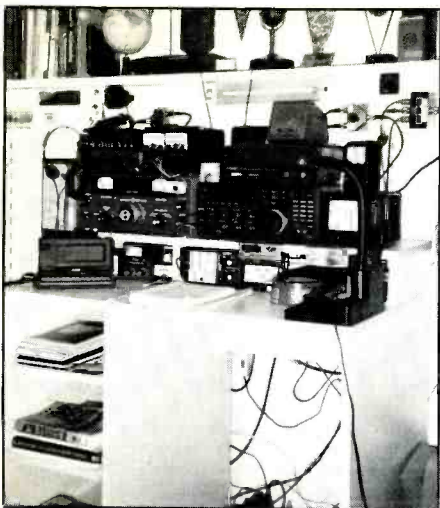

Here's the shack of Thomas H. Schlaeger, Hamburg, Germany. Featured receivers are an NRD-525 and Minix MR-73B.

tening, as well as FM and shortwave and he also has technician's ham license. Mike is interested in getting in touch with other SWL's in the area and you can reach him at 10212 P Street, Omaha, NE 68127.

James P. Ernst in Decatur, Georgia started "the first time I turned it on and discovered that the airwaves were filled with music and voices from around the world." He left the hobby in the late 70's, but the bug has bitten again and he now operates with a Kenwood R-5000, "recording devices" and an Eavesdropper trapped dipole antenna. Good to have you back in the fold, James. Keep those nice reports coming.

That goes for everyone, in fact. We need your logs each month, plus news about shortwave stations, spare QSLs we can use as illustrations as well as shack photos, station photos, schedules and what-have-you. Remember that logs should be arranged by country (alphabetical order isn't necessary) with some cutting room in between and your last name and state abbreviation after each item. We say that every month and every month several don't do it. Those are



James P. Ernst of Decatur, GA does his DX'ing from this neatly arranged shack. Looks like he's picked up some awards along the way.

the reports which are least likely to be used. Thanks for your help and your cooperation!

Here are this month's logs. Broadcast language is assumed to be English (EE) unless otherwise noted as SS (Spanish), FF (French), etc. All times are in UTC.

SWBC Loggings

Alaska: KNLS on 7365 at 0825 with religious program. (Moser, PA) 11715 at 0841 with music, ID, religious messages. (Ernst, GA)

Antigua: Deutsche Welle relay, 6040 at 0146 with German by Radio. (Moser, PA)

BBC relay on 5975 at 2243 (Moser, PA) 0539 (Carson, OK)

Argentina: RAE, 11710 at 0120 with news. (Rocker, NY)

Ascension Island: BBC relay, 7105 at 0632 with English/French lesson. (Carson, OK)

Australia: ABC Northern Territory Service (VL8K, Katherine) on 2485 at 1030 with local commentary. Weak. (Story, TX)

ABC Brisbane, 4920 at 1312 with pops, DJ, ID, weather. (Zamora, CA)

VNG time station on 12984 LSB with CW ID at 1028. (Rocker, NY)

Radio Australia, 9580 at 0957. (Vaage, CA) 15160 at 1036 to SE Asia. (Ernst, GA) 17795 at 0530. (Carson, OK)

Austria: Radio Austria International, 6015, via Canada, at 0530. (Pellicciari, CT) 9870//9875//13730 in GG to abrupt close at 0159. (Moser, PA)

Benin: Rdf. du Benin at 0500 on 4870 with national anthem and discussion in local language. (Story, TX)

Botswana: Radio Botswana with sign on at 0258 on 7255—JS, anthem, ID. (Moser, PA)

Brazil: Radio Brazil Central, 4985 with excited announcer (probably a sports event) in PP. (No time given but presume it was during local evening, editor)

Swiss: Radio International, via Brazilia, 17730 at 0201 with news. (Moser, PA)

Bulgaria: Radio Sofia, 11660//15330 at 2244 with letter program. (Moser, PA) 11865 at 1910 in AA, brief IS and ID in AA at 1930. (Zamora, CA)

Canada: Radio Canada International, 5960 at 0020 and 9755 at 2300 (Cavanaugh, TX) 9535 at 0257 with frequencies. (Moser, PA) 15325 at 1930. (Shumaker, MI)

CHNX, Halifax, 6130 at 1000 with rock. (Story, TX)

CFRX with CFRB relay on 6070 at 1120; traffic report. (Moser, PA)

CKZN, St. John's, 6160 at 1109 with CBC news. (Foss, AK)

Chad: Radiodif. National on 4904 at 0430 with national anthem, mixed regional discussions and modern African music. (Story, TX) Presume all in French, editor)

China: Radio Beijing, 9440 at 1215 in unidentified language. (Northrup, MO) 11750 at 0915. (Moser, PA) 11855 at 1409 news and "News About China." (Zamora, CA) 17705 at 0006. (Shumaker, MI)

People's Broadcasting Station, Kunming, 15670 at 1024 with instrumental music, CC. (Foss, AK)

Haixa 1 (aka Voice of the Strait, editor) 6115 at 1225 in CC but no ID heard. (Northrup, MO)

Colombia: Radio Nacional, 11823 at 2221 with news in SS. (Reyes, Mexico)

La Voz del Llano, 6115.8, announcer in SS, easy listening music at 0651. (Carson, OK)

Caracol Bogota, 6075 in SS at 0805 with news, commercials, music. (Story, TX)

Congo: RTV Congolaise with 0400 sign in FF on 4765. ID in FF followed by news. (Gasque, SC)

Costa Rica: Radio For Peace International, 7375USB at 0625. (Rocker, NY) 13630 at 0130 with ID and interview. (Ernst, GA) 15030 at 0257 with the "Other American Radio" program. ID. (Zamora, CA)

Faro del Caribe, 9645 at 0024 with religious program in SS. (Reyes, Mexico)

Adventist World Radio, religious programming on 9725 at 2301. (Moser, PA) 0455. (Rocker, NY)

Cuba: Radio Havana Cuba, 5965SSB with FF sign on at 0300 after IS. (Watts, KY) 11760 at 0100 and 11835 in SS at 0610. (Cavanaugh, TX) 11950 at 0200. (Shumaker, MI) 15230 at 1326 in SS. (Moser, PA)

Czechoslovakia: Radio Prague International, 5930//7375 at 0101 with news. (Moser, PA)

Abbreviation Used In Listening Post

AA	Arabic
BC	Broadcasting
CC	Chinese
EE	English
FF	French
GG	German
ID	Identification
IS	Interval Signal
JJ	Japanese
mx	Music
NA	North America
nx	News
OM	Male
pgm	Program
PP	Portuguese
RR	Russian
rx	Religion/ous
SA	South America/n
SS	Spanish
UTC	Coordinated Universal Time (ex-GMT)
v	Frequency varies
w/	With
WX	Weather
YL	Female
//	Parallel frequencies

Ecuador: HI2IOA time signals, 7600 at 0255. (Rocker, NY)

HCJB, 9745 at 0229. (Shumaker, MI) 11835 at 0703 and 21455 USB at 1923. (Carson, OK) 15115 at 1403. (Zamora, CA) 15155 at 0100. (Cavanaugh, TX)

Egypt: Radio Cairo, 9475//9740 at 0212. Undermodulated. (Moser, PA) 9900 at 1945 with news. (Rocker, NY)

England: BBC (various sites) 5975 at 0416, 6005 at 0111, 9640 at 0539, 11750 at 0111, 15260 at 2250. (Cavanaugh, TX) 7325//9915//12095 at 0211. (Moser, PA) 15070 at 1900. (Pellicciari, CT) 15670USB feeder at 0246. (Reyes, Mexico)

Equatorial Guinea: Radio Africa, 7189 at 2200 with religious program. (Rocker, NY)

Finland: Radio Finland International, 6120 at 2310. (Ernst, GA) 15400 at 1340. (Rocker, NY) 15400//21550 at 1300 sign on. (Moser, PA)

France: Radio France International, 17850 at 1607 with ID, news. (Zamora, CA) 21635 at 1232 with news. (Ernst, GA)

French Guiana: Radio France International relay, 9800 at 0255. (Rocker, NY)

Radio Japan relay on 15325 at 0235, woman in JJ. (Moser, PA)

Gabon: Radio Japan Moyabi relay, 11735 at 2304 with news, ID at 2306. (Moser, PA)

Germany: Deutschlandfunk, 15155 with GG sign on at 1830 after DW IS, then into Eastern European language. (Watts, KY) (Note: Deutschlandfunk produces some foreign language programs for Deutsche Welle—editor)

Deutsche Welle, 6040 at 0115. (Cavanaugh, TX) 6145 at 0147 with lead up to sign off. (Moser, PA) 9545 at 0319 with DX club, them mailbag. (Zamora, CA)

Ghana: GBC on 4915 at 0559 with anthem, YL with ID, lively drums, time check. (Moser, PA)

Greece: Voice of Greece, 9395//9420 at 0150. (Rocker, NY) These two plus 11645 at 0134. (Moser, PA)

Guam: KTWR, 11650 at 1555 with religious program, ID and address at 1600. Into different language for Africa at 1700. (Zamora, CA) 11805 at 0900 with ID and religious program. (Ernst, GA)

Guatemala: Radio Tezulutlan, 4836, with ID at 0310. Mostly talks in SS over vibraphone music. Off 0313. (Gasque, SC)

AWR-Union Radio, 5981.7 at 1205. ID and local news in SS. (Gasque, SC)

Hawaii: WVVH on 10000 at 0935, woman with time announcements. (Moser, PA)

Hungary: Radio Budapest, 9835 at 0226 with interview. (Moser, PA)

India: All India Radio, 11620 at 2100 with music, ID, news. (Moser, PA) 21735 at 1056 with news. (Rocker, NY)

Indonesia: RRI Sorong, Irian Jaya, 4874.6 at 1081 with rock. (Foss, AK)

RRI Ujung Pandang, 4753 at 1038, man and woman in II. (Foss, AK) 1118 in II with island music. (Story, TX)

Iran: VOIRI on 9022 at 0110 in EE. (Rocker, NY)

Israel: Kol Israel on 9435 and 11605 at 0206, man in unidentified language. (Moser, PA) 11605 at 0000 with news. (Shumaker, MI)

Italy: RAI, 9575 at 0104 with lively YL with news, address and ID. Better than 11800. (Moser, PA) 11800 at 0100. (Cavanaugh, TX) 17795 in AA at 0533. (Carson, OK)

Japan: Radio Japn, 5960 (via Canada) at 0142. (Shumaker, MI) 6120 (via Canada) at 1100 with ID, news. (Ernst, GA) 11735 (via Gabon) at 2345 with mail-bag, off at 0000. (Zamora, CA) 15325 at 0235 (via French Guiana) (Rocker, NY) 17890 at 2145 with DX program. (Gasque, SC)

Kiribati: Radio Kiribati in presumed Kiribati on 14917.5 at 0735 with organ backed vocal groups, man announcer, woman with talk at 0745. EE ID at 0830 with frequency, presumed anthem, 10 second tone and off at 0835. (Gasque, SC)

Luxembourg: Radio Luxembourg, 6090 at 0013 with music and EE. (Moser, PA) 15350 at 0322 with music and EE. (Rocker, NY)

Malaysia: Voice of Malaysia, 7295 at 1305 with Koran, sports, 1330 time check, ID, news. (Zamora, CA) 7455 at 1130 with news and pops. (Story, TX) (New frequency? Editor)

Madagascar: Radio Netherlands relay, 15570 at 1836 with Newsline. (Carson, OK)

Mali: RTV du Mali, 5995 in FF at 0610 with African music, discussion. (Story, TX)

Radio Beijing relay, 11715 at 0301. (Moser, PA)

Malta: Voice of Mediterranean, 9765 at 0600 with program "Maltese Migration" and news. (Pellicciari, CT) 0601 with frequency announcements, music, "Greetings from the Maltese Islands," Monica with program line-up. (Moser, PA)

Deutsche Welle relay on 15425 at 2129 with Malta site ID at sign off. (Moser, PA)

Mauritania: Rdf. Mauritanie, 4845 at 0645 with Koran and mixed African and AA religious music. (Story, TX)

Morocco: RT Marocaine, 15335 at 2146 with mid-east music, AA. (Moser, PA)

Netherlands: Radio Netherlands, 6020 at 0030 with news. (Moser, PA) 11720 at 0334. (Cavanaugh, TX)

Netherlands Antilles: Trans World Radio, Bonaire, 11815//15345 at 1200 with news, religious programming. (Carson, OK) 11930 at 0301 with inspirational music. (Shumaker, MI)

Radio Netherlands Bonaire relay, 9630 at 0733 with

news. (Carson, OK) 6165//15560 at 0031. (Moser, PA)

New Zealand: Radio New Zealand, 9700 at 0902 with America's Cup report and religious program at 0938. Local news and sports at top of the hour. (Gasque, SC) At 1000. (Vaage, CA) 17770, 0450 with political report, Pacific Island news at 0500. (Carson, OK) 0600 with news in EE and Maori. (Pellicciari, CT)

Nigeria: Voice of Nigeria, 7255 at 0503. (Moser, PA) 0604 with business and financial news. (Carson, OK)

Radio Nigeria, Kaduna, 4770 at 0500 with news. (Story, TX) 0515 with news. (Gasque, SC)

Northern Marianas: KHBI on 13625 with world news. (Carson, OK)

North Korea: Radio Pyongyang, 9977 at 1110 with news, patriotic music. (Story, TX)

Norway: Radio Norway, 11925 at 0108 with Norwegian news. (Moser, PA)

Papua New Guinea: NBC, Port Moresby, 4890 at 1022. (Foss, AK)

Paraguay: Radio Nacional, 9735 at 0136 with US pops, SS ID at 0137. (Moser, PA)

Peru: Radio Tacna, 9485 at 0011 with SS sports program, music. (Reyes, Mexico)

Radio San Martin, 4810 in SS with ID 0959, Quechastyle music, ID again at 1005, 1006. (Gasque, SC)

Philippines: VOA Poro relay on 15155 at 1210 with ID. (Moser, PA)

Poland: Radio Polonia, 7270 at 2254 with man in EE. Poor. (Moser, PA)

Portugal: Radio Portugal, 9705 at 0230 with news headlines, weather. (Moser, PA)

Romania: Radio Romania International, 11790 at 0255. (Rocker, NY) 11940 at 0201 with interview. Better than //5990, 9570. (Moser, PA) 11940 at 0402. (Carson, OK)

Saudi Arabia: BSKSA in AA at 1945 on 15345. (Watts, KY)

Senegal: ORTV Senegal, 4890 at 0630 with news in FF. (Pellicciari, CT)

Singapore: BBC relay, 9740 at 1116 with news. (Moser, PA) 15360 at 1138, possible CC. (Foss, AK)

Solomon Islands: Solomon Islands Broadcasting Corp., 5020 at 0926 with man, woman, music, news. Address at 0929. (Moser, PA) 9545 at 0730 with IS, news in EE. (Pellicciari, CT)

South Korea: Radio Korea, 9750 at 1237. (Carson, OK) 11715 via Canada at 1032 with talk on unification. (Moser, PA)

South Africa: Radio RSA, 15365 in FF at 1950 to IS

at 1955. (Watts, KY) 17835 at 0147 with news of Africa. (Foss, AK)

Spain: Spanish National Radio, 9630 at 0412 in SS. (Cavanaugh, TX) 9875 at 2133 with news, music, sports. (Moser, PA) 11880 at 0145. (Shumaker, MI) 12035 at 0631 in SS. (Carson, OK)

Sri Lanka: Sri Lanka Broadcasting Corp., 11835 with ID at 1123, report on churches, music to 1129, off 1131. (Gasque, SC)

Sweden: Radio Sweden, 11705 at 0158 with ID, sign on, headlines. Better than parallel 9695. (Moser, PA)

Switzerland: Swiss Radio International, 6135 at 0203 with news. (Moser, PA) 9885 at 0315. (Cavanaugh, TX) 12035 at 0204. (Shumaker, MI)

Syria: Radio Damascus, 12095 at 2050 with music to ID, time check at 2100. (Moser, PA) 15095, news with music bridges, traditional music at 2000, ID, short local news, frequency schedule, anthem, 30 second tone and off at 2213. (Gasque, SC)

Tahiti: Radio Tahiti, 11825 at 0730 with island music. TT or FF. (Story, TX) 15171 at 0821 with man in FF. Better than 11827. (Moser, PA) (Note: all Radio Tahiti frequencies tend to vary a bit. Editor)

Taiwan: Voice of Free China, via WYFR, 5950 at 0210. (Cavanaugh, TX) 9680 at 0226. (Shumaker, MI) 21710 at 2158 sign on, anthem, news. (Carson, OK)

Tunisia: RTT, Tunisia on 11550 in AA at 0510, ID and music mix. (Story, TX)

Turkey: Voice of Turkey, 9445 at 2255 with IS, anthem and into non-EE. (Moser, PA)

United Arab Emirates: Voice of the UAE, 13605 with tone from 2128 tune in, anthem, frequency/program schedule. Koran recitations in AA followed by EE translation 2205-2216. Episode of "Nights of Scherazade" 2217 2235. Switch to Capital Radio relay at 2234. (Gasque, SC) 13605//15305 at 2200. (Pellicciari, CT) UAE Radio, Dubai, 21605 at 1343 with series on Mohammed. (Carson, OK)

United States: Voice of America, 9350 USB feeder at 1230, news in CC. (Northrup, MO) Radio Miami International, via WRNO at 0100 in SS on 7355. (Watts, KY)

WMLK, 9465 at 0558. (Carson, OK)

WINB, 15185 with religion at 2140. (Carson, OK)

Radio Marti to Cuba, 6030 at 0705 in SS. (Pellicciari, CT)

AFRTS via Barford, England, LSB feeder with news, baseball game at 0200. (Rocker, NY)

USSR: Radio Moscow, 11710 at 0107, 17735 at 2132. (Moser, PA) 11735 at 0220, 11950 at 0235. (Cavanaugh, TX) 11850 at 0202. (Shumaker, MI) 11840 at 1650, 17605 at 0611, 17690//17890 at 0450. (Carson, OK) 17695 at 1900. (Pellicciari, CT)

Vatican: Vatican Radio, 9610 at 0305. (Rocker, NY) 15090//17730 at 0504. (Carson, OK) 17730 at 0459 with IS, sign on to Africa. (Moser, PA)

Vietnam: Voice of Vietnam, 15010 at 2336 with news, commentary on the economy. (Ernst, GA)

Venezuela: Radio Tachira, 4830 at 0315 with radio play in SS. (Gasque, SC)

Radio Nacional de Venezuela, 9540 at 0044 in EE/FF. (Carson, OK)

Ecos del Torbes, 4980 at 0238 in SS with Latin music, commercials, IDs. (Moser, PA)

Yugoslavia: Radio Yugoslavia, 11735 at 2103 with news. (Gasque, SC) 0000 with EE sign on, news. Also 17740 at 1222 with music and comments to sign off at 1227. (Carson, OK)

12 Issues—Only \$19.95

SCORPIO

(ID)Sta: ORT6 (FORTISHEAD RADIO) Location: England
Date: 02-27-91 Regen Prg: 83:17-35 End Prg: Rec: 17-228-00
Mode: PSK Signal
Remarks: SITOR traffic - cargo
Data: 23 > / > / 17-228-00 PSK / Signal() 42882
[Radio] [PSE] [ICL] Terminal Mode [CHG] [CLD] [S/F] [W/O] [LogScan] Log of John Doe [T3]

CHD: AL
MODE: NOW BLIST
** THIS IS AN AUTO TELEX MESSAGE SYSTEM
TRAFFIC FOR THE FOLLOWING VESSELS:
USS FREDRICKS
HNS UINC...
GA=?
Cargo FILE LOADED

Integrated Multi-Function Communications Software for IBM PCs

Simultaneous

Radio Control / Scanning
Log Database Management
TU Digital Control/Disp

- LogScan, AutoLog and AutoTU functions > Interfaces with All Most Terminal Units
- Mouse Function: Key control of Keyboard & Home Keys & RS232 Digital Terminal Units
- Search Log by any field including Remarks > Scan Receiver based on Log Search criteria
- Copy RTTY & other DIGITAL signals > AutoTU sets TU mode as needed during scan
- LogScan has real time UTC and FRQ limit options > AutoLog builds database from "hits"
- Run other programs (DOS) without Scorpio > Includes "Top 100" HF database & Manual

Optional Log Databases available for only \$19.95 each include:
English Language SW Broadcast - MidEast - Utility - Others
\$89.95 - \$415

Int'l
PO Box 830 - Dandridge, TN 37725 - (615-397-0742)
Fax: (615) 397-0466 Computer # 72557, 3560

1-800-666-0908

NEW EQUIPMENT ORDERS & PRICES ONLY, PLEASE

SHORTWAVE RADIOS

SONY - All Popular Models including the ICF2010 and the NEW SW77
SANGEAN - ICOM - JRC - YAESU - GRUNDIG - and the NEW DRAKE R6

SCANNING RADIOS

Featuring the NEW ICOM R1 Handheld and R100 Mobile/base • SHINWA SR001 • UNIDEN BEARCAT • AOR models including AR1000XC

Factory Authorized Dealer for: ALINCO - ICOM - JRC - STANDARD - YAESU
DIAMOND - CUSHCRAFT, etc., Amateur Equipment
Commercial 2-way from ICOM - MAXON - STANDARD - YAESU, etc.

FOR INFO AND TECH HELP CALL (203) 666-6227
OUT-OF-STATE SALES CALL 1-800-666-0908
CONN. SALES CALL (203) 667-9479

LENTINI • COMMUNICATIONS • INC

21 Garfield Street Newington, CT 06111

VISA MasterCard C.O.D.'S O.K. Same-Day UPS Shipping DISCOVER AMERICAN EXPRESS

CIRCLE 155 ON READER SERVICE CARD

CIRCLE 154 ON READER SERVICE CARD

TELEPHONES ENROUTE

BY TOM KNEITEL, K2AES

WHAT'S HAPPENING WITH CELLULAR, MARINE & MOBILE PHONES

We have all become only too aware of the results provided by numerous surveys and polls telling us how well various sitcoms, movies, foods and politicians have managed to get through to the public. But, until now, we never had a really clear picture of the relationship between the public and cellular phones.

A new Gallup study of Americans who use cellars reveals they believe the device has dramatically enhanced their business success and personal lives. You thought it was the Ferrari you bought, but it was just the car phone. You could have bought a Hyundai and installed the same car phone!

Seventy percent of the 650 cellular owners who responded to the survey Gallup took on behalf of Motorola believe they are more successful at business because of their cellular. Better than ninety percent feel they have increased their efficiency and productivity by about 36 percent.

The survey showed that cellars help in reducing job-related stress, and that's why eighty-four percent of the users told Gallup they use their cellars to call people when they realize they're going to be late for a meeting or appointment, or they call people to schedule last minute appointments.

Nearly eighty percent of the users told Gallup that they felt that cellars added about an hour of time to their day. One quarter of those polled thought that the cellular added two more hours to their day.

Fifty-six percent of those who responded said that using cellars has increased their own (or their company's) revenues by approximately 20 percent. In addition, sixty-seven percent felt that use of a cellular saved their company money. More than half reported using the cellular to close a business deal.

About eighty-percent thought cellars strengthened their business relationships with their customers, and more than sixty percent reported that it improved their relationships with their employers.

Three-quarters of cellular users report that the device has let them make the most of their home and leisure time, and therefore made life less stressful. About eight percent mentioned that the phones offer safety uses, and can be used to keep family members informed as to their whereabouts.

Eighty-four percent of cellular users say that having a phone at hand has made traveling less stressful, and about the same percentage felt that they are more willing to travel for business or pleasure because they can always keep in touch.

Motorola reported that there are well over 5-million cellular phones in use in the USA



Angel Rodriguez, an officer with New York State Correctional Services, uses a cellular in conjunction with the rejuvenation of Downing Park, Newburgh, NY.



Cellular technology has helped the expanding custom baking business of Joanne Boris, Buffalo, NY.

at this time, with 33-million projected to be in use by the end of the decade.

Speaking Of Traveling . . .

If you're a guest at the Jefferson Hotel in Washington, DC, you can rent a pocket-sized cellular for \$10 per day, plus air time. It's the first hotel in Washington to offer cellars to-go.

Drivers on the busy Pennsylvania Turnpike are reminded that they can quickly contact the Pennsylvania Turnpike Commission via cellular by dialing-up *11 (STAR-1-1). This is a toll-free call and is good anywhere on the Pike to report accidents, incidents, or calls for assistance. "Incidents" include reports of erratic driving, speeding vehicles, hit-and-run accidents, emergency or dangerous situations or conditions, disabled vehicles and stranded vehicles in need of assistance.

Microcells & Stuff

BellSouth Mobility has been testing out low-power PCN microcells in Miami, FL. Microcells can enhance an established cellular system either by filling a coverage gap or adding additional capacity to a high-traffic area. In the Miami trial, one microcell is being used to fill a coverage gap in an area where a full-sized cell-site isn't feasible. The other is installed on a billboard at the intersection of two major highways where the existing site needs additional capacity.

In the United Kingdom, Unitel and Mercury PCN are working together to develop and develop a new technique known as Parallel Network Architecture (PNA) in the design and construction of transmission networks for competing PCN's. sign and construction of transmission networks for competing PCN's.

This will permit the design and construction of a physically co-existence PCN network, but logically separate transmission networks. As a result, each operator is able to invest in the development and support of competing services over its network, benefiting from the capital and cost-sharing arrangements in the construction of the network.

More Overseas News

The new Moscow cellular system is being provided by US WEST International Holdings, Inc., Millicom Incorporated, and a Soviet partner, plus half-ownership by the Soviet Ministry of Posts and Telecommuni-



Say, just who is that chatting on the Motorola MicroTAC Lite Digital Personal Communicator phone?



The new Motorola MicroTAC weighs in at only 7.7 ounces.

ications. In the USSR, this is a 450 MHz band service. Other systems are in Kiev and Leningrad.

Millicom Incorporated is also putting a cellular system on the air in Asuncion, Paraguay. This is an AMPS 800 MHz system with 50 cell sites and a 2,000 subscriber capacity. Operations should commence within the first quarter of 1992.

Millicom Incorporated is located at 153 East 53rd Street, Suite 5500, New York, NY 10022. US WEST is located at 7800 East Orchard Road, Englewood, CO 80111.

The FCC Said It's Fine With Them

The Victoria Cellular Corp., of Victoria, TX was fined \$15,000 by the FCC for "fail-

ure to file notification of construction of a new cell" for its cellular system.

In May of 1988, Victoria had received FCC authority to construct a new cell and increase power. The authorization stated that it had to be operational within a year. Victoria put the cell into operation within the required time.

The FCC was unhappy, though, that Victoria had failed to "timely notify" the agency that the cell site was in operation by the filing of an FCC Form 489.

Victoria filed a request for temporary authority to operate the cell site pending FCC action on reinstating the expired authorization. The temporary authorization was granted in September of 1990, and a request for extension of the temporary authorization was filed in December, 1990.

Still, the FCC didn't like that Victoria's authority to construct and operate a new cell site had automatically expired in May of 1989 when it failed to mail in the FCC Form 489. Hence the \$15,000 fine.

You can think what you will. My own personal opinion is that a \$15,000 fine for something as piddling as this is unconscionable highway robbery of honest American business firms. I suppose it's as good a way as any to finance those fat pay raises for our Congressional representatives.

Applications Notes

Downing Park, in Newburgh, NY was built more than a hundred years ago by two very talented architects. For the past thirty years, the park has been deteriorating. In an attempt to save this once-scenic park, a master plan has been put into action with the intention of rejuvenating the 35-acre site.

Part of this plan calls for cleanup, maintenance, and restoration of eighteen inmates on a work release program from Camp Beacon, a corrections facility oper-

ated by New York State.

NYNEX Mobile's Newburgh office donated a cellular phone to the Downing Park Planning Committee so that cleanup supervisors can maintain communications from all areas of the park.

Four years ago, Buffalo, NY's Joanne Boris put her baking talents to work and converted her basement into a professional bakery. Calling her company *The Cookie Cupboard*, she began making and fresh-delivering customized cookie gift baskets for local residents.

It wasn't long before she began receiving orders from businesses and large corporations from throughout several counties. As her business expanded, and the phone kept ringing, Joanne found that an answering machine didn't provide the type of personal service she was hoping to provide. Last January, she purchased a cellular and found that at least fifteen orders per week come in over the cellular while she's away from her office.

Her success has permitted the opening of a retail shop at the Forestream Village Plaza, Lancaster, NY. And, she still makes her own deliveries. No matter where Joanne is, no order goes unanswered.

Getting Smaller

Motorola keeps pushing down the size and weight of cellulars. The company's new MicroTAC Lite Digital Personal Communicator weighs a mere 7.7 ounces and measures 11.6 cubic inches. Yet, you can chat for 45 minutes, or let it run on eight hours of standby with the standard battery. Or, with the Talk PAK XT battery, you get two and a half hours of talk-time and a full 24-hours of standby.

Some of the useful features include a 9-1-1 override for use even when the phone is locked, storage of 99 numbers (32 digits each), an alphanumeric directory for phone number storage by name and/or number, auto answer and a menu mode that allows the selection of features from a user-friendly list.

This cellular was designed with a flip-open mouthpiece, like Captain Kirk's communicator on the old *Star Trek*. It looks just great. When you take this out in public, you owe it to everyone within earshot to announce, "Beam me up, Scotty!"

You can get more information on this good looking cellular from Motorola, Inc., Pan American Subscriber Group, 1475 West Shure Drive, Room N232, Arlington Heights, IL 60004.

And we hope to ring you up next issue. If you have any thoughts, ideas, questions on cellulars, paging, IMTS, marine radio, PCN, or related fields we hope you send us a letter or card. And we always like to hear from manufacturers with product information, as well as information from service suppliers on what they are doing. ■

JRC

NRD-535 HF Receiver

- Covers 100 kHz to 30 MHz
- Advanced ECSS Operation For Phase-Lock AM Operation
- 200 Memory Channels
- AM, FM, U/LSB, RTTY, FAX
- Multi Scan Feature



CALL TODAY!

ICOM

IC-R9000

THE FINE ART OF LISTENING

- Continuous, All-Mode Receiver
- Covers 100 kHz to 2 GHz
- 1,000 Memories
- Advanced CRT Display
- Direct Digital Synthesizer System

CALL FOR ALL DETAILS!



ICOM

IC-R71A

SUPERIOR PERFORMANCE RECEIVER

- USB, LSB, AM, RTTY and Optional FM
- Covers .1 to 30 MHz
- 32 Memory Channels
- Multi Scanning Functions
- Keyboard Frequency Entry

CALL TODAY!



KENWOOD

R-5000

HIGH PERFORMANCE RECEIVER

- Covers 100 kHz to 30 MHz
- 100 Memories
- Keyboard or Main Dial Station Selection
- Programmable Scanning

CALL TODAY FOR DETAILS!



Amateur and SWL Accessories



HAMTRONICS, INC.

M, T, W (9-6)
Th, F (9-8)
Sat (9-3)

4033 Brownsville Road, Trevose, PA 19047

For Service & Info (215) 357-1400 For Orders (800) 426-2820 FAX 215-355-8958

FOCUS ON FREE RADIO BROADCASTING

The Voice of Bono's newsletter notes that they are phasing out their Baltimore mail drop and replacing it with the Wellsville drop: PO Box 452, Wellsville, NY 14895. You can have the occasional Voice of Bono newsletter sent to you free by writing to the station at the above address, but please include three units of first class postage.

Now let's get into the loggings. Robert Ross of Canada reports reception of **Omega Radio** on 7416.5 at 0407-0418 sign off carrying religious programming and anti-war messages. Apparently this was a joint broadcast with **Radio USA**. The Blue Ridge Summit and Wellsville addresses were announced. The duo 'cast was also picked up by Damon Cassell in Massachusetts who had them at 0050-0125 and music from an album by a group called Plan B. Hosted by "Dick Tator."

The **Chicago Tunnel Company** was picked up by Bill Morse of Elgin, Illinois on 7415 from 0439 to 0526 with a tell broadcast. Music ranged from big band things to organ music to the Beatles. Bill says he thought an address was announced but reception was very poor so he was unable to copy it.

Pat Murphy in Virginia heard **He Man Radio** on 7412 upper sideband from 0135 to 0149 with music by Paul Revere and the Raiders and a baseball routine. Damon Cassell had this one at 0140 to 0205, mostly with music and a talk with Herman's son, Roy. PO Box 109, Blue Ridge Summit, PA 17214 was given for reports.

Radio USA was spotted by Ken Bailey of Madisonville, Kentucky on 7414-7415 at 0020-0030 with late '60's and '70's rock. Pat Murphy heard the station with the usual Mr. Blue Sky on 7415 at 0125-0204 with James Bond music, a "Sununu Travel Club" routine and rock music. Cassell had this one on 7416 at 0126-0240 with ID's by young children, editorial, "DX Party Lane," and fake commercials. Also included was a tribute to pirates of the past, complete with taped IDs. Announces the Wellsville drop. Cassell heard them again at 2258 with a claimed test and complaint about poor conditions. That show was repeated twice more that evening, says Damon. He also heard the station on 7416.6 airing a program called the "Great Atlantic Radio Conspiracy."

Skip Harwood in California reports **KLOG** on 7406 at 0355-0418 with Hawaiian music and fake commercials.

Harwood had **Radio Free America** on 7415 USB at 0340-0510 with rock music and a statement that it was a free radio broadcaster and not a pirate. Also heard by

PIRATE RADIO STATION QSL No. 0082



WJDI 1620

THIS WILL VERIFY THE RECEPTION OF PIRATE RADIO STATION WJDI 1620 KHZ ON A DATE AND TIME OF DEC 24, 1990 8:45 PM EST BY SHORT WAVE LISTENER PAT MURPHY LOCATED IN THE TOWN AND STATE OF CHESAPEAKE, VA WJDI AT THE TIME OF YOUR RECEPTION WAS OPERATING WITH AN OUTPUT POWER OF 5.1 KILOWATTS.

COVERING MORE THAN 40 STATES IN AMERICA FROM NEW YORK STATE WJDI "THE PIRATE KING" HAS RECEIVED HUNDREDS OF LETTERS FROM OUR LISTENERS IN SUPPORT OF FREE RADIO IN AMERICA. WJDI OPERATES FOR THE MEDIUM AND SHORT WAVE LISTENER TO LOG AMERICA'S MOST POWERFUL PIRATE RADIO STATION... AND THE BEST IS YET TO COME! WJDI HAS BEEN UNDER CONSTANT FIRE FROM THE FEDERAL COMMUNICATIONS COMMISSION WHO WOULD LIKE TO SEE ALL FREE RADIO DESTROYED IN AMERICA.....

FORTUNATELY FOR ALL OF US INVOLVED IN RADIO THEIR FIGHTING A LOSING BATTLE! THANKS FOR THE LETTERS AND SUPPORT...

KEEP LISTENING

George Donahue
CHIEF ENGINEER

Cassell at 0355-0510 with mostly hard rock music and a message to the FCC "wishing them luck" finding the station. They gave 1-800-555-5555 as a request line and claimed 1500 watts output to a vertical antenna. No address announcement heard.

Patrick Brown of Kentucky had **WORK** on 7415 at 0420 with songs about working, "top ten reasons for staying home from a job," fake interview about working in the USSR compared to the US. This one uses the Wellsville address. Pat Murphy had this one from 0247 to 0351 with songs relating to work, "Workers Game Show" and ID as "the workers station." "The Working Man" was the announcer. Cassell heard them at 0400-0440 with talks about beer and work, songs about work, skits and fake commercials. Off abruptly.

Cassell had **Radio Comedy Club International** at 2335-0005, relayed by Radio USA on 7416.6. ID as "RCCI." The station plays comedy songs, stand-up comedy, funny commercials, etc., says Damon. Reports requested via the columns of the A*C*E* bulletins. Pat Murphy had this one, too, at 2337-2355 with a rap music routine, "Ahab the Arab," "You Drive Me Crazy" song and ID "Remember, we're the fun one—RCCI."

Murphy reports **Mega Radio** on 7415 at 0109-0123 with rock music and a jive rou-

tine. I have to wonder if this wasn't actually Omega Radio, Pat. I haven't seen any reports for a "Mega Radio."

Cassell had **WHO** at 0126, ID'ing as "Free Radio on Galifry" and playing funny songs and skits. Claimed 100 watts output and gave the Wellsville address. Damon says that, after sign off, several station operators came on and commented on how professional the broadcast was.

Harwood reports **Radio Freedom** on 7415 at 0540 to 0650 with music of Pink Floyd and the Fine Young Cannibals.

Skip also heard KPN-36 on 7407 at 0345-0445, billing itself as classic golden age radio for the Pacific Basin. It featured classic music from 1936. Suffered from technical problems.

Robert Ross in Canada reports QSL's received from WJDI-1620, Radio Fax (Ireland) on 6205 and 12255, Radio Blandex on 7416.5 and He Man Radio on 7415.

That brings us to the bottom of the pile. Don't forget that pirate loggings are always wanted, along with information on QSL's, including copies for use here, plus news clips and other info about pirates. Special to pirate broadcasters: we are eager to hear from you with news about your stations—format, activities, equipment, future plans and all that kind of thing.

See you again next month!

COMMUNICATIONS CONFIDENTIAL

YOUR GUIDE TO SHORTWAVE "UTILITY" STATIONS

An article in the *Washington Post* indicated that the manned DEW line stations of the US/Canadian North American Aerospace Defense Command (NORAD) will be phased out over a three year period.

Some of the DEW line sites will be upgraded with solid-state radar equipment. The new unmanned stations will be fully automated with the radar tracking data automatically fed to NORAD Headquarters at Cheyenne Mountain in Colorado Springs, CO and North Bay, Ontario, Canada for analysis.

Servicing of the equipment will be accomplished by maintenance teams flown in periodically to the stations.

Radio Officer Jon S. VanAllen aboard the S.S. Buyer referred to the logging by Andy Gordon, CT of the USS California in contact with Midway Island. "I was Radio Officer on the S.S. California, A C-4 Break-bulk Freighter re-activated by MSC for Desert Storm. We also stopped at Midway with a bad fuel transfer service pump. We also called on 2716 kHz, and as a matter of fact, we were 100 miles away when we called. They didn't respond so we called NOJ-Kodiak, AK and they got Midway on the Auto-von phone and told them we were calling and needed priority assistance. Kodiak is well over a thousand miles from our location. 2 MHz propagation was in good shape that evening."

Jon offered some remarks concerning the Ready Reserve Fleet. "As a matter that your readers might enjoy, very little was said about the Ready Reserve Fleet ships and their crews during Desert Storm. 78 ships were activated for the sealift to Saudi and many Merchant Mariners like myself played an important role in the effort including wading through mine fields in the Gulf, issuance and full military instruction on the use of gas-masks, suits, antidote procedures, and survival techniques. We went through several Scud missile alerts, one of which landed about 6 miles from us in Dharan. Besides all that, we had 12 Army personnel on board assigned to escort the equipment from Oakland to Saudi and after we left Singapore through the Straits of Malacca, we had armed "Pirate guard" around the clock because of the frequent pirate attacks in that area."

Jon concluded his letter by indicating that he believed the majority of Radio Officers would be more than happy to QSL any reception reports received. He commented "The frequency shuffle just enacted may spark some interest in the new SSB frequencies that are so frequently used between ships. All RRF ships have SITOR on board (even though a few old timers refused



These photos show the front and rear of the Poste E Telecomunicazioni building at Piazza Garibaldi in Ravenna, Italy. Although difficult to see in the front view, there are numerous antennas on the roof. Photos courtesy of R. C. Watts, KY.

to learn it). Although most official traffic was sent by INMARSAT, we still send a lot of traffic, such as, telegrams by SITOR."

Our thanks to Jon for the foregoing information and hope to receive some loggings from him in the near future as he sails to various locations in the world.

Edward Safir, GA wrote "I am a college student. I just recently took an active interest in SWL and started reading *POP' COMM*."

Shortwave radio has interested me as far back as I can remember; my family has always had at least one radio capable of receiving the HF bands. Several years ago, I acquired a Sony ICF-7600D for Christmas. This has since been my main receiver. At home in Georgia I have a Sony AN-1 active antenna atop a 25 foot mast on top of my roof. I also have a 100 foot longwire antenna. I have added a MFJ 1278 multi-mode decoder to my shack in order to monitor



This building which is adjacent to the Poste E Telecomunicazioni building also has antennas on the roof. Photo courtesy of R. C. Watts, KY.

Z

USCG Radiobeacon, Texas 304 kHz

Robert C. Homuth, Phoenix, Arizona:
This confirms your reception of beacon "Z"
located at PORT ARANSAS, TX on 13
December, 1985 at 1135 Z.
Antenna: 126 FT TOWER (LOADED)
Power in watts: 200
Notes: MOD. FREQ 1070 KHZ RANGE 125 NAT. MILES
Signature: CW02 (ELC) Larry J. Moore

PFC returned to Robert Homuth, AZ.

This will verify your reception of station:

WLC

Rogers City Radio Frequency: 4370 KHz

Date: Nov. 20, 1990

Time: 2306 EST Official Stamp

Antenna: Half Wave Dipole

Power: 150W

Signature: Reino Martins N8IFW

Single-sideband Frequency
 Shunt 426.9 - 4075.4
 2776.4 - 2770.5

Russ Hill, MI sent in this PFC.



This photo shows the layout of Registered Monitoring station KOH8LX, operated by Schon Garcia, OH.

FAX, RTTY, and CW (I know, it's sheer laziness for me not to learn code!).

With my growing interest, especially in the field of data communications, I feel that I have outgrown my little radio and hope to purchase a better model.

In my dormitory room at Harvard, I am limited with just my radio and my bedframe serving as an antenna. Despite the conditions, I have been able to intercept some rather interesting transmissions here in Cambridge in the evenings after my classes."

Geoff Malta, NY advised, "Finally I can send in loggings now that I have a new receiver with digital readout (ATS-803A). No more frustrating guessing-games of what I was hearing and where!

My equipment now includes: ATS-803A, Tempo 2020 tx, HK-232 TNC, DX-160 SW rx, PRO-2004+, MFJ Versa Tuner II, and a 40m dipole antenna. I use an Apple IIE for the digital stuff."

From Finland we heard from Reino Multanen who indicated he was interested in the "Spy Numbers" stations and in VLF stations. "Some weeks ago I built a converter, 10-100 kHz, and have heard many stations from Germany, England, and, of course, from the USSR. Radio has been my hobby and profession for about 50 years."

First time contributor Schon Garcia, Registered Monitor KOH8LX, of OH said he was Texas born, transplanted to Ohio and he is an avid SWL'er. "I started as a kid listening to the shortwave radio in my mother's bedroom after she finished listening to "The Shadow" and all the other greats. I remember using the SW portion of the Philco radio and listened to the world. Some police calls came through also. Living so close to the border in San Benito, Texas, I listened to Mexican stations across the border.

I was mainly interested in the police, military, and naval frequencies. I also listened to ships coming in and going out of Port Brownsville. This particular radio did not have a BFO control so I went to a local shop and found a Hallicrafters S-40A and paid for it on a dollar a week plan. I must have been about 8 years of age and it was hard paying for that radio. I later acquired a Lafayette HE-10 general coverage receiver and recently took it out of the moth balls and am now listening to SW again. A friend passed on an old Lafayette HA-350 HAM receiver and said I could use it until I upgrade to better equipment.

I am a retired law enforcement officer so I have time for monitoring and hope to send in more reports in the future."

And from Dwight M. Brown, Jr in Louisiana, "The enclosed tape was made over a period of a year or so and the newest addition was made just recently. I have been hearing what sounds like outband stuff, possibly Vietnamese fishermen in the Gulf of Mexico. I had both Chinese and Japanese friends listen to the tape, but they were unable to identify the language."

Dwight, I listened to the tape and thought there were a couple of words that sounded like some Vietnamese words that I have on a language reference tape. Your guess that the communications were those of Vietnamese fishermen in the Gulf of Mexico seems quite probable. I thought I detected several mentions of the word "Panama" as might be said by an Oriental speaker pronouncing the word.

In his letter, Dwight also mentioned that his dad started in radio in 1914 as a kid and so Dwight grew up with either home-brew equipment or in the later years, commercial receivers, in the home. "My first was a regenerative receiver when I was in the 5th grade. I have now graduated to the R-1000, S-line, KWM-2, TS440, etc and never have time for as much listening as I would like."

Well, that wraps up the mailbag for this month. Keep those cards and letters coming and remember that photos of communications installations are always welcome.

Ute Intercepts. All Times UTC.

60: Time Signal Station MSF, Teddington, Great Britain in CW at 0002. (Boender, Netherlands)

75: Time Signal Station HBG, Switzerland in CW at 2338. (Boender, Netherlands)

77.5: Time Signal Station DCF77, Braunschweig, Germany in CW at 1055. (Boender, Netherlands)

210: Beacon HL, Wheeling, WV at 1110. (Crabill, VA)

212: Beacon OK, Sandersville, GA at 1139. (Crabill, VA)

216: Beacon YFA, Ft. Albany, Ontario, Canada at 1106. (Crabill, VA)

221: Beacon QU, Grand Prairie, Alberta, Canada at 1124. (Arens, BC, Canada)

230: Beacon YD, Smithers, BC, Canada at 1355. (Arens, BC, Canada)

232: Beacon CO, Indianapolis, IN at 1352. (Arens, BC, Canada)

254: Beacon SPK, Reno, NV at 1258. (Arens, BC, Canada)

272: Beacon XS, Prince George, BC, Canada at 1205. (Arens, BC, Canada)

333: Beacon STI, Mountain Home, ID at 0921. (Vaage, CA)

341: Beacon FO, Ft. Dodge, IA at 0429. (Crabill, VA)

343: Beacon PJG, Willemstad, Curacao at 0400. (Crabill, VA)

346: Beacon LW, Lewisburg, WV at 2338. (Crabill, VA)

347: Beacon BEZ, Loris, SC at 0350. (Crabill, VA)

349: Beacon K, Santiago, Cuba at 0341. Odd keying, 600 Hz?? (Crabill, VA)

353: Beacon ZES, Cape Scott, BC, Canada at 0931. (Vaage, CA)

355: Beacon CS, Columbus, GA at 0523. (Crabill, VA)

359: Beacon YAZ, Tofino, BC, Canada at 0935. (Vaage, CA)

365: Beacon FKV, Gainesville, GA at 0308. (Crabill, VA)

368: Beacon YZH, Slave Lake, Alberta, Canada at 1354. (Arens, BC, Canada)

N2HOQ KNJ2KG

ATS-803A...Tempo 2020...HK-232...PRO-2004...ALD-24T...DX-160...Apple IIe...Cobra 148

Geoff Malta

[] Pse QSL [] Thanks

notes: _____

73!

5 years in radio... and counting

STATION	DATE	UTC	RST/SI/PO	FREQ	MODE/FORMAT

Geoff Malta, Registered Monitor KNJ2KG, and ham N2HOQ, of NJ sent in a copy of his combination HAM/SWL card.

Abbreviations Used For Intercepts

AM	Amplitude Modulation mode
BC	Broadcast
CW	Morse Code mode
EE	English
GG	German
ID	Identifier/led/ication
LSB	Lower Sideband mode
OM	Male operator
PP	Portuguese
SS	Spanish
tfc	Traffic
USB	Upper Sideband mode
w/	with
wx	Weather report/forecast
YL	Female operator
4F	4-figure coded groups (i.e. 5739)
5F	5-figure coded groups
5L	5-letter coded groups (i.e. IGRXJ)

389: Beacon EN, Kenosha, WI at 2359. (Crabill, VA)

400: Beacon LKO, Billings, MT at 0944. (Vaage, CA)

410: VRGH, MV Mineral Europe w/DF activities at 1218; JKRB, MV Koharusan Maru w/VVW DE JKRB at 1446; WPKB, MV Sealand Value w/DF activities at 1615. All CW. (Boender, Netherlands)

418: GNF, Northfjoreland Radio in CW w/CQ DE GNF at 2013. (Boender, Netherlands)

429: OXB, Blavand, Denmark in CW at 0653 w/tfc list. (Boender, Netherlands)

461: PCH, Scjeveningen, Netherlands. Nav warn-ings in CW at 0618. (Boender, Netherlands)

470: DAAD (Collective call for all German ships) DE DAN, Norddeich, Germany in CW at 2202. (Boender, Netherlands)

500: SYBD, MV Cherry Flower clg Oostende Radio in CW at 0728; FFB, Boulogne-Sur-Mer Radio, France in CW at 0820 announcing nav warning on 450 kHz. (Boender, Netherlands)

512: 3ESD, MV Fortune Bell in CW at 2030 passing msgs to u/i stn. (Boender, Netherlands)

521: Beacon INE, Missoula, MT at 0949. (Vaage, CA)

2057: WLO, Mobile, AL sends tfc list in CW at 0307. (Kinsland, GA)

2182: USCG Group Humboldt Bay (NMC11) w/advisory of gale wind warning, in USB at 0425. (Sabo, CA)

2707: YL rptng Papa November at 0000, 0600, 1200 and 1800 on this freq and also on 5015/7404/11108 kHz in AM mode and at 30 mins past these times in USB mode. After 5 mins of announcing Papa November, YL/GG sends 5F grps to various addressees—usually six or seven recipients. (Mason, England)

2716: NQOD, USS Preserver ARS8 clg Naval Station Charleston at 0835; NCAR, USS Carr FFG52 clg Harbor Control Newport at 1015 w/comms re port visit and to receive fuel; NEKF, USNS Lynch T-AGOR clg Canaveral Control at 0915. Cape Radio assisted in responding to this unit. (Stuart, DE)

2980: WSC, Tuckerton, NJ w/"tfc list at 18." CW at 2300. (Malta, NJ)

3535: U/i stns in CW w/tfc which has heading of 149369 0320149 BT ZVE 564 BT AAAAA (and into continuous string of characters which includes some cyrillic characters. (White, ME)

4182: URD, Leningrad Radio DE UTDY, MV Kom-somolets Tadjikistana in CW at 2108. (Boender, Netherlands)

4373: US Navy comms in USB at 2355. (Malta, NJ)

4407: WOM, Ft. Lauderdale, FL in USB at 0040 w/tfc in EE w/Cruise Ship NORWAY. (Lish, FL)

4625: U/i Time Signal Station in CW at 2159. (Boender, Netherlands) This poss VEB2 which is listed as poss located in Canada. (Ed.)

4696: Gander wkg various aircraft, couldn't hear a/c comms but freq 4696 kHz was mentioned for tfc. Hrd at 0058. (Garcia, OH)

5045: YL/EE in AM at 0023 w/3+2F grps. Msg rpted then stn down with "end." (Safir, GA)

5340: Music box tone playing "Swedish Rhapsody" here every Sat at 1900/200 and also on two other freqs 4779 and 6507 kHz. At five mins past hour YL/GG

Centro de Control de Tránsito Aéreo
del Area de Canarias
Estación Aeronáutica de HF "Canarias Radio"
Apartado nº 69
Aeropuerto de Gran Canaria
Las Palmas
SPAIN



Dear Sir,

We had the great pleasure of receiving your letter with details of our transmission. Thank you for your report, it is very interesting to us.

Our equipment is made by ROHDE & SCHWARZ in Germany, and it is composed of:

- Receivers mod VLF-HF EX-070, Control Unit GB-170

- Transmitters, Control Unit GB=853 CI (1Kw Power)

- Active antenna System HE-005, mounted outdoors at about 12 m. above ground, vertically and horizontally polarized. It is located at 275740N 0152411W.

We also work on frequencies:

2.854 Khz	Sunset to Sunrise	South Atlantic
3.452 Khz	" "	" "
5.565 Khz	24 hours	" "
6.535 Khz	" "	" "
8.861 Khz	" "	" "
11.291 Khz	" "	" "
13.315 Khz	Sunrise to Sunset	" "
13.357 Khz	24 hours	" "
17.955 Khz	Sunrise to Sunset	" "
3.016 Khz	Sunset to Sunrise	North Atlantic
5.598 Khz	24 hours	" "
8.825 Khz	" "	" "
13.306 Khz	Sunrise to Sunset	" "
17.946 Khz	" "	" "

Yours sincerely,

(CARLOS RODRIGUEZ)

OPERATOR AT CANARIAS RADIO AERONAUTIC STATION

With the return of his PFC, Dave Sabo, CA also received this letter containing technical details regarding the Las Palmas station.

w/5F grps for 3 addressees. On this particular occasion tfc was for 72906/12345 and 19703. (Mason, England)

5505: Shannon Volmet w/Airport wx forecasts in USB at various times. The usual Irish voices have been replaced w/the same OM/EE automatic voice machine that is used on the RAF Volmet forecasts on 4722/11200 kHz. It will make listening less interesting especially during the evenings when the Irishmen could be heard getting pretty bored with their job at times. (Mason, England)

6200: NLPM, USCGC Chase WHEC718 wkg USCG Comsta Portsmouth at 0030 re position report given as vessel entering Boston Harbor; NRPI, USCGC Gentian WLB290 wkg USCG Comsta Portsmouth (NMN) at 0045 re arrangements to bring this circuit up early next AM. (Stuart, DE)

6380: UQB, Kholmok, USSR in CW at 1950 wkg MV Ermak (UKMN). (Boender, Netherlands)

6650: EE/OM at New York rdo wkg various aircraft. P/p w/flight 202. Plane had engine trouble, one gallon of fuel remaining. Flight control advises 202 to return to Philadelphia per Company orders. USB at 2345. (Garcia, OH)

6720: A31 contacted F6X (I couldn't hear him) at 0944 for rdo check & then answered call from U2G. At 0943, A31 came back up again w/OVERWORK bcst. All USB. (Sabo, CA)

7318: MARS tfc net. AAR2USB, AAR2TM, AAR2GT hrd at 1720 in USB. (Malta, NJ)

7375: YL/GG here every Sat at 1700. On this occasion YL rptd 104 104 104 99647 051 until 1705 when

five dashes were sent. Then YL sent 5F grps for 51 groups length. (Mason, England)

7446: YL/EE announcing KPA2 in AM. Signed off at 0220. (Malta, NJ)

7535: These US Navy ships made emitter tests w/Norfolk SESEF; NIH1, USS Opportune ARS41 at 1700. Note: Opportune is presently the only USN ship commanded by a female C.O.; NDIB, USS Briscoe DD977 at 1500; NOUD, USS Inchon LPH12 at 1400; NHJK, USNS Henry J. Kaiser T-AO-187 and NQSI, USNS Rigel T-AF-58 and NZLL, USS Connole FF1056 from 1830 to 2100; NZDN, USS Fairfax County LST1193 at 1630; NAHM, USS Guam "Tech Control" at 1300. (Stuart, DE)

8173: YL/GG rptng Oscar Kilo w/electronic tones at 2000. At 2005 YL had 5F grps for 319 and 812. (Mason, England)

8241.5: S/V Mercy Louise (ZM2121) wkg USCG CAMSPAC (NMC) re crew member suffering from chickenpox. USB mode from 0505-0520. Vessel advised that it due into Seattle in four days; NMC instructed vessel to contact VGS, Puget Sound upon arrival in area. In the meantime to maintain a 12-hour comm sked w/NMC. Du:lex wkg w/8765.4 kHz. (Sabo, CA)

8440: VCS, Halifax CG Radio, NS, Canada w/"QSX 4,6, and 8 MHz, CHNL 11/5/6" in CW at 0205. (Kinsland, GA)

8470: NMN, Portsmouth sending CQ in CW at 0251. (Kinsland, GA)

8511: FFL2/3/4, St. Lys, France in CW at 0300 w/"QSX 6 or 8 MHz. (Malta, NJ)

8630: WCC, Chatham, MA in CW at 1814 w/"QSX 6 8 12 16 22 MHz OBS QMV QRU?" (Malta, NJ)

8687.5: UJRD, Leningrad w/QSX mkr in CW at 2306. (Boender, Netherlands)

8698: 7TF6, Skikda, Algeria in CW at 2020 clg CQ. (Boender, Netherlands)

8710.5: UAH, Tallinn, USSR in CW at 2310 w/call-sign mkr. (Boender, Netherlands)

8719: NZPU, USS Papago ATF160 wkg NQSSJ, USS Grapple ARS53 at 0100. Grapple was relaying msg to COMSUPRON-8 from Papago re crewman on Papago suffering from Angina, and originally thought to be suffering a heart attack. Hrd while monitoring in Baltimore, MD. (Stuart, DE)

8764: NMN, USCG Portsmouth w/marine wx incl Grenada, Bimini. USB at 1136. (Lish, FL)

8722: VIS, Sydney, Australia in USB at 1157 w/tfc to u/i stn. (Lish, FL)

8808.8: WLO, Mobile, AL w/pp for u/i ship on 8805.7 kHz. USB at 0849. (Garcia, OH)

8861: Air Portugal-206 in USB mode at 0248 wkg Dakar Aeradio w/position report, foll by ASCOT-3206 at 0251 to Dakar w/similar tfc. (Sabo, CA)

8903: Japan Air 3086 in USB at 0909 wkg Tokyo Aeradio w/position report. (Sabo, CA)

8993: MacDill called by COPEK 24 at 1255 for rdo check in USB. Foll at 1258 by COPEK 29 and at 1302 by COPEK 25. (Kinsland, GA)

9075: YL/SS w/5F grps in AM at 0711; LARIAT, PROTOCOL, and PROTOCOL-2 (latter two stns not hrd) conducting circuit checks in LSB mode from 1740. Ref's to MIKE-5 being PROTOCOL's receive, circuit designators B5006 and 35, and the MacDill BCS system. Hrd intermittently throughout the afternoon. (Sabo, CA)

9222: YL/SS in AM mode at 0202 rpts 1-0 counts and 396 396 396 until 0210, then ten tones, Grupo 194 x 2 and into 4F grps. Simulcast on 10665 kHz. (Sabo, CA)

9230: YL/SS w/5F grps in AM mode at 0504. (Sabo, CA)

9452: YL/SS grps in AM at 0500. (Mazanec, OH)

9465: YL/GG W/1-0 count and 789 rptng between 20000-2010. After ten tones Gruppe 117 and into 3/2F grps. Simulcast on 7375 kHz. (Mason, England)

10047: 4XZ, Haifa Naval, Israel in CW at 0300 w/5-alphanumeric-groups. (Malta, NJ)

10048: Honolulu ATC clg "890" at 1237 in USB but no reply. (Kinsland, GA)

10069: Berne Radio wkg a/c "756" in USB at 0433 on Swissair LDOC channel. (Sabo, CA)

10740: YL/GG rptng Tango Papa w/electronic tones at 0900. At 0905 YL has 5F msgs for 696 and 738 or 41 and 53 grps. (Mason, England)

10820: UHF3, Moscow, USSR wkg u/i stn in CW at 1640 w/coded msgs. (Boender, Netherlands)

10888: RMP, Navy Kaliningrad, USSR in CW at 0910 clg Narukwica. (Boender, Netherlands)

11176: U/i comms in USB at 0150. (Malta, NJ) This is a USAF Air/Ground freq. (Ed.)

11191: AVALANCHE ALPHA w/FOXTROT TANGO for rdo c heck. USB at 1213. LANCELOT CHARLIE w/UNIFORM FOUR KILO for rdo check, then QSY to Alligator Playground Delta 27 Hot Fox. Then asked "Have you gone seminal?" at 0124. BRIMSTONE ALPHA came up on freq at 0339 clg FOXTROT TANGO. Wanted U4K to come up on Delta 30 Hot Fox and use seminal minus one for width when up on playground. (Woody, NY)

11214: IWR from 2NV requesting go to freq Tango Yankee Golf Whiskey Delta. IWR kept asking 2NV to repeat for about 2 mins saying he could not receive him. IWR finally gave go ahead. (Garcia, OH)

11227: BLUE EYES calling SPACE CAR in USB at 0152 for rdo check. Reply not heard. (Kinsland, GA)

11240: McClellan in USB at 0215 wkg Zero Whiskey 44 to get "ETA of Victor Papa 742." (Kinsland, GA)

11244: COPPERHEAD sends SKYKING bcst in USB at 0219. (Kinsland, GA)

11247: TIN CAN wkg MacDill in USB at 0223 requesting wkg freq for "Space Team." Reply not hrd. (Kinsland, GA)

11268: Zero Lima Yankee wkg Zero Sierra Romeo in USB at 0220 awaiting pp to Marshall Space Flight Center. (Kinsland, GA)

11462: YL/SS in AM mode at 0713 w/5F grps. Diff YL/SS 5F msg on 9075 kHz at same time. (Sabo, CA)

12240: YL/SS in AM mode at 0543 w/5F grps,

each x 2. (Sabo, CA)

12856: XSG, Shanghai, PRC in CW at 1855 w/QSX mkr. (Boender, Netherlands)

12995: YL/EE in JAM at 2250 w/5F grps. (Garcia, OH)

13159.7: SVN5, Athens, Greece in USB at 2029 w/tfc in Greek. (Lish, FL)

13257: Trenton Military (CHR) wkg CRICKET (not hrd). Ref's to stn COBWEB whom Trenton had hrd approx strength 2 on 9006 kHz. USB mode from 0507-0511. (Sabo, CA)

13279: Khabarovsk Volmet in UJSB from 0609-0610. (Sabo, CA)

13374: YL/SS in AM at 0708 w/5F grps. "Final, Final" at 0709. Carrier stayed up for a while after. (Sabo, CA)

13890: YL/GG rptng Juliet Whiskey w/electronic tones from 2100-2105. Then 5F grps for 081 and 521 of 41 and 50 grps. (Mason, England)

14280: YL/EE in AM at 1300 w/5F grps, each grpt rptd twice. This stn came up on the 2nd Monday in May, June and July and each time rptd the Monday msg on Tuesday. (Brown, LA)

14383.5: NIW, USS Midway CV41 (NNN0CQQ) and NMOB, USS Mobile Bay CG53 (NNN0CAC wkg

their home port NNN0NVT, Yokosuka, Japan at 0800. Both ships were evacuating Americans out of the Philippines. (Stuart, DE)

14441.5: AAFR, US Army Vessel Jame McHenry HLS1 (NNNOCEP) asking for any "Stateside MARS stn" at 0045. This vessel is an Army Heavy Lift ship of the 10th Transportation Bn, Ft. Eustis, Va. (Stuart, DE)

15702: OM/RR at 0800, 0900 & 1000 rptng "Null x 5 for five mins then off. Also on 14408 kHz at 1400, 1500 & 1600 w/same routine. (Mason, England)

16036: YL/EE in RCS at 2100 rptng 358 (x3) counts 1-0 until 2110 then into 3/2F grps. (willmer, MI)

16176: RMP, Navy Kaliningrad, USSR clg u/i stn in CW at 1140. (Boender, Netherlands)

16355: STINGRAY and BUDWISER in USB at 2200 w/pp. STINGRAY also asking if AFC3RI coming up. (Willmer, MI)

17242.7: VCS, Halifax CG Radio, NS, Canada in USB at 0010 wkg u/i stn. (Lish, FL)

17464: LEATHERNECK w/extensive EAM's in USB at 1650. (Willmer, MI)

YL/SS: YL/SS rptng 135 (x3) 00000 in AM until 1604 then off. (Willmer, MI)

19380: YL/EE w/5F grps in USB. Odd presentation. At times in a 3/2F format and some nbrs announced so fast as to be unreadable. Hrd at 2113. (Willmer, MI)

Order Back Issues of

POPULAR COMMUNICATIONS

CELLULAR TELEPHONE MODIFICATION HANDBOOK



How are hackers making cellular phone calls for free? Techniques for decoding and changing cellular phones, the "roaming technique", chip supplier's phone numbers, etc. Schematics for most cellular phones, and diagrams to find and change phone numbers on all models.

Complete Manual \$79.95

MO or COD to Spy Supply, Inc., 7 Colby Court, Bedford, NH 03110
(603) 645-6244

Sold for educational purposes only!



ICOM™ R7000 Sweeping 1300 Channels/Min.

DELTA COMM™ 1.04 gives you a custom interface and optimized software that will not just control but will maximize the potential of your R7000. Spectrum log at speeds in excess of 1300 channels/min. while automatically generating a histogram of frequency/activity. Advanced priority channel monitoring and program control, by channel, of remote tape recorders during scanning. Here are a few (there are many more) examples of the advanced features DELTA COMM has to offer:

- Birdie log during frequency search automatically characterizes your R7000, then locks out those frequencies
- Auto histogram and scan file creation during spectrum log
- Scan file channel lock-out feature allows scanning around channels without removing that frequency from database
- Resume scan and maximum monitor values unique on each channel scanned
- Each frequency within a scan file has an area (40 characters wide) for channel information.



- Auto frequency detection and storage during search and spectrum log
- User friendly installation program reduces need for DOS knowledge
- Full support of serial ports COM1-COM4
- On-screen HELP reduces need to refer to user manual
- REQUIREMENTS MS-DOS microcomputer with minimum 512K memory. DELTA COMM's performance is proportional to baud rate setting, style of display card and type of computer used.

\$299 Incl. Ext. Interface & Components for Cabling.
Check, MO, VISA or MASTER
Accepted + \$4 for S&H
(WI Res. Add 5% Sales Tax)



DELTA RESEARCH

PO Box 13677 • Wauwatosa, WI 53213
FAX or Phone Weekdays (414) 353-4567

CIRCLE 151 ON READER SERVICE CARD

BROADCAST DX'ING

BY ROGER STERCKX, KVT1JH

DX, NEWS AND VIEWS OF AM AND FM BROADCASTING

Trouble In River City: An increasing number of reports are being received relating to air personalities perpetrating pranks and hoaxes over the air. While many view this as fun, there are those who don't see the humor in the approach.

In Salt Lake City, two morning jocks at KBER phoned up a 16-year old girl and identified themselves as police officers. Telling her they were checking out a vandalized car, they said they had found her fingerprints in the vehicle and that she was about to be arrested unless she told them who else was involved in the vandalism. The whole thing was intended as a joke and was suggested by one of the girl's friends.

The girl didn't find the call very funny. Neither did the local police, which were reported to be considering midemeanor charges against the deejays for impersonating police officers. (Thanks to Joseph Bial of Chagrin Falls, OH for telling us about this.)

Police went to Providence (RI) station WALE with their sirens going when after the station announced that a controversial talk-show host had just been shot. The report was a hoax.

Police were deciding about bringing charges. Three station staffers were fired, in any event, including the talk-show host, a newsman, and an engineer. WALE's program director denounced the incident as a "gross error in judgement."

Under the FCC's new schedule of fines, the agency can now deal rather harshly with stations it determines have stepped over the line with the type of material transmitted, including pranks and hoaxes. Among the new fines, misrepresentation or lack of candor rings up \$20,000; false distress broadcasts could cost \$20,000; broadcast of indecent programming might bring about a \$12,500 fine; broadcasting telephone calls without permission charge up at \$5,000 each; failure to identify station on the air is a \$2,500 omission; and even "miscellaneous violations" cost \$1,250.

Direct Approach: WRNJ, a stand-alone AM'er in Washington Township (Morris County), NJ wants an FM outlet. Not long ago, POP'COMM reported that WRNJ's owner, Larry Tighe (a licensed ham) suggested that the FCC reallocate the 6 meter ham band for FM broadcasting purposes.

Thanks to the fact that an FM station in Scranton, PA changed its frequency from 107.1 MHz to 106.9 MHz, it looks as though WRNJ's needs may be satisfied without further threat to the 6 meter ham band. The Scranton move left 107.1 MHz available for allocation in southern NJ. Two parties in southern NJ wanted to use the frequency, WRNJ, and a company wishing to start a new station. WRNJ paid \$25,000 to

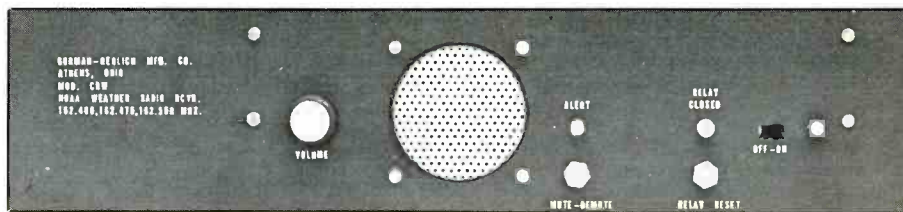

The Gorman-Redlich Model CRW is a professional three channel 162 MHz monitor weather receiver intended for broadcast station use.

the other contender to drop out of the running, although WRNJ felt it probably would have won the use of 107.1 MHz, anyway, in an FCC hearing. (Thanks to Peter Murricane, WB2SGT, for this item.)

Typical of how several competing applicants vie for a single spot on the dial is demonstrated by newly begun WBEY/102.9, California (St. Mary's County), MD. The 3.6 kW station (hoping to go to 6 kW soon) had to go before the FCC and plead for the frequency along with other applicants from St. Mary's County and also King George, VA.

The decision to grant the license to the applicant in the community of California was based upon its size and the lack of FM signals being received in that County from elsewhere. (Thanks to J.D. Delancy, K1ZAT/3, Bryantown, MD for this.)

New Powerhouse: Keep checking 530 kHz at night for signs of the new 100 kW religious station opening there. It's called *Radiovision California*, and located on South Caicos Island in the Caribbean. They hope to be on the air in January with their two combined Nautel ND-50 transmitters operated from a former Coast Guard LORAN site. A 500 ft. tower will be used. Daytime coverage is expected into the Gulf states, and up the East Coast to the Carolinas. *Atlantic Beacon*, on 1580 kHz with 25 kW, will also move to this site and begin running 100 kW. There will also be an FM outlet on 100.1 MHz located on site, as well as two more 100 kW stations eventually sharing time on 530 kHz.

VOA Germany Returns: Last summer the VOA/1197 went back on the air after many years of being silent. The station now runs a daily sked.

Weather Receiver: The FCC allows broadcasters to rebroadcast 162 MHz NOAA weather stations provided that commercials run in connection with the weather rebroadcasts don't convey an endorsement by the government. Broadcast stations therefore usually want to have professional grade monitoring equipment for the NOAA weather channels. The type of equipment they use is demonstrated by the rack mount-



This unmarked van drove up one day, raised its antenna, and remained at one location in Oxford, AL for twenty minutes, then left. We were asked if we knew what it was. Looks like a mobile TV news van that stopped long enough to feed a tape back to the studio by microwave. (Submitted by Herb Griffin, N4ZOV)

ed and fully remotable Gorman-Redlich Model CRW receiver, which is crystal controlled on any three weather channels.

The CRW has a set of 600 ohm outputs on the rear terminal block. It has continuous audio, as well as 600 ohm gated audio output that is activated during an alert and can be used for remote alarm (0 dM). An internal relay provides a contact closure across another set of terminals when an alert takes place. The contact closure can be used to start a tape recorder or set off a buzzer or a light at a remote location.

Built in an all metal enclosure, the double conversion receiver can be used with any 50 ohm antenna, and with a yagi for reception in fringe coverage areas. The receiver's sensitivity is 0.28 uv. The current price of the Model CRW is \$540.

For more information on this professional product, contact Jim Gorman, Gorman-



CBC/740, Toronto, Ontario offers this great looking QSL. (Courtesy Scott Kraus, Cleveland, OH.)

Redlich, 257 W. Union Street, Athens, OH 45701. Be sure to mention you read about it here.

Information, Please: Karim Mawji, of 1802 Teakwood Rd., Victoria, BC V8N 5B6 writes with a question. Although he lives in Victoria, British Columbia, he'd like to listen to CFRN/1250, Edmonton, Alberta. This station is 800 miles distant from him. Although he can copy CFRN at night, it's got interference. Karim didn't describe the type of interference (i.e., co-channel or adjacent channel).

He's new at radio and hopes that someone local to him might have some ideas on equipment or antennas that would improve his reception of the station he'd like to hear.

California Calling: San Diego's KGMG-FM/102.1 changed its call letters to KIOZ a few months ago. The station, known as *Rock-102.1* since June of 1990, but had retained its old call letters (KGMG-FM) from its earlier format and *Magic-102* identity.

The call letter change was now made to help eliminate any residual confusion between *Rock-102.1* and its AM sister station, KGMG/1320, the North County's *Lite &*

Easy Station. The new FM call letters were selected because the "IOZ" has a visual resemblance to "102," the abbreviated nickname given to *Rock-102.1* by its loyal fans.

Rock-102.1 is the leading rocker in the growing San Diego "North County" market. (Thanks to Steve Sellers, News Director at *Rock-102.1* for giving us the inside story on this.)

Now, Here's A Format! Last May, WDDQ/92.1 (sister station of gospel WBIT/1470) of Adel, GA came up with a new format. Gone were Kenny Rogers, George Jones, Dolly Parton, Roy Orbison, and the Judds. The day the music stopped, the station began filling the airwaves with continuous commercials—commercials without stop, without end, and with breaks only for station identification.

There are commercials for restaurants, motels, service stations, oil distributorships, a truck stop, and a clothing store. These businesses are all run by the man who owns the radio station. He decided the country music format wasn't as good an idea as the new format.

The idea behind the new format is strictly

New FM Call Letters Issued

KBVA	Bella Vista, AR
KDAB	Prairie Grove, AR
KFLD	St. Robert, MO
KHOE	Fairfield, IA
KLVV	Little Rock, AR
KLXO	El Centro, CA
KPXP	Saipan, MO
KPXQ	Franklin, TX
KPXS	Vidalia, LA
KQCT	Davenport, IA
KQLB	Los Banos, CA
KUKN	Kelso, WA
KYFL	Monroe, LA
KYOO-FM	Halfway, MO
KYUA	Ashland, MO
KYUB	Victorville, CA
KYUC	Roland, OK
KYUD	Tucson, AZ
WEDG	Edgewater, FL
WFIX	Rogersville, AL
WHEY	Harlem, GA
WJZK	Dresden, TN
WKXX	Attalla, AL
WMXA	Opelika, AL
WRDO	Fitzgerald, GA
WRHA	Johnsonville, SC
WRHE	Kingston, NY
WRHF	Farmington, NY
WRHG	Natchez, MS
WRTX	Dover, DE
WSEJ	Marianna, FL
WSEQ	Reidland, KY
WSEU	Hinesville, GA
WSGQ	Webster, MA
WSKR	Petersburg, NJ
WTFX	Louisville, NJ
WTKW	Bridgeport, NY
WTTL-FM	Madisonville, KY
WUSR	Scranton, PA
WVSL	Valley Station, KY
WXLU	Peru, NY
WYYA	Olive Branch, MS
WYYB	Dickson, NY
WYYC	Battle Creek, MI
WZBG	Litchfield, CT

to appeal to reaching tourists and truckers traveling through the area to and from Florida on Interstate 75. The station has no other intended audience than as "tourism information radio."

An interesting idea, with as many bad points as good ones. (Thanks to Martin L. Tobias, Westfield, MA for sharing this with us.)

Station Upgrade: KRTS/92.1, the classical music station in Houston, TX is upping its power from 3 kW to 50 kW in a move described as "one of the most complicated upgrades ever handled by the FCC." The complicating factor related to the fact that there are fourteen other broadcasting stations in the region whose operations could be affected by the power increase.

The new transmitter is located in Alvin, TX and has been received as far away as Cleveland, TX. (Thanks go to John Stavinoha, Houston, TX for passing this along.)

LPFM?: There are now 895 Low Power



Rock-102.1 in San Diego recently went through a call letter change. (Thanks to Steve Sellers of Rock-102.1)

Applications To Modify FM Facilities

KLRK	Vandalia, MO	100.1 MHz Move to 104.3 MHz
KTSH	Tishomingo, OK	88.3 MHz Move to 99.7 MHz
KZYQ	St. James, MO	99.5 MHz Move to 99.7 MHz
WCKQ	Campbellsville	103.9 MHz Move to 104.1 MHz, 2.25 kW
WKYR-FM	Burkesville, KY	98.5 MHz Move to 107.9 MHz
WYKK	Quitman, MS	98.3 MHz Move to 98.9 MHz

FM Frequency Change

WKNH	Keene, NH	91.3 MHz Move to 91.7 MHz, 200 watts
------	-----------	-----------------------------------------

Applications To Modify AM Facilities

KUET	Black Canyon City, AZ	710 kHz Add nites at 4.1 kW
WWRV	New York, NY	1330 kHz Become non-commercial

Changed AM Facilities

KGGN	Gladstone, MO	890 kHz Dropped to 1.1 kW
KLBS	Los Banos, CA	1330 kHz Added 20 w. synch. xmtr. at San Jose
KLOH	Pipestone, MN	1050 kHz Increased to 9 kW/400 watts
WAFS	Atlanta, GA	920 kHz Added 200 w. synch. xmtr. at Alpharetta
WAMN	Green Valley, WV	1040 kHz Increased to 1.43 kW/250 watts
WART	Port Orange, FL	1020 kHz Dropped to 400 watts

New AM Call Letters Issued

KCCF	Cave Creek, AZ
KUAU	Haiku, HI

Permits Issued To Construct New FM Stations

AL	Opelika	96.7 MHz	3 kW
AR	Bella Vista	106.5 MHz	50 kW
AR	Texarkana	104.7 MHz	3 kW
CA	Groveland	91.7 MHz	7 kW
CA	Lucerne	106.5 MHz	150 watts
DE	Dover	91.7 MHz	708 watts
FL	Panama City Beach	105.1 MHz	50 kW
GA	Montezuma	95.1 MHz	3 kW
GA	Sylvania	106.5 MHz	6 kW
GA	Sylvester	106.1 MHz	3 kW
HI	Princeville	98.9 MHz	100 kW
IA	Fairfield	90.5 MHz	100 watts
IN	Indianapolis	96.3 MHz	593 watts
KY	Hawesville	105.7 MHz	3 kW
KY	Horse Cave	100.7 MHz	3 kW
KY	Madisonville	106.9 MHz	6 kW
MS	Port Gibson	100.5 MHz	3 kW
NY	Jeffersonville	106.1 MHz	1.6 kW
NY	Malone	96.5 MHz	2.4 kW
NY	Mechanicsville	104.5 MHz	3 kW
OH	Greefield	97.5 MHz	2.8 kW
OH	S. Webster	94.9 MHz	3 kW
PA	Burnham	96.7 MHz	450 watts
SD	Huron	105.1 MHz	6 kW
TN	Dresden	95.1 MHz	6 kW
TN	Madisonville	99.5 MHz	2.5 kW
TN	Woodbury	104.9 MHz	3 kW
TX	Carthage	104.3 MHz	6 kW
UT	Salt Lake City	88.3 MHz	750 watts
VI	Charlotte Amalie	97.1 MHz	50 kW

Applications Filed For New AM Stations

AZ	Prescott Valley	98.3 MHz	
CA	Beaumont	100.9 MHz	
CA	Chico	88.3 MHz	1 kW
CA	Garberville	103.7 MHz	7.6 kW
IN	W. Lafayette	89.9 MHz	100 watts
KS	Arkansas City	102.5 MHz	6 kW
KS	Hays	88.9 MHz	
KS	Winfield	95.9 MHz	50 kW
MI	Marlette	92.5 MHz	3 kW
ND	Bismarck	101.5 MHz	100 kW
NJ	Manahawkin	90.7 MHz	950 watts
NM	Hobbs	96.5 MHz	
OR	Florence	106.9 MHz	2.3 kW
PA	Doylestown	91.7 MHz	
PA	Philadelphia	102.1 MHz	40 kW
PA	Pittsburgh	93.7 MHz	
PA	S. Waverly	96.1 MHz	
WA	Wilson Creek	103.3 MHz	6 kW
WI	Adams	106.1 MHz	6 kW

Permit Issued to Build New AM Station

NV	Winchester	620 kHz
----	------------	---------

Requested Change in AM Call Letters

Now	Seeks	
KBAD	KBID	Bakersfield, CA
KESB	KKSB	Santa Barbara, CA
KQIV	KLMC	Litchfield, MN
KROL	KOWA	Laughlin, NV
WCOG	WNFO	Ridgeland, SC
WJOT	WVLC	Lake City, SC
WOCB	WUOK	W. Yarmouth, MA
WPNT	WXJZ	Chicago, IL
WXEM	WLKQ	Buford, GA

Requested Change in FM Call Letters

Now	Seeks	
WKQB	WBUB	N. Charleston, SC
WKZZ	WLYK	Lynchburg, VA

Changed AM Call Letters

New	Was	
KFAN	WDGY	Minneapolis, MN
KIDS	KICK	Springfield, MO
KJIM	KTXO	Sherman, TX
KKZZ	KZTR	Santa Paula, CA
KMMS	KUUB	Bozeman, MT
KPBI	KVOG	Greenwood, AR
KPLS	KSRT	Orange, CA
KRDX	KMCE	Rancho Cordova, CA
KVCM	KHKR	E. Helena, MT
KWDS	KLKY	Prescott Valley, AZ
WJSG	WSJG	Hamlet, NC
WKAL	WKLT	KalKaska, MI
WKKV	WBZN	Racine, WI
WMOM	WQMR	La Plata, MD
WMTX	WHBO	Pinellas Park, FL
WTMY	WSGX	Sarasota, FL
WWCN	WRXX	Ft. Myers, FL
WXEM	WLKQ	Buford, GA
WXLN	WDJX	Louisville, KY

TV (LPTV) broadcasters separate and apart from 5,024 TV translators. There are also 1,861 FM translators, but there are no LPFM stations. It has been the FCC's position that such stations should not be allowed to exist, and that FM translators shouldn't be permitted to originate their own programming.

There has long been sporadic grass roots interest in getting an LPFM service off the ground and approved by the FCC. Nothing has ever gotten up enough momentum to make any difference, but we note that there's now an LPFM movement afoot that looks to have a bit more organization and drive than anything else seen of late.

For further information, check in with Bill Dougan, APW, Broadcast Consortium, PO Box 47473, Phoenix, AZ 85068-7473. Although Doug didn't mention it, it would probably help to include a self-addressed, stamped reply envelope for his response to you.

EBS Status: The Emergency Broadcast

Changed FM Call Letters

Now	Was	
KAXX	KAGR	Ventura, CA
KBMC	KPXB	Bozeman, MT
KBOE-FM	KOSK	Oskaloosa, IA
KCBS-FM	KODJ	Los Angeles, CA
KCDL	KRMK	Cordell, OK
KCDU	KMEZ-FM	Ft. Worth, TX
KCLB	KCHV	Coachella, CA
KELF	KZTR-FM	Camarillo, CA
KFAN-FM	KFAN	Johnson City, TX
KHIT-FM	KIIQ-FM	Reno, NV
KICK-FM	KIDS	Palmyra, MO
KIOZ	KGKG-FM	Oceanside, CA
KKXS	KLXQ	Uvalde, TX
KLLZ	KLLR-FM	Walker, MN
KPPL	KTMX	Colusa, CA
KPSN	KMEO-FM	Phoenix, AZ
KRVE	KIEZ	Brusly, LA
KSAB	KROB-FM	Robstown, TX
KSIR	KKDD	Brush, CO
KVST	KTDD	Huntsville, TX
KYFW	KCEV-FM	Wichita, KS
KZGL	KSMK-FM	Cottonwood, AZ
WBMH	WKXX	Birmingham, AL
WDJX	WDJX-FM	Louisville, KY
WCZQ	WVLJ	Monticello, IL
WJIB	WKME	Kennebunk, ME
WKKV-FM	WBZN-FM	Racine, WI
WKLT	WKLT-FM	Kalkaska, MI
WKOC	WMYK	Elizabeth City, NC
WKOS	WZXY	Kingsport, TN
WKQT	WZYC-FM	Pinellas Park, FL
WLRX	WXJG	Nappanee, IN
WLTV	WMLL	Mobile, AL
WMTX-FM	WMTX	Clearwater, FL
WMYK	WTZR	Moyock, NC
WNLT	WVCZ	Harrison, OH
WSMD	WQMR	Mechanicsville, MD
WTKB-FM	WBVD	Huntingdon, WV
WTMD	WCVT	Towson, MD
WVTY	WHTX	Pittsburgh, PA
WXLN-FM	WXLN	Eminence, KY
WXXP-FM	WLHN	Anderson, IN
WYFE	WFCE	Tarpon Springs, FL
WZFM	WNRV-FM	Narrows, VA
WZZN-FM	WSCG	Corinth, NY

Requests Withdrawn For Call Letter Changes

Now	Wanted	
WPNT	WXRT	Chicago, IL
WOCB-FM	WJIB	W. Yarmouth, MA

System (EBS) was used 634 times between January 1st and the middle of July this year. Some of the reasons included flash floods, tornadoes, severe thunder storms, floods, blizzards, power outages, high winds, chemical explosions, evacuations, small telephone outages, fires and winter storm warnings.

A total of 12,396 EBS activation reports have been received since the voluntary program began in 1976.

The FCC is thinking of initiating technical improvements to EBS, incorporating new technologies that would lead to receivers that are activated only for emergencies of a certain type or in a certain area.

The present EBS alert system consists of a 20 to 25 second two-tone signal. This could

be replaced by different alerting tones that could trigger automatic receivers relevant to particular locations or types of situations.

Our Christmas Story: Station KIEV, Glendale, CA requested the FCC to reduce at \$10,000 forfeiture for violation of rules governing sponsorship identification. The FCC received a complaint that KIEV had broadcast promotional programs without announcing consideration had been paid for the airing of those programs.

KIEV contended that the forfeiture amount was unnecessarily severe for the particular infractions involved. The station argued for a reduction in the instance that their violation was inadvertent.

The FCC replied that they regard inad-

vertence as the same thing as ignorance of the law. Although it did not appear that any listener had been cheated or hurt by the slip, apparently the FCC does not recognize inadvertence or ignorance as being forgivable sins. The agency then dismissed the whole appeal by claiming the KIEV violation wasn't inadvertent, that it was both willful and repeated. The FCC directed KIEV to pay the \$10,000.

On that note, what more can I say other than Merry Christmas to one and all? If you wish to share your bumper stickers, anecdotes, newspapers clippings, recent AM/FM QSL's, station photos, and anything related to AM/FM station activities, we are anxious to hear from you! ■

For 25 years,
our people have
endured long hours
and tough
working conditions
for no pay.



And 9 out of 10 would
do it again.

TO FIND OUT WHY
call

(316) 263-2100

or write

REACT INTERNATIONAL, INC.

242 Cleveland

Wichita, KS 67214

CIRCLE 165 ON READER SERVICE CARD

WASHINGTON PULSE

FCC ACTIONS AFFECTING COMMUNICATIONS

Pennsylvania Pirate Station Shut Down

The FCC's Buffalo Office, in coordination with the Commission's nationwide monitoring network, shut down an unlicensed broadcast station in Pennsylvania. Mark Radecki of Erie, Pennsylvania, was fined \$1,000 for illegally operating on 7415 kHz, a frequency allocated to the International Fixed Public Radio Service. The station had a rock music format.

CB Radio Station Closed; Equipment Seized

U.S. Marshals, with the assistance of Engineers from the FCC's San Juan office, executed an in rem seizure of radio equipment at the home of CB operator Ramon A. Fernandez Camilo of Levittown, Puerto Rico. The seized equipment included linear amplifiers.

This seizure resulted from a lengthy investigation conducted by the FCC's San Juan office as part of a continuing enforcement program to reduce instances of illegal CB operations. Mr. Camilo was fined for unlicensed operation and for failure to allow inspection.

The seizure took place under Federal civil forfeiture provisions initiated by Jose Blanco, Assistant U.S. Attorney for the District of Puerto Rico.

Unlicensed Microwave Station In California Shut Down

Mr. Everett L. Shilts, owner of News/Sports Microwave Rental, Del Mar, California, has been fined \$2,000 for illegal radio operations. The FCC's Los Angeles Office conducted an investigation in Inglewood, California, and found that News/Sports Microwave Rental was operating a microwave radio station in the 17 GHz band, as well as a land mobile station on the frequency 462.7358 MHz, without Commission licenses or authorizations. News/Sports Microwave Rental paid the fine on July 22, 1991. This was News/Sports Microwave Rental's second unlicensed operation. The company previously paid a \$1,000 fine for unlicensed operation in July 1990.

Unlicensed operation of a radio transmitter is a violation of Section 301 of the Communications Act of 1934, as amended. Sanctions may include administrative fines of up to \$10,000 and/or criminal penalties of up to \$100,000 and/or imprisonment for up to one year. Misuse of radio frequencies is a serious offense because of its potential for interfering with safety-of-life services

such as aviation, law enforcement, marine, as well as other licensed stations.

The Commission will continue its vigorous enforcement efforts directed against the operation of unlicensed radio stations and will apply appropriate sanctions against such violators.

New Public Safety Spectrum Available In Mexican Border

Representatives of the Governments of the United States of America and the United Mexican States signed a Memorandum of Understanding (MOU) that permits use of specified channels in the 821-824 MHz and 866-869 MHz bands within 110 km (68.4 miles) of the U.S./Mexican border by entities eligible in the Public Safety and Special Emergency Radio Services. The Chief, Private Radio Bureau, adopted an Order that modified Part 90 of the Commission's Rules to include the terms of the MOU. Specifically, the Order permits public safety and special emergency entities to apply for one or more of the 107 channels set-aside for use by the U.S. In addition, the five nationwide mutual-aid channels are available to licensees in both countries. Applications for channels in the Mexican border area may be submitted after a public safety plan for the relevant geographic region has been filed with the Commission and has been accepted as consistent with both the National Public Safety Plan (General Docket No. 87-112, 3 FCC Rcd 905 1988), and the July 31, 1991 Order.

Use Of 928-929 And 952-953 MHz Bands In the Vicinity Of The United States And Canadian Border

The United States/Canada Radio Technical Liaison Committee (RTLCL) finalized an Arrangement concerning the use of the above bands in the vicinity of the United States/Canada border. The RTLCL is a joint FCC/DOC committee responsible for examining technical issues concerning the use of radio by both countries. This Agreement covers bands allocated principally to Multiple Address Systems under Part 94 of the Rules, but are also used by older, point-to-point systems, and by Public Land Mobile Service users under Part 22 of the Rules. Use of these frequencies by either Canada or the United States between Lines A and B and between Lines C and D requires coordination with the other country. Because use of these frequencies in the border areas was increasing significantly, there was concern in both countries about future access. The

signing of this Arrangement now clears the way for the continued, orderly licensing of facilities in the border areas.

This Arrangement divides the spectrum into three pools: one pool is for primary use by the United States, one pool is for primary use by Canada, and the third pool is to be shared between the two countries on a first-in-time basis. All currently existing stations of both countries in these bands may continue to operate under their current authorizations and are to be grandfathered. The Arrangement also provides for each country to use the channels allotted primarily for use by the other country, subject to meeting specific technical sharing criteria.

For further information concerning this Arrangement contact Edward Jacobs, Deputy Chief, Land Mobile and Microwave Division, Private Radio Bureau, (202) 632-7597. For information pertaining specifically to use of these frequencies by Public Land Mobile Service users under Part 22 of the Rules, contact Michael Pollak, International Staff, Common Carrier Bureau, (202) 632-7834.

Florida Company To Forfeit \$2,000 For Selling Device Not Certified By The Commission

The Commission ordered Discount Discs in Shalimar, FL, to forfeit \$2,000 for willfully violating the Commission's rules by offering to sell on the telephone, a Sierra personal computer that had not been certified by the FCC as required by the rules. J. Mark Brewer, Esq., attorney for Discount, sought review of the monetary forfeiture penalty.

Commission rules prohibits the marketing, including the offering for sale, of radio frequency devices that have not been certified by the FCC. Discount offered to sell the computer to an FCC inspector posing as an individual buyer who wished to purchase a personal computer for use in his home.

Submissions Required Of 20 MHz Applicants

This information is issued to clarify submission requirements under Section 90.713 of the Commission's Rules for applicants for nationwide systems in the 220-222 MHz band.

Section 90.713 of the Rules, adopted in the Report and Order in PR Docket No. 90-552, sets entry requirements for nationwide 220 MHz systems and requires applicants to make specific submissions, including certifications, construction sched-

ules, and financial qualifications. Section 90.713 becomes effective on July 29, 1991, 90 days after publication in the *Federal Register*. See 56 FR 19598 (April 29, 1991). The *Report and Order* stated that after approval of the new information collection requirements by the Office of Management and Budget, we would advise applicants when to make their submissions. No such submissions need be filed at this time. We will apprise nationwide applicants of the procedures for filing Section 90.713 submissions when we determine that it is appropriate to do so.

For further information about this matter, contact Rosalind Allen, Private Radio Bureau, Land Mobile and Microwave Division, Rules Branch at (202)634-2443.

Safety Radio Equipment On All Passenger Boats

The FCC recently conducted a study to determine the condition of marine radio stations on-board small passenger vessels. FCC surveyed 260 vessels and found that 86 percent were in compliance with the safety requirements set forth in Part 80 of the Commission's rules.

The vessels subject to this study were generally small passenger vessels that take paying passengers on fishing and sightseeing day trips in waters off the U.S. coast. Such vessels are required to be equipped with an efficient operational radio station in accordance with FCC rules and U.S. law.

Although most vessels fully complied with the safety requirements for ship radio stations, we are concerned about the vessels that did not. We found that the major reason for a vessel failing to meet the safety requirements was a faulty transmitter. The study also showed that the vessels are more compliant (over 95 percent) within one year of the required FCC inspection. After that time, the compliance rate drops to the 86 percent average.

The FCC is reviewing the results of the study to determine what action should be taken to further improve compliance for these vessels. For additional information, please contact Rockie Patterson, Field Operations Bureau, Enforcement Division, 202-632-6345.

Forfeiture Standards Established

The Commission adopted a policy statement establishing standards for assessing forfeitures. The standards set out a base forfeiture amount as well as upward and downward adjustment criteria for each specific violation.

The Commission has traditionally assessed forfeitures on a case-by-case basis, in light of relevant precedent. In 1989, Congress substantially increased the dollar amounts of FCC forfeiture authority and, as the Commission began implementing the increased forfeiture authority, it decided it

should have more specific standards for assessing these larger forfeitures.

Adoption of these standards will assist the Commission in ensuring that similar violations will be treated the same. The standards will also provide guidance to the public regarding the forfeitures that can be expected in connection with specific violations.

The Commission noted that establishing forfeiture standards was consistent with a recommendation of the Administrative Conference of the United States and is similar to approaches taken by some other independent regulatory agencies.

The Commission also noted that, while it intends to be guided in the future by these standards, it remains free to exercise discretion in specific cases.

Decline To Implement New Personal Locator Transmitter Service For Individuals In Remote Areas

In light of the comments received in response to its rulemaking notice, the FCC declined to amend its rules to establish a Personal Emergency Locator Transmitter Service (PELTS).

The proposal had been made to establish

the service to provide individuals in remote areas with a means to alert others of an emergency situation and to help search and rescue personnel locate those in distress.

The Commission said that while most of the commenters generally agreed that a service such as PELTS could prove valuable in search and rescue work, there was a feeling that the technical requirements of the narrowband technology required would make the equipment too costly to be practical. There was also unwillingness by existing search and rescue organizations to perform the critical monitoring functions that would be required.

The Commission said that while it continued to believe there was a need to improve emergency communications capability in remote areas, there were enough problems with the PELTS system that it would terminate the proceeding and release the channels involved for the private land mobile radio services. It noted that it would continue to work with the search and rescue community, the Interagency Committee for Search and Rescue, and other concerned parties regarding the improvement of emergency communications capabilities in remote areas and the matter of personal locating beacons. ■

JRC Review

(from page 29)

rate. The reviewer applauds JRC for this attention to detail.

After unpacking the receiver and turning it on, the first thing one notices are the beautiful fluorescent frequency display and S-meter. At first, it was thought that the "needle-type" S-meter design would be missed, but this concern was put to rest after a few hours of operation. Tuning with the main tuning knob is very smooth. An electronic tuning lock is selectable from the front-panel as well.

One of the first signals heard was Radio Beijing in the 31 m band. And, this was with just a random length of wire 10 feet long draped over the window sills!

Summary

The new JRC NRD-535 receiver is an improvement over even their earlier highly regarded models. Yes, a few minor carps remain, like the desire to hear audio with more articulation and less bass. But, this is picayune. With a receiver of this class, one looks for areas to complain about, but with the NRD-535 these are very few indeed. The construction quality is commercial-grade, its performance in the "real world" is as close to professional-grade obtainable within consumer market price constraints, and it is operationally very user-friendly. The MSRP of the NRD-535 is \$1995.00. Please contact Japan Radio Co., 430 Park Avenue (2nd floor), New York, NY 10022 for more information. ■

Reviewed by Pop'Comm staff.



Radio Buffs

N4EDQ Amateur Radio Sales

4400 Hwy. 19-A • Mount Dora, FL 32757

1-800-828-6433

Find out why thousands of customers have switched to us.

Japan Radio Co., Ltd.

NRD-535
HF Receiver

AUTHORIZED
JRC
DEALER



Ultimate
Shortwave
Receiver

ASK FOR SPECIAL SALE PRICES

INSIDE THE WORLD OF SATELLITE COMMUNICATIONS

136-174 MHz

If your scanner has the capability of tuning the 136 to 174 MHz band we may have a pleasant surprise for you. Along with the usual occupants of this band, which include aeronautical, fixed, land mobile and maritime mobile among others, you can also hear manned and unmanned spacecraft and search and rescue missions.

Let's start with the 137 to 138 MHz satellite band. This is the place where most of the early satellites started, like the NASA and NOAA experimentals that were the forebears of our current weather and communication satellites. Though new satellites are no longer being allowed to use this band there are still 11 spacecraft using it. Some of the satellites are in geo-stationary orbits while others, like the weather satellites are in a low altitude polar orbit.

By far the most exciting listening between 136 and 174 is the Soviet Manned Space Program. 143.625 MHz is an old standard for followers of the Mir Space Complex. Wideband FM voice communications can be heard here. Other frequencies have been used in the past. These include 142.417 and 121.750 MHz which have been used for voice communications between Mir and approaching Soyuz spacecraft. 143.625 MHz is the primary channel which downlinks Mir voice communications to waiting ships. They in turn relay the signal to Moscow via the Molniya satellite system.

Another easy way to hear your favorite Cosmonaut is to tune 145.550 MHz. The Soviets have operated an Amateur station from Mir since 1988. They are in the process of installing a Packet station. The amateur station uses narrowband FM, just what your scanner likes the most. One additional

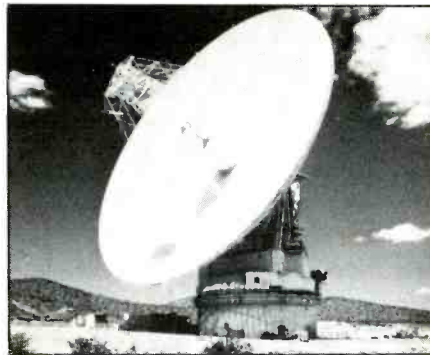

One of Gladstone's 210' dish antennas.

frequency you may want to program in your scanner's memory is 166.0 MHz. This is a telemetry channel used by the Soyuz and Progress supply ships.

Between 149.9 and 149.975 the Soviets operate eight military navigation satellites. On 150 MHz the US and USSR have no less than 16 Navsats. The Soviets also use 153.4 to 153.8 MHz for CW beacons on their spysats. However, these can only be heard in Europe.

If your scanner or receiver operates in the SSB mode you will want to pay some attention to the amateur satellite downlinks in the two meter band. US and Soviet satellites use 145.8 to 146.0 MHz for downlink, so hook up that outside antenna, punch in the numbers and let her run.

NASA

SETI - Search for Extra-Terrestrials Intelligence Microwave Project will begin operation in 1992. Specific targets will be

scanned by the world's largest antennas. The one through three GHz frequency range will be searching for frequency and time domain variations that could indicate an artificially generated signal.

In addition, a complete Sky Survey will be conducted over the frequency range of one to 10 GHz. The antennas of the Deep Space Network (see the Sept 90 issue) will be used for this Survey.

GRO - Gamma Ray Observatory collected data on two X-class solar flares, its first since it was launched by STS-37 in April. X-class solar flares disrupt communications and can damage electrical power distributions systems.

ATDRSS - The fifth Tracking and Data Relay Satellite has been completed and will be ready for operation soon. It was deployed from Atlantis in August. The Advanced Tracking and Data Relay Satellite System (ATDRSS) contracts have been awarded. This new class of spacecraft will ensure space communications through the year 2012.

SPACEHAB - NASA has just signed a contract with Spacehab Inc. to provide a new Spacehab mid-deck lab module for the Space Shuttle, the cost - \$184,236,000.

Mt. Pinatubo - NASA is tracking the 5,000 mile long cloud of sulfur dioxide that has erupted from Mt. Pinatubo in the Philippines. The Nimbus 7 satellite, which measures Ozone levels has been monitoring the plumes. This eruption could have negative effects on both the ozone and regional climate. The Soviets recently launched a Meteor 3 weather satellite which is also capable of monitoring the ozone.

CASSINI - NASA and the European

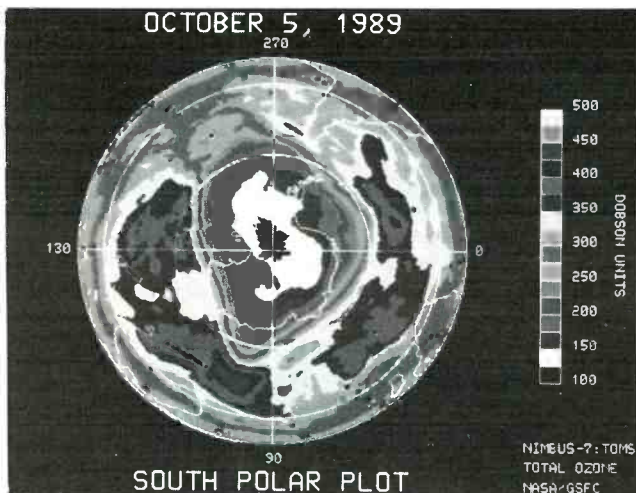

Plot showing the distribution of ozone on October 5, 1989 for the Southern Hemisphere. Photo courtesy NASA.

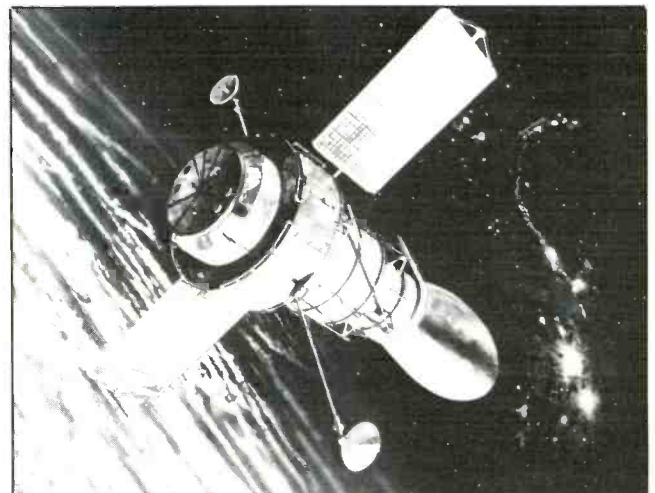

The Department of Defense lent us this photo of the Space Infrared Telescope Facility (SIRTF).

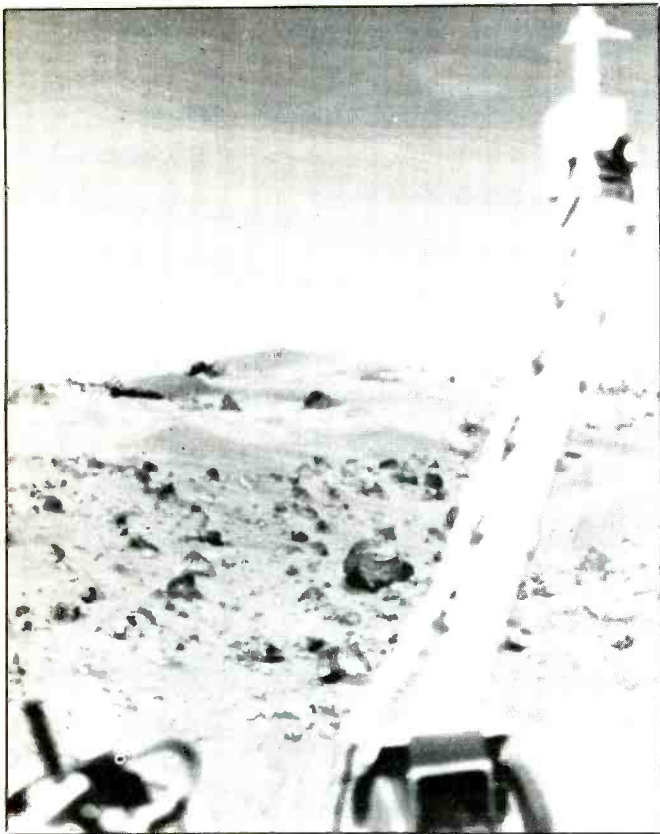

Here's a look at the surface of Mars up close and personal. Photo courtesy of NASA.

Operational Earth Observation Satellites

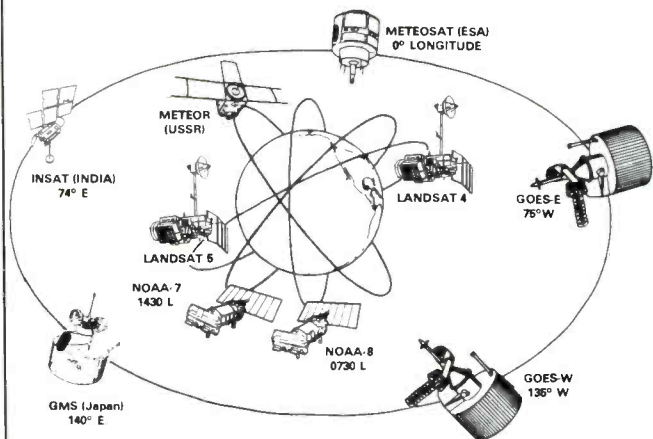

Satellite	Frequency	Orbit
ATS-1	137.350 MHz	Polar/LEO
ATS-3	136.370 MHz	GEO/105°W
GOES-1	136.380 MHz	GEO/105°W
KIKU-2	136.110 MHz	GEO/127.1°E
GOES-2	136.380 MHz	GEO/60.3°W
IUE	136.860 MHz	LEO
GOES-3	136.380 MHz	GEO/176°W
METEPSAT 2	137.076 MHz	GEO/10°W
MARECES B2	137.170 MHz	GEO/55.5°W
NOAA 9	137.620 MHz	Polar
METEOSAT	137.080 MHz	GEO/3°W

Search and Rescue Civil Air Patrol - 143.90 MHz, 148.15 MHz

Space Agency (ESA) have signed an agreement to cooperate in a joint Saturn mission. ESA will build probe called Cassini and NASA will provide the Titan IV launch vehicle. The flight trajectory requires 7 years for the probe to reach Saturn.

Sixty-seven percent of all astronauts suffer from space sickness during shuttle flights. This form of motion sickness is caused

when the otoliths (small stone-like particles in the inner ear) no longer have weight. This causes the visual and inner ear balance information to confuse the brain's perceptions, causing the illness.

Dinosaur's Demise - NASA researchers have discovered what they believe to be evidence of the largest meteor ever to hit the Earth. Located in Mexico's Yucatan state

the 125 mile diameter crater is more than 65 million years old and that would make it the most likely candidate for the planet wide extinction of the dinosaurs.

Tired of chuck holes? DOD's Navstar Global Positioning Satellite System (GPS) is coming to the rescue. This satellite system is used in conjunction with a pair of video cameras mounted on a van. This allows precise location & identification of street, bridges railways equipment and road hazards as well as locations of fatal accidents for future reference and safety considerations. It can even mark road construction areas. It is estimated that we (in the US) spend (or loose) \$16 billion a year in wasted fuel for detours and vehicle repairs. This information would be made available on car computer terminals after the system is perfected and turned over to commercial interest (isn't that Corporate welfare?)

One final note. Dr. M. Patrick McCormick, a Langley Researcher (NASA), has discovered that the Polar Stratospheric Clouds (PSC's) play an important role in the depletion of the Ozone layer. These unique clouds which hover over the poles are central to the chemical chain reaction that depletes the earth's protective layer. When fluorocarbons reach the surface of the PSC's they release active chlorine which attacks ozone.

Well, that does it for this month. Remember, questions, letters, photos, etc are always welcome.

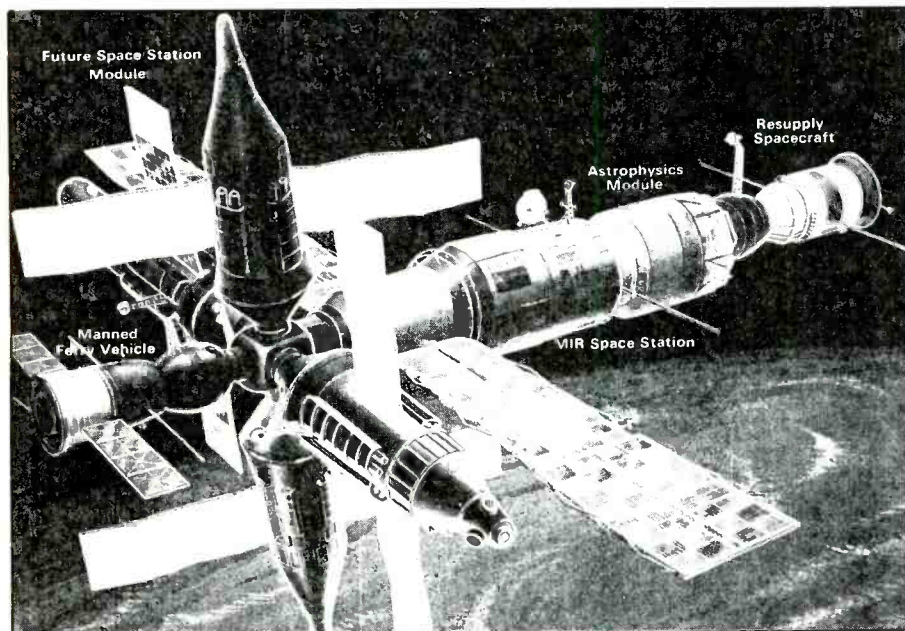

The MIR Space Station

FREE CATALOG!
1-800-648-7938
JERROLD HAMLIN OAK ETC
CABLE TV
DESCRAMBLERS

- Special Dealer Prices!
- Compare our Low Retail Prices!
- Guaranteed Prices & Warranties!
- Orders Shipped Immediately!

REPUBLIC CABLE PRODUCTS, INC.
 4080 Paradise Rd., #15, Dept. 125
 Las Vegas, NV 89109

CIRCLE 168 ON READER SERVICE CARD

SUPER-MINIATURE
FM TRANSMITTER

NEW! POWERFUL! XST500
SUPER-MINIATURE transmitter uses Surface Mount Technology (SMT)! Smallest high performance FM transmitter available anywhere. Transmits whispers to any FM receiver up to a mile away. Uses 9V battery. Complete, easy to assemble, kit with all SMT parts already assembled to circuit board. Call our free 800 order number and order one today!!

\$39.95 CHECK, VISA, or MC
 COD ADD \$5.00

TECH INFO 1-602-829-8152
 ORDERS ONLY 1-800-336-7389

XANDI ELECTRONICS, Dept PC
 201 E Southern Ave, Suite 114
 Tempe, AZ 85282

XST500

ORDER NOW!!!

Or write for catalog today!

CIRCLE 167 ON READER SERVICE CARD

FREE SAMPLE COPY!

ANTIQUE RADIO CLASSIFIED

Antique Radio's Largest-Circulation Monthly Magazine

Articles - Classifieds - Ads for Parts & Services
 Also: Early TV, Ham Equip., Books, Telegraph, 40's & 50's Radios & more...

Free 20-word ad each month. Don't miss out!

1-Year: \$27 (\$40 by 1st Class)
 6-Month Trial - \$15. Foreign - Write.

A.R.C., P.O. Box 802-T7, Carlisle, MA 01741

TOUCH-TONE DECODER/DISPLAY & ASCII CONVERTER BOARD

Model TDD-8 decodes and displays all 16 DTMF digits and provides an ASCII serial output. Digits are displayed on eight LED's. 32 character memory can be scrolled. It will accept almost any audio source, such as a scanner, tape recorder, telephone answering machine, etc. Serial output can be connected to your computer. IBM compatible software included for displaying, storing and/or printing time, date and number for automatic logging.

TDD-8 DTMF DECODER/DISPLAY/ASCII \$99
 CAB-1 AUDIO & COMPUTER CABLES \$20
 PS-12 110VAC TO 12VDC POWER PACK \$10
 add \$5 S/H - VISA/MC ACCEPTED

MoTron Electronics TEL: 1-800-338-9058
 310 Garfield St.#1 (503)-687-2118
 Eugene, OR 97402 FAX: (503)-687-2492

(Touch-Tone is a trademark of AT&T)

SCANNING VHF/UHF

MONITORING THE 30 TO 900 MHz "ACTION" BANDS

BY CHUCK GYSI, N2DUP

If things go as usual, there will be a bunch of scanners given as gifts this month. That means there will be a lot of folks starting a new hobby when they get their radios. There's plenty to hear on the scanner bands, so after you start tuning around, be sure to send some of your catches to this column to share with others.

From my own files, the Second Coast Guard District has changed the times of its regular scheduled broadcasts. Coast Guard marine information broadcasts are transmitted on VHF marine channel 22A, 157.100 MHz. Group Upper Mississippi River has scheduled broadcasts and river stages broadcasts at 2 and 8 p.m. daily and consolidated broadcasts at 2 a.m. and 9 a.m. daily. Group Lower Mississippi River transmits scheduled broadcasts and river stages broadcasts at 1 and 7 p.m. daily and consolidated broadcasts at 1 and 8 a.m. daily. Meanwhile, Group Ohio Valley transmits scheduled broadcasts and river stages broadcasts at 10 a.m. and 3 p.m. daily and consolidated broadcasts at 3 a.m. and 9 p.m. daily.

From Amherst, New York, Joe Galante writes to say that he has a Realistic PRO-34 scanner and he was wondering whether it could be modified to receive the 174-380 MHz band that the scanner eliminates. No, we haven't heard of any possible tricks to have this unit operate out of band. My usual recommendation in this situation is that if this band is of interest to you for a particular reason (such as listening to military aircraft in this instance, for example), then you should purchase a receiver that is capable of doing what you want which would be the AOR AR1000XLT or the Icom R1.

Joe also inquired as to whether there is a guide on the market that lists addresses of police and fire departments across the United States so he may obtain QSL's for skip activity heard. This information would be available on microfiche for those who have access to FCC offices and want to look through license information. However, there is no known directory that I know of that would be detailed enough to list addresses for police departments from What Cheer, Iowa, to Seattle, Washington. My recommendation would be to write to the chief of police or chief dispatcher in care of the name of the police department in the town in which it is located. In case the police department is in a township, checking a scanner directory such as Police Call would show the name of the town where the police department has its HQ. Address your inquiry for a QSL as follows: Chief of Police,



Here's the compact ham shack/listening post of Jack E. McGeorge, N7MWW of Las Vegas, Nevada. Scanning equipment consists of a Realistic PRO-34 and PRO-2005.

Pennsylvania Police Department, Pennsylvania, Iowa 52600. Mail will reach its destination such as a police or fire department without a street address, however, it would be recommended to call your local post office for the zip code.

Paul Loveday of Kasson, Minnesota, says he read here in POP'COMM that the Realistic PRO-2006 would search the cellular bands from 879-894 MHz in the appropriate 30 kHz steps. He went out and bought such a radio, but says he hasn't heard a peep and that he can search only in 5, 12.5 and 50 kHz steps. He wonders what gives. First of all, the PRO-2006 has to be modified to work in the cellular bands. If you are searching other than the band limits mentioned above, you won't hear cellular conversations. Also, when the Realistic PRO-2004, 2005 and 2006 are modified, the radio automatically searches the cellular bands in 30 kHz steps. Unless you make this modification, the sets won't receive cellular bands. To make this modification, check Bill Cheek's *Scanner Modification Handbooks* which offer simple instructions.

Rick Calles of Jackson, Ohio, says he really enjoys Scanning VHF/UHF in POP'COMM. He's a career firefighter-paramedic in Liberty Township near Columbus, Ohio, and he passes along some updates for central Ohio. Columbus fire is scheduled to switch to a 800 MHz trunked radio system

(Continued on page 74)

AEA is the...

Shortwave Solution



The **IsoLoop 10-30 HF antenna** is designed to work in limited space applications — apartments, condos, etc. Don't be deceived by its compact size (43" diameter) — it really works! Features include: Continuous coverage from 10 to 30 MHz; narrow bandwidth to suppress out-of-band signals; comes fully assembled (no mechanical joints); much more.

For complete information on these or any other AEA products, call the toll-free Infoline at (800)432-8873.



Advanced Electronic Applications, Inc.

P.O. Box C2160 Lynnwood, WA 98036
Tech. Support/Sales (206)775-7373
Upgrade Line (206)774-1722
FAX (206)775-2340
CompuServe I.D. 76702,1013

Hayes® Hayes Microcomputer Products.
Hercules™ Hercules Computer Technology, Inc.
Commodore 64 and 128® Commodore Business Machines. Macintosh® Apple Computer Inc. Epson® Seiko Epson Corp.



The **PK-232MBX** is a must for the digital Shortwave Listener. By far the most popular multi-mode controller ever, it can receive seven different types of data signals including Morse code, Baudot, ASCII, TDM (Time Division Multiplex), WEFAX, NAVTEX and Packet. It also features: The indispensable SIAM which automatically identifies many types of digital signals; superior software support for PC compatible, Macintosh and Commodore 64 and 128 computers.



AEA-FAX is simply the best way to demodulate multi-level grey scale fax images received by your general coverage receiver. All necessary hardware and software is included in the package which also features: On-screen tuning "scope"; Autolist feature for unattended image capture and save-to-disk; "Daisy-chain" external RS-232 input allows AEA-FAX to share a COM port with a PK-232MBX or other Hayes-compatible device; up to 16 grey levels (VGA); also supports EGA, CGA and Hercules formats; prints to HP LaserJet or Epson compatible printers.

PICKS UP A WHISPER 50 FEET AWAY!



NEW! High-power
miniature transmitter
on a single chip
assembles in
only 5 minutes!

Simply attach the **VT-75** microtransmitter to any 3V to 12V battery and you can hear every sound in an entire house over 1 mile away! Super-sensitive circuit on a single chip even picks up footsteps from across a large room. Tunable from 80 to 130 MHz. Hear everything on any FM radio or wideband scanner tuned to the "secret" frequency you select. Unlimited uses for security, baby monitor, remote mic, etc. **Not a toy.** The **VT-75** meets many U.S. Gov't Military Specs and with **100mW RF output**, it is the smallest, most powerful miniature transmitter you can buy. Easily assembled even by a youngster in only 5 minutes and performs so well that it is the only miniature transmitter available *anywhere* that comes with a **full unconditional moneyback guarantee!** Dealers welcome. Law Enforcement inquiries invited. **VT-75** microtransmitter chip with miniature microphone, 9V battery connector and instructions - **\$49.98 + \$1.50 S&H** or save - buy 2 for \$45.00 each with free S&H! Call us toll free or send money order, Visa, or Mastercard for immediate shipping by U.S. Mail. COD's add \$4. Personal checks allow 21 days.

DECO INDUSTRIES BOX 607
BEDFORD HILLS, NY 10507
800-759-5553

The leader in wireless design since 1976

CIRCLE 177 ON READER SERVICE CARD

DON'T MISS ANY ACTION!

FM WIRELESS SPEAKER RELAY: Listen to your base scanner or SW receiver on any FM radio up to 1/10 mile away! Plug-in hookup. Enjoy portability with base performance! Complete kit w/attractive case, telescoping antenna: \$28.95. 75% assembled kit: \$37.95.



The **ACTION TAPE CONTROLLER** connects your scanner to your cassette recorder, activating it only while your scanner is picking up some action. Plugs into scanner speaker jack. Great for condensing an entire night's scanning into minutes or for catching rare action on FBI, DEA, SWAT, Customs and other such frequencies. Assembled/tested: \$29.95.

Worldcom Technology, P.O. Box 3364
Ft. Pierce, FL 34948 (407) 466-4640

WR-3 WHISTLER RECEIVER

*** BROADBAND 0.1-10 KHz VLF ***

Receives "Natural Radio" emissions such as:
- LIGHTNING SPERICS - TWEEKS - WHISTLERS
- DAWN CHORUS - TRIGGERED EMISSIONS
- AND OTHER NATURALLY OCCURRING RADIO PHENOMENA

The WR-3 comes with detachable 33-inch telescoping whip antenna and is powered by a 9 volt battery. Uses stereo "Walkman" headphones (not included). 5 page listening guide to Earth's Natural Radio Emissions.

\$48 ppd

(CA RES. ADDTAX)

CONVERSION RESEARCH
P.O. BOX 535
DESCANSO, CA 91916

CABLE TV CONVERTERS

Why Pay A High Monthly Fee? Save \$100's A Year

- All Jerrold, Oak, Hamlin, Zenith, Scientific Atlanta, and more.
- 60 Day Money Back Guarantee
- Shipment within 24 hours
- Visa/MC and C.O.D.

WE WILL BEAT ANYONE'S PRICE

No Illinois Orders Accepted

Purchaser agrees to comply with all state and federal laws regarding private ownership of cable TV equipment. Consult local cable operator

Electronic Engineering

P.O. Box 337, Barrington, IL 60011

Free catalog 1-800-542-9425 Information 1-708-540-1106

212-925-7000

SHORTWAVE RECEIVERS, HAM RADIOS, BOOKS, ANTENNAS, SCANNERS, Business Radios. ICOM, YAESU, KENWOOD, SONY, PANASONIC, MOTOROLA.

... our 40th Year ... Worldwide shipping.
Sales ... Service. Large Showroom. Open 7 days.

Barry Electronics Corp.
You're one source for all Radio Equipment!

Fax 212-925-7001

512 Broadway, NYC, NY 10012

CIRCLE 176 ON READER SERVICE CARD

Scanning VHF/UHF

(from page 72)

within a year and all dispatches will be simulcast on 154.310 MHz for a three-year period. When the switch to 800 MHz occurs, the 154.340 and 154.400 MHz fire-ground channels will go off the air. Meanwhile, Liberty Township's new fire repeater on 154.415 MHz should be operational by the end of this year, with all radio traffic on the 33.86 MHz "county band" to cease when the new system is up and running. New mobile extenders (to low-band radios) on 154.385 MHz will be added for mutual aid communications.

Meanwhile, Rick adds, Delaware County in Ohio is installing a "high-profile" repeater system for volunteer departments. A tentative frequency, 154.190 MHz, has been assigned. Many departments will continue to use 33.86 MHz (dispatch) and 33.82 MHz (fireground) until the new equipment is purchased and installed. Perry Township (northwest Columbus and the city of Dublin) was to leave 33.80 MHz and erect a repeater on 154.205 MHz this past fall. Some other updates in Delaware County, Ohio: The City of Powell is using 155.100 MHz; Liberty Township park rangers and road crews are using 154.995 MHz; Concord

Emergency

(from page 43)

ripple, which is important to keep noise out of your radio equipment when the sets are turned on, and the charger is doing its thing.

Some of the best switching chargers have dual output regulation which allows the unit to sense the output voltage level, and as the battery tries to draw more power than the charger can provide, the charger switches to the constant current mode allowing the voltage output to drop to a predetermined level. As the battery charges, its power requirements diminish, allowing the voltage to rise. When the battery voltage reaches the "predetermined" level, charger operation switches to a constant voltage mode, and current tapers off.

Best of all, for your command post, the switchers run relatively cool. However, they must have good ventilation and must never be mounted near any ignition source, such as fumes from a gas tank. They must be well-bonded to the frame of the vehicle to reduce RFI. On rare occasions, you may find a switching charger that might produce a wandering heterodyne that might get into some of your radio equipment. The charger could ultimately be modified so the errant heterodyne is no longer within the bandpass of your particular radio receiver.

All in all, look to the new switchers as the latest technology in battery chargers as well as AC to DC voltage converters. ■

Township road crews are using 151.085 MHz.

Jay Eger, WB2ZHP, from Sandy Lake, Pennsylvania, faxed some frequencies on Pittsburgh. Public safety administration in the city uses 453.950 MHz. Meanwhile there are six police zones, with dispatch broken up as follows: Zones 1-2, north side, Hill District, downtown - 453.100; Zones 3-4, south side, Mount Washington - 453.250; Zones 5-6, East Liberty, Squirrel Hill - 453.550; citywide dispatch and responding units are switched to 453.850 for fireground and fire command communications. Pittsburgh's 160 paramedics operate medic command on 462.950 and medic tactical on 462.975. River rescue and heavy rescue also operate on the medic channels. Some additional frequencies of interest for Pittsburgh are: 155.235, Allegheny General Hospital Life Flight helicopter; 170.150, WPXI-TV news; 166.250, KDKA-TV news; 161.670, WTAE-TV news.

What are you hearing on your scanners? Do you have a question about the hobby, but don't know who to ask? Send your comments, questions, frequency lists and updates, as well as photos of monitoring stations, antenna farms, dispatch points, etc., to: Chuck Gysi, N2DUP, Scanning VHF/UHF, Popular Communications, 76 North Broadway, Hicksville, NY 11801-2909. ■

You Should Know

(from page 38)

ers of 5 kW or less) on these frequencies. It is also felt the existing AM broadcasters suffering from heavy interference will be given first crack at these new channels (although, contrary to what you might have read in another publication, there have been no firm decisions yet by the FCC on which stations will be allowed to move to this new range.)

This expansion offers two distinct DX opportunities. When the first stations begin operations in this segment, frequencies will be relatively clear and some remarkable receptions will be possible until the band becomes more heavily used. Prior to the official opening on the new band, there will be equipment tests by the new station and facilities. Some testing of this sort is already going on. For example, several DX'ers last year managed to snag KZ2XXB, operated by the National Association of Broadcasters from Beltsville, MD, on 1660 kHz. This station is used to test antenna systems for the new range, and other experimental stations will doubtlessly be authorized for this range in the years ahead.

When the AM band expands, the chirpers, pirates, beacons and other stations will be cleared out. The 1600 to 1800 kHz range will sound very different in a few years compared to what it sounds like today. The DX you hear today in that range will one day be the subject of an article by Alice Brannigan!

"The Largest Dealer of Scanners in the World"

SCANNER WORLD, USA®

10 New Scotland Ave., Albany, NY 12208 • 518/436-9606

Scanner World, USA

SCANNER WORLD EXCLUSIVE UNIDEN BEARCAT BC205XLT

\$259.99 (\$7.00 shipping)

Digital programmable 200 channel hand held scanner with raised button keyboard for easy programming of the following frequency ranges: 29-54 MHz, 118-174 MHz, 406-512 MHz, 806-956 MHz. * Features include: Scan delay, memory backup, key pad lock, sidelit liquid crystal display, channel lockout, 10 twenty channel banks, direct channel access, automatic search, full one year factory warranty, 10 priority channels, Ni-Cad battery pack, AC adapter/charger, flexible rubber antenna carry case are all included. Size is 2-11/16" Wx1-3/8" Dx7-1/2" high. (Optional extended 2 yr. warranty \$29.99, 3 yr. extended warranty \$39.99.) (* Excludes Cellular)
#CC-008 Heavy Duty Leather Carry Case \$27.99

RELM RH-256NB HIGH BAND TWO-WAY RADIO

SPECIAL PACKAGE DEAL \$339.99

(Plus \$9.00 Shipping Each)
16 channel digital readout two-way radio. Covers high band frequency range of 148-162 MHz without retuning. Perfect two-way radio for ambulance, police, fire, tow trucks, taxis, commercial companies who use this band. Features include CTCSS tones built-in, priority, 25 watts output, channel scanning, back lighted keyboard, message light, time out timer, scan delay, external speaker jack. Size is 2 3/4" Hx6 1/2" Wx10 3/4" D.
SPECIAL PACKAGE DEAL includes RH-256NB, mobile microphone, 1/4 wave body mount antenna, mobile mounting bracket and mobile power cord all for the low price of \$339.99

SPECIAL!! LOWEST PRICE EVER FOR A PROGRAMMABLE SCANNER

Cobra

SR-901
AVAILABLE ONLY FROM SCANNER WORLD



ONLY! \$74.99 Each
(Plus \$6.00 Shipping Each)
\$69.99 (2 or more)

Features include: 10 programmable channels, one touch memory programming, external speaker jack, 29-54 MHz, 136-174 MHz, 400-512 MHz, squelch, lockout, full frequency digital readout, AC or DC operation, retains memory up to 3 days without power, scan button, includes AC adapter, telescopic antenna, and complete operating instructions. Size: 7 1/4" W x 2" H x 7 1/4" D. One year factory warranty. (Optional mobile cigarette lighter cord #901MPC \$4.99).

REGENCY R-4010

\$106.99

(\$7.00 shipping each)

10 channel hand-held scanner (Same Scanner as Bearcat 55XL1), 29-54 MHz, 136-174 MHz, 406-512 MHz, digital programmable, keyboard lock switch, lockout, includes rubber flex antenna. (Optional accessory 5W-41, only \$19.99 includes rechargeable Ni-Cad batteries, AC adapter/charger and cigarette lighter cord.)



★ SCANNER WORLD HAS BEEN SELLING SCANNERS FOR OVER 21 YEARS

★ ALL MERCHANDISE NEW, IN FACTORY SEALED CARTONS

RAVIO SCANNERS

BEARCAT BC55XLT	119.99	(7.00)
BEARCAT BC70XLT	129.99	(7.00)
BEARCAT BC100XLT	Call For Price	
BEARCAT BC140	94.99	(7.00)
BEARCAT BC142XL	94.99	(7.00)
BEARCAT BC147XL	99.99	(7.00)
BEARCAT BC172XL	139.99	(7.00)
BEARCAT BC177XL	139.99	(7.00)
BEARCAT BC200XLT	269.99	(7.00)
BEARCAT BC205XLT	259.99	(7.00)
BEARCAT BC210XLT	Call For Price	
BEARCAT BC310A	85.99	(7.00)
BEARCAT BC330A	109.99	(7.00)
BEARCAT BC400XLT	99.99	(7.00)
BEARCAT BC560XLT	109.99	(7.00)
BEARCAT BC600XLT	199.99	(7.00)
BEARCAT BC760XLT	269.99	(7.00)
BEARCAT BC800XLT	249.99	(7.00)
BEARCAT BC855XLT	199.99	(7.00)
BEARCAT BC950XLT	249.99	(7.00)
REGENCY R3020	96.99	(7.00)
COBRA SR901	74.99	(6.00)
REGENCY R4010	106.99	(7.00)

MIDLAND CB Radios	In Stock
COBRA CB Radios	In Stock
UNIDEN CB Radios	In Stock
Two-Way Radio Batteries	In Stock
Scanner Antennas	In Stock
Power Supplies	In Stock

RELM RH606B	414.99	(9.00)
RELM UC202 (2 or more)	129.99	(6.00)

SCANNER ACCESSORIES

BCAD70	14.99	BP55	16.99
BCAD100	14.99	MA917	24.99
BCAD140	14.99	MA518	14.99
BCAD 580	16.99	MA501	14.99
BC003	7.99	ESP25	16.99
BC002	59.99	GRE8002	79.99
PS001	12.99	GRE-HH	54.99
UA502A	12.99	GRE9001	89.99
BP205/200	34.99	GRE 3001	62.99
BP70	16.99	FBE	4.00
VC001	12.99	FBW	4.00
BP4	24.99		

BOOKS

Covert Intelligence	8.95
Air Scan Directory	14.99
Betty Bearcat	4.00
Top Secret (7th)	15.99
Covert Techniques	9.95
Tomcat's Big CB	13.95
World Radio	18.99
Survival Directory	6.95
Rail Scan	7.95
Police Call	7.49
Scanner Modification	17.99

UNIDEN BEARCAT BC-400XLT

\$99.99
(\$7.00 shipping)

Our best selling mobile scanner, 16 channel, AC DC cord, programmable, digital, AC/DC cords, telescopic antenna, mobile mounting bracket, weather search, priority, 29-54 MHz, 136-174 MHz, 406-512 MHz, external speaker and antenna jack



BEARCAT BC-100XLT

100 Channel Digital Programmable Hand-Held Scanner

\$189.99

(\$7.00 shipping)

Our best price ever on a full featured complete package hand-held scanner. Manufactured by Uniden. Features include 11 bands of weather, aircraft, public service, trains, marine, plus more (29-54 MHz, 118-174 MHz, 406-512 MHz), 10 channel banks, 10 priority channels, lighted LCD display, earphone jack, channel lockout, AC/DC operation, scans 15 channels per second, track tuning. Special package deal includes following accessories: AC adapter/charger, rechargeable Ni-Cad battery pack, flexible rubber antenna, carry case.

SANGEAN ATS-803A

SHORT WAVE RECEIVER

\$168.99

(\$7.00 shipping)



AM/FM/LW and 12 shortwave bands plus FM stereo, BFO for SSB reception, clock radio. Includes AC adapter, telescopic antenna, stereo headphones, and shoulder strap.

—SHORT WAVE WORLD BAND RECEIVERS AVAILABLE—

Sangean ATS-800	\$109.99	(7.00)
Grundig Yacht Boy 220	106.99	(5.00)
Grundig Cosmopolit	198.99	(7.00)
Grundig Yacht Boy 230	149.99	(5.00)
World Radio & TV Handbook (1991)	18.99	(*)

Regency R3020

\$96.99 (\$7.00 Shipping)



20 channel digital programmable scanner, frequency coverage 29-54 MHz, 108-136 MHz aircraft, 136-174 MHz, 406-512 MHz. Features: weather key, search, lockout, priority, squelch, AC only, delay button. Size 9 1/2" x 2 3/8" x 7".

(Limited Quantity of R3020 Available)

UNIDEN BEARCAT BC-950 XLT



\$249.99 (\$7.00 shipping)

Digital Programmable 100 Channel Scanner

BC-950 XLT covers the following frequencies: 29-54 MHz, 118-174 MHz, 406-512 MHz, 806-954 MHz (excludes cellular). Features compact size of 6-5/16" Wx1-5/8" Hx7-3/8", scan delay, priority, memory backup, channel lockout, bank scanning, key lock, AC/DC power cords, telescopic antenna, mounting bracket supplied, one year factory warranty, search, direct channel access, track tuning, service search including preprogrammed frequencies by pushing a single button for police fire/emergency, aircraft, weather, and marine services plus exclusive optional features never available on any scanner before. First is an RF receive amplifier for boosting weak signals for only \$34.99 plus a CTCSS tone board is available for only \$59.99 to make this the number one scanner available in the USA. Optional cigarette lighter plug #950 MPC \$4.99.

BEARCAT 70XLT 20 CHANNEL DIGITAL HAND-HELD SCANNER

\$139.99

(SPECIAL PACKAGE DEAL ONLY) (\$7.00 Shipping)

Small size 6" Hx1"Dx2 3/4" W. Full digital readout, priority, search, channel lockout, scan delay, key lock. Covers following frequencies: 29-54 MHz, 136-174 MHz, 406-512 MHz. Package includes rubber antenna, rechargeable Ni-Cad battery pack, AC adapter/charger and vinyl carry-case.

Optional Cigarette Lighter Cord #UA502 \$12.99
Heavy-Duty Leather Carry Case #CC002 \$22.99

BEARCAT BC-147XLT 16 CHANNEL BASE SCANNER

\$99.99 (\$7.00 Shipping)

Programmable, digital, AC/DC operation. Frequency coverage 29-54 MHz, 136-174 MHz, 406-512 MHz. Weather button, priority, lockout button, squelch includes AC adapter, telescopic antenna.

GM-1A GLASS MOUNT SCANNER ANTENNA

—ONLY AVAILABLE FROM SCANNER WORLD—

Frequency coverage 25-1200 MHz — only 22 inches tall. NEW REVISED DESIGN — no holes to drill — no glue needed. Complete with 17 foot cable, Motorola connector, and mounting hardware. Swivels to vertical position — performance unaffected by moisture on the window. Made in USA.

SPECIAL \$39.99
(\$3.50 Shipping Each)

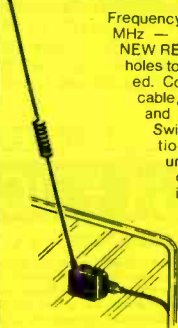

ORDERING INFORMATION: Call (518) 436-9606 to place orders or mail orders to Scanner World, USA®, 10 New Scotland Ave., Albany, N.Y. 12208. Orders will be shipped within 24 hours by United Parcel Service if order is accompanied by MasterCard, Visa, cashier's check, money order, COD (COD shipped by United Parcel Service will be cash or money order only). (If a COD package is refused, customer will be billed for shipping and COD charges.) Mail orders with personal or business checks enclosed will be held 4 weeks for bank clearance. Prices, specifications, and terms subject to change without prior notice. If items are out of stock we will backorder and notify you of delivery date. All shipments are F.O.B. Scanner World® warehouse in Albany, N.Y. We are not responsible for typographical errors. All merchandise carries full manufacturer's warranty. Bid proposals and purchase orders accepted from government agencies only. Free full line catalog mailed 4 times per year. Merchandise delivered in New York State add 7% sales tax. No returns accepted after 7 days of merchandise receipt. * Add (\$) per item, and \$3.00* for all accessories ordered at same time. COD orders will be charged an additional \$4.00 per package. Full insurance is included in shipping charges. All orders are shipped by United Parcel Service to street address only. (No P.O. Box). Shipping charges are for continental USA only. All others ask for quote on shipping charge.

COMMUNICATIONS SHOP

HAND-HELD SCANNERS!

MetroWest is your source for:

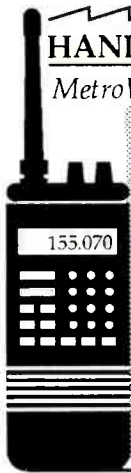

Bearcat Hand-Helds
Double-Life Battery Packs
Drop-In Chargers
Specialty Antennas
Books
and more

Send for our free catalog

MetroWest, Inc.
822 N. Spring
LaGrange Park, IL 60525
(708) 354-2124



CIRCLE 11 ON READER SERVICE CARD

SHORTWAVE LISTENERS

Create customized listening schedules
on any IBM-compatible PC using:

PC SHORTWAVE MONITOR™

Printouts by COUNTRY - or by any combination of
LANGUAGE, PROGRAM, and BC DIRECTION codes.
\$19.95 + 2.50 S/H - or DEMO \$3.50
Please specify 5-1/4 or 3-1/2 disk format.

S. Gitlin 86-29 155th Ave., Ste. 5N
(718) 738-8943 Howard Beach, NY 11414

CIRCLE 133 ON READER SERVICE CARD

CB RADIO OWNERS!

We specialize in a wide variety of technical
information, parts and services for CB
radios. 10-Meter and FM conversion kits,
repair books, plans, high-performance
accessories. Thousands of satisfied
customers since 1976! Catalog \$2.

CBC INTERNATIONAL

P.O. BOX 31500PC, PHOENIX, AZ 85046

CB TRICKS OF THE TRADE I & II

Tricks I and Tricks II, plus a free set of
plans for CB Super Modulation.

Special: \$40.00

Order each book separately for \$19.95

C.O.D. Orders Accepted

Medicine Man CB
P.O. Box 37
Clarksville, AR 72830
(501) 754-2076



CIRCLE 81 ON READER SERVICE CARD

SATELLITE TV

SATELLITE TV BUYING GUIDE
NAME BRANDS AT 50% DISCOUNT
This FREE 24 page Consumer Buying
Guide tells all about Satellite TV and
lists guaranteed lowest prices.

Samman Inc.
6310 N University No 3798 - Peoria, IL 61612

1-800-472-8626

AMIGA & ICOM

create the Ultimate Scanning Combination!

The ONLY system that can directly generate speech! The Amiga may directly control a
tape recorder. Over 1000 channels per file. By channel control lockout, mode, tone,
frequency, say the time, say the frequency, even say the users comment! Range scan
may generate custom scan files. Automatic time and date stamping of hits. Auto lockout
mode. Scan by comment (ie infinite banks) High resolution graphics show all hit activity
Scans at over 1300 channels per minute on ANY speed Amiga. Generates ASCII scan
files. Programmable delays fix all of Icom's scan delay problems. Built in mouse driven
editor for all channel information. No radio modifications required, does not need Icom's
CI-V or speech options. Includes the custom hardware interface for the radio and
cassette player, software, manual, example scan files and shipping in the U.S.

R7000 or R71A (needs UIC-14) \$149 (check / money order / VISA / M-C)
or Multi-radio (\$199) Future Scanning Systems Manual + Demo Disk
Ph. 918-333-7474 PO BOX 654 Bartlesville, OK 74005 \$15

Advertising Rates: POP/COMM subscribers are entitled to one FREE 30-word, non-commercial classified ad per year. Enclose subscription name label with ad copy. For those people not in the previously mentioned group, non-commercial ads are 30 cents per word, including abbreviations and addresses; minimum charge \$6.00 per issue. Ads from firms offering commercial products or services are \$1.00 per word; minimum charge \$20.00 per issue. Boldface words are \$1.20 each (specify which words). Leading key words set in all caps at no additional charge. All ads must be prepaid in full at time of insertion; a 5% discount is offered for prepaid 6 time insertions. All ads must be typewritten double spaced.

Approval: All ad copy is subject to Publisher's approval and may be modified to eliminate references to equipment and practices which are either illegal or otherwise not within the spirit or coverage scope of the magazine.

Closing Date: The 10th day in the third month preceding date of publication. Because the advertisers and equipment contained in Communications Shop have not been investigated, the Publisher of Popular Communications cannot vouch for the merchandise listed therein. Direct all correspondence and ad copy to: PC Communications Shop, 76 N. Broadway, Hicksville, NY 11801.

TOMCAT'S BIG CB HANDBOOK, by Tom Kneitel. Just published. 221 large pages, fully illustrated. Complete guide to world wide AM, SSB, Freeband, 27 MHz operations. Everything they never told you (legal & otherwise) from world's leading CB authority. Only \$13.95 (plus \$3.50 postage to North America) from CRB Research Books, Inc., P.O. Box 56, Commack, NY 11725. (NYS residents add \$1.40 sales tax). Dealer inquiries invited.

TUNE In On Telephone Calls. Tom Kneitel's new 160-page book. Everything you need to know to effectively use a scanner and communications receiver to eavesdrop on private telephone calls from homes, offices, cars, ships, aircraft, trains. Explanatory text, photos, extensive listings section covers USA/Canada on HF, VHF, UHF, and above, thousands of locations, frequency assignments. Explains equipment, best techniques, laws regarding monitoring cellular, cordless, ship/shore, high seas, Air Force 1, airliners, 1-way paging, more. Only \$12.95 (plus \$3.50 postage to USA/Canada/APO/FPO) from CRB Research, Box 56, Commack, NY 11725. NY residents add \$1.32 sales tax. Dealer inquiries invited.

WOW! UNDERSTANDING & REPAIRING CB RADIOS by Lou Franklin. Giant 380-page technical book picks up where THE "SCREWDRIVER EXPERTS" GUIDE leaves off. Includes circuit descriptions and troubleshooting guide for virtually all CB radios: 23 and 40-channel, crystal and PLL, solid-state and tube, AM, FM, SSB, CW, American, British and export models. Covers test equipment, transistor basics, synthesizers, receivers, transmitters, power supplies, T/R switching, antennas, interference, parts and accessory sources. Over 350 illustrations plus huge subject index. Moneyback Guarantee! Only \$29.95 plus \$3.50 U.S. & Canadian Air Mail, VISA/MC accepted. Free catalog of unique CB books, plans, and modification kits with order. Catalog only, \$2. CBC INTERNATIONAL INC., BOX 31500PC, Phoenix, AZ 85046. Thousands of satisfied customers since 1976.

RADIO MONITORS NEWSLETTER OF MARYLAND FOR THE SERIOUS SHORTWAVE AND SCANNER LISTENERS. PO Box 394, Hampstead, MD 21074. For a one year subscription: \$15.00. Sample copy: one dollar.

Radio Newyork International! Listen for us every Sunday night at 9 pm (Eastern), 8 pm (Central), 6 pm (Pacific) over WWCR, 7435 kHz. All of your favorites: Al Weiner, Steve Cole, Pirate Joe, John P. Lightning, & more! Live call-in at 1-(800)-736-9764. QSL's (send SASE) from RNI, 14 Prospect Ave., Yonkers, NY 10705. Spend your Sunday nights with RNI!

SCANNER MODIFICATION HANDBOOK VOL. 1 by Bill Cheek ("Doctor Rigormortis"). New 160-page book. More than 20 performance improvement modifications. Simple step-by-step instructions, many photos. Primarily PRO-2004 & PRO-2005, some for PRO-34, BC-200/205XLT, BC-705XLT, BC-705XLT. Restore blocked out bands, speed up scanning rate, disable "beep," increase number of channels, improve squelch action, add an S-meter, interface with shortwave receivers, etc. Make the PRO-2004 & 2005 into a 6,400 channel scanner; put 3,200 channels into the PRO-34! Plus: cellular frequency charts, antenna info & mods, inside info on frequency management, operating hints, emergency power supplies, scanners & the law, lots more! Only \$17.95, plus \$3.50 shipping to addresses in USA/Canada. Residents of NY State add \$1.72 tax. **Big 220 page VOL. 2** with 18 more mods for PRO-2004/5/6, PRO-34, PRO-2022, BC-760/950XL, BC-200/205XL, now available. \$17.95 plus \$3.50 shipping. NY state residents include \$1.72 tax. If both books ordered at the same time, send only \$4.50 shipping. Order from CRB Research Books, Inc., P.O. Box 56, Commack, NY 11725.

THE NEW YORK MONITOR NEWSLETTER—a monthly Newsletter that provides CB'ers with the latest up-to-the-minute Technical information—Radio Repair and Modification—Phase Lock Loop (PLL) Circuit/Expander—2 YEAR COURSE IN ELECTRONIC COMMUNICATION and much much more!! \$24 per year mail to LORD/WYATT COMMUNICATIONS, P.O. Box 030128PCD, Brooklyn, NY 11203-0001.

CW? NO PROBLEM. You can increase your speed, no matter how many times you've failed before. Results guaranteed when you follow the instructions. PASS Publishing's **CW Mental-Block Buster** program helps you **explode mental blocks** that hold you back. Based on 40 years of research, the **CW Mental-Block Buster** uses guided meditation, dynamic visualizations, and powerful affirmations to blast through mental blocks. **You can do code!** That means new bands, more contacts, more fun! (This is not a CW practice tape.) The **CW Mental-Block Buster** audio cassette and practice booklet are only \$24.95 ppd. in the US (NY residents add \$1.87 sales tax). (Quantity discounts available for classes.) PASS Publishing, P.O. Box 570, Stony Brook, NY 11780.

MORSE code got you down? Why let a mental block stand between you and upgrading? Use PASS Publishing's **CW Mental-Block Buster** to blast through those barriers. Just follow the instructions for 30 days—Results Guaranteed! Based on 40 years of research, the **CW Mental-Block Buster** uses guided meditation, dynamic visualizations, and powerful affirmations to blast through mental blocks. **You can do code!** That means new bands, more contacts, more fun! (This is not a CW practice tape.) The **CW Mental-Block Buster** audio cassette and practice booklet are only \$24.95 ppd. in the US (NY residents add \$1.87 sales tax). (Quantity discounts available for classes.) PASS Publishing, P.O. Box 570, Stony Brook, NY 11780.

SURVEILLANCE-COUNTERMEASURES! Transmitters, detectors, phone security, night vision, stunguns, secret devices, restricted books, **MORE! GUARANTEED LOWEST PRICES! HUGE CATALOG \$5.00 (REFUNDABLE)** Protector, P.O. Box 520294-D, Salt Lake City, UT 84152.

CW Lite is the **easiest** Morse code training method in the world, bar none! And it is the **fastest**, too. Just close your eyes and relax. This powerful **hypnosis cassette tape** does the rest. **Subliminals** speed you along! Only \$14.95 ppd in US (NY residents add \$1.12 tax). Order today! **PASS Publishing**, Box 570, Stony Brook, NY 11780.

MAKE BIG \$\$\$! Become an American Electronics Dealer! Great profit opportunities for new businesses since 1965. Call Todd Parker, 1-800-872-1373.

225-400 MC RECEIVERS Tunable, Government Reconditioned. Satcom Antennas 240-270 MC Military Helical Type. New (419) 726-2249.

WORLD'S MOST UNUSUAL Communications Books! A large selection of outstanding titles covering scanners, "confidential" frequency registries, bugging, wire tapping, electronic surveillance, covert communications, computers, espionage, monitoring, and more! New titles being added constantly! Ask for our big FREE catalog CRB Research, Box 56-PC, Commack, NY 11725.

SATELLITE and cable descrambling. Build your own descramblers. Surveillance and countermeasures. Build your own transmitters, detectors. How to modify your scanner. Eavesdrop for fun manual. Send stamp for free catalog to: Communications Engineering, 76 Boulevard, Hudson Falls, NY 12839.

BIG AIR-SCAN 5TH EDITION by Tom Kneitel. Complete guide to aero comms. Now in gigantic 192-page large-size format containing 60,000 + listings, including 2-30 MHz HF, 118 to 174 MHz VHF, 406 to 512 MHz UHF, and 800 MHz listings. Covers civil, military, private, and unlisted landing areas, heliports, and seaplane bases. Control towers, ground, approach/departure, FSS, unicom, multicom, crop dusters, air-ambulances, federal ops, traffic 'copters, aviation business, airline enroute, airport security/fire, etc. throughout USA. All Canadian mil, civilian airports and seaplane bases listed, plus lots more, including how-to text on aero monitoring. Most comprehensive aero frequency guide ever compiled. Only \$14.95 + \$3.50 postage to USA/Canada/APO/EPO. NY State residents add \$1.48 sales tax. From: CRB Research Books, Inc., P.O. Box 56, Commack, NY 11725, or ask your favorite communications dealer.

COMMODORE 64 HAM PROGRAMS—8 disk sides over 200 Ham programs—\$16.95. 29¢ stamp gets unusual software catalog of Utilities, Games, Adult and British Disks. Home-Spun Software, Box 1064-PC, Estero, FL 33928.

MTC-101 Microphone Test Center—repair and test any CB microphone only \$64.95 S/H included—send to **LORD/WYATT COMMUNICATIONS**, 30 East 54 Street, Brooklyn, NY 11203. (718) 493-3778 7 PM-10 PM EST \$15.00.

BIG 7th Edition: Top Secret Registry of Government Radio Frequencies, by Tom Kneitel. Grown to gigantic 240-pages! 1000's of new listings, frequencies, stations for all scanner owners, nationwide. Includes: FBI, DEA, Customs, Secret Service, FCC, Immigration, Border Patrol, U.S. Attorney, ATF, Treasury, Fed Prisons, U.S. Marshal, CIA, Postal Service, NSA, NORAD, USAF, USN, Army, USMC, FAA, NASA, DOE, NRC, FEMA, Dept. Agriculture, National Parks, USCG, EPA, DOT, V.A., UHF aero (225 to 400 MHz) listings, bugs & surveillance freqs, agents' lingo, codes, many more agencies, lots more info! Expanded Canadian listings. Only \$19.95, plus \$3.50 postage to N American addresses. NY State residents add \$1.88 sales tax. Order now from CRB Research Books, P.O. Box 56, Commack, NY 11725. Dealer Inquiries Invited.

CANADIAN'S Discounted prices on Uniden Scanner's, CB's Cordless and Cellular Phones and Accessories. Send for FREE listing or request quotation. Cellular Communications, 83 Galaxy Blvd, #39 Rexdale, ONT M9W 5X6.

COMMUNICATION AT ITS BEST. AR1000XC, \$399, AR2800 \$419, AR-3000 \$895, BC200XLT \$269. We also sell a variety of CBs, Radar Detectors, Phones, Ans. Machines and Accessories. **FREE SHIPPING V/MC Turbo Electronics**, PO Box 8034, Hicksville, NY 11802. Questions Welcome. (516) 938-1946. To order call 1-800-337TURBO.

IT'S HERE! SHORTWAVE LISTENING GUIDEBOOK by PopComm columnist Harry Helms! Over 320 pages on receivers, antennas, propagation, types of stations, QSLs, and more! Tells when, where, and how to listen to international broadcasters, utilities, hams, AM and FM DX, and more! PopComm called it "a hip, concise, astute, accurate, and honest guide to what's going on and how to get the most enjoyment from a receiver... very highly recommended!" Available from CRB Research, Universal Shortwave, and EEB, or send \$19.95 (CA residents add sales tax) to HighText Publications, 7128 Miramar #15, San Diego, CA 92121. Satisfaction guaranteed!

"TOP SECRET" INFORMATION! The Underground Frequency Guide by PopComm columnist Harry Helms gives over 500 active frequencies for numbers stations, smugglers, guerrilla forces, embassies, and more! Plus details you won't find anywhere else, like actual locations of numbers stations! Available from CRB Research, Universal Shortwave, and EEB, or send \$13.95 (CA residents add sales tax) to HighText Publications, 7128 Miramar #15, San Diego, CA 92121. Moneyback guarantee!

R.S. DEALER. Lowest prices nationwide on all R.S. and Sangean equipment. PRO 2006 and DX440. COTRONICS, 2200 SE, FEDERAL HIGHWAY, STUART, FL 34994. Call 1-800-848-3004. Orders only.

SANGEAN DISTRIBUTOR. We carry all Sangean products. Call for lowest prices nationwide. 1-800-848-3004. COTRONICS Inc., 2200 SE, Federal Highway, Stuart, FL 34994.

DEALERS WANTED. Start your own electronics business. Call COTRONICS Inc., 1-800-848-3004, 2200 SE Federal Highway, Stuart, FL 34994.

PAY TV AND SATELLITE DESCRAMBLING 1991 EDITION IS OUR BIGGEST AND BEST EVER VOLUME OF DESCRAMBLING CIRCUITS, TURNS-ONS AND BYPASSES FOR CABLE, WIRELESS AND SATELLITE TV. ONLY \$14.95. OTHER EDITIONS OF THE PAY TV SERIES ARE ALSO AVAILABLE. **VOLUME 1 (THE BASICS OF ALL SYSTEMS)** \$14.95. **BUILD SATELLITE SYSTEMS UNDER \$600** \$12.95. **WIRELESS CABLE HANDBOOK** \$9.95. ANY 3/\$29.95 OR 5/\$44.95. **SCRAMBLING NEWS MONTHLY** HAS THE LATEST INFORMATION ON THE "PLAIN VANILLA" DESCRAMBLERS WHICH EMULATE B-MAC, VCII PLUS AND ORION. PLUS THE LATEST NEWS, CIRCUITS ETC. \$19.95/YR. SAMPLE \$3. ALL NEW CATALOG \$1. C.O.D.'S ARE OK (716) 874-2088.

ICOM RECEIVERS new in box R-71A - \$550.00. R-7000 - \$6750.00. W.R. Stansbury, VP, Northwest Georgia Bank, PO Box 5377, Ft. Oglethorpe, GA 30742. 404-365-3337/404-861-3012.

SCANNER/HAM RADIO MODIFICATION HANDBOOKS; FREQUENCY DIRECTORIES - UNIDEN, AERONAUTICAL, GOVERNMENT, MILITARY books by CRB, TAB, GROVE, ARRL; others GRE products. Phone orders. VISA/MC. CATALOG \$1.00 (refundable) **DOYLE COMMUNICATIONS-DPC, Route 8, Box 18, Lake Pleasant, NY 12108. (518) 548-5515.**

JEHOVAH'S WITNESSES: Amateurs, SWLs, please send full details, telephone number to: Bob Ellis, Post Office Box 7349, Winter Haven, FL 33883-7349.

NEW RADIO BUFFS SPECIAL. ALINCO MONTH IS EVERY MONTH AT RADIO BUFFS. CALL FOR ALINCO QUOTES! ALSO BEST PRICE ON ALL TEN-TEC, JRC, AMERITRON, MFJ, B&W, BENCHER, AOR, KLM/MIRAGE, COMET, BUG CATCHER, SPI-RO, HAM STICK, AMECO, SANGAN, DAIWA, OUTBACKER, ASTRON, RAMSEY KITS, ARRL PUBLICATIONS, GEOCHRON CLOCKS, PALOMAR. WE STOCK A COMPLETE LINE OF AMATEUR, SWL, AND MARINE RADIO EQUIPMENT AND SUPPLIES. ORDERS ONLY 1-800-828-6433.

WANTED: Gonset G-12 Citizen Band Radio with mounting bracket. Not modified. Good shape. Write to: D.G., 3065 Reen Dr., Toledo, OH 43613.

FOR SALE: 12 CB mobile radios in working order. \$300 for all. R. Larison, RR#1 Box 103, Orleans, NE 68966 (308) 652-2771.

ACTIVE list covering Northeastern New York & central Vermont. Send \$5.00 + \$1.50 postage to: Reginald Clark, 36 Mt. Defiance, Ticonderoga, NY 12883.

SHINWA SR 001, wide band, 25-1000 MHz. 200 ch. Remote included. 10 banks \$325 - MINT. AR-2500, 1-1500 MHz. wide band, 2016 ch. 64 banks. \$300 - MINT. (401) 568-2152. AFTER 5 P.M.

WANTED older quality, tube type general coverage receiver for a beginner. Bob Forman, W9RJH, Box 50, Monmouth, IL 61462.

WANTED: Info on a Regency two-way radio low band. Model Micro-Comm L64A. Lafayette Telsat 924, 23 ch CB, schematic, operating info, etc. Will pay copy and postage, please advise. N. Nicastro, Jr., 18 New York Ave., Spotswood, NJ 08884.

UNIVERSAL M-900 - \$375.00. GRUNDIG Satellit 500 500 - \$425.00. Both in mint condition, barely used. Call Paul at (303) 367-0432.

SONY ICF-2010 very good condition - \$230. Send money order to David VanDensen, 888 E. Shady Lane Lot 241, Neenah, WI 54956, or call (414) 734-2437.

WANTED Service/Technical Manual for a Tandy 3000HD computer and/or "what chip is in position U49?" Mike Nelson, 8 David Dr., Montville, NJ 07045.

MID-CANADA'S LEADING DISTRIBUTOR of CB's, scanners, export gear and more. Uniden, Cobra, AOR, Wilson. Discounted prices. International orders welcome. **COMMTELCO ELECTRONICS**, P.O. Box 1551, Winnipeg, Manitoba, Canada R3C 2Z4. 1-204-774-9313.

CB Radios, and accessories at discount prices. Cobra, Uniden, Wilson, etc. C.O.D. Visa and Mastercard accepted. Tollfree orderline, catalog available. C&H Distributing, PO Box 2286, Coeur d'Alene, ID 83814. (208) 667-5459.

FOR SALE: \$175 Satellite TV System includes receiver, feed horn & LNB, dish actuator and controller. Everything except dish. Works well. Gil Paquette, 42 Strohmaier Rd., Rising Sun, MD 21911 (301) 658-2260.

WANTED: Used satellite TV system. Call or write to: Titus Neckles, 95 Eastern Pkwy, Apt. 1-A, Brooklyn, NY 11238 (718) 636-2074.

HAMMARLUND HQ 180A, Sony 2001, JIL SX 200, VENA, Box 20693, St. Petersburg, FL 33742 (813) 577-9493.

SWL and scanner forums, during Peoria Superfest and Computer Show, September 21 and 22, 1991. For information, send SASE to PO Box 1392, Peoria, IL 61654-1392.

NEEDED: Owner's manual and schematic for Wilson Mark IV VHF handheld. Will pay mailing cost if necessary. Peter Miller, KA1MKN, 14 Chandler Drive, Prospect, CT 06712.

FOR SALE: One TEKK VHF handheld 154.60, one reg UC102 handheld 154.60/154.57 batt/chrgr/holder - both \$175.00. One Commodore printer - brand new 1525, \$65.00. Call Joe (718) 837-8820.

GILFER - first in Shortwave

JRC NRD-535 - the next generation in high performance HF receivers.



All the features: gen. coverage, 0.1 to 30 MHz in AM, USB, LSB, CW, RTTY, FAX, and Narrow FM. **Tunes to 1 Hz** through direct digital synthesis. **Advanced ECSS operation** for phase-lock AM. Variable bandwidth control. 200 memory ch. with scan and sweep. Triple superhetero circuit. Superior sensitivity, selectivity, and image rejection. Dual wide noise blanker, notch filter, 24 hr. clock/timer, fluorescent display, digital S meter, Squelch, RF Gain, Attenuator, AGC & Tone controls. Optional RTTY demod. **Most comprehensive computer interface.**

VISIT GILFER'S STORE

Easy to find, accessible from New York City. Take Garden State Parkway (NE portion of N.J.), Exit 172. Gilfer is in the center of Park Ridge, opposite the Borough Hall. Store hours: M-F 10am-5pm, Sat. 10am-3pm.

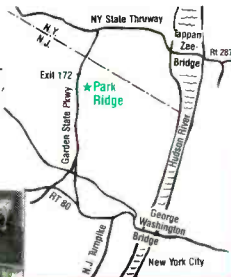

Order operators: 1-800-GILFER-1 (1-800-445-3371) NJ 201/391-7887

GILFER SHORTWAVE
52 Park Ave. • Park Ridge, NJ 07656

CIRCLE 141 ON READER SERVICE CARD

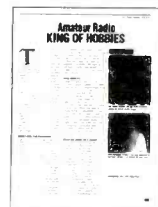

FREE
AMATEUR RADIO-KING OF HOBBIES

This 16-page booklet is packed with information on the basics of ham radio... how to get a license and who to contact for your test. To obtain a free copy, call **NARA** at 1-800-GOT-2-HAM.

YOU CAN PASS THE CODELESS HAM RADIO TEST AND WE GUARANTEE IT!

It's easy and fun with the **NARA Education Package**. You get Don Stoner's Ham Radio Handbook, IBM or Macintosh compatible software to test your knowledge after you have studied the book; a complete list of Contact Volunteer Examiners, the FCC Rules and Regulations for ham radio, a copy of *Amateur Radio—King of Hobbies*, plus a bonus copy of our monthly journal, *The Amateur Radio Communicator*. The **NARA Education Package** is only \$29.95 for the IBM or \$49.95 for the Mac version (3.00 S&H).



NARA
NATIONAL AMATEUR RADIO ASSOCIATION

CALL US TODAY!!

16541 Redmond Way, Suite 232
Redmond, WA 98052
Telephone Free 1-800-GOT-2-HAM

CIRCLE 140 ON READER SERVICE CARD

Advertiser's Index

AMC Sales, Inc.	22
ARRL	13
Ace Communications, IN.	80, Cov. III
Advanced Elec. Applications	73
Alpha Delta Communication	6
Antenna Supermarket	11
Antique Radio Classified	72
Ashton iTC	54
Associated Radio	28
Austin Amateur Radio Supply	4
Barry Electronics Corp.	74
C.B. City International	76
CRB Research	33, 49
Cellular Security Group	22
Communications Electronics	19
Conversion Research	74
DECO	74
Datametrics	49
Delta Research	63
Drake, R.L. Company	5
Electron Processing	45
Electronic Engineering	74
Electronic Equipment Bank	1
Future Scanning Systems	76
GRE America, Inc.	35
Gilfer Shortwave	77
Gitlin, Scott	76
Hamtronics	58
ICOM America, Inc.	Cov. II, 42
ISECO, Inc.	47
Japan Radio Co., Ltd.	31
JoGunn Enterprises	23
Kenwood USA Corporation	Cov. IV
KODE Company	33
Lentini Communications	54
MFJ Enterprises, Inc.	27
Medicine Man CB	76
MetroWest	76
Microcraft Corporation	49
MoTron Electronics	72
National Amateur Radio Assoc.	77
OEI OPToelectronics	15, 39
OFS WeatherFAX	14
POP'COMM Bookshop	37
POP'COMM Buyer's Guide	37
Passport To World Band Radio	79
Radio Buffs	69
React International	67
Republic Cable Products, Inc.	72
SGC, Inc.	46
Sangean America, Inc.	11
Satman, Inc.	76
Scanner World, USA	75
Scrambling News	78
Shinwa Communications of America	7
Signal Engineering	45
Software Systems Consulting	47, 49
Somerset Electronics	23
Spy Supply, Inc.	63
Systems & Software, Int'l. Ltd.	33
Universal Shortwave Radio	3
Viking International	36
WorldCom Technology	74
Xandi Electronics	72

Reach this dynamic audience with your advertising message, contact Don Allen, N9ALK at (217) 344-8653, FAX 217-344-8656.

PAY TV AND SATELLITE DESCRAMBLING ALL NEW 1992 EDITION ALL NEW

It's up to the minute. All new update on cable, wireless and satellite. Turn-ons, bypasses, circuits, chipping, bullets, bags, detect, liberty one, ECM's, data readers, programming, and lots more. Our best yet. Only \$15.95. Other (all different) editions 1991, 1989, Volume One (Basics) \$15.95 each. MDS Handbook \$9.95. Satellite systems Under \$600 \$12.95. Any 3/\$29.95 or 6/\$49.95. Video \$29.95. Scrambling News Monthly \$24.95/yr. Sample \$3. All New Catalog \$1. Shipping costs included.

Scrambling News, 1552P Hertel Ave.
Buffalo, NY, 14216. Voice/FAX (716)-874-2088.
COD'S ARE OK. ADD \$6.

PAN-COM INT'L CATALOG. Over 350 Kits, Plans, Books about Licensed/unlicensed AM/FM broadcasting, Ham/CB/SW/DX amplifiers. 1750M transmitters. Surveillance devices, Computers/Software. Science Projects. MORE. \$1.00 refundable. Box 130-P12, Paradise, CA 95967.

DESCRAMBLERS: OAK M35B, \$39.95. Also **Jerrold, Zenith, Scientific Atlanta**, etc. Guaranteed Cable Plus, 14417 Chase #481-K Panorama City, CA 91402. 1-800-822-9955

PRO-2004/5/6 OWNERS: Search-and-Store finds unknown frequencies automatically. Internal no-holes installation - Key-board control. Wired-tested-postpaid: Ten channel \$24.95 - Selectable to 255 channels \$44.95. US checks or MO. SASE for information. Key Research, POB 846P, Cary, NC 27512-0846.

VSWR, return loss, testing and troubleshooting guide. Complete setup, diagrams and procedures - \$9.95. Morgan's, RD1, Box 1654, Moscow, PA 18444

THE UNIDEN COOKBOOK covers HR2510/HR2600/HR2830/Lincoln/Realistic HTX-100. \$20. Uniden Updates supplements TUC. \$12. Money orders to Bud, KC4HGH, POB 907, Satsuma, AL 36572.

PAY TV AND SATELLITE DESCRAMBLING. ALL NEW EDITION. Our best yet. The very best in descrambling circuits, bypasses, turn-ons, for cable, wireless and satellite. Only \$14.95. Other pay TV edition, VOL. 1 (Basics of all systems) \$14.95. 1989 edition \$14.95. Build Satellite Systems Under \$600 - \$12.95. Wireless Cable Handbook - \$9.95. Any 3/\$29.95 or 5/\$44.95. Scrambling News Monthly has all info on new "Plain Vanilla" descramblers which emulate B-Mac, VCI+, Orion - \$19.95/yr. New catalog, \$1. Special this month. Everything including video and subscription for \$84.95. **Scrambling News, 1552 Hertel Ave., Buffalo, NY 14216. For COD'S (716-874-2088) Voice/FAX.**

AM BROADCAST BAND INTERFERENCE?? Reject broadcast band interference from HF and VLF bands with a precision filter from NCL. Provides 40+ db rejection. Write or call for FREE tech sheet. **NORTHWEST COMMUNICATIONS LABORATORIES**, Dept PC, 813 SW Highland, Suite 310C, Redmond, OR, 97756. (503) 923-2540.

AOR 1000 HANDHELD SCANNER LIKE NEW WITH BOX - \$280.00. WILL SHIP COD CALL BUD JR. AT 314-921-0779 NIGHTS OR WEEKENDS

ICOM RECEIVERS new in box R-71A - \$550.00 R-7000 - \$6750.00. W.R. Stansbury, VP, Northwest Georgia Bank, PO Box 5377, Ft. Oglethorpe, GA 30742. 404-365-3337/404-861-3012.

SCANNER/HAM RADIO MODIFICATION HANDBOOKS; FREQUENCY DIRECTORIES - UNIDEN, AERONAUTICAL, GOVERNMENT, MILITARY books by CRB, TAB, GROVE, ARRL; others. GRE products. Phone orders. VISA/MC, CATALOG \$1.00 (refundable) **DOYLE COMMUNICATIONS-DPC, Route 8, Box 18, Lake Pleasant, NY 12108. (518) 548-5515.**

CABLE TV DESCRAMBLERS - all major brands. Have make/model used in your area when calling. 1-800-327-3407. For a free catalog write K.D. Video, PO Box 29538, MLPS, MN 55429.

RECORD RADIO PROGRAMS. When Away or Home Using Your VCR! Record 8 hours worth on one tape. Easy Hookup Instructions. \$3 and SASE. Jet Jenkins. 1867 Tustin, Dept-PC, Costa Mesa, CA 92627.

TOUCH-TONE DECODER. Decode those tones you've heard on your telephone or scanner! The HB-16 Decoder decodes, stores, and displays touch-tone (DTMF) digits directly from your scanner, tape, recorder, or telephone line. Decode dialed numbers received on cordless, cellular! Plans, PC board and all IC's for only \$29.95! Send SASE for more information. HB Technologies, POB 2771-P, Spring Valley, CA 91979.

CANADIAN FREQUENCY DIRECTORIES! New Ontario Scanner Frequency Directory, gigantic 434 pages, 11,600 Frequencies - \$21.00. Atlantic Provinces Scanner Frequency Directory 2nd edition, 158 pages, over 4,000 Frequencies - \$15.95. Add tax and \$3 postage. Free catalogue, Conscan, PO Box 3009, Tecumseh PS, Windsor, Ontario N8N 2M3.

EAVESDROP ON PC'S! Intercept signals from PC's and see what's on someone's screen from a half mile away! Easy to assemble from a detailed manual, or purchase the ready to use system. Manual, \$39.95, complete systems from \$995.00. MO or COD to Spy Supply, Inc., 7 Colby Court, Bedford, NH 03102. (603) 645-6244.

SHOCKING MANUALS!! Survival Electronics, Computers, Telephones, Energy, Weapons, Financial, Medical, 100+. Plus Special Projects, Technical Research Services. Confidentiality Guaranteed! Send \$3 for catalogs. By John Williams, (CBS "60 MINUTES" fame). Since 1971. **CONSUMERTRONICS**, 2011 Crescent Dr., PO Drawer 537, Alamogordo, NM 88310.

NEW ICR-1 with cellular - \$535; new AOR-1000XC with cellular - \$395. AOR-2500 w/cellular - \$469; AOR-3000 w/cellular - \$969; BC-200XLT - \$249; BC-760XLT - \$279. Sony ICF-2010 - \$349; as well as shortwaves, scanners, CBs, frequency directories, antennas, and much more! 1992 picture price sheets - \$1.25. Free shipping and insurance. Same day C.O.D. shipping! GALAXY, Box 1202, Akron, Ohio 44309. (216) 376-2402 9-5 EST.

UNIDEN MODIFICATION INSTRUCTION MANUAL. A complete collection of modifications for the BC100XLT, BC200/205XLT, BC855XLT, BC580/600XLT, BC760/950XLT, REGENCY 4020, 4030, TS-1, TS-2. Includes cellular mods, adding 50 to 200 channels, increase scan speed to 250 percent, more battery time, remote control, transportable power, frequency charts, pictures and more. ONLY \$12 to: RF PRODUCTS, PO Box 1084, Montgomery, Alabama 36101 (205) 244-2050.

WANTED: E.H. Scott Radios from 1925-1948. Early Scott Radios were often copper shielded and used the names "World Record," "Scott Transformer Co.," and "Selecton" brand coils. Radios in any condition wanted. Literature also pursued. I am attempting to preserve the history of this company and your help is appreciated. John T. Meredith, 1792 Nemoke Trail, Haslet, MI 48840, (517) 349-4348.

NEW LED S-Meter chart for radios with signal lights. Lets you read all signal light meters. 100% accuracy. Send \$22.00 certified check to: Thomas Scalfaro, 4622 James St., East Syracuse, New York 13057.

HIDDEN SIGNALS ON SATELLITE TV. There is more than television on the satellites! Press services, financial services, stock services, SCPC, audio music, data, teletext systems and more. Third edition shows you how to receive on your dish. 240 pages, hundreds of diagrams. \$23.00 delivered UPS. Universal Electronics, Inc., 4555 Groves Road, Suite 13, Dept. PC, Columbus, Ohio 43232, Phone: 614-866-4605. FAX: 614-866-1201.

OFFICIAL AERONAUTICAL Frequency Directory covering HF-VHF-UHF Aviation Frequencies, frequency allocation charts, and Air Carrier Designators, over 400 pages, \$21.95. Now available from Official Scanner Guide, PO Box 712, Londonderry, NH 03053 or your local Radio Shack - Part Number 62-1030.

NRD 525 receiver. mint condition. original box with manual - \$775 ppd. (203) 375-0557.

SHORTWAVE COMPUTER BBS. We have MANY new Shortwave files available! We are waiting for your calls to us. Call: (305) 524-1035, 0300 to 1100 UTC weeknights, 24 hrs a day weekends.

CLEVELAND, OH \$\$\$. If you can scan fire frequencies in the Cleveland Metro area and are interested in extra \$, call 524-9999.

MILITARY RADIO SET, RT-505/PC-25, GOOD CONDITION, WITH HANDSET AND BATTERY BOX. \$235 EA. PAYMENT WITH U.S. POSTAL MONEY ORDER ONLY. LIST OF EQUIPMENT FOR SALE SHIPPED WITH ORDER. MICHAEL P. MURPHY, 11621 VALLE VISTA RD., LAKESIDE, CA 92040-1041, (619) 561-2726/FAX 390 8611.

SANGEAN ATS-803A TAPE OUTPUT JACK WIRING DIAGRAM \$3.00. S.A.S.E. no checks. Brian Pflizer, R2 B-482, Baxter Springs, KS 66713.

MILITARY ANTENNAS FOR SALE vhf/uhf discones, biconicals, broadband dipoles and satcom type. 30-1000 mc. 225-400 mc and 240-320 mc. Custom hardline cables. Call (419) 726-2249

MILITARY RECEIVER REPAIR minor repair to complete overhaul, all models FRR, SRR, URR, GRC, SRC, URC, CEI, DEI and WJ. Specialize in R-390-A, reasonable. Call (419) 726-2249

BOOK IT HOW TO GET ANYTHING ON ANYBODY - ALL NEW Lee Lapin! Tricks from engineers, top cops, agents—cutting edge audio/video surveillance. HIGH PRICED "OFFICIAL" METHODS (and inexpensive counterparts) to read computers from a distance, bypass passwords, obtain unlisted phone numbers, intercept cellular calls, pagers, and faxes, trace and track with new data bases, surveillance proof any room, tap any phone, WHEW! "Really scary stuff." Charles Jaco CNN. " \$38.50 postpaid ISECO, 2228 El Camino Real #349-4, San Mateo, CA 94403.

CELLULAR TELEPHONE MODIFICATION HANDBOOK - How are hackers making cellular phone calls for free? Techniques for decoding and changing cellular phones, the "roaming technique," chip suppliers phone numbers, etc. Schematics for most cellular phones, and diagrams to find and change phone numbers on all models. Complete manual \$79.95. MO or COD to Spy Supply, Inc., 7 Colby Court, Bedford, NH 03110. (603) 645-6244. **SOLD FOR EDUCATIONAL PURPOSES ONLY!**

VIDEOCIPHER II/Satellite/Scanner/Cable repair manuals, modification books and software. Catalog - \$3.00. TELECODE P.O. Box 6426-PC, Yuma, AZ 85366-6426.

The (shortwave) bible just got better.

A year of turmoil. In 1991, the cold war thawed, hot war broke out, and the world's shortwave broadcasters shifted languages, frequencies, times, and targets more than ever before.

Passport to World Band Radio, your bible for shortwave listening worldwide, has kept up with the changes, and then some. In the 1992 edition, you'll find up-to-the-minute information to delight program listeners and DXers alike:

- **The world's best frequency guide**—*Passport's* famous Blue Pages—thoroughly updated to reflect the changing airwaves: 9,700 of 15,630 entries contain new information.
- **A brand new 18-page reference** to stations that respond to inquiries. Here's who to contact, where, toll-free numbers, and other helpful information.

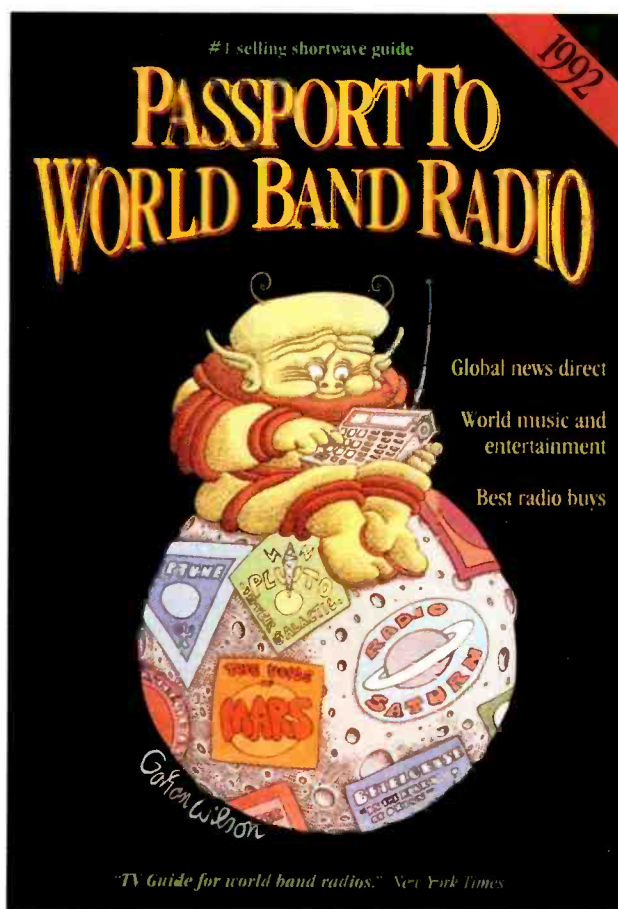

■ **Larry Magne's no-holds-barred reviews** of portable and tabletop receivers sort the diamonds from the turkeys. Find out the inside scoop on the new top guns, including the Drake R8 and the Japan Radio NRD-535.

■ **What's On Tonight?** An hour-by-hour guide to world band shows guides you through the

best of the best and the worst of the worst.

■ **Country-by-country references**, including "Worldwide Broadcasts in English" and "Voices From Home." Newly formatted to make it easy to find the station you want at the time you want.

At your dealer or bookstore now. See why *Passport* has become the largest-selling shortwave publication in North America. For further information, write *Passport to World Band Radio*, Box 300A, Penn's Park, PA 18943 or call (24 hours) 215/794-8252.

AOR Scanners.

Great Performance. Great Service. Great Value.

Free Freight
25-Day Money-Back Guarantee
Toll-Free Service and Support
No Credit Card Surcharge
One Year Warranty



**NEW!
EXTENDED
COVERAGE!**

AR1000

\$429

1000 Channels. 500KHz to 1300MHz

Standard Features:

- Extremely compact size.
- Continuous coverage.
- Antenna attenuator switch, 10db.
- Manual tuning knob.
- Earphone jack, 3.5mm.
- AM, FM and wide band FM tuning modes.
- Backlighted LCD display.
- 10 Scan Banks, 10 Search Banks.
- Selectable Priority Channel.
- Delay, Hold Features.
- Selectable Search Increments, 5-955KHz.
- Permanent memory backup.
- 4 AA Ni Cad batteries included.
- AC adaptor/charger.
- Carry Case.
- Cigarette Lighter Charger.
- Belt Clip.
- Earphone.

Options:

External Speaker. Mobile Mount. MS190 \$19.50
Extended Warranty. 2/3 yrs \$45/\$55

Specifications:

Coverage: 500KHz-1300MHz
Sensitivity: .35uV NFM, 1.0uV WFM, 1.0AM
Speed: 20 ch/sec. scan. 40 ch/sec. search
IF: 561.225, 58.075, 455KHz or 10.7MHz
Increments: 5 to 955KHz selectable/ 5 or 12.5 steps.
Audio: .4 Watts
Power: Input 9 - 13.8 V. DC
Antenna: BNC
Display: LCD
Dimensions: 6 7/8H x 1 3/4D x 2 1/2W. 12oz wt.

AR950/AR900

\$259/\$269



100 Channels. Low, Air, High, UHF & 800MHz.

Standard Features:

- Extremely compact size.
- Unrestricted 800MHz coverage.
- 100 channels permanent memory.
- Earphone Jack.
- Delay, Hold features.
- Channel 1 Priority.
- 5 Scan Banks, 5 Search Banks.
- Two antennas included.
- AC & DC Power cord w/mobile mnt. hrdwr. (AR950)
- NiCad battery w/chgr adapter. (AR900)
- One Year Limited Warranty.

Options:

Base type antenna	AS300	\$59.95
25 to 1000MHz w 50' coax.		
Mag Mnt Mobile Antenna. 15' coax.	MA100	\$25.00
Cigarette Lighter power adaptor.	CP100	\$5.00
Wide band preamp	GW-2	\$89.00
Extended Warranty. 2/3 yrs		\$40/\$55

Specifications:

Coverage: 27-54, 108-174, 406-512, 830-950MHz
Sensitivity: .4uV Lo,Hi. .8uV Air. .5uV UHF. 1.0uV 800
Scan Speed: 15 ch/sec.
IF: 21.4MHz, 455KHz
Increments: 10,12.5,25,30
Audio: 1W
Power: 12.8VDC, 200MA
Antenna: BNC
Display: LCD w/backlight
Dimensions: 2 1/4H x 5 5/8W x 6 1/2D. 14oz wt. (AR950)
5 3/4H x 2W x 1 1/2D. 12oz wt. (AR900)

We offer 100's of communications products.

Unbelievable Price.

AR2500

\$499



2016 Channels. 1 MHz to 1500 MHz

Standard Features:

- continuous coverage.
- AM, FM, wide band FM, & BFO for SSB, CW.
- 64 Scan Banks.
- 16 Search Banks.
- RS232 port built in.
- Includes AC/DC pwr crd. Antenna, Mntng Brckt.
- One Year Limited Warranty.

Options:

Earphone.	EP200	\$2.00
External Speaker. Mobile Mount.	MS190	\$19.50
Extended Warranty. 2/3 yrs.		\$65/\$75
Mobile Mounting Bracket.	MM1	\$14.90
RS232 Control Package (software & cable) offers spectrum display and database.	SCS2	\$295.00
Wide band preamp	G-W2	\$89.00

Specifications:

Coverage:	1MHz-1500MHz
Sensitivity:	.35uV NFM, 1.0uV WFM, 1.0AM/SSB/CW
Speed:	38 ch/sec. scan. 38 ch/sec. search
IF:	750.00, 45.0275, 5.5MHz 455KHz
Increments:	5,12,5,25 KHz
Audio:	1.2 Watts at 4 ohms
Power:	Input 13.8 V. DC 300mA
Antenna:	BNC
Display:	LCD, backlighted
Dimensions:	2 1/4H x 5 5/8W x 6 1/2D Wt. 1lb.

AR3000

\$1095



400 Channels. 100KHz to 2036MHz.

Standard Features:

- Extremely compact size.
- Continuous coverage.
- Attenuation Programmable by Channel.
- Manual tuning knob.
- Tuning increments down to 50Hz.
- AM, FM, wide band FM, LSB, USB, CW modes.
- Backlighted LCD display.
- 4 Scan and Search Banks, Lockout in Search.
- 4 Priority Channels.
- RS232 control through DB25 connector.
- Delay, Hold Features.
- 15 band pass filters, GaAsFET RF amp.
- Sleep and Alarm Features.
- AC adaptor / charger. DC power cord.
- Telescopic Antenna
- One Year Limited Warranty.

Options:

Earphone.	EP200	\$2.00
External Speaker. Mobile Mount.	MS190	\$19.50
Extended Warranty. 2/3 yrs.		\$65/\$75
Mobile Mounting Bracket.	MM1	\$14.90
RS232 Control Package (software & cable) offers spectrum display and database.	SCS3	\$295.00
Wide band preamp	G-W2	\$89.00

Specifications:

Coverage:	100KHz-2036MHz
Sensitivity:	.35uV NFM, 1.0uV WFM, 1.0AM/SSB/CW
Speed:	20 ch/sec. scan. 20ch/sec. search
IF:	736.23, (352.23) (198.63) 45.0275, 455KHz
Increments:	50Hz and greater
Audio:	1.2 Watts at 4 ohms
Power:	Input 13.8 V. DC 500mA
Antenna:	BNC
Display:	LCD
Dimensions:	3 1/7H x 5 2/5W x 7 7/8D Wt. 2lb 10oz.

To Order Call 1•800•445•7717

In All 50 States and Canada. 24 Hours a Day. Fax Orders: 1-800-448-1084, 24 Hours a Day.

ACE Communications Monitor Division 10707 E. 106th Street, Fishers, IN 46038

Int'l Voice# 317-842-7115. Int'l Fax# 317-849-8794.

Service and Support Lines: Mon-Fri 9a.m. to 9p.m., Saturday 10-4. EST

MasterCard, Visa, American Express, Checks, Approved P.O.'s. & C.O.D. (add 5.00)

Prices and specifications subject to change.

KENWOOD

Hear it All!



R-5000
R-2000
High performance receivers.

Scan the world bands with Kenwood's R-5000, R-2000 and RZ-1. Listen in on foreign music, news, and commentary. Monitor local police, fire, and other public safety services, as well as the Marine channels, and the many other services.

(The VHF converter options must be used in the R-5000 and R-2000.)

R-5000

The R-5000 is a high performance, top-of-the-line receiver, with 100 memory channels, and direct keyboard or main dial tuning—makes station selection



R-2000

The R-2000 is an all band, all mode receiver with 10 memory channels and many deluxe features such as programmable scanning, dual 24-hour clocks with timer, all-mode squelch and noise blankers, a large, front-mounted speaker, 110 volt AC or 12 volt DC operation (with the DCK-1 cable kit), and 118-174 MHz VHF capability with VC-10 option.

Optional Accessories R-2000:

- VC-10 VHF converter
- DCK-1 DC cable kit for 12 volt DC use.

R-5000:

- VC-20 VHF converter
- VS-1 Voice module
- DCK-2 for 12 volt DC operation
- YK-88A-1 AM filter
- YK-88SN SSB filter
- YK-88C CW filter
- MB-430 Mounting bracket.

Other Accessories:

- SP-430 External speaker
- SP-41 Compact mobile speaker
- SP-50B Mobile speaker
- HS-5 Deluxe headphones
- HS-6 Lightweight headphones

super easy! Other useful features include programmable scanning, large, built-in speaker, 110 volt AC or 12 volt DC operation (with optional DCK-2 cable), VHF capability (108-174 MHz) with the VC-20 option, dual 24-hour clocks with timer, and even voice frequency readout with the VS-1 option.

RZ-1

Wide-band scanning receiver



The RZ-1 wide-band, scanning receiver covers 500 kHz-905 MHz, in AM, and narrow or wideband FM. The automatic mode selection function makes listening

easier. One hundred memory channels with message and band marker, direct keyboard or VFO frequency entry, and versatile scanning functions, such as memory channel and band scan, with four types of scan stop. The RZ-1 is a 12 volt DC operated, compact unit, with built-in speaker, front-mounted phones jack, squelch for narrow FM, illuminated keys, and a "beeper" to confirm keyboard operation.

- Optional Accessory
- PG-2N Extra DC cable

KENWOOD U.S.A. CORPORATION
COMMUNICATIONS & TEST EQUIPMENT GROUP
P.O. BOX 22745, 2201 E. Dominguez Street
Long Beach, CA 90801-5745
KENWOOD ELECTRONICS CANADA INC.
P.O. BOX 1075, 959 Gana Court
Mississauga, Ontario, Canada L4T 4C2

KENWOOD

...pacesetter in Amateur Radio

CIRCLE NO. 1 ON FREE INFORMATION CARD