

2012 F-650/F-750 SUPER DUTY®





# YOUR TRUCKS. YOUR FUEL. YOUR BOTTOM LINE.

We're expanding our powertrain lineup for 2012 to help you make the best choice for your business. Now you can equip F-650 Pro Loader® and F-650 with our class-exclusive<sup>1</sup> 6.8L Triton® V10 gas engine<sup>2</sup> and TorqShift® 6-speed automatic transmission, or opt for the Cummins® ISB 6.7L Turbo Diesel.<sup>2</sup> A new CNG/LPG Gaseous Engine Prep Package<sup>2</sup> on the V10 may even help you qualify for alternative fuel tax credits and other incentives.<sup>3</sup> Also new for 2012, our voice-activated Ford SYNC®<sup>2,4</sup> is standard on XLT for hands-free control of calls and music. 3 cab choices. Available clean CA. Maneuverability. Massive axle capacities. The 2012 Ford F-650/F-750 Super Duty.®

F-750 XLT Regular Cab. Bright Red. Available and aftermarket equipment.

<sup>1</sup>Class is Medium-Duty Chassis Cabs. <sup>2</sup>Available feature. <sup>3</sup>See your tax advisor to confirm. <sup>4</sup>Available Spring 2012. Vehicles throughout this PDF may be shown with optional and aftermarket equipment.



2012 F-650/F-750 SUPER DUTY® [ford.com](http://ford.com)

# IT'S ABOUT WORKING HARDER AND SMARTER.



## Valuable standards.

- New for 2012: Ford SYNC<sup>®</sup> voice-activated, in-vehicle communications and entertainment system (XLT)<sup>1</sup>
- Overhead console with dual sunglasses bins and map-reading lights (XLT)
- 8" blind spot mirrors (XLT diesel)
- Extended-life Organic Acid Technology (OAT) engine coolant
- Synthetic fluid on Allison Transmission<sup>™</sup>

## Big capability.

- Diesel GVWRs range from 20,500 lbs. up to 37,000 lbs.
- Gas GVWRs range from 20,780 lbs. up to 30,000 lbs.
- Front axle ratings go as high as 14,000 lbs.
- Rear axle ratings climb all the way up to 23,000 lbs.

## Powerful choices.

- New for 2012: 362-horsepower 6.8L Triton<sup>®</sup> V10 gas engine<sup>2</sup> and TorqShift<sup>®</sup> 6-speed automatic transmission on F-650 Pro Loader<sup>®</sup>/F-650
- New CNG/LPG Gaseous Engine Prep Package<sup>2</sup> readies V10 engine for alternative fuels
- 10 Cummins<sup>®</sup> ISB 6.7L Turbo Diesel engine ratings: up to 360 horsepower and 800 lb.-ft. of torque<sup>3</sup>
- 2 Diesel Exhaust Fluid (DEF) tank<sup>2</sup> sizes to accommodate clean CA choices
- 35-gal. fuel tank<sup>2</sup> and 5-gal. DEF tank mounted under cab on driver's side for clean CA
- 50-gal. deep fuel tank<sup>2</sup> and 5-gal. DEF tank
- Proven axles from Dana Spicer<sup>®</sup> and Meritor<sup>®</sup>
- Multiple emissions/exhaust setups
- Regular Cab, SuperCab or Crew Cab
- 40/20/40 split front seat<sup>2</sup> or 6-way power, heated, leather-trimmed driver and front-passenger captain's chairs<sup>2</sup>
- Overhead gauge pod<sup>2</sup>
- Power, heated trailer tow mirrors<sup>2</sup>
- 4 upfitter switches on instrument panel<sup>2</sup>

F-750 XLT Regular Cab. Oxford White. Available and aftermarket equipment.

<sup>1</sup>Available Spring 2012. <sup>2</sup>Available feature. <sup>3</sup>Rating is restricted to emergency vehicles only. SYNC does not include 911 Assist<sup>®</sup>; Vehicle Health Reports; SYNC Services; Traffic, Directions and Information; or AppLink.



2012 F-650/F-750 SUPER DUTY<sup>®</sup> [ford.com](http://ford.com)

## NEW GAS POWERTRAIN ON BOTH F-650 MODELS.

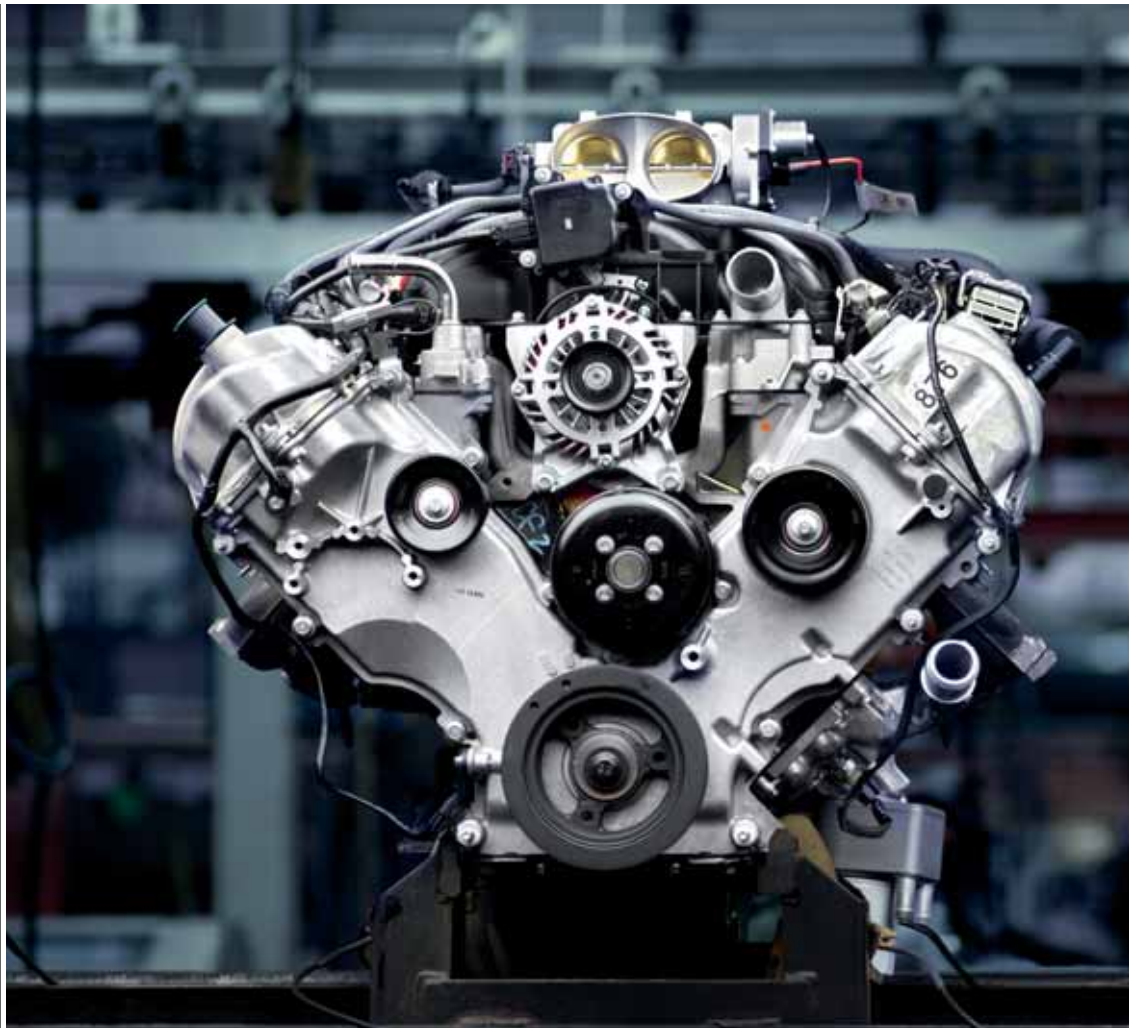

The proven 6.8L Triton® V10 3-valve gas engine<sup>1</sup> is now available on F-650 Pro-Loader® and F-650. For 2012, it's paired with a Built Ford Tough® TorqShift® 6-speed automatic transmission and optional PTO capability. A high-capacity, high-efficiency fluid filter extends the fluid- and filter-change intervals on this rugged transmission up to 150,000 miles. A new CNG/LPG Gaseous Engine Prep Package<sup>1</sup> readies your truck for Compressed Natural Gas (CNG) or Liquefied Petroleum Gas (LPG) upfits. Using these alternative fuels may also help you qualify for tax credits and incentives.

### 6.8L Triton V10 3-Valve Gas Engine

Horsepower	Torque
362 @ 4,750 rpm	457 lb.-ft. @ 3,250 rpm

**Transmission**  
TorqShift 6-Speed Automatic

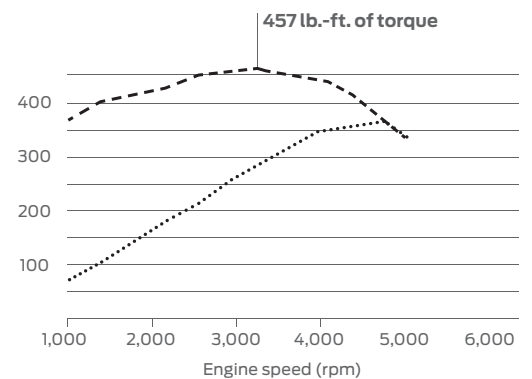

6.8L Triton V10 gas engine.

<sup>1</sup>Available feature.

Engine appearance differs when installed in vehicle.



2012 F-650/F-750 SUPER DUTY® [ford.com](http://ford.com)

## DIESEL DEPENDABILITY ACROSS THE LINEUP.



The venerable Cummins® ISB 6.7L Turbo Diesel<sup>1</sup> features full-authority electronic controls, a high-pressure common-rail fuel-injection system, 24-valve design, the patented VGT™ turbocharger, a particulate filter and more. Excellent power-to-weight ratios help it deliver outstanding fuel economy as it delivers every load. Choose from 10 horsepower and torque ratings. Pair it with your choice of 13 durable transmissions. Build the perfect truck for your business.

### Available Engine Ratings

Horsepower	Torque
200 @ 2,300 rpm	520 lb.-ft. @ 1,600 rpm
220 @ 2,300 rpm	520 lb.-ft. @ 1,600 rpm
240 @ 2,300 rpm	560 lb.-ft. @ 1,600 rpm
250 @ 2,300 rpm	660 lb.-ft. @ 1,600 rpm
260 @ 2,300 rpm	660 lb.-ft. @ 1,600 rpm
280 @ 2,300 rpm	660 lb.-ft. @ 1,600 rpm
300 @ 2,600 rpm	660 lb.-ft. @ 1,600 rpm
325 @ 2,300 rpm	750 lb.-ft. @ 1,800 rpm
340 @ 2,800 rpm <sup>2</sup>	660 lb.-ft. @ 1,800 rpm
360 @ 2,800 rpm <sup>2</sup>	800 lb.-ft. @ 1,800 rpm

### Available Transmissions Horsepower Ratings

#### Allison Transmission™ — Automatics

2200 6-Speed	200/220/240/250/260/280/300
2500 6-Speed	200/220/240/250/260/280/300
3000 5-Speed	250/260/280/300/325
3000 6-Speed	250/260/280/300/325
3200 5-Speed	250/260/280/300/325/340/360
3200 6-Speed	250/260/280/300/325/340/360
3500 5-Speed	250/260/280/300/325
3500 6-Speed	250/260/280/300/325

#### Fuller® — Manuals

FS-5406A 6-Speed	200/220/240
FS-6406A 6-Speed	200/220/240/250/260/280/300
FSO-8406A 6-Speed	280/300/325

#### Dana Spicer® — Manuals

ES56-7B 7-Speed	200/220/240
ESO66-7B 7-Speed	220/240/250/260/280/300

### Cummins ISB 6.7L Turbo Diesel Engine

**Find your perfect fit.** With ratings ranging from 200 hp and 520 lb.-ft. of torque all the way up to 360 hp<sup>2</sup> and 800 lb.-ft. of torque (illustrated below), there's sure to be a 6.7L Turbo Diesel that's just right for your needs. Charge things up with the standard 185-amp Leece-Neville alternator, or go for the 220-amp or 320-amp options.

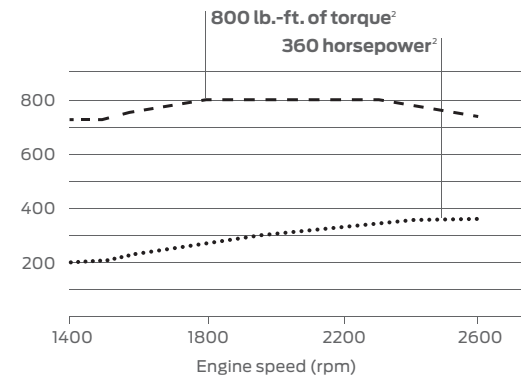

Cummins ISB 6.7L Turbo Diesel engine.

<sup>1</sup>Available feature. <sup>2</sup>Rating is restricted to emergency vehicles only. See your Ford Dealer for details. Engine appearance differs when installed in vehicle.



2012 F-650/F-750 SUPER DUTY® [ford.com](http://ford.com)

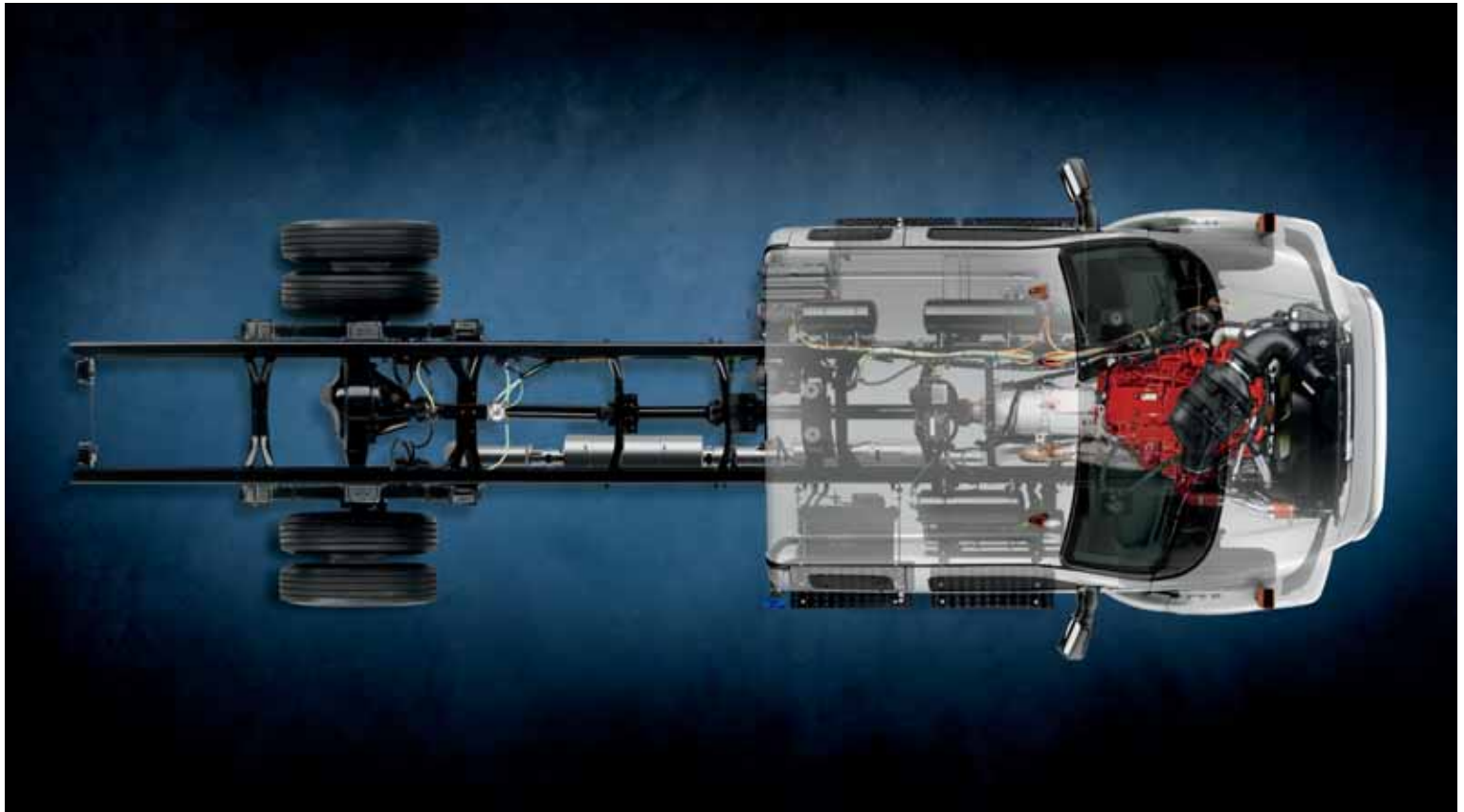

## UPFITTING MADE EASY.

We want your new Ford F-650/F-750 Super Duty® to fulfill your unique needs and surpass your expectations. So we strive to make your upfitting experience as easy as possible. Our frame-rail spacing remains the industry standard at 34." We offer a range of axles from trusted names including Meritor® and Dana Spicer®. Our various emissions/exhaust setups and Diesel Exhaust Fluid (DEF) tank solutions help facilitate a wide variety of upfits. You can choose from over 30 clean CA offerings that range from 60" to 186." Variety. It's what makes our Built Ford Tough® trucks some of the most versatile upfit vehicles on the road today.

**Dana Spicer S140 rear axles**, standard on F-650 straight-frame models, utilize GenTech™ gear sets for quiet operation and synthetic lube for long-lasting durability.

**Battery box location options** vary in combination with exhaust and fuel tank packaging. Choose from 2- or 3-battery setups on diesels with dual 625 CCA, triple 625 CCA, dual 900 CCA or triple 900 CCA. Or go with a temporary battery box for final placement that works best with your diesel upfit.

**Protective air tank positioning** also results in cleaner CAs. The tanks for the available air brake system are packaged adjacent to the frame rails and under the cab on every cab style of diesel models.

**34 fuel tank setups** are available on diesel models. Deep tanks can help you go the distance. Shallow tanks provide up to 19" of ground clearance.

**PowerScope® trailer tow mirrors** adjust, fold and telescope at the touch of a switch. This class-exclusive option includes integrated clearance lamps and turn signals, plus heated glass with manually adjustable integrated blind spot mirrors.



**Regular Cab/SuperCab Diesels** can get a 10-gal. DEF tank option (shown above) mounted outside the frame rails, behind the cab on the passenger side.

**Crew Cab Diesels** can get a 10-gal. DEF tank option mounted under the cab on the passenger side.

**Regular Cab Diesels** can get a 35-gal. fuel tank and 5-gal. DEF tank option mounted under the cab on the driver's side for a clean CA.



**Horizontal exhaust system** (shown above) exits the tailpipe in front of the rear axle, or over the top of it depending on your choice of wheelbase.

**Under-cab horizontal switchback exhaust system** is another option we offer to help make your upfits easy and cost-effective.

**Under-cab vertical switchback exhaust system** is a compact option with pipe routing similar to "big rigs," exiting at the top of the cab on the passenger side.





## HANDS CONTROL THE WHEEL. VOICE CONTROLS THE REST.

New for 2012, voice-activated Ford SYNC<sup>®1</sup> is standard on all XLT models. SYNC makes it easy for drivers to stay connected to their calls and music. No more searching for your phone. No device on your ear. Once paired, SYNC recognizes your phone and automatically transfers your contacts to support voice calling. Just touch a button on the steering wheel and say "Call Kevin." Plug your media player into the USB port and your entire music collection can be accessed by voice, too. Ask for your favorite artist or playlist ("Play genre: Country") and SYNC responds in an instant. Personalize your experience at [SyncMyRide.com](http://SyncMyRide.com).



**Overhead gauge pod** places your optional gauges and auxiliary switches front and center. Possibilities include an hour meter gauge, voltmeter gauge, differential lock switch, air-suspension dump switch, transmission temperature gauge, exhaust brake switch and 2-speed axle switch.



**40/20/40 split front seat** option includes a fold-down armrest with built-in cupholders.

F-650 XLT Crew Cab. Charcoal Black interior. Available equipment.

<sup>1</sup>Available feature. Coming Spring 2012. Requires compatible mobile device. Driving while distracted can result in loss of vehicle control. Only use mobile phones and other devices, even with voice commands, when it is safe to do so. SYNC does not include 911 Assist;<sup>®</sup> Vehicle Health Reports; SYNC Services; Traffic, Directions and Information; or AppLink.



2012 F-650/F-750 SUPER DUTY<sup>®</sup> [ford.com](http://ford.com)

# F-650/F-750 SUPER DUTY® Standard Features

## F-650 Pro Loader®

### Maximum Capabilities<sup>1</sup>

Cummins® ISB 6.7L Turbo Diesel  
GVWR: 26,000 lbs.

6.8L Triton® V10 3-valve gas  
GVWR: 26,000 lbs.

### Equipment Configurations

Front axle: 8,500 lbs. Meritor®  
MFS-08-153B I-Beam (standard)

Rear axle: 13,500 lbs. Meritor  
MS-17-14X-3DLF single-speed  
(standard)

Driveline: 4x2 dual rear wheel only

Bodies: Regular Cab, SuperCab,  
Crew Cab

Trim Series: XL, XLT

## F-650

### Maximum Capabilities<sup>1</sup>

Cummins ISB 6.7L Turbo Diesel  
GVWR: 29,000 lbs.

6.8L Triton V10 3-valve gas  
GVWR: 30,000 lbs.

### Equipment Configurations

Front axle: 8,500 lbs. Meritor  
MFS-08-153B I-Beam (standard)

Rear axle: 17,500 lbs. Dana Spicer®  
S17-140 single-speed (standard)

Driveline: 4x2 dual rear wheel only

Bodies: Regular Cab, SuperCab,  
Crew Cab

Trim Series: XL, XLT

## F-750

### Maximum Capabilities<sup>1</sup>

Cummins ISB 6.7L Turbo Diesel  
GVWR: 37,000 lbs.

### Equipment Configurations

Front axle: 10,000 lbs. Meritor  
MFS-10-122A I-Beam (standard)

Rear axle: 21,000 lbs. Meritor  
MS-21-14X-3DLF single-speed  
(standard)

Driveline: 4x2 dual rear wheel only

Bodies: Regular Cab, SuperCab,  
Crew Cab

Trim Series: XL, XLT



### Mechanical

10-gal. DEF tank (diesel)

12-volt Delco Remy 38 MT Type 300 starting motor (diesel)

12-volt starting motor (gas)

Fuel tank – 42-gal. single rectangular steel, shallow (13" deep),  
frame-mounted on left side (Regular Cab/SuperCab gas)

Fuel tank – 45-gal. single rectangular steel, shallow (13" deep),  
frame-mounted on left side (diesel)

Fuel tank – 60-gal. single rectangular steel, shallow (13" deep),  
frame-mounted on left side (Crew Cab gas)

Allison Transmission™ with synthetic transmission fluid  
(automatic; diesel)

Ford TorqShift® 6-speed automatic transmission  
(without PTO provision; gas)

Alternator – 177-amp, 12-volt, Denso (gas)

Alternator – 185-amp, 12-volt, Leece-Neville, pad-mounted (diesel)

Batteries – 625 Cold Cranking Amps (CCA), 12-volt  
(2 for a total of 1,250 CCA; diesel)

Battery – 900 Cold Cranking Amps (CCA), 12-volt (gas)

Battery box at right-hand frame rail under cab step

BorgWarner fan clutch (diesel)

Bosch DDSA-type parking brake, 12" x 3," rear axle-mounted

Brakes – Meritor® Quadraulic™ split-system, full-power, 4-channel  
Anti-Lock Brake System (ABS)

Donaldson® single element air cleaner with restriction indicator  
(diesel; late availability)

Driveshaft – Spicer SPL100

Emergency flashers

Engine coolant with red, extended-life Organic Acid Technology (OAT)  
-40°F freeze-protection rating

Exhaust – In-line single, horizontal, diesel particulate filter assembly;  
frame-mounted right side back of cab, single horizontal SCR assembly;  
frame-mounted right side back of cab, horizontal tailpipe; exits behind  
rear wheels, right side (diesel)

Exhaust – In-line single, horizontal, muffler, catalytic converter, frame-  
mounted right side back of cab; downward-facing outlet tip (gas)

Fleetguard® fuel/water separator with electric-type heater and primer  
pump (diesel)

Frame-mounted body-builder wiring at back of cab

Front double-acting shock absorbers

Fuses – SAE blade-type

Parking brake control lever, right of driver

Radiator – 717 sq.-in., cross-flow, aluminum with in-tank transmission  
fluid cooler (diesel)

Radiator – 857 sq.-in. aluminum with in-tank transmission fluid cooler (gas)

Rectangular halogen sealed-beam headlamps (includes front-side  
marker lamps with reflectors)

STEMCO® wheel seals (front and rear axle), oil lubricated wheel  
bearings (front and rear)

Taillamps (2) with integrated stop, turn signal, backup and license plate

Vari-rate suspension with multi-leaf rear springs

Viscous fan clutch (gas)

### Cab Equipment – Interior

Air conditioning – Manual with integral heater and defroster

Air registers with positive shut-off

Assist handle on interior A pillars

Coat hooks (2)

Cruise control with steering wheel-mounted controls

Cupholders on 70% front passenger seat fold-down armrest

Floor covering – Black vinyl

Gauge cluster with electronic speedometer (mph/kph), oil pressure,  
coolant temperature, DPF gauge (diesel only), transmission temperature  
(gas only), fuel gauge, tachometer, indicator lights, enhanced 3-button  
message center with odometer, trip odometer, distance to empty for  
fuel, average fuel economy and warning messages

Left-/right-hand front-window demisters

Multifunction, self-canceling turn signal switch

Powerpoints – 12-volt (2)

Rear-mounted dome lamp with integral map lights  
(Regular Cab/Crew Cab only)

Scuff plates – Black molded-in-color

Steering wheel – Black vinyl 2-spoke (15.5" diameter with 8,500-lb.  
front axle; 17.5" diameter with 10,000-lb. front axle)

Tilt steering column

Upfitter switches (4) located in center IP with connector access located  
in engine compartment; 10-amps per switch (XL/XLT diesel, XLT gas)

### Cab Equipment – Exterior

Assist handle on exterior B pillars (Regular Cab)

Assist handle on exterior rear doors (SuperCab)

Assist handle on exterior C pillars (Crew Cab)

Bumper – Front; full-width, chrome-plated steel

Dual electric horn

Grille – Chrome (includes chrome headlamp bezels)

Hood – Frame-mounted front-end-tilting fiberglass hood and fenders  
assembly with torsion-bar assist (includes integrated noise shield, inner  
splash shields and mud flaps)

Lamps – Roof marker/clearance (5)

Mirrors – Auxiliary convex (2), stainless steel, 8" diameter, mounted  
below primary mirrors (XLT diesel only; available only with dual  
stainless steel West Coast-style mirrors)

Mirrors – Dual rectangular, 7.5" x 16.5" stainless steel, West Coast-style,  
102"-wide spacing (diesel)

Mirrors – Dual rectangular, manually adjustable with integrated blind  
spot mirrors, sail-type, 96"-wide spacing (gas)

Window – Fixed rear, solar-tinted

Windshield – Laminated glass, solar-tinted

Windshield wipers – 2-speed intermittent with washer

### Safety & Security

Belt-Minder® safety belt reminder (chime and flashing warning light  
on instrument panel if driver's safety belt isn't buckled)

Safety belts – Color-keyed with fixed D-rings at all positions  
(Regular Cab)<sup>2</sup>

Safety belts – Color-keyed with front-seat adjustable D-rings  
(SuperCab/Crew Cab)<sup>2</sup>

<sup>1</sup>When properly equipped. <sup>2</sup>Always wear your safety belt.

Comparisons based on 2012 competitive models (class is Medium-Duty Chassis Cabs), publicly available information and Ford certification data at time of release. Some features discussed may be optional. Vehicles throughout this PDF are shown with optional and aftermarket upfit equipment. Features shown may be offered only in combination with other options or subject to additional ordering requirements or limitations. Dimensions and capability ratings shown may vary due to optional features and/or production variability. Following release of the PDF, certain changes in standard equipment, options and the like, or product delays may have occurred which would not be included in these pages. Your Ford Dealer is the best source for up-to-date information. Ford Division reserves the right to change product specifications at any time without incurring obligations. Body manufacturers are responsible for compliance certification of the completed vehicle. The Ford New Vehicle Limited Warranty and any government certification made by Ford shall cover only the vehicle as manufactured by Ford and shall not extend to any addition, modification or change of or to the vehicle by the Ford Authorized Pool Account.





# F-650/F-750 SUPER DUTY® Available Features

## Axle & Suspension – Front

EmGard® SAE 50 synthetic manual transmission lubricant

Rubber auxiliary springs

## Axle & Suspension – Rear

Air suspension (requires air brake or compressor; diesel)

Air suspension dump valve with driver-controlled pressure release in overhead pod (diesel)

Air suspension leveling valve (diesel)

Double-acting shock absorbers

EmGard EP 75W-90 synthetic gear lubricant

## Brakes & Brake Equipment

Air brake system – Meritor® Q-plus with ABS, 4-channel

Air brake system with traction control – Automatic transmission (traction control switch in overhead pod; diesel)

Air brake system – Straight truck use only (diesel)

Air brake system – Tractor use only (Regular Cab/SuperCab only; diesel)

Hydraulic brake system with traction control – Automatic transmission (brake system control in overhead pod; diesel)

Air compressor – Cummins® engines; 18.7-CFM capacity (diesel)

Air compressor – Cummins engines; 18.7-CFM capacity; includes direct-reading air pressure gauge and 1 air tank; 1,742 cu.-in. (requires hydraulic brake system; diesel)

Air dryer – Bendix® AD/IP with heater mounted on left frame rail back of cab (restrictions apply; diesel)

Automatic drain valve (Bendix DV-2) with heater (diesel)

Brake chambers spring – Relocated to back of rear axle for maximum ground clearance (n/a on Pro Loader®; diesel)

Powered parking brake – Bosch DSSA type, 12" x 3," rear axle-mounted (requires traction control; diesel)

## Trailer Connections

4-wheel trailer Air Brake Package (n/a on Pro Loader)

7-way trailer connection socket, mounted at rear of frame, for combined trailer stop/tail/turn/marker light circuits

7-way trailer connection socket, mounted at rear of frame, for separate trailer stop/tail/turn/marker light circuits

7-way trailer connection socket, mounted at rear of frame, wired for turn signals combined with stop (compatible with trailers that use combined stop/tail/turn lights; requires air brakes; diesel only)

7-way trailer connection socket, mounted at rear of frame, wired for turn signals independent to stop (compatible with trailers that have amber or side turn lights with independent stop/turn; requires air brakes; diesel only)

## Fuel Tanks

Steel – Shallow (13" depth)

Steel – Deep (16" depth; diesel)

## Engine Equipment

Cummins ISB 6.7L Turbo Diesel

6.8L Triton® V10 3-valve gas (F-650 Pro Loader; F-650 only)

Engine block heater – 750-watt

Engine exhaust brake – Variable Geometry Turbocharger (VGT™) (activation switch is in overhead pod; diesel)

CARB-compliant vehicle (receives clean idle label on hood; diesel)

CARB-exempt vehicle (no label; diesel)

Non-CARB-compliant vehicle (41-state certification; diesel)

CNG/LPG Gaseous Engine Prep Package includes hardened intake valves and valve seats (6.8L Triton V10 gas)

## Driveline & Clutches

Clutch – Fuller® 14," single-plate, adjustment-free (diesel)

Clutch – Fuller 14," 2-plate, adjustment-free (diesel)

EmGard SAE 50 synthetic manual transmission lubricant (diesel)

Ford TorqShift® 6-speed automatic transmission (with PTO provision; gas)

Spicer SPL 140 driveshaft (diesel)

## Exhaust

5-gal. DEF tank – Mounted left frame rail under cab for clean CA on Regular Cab/SuperCab only (diesel)

10-gal. DEF tank – Mounted right frame rail aft of cab on Regular Cab/SuperCab; under cab on Crew Cab (diesel)

In-line single, horizontal, diesel particulate filter assembly; frame-mounted right side back of cab, single horizontal SCR assembly; frame-mounted right side back of cab, includes horizontal tailpipe; exits in front of rear wheels on right side (over-221" wheelbase only; diesel)

Switchback single, horizontal, diesel particulate filter assembly; frame-mounted outside right rail under cab; includes single horizontal SCR assembly; frame-mounted outside right rail under cab; horizontal tailpipe right-side outlet (available on all wheelbases; requires left-side or temporary battery mount; diesel)

Switchback single, horizontal, diesel particulate filter assembly; frame-mounted outside right rail under cab; includes single horizontal SCR assembly; frame-mounted outside right rail under cab; horizontal tailpipe left-side outlet (available on all wheelbases; requires left-side or temporary battery mount; diesel)

Switchback single, horizontal, diesel particulate filter assembly; frame-mounted outside right rail under cab; includes single horizontal SCR assembly; frame-mounted outside right rail under cab; right-side-mounted vertical tailpipe and guard (available on all wheelbases; requires left-side or temporary battery mount; diesel)

Turn-back outlet for vertical exhaust only (diesel)

## Electrical

Alternator – 220-amp, 12-volt Leece-Neville (diesel)

Alternator – 320-amp, 12-volt Leece-Neville (diesel)

Batteries – 900 CCA, 12-volt (2 for a total of 1,800 CCA; diesel)

Batteries – 625 CCA, 12-volt (3 for a total of 1,875 CCA; diesel)

Batteries – 900 CCA, 12-volt (3 for a total of 2,700 CCA; diesel)

Battery box – Temporary mount (dual 625 CCA or dual 900 CCA only; diesel)

Body-builder special wiring harness

Body-builder wiring to end of frame

Daytime running lamps

Electric, 102-decibel backup alarm

Fender-mounted, front- and rear-facing turn signal lamps

Remote-mounted jump-start stud

Truck-Lite® Super 44 stop/turn/tail and Truck-Lite Super 40 backup lamps (includes separate rear reflectors; does not include power module or rubber mount)

Taillamp delete (does not omit cable to end of frame)

## Cab Equipment – Exterior

Front bolt-on-type frame extension, 20," without crossmember (requires fixed grille, swept-back front bumper or front bumper delete; n/a on Pro Loader)

Front bumper – Full-width, painted-steel, Dark Shadow Gray color (n/a on XLT)

Front bumper – Swept-back, painted-steel, Dark Shadow Gray color (requires frame extension)

Front bumper delete

## Cab Equipment – Exterior (continued)

Front license plate holder with upper and lower mounting-plate hardware (diesel)

Front tow hooks (2) – Frame-mounted inside rail (included on XLT)

Grille – Dark Shadow Gray

Grille – Fixed, Dark Shadow Gray

Horn – Air, black, single-trumpet, mounted on frame rail back of bumper (diesel)

Mirrors – Auxiliary convex (2), stainless steel, 8" diameter, mounted below primary mirrors (included on XLT)

Mirrors – Dual stainless steel with heated and lighted heads, rectangular, 7.5" x 16.5," West Coast-style, 102"-wide spacing

Mirrors – Trailer tow, manually telescoping with manual glass and manual 2-way fold (sail mount)

Mirrors – PowerScope® trailer tow, power-telescoping with power glass, power-folding, heated, includes manual convex integrated blind spot mirrors, integrated clearance lamps and turn signal indicators (sail mount; XLT only; n/a with air conditioning delete)

Wheel ornamentation – Front/rear; Ford bright center cap and lug nut covers (polished aluminum wheels only)

## Cab Equipment – Interior

Air conditioning delete; fresh air heater and defroster only (XL only)

AM/FM stereo/single-CD player with MP3 capability, USB port, Ford SYNC® clock and 2 speakers (Regular Cab); 4 speakers (SuperCab/Crew Cab) (included on XLT)

Back panel trim cover (Regular Cab/Crew Cab only)

Color-coordinated carpet floor covering (available on XLT and with leather-trimmed or 40/20/40 split front seats)

Front, floor-mounted mini-console between seats with dual cupholders; open low profile (included with passenger bucket seat)

Front, floor-mounted full console between seats includes dual cupholders and large storage compartment with lid (available only with leather-trimmed seats and carpet; requires automatic transmission)

Hour meter located in overhead pod (pod replaces overhead console if equipped, front map lights relocated mid-cab on SuperCab/Crew Cab; diesel)

Non-self-canceling turn signal switch (tractor use only; n/a on Pro Loader)

Steering wheel – Black leather-wrapped 2-spoke with integral cruise control switches; 15.5" diameter only (available on XLT only)

SYNC Delete – Replaces standard radio with AM/FM stereo/single-CD player with MP3 capability, dash-mounted audio input jack and clock (XLT only)

Transmission temperature gauge/hour meter located in overhead pod (diesel)

Transmission temperature gauge/hour meter/voltmeter located in overhead pod (diesel)

Transmission temperature gauge located in overhead pod (pod replaces overhead console if equipped; front map lights relocated mid-cab on SuperCab/Crew Cab), Allison Transmission only (diesel)

Voltmeter located in overhead pod (pod replaces overhead console if equipped; front map lights relocated mid-cab on SuperCab/Crew Cab; replaces overhead console; diesel)

Upfitter switches (4) located in center IP with connector access located in engine compartment; 10-amps per switch (XL gas)

Cummins is a registered trademark of Cummins Inc. Spicer is a registered trademark of Dana Limited. Meritor is a registered trademark of Meritor Technology, Inc. Allison Transmission is a trademark of Allison Transmission, Inc. VGT is a trademark of Cummins Inc. Fuller is a registered trademark of Eaton Corporation. Microsoft is a registered trademark of Microsoft Corporation. Donaldson is a registered trademark of Donaldson Company, Inc. Fleetguard is a registered trademark of Fleetguard, Inc. Quadraulic is a trademark of Meritor Technology, Inc. STEMCO is a registered trademark of STEMCO LP. EmGard is a registered trademark of Cognis IP Management GmbH. Bendix is a registered trademark of Honeywell International Inc. Truck-Lite is a registered trademark of and proprietary to Truck-Lite Co., LLC.



# F-650/F-750 SUPER DUTY® Trim Packages and Colors



## Standard XL Trim Package

2-person Steel Gray HD vinyl 70% width front-passenger seat with fold-down armrest and cupholders

3-person Steel Gray HD vinyl 60/40 split rear bench seat (SuperCab/Crew Cab)

AM/FM stereo with clock and 2 speakers

Charcoal Black air registers

Door-trim panels with standard armrests

High-back Steel Gray HD vinyl 30% width driver's seat with integrated head restraint

Manual air conditioning

Mirrors – West Coast-style sideview (diesel)

Mirrors – Sail-type sideview with integrated blind spot mirrors (gas)

Molded cloth headliner

Overhead console with dual sunglasses bins and integral map lights (SuperCab/Crew Cab)

Right- and left-hand coat hooks

Sun visors – Driver and front-passenger cloth with passenger-side mirror

## Optional XLT Trim Package

2-person Steel Gray cloth 70% width front-passenger seat with fold-down armrest and cupholders

3-person Steel Gray cloth 60/40 split rear bench seat (SuperCab/Crew Cab)

AM/FM stereo/single-CD player with MP3 capability, USB port, clock and 2 speakers (Regular Cab) or 4 speakers (SuperCab/Crew Cab)

Chrome-trimmed air registers

Ford SYNC® voice-activated, in-vehicle communications and entertainment system

Front tow hooks (2)

High-back Steel Gray cloth 30% width driver's seat with integrated head restraint

Manual air conditioning

Mirrors – West Coast-style sideview with 8" diameter convex blind spot mirrors (diesel)

Mirrors – Sail-type sideview with integrated blind spot mirrors (gas)

Molded cloth headliner

Molded door-trim panels with upper and lower map pockets with soft-foamed armrests

Overhead console with dual sunglasses bins and integral map lights (all cab styles)

Power Equipment Group includes power front windows (Regular Cab/SuperCab), power front and rear windows (Crew Cab), and power door locks (all cab styles)

Right- and left-hand coat hooks

Sun visors – Driver and front-passenger cloth with passenger-side mirror

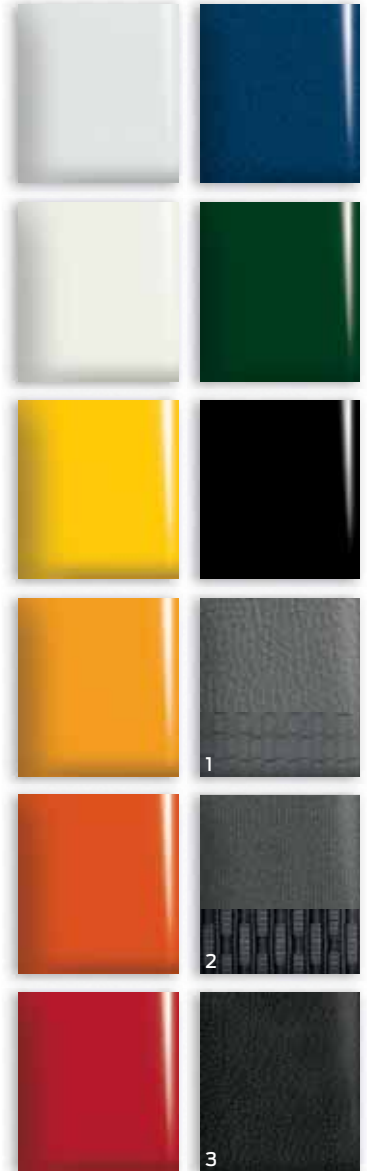









Exteriors	Interiors		
Oxford White	1	2	3
Winter White	1	2	3
Bold Yellow	1	2	3
School Bus Yellow	1	2	3
Tangerine Orange	1	2	3
Bright Red	1	2	3
True Blue	1	2	3
Holly Green	1	2	3
Black	1	2	3

1 Steel Gray HD Vinyl – Standard on XL; Optional on XLT  
 2 Steel Gray Cloth – Standard on XL; Optional on XLT  
 3 Charcoal Black Leather – Optional on XLT

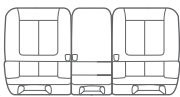
Colors are representative only. See your dealer for actual paint/trim options.

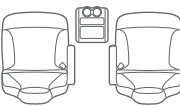
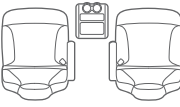

# F-650/F-750 SUPER DUTY® Seating

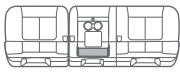
Standard Front Seats		Seat Suspension System	Seating Position Availability	XL <sup>1</sup>	XLT <sup>2</sup>
	30% width high-back bucket with integrated head restraint, fore/aft adjustment, reclining, and armrest	Fixed-spring	Driver	●	●
	70% width 2-person, intermediate-back folding, outboard-position integrated head restraint, fold-down armrest with cupholders	Fixed-spring	Center/Passenger	●	●
<b>Optional Front Seats</b>					
	40/20/40 split front, full-width, fore/aft adjustment, reclining, low-back with adjustable head restraints; driver's seat includes manual lumbar; fixed center seat includes fold-down armrest with tray and cupholders	Fixed-spring	Driver/Center/Passenger	○	○
	40% width high-back captain's chair with integrated head restraint, fore/aft adjustment, reclining with armrest and floor-mounted mini-console	Fixed-spring	Driver	○	○
	Air suspension with integral-pump high-back bucket with integrated head restraint; includes armrest and floor-mounted mini-console (Regular Cab deletes coat hooks on XL; Regular Cab and Crew Cab only)	Air suspension with integrated air compressor <sup>3</sup>	Driver	○	○
	Full air-ride high-back bucket with integrated head restraint, dumping/full reclining with armrest and floor-mounted mini-console (Regular Cab and Crew Cab only)	Air-ride <sup>4</sup> /Fixed-spring	Driver or Driver/Passenger	○	○
	Full air-ride high-back buckets with integrated head restraints, dumping/full reclining, and fore/aft isolation armrests and floor-mounted mini-console (Regular Cab and Crew Cab only)	Air-ride/Fixed-spring	Driver/Passenger	○	○
	Air suspension with integral-pump high-back buckets with integrated head restraints, armrests and floor-mounted mini-console (Regular Cab and Crew Cab only)	Air suspension with integrated air compressor <sup>3</sup>	Driver/Passenger	○	○
	Leather-trimmed high-back captain's chairs with 6-way power adjust, reclining, integrated head restraints, heated driver/outboard passenger, integrated armrests and full center console (diesel only)	Fixed-spring	Driver/Passenger	—	○
<b>Standard Rear Seats<sup>5</sup></b>					
	60/40 split, 3-person rear bench, full-width, fold-up; converts to loadfloor (SuperCab)	High-density foam	Rear bench	●	●
	60/40 split, 3-person full-size rear bench, full-width with folding back (Crew Cab)	Fixed-spring	Rear bench	●	●

● Standard ○ Optional — Not available

<sup>1</sup>Steel Gray HD Vinyl standard; Steel Gray Cloth optional. <sup>2</sup>Steel Gray Cloth standard; Steel Gray HD Vinyl optional. <sup>3</sup>Available only with Hydraulic Brake System option.

<sup>4</sup>Requires air brakes or air compressor option. <sup>5</sup>Rear seat is vinyl with leather-trimmed front seats on SuperCab.



# TECHNICAL SPECIFICATIONS

## FRAMES

Model	Frame Order Code											
	533	534	535	536	537	538	539	53F	53A	53J	53L	412/410
F-650 Pro Loader® gas	—	—	—	—	●	—	—	—	—	—	—	—
F-650 Pro Loader diesel	—	—	—	—	●	—	—	—	—	—	—	—
F-650 gas	●	○	○	○	—	—	—	—	—	—	—	—
F-650 diesel	○	●	●	○	—	—	—	—	—	—	—	—
F-750 diesel	—	—	○	○	—	○	○	○	●	○	○	○
Depth (in.)	9.125	10.125	10.250	10.125	9.125	10.250	10.375	10.125	10.250	10.250	10.375	10.813
Width (in.)	3.062	3.062	3.092	3.580	3.062	3.610	3.705	3.580	3.092	3.610	3.705	3.892
Thickness (in.)	0.312	0.312	0.375	0.312	0.312	0.375	0.438	0.312	0.375	0.375	0.438	0.312
Yield (psi)	80,000	50,000	80,000	120,000	80,000	120,000	120,000	120,000	80,000	120,000	120,000	120,000
Maximum section modulus (cu. in.)	11.47	13.31	15.94	14.84	11.47	17.79	21.05	14.84	15.94	17.79	21.05	29.84
Maximum resisting bending moment (in.-lbs.)	917,600	665,500	1,275,200	1,780,800	917,600	2,134,800	2,526,000	1,780,800	1,275,200	2,134,800	2,526,000	3,580,800

## SUSPENSIONS

Model	Front Spring Rating (lbs.)					Rear Multi-Leaf Springs Rating (lbs.)						Rear Air Suspension Rating (lbs.)				
	8,500	10,000	12,000	13,200	14,000	15,500	17,500	18,500	20,000	23,500	31,000	12,000	15,500	18,500	20,000	23,000
F-650 Pro Loader gas	●	—	—	—	—	—	●	—	—	—	—	—	—	—	—	—
F-650 Pro Loader diesel	●	○	—	—	—	—	●	—	—	—	—	○	○	○	—	—
F-650 gas	●	○	○	—	—	○	—	●	○	○	—	—	—	—	—	—
F-650 diesel	●	○	—	—	—	○	—	●	○	—	—	—	—	○	○	—
F-750 diesel	—	●	○	○	○	—	—	—	—	●	○	—	—	—	○	○

## AXLES

Model	Front Axle Rating (lbs.)					Rear Axle Rating (lbs.) – Single-Speed						Rear Axle Rating (lbs.) – 2-Speed	
	8,500	10,000	12,000	13,200	14,000	13,500	15,500	17,500	19,000	21,000	23,000	21,000	23,000
F-650 Pro Loader gas	●	—	—	—	—	●	○	○	—	—	—	—	—
F-650 Pro Loader diesel	●	○	—	—	—	●	○	○	—	—	—	—	—
F-650 gas	●	○	—	—	—	—	—	●	○	○	—	—	—
F-650 diesel	●	○	—	—	—	—	—	●	○	—	—	—	—
F-750 diesel	—	●	○	○	○	—	—	—	—	●	○	○	○

## DIMENSIONS

	Regular Cab (in.)	SuperCab (in.)	Crew Cab (in.)
A. Overall height	88.3–94.7	88.6–94.6	89.1–95.1
B. Width at front fenders	96.7	96.7	96.7
C. Frame rail spacing	34.0	34.0	34.0
D. Front bumper to back of cab	113.0	134.0	148.0
E. Loadfloor height	33.6–40.4	33.6–40.4	33.6–40.4
F. Front bumper to center of front axle	39.0	39.0	39.0
G. Wheelbase	134.0–281.0	155.0–281.0	170.0–266.0
H. Center of rear axle to end of frame	39.0–120.0	39.0–120.0	39.0–87.0
I. Back of cab to center of front axle	74.0	95.0	110.0
J. Back of cab to center of rear axle	60.0–207.0	60.0–186.0	60.0–156.0

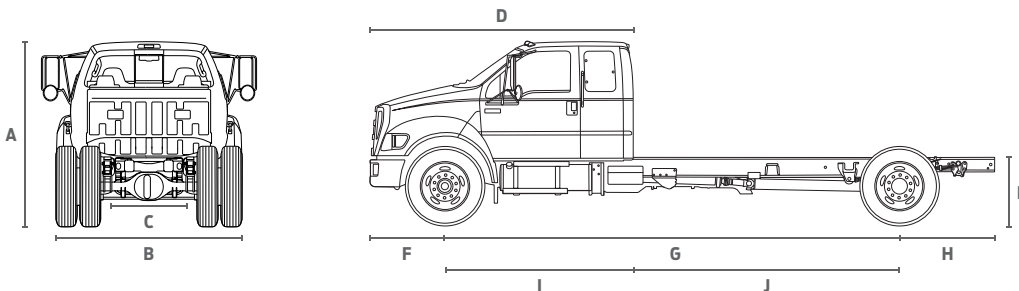

● Standard ○ Optional ● Select availability — Not available

2012 F-650/F-750 SUPER DUTY® [ford.com](http://ford.com)



# TECHNICAL SPECIFICATIONS

## FUEL TANKS

Model	13" Tank Depth – Shallow (gals.)								16" Tank Depth – Deep (gals.)					
	—	42	—	60	—	—	—	—	—	—	—	—	—	—
F-650 Pro Loader® gas	—	42	—	60	—	—	—	—	—	—	—	—	—	—
F-650 Pro Loader diesel	35	—	45	—	65	45/45	65/45	65/65	—	—	—	—	—	—
F-650 gas	—	42	—	60	—	—	—	—	—	—	—	—	—	—
F-650 diesel	35	—	45	—	65	45/45	65/45	65/65	50	65	80	50/50	65/65	80/65
F-750 diesel	35	—	45	—	65	45/45	65/45	65/65	50	65	80	50/50	65/65	80/65

## WEIGHT RATINGS & WHEELBASE/CAB-TO-AXLE RANGES

Model	GVWR (lbs.)	Cab	Wheelbase/Cab-to-Axle Range (in.)	Options
F-650 Pro Loader gas	20,780 – 26,000	Regular Cab SuperCab Crew Cab	158/84 – 242/160 179/84 – 239/144 194/84 – 254/144	5 3 3
F-650 Pro Loader diesel	20,500 – 26,000	Regular Cab SuperCab Crew Cab	134/60 – 242/168 155/60 – 239/144 170/60 – 254/144	6 4 4
F-650 gas	26,000 – 30,000	Regular Cab SuperCab Crew Cab	158/84 – 260/186 179/84 – 281/186 194/84 – 278/168	11 11 10
F-650 diesel	20,940 – 29,000	Regular Cab SuperCab Crew Cab	146/72 – 281/207 167/72 – 281/186 182/72 – 278/168	14 13 12
F-750 diesel	25,999 – 37,000	Regular Cab SuperCab Crew Cab	146/72 – 281/207 167/72 – 281/186 182/72 – 266/156	15 13 11

## WHEEL AVAILABILITY

Wheel (in.)	F-650 Pro Loader		F-650		F-750
	Gas	Diesel	Gas	Diesel	Diesel
19.5 x 6.75 8-lug white powder-coated steel	●	●	○	○	—
19.5 x 7.5 8-lug polished aluminum <sup>1</sup>	○	○	○	○	—
19.5 x 7.5 10-lug white powder-coated steel	—	○	—	○	—
19.5 x 7.5 10-lug polished aluminum <sup>1</sup>	—	○	—	○	—
22.5 x 7.5 10-lug white powder-coated steel	—	—	●	●	●
22.5 x 8.25 10-lug white powder-coated steel	—	—	○	○	○
22.5 x 8.25 10-lug polished aluminum	—	—	○	○	○
Wheel ornamentation –	○	○	○	○	○
Ford bright center cap and lug nut covers	○	○	○	○	○



White Powder-Coated Steel (front)

## TIRE AVAILABILITY

F-650 Pro Loader		F-650		F-750	Tire Size <sup>2</sup>	Load Range (PR)	Steel	Aluminum
Gas	Diesel	Gas	Diesel	Diesel				
○	○	○	○	—	225/70R19.5F	12	○	○
—	○	—	○	—	225/70R19.5G	14	○	○
—	○	○	○	—	245/70R19.5F	12	○	○
●	●	○	○	—	245/70R19.5G	14	○	○
○	○	○	○	—	245/70R19.5H	16	○	○
○	○	○	○	—	265/70R19.5G	14	○	○
—	—	○	○	○	9R22.5F	12	○	—
—	—	●	—	○	10R22.5F	12	○	—
—	—	○	○	○	10R22.5G	14	○	—
—	—	○	○	○	11R22.5G	14	○	○
—	—	○	●	●	11R22.5H	16	○	○
—	—	○	○	○	235/80R22.5G	14	○	—
—	—	○	○	○	255/70R22.5H	16	○	—
—	—	○	○	○	255/80R22.5G	14	○	○
—	—	○	○	○	275/70R22.5H	16	○	○
—	—	○	○	○	275/70R22.5J	18	○	○
—	—	○	○	○	275/80R22.5G	14	○	○
—	—	○	○	○	295/75R22.5G	14	○	○
—	—	○	○	○	295/80R22.5H	16	○	○



Polished Aluminum with Optional Wheel Ornamentation (front)

● Standard ○ Optional ● Select availability — Not available

<sup>1</sup>Outer wheel only – inner wheel is steel.

<sup>2</sup>Due to industry-wide tire availability shortages, tire substitutions may be required at time of vehicle production.





# QUALITY, GREEN, SAFE AND SMART.

[ford.com](http://ford.com)

**Business Preferred Network.** Each of the select dealerships in our Business Preferred Network (BPN) is committed to providing quality commercial-oriented products and service, as well as special financing and billing arrangements, to businesses that rely on Ford products. As a BPN customer, you receive dedicated commercial service at your BPN dealership to help get your vehicle back on the road quickly. □ **Financial Services.** Our commercial purchase plans and lines of credit offer attractive rates, negotiable terms and business-friendly options. If you prefer to lease, our CommercialLease<sup>SM</sup> programs offer a wide variety of package options to meet your needs. For additional information, please visit our website at [fordcredit.com/comlend/](http://fordcredit.com/comlend/). □ **Ford Extended Service Plan.** For a purchase or lease, the Ford Extended Service Plan (ESP) gives you "Peace-of-Mind" protection designed to cover key vehicle components and protect you from the cost of unexpected repairs. Ask your dealer for a Ford ESP, the only service contract backed exclusively by Ford and honored at all Ford dealerships.

