

# 1975 Plymouth GRAN FURY

Gran Fury Brougham  
Gran Fury Custom/Gran Fury





## Gran Fury Brougham

Whatever your motive for buying a new car—looks, comfort, convenience, handling or adult-size security—count on our new Gran Fury Brougham to completely satisfy your most individual motoring needs.

Start with looks. Gran Fury Brougham is a full-size, proud-looking automobile . . . with the kind of beauty that suggests the many luxuries you'll discover inside. For 1975, the die-cast grille and unique front styling are important visual highlights.

A total of 19 carefully selected colors are yours to choose . . . and eight of these are vibrantly new for '75. There are also seven vinyl roofs to complement your choice of body color . . . blue, green, gold, parchment black, white and rich new dark red.

Deluxe wheel covers also add an extra touch of glamour. Brougham 2-Door Formal Hardtop owners gain instant recognition thanks to its distinguished opera windows. The jewel-like hood medallion provides special evidence that you are in command of the flagship of the 1975 Plymouth fleet.

The practical aspects of Gran Fury's beauty offer as much appeal as its styling motif. Its size has a purpose: to accommodate a total of six healthy adults in the kind of comfort they expect in their home . . . without knee-bends or strained necks. The sedan's 20.4 cubic feet of trunk space will handle a full load of family vacation gear. And an expanse of glass area offers a panorama everybody can enjoy.

The total effect, we think you'll agree, is a car that looks and feels and rides like it costs a lot more than it actually does.



Above: The Gran Fury Brougham 4-Door Hardtop.



Below: The Gran Fury Brougham 2-Door Formal Hardtop.

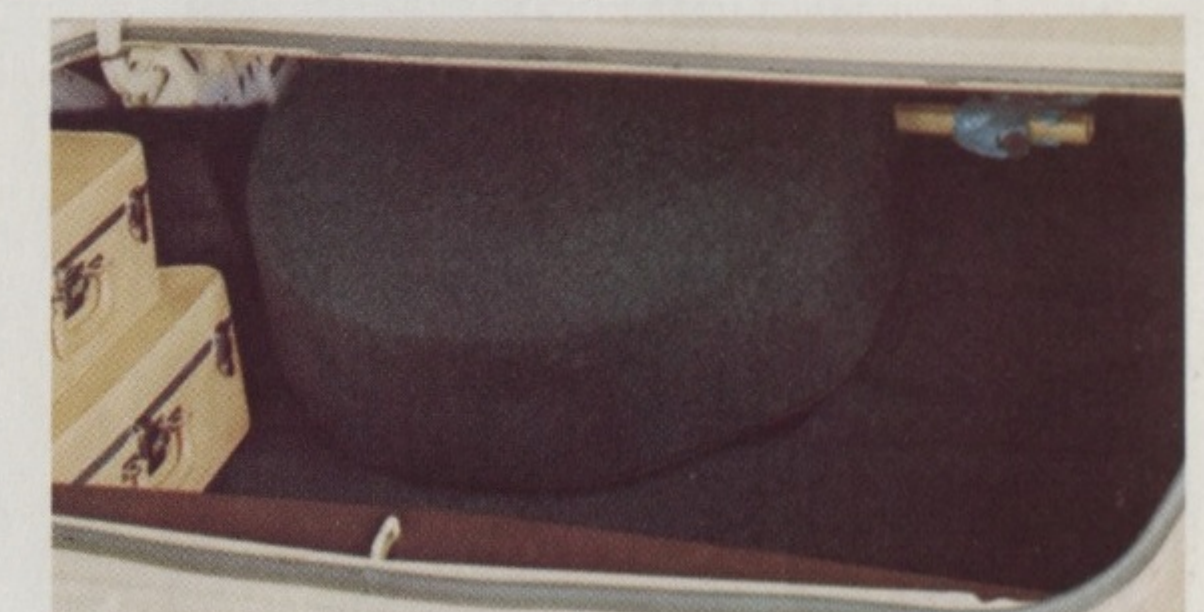

Trunk space signifies Gran Fury's family-size room.



Convenient glove box with coin holder.



Optional Auto Speed Control—helps maintain road speed and avoid wasting fuel.



Below: The illustration shows the richness of this Brougham optional cloth-and-vinyl 50/50 split-bench interior. Seats are gently contoured for driver and passenger comfort. Door panel reflects typical clean, tailored look.



Electronic digital clock is an increasingly popular option.



Gran Fury Brougham standard interior in cloth-and-vinyl with center folding armrest.

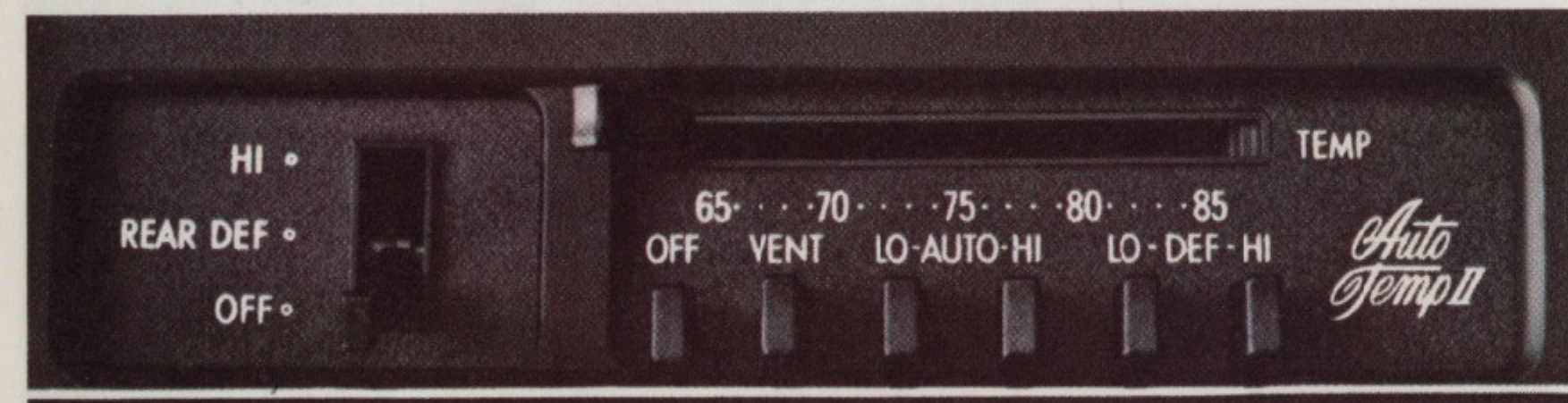

Optional Auto Temp air conditioning permits fingertip selection of temperature.

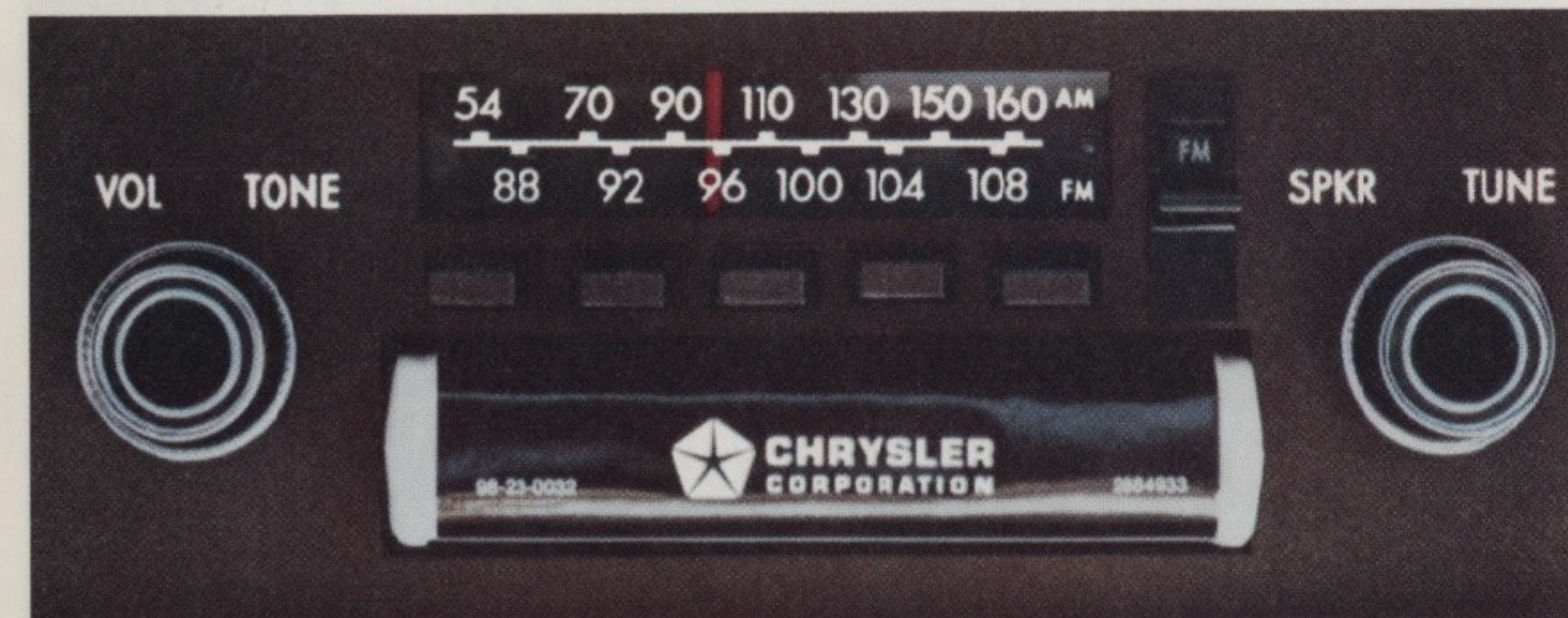

AM/FM stereo with 8-track tape deck is only one of a wide range of optional radios.

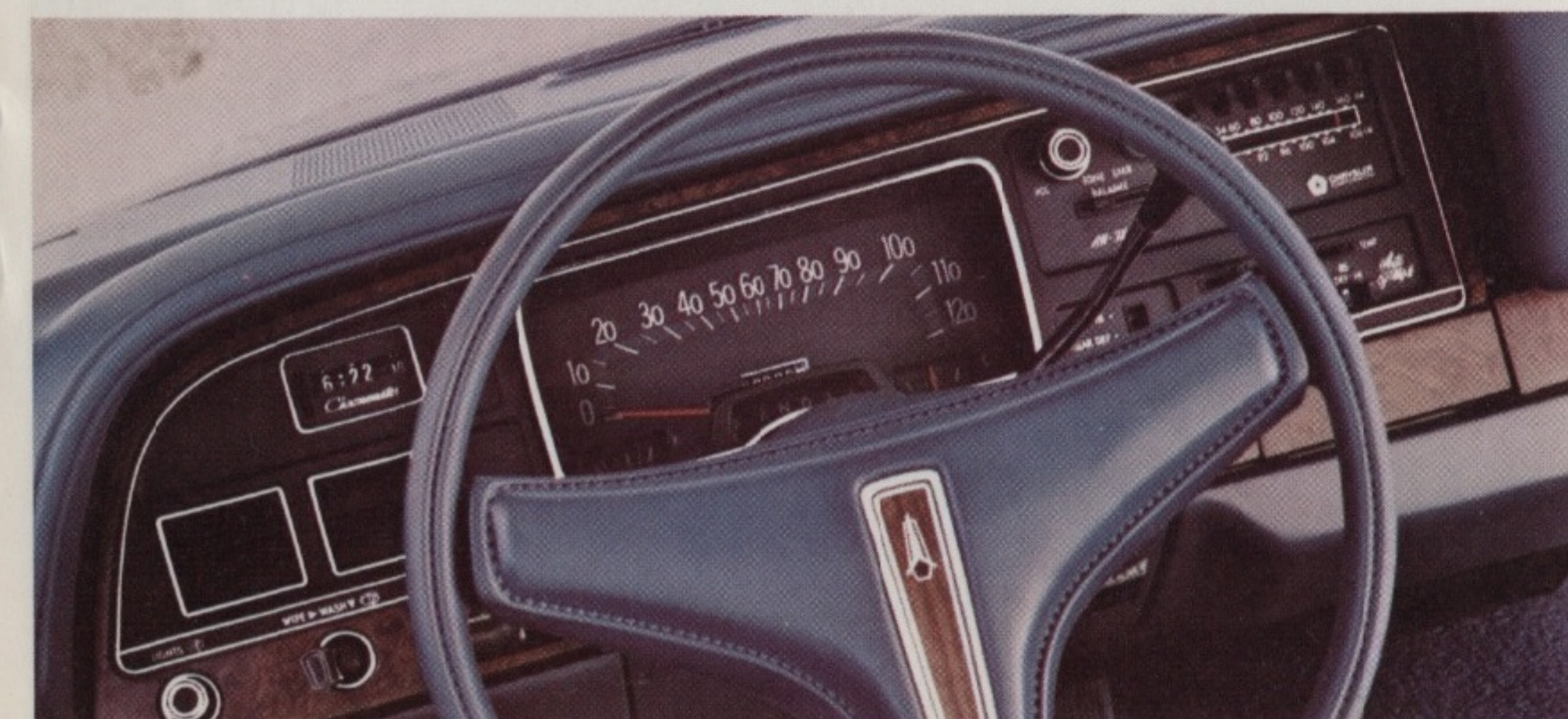

The beautifully finished instrument panel is as easy to use as it is to look at.

## Gran Fury Brougham Interior & Features

You're going to appreciate the remarkable degree of comfort and luxury and convenience provided in the Brougham's tastefully coordinated interiors.

It all has to do with a meaningful word in automotive design: ergonomics. Which simply means that all driving and seating components are meticulously planned for easy use as well as being pleasant to live with. The Brougham, in total, provides the kind of human engineering that makes you feel "right" inside these most luxurious Plymouths.

From the very start, you'll appreciate the Brougham's gently contoured seats. You slide in easily behind the tailored steering wheel. Standard upholstery is a splendid vinyl/cloth combination, deeply cushioned, and providing a pull-down center armrest. In addition, a cloth-and-vinyl 50/50 seat with its relaxing passenger reclining feature (on the 4-door models) and individual adjustment for both sides is an available option.

Nylon deep-pile carpeting lines the floor of the whole passenger compartment and is used to practical purpose on the lower door panel.

To further demonstrate that the Brougham decorators know the score, a number of other welcome features are yours at no extra cost. The instrument panel retains the benefits of the modular concept introduced so successfully in 1974. Each panel can be easily removed for minor service if ever necessary. Operational controls are located at the left, comfort controls at the right. Within a very short time you become completely at home with their position—and that means your undivided attention is saved for the road.

Another welcome design feature is the upper level ventilation system. Constant changes of air make the Gran Fury Brougham's interior pleasant for smokers and non-smokers alike.

Your comfort is additionally served by a number of other important standard features. You are surrounded by Unibody construction with well over 4000 spot welds holding it in a single, sturdy unit. You ride on our torsion-bar suspension. Hydraulic action bumper system helps eliminate damage in case of minor impacts. And layers of mastic sprays, foam seals and pads attest to our efforts to isolate you from bothersome road noises and distraction. Standard equipment also includes power steering—an idea pioneered by Chrysler engineers 23 years ago. Power front disc brakes—mated with standard steel-belted radial-ply tires for secure, smooth stopping. Then, there's Gran Fury Brougham's 400 cubic inch V-8 and Torque-Flite automatic transmission—a much admired combination noted for its smoothness.

Gran Fury Brougham. Yes, you'll wonder how so much luxury can be priced so reasonably.





Above: Gran Fury Custom 4-Door Hardtop.



Gran Fury Custom all-vinyl seats with center armrest are optional.



Standard cloth-and-vinyl bench seat interior for the Gran Fury Custom.

## Gran Fury Custom

If your present car budget is slightly more modest, though your car needs are as compelling as the Gran Fury Brougham buyer, we can't think of a more likely alternative than the cars you see on these pages, Gran Fury Custom 2-Door Hardtop and Custom 4-Door Sedan. (You may find the Gran Fury 4-Door Sedan or Custom 4-Door Hardtop just as interesting.)

All the basic benefits that come with Plymouth's thoughtful engineering are yours in the Custom. Unibody, sound insulation, Electronic Ignition, flow-through upper ventilation, TorqueFlite transmission, power steering and brakes, and a wide range of considerate driving aids.

The most dramatic value to many will be the spacious and undeniably luxurious interiors. The Gran Fury Custom's standard cloth-and-vinyl bench seat is a splendid case in point.

The instrument panel is handsome and functional and interior space is what you expect of this full-size automobile. Full carpeting is standard. Many details like a lighted bin-type glove compartment with convenient coin holder, driver's outside mirror, three-spoke padded steering wheel, flush-type door handles, illuminated instrument panel callouts, handy inside hood release, color coordinated safety belts for the Gran Fury's starter interlock safety restraint system—and many others—all contribute to a value story of sizeable proportions.

Standard power for the Gran Fury is our smooth, efficient and durable 360 V-8. It's ideally sized for the many tasks most people require of their Gran Fury . . . and gets the job done with remarkable efficiency. The 360 is hefty enough to provide a proper reserve for such popular comforts and conveniences as air conditioning, power steering and brakes, or such auxiliary services as trailer towing, while still maintaining its reputation for outstanding performance. Also contributing to your Gran Fury's economy potential are the long-lasting steel-belted radial-ply tires.

You are also free to choose among the many optional comforts and conveniences that make Gran Fury an even more satisfying investment. Our air conditioning system with automatic temperature control provides quiet, efficient interior cooling at a level chosen by a simple dial setting. A complete family of radios, including AM/FM stereo with 8-track stereo tape, is available at extra cost.

Value? You couldn't find a better word for it than Gran Fury Custom—in terms of price and driving satisfaction.



# Gran Fury Options

Options	Gran Fury	Gran Fury Custom	Gran Fury Brougham	Check List
<b>Comfort/Convenience</b>				
Air Conditioning Manual	O	O	O	
Air Conditioning Auto Temp Control	O	O	O	
Automatic Height Control	O	O	O	
Carpets	S	S	S	
Clock—Electric	O	O	S	
Clock—Electronic Digital	O	O	O	
Defroster Rear Window Electric	O	O	O	
Differential Sure-Grip	O	O	O	
Easy Order Group	N/A	O	O	
Emission Control System & Testing	O	O	O	
Engine Block Heater	O	O	O	
Engine Temperature & Oil Pressure Gauges	O	O	O	
Fuel Pacer System	O	O	O	
Gas Cap Locking	O	O	O	
Horns Dual	O	O	S	
Light Package	O	O	O	
Luxury Equipment Package	N/A	O	O	
Power Seat Bench 6-way	O	O	O	
Power Seat Left 6-way	N/A	N/A	O	
Power Deck Lid	O	O	O	
Power Door Locks	O	O	O	
Power Windows	O	O	O	
Radio—AM	O	O	O	
Radio—AM w/8-track Stereo	O	O	O	
Radio—AM/FM	O	O	O	
Radio—AM/FM Stereo	O	O	O	
Radio—AM/FM Stereo w/8-track Tape	O	O	O	
Rear Seat Speaker	O	O	O	
Security Alarm System	O	O	O	
Speed Control Automatic	O	O	O	
Steering Wheel Deluxe	O	O	O	
Steering Wheel—Tilt & Tel	O	O	O	
Deluxe Windshield Wiper Package	O	O	O	
Tinted Glass All Windows	O	O	O	
Tinted Glass Windshield Only	O	O	O	
Trailer-Towing Package—Heavy	O	O	O	
Trailer-Towing Package—Light	O	O	O	
Trunk Dress-Up	O	O	O	
Undercoating and Hood Pad	O	O	O	
Vented Windows—Manual	O	O	O	
<b>Decor/Dress-up</b>				
Door Edge Protectors	O	O	O	
Door Frame Moldings	O	O	N/A	
Floor Mats Color-Keyed	O	O	O	
Mirror—Remote-control Left	O	O	O	
Mirror—Remote-control Left & Right	O	O	O	
Sun Roof With Vinyl Roof	O	O	O	
Tires—Whitewalls	O	O	O	
Wheel Covers—Deluxe	O	O	S	
Wheel Covers—Premier	O	O	O	
Road Wheels—Chrome Style	O	O	O	
Vinyl Body Side Molding	O	O	O	
<b>Performance</b>				
318 V-8 (2-barrel)	O	O	N/A	
360 V-8 (2-barrel)	S	S	O	
360 V-8 (4-barrel) (Calif. only)	O	O	O	
400 V-8 (2-barrel)	O	O	S	
400 V-8 (4-barrel) (Calif. only)	O	O	O	
440 V-8 (4-barrel)	O	O	O	
Battery 500-ampere Long Life	O	O	O	
Heavy-duty Shock Absorbers	O	O	O	
Heavy-duty Suspension	O	O	O	

O—Optional S—Standard N/A—Non-Applicable



Trailer enthusiasts can depend on Gran Fury toughness.

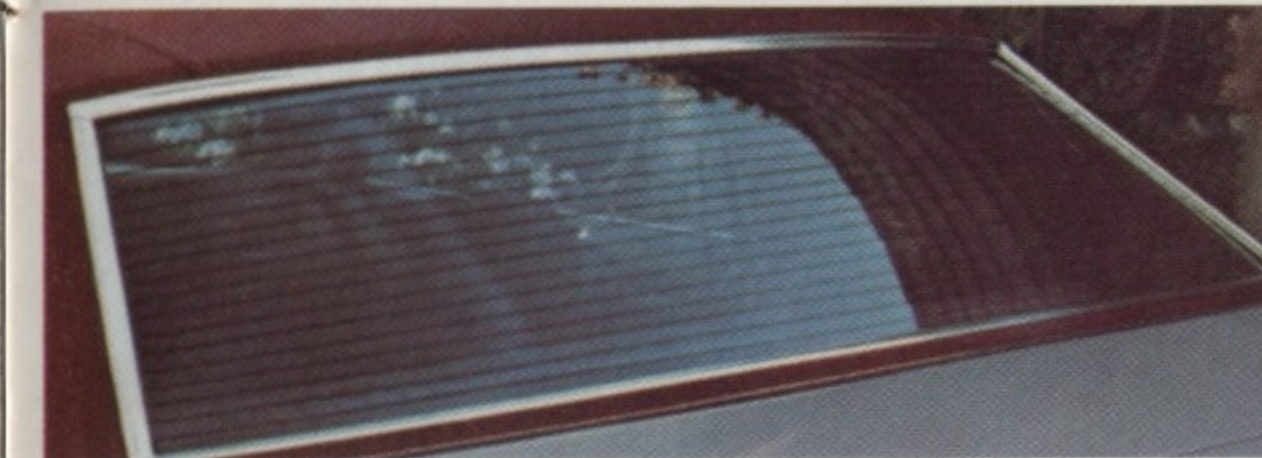

Electric rear window defroster.



Fuel Pacer—a light that saves money.

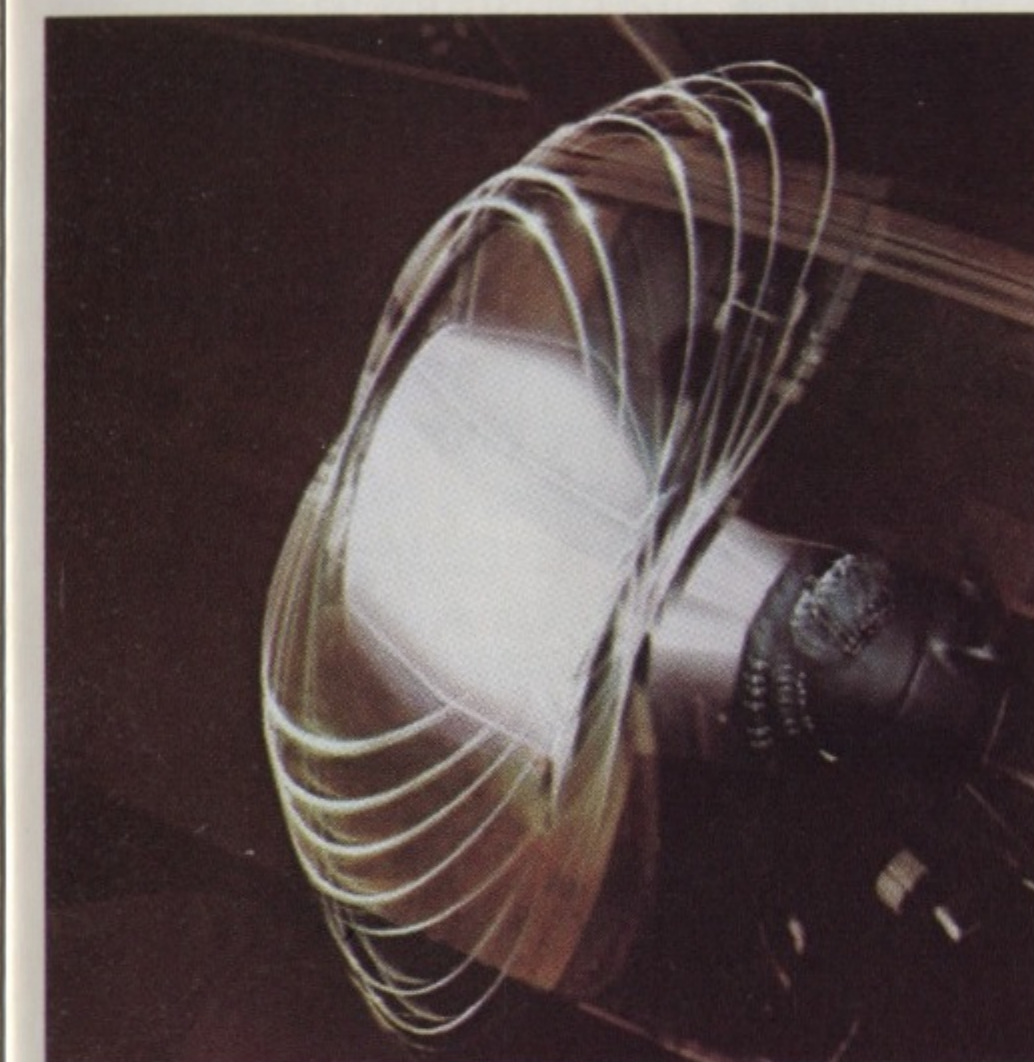

Tilt-Telescope wheel—for personalized driving.



Chrome-styled road wheel—extra sporty look.



Vent Window—aids interior air flow.



Sun Roof—for fresh air enthusiasts.



## Making a fine car investment an ever finer one.

A review of the information already shown in this brochure tells you the '75 Gran Fury offers an outstanding array of standard equipment. There still remain a number of optional features you may choose to make your Gran Fury even more pleasurable and more rewarding.

**Trailer enthusiasts**, for example, benefit from Gran Fury's solid, big car engineering advances. And there are special packages designed to fit your needs—whether you require equipment to meet the demands of trailers in the lightweight category (up to 2000 lbs. loaded weight) or heavyweight category (up to 7000 lbs. loaded weight). There's a special catalog which covers in detail all aspects of trailer towing.

Our **electric rear-window defroster** has become a highly popular choice in wintry climates. Heat conducting elements applied to the glass, offer quick, thorough removal of ice or snow or damp weather fog-up within minutes.

Right for the times is the new **Fuel Pacer System**. Located in the left exterior turn signal indicator housing, it flashes you an amber warning when your foot becomes a bit too heavy.

Something each driver in the family will find to their liking—Gran Fury's **Tilt & Telescope Steering Wheel**. Lets everybody adjust steering angle and reach to the most comfortable position. Wheel can be tilted up for easier entrance and exit.

For a smart, sporty look, you'll like the design of our '75 Gran Fury **Road Wheel**. Available on all Gran Furys.

A manual **Vent Window** is available on all 4-door hardtops and sedans.

You turn your Gran Fury into a sun-filled fun car when you order our all-metal **Sun Roof**. Power operated, it is completely sealed and weather-tight when in closed position.

On the opposite page, we present the full list of options you may wish to consider for your 1975 Gran Fury.

## GRAN FURY WAGONS

You'll discover a number of refinements and engineering improvements that mark the difference between Plymouth's idea of what a wagon should be and its competitors. Be sure to read the details in our complete 1975 Plymouth Station Wagon catalog.



There's an important reason why our 1975 Gran Fury performs so quietly and efficiently and lasts so long. It's called Extra Care In Engineering.

The engineers who work on Plymouth products share the same philosophy as all who design any Chrysler product: if its basic pieces are sound, the whole car is going to show it . . . from the moment you drive it home.

That's why Chrysler "extra care" features . . . the kind we talk about on these pages . . . pay extra dividends in usefulness and driving pleasure.

**Gran Fury: the Quiet One.**

We want you to realize that several layers of mastic sprays, foam seals, jute pads and other noise barriers are built into every Gran Fury. For '75,

thick, deep-pile carpeting is added as a standard feature, further shielding you from the noise of the road. You drive in splendid isolation, completely surrounded by Unibody construction, the single-unit body that's fused together by over 4000 welds. Adding to your relaxed atmosphere is the smooth action of our Torsion-bar Suspension System. Yes, we care . . . because we believe your peace of mind makes you a happier, more satisfied and safer driver.

**Gran Fury: the Performing One.**

It used to be the word performance

was equated with how fast you get from 0 to 60. No more. These days performance is measured in efficiency of operation. And once again Plymouth "extra care" in engineering comes to your aid with a "right-size" 400 cubic inch V-8 engine standard on the Gran Fury Brougham and a 360 cubic inch V-8 standard on all other Gran Furys. We mate these two superb engines to an equally respected TorqueFlite transmission (with economical 2.45 to 1 axle ratio) and put the resultant smooth power on the road via standard steel-belted radial

tires. It all adds up to effortless, efficient performance on the road. Our extra care thinking also provides you with a 26.6-gallon fuel tank to increase your travel radius on long weekends and vacation trips.

**Gran Fury: the Durable One.**

Much of our "extra care" thinking is not immediately apparent, involving benefits people might tend to forget. That is until trade-in time, when, for example, your Gran Fury's 7-step dip-and-spray rust preventative process starts to pay off. Every Gran Fury, you see, is cleaned, coated, sprayed with two coats of primer, baked, sanded, then painted with two coats of tough acrylic enamel. We think you'll appreciate this kind of careful finishing over the many pleasant miles you can expect to drive your Gran Fury.

**Gran Fury: the Pioneering One.**

In the world of electronics, the word today is "solid state". And now, while others are slowly recognizing such equipment, Gran Fury "extra care" brings you a solid state Electronic Ignition System that has no points or condenser and increases spark plug life to 30,000 miles when unleaded fuel is used. This system provides up to 35% more voltage than conventional systems, helps you get started in the foulest possible weather. The added

bonus of an electronic voltage regulator maintains battery charge level more precisely for longer battery life. In addition, all 440 cubic inch V-8 engines (optional on the Gran Fury) are equipped with both long-life spark plugs and a long-life battery. The spark plugs are designed with platinum center electrode for lasting performance when used with unleaded fuel. The battery has shown excellent cold performance characteristics and is rated at 500 amperes.

**Gran Fury: the Safe One.**

Perhaps, the word "packaging" seems out of place in describing Gran Fury's luxurious interior. Yet we take "extra care" to do just that. A collapsible steering column, rugged side impact beams and a most practical and effective impact-absorbing bumper system all directly influence your well-being on the highway—even in the supermarket parking lot. The new driver/passenger restraint system is more convenient and easier to use and is color-coordinated to interior trim. Proper use of the seat belts will significantly reduce the risk of injury in the event of a collision.

Here's how we look at engineering, in summation: we know you care about how well your Gran Fury is designed and built. We want you to know we care, too.

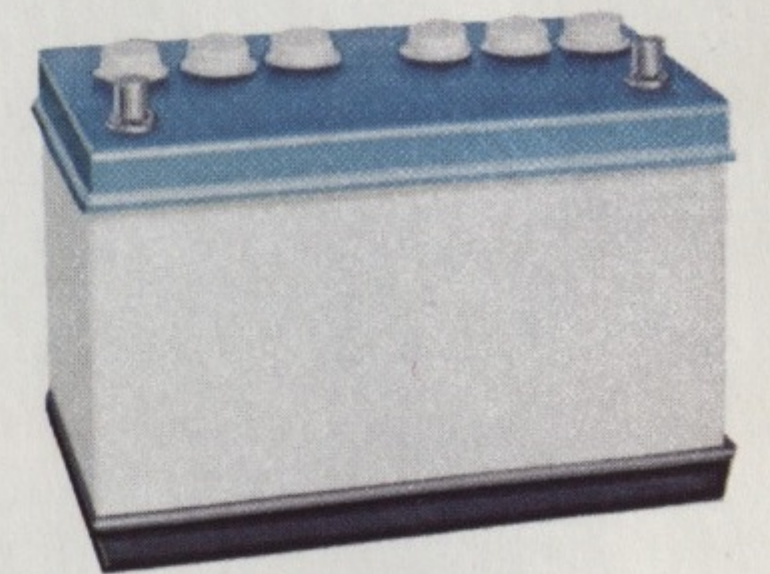

Long-life battery.

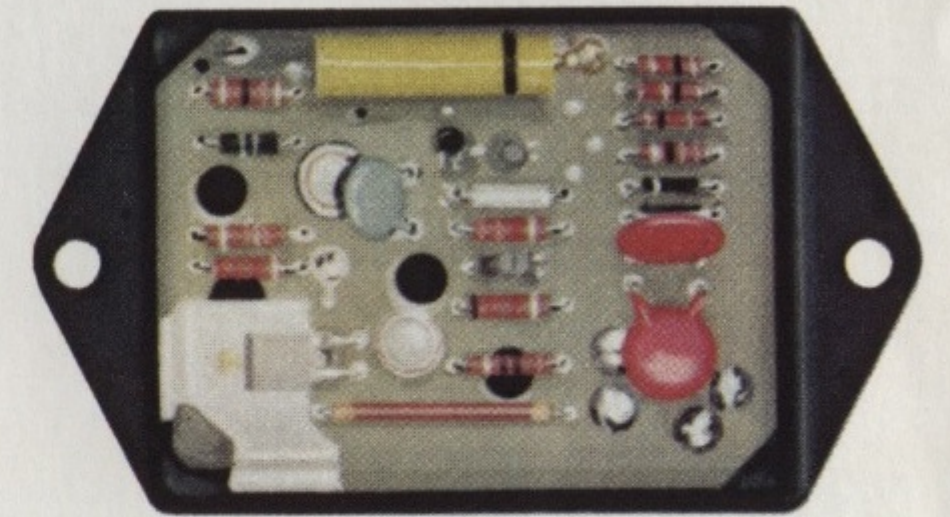

Electronic Ignition System.



Long-life spark plug.

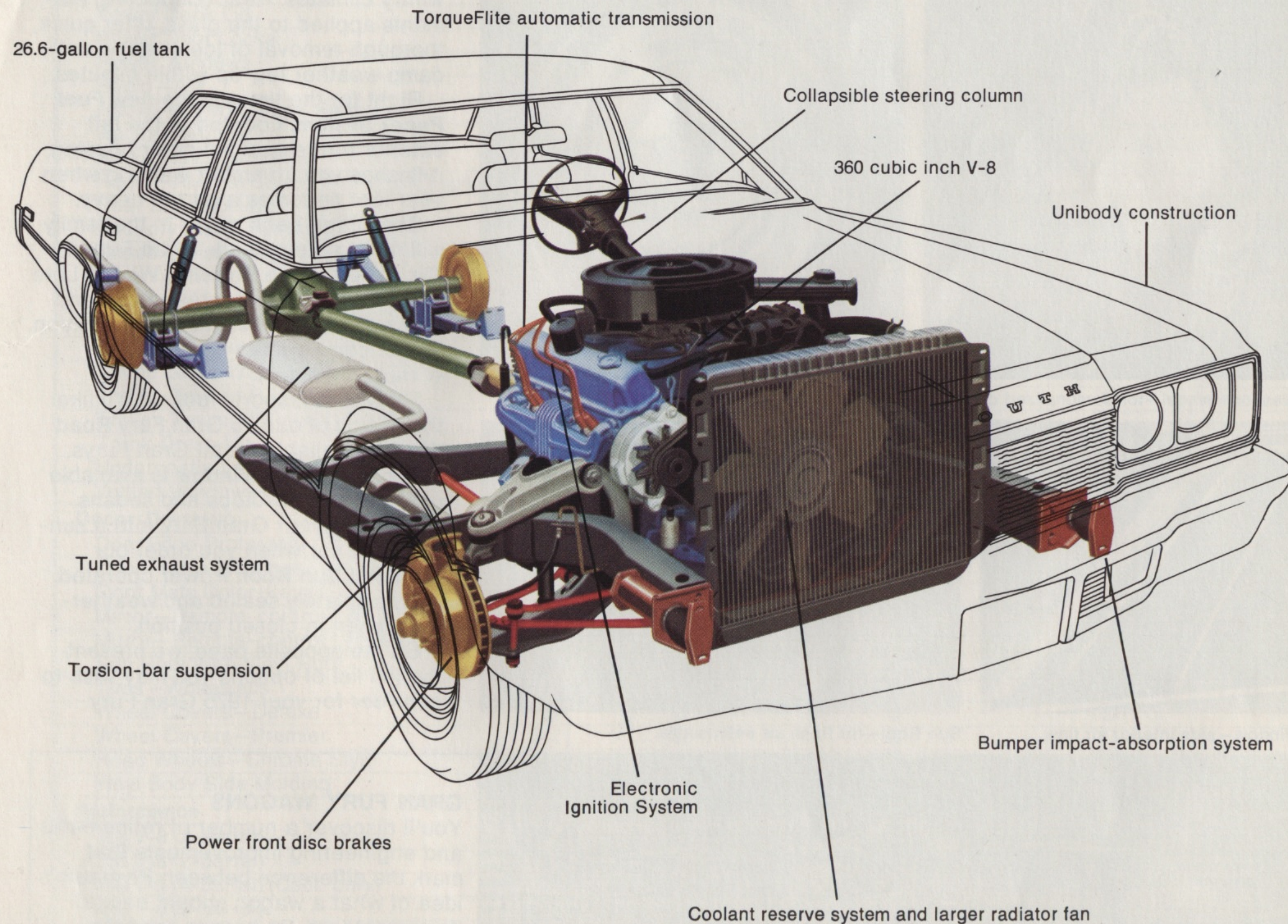

1975 Gran Fury Dimensions

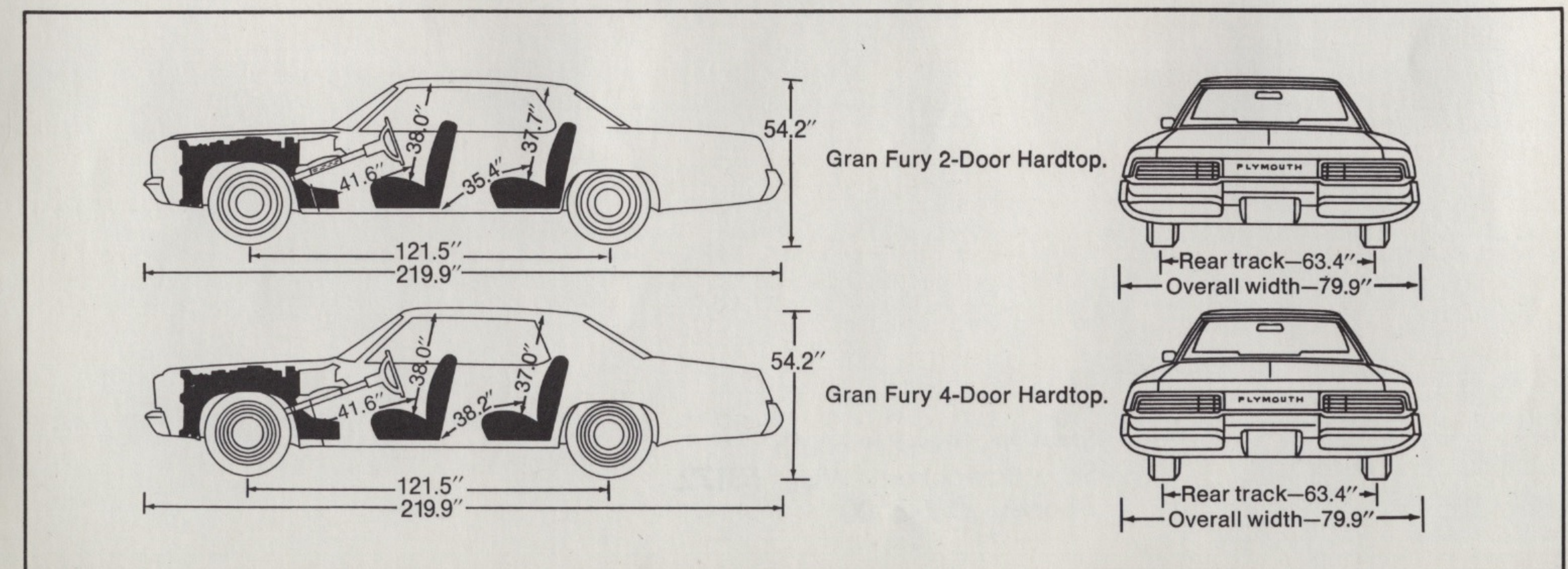



# 1975 Standard Features

## Gran Fury Standard Features

- Steel radial tires (set of 5) • Hub-caps (set of 4) • Outside rearview mirror, driver's side • Keyless door locking • Directional signals with lane change feature • Backup lights • Front and rear bumper guards • Bright drip rail molding • Concealed windshield wipers • Bright ¾-length body side moldings† • Bright full-length body side moldings\* • Bright belt moldings • Deck lower applique\* • Center bin-type glove box with coin holder • Nylon loop-pile carpeting • Flow-through ventilation • Fuel gauge • High-temperature warning light • Ammeter • Low oil pressure warning light • Panel light dimmer and interior lights • Armrests, front and rear • Instrumentation with non-glare lighting • Cigarette lighter • Inside hood release • Glove box lock • Dome light • Front door courtesy light switches • Trunk light\* • Safety door locks • Soft coat hooks • Ashtrays in instrument panel and rear armrests

- Rear compartment sound barriers • Fresh-air heater and defroster • Upper-level ventilation • Ashtray light • Simulated wood-grain accent on instrument panel cluster\* • Glove box light\* • 3-spoke steering wheel with simulated wood-grain insert • Torsion-Quiet Ride • 360 V-8 engine • Torque-Flite automatic transmission • Electronic Ignition System • Power steering • Power brakes, front discs and self-adjusting rear drums • Tuned exhaust system • Front sway bar • 50-ampere alternator • 375-ampere battery • Roof silencer and insulation • Cleaner air system.

†Gran Fury only \*Gran Fury Custom only

## Gran Fury Brougham Standard Features

(All the above plus these additions and substitutions) • Stand-up hood ornament • Sill molding • Body side paint stripes • Deluxe wheel covers • Electric clock • Door pull straps • Lower door panels, carpeted • Cloth-and-vinyl, split-back bench with

center armrest (all-vinyl optional at no extra cost) • Extra rear-seat sound barrier • Dome lamp, rear door courtesy switches • 400 2-barrel V-8 engine.

## Standard Safety Features

Side marker lights and reflectors • Windshield wipers, 2-speed electric • Electric windshield washers • Left outside rearview mirror • Safety-Rim wheels • Passenger restraint system with starter interlock • Flame-retardant interior materials • Locking and energy-absorbing front seat-back and armrests • Energy-absorbing instrument panel padding • Manual door locks—buttons have non-override lock feature, except driver's door • Flush inside door release levers • Padded sun visors • Dual braking system with warning light • Locking latch on all folding front seat-backs • Vinyl-clad day/night inside rearview mirror • Hydraulic impact-absorption bumper system • Fuel-tank impact protection • Side door beams.

## 1975 Plymouth Gran Fury Exterior Colors



Silver Cloud Metallic



Platinum Metallic

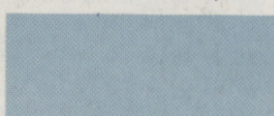

Powder Blue

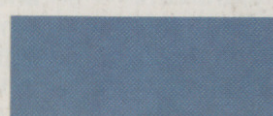

Astral Blue Metallic



Starlight Blue Metallic



Vintage Red



Frosty Green Metallic



Deep Sherwood Metallic



Avocado Gold Metallic

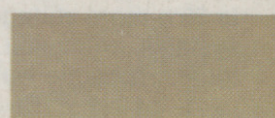

Sahara Beige



Moondust Metallic



Sienna Metallic



Dark Chestnut Metallic

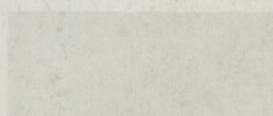

Spinnaker White



Formal Black



Golden Fawn



Bittersweet



Inca Gold Metallic



Spanish Gold Metallic

**NOTE:** Due to occasional printing irregularities, the above colors may vary slightly from actual hues. See your Plymouth Dealer for accurate color chips.

All product illustrations and specifications are based on authorized information. Although descriptions are believed correct at publication approval, accuracy cannot be guaranteed. Some of the equipment shown on product illustrations is optional, at extra cost. Chrysler Motors Corporation reserves the right to make changes from time to time, without notice or obligation, in prices, specifications, colors and materials, and to change or discontinue models.

YOUR SIGNS FOR  
MOTORING SATISFACTION.



SM Chrysler-Plymouth  
So. Milwaukee, Wis. 53172  
Phone: 762-8500

# Plymouth



CHRYSLER  
MOTORS CORPORATION