

05 GRAND PRIX

PONTIAC

05 GRAND PRIX

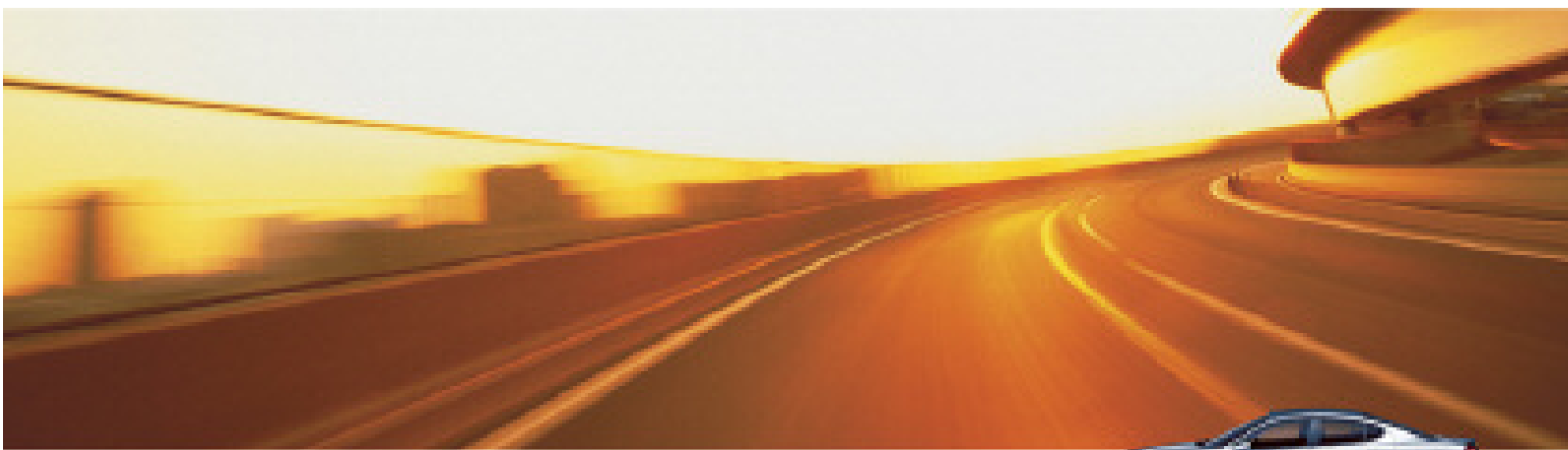

PONTIAC  BUILT FOR DRIVERS

2005 PONTIAC GRAND PRIX.

Grand Prix GTP, with available Competition Group Package, shown in Galaxy Silver Metallic.



ABSOLUTE CONTROL

FOR DRIVERS WHO JUST CAN'T LET GO.

Nothing less than supreme authority for the driver. That is the mantra that defines every aspect of the new generation Grand Prix – from the responsive performance of the 3800 Series III V6 engines to the feeling of absolute control generated by the WideTrack handling system. With Grand Prix, you can exercise control even before you take the driver's seat, with the new factory-installed remote start function on GT and GTP models. You even have mastery over your safety and security, thanks to the OnStar System that is now standard on every Grand Prix model. Once you've experienced this level of control, you'll never let it go. Pontiac Grand Prix. Built for Drivers.

"... cleaner, meaner, and more refined."

– Jeff Bartlett, *MotorTrend.com*

Find more information about
Pontiac Grand Prix at gmcanada.com

PONTIAC  BUILT FOR DRIVERS

EXTERIOR



Grand Prix GTP with available Competition Group Package, shown in Sport Red Metallic.



PERFORMANCE ATTITUDE.

THE WIDETRACK STANCE GIVES GRAND PRIX AN AGGRESSIVE PERFORMANCE ATTITUDE. This isn't a sedan with a few sporty flourishes: it's a sport sedan that embodies a zeal for driving in every detail of its design. The look is made that much bolder by the muscular contours and race-inspired details such as a standard rear deck-lid spoiler. But Grand Prix's style will only serve to heighten your anticipation of what awaits when you grip the steering wheel.

COMPETITION GROUP PACKAGE



Grand Prix GTP with available Competition Group Package, shown in Black.

THE COMPETITION JUST BLINKED.

The Grand Prix GTP with the available Competition Group Package sends a very powerful message to the competition by setting a new standard for performance and handling in its class. Its credentials are strictly top drawer, with the supercharged 3800 Series III V6 mated with the innovative TAPshift automatic transmission. Add to that the grip of the low-profile V-rated 17 inch performance tires and the StabiliTrak Sport stability enhancement system, and you can see how the GTP with the Competition Group Package is filling the competition with envy.



Formula One-inspired TAPshift – short for Touch Activated Power – makes Grand Prix's automatic transmission perform like a true manual. Simple movements of the steering wheel-mounted control paddles rapidly shift gears, allowing the driver to make the most of the GTP's impressive acceleration and cornering. It even holds the gear at redline for true high-end performance. And the Competition Group's Head-Up Display instrumentation relays your gear selection and provides an upshift alert.



The Competition Group Package features unique 17-in. wheels and low-profile V-rated performance tires. They integrate with specific suspension tunings to increase the handling performance. Bushings, dampers and springs are all specially tuned.

CONTROLS



Grand Prix GTP with available Competition Group Package, and Navigation System shown in Dark Pewter.

YOU'LL KNOW IT WHEN YOU FEEL IT.

COMMAND OF THE ROAD isn't simply the product of performance technology – it's the feel it produces. That is the concept behind Grand Prix's driver environment. The comprehensive instrumentation relays a wealth of data through the reconfigurable Driver Information Centre. And the ergonomic layout and design of the controls ensures that everything is right where it should be, making adjustments feel almost intuitive. You can even adjust the temperature with greater precision, courtesy of the newly available automatic dual-zone climate controls. Not only the driving is high-performance in Grand Prix.



It's not only Grand Prix's WideTrack stance that keeps you headed in the right direction. The available in-dash DVD-based navigation system* uses GPS (Global Positioning System) technology to help guide you on your travels.

* Detailed map coverage is available for most urban areas of the United States and certain metropolitan areas of Canada (Quebec City, Montreal, Ottawa, Toronto, London, Windsor, Edmonton, Calgary and Vancouver). Outside these areas coverage is significantly limited. Please speak with your sales consultant regarding Grand Prix's navigation system's geographic coverage.



Grand Prix's standard electronic climate control system uses a film valve technology that directs air across a thin sheet of plastic, for better circulation. The automatic dual-zone system shown here is available on GT and GTP models.



The Head-Up Display instrumentation projects information onto the windshield. This enables you to do everything from checking your speed to seeing what gear you're in without taking your eyes off the road. An exclusive stealth mode also allows you to turn off the instrument panel lighting, further reducing visual distraction.



INTERIOR

Grand Prix GTP with available Competition Group Package, shown with Parchment leather-trimmed seating and Parchment/Dark Pewter interior trim.

A VERY SUPPORTIVE ENVIRONMENT.

GRAND PRIX IS BEHIND YOU ALL THE WAY in your quest for expressive performance-oriented driving. That support can be felt quite literally in the front bucket seats with their side bolsters. Yet this is an interior designed with versatility, not just driving in mind. A case in point: the GT and GTP front-passenger seat can be folded forward to create a convenient work space. And wide-opening rear doors, as well as a large trunk pass-through, provide added cargo capacity to help facilitate a range of your favourite pursuits – other than driving.



You can fold the front-passenger seat forward to create a convenient workspace for your laptop or other items. This seat is standard on GT and GTP and available on Grand Prix.



With the 60/40 flat-folding rear seatbacks and available folding front-passenger seatback in the down position, you can carry items up to 2.74 m (9 ft.) in length with the trunk closed. An envelope-style cargo net keeps objects in position.



Grand Prix's versatility is enhanced by rear doors that open wide – to nearly 90° – allowing easier access to the rear seats. This not only makes it easier for your passengers, but also allows you to load objects as large and bulky as a 27-in. television into the back seat, leaving additional space available in the trunk.

ASPIRATION FULFILLED.

THE KEY TO GRAND PRIX GTP'S PERFORMANCE IS **ASPIRATION** – how its supercharged 3800 Series III V6 acts like an air pump. More incoming air translates into increased output. Just as important, with a supercharger, the boost in power can be felt instantaneously, unlike the lag associated with a turbocharger. Looking for a brand of performance that gives you a charge every time you put your foot down? Your aspiration is fulfilled in the supercharged Grand Prix GTP.

“If power corrupts, prepare to be seduced.”
 – Michael Bettencourt, *Globe and Mail*

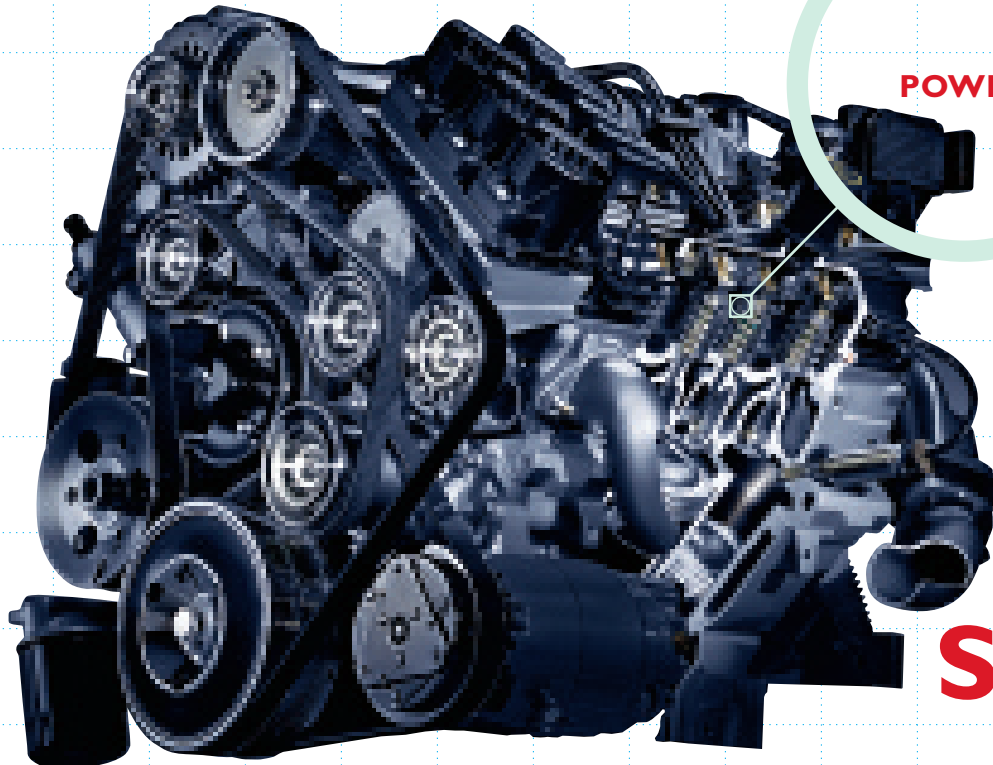

A speed-based drive-by-wire electronic throttle control (ETC) eliminates the mechanical link between the accelerator pedal and throttle, providing instant response. The drive-by-wire system automatically adjusts the throttle action to correspond to the speed you're driving.



The GTP's fifth-generation Eaton supercharger delivers the power and response you'd expect from a V8. Using a belt driven by the crankshaft to rotate a series of impellers, the supercharger forces air into the engine for increased horsepower and torque.

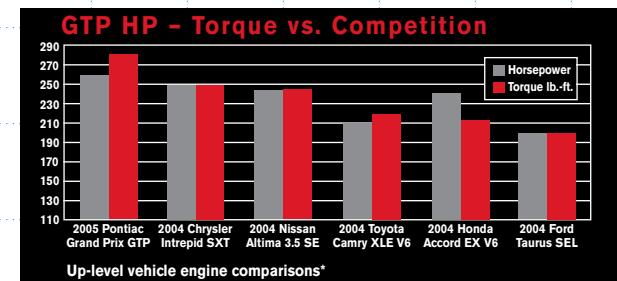
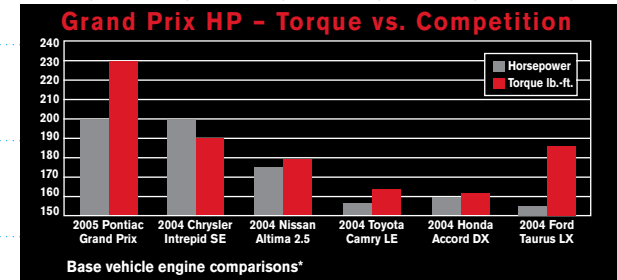

*All competitive information is based on 2004 model year data and the latest published information at the time of printing.

SUPERCHARGED

Grand Prix features a new generation of 3800 Series III V6 engines. The standard 200 horsepower normally aspirated engine is renowned for its quiet operation, excellent efficiency and substantial output at low rpms. The GTP's supercharged version of the engine generates 260 horsepower and 280 lb.-ft. of torque.

AN UNFAILING SENSE OF DIRECTION.

IT ISN'T ONLY GRAND PRIX'S WIDETRACK STANCE AND PRECISION HANDLING that generate such razor-sharp directional control. The GTP's available StabiliTrak Sport stability control system takes it to the next level. The system's progressive actuation acts in a way that is barely perceptible to the driver, keeping you on your desired driving line when a lateral skid is detected. Stay directed toward your driving goals – with Grand Prix.

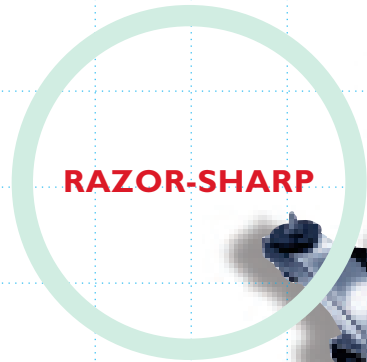

RAZOR-SHARP

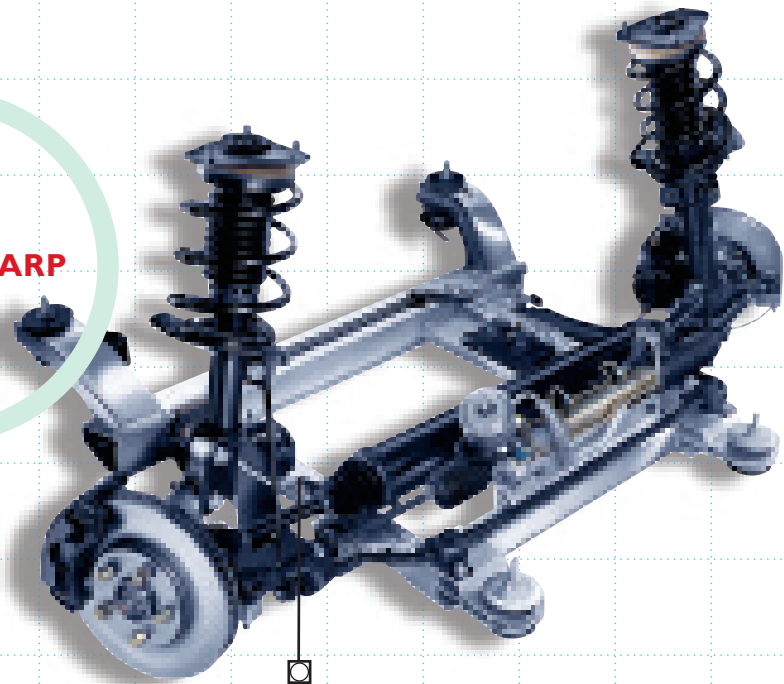

Grand Prix's four-wheel independent suspension employs quadra-stage valving and Teflon-coated pistons, to reduce friction and enhance ride and handling. In addition, the direct-acting front and rear stabilizer bars improve chassis rigidity by 16 percent.

It's not only the trademark WideTrack stance that gives Grand Prix its exceptionally responsive handling. Touring tires were designed to match the desired ride characteristics, with 16-in. S-rated tires on Grand Prix and GT, 17-in. H-rated tires on GTP, and V-rated tires with the available Competition Group Package.



WideTrack

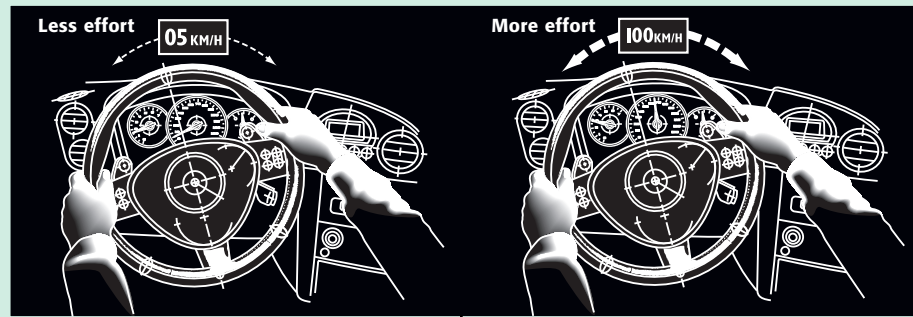
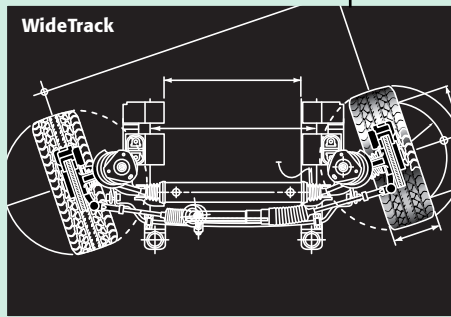

HANDLING

BOOST

Four wheel disc brakes with ABS are standard on GT and GTP, and available on Grand Prix. Electronic brake force distribution, included with the anti-lock braking system, uses a Bosch controller that automatically adjusts to different loads. More braking force is applied to the front wheels when only the driver is in the car. When there is a full complement of passengers, or a significant cargo load in the trunk, the brake pressure is more evenly distributed between the front and rear.

Connecting with the road is that much more direct thanks to the Magnasteer steering system that is standard on GT and GTP models. Magnasteer automatically adjusts the amount of steering assist based on the speed you're driving. It provides more steering assistance at lower speed – when it's needed to execute manoeuvres such as parking. At higher speeds, the assist is reduced, providing the feel that forms an essential part of the performance driving experience.

THE MANUAL ON PERFORMANCE DRIVING.

TECHNOLOGY



THERE ARE NO SHORTCUTS to legitimate performance engineering. And there is not one single component or system that is responsible for creating excellent driving characteristics. It requires a truly integrated approach to design and manufacturing,

one that encompasses everything from the choice of materials to the way systems and components must work together seamlessly. Here are just a few of the entries in Grand Prix's encyclopedia of performance engineering.

1. **LIGHTWEIGHT MATERIALS**
Reducing weight is critical in achieving performance breakthroughs. Everything from acceleration to fuel efficiency is enhanced when unnecessary weight is eliminated. That's why so much effort went into the development of the advanced lightweight materials found throughout the new Grand Prix: from the cast magnesium in the cross-car beam to the martensitic steel in the bumper beam.
2. **GLASS MAT DELCO BATTERY**
Grand Prix's battery incorporates a compressed glass composite material that's similar to fiberglass, eliminating the need for liquid electrolyte within the battery. The result is greater tolerance to underhood temperatures and enhanced durability. In fact, in tests conducted on a Las Vegas taxi fleet, the battery averaged a lifespan of 189,465 km (117,731 mi.) – 160 percent longer than conventional batteries.
3. **ELECTRICAL SYSTEM ARCHITECTURE**
The simpler the better. That describes the principle behind the design of Grand Prix's electrical system. By combining multiple functions on a single microchip, and by using a single wire to transmit a series of different messages, the number of components and connections is reduced, for increased reliability.
4. **QUAD HEADLIGHTS**
Even the headlights set world-class standards for performance by pushing the envelope of halogen technology, enhancing the headlights' illumination path.
5. **ALUMINUM ENGINE CRADLE AND CRADLE MOUNT**
An aluminum alloy cradle is stiff yet lightweight. It achieves a natural frequency of 81 Hz, which translates into reduced vibration inside Grand Prix. The cradle is secured using brackets that strengthen Grand Prix's front end, further minimizing vibration. This is achieved by enhancing the structure around the mount and the attachment bolt.
6. **FOG LIGHTS**
Standard fog lights don't only enhance visibility in inclement conditions, they also emphasize Grand Prix's signature WideTrack stance. The lights are automatically switched off when the ignition is turned off, eliminating unintentional use and preserving bulb life.
7. **SINGLE-PIECE SIDE BODY FRAME STRUCTURE**
Another expression of Grand Prix's less-is-more design philosophy: the body panel was stamped from a single piece of metal, reducing body flex and ensuring a tighter fit between the side panels and the doors.
8. **STANDARD REAR SPOILER**
The spoiler does more than add an emphatic punctuation point to the styling; it also contributes to Grand Prix's impressive .31 drag coefficient.
9. **TRUNK LOADING**
Grand Prix's trunk isn't only spacious, it's also easy to load, thanks to the convenient trunk lid that operates on gas struts, not gooseneck hinges, as well as a wide, low, liftover height. Once you've loaded your cargo, tie-downs help keep it secured.
10. **INTERIOR QUIET**
Inside Grand Prix you can enjoy lots of peace and quiet. That's courtesy of advances in the body panel baffles, thicker window glass in the doors, an improved rear-view mirror design, a U-lip windshield seal, and the use of effective sound absorption material. Even the climate control system is extremely quiet, thanks in part to its compressor.
11. **ENVIRONMENTALLY THOUGHTFUL**
A returnless fuel system and a vapour purge valve help reduce vapour emissions, while a close-coupled catalytic converter helps reduce exhaust emissions. And although premium fuel is recommended for peak performance, Grand Prix GTP's supercharger can operate with regular fuel without damaging the engine.
12. **FOUR-WHEEL DISC BRAKES**
The four-wheel disc braking system with ABS, includes an electronic brake force distribution function. Using a Bosch controller, the system automatically adjusts the proportion of brake pressure directed to the front or rear, based on the weight of passengers and cargo on board. Standard on GT and GTP, and available on Grand Prix.
13. **LARGE WHEELS**
There is no denying the impact that the large 16-in. and 17-in. wheels have on styling. They are also an integral part of Grand Prix's performance.
14. **SUSPENSION SYSTEM**
At the heart of Grand Prix's WideTrack handling system is the four-wheel independent suspension. It features quadra-stage valving and Teflon-coated pistons that enhance responsiveness. Direct-acting front and rear stabilizer bars increase roll control, maintaining a more level ride when cornering. Together, these produce both taut handling and a very smooth ride.

SURROUNDED. BUT NEVER CONFINED.

INSIDE GRAND PRIX, you are protected by the rigid steel safety cage. This knowledge will help to reinforce your confidence behind the wheel. Understanding that the first line of defence in driving is accident avoidance, Grand Prix's extraordinary combination of driver control features will also enhance your peace of mind, not just your sense of gratification.

SAFETY

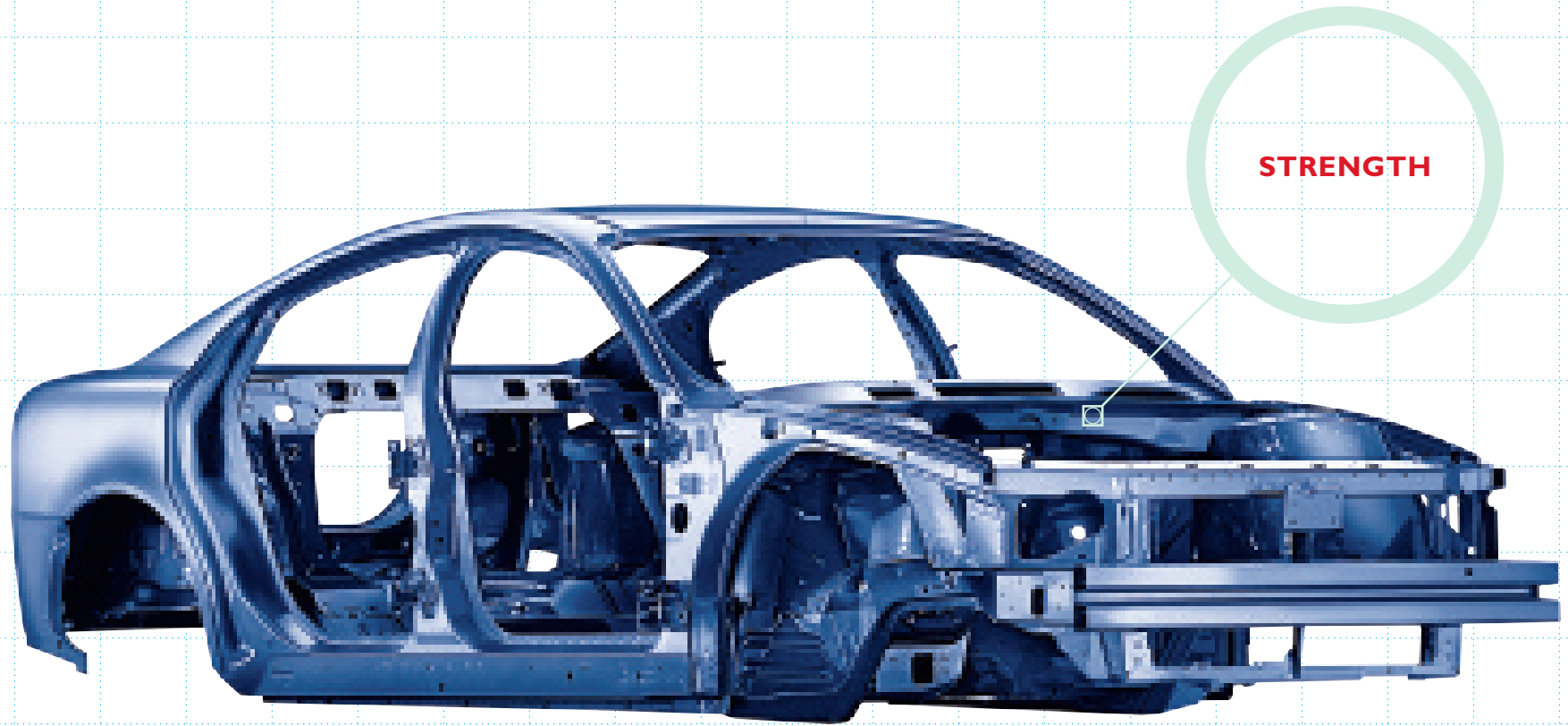

PEACE OF



A General Motors Subsidiary

Always there. Always ready.

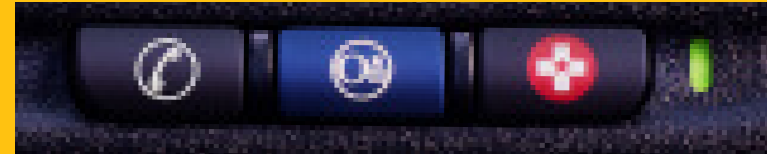

Every Grand Prix features dual-stage frontal air bags.* What advantage does this two-stage inflator system offer? It adjusts the deployment velocity of the driver and front-passenger air bags automatically, depending on the severity of the impact – it's slower during lower speed impacts and instantaneous if triggered by a high-speed collision. Also shown here are the available front to rear head curtain side air bags.

*A NOTE ON CHILD SAFETY: Always use safety belts and proper child restraints, even in vehicles equipped with air bags. Children are safer when properly secured in a rear seat. Never place a rear-facing infant restraint in the front seat of any vehicle equipped with an active air bag. Refer to the vehicle Owner's Manual and child safety seat instructions for more information. Air bag inflation can cause severe injury or death to anyone too close to the air bag when it deploys. Be sure every occupant is properly restrained.

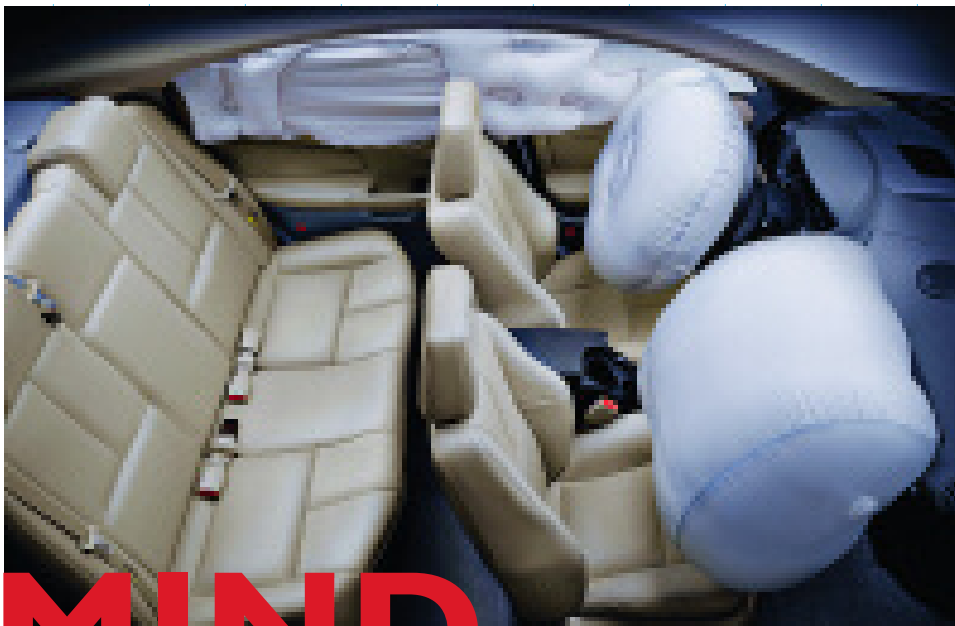

MIND

PONTIAC'S PERFORMANCE ENGINEERING includes more than just powertrains and suspension systems. It also includes the unparalleled safety and security of OnStar. OnStar uses advanced communications technology to enhance your peace of mind whenever you're in your Pontiac. All it takes is the touch of a single OnStar button inside your vehicle to connect you with one of our Advisors at the OnStar Centre.* They are standing by, ready to provide support 24 hours a day, 365 days a year.

What can OnStar Advisors do for you? They not only provide information and a range of other direct assistance services – but also, in an emergency, they will contact emergency service providers. And if air bags are deployed in your vehicle, an Advisor will contact you to determine if you need assistance. Your Advisor can also perform a remote diagnostic check of your engine and the electrical components in your vehicle.

Another convenient feature is OnStar Personal Calling,** which uses a button to activate the hands-free, voice-activated wireless phone that's integrated into your vehicle. It's there just in case your hand-held cellphone is lost, forgotten or has a low battery. Even better, there are no additional monthly system access fees, or additional long distance and roaming charges. And as a new customer, you will receive 30 trial minutes.

Knowing you have OnStar on board provides a powerful sense of added security. Just ask the more than 100,000 people who have become OnStar subscribers in Canada. How hard does OnStar work for you? The facts speak for themselves: every month in Canada, OnStar Advisors handle an average of 7100 routing calls, 2000 emergency calls, 1900 door unlocks and 1050 Roadside Assistance dispatches.

The OnStar System with one year of the Safe & Sound plan is included on all Grand Prix models. OnStar also offers the available Directions & Connections plan that provides route information, as well as a host of other convenience services. See your dealer for more details about the plans available for Pontiac Grand Prix.

OnStar. Always there. Always ready.

*Subscription Agreement necessary. OnStar services require vehicle electrical system and wireless service to be available and operating for features to function properly. OnStar relies on existing emergency service providers as well as wireless and satellite technologies and is subject to their limitations. Due to the transition of the wireless industry from analogue to digital technology, as of January 1, 2008, OnStar plans to offer service only through equipment that operates on the digital network, which may require the purchase of a system upgrade. Call 1-888-4-ONSTAR (1-888-466-7827), see your OnStar Owner's Guide, or visit onstarcanada.com for system information and details.

**Requires OnStar Personal Calling-enabled vehicle, existing OnStar service contract and prepaid calling minutes. OnStar voice recognition system may not recognize all voices. Available in most markets.

SAFETY / ONSTAR

ACCESSORIES



IT'S NOT JUST ANY DRIVER'S CAR.

Start with a vehicle as unique as Grand Prix. Then go one step further and reflect exactly who you are, with the addition of GM Accessories. They are the only accessories that are integrated into the process of designing your vehicle, ensuring excellent fit, finish and functionality. And only GM Accessories are backed by GM's 3-year/60,000 km TOTAL™ Warranty.* They can also be included in your new-vehicle lease or finance agreement through GMAC. Ask your dealer for a complete list of the GM Accessories available for Grand Prix or visit gmcanada.com

*Whichever comes first, when permanently installed by the dealer at the time you purchase or lease your new vehicle.

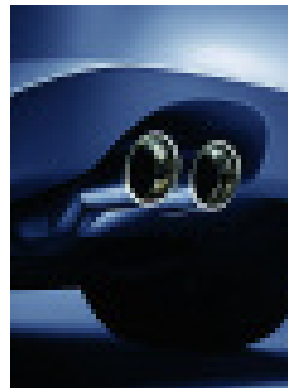

GM Accessories available for Grand Prix include:

- Grille inserts
- Rear deck-lid spoiler
- Stainless steel exhaust tips
- Side-window weather deflectors
- Hard cargo carrier
- Roof-mounted ski carrier
- Hitch-mounted bicycle carrier
- Multi-purpose trunk organizer
- Splash Guards



STANDARD & OPTIONAL EQUIPMENT

SAFETY AND SECURITY	SEDAN	GT SEDAN	GTP SEDAN
	Air bags – driver and front-passenger, frontal	S	S
Air bags – front to rear, side head curtain	–	0	0
Brake/transmission shift interlock	S	S	S
Door locks – automatic power, programmable with lock-out protection and delayed locking features	S	S	S
Headlights – Daytime Running Lights with automatic light control	S	S	S
OnStar In-Vehicle Communications and Assistance Service – includes one-year of the Safe & Sound Plan	S	S	S
Safety belts – front shoulder, height-adjustable	S	S	S
Safety restraints – LATCH (Lower Anchors and top Tethers for Children), rear seats	S	S	S
Security Package – includes remote keyless entry system with trunk release, Panic feature and content theft-deterrent alarm system	S	S	S
Theft-deterrent system – PASS-Key III	S	S	S
Traction assist – Enhanced Traction System (ETS)	0 ¹	S	–
Traction control – electronic, full-function, all-speed	–	–	S
Trunk – internal manual trunk entrapment release handle	S	S	S

¹Included with available anti-lock braking system (ABS).

MECHANICAL	SEDAN	GT SEDAN	GTP SEDAN
	Battery – ACDelco with run-down protection	S	S
Brakes – power, 4-wheel disc	S	S	S
Brakes – 4-wheel anti-lock braking system (ABS) with electronic brake force distribution	0 ²	S	S
Drive – front-wheel	S	S	S
Engine – 3.8L 3800 Series III V6 with SFI Horsepower – 200 @ 5200 rpm, Torque – 230 lb.-ft. @ 4000 rpm	S	S	–
Engine – 3.8L supercharged 3800 Series III V6 with SFI Horsepower – 260 @ 5400 rpm, Torque – 280 lb.-ft. @ 3600 rpm	–	–	S
Engine block heater	S	S	S
Exhaust system – aluminized stainless steel	S	S	S
Exhaust system – split with dual outlets	–	S	S
Exhaust system – 4-pipe stainless steel exhaust tips ³	0	0	0
Steering – power, rack-and-pinion	S	–	–
Steering – power, Magnasteer magnetic speed-sensitive variable-assist, rack-and-pinion	–	S	S
Suspension – 4-wheel independent	S	S	S
Transmission – 4-speed automatic with overdrive	S	S	S
Vehicle starter system – remote	0	S	S

²Includes Enhanced Traction System (ETS) and low tire pressure indicator. ³Regular production accessory, dealer installed.

EXTERIOR	SEDAN	GT SEDAN	GTP SEDAN
	Antenna – rear-window integrated	S	S
Body panels – 2-sided galvanized steel (except roof)	S	S	S
Fog lights	S	S	S
Glass – Solar-Ray, tinted	S	S	S
Grille inserts – satin nickel finish ³	0	0	0
Mirrors – power remote control	S	S	S
Mouldings – accent colour on lower fascia, front and rear	S	S	S
Mouldings – bodyside, body-colour	S	S	S

EXTERIOR (CONT'D)	SEDAN	GT SEDAN	GTP SEDAN
	Spoiler – rear, deck-lid	S	S
Spoiler – alternative rear spoiler design ³	0	0	0
Sunroof – power, sliding glass with express-open feature ⁴	–	0	0
Tires – P225/60R16 all-season performance, S-rated	S	S	–
Tires – P225/55R17 all-season performance, H-rated	–	–	S
Wheels – 16" x 6.5" steel, bolt-on wheel covers (A) ⁵	S	–	–
Wheels – 16" x 6.5" silver-painted aluminum (B) ⁵	–	S	–
Wheels – 16" x 6.5" polished-finished aluminum (C) ⁵	0 ⁶	0	–
Wheels – 17" x 6.5" silver-painted aluminum (D) ⁵	–	–	S
Wheels – 17" x 6.5" polished-finished aluminum (E) ⁵	–	–	0 ⁷
Windshield wipers – 2-speed with variable delay (intermittent)	S	S	S
Competition Group Package – includes StabiliTrak Sport, Magnasteer II magnetic speed-sensitive variable-assist steering, 17" x 6.5" multi-spoke aluminum wheels (F) ⁵ , P225/55VR17 V-rated performance tires, 3.29:1 final drive ratio, unique badging, TAPshift transmission controls, Sport suspension, red finished brake calipers, up-level trip computer and Head-Up Display (HUD) instrumentation	–	–	0
Driver's Package – includes 16" x 6.5" silver-painted aluminum wheels (B) ⁵ and power 6-way driver seat adjuster	0	–	–

³Regular production accessory, dealer installed. ⁴Deletes sunglasses holder. ⁵Wheel shown on page 22. ⁶Requires Driver's Package. ⁷Not available with Competition Group Package.

INTERIOR	SEDAN	GT SEDAN	GTP SEDAN
	Air conditioning – with cabin filter	S	S
Air conditioning – automatic dual-zone, includes up-level trip computer	–	0	0
Console – front floor with dual cupholders and dual auxiliary power outlets	S	S	S
Cruise control – electronic with resume, coast and decelerate/accelerate features	S	S	S
Defogger – electric rear-window	S	S	S
Floor mats – front and rear, carpeted	S	S	S
Heat ducts – rear-seat, floor	S	S	S
Instrumentation – analogue cluster (includes speedometer, tachometer, coolant temperature and fuel gauges – low oil pressure and low coolant indicators)	S	S	S
Instrumentation – Driver Information Centre, reconfigurable	S	S	S
Instrumentation – low tire pressure indicator	0 ¹	S	S
Lifestyle Package – includes front passenger folding seatback, reversible cargo mat and cargo net	–	S	S
Lights – courtesy with delayed entry/exit, theatre dimming, trunk and glovebox	S	S	S
Premium Light Package – includes overhead roof console with holder for sunglasses, front and rear reading lights, LH and RH illuminated visor vanity mirrors and rear assist grips	–	S	S
Retained accessory power	S	S	S
Steering column – tilt adjustable	S	S	S
Steering wheel – leather-wrapped with sound system controls (includes leather-wrapped shifter)	–	S	S
Trunk – release, power remote	S	S	S
Windows – power, driver's express-down and passenger window lock-out features	S	S	S
Information Technology Package – includes up-level trip computer and Head-Up Display (HUD) instrumentation	–	0	0

¹Included with available anti-lock braking system (ABS).

SEATS

	SEDAN	GT SEDAN	GTP SEDAN
Cloth reclining front bucket seats	S	S	S
Reclining front bucket seats with perforated leather-trimmed seating surfaces (includes heated driver and front-passenger seat)	-	0 ⁸	0
Power 6-way driver adjuster	0 ⁹	S	S
Power 4-way lumbar adjuster	-	0	S
Seatbacks – rear, 60/40 split-folding	S	S	S

⁸Includes power 4-way driver lumbar seat adjuster. ⁹Included with Driver's Package.

SOUND SYSTEMS

	SEDAN	GT SEDAN	GTP SEDAN
All Grand Prix sound systems include an electronically tuned Delco AM/FM stereo with seek up/down, digital clock and TheftLock			
AM/FM stereo with CD player	S	S	-
AM/FM stereo with CD and MP3 players	-	0	S
AM/FM stereo with DVD-based GPS navigation system [†] , CD player with programmable equalizer and Moonsoon 9-speaker sound system	-	0	0
6-speaker extended range sound system	S	S	S
Monsoon 9-speaker sound system	-	0	0
Premium Audio Package – includes 6-disc in-dash CD changer and Monsoon 9-speaker sound system	-	0	0

[†]Detailed map coverage is available for most major urban areas of the United States and certain metropolitan areas of Canada (Quebec City, Montreal, Ottawa, Toronto, London, Windsor, Edmonton, Calgary and Vancouver). Outside these areas coverage is significantly limited. Please speak with your sales consultant regarding the Grand Prix navigation system's geographic coverage.

DIMENSIONS

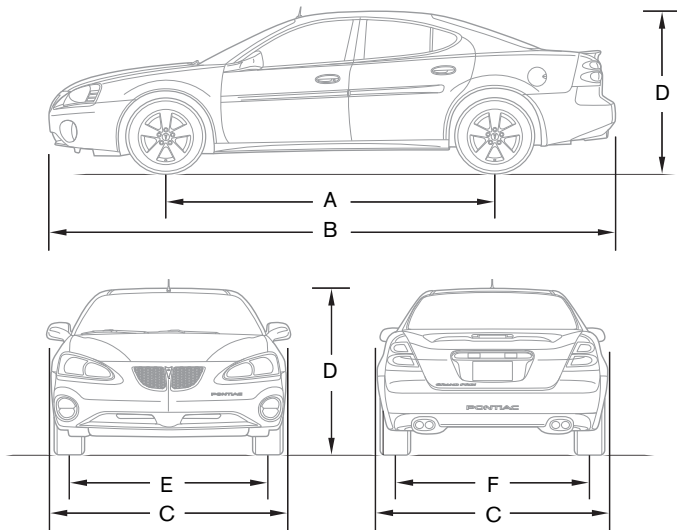

TOWING

3.8L 3800 Series III V6; 3.05 final drive ratio; 454 kg (1000 lb.) maximum gross trailer weight*
3.8L supercharged 3800 Series III V6; 2.93/3.29** final drive ratio; 454 kg (1000 lb.) maximum gross trailer weight*

*When properly equipped. Includes weight of trailer, cargo, passengers and equipment. All towing recommendations are subject to change. Trailer tongue load should be 10% of the maximum trailer weight but should not exceed the load rating specified for that vehicle, engine or hitch combination. See your dealer or refer to the Grand Prix Owner's Manual for details. **Included with the available Competition Group Package.

EXTERIOR, MM (IN.)

Wheelbase (A)	2807 (110.5)
Length (B)	5033 (198.1)
Width (C)	1875 (73.8)
Height (D)	1420 (55.9)
Front tread (E)	1566 (61.7)
Rear tread (F)	1545 (60.8)

INTERIOR, MM (IN.) FRONT/REAR

Headroom	978/928 (38.5/36.5)
Legroom	1076/926 (42.4/36.5)
Shoulder room	1472/1410 (57.9/55.5)
Hip room	1388/1360 (54.6/53.5)

CAPACITIES/WEIGHT

Trunk, L (cu. ft.)	453 (16.0)
Fuel tank, L (imp. gal.)	64 (14.0)
Curb weight (est.), kg (lb.) – Sedan	1577 (3477)
– GT Sedan	1581 (3484)
– GTP Sedan	1625 (3583)

WHEELS.

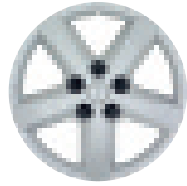

A – 16" steel, bolt-on wheel cover

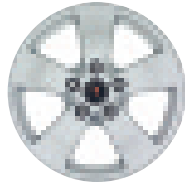

B – 16" silver-painted aluminum wheel

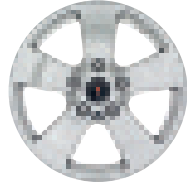

C – 16" polished finish aluminum wheel

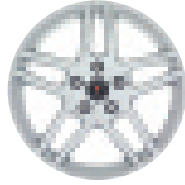

D – 17" silver-painted aluminum wheel

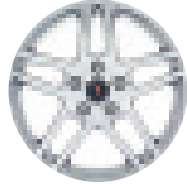

E – 17" polished finish aluminum wheel

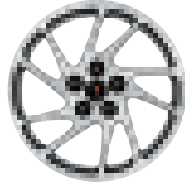

F – 17" multi-spoke aluminum wheel

A word about this brochure

Some of the equipment shown or described throughout this brochure may be available at extra cost. We have tried to make this brochure comprehensive and factual. We reserve the right, however, to make changes at any time, without notice, in prices, colours, materials, equipment, specifications, models and availability. Specifications, dimensions, measurements, ratings and other numbers in this brochure and other printed materials provided at the dealership or affixed to vehicles are approximates based upon design and engineering drawings and prototypes and laboratory tests. Your vehicle may differ due to variations in manufacture and equipment. Since some information may have been updated since the time of printing, please check with your Pontiac dealer for complete details. General Motors of Canada Limited reserves the right to lengthen or shorten the model year for any product for any reason, or to start and end model years at different times.

Privacy Statement

At General Motors of Canada Limited ("GM Canada") we respect your privacy and value our relationship with you. Your personal information will be protected, will never be sold, and will be used only by GM Canada, our affiliates, dealers/retailers, and service suppliers (only to provide services). If you wish to be removed from GM Canada marketing communications; would like to limit only certain marketing communications from us; would like a listing of our specific uses or further information about those with whom your information is shared; or for further information about our Privacy Policy and practices, please contact us at 1-800-GM-DRIVE (1-800-463-7483) or through our Web site at gmcanada.com

A word about assembly

Pontiacs are equipped with engines and components produced and assembled by different operating units of General Motors, its subsidiaries and suppliers and these engines and components may change or be obtained from different sources from time to time. All such engines and components are approved for use in Pontiacs. Certain equipment ordered may be unavailable at the time of assembly and we suggest that you verify that your vehicle includes the equipment you ordered, or if there are changes, that they are acceptable to you.

Trademarks

The marks appearing in this Pontiac Grand Prix brochure including, but not limited to: General Motors, GM, the GM Canada emblem, the GM Canada Web site address, the GM Accessories logo, Pontiac, the Pontiac emblem, Built for Drivers, Aztek, Bonneville, G6, Grand Am, Grand Prix, GTP, Montana, Montana SV6, Pursuit, Sunfire, Vibe, Wave, and their respective logos, emblems, slogans and vehicle model names and body designs; and other marks such as Delco, SMARTLEASE, Solar-Ray, StabiliTrak, TAPShift, the TOTAL Warranty and WideTrack are trademarks of General Motors Corporation and/or General Motors of Canada Limited, its subsidiaries, affiliates or licensors.

GMAC is a registered trademark of the General Motors Acceptance Corporation.

OnStar, the OnStar logo and the OnStar button are registered trademarks of the OnStar Corporation.

PASS-Key III, Magnasteer, Monsoon and TheftLock are registered trademarks of Delphi Automotive Systems.

Copyright

© Copyright 2004 General Motors of Canada Limited. All Rights Reserved. All text, images, graphics, and other materials in this Grand Prix brochure are subject to the copyright and other intellectual property rights of General Motors Corporation and/or General Motors of Canada Limited. These materials may not be reproduced, distributed or modified without the express written permission of General Motors Corporation and/or General Motors of Canada Limited.

Printed in Canada, August 2004.

FABRICS.

EXTERIOR/INTERIOR COLOUR COMPATIBILITY

Exterior	Interior	Parchment	Dark Pewter
12 – Galaxy Silver Metallic			•
15 – Sedona Beige Metallic		•	
26 – Blue-Green Crystal		•	
40 – Ivory White		•	
41 – Black		•	
56 – Fusion Orange Metallic		•	
63 – Sport Red Metallic		•	
88 – Graystone Metallic		•	

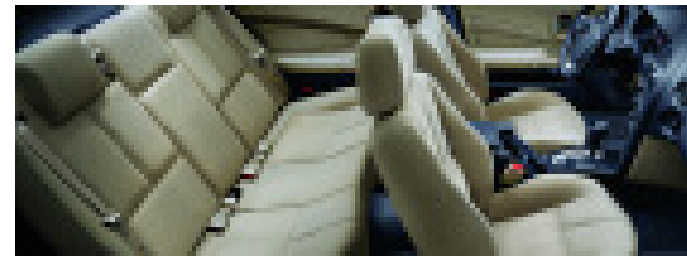

Grand Prix Cloth Parchment



Grand Prix Cloth Dark Pewter



Grand Prix Leather Parchment



Grand Prix Leather Dark Pewter

EXTERIOR COLOURS.

Colours may not be as exactly as illustrated due to restrictions of the printing process. Please see your sales consultant for specific colour and model availability.

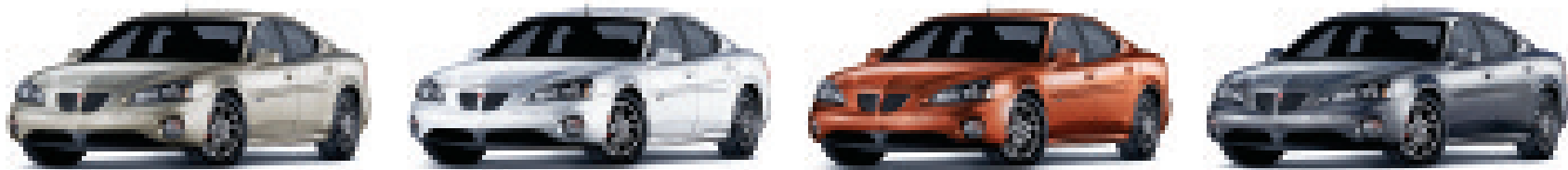

12 Galaxy Silver Metallic	15 Sedona Beige Metallic	26 Blue-Green Crystal	40 Ivory White	41 Black	56 Fusion Orange Metallic	63 Sport Red Metallic	88 Graystone Metallic
---------------------------------	--------------------------------	-----------------------------	-------------------	-------------	---------------------------------	-----------------------------	-----------------------------

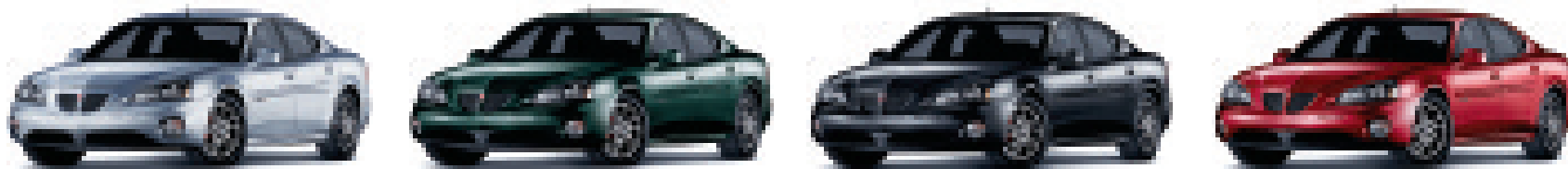

EXTERIOR COLOURS

PONTIAC GRAND PRIX BUILT FOR DRIVERS

AZTEK BONNEVILLE GRAND AM GRAND PRIX G6 MONTANA MONTANA SV6 PURSUIT SUNFIRE VIBE WAVE

HOW DO YOU DESIGN AND BUILD VEHICLES to respond precisely and instantaneously to driver input? With a rigorous and scientific approach to the engineering of every vehicle system and component. That is what separates the Pontiac family of vehicles from everything else on the road. Built to strengthen the connection between drivers and their vehicles. Pontiac. Built for Drivers.

COMMITMENT

Expect nothing less than a 100% commitment. You can feel confident that you're choosing a real driver's car – if it bears the Pontiac name. You can also count on your Grand Prix to continue to exceed your expectations, not just in the way it handles on the road, but also through a comprehensive series of support programs. Some make it easier to purchase or lease a Pontiac Grand Prix. Others help protect you and your vehicle down the road. A powerful example of the level of protection you can expect is the GM TOTAL™ Warranty. It's so thorough it covers your vehicle – from the roof right down to the tires. So when you drive off the lot of your Pontiac dealership, you can do so with total confidence. Peace of mind is knowing that your vehicle is built for the long haul, and is backed by a comprehensive warranty.

THE GM TOTAL™ Warranty:†

The GM TOTAL™ Warranty is your promise of total warranty protection. It covers every new Pontiac Grand Prix for 3 years or 60,000 km.* Complete vehicle repairs are covered,** including parts and labour, with no deductible. The warranty includes:

- 3-year/60,000 km* complete vehicle repair coverage
- 6-year/160,000 km* corrosion perforation coverage
- 8-year/130,000 km* coverage on catalytic converters and powertrain control modules (PCMs).

*Whichever comes first.

**To correct any defects in material or workmanship occurring during the warranty period. Regular maintenance is not included, nor is excessive wear and tear caused by reckless or negligent driving.

OTHER OWNERSHIP PRIVILEGES AND PROGRAMS:‡

- **Roadside Assistance** – 24/7 service via toll-free number during your warranty period, anywhere in Canada or the United States
- **Courtesy Transportation** – may be offered during warranty period
- **GM Protection Plan (GMPP)** – the only extended service contract backed by the resources and commitment of General Motors; GMPP may be purchased at the time of your sale or lease, or subsequently
- **GM Mobility Program** – you may be eligible for reimbursement of up to \$1000 (taxes included) for adaptive equipment for your GM vehicle
- **GM Accessories** – personalize your vehicle with GM Accessories, specifically engineered for your new GM vehicle
- **GM Goodwrench Service** – with GM-certified technicians and GM-approved parts, nobody knows your GM vehicle better.

TO HELP YOU PURCHASE OR LEASE A NEW VEHICLE:

- **GMAC Financing** – on-the-spot financing at your GM dealership^{††}
- **GMAC SMARTLEASE** – a smart alternative to traditional financing^{††}
- **GM Graduate Program** – recent graduates may qualify for up to \$1000 (taxes included) off any new GM vehicle[†]
- **The GM Card** – eligible cardholders may be able to redeem up to \$3500 in GM Card® Earnings toward the total purchase price or lease down payment on selected vehicles. For more information on The GM Card please call 1-800-461-3279.†

INFORMATION RESOURCES:

You can find more information about these programs from your GM dealer, or at these information centres:

- The GM Web site at gmcandata.com
- The GM Customer Communication Marketing Centre at 1-800-GM-DRIVE (1-800-463-7483 or 1-800-263-3830 for TDD users) – for information about any GM product or service, including The GM Card and the GM Mobility Program
- For information about GMAC visit the GM Web site or call 1-800-616-4622.

†Conditions and limitations apply.

††Subject to eligibility.

