

SAAB 900

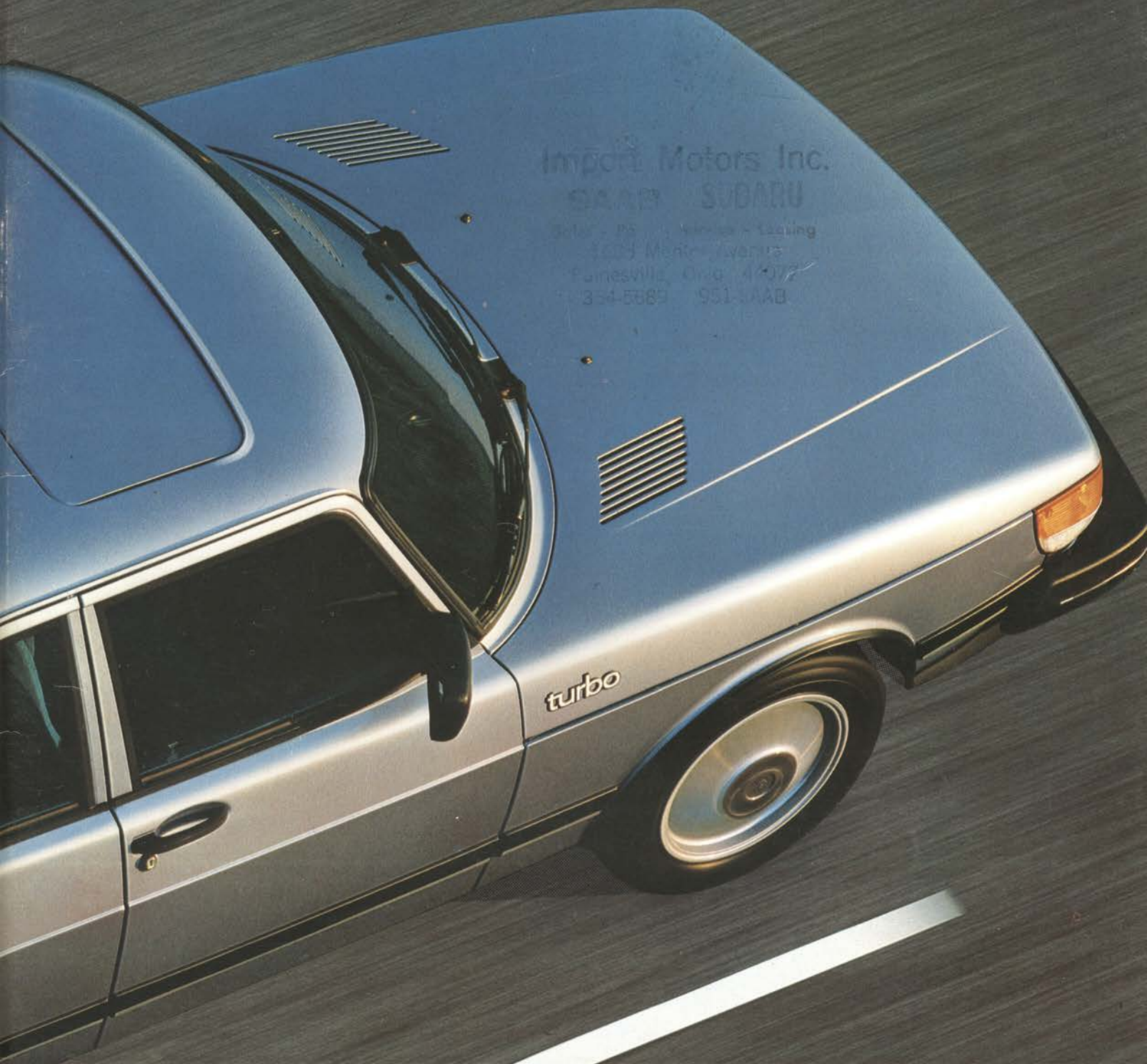

Import Motors Inc.

SAAB SUBARU

Sales - PS - Service - Training

4003 Market Avenue

Fainesville, Ohio 43072

354-5687 951-SAAB

turbo



Saab 900



SAAB 900 S

SAAB

900 turbo

SAAB 900 TURBO

900





THE SAAB ISN'T JUST A CAR
YOU MIGHT WANT. IT'S EVERY CAR
YOU MIGHT WANT.

Something has finally bridged the gap between the car you really want and the car you have to have.

The Saab 900.

It is, in fact, so versatile that there's really only one thing you can't do with the Saab.

Define it.

Is the Saab a big car? A small car? A performance car?
A safe car? An economy car? A luxury car?

Yes.

Which is probably what led an editor at Car and Driver magazine to write, "Saab doesn't build automobiles — Saab builds Saabs, which are a highly original and highly logical answer to at least one facet of the human transportation problem".

SAAB 900 TURBO



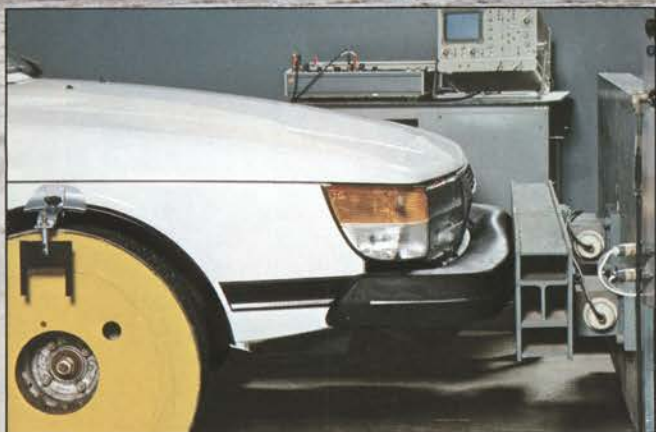

SAAB 900 S







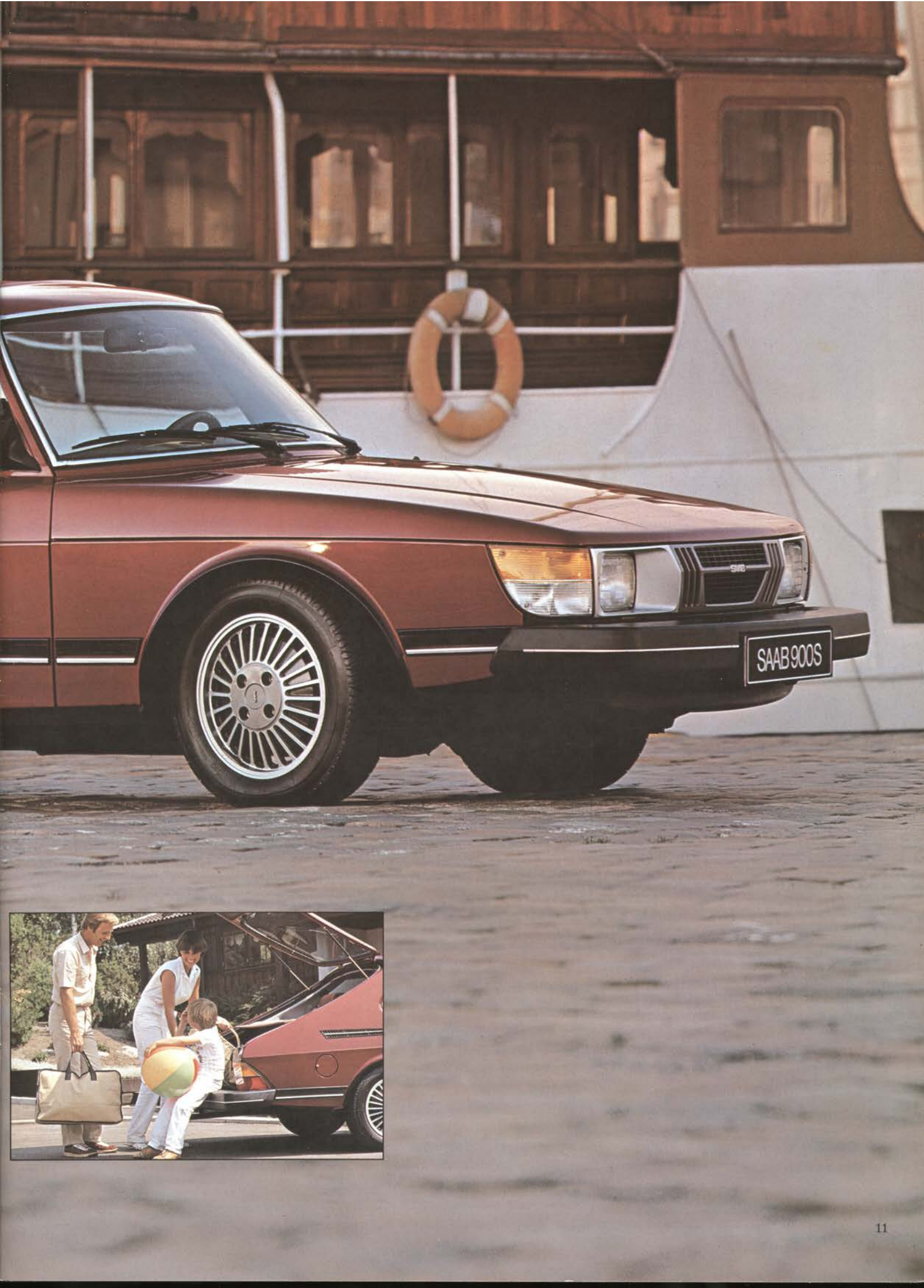

FIRST WE BUILD
A SAFETY CAGE OF THICK
SHEET METAL AND PRESSED STEEL.
THEN WE BUILD A CAR AROUND IT.

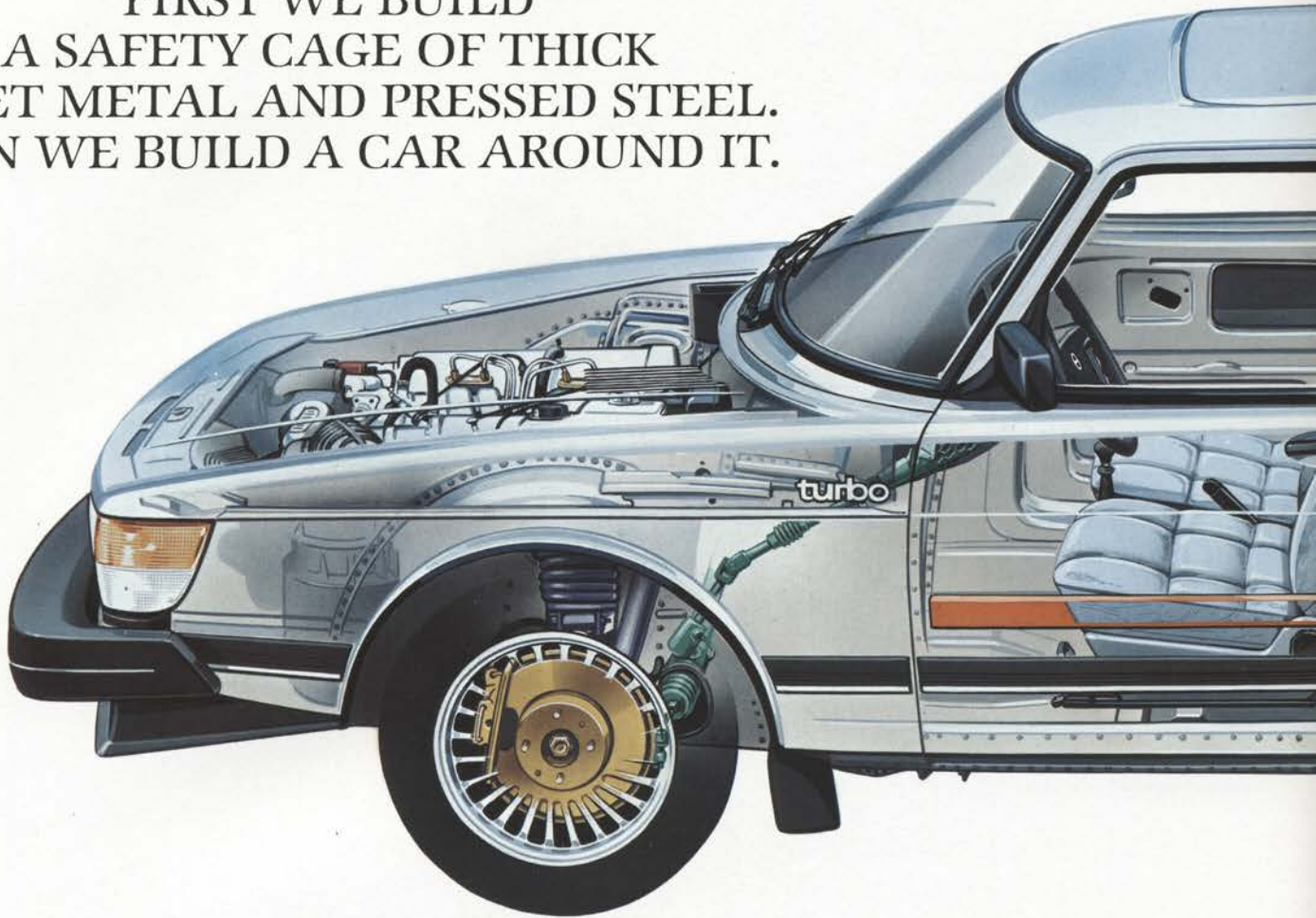

Saabs are designed with front and rear collision zones and a rigid passenger compartment with abundant impact-absorbing material.



Instead of the dubious benefits of gross size and weight to protect you in the event of a collision, the Saab offers something far more reliable.

Engineering:

Strategically placed cross-members in the floor of the Saab, together with rolled steel windshield pillars, rolled steel roof rail and protective bars built into door panels, form the inner defense perimeter of the Saab's passenger compartment.

Saab has established the ideal mutual relationship between instruments, steering wheel rim, steering wheel pad, top and bottom windshield edges, etc.

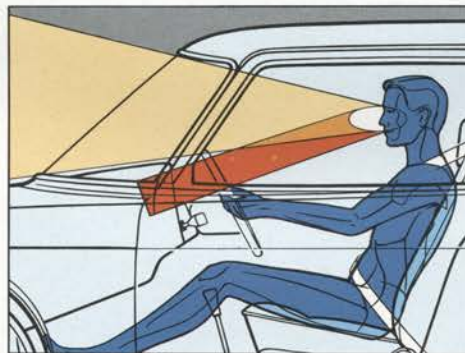

In front of it, steel beams provide stiffening elements between the passenger compartment and the engine.

Underneath it, the car's gas tank has been safely placed out of harm's way, in the tunnel between the rear wheels.

Inside it, the Saab steering wheel is designed to gradually collapse onto its patented steel cage and telescoping steering column, should the driver be thrown against it, absorbing most of the force of impact.

Both the front and rear ends of the Saab are divided into "crumple

The top of the steering column is secured to the same cross-member that supports the entire dashboard.



zones" designed to gradually dissipate the force of a collision before it reaches the passenger area.

In addition, the passengers in a Saab are virtually surrounded by energy-absorbing material:

Specially padded roof liner, padded roof pillars, extra-thick padding around the steering wheel, padded dashboard, specially padded knee protectors and extra-thick padding behind the front seats, to protect rear-seat passengers.

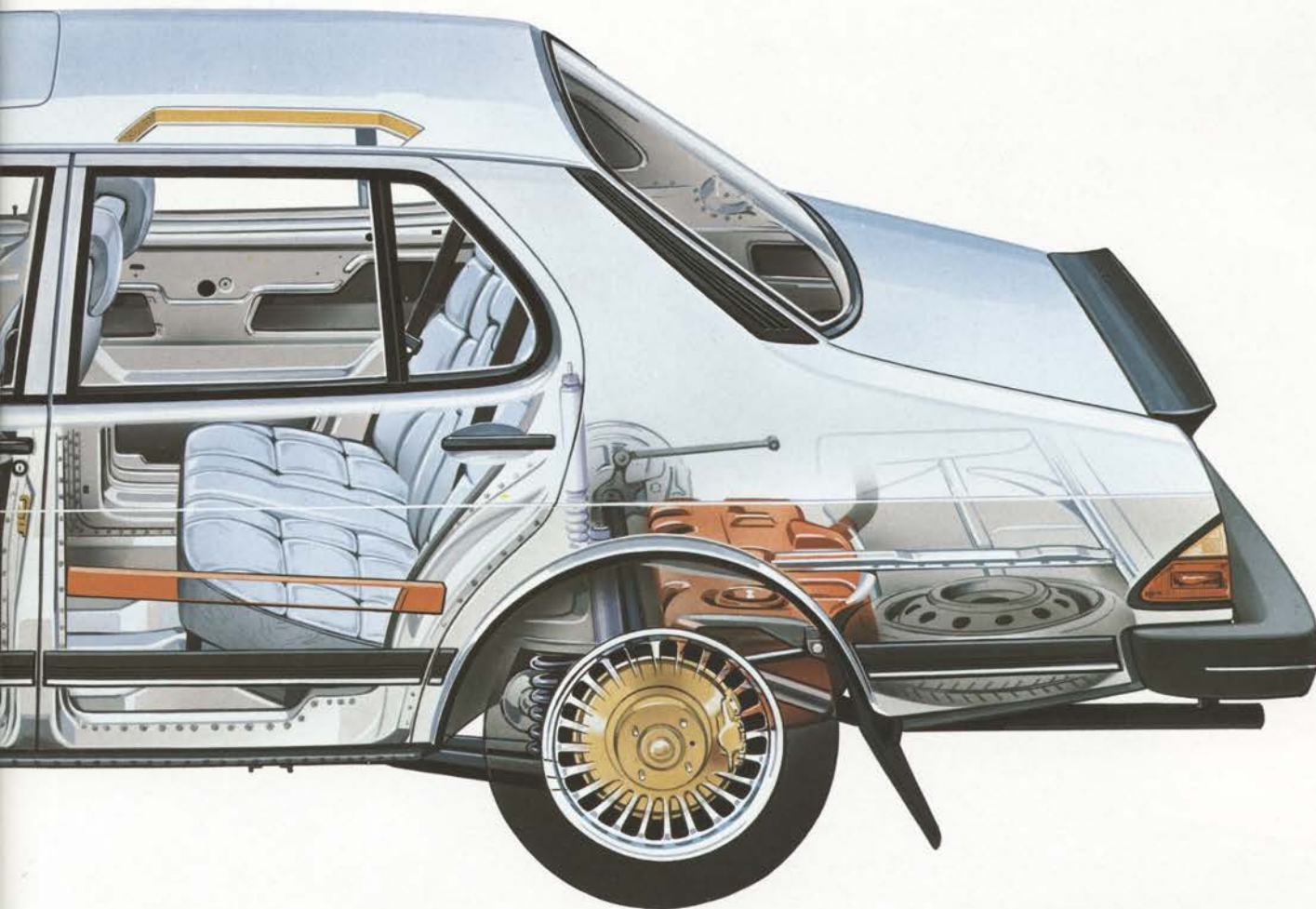

Impact-absorbing leg protector below the dash, designed to protect occupant's knees.

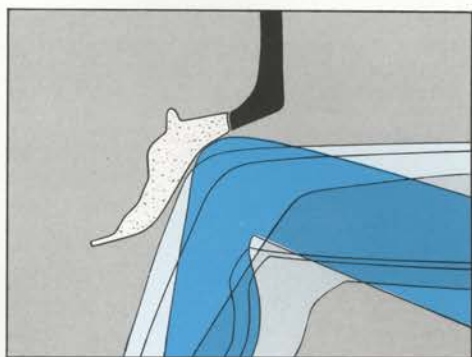

So much for what the engineers call "passive safety".

What about "active safety"—the ability of a car's braking system and handling characteristics to avoid accidents in the first place?

In the case of the Saab, the brakes are disc type, the most effective yet developed. And while other car makers proudly point to their "front discs", the Saab provides self-adjusting, power-assisted disc brakes on all four wheels. With Saab's unique semi-metallic front linings that last at least 20% longer than ordinary linings.

Advanced automatic welding contributes significantly to the overall sturdiness of the body.



The braking system on the Saab 900 is redundant—in the most sensible way possible. It is diagonally split: The left front brake is paired to the right rear, the right front to the left rear. In the event of a failure of one of the two braking circuits, the car is designed to maintain maneuverability and front-line stopping.

Even if both circuits fail, the Saab is equipped with an effective countermeasure: an emergency brake that can actually handle an emergency. The braking effect is about 50 percent of that of the foot brakes

All Saab 900 cars are subjected to a comprehensive anticorrosion treatment at various stages during the manufacturing process.

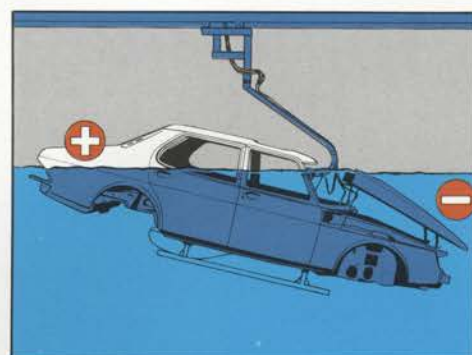

and works in the two front wheels. Where all emergency brakes should work, but don't.

For all the Saab's braking effectiveness, however, you'll no doubt be reassured by the Saab's reputation for superior handling.

If you can't stop in front of it, chances are the Saab's front-wheel drive and rack-and-pinion steering will allow you to get around it.

Anyone who's driven a Saab for any stretch of time will tell you as much.

The car's reputation, like its driving wheels, precedes it.

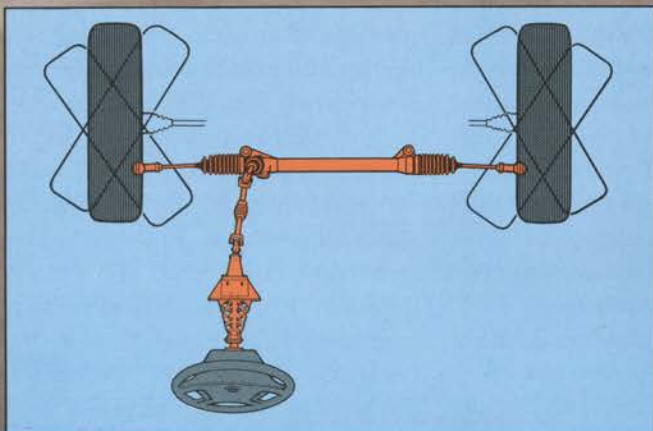

The rack-and-pinion steering responds quickly and accurately to the slightest movement of the steering wheel. Power-assisted steering is standard equipment.



The front-wheel suspension with double wishbones is light but strong. The springs pivot and, therefore, always perform at full capacity, without tending to bend. Together with the long spring travel, this provides superb roadholding, even on irregular surfaces.

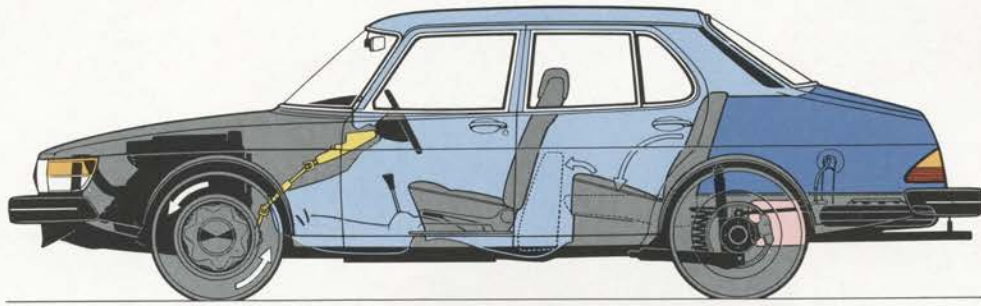

THREE WEEKS AFTER THE VERY FIRST SAABS ROLLED OFF THE PRODUCTION LINE, THEY ENTERED A GRUELING WINTER AUTO RALLY, AND WON. TYPICAL.

Saab's thirty-year string of victories in the world's toughest winter auto rallies and its truly impressive record on the race-track pose a couple of fascinating questions.

First, how to account for such incredible handling in what is essentially not a sports car but a family sedan?

And second, how could any car pull off such a string of accomplishments with a four-cylinder engine?

Handling, in the case of the Saab, is an issue that was basically resolved in 1949, when Saab engineers arrived at the conclusion that a car with front-wheel drive, properly designed, will handle better on slippery roads and high-speed turns than a car with rear-wheel drive.

Many other automakers have recently been struck by the same idea.

But, of course, they haven't had thirty years to develop it.

Over the course of time, for example, it was discovered that the ideal weight distribution for the Saab was 60/40, with 60 percent, of course, over the front wheels.

That the best way to suspend the car was with independent double-wishbones up front, but with a light, unsplit axle in the rear that keeps both tires firmly on the road without affecting passenger comfort, even over bumps and potholes.

When combined with the Saab's precise rack-and-pinion steering, the result is a handling system that few, if any, automobiles can equal.

But handling alone doesn't win races. Or, for that matter, help you build up speed on an acceleration lane.

Which is why the engineers at Saab developed the Turbo.

In general terms, the Saab Turbo can call upon massive amounts of "on demand" power—the equivalent output of, say, a six-cylinder engine or a small V8. At all other times—from 80 to 85 percent of all driving situations—the Saab engine maintains four-cylinder efficiency.

Of course, Saab isn't the only automaker that offers a turbo-charger.

The genius of the Saab's turbo is that it also performs at lower driving speeds than other turbos. Speeds you're more likely to drive at in the real world.

Say, when passing a car on an expressway.

Or entering that acceleration lane.

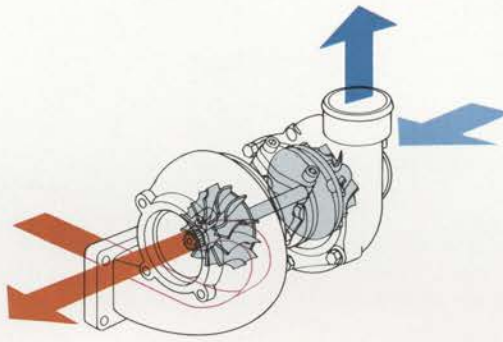

IS IT IRRATIONAL TO DEMAND INCREASED POWER AND INCREASED ECONOMY FROM THE SAME ENGINE?

Many car makers would be justifiably happy to get either. The engineers at Saab, however, have traditionally demanded both. In addition to which, their four-cylinder engines had to be environmentally safe, relatively compact and, for some models, capable of even greater power output.

The request for additional power would have presented no problem to most car makers—their answer to any such request has traditionally been more cylinders.

The fact that this often presents the owner with a far more complicated—and fuel-hungry—engine to maintain seems only recently to have given them pause.

The engineers at Saab, on the other hand, had a somewhat different answer to the request for power.

Turbocharging.

Which is no more than the utilization of exhaust gasses to activate a turbine and compressor, which deliver an increasing amount of pressurized air to the pistons, creating more power with every stroke.

Greater torque is thus produced, but with a smaller amount of extra fuel.

On the face of it, this is nothing new. Turbochargers have long been fitted to the engines of race cars, for example, for the purpose of achieving high top speeds.

Seen in this light, the Saab Turbo would appear to be an entirely original feat of engineering:

It ensures high torque, but not merely at racetrack speeds. Instead, it comes into operation even at the relatively lower speeds encountered in everyday driving. In terms of engine speed, around 1500–2000 rpm.

At a mere 3000 rpm, engine torque is already a third higher than it would be with the turbocharger inoperative.

Thus vindicating a belief long held by the engineers at Saab: A turbo becomes far more useful when not specifically designed to chase other turbos around in circles.

With the advent of stringent emissions control requirements in the early seventies, especially in the United States, came the Saab requirement for an environmentally safe engine that can still perform like a Saab.

A requirement gratifyingly met by fuel injection.

In contrast to the more primitive carburetor system that permits fuel flow only in response to accelerator pedal pressure, fuel injection is designed to respond to pedal pressure, atmospheric pressure, outside temperature, engine temperature and engine load.

Thus, fuel flow is more responsive to the needs of the engine at any given moment, and only the precise amount of fuel needed is injected. Combustion is therefore complete. Resulting in better fuel economy, extremely responsive performance and greatly reduced exhaust emissions. Which, when fed into the Saab's highly advanced Lambda Emission Control System, dwindle to mere traces.

Complicating all the other demands being made on the engine was the fact that the engineers wanted the Saab to have better over-the-hood visibility than other cars. The height of the engine, consequently, had to be restricted.

Which they achieved by ingeniously tilting the entire engine block at an angle of 45°.



Automatic transmission is now also available on Turbo models. All manual transmissions have five forward speeds.

SAAB 900 TURBO

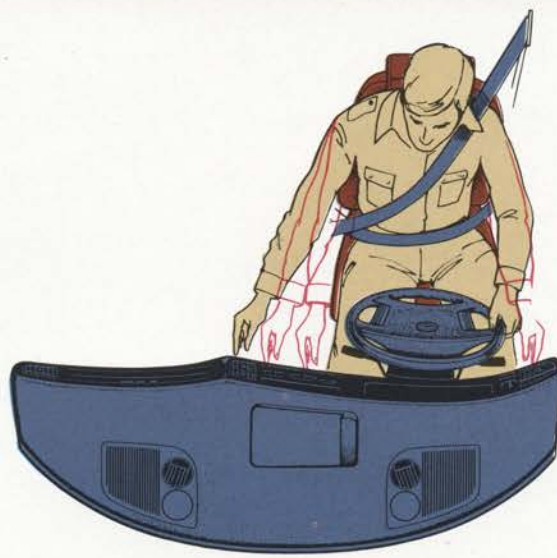





Illustration Saab 900 Turbo.
The radio is available as an optional extra.





WHO WOULD KNOW MORE ABOUT DESIGNING A COCKPIT THAN SOMEONE WHO BUILDS SUPERSONIC JETS?

One of the advantages of being a lot more than a car company is that you can do a lot more than a car company.

Thus, when Saab engineers set out to design the driver's environment of the Saab 900, they were already armed with the results of technical studies and research projects launched by Saab in collaboration with the Saab-Scania Aerospace Division.

They believed from the first that the requirements of the automobile driver were in many respects identical to the requirements of the jet pilot.

Among them, a comfortable and orthopedically beneficial place to sit and the ability to reach all controls and read all instruments without the driver/pilot ever having to shift in his seat or take his eyes from the windshield for more than a moment.

What followed was a search for the ideal relationships between instruments, controls, steering-wheel rim, center pad and the top and bottom edges of the windshield. These were determined on the basis of the eye's "ellipse of vision", enabling the driver to take in, all at once, the relationship between events inside and outside the car.

Extensive human engineering studies were conducted and statistics compiled on key anatomical dimensions to determine the shape of the dashboard, the angle of the steering wheel, the location of the pedals and, of course, the nature of the driver's seat.

The result is an ergonomic masterpiece.

The front seats are among the most orthopedically beneficial in the world.

The dashboard is asymmetrically curved so that the driver can reach all controls quickly and easily without shifting his seating position.

The instruments are deeply recessed and entirely non-reflecting.

The large round displays use white symbols and orange pointers over a black background to relay information. This because tests have shown it's easier to observe changes in the position of a large pointer, using peripheral vision, than it is to observe changes in, for example, a digital instrument window.

All instruments and controls are arranged logically in "zones".

Thus the ignition lock is grouped together sensibly with the gearshift and handbrake in their assigned zone on the center console.

All of which illustrates a belief we've held ever since the Saab cockpit was designed.

It doesn't necessarily take an engineering degree to appreciate the innate intelligence of a car.

Sometimes just getting behind the wheel is enough.



1.



5.

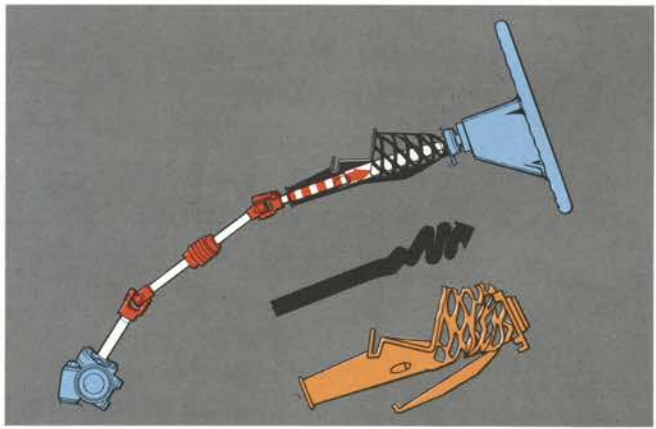

2.



6.



3.



4.

1. The steering wheel rim is covered with an energy-absorbing material that also assures a firm and comfortable grip. The hub pad is designed not to obstruct any instruments on the dash.

Two types of outer rear-view mirrors are available, depending on the model: mechanically adjustable by means of a control inside the door or electrically adjustable by means of two switches on the dash.

2. The steering column is carefully designed to protect the driver in the event of a collision. As far as we know, no safer system exists.

3. In the Saab 900, the controls are assembled in logically arranged groups.

The photo shows the center console, in which all starting controls are assembled: ignition, gear lever, and hand brake. Removing the ignition from the steering column is also a safety measure aimed at preventing knee injuries.

4. Electric window controls mounted in the front doors are standard on certain versions of the Saab 900.

5. Two loudspeakers are built into the top of the dash.

6. Owing to an exclusive vacuum control system, the heating and ventilation system of the Saab 900 is simpler to operate than those of most other cars. The settings are programmed in a carefully studied sequence. The centrally located switches are of the "on-off" type, with symbols illuminated from the inside.



Inside the Saab 900 Turbo 4-door.



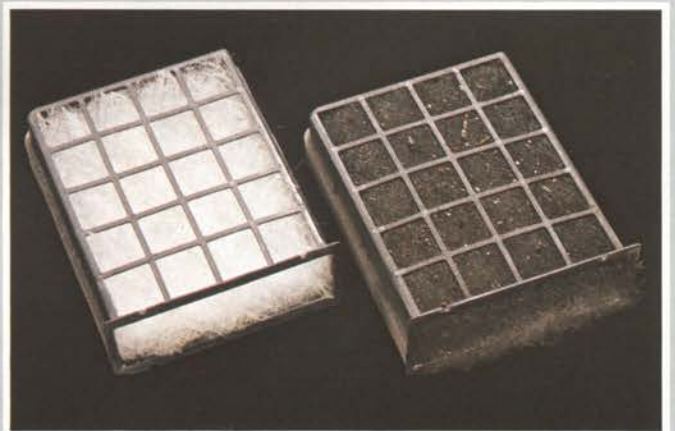

1. Front seat head restraints are vertically adjustable in steps and can thus be preset to suit persons of widely differing statures. The head restraint has excellent energy-absorbing capacity in the event of a collision. It is also designed to gently stop the back-seat passengers should they be thrown forward in a collision.

2. In the "S" series and Turbo models, back-seat comfort is enhanced by plush-covered headrests and folding armrest.

3. Front-seat mountings are placed forward. So back-seat passengers have more legroom and comfortable entry into the car.

4. The unique cartridge-type ventilation air filter arrests all particles larger than 0.005 mm, like pollen and dust. It also prevents outdoor moisture from entering the car and misting up the windows before the interior has warmed up. (Air filter not available on cars equipped with air conditioning.)

5. The seat cushion of the back seat has between four and five times as many springs as a seat cushion of conventional design.

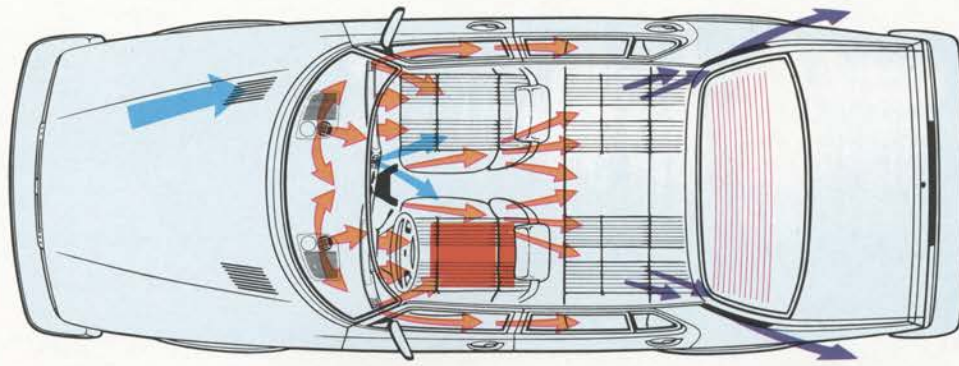

MANY CAR MAKERS THINK INTERIOR COMFORT MEANS STUFFING FOAM RUBBER UNDER YOUR SEAT. IF SO, WHERE DOES THAT LEAVE YOUR BACK, THIGHS, HEAD, SHOULDERS AND LUNGS?

Interior comfort in the Saab doesn't begin and end with the upholstery.

It begins with the size of the interior.

Saab 900s have more headroom, legroom and shoulder room, front and back, than any of their leading competitors.

Small wonder, then, that the Saab 900 3-door, roughly the same size as many compact European sedans on the outside, has been designated a midsize car by the EPA.

Admittedly, the time you spend in the Saab's interior will be spent sitting down.

Admittedly, that calls for some form of upholstered seating.

But please don't confuse the scientifically developed, orthopedically beneficial seats in the Saab with the living room furniture many carmakers seriously expect you to drive in.

Driving is work. At least twenty hours' worth for every thousand miles you're on the road.

And if a car's seat is a driver's workplace, it must somehow

provide him with optimum comfort, even after many hours of driving, and an "anatomically correct" seating position that insures unobstructed visibility on the one hand and places all controls within easy reach on the other.

The front seats in the Saab achieve this by providing both firm support from the neck to the knees and an infinite array of possible seating adjustments.

The backrest and seat cushion, for example, are dished. The backrest incorporates reinforcement for the top of the back and down along the driver's sides, special recesses for the tips of his shoulder blades and reinforcement for the lumbar region.

The lumbar support is elastic and, owing to its pressure distribution profile, adapts itself automatically to the shape of the back.

The rake of the backrest is infinitely adjustable down to the reclining position.

The seat can be moved six inches back and forth and the driver's seat is even adjustable in height and slope—high or low at the front and high or low at the rear.

Recognizing the fact that a cold driver is a dangerous driver, the engineers at Saab have even seen to it that the front seats on certain models are heated automatically whenever the temperature drops below 57 degrees above zero.

As for the Saab's back seat, its seat cushion has between four and five times as many springs as a seat cushion of conventional design. Making the Saab's back seat more comfortable than the average front seat.

But the quest of Saab engineers for the most comfortable interior possible doesn't stop there.

They've carried it into an area every other automaker seems to have taken for granted.

Breathing.

460,000,000 people in the world suffer from allergies and asthma.

The Saab 900 is probably the world's first car equipped to handle their problems.

A specially designed filter in the Saab ventilation system, on certain models, removes pollen and dust particles larger than 0.005 mm.





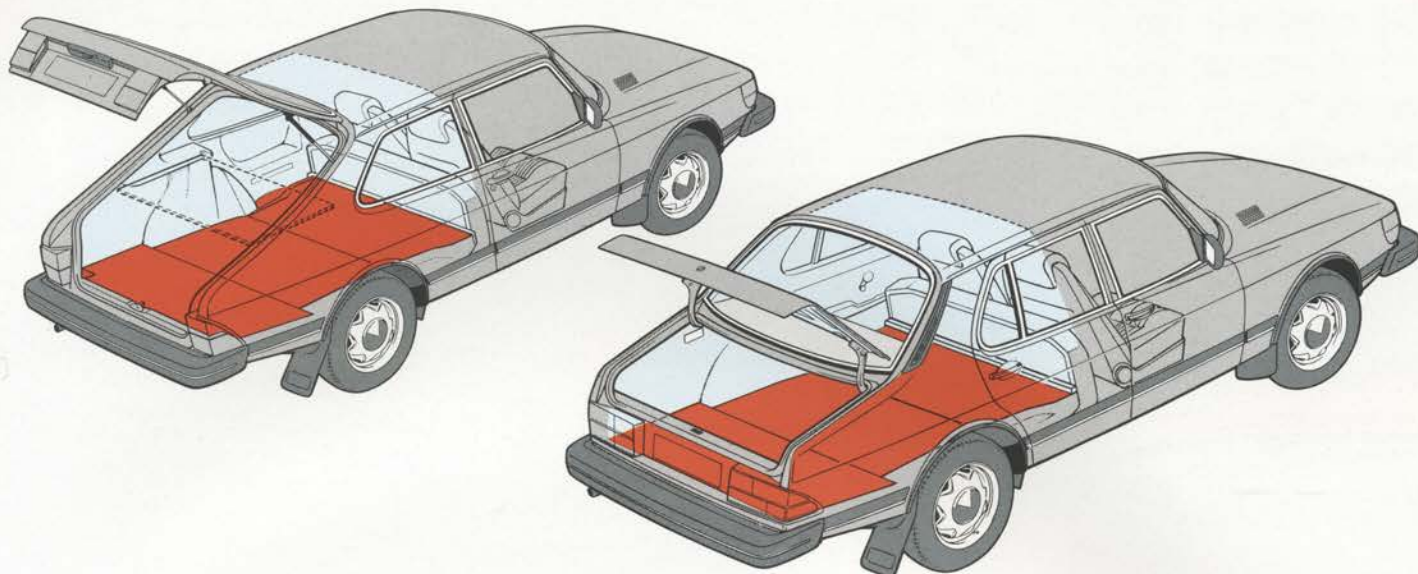

OTHER SEDANS GIVE YOU A TRUNK. THIS SEDAN GIVES YOU A STATION WAGON.

The first Saab, in 1949, had no trunk at all.

Loading and unloading was accomplished by entering the car and reaching into the trunk-like space behind the rear seats.

Naturally, it was a situation the engineers at Saab were unhappy with. But it did help make the Saab one of the least expensive automobiles in the world, which, in postwar Sweden, was exactly what was called for.

The entire production run of 1246 cars was completely sold out in a matter of months. There were nearly four prospective buyers for every car.

By 1974, the needs of the car-buying public had grown considerably more sophisticated.

Saab, by now recognized worldwide as a champion of in-

novative common sense in automotive design, was about to launch yet another new automobile.

As Saab's Technical Director, Henrik Gustavsson, announced the car, it was apparent that the passenger sedan, as the world then knew it, was being changed forever:

"We recently extended our range of 99 models with a hatchback model... a new car concept—a combination of a sedan and a station wagon, in which we replaced the heavy rear door of the conventional wagon with a sloping rear door. The result was an aerodynamically favorable design of the rear section. This new type of car has already been copied by other manufacturers. But our Combi Coupé differs by the absence of a high sill at the rear of the car. So it is extra easy to load and unload."

The Saab 99 Combi Coupé was, of course, the forerunner of the Saab 900.

Yet, in the seven years since the introduction of the Saab sedan/station wagon concept, no car of any size has been able to equal its overall load capacity.

In the three-door models the trunk alone gives you 21.3 cu. ft. (SAE 14.9 cu. ft.) of luggage space—as much as the biggest luxury sedans made in America.

The removable parcel shelf, on three-door models, can make room for a full 27.2 cu. ft. (SAE 19.1 cu. ft.)

And by folding down the rear seat in three-door models, you actually create a station wagon. With a full 56.5 cu. ft. of cargo space, roughly four times as much as sedans of comparable overall length.

It's obvious that at least one thing hasn't changed since 1949.

Saab is still giving people exactly what's called for.



1.



5.



2.



6.

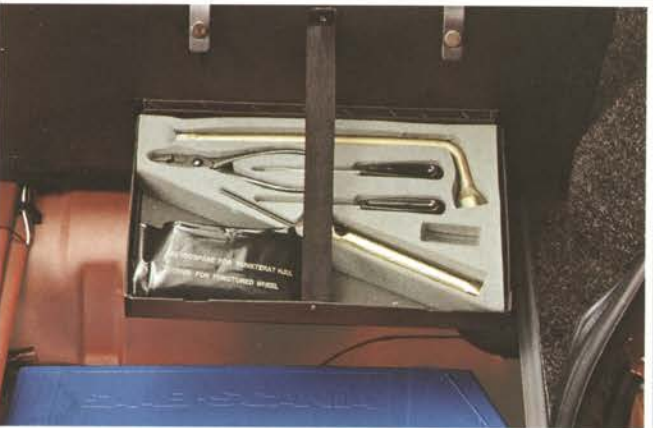

3.



4.

1. The spare tire is tucked away, leaving the voluminous trunk free to carry voluminous quantities of luggage and what have you.

2. The lockable and illuminated glove compartment of the Saab 900 forms an integral part of the dashboard and is therefore stable and rattle-free.

3. The practical tool box under the floor hatch makes for neat storage. The space under the floor hatch also accommodates the spare wheel.

4. The Saab 900 includes provisions for concealed loudspeakers at the rear. In the 4-door Sedan model shown in the picture, the loudspeakers can be located below the parcel shelf.

5. When the back seat is folded down, the parcel shelf in the hatch back model is designed to store transversely on the floor. It can be "locked" in the raised position when loading and unloading.

6. The capacity of the luggage compartment in the 4-door Sedan model is no less than 21.8 cu. ft. (SAE 14.2 cu. ft.) Owing to the low-level sill, the Sedan model is among the easiest in its class to load. As in the case of hatch-back models, the luggage compartment can be converted into a large, flat, load-carrying area by simply folding down the back seat.

ARE SPORTS CARS OBSOLETE?

Saab sedans regularly compete against sports cars in
Sports Car Club of America races.
And Saabs regularly win. So much for sports cars.





Budweiser

SHARP RACING

sleep cheap!

12

12

CAS

TURBO

BOSCH

SAAB



1.



2.



3.



4.



5.





6.



7.



8.



9.



10.

WHEN YOU OFFER THE MOST INTELLIGENT CAR EVER BUILT, WHAT MORE CAN YOU OFFER?

Everything you see here, and more besides. Ask your Saab dealer.

1. A full line of AM/FM radios and stereo radio cassettes. Shown: Blaupunkt 3001.

2. Accessory console. Includes 9-cassette holder, ambient temperature gauge and choice of three other gauges (ammeter, oil pressure gauge, vacuum gauge or oil temperature gauge).

3. Speed control.

4. A selection of auxiliary lighting is available.

5. Decorative, luminescent stripes.

6. Sunroof wind deflectors and window wind deflectors available.

7. Luggage rack. Adaptors for skis, bikes and bulk carrying also available.

8. Rear window louvers to reduce sunlight.

9. Rear-wheel mudflaps.

10. Optional light-weight wheels.

Saab 900, 1981 | MODEL RANGE.



SAAB 900, 3-DOOR.
Fuel injection engine developing
SAE net 110 hp (81 kW).
5-speed manual transmission or
automatic transmission.

INTERIOR COLORS.



Blue fox



Cashmere brown



SAAB 900S, 3-DOOR.
Fuel injection engine developing
SAE net 110 hp (81 kW).
5-speed manual transmission or
automatic transmission.



SAAB 900TURBO, 3-DOOR.
Turbocharged fuel-injection engine
developing SAE net 135 hp (100 kW).
5-speed manual transmission or
automatic transmission.



Blue fox



SAAB 900S, 4-DOOR.
Fuel injection engine developing
SAE net 110 hp (81 kW).
5-speed manual transmission or
automatic transmission.



SAAB 900TURBO, 4-DOOR.
Turbocharged fuel-injection engine
developing SAE net 135 hp (100 kW).
5-speed manual transmission or
automatic transmission.



Moss green



Rosewood

EXTERIOR COLORS.

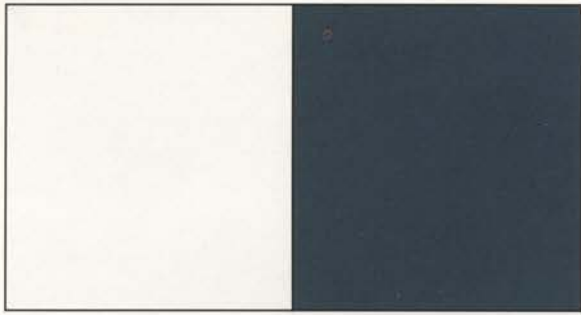

Cirrus white

Midnight blue

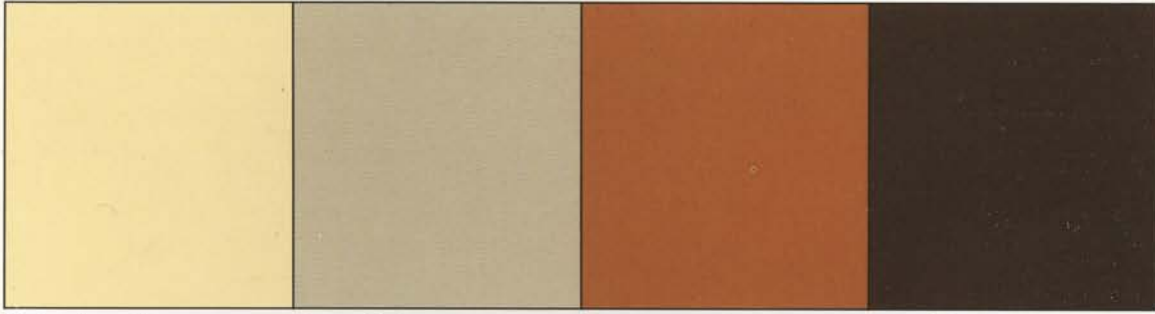

Alabaster yellow

Cameo beige

Terracotta red

Dorado brown

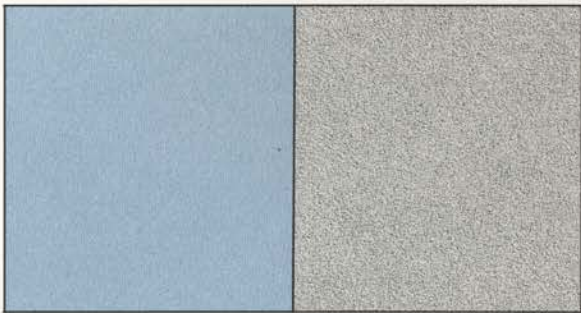

Indigo blue metallic

Silver metallic*

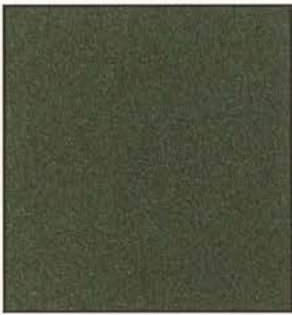

Pine green



Cirrus white

Carmine red metallic

Anthracite gray metallic

Black

*) Not available for national distribution until March, 1981.
Consult your local dealer as to availability in your area.

TECHNICAL SPECIFICATION.

Saab 900, 3-door.

Engine.

4-cylinder, liquid-cooled, in-line engine with overhead camshaft. The longitudinally mounted cylinder head, cam cover and intake manifold. 5-bearing camshaft and crankshaft.

Sodium cooled exhaust valves.

Displacement 121 cu in (1985 cc). Cylinder bore 3.54 in (90 mm). Piston stroke 3.07 in (78 mm).

Compression ratio 9.2:1.

Horsepower SAE net 110 hp (81 kW) at 5250 rpm.

Peak torque 119 ft lbs (161 Nm) at 3500 rpm.

Mechanically controlled Bosch CI fuel injection. Recommended octane 87.5 Minimum Compression Ratio 9.2:1.

12 V/60 Ah battery, maintenance-free.

Alternator with max. output of 930 W, 14 V/70 A. Breakerless electronic ignition system.

Starter motor rating 1.1 hp (0.8 kW).

Cooling system of pressurized type. Cross-flow radiator and separate expansion tank. Cooling fan electrically controlled.

Power Transmission.

Five speed manual transmission: Hydraulically actuated dry-plate clutch; clutch and primary drive shaft.

Chassis.

Four wheel disc brakes. Brake pads area 35 sq in (228 cm²). Brake swept area 388 sq in (2500 cm²). Semi-metallic outer brake linings at the front.

Lateral wishbones and pivot-mounted, progressive action coil springs at the front. Light duty rear springs.

Rack-and-pinion steering gear. Jointed and telescopically collapsible steering column with power assist.

Steel wheels with hub cap, 5J x 15" FHA. 165 SR 15 steel cord tires. (Temporary use-type compact spare on special steel rim.)

Dimensions and Weights.

Overall length 187.6 in (4764 mm). Overall width 66.5 in (1690 mm). Height unladen 55.7 in (1415 mm); 4-door models 69.1 in (1755 mm). Luggage compartment 3-door models 27.2 cu ft (770 litres), SAE 19.1 cu ft (540 litres). Luggage compartment 3-door models only, 27.2 cu ft (770 litres), SAE 19.1 cu ft (540 litres). Luggage compartment 3-door models only, 27.2 cu ft (770 litres), SAE 19.1 cu ft (540 litres).

Curb weight approx. 2612-2702 lb (1187-1228 kg).

Gross vehicle weight rating 3830 lb (1740 kg).

Standard Equipment.

Effective bumpers which are self-repairing after low-speed collisions. Large corner light and interval pulse windshield wipers. Large outer rear-view mirrors with anti-dazzle treatment.

Power assisted steering. Four spoke sports steering wheel with padded rim and impact-absorbing panel. Rheostat controlled green instrument lighting. Full complement of indicating lamps.

Front seats incorporating lumbar support and vertically adjustable head restraint. Stepless doors. Roof lining of moulded glass fiber. Electrically heated rear window. Opening rear window controls for fan, temperature and air distribution; Defroster outlets for both windshield and rear window.

Non-dazzle interior lighting. Ignition key lighting. Map-reading lamp. Glove compartment.

Variable luggage compartment capacity. Carpeted luggage compartment floor. Fabric-covered luggage compartment.

Inside manual adjust exterior rear-view mirrors.

Optional Extra Equipment.

Automatic transmission.

■ International and Diplomat Sales (IDS) is available. Your dealer can supply information.

■ The manufacturer reserves the right to alter the specifications and equipment without notice.

Saab 900S, 3- and 4-door.**Saab 900 Turbo, 3- and 4-door.**

Engine is inclined at 45° and is integrated with the clutch, gearbox and differential; the clutch faces forward. Alloy cast iron engine block. Light aluminum alloy cross-flow

Camshaft and pistons of special type.

8 mm).

Compression ratio 7.2:1.

Horsepower SAE net 135 hp (100 kW) at 4800 rpm.

Peak torque 160 ft lbs (217 Nm) at 3500 rpm.

ane Rating (AKI) by (R+M)/2 method (equivalent to RON). Fuel tank capacity 16.6 US gallons (63 litres).

Turbocharger. Charge pressure control. Safety system with pressure switch.

plant volume, incl. heating system, 10.8 US quarts (10 litres). Electric motor driven, thermostatically controlled radiator fan.

Thermostatically controlled, air-cooled engine oil cooler.

drive at front of engine; gearbox and differential below engine; primary drive by chain; two permanently lubricated universal joints drive each front wheel.

(2504 cm²). Diagonally split dual-circuit hydraulic foot brake system with 9-inch vacuum servo. Self-adjusting foot brake and handbrake. Handbrake acts on the front discs.

ight, straight, one piece rear axle, guided by two leading and two trailing arms and a Panhard rod.

Double-acting gas pressurized shock absorbers all round.

cylindrical sheet metal bellows. Impact-absorbing, perforated sheet metal cage below the steering wheel. Turning circle diameter 33.8 ft (10.3 m).

Light alloy wheels, 135 TR×390 FH. 180/65 HR 390 Michelin TRX tires. (Temporary use-type compact spare on special steel rim.)

in (1420 mm). Wheelbase 99.4 in (2525 mm). Track front 55.9 in (1420 mm). Track rear 56.3 in (1430 mm). Max. luggage compartment length, back seat folded down, 3-door models 21.3 cu ft (602 litres), SAE 14.9 cu ft (421 litres); 4-door models 21.8 cu ft (617 litres), SAE 14.2 cu ft (402 litres). Luggage compartment with parcel shelf removed, ert volume, back seat folded down, 3-door models 56.5 cu ft (1600 litres); 4-door models 53 cu ft (1500 litres).

Curb weight approx. 3-door 2652–2745 lb (1205–1248 kg);
4-door 2739–2790 lb (1245–1285 kg).

Curb weight approx. 3-door 2777–2814 lb (1262–1279 kg);
4-door 2839–2876 lb (1290–1307 kg).

usters with direction indicators, parking lights, cornering lights. Side guidance reversing lights. Rear light clusters include brake lights, parking lights and reversing lights. Two-speed ent. Hazard warning lights. Reflectors on driver's side door edges. Tow lugs front and rear. Anti-corrosion priming by electrodeposition.

bsorbing center pad. Energy absorbing steering column of advanced safety design. Instruments and controls on concave instrument panel. Impact-absorbing shield below instrument Trip meter. Clock. Tachometer. Day/night interior rear-view mirror. Instrument panel mounted stereo loud speakers.

backrest rake adjustment. Driver's seat cushion adjustable in height and tilt. Inertia reel front seat belts. Rear lap belts. Grab handles under instrument panel and above passenger de windows (3-door models). Tinted glass all windows. Heating and ventilation system: Semi-automatic with vacuum control; 12 interior air outlets; Central location of rotary side windows; Air outlets in the front footwells, close to the front doors, and to the rear footwells; Highly efficient ventilation air filter (not available on cars fitted with air conditioning).

ghing. Luggage compartment lighting. Automatic headlamp control (headlamps automatically switched off with the ignition).

red parcel shelf.

Deluxe interior decor. Electrically heated front seats. Folding center armrest in rear seat. Rear seat headrests. Sliding steel sunroof.

Air conditioning. Halogen headlights. Electrically operated rear-view mirrors. Power windows, front doors (4-door only). Front and rear spoilers (3-door only). Black window surround mouldings.

Automatic transmission. Metallic paint.

SAAB

Saab-Scania, Saab Car Division
Nyköping, Sweden

Saab-Scania of America
Saab Drive, Orange, CT. 06477

