



> View price list



View offers > Saloon > Estate



> SOUND WITH POWER



> Mercedes-Benz Magazine

# E-Class

Saloon and Estate



Mercedes-Benz





> View price list



View offers > Saloon > Estate



> SOUND WITH POWER



> Mercedes-Benz Magazine

# The new E-Class. At the top of its game

The new E-Class is designed to make your life easier. With the only exception being, perhaps, the choice of model that's right for you. After all, both the E-Class Saloon and the Estate have been refined with significantly sharper lines for an even more dynamic appearance. Expressively bold details are mixed with the elegant genes the E-Class is renowned for, to create a truly head-turning effect.

The view from behind the steering wheel is equally rewarding: numerous safety systems and electronic assistants ensure you enjoy a comfortable ride whatever the day throws at you. So whether you drive for pleasure or because you have to, the E-Class makes every journey effortless. And with the Estate's outstanding load capacity, you have plenty of room to add whatever you need to your journey. So whether it's tremendous style or extra roominess you're looking for, the E-Class always has the right answer.





> View price list



View offers > Saloon > Estate



> SOUND WITH POWER



> Mercedes-Benz Magazine



**Three ways to make the best impression:  
the presented models at a glance**

**4 | E 350 BlueTEC AMG Sport Saloon**  
Iridium Silver metallic

AMG 5-twin-spoke alloy wheels, Crystal Grey nappa leather upholstery, dark aluminium trim

**8 | E 350 BlueTEC AMG Sport Estate**  
Obsidian Black metallic

AMG 5-twin-spoke alloy wheels, Porcelain nappa leather upholstery, Brown Open-pore Ash wood trim

**13 | E 63 AMG S-Model Saloon**  
Diamond White metallic

AMG 10-spoke alloy wheels, Black nappa leather upholstery, Black Ash wood trim

**The best equipment for every journey:  
all the facets of the E-Class**

**19 | Engines and suspension**

**29 | Safety**

**33 | Comfort**

**43 | AMG**

**51 | Equipment**

**69 | Services**

**71 | Facts and finishes**



With an iPad® you can download the interactive E-Class Saloon and Estate brochure app either by scanning the QR code or by visiting the App Store

Images may show accessories or special equipment that are not part of standard specification





> View price list



View offers > Saloon > Estate



> SOUND WITH POWER



> Mercedes-Benz Magazine

Overview 4

For the record:

Executive position filled





> View price list



View offers > Saloon > Estate



> SOUND WITH POWER



> Mercedes-Benz Magazine

Reach your personal best:  
Success in motion



The eyes light up, your fingertips tingle with excitement: the E-Class Saloon is designed to convince every part of you. The E-Class SE satisfies every demand for comfort and luxury, while the AMG Sport honours its name with athletic styling throughout. Once on the road the real performance begins, full of agility and energy. It's a powerful proposition on all accounts. → Pages 51–58





> View price list



View offers > Saloon > Estate



> SOUND WITH POWER



> Mercedes-Benz Magazine

Clear your diary:

Monday 0.01 am to Sunday 11.59 pm –  
a merger of agility and comfort

6



It's not just design and axle load distribution that are finely balanced in the E-Class. The comprehensive choice of engines ensures there is something for every driver's needs and ambitions, whether you're drawn to a more sporty driving style or committed to long distance trips. The E-Class is equally adaptable as thrilling. → Pages 21–24

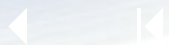



> View price list



View offers > Saloon > Estate



> SOUND WITH POWER



> Mercedes-Benz Magazine



Memo:

## The best place to forget the time

Take a seat and you'll instantly feel transported to a special place: the E-Class interior is fitted with a sophisticated dark aluminium trim. COMAND Online system with Media Interface and DAB digital radio tuner add to the unique E-Class experience. Of course, you can choose from a wide range of equipment options to make this saloon truly your own.





> View price list



View offers > Saloon > Estate



> SOUND WITH POWER



> Mercedes-Benz Magazine

Success prognosis:

Take your pick for the best angle



The E-Class Estate redefines size, showing a flair for sophisticated movement before you're even seated behind the steering wheel. For a truly dynamic appeal the exterior features a contoured side section with bold character lines. Powerful yet efficient engines amply support the E-Class' nature as a true driver's car.







> View price list



View offers > Saloon > Estate



> SOUND WITH POWER



> Mercedes-Benz Magazine

Safety check:

## All systems go



Safety is also a question of trust. Mercedes-Benz Intelligent Drive technologies provide the answer, offering all the assistance you need. They improve visibility for you and others, and help you brake more effectively when it really matters. Intelligent Drive gives you the kind of prudence to help you stay in control, even in today's demanding traffic situations. → Pages 19, 29-32





> View price list



View offers > Saloon > Estate



> SOUND WITH POWER



> Mercedes-Benz Magazine

10

To do:

## Choose detours more often than shortcuts



In an ideal scenario, driving a car should mean less stress – not more. The E-Class assists you with a multitude of helpful systems to ensure you stay relaxed. For example, you can see current speed limits and overtaking bans on the instrument cluster, while your car detects signs of drowsiness and advises you to take a break. As you're in such good hands, you might as well take the longer route. Purely for relaxation purposes, of course. → Pages 29–32, 35–36





> View price list



View offers > Saloon > Estate



> SOUND WITH POWER



> Mercedes-Benz Magazine

Reply to all:

## There's plenty of room for everyone

Life is full of challenges, so it's good to have a car that's ready for anything. The E-Class Estate offers freedom instead of restrictions, pleasure instead of chores, and solutions instead of problems. Like the optional third seat row, for example. So you can do as you please, and a whole lot more. → Pages 39–42

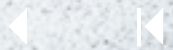



> View price list



View offers > Saloon > Estate



> SOUND WITH POWER



> Mercedes-Benz Magazine

Reminder:

## The best lights come in threes

The E-Class adapts to your requirements at the touch of a button. You can choose from three different ambient lighting colours depending on your mood. This provides a particularly stylish showcase for the dark aluminium trim elements plus numerous seat appointments. Your good taste is your trusty passenger here. → Pages 51-58

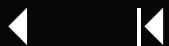



> View price list



View offers > Saloon > Estate



> SOUND WITH POWER



> Mercedes-Benz Magazine

Take note:

## Short-lived trends never catch up with true performance



If you want to reach the top, you'll have to have something special to offer. Like the E 63 AMG S. Its unique acceleration and impressive handling are the result of decades of developments at the highest level. This powerful V8 biturbo engine takes you from 0 to 62 in 4.2 seconds. So you'd better hurry if you want to join this new movement.

→ Pages 45–46





> View price list



View offers > Saloon > Estate



> SOUND WITH POWER



> Mercedes-Benz Magazine

Booked in:

## Circuit training - for those muscles beneath the bonnet



Brace yourself for an impressive encounter. While the powerful E 63 AMG S ignites instant admiration, the exclusive AMG appointments prove just as hard to resist as the choice of alloy wheels. The E-Class proves that poise manifests itself at every angle. → Pages 47-50

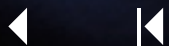



> View price list



View offers > Saloon > Estate



> SOUND WITH POWER



> Mercedes-Benz Magazine

Must-have:

## The power of 585 horses with red brake calipers



To enjoy the power released by the E 63 AMG S you have to control it. Which is why the brakes are as effective as the powerful drive system they counteract. Red-painted calipers signal an immense amount of horsepower to be kept in check. They also demonstrate that at Mercedes-AMG everything is designed with performance in mind. And that includes the brakes as well, of course.





> View price list



View offers > Saloon > Estate



> SOUND WITH POWER



> Mercedes-Benz Magazine



Top priority:

## Pole position for every seat

Inside, the AMG model presents itself just as dynamically as on the exterior: great care has been taken to adapt every minute detail to its sporty character. The special AMG interior with AMG Drive Unit and E-Select shift lever makes you feel like a top athlete, too. Whether you're sprinting or going long distance.







## It's not just Oscar who helps keep you safe. Christian, Hannah and Martin also do their bit

The exterior temperature display in the E-Class shows minus 18°C. The windows are iced up. But inside, it's a pleasant 21°C. As the driver's door opens, Dr Oscar eases out of his seat, his joints creaking a little. "All measurements are complete", announces his colleague. Dr Oscar, meanwhile, does not join in with the discussion. He has neither a PhD nor, in fact, any kind of degree. He is the object of the studies. With his assistance, the engineers are able to measure the perception of hot and cold from temperatures in excess of 70°C down to minus 18°C, which helps answer important safety questions. After all, a driver can only control a vehicle reliably if they are comfortable from head to toe. Our experts call this 'driver-fitness safety'. The chances of achieving this state of mind are higher, the more areas work together perfectly in the car: a pleasant interior temperature, an ergonomic sitting position, intuitive controls and electronic assistants are just a few examples.

Important indicators here include body temperature and heart rate. That's why, in addition to using Dr Oscar, we work with real people like you. The more relaxed our testers are, the more reliable their reactions. Even though palpitations are generally a sign of excitement, in the E-Class the driver's heart beats for relaxation.





## The E-Class in detail

### Engines and suspension

- 19 | Mercedes-Benz Intelligent Drive and Mercedes-Benz Connect
- 20 | BlueEFFICIENCY
- 21 | Diesel engines
- 22 | Petrol engines
- 23 | Alternative drive systems
- 25 | Transmissions
- 27 | Suspension

### Safety

- 29 | Integrated safety concept

### Comfort

- 33 | Multimedia systems
- 35 | Electronic assistants
- 37 | Climate control
- 38 | Seats
- 39 | Load compartment management
- 41 | Load space

### AMG

- 43 | E 63 AMG
- 45 | E 63 AMG S-Model
- 47 | E 63 AMG technology
- 49 | AMG Performance Studio

### Equipment

- 51 | SE
- 55 | AMG Sport
- 59 | *designo*
- 61 | Standard equipment
- 63 | Optional equipment
- 65 | Alloy wheels
- 67 | Retailer-fit accessories

### Services

- 69 | Services

### Facts and finishes

- 71 | Technical data
- 75 | Dimensions
- 76 | Paint finishes

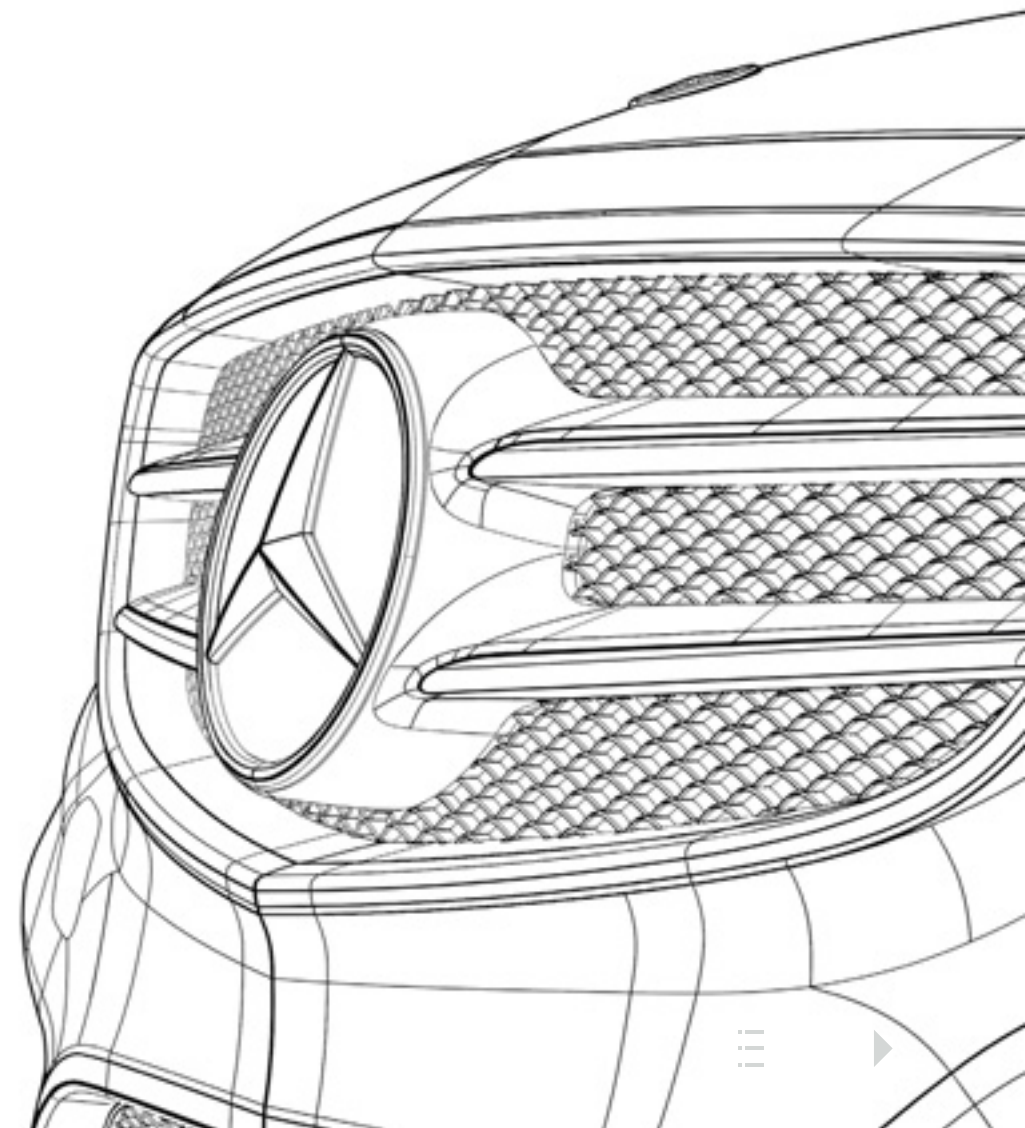



## Connected with all the senses

With Mercedes-Benz Intelligent Drive and Mercedes-Benz Connect, we have taught our cars to think. It takes us one step closer to our vision of accident-free driving.

Our engineers live in the future, constantly aiming to turn innovative thinking into everyday solutions. This aspiration has resulted in many developments with a lasting impact on automotive engineering. In other words, our work ensures that a Mercedes-Benz is always ahead of its time.

Innovative technologies such as the Pre-Safe® anticipatory safety system and Distronic Plus radar-assisted cruise control first made it onto the road in a Mercedes-Benz, setting new standards in vehicle safety. It marked the first time active and passive systems were combined – for even better protection and ride comfort. Time and time again we have pioneered solutions to get closer to realising our vision of accident-free driving.

**Mercedes-Benz Intelligent Drive** takes things a step further by intelligently combining sensors with safety systems and electronic assistants. For us, it's a logical progression as the traffic situation has changed. There are more vehicles on the road, the driver's job is becoming more complex and distractions are increasing.

Radar-assisted Cruise Control with Steering Assist and Stop & Go Pilot marks another important step towards autonomous driving. Steering Assist provides lateral assistance to keep the car in lane. It works with a stereo camera capturing road markings and vehicles driving ahead at low speeds. The system brakes if necessary and accelerates to a preset speed when possible. As a result, your driving comfort is significantly enhanced, especially on long journeys or in slow-moving traffic jams.

**Mercedes-Benz Connect.** Serving as a smart interface between car and Internet, Mercedes-Benz Connect offers a whole range of services for your comfort, safety and information. It's an effortless, highly efficient way to keep the driver connected with the digital world when on the move. The system can be paired with COMAND Online, live traffic information, the Mercedes-Benz Emergency Call System and with many individual Mercedes-Benz apps. While your car remembers your preferences and adapts accordingly, it can even advise you to take specific actions and interact with your social networks. Mercedes-Benz Connect turns our vision of seamlessly connected mobility into reality. In the future, the way we drive will change dramatically, making it more comfortable, more efficient and safer as a result.

A Mercedes-Benz can monitor the road situation, alert you to possible dangers, and if necessary, act independently. Our cars are becoming increasingly intelligent, too. That is why a Mercedes-Benz takes you beyond a specific destination – it takes you straight to the future.

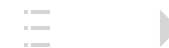



## BlueEFFICIENCY – fast forward to tomorrow

Mercedes-Benz is quicker at getting future technologies to where they matter most: on the road. With ever more efficient vehicles and a production process that wastes fewer and fewer resources. We call this comprehensive approach BlueEFFICIENCY. By way of example, BlueTEC technology for the diesel engine reduces nitrogen oxide

emissions by up to 90%. Our Hybrid models featuring an intelligent combination of internal combustion engine and electric drive can reduce fuel consumption significantly, while the SLS AMG Coupé Electric Drive takes electric mobility to a new level. Technical and aerodynamic optimisation measures right down to the last detail make

the BlueEFFICIENCY Editions available in selected model series true champions of efficiency. But every E-Class model already boasts a raft of BlueEFFICIENCY features – holistic vehicle optimisation measures that are adapted specifically for this model series.



- 1 Efficient alternator charges in deceleration mode
- 2 Optimised aerodynamics thanks to a variable radiator shutter for 4-cylinder models
- 3 New 4-cylinder petrol engine with very low fuel consumption (E 200 and E 250)
- 4 Optimised V8 biturbo petrol engines, including direct injection (E 63 AMG and E 63 AMG S)
- 5 Some diesel and petrol engines already meet EU6 emissions standards
- 6 ECO start/stop function – stops the engine when car is stationary
- 7 Fuel consumption history shown as a bar chart on the COMAND Online display
- 8 Direct Steering – speed-sensitive power steering only requires energy when actually steering
- 9 ECO display
- 10 Tyres with lower rolling resistance (depending on the particular wheel and tyre combination)





# Diesel engines

Maximum pulling power and extremely smooth-running combined with lower fuel consumption and emissions: the E-Class diesel engines make the previously impossible possible.

**4-cylinder engines.** The E-Class is available with a choice of two 4-cylinder diesel engines (E 220 CDI and E 250 CDI). Both display impressively rich torque and low fuel consumption. This is made possible by a comprehensive package of consumption-reducing technologies. The current generation common-rail diesel technology impresses by virtue of an injection pressure increased to up to 2,000 bar, optimised combustion chambers, and extremely fast and precisely controlled piezo injectors. High torque is available in every engine speed range thanks to the high combustion pressure and turbocharging, while two Lanchester balancer shafts offer further refinement. Additionally, the radiator shutter reduces the air resistance if the engines require only moderate cooling.

Two 4-cylinder diesel engines are available for the E-Class:

- E 220 CDI with 170 hp (125 kW) and maximum torque of 400 Nm
- E 250 CDI with 204 hp (150 kW) and maximum torque of 500 Nm

**V6 engines.** The 252 hp (185 kW) E 350 BlueTEC boasts a V6 diesel engine with particularly low-emission BlueTEC technology. Fast and precisely switching piezo injectors, a high injection pressure plus a maximum torque of 620 Nm for the E 350 BlueTEC mean effortlessly superior pulling power in every driving situation. BlueTEC is currently the world's cleanest diesel drive system thanks to the cleansing and treatment of exhaust gases, resulting in exemplary emission figures which meet the latest European emissions standards (EU6).

In addition, the ECO start/stop function helps save fuel when at a standstill. Furthermore, the ECO display in the instrument cluster provides information about your driving style.

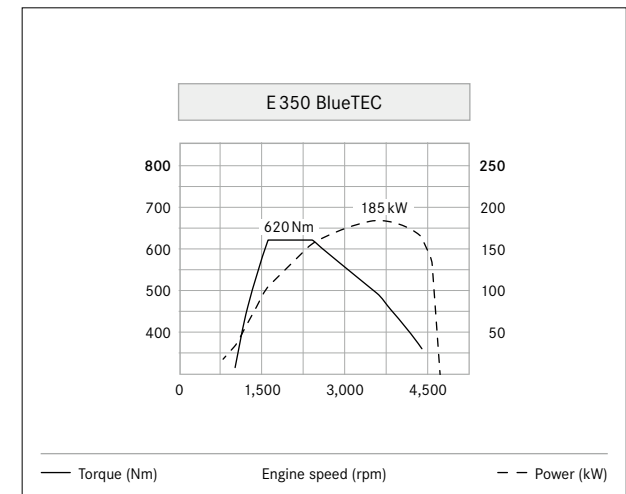

The E 350 BlueTEC reaches its peak torque quickly





## Petrol engines

Advanced efficiency – more agility and motoring pleasure, reduced fuel consumption: a selection of proven engines with innovative technologies reduces the burden on the environment even further. The ECO start/stop function – standard on all petrol models – makes this tangible each time you come to a halt.

**4-cylinder engines.** The 4-cylinder petrol engine with direct injection, variable valve timing and turbocharging boasts better output and torque figures than its predecessor as well as low consumption and emission figures. The multiple direct petrol injection with fast-switching piezo injectors optimises the air/fuel mixture, thus facilitating almost complete combustion of the fuel. The reduced engine weight plus lower internal friction also contribute to the reduction in fuel consumption and emissions, as does the standard ECO start/stop function.

There are two 4-cylinder petrol engines to choose from:

- E 200 with 184 hp (135 kW) and maximum torque of 300 Nm
- E 250 with 211 hp (155 kW) and maximum torque of 350 Nm

**AMG V8 engine.** The 5.5-litre AMG V8 biturbo petrol engine offers comparatively favourable consumption figures for its category. Lightweight design, direct petrol injection and BlueEFFICIENCY technologies all contribute to its powerful, yet efficient performance. The E 63 AMG delivers 557 hp (410 kW) and a maximum torque of 720 Nm available from 1,750 rpm, paired with outstanding acceleration. All of which makes for effortless driving in practically any road situation.





> View price list



View offers > Saloon > Estate



> SOUND WITH POWER



> Mercedes-Benz Magazine

## Alternative drive systems

Technologies to lower fuel consumption and reduce CO<sub>2</sub> emissions even further reflect the innovative strength of Mercedes-Benz: the E 300 BlueTEC Hybrid combines a diesel engine with an electric motor.

**E 300 BlueTEC Hybrid.** Available as both a Saloon and as an Estate, the E 300 BlueTEC Hybrid is one of the most efficient models in its class. The 4-cylinder diesel model boasts 204 hp (150 kW) and a peak torque of 500 Nm. Combined with a compact electric motor delivering 20 kW and 280 Nm, the result is an efficient overall concept. Consumption figures of 61.4–62.8 mpg speak for themselves. As you'd expect, the Hybrid model features

exemplary CO<sub>2</sub> emissions and generous space. Driving it offers a unique experience. The internal combustion engine can be 'disconnected' from the powertrain while driving, thus allowing emission-free 'sailing' at speeds of up to 99 mph.





> View price list



View offers > Saloon > Estate



> SOUND WITH POWER



> Mercedes-Benz Magazine







> View price list



View offers > Saloon > Estate



> SOUND WITH POWER



> Mercedes-Benz Magazine

## Transmissions

The 6-speed manual transmission and the optimised 7G-Tronic Plus automatic transmission are precisely tuned to every engine. What's more, both types of transmission also impress with their intuitive and ergonomic operability.

**6-speed manual transmission.** The E 220 CDI is fitted with a 6-speed manual transmission as standard, offering impressively short throws and hence sporty, rapid gear changes. A display on the instrument cluster indicates recommended gear changes to encourage highly efficient driving.

**7G-Tronic Plus automatic transmission.** The E 250 CDI, E 350 BlueTEC, E 300 BlueTEC Hybrid and both 4-cylinder petrol engines feature 7G-Tronic Plus 7-speed automatic transmission as standard. The transmission can be operated via the Direct Select steering column shift lever or via the steering wheel gear shift paddles. The seven forward gears allow an optimum engine speed at all times, thus helping to reduce fuel consumption. The electro-hydraulic control unit has been further enhanced, while the engine

and transmission software has been optimised, resulting in further improved agility and gear shift quality. Furthermore, the 7G-Tronic Plus ensures a more direct vehicle response to changes in the accelerator pedal position.

**ECO start/stop** (standard). The engine is automatically switched off whenever the vehicle is at a standstill. This achieves a considerable reduction in fuel consumption and emissions, for instance in a traffic jam or at traffic lights.





> View price list



View offers > Saloon > Estate



> SOUND WITH POWER



> Mercedes-Benz Magazine

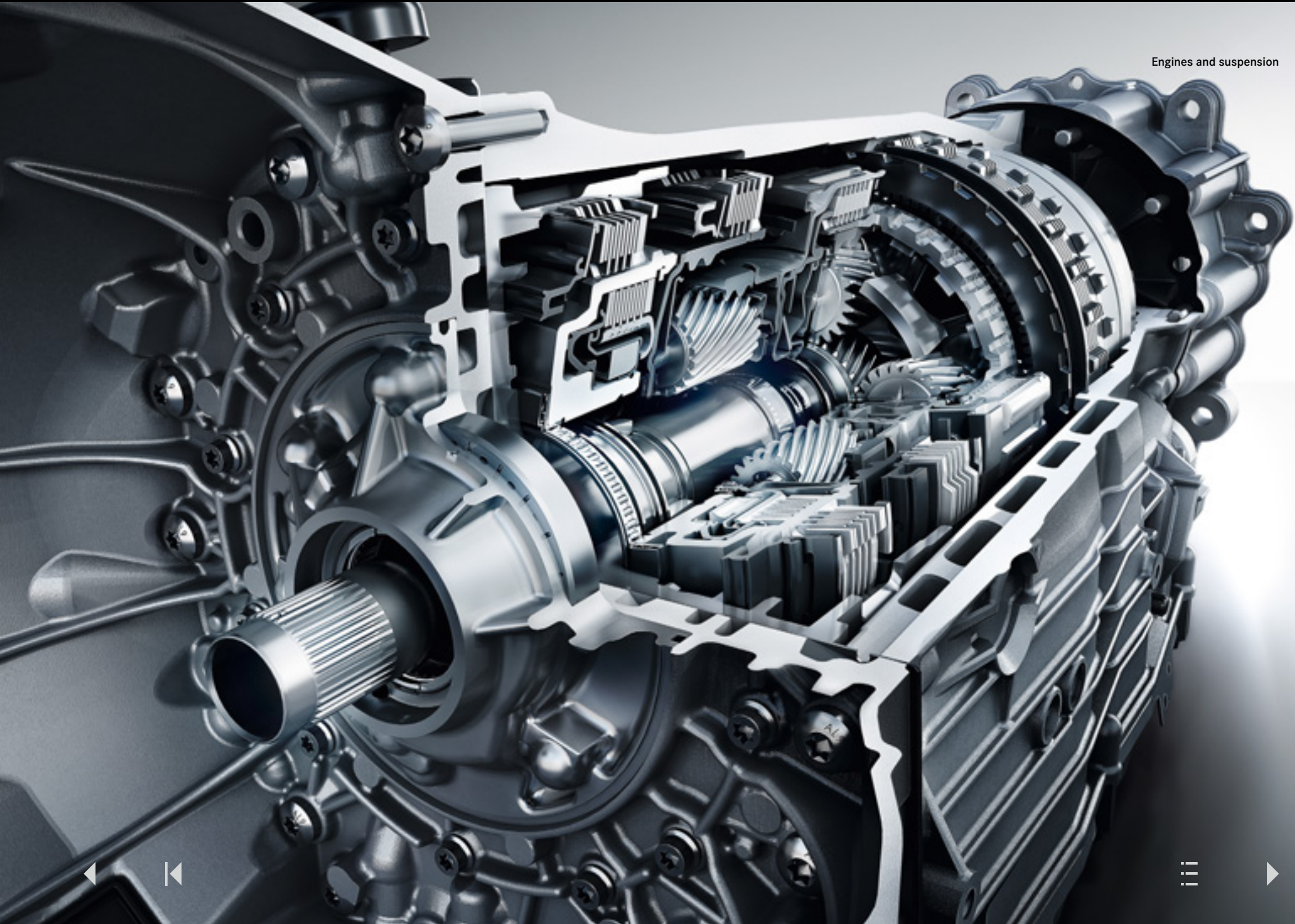



# Suspension

Direct Control suspension and AirMATIC air suspension are designed for a pleasurable experience whatever the road surface. Both offer a high level of comfort and ensure a responsive, sporty drive.

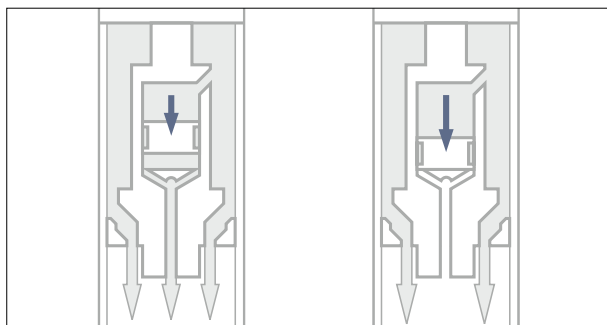

The E-Class Estate features rear air suspension with self levelling as standard. This function maintains a constant ride height – even when fully laden

**Direct Control suspension** (standard on SE; optional on AMG Sport). The Direct Control suspension with selective damping system provides the perfect blend of agility and ride comfort as the dampers are adjusted to suit the current driving situation. Optimised shock absorption and excellent vehicle stability are especially noticeable on poor road surfaces. A Direct Control sports suspension is standard on the AMG Sport (not available for SE). Both suspensions are lowered by 15 mm.

**Direct Steering** (standard). A modified steering ratio reduces the amount of lock required to turn the wheels reducing the steering effort required, for example when taking tight bends. This renders the driving experience both more agile and more comfortable.





> View price list



View offers > Saloon > Estate



> SOUND WITH POWER



> Mercedes-Benz Magazine

**AirMATIC air suspension** (optional). AirMATIC features adaptive shock absorbers which automatically adapt to the current road conditions, load level and individual driving style. AirMATIC air suspension lets you choose between comfort and sport settings – for improved roadholding and individual driving enjoyment.

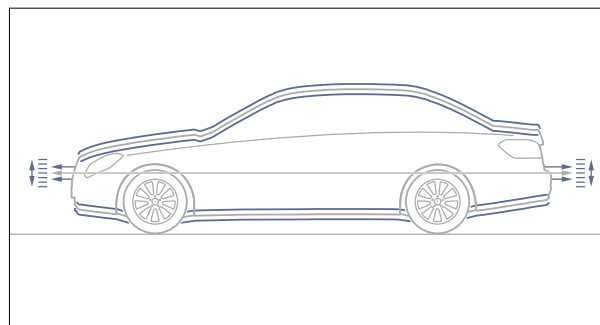

AirMATIC keeps the vehicle at a constant ride height, irrespective of the vehicle load. It can also lower and raise the ride height as and when required





## Integrated safety concept

The vision of accident-free driving spurs us on. Our integrated safety system makes way for a comprehensive approach to maximise safety in every road situation.

As the inventor of the motor car, we feel a particular responsibility towards road safety. That's why we were the first manufacturer to develop an integrated safety concept that seamlessly combines a car's active and passive safety features, thus ensuring optimum all-round protection. This concept covers four different areas – safer driving, anticipating danger, protecting occupants and pedestrians and post-crash safety – and incorporates measures designed to maximise safety in every situation, by helping you to stay safe, alerting you to danger, and assisting you wherever possible. In addition, our unique Pre-Safe® anticipatory safety system recognises likely accident scenarios and takes steps that further enhance occupant protection. If a collision can't be avoided, intelligent passive safety systems help to provide protection where it's needed, while solutions that minimise the consequences of an accident and facilitate emergency assistance are also a key part of this safety concept. A selection of these technologies are presented on the following pages.

**Safer driving: Attention Assist** (standard). Particularly beneficial on long journeys, Attention Assist is a system for detecting fatigue. Between speeds of approx. 50 and 110 mph, it assesses the driver's behaviour via an array of sensors, compares it to the behaviour patterns already stored for that driver and thus registers unexpected changes that may indicate an increase in tiredness or inattentiveness. The system sends timely alerts to warn the driver about serious lapses in concentration or drowsiness. A dedicated menu in the instrument cluster provides the driver with additional information.



When the system detects signs of inattentiveness or tiredness, Attention Assist recommends taking a break

**Safer driving: partial LED headlamps** (standard). The partial-LED headlamps with LED driving lights, daytime running lights and position lights ensure less dazzle in traffic. In addition, they have a very long operating life and are less likely to fail. The indicators and high-beam are halogen.



The E-Class offers a choice of two innovative, efficient LED style technologies for the headlamps





**Safer driving: LED Intelligent Light System** (optional, standard on E 63 AMG/S). The LED Intelligent Light System comprises a variety of modes and functions: high-performance headlamps, Active Light System with country mode, motorway mode, fog mode and cornering light function. It also features Adaptive High Beam Assist, which automatically maximises the headlamps' range then lowers them again as soon as the lights of an oncoming vehicle are detected.

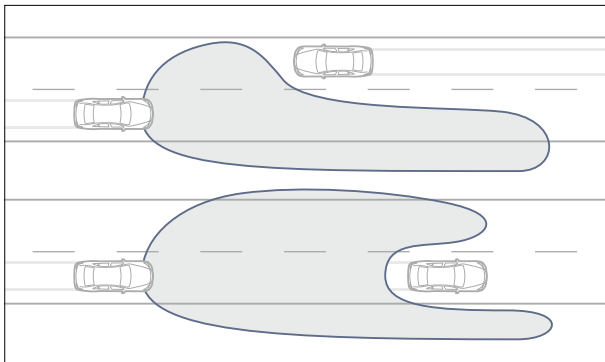

Adaptive High Beam Assist automatically adjusts to oncoming traffic, raising and lowering the headlamps as required

**Safer driving: Driving Assistance Package** (optional). DISTRONIC PLUS with Steering Assist helps the driver maintain the desired distance to the vehicle in front at speeds of 0 to 120 mph. Steering Assist makes the driver's job easier by helping with lane guidance and allows semi-autonomous driving in queuing traffic. Further components include Pre-Safe® Brake with Active Pedestrian Protection, Active Lane-Keeping Assist, Active Blind Spot Assist and Brake Assist (BAS) with Junction Assist, rear-end collision warning and Pre-Safe® Plus protection system.

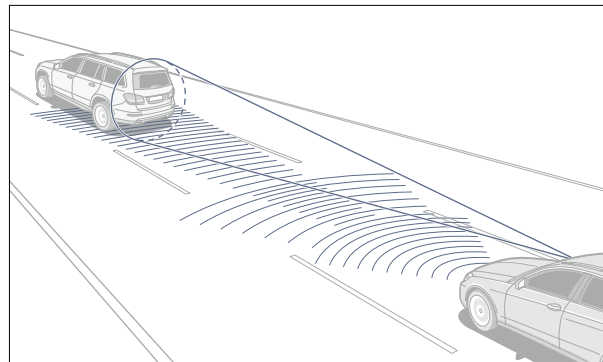

The DISTRONIC PLUS adaptive cruise control with Steering Assist brings the car to a standstill when necessary and then starts it moving again

**Safer driving: Lane-Tracking Package** (optional). Lane-Keeping Assist recognises white road markings and warns you via subtle vibrations of the steering wheel should you unintentionally stray out of lane. Blind Spot Assist monitors the blind spot alongside the vehicle from a speed of 12 mph and can give audible and visual warnings if dangers are detected in this area.

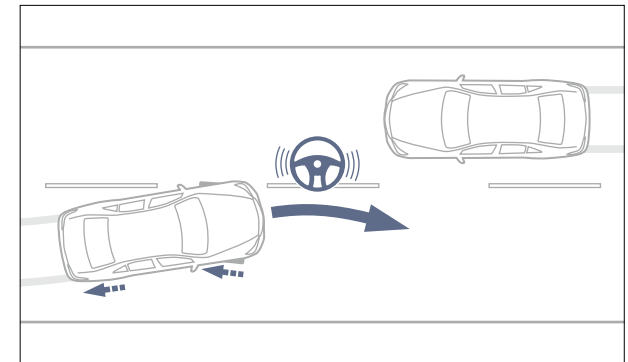

Lane-Keeping Assist alerts the driver if you veer off course unintentionally



**Anticipating danger: Pre-Safe® anticipatory safety system** (standard). If it detects a probable accident scenario, Pre-Safe® can take a range of anticipatory measures to prepare the occupants for an imminent impact. Pre-Safe® evaluates sensor data from systems such as Electronic Stability Programme (ESP®) and BAS, enabling it to analyse heavy over- or understeer and emergency braking. If need be, it can then instantly activate the front seat belt tensioners, close the windows and optional sunroof and move the front passenger seat to a safer position, ensuring maximum protection from airbags and seat belts should an impact then occur. In addition to this, the further enhanced Pre-Safe® Plus (part of the optional Driving Assistance Package) uses a radar sensor in the rear bumper to detect potential hazards to the rear of the car and initiates additional safety measures. If an impact is imminent, the rear indicators flash more rapidly to warn the traffic behind. Furthermore, preventive measures such as an emergency brake can reduce the risk of secondary collisions and lessen the forces of a forwards jolt.

**Anticipating danger: Collision Prevention Assist** (standard). If the system detects an insufficient distance between the car and the vehicle in front, it alerts the driver with an audible warning. If there is a risk of a collision with a slower moving or stopping vehicle within defined speed ranges, the driver receives audible and visual warnings. During braking, Active Brake Assist provides the braking force required to help avoid an imminent collision or at least reduce its severity.

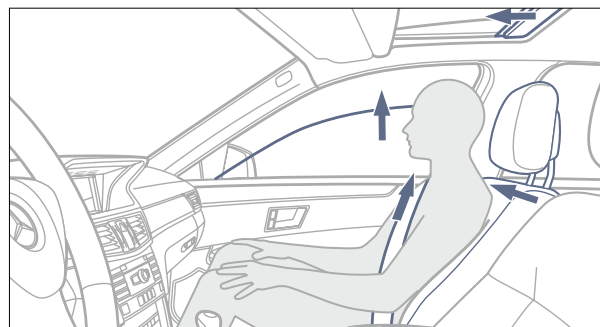

The Pre-Safe® anticipatory safety system recognises dangerous driving situations and initiates measures to protect the occupants

**Anticipating danger: Brake Assist (BAS) with Junction Assist** (as part of the optional Driving Assistance Package). Brake Assist calculates the required brake force to prevent a collision or reduce the severity of the impact. It then initiates partial or an emergency brake if the driver does not apply the brakes hard enough. BAS also provides assistance in situations involving crossing objects. It can also detect pedestrians in the area ahead of the vehicle and increase the brake force applied by the driver if necessary.

**Anticipating danger: Pre-Safe® Brake with Active Pedestrian Protection** (as part of the optional Driving Assistance Package). The three-stage warning and braking system Pre-Safe® Brake is able to intervene before an impending rear-end collision at speeds of up to 120 mph. If the driver fails to respond to a first warning, the system increases the brake force automatically. It can then trigger an autonomous emergency brake if there is still no reaction from the driver. Autonomous braking can help prevent head-to-tail collisions with stationary vehicles and collisions with pedestrians in the area ahead of the car at speeds of up to 30 mph.



**Protecting occupants and pedestrians: Active Bonnet** (standard). The Active Bonnet system can reduce the risk of injury to pedestrians and cyclists in a collision, triggering a spring mechanism that raises the rear of the bonnet by approx. 5 cm. It deploys automatically at speeds of between approx. 15 and 35 mph.

**Protecting occupants and pedestrians: restraint systems** (standard). Three-point seat belts, belt tensioners, belt-force limiters and airbags all work seamlessly together. Nine airbags help to prevent injuries. These include two adaptive front airbags, which can be deployed depending on the severity of the accident, sidebags and pelvisbags for the front seats, as well as two large windowbags. The kneebag further reduces the forces exerted on the driver during an accident. Rear sidebags are available as an option.

**Protecting occupants and pedestrians: Neck-Pro head restraints** (standard). Both the driver and the front passenger seat are fitted with a Neck-Pro head restraint for protection during a rear impact: a spring mechanism moves the head restraints forward and upward; supporting

the head sooner and reducing the strain on the spine.

**Post-crash safety: Mercedes-Benz Emergency Call System** (as part of the standard COMAND Online system). Should the restraint systems' sensors detect an accident, the emergency call system can use a paired mobile phone to automatically contact the emergency services. In addition, it simultaneously sends GPS data and other vehicle information to the Mercedes-Benz emergency call centre, where an operator will attempt to make contact with you by phone. The emergency call system can also be activated manually.

**Post-crash safety: rescue assistance.** Mercedes-Benz has developed a range of measures that help to minimise the secondary consequences of an accident and facilitate occupant rescue. These include automatic engine cut-off, self-activating hazard lights and emergency cabin lighting. In addition, the central locking system is automatically released in the event of an accident, and there are special crash joints between the front doors and wings that make it easier to open the doors after frontal collisions. In addition, Mercedes-Benz provides a rescue guide for emergency services that can be downloaded from the Internet at [www.mercedes-benz.co.uk/rescueguide](http://www.mercedes-benz.co.uk/rescueguide)

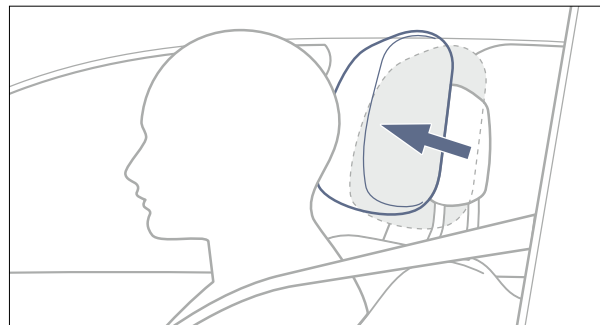

In a rear end collision, the Neck-Pro head restraints help reduce the risk of whiplash significantly





## Multimedia systems

The multimedia functions in the E-Class can be operated intuitively via an easy-to-use controller on the centre console, via buttons on the device itself or via the multi-function steering wheel.



COMAND Online combines audio system, navigation system and telephone functions. All of the main settings can be programmed using Linguatronic voice control

**COMAND Online** (standard). The system combines hard disk drive (HDD) navigation with a high-resolution 7-inch colour display for 3D map viewing. Multimedia functions include radio, DAB digital radio tuner, speed-sensitive volume control, music register with 10 GB of storage for audio files, free European map data updates<sup>1</sup> and live traffic information,<sup>1</sup> which provides precise, up-to-date traffic data for improved route planning and more accurately estimated time of arrival. A USB connection, SD memory card slot, Bluetooth® interface for hands-free access and the Media Interface allow connection to external data storage media. The DVD drive can play video and audio DVDs as well as CDs and MP3 files. The online feature allows access to the Internet and Mercedes-Benz apps via an Internet-enabled mobile phone, including Facebook, Internet radio, parking space search, special destination searches via Google Street View or sending routes from Google™ maps to the vehicle, and hotel finder as well as news and weather reports. You can operate the system via the COMAND controller and the multi-function steering wheel, or simply use Linguatronic voice control. For comprehensive information on operating the vehicle and the COMAND Online system, the Digital Owner's Manual can be called up quickly and easily.

<sup>1</sup>Free of charge for the first three years





**Harman Kardon® Logic 7® surround sound system**

(standard on E 63 AMG and E 63 AMG S; optional on SE and AMG Sport). This high performance 610-watt 14-speaker system delivers a truly first-class audio experience. Its digital surround sound with Logic 7® multi-channel technology and automatic volume adjustment can be optimised to suit the entire interior.

**Bang & Olufsen BeoSound AMG surround sound system**

(optional on E 63 AMG and E 63 AMG S). With 11 high-performance speakers, a 16-channel DSP amplifier and an ICEpower amplifier, this 1,200-watt high-end surround sound system delivers first-class acoustics. The surround sound playback can be individually adjusted to the entire cabin. 3D surround sound and speed-sensitive volume control ensure premium listening pleasure.

**SplitView** (optional). SplitView can show different content

simultaneously on the same COMAND Online display depending on the viewing angle: for example, if the driver wants to check on the navigation system, whilst the front passenger is watching a film. A unique pixel layout provides the key to this effect. The front passenger has convenient access to movies on DVD, radio, Internet or television by remote control. The audio signal is provided via headphones to ensure the driver remains undisturbed.



Ultimate listening experience: the Harman Kardon® Logic 7® surround sound system



11 speakers and 1,200 watts to delight the ears: the Bang & Olufsen high-performance sound system



COMAND Online with optional SplitView





## Electronic assistants

In real life, assistants are tasked with making our life easier. The E-Class does just that: features such as the 360° camera, Speed Limit Assist and Active Park Assist enhance the feeling of comfort and safety.



Using four individual cameras the 360° camera presents a continuous view all around the vehicle

**360° camera** (optional; not in conjunction with reversing camera). This feature works with a close-range camera system comprising four cameras and a control unit which can display a homogenous all-round view. One camera is mounted at the front, there is one in each exterior mirror and one in the centre at the rear of the car. Based on this information, the system calculates various views around the vehicle as well as a true-colour image of the vehicle and its surroundings from a bird's-eye perspective. The different perspectives can be selected using the COMAND controller. The camera is activated when reverse gear is engaged or by selecting it in the COMAND system. The images appear on the multimedia system display and can be changed automatically depending on the direction of travel. Dynamic guide lines help with manoeuvring back onto a trailer's towbar if a trailer coupling is fitted, for example.

**Speed Limit and Traffic Sign Assist** (optional). Speed Limit Assist reads speed limit and no overtaking road signs and displays the permitted maximum speed in the instrument panel until the limit changes.

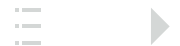
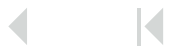



The front-mounted camera detects round speed limit warnings both on roadside signs and in overhead gantries and is particularly useful where the speed limit varies or when passing through roadworks. To help identify the limit correctly, it compares speed limit signs with map data from the navigation system.

**Reversing camera** (optional). This wide-angle camera with dynamic guidelines in the display makes for safer and easier parking manoeuvres, capturing the area immediately behind the car and displaying the image on the central display. The camera is activated automatically as soon as the driver engages reverse.

**Parktronic with Active Park Assist** (standard). When driving slowly, twelve ultrasonic sensors monitor the surroundings and detect suitable parking spaces, indicated in the instrument cluster. A control unit processes the signals and calculates the best angle to steer the car into the space. For the first time, the E-Class can also automatically manoeuvre into perpendicular parking spaces and enter and exit parallel parking spaces thanks to active steering and braking intervention.



COMAND Online and the multi-function display in the instrument cluster show vital Speed Limit Assist and Traffic Sign Assist information



COMAND Online shows the area immediately behind the car when reversing the E-Class



The instrument cluster displays the status of the current parking process





## Climate control

A pleasant atmosphere is paramount when it comes to ensuring stress-free and safe driving. That's why the E-Class climate control system is exceptionally flexible and can be adjusted to meet the needs of each individual occupant.

**Automatic climate control** (standard). With automatic climate control, the temperature and ventilation can be individually adjusted for the driver and front passenger. For example, a sun sensor registers the intensity of the sun and the beam direction. Air recirculation, a cooled glove compartment, a dust filter, and an activated charcoal filter which removes fine particles and improves overall air quality also come as standard.

**Luxury automatic climate control** (optional). This automatic climate control system allows the driver and front passenger to set separate temperatures for each side of the cabin. In addition, the rear passengers have their own control unit. In automatic mode, there are three climate styles to choose from to adapt the system to individual needs.

**Comfort-ventilated front seats** (optional). The air-conditioned seats provide either cooling ventilation or warming heat, ensuring optimum comfort all year round. There is a choice of three-stage heating and three-stage ventilation with automatically reducing output after a set time. The seat settings for driver and front passenger can be adjusted via the centre console.



The luxury automatic climate control controls are ergonomically and intuitively placed





## Seats

Every seat in the E-Class combines ride comfort with ergonomics and safety.



The dynamic multi-contour seats are designed to meet the highest requirements in individual seating comfort, ergonomics and safety

The front seats with standard Neck-Pro head restraints are ergonomically shaped and provide firm support. Their height and backrest angle can be electrically adjusted and optionally actively ventilated and heated. In conjunction with optional dynamic multi-contour seats, ventilation and heating are featured with integrated inflatable air chambers (optional, comfort-ventilated front seats). The outer rear seats are equipped with belt force limiters and belt tensioners as standard.

**Multi-contour seats** (optional). The multi-contour seat ensures comfortable driving and lateral support. Air chambers and seat side bolsters adjust to suit the current driving situation. With the optional dynamic multi-contour seat, your sense of well-being is further enhanced courtesy of a 7-zone dynamic massage function, Neck-Pro comfort front head restraints, adjustable seat cushion depth, backrest side bolsters plus lower and upper lumbar support.





## Load compartment management

The E-Class Estate has plenty of storage space, which can be used very efficiently with the Easy-Pack load compartment management system.

**Easy-Pack Quickfold** (standard on Estate only). Thanks to the Quickfold release levers on the E-Class Estate's D-pillars, the rear seat can be folded forward from the load compartment. The backrest can also be released with a single pull of the rear seat lever. Even with both backrest sections upright, the load compartment offers from a generous 600 litres of luggage space (up to 1,950 litres when folded down).

**Easy-Pack load-securing kit** (optional). A handy way to flexibly divide the load area into two zones, the Easy-Pack load-securing kit features a telescopic bar which attaches to cargo rails. It also includes a collapsible crate and a second load compartment floor. Additionally, the kit features a retractable cargo belt for securing items to the side of the luggage compartment and a sill guard that protects against chips and scratches when loading and unloading.



A release lever on the D-pillar lets you fold the rear seats forward



Greater boot capacity for even greater versatility

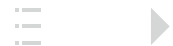



> View price list



View offers > Saloon > Estate



> SOUND WITH POWER



> Mercedes-Benz Magazine



Comfort 40

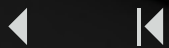





## Load space

With its exemplary load compartment concept and with up to 1,950 litres of load space, the new-generation Estate takes a leading position in its class.

**Easy-Pack automatic powered tailgate** (standard). The Easy-Pack powered tailgate can be opened remotely by the touch of a button on the driver's door, on the tailgate, or by using the ignition key. In addition, it can be stopped part way to avoid contact with low ceilings – when parked in a garage for instance.



The Easy-Pack tailgate can also be opened and closed in a lower position at the push of a button

**Easy-Pack load compartment cover** (standard). The E-Class Estate features a load compartment cover that shields luggage from bright sun and prying eyes. For easy access, it lifts automatically as the tailgate opens and returns to its starting position when the tailgate is closed. The cover comes in your chosen interior colour and also features a safety net that protects the occupants against injury from items in the load compartment.



The Easy-Pack load compartment cover lifts automatically as the tailgate opens

Other practical load compartment details include side nets that enable smaller items to be stowed tidily and safely and a 12-volt socket.



The optional folding rear-facing seats for the load compartment offer space for two extra passengers of up to 140 cm or 50 kg





**Load compartment.** A length of 4.91 metres, a width of 1.85 metres and a height of 1.51 metres are the key to the Estate's large load compartment. Equipped with the optional folding rear-facing seats in the load compartment, the Estate can either accommodate up to seven people or transport a load of up to 1,950 litres with the rear seats folded down. For added versatility, these rear seats can also be folded down separately, with a 1/3:2/3 split.

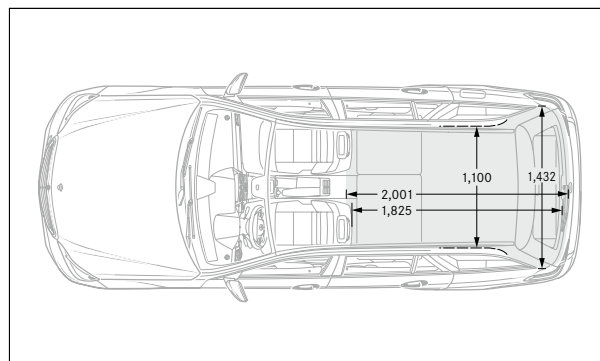

Two-seater

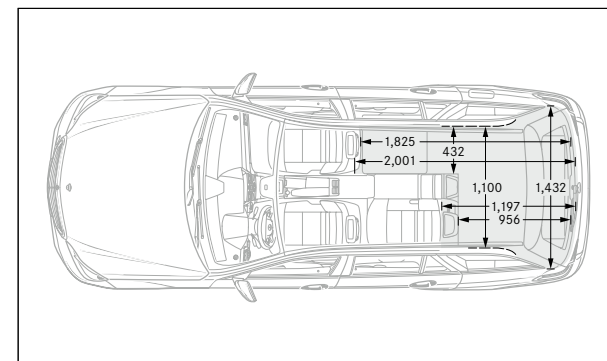

Four-seater

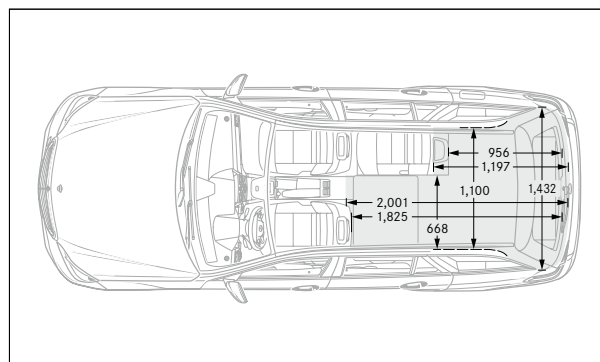

Three-seater

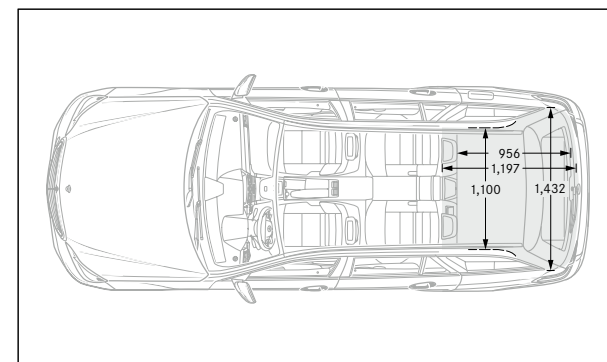

Five-seater





## E 63 AMG

The fresh AMG design heralds poise and choice when it comes to individual styling. The AMG Speedshift MCT 7-speed sports transmission features four driving modes and a 'Race Start' function, which combines thrilling agility with impressive efficiency. This exclusive performance is reflected in the interior, where a wealth of unique AMG appointments includes nappa leather sports seats and aluminium gear shift paddles.

### Exterior

AMG radiator grille with twin louvre in silver chrome and central star

AMG styling with front and rear aprons and side skirts

Flared wheel arches with 'V8 BITURBO' lettering on front wings

LED Intelligent Light System

Twin-pipe exhaust system with squared, integrated tailpipes in stainless steel

### Interior

AMG door sill panels in brushed stainless steel

AMG Drive Unit with E-Select - aluminum selector lever

AMG instrument cluster with AMG menu including Racetimer

AMG Performance Studio 3-spoke multi-function steering wheel in nappa leather with Alcantara® inserts

AMG-specific IWC-designed analogue clock

AMG sports seats in nappa leather with improved lateral support

Door armrests, centre console and door panels in nappa leather; instrument panel and Artico leather<sup>1</sup> upper dashboard with visible stitching

Upholstery in Black nappa leather (code 861), Silk Beige nappa leather (code 865) or Crystal Grey nappa leather (code 868)

<sup>1</sup>Man-made leather



Model shown features optional 19" 10-spoke AMG alloy wheels, *designo* Allantite Grey paint and Driving Assistance Package





[View price list](#)



[View offers](#) [Saloon](#) [Estate](#)



[SOUND WITH POWER](#)



[Mercedes-Benz Magazine](#)

AMG 44



Model shown features optional 19" 10-spoke AMG alloy wheels, *designo* Allantite Grey paint and Driving Assistance Package

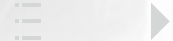



## E 63 AMG S-Model

Destined for the very best in performance: The mighty AMG 5.5 litre V8 bi-turbo engine of the E 63 AMG S delivers 585 hp (430 kW) and 800 Nm torque. It takes the powerful saloon from 0 to 60 mph in just 4.1 seconds, and the estate in 4.2 seconds. When it comes to styling there's no holding back either, as the exclusive AMG equipment reveals inside and out.

### Exterior

AMG rear axle limited-slip differential

AMG boot lid spoiler in body colour

AMG styling featuring front apron in high gloss black with splitter in Silver Shadow

Rear trim strip in Silver Shadow and side sill panels with Silver Shadow inserts

Sports exhaust system with two S-Model chrome twin tailpipes

### Interior

AMG door sill panels with white LED illumination

AMG Drive Unit with E-Select – aluminium selector lever

AMG emblem embossed in front headrests, with grey contrast stitching on seats

AMG instrument cluster with AMG menu including Racetimer with red applications and S-Model lettering

AMG-specific IWC-designed analogue clock

AMG sports seats in nappa leather with improved lateral support





> View price list



View offers > Saloon > Estate



> SOUND WITH POWER



> Mercedes-Benz Magazine





## E 63 AMG technology

With its stunning performance, the E 63 AMG creates a firework of emotions. All the while, the driver can choose between a sporty and a more comfort-oriented driving style. → [www.mercedes-benz.co.uk/amg](http://www.mercedes-benz.co.uk/amg)

**AMG 5.5-litre V8 biturbo engine.** The V8 engine produces 557 hp (410 kW) and 720 Nm torque on the E 63 AMG and increases this to 585 hp (430 kW) and 800 Nm torque on the E 63 AMG S. Direct petrol injection with spray-guided combustion, twin turbochargers, intelligent alternator management and the Controlled Efficiency driving mode with ECO start/stop function all help to achieve this impressive performance in the E 63 AMG engine.

**AMG Speedshift MCT 7-speed sports transmission.** This high-tech transmission offers the ultimate in flexibility. In addition to Race Start, it also provides four individual transmission modes: while Controlled Efficiency achieves outstanding fuel economy, 'S' (Sport), 'S+' (Sport Plus) and 'M' (Manual) deliver a more performance-oriented drive, with upshifts taking less than 100 ms.

**AMG Ride Control sports suspension.** Everything for a sporty drive suited to the driver's style: lightning-fast changes between agility and ride comfort delivered by the electronically controlled damping system. A wider front axle enhancing lateral dynamics. And a selection of individual suspension modes including 'Comfort', 'Sport' and 'Sport Plus'. The driver can also choose between three stages of the dynamic driving system Electronic Stability Programme (ESP®).



Tried-and-tested technology: the AMG 5.5-litre V8 engine's twin turbochargers



The AMG Speedshift MCT 7-speed sports transmission





> View price list



View offers > Saloon > Estate



> SOUND WITH POWER



> Mercedes-Benz Magazine

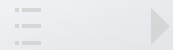
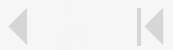





## AMG Performance Studio

AMG Performance Studio offers a wide range of individual optional extras to help you emphasise the sporty side of the E 63 AMG and E 63 AMG S. Individual requests for the personalisation of your AMG Mercedes, right down to unique one-off specimens, can all be answered here.



---

AMG carbon fibre engine cover

---

AMG door sills with white LED illumination

---

AMG Exterior Carbon Fibre Trim Packages

---

AMG Ride Control performance suspension (Saloon only)

---

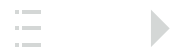



> View price list



View offers > Saloon > Estate



> SOUND WITH POWER



> Mercedes-Benz Magazine

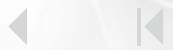



## SE

Elegance and comfort are very much at home in the new E-Class SE. Take the striking front fascia featuring partial LED headlamps, or the 17" 5-twin-spoke alloy wheels, and the well-proportioned rear with LED rear tail lights and twin-pipe exhaust system with squared, integrated tailpipes in stainless steel. The interior is appointed with leather upholstery, a 3-spoke multi-function steering wheel trimmed in nappa leather and dark aluminium trim.

### Exterior

17" alloy wheels in 5-twin-spoke design

Chrome trim strips on sides and front and rear bumpers

Direct Control suspension

Partial LED headlamps – indicators and high-beam are halogen

Radiator grille with two chrome louvres and integral central star

### Interior

Ambient lighting in door panels – three-tone, with dimmer function

Automatically dimming rear-view mirror

COMAND Online system with Media Interface

DAB digital radio tuner

Interior storage – front cup holder, front storage compartment with 12 V socket

Leather upholstery and heated front seats

Nappa leather-trimmed 3-spoke multi-function steering wheel and gear shift

Trim in dark aluminium





> View price list



View offers > Saloon > Estate



> SOUND WITH POWER



> Mercedes-Benz Magazine





> View price list



£ View offers > Saloon > Estate



> SOUND WITH POWER



> Mercedes-Benz Magazine



**Leather<sup>1</sup>**

- 211 Black
- 215 Silk Beige
- 218 Crystal Grey
- 274<sup>2</sup> Chestnut Brown
- 255<sup>2</sup> Porcelain
- 258<sup>2</sup> Crystal Grey

**Nappa leather<sup>3</sup>**

- 811 Black
- 815 Silk Beige
- 818 Crystal Grey
- 854<sup>2</sup> Chestnut Brown
- 855<sup>2</sup> Porcelain
- 858<sup>2</sup> Crystal Grey

**Trim**

- H79<sup>1</sup> Dark aluminium
- H14<sup>3</sup> Light Brown Burr Walnut wood
- H09<sup>3</sup> Brown Open-pore Ash wood
- 736<sup>3</sup> Black Ash wood

<sup>1</sup>Standard

<sup>2</sup>Upper and lower dashboard in Black

<sup>3</sup>Optional





**SE upholstery**

Leather (standard)



Black



211 Black



215 Silk Beige



218 Crystal Grey

Nappa leather (optional)



Crystal Grey



811 Black



815 Silk Beige



818 Crystal Grey



Chestnut Brown



274² Chestnut Brown



255² Porcelain



258² Crystal Grey



Porcelain



854² Chestnut Brown



855² Porcelain



858² Crystal Grey

**SE trim**



H79¹ Dark aluminium



H09³ Brown Open-pore Ash wood



736³ Black Ash wood



H14³ Light Brown Burr Walnut wood

¹Standard ²Upper and lower dashboard in Black ³Optional





## AMG Sport

Celebrating its sporty credentials, the E-Class AMG Sport is equipped with exclusive styling and performance features. The exterior strikes a powerful pose with 18" AMG alloy wheels, AMG front and rear aprons, as well as side skirts. Twin-pipe exhaust system and Direct Control sports suspension also feature as standard. Inside, a nappa leather-clad AMG 3-spoke sports steering wheel with a flattened bottom section and AMG floor mats create pure motor racing appeal. Sports seats with Artico leather<sup>1</sup> side bolsters and centre section in Dinamica microfibre with light contrast stitching complete the dynamic picture.

### Exterior

18" alloy wheels in 5-twin-spoke design

Direct Control sports suspension

Metallic paint

Radiator grille with two chrome louvres and integral central star

Twin-pipe exhaust system with squared, integrated tailpipes in stainless steel

### Interior

Ambient lighting in door panels - three-tone, with dimmer function

AMG 3-spoke sports steering wheel in nappa leather with flattened bottom section<sup>2</sup>

Brushed stainless steel sports pedals with rubber studs

COMAND Online system with Media Interface

DAB digital radio tuner

Instrument cluster with three chrome-silver tubes in sporty design

Sports seats with Artico leather<sup>1</sup> side bolsters and centre section in Dinamica microfibre with light contrast stitching

<sup>1</sup>Man-made leather

<sup>2</sup>With manual transmission, SE 3-spoke steering wheel replaces AMG 3-spoke steering wheel

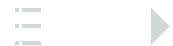



> View price list



View offers > Saloon > Estate



> SOUND WITH POWER



> Mercedes-Benz Magazine







**Artico leather<sup>1</sup>/Dinamica microfibre<sup>2</sup>**

611 Black

**Leather<sup>3</sup>**

241 Black

215<sup>4</sup> Silk Beige

218<sup>4</sup> Crystal Grey

274<sup>4,5</sup> Chestnut Brown

255<sup>4,5</sup> Porcelain

258<sup>4,5</sup> Crystal Grey

**Nappa Leather<sup>3</sup>**

811<sup>4</sup> Black

815<sup>4</sup> Silk Beige

818<sup>4</sup> Crystal Grey

854<sup>4,5</sup> Chestnut Brown

855<sup>4,5</sup> Porcelain

858<sup>4,5</sup> Crystal Grey

**Trim**

H79<sup>2</sup> Dark aluminium

H14<sup>3</sup> Light Brown Burr Walnut wood

H09<sup>3</sup> Brown Open-pore Ash wood

736<sup>3</sup> Black Ash wood

<sup>1</sup>Man-made leather

<sup>2</sup>Standard

<sup>3</sup>Optional

<sup>4</sup>Not available with sports seats

<sup>5</sup>Upper and lower dashboard in Black





**AMG Sport upholstery**

Artico leather<sup>1</sup>/Dinamica microfibre (standard); Leather (optional)

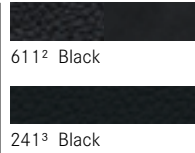

Black

Leather (optional)



Silk Beige

Nappa leather (optional)

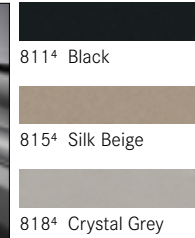

Crystal Grey

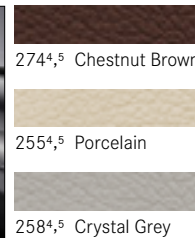

Chestnut Brown

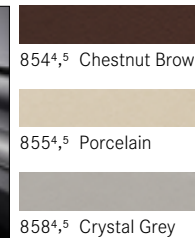

Porcelain

**AMG Sport trim**



H79<sup>2</sup> Dark aluminium



H09<sup>3</sup> Brown Open-pore Ash wood



736<sup>3</sup> Black Ash wood



H14<sup>3</sup> Light Brown Burr Walnut wood

<sup>1</sup>Man-made leather <sup>2</sup>Standard <sup>3</sup>Optional <sup>4</sup>Not available with sports seats <sup>5</sup>Upper and lower dashboard in Black





## *designo*

Exclusive *designo* paintwork, exquisite leather upholstery, high-quality trims and roof linings in the finest Dinamica microfibre – all these carefully chosen ingredients help you create an individual piece of art. Further *designo* appointments and information can be found in the price list or at [www.mercedes-benz.co.uk/designo](http://www.mercedes-benz.co.uk/designo)



### Exterior

Two *designo* metallic paint finishes

Two *designo* Magno matt paint finishes

### Interior

Armrests in doors and top of centre console in *designo* Black nappa leather

*designo* Dinamica microfibre roof lining in two colours

*designo* aniline leather upholstery in eight colours

*designo* two-tone leather-trimmed steering wheel

*designo* Black Piano Lacquer trim

*designo* metal badge in front and rear seat backrests

Door centre sections in single-coloured *designo* leather with continuous edge stripping in *designo* Black leather

Seats in *designo* aniline leather with edge stripping in *designo* Black leather

Velour floor mats with *designo* Black leather edges and *designo* metal badge

Model shown: E 63 AMG





> View price list



View offers > Saloon > Estate



> SOUND WITH POWER



> Mercedes-Benz Magazine

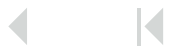



> View price list



View offers > Saloon > Estate



> SOUND WITH POWER



> Mercedes-Benz Magazine

## Standard equipment | Selection



Aluminum-look roof rails (Estate only)



LED rear tail lights



Partial LED headlamps - indicators and high-beam are halogen



Left and right door mirrors, electrically heated and adjustable from inside



Multi-function steering wheel in nappa leather



Door sill panels in stainless steel, front and rear





> View price list



View offers > Saloon > Estate



> SOUND WITH POWER



> Mercedes-Benz Magazine



COMAND Online system with Media Interface



Direct Select lever (in conjunction with 7G-Tronic Plus automatic transmission)



Armrest-mounted controls



Automatic climate control



Neck-Pro front head restraints



Ambient lighting

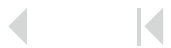



## Optional equipment | Selection



LED Intelligent Light System



Electric glass sunroof



Easy-Pack boot box (Saloon only)



Blind Spot Assist



Panoramic electric glass sunroof



Tow bar

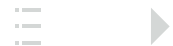



> View price list



View offers > Saloon > Estate



> SOUND WITH POWER



> Mercedes-Benz Magazine



Easy-Pack load-securing kit (Estate only)



Memory Package



Keyless-Go (standard on E 63 AMG)



Folding bench seat for two (Estate only)



The 360° camera: invaluable assistance when parking



Comfort-ventilated front seat controls for driver and front-seat passenger







> View price list



£ View offers > Saloon > Estate



> SOUND WITH POWER



> Mercedes-Benz Magazine

## Alloy wheels



17" 5-twin-spoke alloy wheels with 225/50 R17 tyres (standard on E 220 CDI SE Saloon only, code 44R)



18" 5-spoke alloy wheels with 245/40 R18 front and 265/35 R18 rear tyres (optional on SE; not available on E 220 CDI SE Saloon, code R08)



17" 5-twin-spoke alloy wheels with 245/45 R17 tyres (standard on all other SE Saloon and Estate models, code 44R)



18" AMG 5-twin-spoke alloy wheels with 245/40 R18 front and 265/35 R18 rear tyres (standard on AMG Sport, code 660)

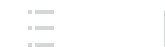



18" AMG 5-twin-spoke alloy wheels with 245/40 R 18 front and 265/35 R 18 rear tyres (optional on AMG Sport, code 795)



19" AMG 10-spoke alloy wheel, high gloss finish, with 255/35 R 19 front and 285/30 R 19 rear tyres (standard on E 63 AMG; no-cost option on E 63 AMG S, code 797)



19" AMG 5-twin-spoke forged wheels painted in Titanium Grey with high gloss finish, with 255/35 R 19 front and 285/30 R 19 rear tyres (optional on E 63 AMG and E 63 AMG S,<sup>1</sup> code 785)



19" AMG 7-twin-spoke alloy wheel with 245/35 R 19 front and 275/30 R 19 rear tyres (optional on AMG Sport, code 770)



19" AMG 10-spoke alloy wheel painted in matt black, with 255/35 R 19 front and 285/30 R 19 rear tyres (optional on E 63 AMG and E 63 AMG S, code 752)



19" AMG 10-spoke alloy wheel painted in Titanium Matt Grey, with 255/35 R 19 front and 285/30 R 19 rear tyres (standard on E 63 AMG S code 662)

<sup>1</sup>Alloy wheels come with red brake calipers on E 63 AMG S





## Retailer-fit accessories

A Mercedes-Benz is not just a car, it's a travel companion that can be tailored to your personal needs – with our wide range of Retailer-fit accessories.

→ [www.mercedes-benz.co.uk/accessories](http://www.mercedes-benz.co.uk/accessories)

**Alloy wheels.** Emphasising the dynamic presence of the new E-Class, alloy wheels come in a range of different sizes and designs, such as 10-twin-spoke wheels painted in Tremolite with a high sheen finish combined with 245/40 R 18 tyres.

**Child seat.** With the KidFix child seat, younger passengers also enjoy a high degree of safety. It's ideal for children aged between around 3½ and 12 years (15–36 kg). The raised seat and height-adjustable back-rest ensure excellent side impact protection.

**Rear seat entertainment system.** Watch your favourite films and images or play video games<sup>2</sup> using the two high-performance 17.8 cm LCD colour screens of the elegant Rear Seat Entertainment System. Rear passengers can view a film together or each watch their own choice of content thanks to separate DVD players. Further storage media can be accessed via the USB interface and SD card slot. The rear seat entertainment system requires no factory pre-installation and can be integrated easily.



10-twin-spoke alloy wheels with 245/40 R 18 tyres<sup>1</sup>



Comfort and safety for younger passengers

<sup>1</sup>Retailer-fit alloy wheels are supplied without tyres, wheel centre caps or wheel bolts. Availability depends on engine type and selected equipment. For more information please contact your Retailer





> View price list



View offers > Saloon > Estate



> SOUND WITH POWER



> Mercedes-Benz Magazine



Premium entertainment for the rear passengers (also available as an ex-factory optional extra)

\*External devices such as games consoles can be connected





## Services

**Test drive.** You've seen the pictures, you've read the facts. Now all that's missing is to experience your dream Mercedes in the flesh. Which is why we invite you to take it for a spin. See it with your own eyes. Rev up the engine, and feel how your chosen Mercedes hugs the road. Relax in style or play with a whole host of exciting onboard technology. Contact your Mercedes-Benz Retailer for a test drive, or simply go online and visit [www.mercedes-benz.co.uk/testdrive](http://www.mercedes-benz.co.uk/testdrive). We can't wait to see you in the driving seat.

**Mercedes-Benz Finance.** At Mercedes-Benz Finance, our single-minded aim is to provide optimum financial solutions for all those who share the Mercedes-Benz philosophy of absolute commitment to quality. Whether you are a private customer or a business user, our finance and leasing packages can be tailored to meet your individual needs. For further information on Mercedes-Benz Finance, please contact your local Mercedes-Benz Retailer.



**Mercedes-Benz Insurance** offers a fully comprehensive 5-star-rated<sup>1</sup> Motor Insurance policy specifically designed to provide the cover you would expect from Mercedes-Benz. For a quotation, please call 0845 600 2180<sup>2</sup>

**Interactive Owner's Manuals.** The website also offers an interactive tour, enabling you to take a closer look at your desired model. This simulation is the ideal way to acquaint yourself with your dream car. You can view key functions in detail, gain an insight into the car's inner workings or look at the benefits of each model. For further details, visit [www.mercedes-benz.co.uk/eclasssaloonmanual](http://www.mercedes-benz.co.uk/eclasssaloonmanual) or [/eclassestatemanual](http://eclassestatemanual)



**Roadside Assistance and Accident Management.** Rest assured that should you ever need help, Mercedes-Benz Roadside Assistance is there for you. In the unlikely event of a technical breakdown<sup>3</sup> you can rely on the Mercedes-Benz Roadside Assistance Team – anywhere in Europe. Mercedes-Benz will also assist you in the unfortunate event of an accident, from recovering your car and delivering it to your preferred Mercedes-Benz Retailer right through to managing your insurance claim in full, you will be looked after by the experts who built your Mercedes-Benz.<sup>4</sup> Minor mishaps are also covered. Whether you lose your key, run out of fuel, or your vehicle is damaged due to vandalism, Mercedes-Benz ensures that you still reach your destination. Often the problem can be rectified on the spot, but if this is not possible, we will naturally ensure that your vehicle is taken to the nearest Mercedes-Benz Retailer to get you back on the road as quickly as possible.

<sup>1</sup>As rated by Defaqto, a leading UK independent financial research company  
<sup>2</sup>Mercedes-Benz Motor Insurance is underwritten by Aviva Insurance Limited. For joint protection, calls may be recorded and/or monitored. All calls are charged at local rate. We may decline to quote in some circumstances

Simply phone our Customer Assistance Centre on 00800 1 777 7777,<sup>5</sup> where our specialists will organise assistance for you.

**Service Care.** To keep a tight grip on costs, Mercedes-Benz offers service plans to cover the costs of an annual service, for two, three and four years. Plans can be paid monthly with interest-free instalments or alternatively, if you pay upfront, should you sell your vehicle any remaining services will be transferred to the new owner. All routine maintenance and additional items are covered. To find out more, please contact your local Retailer or visit [www.mercedes-benz.co.uk/servicecare](http://www.mercedes-benz.co.uk/servicecare)

<sup>3</sup>Cover is initially valid for your vehicle for four years from the date of first registration. This can be extended from the fifth year, up to a maximum of 30 years, on completion of each scheduled maintenance service, providing that this service is carried out by a Mercedes-Benz Retailer. Minor mishap cover is provided at the absolute discretion of Mercedes-Benz

**Mercedes-Benz World at Brooklands.** Discover Mercedes-Benz racing heritage, from its connections to the famous Brooklands circuit through to present-day Formula 1™ brought to life in the most sensational way at Mercedes-Benz World in Surrey. View, touch and sit in every car from the Mercedes-Benz range, and encounter automotive legends like the ‘Gullwing’ and many other classic icons, in the UK’s largest Mercedes-Benz showcase. Then set your pulse racing by booking one of our thrilling AMG or 4×4 Driving Experiences. Relax and refuel in Café 1886, or enjoy the delicious menu and elegant surroundings of the Gullwing Bistro. For more information, visit [www.mercedes-benzworld.co.uk](http://www.mercedes-benzworld.co.uk)

<sup>4</sup>Management of claims for non-fault accidents only  
<sup>5</sup>In non-affiliated European countries: +44 20 7975 7077





## Technical data – Saloon

	Diesel engines			Diesel hybrid
	E 220 CDI	E 250 CDI	E 350 BlueTEC	E 300 BlueTEC Hybrid
Arrangement/cylinders/valves	in-line/4/16	in-line/4/16	V/6/24	in-line/4/16
Capacity – cc	2,143	2,143	2,987	2,143
Power <sup>1</sup> – hp (kW) at rpm	170 (125)/3,000–4,200 [170 (125)/3,000–4,200]	– [204 (150)/3,800]	– [252 (185)/3,600]	– [204 (150)/4,200]
Torque <sup>1</sup> – Nm at rpm	400/1,400–2,800 [400/1,400–2,800]	– [500/1,600–1,800]	– [620/1,600–2,400]	– [500/1,600–1,800]
Acceleration 0–62 mph – sec [auto.]	8.7 [8.4]	– [7.5]	– [6.6]	– [7.5]
Top speed, approx. – mph [auto.]	142 [141]	– [150]	– [155 <sup>2</sup> ]	– [150]
Tyre size – front	225/50 R 17	245/45 R 17	245/40 R 18	245/45 R 17
rear	225/50 R 17	245/45 R 17	265/35 R 18	245/45 R 17
Fuel consumption <sup>3</sup> – mpg				
Urban [auto.]	51.4 [49.6]	– [47.9]	– [39.2]	– [68.9]
Extra-urban [auto.]	70.6 [70.6]	– [65.7]	– [55.4]	– [68.9]
Combined [auto.]	61.4 [61.4]	– [57.7]	– [47.9]	– [68.9]
CO <sub>2</sub> emissions, combined <sup>3</sup> – g/km [auto.]	120–129 [120–131]	– [129–134]	– [154–154]	– [109–110]
Emissions standard	EU5	EU5	EU6	EU5
Tank capacity/of which reserve (approx.) – l	59/8.0	59/8.0	80/9.0	59/8.0
Load capacity – l	540	540	490	505
Turning circle – m	11.28	11.28	11.28	11.28
Kerb weight <sup>4</sup> – kg [auto.]	1,735 [1,735]	– [1,775]	– [1,885]	– [1,845]
Load capacity – kg [auto.]	475 [565]	– [555]	– [555]	– [585]
Perm. GVW – kg [auto.]	2,300 [2,300]	– [2,330]	– [2,440]	– [2,430]

<sup>1</sup>Figures in accordance with Directive 80/1269/EEC in the currently applicable version

<sup>2</sup>Electronically limited

<sup>3</sup>The figures shown were obtained in accordance with the prescribed measuring process (Regulation [EC] 715/2007 in the currently applicable version).

The figures are not based on an individual model and do not constitute part of the product offer; they are provided solely for purposes of comparison between different vehicle models

<sup>4</sup>Figures in accordance with Directive 92/21/EC, version 95/48/EC (kerb weight with fuel tank 90% full, driver, 68 kg, and luggage, 7 kg) for standard-specification vehicles. Optional extras and accessories will generally increase this figure and reduce the payload capacity accordingly  
Values in square brackets relate to vehicles with automatic transmission For further technical data, please visit [www.mercedes-benz.co.uk](http://www.mercedes-benz.co.uk)





## Technical data – Saloon

	Petrol engines			
	E 200	E 250	E 63 AMG	E 63 AMG S
Arrangement/cylinders/valves	in-line/4/16	in-line/4/16	V/8/32	V/8/32
Capacity – cc	1,991	1,991	5,461	5,461
Power <sup>1</sup> – hp (kW) at rpm	- [184 (135)/5,500]	- [211 (155)/5,500]	- [557 (410)/5,500]	- [585 (430)/5,500]
Torque <sup>1</sup> – Nm at rpm	- [300/1,200–4,000]	- [350/1,200–4,000]	- [720/1,750–5,250]	- [800/1,750–5,000]
Acceleration 0–62 mph – sec [auto.]	- [7.9]	- [7.4]	- [4.2]	- [4.1]
Top speed, approx. – mph [auto.]	- [145]	- [151]	- [155 <sup>2</sup> ]	- [155 <sup>2</sup> ]
Tyre size – front	245/45 R 17	245/45 R 17	255/35 ZR 19 XL	255/35 ZR 19 XL
rear	245/45 R 17	245/45 R 17	285/30 ZR 19 XL	285/30 ZR 19 XL
Fuel consumption <sup>3</sup> – mpg				
Urban [auto.]	- [37.2]	- [37.2]	- [20.5]	- [20.3]
Extra-urban [auto.]	- [57.7]	- [57.7]	- [37.7]	- [37.2]
Combined [auto.]	- [47.9]	- [47.9]	- [28.8]	- [28.5]
CO <sub>2</sub> emissions, combined <sup>3</sup> – g/km [auto.]	- [138–142]	- [138–142]	- [230]	- [232]
Emissions standard	EU6	EU6	EU6	EU6
Tank capacity/of which reserve (approx.) – l	59/8.0	59/8.0	80/12	80/12
Load capacity – l	540	540	540	540
Turning circle – m	11.28	11.28	11.35	11.35
Kerb weight <sup>4</sup> – kg [auto.]	- [1,655]	- [1,680]	- [1,845]	- [1,870]
Load capacity – kg [auto.]	- [555]	- [565]	- [545]	- [520]
Perm. GVW – kg [auto.]	- [2,210]	- [2,245]	- [2,390]	- [2,390]

<sup>1</sup>Figures in accordance with Directive 80/1269/EEC in the currently applicable version

<sup>2</sup>Electronically limited

<sup>3</sup>The figures shown were obtained in accordance with the prescribed measuring process (Regulation [EC] 715/2007 in the currently applicable version).

The figures are not based on an individual model and do not constitute part of the product offer; they are provided solely for purposes of comparison between different vehicle models

<sup>4</sup>Figures in accordance with Directive 92/21/EC, version 95/48/EC (kerb weight with fuel tank 90% full, driver, 68 kg, and luggage, 7 kg) for standard-specification vehicles. Optional extras and accessories will generally increase this figure and reduce the payload capacity accordingly  
Values in square brackets relate to vehicles with automatic transmission For further technical data, please visit [www.mercedes-benz.co.uk](http://www.mercedes-benz.co.uk)







## Technical data - Estate

	Diesel engines			E 300 BlueTEC Hybrid
	E 220 CDI	E 250 CDI	E 350 BlueTEC	
Arrangement/cylinders/valves	in-line/4/16	in-line/4/16	V/6/24	in-line/4/16
Capacity - cc	2,143	2,143	2,987	2,143
Power <sup>1</sup> - hp (kW) at rpm	170 (125)/3,000-4,200 [170 (125)/3,000-4,200]	- [204 (150)/3,800]	- [252 (185)/3,600]	- [204 (150)/4,200]
Torque <sup>1</sup> - Nm at rpm	400/1,400-2,800 [400/1,400-2,800]	- [500/1,600-1,800]	- [620/1,600-2,400]	- [500/1,600-1,800]
Acceleration 0-62 mph - sec [auto.]	8.8 [8.6]	- [7.8]	- [6.9]	- [7.8]
Top speed, approx. - mph [auto.]	137 [134]	- [144]	- [152]	- [144]
Tyre size - front	245/45 R 17	245/45 R 17	245/40 R 18	245/45 R 17
rear	245/45 R 17	245/45 R 17	265/35 R 18	245/45 R 17
Fuel consumption <sup>3</sup> - mpg				
Urban [auto.]	47.1 [44.1]	- [43.5]	- [39.2]	- [62.8]
Extra-urban [auto.]	62.8 [60.1]	- [58.9]	- [53.3]	- [61.4]
Combined [auto.]	55.4 [52.3]	- [51.4]	- [46.3]	- [62.8]
CO <sub>2</sub> emissions, combined <sup>3</sup> - g/km [auto.]	133-135 [140-141]	- [143-145]	- [159-159]	- [119-119]
Emissions standard	EU5	EU5	EU6	EU5
Tank capacity/of which reserve (approx.) - l	59/8.0	59/8.0	80/9.0	59/8.0
Load capacity - l	695-1,950	695-1,950	600-1,855	650-1,905
Turning circle - m	11.28	11.28	11.28	11.28
Kerb weight <sup>4</sup> - kg [auto.]	1,845 [1,845]	- [1,885]	- [1,955]	- [1,955]
Load capacity - kg [auto.]	595 [595]	- [595]	- [595]	- [595]
Perm. GVW - kg [auto.]	2,440 [2,440]	- [2,480]	- [2,550]	- [2,550]

<sup>1</sup>Figures in accordance with Directive 80/1269/EEC in the currently applicable version

<sup>2</sup>Electronically limited

<sup>3</sup>The figures shown were obtained in accordance with the prescribed measuring process (Regulation [EC] 715/2007 in the currently applicable version).

The figures are not based on an individual model and do not constitute part of the product offer; they are provided solely for purposes of comparison between different vehicle models

<sup>4</sup>Figures in accordance with Directive 92/21/EC, version 95/48/EC (kerb weight with fuel tank 90% full, driver, 68 kg, and luggage, 7 kg) for standard-specification vehicles. Optional extras and accessories will generally increase this figure and reduce the payload capacity accordingly  
Values in square brackets relate to vehicles with automatic transmission For further technical data, please visit [www.mercedes-benz.co.uk](http://www.mercedes-benz.co.uk)





## Technical data - Estate

	Petrol engines		
	E 250	E 63 AMG	E 63 AMG S
Arrangement/cylinders/valves	in-line/4/16	V/8/32	V/8/32
Capacity - cc	1,991	5,461	5,461
Power <sup>1</sup> - hp (kW) at rpm	- [211 (155)/5,500]	- [557 (410)/5,500]	- [585 (430)/5,500]
Torque <sup>1</sup> - Nm at rpm	- [350/1,200-4,000]	- [720/1,750-5,250]	- [800/2,000-4,500]
Acceleration 0-62 mph - sec [auto.]	- [7.8]	- [4.3]	- [4.2]
Top speed, approx. - mph [auto.]	- [145]	- [155 <sup>2</sup> ]	- [155 <sup>2</sup> ]
Tyre size - front	245/45 R 17	255/35 ZR 19 XL	255/35 ZR 19 XL
rear	245/45 R 17	285/30 ZR 19 XL	285/30 ZR 19 XL
Fuel consumption <sup>3</sup> - mpg			
Urban [auto.]	- [36.2]	- [20.3]	- [20.3]
Extra-urban [auto.]	- [53.3]	- [36.2]	- [36.2]
Combined [auto.]	- [45.6]	- [28.3]	- [28.3]
CO <sub>2</sub> emissions, combined <sup>3</sup> - g/km [auto.]	- [144-147]	- [234]	- [234]
Emissions standard	EU6	EU6	EU6
Tank capacity/of which reserve (approx.) - l	59/8.0	80/12	80/12
Load capacity - l	695-1,950	695-1,950	695-1,950
Turning circle - m	11.28	11.35	11.35
Kerb weight <sup>4</sup> - kg [auto.]	- [1,785]	- [1,945]	- [1,955]
Load capacity - kg [auto.]	- [595]	- [595]	- [585]
Perm. GVW - kg [auto.]	- [2,380]	- [2,540]	- [2,540]

<sup>1</sup>Figures in accordance with Directive 80/1269/EEC in the currently applicable version

<sup>2</sup>Electronically limited

<sup>3</sup>The figures shown were obtained in accordance with the prescribed measuring process (Regulation [EC] 715/2007 in the currently applicable version).

The figures are not based on an individual model and do not constitute part of the product offer; they are provided solely for purposes of comparison between different vehicle models

<sup>4</sup>Figures in accordance with Directive 92/21/EC, version 95/48/EC (kerb weight with fuel tank 90% full, driver, 68 kg, and luggage, 7 kg) for standard-specification vehicles. Optional extras and accessories will generally increase this figure and reduce the payload capacity accordingly  
Values in square brackets relate to vehicles with automatic transmission For further technical data, please visit [www.mercedes-benz.co.uk](http://www.mercedes-benz.co.uk)

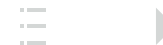



## Dimensions - Saloon

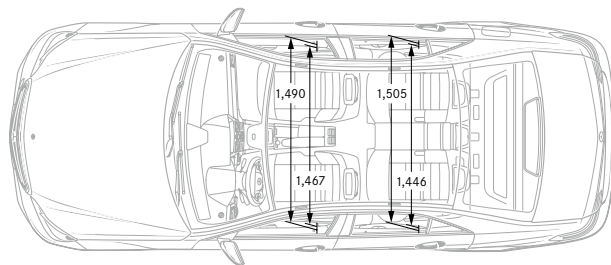
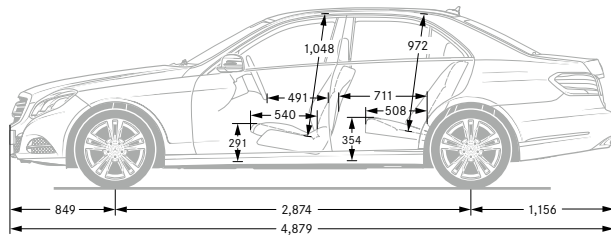
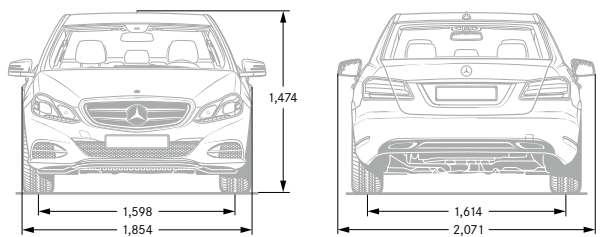

## Dimensions - Estate

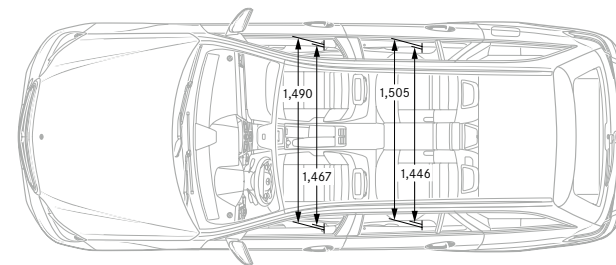
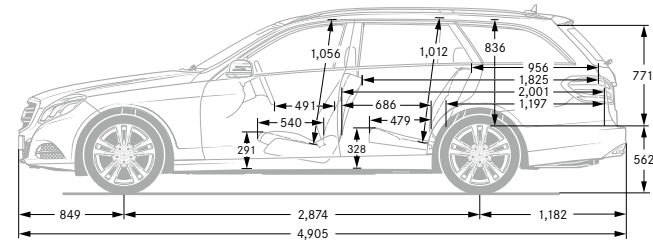
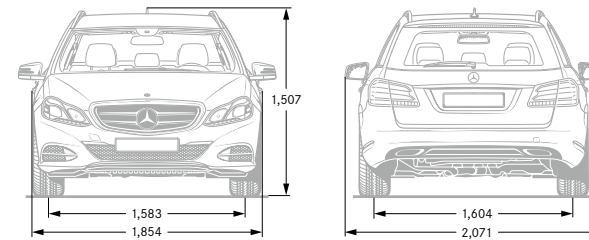

All measurements in millimetres. The dimensions shown are mean values and apply to standard-specification, unladen vehicles

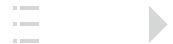



# Paint finishes

The paint system developed by Mercedes-Benz includes one of the best clearcoats on the automotive market and is a key factor behind the car's excellent value retention.

Non-metallic paints (standard on SE)

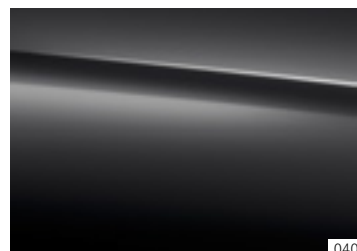

040<sup>1</sup>



149<sup>2</sup>

### Non-metallic paints (standard on SE)

- 040 Black<sup>1</sup>
- 149 Polar White<sup>2</sup>

### Metallic paints

(standard on AMG Sport and E 63 AMG/S)<sup>3</sup>

- 197 Obsidian Black
- 585 Covelline Blue
- 755 Tenorite Grey
- 775 Iridium Silver
- 792 Palladium Silver
- 799 Diamond White<sup>4</sup>
- 890 Cavansite Blue
- 988 Diamond Silver
- 996 Hyacinth Red<sup>4</sup>

Metallic paints (standard on AMG Sport and E 63 AMG/S)<sup>3</sup>



197

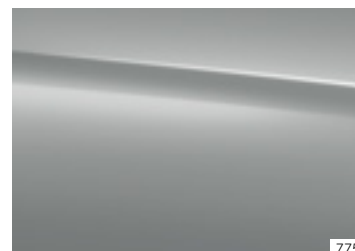

775

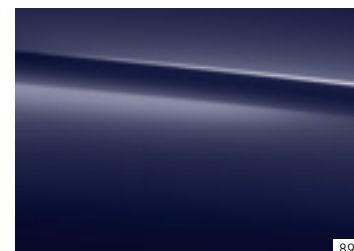

890

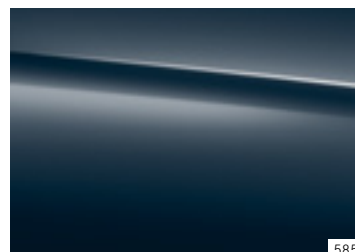

585

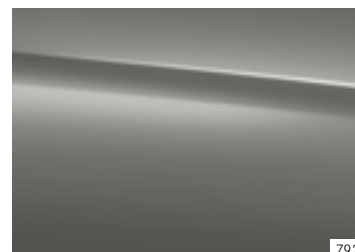

792

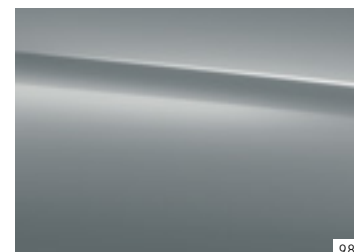

988

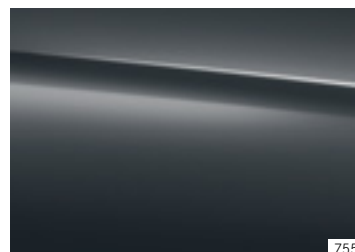

755



799<sup>4</sup>

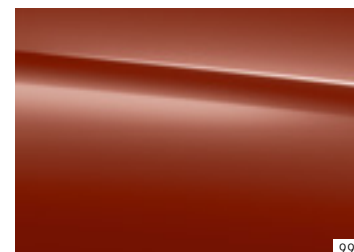

996<sup>4</sup>

<sup>1</sup>Not available on AMG Sport and E 63 AMG/S  
<sup>2</sup>No-cost option for AMG Sport and E 63 AMG/S  
<sup>3</sup>Optional on SE  
<sup>4</sup>Additional-cost option





> View price list



View offers > Saloon > Estate



> SOUND WITH POWER



> Mercedes-Benz Magazine

**Take-back of end-of-life vehicles. Coming full circle.** At the end of its long life, you can return your E-Class to us for environment-friendly disposal in accordance with the EC End-of-Life Vehicle Directive.<sup>1</sup> But that day lies a long way off.

<sup>1</sup>Applies in accordance with national regulations to vehicles up to 3.5 t permissible gross weight. The E-Class has met the statutory regulations governing the suitability of the vehicle's design for reuse and recycling for a number of years now. A network of vehicle take-back depots and dismantlers has been established which will process your vehicle in an environment-friendly manner. The ways in which both vehicles and parts can be recovered are subject to ongoing development and improvement. Consequently, the E-Class will be able to comply with any future increases in the recycling quota within the stipulated time limits. Further information is available at [www.mercedes-benz.co.uk](http://www.mercedes-benz.co.uk) or by calling 0808 156 6606.

**Please note:** this online version of the printed brochure may contain abridged copy or other content changes. The manufacturer reserves the right to make changes to the design, form, colour and specification during the delivery period, provided these changes, while taking into account the interests of the vendor, can be deemed reasonable with respect to the purchaser. Where the vendor or the manufacturer uses symbols or numbers to describe an order or the subject of an order, no rights may be derived solely from these. The illustrations may show accessories and items of optional equipment which are not part of standard specification. Colours may differ slightly from those shown in the brochure, owing to the limitations of the printing process. This brochure has been compiled by Daimler AG of Germany and is distributed internationally. It provides a general indication of the range of models, features, optional extras and/or colours available in various countries. Some of the models, features, optional extras and/or colours shown may not be available in your country or may only be available in a different specification. Additionally some models, features, optional extras and/or colours may only be available in combination with others. For current and more specific information in relation to the range of models, features, optional extras and/or colours available in your country, and their pricing, you should contact your nearest authorised Mercedes-Benz Retailer. E&OE. [www.mercedes-benz.co.uk](http://www.mercedes-benz.co.uk)

Daimler AG, Mercedesstr. 137, 70327 Stuttgart BC/MC 6701 · 0116 · 88-02/1213 Printed in Germany

