

1993 Buick

90 Years of
Quality by Design





Quality. It is both the mandate and the method by which all Buicks are created.

Buick: Celebrating 90 Years of Quality by Design.

Buick quality is *designed* in from the very start,

and is there in every detail that follows. You



experience it in the ride, the

library-hush of the interior, the refined response to a curve. You sense it in the quiet power of the engine. You see it in the flow of information from the gauges. You hear it in the solid sound of a closing door.

It grew out of a vision nearly a century old. Times may have changed but the vision has not. It *is* quality by design.

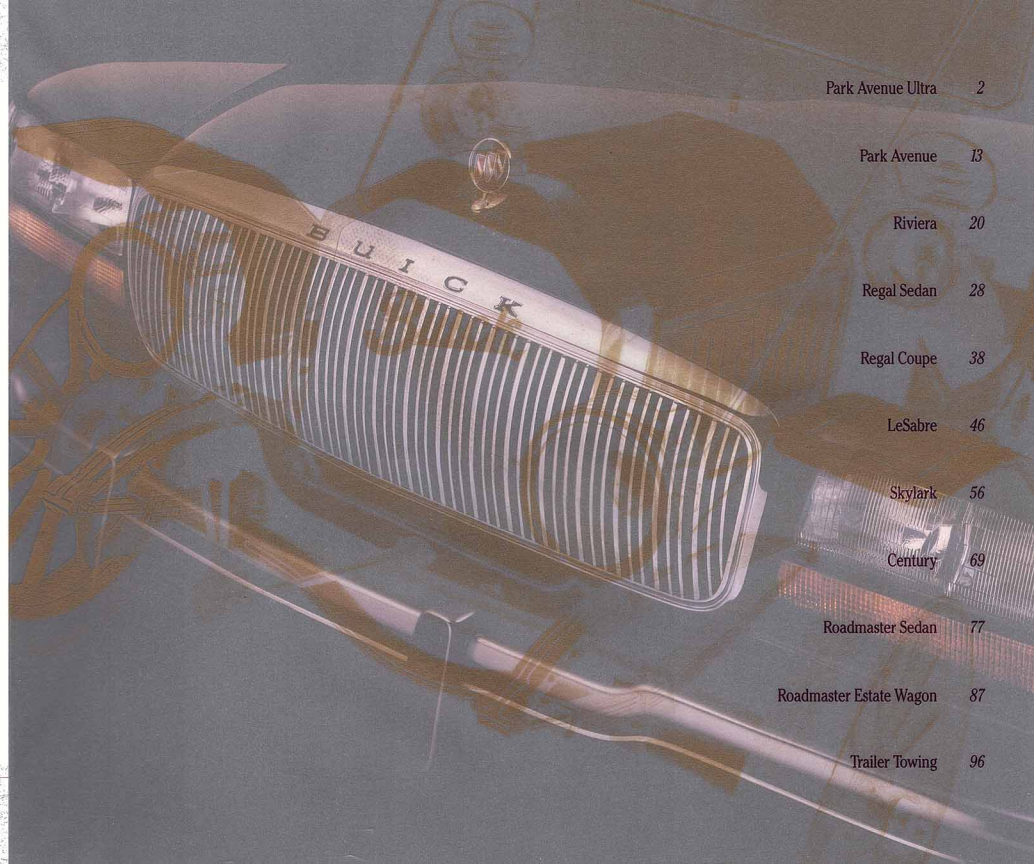

Park Avenue Ultra 2

Park Avenue 13

Riviera 20

Regal Sedan 28

Regal Coupe 38

LeSabre 46

Skylark 56

Century 69

Roadmaster Sedan 77

Roadmaster Estate Wagon 87

Trailer Towing 96

2 Park Avenue Utility

13 Park Avenue

20 Riviera

28 Regal Sedan

38 Regal Coupe

46 Lesabre

56 Skylark

69 Century

77 Roadmaster Sedan

87 Roadmaster Estate Wagon

96 Tailor Towing

Quality. It is both the mandate and the method by which all Buicks are created.

Buick: Celebrating 90 Years of Quality by Design.



Quality. It is both the mandate and the method by which all Buicks are created.

Buick quality is designed in from the very start,

and is there in every detail that follows. You experience it in the ride, the

library-hush of the interior, the refined response to a curve. You sense it in the quiet power of the engine. You see it in the flow of information from the gauges. You hear it in the solid sound of a closing door.

It grew out of a vision nearly a century old. Times may have changed but the vision has not. It is quality by design.



BUICK

Park Avenue Ultra

The 1993 Park Avenue Ultra is the ultimate expression of the premium American motorcar. The powerful supercharged 3800 V6 engine offers smooth, balanced performance. The muscular elegance of Park Avenue Ultra's flowing lines are as aerodynamically efficient as those of famous European sports cars. Its generous comfort and solid suspension bring civilized pleasure to your driving.

The 1993 Park Avenue Ultra: Buick's ultimate expression of quality by design.





Your environment includes easy-to-adjust 6-way power seats with seatback recliners.

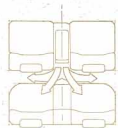

Air flows to the back with rear-seat ComforTemp, which provides directionally controlled air current.



BUICK

Park Avenue Ultra

Our commitment to quality can be a real comfort on the road.

Comfort assumes many forms in Park Avenue Ultra. One-piece body sides and impact-deflecting door beams help provide the structural rigidity necessary for a composed ride. Quality fit helps isolate the interior from noise. Supple leather in the seating areas encourages longer drives. And, comfortable positions are easily selected in 6-way power driver and passenger seats, which include power recliners.



▼ Dual automatic ComforTemp climate control, located on the instrument panel, displays inside and outside temperatures.

Unreserved luxury includes conveniences like dual swing-down lighted vanity mirrors for rear-seat passengers.



Park Avenue Ultra

You are comfortably in control.

The legible analog gauges inform, quickly. The controls are grouped for easy reach and nicely weighted for sure response. Lack of compromise is evident in the many standard features. They include cruise control, power door locks, overhead console, dual cup holders in the front storage armrest and electric seatback recliners for driver and passenger.

▼ Driver air bag provides protection in addition to safety belts in the event of certain severe frontal impacts.



Dual automatic ComfortTemp climate control allows driver and front-seat passenger to adjust their individually desired temperature settings.



Six-position TILT-WHEEL™ adjustable steering column allows driver to adjust the wheel according to individual preference.

The potent 205-hp, computer-controlled supercharged 3800 V6 delivers immediate low-end torque and effortless cruising, in an uninterrupted, broad power band.



► Automatic Ride Control system adjusts for a pleasing ride over varying road surfaces. Optional.



BUICK

Park Avenue Ultra

Substantial. Powerful. Mature. And great fun.

With an abundance of power and smooth handling, Park Avenue Ultra can be driven with enthusiasm. Positive control is exhibited in the curves. The independent rear suspension helps provide for a comfortable ride. The variable-effort power steering is reassuringly communicative. And its anti-lock brakes help bring you to a sure, controlled stop.

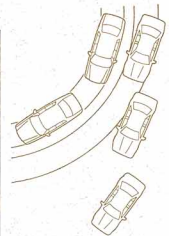

The standard anti-lock brake system (ABS) helps maintain steering and braking control on a wide range of road surfaces and conditions.

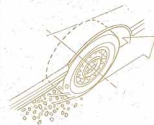

Available Traction Control improves initial acceleration and helps reduce wheel spin on slippery road surfaces.

Park Avenue Ultra



SELF-SEALING TIRES
permanently seal up to 90% of all tread punctures 3/16 inch or less with a special rubber compound that flows to the leak and makes an air-tight seal. This option offers peace of mind.

Engine Type	3.8-litre supercharged 3800 V6	Interior, in.	front/rear
Horsepower	205 @ 4400 rpm	Legroom	42.0/41.6
Torque	260 @ 2600 rpm	Headroom	38.8/37.8
		Shoulder room	58.7/58.5
		Hip room	55.0/54.2
Dimensions, in.		Capacity	
Length	205.2	Trunk, cu ft	20.3
Width	73.6	Fuel tank, gal	18.0
Height	55.1		
Wheelbase	110.8	Base curb weight, lbs	3,639
Front tread	60.4		
Rear tread	60.6		



DELCO/BOSE MUSIC SYSTEM
with ETR® AM stereo[†]-FM stereo radio and cassette.



AUTOMATIC INSIDE DAY/NIGHT MIRROR SYSTEM
option is light-sensitive and dims automatically when a light source is reflected.



DELCO ETR® AM STEREO[†]-FM STEREO RADIO with compact disc player, graphic equalizer and Concert Sound II speakers.



EXTERIOR COLORS

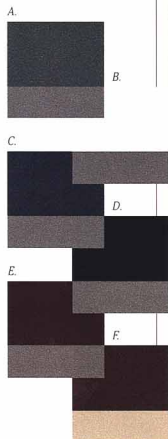

- A. Dark Jadestone Metallic
- B. Bright White
- C. Midnight Blue Metallic
- D. Black
- E. Dark Cherry Metallic
- F. Dark Mahogany Metallic

Model Availability

- Park Avenue Ultra Sedan

Powertrain/Suspension*

- Anti-lock brakes
- Automatic transmission with overdrive (electronically controlled)
- DynaRide 4-wheel independent suspension with automatic level control
- Power front disc/rear drum brakes
- Power rack-and-pinion variable-effort steering
- Supercharged 3800 V6 engine

Standard Equipment*

- Air bag—driver SIR (Supplemental Inflatable Restraint) system with knee bolster
- Air conditioning—dual automatic ComforTemp climate control with rear-seat ComforTemp heat and ventilation
- Armrest—front-seat storage with dual cup holders
- Console—overhead, including front-seat reading lights, garage door opener storage
- Cruise control—electronic
- Defogger—electric rear-window
- Door locks—power
- Glass—Solar-Ray® solar-control

- Instrumentation—backlit analog gage cluster with tachometer and trip odometer
- Mirrors—lighted visor vanity, driver and front passenger, rear-seat passengers
- Mirrors—outside, left and right electric remote
- Radio—ETR® AM-FM stereo with seek and scan, cassette
- Recliners—seatback, power, driver and passenger
- Seats—6-way power, driver and passenger
- Seats—leather and vinyl 55/45 with front-seat storage armrest
- Security locks—rear-door, child
- Steering column—TILT-WHEEL™ adjustable
- Steering wheel—leather-wrapped
- Tail lamp lenses—specific, smoked
- Theft-deterrent system—PASS-Key®
- Tires—P215/70R15 steel-belted, radial-ply, all-season blackwall**
- Windows—power with driver "express-down" and passenger lockout feature
- Windshield wipers—2-speed with low-speed delay

Option Package Equipment

	Park Avenue Ultra			
	SB	SC	SD	SE
Automatic power antenna	X	X	X	X
Door edge guards	X	X	X	X
Whitewall tires—P215/70R15**	X	X	X	X
Low-oil-level indicator	X	X	X	X
Oil-life monitor	X	X	X	X
Trunk convenience net	X	X	X	X
Illuminated driver door lock and interior light control		X	X	X
Reminder Package		X	X	X
Concert Sound II speakers		X	X	X
Cornering lamps		X	X	X
Automatic programmable door locks		X	X	X
Twilight Sentinel headlamp control		X	X	X
4-spoke horn		X	X	X
Lamp monitors		X	X	X
Remote keyless entry system		X	X	X
Theft-deterrent system		X	X	X
Electric trunk pull-down		X	X	X
Automatic day/night rearview mirror		X	X	X
Memory driver's seat and mirrors		X	X	X
Outside mirrors—electric, left and right remote and heated, left automatic day/night		X	X	X
ETR® AM stereo [†] -FM stereo with cassette, graphic equalizer and Concert Sound II speakers			X	X
Self-sealing whitewall tires			X	X
Trunk mat			X	X

Additional Available Options*

	Park Avenue Ultra
Electric Astrorod	X
California emission equipment and testing	X
Monotone paint	X
ETR® AM stereo [†] -FM stereo with compact disc player, graphic equalizer and Concert Sound II speakers	X
Delco/Bose Music System with ETR® AM stereo [†] -FM stereo with cassette	X
Automatic Ride Control suspension	X
Gran Touring suspension	X
Traction-control system	X
Trailer Towing Package	X

*Partial listing only—see your Buick dealer for complete lists and details.
**Note: Use of tire chains with this tire may cause damage to your car.
†Receives C-Quam® AM stereo broadcasts. Most AM stations across the country broadcast in C-Quam but some do not. Check your local stations for compatibility in your area.

EXTERIOR COLORS

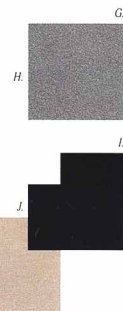

- G. Light Windsor Gray Metallic
- H. Bright White
- I. Black
- J. Champagne Beige Metallic

BUICK

Park Avenue

The impressive 0.31 drag coefficient effectively manages the wind. And its wind tunnel design has made Park Avenue's streamlined shape exceptionally pleasing to the eye. The smooth, linear delivery of muscular V6 power is unrestrained throughout the 3800 engine's broad operating range. And DynaRide® suspension helps smooth out the road.

The graceful, distinctive exterior suggests a refined driving experience. Its looks do not deceive you.





Driver door controls group power windows, with driver-side "express-down" feature, and 6-way power driver's seat.

Wraparound instrument panel communicates beautifully through its available backlit analog cluster.



BUICK

Park Avenue

Stately room, crafted interior.

Park Avenue's generously comfortable interior features a standard 6-way power adjustable driver's seat, full instrumentation that offers available analog gauges that are readable at a glance, well-placed switches and a steering wheel with an air bag.

The roomy interior is crafted for comfort for both driver and passengers.

► Park Avenue interior in the available Sierra grain Ultra Soft leather and vinyl.



▲ Dual automatic ComforTemp climate control, located on the instrument panel, displays inside and outside temperatures.



▲ Remote keyless entry system is a reassuring security option that can be activated from up to 30 feet.



Supplemental sunshades provide expanded sun protection for both front and side at the same time.



Front-seat storage armrest with dual cup holders is a convenience for driver and passenger alike.

Park Avenue

Designed-in safety. A feature, not a luxury.

◀ *Park Avenue has an air bag built into the hub of the steering wheel. It is designed to deploy in certain severe frontal impacts and, in conjunction with seat belts, help prevent injuries.*

Buick's Total Safety Systems™ is a comprehensive package of reassuring features that surround Park Avenue occupants with both accident avoidance and crash protection.

Energy-absorbing crush zone initiators are located in front and back to help protect occupants. Doors have steel side-guard beams.

Fuel system safety is enhanced by a pressure relief system. And, from the dual hood latch to the

folding deck lid, features, both seen and unseen, help safeguard your driving experience.

▶ *The standard anti-lock brake system helps provide for sure stops and steering control while braking, even in slippery road conditions.*

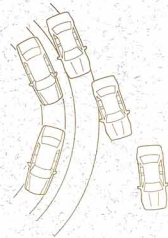

The energy-absorbing steering column in Park Avenue is designed to compress under impact.



A steel side-guard door beam is welded in the doors to help protect you from the force of a side-impact collision.



EXTERIOR COLORS

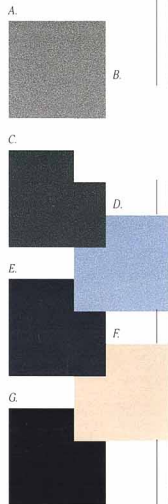

- A. Light Windsor Gray Metallic
- B. Bright White
- C. Dark Jadestone Metallic
- D. Ice Blue Metallic
- E. Midnight Blue Metallic
- F. Alabaster Beige
- G. Black

BUICK

Buyer's Guide

Park Avenue



CORNERING LAMPS brighten turning or parking maneuvers with peripheral illumination. This option also alerts other drivers, as the lamps are automatically activated with the turn signals.

Engine	3.8-litre 3800 V6 with tuned-port injection
Type	3.8-litre 3800 V6 with tuned-port injection
Horsepower	170 @ 4800 rpm
Torque	225 @ 3200 rpm

Dimensions, in.	
Length	205.2
Width	73.6
Height	55.1
Wheelbase	110.8
Front tread	60.4
Rear tread	60.6



DELCO ETR® AM STEREO-FM STEREO RADIO with cassette, graphic equalizer and Concert Sound II speakers.



GRAN TOURING PACKAGE. Available. It includes Gran Touring suspension, 16-inch aluminum wheels and touring blackwells, leather-wrapped steering wheel.



DELCO ETR® AM STEREO-FM STEREO RADIO with compact disc player, graphic equalizer and Concert Sound II speakers.

Interior, in.	front/rear
Legroom	42.0/41.6
Headroom	38.8/37.8
Shoulder room	58.7/58.5
Hip room	55.0/54.2

Capacity	
Trunk, cu ft	20.3
Fuel tank, gal	18.0
Base curb weight, lbs	3,536

Model Availability

- ▶ Park Avenue Sedan
- ▶ Powertrain/Suspension*
 - ▶ 3800 V6 with tuned-port injection
 - ▶ Anti-lock brakes
 - ▶ Automatic transmission with overdrive (electronically controlled)
- ▶ DynaRide 4-wheel independent suspension with automatic level control
- ▶ Power front disc/rear drum brakes
- ▶ Power rack-and-pinion variable-effort steering

Standard Equipment*

- ▶ Air bag—driver SIR (Supplemental Inflatable Restraint) system with knee bolster
- ▶ Air conditioning
- ▶ Armrest—front-seat storage with dual cup holders
- ▶ Carpeting—plush, front and rear
- ▶ Console—overhead, including front-seat reading lights, garage door opener storage
- ▶ Cruise control—electronic
- ▶ Defogger—electric rear-window
- ▶ Defogger—front and side window outlets
- ▶ Door locks—power
- ▶ Glass—Solar Ray® solar-control
- ▶ Instrumentation—backlit cluster with trip odometer
- ▶ Mirror—lighted visor vanity, passenger
- ▶ Mirrors—outside, left and right electric remote
- ▶ Radio—ETR® AM-FM stereo with seek and scan, cassette, 4-speaker system, clock
- ▶ Safety belts—manual lap/shoulder (with front shoulder comfort adjuster) for front and rear outboard passengers
- ▶ Seat—6-way power, driver
- ▶ Security locks—rear-door, child
- ▶ Steering column—TILT-WHEEL™ adjustable
- ▶ Theft-deterrent system—PASS-Key®
- ▶ Tires—P205/70R15 steel-belted, radial-ply, all season blackwall
- ▶ Windows—power with driver "express-down" and passenger lockout feature
- ▶ Windshield wipers—2-speed with low-speed delay

*Partial listing only—see your Buick dealer for complete lists and details.
 †Receives C-Quam® AM stereo broadcasts. Most AM stations across the country broadcast in C-Quam but some do not. Check your local stations for compatibility in your area.

Option Package Equipment

	Park Avenue			
	SB	SC	SD	SE
Automatic power antenna	X	X	X	X
Door edge guards	X	X	X	X
Analog gage cluster instrumentation	X	X	X	X
6-way power passenger seat	X	X	X	X
Whitewall tires—P205/70R15	X	X	X	X
Low-oil-level indicator	X	X	X	X
Trunk convenience net	X	X	X	X
Automatic dual Comfortemp climate control	X	X	X	X
Illuminated driver door lock and interior light control	X	X	X	X
Electric passenger seatback recliner	X	X	X	X
Reminder Package	X	X	X	X
Concert Sound II speakers	X	X	X	X
Cornering lamps	X	X	X	X
Automatic programmable door locks	X	X	X	X
Twilight Sentinel headlamp control	X	X	X	X
4-note horn	X	X	X	X
Lamp monitors	X	X	X	X
Lighted visor vanity mirror—driver	X	X	X	X
Remote keyless entry system	X	X	X	X
Theft-deterrent system	X	X	X	X
Electric trunk pull-down	X	X	X	X
Automatic day/night rearview mirror	X	X	X	X
Outside mirrors—electric, left and right remote and heated, left automatic day/night	X	X	X	X
ETR® AM stereo-FM stereo with cassette, graphic equalizer and Concert Sound II speakers	X	X	X	X
Self-sealing whitewall tires	X	X	X	X
Trunk mat	X	X	X	X
Rear-seat Comfortemp air conditioning	X	X	X	X
Memory driver's seat and mirrors	X	X	X	X

Additional Available Options*

	Park Avenue
Electric Astrotrot	X
California emission equipment and testing	X
ETR® AM stereo-FM stereo with compact disc player, graphic equalizer and Concert Sound II speakers	X
Automatic Ride Control suspension	X
Gran Touring suspension	X
Traction-control system	X
Trailer Towing Package	X
Wire wheelcovers	X
Leather-trimmed interior	X

EXTERIOR COLORS



- H. Dark Mahogany Metallic
- I. Ruby Red Metallic
- J. Champagne Beige Metallic
- K. Dark Cherry Metallic
- L. Sapphire Blue Firemist Metallic**
- M. Smokey Amethyst Metallic

** Extra cost.

BUICK

Riviera

The stylish, gracefully aerodynamic 1993 Riviera exhibits the distinctive silhouette of a premium automobile. Certainly, the demanding driver will appreciate the response of the 3800 V6 tuned-port fuel-injected engine. The electronically controlled 4-speed automatic transmission is a model of smooth operation. The 4-wheel independent DynaRide suspension (or available Gran Touring suspension for a sportier feel) filters out harshness and handles the curves with agility. Plus, the automatic level control system keeps Riviera level, regardless of the weight being carried.





BUICK

Riviera

The acknowledged classic offers more than beauty.

Look beyond the distinctive lines. This powerful, mature classic fulfills the Buick quality by design mandate on many levels.

The 1993 Riviera offers the discriminating driver an abundance of premium features that are both responsive and refined. These include such Buick standards as anti-lock brakes, a long list of reassuring safety features, and 2-side-zinc-galvanized steel panels to help assure Riviera's long-lasting classic status.



▲ *Optional remote keyless entry system increases convenience and peace of mind by locking or unlocking doors, or unlatching deck lid — from a distance.*

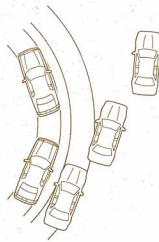

Anti-lock brakes help provide controlled stopping under hard braking conditions, even on slippery roads.

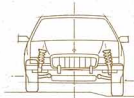

Buick's famous DynaRide suspension smooths the way by isolating passengers from annoying bumps and vibrations.

1993



The standard driver Supplemental Inflatable Restraint (air bag) complements the shoulder/lap belt safety system and deploys in a fraction of a second in certain severe frontal impacts.



The passenger compartment is surrounded by a steel structure that forms a "safety cage" to help protect occupants in a front, rear or side impact.



BUICK

Riviera

Tailored to handle the road, and you.

The elegant Riviera interior surrounds you with premium refinements. The 6-way power driver's seat offers firmly bolstered support and quiet, easy-to-use, door-mounted controls. It even includes a manual recliner. Electronic touch climate control provides ample airflow and constant temperature. The retained accessory power feature keeps the sound system, power windows, wipers and available sunroof operational for 10 minutes, or until the door is opened. Plus, impact-deflecting side-guard door beams and substantial, unitized construction add to the feeling of solid comfort and safety.

◀ Riviera offers available Ultra Soft leather in seating areas.



Electronic, easy-to-read instrumentation includes a tachometer, low-oil level, low-fuel pressure and low-fuel indicators, plus a trip odometer.

▼ Available white leather in the seating areas can be combined with the handsome blue, red or tan interior trim.



A.



B.



C.

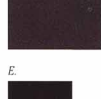

D.



E.



F.

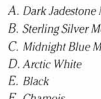

G. Ruby Red Metallic

Buyer's Guide

Riviera



AUTOMATIC INSIDE DAY/NIGHT MIRROR SYSTEM option is light-sensitive and dims automatically.

Engine	3.8-litre 3800 V6 with tuned-port injection
Type	3.8-litre 3800 V6 with tuned-port injection
Horsepower	170 @ 4800 rpm
Torque	220 @ 3200 rpm

Dimensions, in.

Length	198.2
Width	73.1
Height	52.9
Wheelbase	108.0
Front tread	59.9
Rear tread	59.9

Interior, in.	front/rear
Legroom	42.7/35.6
Headroom	37.8/37.8
Shoulder room	57.9/57.4
Hip room	55.9/55.4

Capacity	14.4
Trunk, cu ft	18.8
Fuel tank, gal	
Base curb weight, lbs	3,503



DELCO/BOSE GOLD SERIES MUSIC SYSTEM WITH ETR® AM STEREO-FM STEREO RADIO, compact disc player and cassette.



TWILIGHT SENTINEL HEADLAMP CONTROL turns the headlamps on at dusk or the appropriate time when light has faded. Optional, it also delays "lights out" when you have turned the ignition off.



DELCO ETR® AM STEREO-FM STEREO RADIO with compact disc player, cassette and graphic equalizer.

Model Availability

► Riviera Coupe

Powertrain/Suspension*

► 3800 V6 engine with tuned-port injection

► Anti-lock brakes

► Automatic transmission with overdrive (electronically controlled)

► DynaRide suspension with automatic level control

► Power 4-wheel disc brakes

► Power steering

Standard Equipment*

► Air bag—driver SIR (Supplemental Inflatable Restraint) system

► Air conditioning—electronic touch climate control

► Antenna—automatic power

► Carpeting—plush, front and rear

► Console—full-length operating with armrest and cup holder

► Cruise control—electronic

► Defogger—electric rear-window with front and side window outlets

► Door locks—automatic

► Glass—Solar-Ray® solar-control

► Instrumentation—electronic including tachometer, volt,

temperature, oil, coolant, and low-washer-fluid, low-oil-pressure, low-oil-level, low-fuel indicators, trip odometer, fuel gage and speedometer

► Mirrors—lighted visor vanity, driver and passenger

► Mirrors—outside, left and right electric remote with floodlit controls, deluxe body-color

► Radio—ETR® AM-FM stereo with seek and scan, cassette with auto reverse,

search/repeat, clock

► Safety belts—manual lap/shoulder for front and rear outboard passengers

► Seat—6-way power with floodlit controls, driver

► Seats—cloth bucket with manual recliners

► Speakers—6-speaker Concert Sound

► Steering column—TILT/WHEEL™ adjustable

► Theft-deterrent system—PASS-Key®

► Tires—P205/70R15 steel-belted, radial-ply, all-season whitewall

► Wipers—2-speed with low-speed delay

Option Package Equipment

	Riviera	
	SD	SE
6-way power passenger seat with recliner	x	x
Twilight Sentinel headlamp control	x	x
Automatic day/night rearview mirror	x	x
Electric trunk pull-down	x	x
Remote keyless entry with automatic door locks	x	x
Outside mirrors—left and right remote, left heated	x	x
Theft-deterrent system	x	x

Additional Available Options*

	Riviera
Electric Astrorof	x
California emission equipment and testing	x
Lower accent paint	x
Delco/Bose Gold Series Music System with ETR® AM stereo-FM stereo, compact disc player and cassette	x
ETR® AM stereo-FM stereo with compact disc player, graphic equalizer and cassette	x
Riviera Appearance Package	x
Heavily padded Landau roof	x
Gran Touring suspension	x
15-inch aluminum wheels—car color	x
15-inch aluminum wheels	x
Leather-trimmed interior	x

*Partial listing only—see your Buick dealer for complete lists and details.

†Receives C-Quam® AM stereo broadcasts. Most AM stations across the country broadcast in C-Quam but some do not. Check your local stations for compatibility in your area.

H.



I.



J.



K.



L.



M.



H. Dark Cherry Metallic

I. Alabaster Beige

J. Sapphire Blue Firemist Metallic**

K. Diamond White**

L. Pewter Gray Metallic

M. Light Drillwood Metallic

**Extra cost.

BUICK

Regal Sedan

Regal is attracting an important following, including a number of former import owners. Some of the reasons why: the commanding power of the 3.1-litre V6 with multi-port fuel injection, 4-speed electronically controlled automatic transmission with overdrive, 4-wheel power disc brakes, 4-wheel independent DynaRide suspension, power steering, air conditioning, TILT-WHEEL™ adjustable steering column, and ETR® AM-FM stereo radio with seek and scan. All standard.

Regal Sedan: all the reasons in the world for passing up an import.

► *Regal Limited Sedan.*



BUICK

Regal Sedan

Why Regal is attracting a new generation.

Independent thinkers attach a high value to freedom of choice, and they are choosing the Regals — Limited, Custom and Gran Sport — with increasing enthusiasm.

Gran Sport exemplifies this Regal attraction. Behind its new grille is a powerful 3800 V6 with tuned-port injection. The Gran Touring Package includes a sporty, responsive suspension and wide-surfaced touring tires on 16-inch aluminum wheels, and more. Custom and Limited feature DynaRide suspension and the 3.1-litre V6 engine.

▼ *Foreground: Regal Gran Sport Sedan with standard 16-inch aluminum wheels. Background: Regal Custom Sedan with optional 15-inch aluminum wheels.*

▼ *The lively 3.1-litre V6 offers the efficiency of fast-burn combustion chambers and electronic sensors that precisely meter fuel to fit the pace of the engine.*

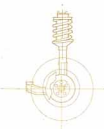

Buick's famous DynaRide 4-wheel independent suspension delivers smoothness, vibration-isolation and crisp handling.





Available dual ComforTemp climate control allows different temperature settings for driver and passenger.

Comfortable Regal Custom Sedan interior.



BUICK

Regal Sedan

A Regal choice is a comfortable one.

A generous assortment of standard features includes plush carpeting, rich cloth upholstery, and a premium sound system with ETR® AM-FM stereo radio, seek and scan, and a clock. The 55/45 front seat design incorporates a center armrest for storing personal items.

1993 Regal Sedan: a comfortable choice.



Driver-operated power door locks with automatic locking feature, and available power window controls, add a welcome touch of convenience.



The energy-absorbing instrument panel is designed for ease and control with logically grouped switches and legible gauges. Features include convenient TILT-WHEEL™ adjustable steering column for the most comfortable angle, and ETR® AM-FM stereo with seek/scan, clock.

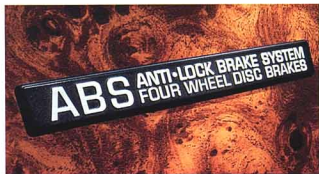

▲ The anti-lock brake system helps provide confident stopping power and steering control during hard-braking situations. Standard on Limited and Gran Sport. Available on Custom.

Strong, unstrained power without peaks and valleys characterizes the optional 3800 V6 tuned-port fuel-injected engine.

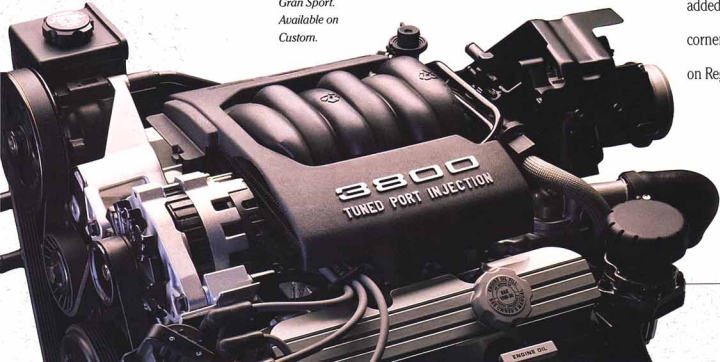

One sitting gives you a lot of reasons to own a Regal.

The Regal Gran Sport, shown right with optional red leather in the seating area, includes front adjustable headrests, reclining bucket seats, a sporty leather-wrapped steering wheel, and full-length operating console with storage in the armrest. The comfortable bucket seats are contoured to give added support to driver and passenger while cornering. This optional interior is also available on Regal Limited.



▲ Sporty, versatile full-length operating console fits neatly between available front bucket seats.

Regal Sedan



ELECTRIC REMOTE OUTSIDE MIRROR can be adjusted through controls located inside the car within easy reach of the driver. *Optional on all models.*

Engine		Interior, in.	front/rear
Type (Custom, Limited)	3.1-litre V6 with MFI ^{††}	Legroom	42.4/36.2
Horsepower	140 @ 4400 rpm	Headroom	38.6/37.7
Torque	185 @ 3200 rpm	Shoulder room	57.8/57.8
Type (Custom, Limited; standard on Gran Sport)	3.8-litre 3800 V6 with tuned-port injection	Hip room	52.7/53.2
Horsepower	170 @ 4800 rpm	Capacity	
Torque	225 @ 3200 rpm	Trunk, cu ft	15.8
		Fuel tank, gal	16.5
Dimensions, in.		Base curb weight, lbs	3,340
Length	194.8		
Width	72.5		
Height	54.5		
Wheelbase	107.5		
Front tread	59.5		
Rear tread	58.0		

^{††}MFI—Multi-port fuel injection



LIGHTED VISOR VANITY MIRROR option features two levels of illumination to aid visibility. *Lights shut off automatically when the cover is closed.*



DELCO ETR® AM-FM STEREO RADIO with compact disc player.



DELCO ETR® AM STEREO-FM STEREO RADIO with cassette and graphic equalizer.



Regal Limited Sedan.

EXTERIOR COLORS

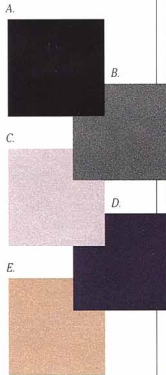

- A. Black
- B. Medium Jadestone Metallic
- C. Sterling Silver Metallic
- D. Adriatic Blue Metallic
- E. Light Driftwood Metallic^{††}

Model Availability

- ▶ Regal Custom Sedan
- ▶ Regal Limited Sedan
- ▶ Regal Gran Sport Sedan

Powertrain/Suspension*

- ▶ 3.1-litre V6 with MFI (Custom, Limited)
- ▶ 3800 V6 with tuned-port injection (Gran Sport)
- ▶ 4-wheel power disc brakes
- ▶ Anti-lock brakes standard on Limited and Gran Sport; available on Custom
- ▶ Steering—power
- ▶ Suspension—DynaRide (except Gran Sport)
- ▶ Transmission—4-speed electronically controlled automatic with overdrive

Standard Equipment*

- ▶ Air conditioning
- ▶ Automatic safety belt system—driver and front outboard passenger
- ▶ Body-side panels—2-side-galvanized
- ▶ Door locks—power with automatic feature
- ▶ Glass—Soft-Ray tinted
- ▶ Instrumentation—analogue gauges with tachometer
- ▶ Mirrors—outside, left remote/right manual, deluxe
- ▶ Radio—ETR® AM-FM stereo with seek/scan, clock

- ▶ Seats—55/45 cloth reclining with storage armrest (Custom)
- ▶ Steering column—TILT-WHEEL™ adjustable
- ▶ Tires—P205/70R15 steel-belted, radial-ply, all-season blackwall (except Gran Sport)
- ▶ Wipers—2-speed with low-speed delay

Additional Limited Features*

- ▶ Lights—front-seat header, reading
- ▶ Seat adjuster—4-way manual
- ▶ Seats—55/45 Limited Cloth with storage armrest

Additional Gran Sport Features*

- ▶ Appearance—specific interior and exterior identification
- ▶ Paint—Pewter Gray Metallic lower accent
- ▶ Seat adjuster—4-way manual
- ▶ Seats—cloth, reclining bucket with operating console
- ▶ Sensor—low-oil indicator
- ▶ Steering wheel—leather-wrapped
- ▶ Suspension—Gran Touring
- ▶ Tires—P225/60R16** steel-belted, radial-ply, Eagle GA touring blackwall
- ▶ Wheels—specific, 16-inch aluminum

Option Package Equipment

	Custom		Limited		GS	
	SB	SC	SD	SE	SD	SE
Rear-window defogger	x	x	x	x	x	x
Front and rear carpet savers	x	x	x	x	x	x
Cruise control	x	x	x	x	x	x
Power windows	x	x	x	x	x	x
Dual Comfort/Temp climate control	x	x	x	x	x	x
ETR® AM-FM stereo with cassette	x	x	x	x	x	x
Automatic power antenna	x	x	x	x	x	x
Remote left and right mirrors	x	x	x	x	x	x
Trunk convenience net	x	x	x	x	x	x
Trunk lock release	x	x	x	x	x	x
6-way power driver seat			x		x	
Concert Sound II speaker system			x		x	
Front overhead console courtesy/reading lights			x		x	
Dome with integral reading lights			x			
15-inch aluminum wheels					x	x
Dual lighted visor vanity mirrors					x	x
Steering-wheel-mounted radio controls					x	
Remote keyless entry					x	x
Door courtesy lights					x	
ETR® AM stereo-FM stereo with cassette and graphic equalizer					x	

Additional Available Options*

	Custom	Limited	Gran Sport
Electric Astrorof with sunshade	x	x	x
Anti-lock brakes	x	s	s
3800 V6 engine	x	x	s
California emission equipment and testing	x	x	x
Chrome luggage rack	x	x	x
ETR® AM-FM stereo with cassette	x	x	x
ETR® AM stereo-FM stereo with compact disc player	x	x	x
ETR® AM stereo-FM stereo with cassette and graphic equalizer	x	x	x
6-way power driver and passenger seats	x	x	x
Gran Touring suspension	x	x	s
Wire wheelcovers	x	x	
15-inch aluminum wheels	x	x	
Leather-trimmed interior	x	x	x

s = standard

*Partial listing only—see your Buick dealer for complete lists and details.

**Note: Use of tire chains with this tire may cause damage to your car.

†Receives C-Quam® AM stereo broadcasts. Most AM stations across the country broadcast in C-Quam but some do not. Check your local stations for compatibility in your area.

EXTERIOR COLORS

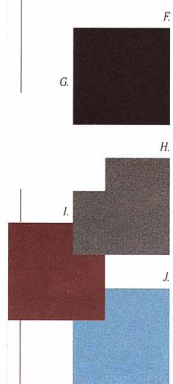

- F. Claret Red Metallic
- G. Bright White
- H. Pewter Gray Metallic**
- I. Ruby Red Metallic
- J. Maui Blue Metallic^{††}

^{††} Not available on Gran Sport.

**Also, standard lower accent color on Gran Sport with Sterling Silver, Bright White, Adriatic Blue, Black, Medium Jadestone, Ruby Red and Claret Red.

BUICK

Regal Coupe

There are no sacrifices here: this lively coupe is a driver's car with balance, style, power, comfort and utility.

The 1993 Regal Gran Sport features a Gran Touring suspension that offers crisp response, and a firm, precise ride. The sporty look of large tires on 16-inch aluminum wheels completes the picture. And behind the matching body-colored grille is a 3800 V6 engine with tuned-port fuel injection.

Regal Gran Sport Coupe: it sacrifices nothing.

► *Regal Gran Sport Coupe.*



BUICK

Regal Coupe

There's nothing basic about Regal Coupe.

That's another good reason it's so popular. Standard features include power steering, 4-wheel disc brakes for confident stopping power, or anti-lock brakes that are standard on Limited and Gran Sport, optional on Custom.

DynaRide 4-wheel independent suspension brings everything that's right to a sporty coupe. It is supple and cushioned over bumps, and smooth and precise on curves. The V6 serves up ample power for all performance needs. And even the trunk contributes 15.6 cu ft of cargo space.



▲ The 3.1-litre V6 with multi-port fuel injection, standard on Custom and Limited, generates 140 horsepower at 4400 rpm, 185 lbs-ft of torque at 3200 rpm.



Optional remote keyless entry system increases convenience and peace of mind by locking or unlocking doors, or unlatching deck lid — from a distance.

▼ Regal Custom Coupe.



▲ Regal Limited Coupe.

BUICK

Regal Coupe

The driving experience: how it measures up to the rest of the car.

The outer beauty and inner comforts of Regal Coupe make certain promises. They are paid in full when you settle into the comfortable interior.

Full instrumentation is standard in all Regals, and the seating is rich, with contoured support.

DynaRide suspension (Gran Touring suspension on Gran Sport) offers remarkable rough-road poise and refined grace on highways. The power of the standard 3.1-litre V6, or the optional 3800 engine, is transferred to pavement by the smooth 4-speed electronically controlled automatic transmission with overdrive.

► Handsome Regal Limited Coupe interior.



Legible instrumentation and rich trim add to the pleasure of an optional CD player and Concert Sound II speaker system. Convenient steering wheel radio controls are also available.

▼ Dual ComfortTemp climate control is an option that shows consideration for your passenger's inclinations.



Front seatbacks feature handy map pockets in the Limited Coupe.



Buyer's Guide

Regal Coupe



GLASS SLIDING ASTROROOF opens up to the great outdoors. Available, it includes a sunshade and mirror with map lights.



DELCO ETR® AM-FM STEREO RADIO with cassette.

Engine	3.1-litre V-6 with MFI ^{††}	Interior, in.	front/rear
Type (Custom, Limited)		Legroom	42.3/34.8
Horsepower	140 @ 4400 rpm	Headroom	37.6/37.0
Torque	185 @ 3200 rpm	Shoulder room	57.6/56.8
Type (Custom, Limited, Gran Sport)	3.8-litre 3800 V6 with tuned-port injection	Hip room	52.0/53.1
Horsepower	170 @ 4800 rpm	Capacity	
Torque	225 @ 3200 rpm	Trunk, cu ft	15.6
Dimensions, in.		Fuel tank, gal	16.5
Length	193.6	Base curb weight, lbs	3,250
Width	72.5		
Height	53.0		
Wheelbase	107.5		
Front tread	59.5		
Rear tread	58.0		

^{††} MFI—Multi-port fuel injection



LUGGAGE RACK. This black-finished rack features integrated center high-mounted stop lamp. Available on the Custom and Gran Sport Coupes.



DELCO ETR® AM STEREO-FM STEREO RADIO with cassette and graphic equalizer.



Regal Limited Coupe

EXTERIOR COLORS



- A. Black
- B. Medium Jadestone Metallic
- C. Sterling Silver Metallic
- D. Adriatic Blue Metallic
- E. Light Draitwood Metallic

Model Availability

- ▶ Regal Custom Coupe
- ▶ Regal Limited Coupe
- ▶ Regal Gran Sport Coupe

Powertrain/Suspension*

- ▶ 3.1-litre V6 with MFI (Custom, Limited)
- ▶ 3800 V6 with tuned-port injection (Gran Sport)
- ▶ 4-wheel power disc brakes
- ▶ Anti-lock brakes standard on Limited and Gran Sport; available on Custom
- ▶ Steering—power
- ▶ Suspension—DynaRide (except Gran Sport)
- ▶ Transmission—4-speed electronically controlled automatic with overdrive

Standard Equipment*

- ▶ Air conditioning
- ▶ Automatic safety belt system—driver and front outboard passenger
- ▶ Body-side panels—2-side-galvanized
- ▶ Door locks—power with automatic feature
- ▶ Electronic warning tone—seat belt, ignition key, headlamps on
- ▶ Glass—Soft-Ray tinted
- ▶ Instrumentation—analogue cluster with tachometer
- ▶ Mirrors—outside, left remote/

- right manual, deluxe
- ▶ Radio—ETR® AM-FM stereo with seek/scan, clock
- ▶ Seats—55/45 cloth reclining with storage armrest (Custom)
- ▶ Steering column—TLT-WHEEL™ adjustable
- ▶ Tires—P205/70R15 steel-belted, radial-ply, all-season blackwall (except Gran Sport)

Additional Limited Features*

- ▶ Lights—front-seat header, reading
- ▶ Seat adjuster—4-way
- ▶ Seats—55/45 Limited Cloth with storage armrest
- ▶ Tail lamp lenses—crystalline

Additional Gran Sport Features*

- ▶ Appearance—specific interior and exterior identification, body-side moldings and aero panels
- ▶ Seats—reclining cloth bucket with operating console
- ▶ Sensor—low-oil indicator
- ▶ Suspension—Gran Touring
- ▶ Tires—P225/60R16** Eagle GA touring blackwall
- ▶ Wheels—specific, 16-inch aluminum

Option Package Equipment	Custom		Limited		GS	
	SB	SC	SD	SE	SD	SE
Rear-window defogger	X	X	X	X	X	X
Front and rear carpet savers	X	X	X	X	X	X
Cruise control	X	X	X	X	X	X
Power windows	X	X	X	X	X	X
Dual Comfor/Temp climate control	X	X	X	X	X	X
ETR® AM-FM stereo with cassette	X	X	X	X	X	X
Automatic power antenna	X	X	X	X	X	X
Remote left and right mirrors	X	X	X	X	X	X
Trunk convenience net	X	X	X	X	X	X
Trunk lock release	X	X	X	X	X	X
6-way power driver seat	X	X	X	X	X	X
Concert Sound II speaker system	X	X	X	X	X	X
Front overhead console courtesy/reading lights	X	X	X	X	X	X
Sail panel courtesy lights	X	X	X	X	X	X
15-inch aluminum wheels			X	X		
Dual lighted visor vanity mirrors			X	X	X	X
Steering-wheel-mounted radio controls			X	X		
Remote keyless entry			X	X		
ETR® AM stereo-FM stereo with cassette and graphic equalizer			X	X		

Additional Available Options*

	Custom	Limited	Gran Sport
Electric Astroroof with sunshade	X	X	X
Anti-lock brakes	X	S	S
3800 V6 engine	X	X	S
Engine block heater	X	X	X
California emission equipment and testing	X	X	X
Black luggage rack	X	X	X
ETR® AM-FM stereo with cassette	X	X	X
ETR® AM stereo-FM stereo with compact disc player	X	X	X
ETR® AM stereo-FM stereo with cassette and graphic equalizer	X	X	X
6-way power driver and passenger seats	X	X	X
Gran Touring suspension	X	X	
Wire wheelcovers	X	X	
15-inch aluminum wheels	X	X	
Leather-trimmed interior		X	X

*Partial listing only—see your Buick dealer for complete lists and details.
 **Note: Use of tire chains with this tire may cause damage to your car.
 †Receives C-Quam® AM stereo broadcasts. Most AM stations across the country broadcast in C-Quam but some do not. Check your local stations for compatibility in your area.

EXTERIOR COLORS

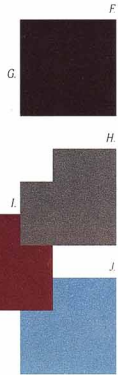

- F. Claret Red Metallic
- G. Bright White
- H. Pewter Gray Metallic
- I. Ruby Red Metallic
- J. Maui Blue Metallic

BUICK

LeSabre

Buick LeSabre for 1993 offers the quiet, impressive power of a tuned-port fuel-injected 3800 V6 engine. How the power is translated to movement is just as impressive: LeSabre glides through the gears in a smooth arc, thanks to the computerized shifting of its sophisticated, electronically controlled 4-speed automatic transmission with overdrive.

DynaRide suspension provides the responsive, fluid ride that has become a Buick trademark.

LeSabre: America's best-selling, 6-passenger, full-size automobile.*

**Based on 1992 model sales, October 1, 1991, through June 10, 1992.*

► *LeSabre Limited Sedan.*



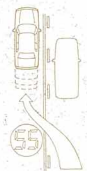

Variable-effort steering delivers a measured amount of power assist at higher speeds for impressive road feel. At low speeds and parking, more power assist is provided. Standard on Limited.



BUICK

LeSabre

Two ways to hit the best seller list.

LeSabre Limited and LeSabre Custom share admirable traits: the refined ride and the deep well of power on demand join the generous list of features LeSabre owners have come to expect.

Safety is simplified by a brake/transmission interlock that prevents shifting out of PARK unless the brakes are applied. Anti-lock brakes, large brake rotors, steel side-guard door beams and one-piece body sides help form the assuringly solid feel of LeSabre, Buick's best-selling full-size car.

◀ Foreground: LeSabre Limited Sedan.
Background: LeSabre Custom Sedan.



▲ PASS-Key® theft-deterrent system activates the ignition sensor in a second. Without it, the ignition system is inoperable.



Driver air bag (standard) provides protection in addition to safety belts, in event of certain severe frontal impacts.

The large, 17.1-cu-ft trunk is both easy to load and unload, thanks to its low liftover height.



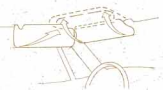

Extendable and supplemental front sunshades shield driver and passenger from unwanted sun rays.



Standard plush 55/45 cloth seats feature manual recliners, to ease the journey of the driver and a front-seat passenger.



BUICK

LeSabre

Exceptional performance.

Six-passenger, full-size LeSabre offers impressive performance in the cabin, as well as the engine compartment. 108.3 cu ft of interior space provides plenty of front legroom (42 inches), and shoulder room that allows real freedom (59.1 inches).

Plush, comfortable seating is contoured. The roomy cabin is hushed at highway speeds, and that benefits yet another sort of performance: the concert sound of the premium audio system with optional CD player. However one measures performance, LeSabre is exceptional.

◀ LeSabre Limited with standard cloth interior.

▼ The front-seat storage armrest features dual cup holders within convenient reach of passenger and driver. Standard on Limited.



Wraparound instrument panel includes backlit analog cluster with trip odometer, optional remote trunk release, ETR® AM-FM stereo radio with seek and scan, four speakers and analog clock. Optional gage cluster shown.





BUICK

LeSabre

It took us 90 years to get here. Your trips will be considerably quicker.

You'll feel the full 90 years of solid Buick heritage in the 1993 LeSabre. Wind tunnel testing assures you acoustic calm in a sealed cabin at highway speeds. Those speeds are reached quickly and smoothly, with the 170-horsepower 3800 V6 and the precision of a computerized automatic transmission with overdrive. And to help you arrive safely, LeSabre comes standard with Buick's anti-lock brake system. It allows confident steering for more controlled stops under hard braking conditions.

LeSabre: a powerful expression of Buick quality.



Advanced 170-hp 3800 V6 with tuned-port fuel injection features one injector at each intake port to help optimize power.

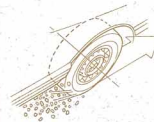

Optional traction control helps reduce wheel spin during initial acceleration on slick surfaces. Available only on Limited.

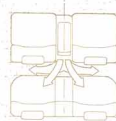

Air flows to the back with optional rear-seat ComfortTemp, which provides directionally controlled air current. Available only on Limited.

Buyer's Guide

LeSabre



REMOTE KEYLESS ENTRY SYSTEM, optional on all LeSabres, increases convenience and peace of mind by locking or unlocking doors, or unlatching trunk—from a distance.

Engine	3.8-litre 3800 V6 with tuned-port injection	front/rear	42.0/40.9
Type		Legroom	39.3/37.8
Horsepower	170 @ 4800 rpm	Headroom	59.1/58.9
Torque	225 @ 3200 rpm	Hip room	55.0/54.4

Dimensions, in.		Capacity	
Length	200.0	Trunk, cu ft	17.1
Width	73.6	Fuel tank, gal	18.0
Height	55.7	Base curb weight, lbs	3,433
Wheelbase	110.8		
Front tread	60.4		
Rear tread	60.4		

Interior, in.	front/rear
Legroom	39.3/37.8
Headroom	59.1/58.9
Shoulder room	55.0/54.4
Hip room	

Capacity	
Trunk, cu ft	17.1
Fuel tank, gal	18.0
Base curb weight, lbs	3,433



DUAL AUTOMATIC COMFORTEMP CLIMATE CONTROL, available on LeSabre Limited, allows the front passenger to adjust individual temperature.



DELCO ETR® AM STEREO-FM STEREO RADIO with compact disc player, graphic equalizer and Concert Sound II speakers.



LeSabre Custom Sedan.

EXTERIOR COLORS

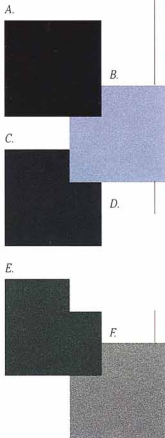

- A. Black
- B. Ice Blue Metallic
- C. Midnight Blue Metallic
- D. Bright White
- E. Dark Jadestone Metallic
- F. Light Windsor Gray Metallic

Model Availability

- ▶ LeSabre Custom Sedan
- ▶ LeSabre Limited Sedan

Powertrain/Suspension*

- ▶ 3800 V6 with tuned-port injection
- ▶ Anti-lock brakes
- ▶ Automatic transmission with overdrive (electronically controlled)
- ▶ DynaRide suspension, front and rear independent
- ▶ Power front disc/rear drum brakes
- ▶ Power rack-and-pinion steering
- ▶ Variable-effort steering (Limited)

Standard Equipment*

- ▶ Air bag—driver SIR (Supplemental Inflatable Restraint) system with knee bolster
- ▶ Air conditioning
- ▶ Defogger—electric rear-window (Limited)
- ▶ Defogger—front and side window outlets
- ▶ Exhaust system—stainless steel
- ▶ Lights—front ashtray, front- and rear-door-operated dome, trunk, engine compartment, glove box and instrument panel courtesy
- ▶ Power door locks
- ▶ Radio—ETR® AM-FM stereo with seek and scan, clock

- ▶ Recliners—manual seatback, driver and passenger
- ▶ Safety belts—manual lap/shoulder (with front shoulder comfort adjuster) for front and rear outboard passengers
- ▶ Seats—55/45 cloth with armrest (Custom)
- ▶ Seats—55/45 cloth with front-seat storage armrest (Limited)
- ▶ Security locks—rear-door, child
- ▶ Speakers—dual, front and rear extended-range
- ▶ Sunshades—extendable
- ▶ Sunshades—supplemental front
- ▶ Theft-deterrent system—PASS-Key®
- ▶ Tires—P205/70R15 steel-belted, radial-ply, all-season blackwall
- ▶ Windows—power with driver "express-down" and passenger lockout
- ▶ Wipers—2-speed with low-speed delay

Option Package Equipment

	Custom			Limited		
	SC	SD	SE	SC	SD	SE
Rear-window defogger	X	X	X	S	S	S
Cruise control	X	X	X	X	X	X
Whitewall tires—P205/70R15	X	X	X	X	X	X
Front-seat storage armrest	X	X	X	S	S	S
Trunk convenience net	X	X	X	X	X	X
Carpet savers, front and rear	X	X	X	X	X	X
Locking wire wheelcovers	X	X	X	X	X	X
Accent stripes	X	X	X	X	X	X
ETR® AM-FM stereo with cassette	X	X	X	X	X	X
6-way power driver seat	X	X	X	X	X	X
Door edge guards	X	X	X	X	X	X
Trunk lock release	X	X	X	X	X	X
Lighted passenger visor vanity mirror	X	X	X	X	X	X
Automatic power antenna	X	X	X	X	X	X
Electric outside mirrors	X	X	X	X	X	X
Door courtesy lights	X	X	X	X	X	X
Automatic dual Comfortemp climate control air conditioning	X	X	X	X	X	X
Rear-seat Comfortemp air conditioning	X	X	X	X	X	X
Concert Sound II speaker system	X	X	X	X	X	X
6-way power passenger seat	X	X	X	X	X	X
ETR® AM stereo-FM stereo with cassette and graphic equalizer	X	X	X	X	X	X
Cornering lamps	X	X	X	X	X	X
Remote keyless entry	X	X	X	X	X	X

Additional Available Options*

	Custom	Limited
California emission equipment and testing	X	X
Analog gauge cluster instrumentation	X	X
Oil-life monitor indicator	X	X
ETR® AM stereo-FM stereo with cassette, graphic equalizer and Concert Sound II speakers	X	X
ETR® AM stereo-FM stereo with compact disc player, graphic equalizer and Concert Sound II speakers	X	X
6-way power driver seat	X	X
Gran Touring suspension with automatic level control	X	X
Traction-control system	X	X
Trailer Towing Package	X	X
Trunk convenience net	X	X
15-inch aluminum wheels	X	X
Leather-trimmed interior	X	X

*Partial listing only—see your Buick dealer for complete lists and details. †Receives C-Quam® AM stereo broadcasts. Most AM stations across the country broadcast in C-Quam but some do not. Check your local stations for compatibility in your area.

EXTERIOR COLORS



- G. Ruby Red Metallic
- H. Champagne Beige Metallic
- I. Dark Cherry Metallic
- J. Polo Green Metallic
- K. Smokey Amethyst Metallic

BUICK

Skylark

This bold, dramatically styled Gran Sport cannot escape notice. It is quality and convenience matched with powerful performance.

A 3300 V6 with multi-port fuel injection is its powerplant: an outstanding performer that develops 160 horsepower, with a torque peak of 185 lbs-ft.

Skylark Gran Sport also boasts a grand assortment of features like standard anti-lock brakes, and the optional Adjustable Ride Control suspension system with SOFT, AUTO and SPORT settings.

1993 Skylark: its lasting impression is by design.

► *Skylark Gran Sport Coupe.*

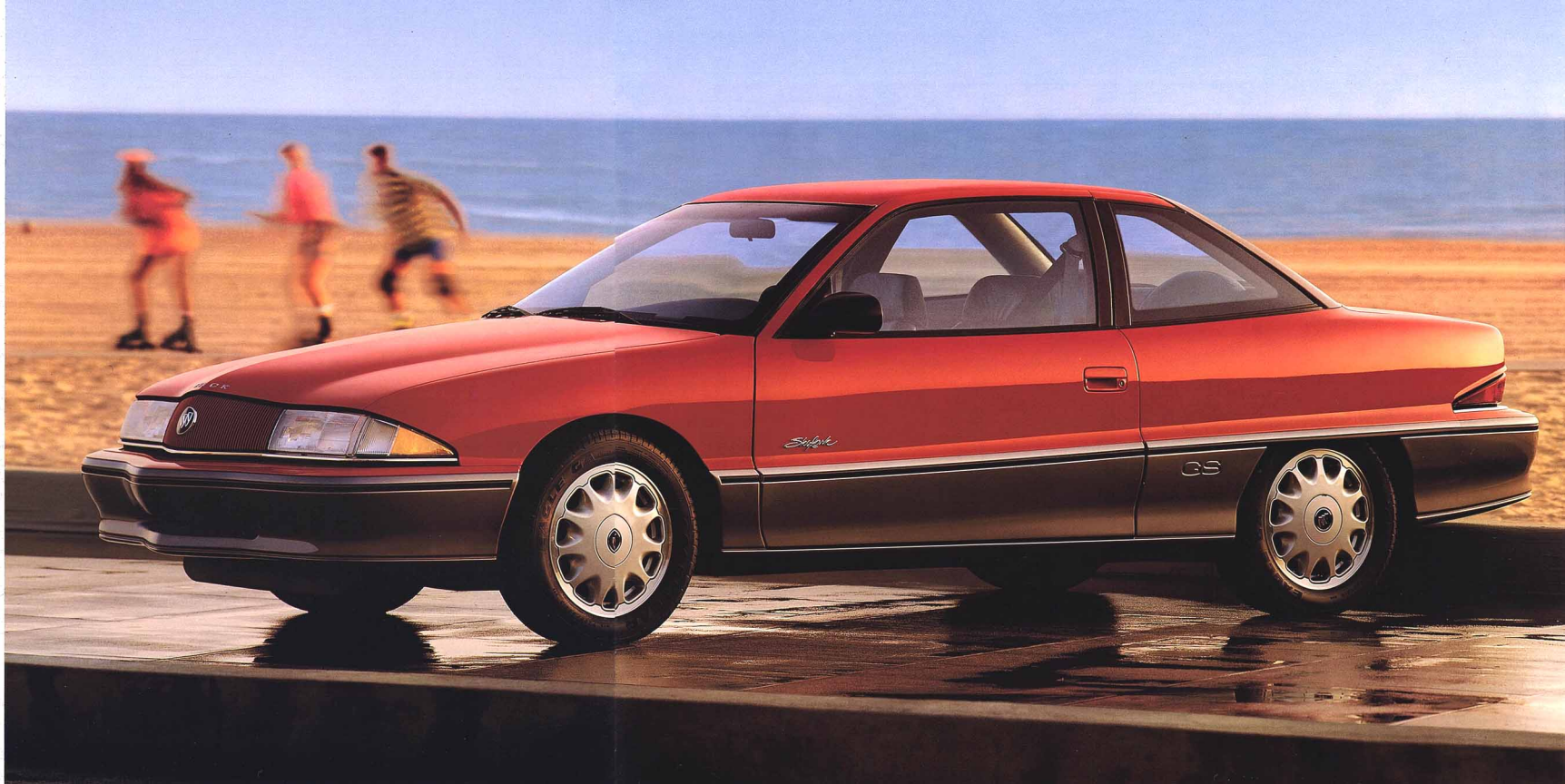

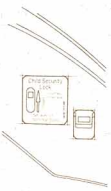

Rear-door child security locks, when activated, prevent opening the rear doors with the interior handles.



Standard remote releases for trunk lid and fuel filler door provide a touch of security and convenience.



BUICK

Skylark

It might be easier to tell you what it doesn't have.

Skylark sports freedom of choice and a wide array of standard equipment. For instance, the Gran Sport features supple leather and soft cloth in the seating area. Other Gran Sport features include a full-length operating console between the bucket seats, adjustable headrests, rear-seat headrests, manual driver and passenger recliners and, of course, power rack-and-pinion steering.

Standard Gran Sport trim with cloth and leather in the seating areas.



The split folding rear seat is convenient for carrying long or bulky items. Standard on Gran Sport, available on Limited.

This Gran Sport design includes full instrumentation with analog gauges, ETR® AM-FM stereo with seek and scan, clock. All controls are within easy reach and logically grouped.



BUICK

Skylark

Anonymity is one of the few things you don't get with Skylark.

But look what you do get. Buick quality. Buick safety. Buick comfort. Buick convenience. The contemporary aerodynamic design will allow you to evade the effects of wind, but not the notice of an admiring public. You can handle it. With DynaRide suspension (standard on Custom and Limited), the

control, and the ride, are superb. The power behind the fun: a spirited 2.3-litre Quad OHC (Custom, Limited) and the 3300 V6 with multi-port fuel injection in the Gran Sport (available in Custom and Limited).

The dramatic silhouette of Skylark, whether coupe or sedan, houses a lot of convenience — except the privilege of getting away unnoticed.

► *Foreground:*
Skylark Gran Sport
Sedan.
Background:
Skylark Limited
Sedan.



All exterior body panels except the roof are protected with 2-side-galvanized steel for corrosion resistance. On top of that, a basecoat-clearcoat paint process provides luster and durability.

▼
Skylark Custom
Sedan.



The power of comfort, and vice-versa.

The comforting reserves of Skylark powerplants are there for passing a truck or smooth cruising. But that is not all there is to driving a Skylark. The smart, inviting interior features stylish, cloth seating with an armrest in front, and manual recliners for both driver and front passenger.

There is comfort in safety, too: standard 4-wheel anti-lock brakes help bring you to a sure, controlled

stop. A safety cage surrounds occupants with reinforced steel, and side-guard door beams help absorb impact energy in side collisions and reduce the amount of force transmitted to the passenger compartment. Add to that the energy-absorbing crush zones, front and rear, and an energy-absorbing steering column, and the feeling of comfort is powerfully reassuring.

► The lively fuel-injected 2.3-litre Quad OHC engine needs only oil, spark plugs and filters for its low-maintenance schedule during the first 100,000 miles. Standard on Limited and Custom.

► Skylark Custom interior features handsome cloth-covered seating.

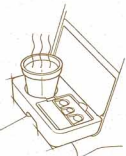

Convenient available center console provides a driver-side cup holder, coin-keeper and ashtray that removes for storage and even more room. Standard on Gran Sport.



Standard power door locks with automatic feature engage when you shift out of PARK or NEUTRAL.

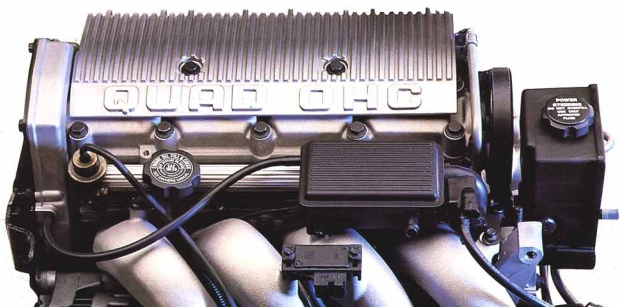

Skylark

Another big reason to follow Skylark's progress:

Skylark is designed to move ahead, with an extremely healthy 3300 V6 that develops 160 horsepower and 185 lbs-ft of torque. The immediacy of lower-end torque may cause an irrepressible smile — and the broad power band guarantees smooth, predictable power delivery throughout the engine's range.

This multi-port fuel-injected engine will continue to delight, thanks to roller lifters that reduce valve train friction, and lightweight pistons that reduce drag on cylinder walls. Standard on Gran Sport and optional on Custom and Limited.

1993 Skylark: you're being followed.

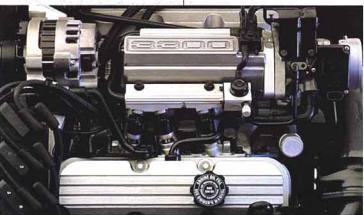

► Adjustable Ride Control allows you to adjust the suspension for varying road conditions, or your personal preference. This option can be set on SOFT, SPORT or AUTO.



Front to back, Skylark is loaded with satisfaction.

The large 13.3-cu-ft trunk space features the low liftover design for easy loading and unloading.

Other conveniences include a smooth-shifting automatic transmission, front-seat center storage armrest, front and side window defoggers, power door locks with automatic locking feature, rear-seat headrests, power steering and anti-lock brakes.

1993 Skylark: out to satisfy America. Again.



► Roomy trunk features a low liftover height for easy loading and unloading.

4-wheel anti-lock brakes help provide controlled stopping on most surfaces.

Computer technology helps you maintain steering direction while braking by adjusting brake pressure rapidly to control wheel lock.



Buyer's Guide

Skylark



CARGO NET helps hold items in place. Available on all Skylarks.

Engine Type (Custom, Limited)	2.3-litre Quad OHC MFI ¹⁾	Interior, in.	front/rear Coupes	front/rear Sedans
Horsepower	115 @ 5200 rpm	Legroom	43.3/34.0	43.3/33.5
Torque	140 @ 3200 rpm	Headroom	37.8/36.5	37.8/37.0
Type (standard on Gran Sport)	3.3-litre 3300 V6 with MFI ¹⁾	Shoulder room	53.6/55.0	54.1/53.8
Horsepower	160 @ 5200 rpm	Hip room	49.1/50.3	49.1/50.6
Torque	185 @ 2000 rpm	Capacity		
		Trunk, cu ft		13.3
Dimensions, in.		Fuel tank, gal		15.2
Length	189.1	Base curb weight, lbs		
Width	67.5	Coupes		2,793
Height	53.2	Sedans		2,855
Wheelbase	103.4			
Front tread	55.9			
Rear tread	54.4			

¹⁾MFI—Multi-port fuel injection



REMOTE KEYLESS ENTRY SYSTEM, optional on all Skylarks, increases convenience and peace of mind by locking or unlocking doors, or unlatching deck lid—from a distance.



DELCO ETR[®] AM-FM STEREO RADIO with cassette and dual extended-range speakers.



DELCO ETR[®] AM STEREO-FM STEREO RADIO with compact disc player, graphic equalizer and Concert Sound II speakers.



EXTERIOR COLORS

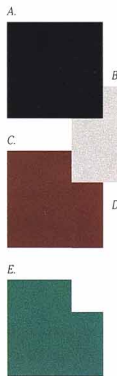

- A. Black
- B. Sterling Silver Metallic
- C. Ruby Red Metallic¹⁾
- D. Bright White
- E. Aquamarine Metallic¹⁾

Model Availability

- ▶ Skylark Custom Coupe
- ▶ Skylark Custom Sedan
- ▶ Skylark Limited Coupe
- ▶ Skylark Limited Sedan
- ▶ Skylark Gran Sport Coupe
- ▶ Skylark Gran Sport Sedan

Powertrain/Suspension*

- ▶ 2.3-litre Quad OHC L4 (Custom, Limited)
- ▶ 3300 V6 with MFI (Gran Sport)
- ▶ Anti-lock brakes
- ▶ Automatic transmission
- ▶ Power front disc/rear drum brakes
- ▶ Power rack-and-pinion steering
- ▶ Suspension—Gran Touring (Gran Sport)
- ▶ Suspension—DynaRide (Custom, Limited)

Standard Equipment*

- ▶ Armrest—front-seat center with storage (Limited)
- ▶ Console—full-length operating (with bucket seats)
- ▶ Defogger—front and side window outlets
- ▶ Door locks—power with automatic feature
- ▶ Fuel door release—remote
- ▶ Glass—Soft-Ray tinted
- ▶ Headrests—rear-seat

- ▶ Instrumentation—analog speedometer, temperature and fuel gages, trip odometer (Custom)

- ▶ Instrumentation—backlit analog gage cluster with speedometer, tachometer, voltmeter, oil pressure, oil level telltale, fuel gage, trip odometer, (Limited, Gran Sport)

- ▶ Mirrors—covered visor vanity with map strap, driver and passenger (Custom)

- ▶ Radio—ETR[®] AM-FM stereo with seek and scan, clock
- ▶ Recliners—seatback, driver and passenger

- ▶ Rundown Protection System
- ▶ Seat—easy-entry, front passenger (coupes)

- ▶ Seat—split, folding rear (Gran Sport)
- ▶ Seats—55/45 cloth split bench (Custom, Limited)

- ▶ Seats—bucket leather and cloth with manual lumbar support (Gran Sport)

- ▶ Speakers—dual, extended-range, front and rear
- ▶ Trunk lock release—remote

- ▶ Wheels—16-inch aluminum (Gran Sport)

Option Package Equipment	Custom		Limited		Gran Sport	
	SC	SD	SE	SB	SC	SD
Air conditioning	X	X	X	X	X	X
Rear-window defogger	X	X	X	X	X	X
TILT/WHEEL™ adjustable steering column	X	X	X	X	X	X
Delay windshield wipers	X	X	X	X	X	X
Carpet savers, front and rear	X	X	X	X	S	S
4-way manual driver seat adjuster	X	X	X	X	S	S
Front-seat storage armrest (split bench seat)	X	X	S	S	S	S
Cruise control	X	X	X	X	X	X
Power windows	X	X	X	X	X	X
ETR [®] AM-FM stereo with cassette and extended-range speakers	X	X	X	X	X	X
Dual covered visor vanity mirrors and courtesy lights	X	S	S	S	S	S
Remote outside mirrors				X	X	X
Automatic power antenna				X	X	X
6-way power driver seat				X	X	X
Assist handles, extendable sunshades, lighted visor vanity mirrors, front- and rear-seat reading lights				X	X	X
Trunk convenience net				S	S	S
Remote keyless entry					X	X

Additional Available Options*	Custom	Limited	Gran Sport
California emission equipment and testing	X	X	X
3300 V6 engine	X	X	S
Lower accent paint		X	X
ETR [®] AM stereo-FM stereo with graphic equalizer, compact disc player and Concert Sound II speakers		X	X
Split folding rear seat		X	S
Cloth bucket seats and operating console		X	X
6-way power driver seat	X	X	X
Adjustable Ride Control suspension system		X	X
15-inch wheelcovers	X	X	
16-inch aluminum wheels		X	S
Remote keyless entry		X	X

*Partial listing only—see your Buick dealer for complete lists and details.
¹⁾Receives C-Quam[®] AM stereo broadcasts. Most AM stations across the country broadcast in C-Quam but some do not. Check your local stations for compatibility in your area.

EXTERIOR COLORS

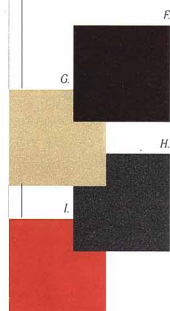

- F. Claret Red Metallic¹⁾
- G. Light Driftwood Metallic¹⁾
- H. Smokey Amethyst Metallic¹⁾
- I. Bright Red¹⁾

¹⁾Not available on Gran Sport.
¹⁾Available with lower accent on Gran Sport.

B U I C K

Century

This classic Buick transforms the road into something special. Advancing surefootedly on DynaRide suspension, it draws confident power from a new standard 2.2-litre port-fuel-injected engine — or the 3300 V6 option.

New colors and body-side moldings enhance the stylish 6-passenger Century's appearance. The long list of standard features includes air conditioning, power steering, power brakes, automatic transmission, variable-rate rear springs and much more.

1993 Century: a prime example of quality by design.

◀ *Century Limited Sedan.*



BUICK

Century

Silent comfort. Sound principles.

Surrounding the solid, hushed comfort in Century's 6-passenger interior are single-piece body framing and latches which hold the doors rigid for a quiet ride.

Another sound principle, generously applied to the well-crafted interior, is that of value. Century owners have come to expect plenty of standard features and they won't be disappointed in 1993. Included are rich cloth seating, Soft-Ray tinted glass, power rack-and-pinion steering, and ETR® AM-FM stereo radio.

◀ *Century Limited Sedan comes with rich, comfortable cloth seating.*

▼ *Driver air bag works with safety belts to help protect driver in certain severe frontal impacts. Standard on Limited and Custom, optional on Special.*



Easy-to-read gages communicate information quickly on Century Limited.



1993

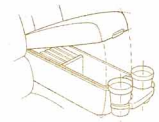

Storage armrest with new dual cup holders is standard on Custom and Limited.



Available 6-way power driver's seat adjusts with fingertip controls — up, down, forward, back and two tilt directions. Power seatback recliners are standard.

Century

Presenting an expanded view.

Century's standard form of power is the transverse-mounted 2.2-litre 2200 L4 engine with port fuel injection. Another way to go is the available 3300 V6 with an even more expansive power band. Either engine provides smooth, unlabored delivery of ample power for effortless highway cruising.

Options abound. Century Wagon provides lots of comfort with loads of usable cargo space and

crowd-pleasing room. And available options like a CD player and remote keyless entry complete the bigger picture.



▲ Steel camshaft and lightweight high-strength pistons help reduce friction and produce optimum power in the optional 3300 V6 with multi-port fuel injection.

► Century Custom Wagon.

▼ Century Custom Coupe.

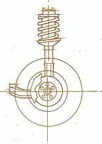

DynaRide suspension is standard on all Century Coupes and Sedans.



Century Wagon offers a convenient storage compartment.



Buyer's Guide

Century



TRUNK CONVENIENCE NET assists in keeping items carried in the trunk upright or from moving around. Available on all Century Coupe and Sedans.

Engine	2.2-litre I4 with PFI ⁽¹⁾		
Type (all models)	110 @ 5200 rpm		
Horsepower	130 @ 3200 rpm		
Torque	3.3-litre 3300 V6 with MFI ⁽²⁾		
Type (all models)	160 @ 5200 rpm		
Horsepower	185 @ 2000 rpm		
Torque			

Dimensions, in.	Coupe	Sedans	Wagons
Length	189.1	189.1	190.9
Width	69.4	69.4	69.4
Height	53.7	54.2	54.2
Wheelbase	104.9	104.9	104.9
Front tread	58.7	58.7	58.7
Rear tread	56.7	56.7	56.7

Interior, in., front/rear	Coupe	Sedans	Wagons
Legroom	42.1/35.9	42.1/35.9	42.1/34.8
Headroom	38.6/38.3	38.6/38.3	38.6/38.9
Shoulder room	55.8/57.0	55.9/56.0	55.9/56.0
Hip room	50.2/53.6	50.0/54.3	50.0/54.3

Capacity	Trunk, cu ft	16.2	16.2	—
	Max. cargo, cu ft	—	—	74.4
	Fuel tank, gal	16.4	16.4	16.4

Base curb weight, lbs	2,903	2,949	3,103
-----------------------	-------	-------	-------

⁽¹⁾PFI—Port fuel injection ⁽²⁾MFI—Multi-port fuel injection



CARGO SECURITY COVER, available on Century Wagons, helps conceal cargo. Stored rear of the second seat, the cover is easily unrolled to cover the load area.



DELCO ETR® AM-FM STEREO RADIO with compact disc player.



Century Limited Sedan.

EXTERIOR COLORS

A.



B.



D.



- A. Slate Gray Metallic
- B. Bright White
- C. Dark Jadestone Metallic
- D. Sterling Silver Metallic
- E. Ice Blue Metallic

Model Availability

- ▶ Century Special Sedan
- ▶ Century Special Wagon
- ▶ Century Custom Coupe
- ▶ Century Custom Sedan
- ▶ Century Limited Sedan

Powertrain/Suspension*

- ▶ 2.2-litre I4 engine with port fuel injection
- ▶ Automatic transmission
- ▶ DynaRide suspension (Coupe and Sedans)
- ▶ Power front disc/rear drum brakes
- ▶ Power rack-and-pinion steering

Standard Equipment*

- ▶ Air bag—driver SIR (Supplemental Inflatable Restrain) system (Custom, Limited)
- ▶ Air conditioning
- ▶ Armrest—storage (Custom, Limited)
- ▶ Automatic safety belt system—driver and front outboard passenger
- ▶ Defogger—front and side window outlets
- ▶ Door locks—power with automatic lock feature
- ▶ Glass—Soft-Ray tinted
- ▶ Instrument gauges—engine temperature, trip odometer and voltmeter (Limited)
- ▶ Lights—ashtray, instrument panel courtesy, glove box, trunk and engine compartments, map
- ▶ Mirrors—outside, left remote/right manual, deluxe
- ▶ Paint—clearcoat
- ▶ Radio—ETR® AM-FM stereo with seek and scan, clock
- ▶ Seat recliner—power, driver and passenger
- ▶ Seats—55/45 cloth with armrest (Special)
- ▶ Seats—55/45 cloth with storage armrest (Custom, Limited)
- ▶ Speakers—dual standard-range front, extended-range rear
- ▶ Steering column—TILT-WHEEL™ adjustable
- ▶ Tires—P185/75R14 blackwall (Special, Custom Coupe)
- ▶ Tires—P185/75R14 whitewall (Custom Sedan, Wagon and Limited)
- ▶ Wheel covers
- ▶ Windshield wipers—2 speed with low-speed delay (Custom, Limited)
- ▶ Woodgrain vinyl applique (Custom Wagon)

Option Package Equipment	Special			Custom			Limited
	Sedan SC	Sedan SD	Wagon SE	Coupe SC	Sedan SD	Wagon SE	Sedan SD
TILT-WHEEL™ adjustable steering column	X	X	X	X	X	X	X
Delay windshield wipers	X	X	X	X	X	X	X
Storage armrest	X	X	X	X	X	X	X
Front and rear carpet savers	X	X	X	X	X	X	X
Rear-window defogger	X	X	X	X	X	X	X
Whitewall tires—P185/75R14	X	X	X	X	X	X	X
ETR® AM-FM stereo with cassette	X	X	X	X	X	X	X
Cruise control	X	X	X	X	X	X	X
Visor vanity mirrors—driver, passenger	X	X	X	X	X	X	X
Power windows	X	X	X	X	X	X	X
Front-seat reading lights	X	X	X	X	X	X	X
Trunk convenience net	X	X	X	X	X	X	X
Remote tailgate lock release	X	X	X	X	X	X	X
Rear-window air deflector	X	X	X	X	X	X	X
Roof rack	X	X	X	X	X	X	X
Cargo security cover	X	X	X	X	X	X	X
Vinyl third seat	X	X	X	X	X	X	X
Gage cluster with trip odometer				X	X	X	S
Trunk lock release				X	X	X	X
Automatic power antenna				X	X	X	X
Left and right remote mirrors				X	X	X	X
Mirror with map lights				X	X	X	X
Body-side stripes				X	X	X	S
Whitewall tires—P185/75R14				X	X	X	X
Wire wheel covers				X	X	X	X
6-way power driver seat				X	X	X	X
Dual front/rear speaker system				X	X	X	X
Remote keyless entry system				X	X	X	X
Lighted visor vanity mirrors—driv, pass				X	X	X	X
Premium speaker system				X	X	X	X

Additional Available Options*	Special	Custom	Limited
Air bag—driver (SIR)	X	S	S
Heavy-duty cooling	X	X	X
California emission equipment and testing	X	X	X
3300 V6 engine & 4-speed automatic transmission with overdrive	X	X	X
Luggage rack	X	X	X
ETR® AM-FM stereo with compact disc player	X	X	X
14-inch aluminum wheels	X	X	X
Tailgate window washer/wiper (Wagon)	X	X	X
Leather-trimmed interior (Sedan)	X	X	X

s = standard

*Partial listing only—see your Buick dealer for complete lists and details.

EXTERIOR COLORS

F.



H.



J.



- F. Midnight Blue Metallic
- G. Light Driftwood Metallic**
- H. Ruby Red Metallic
- I. Chamois**
- J. Dark Cherry Metallic

** Not available on Coupe.

BUICK

Roadmaster Sedan

It is easy to imagine the classic heritage reflected in the highly lustrous sides of the 1993 Roadmaster Sedan, even while loading groceries at the corner store. This is an automobile that brings a high level of dignity and style to everything it does, everywhere it appears.

This classic premium Buick is a full-frame rear-wheel-drive sedan with solid, civilized V8 power and a thoroughly disciplined, fluid ride.

1993 Roadmaster: a distinctive blend of power, prestige and substance.

◀ *Roadmaster Limited Sedan.*





The elegant steering wheel is a masterful dual-purpose design, containing an air bag for added driver safety.

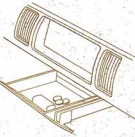

Instrument panel storage drawer. Just the place for pens, coins and keys.

Luxurious Roadmaster Limited interior with available leather in the seating areas.



BUICK

Roadmaster Sedan

This interior is to comfort what a symphony orchestra is to music.

There is an expected level of luxury in a classic like Roadmaster. No one will be disappointed. Classical values blend with ergonomic advancements and an abundance of features. Everything is orchestrated with comfort in mind.

For instance, variable-effort steering (standard on Limited) makes low-speed maneuvers easy, while allowing "road feel" to come through at higher speeds. Other features include anti-lock brakes, power windows, air conditioning, cruise control and TILT-WHEEL™ adjustable steering column.

And, of course, a premium-quality music system.



Standard front-seat storage armrest features dual cup holders.



Analog instrumentation provides quick and easy-to-read information. Also includes tachometer, voltmeter and trip odometer.





BUICK

Roadmaster Sedan

Blending a little past and a lot of future.

True to Buick heritage, the 1993 Roadmaster embodies luxury on a grand scale.

Classic power blended with a remarkably fluid DynaRide suspension brings pleasure to the road.

And it would not be a Roadmaster without a list of standard features as substantial as the car itself. These include a 4-speed automatic transmission with overdrive, variable-effort steering (Limited), electronic cruise control, driver air bag and power anti-lock brakes.

Roadmaster Sedan: a proud past, a bright future.

◀ Foreground: Roadmaster Limited Sedan. Background: Roadmaster with available Landau vinyl top.

▶ Outside remote left and right mirrors heat electronically for frosty climates. Standard on Limited.



▼ Luxuriously large trunk: 21.0 cu ft of trunk capacity for golf clubs, luggage, or lots of groceries.



Lock or unlock doors, unlatch deck lid or turn on interior lights from a distance with remote keyless entry option.

The powerful fuel-injected 5.7-litre V8 engine develops 180 horsepower, 300 lbs-ft of torque — plenty of power for towing, highway cruising or accelerating on the entrance ramp.



Roadmaster Sedan

Every masterpiece should have an impressive frame.

The famous Roadmaster attributes of smooth ride, comfort and quietness — and an unmistakable "solid feeling" — are even better than ever, thanks to its full-frame construction. You see, a full-perimeter frame provides superb structural integrity. That is quality to the core. And Roadmaster delivers it beautifully.

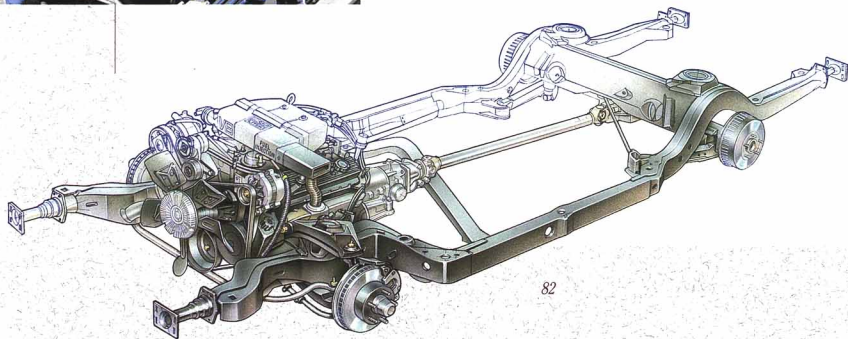

Roadmaster Limited Sedan.

Roadmaster Sedan



ELECTRONIC TOUCH CLIMATE CONTROL air conditioning system is activated through a touch-sensitive control panel. Optional on Roadmaster, standard on Limited.

Engine	5.7-litre V8 with EFI ^{††}		Interior, in.	front/rear
Type			Legroom	42.1/38.9
Horsepower	180 @ 4000 rpm		Headroom	39.2/38.6
Torque	300 @ 2400 rpm		Shoulder room	63.3/63.3
			Hip room	56.9/56.9
Dimensions, in.			Capacity	
Length	215.8		Trunk, cu ft	21.0
Width	78.1		Fuel tank, gal	23.0
Height	55.9			
Wheelbase	115.9		Base curb weight, lbs	4,097
Front tread	61.7			
Rear tread	60.7			

^{††}EFI—Electronic fuel injection



SELF-SEALING TIRES permanently seal up to 90% of all tread punctures 3/16 inch or less with a special rubber compound that flows to the leak and makes an air-tight seal. Optional.



DELCO ETR[®] AM STEREO-FM STEREO RADIO with cassette, graphic equalizer and premium speakers.



DELCO ETR[®] AM STEREO-FM STEREO RADIO with compact disc player, graphic equalizer and premium speakers.



Roadmaster Limited Sedan.

EXTERIOR COLORS

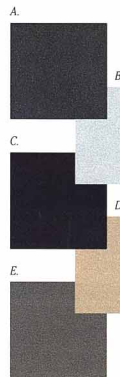

- A. Dark Jadestone Metallic
- B. Sterling Silver Metallic
- C. Midnight Blue Metallic
- D. Light Driftwood Metallic
- E. Pewter Gray Metallic

Model Availability

- ▶ Roadmaster Sedan
- ▶ Roadmaster Limited Sedan

Powertrain/Suspension*

- ▶ 5.7-litre V8 with EFI
- ▶ Anti-lock brakes
- ▶ Automatic transmission with overdrive
- ▶ DynaRide suspension
- ▶ Power front disc/rear drum brakes
- ▶ Power steering (with variable effort on Limited)

Standard Equipment*

- ▶ Air bag—driver SIR (Supplemental Inflatable Restraint) system
- ▶ Air conditioning (Roadmaster)
- ▶ Air conditioning—electronic touch climate control (Limited)
- ▶ Armrest—rear-seat center
- ▶ Coach lamps (Limited)
- ▶ Cruise control—electronic
- ▶ Defogger—electric rear-window
- ▶ Defogger—front and side window outlets
- ▶ Door locks—automatic with automatic relock feature (Limited)
- ▶ Door locks—power (Roadmaster)
- ▶ Exhaust system—stainless steel
- ▶ Glass—Soft-Ray tinted, flush-mounted

- ▶ Instrumentation—analogue gauge cluster including oil pressure, coolant temperature, volts, trip odometer, tachometer
- ▶ Mirror—inside day/night with integral reading lights (Roadmaster)
- ▶ Mirror—automatic day/night (Limited)
- ▶ Mirrors—outside, left remote/right manual, deluxe body-color (Roadmaster)
- ▶ Mirrors—outside, left and right remote, heated (Limited)
- ▶ Radio—ETR[®] AM-FM stereo with seek and scan, clock (Roadmaster)
- ▶ Radio—ETR[®] AM-FM stereo with seek and scan, cassette, clock (Limited)
- ▶ Recliner—electric seatback, driver and front passenger (Limited)
- ▶ Remote keyless entry (Limited)
- ▶ Seats—6-way power, driver and passenger (Limited)
- ▶ Seats—55/45 cloth with storage armrest
- ▶ Security locks—rear-door
- ▶ Wheelcovers—deluxe
- ▶ Windows—power with driver "express-down" and passenger lockout
- ▶ Wipers—2-speed with low-speed delay

Option Package Equipment

	Roadmaster		Roadmaster Limited
	SD	SE	SE
Lighted visor vanity mirrors—driver and passenger	X	X	S
Automatic power antenna	X	X	S
Electric passenger seatback recliner	X	X	S
6-way power driver seat	X	X	S
ETR [®] AM-FM stereo with cassette	X	X	S
Premium speakers	X	X	S
6-way power passenger seat	X	X	S
Electronic touch climate control air conditioning	X	X	S
Door courtesy and warning lights	X	X	S
Automatic door locks	X	X	S
Automatic day/night mirror	X	X	S
Remote keyless entry	X	X	S
Outside mirrors—electric, left and right remote and heated	X	X	S
Automatic trunk pull-down			X
Twilight Sentinel headlamp control			X
Leather-wrapped steering wheel			X
Cornering lamps			X
Self-sealing whitewall tires—P235/70R15			X

Additional Available Options*

	Roadmaster	Roadmaster Limited
California emission equipment and testing	X	X
Heavy-duty transmission heating and cooling	X	X
Lower accent paint	X	X
ETR [®] AM stereo-FM stereo with cassette, graphic equalizer and premium speakers	X	X
ETR [®] AM stereo-FM stereo with compact disc player, graphic equalizer and premium speakers	X	X
Landau vinyl top	X	X
Trailer Towing Package	X	X
15-inch aluminum wheels	X	X
Wire wheelcovers	X	X
Solar-Ray [®] solar-control windshield	X	X
Leather-trimmed interior	X	X

*Partial listing only—see your Buick dealer for complete lists and details. [†]Receives C-Quam[®] AM stereo broadcasts. Most AM stations across the country broadcast in C-Quam but some do not. Check your local stations for compatibility in your area.

EXTERIOR COLORS

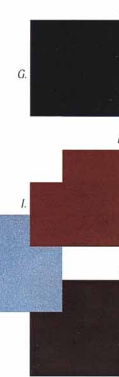

- F. Black
- G. Arctic White
- H. Ruby Red Metallic
- I. Ice Blue Metallic
- J. Dark Cherry Metallic

BUICK

Roadmaster Estate Wagon

This legendary 8-passenger Buick station wagon rolls powerfully and smoothly into 1993.

Roadmaster Estate Wagon blends the utility and versatility of a station wagon with the comfort, beauty and solidity of a true Buick luxury car.

Inside the large cabin is space to carry several full-size sedan-loads of cargo. Still, that does not alter the fact that the rich interior rivals that of any luxury car.

1993 Roadmaster: for a station wagon, it is quite a luxury car.



Roadmaster Estate Wagon

The length of luxury.

Our engineers took the best of everything Roadmaster offered and stretched it and expanded it. The result is the 1993 Roadmaster Estate Wagon. It may be the most luxurious wagon in the world.

This aerodynamic, premium American classic offers a lengthy list of standard features. Power windows with the driver-side "express-down" feature are to be expected. Power steering eases the wagon into tight spaces and air conditioning is there, of course. The list also includes reclining 55/45 front seats and rear-door child security locks. Plus, a passenger window lockout feature is added to the power windows.

1993 Roadmaster Estate Wagon: a solid measure of Buick excellence.



An uncluttered panoramic view of the world is enjoyed through the non-glare, tinted Vista roof. Dual Vista shades are available.



▲ *A powerful 5.7-litre fuel-injected V8 develops 180 horsepower and plenty of torque for pulling power and solid acceleration.*



Driver air bag is neatly packaged into the handsome steering wheel design.



Available front-seat center storage armrest adds even more usable space with dual cup holders, coin holder and plenty of storage.

Available Sierra grain leather in the seating areas.



BUICK

Roadmaster Estate Wagon

The logical extension of luxury.

Solid V8 power and full-frame security are well matched with the warm, rich interior. Eight passengers are afforded luxurious comfort. The generous list of standard features includes TILT-WHEEL™ adjustable steering column, power steering, power brakes, power windows, and the power to pull 5,000 lbs.*

An ETR® AM-FM radio with seek and scan, and extended-range front and rear speakers, is standard as well. This superb system fills the large area with clarity and fidelity.

1993 Roadmaster Estate Wagon: more of a very good thing.

**When properly equipped. Includes weight of trailer, cargo, passengers and equipment.*



Driver-side controls with power door locks and window controls offer handy "express-down" and "lockout" features.

Easy-to-read analog gauges are displayed. Easy-to-reach controls are where one would expect and grouped by function.



Child security locks, when activated, prevent the inside handles from unlocking or opening the door inadvertently.



Standard locking storage compartment keeps precious cargo from prying eyes.

Roadmaster Estate Wagon

The luxury wagon that leaves nothing behind...and nothing to be desired.

With Roadmaster Estate Wagon, you have the luxury of taking more with you than you'll actually need. Just look at the carrying capabilities. Fold down the rear seats and open up the possibilities: a full 92.4 cu ft of cargo space.

The tailgate opens two ways for easy loading. And the rear window is cleared by another standard feature — a rear wiper/washer.

So, if being more at home on the road means taking more of home with you, feel free. This is the wagon that does it all. The eminently desirable Roadmaster Estate Wagon.

Seating configurations are a study in versatility:



Rear seat flush with floor to provide quick-access rear cargo bay.

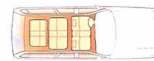

All seats up accommodate up to eight passengers.

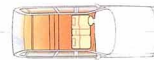

All but front seats down: for large hauling needs.

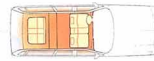

Middle seats down: allow passengers to sit in back and have the luxury of side-door access for luggage.



Clearly, a desirable convenience — the standard rear-window wiper/washer.

Roadmaster Estate Wagon



CORNERING LAMPS brighten turning or parking maneuvers with peripheral illumination. This option also alerts other drivers, as the lamps are automatically activated with the turn signals.

Engine	5.7-litre V8 with EFI ^{††}	Interior, in.	front/rear
Type		Legroom	42.3/37.3
Horsepower	180 @ 4000 rpm	Headroom	39.6/39.4
Torque	300 @ 2400 rpm	Shoulder room	63.4/63.5
		Hip room	56.9/57.1
Dimensions, in.			
Length	217.5	Capacity	
Width	79.9	Maximum cargo, cu ft	92.4
Height	60.3	Fuel tank, gal	22.0
Wheelbase	115.9		
Front tread	62.1	Base curb weight, lbs	4,508
Rear tread	64.1		

^{††} EFI—Electronic fuel injection



REMOTE KEYLESS ENTRY, available on Estate Wagon, adds to your convenience as well as your security. Can be operated up to 30 feet away.



DELCO ETR® AM-FM STEREO RADIO with cassette.



DELCO ETR® AM STEREO-FM STEREO RADIO with cassette and graphic equalizer.



EXTERIOR COLORS

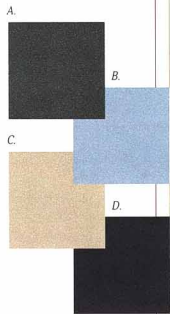

- A. Dark Jadestone Metallic
- B. Ice Blue Metallic
- C. Light Driftwood Metallic
- D. Midnight Blue Metallic

Model Availability

- ▶ Roadmaster Estate Wagon

Powertrain/Suspension*

- ▶ 5.7-litre V8 with EFI
- ▶ Anti-lock brakes
- ▶ Automatic transmission with overdrive
- ▶ Heavy-duty suspension
- ▶ Power front disc/rear drum brakes
- ▶ Power steering

Standard Equipment*

- ▶ Air bag—driver SIR (Supplemental Inflatable Restraint) system
- ▶ Air conditioning
- ▶ Assist handles—third seat
- ▶ Battery—heavy-duty
- ▶ Carpeting—front, rear, load areas
- ▶ Defogger—front and side window outlets
- ▶ Door lock releases—tailgate, tailgate latch, interior locks
- ▶ Door locks—power
- ▶ Exhaust system—stainless steel
- ▶ Glass—Soft-Ray tinted, flush-mounted
- ▶ Headliner—foam, cloth-covered
- ▶ Indicator—"tailgate ajar"
- ▶ Indicators—low windshield washer fluid, low oil, low coolant, low fuel

- ▶ Instrumentation—analog gage cluster including oil pressure, coolant temperature, volts, trip odometer, tachometer
- ▶ Lights—front-seat reading (integral with rearview mirror)
- ▶ Lights—rear roof rail with integrated reading lights
- ▶ Luggage rack—adjustable
- ▶ Net—convenience, dual function
- ▶ Radio—ETR® AM-FM stereo with seek and scan, clock
- ▶ Recliner—manual seatback, driver and passenger
- ▶ Seat—third, rear-facing, vinyl
- ▶ Seats—55/45 cloth with center armrest
- ▶ Security locks—rear-door, child
- ▶ Speakers—dual, standard-range front, extended-range rear
- ▶ Steering column—TILT-WHEEL™ adjustable
- ▶ Storage in door and instrument panel tray
- ▶ Vista roof—tinted glass
- ▶ Windows—power with driver "express-down" and passenger lockout
- ▶ Windshield—Solar-Ray®
- ▶ Wiper—rear-window with washer
- ▶ Wipers—2-speed with low-speed delay
- ▶ Woodgrain vinyl applique

Option Package Equipment

	Roadmaster Estate Wagon		
	SC	SD	SE
Cruise control	x	x	x
Carpet savers, front and rear	x	x	x
Storage armrest	x	x	x
ETR® AM-FM stereo with cassette	x	x	x
Automatic power antenna	x	x	x
Courtesy and warning lights		x	x
6-way power driver seat		x	x
Lighted visor vanity mirrors—driver and passenger		x	x
Storage area security cover		x	x
Electronic touch climate control air conditioning		x	x
Automatic day/night mirror		x	x
Remote keyless entry		x	x
6-way power passenger seat		x	x
Cornering lamps		x	x
Twilight Sentinel headlamp control		x	x
Automatic door locks		x	x
Power passenger seatback recliner		x	x
Electric left and right heated mirrors		x	x

Additional Available Options*

	Roadmaster Estate Wagon
Rear-window defogger	x
California emission equipment and testing	x
Heavy-duty transmission heating and cooling	x
ETR® AM stereo-FM stereo with cassette and graphic equalizer	x
ETR® AM stereo-FM stereo with compact disc player and graphic equalizer	x
Automatic level control	x
Trailer Towing Package	x
Vista shade	x
Wire wheelcovers	x
Leather-trimmed interior	x

*Partial listing only—see your Buick dealer for complete lists and details.
[†]Receives C-Quam® AM stereo broadcasts. Most AM stations across the country broadcast in C-Quam but some do not. Check your local stations for compatibility in your area.

EXTERIOR COLORS

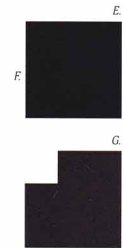

- E. Black
- F. Arctic White
- G. Dark Cherry Metallic

Buick quality pulls a lot of weight.

What is behind Buick quality? Plenty of power. Look behind you; quality pulls a lot of weight with Buick. Depending on the model you choose, the availability of smooth, uninterrupted power is deep enough to accommodate up to 5,000 lbs* of trailering. No wonder Buicks have acquired such a satisfied following.

Skylark and Regal

Capacity: 1,000 lbs*
All Skylarks with the 3300 V6, and Regals, can easily handle lightweight-class trailer loads when properly equipped. You'll come to appreciate their muscle even more when hauling a trailer.

Century

Capacity: 2,000 lbs*
Muscular grace: The term becomes all the more descriptive when hitched to the trailering capacity of Century. All Buick Centurys will pull 1,000 lbs and specially equipped models with the 3300 V6 will tow up to 2,000 lbs.

Park Avenue and LeSabre
Capacity: 3,000 lbs* (2,000 lbs* on Ultra)

How do these 6-passenger sedans haul? Luxuriously, with ease and a great deal of comfort. Standard 3800 V6 power and automatic load-leveling (optional on LeSabre) coupled with a smooth-

operating transmission make a big load seem lighter.

Roadmaster
Capacity: 5,000 lbs*

This is trailering that takes a load

Trailer Towing

1993 Buick Trailer Towing Requirements

	Engine	Final Drive Ratio	Maximum Gross Trailer Weight(lbs)†	HD Engine and Transmission Cooling	Automatic Level Control or Air-Lift Shocks
Skylark	3.3L (L27) (1)	2.39	1,000 (2)	—	—
Century	2.2L (LN2) (3)	3.06	1,000 (6)	—	—
	3.3L (L27)	2.73	1,000 (6)	—	—
			2,000 (6)	—	—
Regal	3.1L (LHO)	3.33	1,000 (2)	—	—
	3.8L (L27)	3.06	1,000 (2)	Required (4)	—
LeSabre	3.8L (L27)	2.84 (4)	1,000	—	—
		3.06 (4)	3,000 (2)	Required (4)	Required (4)
Park Avenue	3.8L (L27)	2.84 (4)	1,000	—	Standard
		3.06 (4)	3,000 (2)	Required (4)	Standard
Park Avenue	3.8L (L67)	2.97	1,000	—	Standard
Ultra			2,000 (2)	Required (4)	Standard
Roadmaster Sedan	5.7L (L05)	3.08 (4)	5,000 (5)	Recommended (4)	Recommended (4)
Roadmaster Estate Wagon	5.7L (L05)	3.23 (4)	5,000 (5)	Recommended (4)	Recommended (4)

Note: Riviera model not recommended for trailer towing.
*When properly equipped. Includes weight of trailer, cargo, passengers and equipment.
†Towing recommendations are subject to change. Check with your Buick dealer for the latest information.
‡Trailer tongue load should be 10% of the maximum trailer weight but should not exceed the load rating specified for that vehicle, engine or hitch combination.
(1) Not recommended for trailer towing on long grades in unusually high temperatures.
(2) Requires Class II frame-mounted trailer hitch.
(3) Not recommended on Century Wagon.
(4) Included in required V92 Trailer Towing Package.
(5) Requires Class III frame-mounted trailer hitch.
(6) Trailer towing in mountainous, high-temperature areas requires the installation of the Dunham-Bush Auxiliary Cooler (dealer installed).

off your mind: You're hauling 5,000 lbs with a 700-lb tongue weight, and instead of wrestling with the load, you're enjoying the smooth flow of the countryside passing by.

Heavy-duty cooling and components

Trailering, especially in hot climates, calls for a heavy-duty cooling system which includes a radiator with higher cooling capacity for both engine and transmission coolants. Available on Park Avenue, LeSabre and Roadmaster, the trailer towing option features powertrain cooling plus suspension and performance enhancements that handle loads up to 3,000 lbs (2,000 lbs on Ultra, 5,000 lbs on Roadmaster).

Increased acceleration demands are met through a high-performance axle ratio. A heavy-duty battery is included to take care of trailer lighting requirements. Roadmaster Estate Wagon and Sedan, when equipped with the Trailer Towing Package, can tow 5,000 lbs.

BUICK SAFETY FEATURES

Occupant Protection

- ▶ Automatic lap/shoulder safety belts, driver and right front passenger (Skylark, Century, Regal), plus Supplemental Inflatable Restraint, driver air bag (Century Custom and Limited, LeSabre, Roadmaster, Park Avenue, Riviera)
- ▶ Manual lap/shoulder safety belts, outboard rear-seat positions
- ▶ Manual lap safety belts, center-seat positions
- ▶ Energy-absorbing steering column
- ▶ Energy-absorbing instrument panel
- ▶ Interlocking door latches
- ▶ Laminated windshield glass, urethane bonded
- ▶ Side-guard door beams
- ▶ Passenger-guard inside door lock handles
- ▶ Folding front seatback locks, inertia type/manual, 2-door models
- ▶ Safety armrests
- ▶ Head restraints, adjustable or integral, front
- ▶ Breakaway inside rearview mirror
- ▶ Security door locks and door retention components
- ▶ Automatic door locking system (Skylark, Century, Regal, Roadmaster Limited Sedan, Riviera)
- ▶ Tempered safety glass, side and rear windows
- ▶ Front and rear crush zones
- ▶ Child security locks (Skylark, LeSabre, Roadmaster, Park Avenue)
- ▶ Pressure-rod radiator cap
- ▶ Dual sun visors
- ▶ Self-aligning steering wheel (Skylark, Century and Regal)

Accident Avoidance

- ▶ Side marker lamps and reflectors
- ▶ Parking lamps
- ▶ Four-way hazard warning flashers
- ▶ Backup lamps

- ▶ Center high-mounted stop lamp
- ▶ Directional signal control
- ▶ Windshield defrosters, washer and manual-speed wipers
- ▶ Inside day/night rearview mirror
- ▶ Outside rearview mirrors
- ▶ Brake system with dual master cylinder plus warning light
- ▶ Starter safety switch
- ▶ Dual-action hood latch
- ▶ Low-grade finish inside windshield moldings, wiper arms and blades, metallic steering wheel surfaces
- ▶ Illuminated heater and defroster controls
- ▶ Illuminated windshield wiper and washer controls (when located on instrument panel)
- ▶ Tires with built-in tread wear indicators
- ▶ Safety road wheel rims
- ▶ Pressure-relief fuel cap
- ▶ Anti-lock brakes (Skylark, LeSabre, Regal Limited and Gran Sport, Roadmaster, Riviera, Park Avenue)
- ▶ Audible disc brake lining wear indicators
- ▶ Door warning light/reflector (Skylark, Century, Regal, LeSabre, Roadmaster Limited Sedan, Riviera, Park Avenue)
- ▶ Brake/transmission shift interlock (Skylark, LeSabre, Roadmaster, Riviera, Park Avenue)

Theft Deterrence

- ▶ Visible vehicle identification number
- ▶ Laser-etched VIN plate
- ▶ Pressure-rod radiator cap
- ▶ Marked body parts (LeSabre, Park Avenue, Riviera)
- ▶ Theft-deterrent steering column lock
- ▶ Theft-deterrent key system (separate ignition key)
- ▶ PASS-Key® personal security system (LeSabre, Park Avenue, Riviera)
- ▶ Remote inside hood release

Important: A word about this catalog.

We have tried to make this catalog as comprehensive and factual as possible. We reserve the right, however, to make changes at any time, without notice, in prices, colors, materials, equipment, specifications, models and availability. Since some information may have been updated since the time of printing, please check with your Buick dealer for complete details.

A word about engines.

Buicks are equipped with engines produced by different operating units of GM, its subsidiaries or suppliers to GM worldwide.

A word about assembly of Buicks.

Buicks are assembled by different operating units of General Motors, its subsidiaries or suppliers to GM worldwide. Buicks incorporate thousands of components produced by different operating units of GM, its subsidiaries or suppliers to GM worldwide. We sometimes find it necessary to produce Buicks with different or differently sourced components than originally scheduled. All such components have been approved for use in Buicks and will provide the quality performance associated with the Buick name. Since some options may be unavailable when your vehicle is assembled, we suggest that you verify that your vehicle includes the equipment you ordered, or if there are changes, that they are acceptable to you.

A word about updated service information.

Buick regularly sends its dealers useful service bulletins about Buick products. Buick monitors product performance in the field. We then prepare bulletins for servicing our products better. Now you can get these bulletins, too. Ask your dealer. To get ordering information, call toll-free 1-800-551-4123.

A word about corrosion protection.

Buicks are designed and built to resist corrosion. All body sheet metal components are warranted against rust-through corrosion for 6 years/100,000 miles. Application of additional rust-inhibiting materials is not required under the corrosion coverage.

The GM Protection Plan.

It offers service protection in addition to that provided by GM's new-vehicle limited warranty. Coverage is currently available only in the U.S.A. and Canada for the 1993 model year. See your Buick dealer for details.

A word about warranty.

The GM 3-year/36,000-mile Bumper to Bumper Plus warranty covers repairs for any new Buick, including labor and parts, to correct any defects in material or workmanship occurring during the warranty period. The complete vehicle (except tires, which are covered by their manufacturer) will be covered for 3 years or 36,000 miles, whichever comes first. Body sheet metal rust-through from corrosion is covered for 6 years or 100,000 miles, whichever comes first. See your Buick dealer for terms of this limited warranty. Supplemental Inflatable Restraint coverage is 3 years regardless of mileage.

SmartLease.™

Many Buick dealers offer you the opportunity to buy or lease a Buick. Ask about SmartLease.™ It may be right for you.

Buick Roadside Assistance.

It provides owners of 1993 Buicks with access to minor repairs or towing for disabled vehicles. It is reached through a toll-free telephone number and operates 24 hours a day, 365 days a year. Just call 1-800-252-1112. See your Buick dealer for details.

Buick Customer Assistance.

Buick's Customer Assistance Center has a special, toll-free 800 number. It puts you in contact with Buick representatives who can handle any product/service question or problem you may have. Simply call 1-800-521-7300.

©1992 General Motors Corporation. All rights reserved. Buick, Riviera, Park Avenue, Roadmaster, LeSabre, Regal, Century, Skylark and  are registered trademarks of General Motors Corporation. Estate Wagon is a trademark of General Motors Corporation.

Buckle up, America!

Printed on recyclable paper from a renewable resource.

Ident. No. 93-BA-100
Printed in U.S.A. 3.0mm



BUICK
The New Symbol For Quality
In America.





1993 Buick

90 Years of
Quality by Design



B U I C K

